

MIX

AUDIO EDUCATION

- Helping Students Find Jobs
- Schools Directory
- DAT Maintenance**

THE RECORDING INDUSTRY MAGAZINE

**Pacific Rim
Recording Studios**

**Special Report:
Analog Multitracks**



**Interview:
Graham Nash**

***** 5-DIGIT 91329
 MX 913290GAND85082 99DEC
 MARK R GANDER 1 0652
 JBL PROFESSIONAL
 8500 BALBOA BLVD BX2200
 NORTHRIDGE CA 91329





THE POWER OF DIGITAL!

Command the highest audio quality, reliability and flexibility with the technical authority and leadership you've come to expect from Mitsubishi. For tracking, mixing and mastering, the 32-track X-880 and the 2-track X-86HS Prodigy format tape machine are the logical choice.

Incorporating the latest in digital technology and building on the decade long success of Mitsubishi's 800/850 family of products, the X-880 offers important improvements in reliability while significantly reducing machine size, weight and power consumption. With the industry's most robust error correction technology, even significant tape damage remains inaudible. A new tape transport mechanism, plus proven glass-filled ferrite technology combine to provide longer head life.

And with the X-86HS, you can get the highest sampling rate of the X-86 series of digital two-tracks, recording at 96 kHz and setting new quality standards for master tapes. You can extend your recorded frequency range all the way to 40 kHz and record and playback at 48/44.1 kHz. And now, made more affordable to you with Siemens financing.

The Power of Digital – The Logical Choice.

 **Neve**
A Siemens Company

Exclusive North American Distributor of

 **MITSUBISHI**
DIGITAL PRO AUDIO

CT: (203) 744-6230 NY: (212) 956-6464 TN: (615) 329-9584 CA: (213) 461-6383 • TORONTO: (416) 365-3363

World Radio History

 **PRODIGI**

THE POWER PACKAGE



Neve VRP Series
Post-Production Console,
Flying Faders Automation,
MITSUBISHI X-880 w/Apogee filters
Roger Nichols, and SOUNDWORKS WEST . . .
. . . it doesn't get any better than this!

SOUNDWORKS WEST Ltd.
Hollywood, California
Tel: (310) 213-859-1515

TEC
TECHNICAL INTELLIGENCE & CREATIVITY
1990
NOMINEE

 **Neve**
a Siemens Company

Exclusive North American Distributor of

 **MITSUBISHI**
DIGITAL PRO AUDIO

CT: (203) 744-6230 ■ NY: (212) 956-6464 ■ TN: (615) 329-9584 ■ CA: (213) 461-6383 ■ TORONTO: (416) 365-3363

World Radio History

MIX

THE RECORDING INDUSTRY MAGAZINE

JULY 1990, VOLUME 14, NUMBER 7

AUDIO

- 14 **Insider Audio:** Rolling Rock
by Ken Pohlmann
- 22 **The Fast Lane:** What If? *by Stephen St. Croix*
- 26 **Juxtapositions:** Analog Multitrack Options
by Mel Lambert
- 49 **The Byte Beat:** Playing with a Full Deck at Digidesign
by Paul Potyén
- 76 **Maintaining DAT Machines**
by Richard Maddox
- 154 **Studio View:** High Tops Shows High-Tech
by Dan Daley



PAGE 14

- 164 **Music and Recording Notes:** The Strange Sound of "Twin Peaks"
by Blair Jackson



PAGE 164

AUDIO EDUCATION

- 32 **Breaking into the Business:** How Recording Schools Help Students Find Jobs *by Tom Kenny*
- 152 **Inside the Student AES** *by Guy DeFazio*

SPECIAL TEC AWARDS SECTION

- 88 **Profiles of this Year's Nominees**



PAGE 88

PACIFIC RIM RECORDING

- 98 **Tracking Down Japan** *by Paul Jackson*
- 99 **Recording in Hong Kong:** Four Case Studies *by Clement Choi*
- 99 **Recording in the Philippines:** A Tropical Music Paradise *by Mike Pedero*
- 108 **Directory of Pacific Rim Studios**

PRODUCTS

- 56 **Analog Multitrack Recorders:** An Update
by George Petersen
- 68 **Preview/Hot Off the Shelf**
- 70 **Auditions:** SSL Logic FX G383 Mic Preamp/Equalizer, Celestion Model 3 Speakers, Prosonus Sampled Strings Library *by George Petersen*



PAGE 56

LIVE SOUND

- 116 **Sound Reinforcement News/Tour Update**
by Mark Herman
- 127 **Power Amplifiers for Sound Reinforcement: A Buyer's Guide**
by Mark Herman
- 134 **New Sound Reinforcement Products**



PAGE 152

TAPE & DISC

- 148 **DAT & CD-R:**
Viable Formats for CD Masters?
by Philip De Lancie
- 158 **Tape & Disc News/Splices**

MUSIC

- 44 **Lunching with Bonzai:**
Graham Nash
by Mr. Bonzai
- 139 **MI Update:**
Whatever Happened to Alternate Controllers?
by Craig Anderton



PAGE 44

DEPARTMENTS

- 6 **From the Publisher**
- 9 **Current**
- 10 **Industry Notes**
- 168 **Coast to Coast**
- 202 **Classifieds**
- 208 **Ad Index**

July Cover: The new control room at Fanshawe College in London, Ontario, was designed and built by Martin Pilchner and Neil Muncy. The studio features a Sony MXP-3036 automated console, Sony APR-24 and APR-5000 tape machines, and S.O.T.A. CF-50 main monitor speakers. **Photo:** Ginette Lamotte and Hank Rintjema. **Inset Photo:** Jay Blakesberg.

DIRECTORY

- 184 **Recording Schools and Programs**



DON'T SETTLE FOR LESS:



World Radio History

THE STUDER A827-24
MULTICHANNEL RECORDER.

'NOW YOU CAN AFFORD STUDER QUALITY AND PERFORMANCE'

Studer quality and performance has just entered your price range with the affordable A827 studio recorder, the first new multi-channel from Studer since its standard setting A820-24.

Superior sound for music recording.

The A827 is clearly ahead of the competition. And why shouldn't it be? With the same transport and head assembly, the same audio quality as its big brother—the A820-24 — this new machine is without a doubt a true Studer, all the way.

Featured for post production.

For video and film sound post production work, the A827 offers the fastest transport in the business—0 to 600 ips in less than four seconds—and with 14" reel capacity. The optional chase lock synchronizer guarantees nobody'll be waiting around on *this* machine.

Post features like Reverse Play with varispeed, parallel control ports and serial RS232/422 control ports make for easy integration into post production facilities.

Available in 24, 16 and 8-track versions, the A827 features a computer controlled transport with 3 tape speeds, varispeed, microprocessor assisted alignment, switchable Dolby HX[®] Pro and phase compensated audio electronics.

There's never been a better time to part ways with those "other"

machines... and move up to the famous Studer sound and quality.

Call us at **800-366-4900** to receive the A820/A827 color booklet. For more detailed information, call your regional Studer office.

Experience the new A827-24 with the best price/performance ratio available.

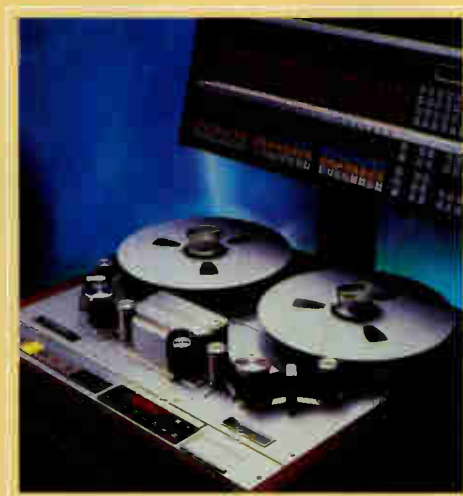

Studer A820-24 Multichannel Recorder

STUDER REVOX

Studer Revox America, Inc. • 1425 Elm Hill Pike • Nashville, TN 37210 • (615) 254-5651

Los Angeles (818) 780-4234, New York (212) 255-4462.

Studer Revox Canada Ltd. (416) 423-2831.

Circle #006 on Reader Service Card

FROM THE PUBLISHER

For the past eight years, *Mix* has devoted its July issue to the topic of audio education—calling attention to the necessity for well-rounded training in this burgeoning industry. In the beginning our efforts met with some skepticism—after all, in 1983 everyone *knew* the way to become a recording professional was to hang around a studio, make yourself useful and wait for that big break! Obviously, times have changed: *Mix's* directory of recording schools and programs now includes over 100 institutions, and the odds are heavily against anyone getting a technical job in a studio these days without formal education.

We at *Mix* take a certain pride in the contribution we have made to the support of audio education, and also in another activity that directly benefits students of audio: the Mix Technical Excellence and Creativity Awards. Since 1985, the TEC Awards have contributed nearly \$50,000 to scholarship programs for students of audio. Half of this money has gone to recording schools that have won the TEC Award: Berklee College of Music (three times), the University of Miami and Full Sail Center for the Recording Arts. The other half has gone to the AES Educational Foundation.

In addition to audio education, the TEC Awards have made substantial contributions to research and education in the cure and prevention of hearing disabilities. Through the House Ear Institute (profiled in the special TEC Voter's Guide in this issue) and other groups, *Mix* has endeavored to raise awareness of the need to protect the engineer's most vital faculty—hearing. As part of this effort, *Mix* has joined with the House Ear Institute to form Hearing Is Priceless, a campaign to increase public consciousness of the dangers of excessively loud music. HIP's honorary chairman, Jeff "Skunk" Baxter, and other music and recording professionals are taking part in programs around the country to inform engineers, young people and others about what they can do to protect their hearing.

As a *Mix* reader, you can help in this effort by attending the TEC Awards, to be held in Los Angeles on September 23, during the AES convention. If yours is a company in the audio field, you may also wish to become a sponsor of the TEC Awards. For more information on any of these opportunities, call the Mix Foundation for Excellence in Audio at (415) 420-0144. Many people, from tomorrow's engineers to deaf children hoping to be cured, will be glad you did.

♦ ♦ ♦

Another new column begins this month. "Coast to Coast" will take a look at regional audio and recording activity throughout the U.S., reporting on interesting sessions, studio news and local events. Special features of "Coast to Coast" will be contributions by Randy Savicky in New York, Amy Ziffer in Los Angeles and Pete Caldwell on the SPARS beat. Please take a close look.

Keep reading.



Hillel Resner
Publisher

 **BPA** Circulation independently audited and verified by Business Publications Audit of Circulation since 1985.

Mix magazine is published at 6400 Hollis St. #12, Emeryville, CA 94608 and is © 1990 by NBB Acquisitions, Inc. *Mix* (ISSN 0164-9957) is published monthly. Subscriptions are available for \$46.00 per year. Subscriptions outside U.S.A. are \$61.00 per year. Single copy price is \$4.95, back issues \$6.00. Missed issues within the U.S. must be claimed within 45 days of publication date and abroad, within 90 days. Send subscription applications, subscription inquiries and changes of address to *Mix* magazine, PO Box 3714, Escondido, CA 92025-3714 or call 1 (800) 888-5139. Outside U.S., call 1 (615) 377-3322. POSTMASTER: Send address changes to *Mix* magazine, PO Box 3714, Escondido, CA 92025-3714. Address all other correspondence to *Mix* magazine, 6400 Hollis St. #12, Emeryville, CA 94608, (415) 653-3307. Fax: (415) 653-5142. Second Class postage paid at Oakland, CA, and additional mailing offices. *Mix* magazine is distributed in pro audio stores, music stores and other related businesses. If you have a recording or music-related business and would like to distribute *Mix*, please give us a call. Display advertising rates, specs and closing dates are available upon request. This publication may not be reproduced or quoted in whole or in part by printed or electronic means, without written permission of the publishers.

S T A F F

EDITOR-IN-CHIEF David M. Schwartz

PUBLISHER Hillel Resner

MANAGING EDITOR Blair Jackson

ASSOCIATE EDITORS

Paul Pothyn Tom Kenny

PRODUCT EDITOR George Petersen

ASSISTANT TO THE EDITOR Alexandra Behr

EDITORIAL ASSISTANT Jeffrey Fortenza

TECHNICAL EDITOR Ken Pohlmann

SENIOR EDITOR John Woram

CONSULTING EDITOR Stephen St. Croix

EDITOR-AT-LARGE Mr. Bonzai

SOUND REINFORCEMENT EDITOR Mark Herman

TAPE & DISC EDITOR Philip De Lancia

TEC AWARDS EDITOR Karen Margroff Dunn

CONTRIBUTING EDITORS

Craig Anderton Iain Blair Lou CasaBianca

Dan Daley Bob Hodas Mel Lambert

Larry Oppenheimer Bruce Pilato

ART DIRECTOR Tim Gleason

ASSISTANT ART DIRECTOR Patricia Law

PRODUCTION ARTIST Linda Gough

PROMOTIONS MANAGER Annie Jenkel

SPECIAL PROJECT DESIGN & PRODUCTION

Michael Zipkin

DIRECTOR OF ADVERTISING SALES

Jeffrey Turner

SOUTHERN CALIFORNIA/SOUTHWEST AD MGR.

Sue Horwitz

EASTERN ADVERTISING MANAGER

Michele Kanatous

NORTHWEST/MIDWEST AD MGR

John Pledger

SALES ADMINISTRATOR Neil McKamey

SALES ASSISTANTS Laura Kujubu Tina Spinelli

ASSISTANT TO THE PUBLISHER Jane Byer

CLASSIFIEDS MANAGER Robin Boyce

CLASSIFIEDS ASSISTANTS Hugh Swartz Mary Cosola

DIRECTORIES ADVERTISING MANAGER

Lauri Newman

DIRECTORIES ASSISTANTS

Jean Mahon Melissa McMillion

Cindy Lukk Annie Acker

DIRECTOR OF CALIFORNIA

OPERATIONS AND PRODUCTION

Anne Letsch

PRODUCTION MANAGER Georgia George

PRODUCTION COORDINATOR Ellen Richman

ADVERTISING TRAFFIC COORDINATOR

Donna Burriston

PRODUCTION ASSISTANT Rosanne Marmor

ASSOCIATE CIRCULATION DIRECTOR

Maria Di Placido

ASSISTANT CIRCULATION MANAGER

Lance T. Newkirchen

BUSINESS MANAGER Craig Kennedy

ASSISTANT CONTROLLER Ron LeRouic

ACCOUNTING CLERK Therese Wellington

OFFICE MANAGER Barbara Kochiovelos

WAREHOUSE MANAGER Charles Nielsen

RECEPTIONIST Angelique McGruder

ACT III PUBLISHING

PRESIDENT Paul David Schaeffer

CHIEF OPERATING OFFICER

Robert C. Gardner

SENIOR VICE PRESIDENT & GROUP PUBLISHER,

Kevin J. Condon

SENIOR VICE PRESIDENT, OPERATIONS & PLANNING

Martha Lorini

VICE PRESIDENT, FINANCE & ADMINISTRATION

Sam Schecter

DIRECTOR OF MARKETING & COMMUNICATIONS

Jennifer P. Ware

DIRECTOR OF CIRCULATION Steve Wigginton

DIRECTOR OF MANUFACTURING

Craig Balick

ACT III PUBLISHING TECHNICAL GROUP

ALSO PUBLISHERS OF

ELECTRONIC MUSICIAN

CORPORATE VIDEO DECISIONS

BME'S TELEVISION ENGINEERING

NATIONAL EDITORIAL, ADVERTISING AND BUSINESS OFFICES, 6400 Hollis St. #12, Emeryville, CA 94608 (415) 653-3307. **IMC 736 FAX**, (415) 653-5142. **SOUTHERN CALIFORNIA ADVERTISING OFFICES**, 19725 Sherman Way, Suite 300, Chatsworth, CA 91306 (818) 709-4662. **EAST COAST ADVERTISING OFFICES**, 401 Park Ave. South, New York, NY 10016 (212) 545-5166. **DIRECTORIES ADVERTISING**, (800) 344-LIST. **CLASSIFIEDS ADVERTISING**, (800) 747-3703. **CIRCULATION OFFICES**, 401 Park Ave. South, New York, NY 10016 (212) 251-5925.

A new justification for investing in a moving fader automation system.

Not everyone's business demands moving fader automation.

But if you've been feeling competitive pressures, as well as pressures related to this technology—like the ability to instantly "re-create" last week's mix with the sonic transparency that only moving faders can provide—we can remove some of the obstacles you've been facing.

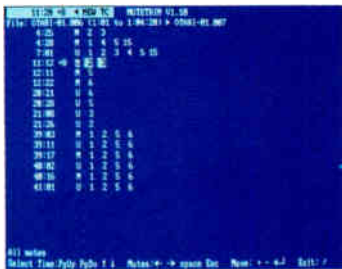

Our new mute trim function allows mutes to be inserted and deleted, or trimmed, on a frame-by-frame basis. Fader values and mutes (and unmutes) may be entered off-line via direct keyboard entry.

First, Otari's DISKMIX 3 Moving Faders system is one of the finest you can buy, and it doesn't carry a premium price tag. And our leasing program makes DISKMIX 3



The highly versatile DISKMIX 3 software is combined with the latest in motorized fader technology from Penny & Giles to create a high quality yet affordable fader/mute automation system.

even easier to put in your studio.

Interested?

DISKMIX 3 is a time-code driven system that provides unlimited mix data storage direct to hard disk, as well as complete off-line editing, including splice, merge, copy, fader and mute set and trim, plus insert and delete. The system uses multiple micro-processors and 10-bit data conversion, while high speed, dual ported RAM distributed over a proprietary bus system facilitates maximum data transfer with no system delays. This technology is

optimized for the latest Penny & Giles motorized faders to provide full fader travel in less than two SMPTE time-code frames.

DISKMIX 3 is designed with a user-interface very similar to that of current VCA-based automation systems. So if you are already using automation systems, DISKMIX 3 will be a quick study. In fact, the entire system is easy to understand and to use. It keeps you abreast of what's happening during all phases of mixing and gives you constant feedback in all modes of automation.

For a new brochure that gives you a complete run-down on these and a host of other features that allow you to deliver a better, more creative product to your clients, call your nearest Otari dealer, or call Otari at (415) 341-5900. Perhaps this time, your decision about fader automation can be a positive one.

DISKMIX™

Circle #044 on Reader Service Card

OTARI DISKMIX 3 automation systems are designed and manufactured in the U.S.A. by Otari Corporation, Console Products Group.

UPGRADE TO ANALOG.



Sony Communications Products Company, 1600 Queen Anne Road, Teterboro, NJ 07666 © 1988 Sony Corporation of America. Sony is a registered trademark of Sony.

INTRODUCING SONY'S ALL NEW APR-24 MULTITRACK RECORDER.

Analog recording has a new state of the art. Sony's APR-24 Multitrack Recorder.

As you'd expect, the APR-24 delivers extraordinary sonic quality. Because it's Sony-engineered from top to bottom. But it also offers some things you might not expect. Like a built-in, multi-featured

synchronization system which accepts video reference, LTC and VITC signals. Which makes it perfectly suited for post production.

There's also a newly designed, remarkably fast transport built on a

rock solid 4-inch casting. Long life amorphous heads. And micro-processor-assisted alignment. All standard on every machine.

So if you're getting ready to upgrade your facility, upgrade with the APR-24. Contact your Sony Professional Audio representative, or call Sony at 800-635-SONY.

SONY®

PROFESSIONAL AUDIO

World Radio History

CURRENT

SPARS Workstation Business Conference

In late May, representatives from the leading workstation developers gathered at a weekend technical conference entitled "Digital Audio Workstations—The Audio Solution for Video Post-Production." Organized by the Society of Professional Audio Recording Services and held at the Nashville Hermitage Hotel, the two-day conference attracted more than 100 attendees who heard hour-long presentations from Alpha Audio, AMS, Digital Audio Research, Lexicon, New England Digital, Otari, Solid State Logic, Sony Pro Audio, Studer-Editech, Symetrix and WaveFrame.

The companies participating in the SPARS conference explored the current state of their respective design solutions during a series of hands-on demonstrations. Of special interest was a two-hour panel discussion during which the 11 firms presented their views on the interchange of digital and system information between different workstations.

While most participants agreed that current Exabyte, audio and Data DAT cartridges could handle 2-channel, unedited material and final mixes, there needs to be more effort made in standardizing various removable, high-density magneto-optical and WORM formats, so that premixes and partially edited material might be transferred from one device to another. In addition, CMX-format EDLs (edit decision lists) are now being used to provide basic listing of time code in/out points for audio conformation projects, although it was pointed out that the ability to export annotated EDLs from a workstation would be a definite advantage.

New England Digital, SSL and

WaveFrame agreed to publish technical descriptions of their respective interconnect protocols and file structures, so that different systems could pass data between themselves in real time or via an intermediary storage format.

A full report of the proceedings from this SPARS workstation conference will appear in my October/AES "Juxtapositions" column.

—Mel Lambert

Russ Berger Design Group

Well-known studio designer Russ Berger has left The Joiner-Rose Group, Inc., and started his own professional consulting firm, The Russ Berger Design Group, Inc., in Dallas. The two firms have pledged to maintain an effective and collaborative working relationship. Berger will continue to specialize in recording and broadcast studio design, architectural acoustics, and technical systems design.

Berger is a two-time TEC Award winner for acoustics/studio design and has been nominated again this year as part of the Joiner-Rose team. Joining Berger at the new company are longtime co-workers Richard Schrag, Randy Kratzer and Elizabeth Everett. Chuck Chiles and Cecil Smith will provide audio and video technical systems design. The company opened for business on May 1.

Heyser Foundation Board Selected

In July 1989 we told you about the Richard C. Heyser Scholarship Loan Fund, honoring one of this industry's most respected figures. Now the Heyser Foundation Board has been selected to administer the funds.

Bart Locanthi, former AES president and now of BNL Research, has been named president; John Prohs of Ambassador College will serve as

vice president; and Amy Heyser, owner of Phillips Music Company, will be secretary-treasurer. David Andrews, Don Eger and Charles Wilts also have been asked to serve on the board.

Heyser says she expects the foundation to grant the first loan to a promising graduate engineering student in need for the 1991-1992 school year. Requests for applications should be sent to 10415 Fairgrove Ave., Tujunga, CA 91042. Donations may be sent to the same address.

TEC Awards Announce Platinum Sponsors

Five leading companies in the professional audio industry have shown their support of the TEC Awards and the Mix Foundation for Excellence in Audio by becoming Platinum Sponsors (\$10,000 contribution) of the 1990 TEC Awards.

"We are delighted that Agfa, Ampex, JBL Professional, Neve, Solid State Logic and Act III Publishing have given their support to the TEC Awards in such a substantial way," says Karen Dunn, TEC Awards executive director. "It's this kind of involvement that will ensure the continued success of the TEC Awards and its beneficiaries."

A limited number of sponsorships are still available. Interested parties can contact Karen Dunn at (415) 420-0144, or Hillel Resner, executive producer, at (415) 653-3307. Complete information about the TEC Awards can be found starting on page 88.

Mix-Ups

The May Northeast Directory included an incorrect phone number for Levelhead Recording of NYC. The correct number is (212) 664-1033.

In the June "Insider Audio," we

INDUSTRY NOTES

Bill Whitlock, an innovator of PCM digital audio recording, was named president of **Jensen Transformers** of North Hollywood, CA, at the request of the late Deane Jensen...*Keyboard* and *EQ* magazines are sponsoring **CyberArts International** from September 6-9 in Los Angeles. The conference will spotlight interactive and multimedia technologies as they apply to the arts. Featured events include panels with Robert Moog and David Smith (of MIDI fame) and performances from George Coates and Matt Heckert, of Survival Research Labs. For information call (415) 267-7646...**Daniel Roberts** joined **Lexicon** of Waltham, MA, as VP of sales and marketing...**Electro-Voice** announced the promotion of **Todd Rockwell** to sales and distribution manager of EV Pro Sound Market and Mark IV Cinema...In Montebello, CA, producer **Karl Moet** is **Tascam's** new show/clinic coordinator...**Michael Wiese** and **Steve Michelson** joined their companies as **Michelson-Wiese Communications**, with offices in San Francisco and L.A., focusing on video producing, directing and marketing...In Bethel, CT, **Orion** and **Neve** signed an agreement allowing the latter control over manufacturing, sales and service of Orion's console line; as part of this change, former Orion president **Rich Hajdu** joined Neve as VP of sales and marketing for Neve North America. **Lisa Vogl** was promoted to director of advertising and promotions...In Columbus, OH, **Solidstate Controls** brought aboard **Peter Benson** as its new president/general manager and **Roger O. Grosso** as VP, sales and marketing...**Digital Microwave Corp.**, San Jose, CA, formed a new division, DMC Digital Video, managed by **James Murray**...Berklee College of Music alum **Brad Strickland** joined **Korg USA** as market development manager in Westbury, NY...**Ralph Jones**, co-author of Yamaha's *Sound Reinforcement Handbook*, is rejoining **Meyer Sound Labs** in Berkeley, CA...**Eric Mendenhall** was hired by **QSC Audio Products**

(Costa Mesa, CA) as design engineer...In Steubenville, OH, **Technimedia Studios** brought aboard producer/engineer **David Mathes** as division manager...**New England Digital** (White River Junction, VT) acquired its Midwest distributor, **Songbird Digital** (Nashville, TN), turning the company into a regional sales/service center. NED opened a similar center in Chicago and hired **Richard Head**, founder of Songbird, as VP of the central division. Head will be in charge of both offices...Sweden-based **Milab** chose **Klark-Teknik** as its exclusive distributor of its microphone line in the States...**Leslie's** (Elgin, IL) is the new rep for **Frazier**, a division of **Sound-Craft Systems** of Morrilton, AR...In Minneapolis, **Illbruck Inc.** hired **Eric Johnson** as national sales manager of the Sonex acoustical materials line; he'll work out of Richmond, VA...In Los Angeles, **American Interactive Media** promoted **Dr. Tyler Blake** as VP, program design and user interface, and **David McElhatten** as vice president of production. **Alty van Luijt** was hired as VP, engineering and technical services...In Pelham, NY, **Paso Sound Products**, commercial sound and communications manufacturer, has two new reps: **MJA Marketing** (St. Charles, MO) and **Palmieri Associates** (Ridgefield Park, NJ)...Post-production company **Intersound** of L.A. moved **Bryan J. Rusenko** up to VP, engineering, and **Garry Morris** to executive director, marketing and publicity...In Wheaton, MD, **Washington Professional Systems** hired new sales assistants: **Paul Freeman** to focus on church and hotel systems, **Gerren Mortenson** for video sales, and **Stephen Sadler** for Sony analog tape machines...**Gefen Systems**, Woodland Hills, CA, appointed **Jon Beachdell** to VP, sales and marketing...In New York City, **Sutcliffe Music** named **Jennifer Countryman** as its rep in the Chicago area...The **National Association of Broadcasters** (Washington, DC) appointed **Edward Reilly**, president of McGraw-Hill, to its TV board of directors. ■

mistakenly said Sonic Solutions was a Los Angeles company. In fact, the company is based in San Francisco.

Grammys Back in NYC

The 33rd annual Grammy Awards will return to New York City in 1991! Mayor David Dinkins, NARAS president Michael Greene and chairman of the New York Host Committee Edwin M. Cooperman jointly announced that the program will air from the famed Radio City Music Hall in late February 1991, and will be televised live on CBS.

"Our decision to bring the Grammys back to New York City salutes this great city, its important recording tradition and the vitality of its music community," Greene said. "I am also very appreciative of the efforts and endorsements of Mayor Dinkins and the New York Host Committee."

The New York Host Committee was established this past March under the directive of Mayor Dinkins to serve as the city's and business community's coordinating unit for the Grammy Awards show. This will be the fifth time that the Grammys have been held in New York, most recently in 1988.

The National Academy of Recording Arts & Sciences, which presents the Grammys each year, also announced the addition of two new categories: "Best Alternative Music Recording" and "Best Rap Performance."

Convention News

To help small-market television stations with sales management, the National Association of Broadcasters will host the fifth annual "Hundred Plus Exchange" in Denver, September 16-18. Contact Susan Kraus at (202) 429-5350.

The International Teleproduction Society will host its 3rd Annual Forum & Exhibition at the New York City Hilton, September 8-12. Contact Jessica Josell at (212) 877-5560. ■

ScreenSound. A fully integrated audio for video editing suite



Post production facilities need to take advantage of the efficiency offered by today's technology. Speed and creative flexibility are essential to commercial success. Digital sound quality is no longer a luxury.

ScreenSound is a fully integrated audio for video editing suite. It combines digital audio storage and editing with machine control of multiple VTRs, Laserdisc or film reproducers. It also interfaces with Quantel's digital video editor, Harry.

Simple to learn and fast to use, a cordless pen, tablet and RGB monitor provide control of all ScreenSound functions.

Multiple sound reels enable music,

dialogue and effects to be laid back to picture and synchronised to the exact video frame.

Edit, review, time offset, track slipping, cross fades and many other production techniques are available at the touch of a pen. Gain and stereo pan controls can be automated to timecode.

AES/EBU interfacing keeps digital audio transfers free of analogue distortions and losses, preserving the highest audio integrity through to the final format.

Above all, ScreenSound is a dedicated system - purpose-built to bring the advantages of hard disk sound manipulation to audio post production.

AUDIO STORE

The hard disk store of sound clips gives title and duration, in addition to powerful search and sort routines.

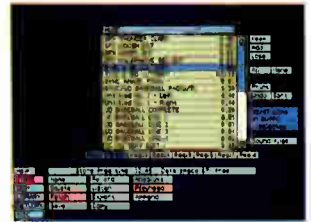

SCRUB EDITOR

Provides accurate edit marking and scrub of audio waveform.

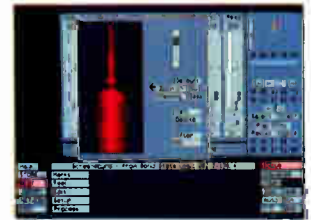

OPTICAL LIBRARY

An off-line library of sound clips and effects can be compiled on a Write Once Read Many (WORM) optical disc.



MACHINE CONTROL

For control of multiple VTRs, laserdisc or film reproducers.



TEC
TECHNICAL EXCELLENCE & CREATIVITY
1990
NOMINEE

SSL DIGITAL
Solid State Logic

Begbroke, Oxford, England OX5 1RU (0865) 842300

London (01) 706 4948 • Paris (1) 34 60 46 66 • Milan (2) 612 17 20 • New York (212) 315 1111 • Los Angeles (213) 463 4444

• Toronto (416) 363 0101 • Tokyo (03) 5474 1144

U.S. Toll Free Number 800 343 0101

RIQUE ALONSO	ANDY JOHNS
DAVID ANDERSON	GEORGE KARRAS
MICHAEL BARBIERO	ACAR KEY
DAVE BARRATT	TIM KISH
DAVID BASCOMBE	DAVID KOWALSKI
DAE BENNETT	FERNANDO KRAL
HILARY BERCOVICI	GARY LANEY
DEVON BERNARDONI	MICHAEL LARDIE
MARTIN BIRCH	STEVE LIPSON
JOE BOGAN	TOM LORD-ALGE
MILAN BOGDAN	BOB LUDWIG
ROB BOZAS	ION MALLISON
BOB BROCKMANN	RICHARD MANIWARING
JAMES BROMFIELD	LEWIS MARTINEE
GERRY BROWN	LEIF MASES
BERNARD BULLOCK	GARY MCGACHAN
BOB BULLOCK	RAFE MCKENNA
CRAIG BURBIDGE	CASEY McMACKIN
RANDY BURNS	GLENN MEADOWS
MATT BUTLER	ANDREW MILANO
GREG CALBI	RODNEY MILLS
MARIO CALDATO JR.	JOHN MORALES
PHIL CASTELLANO	TAAVI MÖTE
BOB CLEARMOUNTAIN	BRYAN NEW
JIM COTTON	LYNN PETERZELL
MIKE COUZZI	CHRIS POTTER
ROSS CULLUM	DENNY PURCELL
DAVID DACHINGER	DAVE RIDEAU
TERRY DATE	BUD RIZZO
NICK DAVIS	BOB ROSA
VINCENT DAVIS	GLENN ROSENSTEIN
ANDRE DEBOURG	CHAS SANDFORD
DIETER DIERKS	JOE SCAIFE
NEIL DORFSMAN	BILL SMITH
DR. DRE	DONOVAN SMITH
ALFRED EATON	KEITH SWEAT
STEVE ETT	IAN TAYLOR
DON FEINBERG	TERRY THOMAS
TOBIAS FREUND	STEVE THOMPSON
NIGEL GREEN	RON TREAT
JAMES GUTHRIE	LESTER TROUTMAN
CHRIS HAMMOND	ROGER TROUTMAN
PETE HAMMOND	ZAPP TROUTMAN
PHIL HARDING	KURT UPPER
TONY HARRIS	MICHAEL WAGENER
JAY HEALY	DUSTY WAKEMAN
SCOTT HENDRICKS	ANDY WALLACE
JAY HENRY	GREGORY WALSH
KAREN HEVITI	MICHAEL WANCHIC
BEAU HILL	MERVYN WARREN
ROSS HOGARTH	ALAN WATTS
STEVE HOYLAND	HANK WILLIAMS
ROD HUI	DAVE WITTMAN
JON JACOBS	MARK WOLFSON
NORBERT JANICKE	D.J. YELLA
TED JENSEN	DAVID Z





MORE ENGINEERS GO GOLD ON AMPEX THAN ON ALL OTHER TAPES PUT TOGETHER



EVERY ENGINEER LISTED HERE HAS EARNED THE PRESTIGIOUS

Ampex Golden Reel Award for engineering a gold album exclusively on Ampex audio tape. In fact, of all the gold albums released last year—and the year before—most of them were laid down exclusively on Ampex tape. And it's a good bet that most of the others used Ampex for the majority of their tracks, too. • At Ampex, we appreciate the passion and precision demanded of audio engineers. It means pushing yourself to the wall so that every note, every beat, every bar will be perfect. It means taking music...and making magic happen. • We've made our own commitment to provide you with the highest quality, most consistent, most dependable audio tape in the world. A tape engineered with the same uncompromising attention to detail that you bring to your sound. • For all the details on what makes Ampex tape so technically advanced, just call or write for a copy of our new 456 Technical Brochure, and see why Grand Master® 456 is engineered like no other tape in the world.



AMPEX
A MASTER OF ENGINEERING

by Ken C. Pohlmann

ROLLING ROCK

It's a helluva sound system. CD player with 4x oversampling filter, auto-reverse cassette deck, AM/FM tuner with diversity antennas, 5-point fixed parametric EQ, 5-preset graphic EQ, full lockout anti-theft system, 6-channel power amplifier with 220 watts maximum output power, and ten independently placed loudspeakers with two bi-amplified subwoofers.

It also comes in a helluva carrying case. Five-speed manual transmission;

engine; turbocharger and dual-inlet, air-cooled intercooler; front and rear MacPherson struts; 200 horsepower at



all-wheel drive on 215/50VR15 radials; transverse-mounted, 4-cylinder, in-line, twin-cam, 16-valve 2.0-liter

6,000 rpm; 200 foot-pounds of torque at 3,200 rpm; driver-side air bag; and ABS braking.

It's the new All-Trac Turbo, Toyota's baddest, meanest Celica ever, complete with Toyota's baddest, meanest sound system. You see, these days, car audio is big business. Americans spent \$800 million on car stereos in 1979 and \$5.25 billion in 1989—about as much as they spent on home audio. Car makers are major

WADIA GLASS FIBER OPTICS

The Ultimate Digital Audio Transmission System

If, like most large studios, you've discovered that using normal cable to carry digital audio more than a dozen feet results in data errors, you should be talking to us!

THE PROBLEM:

Normal twisted-pair cable and XLRs were not designed for AES/EBU, S/P DIF, SDIF-2 and other digital formats. Severe word-clock jitter and edge damage to the self-synchronizing digital clock pulses lead to clearly audible results: a collapse of the stereo image, lack of resolution, and a general mudiness in mid and high frequencies.

THE SOLUTION:

Glass Fiber Optics is the only 100 percent reliable technique for transmitting serial digital data at 3.072 megabits per second across long distances, unaffected by clock jitter, cable dispersion, noise, RFI and ground loops. Wadia knows glass fiber optics. In today's Digital Production Environment, You need Wadia!

To hear the ultimate sonic advantages of an all-glass chain, we also offer a series of reference-quality D-to-A converters. Now accurately monitor the audio quality of data that you've printed to tape, stored to hard-disk or mastered to optical media.

Wadia
DIGITAL CORPORATION

*For the Ultimate in
Glass Fiber Optics and
Studio Reference
Converters, You Should
Be Talking To Us!*

*Call or write for more
information:*



Marshall Electronic, P.O. Box 438, Brooklandville, MD 21022. (301) 484-2220; Fax (301) 486-0280
Wadia Digital Corp., 511 Second Street, Hudson, WI 54016. (715) 386-8100; Fax (715) 386-8116

A Custom Console? No Problem!

D&R developed the **Dayner Series** to meet the many demands of the "nineties" studio. In today's recording environment, the "stock off the shelf" recording console just doesn't offer the configurations and features needed. No matter what your requirements, space, amount of inputs, specs, or functions, **D&R** can customize a **Dayner Series** console for you. Contact the **D&R** Customer Support Department at (409) 588-3411 for a "factory direct" quote today.



Pictured is Eddie Shuler at Goldband Recording Studio with his C-Mix automated **Dayner** console and 24 track **Studer**. Eddie recorded **Dolly Parton's** first record and one of the many hits he's responsible for is "Sea of Love" (recorded in the fifties with one microphone) just recently featured in the MCA movie "Sea of Love" starring **Al Pacino, Ellen Barkin, and John Goodman**.

TOTAL CONTROL

D&R Electronica b.v.

Rijnkade 15B 1382 GS Weesp

The Netherlands

Phone: (011) 31 2940 18014



mixing consoles

Circle #002 on Reader Service Card

D&R Electronics USA

Rt. 3, Box 184-A

Montgomery, Texas 77356

Phone (409) 588-3411

audio vendors; for example, they sold 3.7 million cassette decks in 1988, and they should annually sell a million CD players by next year (the car aftermarket surpasses even this). Ford made \$900 million from audio sales in 1988. When it came time for Toyota to design its fifth-generation Celica, it knew its target audience of youthful, single, affluent, music-loving buyers wanted: a) a low-slung rocketship, b) a dynamite sound system.

What does all this have to do with professional audio? Plenty. Cars have become *the* preferred listening environment for Americans. The radio stations they tune to and the tapes and CDs they buy are increasingly heard on the road. More than likely, the product you mix in the studio will be judged over a mobile sound system. For that reason (and the sheer fun of it), engineers and producers are turning their own cars into reference rooms, complete with CD playback, solid power amplification and quality speakers. It is in the car that critical listening decisions are made.

Hop in this Turbo for a minute and let me take you for a spin. Toyota is great at building cars, but wisely seeks outside help in audio. For the Celica, it turned to Fujitsu Ten for system design. Fu Ten's parent company, Fujitsu, is the 42nd largest corporation in the world and Japan's largest mainframe computer manufacturer, with tons of technology expertise. Fujitsu Ten is its audio company (known in the U.S. under the "Eclipse" nameplate, maker of ultra-cool, aftermarket car audio systems). Working together, Toyota and Fu Ten came up with the premium audio option, System 10.

Taking a clean sheet, Fu Ten and Toyota engineers didn't overlook a single trick in the design of System 10. For example, in the search for bass enclosure volume, instead of using the door as a simple mounting location, they designed a special double-labyrinth seal at the front door glass, turning the door cavity into a 35-liter subwoofer enclosure. In addition, the interior trim panel is designed to be airtight. As a result, the bass response delivered by the pair of 8-inch woofers (mounted to rigid sub-baffles) is improved by 10 dB. They were also uncompromising in their design. In the rear, two 6.5-inch speakers are housed in rigid 8-liter bass reflex enclosures;

the body engineers actually designed the rear structure of the car around these enclosures. Another pair of 5-inch midrange speakers are placed in the front ends of the instrument panel.

Four 1-inch dome tweeters are placed as close as possible to ear level in the car's four corners. The front tweeters are mounted in the rear view mirrors and are crossfired, for example, with the left tweeter aimed at the right seat position. The rear tweeters are mounted on the shock towers, firing forward instead of radiating off the rear glass. The tweeters make use of ferrofluid, strontium magnets and polyamide diaphragms. There are no

coaxials or triaxials here, rather, individual, specific-purpose drivers. Speaker locations are shown in Fig. 1. Together, these ten speakers deliver the full-range audio above 112dB A-weighted SPL.

The amplifiers are all outboard of the two-DIN head unit, mounted in the rear bottom of the vehicle. This remote configuration is not limited by size and heat sink requirements, which allows larger components and discrete circuits where needed. Up front, two 30-watt amplifiers each deliver 11 watts continuous average power at less than 0.1% THD; each drive the front-mounted tweeters and midranges. The

B&K's NEW "TUBE" MIC



The world standard Brüel & Kjaer Series 4000 Professional Microphones are the most accurate, transparent, cost-effective and most revealing audio transducers available today.

However, if you still prefer the coloration of "classic" tube technology, we'll enclose our new "tube-SOX" filter, free of charge, with your order.

For Ordering Call or Write: Brüel & Kjaer Pro Audio
185 Forest Street
Marlborough, MA 01752
(508) 481-7000
Adrian Weidmann
Information Hotline: 1-800-444-4BNK

INSIDER AUDIO

midrange speakers are crossed over at 200 Hz, and are angled downward by 10° to attenuate certain midrange frequencies. The tweeters are pas-

Figure 1

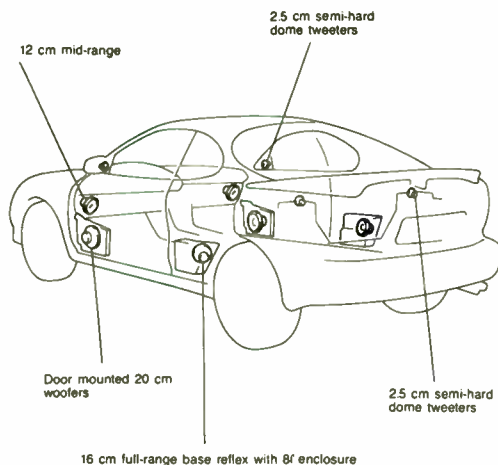

sively crossed over with a first-order network at 10 kHz. A second pair of 30-watt amps each drive the rear-mounted speakers and tweeters. The midrange speakers use their bass reflex

enclosure to roll-off mechanically at 55 Hz, negating the need for highpass filters. The tweeters use an 8kHz passive crossover. To help front-image placement, the rear channels are attenuated by 3 dB. Each front subwoofer is driven by a 50-watt discrete amplifier that delivers 18 watts continuous average power at less than 0.1% THD. The woofers operate at 300 Hz and lower.

In developing the system, engineers employed a grid of 234 separate microphones inside test cars to investigate the system's acoustical response, and to solve the problem of interaction between the vehicle's interior design and materials, multiple speakers and passengers. Among the variables taken into account were driver selection, driver inclination, gain adjustment, phase displacement, crossover points, diffusers, grille material and fixed EQ points. Computer analysis and FFT also helped devise models for equalization, auto loudness, gain balance and phase control.

For example, a pair of fixed equalization circuits manipulate front and rear channels to optimize sound pressure distribution and spatial frequency response characteristics. The front

equalizer has a 3dB rise at 500 Hz to add midrange definition and a 2dB rise at 10 kHz to increase clarity. A third equalization point is needed in between to bring response to a 0dB level; a hybrid parametric function is used. The rear equalizer contains a -5dB point at 120 Hz to overcome the typical rise in resonance found in most automobiles in the 120Hz to 180Hz region. This is caused by ambient road noise, reflections from interior geometry of front and rear windows, and resonance from the transmission tunnel. A -6dB point at 1.6 kHz was selected to maintain a stable soundstage for front seat passengers.

To compensate for apparent attenuation of low frequencies at low listening levels, the volume circuit contains a dynamic, equal-loudness contour controller. In many cars, sound from front and rear speakers arrives out of phase at the driver's listening position. To overcome this problem, System 10 alters phase to the rear channels electronically to correct phase response at low frequencies, shifting 90° at 125 Hz.

Designers upgraded and increased the gauge of all power supply and speaker wiring, with two separate supply lines from battery to amplifiers. Twin-lead 16-gauge wire is used from battery to amplifier and for ground. Audio cable is shielded, premium 16-gauge stuff. The result is clean, crisp sound at concert levels, complete with the all-important kick-ass low end. System 10 is available on the Celica GT, GT-S and All-Trac Turbo, and it ain't cheap.

Folks, let me tell you that I've been driving a Porsche 911 Targa for several years, and it's been a real pleasure. I've also got it tricked out with a pretty interesting sound system. After testing the All-Trac, I'm about ready to make the switch. Am I crazy, selling a Porsche to buy a Toyota? Maybe, but an All-Trac with System 10 is beginning to sound better and better. It is a serious car with serious sound.

A final comment: If you are really into driving, you know what the term "road kill" means. If you buy a black All-Trac with System 10, and have the right kind of CD cranked, you don't even have to hit them, they splatter all by themselves, right beside the road. Trust me. 33. ■

Ken Poblmann is director of the music engineering program at the University of Miami.

THE DAT STORE

DIGITAL AUDIO TAPE RECORDERS

MONDAY THRU FRIDAY: 9:00-6:00 / WEEKENDS: 1:00-4:00

OVER 25 MAKES & MODELS--IN STOCK NOW!

**PANASONIC SONY JVC AKAI
CASIO PIONEER NAKAMICHI
MASCAM SHARP FOSTEX**

& Introducing the smallest DAT to date:

THE AIWA HD-X1

**DIRECT DIGITAL RECORDING MASH FILTERS
DIGITAL IN & OUT RECHARGEABLE BATTERY
256X OVERSAMPLING SUB-CODE EDITING
A/D CONVERTER W/WIRED REMOTE & CASE INC.**

**2624 WILSHIRE BOULEVARD
SANTA MONICA, CA 90403
(213) 828-6487 / FAX (213) 470-6176**

Circle #070 on Reader Service Card

16 Channels 6 Sends 8 Receives \$899

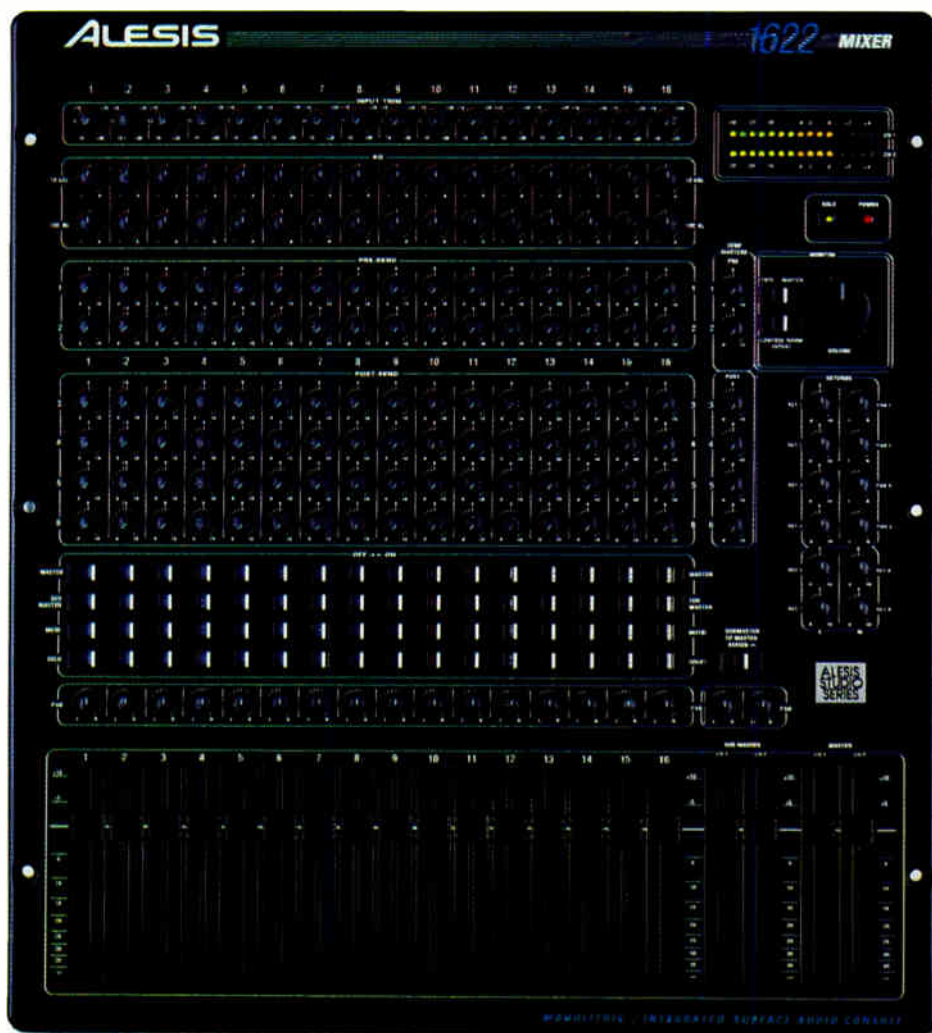

This is the product everybody's talking about. The mixing console that will put you in total command of your music.

We invented a new way to build this mixer to deliver more features and sonic performance than ever before possible.

At less than \$60 a channel, it belongs in your studio right now.

Alesis is very proud to introduce the **1622 MIXER**. The world's first Monolithic Integrated Surface™ Audio Console.

The mix starts at your Alesis dealer now.



LOS ANGELES: Alesis Corporation • 3630 Holdrege Avenue • Los Angeles, Ca. 90016

LONDON: 17, Letchworth Point • Letchworth, Hertfordshire SG6 1ND.

Roland breaks th

Roland S-770 DIGITAL SAMPLER



```

Edit Partial TUF  [1]  Dec / Inc  [2]
Filter Mode  LPF  Envelope
Cutoff Freq  24  -TUF Depth  63
-Key Follow  0  -Vel Sens  63
Resonance    21  -Pitch Depth  0
Vel-Curve    2  Time
Play / Split / TUF / Amp / Unload
    
```

JUMP

F1

F2

F3

F4

F5

EXIT/CTR

CONTRAST

PROGRAM

LOGIC/STAGE

MARKER

PH

If we were to tell you that our new S-770 is the best digital sampler in the world, you'd probably mutter something about truth in advertising and go on about your business. When, as you'll discover momentarily, it's absolutely true. And, as you'll also discover momentarily, the reason for it has less to do with any one feature in particular than it does with several features working in conjunction.

Such as the fact that the Roland S-770 is equipped

with AES/EBU Digital I/O, so it's actually possible to set up a fully integrated digital production facility.

We've also equipped our S-770 with both 20 bit D/A conversion and Differential Interpolation, thereby giving it higher resolution than any other stereo sampler.

And while we're making comparisons, allow us to offer another one. With 24-voice polyphony, the Roland S-770 has more voices than any other comparably-priced sampler. So you're not only assured of getting

e sound barrier.



extraordinary sound but the flexibility to go along with it.

Before we forget, the S-770 is also blessed with an elephant-like internal memory. It can be expanded to 16 megabytes which, for those of you without calculators nearby, translates to 83.5 seconds of continuous stereo sampling time at 48 kHz—twice as much as any sampler in its price range.

While we're on the subject of price, there's one more thing we should mention. On many samplers

you have to add a slew of peripherals. On our sampler, you don't. Things like a 40 megabyte hard disk drive, SCSI port, Digital I/O and RGB video monitor output all come standard.

Of course, these are just the highlights. For the rocket-scientist information, write us at the address below or call (213) 685-5141.

And as far as the sonic boom is concerned, that comes later. When you hear the S-770 being played live.

Roland[®]

Circle #007 on Reader Service Card

by Stephen St. Croix

WHAT IF?

Okay, now, what if we all—that is, if everyone on the entire planet—could actually get together and come up with a standardized protocol for telecommunication by voice? Just think about it. The voice part is pretty easy: Just keep it analog and only go digital within your own closed subsystems.

It's the hand-off and management of the routing that's the problem. We would need one standard set of voltages (or agreed-upon translators), with compatible hardware, routing designs and key signals across the world! Why, people in Kuala Lumpur could actually pick up a phone and dial you up in New York or L.A., and without too much trouble, talk to you!

Just imagine. A standardized format. What a concept. People and companies all over the world working together to improve the state of communication of man.

No, wait a minute...We already *have* that. Sorry. Yes, now that I think

about it there already *is* a kind of worldwide standard in effect. And what's more, it basically works.

Today I can drive along the back roads in the woods of Maryland, feel the urge to get into some serious trouble, push a couple of buttons on the dashboard, speak into the visor, and find out that the project going on in L.A. or Germany has totally fallen apart since I left three days ago and they need me back instantly.

A worldwide network of cooperating companies and governments waiting 24 hours a day to help me get depressed...and it *works*. Of course, it is also pretty nice when you can reach out and wake up someone you miss from six kilo-miles away.

Okay, okay, so we already have that. Well, what about, let's see now...pictures?

Yeah, that's it, pictures on the same existing phone system. If I miss my woman while I'm on the road, I can



ILLUSTRATION: MARTY BRAUN

“WaveFrame At War”

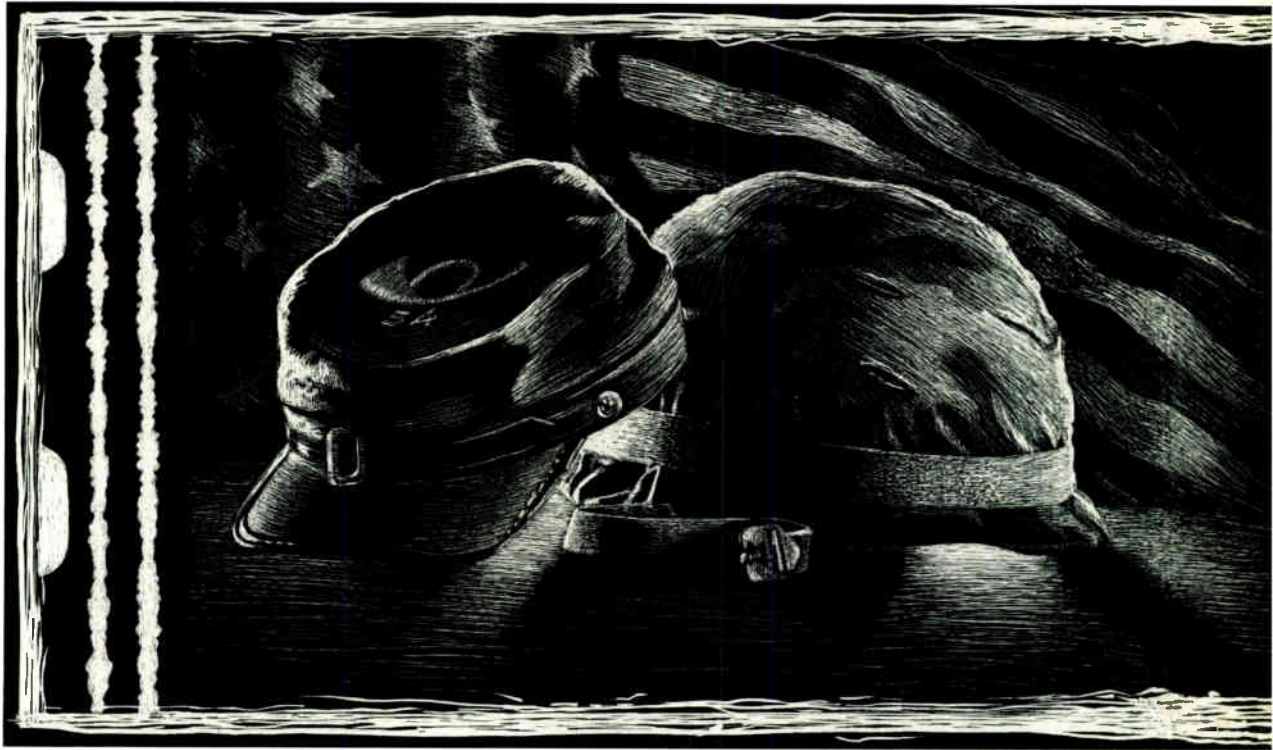

When Scott Gershin and Wylie Stateman of Sound Deluxe in Hollywood were drafted to post the sound effects and Foley work for Universal's award-winning motion picture, **BORN ON THE FOURTH OF JULY**, they turned to the AudioFrame for the firepower they needed.

“Using the AudioFrame's sampler and EDL to spot the sound effects to picture, coupled with its internal mixer and 24-bit multitrack disk recorder, we were able to produce a product which exceeded our expectations for audio quality *and* beat our deadlines significantly.”

BORN ON THE FOURTH OF JULY has been nominated for an Academy Award for Best Achievement in Sound.

Likewise, when James Horner composed the breathtaking score for **GLORY**, he turned to *his* AudioFrame.

“The purity of the sound of AudioFrame lets the beauty of my music come through.”

James Horner's original score for **FIELD OF DREAMS**, which was composed and performed on the AudioFrame, has been nominated for an Academy Award.

So, in *your* battle against man and machine, choose the ultimate weapon.

The **AudioFrame**... by WaveFrame.

 **WaveFrame**

2511 55TH STREET BOULDER, CO 80301 303 447-1572
BOULDER • LOS ANGELES • NEW YORK • COPENHAGEN

— FROM PAGE 22

call her and tell her, but if I miss her too much to explain on the phone, I can send her *pictures* and technical diagrams showing exactly how badly I miss her.

And some people can even do all of this from their cars (I refuse to have a fax in any of my land vehicles).

So what do we have here? A standardized telecommunication system with nearly invisible format and protocol translation where needed, in use, now, here on Earth. Fine.

What else? You can drive from the East Coast of the United States to the West Coast and be relatively assured that you can go up to the nearest fossil fuel dispensing station anywhere on the way, and the nozzle will fit your machine's input port.

Sometimes the level of cooperation between people is inspirational (or at least relational).

Let's bring this a bit closer to home. You can take a 24-track analog tape from Fred's Music Emporium in New Orleans to Electric Lady in New York, and if Fred properly uses a good-calibration tape it will *actually play*.

Or this: A DAT's a DAT, of course, of course, unless that DAT is being forced to play on a dirty head. Standardization again. Competitors (in this case, some serious archenemies) got together and hammered out a standard so it could at least get started, write or wrong. Copy-code stupidity tried to kill the entire concept, and time will tell if it *did* (but that's another story).

CDs (and other government bond investments), AES/EBU, SPDIF, SDIF-2, 110 VAC, 220 VAC, +24 dBm, -10, even MIDI (sorta): successful standardizations, all done for the betterment of humans (or was it the almighty buck)? Who cares what the *reason* was, just so they work.

Now, boys and girls, we leave that old, familiar physical world and enter the scary, powerful realm of the virtual digital environment. *We have to*. How else can we get the type of work that needs to be done today accomplished in the little time that we have to do it?

So we all buy digital editors and disk-based recorders. We buy the ones that best fit our needs (though some will buy the ones that best fit the plans of the salespersons or reps). In any case, it is remotely possible that we

might not all end up with the same machines. Hard to believe, but true.

We do, however, all share a couple of key views. We all got into this for the advantages of living in the digital (and more so, daily), virtual world. We all want to convert sound to a stream of binary numbers as soon as possible, and preferably *never* leave that world, all the way to the end-consumer product. We want to do all our editing, mixing, EQ, compression, limiting, reverb, time fitting, conforming, looping in the mystical digital domain.

This quantum leap in recording technology carries with it inevitable new standards: 44.1, 32, 48, RS-422 transport protocol. You know, the kind of standards that make our jobs and our lives a little more rational, a bit easier.

Simple, basic standards, the bare minimum, like, let's say, being able to transfer soundfiles from one company's machine to another's. Like that time a few months ago when I wanted to take a file out of an AMS AudioFile and put it into a WaveFrame.

Let's see, now. Exactly *how* did I do that? Well, first I...No, that's not it. Oh, yes, I...No, that didn't work either...Now I remember; I didn't do it at all. It couldn't be done. I abandoned the file and started over.

Now *that's* definitely what standardization is all about.

Sometimes it takes a little naive voice in the wind to start the unrest needed to force manufacturers to overcome their insane paranoia and grow the hell up!

Yes, I know that nobody wants to be the first to reveal the wonderful, magical secrets of their internal file management. And I know that nobody else wants to *change* theirs to adapt. The problems are insurmountable. The conceptual and logistical incompatibilities are beyond the scope of mere mortals to resolve.

Yes, yes, manufacturers, I hear you! I am one myself.

Why should you share with your competition, or as some of you seem to see it, your *enemies*? Or, how about this one: Once you got 'em hooked, why let them go when you can keep them locked into your system? The answer is, if not for the betterment of mankind, for the bucks.

Compatibility is crucial for the health of the digital recording/editing market. Customers will actually be more willing to take a chance and try

out your new digital Wazoo 700 workstation if the most they can lose on a bad purchase decision is time and money, but *not* the actual work they've done on it.

Yes, your machines are really cool, but they are nowhere near as important to me as the work I have done on them. Hear me now and believe me later. I know. I hear the customers. I am one myself!

If not standardization, then at least give us serious compatibility, or even realistic compatibility with file format converter utility programs that preserve edit information. Don't tell me you can't do it, or that *you* can, but the other guy won't cooperate. Just do it!

As a customer, I don't give a damn how many phone calls and meetings (or how many R&D hours) it takes to get this to happen. I do, on the other hand, feel a growing resentment that you expect me to give you large amounts of money to get into one of your machines, and actually give up the hard-earned compatibility I enjoyed in the analog days.

As a manufacturer and designer of such machines, I cannot be dismissed as being so naive that I don't grasp the problems in attempting this type of standardization or even compatibility.

The end-users need this, and perhaps my little voice in the wind, made a bit louder with all this ink, can help.

About a year ago I was invited to host a shootout of the then major players in the digital "workstation" arena. Interestingly, they did all manage to agree vehemently on one, and *only* one, point: that they would not agree on a standard in the foreseeable future. Nice, huh?

Be aware there is a currently active dialog among several of these manufacturers on the subject of attempting to arrive at some sort of bridging file transfer concept. This would be based on the Exabyte 8mm tape cartridge system currently used for archiving and backup.

Let's see. I am hoping for some results on this at the SPARS shootout on May 19 in Nashville. I will be there, and I will let you know.

Open Message to Manufacturers: Hi. If *you* do it, I will. If you don't do it, I will anyway. ■

This is contributing editor Stephen St. Croix's only techno-joke: At the Black Hole-tel, light checks in but it doesn't check out.

THE MOST IMPORTANT AUDIO CONTROL EQUIPMENT WORKS FROM HERE TO HERE

Keeping sound clean and accurate can make or break your audio projects. SONEX from illbruck ensures that you're getting the sound you want. Our complete line of acoustical materials gives you total control—in the studio, the control room, or wherever sound quality is critical. There's a reason SONEX continues to lead—nothing works better. Put the leader to work for you; call today for all our performance specs and application guides—800-662-0032.

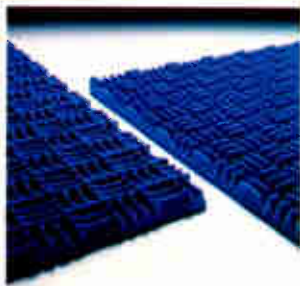

SONEX

The only acoustical foam with the illbruck anechoic-wedge—over 400% more surface area than flat materials. Controls reverb, reflections, and resonances—beautifully. The proven performer.



SONEX 1

The same unbeatable performance of SONEX but in materials that meet all Class 1 regulations. For demanding applications where heat or fire are factors. Safe for you but deadly for sound.



SONEX CEILINGS

Suspended ceiling treatments that deliver new levels of acoustical performance. Unique, contemporary designs. Available in a variety of styles and colors.



BARRIERS & COMPOSITES

When the problem requires more than absorption, illbruck barriers deliver. Single layer vinyls to multi-level laminates. Lead performance without lead price or problems.



illbruck

Sonex Acoustical Division
5155 River Road N.E.
Minneapolis, MN 55421
1-800-662-0032
In MN: 612-521-3555

by Mel Lambert



ANALOG MULTITRACK

RECOGNIZING VIABLE OPTIONS

Technically, the state of the art in analog multitrack is well-advanced. These days we have access to systems that would make Les Paul salivate. Advances in tape formulation, electronic circuitry, transport design and noise-reduction systems have meant that any musician, producer or commercial facility can equip themselves with high-quality, cost-effective recorders.

I wonder, however, if the *art* of multitrack recording—as opposed to the technology that makes it all possible—might have gone sideways along the way. The majority of hardware manufacturers innovate in response to one of two primary forces: Either the firm is responding to complaints from the marketplace for an improved version because of perceived failings or shortcomings of the original, or the company has a new development that offers a fundamental departure from conventional technologies.

In most instances, the developments made by the handful of multitrack manufacturers fall within the first,

rather than the second, category. (dbx, Telcom and Dolby are unconnected with any one tape-transport firm; their research staffs simply responded to repeated cries from the recording and production industries for techniques that would reduce tape noise!)

Not too long ago, we were amazed when companies such as Tascam, Otari and Fostex first came up with narrow-gauge machines that allowed eight, then 16 and now 24 tracks of audio to be recorded onto 1/2-inch or 1-inch tape. In the right hands, these innovations made a great deal of sense, and even facilitated the development of personal-use studios and allowed an increasing number of broadcast, corporate and industrial users to move into affordable multitrack and audio-for-video synchronization.

I have a problem, however, with the ways in which too many users have come to equate a high track-count with enhanced creativity, rather than regarding the medium as a tool and not an end unto itself. Too many of us have forgotten what role the recording

Sample PROSONUS...

"peerless quality ...
extremely well recorded ...
the best sounding CDs
I've heard!"

Craig Anderton
Electronic Musician*

"Their sound library
CDs are an
excellent value..."

Keyboard Magazine**

The PROSONUS Sound Library contains thousands of first generation digital recordings.

Available Now ...

- Electronics (*Synth Stacks*)
- Grand Pianos
- Electric Guitars
- Orchestral Percussion
- Brass Sections
- Trumpets, Cornets and Flugelhorns
- Double Reeds
- Trombones and Bass Trombones
- French Horns, Tubas and Tuba Effects
- Foley
- Sampler Sampler
(191 different sounds from all eight categories)

- New Releases*
- Exotic Percussion
 - Violin/Violin Sections
 - Cello/Cello Sections
 - Viola/Bass and Sections
 - String Ensemble

Also available from PROSONUS ...

SRD Studio Reference Disc contains over one hour of CD quality test material. Various test tones, polarity checks, pitch references, listening tests, control room monitor tests, numerous noise tests and more! A Must for any studio.

CODE DISC CodeDisc turns your CD player into a time code generator. Just slip in the disc and out comes one hour of 30 frame per second non-drop SMPTE code.

Visit your favorite music store or call Prosonus at 1-800-999-6191

PROSONUS™

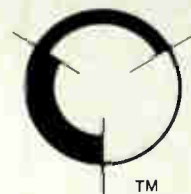

1616 Vista del Mar • Hollywood, CA 90028
213 463-6191 • FAX 213 462-7036

Circle #038 on Reader Service Card

... Because better sounds make better music!!

THE HIDDEN REASONS FOR SUCCESS



The AMS SoundField is internationally renowned as the cleanest sounding and most accurate stereo imaging microphone in the world.

But it's the SoundField's flexibility that really impresses producers and engineers. Because, either during the session or even after the artists have gone home, the effective position of the mic can be electronically altered by remote control, up-down, in a circle, or zooming in and out like a camera lens.

To experience how a SoundField can surpass your collection of studio microphones, and save you money . . . call AMS for a demo.

SoundField
 More than a microphone

AMS Industries plc
 Billington Road, Burnley,
 Lancs, BB11 5ES, UK
 Tel: (0282) 57011 Fax: (0282) 39542

AMS Industries Inc
 Suite C, 1180 Holm Road,
 Petaluma, CA 94954, USA
 Tel: (707) 762 4840 Fax: (707) 762 4811

hardware should play in a session and instead are simply chasing the beast in the vain hope that technology will save us from lack of creative ideas in the studio.

In a nutshell, the increasing availability of recording tracks does *not* bestow divine inspiration upon us automatically. In the hands of people who are not particularly "technology-literate," such hardware can even be detrimental. Small-format is not necessarily beautiful in the hands of all users.

Consider the typical process. Starting with a count of the number of discrete instruments and sound sources to be recorded during the project and when/how the people involved need to overdub additional material, we can make a reasonable estimate of the necessary track format.

At the same time we can begin to make decisions on analog vs. digital; budget considerations and DASH/PD format compatibility if the sessions are going to move across international boundaries; noise reduction if we decide analog (Dolby A or SR, dbx, or nothing); and session organization, depending on the talent's schedule.

Basically, we choose the track format that gets the job done according to the technical and aesthetic criteria of those involved. Analog has served the professional audio industry extremely well for the past several decades, and—thanks in part to modern tape formulations and such innovations as Dolby HX-Pro and auto-alignment capabilities—we can print acceptable signals to analog and recover them at virtually any facility around the world. We all have access to accurate test tapes and can align an Otari MTR-90, Studer A827, Sony ATR-24 or any of the other industry standards.

Problems begin when 16- and 24-track "pro" machines are compared with remarkably innovative "narrow-gauge" recorders. You and I know immediately that the electronic performance of a 16-track 1/2-inch machine cannot match that of a 24-track running 2-inch tape; they are different animals, designed to fulfill different goals. It is foolish to expect these two types of recorders to be directly equivalent. (In much the same way, price considerations aside, a Macintosh portable is not functionally

A Passion for Performance.

Whether it's brash, soulful, or jazzy—every note, every word, every breath comes through.

Sennheiser's MD 518 microphone gives you the power of studio-quality sound. Don't let anything stand in the way of your passion—or your performance.

Sennheiser's MD 518, The affordable Sennheiser. Insist on a demonstration! Ask your Sennheiser Dealer.

 **SENNHEISER®**

SENNHEISER ELECTRONIC CORPORATION
6 Vista Drive, P.O. Box 987, Old Lyme, CT 06371
(203) 434-9190

Circle #009 on Reader Service Card

World Radio History



What a difference a year makes.

Every musician has a choice. You can wait for your big break, hope it comes, and hope it's something you can handle. Or you can make your own break — by getting the finest, most *practical* music education available. Doing it right may not take as long as you think.

If your music is worth a year of your life, a wide choice of one-year programs is waiting for you at the acclaimed Grove School of Music in Los Angeles. Each program offers the intensive precision education you'll need to cut through the competition as a versatile composer, arranger, instrumentalist, singer, or recording engineer.

Dramatically expanding your knowledge of musical styles, harmony, and the

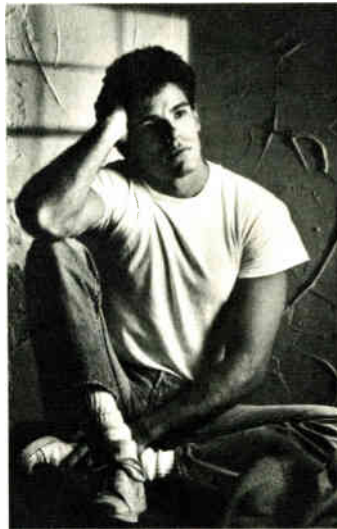

latest technology, the Grove School has one constant mission: preparing you to meet the real demands of today's music industry. That's why all Grove instructors are working professionals with proven ability to make

a living in music.

If you want to make a living doing what you love, find out what a difference a year can make. Send us the coupon below, and we'll send you more information. Or call us toll-free at 800-234-7683 (818-904-9400 within California). See why Grove graduates are the lifeblood of tomorrow's music.

Grove
SCHOOL OF MUSIC

Building careers in music.

Grove
SCHOOL OF MUSIC

MAIL COUPON TO: Grove School of Music, 14539 Sylvan Street,
Van Nuys, California 91411
800-23-GROVE (818-904-9400 within California)

PLEASE PRINT

NAME _____

STREET _____

CITY _____

STATE _____

ZIP _____

PHONE () _____

Mix 7/90

I'd like to know more about the programs checked below:

- | | | |
|---|--|--------------------------------------|
| <input type="checkbox"/> General Musicianship | <input type="checkbox"/> Percussion | <input type="checkbox"/> Bass |
| <input type="checkbox"/> Composing and Arranging | <input type="checkbox"/> Professional Instrumental | <input type="checkbox"/> Guitar |
| <input type="checkbox"/> Electronic Composing and Arranging | <input type="checkbox"/> Recording Engineering | <input type="checkbox"/> Keyboard |
| | <input type="checkbox"/> Songwriting | <input type="checkbox"/> Synthesizer |
| | <input type="checkbox"/> Film/Video Composing | <input type="checkbox"/> Vocal |

equivalent to a Macintosh IIcx, although both are capable of running the same basic set of software.)

These newer devices have a direct and useful role to play in a more restricted number of potential applications. For example, narrow-gauge machines are useful during pre-production, where the various elements can be tracked in sync and trial balances can be set up as the project begins to take shape. Or, they're useful for single-pass soundtrack assembly to picture, where the product is intended for direct replay to the audience, without more than one or two additional generations.

If your budget cannot handle one of the top-end pro machines, look to reduce the track count before you attempt to duplicate the number of tracks in a narrow-gauge format. Examine the technical possibilities of a 1-inch 8-track, rather than 16 on 1-inch. Stereo everything may be a luxury, rather than a necessity, and bouncing off submixes is possible using careful planning, noise reduction and a good ear for sync.

If you do have your sights set on such hardware, be realistic in your production requirements. If you print high-level vocals or synth tracks, leave a guard track between them and any subtle parts, such as acoustic guitar or harmony vocals. (*Always* leave a guard track between the time code track, since 30-frame/80-bit square waves have a nasty habit of curling through narrow head gaps and popping up in the most noxious places!) For lead tracks, print the same material on adjacent tracks. If the azimuth is set correctly, you can gain an extra decibel or two of noise reduction, plus enhanced midrange performance and "punch," simply by doubling the track area.

Narrow-gauge is designed to get the job done. Respect its limitations and the end result will be great audio. Overlook them and you may end up simply wasting both the client's and your time. ■

With over a dozen years of active involvement with professional audio on both sides of the Atlantic, Mel Lambert now heads up Media & Marketing, a high-tech consulting and marketing service for pro audio firms and facilities.

Did you know Record Plant uses



AGFA

Bonnie Raitt's Grammy Album of the Year, Nick of Time, is more than just overdue recognition. It's a tribute to trust, faith and friends.

Engineer Ed Cherney, producer Don Was, and the Record Plant in L.A. — all helped Bonnie turn out the album of her career, mixed on AGFA PEM 468.

Listen closely and you'll hear a warmth much deeper than guitar licks. A legendary studio, a great team, and a perfect mix on an exceptional audio mastering tape.

Nick of Time. It's more than just the album of the year. And more than any person or product involved. It's testimony to how great music can sound when it all comes together — when an album's recorded with a "Thing Called Love."

**AGFA magnetic tape...
the hits are on us.**



Agfa Corp., 100 Challenger Road
Ridgefield Park, NJ 07660 Telephone (201) 440-2500

Left to right: Don Was-Producer Bonnie Raitt-Artist Ed Cherney-Engineer

AUDIO VIDEO PROFESSIONAL

Circle #010 on Reader Service Card
World Radio History

AGFA 

E

*ntering
The Big,
Bad World
of Recording*

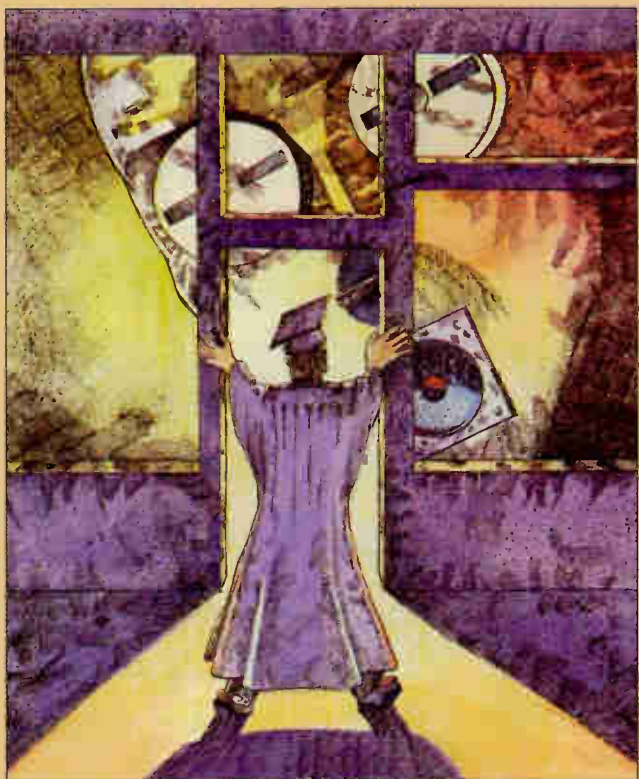

ILLUSTRATION: TONY HILLEGASS

HOW
RECORDING
SCHOOLS
HELP
STUDENTS
FIND
JOBS

“So you want to be an engineer. What school did you go to?”

If you're looking for a job in the recording industry of the 1990s, you're likely to be asked that question, along with a host of others involving grades, equipment experience and internships. You'll probably need a resume, too. And you might even have to go to a job interview!

**by
Tom Kenny**

The days of hanging out in a studio alleyway, hoping to be asked inside for the big break, are on the decline. It's not that you can't find a job by bumping into the



Students in the University of Lowell sound recording technology program find employment in advertising studios, TV and radio broadcasting production, video post houses, manufacturing firms and music recording studios. A student chapter of the AES supports a regular series of lectures by manufacturers and leading figures in the industry to help students become acquainted with the job market. Pictured here is the 24-track studio with a Soundcraft TS 24 console (MasterMix automation) and UREI 811 Time Align monitors.

PHOTO: JOHN NORDELL



PHOTO: TED CRAGER



PHOTO: ED MALLIS

Photos clockwise from top: Berklee College of Music; Full Sail Center for the Recording Arts; Peabody Conservatory; University of Miami music engineering



PHOTO: C.B. NIEBERDING

THEM IS THIS

GUEST LECTURERS:

- Joe Walsh
- Steve Vai
- Melissa Etheridge
- Al DiMeola
- T Bone Burnett
- Bruce Swedien
- David Paich
- Larrie Londin
- David Gates
- Bob Ludwig



ROLLING STONE MAGAZINE, OCT 1989:

"Full Sail's approach cuts right to the job chase, centering on the **PRACTICAL, BANKABLE**



skills students will apply in the job market". **STEVE VAI (WHITE-**

SNAKE): "I never knew a school like **FULL SAIL** existed -- I'm really

glad it does". **1989 MIX MAGAZINE**



TEC AWARD WINNER. KEITH COHEN

(1982 Graduate, Engineer & Co-Producer of PAULA ABDUL'S "FOREVER YOUR GIRL"):

We Take Your Dreams Seriously

"At Full Sail I was able to gain **EXPERIENCE** on studio gear by actually doing sessions...they did a great

job preparing me for



REAL WORLD".

employment in the

Main Office:
3300 University
Blvd, Winter Park,
Florida 32792

Phone:
800-221-2747

In Florida:
407-679-6333

**FULL
SAIL
CENTER FOR THE
RECORDING ARTS**



ORLANDO
LOS ANGELES

"Some of the sharper students who are into computers, synths and MIDI can move up quickly because there's not a lot of people from the 'old school' who can work the stuff."



studio manager at the right time. It's just that studios, like every other business in the audio industry, are turning away from their own apprenticeship training programs for second engineers and are looking to recording schools for potential employees.

"It's been a learning process on both ends," says Ken Pohlmann, director of the music engineering program at the University of Miami. "The academic programs have gotten more real-world knowledge in their curriculums over the last ten to 15 years. And I think the real world has changed and recognized the need and usefulness of a college graduate."

The real world of recording has certainly changed, and it's reflected in the types of jobs students are looking for when they leave school. The number of options available to recording school graduates has never been greater. Sound reinforcement is growing, we found, as is video post. Sales and promotion work has opened up for some. Others are finding work on design teams with major manufacturers. In his *Music Business Handbook and Career Guide*, a bible of sorts at Trebas Institute, David Baskerville lists more than 150 careers that involve audio, and many of them are highly specialized.

Students from Miami are employed by Lion Share Studios, Vision Records and Sony. Full Sail Center for the Recording Arts has placed graduates with CNN, Neve, the McCartney tour and a huge number of studios. Peabody Conservatory graduates are working for National Public Radio, Polk Audio (in loudspeaker design) and Alabama State (instructor). Berklee graduates have even gone on to law school.

Mix asked audio educators from around the country where their students are finding employment and, as important, how the schools are helping to place their graduates. There comes a time in most industries when jobs are no longer thought of as trades

but as professions. We have reached that time in the recording industry.

The Job Market

"Students do themselves a disservice

when they look at the narrow job market of just audio for albums or post-production," says Alan Kefauver, director of recording arts and sciences at Peabody Conservatory in Baltimore.

Do You Know these terms?

Monitor — a reference loudspeaker system for the mixing and mastering of recorded music.

Standard — a reference from which qualitative judgements can be made.

Tracks — (noun) channels on a multi-track recorder (verb) accurately reproduces the audio qualities of another transducer.

Monitor Standard™ — a close-field recording monitor system from RADIANT. *The only one which accurately tracks large recording monitors.*

What does all this mean?

RADIANT's new MM-8 Systems are the only close-field monitors to utilize *full-sized compression drivers*.

RADIANT's new MM-8 Systems reproduce explosive transients with clarity and ease. *No more distortion or break-up from fragile domes and cone tweeters.*

RADIANT's new MM-8 Systems provide *coherent, point-source* sound for superior stereo imaging.



Model MM-8

RADIANT's new MM-8 Systems eliminate the "sweet spot." Their ultra wide-angle (120°) dispersion delivers *the same tonal balance* to everyone seated at the console.

Call RADIANT to arrange for an audition in your recording studio. RADIANT Monitor Standard™ Systems are sold exclusively thru Authorized Dealers.



4520 E. Eisenhower Circle • Anaheim, CA 92807 • (714) 693-9277 • FAX (714) 693-9278

Circle #073 on Reader Service Card

Trebas Institute production/audio engineering students, instructor (second from right) and David P. Leonard, president and founder of Trebas Institute, grouped around audio console in 24-track studio workshop class.



"There are many, many other opportunities in the communications field for qualified audio people. I was surprised, for instance, that the city of Baltimore has an audio engineer. It's a great gig!"

Corporate video, live sound, synth programming, A&R, product design, disc jockeying, instruction, sales and promotions, equipment rental, maintenance, audio-for-video. So many jobs. And for many, there is the computer to thank.

"Computers, synthesizers and the marriage of audio to video seem to be the most significant new avenues of opportunity for our students," says Don Puluse, chairman of the music technology division at Berklee College of Music in Boston.

Duke Gore, program director at

Grove School of Music in L.A., adds: "Some of the sharper students who are into computers, synths, MIDI and programming are finding they can move up quickly because there's not a lot of people from the 'old school' who can work the stuff. Students are finding themselves being hired just to

hook things up, and then moving up quickly."

Kefauver sums it up nicely when he says, "With the advent of the microprocessor, education has become a lot more important."

Still, computers are merely a tool, and jobs seem to be on the rise across

Want To Get The Most From Your Microphones? The Jensen Twin Servo® 990 Mic Preamp

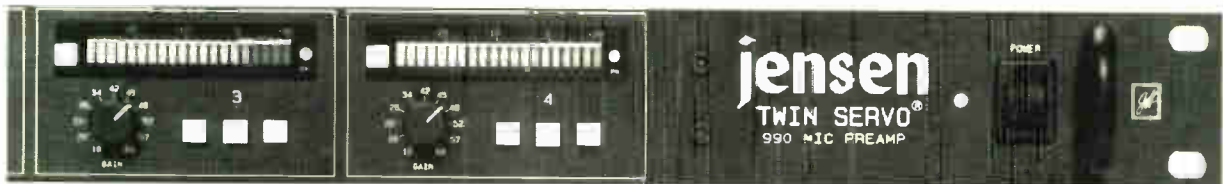

No amount of signal processing can recapture detail lost by the microphone preamp. Now you can capture vocals with *natural* clarity and make them stand out in the mix with *far less signal processing* using Jensen's discrete 990 technology.

Redesigned servo circuitry and new custom-core transformers sonically outperform the best transformerless designs. Enjoy unparalleled immunity from buzz, hum and noise – even near stage lighting on remotes. With low-noise pots for step-free level control and switchable peak/VU meters. You can own *proven* 990 Twin Servo® technology starting at under \$1500.*

- Flat Group Delay to 65 kHz Yields Exquisite Transient Response
- New Transformer Core Alloy Reduces Low Frequency Phase Shift and Distortion
- DC Servos Eliminate Non-Linear Electrolytic Capacitors From Signal Path
- New Compact Size: 1 3/4" x 19" Rack Mount
- Immediate Shipment From Stock

jensen transformers
INCORPORATED

* Single channel price; factory expandable to 2, 3 or 4 channels. Manufactured exclusively for Jensen Transformers by John Harey. *Twin Servo* is a registered trademark of Jensen Transformers, Inc.

10735 Burbank Boulevard • North Hollywood, CA 91601
FAX (818) 763-4574 Phone (213) 876-0059
Closed Fridays, visitors by appointment only

the board. David Pickett, director of recording arts at Indiana University, where a bachelor's degree in audio recording was added this past fall, uses the school's world-renowned music performance program to expose students to classical recording and balancing.

"Jobs are on the increase," he says. "Symphony orchestras are getting into the game by hiring resident recording engineers. At the Indianapolis Symphony, a woman takes care of recording archive material, which at some stage will be aired on radio, and she also provides sound reinforcement when they go into the open-air. The Chicago Symphony has just taken on an archivist. And a lot of the local NPR-type radio stations now employ classical balance engineers."

The manufacturing sector has recently opened up to Miami graduates, and Pohlmann believes it's related to the cost of a four-year education and the appeal of a white-collar job. "It's tough to justify going to work as a second engineer in a studio when you've shelled out many tens of thousands of dollars on an education. There's a lot of pressure for students to go to work for, say, Sony, where it's a high pay scale with all the fringe benefits of corporate life.

"Plus, the expectations of kids are changing. They're not as wild and crazy as they used to be. They're more conservative about their careers, their livelihoods and job security. All those factors converge in a more conservative expectation."

Whether you're looking for a comfortable 9-to-5 slot at Sony or a 5-to-9 position at Power Station, recording schools can help you on your way—if, that is, you use your school's job placement services.

Career Planning

"We spend four years of college and many years after learning how to do a job," Puluse says. "But few of us spend even one hour determining that this is the job we want to be doing."

Don Geppert, professor of recording engineering at Fanshawe College, London, Ontario, says, "We get a lot of students who come into the program with guitars and rock 'n' roll on the brain, but as soon as they start putting sound to picture a lot of their thinking changes."

When you are 18 years old, or even 35 years old, rock 'n' roll engineering sounds mighty attractive. The audio

industry, however, is much more than rock 'n' roll, and part of a recording school's mandate is to expose students to a variety of careers, then help them find employment in their chosen field.

At New York City's Institute of Audio Research, students are required to take a Job Readiness course, a portion of which covers resume preparation, interview techniques, networking and career advancement. At Trebas, all students must take the Music Industry Overview course and a Communication Skills course. Full Sail has students build resumes in one-on-one sessions with one of three full-

time placement officers.

"If the student can't get a job after the education, then we've failed," says Garry Jones, senior vice president at Full Sail, which boasts a 92 percent placement rate in audio-related fields. "We put a lot of effort into telling them the truth about the job market, that jobs are not plentiful in the recording or video/film industries because it's such a glamour profession."

Some of the four-year colleges I talked to provide the luxury of a small number of students and the time to develop different interests. At Peabody, which had five graduates in

212 • 333 • 2206
800 • 445 • 3330

THE INNOVATIVE RENTAL PEOPLE

The **TOY** Specialists

Pro-Audio Rentals

333 W. 52ND ST

NEW YORK, NY

10019

WE PROUDLY OFFER:

- ▶ The largest selection of synthesizers, drum computers, and MIDI devices anywhere.
- ▶ A comprehensive collection of vintage outboard and microphones.
- ▶ All the finest in digital recorders:
 - Mitsubishi X-880/X-850/X-86HS/X-86
 - Sony 3348/3324A/3402/1630
 - AMS Audiofile IV • Studer D820X
- ▶ 'Round the block support anywhere in the USA
- ▶ The best on time record in the industry
- ▶ Offices opened 7 days a week
- ▶ Service available 24 hours a day

▶ WE'RE THE ONLY CALL YOU NEED TO MAKE! ▶

Circle #075 on Reader Service Card

1989, Alan Kefauver works one-on-one with students and helps structure individual curriculums according to the student's career path. That is followed by master's classes in the placement department, which cover everything from resumes to stage fright.

At Miami, individual counseling helps with job leads and pointers, but it's ultimately up to students to do the work of contacting a potential employer and following through with the job search. "It's just one more job skill we try to teach," Pohlmann says. "The idea of 'placing' students isn't fair to

them or the employer. We put a lot of burden on the student, but by the same token, our job vacancy board has anywhere from 30 to 40 jobs available on a typical day."

All the schools I talked to offer some type of career preparation and assistance with resume building. Some go the extra mile and bring in industry veterans to talk to students about career opportunities.

At the Institute of Audio Research, professional development seminars are a part of daily life. Manufacturers demo equipment; producers stop by to chat. Miriam Friedman, director of

the school, explains: "The whole role model concept is very important. It helps with spirit, and it helps rekindle the dream. For example, Keith Andoos came in—he's an engineer in the corporate sector, for a brokerage house—and he's tall and hip-looking, and he inspired the students in an area they thought would put them to sleep."

Most of the faculty at Grove are working professionals, and field trips to studios are part of the curriculum. According to Duke Gore, manufacturers are eager to endorse the school by providing free equipment, then following with a lecture series. Aphex Systems was due to stop in soon after our talk.

Miami hosts a weekly Audio Forum, where some industry-types stop by on their way through town. Berklee hosts alumni seminars. Full Sail and Trebas both bring in working pros. But the student AES chapter at Middle Tennessee State University in Murfreesboro went one step further by hosting a regional AES conference (see page 152) for manufacturers and reps this past March.

"We try to educate our students that there are a lot of jobs in audio that don't necessarily involve sitting behind a console," says Geoffrey Hull, chairman of the Recording Industry Management program. "There are jobs in live sound reinforcement. There are jobs with manufacturers and record companies. We have students who end up working as mastering engineers. There are lots of ways into audio other than being a second engineer."



Two World Powers Team Up To Make You #1

The **Institute of Audio Research**, the world's top audio school and **Solid State Logic**, the world's top audio equipment designer bring you a new dimension in state-of-the-art audio education. Through this unique arrangement, **IAR** students receive hands-on training on the acclaimed **SSL G series console** and **Studio Computer**.

IAR also offers one-day **SSL** seminars to working engineers on console operation and automation software, as well as five-day courses in **SSL** console maintenance.

Solid State Logic

IAR is proud of its special relationship with **SSL**. We're also proud of our 1990 **TEC** award nomination. We encourage everyone – beginner and pro alike – to take advantage of the opportunities created by this groundbreaking linkage. For further information contact:



Institute of Audio Research

64 University Place • New York, NY 10003-4595

800 544-2501 • (NY, NJ, CT.) 212 777-8550

The Internship

Everybody wants to talk internships. To some schools it is the most critical part of the educational process, and they either provide an internship or place the burden on the student as part of the job-search training. To others, the time spent in an internship is better spent in the classroom. To students, it's often that first glimpse into a professional environment.

David Leonard, founder and president of Trebas Institute, comes to audio from the industrial training sector, where "internship" has a specific meaning. "The term 'internship' can be thrown around loosely these days," he cautions. "To me, an internship is a monitored course where the student gets college credit. Before a student goes out to a company, we make sure the company has a *meaningful* internship. If they're

Circle #076 on Reader Service Card

Dual Domain Audio Testing



Analog and Digital

There are two worlds of audio... analog and digital. These two domains share many basic attributes but when it comes to audio testing, they're distinctly different. Until now custom hardware was needed to test digital audio devices in their own domain. Now the System One Dual Domain combines both analog and digital testing capability in one unit.

ANALOG audio testing with System One Dual Domain is even more comprehensive than before. Data acquired can be further analyzed using the Digital Signal Processor, which adds harmonic analysis, waveform display and FFT spectrum analysis to the already extensive list of System One's capabilities. New version system software supports color VGA graphics and on-screen cursor function with numeric readouts.

DIGITAL audio testing directly in the digital domain is available for the first time. System One Dual Domain provides signal generation, analysis and Input/Output capability and also mirrors familiar analog measurement techniques, now implemented digitally. The multiple-DSP architecture supports both AES/EBU serial and two-channel parallel inputs and outputs at a variety of sampling rates.

Integrated analog and digital domain audio testing... only from Audio Precision.

System One

Audio precision

P.O. Box 2209, Beaverton, OR 97075
503/627-0832 1-800/231-7350
FAX: 503/641-8906, TELEX: 283957 AUDIO UR



INTERNATIONAL DISTRIBUTORS Austria, Eastern Europe: ELSINCO elektron GmbH 722871751 **Benelux:** Trans European Music NV Brussel (02) 4669010 **Canada:** Glentronz Ltd. (6) 4758494 **China, Mainland:** Harvest Scientific and Technology Company Ltd. Hong Kong 5 742983 **Denmark:** npp Elektronik ApS Bv 57 15 11 **Finland:** Jala OY 0 755 711 **France:** IS Mesures (1) 45 83 65 41 **Germany, West:** RTW GmbH 1291709130 **Hong Kong:** TRP Consumer Electronics, Ltd 5 887 2008 **Italy:** Medica Srl 2445828 **Japan:** TOYO Corporation 3 790 771 **Greece:** Monami Corporation 784 9642 **Mexico:** VARI S.A. 250 7394 **New Zealand:** Audio & Video Wholesalers, Ltd 7173414 **Norway:** Lydcosmalt (09) 19 03 81 **Portugal:** Acufon Lda 251 40 87 **Singapore & Malaysia:** IME Systems PTE Ltd 286 4608 **Spain:** Iolco Electronics, S.A. 91 42 42 42 **Sweden:** World Radio Sweden: Ed & Leo AB 31003620 **Switzerland:** Tecmad SA (071) 806 06 06 **Taiwan:** Audio Technologies Ltd 70 16 70 **UK:** SSE Marketing Ltd 1937196

A.R.T. INTRODUCES THE FIRST SIGNAL PROCESSORS OF THE 21ST CENTURY

THE SGE MACH II

The stunning new Wonder-processor offering 12 effects simultaneously! The Mach II has over 70 different effects including an exciter, equalizer, compressor, limiter, noise gate, expander, sampler, env. filter, pitch transposer, line EQ, stereo panner, stereo chorus and flange, 12 killer distortions, 21 delay types (2 full seconds) and 24 different reverb algorithms! Real time midi, 200 memories and bandwidth to 20 kHz.



THE DR-X

The all new Studio Digital Reverberator/Dynamics Processor/Pitch Transposer/Sampler offering 160K bytes of audio ram, bandwidth to 20 kHz, sampling, 10 simultaneous audio functions, an exciter, equalizer, compressor, limiter, expander, noise gate, stereo panner, stereo chorus and flange, 21 different delays (2 full seconds), 24 reverb algorithms, 200 memories, amazingly comprehensive real time midi control.

THE MULTIVERB III

A new age of technology and 400% more processing offers digital reverb and spatial enhancement that defies description! The Multiverb III has over 53 effects to choose from (up to four simultaneously) including sampling, stereo chorus and flanging, 21 delay types (2 full seconds), stereo panning, pitch transposing, 24 reverbs, 200 memory locations, full programmability and Performance Midi™.

THE MULTIVERB LT

The Multiverb LT gives you the power of the Multiverb with the simplicity of 1-touch control. The LT has 192 of the finest studio multi-effect combinations ever created! For those who don't have time for the complexity of programming, the LT gives you all the power you can use at a great price! Midi addressable.

Export Distributors:

THE NETHERLANDS/Audio script B.V./Soest/02155-2044 FINLAND MS-Audiotron Helsinki 90-5664644 SWEDEN Muskantor & Co./Molndal/031-878080/France/High Fidelity Services SA Paris (1) 42.85.00.40 CANADA/Yorkville Sound LTD. Scarborough 416-751-8481/ITALY/ital C.I.D.A. SPA Parma 0521 590158 WEST GERMANY/PME Audio Haulfweg 07136-6029 SWITZERLAND/Musikengros P. Gutter Sissach 061-981757 HONG KONG/Audio Consultants LTD. Kowloon 3-7125251 JAPAN/Nihon Electro Harmonix Tokyo (03)232-7601 THAILAND/Beh Ngeep Seng Musical Instrument Bangkok 222-5281 INDONESIA/PT Kirana Yudha Teknik Jakarta 3806222 SINGAPORE/Lingtec PTE. LTD. 7471951 SPAIN/ Aplicaciones Electronicas Quasar SA Madrid 6861300 TURKEY/Kadri Cadmal/Istanbul (1) 1661672 AUSTRALIA/Hi-Phon Distrib. Pty. LTD. Chatswood NSW 024177088 DENMARK/M.I. Musik Kobenhavn 1-854800 U.K./Harmon U.K./Slough/075376911 NEW ZEALAND/Maser Digitek/Auckland 444-3583 4 ISRAEL/More Productions Tel Aviv 03-454003-442697 ARGENTINA/Lagos Sarmiento/Buenos Aires 40-6455/NORWAY/AUDIOTRON OSLO 2 35 20 96

APPLIED RESEARCH & TECHNOLOGY INC., 215 Tremont Street, Rochester, New York 14608, (716) 436-2720, TELEX: 4949793 ARTROC, FAX (716) 436-3942

Circle #036 on Reader Service Card

World Radio History



looking to have a student file or drive a truck, then it isn't an internship."

To ensure students find worthwhile internships, Trebas follows a complex monitoring process, whereby students evaluate employers and vice versa. Also, weekly reports are filed with the placement office, and files are kept on each employer so that next year's students can make an educated selection.

Middle Tennessee State has a similar evaluation process, and the department maintains ongoing relationships with a number of Nashville studios. The internship may take place at a record company, publishing house or recording facility, but only after the student has at least nine hours of college credit in the specialty course related to his or her internship. Usually, it takes place in the student's senior year, and the burden is on the student to find it.

At Full Sail, students walk into the placement office with a list of six companies where they want to spend their 240-hour internship. From there, the placement department takes over. "We have three full-time placement officers," Garry Jones states. "Their goal is to first find all our students internships—which we guarantee 100 percent—and second, to help find jobs if the internships don't work out."

Naturally, not all internships lead to jobs. Miriam Friedman says that roughly 50 percent of the IAR internships lead to immediate placement, but to her, that's not the point. "Part of the internship program is getting the internship," she says, "which provides a protected environment for what it's like to get a job. Students learn a lot of hard lessons that way, about behavior and protocol, about how to conduct themselves, about how to use the telephone and appear in person. We feel this is probably the softest way to learn.

"The big thing a student has to understand," she continues, "is that a recording studio is a commercial operation. The internship is sort of a halfway house where they learn the realities of the business world."

Peabody also requires an internship, 320 hours, and the student is responsible for nailing it down. Alan Kefauver provides a list to provide a starting point. but, like Friedman, he believes it's a skill worth learning by doing.

Both Fanshawe and Grove have informal relationships with studios in lieu of traditional internships. Fan-

A Bachelor of Science Degree in RECORDING INDUSTRY MANAGEMENT

The Past:

Founded 1974
 First on-campus multitrack Studio 1978
 First all-student LP 1982
 First all-student CD 1985
 Five TEC Award Nominations 1985-89
"the most comprehensive four-year program in music merchandising"
 —NARM



The Present:

N.A.R.A.S. Student Music Award 1989
 TEC award nomination 1990
 Digital multitrack and MIDI studios on campus
 \$15 million recording/video/MIDI production center under construction
 Minors in Music Industry, Mass Communications, Entertainment Technology, Electronics, and Business Administration



The Future? Join us and find out!



MIDDLE TENNESSEE STATE UNIVERSITY
 P.O. Box 21
 Murfreesboro, Tennessee 37132

Circle #078 on Reader Service Card

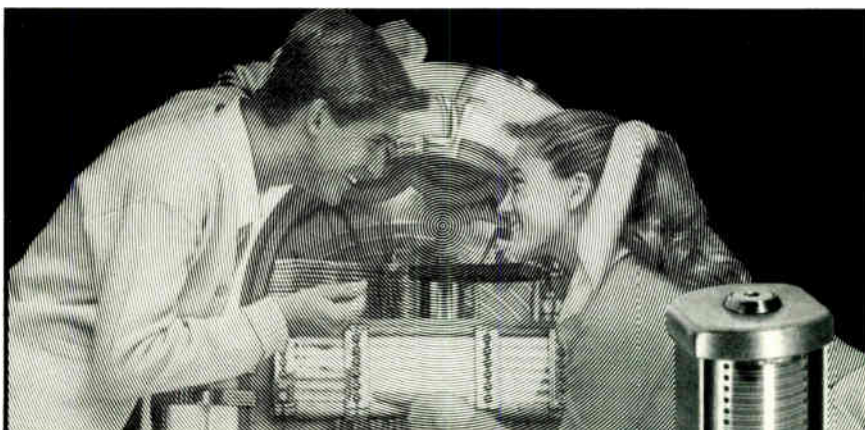

SOUND ADVICE From The Magnetic Head Specialists

Timely Maintenance is Essential. Reconditioned and Aligned Heads will:

- RESTORE signal amplitude stability
- ELIMINATE tape/head generated distortion
- ENHANCE top end response
- REMOVE causes of oxide shedding & build-up
- STABILIZE tape-path tracking



For the best sound, always rely on the best service.

Head Replacements — Reconditioning — Optical Alignment — Time Code Kits — Alignment Tapes.

249 Kennedy Road • P.O. Box 121 • Greendell, NJ 07839
 Tel.: (201) 579-5773 • Telex: 325-449 • Fax: (201) 579-6021

Circle #077 on Reader Service Card



HEAD RELAPPING

The contour and performance of your heads are restored to factory specifications before a precise optical/digital assembly alignment is performed. Original replacement heads also in stock.

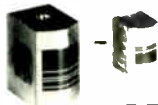

MOTOR REBUILDING

Your Capstan, Reel, and Tachometer motors are rebuilt to quiet, flutter free perfection.



— Become an AMP SERVICES customer and enjoy a level of quality workmanship and individual attention rare in today's business environment. Call:

Audio Magnetic Professionals



224 Datura Street, Suite 614
West Palm Beach, FL 33401
1 (800) 826-0601 In Florida (407) 659-4805
Authorized OTARI, SONY, TEAC Parts Dealers

Circle #079 on Reader Service Card



Grove School of Music's Studio B during a film scoring session.

shawe works with a half-dozen studios in the Toronto area, some 200 kilometers away. Grove works informally with Group IV and other studios in L.A.

For students at Miami, Berklee and Indiana, the internship is strictly optional, though it can count toward college credit. Miami discontinued its formal internship program three years ago, because, according to Pohlmann, the student was served better by staying in school and working in the campus studios.

"Our [100 percent] placement record was so good that we didn't need the internship," Pohlmann says. "Three years ago we felt that students needed a bridge between academia and the pro world. What was happening, however, was that students were getting jobs and leaving school a semester early. So we discontinued it."

Berklee doesn't want to lose that one semester out of eight to an internship, either. Nor does Indiana. At both schools students are, however, responsible for student-run productions, which serve as an internship of sorts. "If studios are looking for second engineers, most studio owners name attitude as the number one criteria," Don Puluse says. "The proper attitude comes from being in those situations of seeing how a product or project comes together on a daily basis."

"What happens in these four years is an *introduction* to learning," he continues. "They will still have to learn the peculiarities of the studio they're going to."

The Alumni Network

Well, the 100 resumes brought no response. And the internship in New York didn't pan into the film career you imagined. School's out. What next?

Just because school is out doesn't mean you can't go back to school, more specifically, the placement of-

—CONTINUED ON PAGE 178



Hands On Success

Northeast Community College

Professional Audio and Recording Program

with **Hands On Experience**

Midi In House Studio TEF®
Concert Sound Theatre Sound

SEARS
Roebuck & Co.

Northeast Community College
P.O. Box 469 • 801 Benjamin Avenue
Norfolk, NE 68701 • (402) 371-2020

Circle #080 on Reader Service Card

Another Smash Hit!

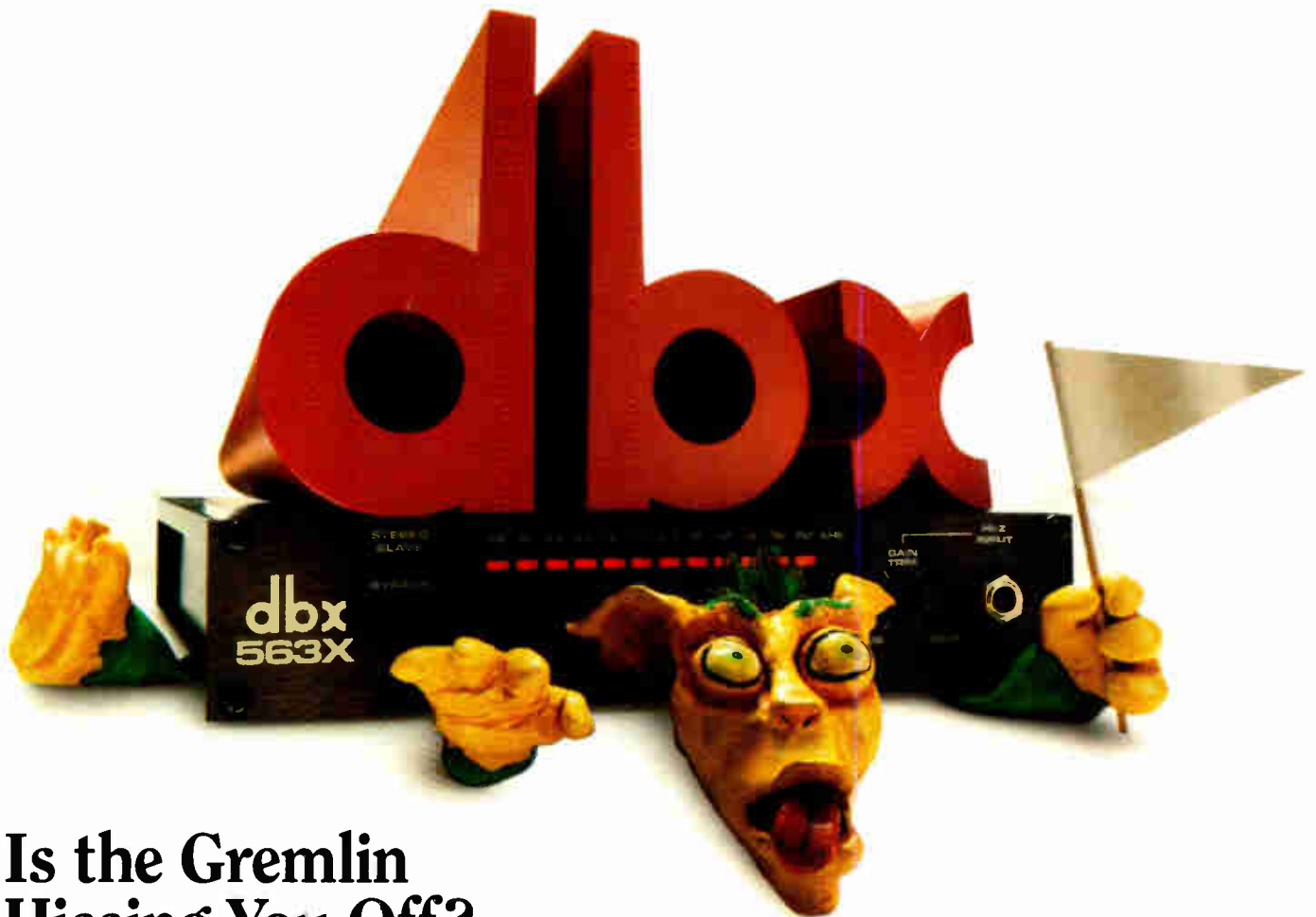

Is the Gremlin Hissing You Off?

If so, the dbx 563X Hiss-Reducer® will put a smile back on your face and your sound back on the charts. Our patented dbx circuitry is easily adjusted to wipe out the hiss and noise gremlins that plague your system. Digital hiss, "I've-got-a-million-effects-boxes" hiss, tape hiss, whatever—our 563X will flatten the hiss before the hiss flattens your music.

Cut the Hiss, Not the Music

Most Hiss Gremlins live in the same frequencies that add brightness to music. That's why equalizers and other noise reduction solutions usually zap your sound along with the hiss.

"I'll be back."



The 563X gets rid of steady state hiss, but preserves those high frequencies that add punch to your sound. Our system simply works better—you can hear it right away for yourself.

Don't Get Hissed, Get Even

Don't let the Gremlins get you. Call dbx now for the name of your local 563X dealer. Hear why the 563X is a smash with performers and engineers!



A division of
AKG Acoustics, Inc.
1525 Alvarado Street
San Leandro,
California 94577, USA
Tel: (1) 415/351-3500
Fax: (1) 415/351-0500

INDUSTRY STANDARD

COMPRESSOR/LIMITERS • NOISE REDUCTION SYSTEMS • EQUALIZERS • MODULAR PROCESSORS

Circle #034 on Reader Service Card

World Radio History

by Mr. Bonzai

GRAHAM NASH

FEEL THE DREAMS

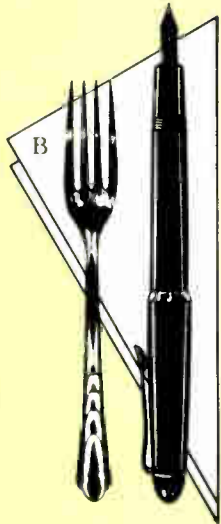

Sessions at the top can be pretty serious, what with the big meter running and careers forging on. But the mood today is relaxed, upbeat and friendly as Graham Nash steps out of the control room and joins me in the canteen. The pinball machine fires off a synth riff as the room fills with the aroma of freshly microwaved, gourmet popcorn.

Like millions around the world, I've been touched by this man's music for many, many years. He was a founding father of The Hollies, the only group to score more Top Ten hits in England than the Beatles. Perhaps the most enduring soldier of the British Invasion, he pulled up his roots and changed his life at the Woodstock

a "group" in the traditional musical sense.

"The individualism became a dominant part of what it was that we wanted to say," Nash explains. "We wanted to let people know that we were no longer going to be in a group, that we would be individuals who came together to make music and could make music with whomever and in whatever form we wanted. Consequently, when people say, 'They broke up, they re-formed, they re-broke up, they re-formed,' it's all bullshit."

Nash has had success as a solo artist, as a member of a group and as a member of a non-group. He's living proof of strong individuality working in harmony with others. When we look at his social activism, we might note that his first memories are of air-raid sirens and the bombing of England in the final days of World War II.

Before he goes back to work on the latest tale in the CSN saga, let's wake up, smell the corn and pop a few questions.

Bonzai: How are things going with the new album?

Nash: I couldn't be happier. From what we've finished and roughly mixed, I feel we are indeed able to move forward and take what it is we do best into the '90s. It's great as far as I'm concerned, because it would be very easy, especially with a band like ours, to rest on

our laurels and stay back there in the past. None of us has any interest in doing that.

Bonzai: Any particular departures from previous work?

Nash: We've been more open to being guided. We're working with Stanley



With Crosby and Stills, 1979

debut of Crosby, Stills & Nash.

It's appropriate that CSN is three names, three distinct musical personalities. What's remarkable is the harmonious blend that became a three-headed (and sometimes four-headed) chimera. But this group has never been

Johnston, our engineer/producer, and Joe Vitale, our musician friend/producer, with myself, David and Stephen as artists/producers. We're more open to suggestions, to a different direction, more open to different songwriters, and we've never done that in the past.

Bonzai: How do the songwriting credits break down on this album?

Nash: That's hard to say right now because we've cut 19 tunes, but the way it looks, the single may be "Live It Up," written by Joe Vitale. Stephen wrote "Tomboy" and "Standing Alone" with Tony Beard. Tony wrote "Straight Line." David and Michael Hedges wrote "Arrows" and "Street to Lean On." I wrote "House of Broken Dreams" and "Dolphin" with Craig Doerge, and "Yours and Mine" with Craig and David. We've split up the songwriting tasks. The ten songs we are concentrating on now seem to make the best album, the best balance between tempos, subject and melodic structure.

Bonzai: Wasn't Van Dyke Parks in conducting his orchestral arrangements for one of the songs?

Nash: That was for Stephen's song "Mystery." We're not sure if that will be on this album, but my feeling is that it's one of Stephen's best songs of late, and is a great solo Stephen Stills song. I'm not past helping with the vocals, and neither is David, but because of the melodic structure it's a difficult song to turn into a CSN three-part song.

Bonzai: A friend of mine and I were talking about the different identities within the group. He suggested that Stephen comes from a guitarist direction, David is more of an intuitive writer, and you are more of a writer in the structured sense of classic rock/popular songwriting. Does that make sense to you?

Nash: I think it makes perfect sense, although none of us likes to be pigeonholed. But it is true. I came from a past of 21 Top Ten hits with The Hollies. The Hollies were great at the three-minute pop song, and I was trained from the late '50s, early '60s in that vein. Most of my favorite records are around three minutes long. I figure if you can't say it in that length of time, you can't say it, although I've obviously written songs that are longer than that.

David definitely comes from a more intuitive place. He's the most interesting writer of the three of us, to my ear.

Bonzai: Let's jump back to your early days. You're from Manchester, Eng-

land, aren't you?

Nash: Yes, in the north of England.

Bonzai: Were you musically inclined as a child?

Nash: Yes, I was. Allan Clarke and I

music came to England from America via Lonnie Donegan. Skiffle was a simple form of folk music, basically three chords. It was fast and easy and fun. We got into skiffle in a big way.

Then with the coming into our lives of the Everly Brothers, Elvis Presley,



Nash onstage, 1989

met when I was 5 years old, and we started to sing together immediately. I don't know why, but we were singing school prayers, and we harmonized in school choirs and minstrel shows. Then in the late '50s, skiffle

Jerry Lee Lewis, Buddy Holly, Fats Domino, The Platters, Gene Vincent, etc., we began to really realize that, a) we needed drums and bass, and b) that this two-part singing which we had been doing for many years was coming

of age. So we found ourselves in the early '60s forming a band called The Hollies, with basically Allan and myself singing lead, occasionally three-part with Tony Hicks. We cut our first hit record in 1963, and I haven't looked back since.

I left the Hollies in 1968 because of several musical differences and personality conflicts. We had been coming to America since 1965, and this was an entirely different environment for me. It was one in which I thrived, one which I loved. I got turned on to smoking marijuana, hashish, to LSD

and expanding my consciousness. I gradually grew apart from the rest of The Hollies, who were basically more interested in their drug of choice: beer.

At that time I had been hanging out with David and Stephen, so I knew that we had something tremendously vital. I was writing songs that The Hollies were not interested in recording, songs that I felt were deeper, more meaningful than what we had done earlier. All those factors came together in late 1968, and I decided to live here.

Bonzai: So, 1968 saw The Hollies behind you, CSN ahead of you. Singles had been the style of the record business, and your formation of CSN

was around the time of album domination and FM radio.

Nash: Well, *Sgt. Pepper* helped change that a lot. But it began to be obvious that the art form of albums was much more interesting than singles. The singles were like ads for the albums. I knew when I sang with David and Stephen what it was I wanted to do. We also knew we had tremendous song potential because we were three reasonably strong writers—young, naive maybe, but interesting.

Our first record [*Crosby, Stills & Nash*] was brought out in the time of pre-heavy metal and stacks of Marshalls. We came out with this acoustic-feeling album, and it threaded right through everything and made its mark. We knew when we left the studio with that 2-track master that we had a hit record.

Bonzai: You've also had solo success, such as *Songs for Beginners*, which still sounds so fresh and alive.

Nash: I was very pleased with that record. I think I'm most pleased with its longevity. I get kind comments from people all the time about it being one of their favorite albums. I've tried to think what it was about that album that was so attractive, and I can't really figure it out. I think it was very simple, very straightforward, and it had a very live feeling. There are some good songs, but I've never been really able to pin what it was about that album. I'm kind of glad, because I certainly don't want to repeat it.

Bonzai: So much of your compadres' music captures a period. It's been said that if you want to go back and feel Woodstock, you listen to CSN and the Grateful Dead.

Nash: Kind of an awful place to be stuck, isn't it? [Laughs]

Bonzai: But let's talk about your music as historic anthems in times of social upheaval.

Nash: One of the things that was upsetting me during my association with The Hollies was that there were social things happening that were far more relevant than the kinds of singles we got into—the "moon, June, spoon," in the back of the car, summer days types of songs. I'm not against that, but there is certainly more to be concerned with.

So when I joined David and Stephen, I knew that we had three writers who felt similarly. Things were happening sociologically that were extremely important from our point of

BEYOND™
FOR THE APPLE MACINTOSH

Our new Mac sequencer has specs that speak for themselves: a complete realtime graphic user interface; "smart" instrument setups; 480 PPO resolution; MTC support; many edit features plus transpose, reverse, harmonize, and invert based on scales; SMPTE display on edit screens; graphic song display of 32 Sections with 99 tracks per Section; 32 onscreen graphic sliders; SYSEX recording; and a manual by Craig Anderton. And the list price is only \$319!

Dr. T's
MUSIC SOFTWARE
220 Boyston Street
Chestnut Hill, MA. 02167
(617) 244-6954

BEYOND is a trademark of Dr. T's Music Software and Macintosh is a registered trademark of Apple Computer.

Circle #193 on Reader Service Card

view, as artists, to make comments upon. I think it's been the role of the artist throughout history to bring news from one village to another, to spread

"If I wasn't an optimist, I wouldn't bother being here making a record. I'd just be watching TV with a beer."

tales of what's happening. In many ways, you're not getting the real truth from the mass media. You're only getting a part of the truth. What we have always tried to do as artists is reflect what is going on around us, reveal what is going on inside us, and express how we feel about certain subjects.

We have the ability, because we are writers, to internalize situations and then bring them out as music. I'm not sure what enables us to do that, but I guess that's what an artist is.

Bonzai: With the great effect you have on your audience throughout the world, where are you putting your energies in the '90s?

Nash: After thinking about it for many years, I've come to believe that the only true currency is time. Given that I believe that, to prioritize my time I have to find what is more important to me as a person. What's most important to me is the health and well-being of my wife and family, my music, and everything else follows.

Obviously there is a great demand on our time from people who want us to help. There are causes that at first might seem trivial, such as the problem of broken glass on the beach, which we were asked to do a benefit for. I realized as a parent what a drag it was that you couldn't let your children run on the beach for fear of slicing a foot open. Everything is important to somebody, but I have to figure what is most important to me right now, apart from the personal wants of my wife and family.

We need to unlock the paralysis of children's minds, to instill in them a sense of hope for the future, to overcome the vast damage that we have done to this planet in terms of the storage of nuclear waste, to try and combat environmental problems that run from the ozone layer to acid rain to fouling of the water and the soil. And that should take me a few lifetimes.

Bonzai: Are you an optimist?

Nash: I have to be. If I wasn't an optimist, I wouldn't bother being here making a record. I'd just be watching TV with a beer. It's easy to do, because the problems that face us are overwhelming. But I look in the faces of my kids and I get a sense of hope.

Bonzai: Let's talk about the chemistry of collaboration within the band. How has that evolved? Is it an extension of what it was in the past? How does it work?

Nash: The chemistry of CSN, of CSNY, has been an ever-evolving, ever-changing chemical equation. In the early days, a certain member of the band would be stronger and would be the guiding influence. In the middle period, that role was taken over by somebody else, and now in this later period, the role has been taken over by somebody else. It's a constantly evolving partnership that works. Our egos are such that we don't care who runs this as long as it's moving forward. So the chemistry is always volatile, always explosive. Crosby put it best when he said it's like juggling four bottles of nitroglycerine. It's okay to do that until you drop one. But you don't just drop one, you drop all of them.

Bonzai: We're talking about a lot of energy to deal with.

Nash: A tremendous amount—four very strong people with very divergent programs and different ways of looking at things. But we collectively know that the most important part of our existence as musicians is the *music*. There is nothing more important. Not the amount that we love each other. Not the amount that we hate each other. Not the amount of fighting we've done in the past, or maybe in the future. The most important thing is the music, and that will far outlive us.

Bonzai: Looks like it'll be around long after all of us are gone.

Nash: I hope so. I can see it in the faces of 14-year-old kids at our concerts who are singing the words to

"Teach Your Children." They are singing songs that were conceived before they were. I can only come to the assumption that the music has longevity, has lasting and staying power. As a musician, I can't ask for anything more than writing music that will outlive myself.

Bonzai: There's been a lot of talk lately about you and your collection of photographs.

Nash: I come from a poor family and my father was an amateur photographer. He first turned me onto the magic of photography, watching in my bedroom, as images appeared from a white sheet of paper in what looked like water. My dad would say, "Watch, just watch..." And all of a sudden, images floating into reality from nowhere. It was magic to me. That sense of wonderment has remained with me all my life.

Bonzai: What is your strongest human trait?

Nash: I think it is my incessant drive for people to be comfortable around me, and my appreciation of beauty.

Bonzai: In your long and varied career, what was the most exciting and heartfelt moment on stage?

Nash: There are many of them, going back to the trepidation we felt at Woodstock, to the 70,000 fans in Atlantic City in the stadium who had waited for four hours in the pouring rain. I remember our determination, against the advice of our crew, to play in a rainstorm with the hazard of lightning, and the way we felt playing for

"For the last 20 years, I've tried to write music that is truthful. When you do that, I've found you change people's lives."

those people and their appreciation. Recently, I'm reminded of the Bridge Concert we played in San Francisco for the school for handicapped children that is run by Neil [Young] and

At Last!

An Affordable Master Recording Program Taught by Award-Winning Professionals



Licensed By The Arizona State Board For Private Postsecondary Education
Authorized For Foreign Students

If your goal is to succeed in the music and recording industries, our professional training program will give you the hands-on experience and technical know-how sound engineers and producers need.

FOR INFORMATION
AND CATALOG CALL

1-800-562-6383

1110 E. Missouri, #400, Phoenix, AZ 85014

Take A Giant Step Forward Into Your Future!

Circle #066 on Reader Service Card

COMPLETE DIGITAL SERVICES FOR CD PREPARATION

Music Editing
Format Conversion

NEVE DTC and HARMONIA MUNDI
DIGITAL CONSOLES

KDISCmastering
6550 Sunset Blvd., Hollywood, California 90028 • (213) 466-1323 • FAX (213) 466-7237



COMPLETE MASTERING SERVICES
DMM and Lacquer Cutting

Circle #067 on Reader Service Card

LUNCHING WITH BONZAI

his wife, Peggi, and seeing kids in wheelchairs, and this 10-year-old girl starting to cry and a little boy slowly moving to help her. It inspired a new song, called "Try to Find Me." There are many memories—I've had a fantastic life! I feel extremely lucky, and I will get away with it as long as the gods let me.

Bonzai: Were there any dangerous moments in your touring?

Nash: A few. One of them involved a helicopter when I was in The Hollies. The fans were so crazy that they had pushed to the helicopter to get to us with the rotor blades spinning. Another time I had my tie grabbed by an ardent fan and tightened so much that I was choking. The tail rotor of the helicopter that took us into Woodstock failed and slammed into the ground—pretty hairy. The helicopter ride to Atlantic City in the thunderstorm was not one of my favorite experiences either.

Bonzai: Do you have any thoughts for young people thinking about a career in music?

Nash: The only thing that kept me alive, that kept me moving forward, that kept me on the ball, is a love for what I do. I don't want to get heavy-handed, but there is a great responsibility as a musician to write true music, meaning that it comes from within your soul. I spent many years not doing that and I love those years, but I regret them at the same time. I realize it was part of the growth process that brought me to the point where I am right now. For the last 20 years, I've tried to write music that is truthful, that comes from within me, and which is not manufactured. When you do that, I've found, you change people's lives. You give them a different perspective to view and judge everything from.

It helps tremendously in realizing several things: that they are not alone, that they are not crazy, and that they are one of a race we laughingly refer to as human beings, with all its inherent problems and all its inherent greatness. We are all together in this incredible ride on this spinning ball of mud in space, and we better get on with it and make the best of it. ■

Contrary to popular belief, that is not roving editor Mr. Bonzai leading the muddy "No rain!" chant in the film Woodstock.

by Paul Potyem

PLAYING WITH A FULL DECK AT DIGIDESIGN

Every time I walked by the Digidesign booth at San Francisco's MacWorld Expo in April there was a huge crowd on hand checking out the demos there. In this three-day event that had more than its share of remarkable new products, Digidesign's were among the most noteworthy, particularly for *Mix* readers. As a result of what I saw at Macworld, I decided to spend a day the following week at Digidesign's headquarters in nearby Menlo Park to learn more about the latest goings on there.

In the year since Digidesign's Sound Tools Digital Recording and Editing System for the Macintosh was released (see *Mix* 12/89 "Field Test"), the company has shipped over 1,600 units,

an impressive number for such a vertical market product. And as I walked down the hallway to the studio at the company's headquarters, I found myself negotiating my way around hundreds of boxes containing Sound Tools for the Atari about to be shipped to fill orders from distributors. But while Sound Tools is Digidesign's biggest success story to date, it's only one part of a larger, still developing story.

What had attracted my attention at Mac World Expo was Deck, a new software package that turns a Mac II into a CD-quality 4-track digital recording environment. And then there was MacProteus, Digidesign's \$895 NuBus card version of E-mu Systems' popu-

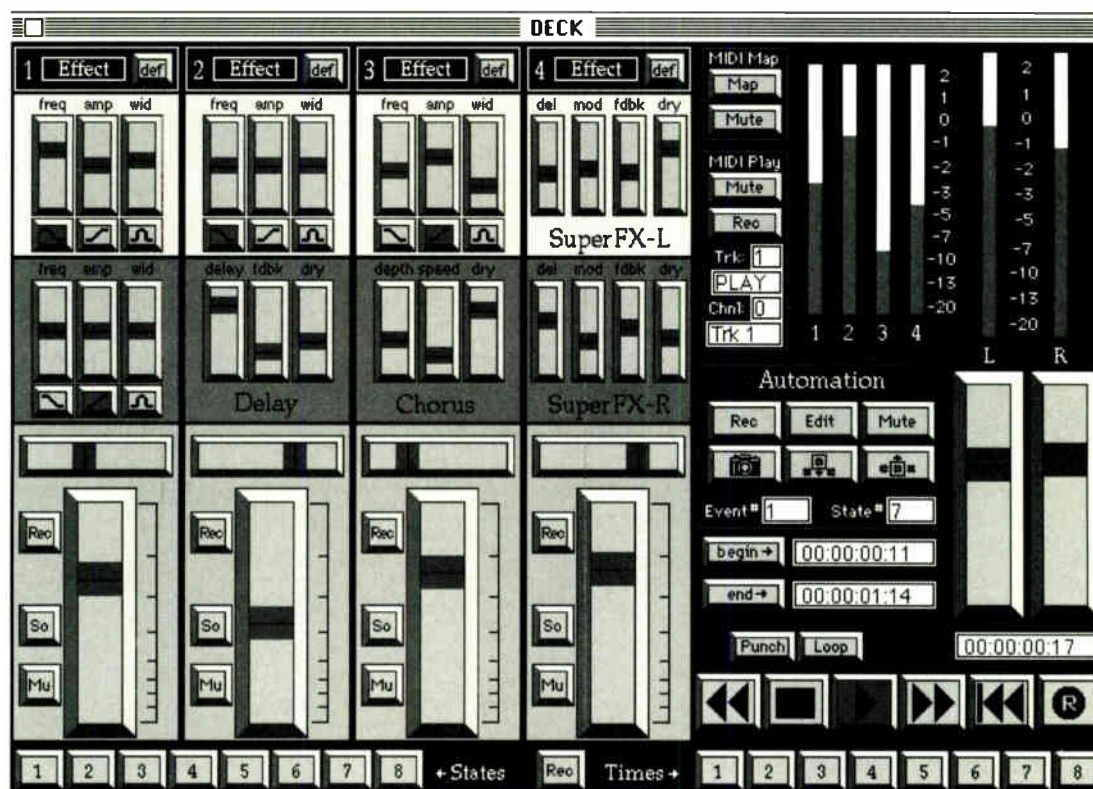

Mac II screen display of Deck

FULL COMPASS SYSTEMS

No matter what your direction...



Compass Systems

carries over three hundred brands of professional equip-

ment to all of your needs, so if you need



or any other

audio, video or lighting

device — and want



quality at rock (4) prices

— then the friendly



at Full



Systems.

1-800-356-5844.

FULL COMPASS SYSTEMS

A step in the right direction!

5618 Odana Road,
Madison, WI 53719
Consultation: 608-271-1100

lar Proteus rack-mount sound module. My self-appointed mission was to use Deck with MacProteus (both were still in beta versions at this time), Opcode's front panel software (free with MacProteus), Opcode's Vision MIDI sequencer and Digidesign's Audiomedia, all wired together via Apple's MIDI Manager.

First, a little background info: Deck was developed by OSC, a San Francisco technology group that also developed Sound Access, the set of XCommands used to incorporate Digidesign soundfiles into Director and HyperCard. With Deck and either Sound Tools or Audiomedia, you can create up to four tracks of 44.1kHz digital audio, with the ability to record while playing back previously recorded tracks. It also offers automated mixing, digital equalization and effects, and support for simultaneous MIDI file playback.

While Deck is designed to work with both Sound Tools and Audiomedia, there are some differences in what you get from the two systems. You may

of the original system. As a result, the technology incorporated into the newer, leaner Audiomedia package allows for increased integration of some of Deck's features. (Don't worry, Sound Tools owners, you're not being abandoned. Keep reading.)

Here are the major differences between the two system configurations: signal-to-noise ratio with Deck and Audiomedia is less than with Sound Tools at >85 dBm vs. >90 dBm; and Audiomedia does not support SMPTE or digital I/O, as Sound Tools does. On the other hand, using Deck with Audiomedia real-time and non-real-time digital effects are available. You can monitor up to three tracks while recording; and you can record two channels simultaneously. The current version of Sound Tools allows only non-real-time digital effects, monitoring of two tracks and recording on only one channel at a time. I was assured that before the end of the year Digidesign will introduce a new multitrack version of Sound Tools with new hardware and software, and a professional version of Deck, with a generous upgrade policy for existing

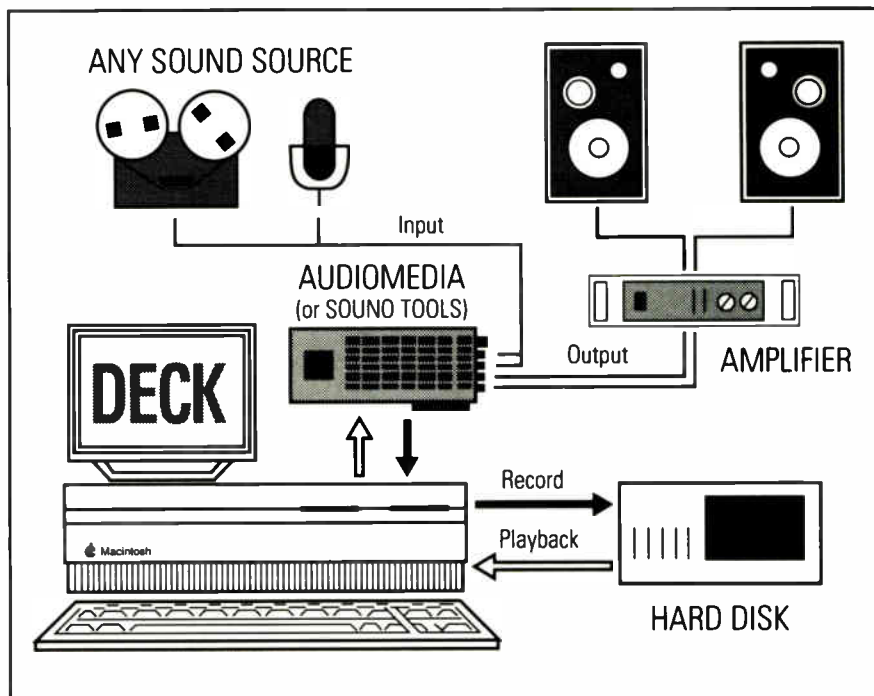

A typical system configuration.

transfer tracks recorded using Deck to either Sound Tools or Audiomedia, for editing and more sophisticated processing, and then reload them into Deck. Audiomedia was introduced several months after Sound Tools to address the needs of users who did not need all the professional features

owners of these systems. (How many companies do you know that offer hardware upgrades?)

Anyway, back to my Mission Improbable. For my musical vehicle I chose to cover the classic theme "Fishing Hole" from television's *Andy Griffith Show*. After configuring the

Herbie Hancock

"Vision is a new era in music composition and recording, it's the easiest to use and most complete sequencer I've seen to date."

Thomas Dolby

"As for which sequencer you choose, I think that depends on what style of musician you are. The one that I've finally settled on, and which I'll use for the next album, is Opcode's Vision."

Jan Hammer

"If you compare all the really good sequencers on the market, Vision is more than the sum of all of those sequencers."

Michael Boddicker

"I'm a convert and a true believer."

Howard Jones

"Just wanted to drop a line to say what a fantastic program Vision is. I am having a great time using it. Keep up the fab work."

MacUser

"Vision has emerged as the new leader in sequencing technology... this is the Vision of the future... a new standard in Mac sequencers... spectacular."

Electronic Musician

"Vision is a deep, complex program, with an exceptional number of little goodies. Expect to be amazed." Features: 10; Stability: 10; Overall: 10; Craig Anderton.

Keyboard Poll

"Keyboard Magazine Reader's Poll... remains the one true barometer of what's hot and who's happening in the world of keyboard music." Vision captures first prize as "Software Innovation of the year."



Vision

Professional
Sequencing Software
for the Macintosh

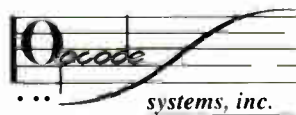

Something wonderful
is about to happen...

Call us for a demo disk or free brochure.
Opcode Systems, Inc. 3641 Haven, Suite A Menlo Park, CA 94025-1010 (415) 369-8131

AVOID BIG PRODUCTION NUMBERS.

Music and sound effects production used to be a tedious, expensive, and drawn-out routine.

But something's come along to change all that: the Emulator III™ from E-mu Systems. Finally,

sound production isn't a big production any more. It's even become creative again.

For the audio professional, the Emulator III is a complete, affordable digital sound factory. More precisely, a 16-bit audio computer and SMPTE-based event sequencer that records, edits, and plays back multiple sounds simultaneously in stereo with CD quality. Producing a system so versatile, it's the perfect choice for soundtracks, sound effects, and digital Foley.

Our experience has enabled us to build a true 16-bit linear design that maintains the integrity of the sound throughout the hardware. Giving you output of unsurpassed quality.

That's immediately evident in every stereo sample for the Emulator III. And there are literally thousands of instruments and sound effects available. On CD-ROMs, rewriteable optical disks, floppy disks, or removable hard disk cartridges.

For all this sophistication, the Emulator III is amazingly easy to use. Enabling you to focus on your work instead of the equipment.

The Emulator III digital sound production system created blockbuster music and sound effects for films like Batman, Dick Tracy, and The Hunt for Red October.

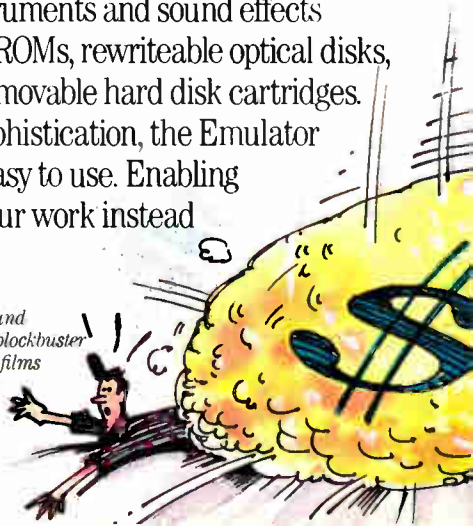

With our Remote Controller, you can completely operate one or more Emulator IIIs from the Apple® Macintosh®. Anything you want the system to do — trigger sounds, edit them, layer or change them — is handled by an on-screen control panel or computer keyboard. And pop-up menus make everything as fast and intuitive as the Mac® itself.

There's another incredibly powerful facet to the Remote Controller. A Librarian that locates and retrieves any sound on any media in your library in seconds. So you no longer waste hours cross-referencing log books to locate a particular sound or effect. The Librarian is also smart enough to update itself and print out a current catalog at any time.

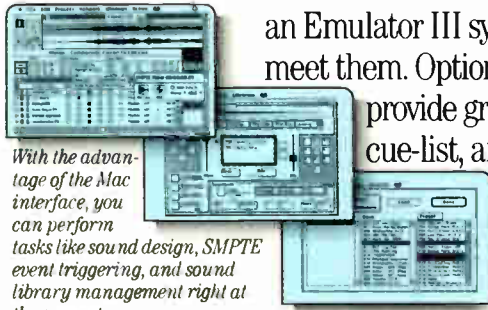

With the advantage of the Mac interface, you can perform tasks like sound design, SMPTE event triggering, and sound library management right at the computer screen.

an Emulator III system can be configured to meet them. Optional Mac hardware and software provide graphic wave-form editing, SMPTE cue-list, and direct-to-disk recording. There are also a number of flexible storage solutions (including a 600MB *rewriteable* optical drive).

No matter what you select, E-mu long-term support ensures the Emulator III system can adapt as your needs and technology evolve.

If all this sounds good on paper, listen to how it performs in the studio. Danny Elfman, the composer of *Batman* and *Dick Tracy*, praises the Emulator III as

"by far the most powerful sampling system in or near its price range. The combination of two Emulator IIIs, a Mac II, a read/write optical drive, and the new Remote Controller/Librarian software creates a high-end system that costs a fraction of the closest competitor."

Frank Serafine is just as enthusiastic: "I rarely go to tape or multi-track anymore. Every sound effect I created in *The Hunt for Red October* came from my Emulator III."

For an even closer listen call E-mu — the pioneers of digital sampling. And talk to the people who build and support the Emulator III.

Then ask for an Emulator III demonstration. You won't get the same old song and dance.



Thousands of sound effects — like the slam of a car door — are at your fingertips. And, unlike taxis, they're always right there when you need them.

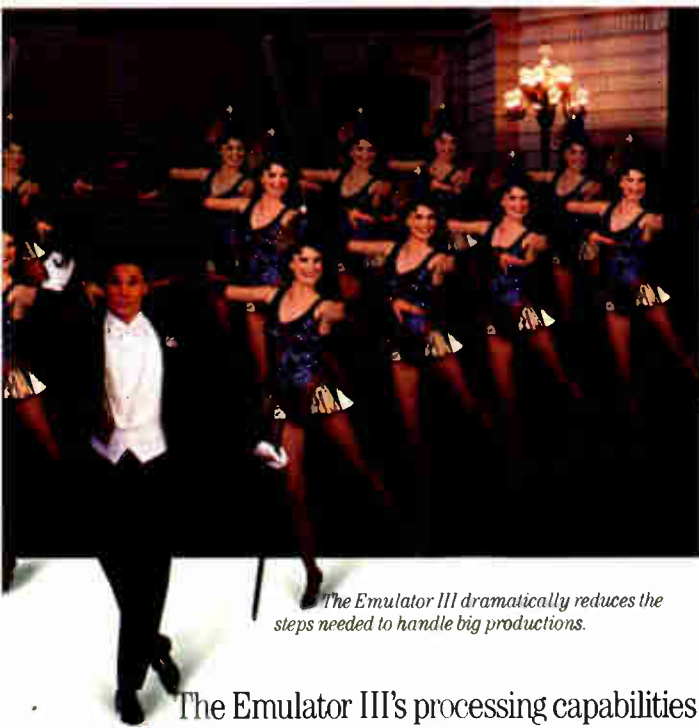

The Emulator III dramatically reduces the steps needed to handle big productions.

The Emulator III's processing capabilities are equally impressive. Compression, EQ, dynamic filters, and gain normalization are processed completely in the digital domain. And a scrub wheel allows instant access to any point in a sound.

Whatever your professional needs,

Thanks to an intelligent design and system modularity, you don't have to drop a ton of cash to satisfy your professional audio requirements.

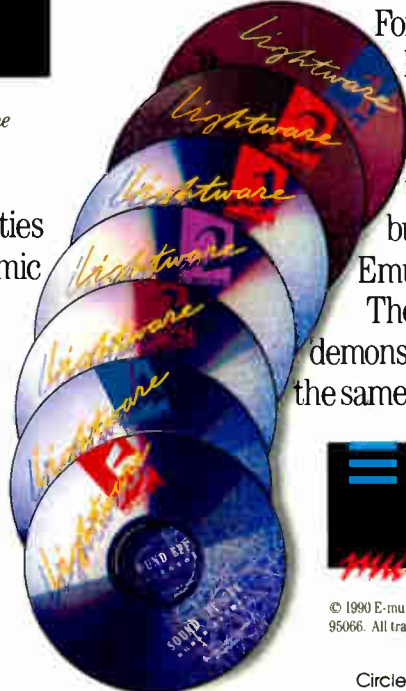

E-mu Systems, Inc.
applied magic for the arts

© 1990 E-mu Systems, Inc. 1600 Green Hills Road, Scotts Valley, CA 95066. All trademarks are property of their respective companies.

Circle #001 on Reader Service Card



The Studiomaster Mixdown consoles are specifically for today's smaller studios; studios which are using more and more sequenced instruments, and need many inputs for them.

The 16.4.8 and 16.8.16 Mixdown consoles have 26 and 34 inputs at stereo mixdown, respectively. Put into perspective, other similarly priced 16.4.2 and 16.8.2 consoles would need to be in 24.2 or 32.8.2 formats before they could match this capability.

The main benefits of this are that re-patching during session is considerably reduced, if not eliminated, and a smaller multitrack tape machine can be used. This is because only the 'live' instruments need to go on tape, since MIDI sequenced drum machines, keyboards and effects can simply be monitored during the recording, then added at the stereo mixdown.

Few consoles rival the Mixdown's features, and fewer still match specifications like a T.E.I.N. of -129dB and cross talk between subgroups (at 1kHz) of -88dB. And with these features and specifications, none can match the price.

Key features of Mixdown include balanced inputs, 3 band sweep EQ, 6 auxiliaries, 'auxiliary line inputs' (on 16.4.8, 16 on 16.8.16), upper AL inputs have 2-band EQ, DIRECT OUTS, 48V Phantom Power, effects AND foldback sends on subgroups/AL inputs, fader reverse, stereo aux return, 100mm faders, expandable inputs to 40.

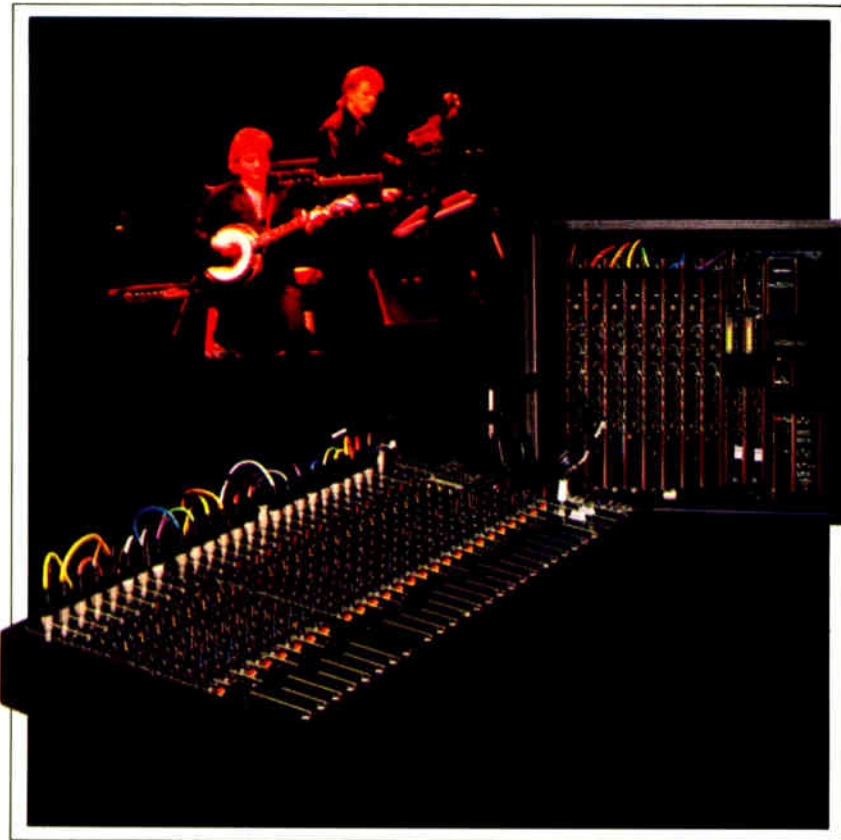

The Studiomaster Session Mix stereo consoles are ideal for P.A., club installations and keyboard and drum machine submixing. They are available in THREE formats: 8.2, 16.2 and 12.2R.

Though not expensive, the Session Mix range does offer features you may only expect on more costly alternatives. All models have electronically balanced inputs, 3-band EQ, 4 auxiliaries, 2 auxiliary returns, 5-pin DIN Record/Playback socket and 12 segment LED output meters. 12.2R and 16.2 versions have stereo returns. The 16.2 has in addition to the features above, a sweep on the Midrange EQ, EQ on the outputs (switchable on stereo returns), pre-fade SOLO, 100mm faders, post-fade DIRECT OUT sockets on inputs and channel mute buttons.

The 8.2 can be rack mounted (in 2 positions) occupying 10U, stood flat or wall mounted due to its special endcheeks. It can also be expanded to a 16.2. The 16.2 can be expanded to 24.2. The 12.2R is rack mount only and occupies 10U.

Note: New Address

For detailed color literature, contact Jim Giordano, Paul Reeve or Tony Allen at STUDIOMASTER, INC., 3941 East Miraloma, Anaheim, CA 92807 Tel (714) 524-2227 FAX (714) 524-5095

STUDIOMASTER

THE SOUND EXPERIENCE

Studiomaster Canadian Dealers: CALGARY Mother Music (403) 241-3755 EDMONTON Mothers Music (403) 439-0007 HALIFAX Music Stop (902) 499-5671 MONTRÉAL Steves Music Store (514) 878-2916 OTTAWA Steves Music Store (613) 939-1151 QUÉBEC Music Store Richard Gendreau Inc. (418) 529-2877 ST. JOHN SUR RICHMOND Guy Berger Sound E-Lumina (514) 346-5310 TORONTO Steves Music Store (416) 595-8888 VANCOUVER Mothers Music (604) 438-3341

Circle #012 on Reader Service Card

MacProteus using the Opcode software, I used Vision to record guitar, bass and drum tracks. Then I saved the sequence as a MIDI file and opened up Deck. Importing the MIDI file was a snap, and it played perfectly from Deck. (It's worth mentioning that there are limited MIDI editing features, as well as the ability to record up to 16 MIDI tracks, all from within Deck. But don't think of it as a substitute for your sequencer.)

Then came the moment of truth: Would I be able to whistle on key? Let's just say that Deck faithfully and easily captured my lead and harmony whistling performances on tracks 1 and 2. I used track 3 in Loop and Sound on Sound modes to record four consecutive, continuous passes of finger snaps, while monitoring tracks 1 and 2 along with the MIDI file.

Then I unloaded the finger snap audio track into Audiomedia, where I eliminated some microphone noise in between snaps that resulted from my sloppy mic technique, and reloaded into Deck's track 3. I did the same thing with the lead whistle track, introducing a 60ms delay in front of the soundfile, and loaded the resulting delayed track into track 4. (I could have also accomplished the same thing using the digital effects option in Deck itself.)

In order to set up for a mix, you can take as many as 200 snapshots of fader/pan/EQ states, eight of which can be assigned to front panel buttons. You can use the automation options to specify begin and end times for a state, and transition times between them. Mixes are recorded separately from the soundfile data, making it easy and economical to try many different mixes of a recording.

There were too many features to elaborate on in this space, but here's an example: You can go back into your MIDI sequencer and edit it, and then easily reload it into Deck. No syncing problems here. It's modular recording and editing at its best.

Here's another example: Deck offers 2:1 and 4:1 data compression options to save disk space. At 4:1 compression you can fit over eight minutes of 4-tracks on a 45Mb cart.

All the while I was playing with this stuff the people from Digidesign were wringing their hands, saying, "You

—CONTINUED ON PAGE 200

CATCH THE DIGITAL WAVE!

CONVERT ANY IBM PC/AT INTO A COMPLETE DIGITAL AUDIO WORKSTATION

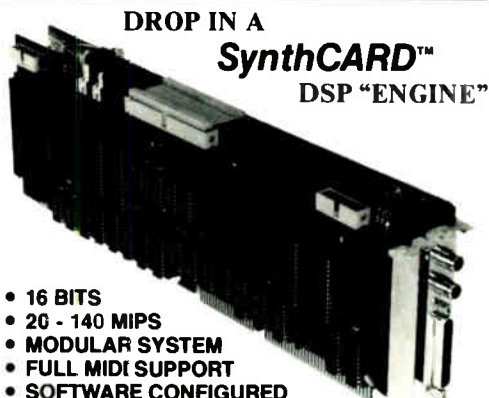
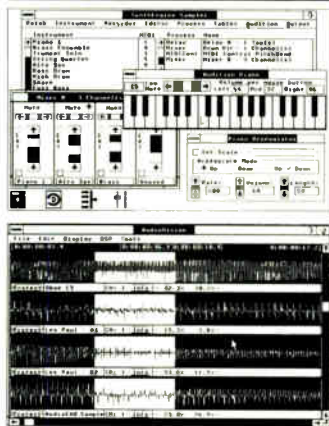

DROP IN A

SynthCARD™

DSP "ENGINE"

- 16 BITS
- 20 - 140 MIPS
- MODULAR SYSTEM
- FULL MIDI SUPPORT
- SOFTWARE CONFIGURED
- SUPPORTS 32, 44.1 & 48KHZ
- CD/DAT INTERFACE BUILT-IN
- REALTIME SIGNAL PROCESSING
- DAUGHTER BOARD SUPPORTS 4MB DRAM
- HARD DISK RECORDING — 2 TO 16 TRACKS!
- EXPANDABLE UP TO 7 CARDS PER SYSTEM
- AudioCAD™ - ALGORITHMIC SOUND DESIGN
- SynthEngine Sampler™ - 16 VOICE POLYPHONIC
- Digital Studio™ - 16x2 MIXER/PLAYLIST EDITOR
- AudioVision™ - 16 TRACK GRAPHIC EDITOR

TEC
TECHNICAL EXCELLENCE & CREATIVITY

1990
NOMINEE

SPECTRAL
SYNTHESIS

18568 - 142nd Avenue NE
Woodinville, WA 98072
(206) 487-2931

Circle #068 on Reader Service Card

BRING NEW LIFE

TO YOUR WORN HEADS
WITH OUR REFURBISHMENT SERVICES

24 HOUR TURN-AROUND ♦ SUPERIOR QUALITY ♦ COMPETITIVE PRICING



FILM
REEL TO REEL
AUDIO FOR VIDEO
VOICE LOGGER
NEW REPLACEMENT HEADS
AVAILABLE
WE STOCK PARTS FOR ALL
MAJOR RECORDERS

15720 Staag Street
Van Nuys, CA 91406
Phone: 818-994-6602
Fax: 818-994-2153
Telex: 745239

New York Office:
2275 East Meadow
New York 11554
Phone: 516-731-5711
Fax: 516-731-5943



SPRAGUE
MAGNETICS, INC.

1-800-553-8712

CA:

1-800-325-4243

Circle #069 on Reader Service Card



ANALOG MULTITRACK RECORDERS

by George Petersen

About a decade ago, most prophets and prognosticators of the audio realm predicted the eventual demise of analog multitrack. Certainly by 1990 we'd all be recording on digital bistorage silicon cubes, with unlimited tracks available to our every whim, or for that all-essential third tambourine harmony part on the second verse. Well, analog is still here, still selling well and probably sounding better than ever, especially with some help from a couple of nearby Dolby SR racks. Today's infusion of

microprocessors into the transport control environment has yielded faster, smoother decks that can do everything but turn on the studio espresso pot. Now with a *latte*-to-SMPTE converter under ESBUS protocol...

Back to reality. Here are the latest offerings in the world of analog multitrack, with details on what's available, and suggested retail pricing. Because manufacturers use a variety of methods for measuring performance specs, we have omitted these from the report. For more information, contact the manufacturer

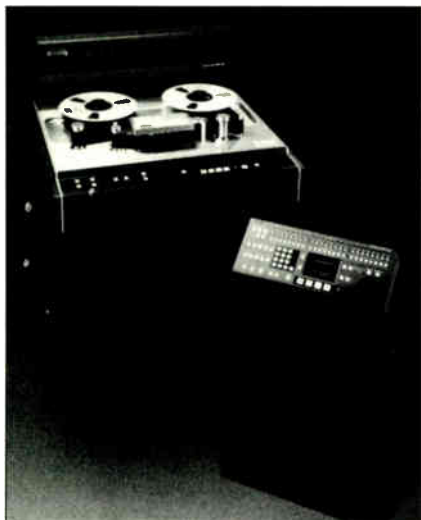

**Sony APR-24 analog
tape recorder**



Otari MTR-100 tape recorder



**Studer A820 24-track
with remote**

Technology Embraces Art.

There was a time when these words were seldom used together. The disciplines necessary to produce *art* had little patience for technology. *Today* the union is prerequisite. With this fusion in mind, Trident engineers set out to combine vintage sonics with adaptable studio integration and control.

The Vector 432 in-line console. Featuring balanced bussing, 32 groups, 4 stereo mix busses, 4 band equalizer splittable between channel and monitor and 8 auxiliary send busses. The 16 mute groups, fader automation, and multiple machine control are all accessible from our Central Command Panel.

With Audio specifications straining theoretical limits and sonics that can only be described as Trident, the Vector 432 is clearly the console for the creative. Audition a Vector and hear for yourself. After all, you've been listening to us for years.

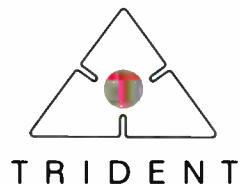
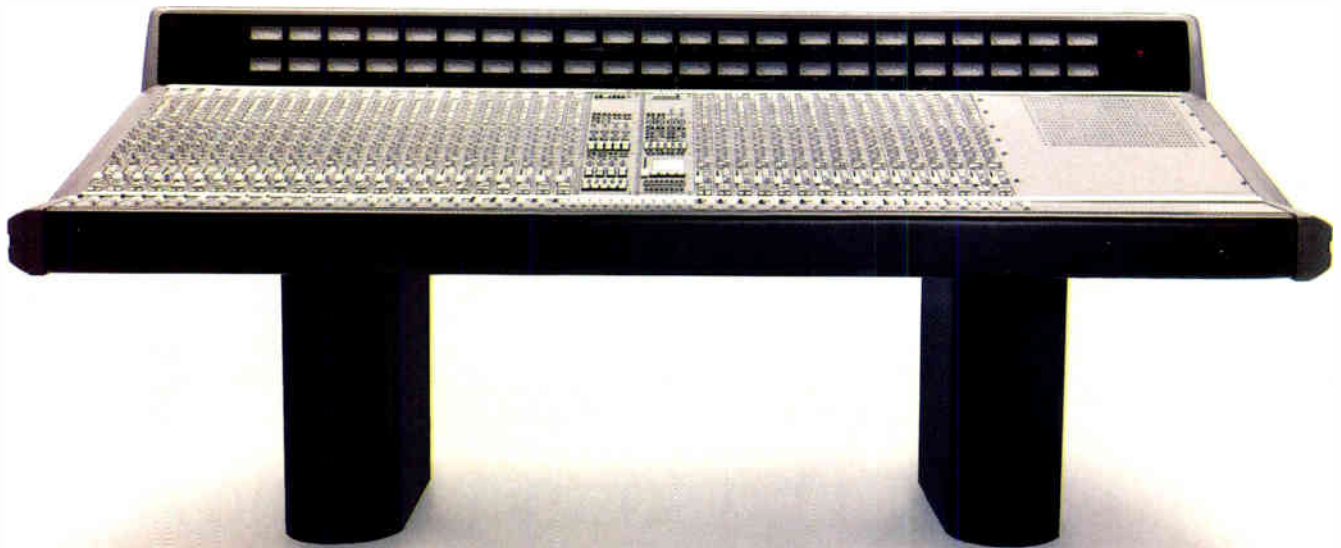

TEC

TECHNICAL EXCELLENCE & CREATIVITY

1990
NOMINEE

TRIDENT AUDIO DEVELOPMENTS LTD • Trident House, Rodd Estate, Govett Avenue, Shepperton, Middlesex TW17 8AQ, England • Phone 0932-224665 • Fax 0932-226721
TRIDENT AUDIO USA • 2720 Monterey Street, Suite 403 • Torrance, California 90503, USA • Phone 213-533-8900 • Fax 213-533-7072
TRIDENT AUDIO NEW YORK • 914-591-3741

World Radio History



Dolby SR. The sound investment for analog multitracks.

When everyone else was making noise about digital, we quietly developed Dolby SR. But it's no secret: Dolby SR makes analog multitrack recording a cost-effective alternative to digital.

Improves the preferred sound of analog

At both 15 and 30 ips, Dolby SR dramatically increases headroom, and virtually eliminates tape hiss and modulation noise. Dynamic range is improved by more than 25 dB over unassisted analog, preserving all the warmth and purity of the original sound.

Increases the return on your investment

Dolby SR upgrades your multitrack at a fraction of digital's cost. Add our Model XP SR (configured for up to 24 channels), or update an existing Dolby mainframe with plug-in SR modules. If you are in the market for a new multitrack, Otari and Studer offer models with Dolby SR built-in.

Simple to use

Set-up is quick and easy with Dolby SR. A unique

Auto Compare feature lets you instantly verify frequency response and playback calibration.

And editing is as convenient as ever, with no need for special equipment.



Worldwide acceptance

Tapes recorded with Dolby SR can go anywhere, anytime. In fact, with more than 25,000 channels in over 30 countries, analog with Dolby SR is a firmly-established format you can't afford to ignore.

Put it to the test

Call your Dolby dealer to arrange for a demo at your facility. Hear for yourself why Dolby SR is

the sound investment for analog multitracks in today's competitive marketplace.



100 Potrero Avenue, San Francisco, CA 94103-4813 Phone 415-558-0200, Telex 34409, FAX 415-863-1373 346 Clapham Road, London SW9 9AP, Phone 01-720-1111, Telex 919109, FAX 01-720-4118 Dolby and the Double-D symbol are trademarks of Dolby Laboratories Licensing Corp. © Dolby Laboratories Inc., 1989 589/8676

or your local dealer.

Akai

First introduced in 1984, Akai's 12-track format (using proprietary 1/2-inch cassettes) still seems to be doing quite well. In fact, Akai has just completed the implementation of an improved transport, which begins shipping this month. Not to be confused with Akai's A-DAM digital 12-track system, the company's line of analog 12-tracks includes the MG14D rack-mountable recorder and the MG1214, which uses a similar tape transport in conjunction with an internal 12-channel mixer.

Priced at \$5,999.95 (or \$5,499.95 without an autolocator), the MG14D offers 12 tracks of recording capability, as well as two aux channels for control-track or SMPTE time code recording. With the Akai MK20 tape, the system has a maximum recording time of ten minutes at 7.5 ips or 20 minutes at 3.75 ips. Both XLR-type balanced and unbalanced RCA line inputs/outputs are provided. Other amenities include: $\pm 12\%$ pitch control; internal dbx Type I noise reduction; and a 25-pin "D" port for connecting external synchronization systems. The unit includes the ML14, a compact, programmable autolocator featuring full transport control, along with auto punch-in/out, fluorescent displays of real tape time and the next memory point, nine memory locations, auto playback muting, a numerical data entry pad, and the ability to store all memory points for up to one week.

Akai's MG1214 (\$8,999.95) combines the MG14D's 12-track transport into an integrated package with a 12-channel mixer and unique computerized patching system that lets the user route any channel signal to any track with the touch of a button. The mixer section features: balanced XLR mic inputs; 1/4-inch line inputs; sweepable 3-band equalization on each channel; individual channel insert points; in-line track monitoring; and two effects sends (each with independent stereo effects returns).

Fostex

Fostex pioneered the 1/2-inch 16-track format with the B-16, and has continued to refine it with the introduction of the G-16. Priced at \$8,000, this flagship of the Fostex line offers the option of integrated SMPTE synchronization through an optional plug-in card. The G-16 can operate in master



Akai's MG14D offers 12 tracks on 1/2-inch cassettes

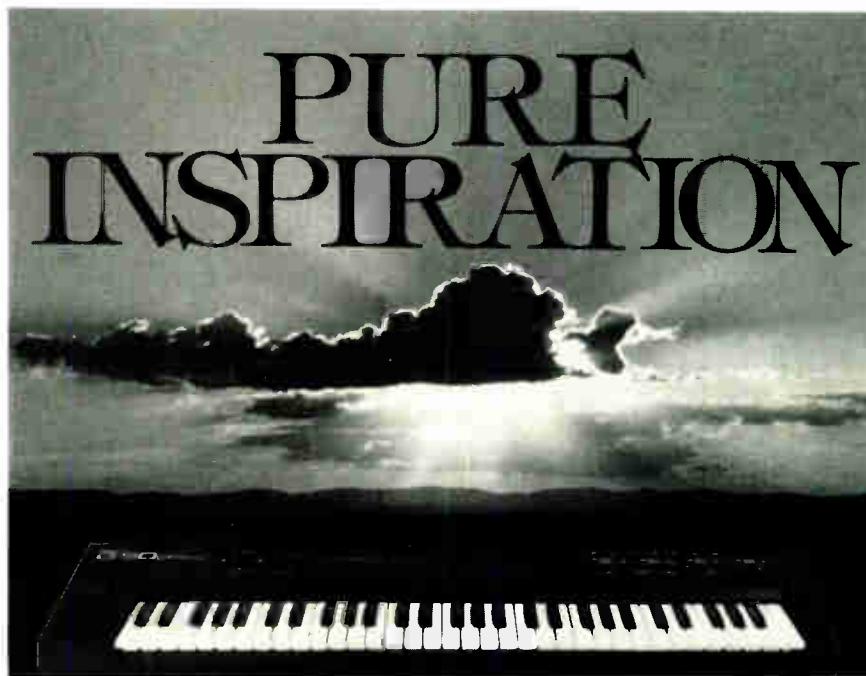

At Last!

Personal Composer[®] version 3.3 gives you everything you need to create, arrange, orchestrate, transpose, and print out music. It even comes with a built-in, (and growing,) library of traditional scores.

Never Used a Computer Before?

Personal Composer's unique online Hyperhelp systems and tutorials will guide you through every aspect of this easy-to-use yet powerful program. An extremely "user-friendly" system of pull-down menus, simple mnemonic commands, and optional mouse makes using Personal Composer[®] a breeze. Full MIDI support means that you can play in your music from any electronic instrument, or you can use the program's Score Editor to enter music in traditional notation directly from your computer's keyboard. What's more, Personal Composer[®] delivers incredibly high-quality printouts from any kind of printer—even dot matrix!

Sometimes all you need is a little inspiration.

Making music has never been easier!!

Available for the IBM PC computer (or compatible),
and priced at only \$595.00.

For more
information
write or call:

Personal Composer[®]
2448 76th Ave. S.E.
Mercer Island, WA 98040
1-800-446-8088



Circle #196 on Reader Service Card

DISC MAKERS

Complete manufacturing for the audio industry.

COMPLETE PACKAGES FOR:

Cassette Duplication
Record Pressing
Compact Disc Replication

All packages are completely retail ready, and include all necessary steps



In-house art department for complete design, typesetting, film work, and printing. In-house mastering department for a great sounding product.



CALL FOR OUR
FREE FULL COLOR
CATALOG.

1-800-468-9353
(In PA: 215-232-4140)

DISC MAKERS

1650 Broadway, Suite 1010 New York, NY 10019
(212) 265-6662

Circle #081 on Reader Service Card

"Please pass the Talkback"

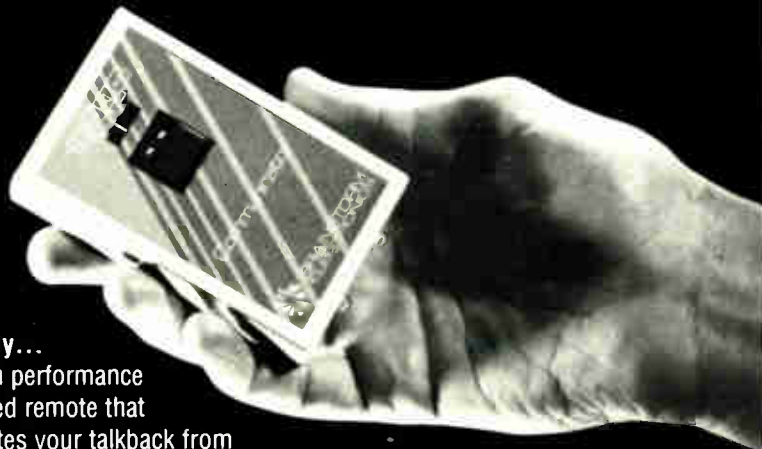

Finally...

A high performance infrared remote that activates your talkback from *anywhere* in the control room.

- No aiming necessary
- Easy installation
- Very affordable

Call for more information.



TB-4 Communicator

**BRAINSTORM
ELECTRONICS, INC.**
(213) 475-7570
1515 Manning Ave. #4
Los Angeles, CA 90024

Circle #082 on Reader Service Card

or slave (chase-lock) modes, and sync operation controls are already built into the deck's front panel, which removes easily and can be located up to 10 feet from the transport.

With the optional sync card, the deck's transport controls can also be controlled externally by a keyboard or sequencer, and a serial port is provided for connection to RS-232 C22-equipped devices and PCs.

The G-16 operates at 15 ips ($\pm 12\%$ pitch control is standard) and features phono jack inputs/outputs; a built-in jog wheel with spot erase capability; defeatable Dolby C noise reduction; three metering modes—permanent peak hold, peak reading and temporary peak hold—as well as a fine mode that displays levels in 1dB increments for precise calibration; bright LED displays of real tape time and memory locations (used with a synchronizer, these show master and slave offset times in units up to 1/64th frame); and easy access to the alignment trim pots. Autolocation functions include up to ten memory points, one-to-nine-second preroll and auto play return modes, while the G-16's software-based design allows the user access to internal functions (such as defining spooling speeds or resetting the timer to display remaining time). A rack-mounting kit is optional.

The Fostex E-8 (\$4,095) is a 1/4-inch 8-track recorder featuring 15 ips operation ($\pm 15\%$ pitch shift), Dolby C noise reduction, unbalanced RCA-type inputs/outputs, 10.5-inch reel capacity and two memory location points. The first four inputs of the E-8 are normaled, so users don't have to repatch to record on tracks 5 through 8 when using the E-8 with a 4-bus console. The unit also includes a synchronizer port for interfacing with SMPTE-based systems. When used with the Fostex 4050 autolocator and MIDI-to-SMPTE synchronizer, the system provides auto punch-in/out, 100-point autolocate, and the ability to locate to the bar and beat.

Priced at \$2,800, the Fostex R-8 is a compact, 1/4-inch 8-track deck with 7-inch reel capacity. The recorder offers 15 ips operation (with $\pm 10\%$ pitch shift), defeatable Dolby C noise reduction, selectable meter ballistics and unbalanced RCA-type line inputs/outputs. Like the G-16, the R-8's front panel can separate from the deck for more convenient placement in a crowded control room. Autolocation features include up to ten memory

points, programmable preroll, auto return, auto play and footswitch-controllable play, locate commands. Built-in serial and synchronizer ports facilitate using the R-8 in a SMPTE- or MIDI-based environment, with the addition of the optional MTC-1 MIDI interface or 4030/4035 family of synchronizers.

Otari

Introduced at the winter 1988 AES convention in Paris, the Otari MTR-100A (\$59,950) is a high-performance, 2-inch 24-track that offers fully automatic record and reproduce alignment capability in less than four minutes. The MTR-100A uses a gentle, pinch-rollerless tape transport operating at speeds of 7.5/15/30 ips ($\pm 50\%$ varispeed), with a maximum reel capacity of 14 inches. Four non-volatile memory locations per tape speed are provided (12 total), storing alignment data for different tape types. A cue shuttle wheel allows jog and shuttle mode operations and the selection of library pack or fast winds, with speeds up to 474 ips. The flexible transport even permits phase-locked reverse play, as well as reverse recording and erase operations.

Some of the MTR-100A's features



Tascam ATR-80 24-track

include: internal Dolby HX™ circuitry (for enhanced HF performance at lower tape speeds); an automatic tape end detector for end-of-reel slow-down; a tiltable VU meter panel for better visibility and improved access for servicing; active, balanced XLR-type inputs/outputs; and room inside the machine for an optional Dolby SR card cage. A full-function remote session controller is standard and pro-

vides seven non-volatile cue memories and two speed-search functions. The controller can be placed up to 100 feet from the recorder. Among the available options are the EC-103 chase-lock synchronizer, an SSL console interface and the CB-120 autolocator (offering up to 99 memories, tach or time code operation, and automated rehearse and punch-in/out capability).

Over the years, the MTR-90 has

don't forget your lunch!

THE 512b MIC PRE:

The new API 512b-
An all discrete EQ size
mic preamp/instrument
direct box in one.

THE 550b EQ:

The new API 550b-
The same circuit as
the famous all discrete
550A, but with four
bands and more
frequencies.

THE 500-b4:

The new API 500-b4-
A portable rack for API
modules, with the
traveling engineer or
musician in mind.



api

WORLDWIDE DEALER/REPRESENTATIVES:

EAST COAST: STUDIO CONSULTANTS, INC. 212-586-7376	MID-US: MILAM AUDIO 309-346-3161
WEST COAST: WESTLAKE AUDIO 213-851-9800	EUROPE: SYCO SYSTEMS (LONDON) 01-724-2451
	JAPAN: NISSHO WAI (NY) 212-704-6692

api audio products, inc.
7951 TWIST LANE,
SPRINGFIELD, VA 22153
703-455-8188 FAX 703-455-4240

Circle #083 on Reader Service Card

come to be regarded as the mainstay of Otari's multitrack line, and has seen constant upgrades since its introduction. The current model, the MTR-90 Series II, is available in 2-inch 16-track (priced at \$36,750 and prewired for 24-track) and 24-track (\$39,950) versions. Two speeds (15 and 30 ips) are selectable, although a simple mod allows operation at 7.5 ips. The MTR-90 Series II offers: 14-inch reel capacity; bidirectional shuttle operation; $\pm 20\%$ varispeed; transformerless, balanced XLR-type inputs/outputs; and a full-function session remote controller. Options include phase-locked reverse play (with an accessory PCB),

plug-in chase synchronizer (EC-101), CB-115 ten-memory locator, and the 99-memory CB-120 autolocator.

Available in three 2-inch configurations (24-track, 32-track and 24 prewired for 32-track), the MX-80 is Otari's most affordable 24-track, priced at \$29,950. The transport handles 10.5-inch reels at speeds of 7.5, 15 or 30 ips, with $\pm 50\%$ varispeed. Inputs and outputs are transformerless, balanced XLR-type and switchable for operation at -10dBv or $+4\text{dBm}$ levels (outputs can be jumpered for unbalanced use). Like the MTR-90 Series II and the MX-70, the MX-80 includes a microprocessor-controlled, constant-tension

transport, a full-function remote session controller, and external control connections to interface to SMPTE-based editors, synchronizers or controllers. Other features include Dolby HX-Pro™ bias optimization circuitry, phase-locked reverse play and mini-autolocators on the machine and remote, with seven memory locations. The CB-119 (eight memory) and CB-120 (99 memory) locators are optional, as is an SSL control interface.

Otari's MX-70 line of 1-inch multitracks is available in three versions: 16-track (\$21,650), 8-track (\$17,200) and 8-track prewired for 16-track. Any of these can be converted to 1/2-inch 8-track operation via an optional kit. Tape speed is switchable between 7.5/15 or 15/30 ips pairs, with $\pm 20\%$ variable speed. Inputs and outputs are transformerless, balanced XLR-type and -10dBv or $+4\text{dBm}$ operation is possible. A CB-117 full-function remote session controller is standard, offering search-to-cue and return-to-zero memories, and the MX-70 can be operated via the optional CB-119 and CB-120 controllers.

In the 1/2-inch 4-track market, Otari has two models available based on its MTR-10 and MTR-12 lines. The MTR-12-I (\$13,525) offers 12.5-inch reel capacity, while the MTR-10-I (\$12,550) has a maximum reel size of 10.5 inches. Both feature three-speed operation (3.75/7.5/15 or 7.5/15/30 ips, user-selectable), come in floor console configurations and can be adapted to the 1/4-inch format via an optional kit. Inputs and outputs are balanced, transformerless XLR-types, and all transport functions, tach data, and 9,600Hz control signals are available on the rear panel for interfacing with SMPTE synchronizers and external controllers.

Otari's MX-5050 Series use a time-tested transport that easily interfaces to external synchronizers and a number of optional remote controllers. All are three-speed machines, with 3.75/7.5/15 ips in user-selectable pairs, and feature 10.5-inch reel capacity, $\pm 7\%$ varispeed, a three-head design, XLR-type unbalanced inputs/outputs with switchable -10dBV or $+4\text{dBm}$ operation, headphone output monitoring, internal 1kHz/10kHz oscillator, real-time LED tape counters with return-to-zero function, and compatibility with dbx noise reduction systems. The MX-5050 MkIII-8 (\$5,495) is a 1/2-inch 8-track in a tabletop, overbridge VU meter configuration. In a similar

Saki vs. Otari 24-track Replacement Heads: You'll Like the Difference.

Otari's own MTR-90 record and playback heads are excellent. Proven Permalloy cores and shields. Clean response with low crosstalk. Troublefree.

Just like Ours.

In fact, we guarantee to deliver the same mechanical and performance specs to your 100% satisfaction, or your money back.

So why change to Saki when replacement time comes? Because our Made in U.S.A. heads are priced about 25% less than Otari, and we offer immediate delivery from stock.

Ours vs. theirs—the difference is worth a closer look.

Call us now for all the details.

SAKI®

SAKI MAGNETICS, INC.

26600 Agoura Road, Calabasas, California 91302
Phone: (818) 880-4054 Telex 244546 Fax (818) 880-6242

Circle #084 on Reader Service Card



Not your average woofer and tweeter.

Loudspeakers are wholly man-made devices. In the evolutionary calendar of man, the loudspeaker is just milliseconds old. By sheer ingenuity, man has refined a system which is capable of mimicking natural sounds.

The degree of realism, and hence the quality of natural reproduction, can simply be defined as **characteristics added** to the original sound. The quantification of these clues given to the human ear, decipher whether the sound is real

or reproduced by a loudspeaker on the end of an audio system.

The design and production of high quality loudspeakers is dependent on being able to measure, assess and therefore, rank and quantify these **added characteristics**. Having assessed the characteristics, the next and most important step is to select materials and techniques which will minimize or eliminate these

added characteristics altogether.

Differential Material Technology - An essential in the realization of Advanced Reference Monitoring.

For more information on Differential Material Technology call or write:

TANNOY

Tannoy / TGI North America Inc.
c/o Bill Calma
300 Gage Ave., Unit 1, Kitchener,
Ontario, Canada N2M 2C8
(519) 745-1158 Telex 069-55328
Fax (519) 745-2364



CASSETTE MULTITRACKS THE TINY FORMAT GROWS UP

It all began with the 1981 introduction of the Tascam Model 144 Portastudio™, a modest 4-track recorder with a simple 4-input mixer. Other developments followed, along with the adoption of 3.75 ips (double normal cassette speed) as an easy way to improve audio performance. By 1984, at least seven manufacturers had entered the fray, including Fostex, whose revolutionary X-15 (priced at \$495) made multitrack accessible to a wide audience. And British company Studiomaster made quite a splash with its rack-mount Studio 4, which featured a 6-input mixer with XLR mic inputs, 48-volt phantom power and 3-band EQ. The quest for hypertracking had begun.

Today, you can get just about anything you need in a cassette studio system, which is offered by Akai, Fostex, Sansui, Peavey/AMR,



Tascam 688 MIDIstudio

Tascam, Toa, Vesta, Fire and Yamaha. Both Toa and Tascam are now hawking units that pack eight tracks onto that tiny 1/8-inch ribbon of oxide, while Sansui's WS-

516-track recorder is an integrated unit that also includes an 8-channel mixer, stereo cassette deck and even a digital delay. Going a couple of steps further, Tascam's new 688

Maxell has the classics.



MIDIstudio (\$3,299) combines an 8-track cassette and a comprehensive 10 x 4 mixer (featuring 20 inputs in remix, XLR mic inputs, 3-band EQ and four stereo subgroups) in an environment under MIDI-synchronous control of the transport with mix channel mute automation.

While Tascam's 688 probably has more technology than the average cassette multitrack "sketchpad" user is likely to need, it aptly demonstrates the power available to virtually anyone with a bit of ingenuity and even a modest home setup. Connect an inexpensive tape sync box—Yamaha YMC10, Cooper PPS-1, etc.—to a MIDI sequenced tune, overdub some vocals on your cassette multitrack, and you could be in for some hip sounds. Bruce Springsteen made audio history with his 1982 *Nebaska* release (the first major label album recorded on a multitrack cassette deck), but with the advent of affordable tape sync, the real revolution may be just around the corner.

—GP

overbridge package is the MX-5050 MkIII-4 (\$5,935), a 1/2-inch 4-track, which, like its MX-5050 BQ-II cousin (a compact 1/4-inch 4-track priced at \$4,345), includes mic preamp inputs and onboard line/mic mixing.

Revox

The 270 Series from Studer/Revox is a line of rack-mount 2-, 4- and 8-track recorders designed for the pro user. The C278 is a 1/2-inch 8-track priced at \$5,995, while the 1/4-inch C274 4-track lists at \$4,995. Both feature three-speed operation (3.75/7.5/15 ips), +50/-33% varispeed, Dolby HX Pro, selectable library rewind, RS-232 port for externally controlling all machine

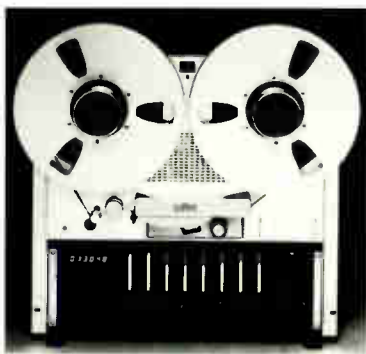

Revox C278 1/2-inch 8-track

functions, and internal monitor speaker and headphone output jack with track monitor select. Transport functions include one-hand cueing in edit mode, LED hours/minutes/seconds real-time display, and return-to-zero and search-to-cue memory points. The audio electronics on all models in the series are of a modular construction and are accessible from the front of the recorder, even when rack-mounted.

Sony

The APR-24 is the first analog multi-track recorder to be designed by Sony from the bottom up. Borrowing the audio cards, 16-bit microprocessor control and alignment system from Sony's successful APR-5000 Series of mastering decks, the 24-track APR-24 improves on the technology with a few tricks of its own, such as an internal SMPTE synchronizer for 48-track recording or locking to picture, and alignment preset storage capability. Basically, the APR-24 is a 2-inch, 15/30 ips machine with $\pm 50\%$ varispeed, displayed in percent, ips or semitones. Other features include transformerless, balanced inputs and outputs via rear panel Tuchel multipin connectors; XLR

And now, heavy metal.



D2 Composite Digital Video Cassettes

1/2 inch Betacam SP

Whatever you're into, Maxell makes a full line of superior media. Like new BQ betacam tape. And, after a decade of making innovations in metal, we offer new SP metal betacam and D-2 tapes.

These new metal tapes have a ceramic surface coating to inhibit corrosion, not output. A conductive backcoating to resist dust, static,

and instability. With an ultra-smooth binder system to make our oxide coatings invincible, even to relentless shuttling while editing.

Of course, all our video and audiotapes, and video floppy disks share this level of durability. And technology. But most of all, Maxell shares your taste — for the very best.

maxell

22-08 Route 208, Fair Lawn, NJ 07410
© 1989 Maxell Corporation of America

ENTER THE NEW REALM OF TONAL CONTROL

Announcing the MPE 28, MPE 14 and MPE 47 MIDI Programmable Equalizers

M Meet the new generation of tonal controllers. More than mere equalizers, these are flexible instruments that actually give you power to enhance your music and your performance. Imagine a device that could give you this:

CREATIVE CONTROL: your guitar screams with sizzling brilliance on your lead cuts, then instantly switches back to a gutsy punch for your rhythm chops. Right on cue. And completely automatic through MIDI sequencer control.

POWERFUL EXPRESSION: the after-touch command from your synthesizer builds an earth-shaking rumble into the lingering sound. At your next patch change, the new voice instantly becomes crystalline with presence.

CONSISTENT SOUND QUALITY: you get the perfect PA sound at one of your regular clubs, then punch the EQ settings into memory. Next club, next button. Instant recall. Great sound.

This is but a small sample of the kind of magic you can achieve with the new MPE Series of MIDI programmable equalizers. The MPE 28 1/3-Octave design. The MPE 14 dual 2/3-Octave format. The MPE 47 four-channel fantasy machine. We've combined our proven leading-edge filter technology with micro-processor control and an exclusive built-in software package. The result: actual expressive capabilities never before achieved by any equalizer.

Discover for yourself the new creative dimension that an MPE Series tonal controller can give you. Then let your musical imagination soar.

Circle #049 on Reader Service Card



RANE

10802-47th Ave. W.
Everett, WA 98204
(206) 355-6000

input/output for time code, external parallel synchronizer port (the long-awaited serial interface is slated for delivery in the next few months); 14-inch reel capacity; tape spooling at up to 475 ips; storage of three alternative alignments per tape speed; and bi-color LED bar graph meters, with a "zoom" mode for 0.25dB resolution.

A full-function remote (with stand, in the U.S.) is included with the APR-24's list price of \$45,500. The remote duplicates the APR-24's transport controls (including the shuttle/jog wheel), and among its other features are selectable time code or tape timer displays, memory for up to 25 location points, rehearse functions, and five edit registers for storing record ready presets, pre/post-roll times, or any "snapshot" of the machine's operational status.

Studer

At a list price of \$74,900—including remote control, autolocator and pre-wired drawers for Dolby Spectral Recording (SR cards not included)—the Studer A820-24 is obviously *not* for low-budget recording applications. The microprocessor-controlled A820-24 is a 2-inch 24-track machine (also available in 8- and 16-track versions) featuring 14-inch reel capacity, three tape speeds, reverse play capability, precision modular headblocks for simplified interformat transitions, Dolby HX Pro, and fast wind speeds up to 600 ips.

All of the A820-24's operating keys are user-programmable, with a choice of more than 40 functions from its internal software. The machine also offers the automatic alignment of audio parameters for all 24 channels simultaneously, with onboard storage for two tape formulations, along with programmable control of tape tension, spooling speeds, etc. For convenience in machine room installations, the meter bridge can be located up to 300 feet from the transport (via a single 4-conductor cable), and Studer recently announced the availability of a compact bar graph meter option that mounts in the remote control stand.

Having exhibited its first production models less than a year ago, Studer has since delivered over 125 of the A827 multitracks worldwide. Priced at \$49,900 (including remote control and autolocator), the A827-24 is a 2-inch 24-track recorder (also available in 8- and 16-track versions) that offers the

same transport, head assembly and audio quality as its elder sibling, the A820-24. Features include: 14-inch reel capacity, three tape speeds, switchable Dolby HX Pro, microprocessor-assisted alignment, reverse play with varispeed, RS-232/422 ports and an optional chase-lock SMPTE synchronizer.

The A807 VUK-HS (\$10,995) is Studer's mainstay in the 1/2-inch 4-track market. This freestanding, console-mounted recorder features three-speed operation (7.5/15/30 ips), 14-inch reel capacity, tape shuttle control, overbridge metering and an RS-232 port for external control applications. The machine is also available in a 4-track version with center-track time code capability for \$12,995.

Tascam

The ATR-80 is a series of 2-inch recorders from Tascam, a company that makes an extraordinarily wide range of multitrack machines, from the \$499 Porta 05 Ministudio to the DA800/24 DASH 24-track digital at just under \$100,000. Available in 24-track (the ATR-80-24 is priced at \$34,999) and 32-track versions (the \$44,999 ATR-80-32), both recorders offer a microprocessor-controlled transport, with 14-inch reel capacity and a choice of 15 or 30 ips operation, with $\pm 20\%$ varispeed. Forward/reverse shuttle (at up to 150 ips) is provided via a rotary control found on the transport and the supplied RC-824 remote controller. Inputs and outputs are electronically balanced, XLR-type, and the outputs can be switched to unbalanced operation if desired.

Options for the ATR-80 include an RS-232/422 interface unit, a transformer-balanced input/output kit and the AQ-80 autolocator. The latter offers 20 memory locations, programmable preroll times of up to 20 seconds and a digital stopwatch for convenience.

For those who insist on 24-track flexibility, but are hampered by budget constraints, Tascam's MSR-24 is priced at \$13,999, making it the most affordable 24-track on the market. Using a 1-inch format with 10.5-inch reel capacity, the MSR-24 offers 7.5 or 15 ips tape speeds ($\pm 15\%$ pitch change), built-in dbx Type I noise reduction, two location memories (plus return to zero), tabletop or rack-mount use, onboard power supply,

—CONTINUED ON PAGE 147

POST MOUSE BALL

As you might expect, Fairlight ESP has taken an intuitive approach to Digital Audio Post.

Call us old fashioned, but we think that a few knobs and buttons can be worth a multitude of mice and balls - especially when you're having to chase them all day long.

Our revolutionary old fashioned approach is centered around a purpose built console with buttons, a knob and a very informative display.

It's called MFX.DR - a RAM and disc based editing and production system with integral machine control - for those brave folk who wish to venture beyond mouse-ball literacy.

THE DIGITAL SUPPORT GROUP
626 N BEACHWOOD DRIVE
LOS ANGELES CA 90004
Tel: (213) 460-4884 Fax: (213) 460-6120

ELECTRIC SOUND & PICTURE



FAIRLIGHT ESP PTY. LIMITED
30 BAY STREET, BROADWAY,
SYDNEY, N.S.W. AUSTRALIA 2007
Tel: 011 61 (2) 212-6111
Fax: 011 61 (2) 281-5503

Circle #085 on Reader Service Card

by George Petersen

PRODUCT CRITIQUES AND COMMENTS

SSL Logic FX G383 Mic Preamp/Equalizer

SI don't own an SSL console; I probably never will. Not that I have anything against this company, it's just that the mid-priced 32 x 8 x 24 board that resides in my small studio is the audio equivalent of a Chevy, and I'm not ready to enter the big leagues. At least not this week. In the meantime—that is, for the past couple of months—I've had the world-class sound of an SSL G Series board, without having to take out a second mortgage on my house. Let me explain.

The Logic FX Series is a line of rack-mount outboard gear based

of the unit's internal circuit boards to reduce the size of the device. However, the layout of the internal circuitry is extremely clean—servicing should be no problem—and the construction quality and components used are first-rate throughout.

The preamp has a 66dB gain range, with an indented control for precise resetability. One of the G383's unusual features is an impedance adjust pot (with a 600 to 6.2k ohm range), allowing the user to match the preamp to the impedance of the input source. By pulling on this

on electronics designs from the Solid State Logic G Series consoles. Priced at \$4,475, the G383 is a stand-alone unit providing two channels of microphone/line amplification and two 4-band equalizers in one package.

Each of the G383's channels includes: electronically balanced XLR input/send/return/output jacks; switchable phantom power supply; phase reverse switch; six-element, LED input meter; 4-band parametric EQ with variable bandwidth on the two MF sections; 18dB/octave highpass filter; peak LED after the EQ stage; and a universal input amplifier for line or mic-level signals.

The first thing you'll notice about the G383 is its size. At 17 inches, this is one of the deepest signal processors I have ever encountered, and this dimension may cause mounting problems in some studio racks. Perhaps SSL should have considered stacking some

control, the impedance is fixed at a standard value of 1,400 ohms and an indent is provided at the high end of the scale. Although the main use of the G383 is as a mic preamp, the addition of the impedance matching feature (along with its wide-ranging gain control) makes the unit ideal as a matching amplifier for printing synth, sampler and drum machine tracks directly to tape.

The G383 is fast and straightforward to use, with several nice touches that simplify operation. A bicolor LED glows green when the unit is powered up, and changes to red whenever a signal overload condition exists past the EQ stage. Each channel has seven LEDs displaying operation status at a glance, and a "split" control allows the user to repatch the highpass filter to follow the mic preamp in the signal flow. This is useful for those situations where you want to use a bit of low-end rolloff on the mic before routing the signal to an outboard device via the insert send jack.

After using the G383 for a six-week

SSL Logic FX

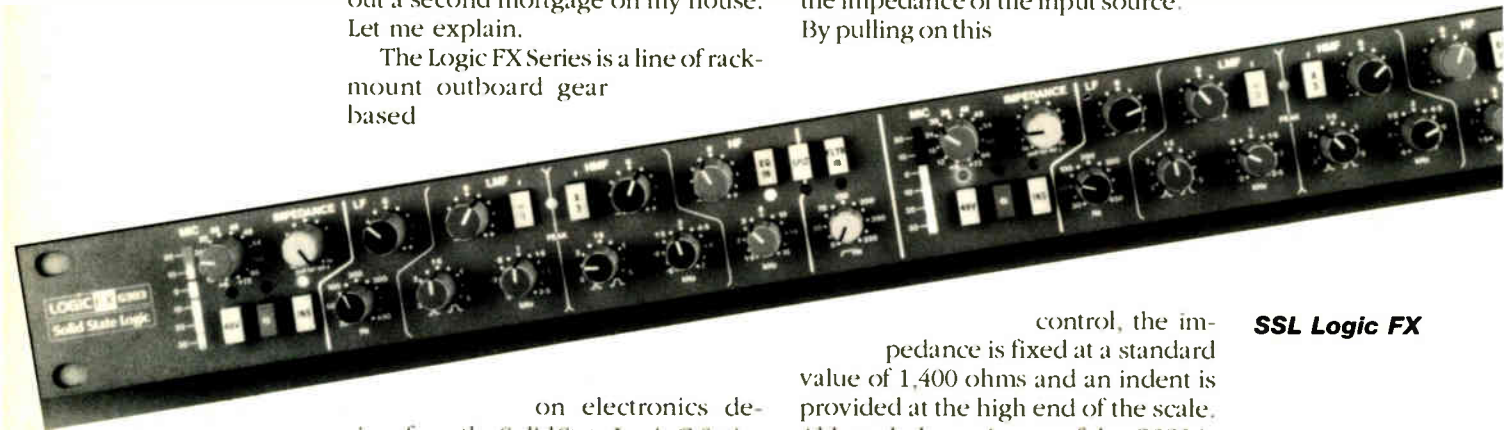



Finally, MIDI programmable equalizers that make sense.

TEC
TECHNICAL EXCELLENCE & CREATIVITY
 1990
 NOMINEE

99 memory locations and one button. That's it. Set your levels and push a button, the MEQ 14 will do the rest.

Recall? Touch a button. Programming? It's just as easy. LEDs light up the settings and the touch of a button sets them. MIDI Programmable EQs have never been this easy.

The MEQ 14 also features EQ curve comparison, independent MIDI access for each channel, standard ISO frequency



Now you can customize your curves and store them in 99 locations with the touch of a button.

centers, non-volatile memory and a full security lock-out system.

DigiTech MIDI Programmable Equalizers also come in 4-channel, MEQ 7, and single-channel, MEQ 28. Try one on at your DigiTech dealer.

Spending less time with your equalizer will give you more time to make

music. Now doesn't that make sense?

DigiTech
Start at the top



MEQ 28 Programmable Single Channel 1/3rd Octave Graphic Equalizer



MEQ 7 Programmable Quad Channel 1-1/3rd Octave Graphic Equalizer

DigiTech is a registered trademark of the DOD Electronics Corp. © 1989 DOD Electronics Corp. Manufactured in the U.S.A. 5639 South Riley Lane, Salt Lake City, Utah 84107 (801) 268-8400

Circle #013 on Reader Service Card

AUDITIONS

period on a variety of projects, including vocals and guitars on an all-digital solo album featuring guitarist Danny Kalb (of the Blues Project), I became quite attached to the unit. Acoustic guitar tracks, in particular, really spotlighted the sonic transparency of the preamps, and the equalizer is musical and extremely versatile. For some reason, the cut/boost levels are not indicated on the EQ gain controls, and after making a quick call to SSL, I was surprised to discover that the two center bands are ± 22 dB while the outer bands are ± 20 dB. My guess was that the cut/boost range was in the ± 15 dB range. Be warned that the EQ is so smooth that you may be lulled into using more than is necessary. The four EQ bands are wide-ranging and overlap extensively. (LF: 30 to 450 Hz; LMF: 66 to 2,500 Hz; HMF: 600 to 21 kHz; HF: 1.5 to 16 kHz) and with 20 to 22 dB of cut available, the EQ section can also serve as a notch filter.

The Solid State Logic FX G383 is a well-designed, versatile and superb sounding unit that has much to offer any studio or independent engineer who wants that SSL G Series sound in



Celestion Model 3

a portable package. Priced at \$4,475, it is not inexpensive, but is worth consideration by the serious recordist.

Solid State Logic, 320 W. 46th St., New York, NY 10036; (212) 315-1111.

Celestion Model 3

Celestion speakers are nothing new. In fact, the fruits of this British com-

pany's labors have won acclaim and praise from users worldwide over the years. Guitar players—particularly those who prefer certain 4 x 12 cabinets—are especially fond of that Celestion 12-inch sound; the company's line of portable sound reinforcement speakers are beginning to gain a foothold in this country; and Celestion

ECHO SOUND RECORDING

- ▷ Trident 80C & 80B Consoles
- ▷ Studer A827 & Sony/MCI JH-24
- ▷ Digital Creations ARMS-II Console Automation

Elegant, comfortable working atmosphere.

Los Angeles (213) 662-5291

Circle #086 on Reader Service Card

tion's hi-fi speakers (such as its DL and SL Series) have found favor among both home listeners and many classical recording engineers. What is new, however, is that Celestion has begun marketing its monitors through pro recording outlets, and the Model 3 is the first product in this series.

The Model 3 is a two-way system consisting of a 5-inch, felted-cone, mid/bass driver combined with a 1-inch titanium dome tweeter crossing over at 5 kHz. The enclosure is sealed, constructed of half-inch particle board with a black ash or walnut vinyl veneer, standing just slightly over 12 inches and weighing 8.4 pounds. The grille covers remove easily for cleaning or to appease the majority of us who think that such attachments are unnecessary in the studio environment. Actually, the grilles do provide some protection for the drivers when transporting the speakers, a likely scenario for many traveling engineers.

Specs include a frequency response of 75 to 20 kHz (-3 dB), 60 watts of program handling and a sensitivity of 86 dB at 1W/1m. While the Model 3s are fairly inefficient, they are capable of delivering a maximum sound pressure level of over 100 dB at one meter (at the maximum recommended power)—adequate for my near-field listening needs, which are fairly conservative in terms of overall SPLs. If your taste for average listening levels runs in the greater-than-105dB range, then the Model 3s may not suit your needs (or eardrums).

Since the Model 3 has compact dimensions and lightweight cabinets (ideal for console-top mounting), I was anxious to try them out in a near-field listening environment. The speakers are equipped with what appears to be five-way binding posts, located in a recessed area on the rear baffle. However, the lugs are too widely spaced to accommodate standard, dual banana connectors, and the holes that allow wires to be inserted through the lug shaft are too small to handle wires thicker than 16 gauge. Perhaps this could be remedied in future versions for the pro market, as many studio installations use banana plugs as a convenient way of "quick changing" between various pairs of small, console-top reference speakers.

After listening to the Model 3s for a while, I became accustomed to their "sound." Stereo imaging was natural, especially with the speakers at a typi-

cal near-field listening distance of about one meter, with the enclosures about one meter apart. Midrange balance was consistent throughout the all-important vocal range (as well as at the 5kHz crossover point), while highs were crisp and free of exaggeration.

Low-frequency performance was certainly adequate, considering the system's small dimensions, and after reaching the Model 3's 3dB downpoint (75 Hz), the lows taper off quickly, reaching a 6dB downpoint at 60 Hz. However, bass reproduction is greatly improved when the Model 3s are placed near a wall, which is often the case when consoles are placed flush against a wall, as in many small studios, electronic music setups and video suites. Speaking of the latter, the speakers didn't cause any noticeable visual distortion when kept at least six inches away from a video or computer display, although I advise keeping magnetic media (disks, tapes, credit cards) away from the strong flux fields that may be encountered near any speaker.

Overall, the Celestion Model 3s are consistent and fairly accurate reference speakers, whose compact size and reasonable price of \$280/pair make them a suitable choice for the traveling engineer, independent producer or cost-conscious facility.

Celestion Industries, 89 Doug Brown Way, Holliston, MA 01746; (508) 429-6706.

Prosonus Sampled Strings Library

Over the years, Prosonus has earned a solid reputation for delivering top-quality sampling discs, and it has continued the tradition with a new, four-disc set of stringed sounds.

The collection includes full orchestra (disc 2); violin solo and sections (disc 3); solo and section cellos (disc 4). Disc 5 contains viola and bass, both solo and ensemble. Each disc provides a variety of sounds, including sustained notes sampled in fourths and presented in forte, piano and muted versions, along with pizzicato, tremolo, marcato, glissando and *sul ponticello* (bowed near the bridge) effects. In case you're wondering what happened to disc 1 of the Prosonus strings series, it's a collection of electric guitar sounds released in 1988.

If you've never sampled from a CD sound collection before, you're in for

CD-LIKE
QUALITY
ON CASSETTES!!

KLARITY
CASSETTE

REAL-TIME
CASSETTE DUPLICATION

"THE
ULTIMATE
RESPONSE"

... Find Out How ...

Post Office Square
Waterville, ME 04901
1-800-458-6405
207-873-3911

Circle #087 on Reader Service Card

A SINGER'S DREAM!



REMOVES VOCALS FROM RECORDS!

Our VOCAL ELIMINATOR can remove most or virtually all of a lead vocal from a standard stereo record and leave most of the background untouched! Record with your voice or perform live with the backgrounds. Used in Professional Performance yet connects easily to a home component stereo system. Not an equalizer! We can prove it works over the phone. Write or call for a free brochure and demo record.

Listen..

Before You Buy!

- Time Delay
- Reverberation
- Crossovers
- Noise Reduction
- Compressor/Limiters
- Expanders
- Spectrum Analyzers
- Parametric EQ

Don't have regrets about paying too much for a lesser product. In demos and comparisons, we'll show you why we're Better! Our Factory Direct sales allow us to produce a Superior product and offer it to you at a Lower price. Call or write for a free full length Demo Album and 24 page brochure.

LT Sound, Dept. MX-9, 7980 LT Parkway
Lithonia, GA 30058 (404) 482-4724
24 HOUR PHONE DEMO LINE: (404) 482-2485

a pleasant surprise. Just find the sound range you need, hit "pause" on your CD player, arm your sampler, and load the sounds in. The process is even faster if your CD player can access sub-index points. Since the discs provide sustained note lengths of over four seconds, sampling and looping is a simple matter. A voice announces each upcoming note or section, which is convenient (although the voice can be difficult to hear, since its level is about 20 to 25 dB lower than the samples).

Audio quality for the discs is excellent throughout. Samples were made

using a well-known East Coast orchestra (Prosonus isn't saying exactly who) and were recorded direct to Sony PCM-1630 using two matched Schoeps mics. Post-production and CD prep were handled entirely in the digital domain on a Sonic Solutions Sonic System at the Prosonus studio facility in Southern California.

The solo violin disc includes *col legno* (with wood) sounds, along with knocks, crunches and scrapes. Speaking of the latter, with cuts #33 and #34 on disc 3 (scrapes and more scrapes), you can almost feel the rosin on the bow. This assortment of effects can add a nice touch of verisimilitude to

any string sample.

The collection provides a variety of glissandi and chromatic runs that can be used as-is—even without a sampler—as segues or sound effects. Many of the sounds, such as random pizzicati, harmonic glissandi, *sul ponticello* tremolos, "behind the bridge" and others inspire all kinds of creative applications. Loop one of these, and let it run while you add random string parts playing minor seconds, and in no time you've got an eerie, Bernard Herrmann-esque score that would be perfect for any low-budget sci-fi or horror flick.

If you've been looking for exquisite string samples, the Prosonus String Collection is just the ticket. While the four CD set may seem a bit expensive at \$349.95 (or \$99.95 per disc), having the best string sounds in town will certainly wow your clients a lot more than having yet another \$400 reverb.

CHECK YOUR BALANCE.

Before you invest in a professional DAT recorder, check to see if it stacks up against the Sony PCM-2500:

- Records at 44.1kHz as well as 48kHz
- Has professional SDIF-2, AES/EBU and S/P DIF interfaces
- Has built-in error indicator
- Operates on 100/120/220/240V, 50/60Hz
- Is supplied with both wired and wireless remote control
- Can individually trim L/R analog input and output



If it's a Sony, you can check all of the above — which is what you'd expect from The Leader in Digital Audio™. For more information call 1-800-635-SONY.

PCM-2500

- Recording and erasure of Start ID, Skip ID and Program Number subcodes
- Two-hour recording time (with DT-120 Sony DAT cassette) •Less than 0.005% Total Harmonic Distortion at +4dB •Greater than 90dB dynamic range
- High-speed locate capability at 60 times normal playback speed

SONY®

PROFESSIONAL AUDIO

Sony Communications Products Company,
1600 Queen Anne Rd., Teaneck, N.J. 07666
© 1989 Sony Corporation of America.
Sony and The Leader in Digital Audio are
trademarks of Sony

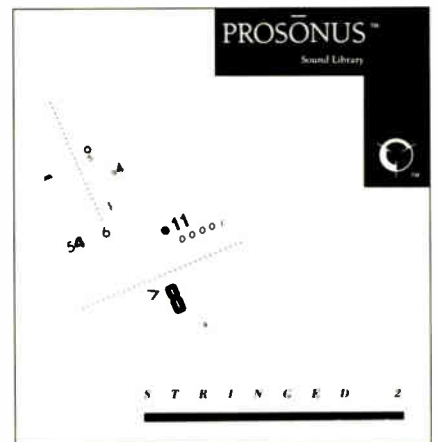

The sampled string collection from the Prosonus Sound Library.

Besides, it's a lot cheaper than hiring the local philharmonic every time you want to sweeten some tracks. On a related note, Prosonus has recently released portions of its sampling collections on preformatted disks for the Akai S900/950, Ensoniq EPS and Akai S1000. The complete string library is also available from New England Digital, in optical disk format for the Synclavier, PostPro and Direct-To-Disk™ workstations.

Prosonus, 11126 Weddington Street, North Hollywood, CA 91601; (800) 999-6191 or (213) 463-6191. ■

Mix products editor George Petersen got his start in the music business playing in bands in Europe during the mid-'60s, where he learned that the Italian word for *bi-hat* is "Charleston."

How To Get The Perfect Mix.

With MAGI II Console Automation Series from J.L. Cooper Electronics.

The mix down process isn't what it used to be. Recording engineers are finding it increasingly difficult to maintain calm, creative control over both the console and the battery of outboard gear. As these demands escalate, the need for console automation is further amplified by the need for perfection. The MAGI II and MAGI III Console Automation Series from J.L. Cooper Electronics are designed to save you time, money and give you the ability to achieve perfection!

Freedom Of Choice

Both MAGI II and MAGI III interface with virtually any console to provide precision SMPTE-locked automation for 8 to 64 channels. The MAGI II is an outboard system for the audio facility preferring "portable" automation that can be moved from desk to desk. The MAGI III is an internally installed system that uses the console's existing faders.

Flexibility & Control

MAGI II memorizes fader, mute and other real time events. These events can be performed in as many passes as you wish, or you can work on the mix one section at a time, or even one track at a time. MAGI II can be used to automate effects sends and sub-groups as well as controlling your outboard effects processors. The MAGI II allows



MAGI II External System

a very complicated mix to be quickly constructed, edited, and refined in real time or off-line with absolute accuracy. In addition, these mixes can be saved to disk for future use.

Fast, Intuitive & Transparent!

Every aspect of MAGI II has been designed for the working engineer. MAGI II features a straight ahead user-interface incorporating clean, uncluttered moving fader graphics that make it extremely easy to learn and use. Even a "guest engineer" can be up and running in 15 minutes!

MAGI II and MAGI III Features:

Both the MAGI II and MAGI III feature high quality dbx VCA's for audio transparency. The MAGI II Controller reads and generates all SMPTE formats. The powerful software program runs on either a Macintosh or Atari computer.

standard music recording, to film, TV, broadcast, commercial and live sound. MAGI is automating consoles from Trident, Soundcraft, Allen & Heath, Harrison, D & R, Biamp, Neotek, Tascam, DDA, Soundworkshop, Soundtracs, AMEK/TAC and Ramsa.

Guaranteed Satisfaction!

J.L. Cooper Electronics and its Authorized Dealers are confident that once you own MAGI II, you'll never go back to manual mixing again. So confident that we're putting our money where our mouth is. For a limited time, our participating dealers are offering a money back guarantee.* If you're not totally satisfied within 30 days, return the system and they'll refund your money.

With the cost of perfection finally within reach, why wait? Call us today for the location of a dealer in your area. It's time to see what MAGI II can do for your mixes.

Mixes may be performed and edited in real time, or off-line with MAGI II's powerful cue list. Cut, Copy, Paste, Merge, Undo, Redo, and other precise numeric edit decisions are fully supported. Our MIDI Event Generator allows the recording and triggering of all types of MIDI events. Film and Video composers can take advantage of our hit list to spot cues in real time. No other automation system gives you this flexibility!

The Bottom Line

Other manufacturers would like you to believe that an automation system must have a high price tag to be on the cutting edge. The MAGI II dispels that myth. The MAGI system with its wealth of professional features starts at just \$5,000.00, and it works! That's the bottom line.

MAGI is being used in a number of applications from

The Video

You can preview the MAGI II with our video demonstration. This Video offers a complete overview of the system's operation. It's just \$13.95 and can be charged to your VISA or MasterCard. To order, contact J.L. Cooper Electronics at:

(213) 306-4131.

JL COOPER ELECTRONICS

13478 Beach Avenue · Marina del Rey, California 90292 · FAX 213-822-2252

*limited restrictions may apply, contact your local dealer for details

World Radio History

Circle #056 on Reader Service Card

USING DAT

A Maintenance Point of View

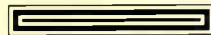

by **Richard
Maddox**

A

little over three years ago, Muzak™, the background music industry leader, decided to go digital. The plan was to transmit several Muzak channel formats, via satellite, directly to end-users. An integral part of this plan was to automate playback using Sony CD jukeboxes.

Muzak uses large quantities of music not available on CD, therefore it was necessary to find a CD-equivalent tape playback system—one that didn't cost a fortune and that could be integrated quickly. DAT seemed to be just the ticket.

Since the decision was reached, Muzak has put almost 100

DAT machines into service, predominantly Sony DTC-1000ES decks, although the company also uses a dozen Sony PCM-2500s and a half-dozen Fostex D-20s. Muzak is the biggest user of DAT machines in the U.S. today.

The first units went online two years ago, and since that time Muzak has found itself intensively involved

with DAT maintenance. In fact, the Sony parts depot in Kansas City sometimes has a hard time keeping up with Muzak's orders for DAT spare parts.

This brings up the hidden cost of using DAT. The format seems fairly inexpensive at the start—under



\$3,000 for a semipro digital deck with specs that equal or beat the highest priced analog reel-to-reel machine. But with this new format, you must also factor in the cost of new test tapes, test fixtures, service manuals, specialized test gear and tools, and a raft of spares for those inevitable emergencies.

The bottom line: Even with an affordable format like DAT, digital audio doesn't come cheap. Whether maintenance is handled in-house or contracted

out, there are a lot of expenses that may not seem apparent at the onset.

Tooling Up for DAT

For most studio managers, tape deck maintenance is a cut-and-dried part of the budget. Regular cleaning and alignment is understood, as is the fact that heads wear out and must be reconditioned, reel table motors go south and must be rebuilt, and pinch rollers

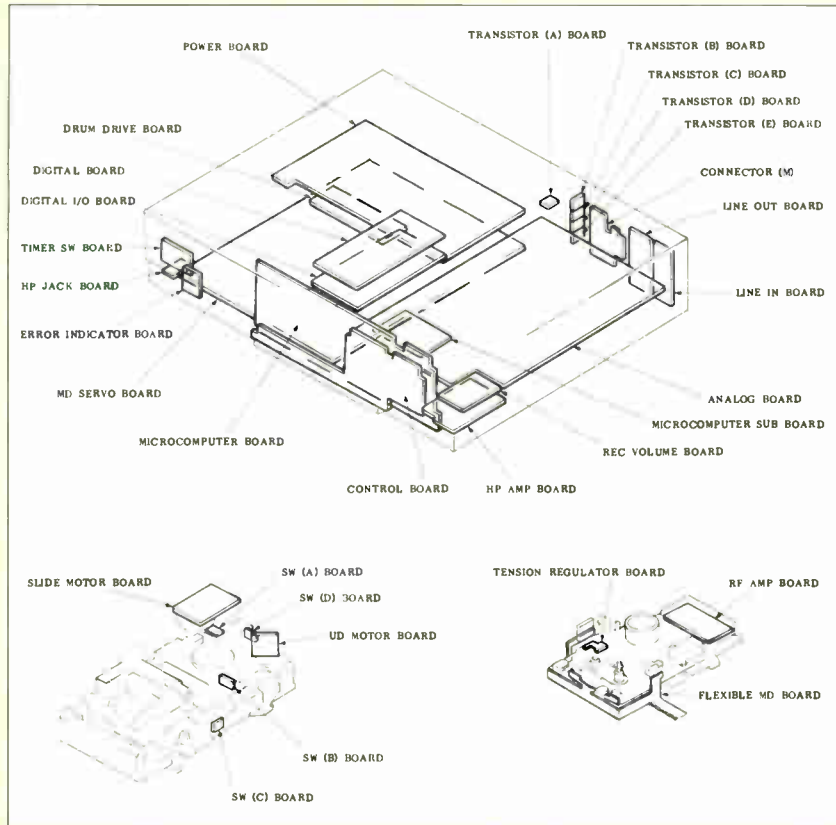

Figure 1: Circuit board locations in the Sony DTC-1000ES and PCM-2500.

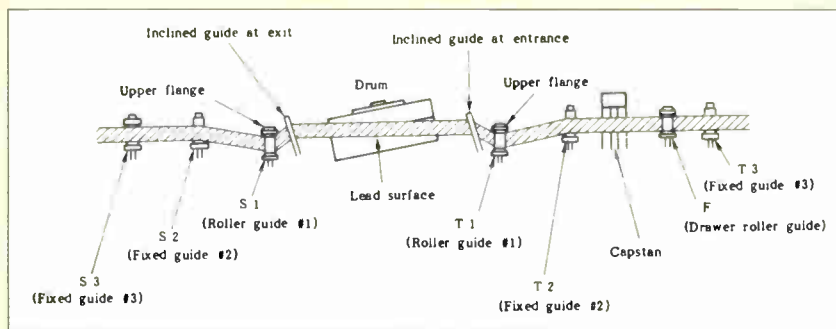

Figure 2: Tape path is very important to DAT reliability and tape interchangeability. In most cases only S1 (supply roller guide) and T1 (take-up roller guide) require adjustment. This is especially true when the head drum is replaced.

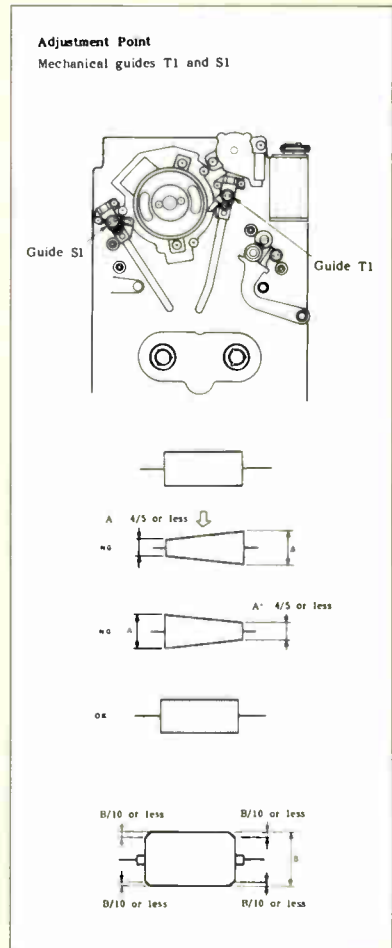

Figure 3: Mechanical adjustments are performed using an alignment tape and monitoring the RF envelope. The S1 guide controls the leading edge envelope squareness, while T1 adjusts the trailing edge squareness.

The World's Most Advanced Stereo Broadcast Consoles



The SL 5000 M Series is an open architecture console system comprising a wide range of standard audio and control cassettes in a variety of mainframe sizes. It can be configured to exactly match your current and future requirements. The use of standard cassettes eliminates the service and maintenance problems often associated with systems of this sophistication.

A unique sectional grid distributes audio and control busses throughout the mainframe, interlocking master and local facilities in virtually any combination you desire. This makes a wide range of applications possible – live radio, continuity, outside broadcast, film and video post production.

The SL 5000 M Series retains the full benefit of computer-assisted operation and centralised assignment, where appropriate. Dynamic fader automation, optional motorised faders, and SSL's Instant Reset™ and Total Recall™ computer systems provide maximum control of these advanced functions.

At last the specialised requirements of broadcast audio production can be served by a new level of operational efficiency and creative flexibility.

SL 5000 M Series mainframes are available in 3 depths and from 8 to 128 channels wide, allowing consoles of almost any size and capacity.

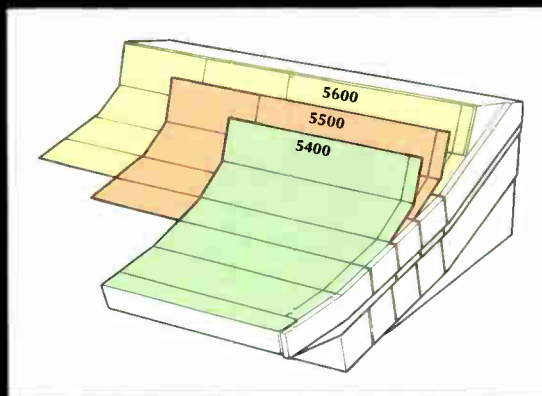

The SL 5000 M Series is used by:

ABC TV, USA	Nippon Hoso, Japan
Bayerische Rundfunk, FRG	Paris Omnisport, France
BBC Radio, UK	RTE, Eire
BBC TV, UK	SRG, Switzerland
Radio Bremen, FRG	TBS, Japan
Fox TV, USA	TVS, UK
ITN, UK	Videotime, Milan
NRK, Norway	YTV, UK

Solid State Logic SL 5000 M SERIES

Begbroke, Oxford, England OX5 1RU (0865) 842300

London (071) 706 4948 • Paris (1) 34 60 46 66 • Milan (2) 612 17 20 • New York (212) 315 1111 • Los Angeles (213) 463 4444

• Toronto (416) 363 0101 • Tokyo (03) 5474 1144

U.S. Toll Free Number 800 347 0101

harden and must be replaced.

But you cannot apply the same principles to DAT machines, because their maintenance requirements do not resemble reel-to-reel or cassette machines at all. Their maintenance budget and schedules are closer to those of VCRs, as are the requirements for test gear and procedures.

Table 1 lists some of the test tools, tapes and jigs necessary to do any alignment or service on Sony or Fostex DAT recorders. Other decks, such as Tascam, Nakamichi, JVC, Panasonic, etc., will require many of the same items, although their test tape requirements may vary.

It's not a long list, but the prices add up. For instance, the Sony head checker is \$141 and the Sony DAT test tapes run \$56 to \$79 each. Add in a torque tape or two at \$158 each, the error checker jig at \$31 (the best investment there is), the hold down jig at \$70 (for running tapes when the elevator assembly is out), a service manual or two at \$25 each, and you're in the \$800 range—just for test tapes and test fixtures for the Sony machines.

Add on top of this a dual-trace, 60MHz or better scope—without which you'll have a hard time doing several alignments—and specialized tapes and tools necessary for any other model DATs you may have, and you can see that maintaining your DAT machines will be an expensive proposition.

If you don't intend to do in-house repair on your DATs, you'll have to rely on factory service, as trained DAT technicians are not in abundance in most sections of the country.

Sony DAT Spare Parts

The availability of replacement parts for DAT recorders is currently unreliable. Typically, it takes Muzak up to three months to get parts from Sony, since Kansas City often doesn't have them in stock. Even head drums—a high usage item as the machines age—are not kept in stock.

Table 2 lists the most commonly replaced Sony parts and their prices, but you can figure any DAT will need similar parts (at equal or higher prices).

This is especially the case with head drum assemblies, since their lifespan is only 1,000 to 2,000 hours. In Muzak's case (running two shifts per day) some machines require head drum replacement after only six months of use. Even in machines that operate around 20 hours per week, 1,000 head drum

hours are achieved after only a year of use.

Troubleshooting DAT problems can be nearly impossible without a complete set of digital boards for substitution, since virtually any problem is manifested by audio dropouts or digital glitches in the music. There are so many LSI chips tying directly together that even Sony's service centers don't try to troubleshoot some boards to the component level. (See Fig. 1.)

However, most DAT problems are mechanical rather than electronic in nature, but without spare test boards

or a functioning second machine from which you can borrow parts, you can end up spending hours making mechanical and electronic alignments to no avail. The DAT's servo system is much like any modern tape transport system, with interlocking drive and feedback that can cause a problem in one section to show up everywhere in the loop.

DAT Maintenance

Regular cleaning and maintenance on all but the Nakamichi 1000 (which offers an easily exposed head drum) requires removing the top cover to

**CONSOLES • ANALOG/DIGITAL • INSTA
RECORDERS • MAG FILM RECORDERS •
WORKSTATIONS • DAT • VIDEO MIXERS
SYNCHRONIZERS • MICROPHONES • W
SPEAKERS • PROJECT CONSULTATION •
INSTALLATIONS • WIRING • TAPE • ENGI
ENGINEERING • MOTION CONTROLLER
EDITORS • TURNKEY SYSTEMS • CONSO
ANALOG/DIGITAL RECORDERS • MAG I
RECORDERS • WORKSTATIONS • DAT • V
VIDEO MIXERS • SYNCHRONIZERS • MA
SPEAKERS • MICROPHONES • PROJECT
CONSULTATION • INSTALLATIONS • EDI
WIRING • ENGINEERING • TAPE • MOTIC
EDITORS • TURNKEY • T
CONSOLES • ANALOG/DIGIT
MAG FILM RECORDERS •
• DAT • VIDEO • MIXERS
S • MICROPHONES • M
JECT CONSULTATION •
• WIRING • TAPE • ENGI
ENGINEERING • MOTION CONTROLLER
EDITORS • TURNKEY SYSTEMS • CONSO
• ANALOG/DIGITAL RECORDERS • MAG
FILM RECORDERS • DAT • VIDEO MIXERS •
VIDEO MIXERS • SYNCHRONIZERS • MA
SPEAKERS • MICROPHONES • PROJECT
CONSULTATION • INSTALLATIONS • EDI
WIRING • ENGINEERING • TAPE • MOTIC**

**NO
TROUBLE
AT
ALL!**

**INTRODUCING THE
SONIC SYSTEM™
COMPLETE
COMPACT DISC
EDITING, PREP AND
CD RECORDING.**

AUDIO INTERVISUAL DESIGN
1032 N. SYCAMORE AVE. • HOLLYWOOD, CALIFORNIA 90038 • (213) 469-4773

MICROPHONES • SPEAKERS • PROJECT

Circle #095 on Reader Service Card

MC • VISA • AMEX • DINERS • DISCOVER HRS: MON-FRI 10AM-6PM SAT 12PM-5PM

DAT

AUDIO GALLERY

AMERICA'S BEST PLACE TO BUY
DIGITAL AUDIO TAPE RECORDERS

- Best Prices
- Best Service & Best Warranty
- Newest Models in Stock
- Demos Available
- No Commission Sales Staff
- DAT Accessories, PCMs, more

*Don't be deceived by imitators.
We are the original DAT stereo
store in the USA! We're the
1st and we're still the best.*

Call us before you buy elsewhere

AUDIO GALLERY

"the friendly store"

213 • 829 3429

2716 Wilshire Blvd
Santa Monica, CA 90403
FAX: 213 • 829 0304

*Ask about the DATRAX 60,
an attractive solid
oak DAT tape
storage unit!*

Circle #096 on Reader Service Card



ACE MUSIC CENTER

THE PRO'S CHOICE
FOR PROFESSIONAL
EQUIPMENT FOR
OVER 30 YEARS.

CALL **ACE**
AND FIND OUT WHY

1-800 446-4ACE

13630 WEST DIXIE HWY.
N. MIAMI, FLA. 33161

Circle #097 on Reader Service Card

**Table 1: Alignment Tapes and
Test Fixtures for Sony DAT Maintenance**

TOOLS

- ISO #1 and #2 screwdrivers
- #0 Phillips screwdriver
- #0 flat blade screwdriver
- Chamois tip swabs (Chemtronics CC50 or equiv.)
- Cotton swabs (3- or 6-inch wooden stick type)
- Alcohol
- Freon (or Trichloroethane)
- Rubber cleaner
- Metrix hex set

TEST TAPES & FIXTURES

- Service manuals
- DAT error indicator board (for Sony DTC-1000, PCM-2500)
- Sony TY-7111 test tape, for RF envelope
- Sony TY-7251 test tape, for ATF
- Sony TY-7551 test tape, for level and function
- Hold down jig
- Head checker
- Work stand for Sony DTC-1000/PCM-2500
(can be fabricated out of the wooden side panels that
come on the DTC-1000)

gain access to the transport area. Sony recommends head drum cleaning after every ten hours of use. Muzak's experience has shown that regular cleaning, every two to four weeks, is sufficient for decks that are used about 20 hours per week.

There are commercial cleaning tapes available, but most DAT users have found that these don't properly clean the head drum. The same is true of VCR cleaning tapes. These are a

poor substitute for using a deerskin or chamois head cleaning swab soaked in ethyl alcohol or another head cleaning chemical.

As with other tape transports, the DAT capstan needs cleaning on a regular basis, as do the pinch roller and tape guides. A standard 3-inch cotton swab, soaked in Freon or other light solvent, works well.

Muzak mounts its DAT machines on 19-inch rack shelves. On the Sony

Table 2: Sony DAT Spare Parts

<i>Sony number</i>	<i>Part Name</i>	<i>List Price</i>
X-3337-610-1	Pinch Roller Assy.	\$14.61
8-848-501-01	Head Drum Assy.	144.92
8-835-205-01	Reel Motor Assy.	169.88
8-835-206-01	Capstan Assy.	124.21
A-2020-081-A	MD Servo PCB	218.71
A-2096-052-A	RF Amp Assy.	64.78
A-2095-597-A	Drum Drive PCB	62.91
A-2097-007-A	Digital PCB	192.34
3-337-626-01	Pinch Roller Cap	—
3-701-436-11	Plastic Retainer Clip	—
	Rubber Cleaner	
	Metrix Hex Set	



Westwood One Companies

proudly

salute

our

nominee

for this

years

Technical

Excellence

&

Creativity

Award



THE WESTWOOD ONE MOBILE RECORDING UNITS

For Outstanding
Institutional Achievement/
Remote Recording Facility

DTC-1000ES models the wooden side panels and all cover screws except for the front pair have been removed. This way, a unit can be easily cleaned while in the rack, simply by pulling it out about six inches, removing the remaining two cover screws, and sliding the cover back to expose the transport.

Opening the drawer moves the elevator assembly out, exposing enough of the drum area for manual cleaning of the heads with a chamois swab. This is preferable to the Sony-suggested method: removing the elevator assembly from the transport,

which means taking off the front panel of the machine.

Use a cotton swab to hold the drum still for cleaning and to turn it to gain access to both heads (or all four in the case of 4-head drums). The chamois stick should be lightly rubbed against the head in the direction of head rotation. No up/down movement should be used as the head is small and fragile and can be damaged with an up/down pressure. Clean the capstan and pinch roller at the same time. The guides rarely need cleaning, but should be inspected.

If you find that the head drum

becomes clogged (i.e., dropouts or digital errors are detected) after less than a week of steady use, it's a good indication that the heads are on their way out. This is especially true if the machine has over 1,000 hours of use. To simplify the determination of head drum wear, Sony added an elapsed time indicator in its TCD-D10PRO portable DAT machine.

Maintenance Tips

The Fostex D-20 comes with a series of DIP switches on the back panel that put the machine into various test modes and special functions. When DIP switch A-8 is turned on and PROG. NO. is selected using the Display Key, the display reads out the number of errors that are being detected as a tape plays back. It magnifies the accuracy over that shown by the front panel green and red LED error and correction indicators. An ideal count would be in the zero to four range, while a count of 20 or more errors will light the green correction LED.

To put the Sony DTC-1000 or PCM-2500 into test mode, one of the test points inside the machine (pin 2 of CNT51) must be grounded. The easiest method is to make a test lead by crimping a female RS-232 pin onto a 12-inch test lead with a mini-alligator clip on the other end. The alligator clip is attached to the chassis. The test mode can be confirmed by pressing the front panel Counter Mode key three times.

Sony's error checker board plugs into the digital board and uses three LEDs (green, yellow, red) to indicate relative error rates. A properly aligned head should show no LEDs, or at worst a few flashes of the green LED per minute. Solid green or heavy flashing of green and yellow indicates alignment problems or head clogging. Red flashes usually indicate serious misalignment or head clogging, and often can result in muting or audio dropouts. The error checker board is essential to monitoring head alignment accuracy.

When working on Sony DATs, you must swing the MD servo board out from the chassis. To operate the machine, you can construct a test stand. If three sets of the wooden side panels (from the DTC-1000ES) are available, they can be bolted together in a U-shape and then fastened onto the machine using the original cover mounting screws. This allows the MD servo board to hang vertically below

Call Get A 77 Page Free Catalog

Name Brands

No
Down
Payments

At The End You Will Own For Only \$1.00

Mixing Consoles 40-Channel	per mo. \$495.00
Mixing Consoles 32-Channel	per mo. \$410.00
Mixing Consoles 24-Channel	per mo. \$295.00
Mixing Consoles 16-Channel	per mo. \$165.00
Digital Processors/Effects	per mo. \$ 45.00
Digital Mixers & Digital Peripherals	per mo. \$ 45.00
Signal Proc., Power Amps, Speaker Sys.	per mo. \$ 40.00
	per mo. \$ 35.00

Commercial Power Amps
Keyboard Mixers
Power Mixers
PA Speakers
Stage Monitors
Microphones
Recording Equipment

NO
TAX
RETURNS

NO FINANCIAL STATEMENTS

24 HOUR APPROVAL

CALL

504-837-7368 800-231-0486

* CREDIT PERMITTING

Universal Entertainment Group

Accessories and Much More

Circle #089 on Reader Service Card

TAKE YOUR FIRST STEP TOWARD A CAREER IN THE MUSIC BUSINESS.



- Highly selective, two-year training program
- Campuses throughout North America
- Current theory mixed with practical hands-on training
- Modern state-of-the-art 24-track recording studios and digital audio labs
- All classes taught by qualified, working professionals
- Job placement assistance
- Financial assistance available
- Fully accredited by ACCET

TEC
1989 NOMINEE

TEC
1990
NOMINEE

TREBAS

INSTITUTE OF RECORDING ARTS

6464 Sunset Blvd., Penthouse Hollywood, CA
U.S.A. 90028 (213) 467-6800

112 East 3rd Ave., Suite 305, Vancouver, B.C.,
Canada V5T 1C8 (604) 872-2666

410 Dundas St. East, Toronto, Ontario,
Canada M5A 2A8 (416) 966-3066

440 Laurier Ave. W., Suite 200, Ottawa, Ontario,
Canada K1R 7X6 (613) 732-2231

451 St. Jean Street, Montreal, Quebec,
Canada H2Y 2R5 (514) 845-4141

the chassis for hooking up test probes and adjusting trim pots.

Changing Head Drums

Sony offers a head-checker tool, which is similar to a battery tester in that it gives a simple yes/no indication of head wear. Once the scale indicates "replace head drum," it's time to change your head drum. Can't get much more simple than that.

Lacking a head-checker tool, you can check for excessive head drum wear by looking for dropouts and digital glitches shortly after cleaning the head drum. Recleaning the drum

will alleviate the symptoms for a short time (one or two tapes will play before dropouts start to occur again), a pattern that is identical to head wear on VCRs.

Changing a DAT head drum is easier than changing heads on a cassette machine since there is no physical alignment required on the drum itself. All models are keyed to simply drop in place and tighten down.

Alignment of the S1 and T1 roller guides (see Fig. 2) is usually required and is critical to proper functioning of the machine, as is RF gain and head switch timing. Fig. 3 shows the Sony

mechanical transport with examples of good and bad RF signals. The S1 guide adjusts the input side of the RF envelope, and the T1 guide adjusts the exit side of the envelope. Usually, most other alignments are within specifications after a head drum change.

The most time is spent getting to the head drum assembly in the first place. In the Sony machines, this requires that the top and bottom covers, the front panel and the elevator assembly be removed, and that the MD servo board be opened up (which requires the test stand).

The head drum is held in place by two #0 Phillips screws. A flat cable connects the head drum to the drum drive board, and two cables (for the heater and the RF in/out) go to the power supply board and RF amplifier. These must be unsoldered and then attached to the new head drum assembly.

When mounting the Sony head drum be sure that the flat cable going to the drum drive board is looped below the board rather than above, where it may rub against the drum.

Typical Sony DAT Problems

As DAT recorders age, Muzak has noted certain recurring problems. Some of these are common to all machines, caused by mechanical and/or electronic drifting as components wear, but others are unique to the Sony DTC-1000/PCM-2500/TCID-D10PRO transport.

1. *Eating Tapes.* Check for sticky guide arms. This is especially prevalent after about six to ten months of use. The "F" drawer roller guide (after the pinch roller) is spring-loaded to easily retract as the tape is pulled back into the housing during unloading. If this guide becomes sticky, the tape will not be pulled into the housing completely before the elevator assembly lifts up, closing the cover onto the extended tape.

To clean the guide, the capstan assembly must be removed (this requires opening the MD servo board), and then the guide must be removed and cleaned with freon. It's held in place with a very small plastic retainer clip. Fortunately, the capstan is easy to remove, being held in place with three #0 Phillips screws accessed from the top side of the transport.

2. *Dropouts.* Muting, dropouts and digital glitches can be caused by anything and everything in a DAT machine. It is probably the most com-

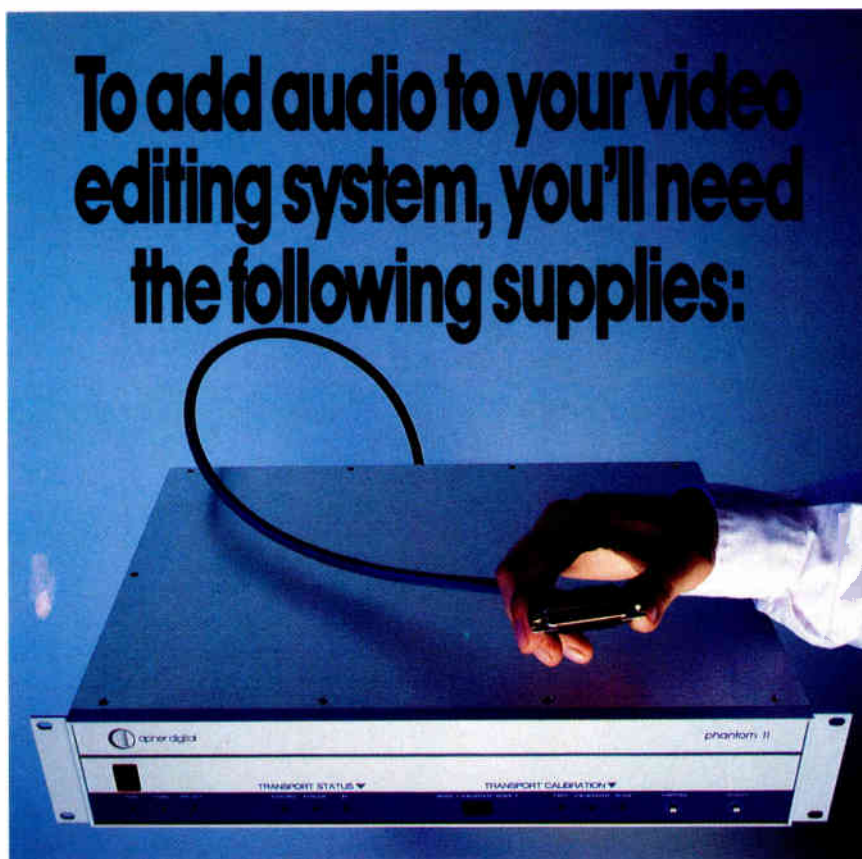

The only equipment you'll need to add audio to your video editing system is the Phantom II VTR Emulator from Cipher Digital. The Phantom II can interface any video editing system that uses Ampex, Sony, or CMX protocol with 77 different tape machines — even older VTRs like the VPR-2.

To find out if your equipment is compatible with the Phantom II, or if you'd like a copy of our complete list of compatible audio transports, just give us a call toll-free at 1-800-331-9066.



cipher digital, inc.

5734 INDUSTRY LANE, FREDERICK, MD 21701
TOLL-FREE 1-800-331-9066
(301) 695-0200 FAX: (301) 694-5152 TELEX: 272065

Circle #099 on Reader Service Card

Ear Candy

Suggested U.S. Retail Price \$349.00



Introducing MIDIVERB® III, the new Alesis multi effects processor that's like candy for your ears. 16 bit digital reverb, delay, chorus/flange, and E.Q. available simultaneously to sweeten your mixes with the kind of legendary MIDIVERB sound that won the TEC Award* for technical excellence.

MIDIVERB III's all new design delivers more depth and character than you've ever heard in a digital signal processor. And it's so easy to use you won't believe it's programmable. A friendly user interface makes personalizing the 100 factory presets a breeze. And you can store

your custom effects in 100 additional memory slots. That's 200 programs in all: 100 of ours and 100 of yours.

15 kHz bandwidth, real time MIDI control, and programmable reverb and delay levels complete the package.

But the most important feature of MIDIVERB III is its presets. The best sounding preset effects programs available anywhere at any price. So you can choose a program and start making music immediately.

Pick up a MIDIVERB III at your Alesis dealer today. Great sound. Great presets. Easy programming. And, it's a MIDIVERB.

TEC
TECHNICAL EXCELLENCE & CREATIVITY

1990
NOMINEE



LOS ANGELES:
Alesis Corporation • 3630 Holdrege
Avenue • Los Angeles, Ca. 90016
LONDON:
Alesis Corporation •
15, Letchworth Point • Letchworth,
Hertfordshire SG6 1ND.

* Midiverb II won the 1988 TEC award for technical excellence and creativity in signal processing. Awarded each year at the Audio Engineering Society Convention.

Circle #022 on Reader Service Card

World Radio History

The MIDI LAN*
has Arrived...

MidiTap...
Create the
Virtual
Studio...

COMMAND

EDIT

EXIT

ENTER

LANSCAPE STUDIO

MODE

STATUS

PARAMETER

MidiTap

VirtualLink

LONE WOLF



LONE WOLF



1505 Aviation Boulevard Redondo Beach CA 90278 (213) 379-2036 Fax: (213) 374-2496

World Radio History

* MIDI LAN - MIDI Local Area Network

Circle 20 on Reader Service Card

mon symptom. If there is a rhythmic quality to the dropouts or muting (occurring about every one to two seconds), then suspect the RF amp module. It normally switches the heads between record and playback, and if defective, can oscillate between recording/playback sections.

Dropouts are often caused by dirty or worn heads, although it is just as likely that either the S1 and T1 tape guides are off or an electronic adjustment has drifted.

Dropouts can also be caused by the DAT cassette cover slipping forward and hitting the reels during record or playback. Because the DAT transport has a very low torque, this extra drag can adversely affect transport operation. This can also cause the Caution indicator to be displayed. Sony DAT tapes are sometimes prone to this occurrence. Because of their construction, the holdback springs seem to loosen after only ten or 20 openings and closings. As a result, Sony alignment tapes typically must have their reel covers taped in the "open" position during use.

3. "Caution" Errors. The Caution light indicates that the tape has stopped moving or there is excessive moisture inside the machine (which can cause the tape to stick to the head drum). In many cases, this can be traced to sticky reel table brakes. Cleaning the reel table and brake pad will sometimes help, although replacing the assembly is an alternative if a spare is available. Often this will occur when the unit is first powered up after sitting in a cold studio overnight, so the easy solution is to leave it on full time.

In short, startup and maintenance costs for DAT can put a small studio in over its head financially. But in light of the fact that DAT is indeed the lowest priced digital recording technology available, these limitations may seem minor. Studio owners would be well-advised to weigh DAT's limitations (head wear, lack of servicing options, and the new test tools that must be acquired) against its advantages (signal-to-noise ratio, frequency response and distortion) to see how well DAT fits into their mix. ■

Richard Maddox is senior studio engineer at Muzak, a freelance writer and author of World Satellite TV and Scrambling Methods and Troubleshooting and Repairing Satellite TV Systems.

CRT

Custom Products, INC.

- CRT OFFERS COMPLETE CUSTOM PACKAGING ON ALL ORDERS.
- JACKETS, VHS BOXES, CASSETTE INSERTS, ETC. DESIGNED BY OUR COMPLETE, IN-HOUSE ART DEPARTMENT.
- WE SPECIALIZE IN FOUR-COLOR PRINTING: BROCHURES, POSTERS, COMMERCIAL PRINTING AND MUSIC RELATED PRODUCTS—SUCH AS 12" and 7" RECORD JACKETS, BACKDROPS, VIDEO BOXES & LABELS, CD PACKAGING.
- QUALITY, CUSTOMER SERVICE, EXPEDIENCY AND CLOSE PERSONAL ATTENTION ARE GUARANTEED IN THE MANUFACTURING OF YOUR ORDER.
- CRT'S PRICING IS VERY COMPETITIVE IN THE CUSTOM MARKET. WE STRIVE TO KEEP OUR PRICES AS LOW AS POSSIBLE, MAINTAINING THE HIGHEST QUALITY.
- CRT IS COMMITTED TO PROVIDE THE BEST SERVICES. OUR CUSTOMERS DESERVE AND EXPECT NO LESS.

COMPLETE CUSTOM PACKAGING

- CASSETTE DUPLICATING
- COMPACT DISCS MANUFACTURING
- FULL COLOR PRINTING
- VHS & CASSETTE BOXES



• Call for personal quote today our **TOLL FREE NUMBER 1-800-453-2533** •
 In Tennessee call (615) 298-4533 • Fax (615) 383-2090
 or write
 CRT, CUSTOM PRODUCTS, INC. • 4800 TENNESSEE AVE. • NASHVILLE, TENNESSEE 37209-2238

Circle #100 on Reader Service Card

DIGITAL MASTERSOUND FULLERSOUND

COMPLETE DIGITAL MASTERING SERVICES FOR:

- Compact Disc •
- Records •
- Cassettes •
- Archiving Analog to Digital •

NEVE DTC DIGITAL TRANSFER CONSOLE:

All mastering parameters performed completely in the digital domain and fully automated for precise accuracy and repeatability.

Sony 1630/DMR-4000
 Sony 3202 DASH
 Sony 2500 R-DAT
 Sony 601 (Beta/VHS)
 Mitsubishi X-80

CREDITS: Dirty Dancing Soundtracks, Eric Carmen, Expose, Will to Power, Eric Clapton, Betty Wright, Bee Gees, Judas Priest, Julio Iglesias, and many more.



FULLERSOUND, INC.



1990
NOMINEE

Engineer: Michael Fuller

1755 N.E. 149 STREET / MIAMI, FLORIDA 33181 / (305) 945-6697

Circle #101 on Reader Service Card

World Radio History

JULY 1990, MIX 87



THE 1990 TECHNICAL EXCELLENCE & CREATIVITY AWARDS VOTER'S GUIDE

In 1984 it was just an idea—a way to generate publicity and acknowledge a little-recognized segment of the audio industry. The publishers of *Mix* magazine sat down and decided to create an awards show with a twofold purpose: to honor the imagination and achievement of the people and products behind the scenes in professional audio; and to raise money for audio scholarships and charitable organizations that work in the field of deafness research and hearing disabilities. No one could have foreseen that the Technical Excellence & Creativity Awards would become such a respected part of the industry so quickly, with the unique TEC Award a coveted symbol of achievement.

“Nothing that *Mix* magazine has accomplished over the past six years has been more gratifying to me than the enthusiasm and generosity shown by our industry toward the TEC Awards,” says Hillel Resner, publisher of *Mix* magazine and executive producer of the TEC Awards. “No one had to support this effort. That almost everyone has is a real tribute to audio professionals.”

Now, six years later, the TEC Awards have been attended by almost 3,000 people and raised close to \$100,000, contributing nearly \$50,000 to scholarship programs for students in audio. Half of this money has gone to recording schools which have won the TEC Award for Outstanding Recording School/Program: Berklee College of Music (1985-87), University of Miami (1988) and Full Sail Center for the Recording Arts (1989). The other half has gone to the AES Educational Foundation.

In addition to audio education, the TEC Awards have made substantial contributions to research and education in the cure and prevention of hearing disabilities through the Deafness Research Foundation (1985) and the House Ear Institute (1986 to the present). Each year the TEC Awards target a different area to receive the money. This year the funds generated will go to the House Ear Institute's Hearing Is Priceless (HIP) campaign, co-sponsored by *Mix* magazine.

“*Mix* magazine and the TEC Awards are doing something wonderful,” says Dr. John House of the House Ear Institute. “They are helping to prevent hearing loss by educating the public.”

In an effort to build upon the accomplishments of the TEC Awards, *Mix* magazine and ACT III Publishing have created the Mix Foundation for Excellence in Audio, a tax-exempt charitable organization incorporated in the State of California. The foundation was formed to encourage public interest in and understanding of the audio, video, music and other communications media arts. As part of this general purpose, the foundation will support and/or present charitable and educational programs to encourage excellence in this field, as well as programs which work to cure, prevent and promote understanding of hearing impairment and other hazards related to the communications media arts.

The TEC Awards will be a cornerstone of this new foundation. Beginning this year, all proceeds of the TEC Awards will be donated to the Mix Foundation for Excellence in Audio, which will be responsible for distributing the funds to the beneficiaries.



C. F. KING



The awards are divided into three major categories—Technical, Institutional and Creative Achievement—and 21 sub-categories. Choosing the TEC Awards winners is a two-step process. The initial selection is made by the Nominating Panel, comprised of prominent members of the audio industry. *Mix* subscribers then vote on the 126 nominees whose names appear in this issue; the ballots are tabulated by a certified public accountant. The results will be announced at a gala ceremony to be held on Sunday, September 23, at the Biltmore Bowl in Los Angeles.

In 1988, the producers of the TEC Awards created the TEC Awards Hall of Fame in order to recognize the contributions of those special individuals who, during their lifetimes, have exemplified the pursuit of excellence in our industry. Past inductees are Wally Heider, Bob Lifting, Les Paul, George Martin and Rupert Neve. This year the Hall of Fame will honor Deane Jensen, Quincy Jones and George Massenburg.

If you would like more information about the TEC Awards or the Mix Foundation for Excellence in Audio, contact Karen Dunn, TEC Awards Executive Director, at (415) 420-0144.



HEARING IS PRICELESS

No human faculty is more critical to our own industry than the ability to hear. Ironically, as the technological knowledge of sound reproduction has developed to previously unimagined levels, so to has the threat to our hearing from sophisticated sound sources. It seemed both sensible and responsible to the founders of the TEC Awards to contribute a part of the proceeds to the research and prevention of hearing disabilities.

For the past five years, 50% of the ticket revenues have been donated to the House Ear Institute of Los Angeles, California.

HEI is a world-renowned research center dedicated to clinically applied research, professional education and the prevention, treatment and diagnosis of hearing disorders. Affiliated with the Saint Vincent Medical Center and the USC School of Medicine since 1960, HEI is best known for its development of the cochlear implant, which provides some hearing capability to the profoundly deaf. Contributions by the TEC Awards have been used for general research, a cochlear implant for a needy child, and scholarships for families to the "Sharing is Caring" family camp, which brings together families with both deaf and hearing children in an attempt to help all members of the family better understand each other's worlds.

HEI's share of this year's proceeds will go to the Hearing Is Priceless (HIP) campaign. Co-sponsored by *Mix* magazine, this nationwide effort is attempting to increase the public's awareness about the adverse effects of loud noise on hearing. The program will include two phases. The first, launched at Hollywood High in Los Angeles in January 1990, targets the youth audience and emphasizes the dangers of loud rock music. The second phase will be aimed at excessive noise in other forms of recreation, including motorcycles and race cars.

In Southern California, the campaign included the distribution of a record espousing the virtues of HIP and hearing safety, featuring lyrics and music by Brooks McCarter, at Musicland and Sam Goody music stores. Nationally, there have been media interviews with HEI physicians (including a recent piece by Dr. Art Ulene on the *Today Show*), public service announcements and resource literature.

The HIP advisory board is headed by guitarist Jeff "Skunk" Baxter" (former member of Steely Dan and the Doobie Brothers), and is composed of leading





recording and entertainment figures from around the country, including *Entertainment Tonight's* John Tesh, soap opera star and musician Michael Damien, one of the original MTV VJs Nina Blackwood and former Ambrosia band member David Pack.

If you are interested in learning more about the HIP campaign or the House Ear Institute, contact Charlie Lahaie, Director of Public Relations for the House Ear Institute, at (213) 483-4431.

CONTRIBUTING TO THE EDUCATION OF OUR FUTURE

Over the past six years, the TEC Awards have contributed nearly \$50,000 to three different schools of audio and the AES Educational Foundation. The money has been used in a variety of ways, but in all cases it has helped students further their education in audio.

Berklee College of Music, of Boston, MA, won the award for Recording School/Program in 1985, '86 and '87. With its share of the proceeds, the college created an endowment fund—the Mix Magazine Scholarship Fund.

"We look for the top student with the highest levels of performance and achievement," says John Collins, director of development for Berklee. "We generate about six scholarships a year.

"The money helps," Collins continues, "but its more an acknowledgement of the student's achievement in front of his or her peers."

The University of Miami, winner in 1988, put its portion of the proceeds into the bank, creating the TEC Awards Scholarship Fund. A cash award, based on the interest of the principal amount, is given each year to an outstanding senior. The first award went to Paul Griffith, who is currently working at a recording studio in Poland.

"Winning the TEC Award made a lot of difference," says Ken Pohlmann, director of Music Engineering. "It's an honor winning the award, and an honor picking out the outstanding student. Money is not the issue, although it doesn't hurt."

Full Sail Center for the Recording Arts, in Winter Park, Florida, won the TEC Award in 1989. They created the TEC Scholarship Fund for Needy Students with their portion of the ticket proceeds. "It's for students who have enrolled in the course, run into financial trouble, and need our assistance," says Garry Jones senior vice president and director of education for Full Sail. "It will benefit students who are here in class, devoted and already with us."

Jones says that he has already interviewed 21 students over the past eight weeks. The next step is to take the list of students before the Board of Directors and determine the students who are most in need.

"It was a big deal for us to win the TEC Award," says Jones. "Many of our new students are aware that we're the TEC winner. It's a nice prestige thing."

Each year since 1985, the Audio Engineering Society Educational Foundation has received 25% of the ticket proceeds. The money has gone into a general fund that furnishes grants for graduate students in the field of audio engineering. Since 1984, grants have been issued to 24 students, with the TEC Awards contributing almost \$30,000.

"The money received from the TEC Awards has definitely made a difference," says Emil Torrick, AES Educational Foundation president. "We've been able to do a significant amount more than we would have without it."



DON'T MISS THE TEC AWARDS

Sunday September 23 in Los Angeles
Call Karen Dunn (415) 420-0144 for ticket information.



THE 1990 TEC AWARDS NOMINEES

I. Outstanding Technical Achievement

Awarded to those products or innovations that have made the most significant contributions to the advancement of audio technology during the eligibility period.

A. Recording Devices/Storage Technology

Akai A-DAM System: Akai's original digital recording format, A-DAM (Akai Digital Audio Multi-Track) uses six helical scanning heads (three for recording, three for playback) and can record 12 digital channels on 8mm tape. A special analog track can record SMPTE time code or other sync signals. The DL1200 autolocator provides 105 memory locations, 4 channel-status presets, a variety of locating functions, and can be used to simultaneously control three DR1200 transports, creating a 24- or 36-channel digital multitrack recording system.

Lexicon Opus/e: This random access digital audio production system is designed to bring the Opus editing capabilities to existing film, video or music production environments. Opus/e edits, time-aligns and processes audio signals in the digital domain, stores more than 14 hours of material on hard disk, and archives on 8mm streaming tape. Opus/e can be used with any analog or digital mixer or as a stand-alone digital editing or mixing system with its internal 8 x 2 stereo digital mixer.

Panasonic SV-255 Portable DAT Recorder: The SV-255, a lightweight, portable DAT recorder, features a multi-function LCD display, auto or manual program number recording, end-search, 32-step playback programming, high-speed number search and digital output (SPDIF). The SV-255 samples incoming audio at 64 times oversampling, using Panasonic's "MASH" 1-bit delta/sigma A/D conversion system. The newly designed, low-noise mic preamps feature a trim-type input level control (not a fader) to maintain a -128dB EIN specification from low-level mic to line source.

Solid State Logic ScreenSound: This multitrack digital recorder and automated mixing console offers comprehensive editing capabilities. Designed for audio post-production, it provides machine control of multiple VTRs, ATRs, film dubbers, laserdiscs, and Quantel Harry. Edit and sound clip review is immediately available from the hard disk store. All functions are accessed and executed through menu boxes, using only a pen and tablet. Other features include digital audio sample rate conversion of inputs and outputs, and the capability to use multiple working disks.

Sony TCD-D10PRO: The TCD-D10PRO is a compact, portable DAT recorder, featuring balanced inputs, AES/EBU I/O, a built-in speaker, a bright multi-function display, pistol-grip remote control, oversampling A-to-D and D-to-A converters, and a limiter. Its compact size and all-in-one design makes the D10PRO suitable for a variety of location recording tasks.

Studer Editech Dyaxis System 2.4: This hard disk recording and editing system offers advanced digital signal processing power with a wide spectrum of recording and editing capabilities for use in music production, broadcast production, CD mastering, and video and film production. Features include a SMPTE/VITC reader/generator that syncs the Dyaxis system to video sync, film tach or LTC; time code playback and master control for two Dyaxis processors in the 2+2 configuration; the Excelerator card (a Motorola

56001-based card that provides real and non-real time digital signal processing functions); and streaming tape backup system running StuderBacker 2.3 backup software.

B. Signal Processing Technology

Alesis MIDIverb III: The MIDIverb III offers 100 factory presets, along with space for an additional 100 user programs—all with 16-bit clarity. Up to three effects—delay, reverb, chorus or flange—can be used simultaneously, as well as high-frequency roll-off. Other features include real-time MIDI parameter control, MIDI mapping and the system exclusive program dump capability.

ART SGE Mach II: Offering 12 simultaneous audio functions, the SGE Mach II features an exciter, compressor, limiter, noise gate, expander, equalizer, envelope filter, pitch transposer (over two octaves), 12 different distortions and overdrives, 24 different reverb algorithms, stereo chorusing, flanging, panning, and more than 20 types of delay. All parameters are fully programmable and some patches offer more than 30 different parameters. The LCD will also display real time MIDI information as it happens, and will give a numerical readout of aftertouch, channel pressure, note on/off, pitch bend, etc.

Bedini BASE™ (Bedini Audio Spacial Environment): BASE cues the brain with a simulated binaural signal producing a sound with minimal cancellation, more highs, better clarity, more accurate point source and better separation of instruments. It can be adapted to all recording systems in real time. The operator can separate the center information from the complete mix and move it forward, backward or side to side, while simultaneously increasing or decreasing the stereo spread. This multi-dimensional effect can be heard through any conventional stereo system.

DigiTech MEQ Dual 14 MIDI Programmable Equalizer: The MEQ 14 is a 2/3-octave, stereo graphic EQ with 14 bands per channel, utilizing 12 dB cut/boost. It sports 99 memory locations and has the first constant EQ curve readout. Specifications include 90 dB S/N ratio, less than 0.03% THD, 20 Hz to 20 kHz bandwidth, independent MIDI continuous control of each channel, standard ISO frequency centers and a nonvolatile memory. The MEQ 14 is designed for professional and home studios, live sound applications, sound contractors and home system audio-philes.

Eventide H3000SE Studio Enhanced Ultra-Harmonizer®: The H3000SE is the most powerful multi-effects device manufactured by Eventide. Its 19 pitch shift, reverb and delay algorithms include Instant Phaser®, band delay, stutter, string modeller and patchfactory, natural Reverb II, a linear predictive vocoder and multishift, and the first 6-octave, multi-internal pitch shifter. The 200 presets are arranged by type, with thickeners, reverbs and pitch shifters grouped together. Other features include a function generator modulating any parameter with one of 19 LFO waveforms, soft functions for customizing the front panel, MIDI program change and real-time parameter control.

Lexicon LXP-5: The LXP-5 is a compact digital effects processor that provides five simultaneous effects, 64 preset sounds, 128 user-programmable sounds, and comprehensive MIDI implementation for effects networking. The LXP's repertoire includes pitch shifting over a 3-octave range, delay effects with continuous sweep delays, high and low pass equalization filters, ambience and reverbation. All effects parameters can be controlled from the front panel or via MIDI using Lexicon's MRC MIDI Remote Controller.

C. Console Technology

Alesis 1622: Using a monolithic Integrated Surface™ design, the 1622 is suitable for 4- and 8-track recording, MIDI production and sound reinforcement applications. The unit features 16 input channels (eight with XLR mic inputs), two subgroups, six aux sends with eight returns, solo and mute switching on all inputs, and a design that accommodates freestanding or rack-mount installations.

Amek Mozart: The Mozart has two principal formats: All-Input, (input modules are identical and function as mic, line, DI, bus or tape inputs, as required); and In-Line, (inputs use an in-line monitoring system, but in the dual-path mode—each channel accepts two signals simultaneously). Chassis are configured for 40, 56 and 80 inputs and All-Input, In-Line and stereo modules can be mixed. Other features include 32 buses, up to 16 aux sends and comprehensive 4-band EQ. The on-board computer offers "master status" control over many switching functions such as record/mix, bus/tape, EQ in/out, aux sends on/off and mute groups.

Neve VR Series: Designed to easily perform the most complex track laying, overdubbing and mixdown operations, the VR can accurately store console settings (of rotary, pushbutton and fader controls) and recall the configurations from memory. A high-resolution, color graphics display gives a precise representation of the actual control surface. Other features include: Neve Formant Spectrum Equalization; in-channel dynamics control; a mix cue system with variable balance on each overdub track; a solo system combining the advantages of in-place solo, after-pan listen and pfade listen with versatile latching and eight mono/four stereo auxiliaries.

Otari Diskmix 3: Diskmix 3 automation provides for unlimited mix data storage on hard or floppy disks, as well as complete offline editing, including splice, merge, copy, and fader and mute set. The Diskmix 3 Moving Faders is a time code-driven system combining the power of multiprocessors with Penny & Giles fader technology. Diskmix 3 VCA provides all the features and performance of Diskmix 3 Moving Faders, except the motorized fader-specific functions, but includes such VCA specific features as auto-nulling entry into write and update.

Soundcraft 200 Delta: The creation of individual group modules and a separate master section enables the 200 Delta to be configured with less than four subgroups or even as a straight stereo mixer with no subgrouping facilities. Soundcraft's proprietary padless mic pre and patented active pan pots provide the most advanced low-noise circuitry available. The Delta offers access to six aux sends, and the console can be user-specified with any combination of input modules: standard, deluxe, stereo or dual line, available in four frame sizes (8, 16, 24, 32) or as an 8-channel rack-mount.

Trident Vector: Available in frame sizes from 32 to 72 inputs, the Vector features four stereo buses, a 16-mute programmable system that can operate from SMPTE or MIDI time code, and 32 group outputs. Its comprehensive central facilities section includes an extensive cue system, a compressor/limiter on the main output and a matrix system for applications requiring multiple stereo buses. Sonic specifications, including input and output headroom and noise, exceed the requirements of digital recording.

D. Transducer Technology

AKG C-426 Stereo Microphone: A direct descendant of AKG's large-diaphragm stereo microphones (the C-422 and C-24), the C-426 features two twin-diaphragm condenser capsules in a coincident pair, rota-



table over 270 degrees, with LED aiming lights for remote operation. The S-426 remote control unit allows the user to select one of nine settings between omni, cardioid and figure-eight pickup patterns for each capsule. The change in polar patterns is completely free of noise and can be made during the recording process, if necessary. A 10dB pad and a 12dB/octave, 75Hz bass roll-off filter are supplied.

Apogee AE-4 Speakers: The single-amped AE-4 loudspeaker and A-4 processor comprise a music and/or speech reproduction system ideal for churches, clubs, auditoriums and portable A/V usage. The 18 ply per inch, Finland birch enclosure is loaded with a 12-inch high-power cone driver and 1-inch, fluid-cooled compression driver coupled to a uraltite horn. The system processor features a "user preset" mode, which tailors the limiter circuit to the amplifier's dynamic headroom characteristics to prevent clipping.

Crown SASS Microphones: Utilizing a patented design, the SASS-P (Stereo Ambient Sampling System) stereo condenser mic is configured in a near-coincident array featuring two high-grade PZM microphones mounted on boundaries, making each mic directional. To reduce the chance of phase cancellation (resulting from acoustic crosstalk) when operating in mono, a foam barrier divides the mic capsules. A similarly shaped SASS-B, built as a stereo boundary mount for Bruel & Kjaer 4003/4006 microphones, is available for applications requiring extremely low noise.

Intersonic ServoDrive Bass Tech 7: The ServoDrive Bass Tech 7 loudspeaker is a horn-loaded subwoofer, utilizing Intersonics' patented ServoDrive operating principle, which substitutes a high-speed servomotor and belt-drive system for the traditional loudspeaker voice-coil/magnet transducer. The Bass Tech 7 also includes Intersonics' patented Power Cooling system, which virtually eliminates efficiency loss due to power compression. The Bass Tech 7's frequency response is flat to below 28 Hz. A single unit will deliver an SPL of 134 dB (137 dB peak) at full rated power (400 watts RMS).

JBL 2200 Series Low Frequency Transducers: The JBL 2206, 2226 and 2241 low-frequency transducers use Vented Gap Cooling™ (patent pending), a direct voice-coil-to-air heat dissipation method. This process pumps air through the magnetic gap and directly over and around the voice-coil to provide immediate heat transfer, thus reducing operating temperature. Computer-aided magnet optimization and analysis techniques make the 2200 Series speaker lighter with lower distortion characteristics.

Meyer HD-1 Monitors: The HD-1 loudspeaker system is designed for critical sound reproducing applications such as close field monitoring or as a reference for acoustical and psychoacoustical research. Each unit is aligned and optimized to closely approximate a true point-source radiator. The system is comprised of proprietary drivers (8-inch low-frequency cone and 1-inch high-frequency silk dome) housed in a compact, vented cabinet with built-in power amplifiers. The unit also features an active crossover, driver protection circuitry and optimized pole-zero response correction filters for flat phase and frequency response.

E. Musical Instrument Technology

E-mu Proteus™: Proteus is a family of 16-bit, 32-voice polyphonic, digital sound modules. Housed in a one-rack-space enclosure, Proteus uses custom E-mu VLSI technology to combine true 16-bit Emulator III sound quality with a comprehensive level of creative control. Proteus/1 contains 4MB (expandable to 8MB) of high-quality, 16-bit "pop/rock" samples selected from the Emulator III sound library

and stored in ROMs for instant access. Proteus/2 contains 8MB of "orchestral" sounds. Proteus can take apart and reassemble sounds in an almost limitless number of new sounds, combining parts of one sound with another or with any of a selection of digital waveforms also stored in ROM.

Ensoniq VFX-SD Music Production Synthesizer: The VFX-SD brings together wavetable synthesis, effects processing, sequencing and disk storage into a single keyboard. Each sound is composed of six independent sound sources with over 1,900 wave possibilities, including 41 drum and percussion samples. They are layered to create new textures combining analog, sampled and digital sounds. Features include custom 24-bit signal processing, a 24-track sequencer with 25,000-note memory (expandable to 75,000 notes), automated punch/edit points and polyphonic outputs.

Korg T-Series: The T-Series keyboards feature a four Megaword (8 MB) PCM sample ROM, a 50,000-note sequencer, master MIDI controller functions and a disk drive for storage of programs, combinations, global data, sequence data and PCM data. The T1 offers an additional 512K Word of RAM memory for loading new samples through MIDI, T disk or DSM1 performance disks. The T1 has an 88-note weighted, wooden keyboard, the T2 has a 76-note non-weighted (synthesizer-type) keyboard, and the T3 has a 61-note non-weighted keyboard. The entire M1 card library is fully compatible with the T-Series.

Peavey DPM-3: Peavey's first keyboard product, the DPM-3 uses a digital phase modulation synthesis scheme. With a 27MHz voice data rate, the unit offers the processing power of six personal computers in a totally software-based architecture. Other features include an onboard 9-track, 20,000-note sequencer; dual multi-effects signal processing with up to six simultaneous effects; 61-key velocity-sensitive keyboard; and internal floppy drive for storing program, effects and sequence data.

Roland U-220 RS-PCM Multi-Timbral Sound Module: The U-220 has 128 multi-sampled sounds stored in 24 MB of ROM, and two slots allow access to additional sounds from Roland's U-Series Sound Card library. The U-220's multi-timbral capabilities and 30-voice polyphony allow the user to play up to six instrument parts and a separate rhythm part simultaneously. Sounds can be routed to any of three sets of stereo outputs that can be set to function as six polyphonic individual outputs. Other features include onboard Chorus/Flanger and Reverb/Delay effects.

Yamaha SY77 Digital Synthesizer: The SY77 not only allows sampling and frequency modulation to be used separately or combined, but it also allows sampled waveforms to be integrated into the advanced frequency modulation. Part of the SY77's power comes from its Realtime Convolution and Modulation Synthesis (RC&M). Up to eight digital filters per voice allow real time filtering of all sound. The synthesizer also includes four digital signal processors, a 16-track sequencer, 61-note velocity and aftertouch keyboard, a large backlit display and a 24-bit output digital-to-analog converter.

F. Computer Software/Peripherals

Lone Wolf MidiTap: MidiTap is a rack-mount unit using a new protocol—Media Link. It provides bidirectional, fully merged, high-speed communication equal to 32,000 separate MIDI cables over one fiber optic cable. MidiTap provides for configuration of all devices with full electronic patch bay capability from any MidiTap. MidiTap has four MIDI ports, two fiber optic ports and a RS-232/422 port. The fiber optics can link to 255 MidiTap-4s communicating at 2 megabaud. The protocol allows for other

types of data such as SMPTE, video, digital audio, etc., to simultaneously share the cable.

Mark of the Unicorn Performer 3: Performer Version 3 is the first sequencer on the Mac to incorporate editing of music using notation on a grand staff. Notes can be inserted or moved to any pitch or beat. Automated Sliders offers real time control over continuous controller data such as volume and pan. A graphic sequence chaining feature called Chunking™ allows the user to build songs and live performance sets quickly. With chunking, sequences and songs appear on a Song Grid as icons that can be arranged in any order and stacked for consecutive and simultaneous playback.

Passport Designs Pro-4: Pro-4 combines an intuitive, logical user interface with professional features in a flexible sequencer for the creative musician. The program features an integrated track editor for recording up to 64 tracks, a unique graphical song editor, graphic and event list step editing, complete graphic editing of MIDI controllers, a playlist for live performance, support of industry standard MIDI files, real time editing, a global change filter, and a system exclusive utility and keyboard control mapper. Recording and playback can be synchronized to film, video or multitrack audio tape for audio or video post-production work.

Spectral Synthesis SynthCARD™ DSP System: The SynthCARD is a two-board, high-quality digital signal processing system for IBM PC/AT. A unique system architecture allows total freedom in the creation and manipulation of sound and music completely in the digital domain. The SynthCARDs each have two TMS320C25 DSP devices sharing data over the Spectral high-speed FlyBy Bus™. Up to seven SynthCARDs may be paralleled for over 140 MIPS. SPDIF (CD/DAT) digital I/O is built into the system. A separate "daughter" board containing 4 MB of RAM can expand the system to a 16-bit polyphonic sampler.

Steinberg/Jones Cubase Version 1.51: This Atari ST-based system incorporates Visual-Song-Processing (VSP) and Steinberg MIDI-Realtime-Operating System (M.ROS), allowing users to record, edit, arrange and save an entire song without stopping the sequencer. Cubase uses a flexible window-management environment with 16 Arrange-Windows, each with 64 tracks. All patterns are displayed graphically. Edit windows include Key Edit, Drum Edit, Score Edit and Grid Edit. The Dynamic MIDI Manager allows the user to draw their own faders, knobs, buttons, etc., which can produce virtually any MIDI command, so an entire MIDI studio can be automated.

Words & Deeds Archie 2.0: Archie is a complete recording studio information management system for the Mac, written by a record producer and former studio manager. It creates track sheets including setup, microphones, track allocation (to 48 tracks), start/stop cues on titles (tape or SMPTE), artists, producers, engineers, master tape ID, and outboard equipment for up to 12 studio rooms. Archie can also prepare time sheets and invoices automatically, using negotiated or book rates; maintain payable and receivable ledgers and checkbooks; manage master tape libraries; and keep inventory of equipment and supplies, and maintenance scheduling.

G. Ancillary Equipment

Adams-Smith Zeta-3B Synchronizer: The Zeta-3 "B" is identical in performance to its parent, the Zeta Three audio/video/MIDI synchronizer, except that all of the front panel controls and displays have been removed from the "B," and its price has been substantially reduced. The "B" is designed to operate in conjunction with the Zeta Remote Autolocator/



Controller, which contains the controls in a convenient, compact package. The synchronizer features a time code generator, two time code readers, tape synchronizer, and a MIDI synchronizer with tempo, map storage, and a computer interface.

Ampex DATpak™ Mastering Storage System: The DATpak Mastering Storage System is a packaging/labeling system designed specifically for problems associated with the DAT cassette's smaller size. The DATpak includes a two-cassette storage tray with or without the album box; documentation storage for track sheets, recording information and/or duplicating instructions; and a professional labeling system with check-off boxes, track sheets, cassette labels and extended insert cards. Smaller APRS/SPARS-style labels also fit the DAT cassette, while a reduced-view window maximizes labeling space.

Audio Precision System 1+DSP Test System: The System One Dual Domain provides digitally based analysis and synthesis of test signals in both analog and digital domains. Harmonic and spectrum analysis is available for making precision analog measurements. By operating the DSP as a programmable high-selectivity bandpass filter, the system can measure individual harmonic distortion, erasure depth and other wave analyzer-type measurements. System One Dual Domain is the only commercially available test set to allow full testing of consumer and professional digital audio equipment in the digital domain, showing the separation and measurement of the effects of the A/D and D/A conversion system on the audio.

Jensen Twin Servo® 990 Microphone Preamplifier: The Twin Servo 990 mic preamp, housed in a rack-mount unit that holds up to four channels, features front panel-switchable VU/peak LED meter, stepless level control, and back-lighted switches for phantom, polarity and impedance. Dual patented, JE-990-C amplifiers exhibit distortion of less than .003%, even at the maximum gain of 60 dB. DC servo amplifiers and bias compensation eliminate DC currents in the transformers. Overall response, flat from under 1 Hz to over 100 kHz, is the result of computer-matched components and no phantom blocking capacitors.

Tascam MIDlizer Synchronizer: Designed for a wide range of music production applications, the MIDlizer functions as a transport synchronizer that chases lock time code between two multitrack recorders, a MIDI synchronizer for locking virtual MIDI tracks to tape transports, and a MIDI synchronizer. Features include sub-frame accuracy, LCD status display, tempo mapping, SMPTE-based locating and 20-point cueing.

TimeLine Lynx Keyboard Control Unit: The KCU is a six-machine post-production center. It can be used in a variety of applications, including multitrack music recording, dialog re-recording, spotting of effects for video and film, and digital audio sequencing. In addition to operating tape and film transports, the KCU provides two GPI relays for events triggering or talent cueing.

H. Sound Reinforcement Product of the Year

Apogee AE-4 Speakers: The single-amped AE-4 loudspeaker and A-4 processor comprise a music and/or speech reproduction system ideal for churches, clubs, auditoriums and portable AV usage. The 18 ply per inch, Finland birch enclosure is loaded with a 12-inch high-power cone driver and 1-inch, fluid-cooled compression driver coupled to a uraltite horn. The system processor features a "user preset" mode, which tailors the limiter circuit to the amplifier's dynamic headroom characteristics to prevent clipping.

Crown System IQ-2000: Powered by custom Macintosh or IBM software, enabling the user to remotely monitor and control the functions of up to 2,000 amplifiers in a single sound system, the IQ System 2000 is made up of three components: a host computer, an IQ-PIP Card and an IQ System Interface. The IQ System has ten major monitoring functions, including the ability to review the on/off status of each amp channel, input and output, and the IOC (Input/Output Comparator) and ODEP (Output Device Emulator Protection) signals.

Crest/Gamble Series EX House Console: The Series EX console is designed for high-quality, live sound reinforcement work. The standard console consists of 56 input channels, eight stereo subgroups, eight stereo matrices and a comprehensive internal patch bay packaged in 74 inches. Features on each input channel include a 4-band fully parametric EQ, 24 dB per octave sweepable low cut filter, ten aux sends, eight programmable scene mutes and a 20-segment LED meter.

JBL 2200 Series Low Frequency Transducers: The JBL 2206, 2226 and 2241 low-frequency transducers use Vented Gap Cooling™ (patent pending), a direct voice-coil-to-air heat dissipation method. This process pumps air through the magnetic gap and directly over and around the voice-coil to provide immediate heat transfer, thus reducing operating temperature. Computer-aided magnet optimization and analysis techniques make the 2200 Series speaker lighter with lower distortion characteristics.

Showco Prism™ Digital Control System: Based on the latest DSP technology, the Prism Digital Control System is the self-contained control system for Showco's Prism sound system. All functions are software-controlled. The system has in-depth diagnostic capability with clear status indications for the operator. Protection circuitry prevents damaging signals from reaching the power amplifiers as well as level display feedback from all inputs and outputs. The application of proprietary DSP circuitry and software enables precise, integrated control of the Prism system operating parameters.

Soundcraft 200 Delta: The creation of individual group modules and a separate master section enables the 200 Delta to be configured with less than four subgroups or even as a straight stereo mixer with no subgrouping facilities. Soundcraft's proprietary padless mic pre and patented active pan pots provide the most advanced low-noise circuitry available. The Delta offers access to six aux sends, and the console can be user-specified with any combination of input modules: standard, deluxe, stereo or dual line, available in four frame sizes (8, 16, 24, 32) or as an 8-channel rack-mount.

I. Recording Product of the Year

Akai A-DAM System: Akai's original digital recording format, A-DAM (Akai Digital Audio Multi-Track) uses six helical scanning heads (three for recording, three for playback) and can record 12 digital channels on 8mm tape. A special analog track can record SMPTE time code or other sync signals. The DL1200 autolocator provides 105 memory locations, 4 channel-status presets, a variety of locating functions, and can be used to simultaneously control three DR1200 transports, creating a 24- or 36-channel digital multitrack recording system.

Gotham CDR-90 CD Reference System: Combining advanced technology from companies such as Yamaha, Dell Computer, Harmonia Mundi Acustica and Fuji Film, the CDR-90 is an integrated system allowing studios and mastering houses to cut reference CDs for clients. The CDR-90 discs are an exact replica of the final CD product, including all track

and indexing data. Other applications for the system include the production of CDs for radio spots, effects libraries, A/V displays and other short-run applications.

Neve VR Series: Designed to easily perform the most complex track laying, overdubbing and mixdown operations, the VR can accurately store console settings (of rotary, pushbutton and fader controls) and recall the configurations from memory. A high-resolution, color graphics display gives a precise representation of the actual control surface. Other features include: Neve Formant Spectrum Equalization; in-channel dynamics control; a mix cue system with variable balance on each overdub track; a solo system combining the advantages of in-place solo, after-pan listen and prefade listen with versatile latching and 8 mono/4 stereo auxiliaries.

Solid State Logic ScreenSound: This multitrack digital recorder and automated mixing console offers comprehensive editing capabilities. Designed for audio post-production, it provides machine control of multiple VTRs, ATRs, film dubbers, laserdiscs, and Quantel Harry. Edit and sound clip review is immediately available from the hard disk store. All functions are accessed and executed through menu boxes, using only a pen and tablet. Other features include digital audio sample rate conversion of inputs and outputs, and the capability to use multiple working disks.

Studer Editech Dyaxis System 2.4: This hard disk recording and editing system offers advanced digital signal processing power with a wide spectrum of recording and editing capabilities for use in music production, broadcast production, CD mastering, and video and film production. Features include a SMPTE/VITC reader/generator that syncs the Dyaxis system to video sync, film tach or LTC; time code playback and master control for two Dyaxis processors in the 2+2 configuration; the Excelerator card (a Motorola 56001-based card that provides real and non-real time digital signal processing functions); and streaming tape backup system running StuderBacker 2.3 backup software.

Tascam MSR-24 24-Track Recorder: Using a 1-inch tape format with 10.5-inch reel capacity, the MSR-24 offers 7.5 or 15 ips speeds with +/-15% pitch change, built-in dbx Type 1 noise reduction, two location memories (plus return to zero), table-top or rack-mount use, bargraph meters with peak hold, and parallel and serial control ports.

II. Outstanding Creative Achievement

Awarded to those individuals or teams who, during the eligibility period, have achieved the highest levels of excellence in professional audio.

A. Recording Engineer

Ed Cherney: During the past year, Ed Cherney engineered and mixed Bonnie Raitt's Grammy Award-winning album *Nick of Time*, mixed the single "Anything Can Happen" for Was (Not Was); produced, engineered and mixed the Bonedaddy's *World Beat-nicks*; and recorded and mixed the new Was (Not Was) LP *Are You OK?*. He also engineered and mixed music for other projects, including Cry Before Dawn's *Witness to the World*, Michael McDonald's *Take It to The Heart* and *Get The Word Started*, the



debut album *Janata*, and Nathalie Archangel's debut LP, *My Older Lover*. He also recorded and mixed tracks for such films as *Dick Tracy* and *Always*, and recorded the TV themes for *Sister Kate* and *Jesse Hawkes*. Jingle work included The Home Club's "Do It Yourself" and Burger King's "Break the Rules."

Bob Clearmountain: During the eligibility year, two-time Grammy winner Bob Clearmountain produced albums for King Swamp and Cindy Bullens, and mixed tracks on albums for Michael Penn and Tears for Fears.

Keith Cohen: During the eligibility year, Keith Cohen's mixing credits included work for Paula Abdul, Prince, Bobby Brown, Miami Sound Machine, After 7, Earth Wind & Fire, Robert Palmer, Louis Louis, Callows, Aftershock, Brother Beyond and Glen Medeiros.

Kevin Killen: Over the past year, Kevin Killen co-produced, engineered and mixed Elvis Costello's *Spike*; mixed and did overdubs on Kate Bush's *Sensual World*; mixed Jane Siberry's *Bound By The Beauty and Shawn Colvin's Steady On*; and mixed Jerry Lee Lewis' "Great Balls of Fire" single for re-release in the movie *Great Balls of Fire*.

George Massenburg: During the eligibility period, George Massenburg engineered Flim & the BB's *New Pants*, Little Feat's *Representing the Mambo* and Linda Ronstadt's *Cry Like A Rainstorm, Howl Like the Wind* album (given the Best Engineered Non-Classical Grammy Award in 1990).

Shelly Yakus: Shelly Yakus, of A&M Records, engineered Belinda Carlisle's latest LP and Don Henley's *End of the Innocence* album during the past year.

B. Remote/Broadcast Recording Engineer

Guy Charbonneau: Last year's projects for Guy Charbonneau included tours with Bad Company, Joe Cocker and dates with Metallica. In Seattle, Charbonneau recorded Fine Young Cannibals using Westwood One's remote truck. Special events included the Montreal Jazz Festival; the AIDS Benefit in Oakland, CA; songs for Cirque de Soleil; the EICC Benefit Concert for Cinemax/HBO; and the Roy Orbison Tribute to Benefit the Homeless. Soundtracks for feature films included *Dick Tracy* and *Postcards From the Edge* with Record Plant and Studio on Wheels remote trucks. All projects, except the Jazz Festival, were recorded with Le Mobile.

Bob Clearmountain: During the eligibility year, two-time Grammy winner Bob Clearmountain mixed live broadcast concerts of the Rolling Stones, The Who's rock-opera "Tommy," and the Roy Orbison Tribute for the Homeless.

Ron Estes: Ron Estes has been with NBC for more than 20 years. During the eligibility year he was the audio mixer for *The Tonight Show*.

Randy Ezratty: Randy Ezratty has been making location recordings since 1980, when he established E-fanel Music. During the past year, Ezratty worked on major live recording events including The Who's "Tommy" pay-per-view special and album; The Rolling Stones' "Steel Wheels" pay-per-view concert; Depeche Mode's *101* LP and film soundtrack; Prince's "Saturday Night Live—15th Anniversary" performance; Carly Simon's *My Romance* HBO special; Ruben Blades *Live*; and "Late Night with David Letterman 8th Anniversary Special."

Ed Greene: Over the past year, Ed Greene worked on the 1990 Grammy Awards; the Emmys; the Tony Awards; Kennedy Center Honors; Christmas in Washington; AFI Salute to David Lean; Easter Seal Telethon; Grammy Living Legends; "Kenny, Dolly and Willie" (which won an Emmy); *Star Search* and

Carol & Co. Greene is a partner at Greene, Crowe & Co., and consults with Complete Post.

David Hewitt: David Hewitt is president of Remote Recording Services, Inc., based in Bucks County, Pennsylvania. During the past year, Hewitt worked on Neil Young's album *Freedom*, Van Morrison's live video and Lou Reed's *Live in Montreal* video.

C. Mastering Engineer

Gregory Fulginiti: During the eligibility year, Fulginiti mastered the Grammy Award-winning Album of the Year, *Nick of Time*, by Bonnie Raitt, *Pump* for Aerosmith, and *The Chess Box Set* for Chuck Berry, as well as records by Cher, Jan Child, Eric Clapton, Andrew Dice Clay, Joe Cocker, Great White, Chris Isaak, Elton John, Kiss, Randy Newman, Starship, Vixen, Muddy Waters, Whitesnake and The Who.

Bernie Grundman: Bernie Grundman, owner of Bernie Grundman Mastering in Hollywood, mastered recordings by such artists as Michael Jackson, Billy Idol, Anita Baker, Prince, Barbra Streisand and Quincy Jones during the past year.

Ted Jensen: Ted Jensen is chief engineer for Sterling Sound. During the past year he mastered albums and CDs for Billy Joel, Duran Duran, Special EFX, Spyro Gyra, Carly Simon, Winger, The Rolling Stones and Eric Clapton.

Bob Ludwig: Masterdisk Corporation vice president and chief engineer Bob Ludwig mastered work for Phil Collins, Lou Reed, Tracy Chapman, Pat Metheny, and many jazz and classical projects such as the Kronos Quartet during the past year.

Steve Marcussen: During the eligibility year, Steve Marcussen mastered many albums, including work by Don Henley, Bruce Hornsby, Roy Orbison, XTC, Chicago, Gary Numan, Yellowjackets, Belinda Carlisle, Madonna, Fleetwood Mac, Julee Cruise, Bobby Z, Youssou N'Dour, Cold Cut, Lonesome Romeos, Trevor Rabin, Black Velvet Band, Michelle Shocked, Dwight Yoakam and Martika.

Denny Purcell: Denny Purcell, owner and president of Georgetown Masters, mastered work for Take Six, BeBe & CeCe Winans, Sandi Patti, Whitney Houston, Hank Williams, Jr., Ricky Van Shelton, Garth Brooks, Don Williams, Highway 101, The Highwaymen, Vern Gosdin, Restless Heart, Alabama, Kathy Mattea and Dolly Parton during the eligibility year.

D. Sound Reinforcement Engineer

Rob Colby: During the eligibility year, Rob Colby was house engineer with The Cure, Prince and Phil Collins.

Clive Franks: Clive Franks spent almost all of 1989 working on The Who's 25th Anniversary World Tour, and is currently on tour with Robert Plant.

Dave Kob: During the eligibility year, Dave Kob engineered on tours by Don Henley and Elton John.

Benjamin Lefevre: Independent sound reinforcement engineer Benji Lefevre designed the stadium sound system and mixed the "Steel Wheels" American tour for The Rolling Stones during the eligibility year.

Mike Ponczek: Employed by Showco, Inc., since 1977, Mike Ponczek served as audio mixing engineer for Eric Clapton's Europe/Israel tour, and Mike and the Mechanics' European tour in 1989/90. He is currently mixing the Paul McCartney World Tour throughout the UK, Europe, North America, Japan and Brazil.

Brian Ruggles: During the past year Brian Ruggles worked with Billy Joel, mixing the world "Storm Front" tour.

E. Record Producer

Peter Asher: During the past year Peter Asher produced Linda Ronstadt's *Cry Like A Rainstorm, Howl Like The Wind* and was awarded the 1989 Grammy for Producer of the Year. He also produced 10,000 Maniacs' *Blind Man's Zoo* and seven tracks on Peter Dinklage's *Harry's Cafe De Wheels*.

Jimmy Jam/Terry Lewis: During the eligibility year, Jimmy Jam and Terry Lewis, owners of Flyte Tyme Studios, produced Janet Jackson's *Rhythm Nation: 1814*. They also completed work on albums for Johnny Gill and Michael Jeffries.

Quincy Jones: Quincy Jones produced his own *Back on the Block* album during the eligibility year.

Daniel Lanois: During the past year Daniel Lanois produced Bob Dylan's *Oh Mercy*, The Neville Brothers' *Yellow Moon*, and his own album, *Arcadia*.

Hugh Padgham/Phil Collins: During the eligibility year the team of Hugh Padgham and Phil Collins produced and recorded Phil Collins' *...But Seriously*.

Don Was: 1990 Grammy Award winner Don Was produced Bonnie Raitt's *Nick of Time*, four tracks on the B-52's *Cosmic Thing* (including the single "Love Shack") and work by Carly Simon, Mitch Ryder, Iggy Pop, Dion, Voice of the Beehive, Andrew Dice Clay, Was (Not Was) and the Rolling Stones (12-inch remixes) during the past year.

F. Audio Post-Production Engineer

John Alberts: During the past year, John Alberts' credits included audio post-production for "Late Night with David Letterman 8th Anniversary Special" and *Sensibilities and Sense* for PBS/American Playhouse; sound design and audio post-production for The Who—"Tommy" for FBN/CBS Home Video and *Spike Lee Presents Doin' It Acapella* for PBS; and music mix, sound design and audio post for *Spy Magazine—How To Be Famous*. Alberts also did audio post work for *Michelob Presents Sunday Night and Saturday Night Live*, including all videotaped segments, music pre-records and all shows for rebroadcast.

Bruce Botnick: During the eligibility period, Bruce Botnick produced and engineered the soundtracks for *The Burbs* and *Star Trek V: The Last Frontier*, and engineered the soundtrack for *Blaze*.

Ben Burtt/Richard Hymns/David Slusser/Gary Summers: During the eligibility year, the team of Ben Burtt, Richard Hymns, David Slusser and Gary Summers worked on *Indiana Jones & The Last Crusade* and *Always*.

Tom Fleischman: During 1989 Tom Fleischman, of Sound One in New York, worked on *New York Stories*, *Second Sight*, *Little Monsters*, *Do The Right Thing*, *Miami Blues*, *An Innocent Man*, *The Handmaid's Tale*, *She Devil* and *A Shock to the System*.

Scott M. Gershin: During the eligibility year, Scott Gershin, a sound editor at Soundelux, worked on *Born on the Fourth of July*, *Honey, I Shrank the Kids*, *Glory*, *Steel Magnolias*, *Uncle Buck* and *Christmas Vacation*. *Born on the Fourth of July* won Gershin and the Soundelux team a Golden Reel award for best sound editing for a feature film. *Glory* won an Oscar for best sound.

Ken Hahn: Ken Hahn, a partner at Sync Sound in New York City, worked on a variety of projects during the eligibility year, including the *Luther Vandross Live at Wembley* home video, the NBC-TV series *True Blue*, the *Van Morrison Live at the Beacon* video, the "Bud Bowl II" Super Bowl series for Anheuser-Busch, Barbara Walters' specials, Howard Stern's *Open Soars* home video and the Grammy Award-winning cast album *Jerome Robbins' Broadway*.



III. Outstanding Institutional Achievement

Awarded to those companies, facilities or institutions that have contributed most significantly to excellence and innovation in audio during the eligibility period.

A. Acoustics/Studio Design Company

Tom Hidley Design Service, Montreux, Switzerland: During the eligibility year, Tom Hidley completed King Records in Tokyo; Kiva Sound in Memphis, TN; Odyssey Studio in Nashville, TN; the fourth room at Masterfonics in Nashville, TN; and Nomis Studios in London.

The Joiner-Rose Group, Inc., Dallas, TX: During the nomination period the Joiner-Rose Group, under the direction of Russ Berger, performed work on NBC's *Saturday Night Live* audio post facilities; audio studios at National Capital Music Building, Washington, DC; JC Penney's corporate television studios and A/V/V facilities; Middle Tennessee State University's 100,00-square-foot Mass Communications facility; a personal studio for Steve Miller; WLS-FM, Chicago; WLUP-FM, Chicago; W*USA-TV, Washington, DC; WFDD-FM, Winston-Salem, NC; South Carolina Educational TV; and USA Radio Network.

Perception, Inc., Los Angeles, CA: Founded in 1970 by George Augspurger, Perception, Inc., is a consulting group specializing in architectural acoustics and studio design. A list of clients during the eligibility period was not available at presstime.

RLS Acoustics, San Francisco, CA: RLS is a full-service technical facilities design and engineering firm. Specializing in broadcast, audio and video production facilities, RLS provides architectural acoustic and systems design. Recent projects include on-air broadcast facilities for Tandem Computer, Inc.; business television and production facilities for Hewlett-Packard, Inc.; audio production and telecine suites for One Pass, Inc.; TV production facilities for Stanford University's Hoover Institute; the corporate boardroom for the GAP, Inc.; the Center for New Music Technology at UC Berkeley; full-service video production facilities for Flesling & Flesling Co.; conferencing facilities for Digital Equipment Corporation's Systems Research Center; and building acoustics and HVAC noise control for the Shearwater Complex in San Francisco.

John Storyk Design Group, New York, NY: John Storyk has provided design and construction supervision services for the professional audio recording community since 1969. During the past year his media facility projects included completion of the 23,000 sq. ft., six-studio complex for Full Sail Center for the Recording Arts and Platinum Post (Winter Park, FL); audio room installations for Soundshop (Nashville, TN); Crawford Post (Atlanta, GA); a private studio designed for Taylor Dayne's producer, Rick Wake; a new HDTV video post facility for Rebo Video (New York, NY); a five-studio complex for the L.A. Studios, "Margarita Mix"; installation of the newest room for Howard Schwartz Recording (New York, NY); and completion of the 15,000 sq. ft. Bearsville Theatre (Woodstock, NY).

Waterland Design, Hollywood, CA: During the eligibility period, Waterland Design executed the design and construction of Post Logic Studios in Hollywood; worked in cooperation with Studio Works (Venice, CA) to write a programmatic report on the proposed addition of two recital halls and additional rehearsal spaces on campus for USC's School of Music; added a mix room to One on One Studio (North Hollywood, CA); and designed Saturn Studio (Burbank, CA). All design was under the direction of Vincent van Haaff

and George Newburn, with construction by Lawrence Buckley, Lyle Ireland and Paul Reynolds.

B. Recording Studio

A&M Recording Studios, Hollywood, CA: Founded in 1967 by Herb Alpert and Jerry Moss, A&M's Studios include five recording studios, a post-production duplication facility operating 130 cassette machines in real time and a digital mastering suite featuring the Sonic System. Artist credits were not available.

Conway Recording Studios, Hollywood, CA: Musical ventures performed at Conway over the past year include Billy Idol's *Charmed Life*, Cher's *Heart of Stone*, and work by artists such as Quincy Jones, Aretha Franklin, Al B. Sure, Jackson Browne, Steve Perry and Jeffrey Osborne. Soundtrack work included *Pretty Woman*, *Hard to Kill* and *Another 48 Hours*. Conway's Studio A and B are both equipped with Neve VR 72s and GML moving fader automation and recall. In addition, the studio provides three 24-track Studer A827s, three 32-track digital Mitsubishi X-880s, two 2-track digital Mitsubishi X-86HS, and an extensive assortment of outboard gear.

Ocean Way Recording, Hollywood, CA: During the eligibility period, Ocean Way Recording worked with numerous artists including Anita Baker, Barbra Streisand, Bonnie Raitt, Bruce Springsteen, Cher, Linda Ronstadt, Madonna, Mike and the Mechanics, Michael Jackson, Paula Abdul, Taylor Dayne, Was (Not Was), Bette Midler, Bruce Hornsby & the Range, Iggy Pop, Kenny G, and Roy Orbison, among others. Film and TV credits included the Academy Awards, *Cheers*, *Dear John*, *Mancuso*, *Blaze*, *Dick Tracy*, *The Guardian*, *House Party*, *Steel Magnolias*, *Star Trek V*, *Wild at Heart*, *Shirley Valentine*, *Karate Kid III*, *Opportunity Knocks* and *Wild Orchids*.

Power Station, New York, NY: Power Station's four studios house a Neve 8068 Series console (Studio A), an SSL SL4000E with Total Recall (Studios B and Studio C), and an SL4000E. The new Audio-Video IU mixing suite has an SSL 4072 G Series console that enables recording and mixing audio as well as post-production for film and video. Recent clients include Eric Clapton, Judy Collins, Whitney Houston, Billy Squier, Rolling Stones, James Taylor, Grateful Dead and Carly Simon. Film credits include *Cadence*, *Turner and Hooch*, and *Lethal Weapon 2*. National commercial work includes Chevy, Coca-Cola, American Express and Budweiser.

Real World Studios, Bath, England: Founded in 1986 by Peter Gabriel, Real World Studios houses three control rooms and five live spaces which can be connected in any way to suit individual projects. All control rooms have SSL consoles, and both analog and digital recording equipment is available. Recent clients include New Order, Wet Wet Wet, Clannad, The Guo Brothers, Geoffrey Oryema, The Mighty Lemon Drops, Carmel, Mica Paris, Hue & Cry, Nusrat Fateh Ali Khan, Oleta Adams and Breathe. Real World Studios is also the center for Real World Design, Post Haste Television and Real World Records.

Skyline Studios, New York, NY: Recent upgrades at Skyline include the renovation of the third-floor studio and control room, with the installation of a 64-input SSL G Series console and two Studer A800s. The past year's projects include tracking for Eric Clapton's *Journeyman* and the latest releases by Lloyd Cole, Tom Jones and Buster Poindexter. Skyline also recorded and mixed Suzanne Vega's most recent release (with Hugh Padgham mixing). Other albums included They Might Be Giants' *Flood*, the B-52's *Cosmic Thing*, Seduction's debut LP, and Shawn Colvin's album (Kevin Killen mixing). Neil Dorfsman's projects at Skyline included mixing Laurie Anderson's *Strange Angels*, the upcoming album from Tom Kimmel, and Just William's debut. Skyline also mixed Michael Bolton's single "Georgia" and jazz albums by Mike Stern Najee and John Zorn.

C. Sound Reinforcement Company

Audio Analysts, Plattsburg, NY: Now in its 22nd year, Audio Analysts worked with such groups as Billy Joel, New Kids on the Block, Heart and Richard Marx during the eligibility year. The company has also installed permanent house systems at the Montreal Forum and the National Arts Center in Ottawa, Canada, and a semi-permanent installation at Pacific Amphitheater in Costa Mesa, CA. Last year Audio Analysts opened a Los Angeles office and now keeps full systems on both coasts. The company has also been busy in the R&D Department, and in December launched its first custom console, the AA/CADD-SM-1H, a 64-input house console.

Clair Bros., Lititz, PA: Clair Bros. is a worldwide business, with offices in London, the U.S. and Tokyo, capable of fielding 14 sound systems on the road simultaneously. Company credits include sound reinforcement for Bon Jovi, R.E.M., Kenny Rogers, Elton John, Duran Duran, Amy Grant, Paul Simon, The Who, Don Henley, Stevie Nicks (including Fleetwood Mac in Australia), Janet Jackson, Fine Young Cannibals, The BoDeans, The Waterboys and Madonna. Clair Bros. also provided the sound for "Hollywood Rock" in Sao Paulo and Rio de Janeiro.

Electrotec Productions, Inc., Canoga Park, CA: Electrotec Productions, Inc. provides touring sound production services from Canoga Park, CA, Nashville, TN, and London, England. During the past year, touring clients included Alabama, Barry Manilow, Randy Travis, Cheap Trick, Ozzy Osbourne, Rod Stewart, Hiroshima, Elvis Costello, Tesla, Great White, Marlboro, Tom Petty, Cher, Jefferson Airplane, Eurythmics, Trevor Rabin, Alice Cooper, Rush, Rickie Lee Jones and Lenny Kravitz. Principals include Pierre D'Astugues, president and chief operating officer; Mick Whelan, research & development division; Jim Douglas, equipment manager; and David Gautrey, chief service engineer.

Maryland Sound Industries, Inc., Baltimore, MD: Maryland Sound specializes in custom audio engineering and design services for international installations and touring. The Permanent Systems Department is currently providing design services for Sanrio and Oita Theme Parks in Japan, and is doing installation services for Sandcastle, Inc., in Guam; NASA Space Station Freedom Headquarters in Maryland; and 11 attractions at Universal Studios in Florida. The Touring Department's client roster during the eligibility year included Pink Floyd, David Bowie, Depeche Mode, Chicago, Neil Diamond, Tears for Fears, Dan Fogelberg, Bobby McFerrin, the Pointer Sisters, Belinda Carlisle, Joe Jackson, Paul Simon, Debbie Gibson, Whitney Houston, Hall & Oates, Dolly Parton, Gloria Estefan and the Miami Sound Machine, Crosby, Stills & Nash, Neil Young, Sheena Easton, Frankie Valli, The Cure, Anne Murray, Kenny G, Patti LaBelle, Peter Allen and Roberta Flack.

Showco, Inc., Dallas, TX: Recently celebrating its 20th anniversary, Showco added a European operations base during the eligibility year and had 1989/90 touring credits on all the inhabited continents. Over the past year, the Showco Prism sound system was the choice of the Rolling Stones, Paul McCartney, Phil Collins, Eric Clapton, Diana Ross, Linda Ronstadt, Stevie Ray Vaughan & Double Trouble, Jeff Beck, Little Feat, Carole King, the Bee Gees, Reba McEntire and Joe Satriani. Showco also introduced the Prism Digital Control System in September 1989.

Ultra Sound, San Rafael, CA: Ultra Sound is an audio service and development company started in 1978 by Don Pearson and Howard Danckick. The company has provided sound for many bands, with the Grateful Dead their oldest and largest account. Their systems feature Gamble house and monitor consoles, Crest amplifiers and Meyer speakers. Ultra Sound also builds custom cases and cabinets for their clients.



D. Mastering Facility

Artisan Sound Recorders, Hollywood, CA: Artisan Sound Recorders was the first independent mastering studio on the West Coast. During the eligibility year, Greg Fulginiti mastered the Grammy Award-winning Album of the Year, *Nick of Time*, by Bonnie Raitt, and *Pump* by Aerosmith, as well as recordings by Cher, Jane Child, Andrew Dice Clay, Joe Cocker, Black Crowes, Chris Isaak, Elton John, Kiss, Randy Newman, Vixen, Muddy Waters and Whitesnake.

Fullersound, Inc., Miami, FL: Fullersound is a state-of-the-art, full-service mastering facility. Catering to all musical fields, Fullersound can accommodate almost all analog and digital formats and is equipped with Neve DTC, Sony 1630, DAT, F1, Mitsubishi, Sony DASH and Dolby SR. Clients during the past year included Expose, Julio Iglesias, Barry Manilow, Nestor Torres, Kashif, Jimmy Cliff, 2 Live Crew, Shana, Bandera, Marcia Griffith, Betty Wright, The Young & The Restless, Professor Griff, Jose Luis Rodriguez, Ricardo Montaner, Paris By Air, Company B and Luis Enrique. Staff engineers are Michael Fuller and Rod Fuller.

Bernie Grundman Mastering, Hollywood, CA: During the eligibility year, Bernie Grundman Mastering worked on recordings for such artists as Michael Jackson, Billy Idol, Anita Baker, Quincy Jones, Barbra Streisand, Rickie Lee Jones, Janet Jackson, Prince, Eazy-E and Depeche Mode. Bernie Grundman Mastering offers three fully equipped studios, capable of all-digital domain processing, with a hard disk editing system and a digital evaluation room complete with a CD reference disc cutting system.

Masterdisk, Corp., New York, NY: During the eligibility period, Masterdisk Corp. worked with 3rd Bass, The Beastie Boys, De La Soul, Debbie Gibson, Justice, James Brown, Jethro Tull, Tina Turner, Tone-Loc, Young MC, Sinead O'Connor, Sound Garden, Stetsasonic, The Ramones, DJ Jazzy Jeff & The Fresh Prince, LL Cool J, New Kids on the Block and Public Enemy. They also worked on Prince's *Batman LP*. Masterdisk engineers include Bob Ludwig, Howie Weinberg, Tony Dawsey, Scott Hull, Andy VanDette and Don Grossinger.

Precision Lacquer, Hollywood, CA: During the eligibility period Precision Lacquer mastered over 120 albums. These included work by Don Henley, Bruce Hornsby, Roy Orbison, XTC, Chicago, Gary Numan, Yellowjackets, Belinda Carlisle, Madonna, Fleetwood Mac, Julee Cruise, Bobby Z, Youssou N'Dour, Cold Cut, Lonesome Romeos, Trevor Rabin, Black Velvet Band, Michelle Shocked, Dwight Yoakam, Steve Jones, Vonda Shepard, Eighth Wonder, Sadao Watanabe, Bonham, Lou Gramm, Bang Tango, Peter Case, Tragically Hip, Mary's Danish, The Creatures, Laura Branigan, Havalinas, Alisha and Martika, and soundtrack albums for *Born on the Fourth of July*, *The Last Temptation of Christ* and *Indiana Jones and The Last Crusade*.

Sterling Sound, New York, NY: Sterling Sound is outfitted with Neve DTCs, Sony and Mitsubishi digital playback systems, the Teldec DMM system and the Audio Animation Muse Digital Transfer system. Mastering engineers include George Marino, Ted Jensen, Greg Calbi and Jose Rodriguez. During the eligibility year, Sterling Sound mastered projects for Heart, Eric Clapton, the Rolling Stones, Motley Crue, Luther Vandross, Bad English, Warrant, Skid Row, Taylor Dayne and The Cult, and the soundtrack for *Pretty Woman*.

E. Remote Recording Facility

Effanel Music, New York, NY: Established in 1980, Effanel Music has two trucks and features an SSL G Series console, Meyer HD-1 monitors and dual Sony 3348 48-track digital recorders. Credits for the past

year include The Rolling Stones' "Steel Wheels '89"; The Who's "Tommy"; NBC's "Late Night with David Letterman 8th Anniversary Special"; the *Night Music* TV series, the Daytime Emmys, Depeche Mode's *101*; "Kathleen Battle and Jessye Norman—Live From Carnegie Hall"; and "New Kids on the Block—Live From Nassau Coliseum." The Effanel team is Randy Ezratty, John Harris, Mark Shane and Adam Pinch.

Fanta Professional Services, Nashville, TN: Fanta Professional Services specializes in mobile recording for the entertainment industry. Clients include all four major TV networks, several major film companies, radio networks and syndicators, and most major record labels. During the past year, projects included *Super Bowl XXIV*, *Night Before Super Bowl*, New Orleans Jazz & Heritage Festival, *Hank Williams Story* on PBS, and a long-form video for Kitaro. Fanta president Johnny Rosen serves on the boards of the AES, NARAS, NATAS, NEA, SPARS, Nashville Symphony Association, and the advisory board for the Belmont College Music Business Program.

Le Mobile, North Hollywood, CA: Le Mobile is a fully equipped mobile recording studio with an automated Neve 8058 console, two Studer A800 24-track recorders with Dolby SR and an array of outboard gear. During the past year, Le Mobile did tours for the Grateful Dead, Joe Cocker and Bad Company. Special events included the Roy Orbison Tribute to Benefit the Homeless at the Universal Amphitheater in L.A.; the AIDS Benefit in Oakland, CA; and the *EICC Benefit Concert* for Cinemax/HBO. At Universal, Le Mobile recorded Madonna for *Dick Tracy*. Le Mobile also recorded the audio for concert videos for Carole King, Chick Corea, and Anderson, Bruford, Wakeman & Howe. Other recordings included Pat Benetar and Metallica.

Record Plant Remotes, Los Angeles, CA: The Record Plant Remote mobile unit II is a specially designed 44-input API console with JBL monitors. Mobile unit III offers a 44-input API with John Meyer monitors. Otari MTR-90IIs come stock with the mobile unit package, with any digital configuration available as an option. During the past year Record Plant Remotes has worked with Neil Young, Reba McEntire, The Gatins, Ringo Starr's All Starr Band, Chicago, the San Francisco Opera, New Kids in Town, Don Henley, Jefferson Airplane, Melissa Etheridge, Sound Garden, Kenny G, the Academy Awards, the Grammy Awards and the Country Music Awards.

Remote Recording Services, Lahaska, PA: Probably best known for operating the "Black Truck," Remote Recording Services started 1990 with the "Silver Studio," a brand new, 41-foot tractor-trailer specifically designed for large-scale concerts, with a massive TV and broadcast interface. It features a 48 x 48 API console, Studer A820s with Dolby SR or optional Sony 3324/3348 digital recorders. Recent credits include Neil Young's *Freedom* album, Van Morrison's live video, and Lou Reed's *Live in Montreal* video.

Westwood One Mobile Recording Division, Culver City, CA: The Westwood One Companies are the world's largest producer of nationally and internationally sponsored radio programs, specials and concerts. During the past year, Westwood One worked with such artists as Randy Travis, K.T. Oslin and Hank Williams, Jr.; Guns N' Roses, Living Colour, Bon Jovi, Skid Row, Steve Miller, Jackson Browne, Don Henley, Fine Young Cannibals, Bobby Brown, Cowboy Junkies, Stevie Nicks, The Who, The Winans and Frank Sinatra. Chief recording engineers Biff Dawes (Los Angeles) and Dale Peters (Cleveland Mobile) are headed by vice president Richard Kimball.

F. Recording School/Program

Berklee College of Music, Boston, MA: The Music Technology Division offers a four-year degree/diploma program focusing on professional production,

engineering, music synthesis skills and extensive hands-on training. The Berklee facilities include seven fully equipped studios (three 24-track); a digital/video post-production editing room; three synthesis rooms with individual workstations and MIDI-equipped ensemble/recital rooms. Courses include analog/digital audio, automated mixing, digital/video post-production, maintenance, music business, sound reinforcement and MIDI-SMPTE synchronization systems.

Full Sail Center for the Recording Arts, Winter Park, FL: Full Sail's emphasis is on in-studio, hands-on, practical experience in recording/engineering, film and video production and other industry-related fields. The school is situated in a 30,000-sq.-ft., nine-studio mega-complex, with a Neve VR 60-input console, five 24-track tape machines, three Synclavier suites with Direct-to-Disk, and a MIDI studio. The school is the official training center for both Neve and New England Digital.

Institute of Audio Research, New York, NY: In 1989, IAR started a new training program with Solid State Logic, assuming all training responsibilities for SSL in the U.S. The program features training for SSL employees and clients, as well as the freelancing engineering community. All IAR students are able to take sessions specifically geared to operational familiarity with the SSL G Series console. Founded in 1969 by Al Grundy, IAR is now graduating over 200 students a year. IAR is currently introducing advanced training programs so that working engineers can keep abreast of rapidly emerging technologies and developments.

Middle Tennessee State University, Murfreesboro, TN: The Recording Industry Management (RIM) program stresses both the audio/production and business side of the music industry. Audio and production classes are taught in two on-campus studios—24-track analog and 24-track digital. Construction is underway for the new Mass Communications building that will house two new digital studios, a MIDI lab, a digital editing room, TV soundstage and remote truck, and other mass communications facilities. Each recording studio will have a unique teaching lab attached to the control room.

Trebas Institute of Recording Arts, Hollywood, CA: Trebas Institute offers over 50 courses in three Diploma programs: Recorded Music Production, Audio Engineering and Music Business. Trebas recently moved the Hollywood flagship of its five campuses to the former Motown penthouse, increasing space by 300%. The new site includes multitrack audio-for-video studios; and music technology and computer labs. The library has 1,000 books, 3,000 magazines and 600 articles on the music business. The school also offers an internship program with major companies. Trebas placed 100% of last year's Hollywood graduates. They have worked on projects with Paula Abdul, Robert Palmer, Michael Jackson, Madonna, Richard Marx and Barbra Streisand. Trebas has sponsored conferences with ASCAP, BMI, NARAS and SPARS.

University of Miami, Coral Gables, FL: The Music Engineering Program placed 100% of its graduates in the professional audio industry during the past year. Two compact discs of UM ensembles were recorded by students and released on Bainbridge Records. Students also completed research projects on cochlear implant simulation, auditory localization and fiber optic MIDI. Faculty member Ken Pohlmann was presented with the AES Board of Governors award for chairing the Digital Audio Conference in Toronto; John Montforte presented technical seminars in Latin America on behalf of Sony; and Clyde Hagler supervised the design of Saban's new post-production complex. George Augspurger also completed the acoustic design of the program's new \$2 million recording and performance center.

Looking for Disk-Based Digital Audio?



ProDisk-464 the Real Alternative to Reel-to-Reel

The ProDisk-464 is a four to sixty-four track hard disk audio recording and editing system, priced below what you'd expect to pay for a multi-track digital tape recorder. The ProDisk-464 is a second-generation random access disk-based system that will **DRAMATICALLY** cut your production costs through the advantages that only disk-based digital audio can provide!

But don't plunge into anything before you've asked a few tough questions... and here are the ProDisk-464's answers!

1. Can I record on ALL TRACKS simultaneously? Can each track be routed out a separate output?

Yes! The ProDisk-464 is a true multi-track hard disk recording and editing system — and can record and/or play back on any combination of tracks, with as many inputs and outputs as you have tracks.

2. How close together can I place edits? Is there a limit to how many edits I can have per track, or per project?

As close as one sample apart! Some other manufacturer's systems can't place edits any closer than 17 milliseconds (a half a frame), and many systems limit the number of edits allowed on a track or project. The ProDisk, however, can place as many edits as you need, with no limit — and these edits may be as close as one sample apart!

3. Can each edit have an individual crossfade time? How long can each crossfade be?

How long do you want it? While other systems do permit crossfade times on edits, they often limit both the crossfade time range and maximum duration. The ProDisk provides crossfade entry in milliseconds, *individually* for each edit, including crossfades on cuts, spot erases, and pastes. And, there is no limit to how long the crossfade can be!

4. Do I have to manage the disk time, or does the system manage the disks for me?

The ProDisk does it for you! The ProDisk keeps constant track of recorded material, and constantly optimizes the disk to provide the most available space. Therefore, you don't have to allocate track time, or worry about destroying material recorded in other projects. A Track Status display tells you how much time is available on the disk.

5. Are cues used in one project protected from accidental change in another project?

Only on the ProDisk! Unlike many other systems, the ProDisk protects cues used in one project from being accidentally damaged when used in other projects — **EVEN IF A CUE IS EDITED FOR ANOTHER PROJECT!** The ProDisk's unique disk data management design prevents the possibility of damage — providing a truly *non-destructive* working environment.

6. Does the system use state-of-the-art hardware for reliability?

The ProDisk does! Using the latest, most state-of-the-art hardware, plus the best chassis components available anywhere, make the ProDisk into a rugged, reliable product. Easy to service PC boards allow any part of the system to be replaced in less than 15 minutes, getting the system back on line **FAST!**

And, the most important question of all...

7. Is the system a real alternative to using analog audio tape?

The ProDisk is! With many hard-disk digital audio systems running into six figures, it just wasn't cost effective to take advantage of digital audio. However, with the ProDisk's price/performance breakthrough, you can get a system you can live with, with the speed that you need, at a fraction of the high cost. Plus, the ProDisk's expandable design allows you to expand the system as your business grows!

Before you "go digital," be sure to get the right answers! Go with the ProDisk! The ProDisk-464 — a real alternative to reel-to-reel.™

Write or call for the ProDisk-464 brochure and to arrange for a demonstration.



Digital Dynamics

Digital Dynamics, Inc.
270-02 East Pulaski Road
Greenlawn, NY 11740
(516) 271-5600 FAX (516) 271-5607

RECORDING IN THE PACIFIC RIM

Tracking Down Japan

by Paul Jackson

Editor's Note: Noted bassist Paul Jackson, former member of the Head-Hunters, lives in Japan with his Japanese wife and son, where he is recording, producing, playing and supporting a huge sushi habit. We asked him to offer his unique perspective on Japanese recording studios.

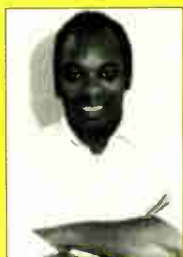

Hello, America; music is alive and well in Japan! Somewhere out there is the Japanese Prince, but producer/musicians like myself have not been able to get him or her to

drop the "I want to be a cute idol singer" act yet. Hey, just sing your butt off for once will ya! Oh, well, maybe next year.

There *is* significant talent here that is not being developed, but it is not because there's no place to record. However, studio costs are as high as everything else in Japan.

The Japanese music industry is



Toshiba EMI

growing much faster than a lot of other businesses, but in the world market it mostly imports talent for concerts, etc., rather than exporting domestic talent—at least so far.

The Japanese do not have a lack of facilities, as indicated by the following stats:

- There are at least 147 24-, 32- or 48-track rooms in the Tokyo metropolitan area (according to *Nikkei* entertainment magazine). These range from tiny mixing rooms, sometimes only big enough for the engineer to slide behind the console, to huge rooms with 96-input consoles and 9-meter ceilings.

- Forty percent of all rooms use SSL consoles, with the other 60 percent divided between Amek, API, MCI, Neve and custom-made units.

- Two out of three rooms in

Studio Terra

Tokyo are equipped with digital recorders, and one-third of these have both 24- and 48-track Sony digital recorders.

It breaks down like this: Studer A80 or A800 Series recorders are predominant in most studios, whether they have digital or not, with more than 87 recorders in place; next popular is Otari, followed by MCI recorders. The studio owners are constantly upgrad-

Photo below: Sound Design



ing their equipment, so it is difficult to keep track of who has what over here. Sometimes it seems that everybody has everything. Now, you might ask, what does all this wonderful stuff cost?

—CONTINUED ON PAGE 100

Recording in Hong Kong: Four Case Studies by Clement Choi

It is not too surprising that most people consider Hong Kong to be one of the few truly cosmopolitan cities in the world, on a par with New York or Paris. People from nearly every part of the world come to Hong Kong and find jobs easily. And they enjoy a much lower cost of living compared to other major cities.

True to that cosmopolitan reputation, Hong Kong welcomes people from many different cultures. Music, as an indispensable part of this unique cultural mix, has changed considerably during the last decade in terms of style, content and production techniques.

Hong Kong's first multitrack studio opened in the late '70s, and, subsequently, the number of recording studios grew rapidly, with many facilities being constructed to attract clients from independent record companies, advertising agencies and video/film post-production houses.

Today there are about 20 24-track music studios, and over 40 16- and 8-track music and post-production studios in operation in Hong Kong. Perhaps the biggest news is the recent opening of three digital 8-track audio



TRACKStudio, Philippines

workstation facilities mainly for post-production.

A current trend in the industry is toward more original local production. There is currently much conjecture concerning how the industry can further develop, since the local market is relatively small. It is a subject of interest to studio owners, sales consultants, equipment suppliers and audio engineers in Hong Kong, as well as to foreign equipment manufacturers and overseas artists and production companies, especially from Southeast Asia, who are looking for a favorable recording environment. By looking closely at several

—CONTINUED ON PAGE 106

Media Business Services audio/video post-production room in Hong Kong

Recording in the Philippines: A Tropical Music Paradise by Mike Pedero

Recording in Southeast Asia—despite any previous notions based on old information—can be a surprisingly worthwhile experience. While the Philippines may not have its share of SSLs or 3348s, there is an increasingly broad choice of well-equipped facilities doing brisk business. Add to that unspoiled, lush tropical vegetation, vast white beaches and friendly people, and the Philippines begins to look like an attractive recording alternative.

Located in the middle of the Pacific Rim, the Philippines is 14 hours by jet from San Francisco, four hours from Tokyo, three hours from Singapore and less than two hours from Hong Kong. The islands boast a healthy recording industry rich with musical talents (several are now mainstays in the hit London musical *Miss Saigon*).

—CONTINUED ON PAGE 109

—FROM PAGE 98, JAPAN

Well, dig deep, buddy, because the pricing structure over here will wear out some of the deepest pockets unless you have a recording contract to fall back on, or have a deal with a production company to cover your expenses.

The list price of the studio (\$56 to \$340 per hour) does not *always* include the use of the recorder; sometimes it's extra! In quite a few cases the list price means only use of the room and not the use of the equipment in that room. The price of recorders range from \$37.50 per hour for an analog multitrack to \$75 for a Mitsubishi or Sony digital, *on top of* the base studio price. You must also add up to \$75 per hour for the engineer and/or assistant to the base price. Add to that extras such as outboard equipment, and you're talking about an average cost range of \$330 to \$550 per hour for making your dreams come true in Tokyo.

Let's briefly look at three studios. Pan Studio features a 24-track Studer A800. This Yokohama studio is owned by producer/composer/musician

Micky Yoshino, who is a Berklee School of Music graduate. He and one of Japan's ace SSL engineers, Tsuneo Matsumoto, have created a super environment mostly to deal with Yoshino's many ongoing projects. Yoshino is a well-known keyboard artist here, as well as an adviser to Roland and IBM Japan. The studio, located on the second floor of a new four-story building, has some unique features.

The first floor is a combination office and lounge, but it also has three small rooms used for programming sequences before they are taken upstairs for recording. The entire third floor is sealed off as a bass trap, with only a staircase going up to the fourth floor where Yoshino has his apartment (no zoning problems here; L.A. eat your heart out!), and Matsumoto has his apartment in an adjoining building. Rates for the studio are \$210 per hour, all-inclusive, with use of an optional 32-track Mitsubishi X-850.

There is no sign on the door outside Sound Design Studio, located near the Olympic pool in central Tokyo. This wonderful little room with a 24-track Studer A80 MkII, Sony 3348 and Neve V console is set up to do video

as well as audio. The going rate is \$340 an hour, also all-inclusive. It's the centerpiece of an operation that is also presently constructing the only privately owned mobile recording (48-track Sony PCM-3348/Neve V Series console) truck in Japan. The truck? What else but a Mercedes-Benz, semi-imported for the occasion.

All this is held in place by a guy who makes me lose weight if we're in the same room together. Mr. Nanri is an individualist—atypical of most businessmen in Japan (or in the USA for that matter)—and the sole owner of Sound Design, with the exception of his wife, Moko, whom he calls "Boss." He has gone up against the system here by importing his equipment directly from the USA and England, thereby avoiding a 40 percent service charge nailed on by Japanese distributors. Pretty daring. Maybe more people over here will catch on to what the real prices are for the equipment they buy. His operation as a record company in Japan will soon be expanding to L.A. by 1991. Watch out for this guy—he's hot!

"Down by the Riverside" is not only a song, in Tokyo it's a place. Toshiba-EMI has spared little and bought much here. Located in a new building in a waterfront section of town, studio-TERRA even has an elevator for your car to the rooftop parking lot, plus kitchen, sleeping and shower facilities, all under the same roof. Here is one of the all-the-way-uptown, get-down studios in Japan. You want something? Name it and it'll be there in an hour! (Although the hour will cost you \$440 and up.) There are three main rooms: A and B studios, which together can be opened to form one huge space with two complete control rooms connected to it, and C studio, which is used mostly as a video/mixdown room. It has a small booth for recording vocals. There's a separate air-conditioned soundproof machine room for each studio that has what looks like a million dollars worth of digital multitrack recorders in addition to the normal complement of Studer A80 and A800s. What you get is what you pay for.

I have a partnership in a small 16-track MIDI studio (STUDIO BE) with sound engineer Hidekazu Noritake, where we produce commercials, videos and soundtracks. We also rent out the space for rehearsals.

Of course, it would take a lot more

—CONTINUED ON PAGE 104

JOHN M. STORYK

ARCHITECTURAL & ACOUSTICAL DESIGN

SYNCHRO SOUND
'THE CARS' STUDIO
BOSTON, MASSACHUSETTS

TEC
1990
NOMINEE



A DIVISION OF
WALTERS-STORYK DESIGN GROUP, INC.

31 UNION SQUARE WEST, NYC, NY 10003 • (212) 675-1166
134 MAIN STREET, NEW PALTZ, NY 12561 • (914) 255-2255

Circle #102 on Reader Service Card



TEC

TECHNICAL EXCELLENCE & CREATIVITY

1990
NOMINEE

IF A·DAM IS JUST ANOTHER
DIGITAL MULTI-TRACK,
STEVIE IS JUST ANOTHER MUSICIAN.

You know how good this guy is. For total musical abilities there's simply no one better. So when an impressive guy like Stevie tells us he's real impressed with A·DAM, its music to our ears.

Well, what Stevie is doing for music, Akai is doing for digital multi-track. A·DAM. The world's first portable digital multi-track, with the convenience of universally accepted 8mm tape, gives you the flexibility to expand to 36 tracks. It's the only digital machine within the means of any professional application.

A·DAM is the ultimate satellite multi-track. In a midi facility, A·DAM is the ideal primary machine because its SMPTE

compatibility lets you devote 12 digital tracks to vocals. And with single frame editing, you can now eliminate the most difficult breaths and pops with absolute precision.

A·DAM. Just another wonder from Akai. Call today for the authorized AKAI Digital dealer nearest you.

AKAI
DIGITAL

P.O. Box 2344 · Fort Worth, TX 76113
(817) 336-5114

Circle #041 on Reader Service Card

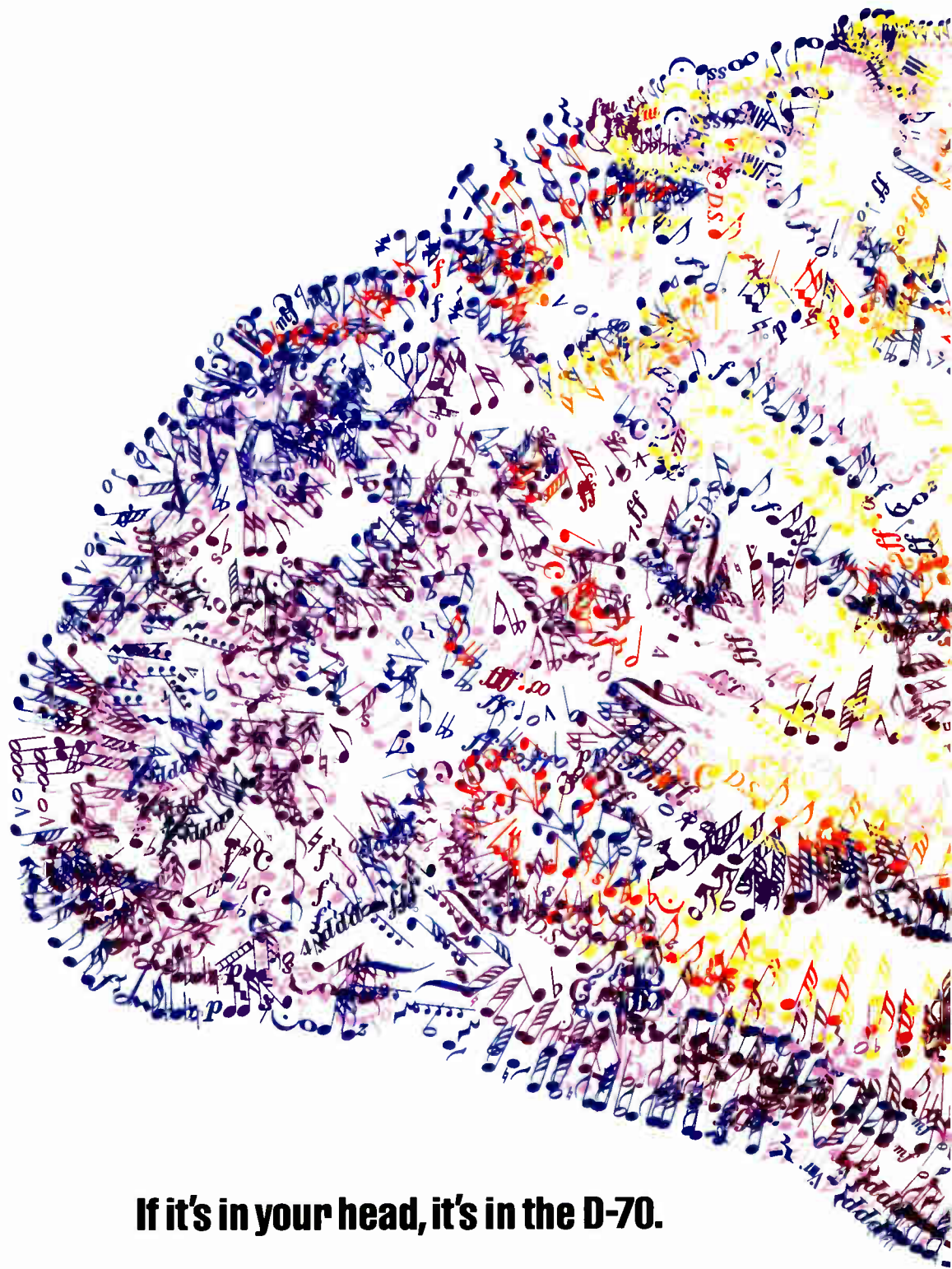

If it's in your head, it's in the D-70.

As scientists see it, 90 percent of your brain's creative potential is untapped. Which, as we see it, isn't so much a reflection on your brain as it is on not having the right tool to do the tapping—a tool that now exists in the extraordinary new D-70 Super L/A Synthesizer from Roland.

The D-70 provides a radically new level of creative flexibility. Thanks to our new Differential Loop Modulation technology, there are thousands of new distinctive, modulated waveforms

and a slew of new PCM samples to work with. And since the D-70 layers up to four multi-samples at once, it's not only easier to create new sounds the moment you conceive them, it's also possible to produce some of the brightest, fattest sounds imaginable.

The D-70 also delivers tremendous hands-on creative control, courtesy of a Tone Palette editing system which gives instant access to the most widely-used synthesizer parameters. And since you can use the four sliders to modify any of four

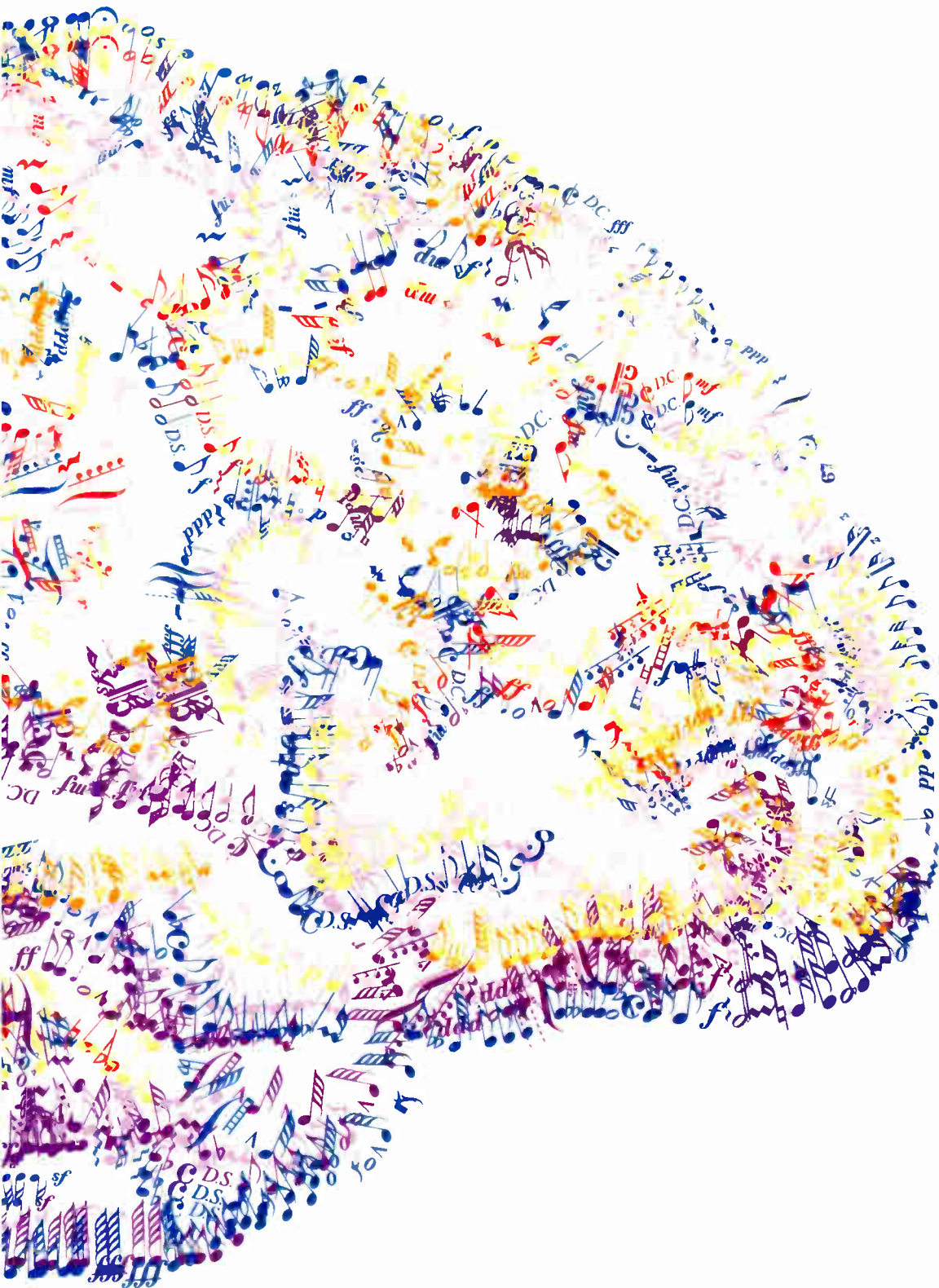

Tones simultaneously in real time, you can create new sounds instantly.

We realize this is a lot for 10 percent of your brain to take in. So if you have questions, call (213) 685-5141. And if you want to skip the call and just buy one, **Roland**® that's ok with us, too.

Roland Corp U.S. 7200 Dominion Circle, Los Angeles, CA, 90040-3647



WOULDN'T YOU LIKE TO WORK WITH A LEGEND?



MIX Magazine's reviewer had this to say about BIAMP's **LEGEND** recording console . . .

" . . . the general construction of the board is quite impressive . . . the LEGEND's configuration, flexibility, and the bottom line . . . the way the board sounds . . . is first rate. Headroom, frequency response and overall sound warmth make the LEGEND a strong contender. . . "

- * Space saving in-line format
- * Modular construction
- * Balanced Group outputs and Tape Returns with complete tape monitoring
- * Four-transistor discrete preamplifier section . . . unexcelled sonic performance
- * Transparent sweepable EQ with switchable bypass and HPF
- * Complete control room and studio communication system

Call us toll-free at 800-826-1457 for the name of the LEGEND dealer nearest you . . . and ask us about the LEGEND/J.L. Cooper automation package, too . . . affordable automation without sacrificing sonic performance.

biamp  **AMERICAN
SOUND
CRAFTSMANSHIP**

14270 N.W. Science Park, Portland, OR 97229
(503) 641-7287

Circle #103 on Reader Service Card

—FROM PAGE 100, JAPAN

print space than I have available to make a thorough investigation of the many multitrack studios in the Tokyo metropolitan area. The listing by *Nikkei* is updated only twice a year and does not even take into account the number of house/apartment-run businesses (you can do that here). Who knows how many 4/8/12/16/24-track private studios there are here?

Japan has an urgent need for engineers/producers with the creative talent to use all these wonderful toys. Don't get me wrong; there are some great engineers here. Anything they record will go on the tape perfectly, but there is a lack of engineer/producer types who can give a strong, creative input to the artist over here. Engineers tend to be primarily technicians who record well and balance the sound in a mix. I heard recently that SSL consoles shipped to Japan have some of their features disconnected, because there is almost never a situation where there would be a single operator. (This is a fact, Jack!) This is in part a fault of the nature of the music business over here, which is controlled more by advertising interests than by artistic talent. A first consideration for a Japanese artist is how you look, and not how you sound.

They have the tools here in Japan to do anything they want (albeit expensively). However, there needs to be a movement in the recording/advertising/production industry to make more music along with making money. ■

Editor's Note: The address for Nikkei Entertainment Magazine is: Nihon Keizai Shinbun, Book and Information Corner, 1-9-5 Ohtemachi, Chiyoda-Ku, Tokyo.

LYREC EQUIPS KOREAN FACILITIES

Koreamusik is the latest Korean client for Lyrec of Denmark, having ordered a set of duplicating equipment consisting of a bin loop master, ten slave units, a stereo tape recorder, a Mastermaker and Quality Control machine.

Also ordering equipment from Lyrec was Seoul Records. Korean technical support for Lyrec is provided by Far East representative Seoul Sound Technology.

89TH AUDIO ENGINEERING SOCIETY CONVENTION

AES

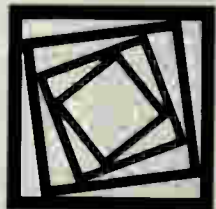

1990



Creating Illusions in Sound—The Fusion of Art, Technology and Imagination

SEPTEMBER 21-25, 1990 □ **LOS ANGELES, CALIFORNIA**

EXHIBITS, TECHNICAL PAPERS & SEMINARS, HANDS-ON WORKSHOPS, AND TECHNICAL TOURS □ □ **ALL AT THE LOS ANGELES CONVENTION CENTER**
AUDIO ENGINEERING SOCIETY 60 E. 42nd St., New York, NY 10165 □ (212) 661-8528 or (800) 541-7299 (except NY)



—FROM PAGE 99, HONG KONG

typical operations, a clearer picture of the whole scene may be painted.

At a time when most people in the Hong Kong audio industry were budget-conscious, Media Business Services spent about \$800,000 last year on audio equipment alone. MBS set up a new audio/video post-production center, as well as one of the biggest touring P.A. systems in Southeast Asia, both equipped with state-of-the-art gear.

For the P.A. system MBS carries a 50kW Meyer/Crown system for sound

amplification; Yamaha PM3000 and Ramsa WR-S840 for house and monitor mixing; Clear-Com wireless system; Sennheiser UHF wireless microphone systems; BSS, Drawmer, Klark-Teknik and Yamaha outboard gear; and a wide range of other accessories.

An AMS Audiofile is installed as a central audio workstation in the post-production studio. Other equipment includes an Amek BCII mixing console, Crown and QMS monitoring systems, Fostex D-20 and Sony PCM-2500 DAT machines, and Otari MX-55 2-track recorder. With the recently purchased Sony PCM-1630 processor, the studio has further expanded its

business to include digital mastering.

"Professional means quality, and quality usually means money," says Kinson Tsang, general manager of MBS, who strongly believes that there is a market for high-end production in Hong Kong. "We don't mind spending money, because we think that we can get it back by providing professional services, and actually we are quite happy so far with the outcome." MBS has recently finished some Karaoke productions featuring high-quality audio and interesting video special effects. These productions of songs, minus the lead vocal in video format, include lyrics for people to sing along with, and can be found in nearly every popular Karaoke club in downtown Hong Kong.

MBS is affiliated with Asia Television (ATV), one of the major television stations in Hong Kong, and, as such, handles a lot of post-production work for that station.

EMI HK represents another kind of studio operation in Hong Kong. The studio, located near the airport, is built to have good isolation from the outside world and has a large studio area for acoustic recording.

The studio recently installed a new Solid State Logic 4040E-32 console. "Nearly every engineer likes to work in front of an SSL desk," studio engineer David Sum says. "It's so easy and efficient to use. We know that there are other alternatives in the same class, such as Amek, Sony or Neve, but we still think this console is the best buy for the money."

By affiliating with EMI (HK) Limited, one of the oldest record compa-

Put *Just* the Control at Your Finger Tips

Power amplifiers should be heard — not seen!

The remote gain capability of the TTD-200 40W Dual Power Amplifier allows you to *rack* the amplifier—console space is then made available for other equipment, heat is reduced, and the need to run audio into the console is eliminated.

Two wires and a pot are all you require to control the level to your speakers. Multiple amplifiers can be controlled by a single pot.

The TTD-200 also features virtually indestructible 150W power op-amps which provide 100% protection against short circuits, over-voltage, and excess temperatures.*

The TTD-200 will drive both channels at 60 Watts into 4 ohms and the mono-bridge mode will produce 120W into 8 ohms. The differential, instrumentation type input stage allows balanced or unbalanced inputs without loss of signal level.

The TTD-200 is new and innovative. Call for an Applications Note.



*Would you short the output of your present amplifier at max output power and expect it to survive? We'll provide the extra fuse so you can do it to the TTD-200.

TARGET TECHNOLOGY, INC.
P.O. Box 609, Penn Valley, CA 95946
FAX: 916-639-2212
TEL: 916-639-2102

APPLE FILES SUIT IN TAIWAN

Apple Computer recently announced that it has filed a criminal complaint in Taiwan against five individuals for infringement of Apple's copyright and trademark rights under Taiwanese law.

After the complaint was filed, the prosecutor's office of the Taipei District Court, with the assistance of the Taipei police, conducted raids on Flive Computer Corporation and premises occupied by persons doing business under the name Akkord Technology, Inc. The prosecutor's office is now examining the evidence for the purpose of issuing indictments against the five individuals.

nies in Hong Kong, the studio is guaranteed basic studio bookings. Still, EMI welcomes outside clients. Having standard studio equipment like the SSL desk, Studer A80 24-track, Dolby XP24A noise reduction, Lexicon 480L reverb, a good environment for acoustical recording, and perhaps most importantly, a modest studio rate has attracted clients from Japan and Taiwan to EMI recently.

Studio S & R is one of the most familiar names on the back of the latest hot albums in Hong Kong. The studio is run as an independent commercial studio.

The studio is located on the ninth floor of a commercial building with just ten feet of ceiling height for each floor. Its two rooms are packed into a 1,500-square-foot space. Studio A was the first to open, with a MasterMix automated Amek G2520, Otari MTR-100, Dolby XPR24 SR, Lexicon 480L, AMS RMX 16, Eventide H3000 and a Macintosh. The smaller Studio B opened at the end of last year with an automated Amek Angela, Otari MTR-100, Dolby XPR24 SR, Lexicon PCM70, Yamaha SPX and a Macintosh.

"We like automated mixing because it allows fine adjustments of nearly all important parameters at the final stage. Also, we like to use many different effects for different tracks, because this helps us a lot in making good sound images for a mix," states studio manager and mixing engineer David Ling.

In spite of the limited space for conventional acoustical recording, the studio has produced many albums using MIDI instruments in the two studios, which are synchronized to tape via the Macintosh and SMPTE/MIDI converter boxes.

Besides providing attractive studio facilities for recording and mixing, the studio also employs four experienced engineers—certainly one reason for the success of Studio S & R.

As space is so precious in Hong Kong, most of the studios have size restrictions. Musicad, a successful personal studio, is another case in point. The studio occupies 300 square feet and is situated on the 16th floor of a residential building. Little acoustic treatment was used inside the studio. Nevertheless, it is equipped with nearly everything one needs in a personal studio. One of the owners, Romeo Diaz, who is also a talented musician/composer, brought many

MIDI samplers and synthesizers, such as Emulator III, Oberheim expander, Roland Jupiter, Akai samplers and Yamaha DX7IIFD, into the compact facility to provide a wide choice of sound combinations for his film music scoring and jingles. Since getting the studio in operation almost two years ago, Diaz has written music for nearly 20 films and jingles.

"We are happy with our gear: the MIDI equipment, the Soundtracs MR24/8 console and the Fostex B-16. I think they are good for our scale of production," Diaz says.

In the near future, Diaz and his partner, James Wong, will open a 24-

track studio. "We are not a big company that can afford to spend much money without sufficient return. We have to calculate very carefully, especially taking the recent political situation in mainland China into account. We are confident with our production from our past experience, but sometimes we just cannot control everything!" ■

Clement Choi is a graduate in electronic engineering from the University of Hong Kong. He is now an independent pro audio sales consultant in Hong Kong.

SIMPLY THE BEST!



Simon Systems™ is setting a new standard of excellence in professional audio signal processing equipment. It began with the **DB-1A Active Direct Box**. Boldly designed and independently powered*, the DB-1A delivers performance that blows every other DI away. The DB-1A's unique design is based on totally active (transformerless) circuitry with no insertion loss. With features like line level output, rechargeable battery capability, and automatic power system check, it's easy to understand why so many professionals refer to it as simply the best direct box money can buy!

Then came the **CB-4 Headphone Cue Box**. With four outputs independently controlled by conductive plastic stereo power controls, the CB-4 allows up to four headphones to be driven from the same amplifier. A three-position switch selects left mono, right mono, or stereo mix, and XLR input/output connectors are provided for paralleling additional cue boxes. It's no wonder why the CB-4 has become a standard in the industry.

The tradition of excellence continues with the **RDB-400 Integrated Direct Box**. Based on the same design technique which made the DB-1A the premier direct box of the industry, the AC powered RDB-400 is four direct boxes in one. It can be rack or floor mounted and has countless uses. It features line level output mode with infinitely variable trim, attenuation mode with stepped variable trim, input overload LED, speaker level input pad, balanced and unbalanced buffered outputs with front and rear XLR connectors, ground isolation switch, and a toroidal power transformer.

*Simon Systems PS-1 Power Supply is recommended



So the next time you think signal processing equipment, think like a pro:
Simon Systems — Simply the Best!™

Thanks for setting the trend:

GLENN CAMPBELL • JOHN COUGAR • FLEETWOOD MAC • WHITNEY HOUSTON
KENNY LOGGINS • JEAN-LUC PONTY • JEFF PORCARO • RED SPEEDWAGON
UNIVERSAL STUDIOS • TITO JACKSON



SIMON SYSTEMS™ ENGINEERING, INC.

707 Clear Haven Drive, Agoura Hills, CA 91301. (818) 707-9980

Circle #105 on Reader Service Card

Pacific Rim Facilities

AUSTRALIA

AAV AUSTRALIA; 180 Bank St., PO Box 296; South Melbourne, VIC 3205 Australia; (61) (3) 699-1844.

ABC RADIO BROADCASTING CENTRE STUDIOS; PO Box 9994; Hobart, TAS 7001 Australia; (61) (2) 35-3251; Telex: AA58032; FAX: (61) (2) 35-3220. Manager: Vic Holloway.

BRUCE ADDERLEY SOUND STUDIOS; Lot 5 Fairmaid Rd.; Kialla, VIC 3631 Australia; (61) (58) 27-1300. Manager: Bruce Adderley. Heather Adderley

ADELAIDE RECORDING STUDIOS PTY. LTD.; 7 Moger Ln.; Adelaide, SA 5000 Australia; (61) (8) 223-7755.

ALBERT STUDIOS; 9 Rangers Rd.; Neutral Bay, NSW 2089 Australia; (61) (2) 909-3111; FAX: (61) (2) 909-3035. Manager: Bruce Brown.

ATA SOUND STUDIOS; 96 Glebe Point Rd.; Sydney, NSW 2037 Australia.

AUDIO LOC SOUND DESIGN PTY. LTD.; 255B Penhurst St.; Willoughby, NSW 2068 Australia; (61) (2) 411-3157.

AXENT RECORDING STUDIO; 11A Queen Victoria St.; Kogarah, NSW 2217 Australia; (61) (2) 587-0694; (61) (2) 587-7946. Manager: Ross McGregor.

BARCOO STUDIOS; 32 Barcoo St.; East Roseville, NSW 2069 Australia; (61) (2) 406-5535.

BENDIGO STREET PRODUCTIONS; 22 Bendigo St.; Richmond, VIC 3121 Australia; (61) (3) 229-0201.

BLUE HARBOUR RECORDING STUDIO; 3rd Fl., 357 Sussex St.; Sydney, NSW 2000 Australia; (61) (2) 267-2752. Manager: Louie Shelton.

BUSH TRAKS RECORDING STUDIOS; Unit 1 Bush Factory; Cullen St.; Nimbin, NSW 2480 Australia; (61) (66) 89-1290; FAX: (61) (66) 89-1109. Manager: Ruth Miller.

CASTLERIDGE STUDIOS; 166 Centre Rd.; Bentleigh, VIC 3204 Australia; (61) (3) 557-3667.

CBS STUDIO; 11-19 Hargrave St.; East Sydney, NSW 2010 Australia; (61) (2) 332-0320; Telex: AA121246; FAX: (61) (2) 331-1377. Manager: David Spargo.

CENTRAL RECORDERS; 420 Elizabeth St.; Surry Hills, Sydney, NSW 2010 Australia; (61) (2) 699-7931.

CHARLES STREET STUDIOS; Charles St.; Prahan, VIC 3181 Australia; (61) (3) 529-2388.

CINEMA INTERNATIONAL CORP.; 278 Stirling St.; Perth, WA 6000 Australia; (61) (9) 328-5677.

THE CITY STUDIO; 186 Rochford St.; Erskineville, NSW 2043 Australia; (61) (2) 519-8952.

CLARION; 63 Thompson Rd.; North Fremantle, WA 6159 Australia.

THE COTTAGE; 514 Springsvale Rd.; Nunawading, VIC 3131 Australia; (61) (3) 232-4133; FAX: (61) (3) 235-4225.

CREATIVE SPACE SOUND STUDIOS; 22 Heussler Terrace; Milton, QLD 4064 Australia; (61) (7) 369-8108.

DEX AUDIO; 87-91 Arden St.; North Melbourne, VIC 3051 Australia; (61) (3) 329-2877; Telex: AA30625 (attn. ME2346); FAX: (61) (3) 326-5282. Manager: Daniel Desiere. Greg Williams

EARTH MEDIA RECORDING CO.; 14 Glen St.; Milsons Point, NSW 2061 Australia; (61) (2) 929-8869; (61) (2) 929-4808. Manager: Alan Lancaster.

EGGAT FIVE UNION STREET; 16 A Chatsworth Ave.; Brighton, VIC 3186 Australia; (61) (3) 596-4338.

The following listings have been supplied by manufacturers and other sources. *Mix* does not claim responsibility for the accuracy of these facilities included here. Any facility that would like to be included here can fax: (415) 653-5142, or call: 1 (800) 344-LIST or (415) 653-3307.

EMERALD CITY STUDIO; 5/505 Pittwater Rd., PO Box 704; Brookvale, NSW 2100 Australia; (61) (2) 939-1943; (61) (2) 938-3664; FAX: (61) (2) 905-0676. Manager: John Zulakha.

FAIRLIGHT INSTRUMENTS; 15-19 Boundary St.; Rushcutters Bay, NSW 2011 Australia; (61) (2) 331-6333; Telex: AA27998; FAX: (61) (2) 332-3362; E-Mail: FAIRLIGHT-AA. Manager: Rob Young.

FAST FORWARD RECORDERS; 219 Wonga Rd.; Waranwood, VIC 3134 Australia; (61) (3) 876-2211; FAX: (61) (3) 876-4253. Manager: Graham Williams.

FESTIVAL RECORDS; 63-79 Miller St.; Pyrmont, NSW 2009 Australia; (61) (2) 660-4022; FAX: (61) (2) 692-8058. Manager: Barry Nagel.

FOX COLUMBIA FILM DISTRIBUTORS; 505 George St.; Sydney, NSW 2000 Australia; (61) (2) 264-7877; Telex: 26278.

GRAPEVINE STUDIOS; 138 Gover St.; North Adelaide, SA 5006 Australia; (61) (8) 267-4455. Manager: Brian Braidwood.

GREVILLE RECORDING STUDIOS; 26 Wallace St., PO Box 312; Albion, QLD 4010 Australia; (61) (7) 262-8422; (61) (7) 262-8228; FAX: (61) (7) 862-1422. Manager: Rodney Jacobson.

HADLEY STUDIO; 5 Egret Pl.; Calala; Tamworth, NSW 2340 Australia; (61) (67) 65-7813. Manager: Eric Scott.

HENDON STUDIOS; 113 Tapley's Hill Rd.; Hendon, SA 5014 Australia; (61) (8) 45-2277; Telex: AA88206.

ICOM; 175 Gibbes St.; Chatswood, NSW Australia; (61) (2) 406-5488.

ILOURA PRODUCTIONS; 50 Rouse St.; Port Melbourne, VIC 3207 Australia; (61) (3) 645-3233.

IDENTITIES; 32 Berry St.; Clyde, NSW 2142 Australia; (61) (2) 897-1878; FAX: (61) (2) 897-1969. Manager: Steve Gibbins.

JUMBUCK PRODUCTIONS PTY. LTD.; 73 Amelia St.; Fortitude Valley, QLD 4006 Australia; (61) (7) 52-8577.

LABSONICS; 72 Tope St.; South Melbourne, 3205 Australia.

LIPS STUDIO; 67 Lipson St.; Port Adelaide, SA 5015 Australia; (61) (8) 47-8266.

L.P. RECORDING STUDIOS; 92 Nelson St.; Fairfield, NSW 2165 Australia; (61) (2) 722-369.

MELBOURNE STREET PRODUCTIONS; 97 Melbourne St.; North Adelaide, SA 5006 Australia; (61) (8) 239-0344; FAX: (61) (8) 267-3682. Manager: Phil Jones.

METROPOLIS AUDIO; 180 Bank St., PO Box 296; South Melbourne, VIC 3205 Australia; (61) (3) 696-2111; FAX: (61) (3) 696-2895. Manager: Ernie Rose.

MOONLIGHT STUDIOS; 15/104 Old Pittwater Rd.; Brookvale, NSW 2100 Australia; (61) (2) 939-2462. Manager: John Cobbin.

PARADISE RECORDERS; PO Box 165; Kings Cross, NSW 2011; 70 Judge St.; Woolloomooloo, NSW 2011 Australia; (61) (2) 357-1599. Manager: Kevin Davidson.

PLANET SOUND STUDIOS; 22 Olive St.; Subiaco, WA 6009 Australia; (61) (9) 382-2211; FAX: (61) (9) 381-5372. Manager: Graham Owens.

PLATINUM AUSTRALIA PTY. LTD.; 643 Chapel St.; S. Yarra, VIC 3141 Australia; (61) (3) 241-7483; FAX: (61) (3) 824-0370. Manager: Chris Gough.

POONS HEAD STUDIOS; 2386 Canning Highway E.; Freemantle, W. Australia; (61) (2) 683-1254; Telex: 10715679.

POWERHOUSE STUDIOS; 26A Bowden St.; Alexandria, NSW 2015 Australia; (61) (2) 318-1220. Manager: Doug Henderson.

POWERPLANT RECORDING STUDIOS; 22-24 Little Cardigan St.; Carlton, VIC 3053 Australia; (61) (3) 348-1300; FAX: (61) (3) 348-1649. Manager: Adrian Barker.

PRO IMAGE; 182 Normandy Rd.; S. Melbourne, VIC 3205 Australia.

THE PRODUCTION WORKSHOP; 335 Queensberry St.; North Melbourne, VIC 3051 Australia; (61) (3) 328-3085. Manager: David Briggs.

PYRAMID STUDIOS; 1 Leigh St.; Victoria Park, Perth, W. Australia; (61) (9) 361-7586.

REEL TIME; 48 Oxford St.; Darlinghurst, NSW 2010 Australia; (61) (2) 331-3313. Manager: Mark Tinson.

REGENCY RECORDING; PO Box 217; 4/13-17 Japaddy St.; Mordialloc, VIC 3195 Australia; (61) (3) 587-1956; FAX: (61) (3) 587-2384. Manager: Fiona Horman.

RHINOCEROS STUDIOS; 200-218 Goulburn St.; Sydney, NSW 2010 Australia; (61) (2) 211-5833; FAX: (61) (2) 281-3248. Manager: Jaqueline Murray.

RICH MUSIC STUDIOS; 432 Kent St., 1st Fl.; Sydney, NSW 2000 Australia; (61) (2) 264-7734; FAX: (61) (2) 264-2397. Manager: Paul Rich.

RICHMOND—THE STUDIO; 12 Adolph St.; Richmond, VIC 3121 Australia; (61) (3) 429-4922. Manager: Michael Holmes. Lobby Loyde.

ROSSWOOD PRODUCTIONS PTY. LTD.; 36 Gosbell St.; Paddington, NSW 2021 Australia; (61) (2) 331-5154; (61) (2) 331-5028; Telex: AA20967; FAX: (61) (2) 360-1583.

SAE STUDIOS; 68-72 Wentworth Ave.; Sydney, NSW 2000 Australia; (61) (2) 211-3711; FAX: (61) (2) 211-3308. Manager: Guy Nicholson.

SHELTER RECORDING STUDIOS; 23 Franklin Rd.; Wanneroo, WA 6065 Australia; (61) (9) 405-3788; FAX: (61) (9) 306-2177. Manager: Andy Priest.

SILKWOOD SOUND STUDIOS; Rear 62 York St.; Bakehouse Ln.; North Fitzroy, VIC 3068 Australia; (61) (3) 486-2716; FAX: (61) (3) 482-2731. Manager: Vyt Karazija.

SING SING RECORDING STUDIO; 9 Gordon St.; Richmond, VIC 3121 Australia; (61) (3) 438-4622. Manager: Trevor Reading.

SOUND AUSTRALIA; 4th Floor, 131 Leichhardt St.; Spring Hill, QLD 4000 Australia; (61) (7) 221-8588.

SOUND BARRIER RECORDING STUDIOS; 23 Lambert St.; Camperdown, NSW 2050 Australia; (61) (2) 517-2968. Manager: Greg Black.

SOUNDTRACK AUSTRALIA; 105 Rundle St.; Kent Town, SA 5067 Australia; (61) (8) 42-2251; FAX: (61) (8) 42-2252. Manager: Bob Allan.

SPECTANGLE PRODUCTIONS; 40 George St.; North Hobart, Tasmania, 7002 Australia; (61) (02) 346-687.

STUDIO RB-X; 356 Swan St.; Richmond, VIC 3121 Australia; (61) (3) 429-6199. Manager: Janette Ashley.

STUDIO 78; 78 Chandos St.; St. Leonards, NSW 2065 Australia; (61) (2) 439-7888; Telex: AA23361 RNP.

EXPERTS
WORLDWIDE
REPORT THE
Steinberg
SEQUENCER
'CUBASE'
WORLD
CLASS

"La manipulation est rapide, logique mais conviviale". Translation: "Manipulation is fast, logical and friendly"

Keyboards (France), Alain Manganot, June '89.

"Aber auch was den groove angeht, arbeitet das program einfach umwerfend. Das was man mittlerweile schon als 'MIDI-bedingte ungenauigkeit' mehr oder weniger akzeptiert hat, tritt bei Cubase erst gar nicht auf."

Translation: "Speaking of groove, the software is simply great. What one has accepted as inaccuracies due to MIDI doesn't exist when using Cubase."

Keyboards (Germany), Hagü Schmitz, July '89.

"I feel that I've written some of my best music with Cubase, and consequently don't want to lose a single note of it."

Sound on Sound U.K. David Hughes, Aug '89.

"Wertung, Stärken:

Echtes Multitasking

Hervorragende Benutzereführung

Umfang der funktionen

Schwächen:

Keine schwächen im test aufgefallen

Fazit: Ein absolut professionelles program für höchste ansprüche"

Translation:

"Evaluation, Strengths:

Real Multitasking

Excellent user interface

Multiplicity of functions

Weaknesses:

No weaknesses while testing

Conclusion: An absolute professional program for highest claims."

Happy Computer (Germany), Justus Köhncke, Aug '89.

特に印象的だったのが、その徹底したイー
ジー・オペレーションぶりと処理の速さだ...
M. R O Sの採用と、グラフィック・エディ
ットの採用に講うところが大きい。

Translation: "The most impressive aspect was, above all, its consistency in easy operation and fast process. The M•ROS and Graphic Editing are the main sources of these advantages."

Keyboard Magazine (Japan), Yasuhiro Suzuki, Aug '89.

"Wertung:

Bedienungsfreundlichkeit: Hervorragend

Funktionsvielfalt: Sehr Gut

Handbuch: Sehr Gut

Gesamtwertung: Sehr Gut"

Translation:

Evaluation:

Use friendliness: Excellent

Number of functions: Very good

Manual: Very good

Conclusion: Very good

ST Magazine (Germany), Sept '89.

"Cubase verdient lof met name viir de manier van bediening en de gebruikersinterface. Voor zowel de beginnende als gevorderde MIDI muzikant is het zeer aangenaam en intuïtief werken met Cubase.

Translation: "Cubase deserves a lot of praise for it's user friendliness and it's user interface, a MIDI music beginner and also a MIDI music professional can work pleasantly and intuitively with CUBASE."

MIDI Magazine (Holland), Armand Ten Dam, Sept '89.

"it is the work of a few minutes to produce a handful of songs of differing feel and structure from the same set of individual parts.

With Cubase on stream, the days of feeling loath to remix or rearrange a piece of music simply because the original version took so long to put together are at an end."

Music Technology U.K., Nigel Lord, Sept '89.

"The program's main strengths are its consistent command syntax and its visual orientation. In plain English, it's easy to learn, and it allows you to think like a musician, not a computer programmer."

Keyboard Mag, USA, Jim Aikin, USA Oct. '89.

"I found Cubase to be a fun program with powerful features to satisfy the most serious MIDI programmer yet easy enough for the musician"

ST World USA, Mike Rosen, Nov '89,

"it is a really massive system, and yet at no time did I feel lost in it"... "For the time being at least, Cubase is the Rolls Royce of Atari Sequencers."

Home and Studio Recording U.K., Dave Pickering Pick, Dec '89.

Readers, voted "CUBASE" the best keyboard software of the year 1989.

Fachblatt Magazine (Germany)

"Multitasking aside, I'd snatch up Cubase in a minute for high-end sequencing. The graphics are glorious--getting a tremendous amount of information into a minimum amount of space, and operations show considerable attention to detail with a musician's emphasis, rather than a programmer's."

Electronic Musician, Jim Pierson-Perry, USA Jan. '90

M-R-O-S対応ソフトが開発されたことにより、実際に音楽制作の現場でわれわれが今必要としている「見て、聞いて、編集する」という一連の作業を簡単に実現してくれています。

Translation: "The ease of use is brought out by the visual editing features, which simulates the series of operations required in music production."

Let's Play Computer Music (Japan), Takaaki Toki, Mar. '90.

LOGICAL, EASY, FAST
FRIENDLY, INTUITIVE
PROFESSIONAL &
POWERFUL

17700 Raymer St., Suite 1001
Northridge, CA 91325
Ph: 818-993-4091
FAX: 818-701-7452

Pacific Rim Facilities

STUDIOS 301 (EMI RECORDS AUSTRALIA); 301 Castlereagh St., Sydney, NSW 2000 Australia; (61) (2) 217-7701; FAX: (61) (2) 217-7799. Manager: Fiona Simpson

SUITE 16 AUDIO PRODUCTIONS; 70 Sylvan Rd., Toowong, QLD 4066 Australia; (61) (7) 371-6822; FAX: (61) (7) 870-9224. Manager: Murray Lyons

SUN STUDIOS; 8th Fl., 8-24 Kippax St., Surry Hills, NSW 2010 Australia; (61) (2) 212-3537. Manager: Peter Radnai

SUNSHINE STUDIOS; 10 Buchanan St., West End, QLD 4101 Australia; (61) (7) 844-6844; (61) (7) 844-6845. Manager: Leon Prescott

SUPREME STUDIOS; 11 Young St., Paddington, NSW 2021 Australia; (61) (2) 331-2666.

TAIMAC; William St., Northbridge, 6000 Australia.

TASMANIAN FILM CORPORATION; 1-3 Bowen Rd., Moonah, Tasmania, 7008 Australia; (61) (2) 286-263.

TRACKDOWN STUDIOS; Briggs & Church St., Camperdown, NSW 2050 Australia; (61) (2) 516-4533; FAX: (61) (2) 519-1258.

TRACKS STUDIOS; 1152 Hay St., West Perth, WA 6005 Australia; (61) (9) 321-4522; Telex: AA92881 (PE 527 WOOMERA); FAX: (61) (9) 322-2316. Manager: Amanda Curtin

TRAFALGAR RECORDING STUDIOS; 74B Trafalgar St., Annandale, NSW 2038 Australia; (61) (2) 660-0385; FAX: (61) (2) 660-7180. Manager: Donna Francis

TRANSISTOR MUSIC; 78 Mansfield St., Rozelle, NSW 2039 Australia; (61) (2) 810-6999; Telex: AA70842; FAX: (61) (2) 810-5395; E-Mail: TRANSISTOR-AA. Manager: Simon Riley

ULTRA ART; 56 Robert St., Rozelle, NSW 2039 Australia; (61) (2) 810-0779; (61) (2) 818-3586; Telex: AA127113 ULTRA ART; FAX: (61) (2) 290-3278.

UNITED SOUND; 21 Pier St., Sydney, NSW 2000 Australia; (61) (2) 261-381.

THE VOICE PLANT; Basement, 440 Queen St., Brisbane, QLD 4000 Australia; (61) (7) 229-2577.

WAREHOUSE SOUND SYSTEMS PTY. LTD.; 77 Argyle St., Fitzroy, VIC 3065 Australia; (61) (3) 417-4866.

ZAP PRODUCTIONS PTY. LTD.; 24 Carlotta St., Artarmon, NSW 2064 Australia; (61) (2) 438-4333; FAX: (61) (2) 439-5172.

CHINA

CHINA RECORD CORPORATION; 2 Fuxingmenwai St., Beijing, China; (86) (1) 866-788; Telex: 222 309 CRC ON. Manager: Wang Subo

JIANGSU PEOPLE'S BROADCASTING STATION; 8 West Ci Tang Ln., Zhong Shan Rd. East; Nanjing, China; (86) 401-232. Manager: Lu Ming Ming

LIAONING PEOPLE'S BROADCASTING STATION; #1, Block 2, Section 1; Guangrong St., Heping District; Shenyang, China; (86) 369-445. Manager: Li Xin Hua

HONG KONG

CBS/SONY HK LTD.; 22 Nanking St., Hong Kong, Hong Kong; (852) (3) 327-087.

CROWN RECORDS; 84 Gloucester Rd., Wanchai, Hong Kong; (852) (5) 273-828.

EMI (HONG KONG) LTD.; 11 Fa Po Street; Yau Yat Chuen, Kowloon, Hong Kong; (852) (3) 3810-321; FAX: (852) (3) 3970-213.

K.P.S. STUDIOS LTD.; 3 Somerset Rd., Kowloon Tong, Kowloon, Hong Kong; (852) (3) 387-157; Telex: 84198 KAKUI HX.

PANASONIC STUDIOS; 635 King's Rd., North Point, Hong Kong; (852) (5) 615-086.

POLYGRAM RECORDS LTD.; Garley Bldg., Rm. 1001; 233-239 Nathan Rd.; Kowloon, Hong Kong; (852) (3) 735-5491; FAX: (852) (3) 735-5345.

REDIFFUSION (HONG KONG) LTD.; Television House, Broadcast Dr.; Kowloon, Hong Kong; (852) K-374-111.

SALON FILMS (HONG KONG) LTD.; Mayson Garden Bldg.; 2C-E Ground Fl., Wing Hing St.; Causeway Bay, Hong Kong; (852) (5) 781-051-4; Telex: 75303 SALON HX.

SILVER PLANET RECORDS LTD.; Sing Tao Bldg., 1 Wang Kwong Rd.; Tower B, 2nd Fl.; Kowloon Bay, Kowloon, Hong Kong; (852) (3) 798-2528; FAX: (852) (3) 795-3015. Manager: Hon-Leung Yip

STUDIO 'A' PRODUCTION COMPANY LTD.; 45-47 Kimberley Rd.; Tsimshatsui; Kowloon, Hong Kong; (852) (3) 721-3391-3.

TOPMOST STUDIO; 263 Prince Edward Rd.; Kowloon, Hong Kong; (852) (3) 713-1105.

INDONESIA

GRANADA RECORD; Pluit Murni I/15; Jakarta, Indonesia; Manager: Mr. Akang

JACKSON RECORDS & TAPES; Jalan Pinangsia Raya; Glodok Plaza Blok. A No. 11A; Jakarta Barat, Indonesia; (62) (21) 623-336. Manager: Beri Berlian

JK RECORD; Jin Jembatan Tiga; No. 38, Block B-13; Jakarta, 14450 Indonesia; (62) (21) 669-1846; FAX: (62) (21) 669-4644. Manager: Judhi Kristiantho

MUSICA STUDIO RECORD; Perdatam 3 Pasar Minggu; Jakarta, Indonesia; (62) (21) 799-2327; FAX: (62) (21) 799-7568. Manager: Senjaya Wijaya

PT NEW MARUI KORPO (3M); J1 Ir. H Juanda 111/36; Jakarta Pusat, Indonesia; (62) (21) 362-652. Manager: Bartje Van Houten

BUILDING QUALITY CASES SINCE 1952

A.T.A. heavy-duty shipping to lightweight carrying cases

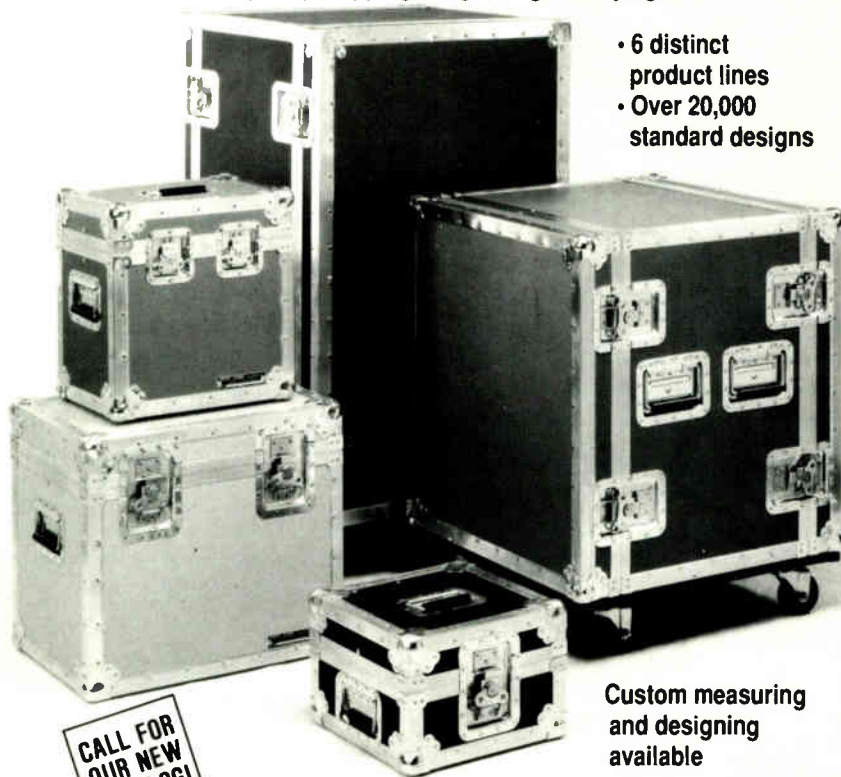

- 6 distinct product lines
- Over 20,000 standard designs

Custom measuring and designing available

CALL FOR OUR NEW CATALOG!

Call Today For More Information

ANVIL CASES
SUBSIDIARY OF ZERO CORPORATION

15650 Salt Lake Ave., City of Industry, CA 91745 • P.O. Box 1202, La Puente, CA 91747
(800) FLY-ANVIL (800) 359-2684

Circle #107 on Reader Service Card

ALFA RECORDS; 3-5-39 Minato-ku; Tokyo, 108 Japan; (81) (3) 454-6651; FAX: (81) (3) 452-5763. Manager: Norio Yoshizawa.

AMP RECORDING; Ploraiya Bldg.; 5-2-1 Rappongi; Minato-ku, Tokyo, 106 Japan; (81) (3) 404-9111; Telex: 23715.

AMUSE STUDIOS; 5-16-3 Nakamachi, Setagaya-ku; Tokyo, Japan; (81) (3) 702-0909.

AMVOX STUDIO; Kyo-Cera bldg. 6-27-8 Jingumae; Shibuya-ku; Tokyo, 150 Japan.

AOI STUDIOS; 1-1-14 Azabu-juban; Minato-ku; Tokyo, 106 Japan; (81) (3) 582-7311; FAX: (81) (3) 582-9682. Manager: Kenji Kuroda.

APORON ONGAKU KOGYO; 1-5 Wakaba, Shinjuku-ku; Tokyo, Japan; (81) (3) 353-0191.

APPO SOUND PROJECT; 1-43-8 Nishikubo Musashino; Tokyo, Japan; (81) (422) 54-7345.

ARCADIA; Nikko Palace Minami Aoyama 102; 6-9-2 Minami Aoyama Minato-ku; Tokyo, Japan; (81) (3) 486-9233.

ARIKI CROW STUDIOS; 3-2-15 Etchu-jima, Koutou-ku; Tokyo, 135 Japan; (81) (3) 630-1600; FAX: (81) (3) 630-8118. Manager: Masashi Nitta.

ART PLAZA 1000; 3-5-6 Minami-Aoyama, Minato-ku; Tokyo, 107 Japan; (81) (3) 746-2121; FAX: (81) (3) 746-2120. Manager: Katsuji Hatakeyama.

ASAHI SOUND; 6-4-10 Roppongi Minato-ku; Tokyo, Japan; (81) (3) 405-3056.

AUDIO GRAPHICS INSTITUTE; 7-20-6 Roppongi, Minato-ku; Tokyo, 106 Japan; (81) (3) 423-0033; FAX: (81) (3) 423-4268. Manager: Koula Akutsu.

AVACO CREATIVE STUDIOS; 2-3-18 Nishi-waseda; Shinjuku-ku; Tokyo, 169 Japan; (81) (3) 203-4181; FAX: (81) (3) 207-1398. Manager: Noboru Matsumoto.

AVIC; Shin Yotuya Ekimae Bldg. 8F; 1-5 Yotuya Shinjuku-ku; Tokyo, Japan; (81) (3) 356-8052.

BACK PAGE; Akasaka Bldg. B1; 4-9-6 Akasaka Minato-ku; Tokyo, Japan; (81) (3) 479-0974.

BAY BRIDGE STUDIO; 3-7-17, Kaigan, Minato-ku; Tokyo, 108 Japan; (81) (3) 769-7121. Manager: Mr. Sakuma.

BIRDMAN; Roppongi Sangyo Bldg.; 3-7-17 Roppongi Minato-ku; Tokyo, Japan; (81) (3) 403-2832.

BUNKA MURA; 2-24-1 Dogen-zaka; Shibuya-ku; Tokyo, 150 Japan.

BURNISH STONE RECORDING STUDIO; Burnish Setagaya B1, 4-14-5 Setagaya; Setagaya-ku; Tokyo, 154 Japan; (81) (3) 427-5550; FAX: (81) (3) 429-9229.

CBS SONY ROPPONGI; 3-17-7 Roppongi Minato-ku; Tokyo, Japan; (81) (3) 585-5399.

CBS SONY SINANOMACHI; 6-8 Minai Motomachi Shinjuku-ku; Tokyo, Japan; (81) (3) 358-8071.

CHERRY ISLAND; Miyahiro Bldg. 4F; 3-55 Kita Aoyama Shibuya-ku; Tokyo, 150 Japan; (81) (3) 478-7781; FAX: (81) (3) 423-0403. Manager: Kyouko Inoue.

CHUROKU CREATION STUDIO; Yoko-Tsukiji Bldg. 8 Fl.; 2-1-17 Tsukiji, Chuo-ku; Tokyo, 104 Japan.

COLUMBIA RECORDS; 4-14-4 Akasaka; Minato-ku; Tokyo, 107 Japan; (81) (3) 584-8111; FAX: (81) (3) 582-9857. Manager: Norio Akada.

CROWN RECORDS; 2-10-8 Akasaka; Minato-ku; Tokyo, Japan; (81) (3) 562-4745.

C.R.S. CO., LTD; 2-10-8 Akasaka Minato-ku; Tokyo, 107 Japan; (81) (3) 589-8664; FAX: (81) (3) 582-9788. Manager: Yoshio Uchida.

DELTA STUDIO; 4-6-1 Hyakunin-cho; Shinjuku-ku; Tokyo, 169 Japan; (81) (3) 367-6211; FAX: (81) (3) 367-6214. Manager: Yoji Ikeura.

DIGITAL STUDIO; 1-4-1 Higashi-yama; Meguro-ku; Tokyo, 153 Japan; (81) (3) 711-7744; FAX: (81) (3) 411-7743. Manager: Yoskiaki Kenmochi.

DISCOMATE; Villa Gloria 7F; 2-31-7 Jingumae Shibuya-ku; Tokyo, Japan; (81) (3) 470-2256.

DOWNTOWN; Miyabi Bldg. 1F; 3-8-9 Shimoya Taito-ku; Tokyo, Japan; (81) (3) 874-4534.

DVC; 29-3 Ichigaya-Sanal-cho; Shinjuku-ku; Tokyo, 162 Japan; (81) (3) 266-2514; FAX: (81) (3) 266-6969. Manager: Seiji Kishi.

ECHO HOUSE; Echo Bldg. B1; 6-15-23 Roppongi Minato-ku; Tokyo, Japan; (81) (3) 403-8495.

EGM; 3-4-13 Takaban Meguro-ku; Tokyo, Japan; (81) (3) 792-6493.

EMUZU PLOT; 2-2-2 Hinodai Hino-shi; Tokyo, Japan; (81) (425) 82-0622.

EPICURUS; 8-27 Sakuragaoka Shibuya-ku; Tokyo, Japan; (81) (3) 476-5623.

FARM STUDIO; 3-5-7 Azabu-juban; Minato-ku; Tokyo, Japan.

FIRST SOUND; Yokokura Bldg.; 6-10-9 Jingumae Shibuya-ku; Tokyo, Japan; (81) (3) 499-1215.

FREEDOM STUDIOS; 2-16-36 Okubo; Shinjuku-ku; Tokyo, 162 Japan; (81) (3) 200-3481; FAX: (81) (3) 200-3704. Manager: Hideo Kamioka.

FREEPORT STUDIO; #2 Seiko Bldg.; 2-20-7 Akasaka, Minato-ku; Tokyo, 107 Japan; (81) (3) 589-2931; FAX: (81) (3) 584-2395. Manager: Saburo Nakamura.

GOLD RUSH STUDIO; 2-17-10 Kojima-cho; Taito-ku; Tokyo, 111 Japan; (81) (3) 851-6102; FAX: (81) (3) 851-7947. Manager: Kinji Yoshino, Afsuo Takada.

GOTO STUDIO; 2-2-47 Kamitakaido, Suginami-ku; Tokyo, 168 Japan.

Get in Gear for the 90's

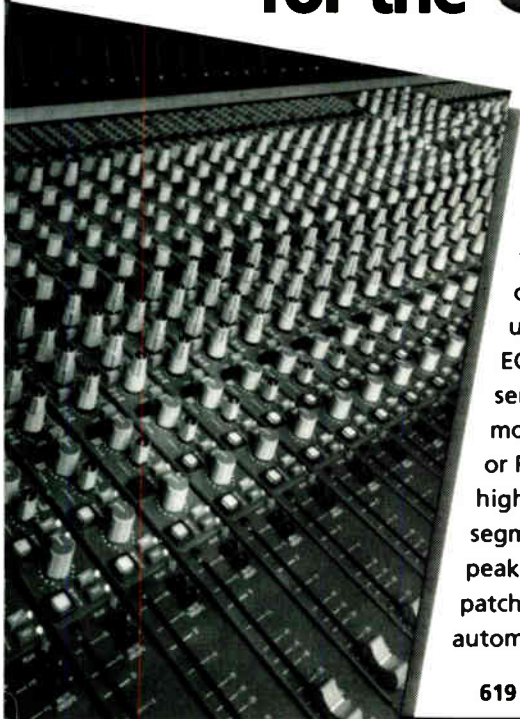

▼ TAC MAGNUM

24 buss in-line recording console with 32-track option, 4-band EQ, up to 72 inputs with EQ at mixdown, 8 aux sends assignable to monitors, in-place solo or PFL, 2 mute groups, high-resolution 30-segment bargraphs with peak hold, 288 point patchbay, fader muting/automation ready.

▼ OTARI MX-80 2" RECORDER

MX-80 features a microprocessor-controlled constant-tension transport, a full-function remote

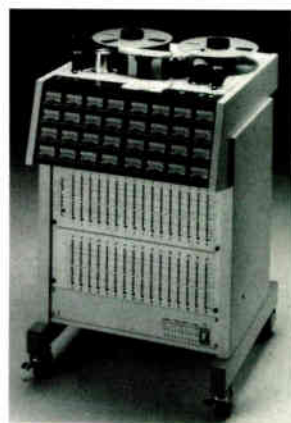

controller, exceptional audio electronics, and connectors for interfacing to any SMPTE/EBU timecode-based editing system, controller, or synchronizer. Available as: 24-track, 24/32-track.

**BEST SERVICE
BEST PERSONNEL
BEST PRICES**



619 So. Glenwood Place, Burbank, CA 91506. Tel: 818/843-6320. Fax: 818/843-5754

Pacific Rim Facilities

GREEN DOOR; 1-12-1 Shinjuku, Ste. 404; Shinjuku-ku; Tokyo, 160 Japan; (81) (3) 356-5019; FAX: (81) (3) 356-5178. Manager: Kinji Yoshino.

HARAJUKU VIDEO CENTER; 6-33-14 Jingu-mae, Shibuya-ku; Tokyo, 150 Japan; (81) (3) 5485-3221; FAX: (81) (3) 5485-3224. Manager: Maki Sato.

HAYASHI STUDIO; Park Nova Jingu-mae 204; 2-35-5 Jingu-mae, Shibuya-ku; Tokyo, 150 Japan.

HITOKUCHIZAKA STUDIOS; 4-3-31 Kudan-kita; Chiyoda-ku; Tokyo, 102 Japan; (81) (3) 263-1097; FAX: (81) (3) 239-6579. Manager: Masahiro Araki, Syoko Abe.

HUMAX ALPHA CHANNEL; 9-11 Tomihisa-cho, Shinjuku-ku; Tokyo, 162 Japan; (81) (3) 351-1164; FAX: (81) (3) 351-1610. Manager: Shotaro Tarada.

IMAGE STUDIO 109; 2-24-12, Shimo-meguro, Meguro-ku; Tokyo, 153 Japan; (81) (3) 779-0109; FAX: (81) (3) 779-2054. Manager: Masaki Ikeura.

IMAJICA; 3-13-6 Higashi Shinagawa; Shinagawa-ku; Tokyo, 140 Japan; (81) (3) 458-1681; FAX: (81) (3) 472-2445. Manager: Mr. S. Kanamaki.

IMPULSE; 103 Hainesu Minami Azabu; 1-1-5 Minami Azabu Minato-ku; Tokyo, Japan; (81) (3) 457-5223.

JAK; Azabu Nagasaka Bldg. 1F; 1-4-8 Azabu 10 Ban Minato-ku; Tokyo, Japan; (81) (3) 587-2393.

JIVE; Amenity Fukazawa; 8-10-17 Fukazawa Setagaya-ku; Tokyo, Japan; (81) (3) 705-2471.

JVC VICTOR STUDIOS; 2-21-1 Jingu-mae; Shibuya-ku; Tokyo, 150 Japan; (81) (3) 403-0111; FAX: (81) (3) 404-7406. Manager: Ryoichi Muraoka.

KAN'NON-ZAKI MARINE STUDIO; 2-1157-2 Hashirimizu; Yokosuka-shi; Kanagawa, 239 Japan; (81) (468) 43-6144; FAX: (81) (468) 43-5493. Manager: Hitoshi Shishido.

KAWAGUCHIKO; 5631 Funatu Kawaguchiko-cho; Minami Tsuru-gun; Yamanashi, Japan; (81) (555) 73-1097.

KEY STONE IZU; 1030-55 Aza Ushitose Yahatano; Ito-shi Shizuoka, Japan; (81) (557) 54-0911.

KEY-STONE STUDIO; 1-8-4 Ohashi; Meguro-ku; Tokyo, 153 Japan; (81) (3) 780-1731; FAX: (81) (3) 780-1733. Manager: Mika Itagaki.

KIM; Nikko Palace Minami Aoyama B1, 1, 2F; 6-9-2 Minami Aoyama Minato-ku; Tokyo, Japan; (81) (3) 498-8860.

KING RECORD CO., LTD.; 2-12-13 Otowa; Bunkyo-ku; Tokyo, Japan; (81) (3) 945-2116; Telex: J24963 KINGRECD. Manager: Toshio Kikuta.

L.D.K.; Kyoritz Bldg. 1F; 1-26-11 Otowa Bunkyo-ku; Tokyo, Japan; (81) (3) 946-3105.

MAD; Beruza Roppongi B1; 4-1-9 Roppongi Minato-ku; Tokyo, Japan; (81) (3) 583-3515.

MAGNET STUDIO; Azabu-dai National Court, 3-4-41; Moto-azabu, Minato-ku; Tokyo, 106 Japan; (81) (3) 403-8495; FAX: (81) (3) 423-4485. Manager: Masahiko Yamaura.

MARINE STUDIO; 2-1157-2 Hashirimizu; Yokosuka-shi; Kanagawa-ken, Japan.

MEDIA BAM STUDIOS; 2-4-1 Shibakoen, Minato-ku; Tokyo, Japan; (81) (3) 433-3182.

MEGURO STUDIO CO. LTD.; 15-22 Shimomeguro 6-Chome; Meguroku; Tokyo, 153 Japan.

MEIJO-AVA STUDIO; 5-1-15 Nishitemma, Kita-ku; Osaka-shi; Osaka, 530 Japan; (81) (6) 362-6433; FAX: (81) (6) 362-6437. Manager: Masaki Hamaguchi.

MELDAC; 4-26-15 Sendagaya; Shibuya-ku; Tokyo, 151 Japan; (81) (3) 404-0555; FAX: (81) (3) 401-8426. Manager: Saitoh Hayakawa.

MIT STUDIO; 4-3-14 Shiba, Minato-ku; Tokyo, 108 Japan; (81) (3) 454-3996; FAX: (81) (3) 452-0950. Manager: Tatsuya Ikeda.

MOURI STUDIO; 3-5-5 Meguro, Meguro-ku; Tokyo, 153 Japan; (81) (3) 712-0151.

MOVIE CENTRE; 1-13 Yotsuya, Shinjuku-ku; Tokyo, 160 Japan.

M'S PLOT; 2-2-2 Hinodai, Hino-shi; Tokyo, 191 Japan.

MUSIC INN; 4-26-15 Sendagaya; Shibuya-ku; Tokyo, 151 Japan; (81) (3) 404-0555; FAX: (81) (3) 401-8426. Manager: Saitoh Hayakawa.

MUSIC STUDIO WILL; 4-17-3 Sugao Miyamae-ku Kawasaki; Kanagawa, Japan; (81) (44) 977-0321.

NICHION STUDIOS; #32 Mori Bldg., 3-4-30 Shiba-koen; Minato-ku; Tokyo, 105 Japan; (81) (3) 437-5644; FAX: (81) (3) 437-5666. Manager: Toshio Kurebayashi.

NIKKATSU STUDIO CENTER; 9-6-24 Akasaka, Minato-ku; Tokyo, Japan.

NIPPON COLUMBIA; 4-14-14 Akasaka; Minato-ku; Tokyo, 107-11 Japan; (81) (3) 584-6230; FAX: (81) (3) 584-7341.

NIPPON GAKKI SEIZO (YAMAHA); 10-1 Nakazawa-cho, Hamamatsu-shi; Shizuoka-ken, Japan; (81) (532) 61-1111.

NIPPON PHONOGRAM; Wako Bldg., 4-8-5 Roppongi; Minato-ku; Tokyo, 160 Japan; (81) (3) 479-3712; FAX: (81) (3) 403-7550. Manager: Suenori Fukui.

NOTA; Lion's Mansion Kojimachi B1; 2-5-3 Kojimachi Chiyoda-ku; Tokyo, Japan; (81) (3) 234-0769.

ONE WORLD PRODUCTION; 4-17-3 Sugao, Miyamae-ku; Kawasaki, 213 Japan; (81) (44) 977-0321; FAX: (81) (44) 976-5988. Manager: Mr. Miyazaki.

ONGAKUKAN; 28 Sakacho Shinjuku-ku; Tokyo, Japan; (81) (3) 359-3621.

ONKIO HAUS, INC.; 1-23-8 Ginza; Chou-ku; Tokyo, 104 Japan; (81) (3) 564-4181; FAX: (81) (3) 567-0935. Manager: Hisao Yamamuro.

PALE GREEN; 6-4-20 Akasaka Minato-ku; Tokyo, Japan; (81) (3) 585-9950.

PAN STUDIO; 3-11-18 Isogo-ku; Yokohama-shi; Kanagawa, 235 Japan; (81) (45) 761-0332; FAX: (81) (45) 753-2192. Manager: Tsuneo Matsumoto.

PENINSULAR; 1-20-4 Komazawa; Setagaya-ku; Tokyo, Japan.

POLYDOR KK STUDIOS; 1-8-4 Ohashi, Meguro-ku; Tokyo, 153 Japan; (81) (3) 462-5131.

PRO-CEN STUDIO; To-kei Bldg., 1-4-2 Akasaka; Minato-ku; Tokyo, 107 Japan; (81) (3) 404-4880; FAX: (81) (3) 404-8083. Manager: Masayuki Aihara.

RANT; 7-9-15 Minami Aoyama; Minato-ku; Tokyo, Japan; (81) (3) 486-1731.

RED STUDIO; 5-14-4 Nishi-Temma, Kita-ku; Osaka-shi; Osaka-fu, 530 Japan.

SANWA VIDEO CENTER; 5-3-1 Toyosaki, Kitaku; Osaka, 531 Japan; (81) (6) 375-3001; FAX: (81) (6) 375-3007. Manager: Mr. A. Kobayashi.

SEDIC (SEIBU DIGITAL COMMUNICATIONS); Wave 7F, 6-2-27 Roppongi; Minato-ku; Tokyo, 106 Japan; (81) (3) 470-9701; FAX: (81) (3) 470-9530. Manager: Shino Tsuru.

SHALOM; 4-7-6 Aobadai Meguro-ku; Tokyo, Japan; (81) (3) 465-2411.

SHANGRI-LA STUDIO; 2-27-3 Jingu-mae; Shibuya-ku; Tokyo, 150 Japan; (81) (3) 404-8400; FAX: (81) (3) 404-8957. Manager: Teruo Yamaguchi.

SMILE GARAGE; Yokohama Soko, 3-20-20 Kaigan; Minato-ku; Tokyo, 108 Japan; (81) (3) 453-5438; FAX: (81) (3) 453-5462. Manager: Masayuki Matsumoto.

SOL; #2 Seiko Building, 2-20-7 Akasaka; Minato-ku; Tokyo, 107 Japan; (81) (3) 589-2931; FAX: (81) (3) 584-2395. Manager: Masayuki Kosugi.

SOMEWHERE STUDIO; 1-29-1 Gohongi, Meguro-ku; Tokyo, 153 Japan; (81) (3) 793-0655; FAX: (81) (3) 793-0532. Manager: Aoi Nitta.

SOUND ATELLER; 2-19-2 Daida, Setagaya-ku; Tokyo, Japan.

SOUND CITY CO., LTD.; 2-2-1 Azabudai; Minato-ku; Tokyo, Japan.

SOUND CREATORS, INC.; 4-7-6 Akasaka Minato-ku; Tokyo, Japan.

SOUND DESIGN; 2-32-1 Sendagaya Shibuya-ku; Tokyo, Japan; (81) (3) 404-6797.

SOUND INN STUDIOS; NTV Annex, 6th Fl., 5-6 Yonbancho; Chiyoda-ku; Tokyo, 102 Japan; (81) (3) 234-4311; FAX: (81) (3) 234-4385. Manager: Yoichi Akikawa.

SOUND SKY; 3-2-10 Nakano Nakano-ku; Tokyo, Japan; (81) (3) 381-2611.

SOUND VALLEY STUDIO; BF Haketa Bldg., 21 Honshio-cho; Shinjuku-ku; Tokyo, 160 Japan; (81) (3) 353-7731; FAX: (81) (3) 351-7459. Manager: Takayuki Haketa.

SOUNDCRAFT; 75 Waseda-cho Shinjuku-ku; Tokyo, Japan; (81) (3) 202-2341.

STUDIO A; Studio City Bldg., 3-5-39 Shibaura; Minato-ku, Tokyo, 108 Japan; (81) (3) 455-1791.

STUDIO CAROL; 5-16-15 Haku-toh-boh B1F, Hirco; Shibuya-ku, Tokyo, 150 Japan; (81) (3) 280-3230; FAX: (81) (3) 280-3233. Manager: Kinji Yoshino, Atsuo Takada.

STUDIO CMS; 2-17-10 Kojima, Taito-ku; Tokyo, 111 Japan; (81) (3) 863-3946.

STUDIO DIG; 12 Sumiyoshicho, Shinjuku-ku; Tokyo, 162 Japan; (81) (3) 351-0421. Manager: Mr. T. Yoshida.

STUDIO ING; 12-6 Napeidaicho, Shibuyaku; Tokyo, 150 Japan; (81) (3) 462-0432. Manager: Mr. Fujita.

STUDIO PENINSULA; 1-20-4 Komazawa, Setagaya-ku; Tokyo, 154 Japan; (81) (3) 795-8931; FAX: (81) (3) 795-8932. Manager: Mr. Nagai.

STUDIO SKY (TECHNICAL 88); 5-10-1 Jingu-mae, Shibuya-ku; Tokyo, 150 Japan; (81) (3) 409-1031; FAX: (81) (3) 409-8434. Manager: Masanori Fujii.

STUDIO THREE EIGHT; 4-21-12 Shinbashi, Minato-ku; Tokyo, Japan; (81) (3) 578-0038.

STUDIO TWO TWO ONE; 4-26-15 Sendagaya; Shibuya-ku; Tokyo, 151 Japan; (81) (3) 401-8221. Manager: Katsuyuki Handa.

STUDIO Z'D, INC.; 4-26-15 Sendagaya, Shibuya-ku; Tokyo, Japan.

SUNRISE STUDIO; 4-11-10 Roppongi; Minato-ku; Tokyo, Japan.

TAIHEI RECORDING; Taihei Bldg., 1-20-1 Nishi Shinjuku; Shinjuku-ku; Tokyo, Japan; (81) (3) 343-1111.

TAKARAZUKA SOUNDS ATELIER; 6-10 Sakae-cho, Takarazuka-Shi; Hyogo, 665 Japan; (81) (79) 784-1280; FAX: (81) (79) 786-5264. Manager: Toun Ueyama.

TAKE ONE STUDIO; 2nd Take Building, 1-9-1 Shinjuku; Shinjuku-ku; Tokyo, 150 Japan; (81) (3) 354-3317; FAX: (81) (3) 341-4720. Manager: Ken-ichi Akino.

TALK STUDIO; 1-26-3 Zempukujii, Suginani-ku; Tokyo, 167 Japan; (81) (3) 394-4368.

TAMCO; 4-13-5 Akasaka Minato-ku; Tokyo, Japan; (81) (3) 585-5618.

TAMUCO; 2-1 Shiba-kouen; Minato-ku; Tokyo, Japan.

TDK CORE; 9th Fl., Fujikage Bldg.; 1-1-5 Moto-saka-saka, Minato-ku; Tokyo, 107 Japan; (81) (3) 470-1701; FAX: (81) (3) 470-1698. Manager: Tsuneo Akiba.

TEICHKU SUGINAMI STUDIO; 3-20-1 Suginami-ku; Tokyo, 166 Japan; (81) (3) 312-1191. Manager: Seizho Ohsaki.

TOKYO SHASHIN SENMON GAKKO; 11 Yonban-cho, Chiyoda-ku; Tokyo, Japan; (81) (3) 221-0202.

TOKYO TV CENTRE CO. LTD.; 1-2 Hamacho, Nihombashi, Chuoku; Tokyo, 103 Japan.

TOKYUFUN RECORDING STUDIO; Bunkamura, 2-24-1 Dogenzaka; Shibuya-ku, Tokyo, 150 Japan; (81) (3) 477-9140; FAX: (81) (3) 477-9163. Manager: Kimiko Hidaka, Tamami Tezuka.

TOSHIBA-EMI; 2-2-17 Akasaka, Minato-ku; Tokyo, 107 Japan; (81) (3) 587-9019; FAX: (81) (3) 224-9527. Manager: Yukio Ohtauki.

TOTSU AV CENTER; 1-16-7 Oyodonaka, Oyodo-ku; Osaka, 531 Japan; (81) (6) 451-8833; FAX: (81) (6) 451-8975. Manager: Hiroaki Niyama.

In a recent field test in the April 1990 issue of **MIX magazine**, reviewer Mel Lambert praised **Solid State Logic's ScreenSound** digital audio-for-video editing suite as an advancement in digital technology that will replace analog as "the definitive way of the future."

The following month a MIX Magazine Panel obviously agreed: they nominated ScreenSound as the **TEC Awards "Recording Product of the Year."**

"Given the amount of conventional hardware that it replaces in a music recording, broadcast production, or video post facility — not to mention the enhanced creativity and sonic quality offered by digital recording and processing," says Lambert. "The asking price (of ScreenSound) seems extremely reasonable...I was surprised at how quickly I became used to this new way of working."

SoundCastle/Post Modern was the first L.A. studio to install ScreenSound.

"ScreenSound is a new frontier for us and for the entire industry," says SoundCastle/Post Modern owner-manager **Buddy King**. "Recently, we were the first to use ScreenSound with the **TEAC WORM** laser optical disc for ADR work, giving us instant audio and picture access. We did 44 lines and the director saved five minutes a line. That really adds up."

SoundCastle/Post Modern L.A.



The first ScreenSound-posted project to come out of the recently merged SoundCastle/Post Modern facility is the recent "**Steven Spielberg Presents — Tiny Toon Adventures.**"

This optical-disc/hard-disc sound editing innovation allows digital soundtrack assembly, complete with music, dialogue and effects from a tablet and wireless pen controller.

changeable and moveable. I've demo'ed it for my clients and they're all completely blown away."

Soundtrack is currently in the process of using ScreenSound to transfer its effects library to optical disc, Giammarco says. "We're uploading as we go along," he explains. "Ultimately, there will be no more need to run the CD catalog. It will be phenomenal."

ScreenSound™

SSL's Product of the Year

SoundCastle is currently refurbishing its facilities to create a new "digital editorial suite" especially for ScreenSound. A dubbing theater and Foley/ADR room will be constructed next door to the suite, King says.

Soundtrack Recording Studios in New York debuted ScreenSound's ed-

Soundtrack N.Y.

iting and assembly powers to the east coast market — for commercial as well as album work.

"Its performance is fantastic — we've done 90 spots in 10 hours," says chief engineer **Bob Giammarco**. "It lets the user interface with the mixing process, and the clients can see how things operate. It gives you the tape feel with all the benefits of digital audio — and everything is instantly

Digital Services, one of the nation's leading digital recording specialists in Houston, Texas, installed ScreenSound after an extensive 18 month evaluation of all competitive products.

"After it was installed for our evaluation, we never let it leave," explains Digital Services owner **John Moran**. "We tested every manufacturers' units in our facilities and nothing else came close to ScreenSound in terms of audio-for-video applications."

Among the features that impressed Moran and his clients most was the way the system interfaces with all the other equipment in the room. "It is the only system that is capable of complete machine control without



TEC
AWARDS
WINNER

the need for an external controller," he says.

Digital Services uses ScreenSound to control their Sony video machines, Sony PCM 3324 multitracks, and also Otari 1/4-inch center-track recorders.

Craig MacGowan, agency producer at Lintas-Campbell Ewald in Detroit, and a leading advocate of quality sound in commercial production, is hooked on using ScreenSound for his projects.

Creator of the award-winning "Heartbeat of America" campaign for Chevrolet, MacGowan explains, "I've used about every audio workstation out there, and ScreenSound is *it*. It's the easiest to use. It is the best laid out and best thought out sound device for this purpose. If you are dealing with advanced editors who are heavily into the electronic editing systems, ScreenSound will become their right hand.

"I foresee the day when everyone is going to have to have one of these."

MacGowan works on ScreenSound at Detroit's **Image Express**, which selected the machine after two-years' evaluation of competitive products. Says **Bill Riss**, Image Express vice president and senior editor, "ScreenSound is a natural progression from digital picture editing. This way we handle our digital audio the same way we do our digital video."



WGBH/Boston

Image Express is using ScreenSound to control a 3/4-inch tape machine as well as a TEAC optical disc recorder. It has also been interfaced with a Gefen System compact disc jukebox upon which the company has built and data-based its entire sound effects library.

Vancouver Studios, which recorded

and ADR work for a major new television series and for the company's production unit, West Coast Post.

ScreenSound™

WGBH in Boston demonstrated ScreenSound to complete audio/video post production on a broadcast of the **Boston Pops**. While the entire process was completed in half the usual time, the overall sound quality was improved by more than three generations. **WGBH** audio post supervisor for the project, **Steve Colby**, used the system's visual references to build a mix without being hindered by time synchronization problems.

this year's Grammy Award-winning album "Torch & Twang" by k.d. lang, is diversifying into audio-for-video post production with the purchase of two Solid State Logic ScreenSound digital audio-for-video editors.

ScreenSound mixes are built by using visual references to mix the audio with the video, but timecode is also available.

"ScreenSound proved itself on its speed and flexibility," proclaims

V. P. Bruce Levens. "The fact that the very top film and television studios are moving toward the system was another factor. So was the strong support we have received from SSL over the years."

The ScreenSound editors will be used for dialogue editing, sound effects editing,

For more information about ScreenSound or for your free copy of the ScreenSound demonstration videocassette, contact your nearest SSL sales office:

SSL International Headquarters, Begbroke, Oxford, England, Tel: 011-44-865-842-300, Fax: 011-44-865-842-118.

SSL American Headquarters, New York: 320 West 46th Street, 2nd Fl., New York, N.Y. 10036; Tel: 212-315-1111; Fax: 212-315-0251.

SSL Western Sales/Service Office, Los Angeles: 6255 Sunset Blvd., Suite 1026, Los Angeles, CA 90028; Tel: 213-463-4444, Fax: 213-463-6568.

SSL Canada, Toronto: 248 The Esplanade, Toronto, Ontario, M5A 4J6; Tel: 416-363-0101, Fax: 416-363-3951.

Magnetic North Toronto



TS STUDIO; 1-8-5 Kamata, Setagaya-ku; Tokyo, 157 Japan; (81) (3) 708-6571; FAX: (81) (3) 708-6572. Manager: Masayuki Alhara.

TV TECHNICA; Akasaka Aral Bldg. 1F; 7-4-10 Akasaka, Minato-ku; Tokyo, 107 Japan; (81) (3) 505-2351; FAX: (81) (3) 505-2202. Manager: Tautomu Horuchi.

VALLEY STUDIOS; B1 Hageta Bldg., 21 Honshio-Cho; Shinjuku-ku; Tokyo, Japan; (81) (3) 355-3088.

VIDEO COMPANY; 5-35-6 Nakakasai, Edogawa-ku; Tokyo, 134 Japan; (81) (3) 5696-2531; FAX: (81) (3) 5696-2530. Manager: Mitsutoshi Kunisue.

VINCENT STUDIO; BF Villa Paltanon; 3-55-12 Sendagaya, Shibuya-ku; Tokyo, 151 Japan; (81) (3) 497-1961; FAX: (81) (3) 497-1962. Manager: Hiromi Banka.

WARNER PIONEER; Roppongi Fuji Bldg.; 4-11-10 Roppongi, Minato-ku; Tokyo, 106 Japan; (81) (3) 404-6359. Manager: Masayuki Amano.

WEST LAKE STUDIO; 5-10-2 Shirogane, Minato-ku; Tokyo, 108 Japan; (81) (3) 442-4100; FAX: (81) (3) 442-5857. Manager: Mr. Sagi

WONDER STATION; 6-4-5 Roppongi; Minato-ku; Tokyo, 106 Japan; (81) (3) 405-5586; FAX: (81) (3) 405-7937. Manager: Hideaki Ara.

YAMAHA EPICURUS STUDIOS; 8-27 Sakuragaoka; Shibuya-ku; Tokyo, 150 Japan; (81) (3) 476-5623; FAX: (81) (3) 476-3261. Manager: Mitsuko Naito.

YAMAHA MUSIC FOUNDATION; 3-24-22 Shimo-meguro; Meguro-ku; Tokyo, 153 Japan; (81) (3) 719-9101; FAX: (81) (3) 719-3201. Manager: Takayuki Fujiwara.

ZERO STUDIO; 2-13 Sarugaku-cho; Shibuya-ku; Tokyo, 150 Japan; (81) (3) 496-6969; FAX: (81) (3) 496-7119. Manager: Masahiko Iwase.

MALAYSIA

AOAUDIO SON. BHD.; 6 Jalan 17/54, 46400; Petaling Jaya, Malaysia; (60) (03) 756-0600; FAX: (60) (03) 756-0470.

BETAREC SDN BHD; 60 Jalan 19/3; Petaling Jaya, Malaysia; (60) 755-2967. Manager: Freddy Fernandez.

THE CHANNEL ELEVEN (M) SDN BHD; 23 Lorong Haji, Hussein Satu; Kuala Lumpur, 50300 Malaysia; (60) (3) 293-0793; FAX: (60) (3) 931-2382. Manager: Teh Kung Teong.

FAMILY GROUP MUSICAL SDN BHD; #1074 Jalan Sentai Pesar; Kuala Lumpur, 13-16 Malaysia; (60) (3) 442-5103. Manager: Yahaya Koming.

KINE GRAPHIC SDN BHD; 204 Jalan Mahkota; Taman Maluri; Jalan Ceras, Kuala Lumpur, 55100 Malaysia; (60) (3) 985-4552; Telex: FOTO MA 32789. Manager: Kan Karunanithy.

KING MUSICAL IND SDN BHD; Lot 5 Jalan 13/2, Petaling Jaya; Selangor, Malaysia; (60) 756-1103; FAX: (60) 755-4926. Manager: Ng Cheong Kien.

REDIFFUSION (M) SDN BHD; 17 Jalan Pahang; Kuala Lumpur, 53000 Malaysia; (60) (3) 442-4544; FAX: (60) (3) 442-4614.

R.K. STUDIOS; 3 Jalan 5524111; Taman Megah, Petaling Jaya; Selangor, Malaysia; (60) 759-719; (60) 759-485.

SAMICHAEL SDN BHD; 71-1 Medan Setia Satu; Plaza Damansara, Bukit Damansara; Kuala Lumpur, 50490 Malaysia; (60) (3) 255-8211. Manager: A. Rahman Sulaman.

SOUND STUDIO RECORDING SDN BHD; No. 9 Jalan Jintan; Taman Supreme Cheras; Kuala Lumpur, 56100 Malaysia; (60) (3) 931-1730.

SUMMIT AUDIO ENTERPRISE (M) SDN BHD; 35, Jalan 1-119 Jalan Cheras; Taman Bukit Hijau, Cheras; Kuala Lumpur, 56000 Malaysia; (60) (3) 930-1188; FAX: (60) (3) 971-8871. Manager: K.C. Lee.

SYNCHRO SOUND RECORDING STUDIO; PO Box 2975, 93758 Kuching; Sarawak, Malaysia; (60) (82) 457-040; (60) (82) 457-050.

NEW ZEALAND

CRESCENDO; 58 Kent Terraces, 1st Fl.; Wellington, New Zealand; (64) (4) 851-718.

CRYSTAL PALACE SOUND STUDIOS; 537 Mt. Eden Rd.; Auckland, New Zealand; (64) (9) 687-398.

ECHO PARK; 16 Liverpool St.; Auckland, New Zealand; (64) (9) 796-297.

HARLEQUIN; 112 Albert St.; Auckland, New Zealand; (64) (9) 779-353.

MANDRILL RECORDING STUDIOS; 11 York St.; Parnell, New Zealand; (64) (9) 793-222.

MARMALADE STUDIOS LIMITED; 173 Victoria St.; PO Box 27266; Wellington, New Zealand; (64) (4) 859-051; FAX: (64) (4) 852-792. Manager: Dave Ginnane.

MASCOT RECORDING STUDIOS; Auckland, New Zealand; (64) (9) 793-763.

SONIC RECORDING STUDIOS; 17-19 Elizabeth St.; Wellington 1, New Zealand; (64) (4) 849-395.

SOUNDTRAX (NZ) LTD.; 175 Victoria St.; PO Box 27195; Wellington, New Zealand; (64) (4) 859-727; Telex: NZ30384.

SOUNDWORKS STUDIOS LTD.; 4-8 Couldry St., Eden Terrace; PO Box 47-288; Ponsonby, Auckland, New Zealand; (64) (9) 392-340.

STEBBING RECORDING STUDIOS; 108-114 Jervois Rd.; Herne Bay, Auckland, New Zealand; (64) (9) 762-426.

STUDIO CENTRE; PO Box 2396, Bowan St.; Wellington, New Zealand; (64) (4) 721-777.

VILLAGE SOUND RECORDERS LTD.; The Production Village—26 Wright St.; PO Box 6593; Wellington, New Zealand; (64) (4) 850-781. Manager: Malcolm Crombie.

PHILIPPINES

ABBEY ROAD RECORDING STUDIOS; 2367 Marconi St.; Makati, Metro Manila, Philippines; (63) (2) 832-0171. Manager: Kele Go Cenderio.

ABS-CBN STUDIOS; Mother Ignacia St.; Quezon City, Philippines; (63) (2) 964-110; (63) (2) 989-418; FAX: (63) (2) 922-7954. Manager: Gabby Lopez III.

INNOVATIVE SOLUTIONS FOR PROFESSIONALS



AKAI A.D.A.M. 12-TRACK DIGITAL AUDIO RECORDER

ALESIS, T.C. ELECTRONICS & AUDIO LOGIC • D.A.T. FEATURING THE SONY TC-D10 PRO & PCM 2500 AND THE PANASONIC SV-3500 & SV255 • SAMPLERS FEATURING THE AKAI S-1000 & S1000HD, THE ROLAND S-770, S-550, & S-330, THE EMU EMAX II, EIII & PROTEUS • INTRODUCING D.A.R. DIGITAL WORKSTATION – POST PRODUCTION POWER TOOL • DRAWMER • CALZONE CASES • MUCH, MUCH MORE ...



TASCAM ATR-80 JAPAN'S FINEST 2" 24-TRACK

NEW YORKS LARGEST PRO AUDIO INVENTORY

SanAsh

PROFESSIONAL

723 SEVENTH AVENUE (THIRD FLOOR) NEW YORK CITY • 10036 • (212) 719-2640

- DESIGN • SALES • SERVICE • PARTS
- INNOVATIVE FINANCING PLANS
- RUSH DELIVERY

Pacific Rim Facilities

AD & AD RECORDING STUDIO; 400 Shaw Blvd., Mandaluyong; Metro-Manila, Philippines; (63) (2) 780-866. Manager: Cesar Dumiao.

AUDIO ARTS RECORDING STUDIO; Rm. 207 First Midland Condominium; Gamboa St., Legaspi Village; Metro Manila, Philippines; (63) (2) 815-1097. Manager: Arnedo Lucas.

AUDIO CAPTAIN STUDIOS; La Fuerza Compound; Pasong Tamo St., Makati; Metro-Manila, Philippines; (63) (2) 871-521. Manager: Jaime Godinez.

AUDIO POST RECORDING STUDIOS; First Midland Condominium; Gamboa St., Makati; Metro-Manila, Philippines; (63) (2) 815-1097. Manager: Dodie Lucas.

CHARO UNITE PRODUCTIONS; 58A Gallery Bldg., Amorsolo St., Makati, Philippines; (63) (2) 817-6840; (63) (2) 816-4422. Manager: Charo Unite.

CINEMA AUDIO INC.; 841 Torres St. Mandaluyong; Metro-Manila, Philippines; (63) (2) 793-786. Manager: Dindo Aldecoa.

FULLERTON STUDIOS; Marbella Condominium, Roxas Blvd.; Pasay City, Philippines; (63) (2) 833-3831; FAX: (63) (2) 834-0248. Manager: Tommy Tanchangco.

GREENHILL SOUND STUDIO; 74 Valencia St.; Quezon City, Philippines; (63) (2) 773-796. Manager: Jaime Chua.

JR PRODUCTIONS; JR Productions Bldg., Manalac St.; Makati, Philippines.

PEDEROMUSIC STUDIOS; cor. Buendia Ave. and Marconi St.; Makati; Metro-Manila, Philippines; (63) (2) 877-936. Manager: Nonong Pedero.

RJ RECORDING STUDIOS; 3rd Fl., Hastings House II; Makati Ave.; Makati, Philippines; (63) (2) 819-1535. Manager: Ramon Jacinto.

SONATA; 2nd Fl., Celta Bldg., Casino St.; Makati, Philippines; (63) (2) 861-279.

STUDIO ONE; 6 B Church St., Grace Village; Quezon City, Philippines; (63) (2) 342-191; (63) (2) 347-021. Manager: Wallace Chamsay.

TRACKSTUDIOS; 9 Shaw Blvd., San Buena Bldg.; Pasig; Metro-Manila, Philippines; (63) (2) 673-6541; (63) (2) 673-6542; FAX: (63) (2) 693-6451. Manager: Mike N. Pedero.

VICOR MUSIC CORP.; Vicor Bldg., 782 Aurora Blvd., Cubao; Quezon City, Philippines; (63) (2) 721-8297. Manager: Chito Ilagan.

WORKS AVE.; 10th Fl., Sagittarius Bldg.; De La Costa St., Makati; Metro-Manila, Philippines; (63) (2) 818-8661. Manager: Raymond Miranda.

SINGAPORE

AUDIO MUSICAL PTE LTD.; 1628 Rangoon Rd.; 0821 Singapore; (65) 292-9896; FAX: (65) 291-6009. Manager: Paul Edwards.

AUDIO VISUAL WORKSHOP PTE LTD.; 1 Raffles Pl. #03-04; OUB Centre, 0104 Singapore; (65) 535-0913. Manager: Chia Lai Meng.

BOOGIE PRODUCTIONS PTE LTD.; 45A MacPherson Rd.; 1334 Singapore; (65) 282-8789; FAX: (65) 286-1348. Manager: Reggie Verghese.

BOSS STUDIO PTE LTD.; #06-01 Citipoint Ind Complex; 1140 Singapore; (65) 743-2020; FAX: (65) 748-0648. Manager: Eric Chong.

CATHAY FILM SERVICES (PTE) LTD.; Cathay Cinema Bldg. 1st & 2nd Fls.; Dhoby Ghaut, 0922 Singapore; (65) 323-295; (65) 323-296; Telex: CATHAY RS 21124.

DIGIT STUDIO (S) PTE LTD.; 315 Outram Rd.; #12-07 Tan Boon Liat Bldg.; 0316 Singapore; (65) 222-8809; (65) 221-8421. Manager: John Teo.

FANTASIA STUDIO; 41 Genting Ln.; 1334 Singapore; (65) 747-0536; FAX: (65) 747-7273. Manager: Richard Hoh.

FORM PTE LTD.; Blk 994 Bendemeer Rd. #02-01; 1232 Singapore; (65) 293-6112; FAX: (65) 298-0667. Manager: Ang Choon Beng.

J.J. JINGLES & MUSIC PRODUCTIONS PTE LTD.; #03-05 Serene Centre, 10; Jalan Serene, 1025 Singapore; (65) 466-6777; FAX: (65) 466-3154. Manager: Jeremy Monteiro.

METROPOLIS PRODUCTIONS; 5001 Beach Rd. #0398H; Golden Mile Complex, 0719 Singapore.

MIDI-CITI STUDIO PTE LTD.; Blk 26, Kallang Pl. #07-16/17; 1233 Singapore; (65) 298-9288; FAX: (65) 298-0988. Manager: Andrew Teo.

NEW LEE SENG QUAD STUDIO PTE LTD.; #06-09 994 Bendemeer Rd.; 1232 Singapore; (65) 296-3666; FAX: (65) 294-5241. Manager: Lee Leng Huat.

OSCAR STUDIO PTE LTD.; 315 Ourtram Rd., #15-01/02; Tan Boon Liat Bldg.; 0316 Singapore; (65) 223-7055. Manager: Lum Gek San.

POLYGRAM RECORDS PTE LTD.; 115B Commonwealth Dr.; #02-00 Tanglin Halt; 0314 Singapore; (65) 473-4527. Manager: Johnny Herbert.

THE POST PRODUCTION SHOP PTE., LTD.; 1-G Paya Lebar Rd.; 1440 Singapore; (65) 344-3244; Telex: 37233 PPSHS.

SBC MUSIC STUDIO; Caldecott Hill, Andrew Rd.; 1129 Singapore; (65) 256-0401 x2216; FAX: (65) 253-8808. Manager: Jibby Jacob.

SOUTH KOREA

ASIA RECORDS; 167-14 Whayang-dong; Sundong-ku; Seoul, 133-130 South Korea; (82) (2) 462-1611; FAX: (82) (2) 462-1613. Manager: Lee Jung Gaf.

DONAM STUDIO; 136-051, 85-65, Dongsun-Dong; Seoul, South Korea; (82) (2) 923-9149; FAX: (82) (2) 922-3669. Manager: Young-Won Jung.

HANKOOK RECORD; 541-9 Shinsa-dong; Kangnam-ku; Seoul, 135-120 South Korea; (82) (2) 542-1833; FAX: (82) (2) 544-3214. Manager: Yun Won Yun.

JIGU RECORDS; 233 Daeja-ri, Byokje-eup; Koyang-kun; Kyunggi-do, 411-830 South Korea; (82) (2) 387-3111; FAX: (82) (344) 63-9261. Manager: Jang In Suk.

KANG PRODUCTION; 1009-3, Deokyoong Bldg., 2nd Fl.; Bangbae-Dong, Seocho-ku; Seoul, South Korea.

OASIS RECORD; 196-18 Anyang 7-dong; Anyang City; Kyunggi-do, 430-017 South Korea; (82) (343) 2-3660; FAX: (82) (343) 46-9660. Manager: Kim Man Kyu.

ORICOM; 135-280, 988-4 Daechi-Dong; Kangham-Ga; Seoul, South Korea; (82) (2) 562-7251; FAX: (82) (2) 542-3966. Manager: Jun-Ki Bae.

SEOUL AUDIO; 100-013, 57-1, Chungmuro, 3-Ga; Chung-Gu; Seoul, South Korea; (82) (2) 274-0409. Manager: Do-Hyang Kim.

SEOUL RECORDING STUDIOS; 300-16 Echong-dong; Yong San-ku; Seoul, 140-030 South Korea; (82) (2) 794-1193; FAX: (82) (2) 793-0348. Manager: Choi Se Young.

SHINSEGYE SOUND; 35-8, 1 ga Jangchung-dong; Choong-ku; Seoul, 100-391 South Korea; (82) (2) 267-7163; FAX: (82) (2) 267-7164. Manager: Jung Do Won.

SUNGEUM STUDIO; 133-120, 300-14, Sungsu-2 Ga; Sungdong-Gu; Seoul, South Korea; (82) (2) 462-0709; FAX: (82) (2) 467-2844. Manager: Sung-Hee Lee.

SUNGWON-STUDIO; 110-170, 87-1 Kyunji-Dong; Jongro-Gu; Seoul, South Korea; (82) (2) 733-3071; FAX: (82) (2) 733-3175. Manager: Jung-Gu Hu.

TEAKWANG RECORD; 205-10 Anyang 7-dong; Anyang; Kyunggi-do, 430-017 South Korea; (82) (343) 3-4448; FAX: (82) (343) 46-3369. Manager: Lee Hun.

UNIVERSAL RECORDING STUDIO; 345-1 Majang-dong; Sungdong-ku; Seoul, South Korea; (82) (2) 293-3390. Manager: Lee Chung.

WON'S RECORDS AND PROMOTION; 1024-12 Hwagok-Dong, Kangseo-ku; Seoul, South Korea.

YEASUNG STUDIO; 156-020, 347-3, Daebang-Dong; Dongjak-Gu; Seoul, South Korea; (82) (2) 815-5960; FAX: (82) (2) 815-5960. Manager: Ui-Do Cho.

TAIWAN

A-STRING RECORDING STUDIO; 224 Sec. 4 Pa-Teh Rd.; Taipei, Taiwan, Republic of China; (886) (2) 764-2378; (886) (2) 761-0121. Manager: Chen-pin Chen.

CHEN-KUNG STUDIO; 5th Fl., No. 8, Alley 9, Ln. 323; Chen Kung Rd., Sec. 4 Nei Hu; Taipei, Taiwan; (886) (2) 790-5621. Manager: S.L. Wong.

CORDEN RECORD; No. 53, Ln. 216, Chung Hsiao E. Rd.; Sec. 4; Taipei, Taiwan; (886) (2) 777-1140. Manager: Kou Wei.

CREATOR AUDIO & VIDEO INT. STUDIO; Fl. 7, #2, Lane 497 Chung-Cheng Rd; Hsin-Tien, Taiwan; (886) (2) 917-9768; FAX: (886) (2) 917-9816. Manager: Bezeleel Law.

CROWN SOUND STUDIO; 3 Fl., No. 82, Chung Ching S. Rd.; Sec. 2; Taipei, Taiwan; (886) (2) 307-7069. Manager: Showman Hsu.

DIGIMAX PRODUCTION CENTER; 3F, No. 22.24, Lane 50, Sec. 3; Nan Kang Rd.; Taipei, Taiwan, ROC.

FIRST RECORDS/PLATINUM STUDIOS; 2F, 33 SEC2, Kienkwo North Rd.; Taipei, 10433 Taiwan; (886) (2) 509-1221; FAX: (886) (2) 504-2530. Manager: C.C. Yeh.

FU-KOA STUDIO; 6F, No. 2, Alley 2, Lane 250; Sec. 5, Nan Ching East Rd.; Taipei, Taiwan, ROC.

GOOD SOUND STUDIO; 12th Floor, 1256 Chen-Te Road; Taipei, Taiwan; (886) (2) 882-6719. Manager: You S.L.

HI-LI STUDIO; No. 147, Chin Hai Rd., Sec. 2; Taichung, Taiwan; (886) (4) 254-322. Manager: L.C. Chou.

HO-MIN STUDIO; No.1, Ln. 257, Chung Ching S. Rd.; Sec. 3; Taipei, Taiwan; (886) (2) 592-1053. Manager: S.H. Yeh.

KO-LIN RECORD; No. 40-1, Chung Shan N. Rd., Sec. 2; Taipei, Taiwan; (886) (2) 521-6551.

LIFE RECORDING STUDIOS; 4F, No. 82, Sec. 2, Chung Ching S. Rd.; Taipei, Taiwan, ROC.

LUCKY STUDIO; No. 8, Ln. 37, Sung Chiang Rd.; Taipei, Taiwan; (886) (2) 508-4181. Manager: Charli Lai.

MIDI STUDIO; 12F, No. 248, Sec. 5; Chung Hsiao E. Rd.; Taipei, Taiwan, ROC.

NATIONAL CHIANG KAI SHEK CULTURAL CENTER R.O.C.; National Theater Concert Hall; No. 21, Chung Shan S. Rd.; Taipei, Taiwan; (886) (2) 392-5060; FAX: (886) (2) 391-5529. Manager: W.S. Chen.

PLATINUM STUDIOS; 116 Cheng-Yi North Rd.; San-Chung City, 241 Taipei Hsien, Taiwan; (886) (2) 971-2462.

PLUS STUDIO; No. 28, Lane 46 Shih Lin; Shih Tung Rd.; Taipei, Taiwan, ROC.

RYTHAM STUDIO; 4th Fl., No. 559, Kuang Fu S. Rd.; Taipei, Taiwan; (886) (2) 705-6327. Manager: T.C. Ko.

SHANG YANG RECORD; No. 77-4, Chung Shan N. Rd., Sec. 2; Taipei, Taiwan; (886) (2) 551-8085. Manager: David Wong.

TOP STUDIO; 5 Fl., No. 329-3, Chung Hsiao E. Rd.; Sec. 4; Taipei, Taiwan; (886) (2) 762-6222. Manager: C.W. Chen.

UFO RECORD; 9th Fl., No. 383 Ming Sheng E. Rd.; Taipei, Taiwan; (886) (2) 508-0368. Manager: E.P. Lun.

THAILAND

BUTTERFLY; 22/5 Sukumvit 11; Bangkok, 10110 Thailand; (66) (2) 255-1122-3. Manager: Nantika Kanhanawat.

CENTER STAGE RECORDING; 110 Soi P.S. Krungthep-kreeta Rd.; Bangkok, 10240 Thailand.

M.M. STUDIO ENTERTAINMENT CO. LTD.; 2508/7 Flat 1, Project 3; Dindang Rd.; Phayatai, Bangkok, 10400 Thailand; (66) (2) 246-0906; (66) (2) 246-7093. Manager: Prathuang Udomkijunap.

N.T. PROMOTION CO. LTD.; 1/79-80 Chinnaket Soi 10; Ngarm Wongwam Rd.; Bangkok, 10210 Thailand; (66) (2) 589-0026. Manager: Vichien Ussuwakul.

SRI SIAM SOUND STUDIO; 473 Soi Suthiporn, Prachasongkhrao Rd.; Khet Huaykwang; Bangkok, 10400 Thailand; (66) (2) 245-5982; (66) (2) 245-2363; Telex: 87341 TNPC TH. Manager: Satit Klongvessa.

Power. Play.



Loudspeaker design: To achieve high power handling capability, sensitivity suffered. You could get more power, but you had to accept less play.

Another Advance From JBL

Ever since Jim Lansing flattened voice coil wire in the early thirties, JBL has continually edged loudspeaker design closer and closer to perfection. The introduction of our new 2200 Series models marks another JBL advance in transducer technology.

Vented Gap Cooling™

As a voice coil's temperature rises, so does its impedance, causing power compression. Every dB of power compression translates into one less dB of output.



To reduce power compression and gain overall sensitivity, JBL created vents from the voice coil, through the magnet structure, to the rear of the loudspeaker. As the cone travels, heat is dispersed and cool air returned to the voice coil.

The result, a true 600 watt loudspeaker with high sensitivity. You get twice the power handling plus greater output.



New SFG™ Magnet Structure.

Through computer modeling and simulation, the 2200 Series SFG magnet structure achieves optimum flux density and significantly lower distortion while realizing up to 20% weight reduction.

We Heard You Loud And Clear.

Whether you're looking for a mega-watt touring loudspeaker, or for a low distortion critical listening device, JBL has the model for you. All with the new SFG magnet structure with Vented Gap Cooling. The new 2200 Series models give you the best of both worlds. Power, and play.



JBL Professional
8500 Balboa Boulevard, Northridge, CA 91329 USA
A Harman International Company

by Mark Herman

SOUND REINFORCEMENT NEWS



Mega EQ. Clair Bros. Audio (Lititz, Pa.) just received two of 30 custom-built TC 6032 graphic equalizer remote controllers ordered from TC Electronic of Denmark, along with 130 of the popular TC 1128 programmable EQs. TC, in conjunction with

Clair Bros., designed the controllers to assist monitor engineers in controlling of multiple 1/3-octave graphic equalizers. Each TC 6032 is packaged with 16 TC 1128s.

High-speed motorized faders replicate the equalizer memory



Above: Main dance floor at the King & Queen nightclub in Kobe, Japan. The reinforcement system, designed by Marsato Machino of Sound System Research, Ltd., uses Toa sound components throughout. The left inset shows how various elements of the sound system (15 Toa P-300D power amps) were utilized as part of the club decor. Right inset: The DJ mixing position.



More Power To You.

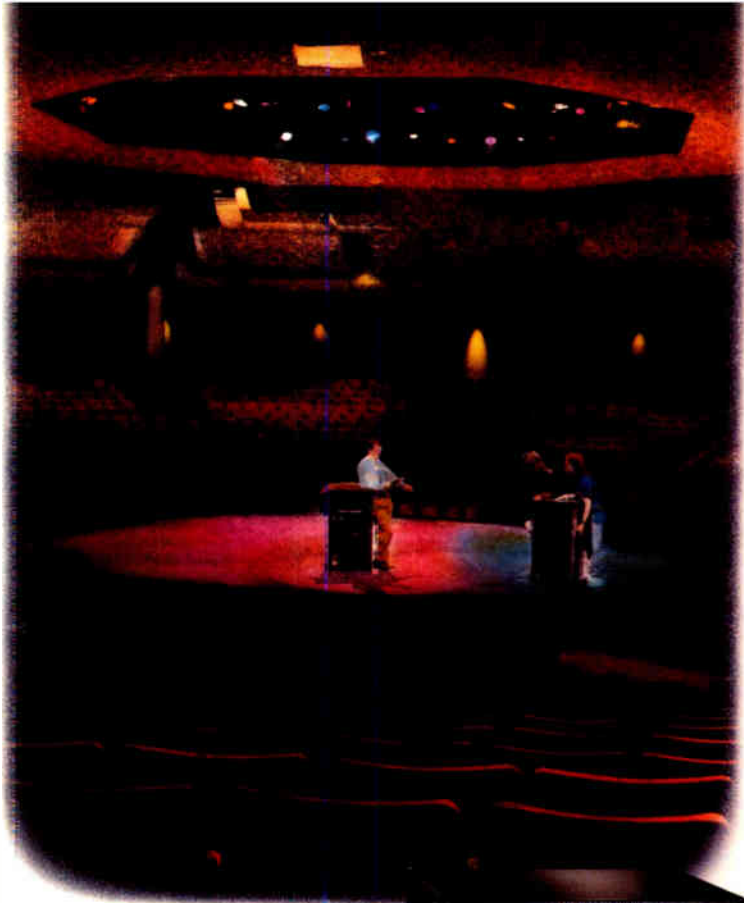

The JBL/UREI ES Series Power Amplifiers achieve a level of design that boldly underscores our commitment to electronics. All five models feature highly advanced circuitry, enviably cool operation, significantly reduced weight, very compact size and exceptionally clean power output.

To give you precise level control, 1 dB per step to -20 dB, all ES Series models incorporate a digital attenuator circuit. This circuit can also be coupled to an optional RS-422 port, letting you use a PC to remotely adjust and set levels. When you have multiple amplifiers in a large system and want to power-up without dimming every light in the house, you can trust the ES Series' inrush current surge limiter circuit to give you a soft turn-on.

To keep operation of the ES Series ultra-cool and ultra-quiet, all models incorporate a continuously variable fan system that senses heat sink temperature and alters fan speed accordingly.

The ES Series uses front-panel LEDs to give you operational status at a glance. The modular construction of ES Series, plus JBL's distinctive two-piece case design, allows you to swap amplifier channels in less than five minutes. Plus you get a defeat switch to prevent accidental or unauthorized level adjustment.



Another feature of the ES Series is High Frequency Power Conversion resulting in a dramatic reduction in weight for a given power output. How dramatic? The ES1200 for example delivers 600 watts per channel into 4 ohms yet weighs only 39 pounds.

So, the next time you sit down to spec-in amplifiers, from 75 to 600 watts per channel, just remember two things, JBL has the right amp for your application, and JBL is in the amp business to stay.



JBL Professional
8500 Balboa Boulevard, Northridge, CA 91329
A Harman International Company

added 16 KF850s to its existing 24-box KF600 system...**All Pro Sound** (Pensacola, Fla.) installed eight KF600s at the 5,000-seat Word of Faith Church (Dallas)...**Tech Audio** (Paris) installed a KF600 system in the Notre Dame Cathedral...**Entertainment Sound** (Washington, D.C.) added six KF300s and six SM222s to its rental gear that already includes 16 KF850s and many FR253s...**Audio 300** (Albany, N.Y.) added six DS123Hps...**Concert Sound** (Lon-

don) has taken delivery of a 16-box 850 system...Two new systems for Disneyworld (Orlando, Fla.) used EAW: one KF850 system for the Muppet Theater, and weatherproofed KF850, 600 and 300s for Pleasure Island...**Pro Sound & Lighting Service** (Miami) completed an installation at the Jackie Gleason Performing Arts Center that required KF600s, KF300s and SM202 stage monitors...**Scorpio Sound** (Bridgewater, Mass.) added ten MH102-60 mid/high cabinets...**Staging Techniques** (New York)—one of the original

KF850 users—expanded with eight KF850s and four SB850s...**Superior Productions** (Shreveport, La.) took delivery of eight KF600s.

First Paragon Sold...South-eastern regional production company **Frank Mayes Associates Sound & Lighting** (Atlanta) became the first to purchase the new high-end ATI Paragon 40-channel house/stage mixing console. Owner **Chip Mayes** says, "We wanted to stand out above our competition with a superior product. It should enable us to break into a larger market, including touring and large summer festivals. After first using it, we found the Paragon to be very user-friendly, and it sounded great."

Mayes originally started the company in the late '70s, but in 1984 began acquiring more equipment and clients. Frank Mayes Associates works several country music parks and summer festivals with up to 30,000 people, provides full production for many events with the Martin Luther King Center in Atlanta, regularly services several artists, and has traveled on small venue tours throughout the East Coast and parts of the Midwest and Texas. Now it's a full production company with its own tractor trailer for touring, full sound and lighting rigs, and stages complete with tops, sound wings and several sets.

For main P.A. loudspeakers, Frank Mayes Associates has 26 FM-3 full-range, proprietary, three-way JBL-loaded enclosures (with another eight under construction). Mike O'Rourke (from speaker manufacturer OAP) helped Mayes design the cabinets with the aid of a JBL computer program. The 4 ft. x 4 ft. flyable box consists of two 18-inch and two 12-inch direct-radiating speakers and a 2-inch 2445 driver on a bi-radial horn. "We build them four to a pod," says Mayes. "They are mirror-imaged in order to be acoustically coupled. When the cabinets were built we called on the independent Acoustic Physics Lab in Atlanta to help us fine-tune them and set the crossover frequencies. We use a BSS 360 crossover with our special cards."

FM's sidefill cabinet is exactly

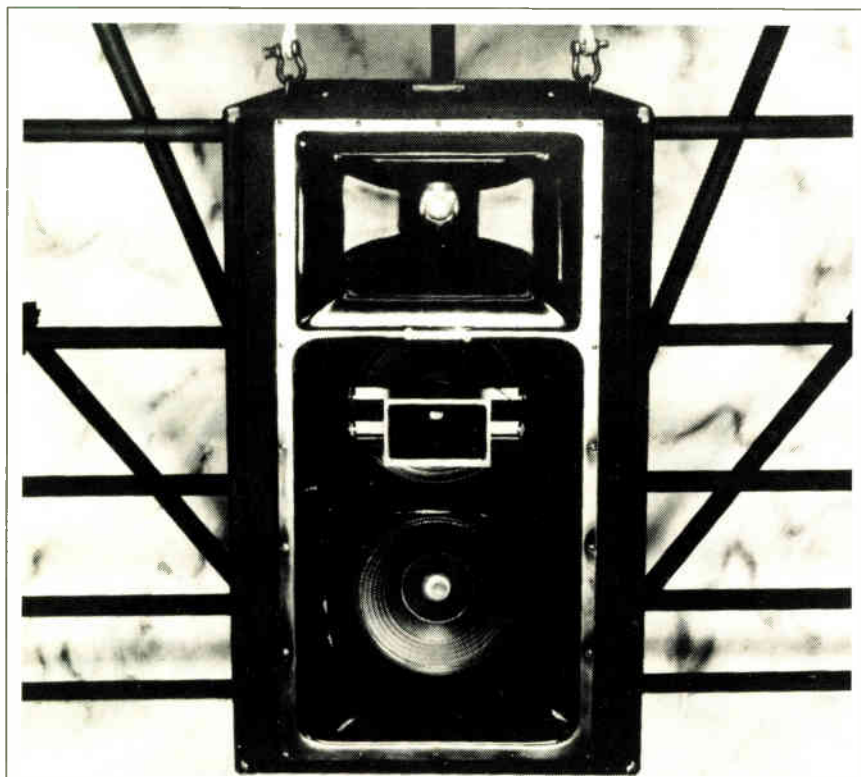

Puts the others in perspective...

Community's new RS880 loudspeaker system flies heads above all others with its trapezoidal, three-way Wavefront Coherent™ horn-loaded design. Dynamically controlled from a single rack space with our 880EQ, the RS880 additionally features unique feedback-loop sensing circuitry, and reinforced D-rings which can get you off the ground quickly and smoothly. For room-shaking bass response, our VBS415 subwoofer can also be added to extend the system.

Community

PROFESSIONAL SOUND SYSTEMS

333 East Fifth Street • Chester, PA 19013 • (215) 876-3400 • Fax (215) 871-0190

Circle #108 on Reader Service Card

like the house FM-3, except that it's loaded with the 60° instead of the 90° radial horn. Special drum monitors are similar to the FM-3 except they're smaller and loaded with 10s instead of 12s. Floor monitors are FM's custom JBL-loaded, dual 15-inch wedges with a 2-inch JBL short exponential horn. The wedges are also equipped with flying hardware. Mayes says, "Our newest version is loaded with the new neodymium 2450 compression driver. We think they sound very smooth."

The main boxes are driven by Crown Macro-Tech 2400 (lows) and Macro-Tech 600 (highs) power amplifiers loaded with the IQ 2000 modules. Floor wedges are powered by Crown Micro-Tech 1200s, 1000s and 600s; sidefills use PSA-2s. Mayes plans to incorporate the IQ 2000 system sometime soon. "I've been using Crown amps since the '70s and have seen them dropped, eat dust, have water, beer and coke spilled on them—and they still keep on working. I've had nothing but constant, reliable service from my Crown amplifiers."

House consoles are the new ATI Paragon and a 32-channel Soundcraft 800B for support acts. The primary monitor console is a new Ramsa WR-S840 40 x 18, and the backup is a Soundcraft 400B. Signal processing devices include Yamaha REV-7, SPX90, Lexicon PCM70, dbx 166, 160A, DDL and Roland SDE-3000. Monitor output EQs are Klark-Teknik DN360s for the ten main mixes and Yamaha 2031s for the other eight. BSS 310 cross-overs handle the bi-amped wedges and BSS 360s for the tri-amped drum boxes. Other new equipment includes a new four-way splitter system from Whirlwind.

Odds & Ends...Sound reinforcement company **Ultrasound East** is no more. **Ultrasound** (San Rafael, Calif.) and **Audio Support** (Irvington, N.Y.) have dissolved their joint association. All of Ultrasound's gear is returning to the West Coast. **Sean McCormick** is overseeing Audio Support's former

ARE YOU TIRED of



We're Looking For A Few Clients Who Care

ULTRASOUND

70-V WOODLAND AVE,
SAN RAFAEL, CA 94901

(415) 459-0100
FAX (415) 457-0264

Circle #109 on Reader Service Card



Australian Monitor

Mosfet power amplifiers

AVAILABLE IN

1600 WATTS
1000 WATTS

1200 WATTS
QUAD. 4 CHANNEL

TWO NEW MODELS

1K2 — 1200 WATTS
K7 — 700 WATTS

AVAILABLE APRIL



AUSTRALIAN MONITOR IS DESIGNED AND MANUFACTURED BY:
AUSTRALIAN MONITOR PTY. LTD., 53 COLLEGE STREET, GLADESVILLE, NSW 2111, AUSTRALIA
TELEPHONE: 61-2-8163544 Fax: 61-2-817 4303

Enquiries

USA **GRAFTON SOUND** USA
Professional Audio &
Sound Systems Rental
Tel: (213) 466 2416
Fax: (213) 851 9586

CANADA **AUDIO
CONCEPT**
Tel: (514)527-8366
Fax: (514)525-5949

Circle #110 on Reader Service Card

equipment inventory, which includes Crest-powered Meyer main and monitor systems... Mixing console rental specialists Hi-Tech Audio Systems (Half Moon Bay, Calif.) announced the recent purchase of new Yamaha PM3000 40C, Ramsa WR-S840 (monitor), TAC Scorpion II and TAC Scorpion (monitor) mixing consoles. Other new equipment includes two complete Crest-powered MacPherson monitor systems. Hi-Tech's Louis Adamo says, "The MacPherson wedges have

been well-received by our rental clients; their initial skepticism of the small LPM-2 wedge quickly turns into acceptance after actually using it. For their size they are hard to beat."

NSCA Observations (Las Vegas) ...Soundcraft pulled one of the few pro mixing console surprises at the April NSCA show when it unveiled its new Venue 8-bus house mixing console, which will soon be available in the U.S. with seven combinations of four frame sizes. The standard input module features 4-band EQ (two sweepable mids), six aux

sends, four programmable scene muting groups, insert points, phantom power, phase reverse, high-pass filter and an active pan pot. Four stereo return modules are standard, while stereo input and dual matrix modules remain optional. The Venue is targeted for the same market as the recently discontinued Soundcraft 500 line. A monitor version of the Venue is expected to be debuted at the fall AES convention (September 21-25) in Los Angeles... The J.L. Cooper SA-1000 scene automation system for sound reinforcement mixing consoles provides computer-automated control of audio levels, MIDI parameters and muting, as well as instant recall of thousands of mix scenes. It is currently available for installation on selected manufacturers' consoles. The SA-1000 seems suited for theatrical and custom install applications.

Lester Audio Labs caused quite a stir in the fiber optic field with its DAS 2000 Series optical splitting, digital distribution and routing, fiber optic snake system with A/D and D/A converters and a programmable SOFT PATCH™ 64 x 64 matrix. The DAS 2000—now being beta-tested by many of the industry's leading sound companies—is capable of driving signal 15,000 feet with no appreciable RFI interference or signal loss. This could be the cabling wave of the future... Meyer Sound showed off its impressive Meyer-powered MSL-10A speaker system in the parking lot of the Las Vegas Hilton. Two MSL-10 cabinets bolted together produce an incredible SPL level that parallels the hefty \$35,000 price tag. The MSL-10 is ideally suited for large stadium use.

Proshow USA (Bellevue, Wash.) reports the installation of 24 new Electro-Voice MT-4H and six MT-4L cabinets in the Seattle Kingdome. The MT-4s are hung in six clusters of four enclosures each. According to Proshow's **Mike Fisher**, "The new ownership of the American League Seattle Mariners baseball club wanted a system that would really rock 'n' roll. They didn't want a typical stadium announcing system. Something more exciting was required, so we chose the MT-4. We wanted

When is 4 greater than 9?

Four ServoDrive Bass Tech 7 Servomotor-Driven, Horn-Loaded Subwoofers

Required Power: 1600 Watts

Nine High-Quality Dual-Driver Vented-Box Subwoofers

Required Power: 5400 Watts

Only when you stack ServoDrive subwoofers against conventional models.

Let's say you need to produce 122 dB in the range of 28 to 100 Hz, outdoors at 10 meters. You have a choice:

You can obtain 9 to 12 conventional vented-box subwoofers with dual 15-inch or 18-inch drivers.

Or you can use new ServoDrive Bass Tech 7 subwoofers. You'll get the same SPL's using an array of only four Bass Tech 7's, thanks to Intersonics' patented servomotor-drive concept and exclusive



Power Cooling system. Plus, you'll get flatter response, more low end and the lowest harmonic distortion of any professional subwoofer on the market.

So don't waste freight and power amplifier dollars on inefficient conventional subwoofers. Not when ServoDrive can give you the cleanest, most accurate bass available, with much less bulk and wattage. Call or write us today for more information.

SERVO DRIVE™ by **INTERSONICS** INCORPORATED

1990 TEC Award Nominee

3453 Commercial Avenue • Northbrook, IL 60062-1818 • 708/272-1772 Phone • 708/272-9324 FAX

RELIABLE PLAYERS

CRYSTAL TALIEFERO ON QSC.

I always work with the best.
Billy Joel, John Mellencamp, Bob Seger,
and QSC in my monitors.

I like my vocal mix loud.

After all, background vocals
aren't always in the background.

*QSC Power Amplifiers... as reliable as
the players who use them.*



QSC

A U D I O

QSC Audio Products, Inc.
1926 Placentia Ave., Costa Mesa, CA 92627
714-645-2540



something with a pretty tight Q, and the MT-4s seem to have a good pattern."

Making life challenging for Proshow's stadium install was the fact that there wasn't much time before the opening of the baseball season. The Kingdome was so heavily booked this spring with conventions and trade shows that only two days were available for the actual installation (where Proshow had to bring in a 180-foot crane). Crown Macro-Tech amplifiers and Crown's IQ 2000 system were located together in a special air-conditioned room. Fisher says, "We put in 21 Crown Macro-Tech 1200 and 2400 amps, all controlled by the IQ 2000. Even with speaker cable runs up to 1,400 feet, the powerful Macro-Tech 2400s still provide plenty of power for the high SPL MT-4 boxes."

Electro-Voice MT-4, DeltaMax and Sentry speaker systems were installed in the new Club Quick in Manhattan...The large indoor Forest Fair Mall in Cincinnati had

E-V components installed in the main assembly area...The **Lenin Circus** of Moscow now uses central and surrounding clusters of DeltaMax DML-1152, DML-2181 and S-80 boxes... Singapore's Hard Rock Cafe recently put in a DeltaMax system.

George Relles Sound (Eugene, Ore.) was started in 1975 by owner **George Relles**. "When I first started the sound company I was the banjo player in Mason Williams' [Classical Gas] band. I was always disappointed in the way sound companies handled acoustic music in the '70s, so I started a company oriented toward superior acoustic sound reinforcement. Gradually, I've gained a reputation around the Northwest for symphony, jazz, folk and bluegrass productions for up to 10,000 people. I also do smaller mainstream rock and pop shows. We're still a small regional company but we travel quite a bit."

An interesting story accompanies Relles' current Meyer speaker system. In '86 he bought his first Meyer system boxes from the Bhagwan Shree Rajneesh's notorious cult that was located in Oregon at the time.

When the Bhagwan himself was forced to leave the country, the seldom-used Meyer sound system went up for sale. Six MSL-3s and several UPA-1s had been hung in the cult's sacred cathedral, with only the Bhagwan allowed to speak through them. They were even called "the Sacred Speakers" by the cult's followers. Ironically, several weeks after taking shipment the Bhagwan spoke through the Meyers twice and then proceeded to take a two-year vow of silence. Relles has since added two more MSL-3s, six 650 subwoofers, four UPA-1s and four UM-1 wedges.

Relles' other main P.A. system is composed of six Harbinger 508 and six 512 cabinets. Amplifiers for the Meyer house and monitor systems use the new Hill LC 1200 Series. According to Relles, "The Hill amps have worked out well. They sound good and have always been very reliable." Mixing consoles are a Gamble HC 40 x 16 x 2, Hill 4400 Concept 32 x 8 x 2

—CONTINUED ON PAGE 177

2400 WATTS* • 40 LBS. • 2 RACK SPACES HAVE WE GOT YOUR ATTENTION?

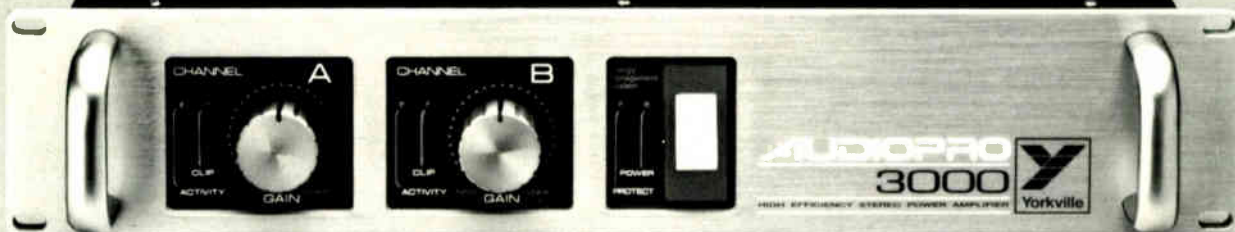

CHECK 1 2 3...

New High Efficiency Technology from Yorkville Sound brings you a stereo power amplifier capable of delivering the full dynamic range of today's music. The AUDIOPRO 3000 is an outstanding value in terms of performance, size and reliability.

CHECK OUR SPECS

POWER: 1200 W/ch @ 2 ohms, (both channels driven)
750 W/ch @ 4 ohms, (*2400 W Bridged Mono)
475 W/ch @ 8 ohms, (1500 W Bridged Mono)

THD: 0.004% full power @ 4 ohms

SLEW RATE: 30V/ μ sec. (60V/ μ sec. Bridged)

HUM & NOISE: -105 dB Unweighted, -115 dB A-Weighted

DAMPING: >600

CHECK OUR FEATURES

- High efficiency power conversion approaches the performance of digital switching, but with the response and low distortion of the best analog designs.
- Energy Management System (EMS). Monitors and regulates line current making it possible to achieve high power from ordinary 15 amp AC line.
- MOSFET drivers eliminate secondary breakdown.
- 2-Year Unlimited Warranty. (Even if you break it!)

CHECK IT OUT

If your sound demands no compromises in quality and reliability check out the AUDIOPRO 3000. Watts/\$ and Watts/lb., no other amp matches its performance.



U.S.: 4600 Witmer Industrial Estate
Niagara Falls, N.Y. 14305

CANADA: 80 Midwest Rd.
Scarborough, Ont. M19 4R2

Circle #112 on Reader Service Card

Engineered For Those With A Passion For Performance.

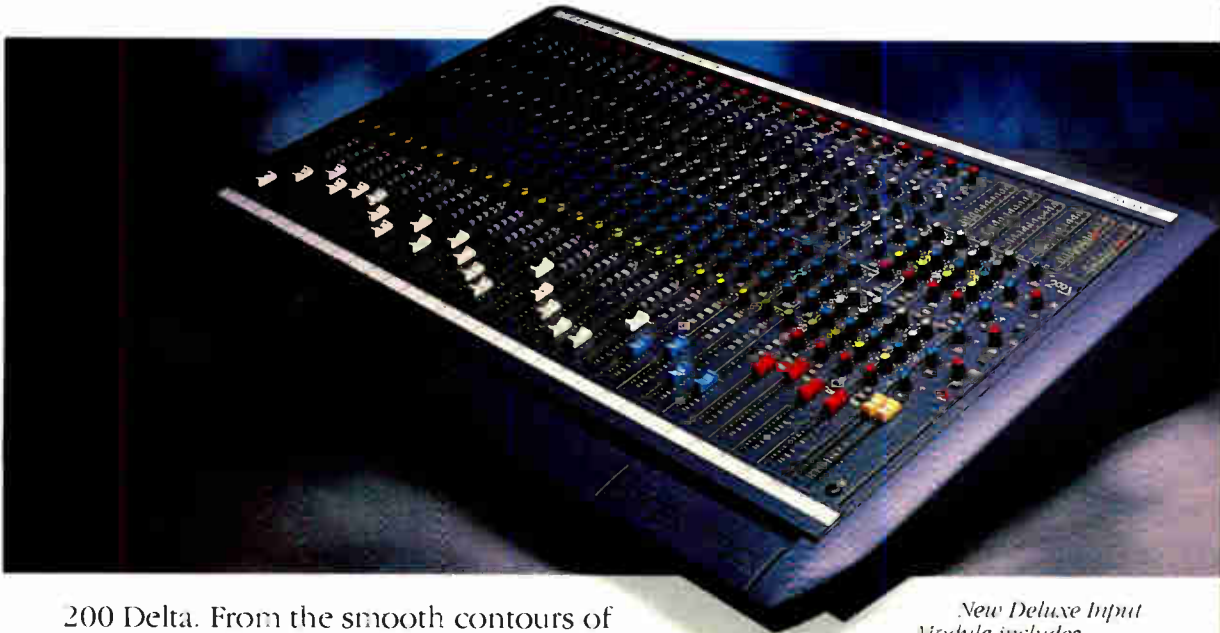

200 Delta. From the smooth contours of its sleekly styled shell to the advanced circuitry that delivers unprecedented performance, Delta is the compact console of the nineties. Expanding on the modular versatility of its 200 Series predecessors, Delta incorporates many innovations unique to Soundcraft. Advances in low profile console design that go well beyond the obvious restyling.

Delta delivers superb sonic quality, with an improved electronic design that incorporates a new microphone preamp and active panpot. And, because Delta selectively bypasses any circuitry not in operation, you can be assured of optimum transparency.

Delta delivers unmatched versatility and control. With Standard, Deluxe, Stereo and Dual-Line Input Modules, Delta can meet a wider variety of applications. By adding up to four Group Modules, configuring just the right console for your application couldn't be easier.

200 Delta. Engineered for those who hunger for perfection.

New Deluxe Input Module includes expanded 4-band EQ with two mid-sweeps, high pass filter and post-fader direct output. The rackmount Delta, shown below in a 12x2 version using Deluxe Inputs, can be expanded to 24x2 using Dual Line Inputs. Both the streamlined consoles and rackmount models are built to withstand the demands of recording and sound reinforcement.

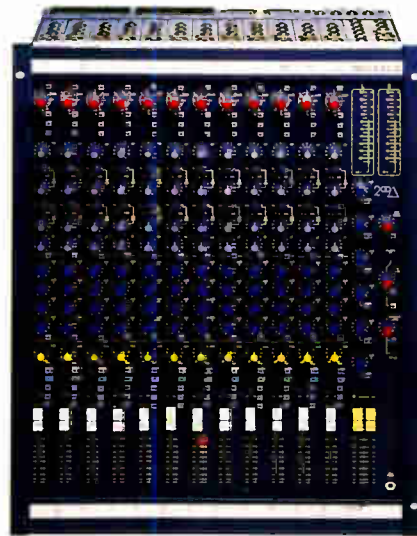

1990
NOMINEE

Soundcraft



Soundcraft USA / JBL Professional
8500 Balboa Boulevard, Northridge, CA 91329

H A Harman International Company

We could have...

But we didn't.

We've just replaced our popular BGW Professional Series power amplifier models 150 and 250 with the new, twice-as-powerful models 200 and 350.

In designing these new amps, we *could* have followed an industry trend by replacing our fully discrete circuitry with ICs. That would have reduced our costs significantly. But we didn't, because the best ICs available still fall short of our standards for sonic quality.

We *could* also have reduced the size and mass of our heat sinks. That would have saved money and still allowed us to meet published specifications with a comfortable margin. But we're not ready to shorten the life of BGW output devices by placing added thermal stress on them. Our standards for long term reliability won't allow it.

We *could* have replaced our expensive precision stepped input attenuators with less expensive detented pots. But we didn't want to give up the precise level control of precision stepped attenuators.

We *could* have used a thermal circuit

breaker rather than the costly magnetic breaker you'll find in every BGW Professional Series amp. But thermal breakers trip-off early in warm summer temperatures. To us, that's unacceptable.

For almost two decades, BGW Professional Series power amplifiers have been designed to meet the exacting performance and reliability criteria of the best facilities in the world. Other manufacturers may be willing to cut corners in order to cut costs. Not BGW. We hold firm in our dedication to building the very best. Not the very cheapest.

To find out exactly what our total quality commitment can mean to you, call us at 800-468-AMPS (213-973-8090 in California) for more information on the new 200 Watt* BGW 200 and 400 Watt* BGW 350/350A or the legendary 600 Watt* BGW 750F and 750G†. Then, for a limited time, we'll triple

our standard warranty at no extra charge when you decide to purchase one.

Thinking of settling for less than BGW?

Well, you *could*...

But you shouldn't.



*Both channels driven into 8 Ohm loads. †Studio version available with low-noise fan.



13130 Yukon Avenue • P.O. Box 5042 • Hawthorne, CA 90251-5042
Tel 800-468-AMPS (213-973-8090 in CA) • Fax 213-676-6713

POWER AMPLIFIERS

FOR SOUND REINFORCEMENT

A BUYER'S GUIDE



Power amplifiers have always been controversial among audio professionals. Ask two engineers for their feelings on the subject and you're liable to get three opinions: two right, two wrong and one undecided, or something like that. But seriously, today's power amplifiers are lighter, more powerful and more reliable than ever. Significant advancements in protection circuitry have enabled this new generation of amplifiers to deliver top-grade performance under grueling conditions that just a few years ago would have spelled disaster in the live performance environment.

The charts on the following four pages list more than 140 power amplifiers currently manufactured by 22 different companies. While the information presented here is substantial, it is by no means comprehensive. With that in mind, we have included telephone numbers for each manufacturer.

In order to keep the charts from becoming unmanageable, I have limited their scope to dual-channel amplifiers with a rating of at least 100 watts at 8 ohms. It should be noted, however, that an increasing number of companies—such as Altec, BGW, Rane, Soundcraftsmen and Australian Monitor—are now marketing multichannel models that are becoming popular, particularly in stage monitoring applications.

All information was obtained from the manufacturers, and prices and specifications may be subject to change by the time you read this.

by
**Mark
Herman**

Power Amplifiers for Sound Reinforcement: A Buyer's Guide

Manufacturer (Telephone No.)	Model	Retail Price	Lbs.	Rack- space	Depth (in.)	Cooling*	Indicators**	Input Conn.***	Balanced Inputs	Output Conn.***	Stow v./L	Gain dB	S/N dB
AD International (818) 783-7800	400	\$570	29	3	13.4	C	0,C	1/4"	N	BP	40	28	104
	1100A	\$1,199	40	2	NA	C	0,S,C	XLR,1/4"	Y	BP	40	32	104
	1200C	\$2,495	65	3	NA	F	0,S,C,L	XLR,1/4"	Y	BP	40	NA	104
	800LX	\$849	33	3	NA	C	0,C,P	XLR,1/4"	Y	BP	40	28	104
	9 00A	\$899	35	3	NA	C	0,S,C	XLR,1/4"	Y	BP	40	30	104
Altec Lansing (415) 324-5311	9442A	\$770	32	3	11	C	0,C,P	XLR,BS	Y	BS	>18	30	100
	9444A	\$990	38	3	12.75	F	0,C,P	XLR,BS	Y	BS	>25	33	100
	9448A	\$1,890	52	3	15.75	F	0,C,P	XLR,BS	Y	BS	>30	38	>100
ARX Systems (714) 840-2340	SB1200VC	\$1,340	29	2	12	F	0,C	XLR,1/4"	Y	BP	50	NA	80
Ashly Audio (718) 544-5181	FET-1000C	\$899	37	2	18	F	0	1/4",BS	Y	BP	50	28	>110
	FET-1000M	\$1,099	58	2	18	F	0,S,C,P,L	XLR,1/4"	Y	BP	50	29	>110
	FET-1000N	\$788	37	2	18	F	0,S,C,P,L	XLR,1/4"	Y	BP	50	28	>110
	FET-1500C	\$798	39	2	18	F	0	1/4",BS	Y	BP	50	29	>110
	FET-1500M	\$899	38	2	18	F	0,S,C,P,L	XLR,1/4"	Y	BP	50	29	>110
	FET-2000C	\$899	58	2	18	F	0	1/4",BS	Y	BP	50	29	>110
Australian Mon. (213) 488-2418	AM 1000	\$2,150	55	3	14.8	F	0,C,P,L	XLR	Y	XLR,BP	80	34	105
	AM 1800	\$2,580	68	3	14.8	F	0,C,P,L	XLR	Y	XLR,BP	85	38	105
B&W Systems (213) 873-8080	200	\$999	14	1	11.8	C	0,S,C	XLR,1/4"	Y	BP	20	29	U/103
	320B	\$999	38	3	11.75	C	0,C	XLR,BS	N	BS	20	32	U/100
	350A	\$1,349	34	3	11.8	C	0,S,C,P	XLR,1/4"	Y	BP	20	30	U/108
	820B	\$1,329	58	5	11.75	C	0,C	XLR,BS	N	BS	20	35	U/100
	7500T	\$849	36	3	10.78	C	S	1/4",BS	N	BS	20	30	U/110
	750G	\$1,849	55	4	15	F	0,S,C,P,L	XLR,1/4"	Y	BP	20	30	115
	8500T	\$1,289	50	3	14.1	F	0	1/4",BS	N	BS	20	30	110
	GTA	\$2,189	78	3	14.5	F	0,S,C	XLR,1/4"	Y	BP	20	30	110
	GTB	\$1,539	50	3	13	F	0,S,C	XLR,1/4"	Y	BP	20	30	110
	Blomp Systems (513) 841-7287	Adv. CPA 850	\$798	33	3	11	C	0,C	BS	Y	BP	NA	32
XA 1000		\$1,349	35	3	12	F	0,S,C	XLR,1/4"	Y	BP	30	31	NA
XA 300		\$899	21	2	15	F	0,S	XLR,1/4"	Y	BP	30	28	NA
XA 800		\$899	24	2	15	F	0,S	XLR,1/4"	Y	BP	30	28	NA
Bryson (800) 873-7898	3 B	\$1,275	35	3	9	C	0,S,C	XLR,1/4"	Y	BP	80	38	U/100
	4 B	\$1,875	45	3	13.5	C	0,S,C	XLR,1/4"	Y	BP	80	38	U/100
Carver Corp. (800) 443-2287	PM 1200	\$1,250	21	2	12	F	0,S,C,P,L	XLR,1/4"	Y	BP	25	32	110
	PM 300	\$890	13	1	12	C	0,S,C,P,L	XLR,1/4",BS	Y	BP	25	28	95
	PM 800	\$820	23	2	12	C	0,S,C,P,L	XLR,1/4",BS	Y	BP	25	28	110
	PM 800	\$895	24	2	12	F	0,S,C,P,L	XLR,1/4",BS	Y	BP	25	31	110
	PT 1250	\$1,500	11	2	11	F	0,S,C,P,L	XLR,1/4"	Y	BP	25	32	195
Carvin (800) 854-2235	FET 400	\$518	31	3	10	F	0,S,C,P	XLR,1/4"	Y	BP,1/4"	30	30	U/100
	FET 900	\$889	35	3	10	F	0,S,C,P	XLR,1/4"	Y	BP,1/4"	50	30	U/103
Crest (201) 423-1300	4801	\$1,589	48	3	15	F	0,S,C,P	XLR	Y	BP	35	32	105
	8001	\$2,189	51	2	15	F	0,S,C,P	XLR	Y	BP	35	32	105
	7001	\$2,589	52	2	15	F	0,S,C,P	XLR	Y	BP	35	32	110
	8001	\$3,189	80	3	15	F	0,S,C,P	XLR	Y	BP	35	32	100
	CC151	\$1,189	38	3	14	C	0,S,C,P	XLR,BS	Y	BP,BS	35	32	100
	CC301	\$1,889	51	3	14	C	0,S,C,P	XLR,BS	Y	BP,BS	35	32	100
	CV801	\$1,989	51	3	14	C	0,S,C,P	XLR,BS	Y	BP,BS	35	32	100
	FA1201	\$1,315	38	2	13	F	0,S,C,P	XLR,BS	Y	BP,BS	35	38	103
	FA2401	\$1,785	55	2	15.25	C	0,S,C,P	XLR,BS	Y	BP,BS	35	37	103
	FA801	\$879	33	2	13	F	0,S,C,P	XLR,BS	Y	BP,BS	35	38	183
Crown Int. (218) 284-8080	0C 300A S-II	\$1,985	45	4	9.75	C	0	1/4"	N	BP	8	29	110
	MacroTech 1200	\$1,585	44	2	18	F	0,S,C,P	XLR,1/4",P	Y	BP	13	28	110
	MacroTech 2400	\$1,985	52	2	18	F	0,S,C,P	XLR,1/4",P	Y	BP	13	29	110
	MacroTech 800	\$1,285	40	2	18	F	0,S,C,P	XLR,1/4",P	Y	BP	13	28	110
	MicroTech 800	\$985	38	2	18	F	0	XLR,1/4"	Y	BP	13	28	110
	MicroTech 1200	\$1,285	41	2	18	F	0	XLR,1/4"	Y	BP	13	29	110
	Power Base 1	\$789	30	3	18	F	0	1/4"	Y	BP	13	28	100
	Power Base 2	\$1,049	32	2	18	F	0	1/4"	Y	BP	13	28	100
	PS 200	\$850	25	2	10.25	C	0,S	1/4"	N	BP	12	29	112
	PS 400	\$1,089	55	4	10.1	C	0,S	1/4"	N	BP	12	28	112
PSA 2X	\$1,985	57	4	14.75	F	0	1/4"	Y	BP	30	28	115	
Dyncord Elect. (213) 438-2870	PCA 2250	NA	35	2	17.8	F	0,S,C,P,M	XLR,1/4"	Y	BP	70	32	101
	PCA 2450	NA	38	2	17.8	F	0,S,C,P,M	XLR,1/4"	Y	BP	100	32	101
	PCA 2544	NA	84	5	17.8	F	0,S,C,P,M	XLR,1/4"	Y	BP	100	32	101
Electro-Voice (818) 895-8931	7300	\$884	39	3	12.75	F	0,C,P	XLR,1/4"	Y	BP	30	32	>100
Harner (802) 987-3585	Pro 2400	\$830	27	3	10.5	C	None	XLR,1/4"	Y	BP	45	28	>100
	Pro 5000	\$1,200	45	2	14	F	0,S,C	XLR,1/4"	Y	BP	40	31	>105
	Pro 8000	\$1,350	40	3	12	F	0,S,C,P	XLR,1/4",ACA	Y	BP	75	38	>100
Hill Audio (800) 445-5178	DX1000 A	\$2,489	40	3	12	F	0,S,C,P	XLR,1/4"	Y	BP	>80	NA	>100
	DX2000	\$2,799	78	3	18	F	0,S,C,P	XLR,1/4"	Y	BP	>45	NA	>100
	DX3000	\$3,099	81	3	18	F	0,S,C,P	XLR,1/4"	Y	BP	>80	NA	>100
	LC 1200	\$1,749	35	2	14.25	F	0,S,C,P	XLR,1/4",BS	Y	BP	>40	NA	>100
	LC 400	\$1,249	17	2	14.25	F	0,S,C,P	XLR,1/4",BS	Y	BP	>40	NA	>100
	LC 800	\$1,389	30	2	14.25	F	0,S,C,P	XLR,1/4",BS	Y	BP	>40	NA	>100

Performance you can take to the bank.



Phil, George and Dan Zeo — of Zeo Brothers' Productions in Hatboro, Pennsylvania — their livelihoods depend on component performance.

They use Electro-Voice EVX woofers exclusively in their low-frequency boxes.

Each EVX 150 and 180 can handle up to 1,000 watts of continuous power, delivering extremely high output and low distortion.

Our exclusive HeatWick™ design efficiently dissipates heat, providing high power handling and long-term reliability.

And our specially designed, extended-length 4-inch voice coil virtually eliminates dynamic-range power compression.

Previously the Zeo's had been using components from another major speaker manufacturer. "Since we started using the EVX's, we haven't had a single failure due to overpowering — and they've been in continuous use."

"They're also an easy replacement for the other drivers, which meant we could use EVX's in our existing low-frequency cabinets."

"We think EVX woofers are the finest low-frequency reproducers in the world. Nothing moves air like an EVX."

If your curiosity has been piqued, and you would like to arrange an EVX demo, please contact Ivan Schwartz, Electro-Voice concert sound marketing manager — 616/695-6831. Additionally, we would be happy to provide free technical assistance for box design. EVX woofers — a sound investment guaranteed to play reliable dividends.



Electro-Voice®
a MARK IV company

Electro-Voice, Inc.
600 Cecil Street
Buchanan, Michigan 49107
Phone: 616-695-6831

Mark IV Audio Canada, Inc.
345 Herbert Street
Gananoque, Ontario K7G2V1
Phone: 613-382-2141

Zeo Brothers' Productions — providing sound reinforcement for concerts and events with acts ranging from the Outlaws to Harry Connick Jr.

LEXICON THE ART AND SCIENCE OF SOUND

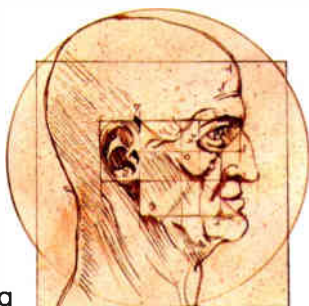

Leonardo Da Vinci was one of those rare individuals to whom both artistic and scientific excellence came easily. The concept of digitally reproducing and shaping analog sounds would have fascinated him.

Achieving excellence in digital audio technology requires a combination of scientific precision and artistic interpretation



that is as rare today as it was in Leonardo's time. It requires mastery of both the art and the science of sound.

Lexicon has devoted nearly two decades perfecting clean, natural digital audio sound without the quirks that digital technology is often accused of. It's called the **Lexicon Sound**, and you'll find it in every product we make.



When Lexicon introduced the world's first digital audio product in 1971, it was heralded as a major technological achievement, a breakthrough. We've built on that reputation with

other achievements, like reverberation and time compression/

expansion, that have earned us more than a dozen awards, including an Emmy.

Today Lexicon products serve more digital audio applications than ever before. There is

OPUS, the world's only fully integrated random access digital audio production system.

OPUS replaces a room full of equipment with a comfortable console and single equipment rack. Digital editing and mixing has never been smoother, more accurate, and more natural.

And everyone has a LARC. The Lexicon Alphanumeric Remote Console harnesses the power of the 480L Digital Effects System. The 480L produces a broad variety of superb effects from a growing library of software. It's no wonder you'll find LARC and the 480L in virtually every major recording studio throughout the world.

Lexicon's LXP-1 and LXP-5 effects processors provide a compact, economical way to include the Lexicon Sound in your productions. Each processor provides significant effects capability all by itself. But combined, the number and

breadth of their effects is astonishing.

The CP-1 Digital Audio Environment Processor extends the Lexicon Sound into the living rooms of America. It's been lauded as one of the truly great digital audio products of all time, and



Stereophile ranked it as "one of a handful of genuine advances in sound reproduction".

These are just a few samples of Lexicon's digital expertise. Our full range of products serves the needs of recording engineers, musicians, film and video producers, radio and television broadcasters, as well as discerning audiophiles. In each product we've merged



technical excellence and artistic elegance. The result is the Lexicon Sound.

For more information about Lexicon products or a demonstration of their complete capabilities, contact us at (617) 891-6790, FAX (617) 891-0340, or write Lexicon, Inc., 100 Beaver St., Waltham, MA 02154.

Lexicon
The Art and Science of Sound

Power Amplifiers for Sound Reinforcement: A Buyer's Guide



THD @	THD %	Damp. %	Power factor	Pwr. Method	Dist. at 0.5% 2	Pwr. %	Dist. at 4.5% 2	Pwr. %	Dist. at 2.5% 2	Model	Manufacturer (Telephone No.)	
0.01	0.1	250	FTC	144	0.1	NA	0.1	-	-	400	AB International (818) 783-7800	
0.01	0.1	250	FTC	450	0.1	881	0.1	940	0.1	1100A		
0.01	0.25	250	FTC	800	0.1	1380	0.15	1500	0.3	1200C		
0.01	0.1	250	FTC	244	0.1	370	0.1	-	-	808LX		
0.01	0.1	250	FTC	298	0.1	453	0.1	504	0.1	800A		
<0.1	<0.1	>200	EIA	100	<0.1	150	<0.1	-	-	9442A	Altec Lansing (415) 324-5311	
<0.05	<0.1	>200	EIA	200	<0.05	300	<0.1	-	-	9444A		
<0.05	<0.1	>250	EIA	400	<0.1	800	<0.1	-	-	9448A		
NA	0.03	200	RMS	425	0.03	625	0.05	-	-	SS1209VC	ARX Systems (714) 848-2348	
0.004	0.05	>100	EIA	120	<1	180	<1	225	<1	FET-1000C	Ashby Audio (718) 544-5181	
0.004	0.05	>100	EIA	300	<1	500	<1	885	<1	FET-1000M		
0.004	0.05	>100	EIA	120	<1	190	<1	225	<1	FET-1808M		
0.004	0.05	>100	EIA	200	<1	300	<1	408	<1	FET-1500C		
0.004	0.05	>100	EIA	200	<1	300	<1	400	<1	FET-1500M		
0.004	0.05	>100	EIA	300	<1	500	<1	885	<1	FET-2080C		
<0.15	<0.05	850	FTC	380	<0.05	520	<0.05	700	NA	AM 1000	Australian Mon. (212) 488-2418	
<0.15	<0.05	850	FTC	470	<0.05	810	<0.05	1100	NA	AM 1800		
0.02	0.08	480	FTC	180	0.08	NA	-	-	-	280	BGW Systems (212) 873-8800	
0.05	0.2	150	FTC	100	0.2	NA	-	-	-	320B		
0.03	0.02	400	FTC	280	0.03	325	0.08	-	-	358A		
0.08	0.25	120	FTC	200	0.25	NA	-	-	-	820B		
0.05	0.1	300	FTC	280	0.1	380	0.15	-	-	7500T		
0.01	0.03	500	FTC	380	0.03	450	0.08	-	-	750C		
0.05	0.1	380	FTC	300	0.1	450	0.15	850	0.3	8500T		
0.03	0.1	580	FTC	380	0.1	825	0.15	1000	0.3	CTA		
0.03	0.1	500	FTC	300	0.1	450	0.15	850	0.3	GTB		
0.3	0.08	NA	<80kHz	200	0.08	325	0.08	-	-	Adv. CPA 850		Bimpo Systems (512) 841-7287
0.1	0.1	>150	<80kHz	300	0.1	500	0.1	-	-	XA 1000		
0.1	0.07	>150	<80kHz	190	0.07	150	0.07	-	-	XA 300		
0.1	0.07	>150	<80kHz	280	0.07	380	0.07	-	-	XA 800		
<0.1	<0.1	500	EIA	100	<0.1	200	<0.1	-	-	3-B	Bryson (808) 873-7898	
<0.1	<0.1	500	EIA	250	<0.1	400	<0.1	-	-	4-B		
0.1	0.5	200	FTC	450	0.5	800	0.5	-	-	PM 1200	Carver Corp. (800) 443-2287	
0.1	0.5	280	FTC	110	0.5	150	0.5	-	-	PM 380		
0.1	0.5	200	FTC	280	0.5	380	0.5	-	-	PM 680		
0.1	0.5	200	FTC	350	0.5	450	0.5	-	-	PM 880		
0.1	0.5	200	FTC	485	0.5	825	0.5	-	-	PT 1250		
NA	<0.05	>500	@ 1kHz	100	<1	200	<1	-	-	FET 400	Carvin (800) 854-2235	
NA	<0.05	>500	@ 1kHz	280	<1	300	<1	450	<1	FET 800		
<0.15	<0.08	400	EIA	400	0.05	575	0.05	750	0.1	4801	Crest (281) 423-1300	
<0.05	<0.08	480	EIA	525	0.05	780	0.05	880	0.1	8001		
<0.01	<0.08	480	EIA	579	0.05	810	0.05	850	0.1	7001		
0.015	<0.08	400	EIA	750	0.05	1225	0.05	1400	0.1	8001		
<0.15	<0.08	400	EIA	280	0.05	325	0.05	-	-	CC151		
<0.025	<0.08	400	EIA	380	0.05	540	0.05	-	-	CC301		
<0.02	<0.08	400	EIA	850	0.05	NA	-	-	-	CV801		
<0.04	<0.08	400	EIA	300	0.05	475	0.05	680	0.1	FA1201		
<0.04	<0.08	400	EIA	350	0.05	600	0.05	770	0.1	FA2401		
<0.04	<0.08	400	EIA	280	0.05	375	0.05	440	0.1	FAD01		
<0.05	<0.01	>400	MAP	175	0.1	385	0.1	-	-	DC 300A S-II		Crown Int. (212) 294-8800
<0.05	<0.02	>400	MAP	320	0.1	485	0.1	680	0.1	MacroTach 1200		
<0.05	<0.02	>400	MAP	535	0.1	820	0.1	1100	0.1	MacroTach 2400		
<0.05	<0.02	400	MAP	235	0.1	340	0.1	410	0.1	MacroTach 680		
<0.05	<0.02	480	MAP	235	0.1	340	0.1	410	0.1	MacroTach 880		
<0.05	0.02	480	MAP	320	0.1	485	0.1	680	0.1	MacroTach 1200		
<0.05	0.02	480	MAP	205	0.1	230	0.1	-	-	Power Base 1		
<0.05	0.02	>400	MAP	320	0.1	400	0.1	-	-	Power Base 2		
<0.05	<0.01	>400	MAP	100	0.1	170	0.1	-	-	PS 200		
0.05	<0.01	>400	MAP	180	NA	330	NA	-	-	PS 400		
<0.05	<0.05	400	MAP	275	0.1	480	0.1	700	0.1	PSA 2X		
NA	0.03	>380	EIA	180	NA	150	NA	-	-	PCA 2250	Dymond Elect. (213) 430-2878	
NA	0.03	>300	EIA	300	NA	250	NA	-	-	PCA 2450		
NA	0.03	>300	EIA	380	NA	300	NA	-	-	PCA 2544		
0.03	0.05	>200	FTC	280	0.05	380	0.1	-	-	7300	Electro-Voice (818) 885-8831	
<0.05	<0.025	380	RMS	120	0.03	175	0.04	-	-	Pro 2480	Hofner (802) 867-3585	
<0.07	<0.015	250	RMS	250	0.02	350	0.03	-	-	Pro 5000		
<0.1	0.1	>500	RMS	380	0.1	500	0.1	845	0.1	Pro 8000		
<0.002	0.02	800	RMS	500	0.02	800	0.02	-	-	DX1000 A	MM Audio (800) 445-5178	
<0.002	0.02	2000	RMS	400	0.02	850	0.02	1080	0	DX2000		
<0.002	0.02	2000	RMS	550	0.02	900	0.02	1500	0	DX3000		
<0.1	<0.3	>300	RMS	350	0.03	800	0.03	-	-	LC 1280		
<0.1	<0.3	>300	RMS	120	0.03	280	0.03	-	-	LC 400		
<0.1	<0.3	>300	RMS	250	0.03	480	0.03	-	-	LC 880		

Power Amplifiers for Sound Reinforcement: A Buyer's Guide

Manufacturer (Telephone No.)	Model	Retail Price	Lbs.	Rack- space	Depth (in.)	Cooling*	Indicators**	Input Conn.***	Balanced Inputs	Output Conn.***	Shew V/LR
I. R. P. (708) 840-8553	OH-4020	\$885	14	1	10	C	O,S,C,P	XLR, 1/4", BS	Y	BP, BS	20
Intl. Strength (213) 821-2341	PA700	\$888	28	3	13.5	F	O,C,I	XLR, 1/4"	Y	BP	NA
Intl. P.A. (213) 802-8842	MA-420	\$848	30	2	15.5	C	O,C,P	XLR, 1/4"	Y	BP	85
	MA-820	\$788	40	3	15.5	C	O,C,P	XLR, 1/4"	Y	BP	85
	MA-920	\$875	48	3	15.5	F	O,C,P	XLR, 1/4"	Y	BP	85
HH Electronic (213) 373-2034	VK 450	\$1,898	35	2	15	F	O,C,S,P	XLR, 1/4"	Y	XLR, BP	70
	VK 600	\$2,148	38	2	15	F	O,C,P	XLR, 1/4"	Y	XLR, BP	70
	VK 900	\$3,288	48	3	15	F	O,C,P	XLR, 1/4"	Y	XLR, BP	70
	VK 1200	\$3,048	54	3	15	F	O,C,P	XLR, 1/4"	Y	XLR, BP	70
	V 800	\$2,388	47	4	15	F	O,P,I	XLR, 1/4"	Y	XLR, BP	45
JBL (818) 893-8411	B280	\$1,045	45	4	11	C	O,C	XLR, 1/4"	Y	BP	>40
	B290	\$1,570	83	4	14	C	O,C,P	XLR, 1/4"	Y	BP	>40
	SR 8630	\$895	34	2	17.5	F	O,C,S,P	XLR, 1/4"	Y	BP	>40
	SR 8650	\$1,185	42	2	17.5	F	O,C,S,P	XLR, 1/4"	Y	BP	>40
	ES 800	\$895	40	2	18	F	O,C,S,P,I	XLR, BS	Y	BP	>40
	ES 800	\$1,285	38	3	18	F	O,C,S,P,I	XLR, BS	Y	BP	>40
	ES 1200	\$1,585	38	3	18	F	O,C,S,P,I	XLR, BS	Y	BP	>40
Meyer Sound (415) 488-1188	MS-1000A	\$2,284	88	3	18.8	F	O,S,C,P	XLR	Y	BP	50
Parsons (800) 822-8802	NCA-2200	\$1,385	55	4	14	C	O,P	XLR, RCA	Y	BP	88
	NCA-1200	\$895	38	4	14	C	O,C,P	1/4", RCA	N	BP	45
	NCA-800 II	\$385	24	4	12	C	O,P	1/4", RCA	N	BP	28
Peavey Elec. (801) 483-5372	CS-1000	\$1,000	53	3	14.25	F	O,C,P,I	XLR, 1/4"	N	BP, 1/4"	50
	CS-1200	\$1,400	71	4	18	F	O,C,P,I	XLR, 1/4"	N	BP, 1/4"	50
	CS-400	\$780	40	3	12.38	F	O,C,P,I	XLR, 1/4"	N	BP, 1/4"	40
	CS-800	\$880	45	3	14.38	F	O,C,P,I	XLR, 1/4"	N	BP, 1/4"	40
	DECA 1200	\$1,400	37	2	18	F	O,C,P,I	XLR, 1/4"	Y	BP, 1/4"	NA
	DECA 528	\$880	12	1	13.5	F	C,P	1/4"	N	1/4"	NA
	DECA 724	\$1,000	37	2	18	F	O,C,P,I	XLR, 1/4"	Y	BP, 1/4"	NA
Perrenn Corp. (714) 877-3000	E-1000	\$1,088	18	3	12.75	C	O,C	XLR, 1/4"	Y	BP	NA
	E-2000	\$1,388	28	3	17.75	C	O,C	XLR, 1/4"	Y	BP	NA
QSC Audio (714) 845-2540	1200	\$588	24	3	8.5	C	O,C	XLR, 1/4", BS, D	Y	BP	12
	1400	\$788	34	3	8.5	F	O,C	XLR, 1/4", BS, D	Y	BP	18
	1700	\$1,248	54	4	10.8	F	O,C	XLR, 1/4", BS	Y	BP	21
	3500	\$1,488	50	2	15.8	C	O,S,C,P	XLR, 1/4", BS, D	Y	BP, BS	20
	3800	\$1,858	75	2	NA	C	O,S,C,P	XLR, 1/4", BS, D	Y	BP, BS	20
	MX 1500	\$1,098	47	2	17.0	F	O,C,P	1/4", BS	Y	BP	20
	MX 2000	\$1,488	70	3	17.0	F	O,C,P	1/4", BS	Y	BP	20
	MX 4000	\$2,788	84	3	17.0	F	O,S,C,P	XLR, BS	Y	BP, SD	20
	MX 700	\$588	75	2	NA	F	O,C	1/4", BS	Y	BP	20
Ramsa (714) 373-7277	WP-8110	\$840	28	2	15	F	O,S,C,P	XLR, 1/4"	Y	BP, 1/4"	NA
	WP-8220	\$1,060	38	3	15	F	O,S,C,P	XLR, 1/4"	Y	BP, 1/4"	NA
	WP-8440	\$2,180	75	3	18	F	O,S,C,P	XLR, 1/4"	Y	BP, 1/4"	NA
Rass (817) 338-5114	Mega Amp 400	\$588	40	2	NA	C	O,C,P	XLR, 1/4"	N	BP, 1/4"	15
	Mega Amp 800	\$788	38	3	NA	C	O,C	XLR, 1/4"	Y	BP, 1/4"	15
Sound Code Sys. (714) 554-8803	2150A	\$858	24	2	11	C	O,C	1/4"	Y	BP	70
	2200S	\$1,148	28	2	13.1	C	O	XLR	Y	BP	40
	2350A	\$828	38	3	14.5	F	O,C	1/4"	Y	BP	70
	2450A	\$888	44	3	14.5	F	O,C	XLR, 1/4"	Y	BP	70
	2800A	\$1,188	48	3	14.5	F	O,C	XLR, 1/4"	Y	BP	70
Sound Tech (788) 541-3520	A 1000	\$1,148	47	3	15.75	?	O,C,P,I	XLR, 1/4"	Y	BP	85
	A 300	\$588	18	2	15.5	C	O,S,C,P,I	XLR, 1/4"	Y	BP	85
	A 800	\$778	38	3	15.75	C	O,C,P,I	XLR, 1/4"	Y	BP	85
	PL 500	\$588	38	2	18	F	O,C,P	XLR, 1/4"	Y	BP	40
Soundcraftsmen (714) 558-8181	450 X2	\$848	30	2	11.75	F	C	XLR, 1/4", BS	Y	BP	50
	900X2	\$1,588	85	3	18.5	F	O,C	XLR, 1/4", BS	Y	BP	50
	PM 880	\$588	20	2	13	F	O,C	1/4"	N	BP	50
	RA 7501	\$848	50	2	15	C	O,C	1/4"	Y	BP/Intl.	50
Sumi/Fender (714) 880-0808	SPL 7250	\$750	25	2	12.5	F	O	XLR, 1/4"	Y	BP, 1/4"	30
	SPL 7450	\$888	38	3	13.4	F	O,C	XLR, 1/4"	Y	BP, 1/4"	20
Tan Electronics (415) 588-2538	P-150 D	\$1,238	44	3	18.8	C	O,S,C,P	XLR, 1/4"	Y	BP	20
	P-300 D	\$2,218	77	5	18.8	C	O,S,C,P	XLR, 1/4"	Y	BP	40
Yamaha (714) 522-8811	P1150	\$545	28	3	NA	F	O,S,C,P	XLR, 1/4"	Y	BP, 1/4"	90
	P2150	\$745	37	3	NA	F	O,S,C,P	XLR, 1/4"	Y	BP, 1/4"	50
	P2250	\$845	42	3	NA	F	O,S,C,P	XLR, 1/4"	Y	BP, 1/4"	80
Yorkville Sound (718) 287-2820	Audiopro 1200	\$1,200	35	2	15	F	O,S,C,P	XLR, 1/4"	Y	BP	30
	Audiopro 3000	\$1,588	40	2	15.75	F	O,S,C,P	XLR, 1/4"	Y	BP	30
	Audiopro 500	\$788	40	2	13.5	F	O,C,P	XLR, 1/4"	Y	BP, 1/4"	30
	BETA 800	\$1,088	57	3	14	F	O,C	1/4"	N	1/4"	30

Power Amplifiers for Sound Reinforcement: A Buyer's Guide



Gain dB	S/N dB	THD %	THD %	Damp. factor	Power Method	Pwr. at 4Ω	Dist. %	Pwr. at 4Ω	Dist. %	Pwr. at 2Ω	Dist. %	Model
20	105	NA	0.1	100	CONT.	100	0.1	140	0.15	-	-	DH-4020
NA	115	NA	NA	300	NA	250	NA	400	NA	-	-	PA700
20	115	0.01	0.01	300	FTC	130	0.01	180	0.01	225	0.1	NA-420
20	115	0.01	0.01	400	FTC	240	0.01	325	0.01	385	0.1	NA-620
32	115	0.01	0.01	400	FTC	315	0.01	480	0.01	500	0.1	NA-820
NA	100	0.03	0.03	300	EIA	138	0.03	225	0.03	-	-	VX 450
NA	100	0.03	0.03	300	EIA	185	0.03	300	0.02	-	-	VX 600
NA	100	0.03	0.03	300	EIA	280	0.03	450	0.02	-	-	VX 900
NA	100	0.03	0.03	300	EIA	350	0.03	800	0.02	-	-	VX 1200
NA	100	0.03	0.02	300	EIA	280	0.03	400	0.02	-	-	V 800
30	>100	<0.05	0.1	>200	FTC	150	0.1	300	0.1	-	-	0200
33	>100	<0.05	0.1	>200	FTC	300	0.1	800	0.1	-	-	0200
31	>100	<0.05	0.1	>200	FTC	180	0.1	300	0.1	500	1	SR 0830
33	>100	<0.05	0.1	>200	FTC	300	0.1	500	0.1	850	1	SR 0850
31	>100	<0.05	0.1	>200	FTC	180	0.1	300	0.1	-	-	ES 000
33	>100	<0.05	0.1	>200	FTC	300	0.1	450	0.1	-	-	ES 000
34	>100	<0.05	0.1	>200	FTC	300	0.1	800	0.1	-	-	ES 1200
20	>100	<0.1	<0.1	>1000	FTC	800	<0.1	1000	<0.1	-	-	MS-1000A
NA	115	0.05	0.05	140	NA	220	0.05	305	0.05	850	0.1	HCA 2200
NA	110	0.05	0.05	130	NA	200	0.05	300	0.05	-	-	HCA 1200
NA	110	0.05	0.05	>100	NA	100	0.05	140	0.05	-	-	HCA 800 H
30	U/100	NA	0.03	400	RMS	300	0.03	500	0.03	-	-	CS-1000
31	U/100	NA	0.03	400	RMS	350	0.03	800	0.03	-	-	CS-1200
20	U/100	NA	0.05	400	RMS	120	0.03	200	0.03	-	-	CS-400
20	U/100	NA	0.03	400	RMS	240	0.03	400	0.03	-	-	CS-800
31	U/100	NA	0.15	NA	RMS	NA	-	800	0.15	-	-	DECA 1200
31	U/85	NA	0.1	NA	RMS	NA	-	200	0.1	-	-	DECA 528
31	U/85	NA	0.1	NA	RMS	NA	-	350	0.1	-	-	DECA 724
NA	U/100	0.003	0.003	500	NA	200	0	300	0	-	-	E-1000
NA	U/100	0.003	0.003	500	NA	100	0	180	0	-	-	E-2000
20	100	<0.025	<.1	200	FTC	100	0.1	150	0.1	-	-	1200
32	100	<0.025	0.1	200	FTC	200	0.1	300	0.1	-	-	1400
34	100	<.01	<.1	200	FTC	325	0.1	500	0.1	-	-	1700
34	100	0.015	0.1	200	FTC	300	0.1	450	0.1	700	1	3500
35	100	0.025	0.1	200	FTC	375	0.1	800	0.1	850	0.2	3800
34	100	0.02	0.1	200	FTC	330	0.1	500	0.1	750	1	MX 1500
34	100	0.025	0.1	200	FTC	375	0.1	800	0.1	1000	1	MX 2000
34	100	0.05	0.1	200	FTC	750	0.1	1125	0.1	1500	0.1	MX 4000
31	100	0.025	0.1	200	FTC	150	0.1	225	0.1	350	1	MX 700
27	>100	<.05	<.1	100	NA	100	<.05	150	0.05	-	-	WP 8110
30	>100	<.05	<.1	100	NA	200	<.05	300	0.05	-	-	WP 8220
33	>100	<.08	<.08	150	NA	350	<.05	NA	-	-	-	WP 8440
40	100	0.05	0.1	150	EIA	150	0.1	200	0.1	-	-	Mega Amp 400
40	104	0.05	0.1	250	EIA	245	0.1	400	0.1	-	-	Mega Amp 800
30	105	0.175	0.088	350	EIA	100	0.04	150	0.08	-	-	2150A
30	88	0.5	0.5	18	EIA	125	0.4	200	0.05	310	1	2200S
30	105	0.025	0.080	350	EIA	245	0.1	350	0.1	-	-	2350A
30	108	0.025	0.205	350	EIA	275	0.1	440	0.1	-	-	2450A
30	110	0.028	0.198	350	EIA	350	0.1	584	0.1	-	-	2800A
32	115	NA	0.005	400	NA	312	NA	480	NA	-	-	A 1000
28	115	NA	0.01	300	NA	124	NA	188	NA	-	-	A 300
28	115	NA	0.008	400	NA	240	NA	324	NA	-	-	A 800
28	100	NA	0.05	300	NA	185	NA	250	NA	-	-	PL 500
NA	105	0.05	0.05	200	FTC	205	0.05	300	0.05	-	-	450 X2
NA	105	0.05	0.05	200	FTC	375	0.05	800	0.05	-	-	800X2
NA	105	0.05	0.05	200	FTC	205	0.05	300	0.05	-	-	PM 880
NA	105	0.05	0.05	250	FTC	250	0.05	375	0.05	-	-	RA 7501
28	105	<0.01	<0.01	>400	EIA	150	0.1	250	0.1	-	-	SPL 7250
30	105	<0.1	<0.01	400	NA	280	0.1	450	0.1	-	-	SPL 7450
30	110	0.05	0.1	150	FTC	150	0.1	220	0.15	-	-	P-150 0
33	110	0.05	0.01	280	FTC	300	0.1	480	0.15	-	-	P-300 0
28	115	0.005	0.003	110	FTC	100	0.05	150	0.05	-	-	P1150
28	115	0.005	0.003	110	FTC	100	0.05	150	0.05	-	-	P2150
28	115	0.01	0.003	110	FTC	170	0.05	250	0.05	-	-	P2250
33	U/115	0.01	0.05	>800	FTC	350	0.04	525	0.05	-	-	Audiopro 1200
38	U/115	0.01	0.04	>800	FTC	425	0.04	850	0.05	950	0.1	Audiopro 3000
30	U/84	0.01	0.1	>200	FTC	125	0.1	200	0.1	-	-	Audiopro 500
30	U/100	NA	0.1	>400	cont.	250	0.1	400	0.1	-	-	BETA 800

NOTES: * C=Convection F=Fan ** D=Dr; C=Clip; S=Signal present; P=Protect; L=Level *** B=Barrier Strip; BP=Binding Post; P=Plug-in Point; O=Open circuit; SO=Speak-on

SOUND REINFORCEMENT NEW PRODUCTS

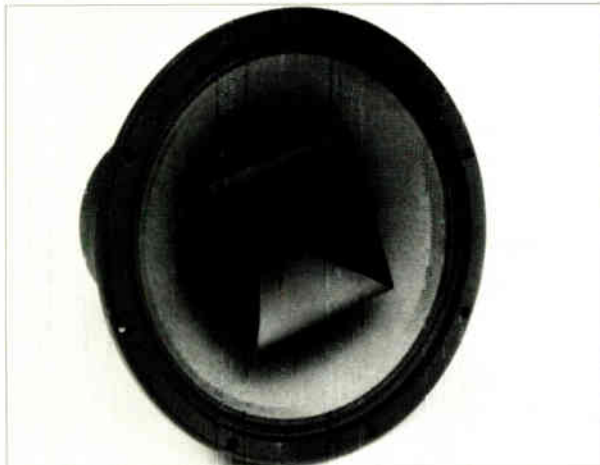
**JBL 2100 SERIES COAXIAL LOUDSPEAKERS**

New from JBL Professional (Northridge, Calif.) are three large-format coaxial drivers, designed to address the needs of "real-world" sound installations. All offer 80° coverage angles. Models 2152H and 2155H are 12- and 15-inch LF drivers combined with titanium dome compression drivers and flat-front, Bi-Radial™ horns. The 2142H features a 12-inch LF section and a 1.75-inch titanium dome HF section.

Circle #101 on Reader Service Card

E-V COMPACT MANIFOLD SYSTEM

Electro-Voice (Buchanan, Mich.) has unveiled the MT-2, a half-sized version of the popular MT-4 Manifold Technology speaker system. The MT-2, consisting of the MTH-2/94 mid/high-frequency cabinet and a matching MTL-2 LF box, can be used as a mains system in smaller venues, or as an expansion option with the MT-4 system in down-fill and medium-throw applications. Highs are handled by two modified DL10X drivers manifolded into a 90° x 40° horn and two DH1A drivers manifolded into a smaller 90° x 40° horn. Both horns can be rotated for horizontal or vertical coverages. The MTL-2 LF box is a manifold design with two DL18MT woofers. Both are carpeted 36 x 22.5 x 30-inch boxes and include Aeroquip L-track flying hardware.

Circle #102 on Reader Service Card



—CONTINUED ON PAGE 136

©1990 Crest Audio Inc.

Crest Audio proudly announces the birth of a new Gamble.

The Series EX MONITOR CONSOLE

Finally. A console optimized specifically for the task of stage monitor mixing.

48 Input Channels - Each with 4 band full parametric EQ, 24 db per octave sweepable low cut filter, 1 stereo and 16 mono sends.

8 Programmable Scene Mutes of inputs and outputs.

20 Segment LED Meters on all inputs and outputs.

16 Mix Outputs are routed through a 16 x 16 matrix that feeds into 16 output channels; each with a 5 band full parametric EQ.

Integral Comprehensive Patchbay System including patch-points on all inputs and outputs, 96 tie lines, stage box and mic scrambling.

TEC
1990
NOMINEE

As in the Series EX House Console, only the finest components are used including: **Clarostat** pots, **P&G** faders, **Wima** capacitors, **Resista** resistors, and **Analog Systems** IC's. Call Crest Audio for a detailed brochure and delivery information. Available now.

 **CREST AUDIO**

CREST AUDIO INC. 150 Florence Avenue Hawthorne, New Jersey 07506 USA tel: (201) 423-1300 fax: (201) 423-2977

Circle #113 on Reader Service Card

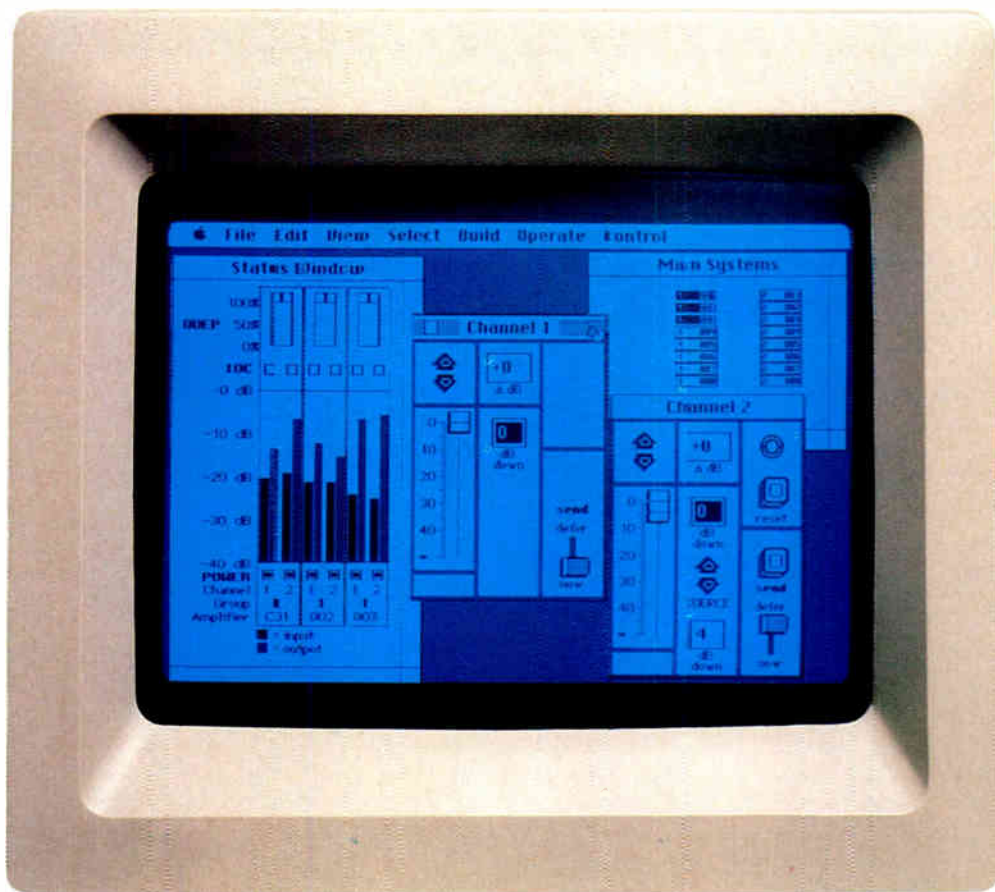

Test Our IQ.

Install Crown's new IQ System 2000,[™]
the smartest way *ever* to monitor and control amplifiers.

You're looking at something that no sound contractor has ever seen, or possibly even *imagined*, before. A system that can digitally monitor and control each channel of up to 2,000 remote amplifiers at once. All from one cost-saving location.

It's the incredible new IQ System 2000 from Crown. Using a common personal computer, easy-to-install IQ components, and Com-Tech[™] amplifiers, you can now do in *minutes* what used to take days.



IQ Interface, Software & P.I.P. Module

Simultaneously adjust levels, power up, change polarity, monitor features (like Crown's exclusive IOC[™] and ODEP[™]), do diagnostics, and more. No running back and forth to each remote location. No expensive, long runs of speaker cable.

With the IQ System 2000, you're free to locate amps *anywhere* you like—even in previously impossible remote locations.

To learn more about this innovative new system, contact Crown today. Because when it comes to combining advanced technology with surprising cost efficiency, the Crown IQ System 2000 just could be the smartest choice you'll ever make.

TEC
TECHNICAL EXCELLENCE & CREATIVITY
1990
NOMINEE

 **crown**[®]

1718 W. Mishawaka Road, Elkhart, IN 46517
219/294-8000

Circle #024 on Reader Service Card

SOUND REINFORCEMENT NEW PRODUCTS

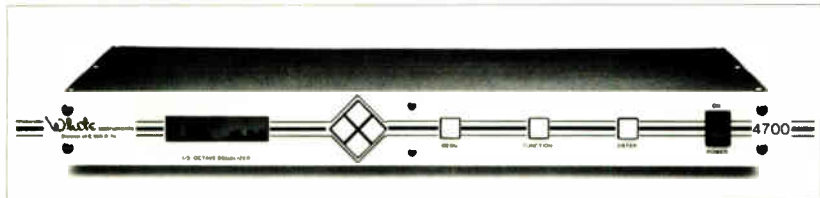
**WHITE MODEL 4700**

From White Instruments (a division of C Van R, Austin, Texas), is a digitally controlled equalizer providing 1/3-octave filtering in a single rackspace box. The single-channel Model 4700 features 28 bands of ± 10 dB control on ISO standard frequency centers from 31.5 to 16k Hz, along with 12dB/octave HP and LP filters, adjustable in eight steps. Model 4700 can store up to ten user presets in non-volatile memory; an unlimited number of presets can be stored externally via optional RS-232/EIA-422 interfaces. Model 4700-2 is dual-channel.

Circle #103 on Reader Service Card

SAMSON SUPER TD

Featuring optional powered FM antennas—said to increase transmission range by over 25 percent in crowded RF areas—and a sensitive receiver for improved headroom is the Super TD VHF wireless system from Samson of Hicksville, N.Y. The receiver uses a Cavity Tuned design with twice the sensitivity of its predecessor, along with inductor decoupling of internal stages to reduce the chance of RF entering the audio path. Transmitters include a powerful belt-pack system and handheld units offering popular condenser and dynamic mic elements.

Circle #104 on Reader Service Card

**JL COOPER SA-1000
CONSOLE AUTOMATION**

Based on the successful Magi II system, the SA-1000 from JL Cooper Electronics (Marina Del Rey, Calif.) installs in any sound reinforcement console to provide computer-assisted control of channel faders and mute information. Thousands of mixes can be selected as "scenes" and can be programmed, stored and recalled for later use. Features include up to 64 channels of high-quality dbx VCA control, disk storage and archiving, auto punch-in of changes, moving fader graphics, online or cue list editing, 16 software-based subgroups, and MIDI automation events. Other aspects include signal processing, equalizers, lighting effects and more. The SA-1000 requires a Macintosh or Atari ST computer with at least 1MB of RAM.

Circle #105 on Reader Service Card



6 New Amps

Now we are six.

Six powerful new power amp designs from the Pros at Carver. 60 to 625 watts a side*.

With extra features you've asked us for, exceptional reliability and our legendary watts-to-weight ratio.

Call 1-800-443-CAVR toll-free for the intimate details. Or head into a Carver Professional Dealer and meet the six that pack solutions to any amplification problem from PA to permanent install.

CARVER
PROFESSIONAL
Lynnwood, Washington USA

PM-120 (60 w/ch. *)
PM-300 (150 w/ch. *)
PM-600 (300 w/ch. *)
PM-900 (450 w/ch. *)
PM-1200 (600 w/ch. *)
PM-1250 (625 w/ch. *)

*into 8 Ω both channels driven 20-20kHz

TOMORROW'S VINTAGE MIC TODAY'S REVOLUTION



INTRODUCING

EQUITEK II

Multipattern Side Address
Condenser Microphone

A dual capsule condenser microphone featuring a frequency response of 20-20,000Hz, cardioid, Figure 8 and omnidirectional patterns, and exclusive I.N.R.™ (Impact Noise Rejection) internal shock mount system.

From Conneaut Audio Devices, a revolution in performance at an absolutely incomparable price.

1-800-762-9266



Conneaut Audio Devices

CTI Audio P.O. Box 120 Harbor & Jackson Streets Conneaut, Ohio 44030-0120

World Radio History



"I've waited 14 years for a monitor this accurate.

The HD-1 is worth the wait."

Roger Nichols
Engineer/Producer

*Grammy Winner for: Aja,
F.M., Gacho-Steely Dan
Grammy Nominee: for Rikki
Lee Jones-Rikki Lee Jones;
Nightfly-Donald Fagen*

HD-1 High
Definition
Audio
Monitor

Meyer
Sound

HD-1 High
Definition
Audio
Monitor

Meyer
Sound

Meyer Sound redefines the near-field monitor with the introduction of our HD-1 High Definition Recording Monitor. The HD-1 was designed to provide the most stable, accurate imaging available today. With an extended low frequency response to 32Hz, the HD-1 needs no external

subwoofer. And the control electronics and power amplifier are built in the cabinet, eliminating the need for additional equipment or rack space. Contact us or your Meyer Sound dealer and listen to the HD-1.

There's no need to wait any longer.

TEC
1990
NOMINEE

World Radio History

 **Meyer
Sound**

Meyer Sound Laboratories, Inc.
2832 San Pablo Avenue
Berkeley, California 94702
(415) 486-1166
FAX (415) 486-8356

Circle #020 on Reader Service Card

by Craig Anderton

WHATEVER HAPPENED TO ALTERNATE CONTROLLERS

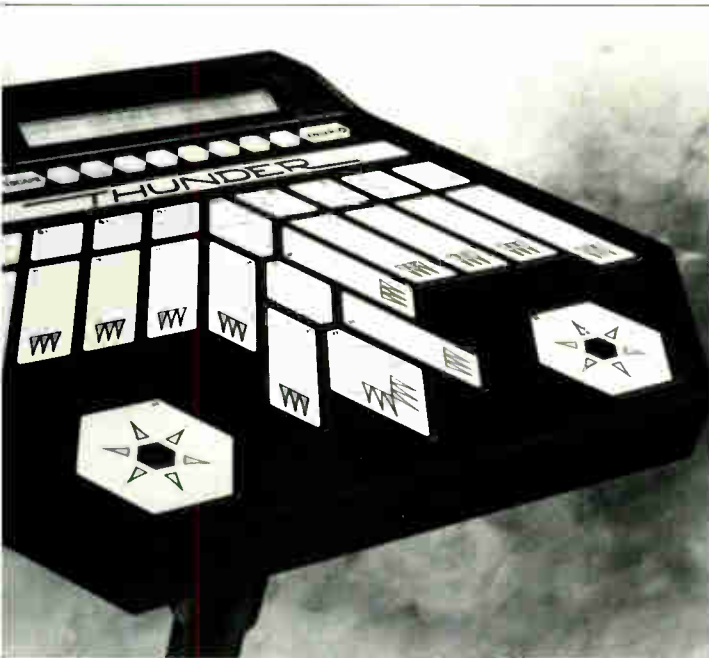

"kiddie guitar" controllers any more; Stepp is out of business; Yamaha has discontinued the G10; and the Quantar is (at least for the present) languishing in product limbo. Roland is still actively pursuing the market, buoyed by the relative success of the GR-50; but then again Roland has stuck with guitar synthesis through thick and thin, so by now it's offering a mature and cost-effective product.

On the wind side of things, matters haven't been much better, with early entries being discontinued often due to lack of sales. Drum controllers? Simmons has been on the ropes, although devices like the Kat and the Octapad remain popular. Marimba/vibe controllers are few and far between: Fairlight's VoiceTracker is but a memory; and MIDI accordions and harmonicas haven't exactly taken over

Left: Don Buchla's new Thunder.
Bottom: The Drum Kat.

When most people think "synthesizer," they think "keyboard." Although alternate synthesizer controllers designed for guitarists, wind players, drummers and vocalists have existed for years, they've never really caught on in a big way. Compare the number of keyboard synths and pianos sold, then compare the number of guitar controllers and guitars sold, and you'll see what I mean.

For years, mass-market guitar synthesis has been touted by many (including this author) as being "just around the corner." Yet at the last NAMM show, only Gibson showed new guitar synth technology, and that was an (admittedly major) update of its existing Photon system. Suzuki doesn't make its woefully underrated

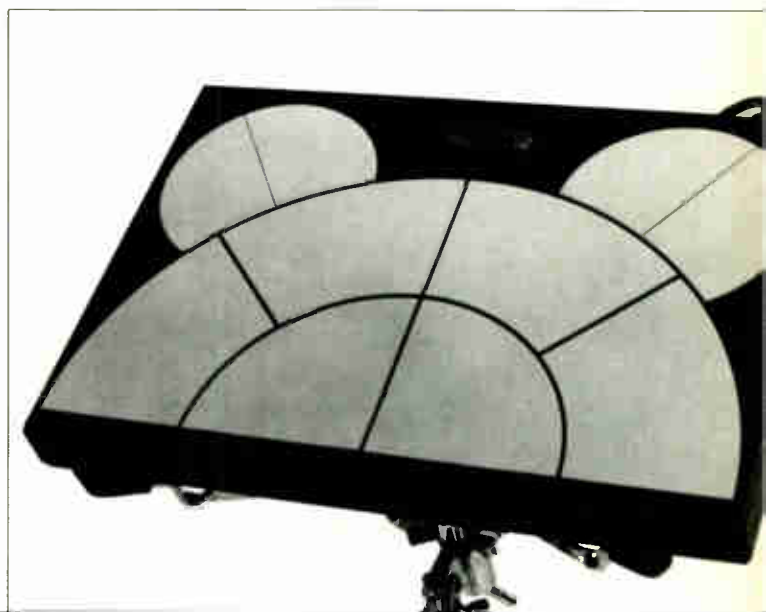

**...EVERYTHING
for Production Sound!**

When it comes to Production Sound and Radio Communications Equipment your best source is always Audio Services!

We support our clients (anywhere in the world) with one of the largest inventories of Sales and Rental Equipment, a complete Service Department, and a staff of over 60 experienced professionals.



AS AUDIO SERVICES CORPORATION
10639 Riverside Drive, North Hollywood, CA 91602
Call us for a competitive quote! 818 - 980-9891
Toll-free outside Calif. 1-800-228-4429 FAX 818-980-9911
San Francisco area 415-522-3650
Orlando Florida: Topham Audio 407-649-6444

Circle #091 on Reader Service Card

MI UPDATE

the world.

The implications of this have been felt mostly in the softening keyboard market. Several companies realized

cilessly hyped and hopelessly over-sold, it couldn't deliver one-tenth of what it promised. Guitarists were unimpressed with the sound, tracking and reliability. Dealers were unimpressed with the sales. A short time

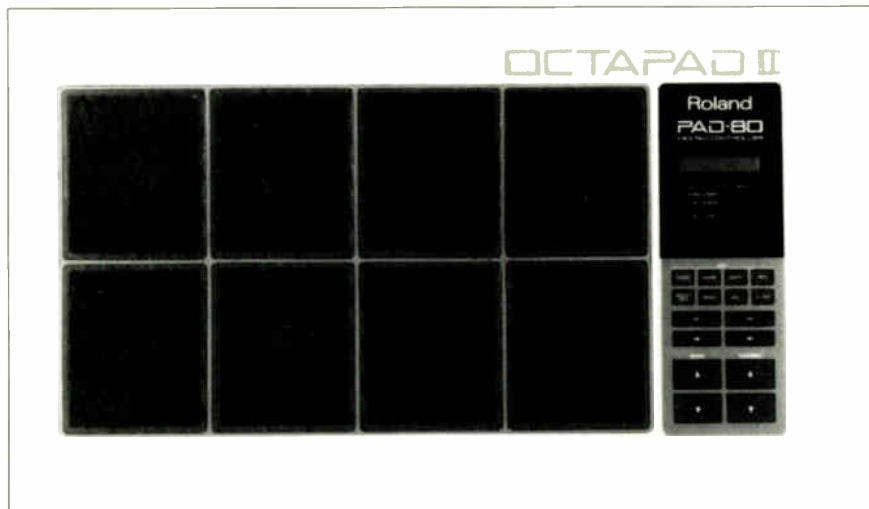

Roland Octapad II

that this market was being saturated by the influx of hundreds of thousands of DX7s, CZ-101s, D-50s, MIs and so on, and hoped to stake out new territory by getting guitarists, wind players, percussionists and others into the MIDI fold. This would not only open up a new market for controllers, but also stimulate sales of MIDI rack-mount expander modules, voicing software and other accessories. The numbers were impressive. The huge, untapped market of non-keyboard musicians was enough to make a marketing department salivate. Capturing even a fairly small percentage of those players would provide a much-needed new market, as well as some stability in the otherwise topsy-turvy, fashion-driven music market.

later ARP went out of business, and according to some people close to the company, the dismal failure of the Avatar was a big contributor. Thus the era of guitar synthesis was born, or perhaps I should say stillborn.

Price is another factor. A guitarist can spend \$1,500 and get an excellent guitar and amplifier. A top-of-the-line MIDI system based on a controller, like the G10, lists as follows: G10 (\$2,500), suitable multitimbral synth module (\$500 to \$2,000), new amplifier since guitar amps don't work all that well with synths (\$??) and MIDI paraphernalia such as cables. But it doesn't stop there. Patches for guitar synth have to be modified to accommodate both the player and controller, so not only does a guitarist have to spend a lot of money, but also has to deal with a MIDI implementation far more complex than that of a keyboard—and know enough about synthesis to at least customize existing patches.

**Thus,
the era of guitar
synthesis was born, or
perhaps I should say
stillborn.**

Alas, this was not to be. What went wrong?

From the beginning, keyboard players could relate to synths because the concept wasn't that far off from a conventional organ. Guitar synth never had a similar precedent in the world of guitar, and there were several problems, starting with the introduction of the ARP Avatar in the mid-'70s. Mer-

That's a tall order for someone who just wants to get into playing "synth guitar." What's more, a synth guitar requires a different, and far more finicky, playing technique that doesn't

Uniquely Markertek!

MARKERFOAM™ ACOUSTIC FOAM



**GIANT
54" x 54"
\$19.99
Per Sheet!!**

Blue
or
Grey

KILL NOISE QUICK! Soundproof studios, rehearsal spaces, vans, rooms with super-effective, E-Z mount, 2" thick studio gray or natural blue (specify color). Markerfoam offers outstanding sound absorption qualities. Immediate shipping. Add \$3.50 sheet shipping. NYS residents add 7% tax. MC/Visa/Amex COD-Check Terms. 3-inch sheets also available at \$29.99.

MARKERTEK BLADE TILES™

HIGH PERFORMANCE,
LOW, LOW COST!

\$2.99 per tile, 16 x 16 x 2"
America's best acoustic tile value,
only from Markertek! Specify blue
or grey. Also available 16x16x3"
as shown \$3.99 each



MARKERSTIK™ foam adhesive
Works with any standard caulking
gun. Mounts up to 50 square feet. \$3.80 per tube

**Get our FREE 120-page catalog of
over 3,000 exclusive and hard-to-
find supplies for audio & video.**

800-522-2025 America's most unique
(In NY 914-246-3036) catalog for audio & video!

MARKERTEK™
145 Ulster Ave., Saugerties
New York 12477 U.S.A. **VIDEO SUPPLY**

Circle #092 on Reader Service Card

ANNOUNCING THE BRYSTON TWENTY YEAR WARRANTY

For over a quarter-century Bryston has been committed to designing and producing audio products with reliability, musical accuracy and value as our primary focus. It is widely known that Bryston's policy on the warranty of our products has always been extremely generous if ever required. To further enhance our long term commitment Bryston is instituting a 20 year warranty program as of January 1st, 1990. This, as far as we know, is a first in our industry and as such will further demonstrate our continuing dedication to our customers.

We are able to offer this for several reasons. One is because we consider reliability to be exceedingly important. We have applied techniques and materials in our everyday construction of electronic equipment more



Bryston 10B electronic crossover

typically utilized in the military and aerospace industries. All components used in Bryston power amplifiers are specified for continuous duty at maximum power, with typical safety margins of 250%. Also, the power transistors used in all Bryston amplifiers are 100% tested for safe operating area, both before and after installation in the circuit. They are then taken to a "burn-in" table where they are given a

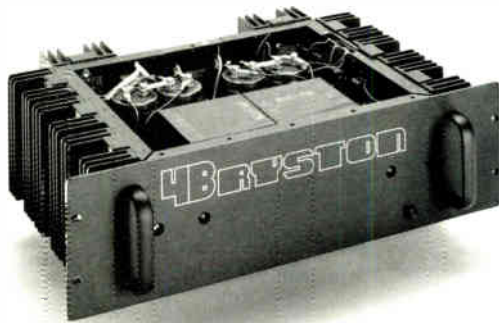

Bryston 4B amplifier
Power amplifiers range from 50-800 watts

capacitor load, a square-wave input signal, and set at slightly under clipping for a period of 100 hours. During this time, the input signal is cycled three hours on to one hour off, to exert additional thermal stress.

Following the burn-in period, the amplifiers are monitored for DC bias stability for approximately another full day. At this point, they are returned to the test bench for another complete checkout of all operating parameters and functions, at which time a test sheet is made, and included in the packing with the unit. At Bryston, we take very seriously the accurate functioning and long term reliability of our products.

This new twenty year warranty is also retroactive. It includes all audio products previously manufactured and sold under the Bryston name. This warranty is also fully transferable from first owner to any subsequent owners.

Bryston has always been dedicated to designing and producing products that deliver uncompromised performance, outstanding reliability and exceptional value. We believe our new 20 year warranty is one more example of our commitment.

Bryston Marketing Ltd.
Tel: (416) 746-0300 Fax: (416) 746-0308
Brystonvermont Ltd. Tel: 1-800-673-7899

produce anywhere near the degree of subtlety associated with a standard electric or acoustic guitar. And just for fun, every now and then a MIDI guitar will glitch itself into hyperspace. According to Murphy's Law, hyperspace will always be in the wrong key.

A further complication is the two divergent philosophies of guitar synths. In one camp, Roland, Zeta, Casio and several others believe that any guitar system should be based on a standard guitar and that the guitarist must be able to play conventionally as well as through MIDI on the same

instrument (and in the case of Roland, on the instrument the guitarist normally uses). The trade-off is that converting a conventional guitar signal to a glitch-free MIDI signal is a difficult task. The other camp (including Yamaha, Quantar, Stepp, Gibson and SynthAxe) has taken the approach of using a dedicated controller, which cannot be played like a conventional guitar (e.g., all the strings may be the same gauge, or the controller may not even use conventional strings). This can offer much better tracking, but sacrifices the great layered effects that can be obtained by playing synth and guitar together, as well as loses the

natural "feel" of the guitar.

Wind players face similar problems. Not being a wind player, I asked industry consultant and MIDI wind player Tim Tully for his take on why more wind players haven't gotten MIDI-fied. According to Tully, "The controllers are fine as far as they go, but there are problems with transducer technology, the MIDI standard itself and synthesizers. A reed instrument sounds as expressive as it does because it's controlled by the human vocal organs, whose muscles are extraordinarily flexible and sensitive. The interface a natural reed instrument provides between those organs and a sound-producing apparatus is sensitive to all these subtle gestures, which affect pitch, coloration and level. With a MIDI controller, you have a limited number of gestures feeding a limited number of synth parameters. Just controlling level with breath and opening a filter with lip pressure doesn't come close to capturing the nuances of an acoustic instrument.

"FM synthesis is capable of a great degree of expressiveness, but it would require multiple continuous controllers and a great deal of programming to get the same level of expressiveness. Also, people haven't been hip to programming synth patches that worked well with the gestures these devices could produce. As to why they've never taken off—to a horn player who isn't a techno-junkie—the first reaction is usually, 'It just doesn't feel like a horn.' The musicality you get by using those intimate speech organs is just not there."

Nonetheless, Tully still uses wind controllers a lot in his own work because he finds that "you do get a lot of additional timbres, and something like the WX7 is more expressive and easier for me to play than a keyboard."

MIDI guitar offers many of the same advantages to guitarists. You have access to more sounds, using an interface that more closely resembles a guitar than a keyboard. MIDI guitar opens the world of sequencers, notation and all those other MIDI goodies; despite the occasional quirks, I use MIDI guitar (Roland GM-70 and Yamaha G10) quite a bit. But I always stress to would-be MIDI guitarists that you have to realize you are not playing *guitar*; you are playing *synthesizer* through something that just happens to be a bit more guitar-like. Some people might actually find it easier

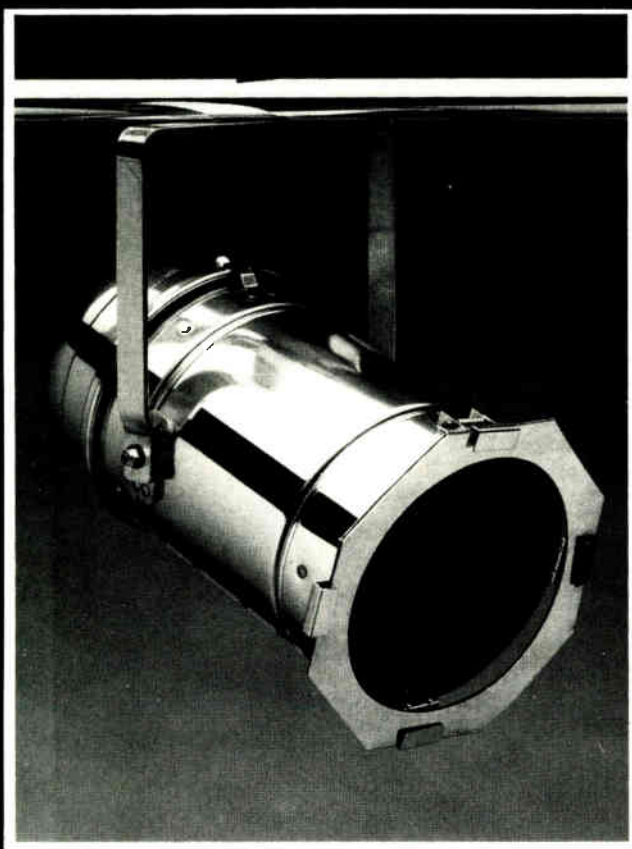

Stage Lighting Systems

Box Trussing • Ground Support

HEAD WATER

NEW JERSEY
(201) 423-4404

DETROIT
(313) 961-9111

HOUSTON
(713) 855-9227

LOS ANGELES
(805) 499-5932

CANADA
(519) 256-5665

Circle #093 on Reader Service Card

An interview with "Orbie," the Orban Dalmatian.

HOME: San Francisco, California

PROFESSION: Orban Products spokes-dog.
(Eat your heart out Spuds!)

AGE: 35 (that's 5 in human years).

QUOTE: "Orban has a passion for quality that is exceptional among companies today."

PROFILE: Reliable, versatile and technically outstanding (like Orban products).

ON ORBAN: "Orban maintains the highest technical standards and delivers the most thoughtfully engineered audio processors on the market. Reliable products, purpose-built and backed by great customer service. That's dogged perfection!"

FAVORITE PRODUCTS: "Compressor/Limiters, De-Essers, Stereo Synthesizers, Parametric Equalizers, Spatial Enhancers, Programmable Processors and of course, the OPTIMOD. The entire line is unsurpassed in quality."

FAVORITE SONG: "You Ain't Nothing but a Sound Dog."



orban

a division of AKG Acoustics, Inc.

1525 Alvarado Street
San Leandro, CA 94577 USA
Tel: (1)415/351-3500
FAX: (1)415/351-0500

LISTEN TO THE DIFFERENCE.

Compressor/Limiters, De-Essers, Stereo Synthesizers, Parametric Equalizers, Transmission Processors



Circle #018 on Reader Service Card

Any console with this much flexibility deserves a closer look.

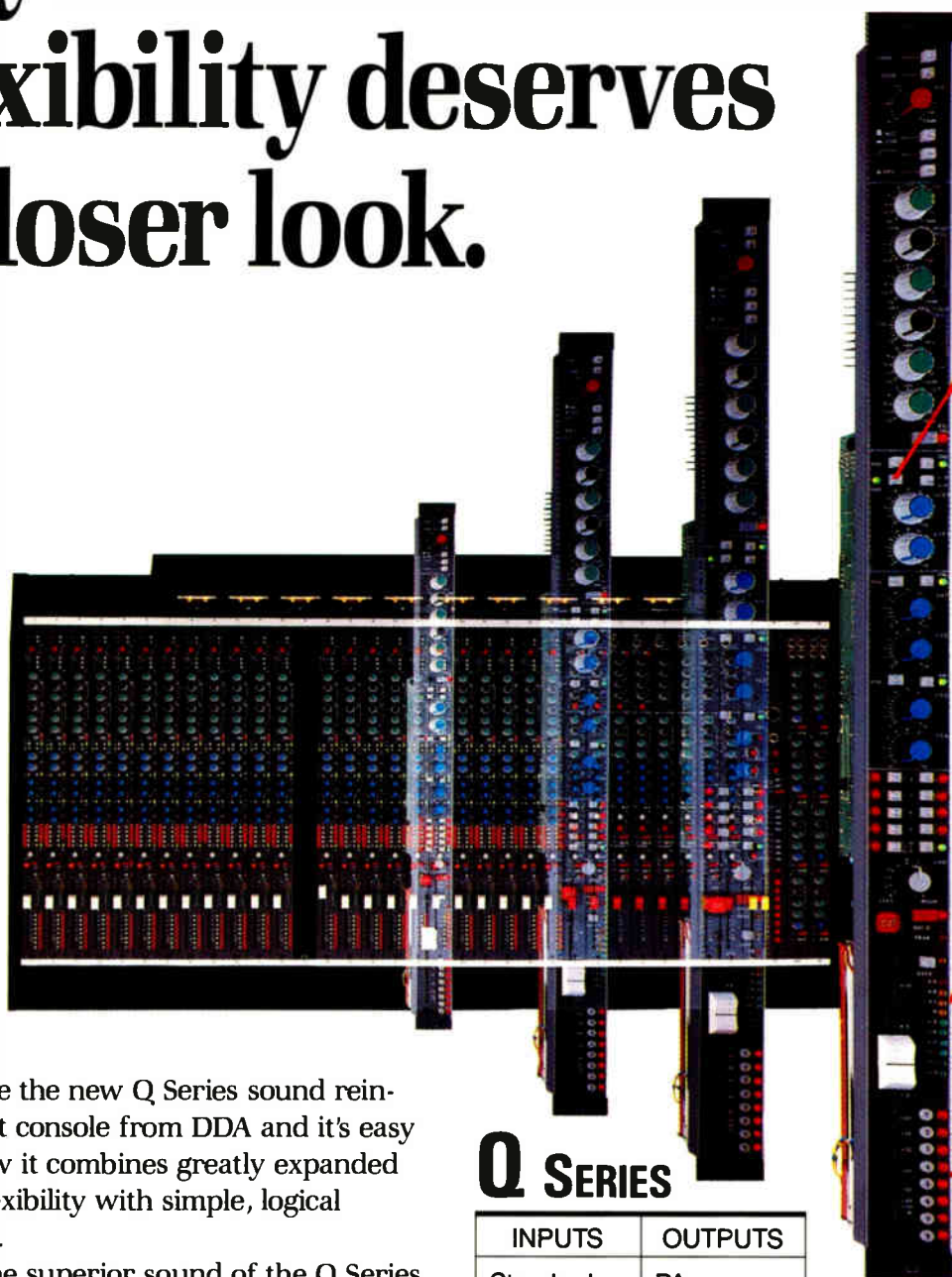

Q Series features a Direct Output with level control on every input, a unique design from DDA.

Q Series provides 8 Aux Buses from every input with 3-Band EQ on the Aux Master Sends.

Input Level Metering with a 10 segment L.E.D. indicator (Q-Mute Input version).

8 Mute Groups (Q-Mute Input Version).

Examine the new Q Series sound reinforcement console from DDA and it's easy to see how it combines greatly expanded mixing flexibility with simple, logical operation.

From the superior sound of the Q Series mic inputs to its versatile EQ section, every aspect of this powerful console reflects the quiet, transparent audio quality DDA is famous for. Immune to noise and hum at every stage, the Q Series offers sonic performance 20 dB quieter than the leading competitor.

All of the main inputs and outputs are electronically balanced with transformers

Q SERIES

INPUTS	OUTPUTS
Standard Mute	PA Matrix

Any Input can be used with either Output version.

optional. The Q-PA Output version features 3-stage Equalization on the Group Outputs. And the versatile Q-Matrix Output version includes 8 Group Outs, 4 Matrix Outs and 8 Aux Returns with EQ.

Q Series. So much flexibility, you can't help taking a closer look.



DDA: Exclusively distributed by Klark-Teknik Electronics Inc., 30B Banfi Plaza North, Farmingdale, NY 11735 Tel: (516) 249-3660 Fax: (516) 420-1863

Dearden Davies Associates Limited: Unit 1, Inwood Business Park, Whitton Road, Hounslow, Middlesex, TW3 2EB, England, Tel: (01) 570 7161 Fax: (01) 577 3677 Telex: 932905 LARCH G ATT.DDA 322

Circle #005 on Reader Service Card

(and more glitch-free) to play a MIDI-fied Chapman Stick than guitar if they're willing to make more of a conceptual leap.

We also must recognize that the problem lies not just with technology or manufacturers, by any means. In fact, Yamaha provided a great deal of support for G10, and Roland's GR-50 MIDI guitar is as close to "plug and

I sometimes think that conventional alternate controllers are analogous to trying to make a wind instrument by blowing real hard on piano strings to make them vibrate.

play" as you can get (as is the Yamaha WX11 wind controller). Those musicians who have taken the time and trouble to master these new tools have acquired new and exciting means of expression, but many musicians simply can't be bothered to expend the effort necessary to learn new ways of playing and thinking. That's a tough obstacle to overcome for any manufacturer or technology.

So where do we go from here? I see two main options. Option #1 is more of the same. The idea of making controllers that appeal to players other than keyboardists has such economic appeal that companies will continue to pursue the Holy Grail of perfected instrument-to-MIDI conversion. Option #2 is to make a controller from scratch that may or may not have anything to do with traditional musical instruments, but is instead optimized to interface with electronic music devices. I sometimes think that conventional alternate controllers are analogous to trying to make a wind instrument by using a piano and blowing real hard on the strings to make them vibrate. Obviously, hav-

ing a cavity that you blow into is a better approach; there are probably several great ways to trigger electronic devices that nobody has thought of yet. Not that people aren't trying.

Robert Moog has done a lot of work with controllers (starting with Theremins and ribbon controllers a couple of decades ago), but most of these have never been mass-produced. Don Buchla has favored alternate controllers from his earliest instruments. His most recent controller, Thunder, looks very promising from an ergonomic standpoint. Meanwhile, Atari has released the Hotz Translator, an alternate controller that also represents a

fundamental rethinking of how to trigger electronic sounds from a non-traditional control surface. Whether these two latest entries become The New Standard or another footnote in the history of musical electronics is yet to be determined. But one of these days, someone will invent a controller that takes to electronics as comfortably as a guitar takes to strings. When that happens, look out. ■

Craig Anderton currently divides his time between writing books, recording, consulting to musical equipment manufacturers, and giving seminars in the U.S. and Europe.

Discover The Secret Of The Pyramids.

We've discovered a new acoustical foam that outperforms any we've ever seen (or ever sold).

AZONIC Acoustical Foam.

The secret is in its unique pyramid design.

Performance. AZONIC Pyramids have a superior ability to absorb low-end ambient noise. No other product can compare.

Pattern. AZONIC Pyramids' uniform pattern means easy matching for an attractive installation. Other products require random matching.

Packaging. All AZONIC products are UPS shippable. Others aren't.

Alpha Audio has discovered the secret of the pyramids. And we're impressed. That's why we now offer AZONIC Acoustical Foams to our customers. Call us. We'll gladly send you a brochure and a free sample.

Call 1-800-782-5742.

Alpha Audio 
Acoustics

2049 West Broad Street
Richmond, Virginia 23220-2075

WHAT WE DID FOR AN ENCORE.

Improving on the original H3000 Ultra-Harmonizer—the most successful Harmonizer® in Eventide's history—wasn't easy. But the new H3000SE Studio Enhanced Ultra-Harmonizer already has leading audio professionals shouting "Bravo!"

The first H3000 produced its impressive variety of effects with 11 algorithms. Now the H3000SE adds eight stunning new ones—the classic Instant Phaser®, imaginative ear-openers like Band Delay, Stutter (instant rap!), String Modeller and Patch Factory, plus smooth, natural Reverb II, a linear predictive Vocoder and MultiShift, the world's first six-octave multi-interval pitch shifter. No wonder engineers and producers are raving about the 200 factory presets. Especially since Ultra-Harmonizer audio quality stands out even among other 16 bit digital devices.

Audio explorers are also applauding the new *Function Generator* that lets you program autopanning, arpeggios, sweeping flangers, randomized vocal doublers and much more. And *Soft Functions* that lets you customize your own H3000SE front panel to get the precise sound you need faster and easier. You can even add Eventide's exciting new HS322 Internal Sampling Board—it gives any H3000 up to 23.7 seconds of 16 bit, 44.1 kHz sampling at a breakthrough price. If you already own an H3000, you can add the new SE capabilities with a conversion kit. If you don't, you're trying to do your best work without one of the most powerful audio production tools ever developed. So visit your Eventide dealer and hear how much our encore can do to enhance your performance.

Eventide

One Alsan Way • Little Ferry, NJ 07643
TEL: 201-641-1200 • FAX: 201-641-1640

TEC
TECHNICAL EXCELLENCE & CREATIVITY
1990
NOMINEE



Circle #048 on Reader Service Card
World Radio History

bar graph meters with peak hold, and parallel and serial control ports. Options include the RC-424 full-function remote controls.

Flagships of Tascam's ATR-60 line are the ATR-60-16, a 1-inch 16-track priced at \$15,999 and the ATR-60-8, a 1/2-inch 8-track retailing for \$6,000. Both of these console-mounted machines feature active balanced XLR-type inputs/outputs, 7.5 or 15 ips operation, 10.5-inch reel capacity, and dual pitch controls with separate (coarse) $\pm 15\%$ and (fine) $\pm 0.7\%$ adjustments. The optional AQ-65 autolocator has nine memory locations and full transport controls.

The MS-16 (\$8,999) is a 1-inch 16-track in a rack-mount configuration. Features include: 10.5-inch reel capacity, 15 ips tape speed, separate coarse and fine pitch controls, and both RCA unbalanced and XLR balanced line inputs and outputs. Options include: the AQ-65 autolocator, dbx noise reduction, a remote transport control, and a roll-around console and overbridge meter mount.

Tascam's MSR-16 (\$7,499) is a 1/2-inch 16-track that shares a common transport design with the MSR-24 24-track recorder. The rack-mount MSR-16 operates at 7.5 or 15 ips, with $\pm 15\%$ pitch control. Other features include: 10.5-inch reel capacity, unbalanced RCA line inputs/outputs, two autolocation points and internal dbx Type 1 noise reduction (switchable). Serial and accessory ports allow use of the unit with external synchronizers, such as Tascam's MIDiiZER and ES-50/ES-51. The TSR-8 (\$3,499) is similar to the MSR-16, but offers eight tracks on 1/2-inch tape at a fixed, 15 ips speed with $\pm 12\%$ pitch control.

In the 1/4-inch 4-track genre, Tascam offers several choices. The 44-OB (\$4,349) has 7.5 or 15 ips tape speeds, with $\pm 12\%$ pitch shift, return-to-zero and search-to-cue location, unbalanced RCA or balanced XLR-type line inputs and outputs, and a 10.5-inch reel capacity. Also offering 10.5-inch reel capacity is the Model 34 (\$2,199), which features 7.5/15 ips operation, headphone jack, unbalanced RCA line inputs/outputs, 1/4-inch microphone inputs with -20dB attenuators, return-to-zero and $\pm 12\%$ pitch control. The 22-4 (\$1,649) is a two-speed (7.5/15 ips), 7-inch reel capacity recorder with RCA-type line inputs/outputs. ■

IMPERIAL TAPE Company, Inc.

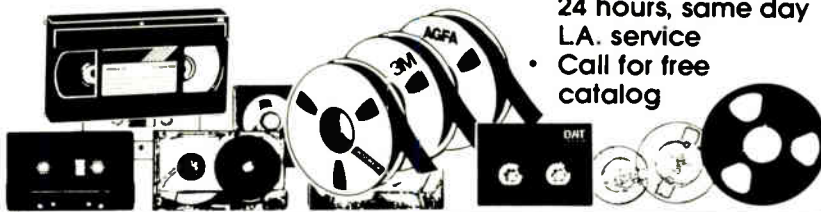

- Manufacturers of custom length blank audio and video cassettes
- Top quality audio and video cassette duplication
- Shipment within 24 hours, same day L.A. service
- Call for free catalog

Service · Quality · Integrity

Nation's Leading Authorized Distributor
AGFA AMPEX 3M MAXELL TDK BASF

1 · 800 · 736 · 8273

FAX 213 · 395 · 8255

213 - 393 - 7131

1014 Broadway, Santa Monica, CA 90401

Circle #114 on Reader Service Card

M-1

MICROPHONE PREAMPLIFIER

SUPERIOR SOUND QUALITY. RE-DISCOVER YOUR MICROPHONES!

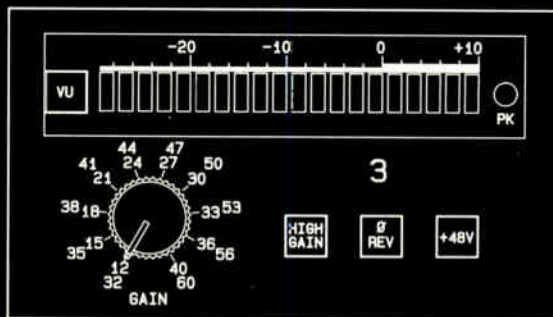

(ACTUAL SIZE)

- THE BEST JENSEN INPUT TRANSFORMER: THE JE-16-B.
- THE BEST OP-AMP: THE 990 DISCRETE OP-AMP.
- DC-SERVO ELIMINATES ALL COUPLING CAPACITORS.
- THE BEST JENSEN OUTPUT TRANSFORMER OPTION: THE JE-11-BM.

- ILLUMINATED SWITCH BUTTONS.
- TOROIDAL POWER TRANSFORMER.
- UNIVERSAL POWER SUPPLY.



- XLR CONNECTORS. GOLD OPTIONAL.
- TWO METER OPTIONS. VU-1 SHOWN.
- CUSTOM KNOB & PUSH BUTTONS.

THE JOHN HARDY COMPANY

P.O. Box AA631
Evanston, IL 60204

(708) 864-8060

Telex: 910-380-4670
(JOHN HARDY CO)

Circle #115 on Reader Service Card

by Philip De Lancie

DAT AND CD-R

VIABLE FORMATS FOR CD MASTERS?

When tape recorders replaced cutting lathes in recording studios, the need arose for a place to transfer master recordings to the formats used by manufacturers in making products for consumers. In the days when phonograph records were king, this transfer function required a lacquer cutting system. But today, with vinyl in decline, what's really needed is the Sony PCM-1630/DMR-4000 combination for recording CD "pre-masters." The 1630's dominance in this area has been virtually complete since the CD first emerged, but new possibilities have recently arisen that may eventually break the 1630's hold.

The first and most obvious challenge to the 1630 comes from DAT. With agreement imminent on

a SMPTE time code standard for the format, the cost barrier to acquiring truly professional digital recording capability will soon evaporate. On first thought, that might be seen as bad news for mastering houses, because recording studios that had been previously inclined to let someone else pay big bucks for a 1630 system might now be tempted to make their own CD masters on DAT. The world would be awash with studios expanding their services into the mastering business, and traditional mastering houses would be reeling from the one-two punch of lacquer's demise and increased CD-prep competition.

The above scenario is flawed because the cost of a 1630 setup, though extremely high for a stereo recorder, isn't enough to explain the fact that there hasn't already been a stampede of studios onto mastering turf.

It continues to have their hands full with new product and reissues in up to three release formats.

It's not merely the fact of owning a lathe, a 1630 or any other transfer device that has set mastering houses apart and kept them viable as independent entities. It's the expertise they've developed by specializing in the integration of individual selections into a unified whole. Clients bring their projects to mastering engineers for a combination of fresh and objective ears, experience in stereo program enhancement (as contrasted with enhancement of individual instruments in a mix) and familiarity with the requirements of each release format and the plants that manufacture them. DAT with time code might lower the ante for would-be competitors, but existing houses whose efforts have added to their clients' success should continue to thrive.

Instead of being a threat, what SMPTE-capable DAT could do for the mastering business is to lower the capital costs of expansion. At the same time, if it proves feasible as a CD mastering format, it might open the door for other formats as well. That brings up the possibility of using a recordable CD setup, such as that introduced by Sonic Solutions and Start Lab (see "Tape & Disc News," June 1990), to make CD masters. The cost of such a system becomes far more palatable if it can be used to record not only reference discs, but masters too. But are DATs and CD-Rs readily adaptable to the working environment and procedures of CD plant cutting rooms? Will replicators be willing to cut their glass masters from these alternative for-



While the Sony PCM-1630 digital audio processor is the worldwide standard for CD master tapes, new technologies—such as DAT with time code—may be a viable alternative to this format in the future.

ignores the reasons for which independent mastering houses developed their current place in the record industry. The demand for such facilities arose even though most pressing plants already offered in-house cutting services. Despite the tapering off of demand for lacquers, mastering engineers

mats instead of 1630 tapes? Or are there technical factors that preclude their consideration for use as cutting masters? To find out, I posed some basic questions to cutting room supervisors at three domestic replicating facilities.

Mix: What is technically required of a digital recording format in order for it to serve as a master from which glass CD masters may be cut?

Allan Hardigree, associate engineer, Denon Digital Industries, Madison, Ga.: It must have SMPTE time code available for one minute before the beginning of the first track. It must record and play back at 44.1kHz sampling rate. The hardware must have an SDIF output to interface with our encoding equipment. And since we have no control over errors that are present at that point, we have to be able to verify that the data being delivered to the encoder is accurate. So whatever playback format we use, we would have to have the same degree of connections with our control computer that we have using the 1630 to feel confident we are recording good data. There would have to be some handshaking going on. It would also have to have a transport control mechanism compatible with the control computer so the computer can tell it when to start and when to stop.

Right now we run the DMR-4000 in remote control, so it is not operator-dependent. The computer rewinds the tape to the beginning and puts the machine in standby mode. When the proper position is reached on the cutting machine, it starts the tape. As far as P&Q subcode editing, some plants are set up to work with P&Q encoding on audio track 1 of the 1630. But we don't use that track on the tape. Instead, we store it on a floppy disk, which travels with the master to the mastering room. There the information is loaded into the control computer and preverified before we begin cutting the glass. During cutting, the computer watches the time code. When the proper time codes occur, the proper P&Q codes are

inserted.

Tom Sweeney, CD mastering technologist, Specialty Records, Olyphant, Pa.: It would need a time code track free of any jumps. It would probably have to have an A>B confirming head set-up for error checking. We need SDIF ins and outs. The way we are set up right now, there would have to be an audio channel for PQ codes, which go on in table of contents in the first 30 seconds of the tape. And you would definitely have to have some kind of error-checking device like the DTA-2000, with hard copy for verification, or else you are going to be recording errors onto the disc without knowing it.

Chris Formato, manager of mastering and electroplating, U.S. Optical, Sanford, Maine: We would need a format that has time code on it and has a provision to store cue codes. Error-checking would have to be incorporated in some way. All machine functions would need to be remote-controllable. That includes insert editing, because our Philips subcode processor allows us to add text information to the subcode like titles, client and mastering date. That information never gets to disc, but we can store it on tape on channel 1 with the system we have right now. As far as interfacing goes, we would need to have SDIF.

Mix: Are there things about the Sony PCM-1630 format that make it particularly well-suited to be the CD mastering source format? And what, if any, are its drawbacks?

Hardigree: A large part of the reason the 1610/1630 is used is that that's what Sony came up with first. One nice thing about the 1630 is that when we play a tape back we can have a high degree of confidence that we won't have a problem with errors. We run it in read-after-read mode, so errors are corrected before they reach the cutting equipment. And our control computer is set up to monitor the 1630 and duplicate the functions of the DTA-2000. It watches for those flags that occur when data is not readable by either the A or the B head. So if we

The Alternative Music Library!

Call for our Compact Disc Demo

800-227-1954

212-333-5766

FAX

212-262-0814



MANHATTAN

PRODUCTION MUSIC

P.O. Box 1268, Radio City Station
New York, New York 10101

Circle #116 on Reader Service Card

CASSETTE INSERTS IN



DAYS

CS Printing

111 Oak Lawn Ave.
Dallas, Texas 75207

(214) 747-8705

FAX: (214) 748-9922

Circle #117 on Reader Service Card

have an "Average," "Hold" or "Mute," we know it, and we have a print-out that tells us what happened. If we used some other equipment that does not have the 1630's level of integrity of error-correction, we would have a higher risk factor. The 1630 is also a very rugged device. We've never had a unit fail. It works day and night without causing any problems. We haven't had mechanical problems with the 1630 tapes either, to any great degree. But the tape life is fairly limited. Four or five years is the limit, and that's for tapes that have been kept in a temperature- and humidity-controlled room. Beyond that, I wouldn't have any confidence that a tape is going to play. For archiving the music, the CD itself is probably the best device.

Sweeney: The advantage of sticking with the 1630 is that right now there is one accepted standard, so everything is compatible. That's what the studios give us, and that's what we're geared up for. And as far as I know the 1630 is superior.

Instead of being a threat, SMPTE-capable DAT could lower the capital costs of expansion for the mastering business.

Ours is part of a turnkey system that has been tested for performance and longevity, so we're sure that all the components work well together. We did have problems with some 1630 tapes before we instituted our pre-mastering studio. Now the tapes are all screened before they reach the actual cutting stage. We do find some damaged tapes and tapes with high errors.

Formato: As far as I'm concerned, the 1610/1630 format is used because that's all there was. But if we are looking just at the process of transferring the signal to the cutter, then I'd say that the tape-based system

works well. We've only had a handful of instances where we've had to ask that a tape be replaced.

Mix: Both the DASH and ProDigi open-reel digital 2-track machines were designed with the requisite features for CD mastering, but 1630 remains the format of choice for that purpose. What are the reasons that the others haven't really been accepted?

Hardigree: The obvious reason is the handling of the tape. A cassette format is much more convenient. It's quicker and easier to load. You don't have to take the time to cue up the tape, and you don't have tape running off the end of the reel.

Sweeney: Convenience is the biggest thing. It's nice to have the complete package to just throw in the DMR. And with an open-reel there is always the possibility of edge damage.

Formato: One reason is the size of those machines. You can just mount a DMR-1000 right into a rack, versus having a tape machine that you have to thread up

—CONTINUED ON PAGE 157

in 1972 apex invented and introduced the first two sided automatic on-cassette printer which has printed billions of cassettes and is still in production today !!

in 1990 apex is happy to introduce a new version of their incredible on-cassette printer incorporating new technology never seen before !!!

The new CA-20.

- fully automatic 2-sided printer
- 100/min.
- auto infeed
- auto restacker

FOR LESS THAN \$20,000.

FOR FURTHER INFORMATION PLEASE CALL BOB CONINGSBY
apex machine company

3000 n.e. 12th terrace • ft. lauderdale, fl 33334 usa
phone: 305-565-apex • fax: 305-563-2844 • telex: 271601 apex ur

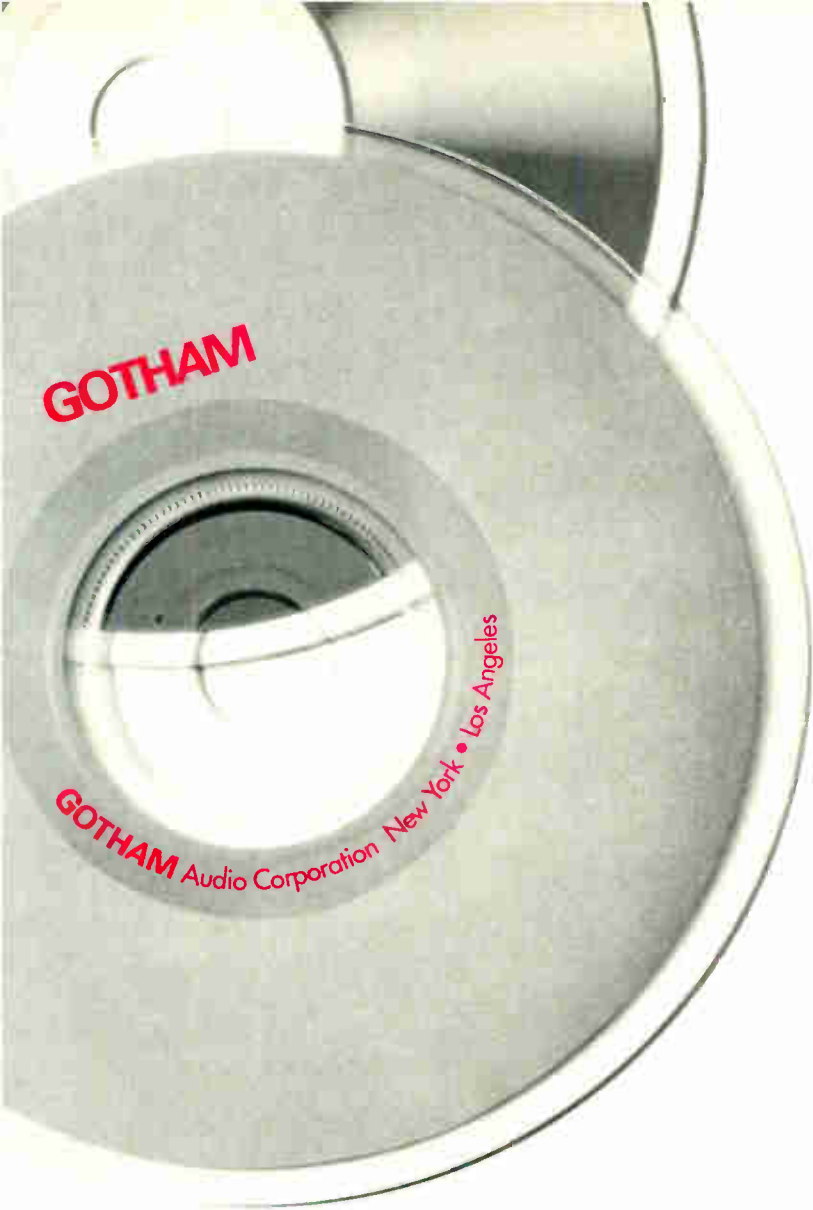

CDR 90

**dazzling
performance**

Recordable CD is now a reality! Our CDR 90 is a complete system made possible by advanced technology from companies like Yamaha, Dell Computer, Harmonia Mundi Acustica and Fuji Film. CDR 90 systems are already in daily operation at major studios cutting reference disks for producers, artists and broadcasters. The applications are mind-boggling. . . the price is surprisingly affordable. . . and delivery is immediate. Phone us now about the details.

GOTHAM
AUDIO CORPORATION

TEC
TECHNICAL EXCELLENCE & CREATIVITY™
1990
NOMINEE

1790 Broadway, New York, NY 10019
New York • 212/765-3410 Los Angeles • 818/785-2211 FAX • 212/265-8459

STUDENTS



THE AES

With the seemingly overwhelming demands of a full academic workload, and a typically hectic class schedule determining the events of their daily life, how can audio engineering students find time to travel to four-day audio conventions, or even drive across town to attend local AES meetings? Not very easily.

The AES recognizes the time and scheduling restrictions of its student members and encourages the formation of local AES student chapters. Local AES chapter activities typically include: guest lecturers discussing current developments in their areas of expertise; field trips to audio production and audio manufacturing facilities; and hands-on workshops, where industry professionals demonstrate modern production techniques and manufacturers demonstrate recent technologies. The only visible differences between a student chapter meeting and a regular local meeting are the worn-out backpacks and lecture rooms with permanently affixed chalkboards.

b y G u y D e F a z i o



PHOTO: BILL SCHWOB

The incentive for audio production facilities to host AES tours is obvious. The average meeting turnout of approximately 50 to 60 members of the local audio community represents a healthy group of potential clients. Likewise, the opportunity for manufacturers to present their newest products facilitates greater product awareness among present and future customers.

That same incentive applies to student chapters. Students are industry professionals in training. They represent informed future clients and customers from all over the country, enabling broader national recognition for the participating local manufacturers and facilities.

The AES is a non-profit organization whose purpose is to meet the needs of its members and the industry. By supporting student chapters, the AES is not only encouraging continued communication in the audio industry, but it is also establishing "farm clubs" of future AES members. Historically, student members will upgrade to full members once they've become working professionals.

The first step to becoming an AES student member is to be enrolled currently in a recognized school, college or university for a course of academic or practical training in science, technology, audio engineering or its allied disciplines (music, acoustics, broadcast, film, video, etc.). The next step is to submit an AES membership application. The student application dues are \$30

(\$60 for full members) per year. Student applicants must include a reference (preferably two) from a faculty member or administrator who can attest to their student status and curriculum.

Student AES members are entitled to all rights and privileges of the society except the right to vote, hold office or serve on a standing committee. However, students are eligible to serve on committees in their student chapter. In fact, serving on the executive committee of a student chapter is an excellent opportunity for student members to work directly with national officers.

The first and most important step toward organizing an AES student chapter is the appointment of a faculty member or administrator to act as an ongoing adviser. This faculty adviser assists the student AES executives, helps organize on-campus events and equipment rentals, and serves as liaison between the local student chapter and the society. Additionally, as new student AES executive committees come and go with each graduating class, the faculty adviser helps maintain continuity.

The organization of an AES student chapter is identical to that of all other national and international AES chapters. The elected representatives of the executive committee, consisting of a chairman, vice chairman, secretary, treasurer and several committee members, organize events that meet the needs of their chapter.

—CONTINUED ON PAGE 180



Students
are industry
professionals in
training. They
represent
informed
future clients
and customers.



by Dan Daley

HIGH TOPS SHOWS HIGH-TECH

THE NEW MIDDLE-CLASS PROJECT STUDIO

The scuffy sneakers in High Tops Music House's logo might readily bring up images of a recording environment for NRBQ or a Joey Ramone Christmas card. Actually, they're high irony. As project studios go, High Tops is high-tech.

Dennis Michaels, High Tops' founder and creative director, opened the production house a little over a year ago in the SoHo loft he and his wife have occupied for more than a decade. A guitarist who soured on the reptilian Manhattan bar band scene, Michaels wanted to pursue the lucrative but

exigencies of the jingle field, then providing them with modems, software and access to a Proteus/1. Each



tightly knit commercial and industrial music field. He purchased some advanced yet affordable technology and then went one step further. He cast about for a way to attract a consistent pool of talent without having salaries drain start-up capital.

Michaels hit upon the idea of setting up contracts with a group of talented writers, initiating them to the

of the five writers continues to work at home, but they receive their projects via modem; in the same way, drafts are sent back to Michaels for client approval and changes. Then the writers can finish the projects themselves or send the sequence and sound information among themselves for finishing, all over phone lines.

"I may have one writer doing most of the work on a project," Michaels explains. "Then I might decide that another could do the bass part better, so I send it to him over the modem. A number of writers can have input on a given project, all bringing to it what they do best."

High Tops is, then, less a studio than an electronic hub. Phone lines connect satellite writers in a two-way web with more interconnection pos-

Above: Looking from the voice-over room into the control room. Left: High Tops founder Dennis Michaels at the helm.

sibilites than a 300-point patch bay. Clients this year for the fledgling operation include Aramis and Getty Petroleum.

Michaels built the High Tops space himself with fine-tuning by local acoustics maven Al Fierstein. Taking up about one-third of the loft's 4,000 square feet, the physical studio is made up of a small iso booth facing onto a control room, which is the leg of the L-shaped office. Voice talent in the booth can gaze through the large windows of the office/control room out to the spectacularly ornate loft building across Broome Street, 11 floors below. "That's one of the aspects of this space that attracts people," says Michaels. "The sense of light and space has a good effect on people's attitudes and creativity."

In terms of hardware, an Akai MG1212 combination 12-track recorder/console sits on a desk. Mixdowns are done to a Revox PR99 2-track. The computer is an Atari. Outboard is minimal: a Yamaha SPX90 and a Symetrix compressor among the sparse rack. An Emax is used for keyboard and sampling work. The critical pieces, according to Michaels, are the Proteus/1 rack-mount unit and the Creator/Notator software program, standard issue to High Tops writers. "Proteus is more powerful than people are aware of," Michaels says. "This is the key tool that makes the technology accessible and inexpensive. Its multitimbral capabilities mean we don't have to have racks and racks of sound modules, and each writer has access to the same sounds, making the communication aspect easier." The Creator/Notator software package allows users to simultaneously load the music program and the Flash communications program that High Tops uses during modem sessions.

The spartan interior of the studio reflects its creator's belief that the '90s will be considerably stripped down compared with the preceding decade. "The '80s were a fat decade, like the junk bonds that characterized them," Michaels says. "The '90s will be slimmed back. Agencies like Saatchi & Saatchi are moving into this neighborhood [on nearby Hudson Street]. The era of the agencies all on Madison Avenue is changing, and they're cutting back on their staffs and expenses."

High Tops' approach, he claims, dovetails with the expediencies of the new decade. With modems, he can offer a wide range of talent on a real-time basis without the overhead of a staff. Further, while High Tops' five writers—Chris Thall, Paul Morris, Chris Haynes, Maurice Minchino and Dave Smith—are spread out over Manhattan, Queens, New Jersey and Westchester, he envisions eventually contracting with writers in Los Angeles and Chicago via modem, offering advertising and industrial clients a national talent pool.

"It doesn't have to cost as much as it has cost [to do commercials in the past]," he says. "There's always been so much fat at the agencies; and, like the stock market, it reaches a point where it can't go anywhere but down. Technology will make it happen; talent is the key."

Michaels uses traditional commercial multitrack recording studios on some of the larger-budget finals, but they're the last link in the process and serve little of the creative aspect. He generally goes in with a disk and simply downloads sound to tape. "I'm not trying to compete with them," he explains. "It's just a lot of what they offer isn't as necessary as it once was." His future plans for High Tops include a Dyaxis 2+2 disk-based recording system, reflecting his feeling that tape is a doomed medium on the front lines. "For \$31,000 I can have an hour of recording time on disk," he says.

Michaels says the future bodes well for musicians in the field, as well as the new approach studios like his are taking. Smaller, more prolific creative enterprises will spread the work around. And the fear that home recording will turn us into a community of technological bookkeepers working in sterile environments out of touch with each other is displaced, he counters, with the interaction offered by modem connections. "There's something great about bringing musicians together again," he sighs. "We've gotten lost into our own little environments. I want us to get back to communicating, and the only way to do that is through technology." ■

Dan Daley is a Mix contributing editor. He disclaims any intentions of world domination; all he wants is the Ruhr Valley, the Polish Corridor and a small piece of Austria.



600 KILLER EFFECTS PROGRAMS

The A3 is the only affordable all digital multi-effects processor you can update with new effects. And new multi-effects programs.

Combine the A3's 100 on-board programs with the five new A3 cards from the Korg Sound & Program Library. That's over 70 different effects and 600 multi-effects programs. The possibilities are endless.

Write to us for more information on the A3 multi-effects processor and cards at:

Department A31,
Korg USA, 89 Frost St.,
Westbury, NY 11590.

KORG®

© KORG USA 1990

Circle #071 on Reader Service Card

Fostex RM Monitors Leave No Room For Error.

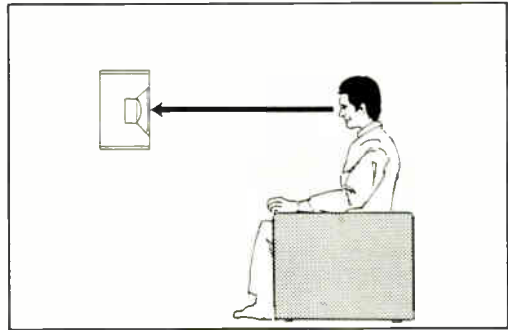
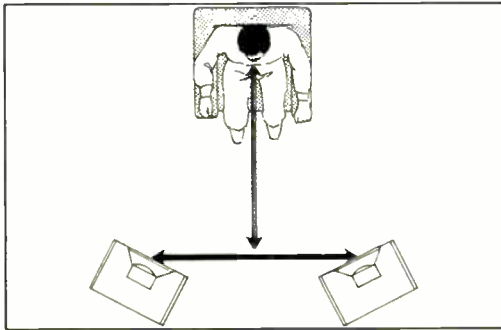

Fostex RM monitors are significantly more directional than almost all other near-field designs. RMs eliminate those confusing reflections in the listening room so effectively that you maintain a crystal clear sonic picture at all times.

The RM high directional design is a true coaxial point-source reference. All the sound reaches your ears at the same time, just like in nature. Thus RMs are working tools for those who work with sound. They are especially good for mixing because what you hear is what you get.

Now you can end the frustration of mixing something in the studio and hearing it sound different on home and car systems or in other studios. The mix you create on your RMs will sound proportionally the same on all other playback systems.

Our patented ribbon technology is so precise we had to provide a control for what is called the "boundary effect"--where accurate speakers exhibit different characteristics in a free-standing field [4 pi steradian] vs. a wall/soffit mount [2 pi steradian].

RMs are designed for the classic listening arrangement: placed the same distance apart as from the center point to the listening area or "sweet spot", with our drivers and your ears on the same horizontal plane.

In fact, a good test of correct placement is to sit down after arranging a pair of RMs as shown above. Listen for a few minutes, repeat the program material and after 30 seconds, stand up.

The sound changes radically because your ears are now out of position. Try this simple, effective test with other so-called near-field monitors. Then ask yourself this musical question: "Who's kidding whom?"

So listen to a pair of Fostex RM monitors--one of our three models will best suit your application. A neutral, accurate reference you can rely on, leaving no room for error.



RM-800

6.5" Woofer
Patented
RP Tweeter

RM-900

8" Woofer
Patented
RP Tweeter

RM-1000

12" Woofer
Patented
LSA* Tweeter
*Large Surface Area

Fostex®

© 1990 Fostex Corporation of America, 15431 Blackburn Ave., Norwalk, CA 90650

—CONTINUED FROM PAGE 150, DAT

every time sitting next to all your other equipment.

Mix: Do you feel that DAT could be an acceptable alternative to 1630 once a SMPTE time code standard for the format is finalized?

Hardigree: From what I know about it now, I don't see why not. We've talked about it internally here at the plant, and I think the day is coming when we will see DAT. I don't see any large obstacle that couldn't be overcome, though I haven't really had enough experience with the error-correction capability to be sure on that. A provision I read from Sony allows a DAT machine to be connected to a 1630 decoder, using AES or some other interface. Then it would simply be a matter of plugging in the DAT, and all the error-monitoring is taken care of. Apparently, there is also a device available from Sony as an extension of the interface on the 2500 Pro DAT machine that logs error rates. So there is movement in that direction. If they provided us with something that has the same plugs, we could just slide it in the rack and replace—or supplement—the DMR 4000/1630 combination. You could just flip a switch and go to either format. For one thing, DAT would be much easier to store. We've done over 6,700 albums, and we've got several rooms filled with tapes. As far as degradation over time, DAT might not be any better, but I don't think it would be any worse than what we are running into with the 1630 tapes.

Sweeney: I wouldn't see any objection to DAT once there is standardization. It's the same theory as the 1630. As long as you have that pure digital information on tape, and you've got something correcting the errors, it's going to be the same output as a 1630.

Formato: Yes. I think DAT could be used, if you can control all the remote functions on the player. A lot of our clients are really interested in giving us DATs. You would have to be sure that the music on the DAT doesn't begin until a minute or two into the tape. Then you could store the cue codes at the head on either of the digital audio channels, recording it through the

analog inputs and retrieving it through the analog outs. There is no requirement that the space on tape for cue codes is available once the actual program starts.

Mix: WORM CD recording systems are available from both Start Lab through Sonic Solutions, and Yamaha, through Gotham Audio. Would a WORM CD make an acceptable source for glass master cutting?

Hardigree: It could, but the equipment I've seen would have to be modified to be able to read the lead-in area of the disc and verify time code prior to the start of music. We encode approximately three minutes of information prior to the first track, and I don't know if that is also done on these WORM drives. We've got to have time code at least 15 seconds before the first cue point. But the CD cues up right to the first cue point, and you would have some disagreement in your time code, possibly several frames, even if the machine started when a remote-control device told it to. I can see some problems there, but nothing insurmountable. Even if WORM recording isn't being done exactly the way we need it right now, it certainly could be.

Sweeney: In the future, yes. It would be beneficial, because you wouldn't have the problems of edge damage or other physical damage that can't be corrected. The CD players are capable of playing just about anything. So it would definitely be a superior format, but it would be a matter of gearing up for the hardware to accept that incoming format. It would have to interface with the rest of our electronics through IC communication to the mainframe.

Formato: We could cut from CDs, if the player had digital outputs and could interface with the Philips control rack. The Philips is going to want to see the table of contents to dump into its processor, and if you could shuttle through the lead-in, and it was formatted to be Red Book-compatible, you could get that off the disc. So yes, I can foresee eventually being able to do that. ■

Tape & Disc editor Philip De Lancie is a mastering engineer at Fantasy Studios in Berkeley, Calif.



600 KILLER EFFECTS PROGRAMS

The A3 is the only affordable all digital multi-effects processor you can update with new effects. And new multi-effects programs.

Combine the A3's 100 on-board programs with the five new A3 cards from the Korg Sound & Program Library. That's over 70 different effects and 600 multi-effects programs. The possibilities are endless.

Write to us for more information on the A3 multi-effects processor and cards at:

Department A31,
Korg USA, 89 Frost St.,
Westbury, NY 11590.

KORG®

© KORG USA 1990

by Philip De Lancie

TAPE & DISC NEWS

E Media's CD RackPack offers an innovative solution to the CD packaging dilemma, while providing storage for up to 18 discs.



In the wake of Earth Day, worldwide awareness of our planet's precarious environmental condition has been heightened. In developed countries, overpackaging contributes to both resource waste and refuse disposal problems. The U.S. has the unfortunate distinction of being the sole remaining nation in which CDs are sold in packages that, at 6 x 12 inches, are more than twice the size of the product they enclose. Record companies blame the practice on retailers, who claim the larger packaging is needed to discourage shoplifting. According to *Billboard*, some companies, including Elektra, Warner Bros. and Rykodisc, have responded to the problem by using recycled paperboard for their longboxes. Other major labels have made token gestures of concern, issuing a few releases incorporating recycled materials, but usually only at the insistence of eco-minded artists.

Now E Media of Kennebunkport, Maine, has come up with an idea to minimize the disposable content of CD packaging. The CD

RackPack is a rigid plastic (recycled and recyclable) rectangular frame, the same size as a longbox, into which one or two jewel-boxed CDs may be snapped. In retail, the shrink-wrapped package allows easy viewing of jewel box insert graphics on both sides and fits standard display bins. At home, removal of the purchased CD leaves a rack into which up to 18 CDs may be inserted for storage and flip-through viewing. The company is promoting the combination of merchandiser and storage rack sales premium for its appeal to socially conscious labels, retailers and consumers.

♦ ♦ ♦

Fast-Trax Digital Technologies has introduced an encoding system using still-frame video signal storage and 300:1 compression to record vast amounts of audio on CAV and CLV videodiscs. The Music Archiver combines a WORM drive with a set of three encoder boards that fit in IBM AT-compatible computers. The system allows one side of a 12-inch laser disc to store up to 150 hours of lim-

ited bandwidth mono audio, or ten seconds per video frame. For stereo program with dynamic range of 78 dB and frequency response of 11 kHz (which the company charitably calls hi-fi), capacity is 23 hours. Audio capacity is reduced as video, still pictures or digital data are added to the program. To owners of Pioneer's LVD 8000 CLV machine, the company promises even greater capacity, up to 92 hours of stereo hi-fi. Fast-Trax plans to market its system as an alternative to CD-I and DVI for interactive applications in business and educational markets.

♦ ♦ ♦

Sony Classical will be among the first labels to release prerecorded DAT product, and the company is also leading the way introducing DAT to U.S. consumers. But according to Jim Pagliaro, director of Sony's Duplication Systems division, Sony isn't rushing into the sale of high-speed DAT duplication gear. Most of the basic product development is already

AMS AUDIOFILE.. THE PLUS POINT

During the 1980's, one hard disc recorder both established and dominated the market - AMS AudioFile!TM

AMS now announce AudioFile PLUS!TM as part of a continuing policy of upgrades that take AudioFile into the 90's and beyond.

With a transfer of operating software to the latest technology 32 bit, 4 Megabyte transputer platform, AudioFile PLUS!TM offers yet faster operation and the ability to accommodate a range of major new features - further distancing AudioFile from other disc based recorders.

Extended System Architecture also provides for 8 simultaneous inputs/outputs, in analogue and/or several digital formats.

Whether you have yet to make up your mind about hard disc recording or you already own an AudioFile, you'll find it comforting to learn that this system upgrade is once again available for all existing AudioFiles.

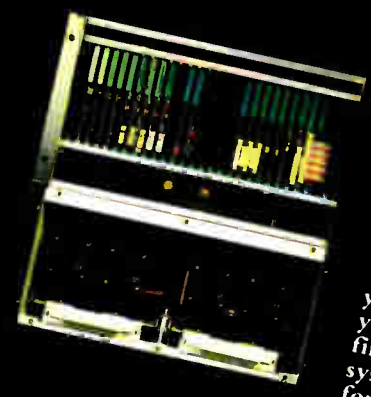

ams
AUDIOFILE+



Setting the pace for hard disc recording

AMS Industries plc
Billington Road, Burnley,
Lancs, BB11 5ES, UK
Tel: (0282) 57011 Fax: (0282) 39542
AMS London: (01) 722 3925 AMS USA: (707) 762 4840
New York: (212) 586 7376 Chicago: (312) 527 4569
LA: (818) 845 0199 Seattle: (206) 842 7182

Circle #025 on Reader Service Card

We Are Proud to Join the
American Association
of Advertising Agencies
in Launching the
Newest Addition to
the ACT III Family
of Publications.

A PUBLICATION OF THE AMERICAN ASSOCIATION OF ADVERTISING AGENCIES

AGENCY



ACT III

PUBLISHING

401 Park Avenue South
New York, N.Y. 10016 (212) 545-5100

complete, because such a system would be largely based on Sony's Sprinter line of high-speed video duplicators. But the current market, Pagliaro says, doesn't justify introduction of a DAT Sprinter, though Sony could be "very responsive" once a decision is made to go forward.

Video Sprinters are now available incorporating factory-installed improvements previously offered in the form of an upgrade kit. The 5000-C combines higher print speed and faster rewind to raise output 12 percent to 18 percent depending on program length. The new model also uses an iron transfer drum for improved signal transfer, yielding higher output from copy tapes, which may now be wound onto hubs rather than take-up reels.

• • •

Personics (Redwood City, Calif.) has added "Intelligent Couponing" to its in-store custom cas-

sette duplication system to allow record companies to target purchase incentives to likely buyers. A customer who selects a given artist for inclusion on a custom cassette could receive a coupon, laser-printed by the system on the spot, good for a discount on a regular prerecorded album by the same artist. Or someone who chooses music from a given style category (country, heavy metal, etc.) could be given a discount coupon for product on the same label by other artists working in the same style. MCA and EMI are among the labels participating in the program, whose redemption costs are shared by retailers and labels. Personics absorbs the costs of administration.

• • •

Real-time duplicator Clarity Cassettes is working with Shape Inc. to provide field test feedback for further improvement of Shape's Mark 10 Generation II audio cassette shell. The new shell is already in production at Shape's plant in Biddeford, Maine. But according to Mike Pepin of Clar-

ity, Shape is taking advantage of Clarity's ability to computer monitor the performance of prototype shells as tapes are being recorded. Results are analyzed as designs are refined. He says the biggest improvement in newer shells will be a "revolutionary" design to optimize the tension of the pressure pad spring.

• • •

Akai Digital of Fort Worth, Texas, is offering a stereo disk-based recording and editing system using rewritable optical media. With the rack-mountable DD1000, removable disks can record 25 minutes of audio per side at 44.1 or 48kHz sampling rates. An external drive may be connected via SCSI for additional capacity. The companion DL1000 is a remote control for the unit featuring a built-in time code generator and control of editing functions for up to seven DD1000s, including splicing, fades and SMPTE-referenced random access replay of samples.

Write or Call for **FREE CATALOG**

Toll Free: 1-800-331-3191

In NY: 516-678-4414

FAX: 516-678-8959



Distributors of **3M** Professional
Audio and Video Products including:

- Digital Mastering Tape
- Logging Tape
- Leader & Splicing Tape
- Reels, Boxes, Flanges
- All hard-to-get audio & video products
- Custom loaded cassettes
- R-DAT & other packaged cassettes
- Calibration Tape & Splicing Blocks

Shipped From Stock - Priced Right - Immediate Delivery

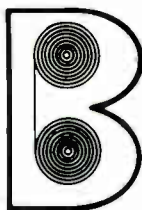

Burlington Audio / Video Tapes, Inc.

106 Mott Street • Oceanside, New York 11572



SPLICES

Memory-Tech, a CD replication venture started in Plano, Texas, by Mitsubishi and ElectroSound Group, has been acquired by Discetronics. The plant joins Discetronics facilities in California, Alabama, Australia and the UK... **Digital House**, a New York City-based purveyor of CD and cassette production services, has announced the appointment of RPS Communications as its public relations consultant... **Optical Disc Mastering** (Charlotte, N.C.) is targeting its new CD-Integrated Manufacturing System to companies with annual production needs of about 2,000 masters and 2 million discs. Billed as an all-in-one tape-to-disc production facility for CD-Audio or CD-ROM, the modular system requires the addition only of floor space (60 ft. x 60 ft.), electrical, water and drainage provisions. Elapsed time from data formatting to finished discs is only six hours. The company has also introduced the LHH 3200 Data Formater for

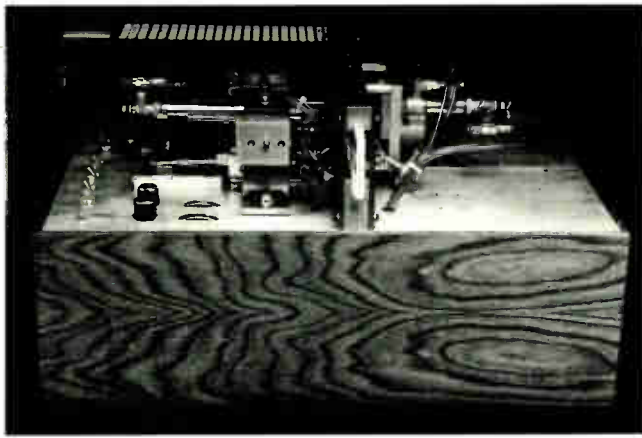

**Arcoset
Mini
Printer**

CD-ROM, CD-I and CD-ROM XA, featuring real-time mastering from 9-track and fully automated subcode handling...

Archon Corp. of Danvers, Mass., is now shipping its Arcoset Mini Printer, an on-cassette printing system. The modular and expandable units are available in models ranging from manual to two-sided fully automatic... Seattle's **Martin Audio Group** has teamed up with CD replicator **American Helix** to offer CD "Airplay Packages" that include glass mastering, pressing, label printing (two-color) and a Tyvek sleeve. Three sizes are available, from \$999 for 50 discs to

\$1,425 for 200... A pair of complementary, free-standing Portable Reference Conversion Systems are now available from **Apogee Electronics** of Santa Monica, Calif., for audio conversion to and from the digital domain. The units offer a variety of professional digital interfacing capabilities, including AES EBU. They also feature company-designed dither, clock and filter systems, also available for OEM applications. Apogee claims that its dither design yields the equivalent of three added bits, decodable by any replay system. The AD1000 and DA1000 list for \$999 each. ■

SONY PROVES THAT QUALITY CAN BE DUPLICATED.

Trust Sony to develop a line of high speed audio cassette duplicators with distinct advantages for the educational and professional marketplace. Like superior sound, ease-of-use, durability and automated trouble-free features. Plus one or both side duplicating capability, short tape warning, automatic copying and direct drive transport for unmatched reliability and precision tape handling.

The high end stereo systems can produce up to 43 copies at 8 times normal play speed. Monaural systems can produce up to 11 copies at 16 times normal play speed. So don't wait to put the Sony advantages of quality and reliability to work for you. To find out more about the Sony duplicators call **1-800-326-SONY**.

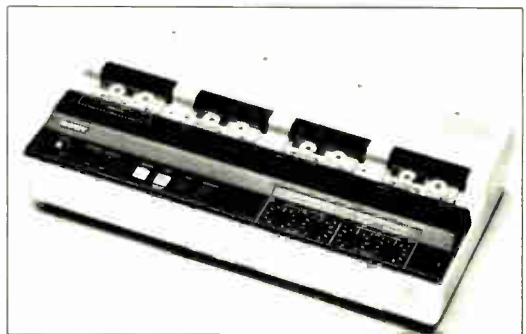

SONY®

Audio Visual Products

Sony Communications Products Company, A Division of Sony Corporation of America, 10833 Valley View Street, P.O. Box 2100, Cypress, California 90630

LUCASFILM Ltd

SOUND EFFECTS LIBRARY

Lucasfilm Ltd.

The world's greatest innovator of sound design

&

Sound Ideas

The world's largest creator of sound effects

HAVE JOINED FORCES TO PRODUCE A UNIQUE SIX CD SOUND EFFECTS COLLECTION. NOW FOR THE FIRST TIME EVER YOU CAN HAVE ACADEMY AWARD WINNING SOUND EFFECTS ORIGINALLY USED IN MANY OF LUCASFILM'S MAJOR MOTION PICTURES PLUS NEW EFFECTS SPECIALLY CREATED BY SOUND IDEAS FOR THIS INCREDIBLE CO-PRODUCTION.

EXCLUSIVELY DISTRIBUTED BY:



105 WEST BEAVER CREEK ROAD
SUITE 4
RICHMOND HILL, ONTARIO
CANADA L4B 1C6
(416) 886-5000
U.S.: 1-800-387-3030
FAX: (416) 886-6800

CALL TODAY TO RESERVE YOUR LIBRARY

Circle #026 on Reader Service Card

World Radio History

by Blair Jackson

“TWIN PEAKS”

PEOPLE ARE STRANGE AND SO IS THE SOUND.

Sheriff Harry S. Truman (left, portrayed by Michael Ontkean) and special agent Dale Cooper (Kyle MacLachlan) are two of the “good guys” on Twin Peaks.



By the time you read this, you may know who killed Laura Palmer. You'll know whether it was a clue from the dream sequence in episode three that tipped off special agent Dale Cooper to the murderer's identity, or whether it was some hard-nosed investigative work done in conjunction with sheriff Harry S. Truman that did the trick. You'll have learned the terrible secret of One-Eyed Jack's, gleaned a little more about what makes Audrey tick, and maybe even found out what the talking log had to say.

But as I write this in early May, I have more questions than answers about the goings-on in the very strange, even surreal, world of *Twin Peaks*, and like millions of other

viewers around the country, I'm basically living for Thursdays to come around so more of this prime time puzzle will be revealed. It's not that I'm a TV junkie—far from it, actually—but this one snared me from the opening theme on the two-hour pilot back on April 8, all that slow, twangy guitar over a pretty dirge of a melody, like Duane Eddy on Quaaludes.

The very thought that David Lynch—the director of what is unquestionably the most twisted popular film of the '80s, *Blue Velvet*—could make it to network TV with a series as weird as *Twin Peaks* boggles the mind. After all, this is the network that gave us *America's Funniest Home Videos* around the same time, and Lynch doesn't exactly have a track record with mainstream America. But occasionally something odd slips through the cracks and—surprise, surprise!—even becomes a hit. The pilot was one of the most-watched programs of the season. Just think, right now hundreds of would-be screenwriters living in the L.A. area are probably working on rip-offs of *Twin Peaks*, each one trying to write more unusual story lines than the others. A lucky handful will make it into development, and one or two particularly rotten ones may even make it to the pilot stage. Why, it makes me proud to be an American!

But this spring's *Twin Peaks* (its eventual fate as a series is still in question as we go to press) really *was* different than regular TV, in its characters, the way it looked and even the way it sounded. The two-hour pilot, directed by Lynch, was surely one of the most intriguing "TV movies" ever aired, and the world that was created—aurally and visually—formed the basis for the episodes that followed. So even though Lynch directed only one other episode, the series as a whole had a textural continuity that was in keeping with Lynch's original vision.

Lynch was heavily involved in every aspect of the pilot, including the sound. According to Doug Murray,

sound designer on that show, "David likes to keep an eye on everything that's going on, but at the same time, he gives people room to be creative. In the case of the sound, he certainly had some ideas that he vaguely sketched out to me, and there were a few instances where he had very specific ideas of what he wanted to hear, but he gave me a lot of latitude and was always open to new things. He told me that he liked the general style of the *Blue Velvet* [sound] track, and asked me to, where appropriate, emulate some of the things done in that film, but most of what we ended up with was pretty original."

For most of his films, Lynch has worked with sound designer Alan Splet; together they've forged a style that combines the use of unusual natural and machine noises, and music that is alternately lulling and jarringly melodramatic, into a strangely cohesive whole that inexplicably *works*.

Lynch and Splet still work together, but for this TV project, Lynch chose Murray, an independent who works out of Bay Area's Saul Zaentz Film Center, to handle the sound chores. Murray's previous sound editor credits include the excellent "little" films *River's Edge* and *Smooth Talk*, and the big-budget hit *Colors*. "It was a three-week cut and mix schedule, which is more than some TV schedules, but less than a conventional feature film," Murray says. "It was pretty intense." Just like the show.

"One of the things David likes," Murray says, "is to take sound effects of machines and slow them way down to make almost musical textures

out of them and mix them together in abstract ways to create backgrounds that have emotional impact the way music often does. I'd done a little of that sort of thing before, but most directors aren't interested in pushing things in that direction."

No doubt about it, Lynch dares to be weird. For instance, to make the dream sequence mentioned above



Doug Murray at work in Berkeley's Saul Zaentz Film Center

THE CONSOLE COMPANY

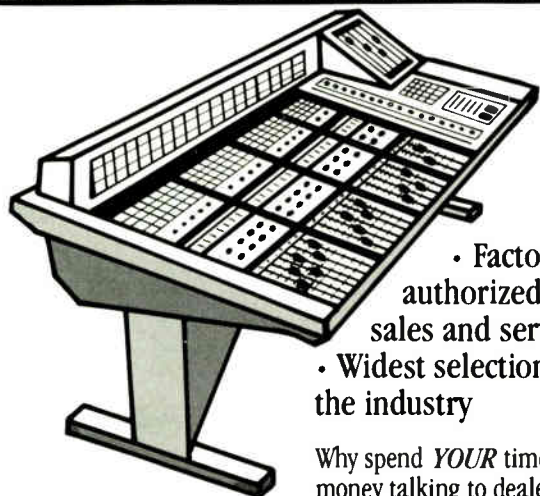

- Factory authorized sales and service
- Widest selection in the industry

Why spend *YOUR* time and money talking to dealers offering *THEIR* limited selection of consoles? One phone call to The Console Company and...

The choice is *yours*.

EAR
2641 E. McDOWELL

602-267-0600

PROFESSIONAL AUDIO/VIDEO
PHOENIX, AZ 85008

Circle #121 on Reader Service Card



Soundcraft

YAMAHA

TASCAM
TEAC Production Products



Conneaut Audio Devices



sound workshop

AMEK

RAMSA

MUSIC & RECORDING NOTES

as bizarre as possible, the actors actually spoke their lines and performed all their motions *backward*, and then the film was shown in reverse so it all looked and sounded "normal." Well, almost. But it's those odd, unexpected touches that Lynch and his crew come up with that make his work so memorable. Weeks after the airing of the pilot, I'm still haunted by scattered sounds and images—the mournful ringing of a lone bell-buoy, the grating intermittent buzz of a defective light in the morgue, the horrifying blue-gray pallor of the victim's skin.

The sound effects Murray worked with came from a number of sources: Alan Splet's personal library of sounds ("David had a few specific ones he liked from previous films," Murray notes); sound libraries of other friends in the business; DAT recordings made on the show's Washington state locations by John Wentworth, who went on to be the post-production supervisor on the series; and recordings Murray made himself after seeing a rough cut of the pilot.

"I also used a couple of things from commercial sound effects libraries," Murray says, "but I prefer unique stuff." Murray used an Emulator III as his primary tool, and also made extensive use of an Eventide Ultra-Harmonizer.

Wherever possible, Murray and his assistant Donny Blank (developer of Alchemy software, which they used as an editor, librarian and sound processing tool) did their own effects premixes. "That meant there were fewer choices when it came to the main mix, but it worked out very well," Murray says. "We used a Dyaxis and it proved to be a very useful tool for mixing down and bouncing tracks. So we could lay down six tracks of sound, then mix down to the Dyaxis and lock that to picture, lay it back over to the multitrack recorder, which is an 8-track with six usable tracks, because of the sync."

Since Angelo Badalamenti's music for the show was layed in after the FX were completed, Murray was unsure of how prominent his work would be until the final mix. "It was a little competitive," he admits. "I tried to get the effects so good that they would be featured instead of the music whenever possible."

"In the boxcar scene [an eerie, abandoned train that police investi-



FOR RENT!

The Industry's Best Names

Mix rents mailing lists of recording and sound production professionals. These lists, the most reliable in the industry, are available by business category and job title. They can be broken down by either state or major market.

Mix lists are available in a variety of label options. Prices are reasonable and *Mix* advertisers are eligible for a special discount on list rentals.

For complete information call the circulation department, (415) 653-3307.



MIX THE RECORDING INDUSTRY MAGAZINE

gators hypothesize was the murder site), the sound effects were very textural and musical in a way that was evocative of a train graveyard. I used slowed-down train whistles and train tracks rat-a-tat-tatting, and dogs and drips and all kinds of other sounds mixed in there, and it got used without any music at all. They went into the scene with music, then favored the effects, and then went out of it musically. It happened so seamlessly you didn't realize it wasn't one continuous flow of sound. It was all part of the 'musical score,' and it took you down to this deep, dark place."

The actual music in the pilot and the weekly series that followed was similarly unconventional. According to Murray, Badalamenti "created a number of themes, arranged them in different ways and recorded a lot of variations of the themes in different arrangements, with different tempos, different instrumentation. None of them had any hard sync reference to any scene in the movie, which is somewhat unusual.

"Then David and [music editor David] Slusser would cut from one arrangement to another during the course of a scene," Murray continues. "They would take a 24-track with different instruments on the separate tracks and mix down a selection into one possible arrangement. Then they'd try other combinations, so on one there might be guitar, drums and harmonica; on another, just strings and guitar. So there might be the same guitar part on these different variations on the theme, but the way the instruments were combined changed their effect on the scene. There were half a dozen different arrangements of the various themes at each tempo. Lots of really interesting things were tried out along the way. I really think it's the most unusual music I've ever heard on television."

Murray's involvement with *Twin Peaks* ended after the pilot, but it's fair to say that his sound work on that show established a mood that continued on the series, which was posted at Todd A0. "They didn't need to create a whole new world," he says of those who came after him, "because the world is already there. It's more like they're exploring the mansion we've already built." ■

When not traipsing in Europe, Blair Jackson is managing editor of Mix.

Very Loud, Very Quiet, Very Rugged, Very Good

BRYSTON

Bryston from Studio Consultants:

Power Amplifiers

From 50 Watts/channel into 8 ohms stereo (the 2B-LP) to 800 Watts mono into loads as low as 1 ohm (the 6B).

Preamplifiers

Broadcast-quality phono and line-level preamplifiers.

Crossovers

The new 10B 2-way stereo, 2 or 3-way mono electronic crossover, with selectable crossover frequencies and slopes (6, 12, or 18 dB/octave).

*Bryston is the only amplifier we sell.
Let us show you why.*

AKG, AMS, Aphex, API, Bryston, Calrec, Soundcraft, T.C. Electronic, Valley International, Westlake, White Instruments, and other exceptional audio products.

studio consultants, inc.

321 West 44th Street, New York, NY 10036 (212) 586-7376

Equipment, support, and design services for professional audio facilities and broadcasters.

Circle #122 on Reader Service Card

HELP... WE'RE OVERSTOCKED!

If you're looking for musical or studio equipment, now is the time to buy!
Hundreds of major brands.
Fast delivery.
No matter how large or small your needs are, call us!
The call is free!



MUSICMAKERS

4914 N.W. Loop 410, San Antonio, TX 78228

CALL NOW: 1-800-395-1005





(Financing Available)

Circle #123 on Reader Service Card

COAST TO

L.A. GRAPEVINE

Greetings from the Left Coast! As part of the new "Coast to Coast" column, I'll be giving you the view from Los Angeles each month. As everyone who works here knows, L.A. is a unique market that, like New York, demands an in-depth look. Anything and everything will come under my scrutiny: special events, developing trends, equipment acquisitions, sessions of note, studio openings and more. So, Angeleños, get on the horn. You can contact me by phone at (818) 341-1951. You can

fax to the same number, but the fax must be preceded by a voice call. By mail, I can be reached care of the *Mix* office at 19725 Sherman Way, Suite 380, Canoga Park, CA 91306. You can also fax directly to the *Mix* office at (818) 709-6773. See you next month with a report... ■

Amy V. Ziffer is a graduate of the Berklee College of Music's audio engineering program. She has worked as recording engineer, author and is the former editor of Home & Studio Recording magazine.

SESSIONS & STUDIO NEWS

SOUTHEAST

Way down yonder in New Orleans—actually the New Orleans suburb of Metairie—**Southlake Recording Studios** reports: **The Subdudes** recorded tracks for their upcoming album, with producer **Rob Fraboni** and **Steve Himelfarb** assisting; and new band **RagDoll** recorded five songs for **Feldsott Productions** with **Kirk Yano** producing...At **Digital Recorders** of Nashville, TN, **Eddie**

—CONTINUED ON PAGE 170



▲ **Record producer and industry veteran David Kershenbaum announced the addition of Hollywood's Studio 55 as the third facility in the Powertrax Entertainment Studio Group. The studio will now be the headquarters for the entire Powertrax Entertainment organization. Pictured left to right: David Dubow, Powertrax/55 studio manager; Sheila Minard, Powertrax/55 executive vice president; David Kershenbaum, Powertrax/55 president; Richard Perry, former owner of Studio 55.**

FRIENDS stopped by to celebrate the release of Hal Blaine's autobiography, *Hal Blaine and The Wrecking Crew*, April 19, at the Baked Potato Club in Studio City, Calif. The party, hosted by *Mix* and Ramsa, attracted many of the original Wrecking Crew studio musicians responsible for hundreds of hit records recorded in Hollywood during the '60s and '70s. Hal's book is available through Mix Bookshelf (800) 233-9604.

C O A S T



N.Y. METRO REPORT

Whether working in New York or in other parts of the world, we as audio professionals need to know all we can about the special dynamics of the New York market-

◀ **Avery Fisher Hall's head stage electrician (IATSE) Bob Jacobi (left) discusses the installation of the DDA S Series console in the Avery Fisher Hall sound booth with Jack Kelly (right), president of Klark-Teknik Electronics, Inc.**

(l to r) Hal Blaine, ▶
Wrecking Crew mate
Al Casey, super-producer
Phil Spector, arranger
Jack Nitsche and
renowned session
drummer Earl Palmer.



PHOTO: LISSA WALES

◀ **Record producer Al DeLory (left) and Beach Boy Brian Wilson join Hal in the celebration.**

PHOTO: LISSA WALES

**Beach Boys ▶
Bruce Johnston (left)
and Al Jardine
boogie with Michelle
"Mama" Phillips.**



place. After all, the city contains not only some of the world's top recording facilities, but an equally strong representative sampling of every kind of professional sound application imaginable. And so, starting in the next issue a new column will report on the latest news, trends and developments in the vibrant New York music, recording and professional sound market.

In order to make this column as timely and as relevant as possible, I'll need your assistance each month. Please send press releases with the latest news on your facility or company directly to me at my office (RPS Communications, 520 Arthur Street, Centerport, NY 11721). You can reach me by phone at (516) 423-4038, or by fax: (516) 423-6155). I look forward to hearing from you. ■

Randy Savicky is president of RPS Communications, a full-service public relations and marketing company, and a journalist actively involved in music, audio and video for over 15 years.

YOU CAN'T STUDY SOUND IN A VACUUM

YOU HAVE TO GO
WHERE SOUND HAPPENS.
THE CENTER FOR THE MEDIA ARTS
LOCATED IN THE CENTER OF IT ALL
NEW YORK CITY
OUR INDUSTRY-ACTIVE FACULTY
SHOWS YOU WHAT IT TAKES TO
HEAR IT & MAKE IT.

CENTER FOR THE MEDIA ARTS

A SOUND START FOR YOUR AUDIO CAREER
226 W 26 ST NEW YORK, NY 10001 **212/929-6999**
AUDIO ARTS • TELEVISION PRODUCTION • BROADCAST ANNOUNCING
(See our Listing in this issue)

Circle #124 on Reader Service Card

—FROM PAGE 168, SESSIONS & STUDIO NEWS

Rabbitt was in doing a project for Capitol Records, with **James Stroud** and **Randy McCormick** producing and **Lynn Peterzell** engineering; **Vanessa Williams** did overdubs with **Keith Thomas** producing and **Jeff Balding** engineering; **Johnny Van Zant** was in doing a tribute to Lynyrd Skynyrd, with **Robert Johnson** and **Brian Foraker** producing and Foraker at the board... **Soundtrax Recording Inc.** of Johnson City, TN, had **Brian Courtney** recording his debut hit "I Believe" for Cameroon Records, and **Bad Influence** recording an upcoming project. **Rick Monday** engineered the sessions. ... **The Neville Brothers** completed the recording of Cole Porter's "In the Still of the Night" for the Chrysalis anthology of Porter songs benefiting AIDS research, *Red, Hot and Blue*... In Atlanta, jazz artist **Jim McConnell** produced his own three-song demo, with **Sam White-side** engineering and **Bret Richardson** assisting at **Master Sound Studios**...

SOUTHERN CALIFORNIA

At **Larrabee Sound Studios** (West Hollywood), **Keith Cohen** mixed the 12-inch version of **Earth, Wind & Fire's** "For the Love of You" and "How the Heart Behaves" by **Was (Not Was)**. Also at Larrabee, producer **Don Gehman** and **Bruce Hornsby** were in mixing "Carry the Water" with engineer **Ed Thacker** for the new **Bruce Hornsby & the Range** album... At **Studio Masters** of L.A., **Sheena Easton** was in doing vocals for a new album. **David Frank** produced and **Peter Arata** engineered with **Wolf-gang Aichholz** assisting... At **Sunnyside Recording Studios** (L.A.), roots-rockers **The Paladins** recorded and mixed their new album, *Let's Buzz!*, with **Mark Linnett** and **Steve Berlin** (Los Lobos) producing and Linnett engineering. The song "Kiddio," off the new LP, features veteran New Orleans tenor sax player Lee Allen, and Berlin on baritone sax... At the **Sunset Sound Factory** in Hollywood, **Mr. Mister** was in working on their new album along with Trevor Rabin of Yes doing guitar overdubs. Producer/engineer was **Paul De Villiers**, assisted by **David Knight**. **Tom Waits** was in recording the Cole Porter tune "It's Alright with Me" for the Chrysalis project *Red, Hot and Blue*. **Bill Jackson** engi-

MUSIC CITY

WE HAVE IT ALL!
Do Yourself a Favor—Call Now!
(800) 477-MUSIC
(800) 477-6874

Hours:
M-F 8 am - 8 pm
Saturday 10 am - 5 pm
4416 Johnston St.,
Lafayette, LA 70503

VISA MasterCard

Circle #125 on Reader Service Card

neered and **Tom Nellen** assisted. ...**REO Speedwagon** was in at **The Enterprise** (Burbank) laying down vocal, guitar and organ overdubs for their forthcoming album. **Tom Alge** engineered with **Fred Kelley** assisting...Also in Burbank, **John Mayall** was at **Master Control** tracking his new record, with **Bobby Fields** producing and **Dave McNair** engineering; **Devo** were in tracking, overdubbing and mixing their latest record, with **Bob Casale** engineering and **Femi Jiya** and **Jeff Lord-Alge** mixing; and **The Pixies** were in with producer **Gil Norton** and engineer **Al Clay** doing work on their new record...At **Skip Saylor Recording** (L.A.), **Kim Basinger** was mixing a song with **Jeff Lorenson** engineering and **Chris Puram** assisting; **The Jets** were mixing "Question of Time" with engineer **Liz Cluse** and producer **Greg Royal**...At **Hit City West** of Los Angeles, **Thelma Houston** was programming and doing 24-track transfer of the upcoming song "A Man Who Isn't So Smooth," with producers **Richard Perry** and **Andy Goldmark** and engineer **Kevin O'Connor**...

NORTHWEST

Digital Underground was in at Hyde Street Studios in San Francisco mixing a project for an upcoming release. **Matt Kelley** engineered with **Tom Doty** assisting...**Erasure** took a quick break from touring to record a new single at **Different Fur Recording** (San Francisco). **Mark Slagle** engineered and **Ron Rigler** assisted. Also at Different Fur, **Boz Scaggs** produced San Francisco's own funksters **Smoking Section**. **Dan Garcia** engineered and **Ron Rigler** assisted...Up in Portland, OR, **The Polka-tones** returned to **Spectrum Sound Studios** to record their latest record project; **Bob Southard** produced. Spectrum also provided the sound design and audio sweetening for the *American Fisherman's* one-hour television special on halibut fishing in Alaska...At **Dave Wellhausen Studios** of San Francisco, harmonica ace **Gary Smith** and his band were cutting a new album with **Dave Wellhausen** engineering. The **Nite-cry Band** were also in the studio recording their new album, with Wellhausen engineering and producing...At **Soma Sync Studios** in San Francisco, **Bonnie Hayes**, songwriter for a couple tunes on **Bonnie Raitt's**

KABA AUDIOPHILE DUPLICATION SYSTEM

recreates what was on your final mix down
the way you want it heard.

LISTEN TO AN EXAMPLE

Send for this free demo tape



Find out how easy and economical it is
to produce cassette copies you'll be
proud to have carry your name.



Toll-Free 800-231-TAPE From California (415) 883-5041
KABA Research & Development 24 Commercial Blvd., Suite E, Novato, CA 94949

Circle #126 on Reader Service Card

*"You perceive sounds coming from the edges of
the speakers and above and below the speakers!"*



Photographed at Aire L.A. Studios, Glendale, California

Robert Margouloff
Grammy Award Winning Producer

B.A.S.E.
BEDINI AUDIO SPACIAL ENVIRONMENT
A GAMMA ELECTRONIC SYSTEMS, INC. SUBSIDIARY

Circle #127 on Reader Service Card

Lowest Prices on AMPEX Tape

Ampex 456 Grand Master[®] Studio Mastering Tape

As low as... 2" \$114.08 per reel

As low as... 1" \$ 52.68 per reel

As low as... 1/2" \$ 30.43 per reel

As low as... 1/4" \$ 9.43 bulk

COMPLETE CATALOGUE AVAILABLE UPON REQUEST.

AEG-Telefunken Mastering • Telefunken/Lyrec Duplicating
3M Audio Distributor • Audio-Video Cassette Duplication
R-DAT Digital Tape • J-Card Printing
Sony Pro Video • Custom Video Cassette Loading
Audio & Video Accessories • Ampex Pro Video

HRC Magnetics 1611 Herring Waco, Texas 76708
CALL TOLL FREE 1-800-443-8457 Nationwide FAX 817-756-0082

Circle #128 on Reader Service Card

RECORDING EQUIPMENT

—All Major Brands—

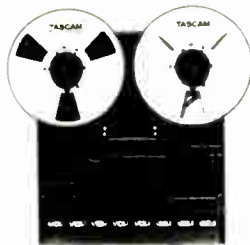

FOR STUDIOS/HOMES CHURCHES/CLUBS

- Reel to Reel Decks (2-4-8-16 Track)
- Cassette Decks • Mixing Boards
- Mikes • Studio Monitor Speakers
- Special Effects Units Accessories

TASCAM
Hi-Fi Production Products

- VOLUME DEALER
- NEW & USED
- E-Z TERMS
- ALL MAJOR CREDIT CARDS
- PROFESSIONAL ADVICE

Call for a catalog and pricing information.

RHYTHM CITY

287 East Paces Ferry Road N.E.
Atlanta, Georgia 30305
1-404-237-9552 • 1-404-237-8526
CALL TOLL-FREE IN GA 1-800-282-7995

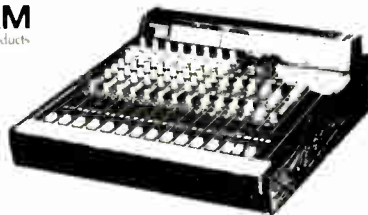

Circle #130 on Reader Service Card

—FROM PAGE 171. SESSIONS & STUDIO NEWS
Nick of Time, was working with producer/engineer **Steve Savage** on an album project...

NORTH CENTRAL

Heavy metal group **Battalion** was in recording and mixing their new album at **Dave's Tracks** of Ft. Dodge, Iowa... At **The Recording Workshop** of Chillicothe, Ohio, **Tony Cottrill** engineered **Southpoint's** smash single "Love Games"; **Alice Jeffers** recorded the upcoming album for **Bad Reputation**; and **Steve Albanese** recorded the soundtrack for the feature film *Invasion of the Cliché Men*... **ARS Recording Studios** of Alsip, IL, reports that **Michael Houston** completed mixdown of his upcoming album release, with Houston producing and **Gary Cobb** engineering... At **Studio A** (Dearborn Heights, MI), gospel singer **Alexis** was working on tracks for her upcoming album, with **Michael Brooks** producing and **Randy Poole** engineering; jazz fusion guitarist **Spencer Barefield** was mixing tracks for his latest, self-produced release with **John Jaszcz** behind the board...

NORTHEAST

At **Calliope Productions** of New York City, **De La Soul** was in cutting their second album with producer **Prince Paul** and engineer **Mike Teelucksingh**; the **Jungle Brothers** were in working on their new album; **Lenny Kravitz** was working with engineer **Ez Reed** on a remix for Virgin Records; **Deee Lite** was remixing **They Might Be Giants**, as well as cutting their tracks with **Robert Power** on the faders... **D&D Recording** (NYC) reports producers **Tommy Musto** and **Frankie Bones** of **Northcott Productions** were in working on a remix of "If You Love Someone" for the **Blow Monkeys**, with **Mike Rogers** engineering; and **Tommy McCook** dropped in with the **Ska-Ta-Lites** to do vocal tracks for an upcoming release with **Dennis Thompson** at the board... **Left Exit** was in at **Sure Fire Studios** of Long Branch, NJ, recording their first, self-produced album, entitled *Do It Anyway*. Due out this summer, the project was engineered by **Jan Topolski** and **Michael Hommel**... The New School jazz master classes were recording at **Crystal Sound Recording** of Manhattan. Under the direction of re-

owned jazz musicians including Donald Byrd, Andrew Cyrille and Joanne Brackeen, the direct-to-DAT project was engineered by **Steve Vavagiakis** and **Larry Buksbaum**... At **Power Play Studios** of Long Island City, NY, **LL Cool J** joined veteran producer **Marley Marl** for his next 12-inch release, **David Kennedy** engineered with the assistance of Rob Sutton. **Ladysmith Black Mambazo**, the South African choir from *Grace-land*, was also working with Marl for an upcoming release. **KRS-One** was working on his next release... **James Earl Jones** was recently at **Soundwave** in Washington, DC, to record voice-overs for Bell Atlantic. **Monica Petersmidt** engineered the session in Soundwave's Studio A on a Neve 8232 console... At **Sabella Recording Studios** of Roslyn Heights, NY, alternative music artists **Lifehouse** cut a three-song demo, and **Crystal Clear** were in working on a four-song, jazz-influenced, psychedelic demo; **Jazz Sabella** produced both sessions...

SOUTHWEST

Doug Sahn, Augie Meyers, Flaco Jimenez and Freddy Fender, going under the name the **Texas Tornados**, recorded their debut album at the **Fire Station Studios** (San Marcos, TX) for Warner Bros. The album was engineered by **Bill Halverson** and **Gary Hickenbotham**, and produced by **Bill Halverson**... **Manuel R. Guerra**, owner of **Amen Recording Studio** in San Antonio, reports **Richard Castillon y La Diferenza**, **Oskar G.**, **Cindy and Klazz**, **Ernie Martinez**, **Los Hermanos Farias**, **Laura Reyes** and **Joe Bravo** were in to record... **Jeff G. Peters**, owner of **Chateau Productions** (Arlington, TX), completed arranging and recording the music for two review shows at Six Flags Over Texas, a theme park in the Dallas/Ft. Worth area. Also at Chateau, *The Razzmajazz Dixieland Band* album was produced by **Jon Stutler** and engineer/producer Peters.

STUDIO NEWS

Poolside Studios (San Francisco) completely updated its main control room with the installation of the Euphonix Crescendo automated mixing console, a Studer A-80 24-track recorder and Macintosh II with Digidesign Sound Tools disk-based recording system. In conjunction with

c2

Free Catalog of Professional SOUND recording & duplicating SUPPLIES



- POLYLINE™ EMPTY REELS & BOXES
- BLANKLOADED CASSETTES
- BOXES ALBUMS LABELS
- AGFA AMPEX 3M Scotch TDK maxell tapes

now from
STOCK
in
CHICAGO
and
L.A.

Call Polyline
708/298-5300
8:30 am - 5 pm Central Time

Polyline
Corp.
1233 Rand Road
Des Plaines, IL 60016

Circle #131 on Reader Service Card

*"It's *@#&!% incredible!"*



Jeff "Skunk" Baxter

B.A.S.E.

BEDINI AUDIO SPACIAL ENVIRONMENT
A GAMMA ELECTRONIC SYSTEMS, INC. SUBSIDIARY

Circle #132 on Reader Service Card

**"AUDIOPHILE
QUALITY"...**

EUROPADISK, LTD.

• **CASSETTES**

*Finest European HX PRO
Equipment - Lyrec/Studer
THE BEST AT NO EXTRA
COST!*

• **COMPACT
DISCS**

*Low-cost packages
from ANY source!*

• **DMM LP
MASTERING
& PRESSING**

*ONLY THE FINEST!
DMM Quality
-Imported Vinyl!*

• **GRAPHICS
PACKAGES**

*Cassette, CD, LP
Printing & Artwork*

• **DIGITAL
STUDIO**

*CD Premastering, Sony
Editing, Neve Digital EQ,
Format Conversion*

**Call, write or FAX
for our brochure**



EUROPADISK, LTD.

75 Varick Street,
New York, NY 10013
(212) 226-4401 • FAX (212) 966-0456

Circle #136 on Reader Service Card

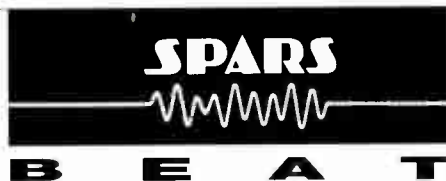

This is the first in a series of reports to be published regularly in *Mix* concerning the activities of the Society of Professional Audio Recording Services. It is the hope of the SPARS board of directors and all of the society's members that this column will become a forum for information about the organization's programs and events.

The Manufacturer Interface program is one of our cornerstones. These meetings were a *raison d'être* for the formation of SPARS ten years ago, and they continue to be one of the most successful. They're simply an open exchange of ideas between SPARS member studio owners and manufacturers of the equipment they use. Discussion topics stretch from industry trends and prognostications to the nuts and bolts of equipment design, application, interface and cost. It is a chance for manufacturers to see how their products are perceived and used in the field, and to understand some of the real-world challenges of running a recording studio. Studio owners can see and hear first-hand the problems of manufacture and sales of professional audio equipment. These discussions are rarely dull.

The manufacturers who participate in this program are SPARS advisory members; the list is impressive, a roll call of virtually all the major manufacturers of audio recording equipment in the world.

Most recently, SPARS members met with Sony, Studer/Revox and Dolby Labs. The discussions with Sony in Ft.

Lauderdale, Fla., centered around serial interface protocol and the design of the console of the future. There was particular interest in the configuration of future console control surfaces.

At Studer/Revox in Nashville, Tenn., Studer North American president Tore Nordahl summarizes the SPARS Manufacturer Interface program, "We at Studer see this as an opportunity to come closer to reality in getting direct feedback from the leaders of our studio industry." A detailed discussion took place about why digital has been slow to take an industry-wide hold in professional audio, and members talked at length about DAT and its future.

Dolby president Bill Jensen hosted the most recent interface at Dolby headquarters in San Francisco. Technical discussions of noise reduction systems were followed by an informal analysis of analog recording's future and an evaluation of Dolby's image in the industry and marketing strategies.

Detailed reviews of SPARS Manufacturer Interface meetings are available to SPARS members on a timely basis in *Data Track*, our newsletter. The next interface is scheduled in August of this year. SPARS members will travel to Vermont to meet with New England Digital.

For SPARS membership information call (407) 641-6648. ■

Pete Caldwell, president of Doppler Studios in Atlanta, is currently first vice president of SPARS.



*(pictured, l to r)
Dolby director
of marketing Bill
Mead; SPARS first VP
Pete Caldwell (Doppler
Recording); SPARS
executive director
Shirley Kaye; SPARS
president David Porter
(Music Annex); SPARS
board member
Tom Kobayashi
(Skywalker Sound).*

—FROM PAGE 173, SESSIONS & STUDIO NEWS

its existing Otari MX-70, Poolside's new setup makes 40-track recording and mixdown possible...Recording engineers **Brian Tarner** and **Lew Hahn** have joined **Superdupe**, a New York-based audio facility....**Video-mix** audio-for-video post-production studios added sound mixer **Barbara Flyntz-Bradley** to its staff...**Foto-Kem/Foto-Tronics**, a Burbank-based motion picture laboratory and post-production facility, purchased its first Sony digital 2-track PCM-3402 DASH recorder. The unit has already been used in a project to save rare film footage of some early Neil Young performances...NYC's **Rawlston Recording** updated its facility, adding equipment such as a Mac SE 30 and a Panasonic SV-3500 DAT machine. The studio is also under new management. For further information contact **Akili Walker** at (718) 622-0010...Minneapolis' **Metro Studios** added a second 24-track studio and named **Tommy Tucker Jr.** chief engineer...Noted studio designer/architect **John Storyk** announced his latest project: the improvement and redesign of **Crawford Post Production's** (Atlanta) largest control room, Audio A. Storyk will also be designing and supervising construction on two new audio post-production suites at Crawford...**Ron Montgomery** of **Technical Audio Systems**, Norcross, GA, and the U.S. Astronaut Hall of Fame announced the installation of a new stereo surround sound system at the Space & Rocket Center theater in Titusville, FL...To prepare for the upcoming release of a new album, **Nona Hendryx** outfitted her studio with a Tascam MM-1 keyboard mixer...After ten years on the North Shore of Oahu, **Sea-West Recording Studios** and **Sea-West Productions** have moved to the island of Hawaii...**Pro Mix**, an audio systems company of Farmingdale, NY, installed three DDA consoles at New York's prestigious Lincoln Center. Two S Series consoles were installed at Avery Fisher Hall and a Q Series 16 was plugged in at Alice Tully Hall. ■

CORRECTION: In the May Northeast Studios Directories cover, the photograph of Messina Music in New York City was reversed. Messina still features a new 56-input API Discrete Series console. The photo is still by Lightscaapes. Our apologies.

American Helix Technology Corporation
1857 Colonial Village Lane
Lancaster Pennsylvania 17601

717 392 7840
717 392 7897 Fax
800 525 6575

Disc Manufacturers

Compact



AmericanHelix™



Product Development
Music Licensing
Visual Design
Pre-mastering
Mastering
CD Replication
Cassette Duplication
Custom Packaging
5 & Full-Color Disc Printing
Fulfillment Services

B.A.S.E. would like to thank *Mix Magazine*
and the *Mix* readership for this year's
TEC Award nomination.

Look for the **B.A.S.E.** logo
on these upcoming events:

Chicago's new album
Winger's new album
Thelma Houston's new album
Barbra Streisand's new album
Exorcist, 15 Years Later
Frankenstein Unbound
Black Out
Las Vegas Hilton showroom

Milli Vanilli's tour
Rush's tour
Anita Baker's tour
Luther Vandross' tour
Concrete War
Waiting for the Light
Home Grown
Keys to Freedom

To experience the true innovation of **B.A.S.E.** technology
before voting, please call (818) 500-4171
for a free demonstration CD.

B.A.S.E.
BEDINI AUDIO SPACIAL ENVIRONMENT
A GAMMA ELECTRONIC SYSTEMS, INC. SUBSIDIARY

Circle #135 on Reader Service Card



The Latest in

RECORDING TECHNOLOGY

StudioTECH'90

Saturday, July 21

10:00 a.m.-7:00 p.m.

Golden Gateway Holiday Inn

Van Ness at Pine

San Francisco

- **New Equipment**
- **Studio Design**
- **Production Techniques**
- **Auditory Health**
- **Career Opportunities**

\$10 at door

\$8 in advance; call (415) 441-0662

WORKSHOPS

- Media Production
- Tape Recorder Alignment
- Near-field Studio Monitors
- Drum Miking for the Studio
- Music Production for Film Applications

- Storage, Handling and Restoration of Tape
- Digital Standards and Interfacing Equipment
- Recording/Production Using Hard Disk Recording Systems
- Evaluating Tape Recorder Performance and Specifications

DEMONSTRATIONS

- Roland S-770 Sampler
- Orban Digital Signal Processing
- Dolby SR Noise Reduction System
- Panasonic SV-3500 & SV-255 DAT
- WaveFrame Digital Workstation System
- TASCAM MIDlizer Synchronizer System
- Lone Wolf MIDI Network

- Otari MTR-100A Auto-Aligning 24-track
- Digidesign Sound Tools Hard Disk Recording
- Meyer HD-1 Studio Reference Monitor System
- Lexicon 480L, LXP-1, LXP-5, and the MRC Controller
- Eventide H3000SE/B Stereo Harmonizer w/ Time Compression

FEATURED SPEAKERS

Hal Blaine
Mike Greene
Walter Afanasieff
Kathy Peck
John Barsotti
Ron Arbatier
Bob Berke
John Carey
Paul Stubblebine

Chips Davis
David Porter
Arne Frager
Bob Skye
Joanie Shoemaker
Michael Bard
Jay Bradshaw
Blair Jackson

John Storyk
Fred Catero
Greg Errico
Hillel Resner
Denny Jaeger
Richard Beggs
Michael Babbitt
Linda Jacobson

Jeff Baxter
Susan Skaggs
Dave Schwind
Neil Fink
Gus Guinness
Sandy Pearlman
Wayne Desmond
Keith Hatschek

co-sponsored by

AGFA 

**AUDIO
Images**

MIX THE
RECORDING
INDUSTRY
MAGAZINE

—CONTINUED FROM PAGE 124. SR NEWS (with four VCAs) and Soundcraft 500 32 x 12 for monitors. Signal processing gear includes Lexicon PCM70, LXP-1s and LXP-5s, Valley PR10 rack, and the new Drawmer M500. "I've tried to build a company that offers high-quality sound in a relatively small package," he comments.

Northeastern regional sound reinforcement company **Audio Technologies Inc.** (Watertown, Conn.) works national one-offs, mini tours and dates throughout the Northeast. The company specializes in jazz, symphony and artists such as NRBQ and Donald Fagen. It also does some installations, dance and ballet productions, and a large number of college functions. Owner **Gary Peck** started the company in 1983.

Audio Technologies' main P.A. system is comprised of 16 proprietary ATI MH-3 55° horizontal-dispersion, three-way trapezoidal boxes loaded with dual 12-inch E-V M Series 2 speakers, a Renkus-Heinz 3301 2-inch compression driver on a DDS horn, and a JBL bullet tweeter. For the low end there is a choice of 16 triple 15-inch ATI 315 folded horns or ten dual 18-inch ATI 218 direct radiators. Crest 4001 and 7001 amps power the main system, with 4001s and 3001s for the three proprietary monitor wedge models. House consoles are a TAC Bullet 30x8x2 and two Yamaha 2404s; monitors are handled with Yamaha 2408M monitor consoles. House processing uses Ashly equalizers and crossovers, dbx compressors on the mains, and Yamaha reverb devices.

(Note: Some of the data in this column and in "On the Road" is based on information provided by the companies. Address all correspondence and photos to Mix Publications, Sound Reinforcement Editor, 6400 Hollis Street, Suite 12, Emeryville, CA 94608.) ■

When not writing for Mix, Mark Herman operates a rental company specializing in sound reinforcement consoles.

SCS
SOUND CODE SYSTEMS

MOS-FET Audio Amplifiers

**MORE POWER & FIDELITY
FOR LESS MONEY**

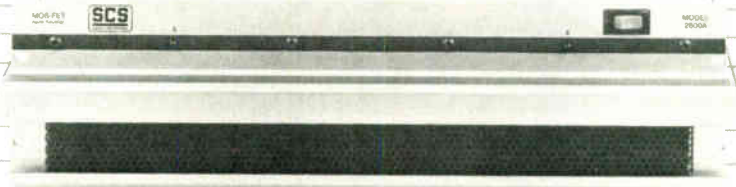

Your recordings may be better than you know.

The amplifier in your home studio is no less important than that of a world class studio. High slew rate, high damping factor and high current output are critical for accuracy. This is fidelity and SCS Audio Amplifiers deliver.

Avoid over-equalization.

Pull lows out of the mud and put sparkle into your highs. Pump life back into dead vocals, naturally. Call today for the SCS dealer nearest you. Listen to what you've been missing. We'll also send you information explaining MOS-FET applications in audio.

"The Ultimate No Frills Amplifier"

SCS, P.O. BOX 2198, GARDEN GROVE, CA (714) 554-0903

In Canada: Audionova (514) 631-5787

Circle #137 on Reader Service Card

**THOROUGHbred
MUSIC**



When you deal with us it all clicks together: Every department: guitars, keyboards, pro audio, lighting, percussion, and accessories is wired for your call. We keep turning you on after you plug it in with service after the sale.

2204 E. HILLSBOROUGH AVE. TAMPA, FLORIDA 33610 813-237-5597 OR FAX 813-238-5443

Circle #138 on Reader Service Card

CALL



1 (800) 780-4654



FOR FAST SERVICE



ON MOST MAJOR BRANDS

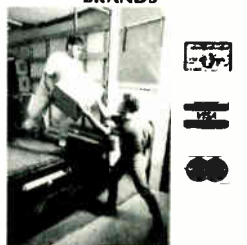

—FROM PAGE 42, SCHOOLS

fice. Most placement offices keep data on alumni—where they're working, how to contact them—and the alumni network has become increasingly valuable. Business schools and liberal arts programs have used it for years. And now recording schools have caught on.

"We get a lot of calls from former graduates who have risen through the ranks and are now in a position where they are hiring employees," Pohlmann says. "And, of course, the first place they look is their alma mater."

Though Fanshawe College has placed a dozen students in California studios, the target of their alumni drive is Toronto. "Our market has been primarily recording studios," Don Geppert says. "Having been in business for 15 years and having so many students find work in Toronto, we now have an awful lot of people in the upper echelons, and they're doing the interviewing."

At Middle Tennessee, Grove, Trebas and others, the alumni network typically involves phone calls

.....

***"It's tough to
justify going to
work as a second
engineer in a studio
when you've shelled
out tens of thousands
of dollars on an
education."***

.....

from graduates with job openings. Informal but effective. A recent graduate from Full Sail, working in live sound, stopped by the facility as the Richard Marx tour moved through Orlando. He brought a class of 60 out to the venue, took them through the stage setup, then ran through a soundcheck. Hands-on and effective.

Berklee and IAR, meanwhile, have gone to great lengths to reach out to alumni. The placement office for the music technology division at Berklee maintains a HyperCard stack containing voluntary data on all alums and an industry-wide database on manufacturers and facilities, to quickly identify who has hired Berklee grads in the past.

"[The alumni network] is a very powerful thing," Puluse says. "We also have a volunteer contact in each geographical area. If a student is going to L.A., for instance, we put them in contact with this one person who kind of keeps an ear to the ground for opportunities and even knows where the kid can stay for a couple of days while relocating. We

**Bring
A Saxophone,
A Space
Bass,
And
A String
Quartet To
Your Next
Session.**



◆ Now you can get a whole universe of professional quality sounds—without the hassles usually associated with sampling.

No hunting for floppy discs or waiting while they load. A single one of our CD-ROMs holds hundreds of instruments. And no tedious mapping and looping, because all our sounds come completely pre-processed. You get looped, normalized samples with a great selection of pre-sets to choose from—and over 20 CD-ROM disc titles!

So the next time you need a funk bass, a bamboo flute, or a flock of birds for your Akai, E-mu, or Roland sampler, please give us a call at:

800-347-2664 or 408-395-4332



**OPTICAL MEDIA
INTERNATIONAL**

485 Alberto Way • Los Gatos, CA 95032



Requires a compatible CD-ROM player available from OMI. ©1990 Optical Media International.

World Radio History

Circle #033 on Reader Service Card

call that person the 'hub,' and we have them in foreign countries as well." Both the contact person and the HyperCard stack are available to every Berklee grad, past and present.

IAR, which considers itself a feeder school for New York City, convenes a Board of Technical Advisers annually. The board is made up of alumni and heavy hitters in the industry who help direct the curriculum in response to the job market and offer time and assistance to grads.

More impressive, however, is the alumni newsletter that goes out first-class, once a week. (Trebas also circulates a newsletter, though less frequently.) The newsletter lists job openings at all levels, so alumni who are moving up can take full advantage. The computerized database even breaks it down so that if the listings are strictly entry-level, the newsletter will be targeted toward graduates of the past year. "It's expensive," Friedman says, "but oh, so valuable."

There are no shortcuts to a gold

.....
"The expectations

of kids are changing.

They're not as wild and

crazy as they used

to be. They're more

conservative about

their careers, livelihoods

and job security."

record credit or a breakthrough in product design. Whatever a school offers in terms of job placement services is only as strong as its curriculum and a student's desire to become well-grounded and well-rounded.

Friedman says, "You have to be technically sophisticated to be employable. I wouldn't call that the news of 1990. It's been the key all along."

"Any education is only as good as its building blocks," Kefauver continues. "If the fundamentals are not solid, the more advanced concepts are shaky. If you can't refer back to why a circuit does this, to the fundamental principles, it's difficult to conceptualize the whole chain of events, whether you're working with a microprocessor, an input/output console or a hard disk-based system. We take it even further in that you have to understand the music before it becomes electronics." ■

Tom Kenny is an associate editor at Mix.

WANT TO IMPROVE YOUR RECORDING SKILLS?

Then sit next to a top-flight engineer as he demonstrates all the elements that go into great recordings!

The SHAPING YOUR SOUND videos are a complete guide to professional recording techniques. Each tape is packed with demos, computer graphics and live musical examples, that let you see and hear exactly what the sound is doing.

You'll learn from noted engineer, producer and teacher Tom Lubin, whose nationally acclaimed seminars have helped thousands of recording professionals learn more about their craft. Tom gives you proven techniques to put to work on your very next session!



"Shaping Your Sound can do what no book on the subject has ever been able to accomplish!"
 MIX MAGAZINE

SHAPING YOUR SOUND with MIXERS & MIXING

Reading the Block Diagram - A Simple Mixer - Inputs - Effects Loops - Outputs - Meters and Peak Lights - Mixing in Layers - Rough Mixes - Preparing for the Mix - Mixing the Rhythm Section - Adding Sustain Instruments and Pads - Setting Up the Reverbs - Adding Lead Instruments and Vocals - Completing the Mix - Editing the Mix

SHAPING YOUR SOUND with MULTITRACK RECORDING

The Record Head - Recorder's Signal Path - Tape Speed & Track Width - Distortion & Noise - Setting Levels - Crosstalk - The Recording Session - Preproduction - Preparing for the Session - Cutting Basics - Strategies for Bouncing - Overdubbing - Punching In & Out - Creative Erasure - Tape Editing - Backwards Tape Effects - Shifting Pitch & Changing Speed

SHAPING YOUR SOUND with EQUALIZERS, COMPRESSORS & GATES

Building Blocks of Signal Processing - Putting Signal Processing in the Signal Path - Types of Equalizers - EQ Curves - EQ Procedure - Subtractive EQ - Interaction of Signals - EQ & Headroom - EQ in the Mix - Compressors & Limiters - Threshold, Ratio & Range - Expanders & Gates - Attack & Release Time - Gating Toms - External Control - Stereo Variable Gain

SHAPING YOUR SOUND with REVERB & DELAY

Phase Shift & Haas Zone - Regeneration - Swept Delay - Depth Control - Automatic Sweep Rate - Flanging & Phasing - Chorusing & the Doppler Effect - Tape Delay - Electronic Delay - Natural Reverb - Programs & Presets - Unnatural Reverb - Predelay & Early Reflections - Diffusion & Definition - Depth - Setting Up Reverb - Controlling Decay - Overlapping Environments

SHAPING YOUR SOUND with MICROPHONES

Diaphragm Diameter & Frequency Response - Diaphragm Mass & Transient Response - Types of Microphones - Pickup Patterns - Polarity - Comb Filtering - Stereo Miking Techniques - Microphone Selection - Microphone Accessories - Miking Drums - Miking Acoustic & Electric Guitars - Miking Horns - Miking Strings - Miking Pianos - Miking Vocals

Invest in the most important part of your recording system - YOURSELF!

CALL FREE TODAY (800) 777-1576

First Light Video Publishing, 374 N. Ridgewood Pl., Los Angeles, CA 90004

Circle #140 on Reader Service Card

—FROM PAGE 153, STUDENTS & THE AES

Executive committee meetings are the planning sessions where local activities are discussed, arranged and executed. Once the committee decides on an event, the chairman is responsible for seeing that all members of the committee carry out their allotted tasks. The vice chairman assumes specific duties upon the request of the chairman. The secretary prepares meeting notices to be mailed out to the local members, arranges for the location of the activity and records the proceedings of the activity for publication in the *AES Journal*. The treasurer approves and authorizes payment of checks for expenses involving: printing of meeting notices, mailing and postage, equipment rentals, etc. Committee members assist section officers in their duties and are expected to keep up with these offices so that they can step in if needed.

The term of office for AES executives is one year. Students in four-year audio degree programs can run for election to a committee position during their freshman year, move on to a treasurer or secretary position during their sophomore year, and

—CONTINUED ON PAGE 182

MTSU Students Produce More than Music

Nashville has long been considered a music industry center, but it is often overlooked when it comes to trade shows. After attending the

Audio Engineering Society convention in New York last fall, a few ambitious students at Middle Tennessee State University in Murfreesboro decided to put together their own trade show.

"The idea came up before then," says Rick Jensen, secretary of

Jerry Bruck speaks to a full house about microphone techniques.



PHOTO: RICK JENSEN

AL'S
SECONDHAND
24-TRACKS

CUT A DEAL THEN CUT A TRACK

MTSU's AES student chapter and an executive coordinator for the convention. "That's one of the reasons why we wanted to go to New York."

With a staff of about 12 people, the students pulled together to organize and successfully execute Audio Education for the '90s. This was the first event of its kind in the Southeast. The technical trade show was presented March 28-29 on the MTSU campus. "All of the real work was done by the students," says Christian Haseleu, MTSU AES adviser.

Though the students had a little difficulty getting things off the ground, they found support in Nashville. "All of the vendors we talked to have been incredibly understanding of our position," Jensen says. "We told them right off the bat that this has never been tried, but we're going to do the best job we possibly can."

For many of the exhibitors at the show, the tide is turning toward education. Steve Smith, Ampex marketing manager of audio and

tape production, agrees. "We feel that the future of our business is in the students and up-and-coming artists and engineers. We try to talk to people at the beginning of their careers. We see all major companies doing this."

"It's not just digital keyboards

anymore," says Vincent Smith, district sales manager for Korg. "The old guard who says, 'That's electronic, it's not music' is starting to fall by the wayside. You're seeing huge MIDI labs. Now it's such an essential part of learning because

—CONTINUED ON PAGE 183

SSL gives a demo of its ScreenSound system.



PHOTO: RICK JENSEN

OR, FOR JUST \$13,999 YOU COULD BUY A NEW MSR-24.

Maybe at one time it was worth risking second-hand sound, iffy reliability and outmoded technology to save money on a used 24-track. Not any more.

At \$13,999* the MSR-24 actually costs thousands less than most used machines. And its cost-effective one inch format saves you even more.

But despite its low price, the MSR-24 has micro-electronically controlled functions that recorders even a year or two old can't match.

And when it comes to lock-up speed, no used machine can compete.

Best of all, the MSR-24's incredible sound will knock you out, thanks to features like our superior head design, gapless punch in/out and spot erase. And, of course, you also get Tascam's legendary reliability.

See your Tascam dealer and try out the brand-new, very affordable MSR-24. And let AI keep the hand-me-downs.

*Manufacturer's suggested retail price.

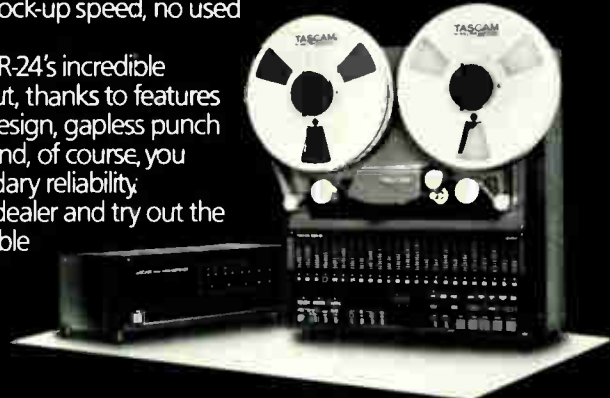

TASCAM®

© 1989 TEAC America, Inc., 7733 Telegraph Road, Montebello, CA 90640, 213/726-0303.
World Radio History

TEC
TECHNICAL EXCELLENCE & CREATIVITY
1990
NOMINEE

then, with a solid background of experience in the activities of their chapter, run for the office of vice chairman or chairman during their junior and senior years. While that would be an ideal route to a chairman's position, there is always room for an enthusiastic committee member to earn a nomination to the chairman's seat at any time.

Stimulating enthusiasm in the audio industry is a large part of what the AES is all about. All AES members receive: ten issues of the *AES Journal* per year, advance notice of AES conventions and conferences, meeting notices and newsletters on local activities, reduced admission to AES conventions and conferences, and are eligible to participate in AES group insurance programs. Furthermore, through the AES Awards Program, students at the graduate level qualify for achievement-based scholarship money from the AES Educational Foundation.

The AES encourages all its student members to actively participate in AES-sponsored events. If you are a student AES member attending an institution that does not have an established student chapter, you can still attend

Students can make valuable industry contacts as well as get the jump on job opportunities.

and benefit from all the activities of other student chapters or local chapters in your area. In fact, even if you are a member of an active student chapter, by participating in the events of local non-student chapters you can make valuable industry contacts, as well as possibly getting the jump on local job opportunities that are often posted at the meetings.

In its continuing effort to promote audio education and allow schools with audio programs to make them-

selves available to potential audio students, the AES is sponsoring an Education Fair on Saturday, September 22, at the 89th AES convention, being held at the downtown Convention Center in L.A. Schools and universities from throughout the world will be on hand to distribute literature and answer questions on their programs.

Immediately following the Education Fair at the Convention Center, an AES-sponsored student reception will be held at the Hilton. Student members are invited to join in this opportunity to meet and socialize with fellow student members, student chapter leaders, educators and members of the AES education committee. Finally, on September 23, an open-panel education workshop will address issues in education, including curriculum design, internships and educational trends. The workshop and fair will be open to all students. For more information, contact your local AES chapter. ■

Guy DeFazio is a past chairman of the University of Miami student chapter of the AES and is currently a committee member of the Los Angeles chapter.

64 CHANNELS. CABLE READY.

Sometimes it seems like you can't get there from here. You've got a thousand great ideas, and just about as many plugs in your hand. What you don't have is enough input channels.

Well, allow us to give you some input about a new way to solve your dilemma. It's a Tascam M3500 in-line mixing console. Choose either the 24 or 32-track mixer and by simply flipping a switch, you can double it to 48 or 64 mix positions.

And, with a suggested retail price of \$7,499 for 24 inputs or \$8,499 for 32, it won't take up a lot of your budget, either.

If you're planning to build a 24-track development studio, here's another advantage: The M3500 is the perfect match for the MSR-24, Tascam's one-inch 24-track recorder. Together, they make the most cost effective studio available.

It just may be that you don't need a huge console to enlarge your capabilities. The M3500 offers you a new, more effective approach to traditional mixing that is both compact and low cost. And when you need more inputs, all you'll have to do is switch channels. From 24 to 48. Or from 32 to 64.

TASCAM®

© 1990 TEAC America, Inc., 7733 Telegraph Road, Montebello, CA 90640, 213/726-0303

Circle #046 on Reader Service Card

—FROM PAGE 181, MTSU STUDENTS

MIDI systems are such great tools to learn on. We'd like to see more of this on a university level."

In addition to vendor exhibits, the show featured several workshops and demonstrations. Agfa provided a slide/lecture presentation on the restoration of audio tape. New England Digital demonstrated its Synclavier Direct-to-Disk™ system in the university's 24-track studio. Other demonstrations included Korg current products, a WaveFrame digital editing system, Meyer Sound SIMcad and Neve Flying Faders. The highlight for many who attended the program was a seminar by Jerry Bruck of Posthorn Recordings on stereo microphone techniques.

Other vendors included Analog Devices, Audio Animation, Audio Prints, BASF, Bose, Neotek, Neve, Pro Audio Shoppe, Redwood, Sam's Music, Studer-Revox and Trident. According to Smith, "It's a first-class job. Everything is exactly like it's supposed to be."

Chairman of the MTSU AES and

event executive coordinator Rodney Morgan says: "Our goal is to get the AES or some other organization to start having a convention here in Nashville. Nashville is always competing with New York and L.A. Yes, it's a recording center, but it is not equal. It would be wonderful if we could have a trade show here every year or two."

This show was a little different from other trade shows. Neither the vendors nor the public was charged. "We tried to pull this off as a service to the community, the school and the students, as well as for our own experience," Jensen states.

"This was done on no budget at all," adds Morgan. "This is a convention on a shoestring." Funds for the convention were allocated to the students from the national AES in New York and the university.

"We were basically doing this blind," says Jensen. The students sought advice from teachers and other students, as well as industry people.

According to Haseleu the show

was very successful. Attendees included professionals from Nashville, MTSU students and students from Belmont College and Vanderbilt University in Nashville. The registered guests totaled nearly 350, but it is estimated that at least 100 others visited the convention.

"One of the things we're trying to do here at MTSU is not just train fader-pushers," Haseleu says. "We want to produce people who understand about marketing, about vending, about running shows like this. This was really an educational experience that [the students involved] can take with them. I'm sure some of these students are going to end up working for an organization like the AES or maybe work for one of the manufacturers. They understand now what it takes to get something like this together."

"People who come here become engineers, and we want to help those people," he adds, "but we also want to make sure that they know there are other options in the industry."

—Missy Baker

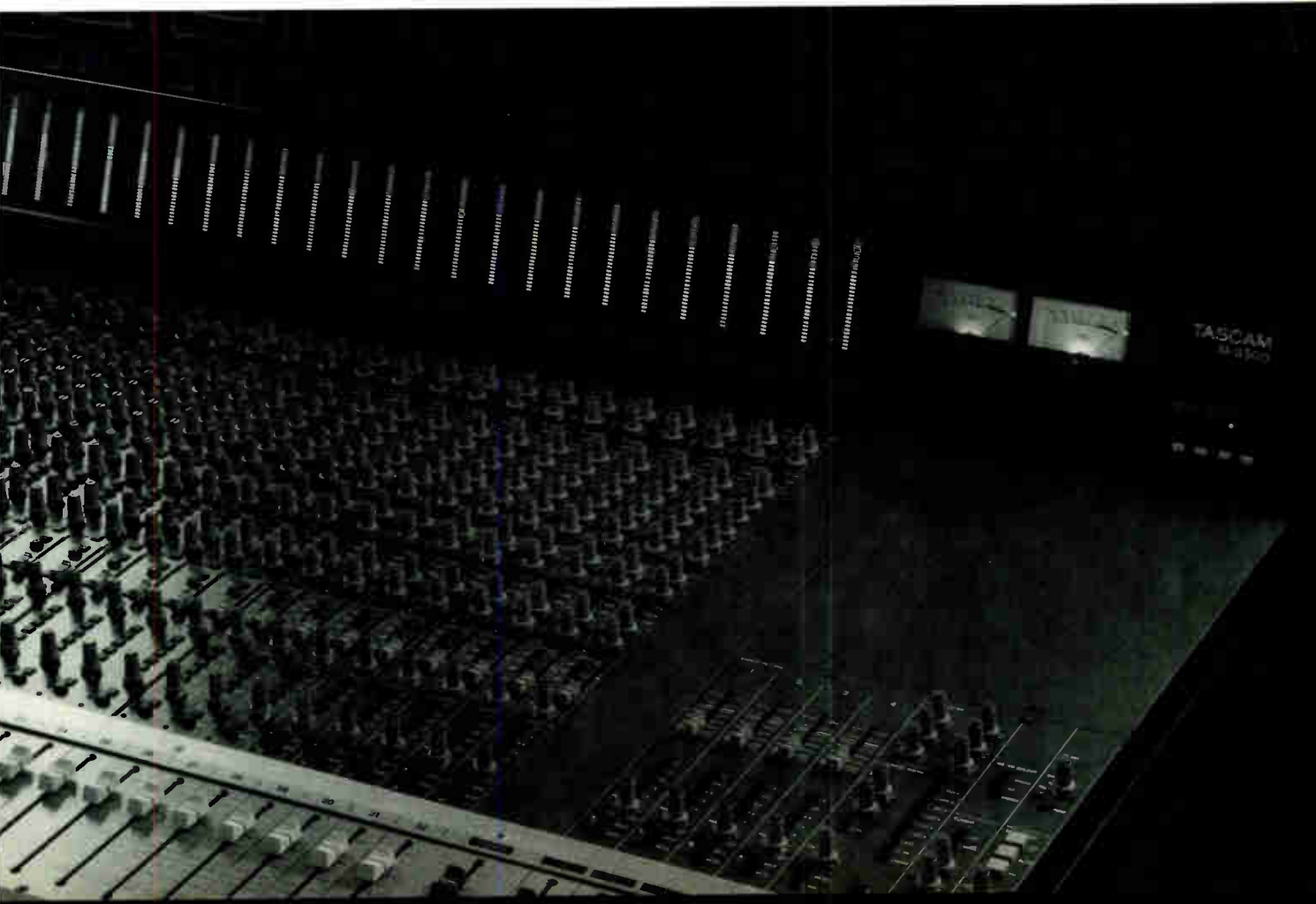

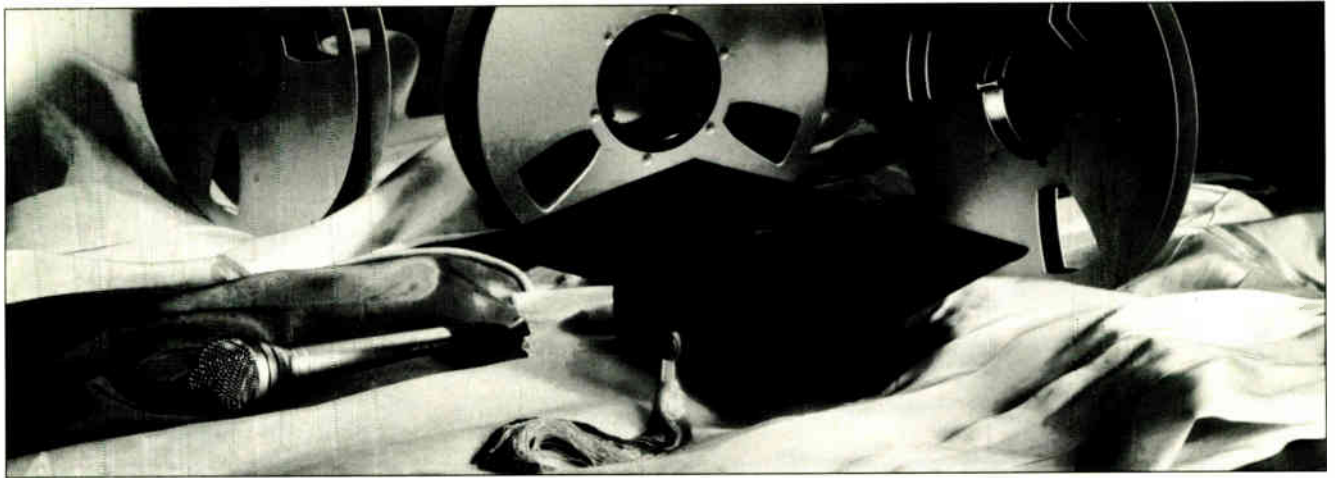
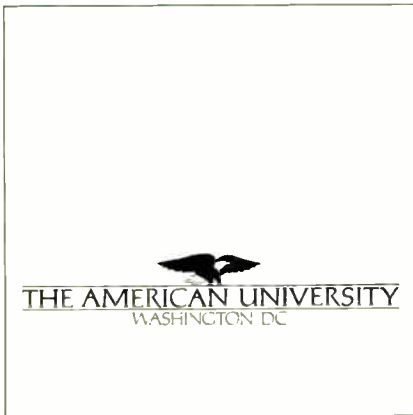

PHOTO: BILL SCHWOB

U N I T E D S T A T E S

RECORDING SCHOOLS

EASTERN



THE AMERICAN UNIVERSITY
Washington, DC

THE AMERICAN UNIVERSITY; 4400 Massachusetts Ave. NW; Washington, DC 20016-8058; (202) 885-2743. Chief Administrator: Romeo Segnan. Program: The American University Physics Department offers a Bachelor of Science degree in Audio Technology. It concentrates on technologies of electronic sound recording and production. It is multidisciplinary and utilizes other departments for courses in mass media, music, theater production, business and computer science. The program's faculty is comprised of three full-time and several adjunct professors providing individualized guidance for students. Our main studio has a 24 x 16 x 2 TAC Scripion mixing console, an Ampex 16-track recorder, a full range of analog and digital effects, an 8-track Tascam, and two Revox 2-track and cassette recorders. Our electronic music lab has various analog and digital synthesizers, samplers and MIDI controllers; two 8 x 4 mixing consoles; and 8-track, 4-track and 2-track open-reel recorders. Program acceptance demands at least 2.0 GPA; unlike similar programs, no audition necessary. For tuition and financial aid information, contact the Office of Admissions.

ART INSTITUTE OF FT. LAUDERDALE; Course/Program Title: Music and Video Business; 1799 SE 17th St.; Fort Lauderdale, FL 33316; (800) 327-7603. Chief Administrator: John Morn. Program: The Music and Video Business program prepares students for careers in the industries of video production, sound engineering, concert production, management

Following is a briefly annotated list of schools and programs offered in the areas of audio and music education, compiled from questionnaires received from those institutions earlier this year. The courses vary greatly in scope, intent and cost, and we urge those interested in attending any program to investigate very carefully before making their decisions. *Mix* claims no responsibility for the accuracy of the information provided by the institutions.

and sales. The music, video and entertainment industries are among the fastest growing in the country. With new developments in videodisc technology, videocassette, cable television and compact discs, the entertainment industries are on the verge of even greater expansion. This growth creates a demand for individuals trained in music and video's technical and business aspects. The Music and Video program is taught by an experienced group of professionals. Students learn recording and video with engineers and producers, legal issues with lawyers, and concert promotion with promoters. They study the development of a hit record and the production of live concerts and videos. In addition to classroom lectures, there are scheduled hands-on classes in the college's recording studio and live performance venues. Guest speakers frequently lecture and share their experiences with students. The college also assists graduates in their job search.

AUDIO RECORDING TECHNOLOGY INSTITUTE; Course/Program Title: Theory & Practice of Audio Recording; 756 Main St.; Farmingdale, NY 11735; (516) 454-8999; (800) 543-ARTI (in NY or CA). Chief Administrator: James J. Bernarc. Program: Theory and practice of Audio Recording, 90-hour semiprivate, hands-on course. Classes held during evening hours. Extensive, hands-on experience, affordable tuition w/financing. Graduates qualify for membership in REA (Recording Engineers Association). Use of studio for their own private recording sessions. Locations in N.Y. and California.

THE AUDIO WORKSHOP SCHOOL (DIV. COMMUNICATIONS RESEARCH GROUP); Course/Program Title: Studio and Stage Sound Production: SSP 300 + 400 Series; 119 Fresh Pond Pkwy.; Cambridge, MA 02138; (617) 547-3957. Chief Administrator: Steve Langstaff. Program: New England's oldest audio school has been guiding aspiring engineers, producers and musicians since 1972. We offer comprehensive training in theory and techniques of sound engineering in collaboration with top 24/32/48-track Boston studios. Four-month program meets weekday evenings and weekends in classes that are small and personal. Program covers Acoustics, Hearing and Perception, Microphones, Analog and Digital Media and Processing, Mixing, Automation, MIDI, SMPTE, Studio and Location Production of Music, Commercials, and Audio Post for Film, Video, Vinyl and CD, Equipment Interface and Maintenance, Sound Reinforcement, Audio Business and

Finance. It includes 24-track analog and 32-track digital student projects. Harvard-educated instructor Steve Langstaff is a respected music and acoustical engineer, consultant and producer, and a member and former chairman of the New England section of the Audio Engineering Society. Noted guest instructors include Paul Lehrman, Walter Lenk and Stuart Cody. No prerequisites for SSP-301. Licensed by the Massachusetts Department of Education. Modem to Macintosh (617) 876-5159.



BELMONT COLLEGE
Nashville, TN

BELMONT COLLEGE; Course/Program Title: Music Business; 1900 Belmont Blvd.; Nashville, TN 37212; (615) 388-4504. Chief Administrator: Robert E. Mulloy. Program: Established in 1974. The program leads to a Bachelor of Business Administration (BBA), a professional degree. Students who complete the degree requirements graduate with a major in Music Business. The program stresses a strong liberal arts emphasis. Music business and traditional business courses complete the four-year degree. Forty-four courses offered allow for electives to determine the industry direction of the student. The program discourages "glamour and glitter" concept. A 24-track professional analog recording studio is housed on the campus with a second studio scheduled for completion this year. Both studios are available to Music Business majors. An industry intern program complements the academic work. An active Music Business Board of Advisors from the Nashville Music Industry serves as an advisory system for the program. The program stresses the real-world application to the academic classroom setting. Four full-time faculty and 19 adjunct professors.



BERKLEE COLLEGE OF MUSIC
Boston, MA

BERKLEE COLLEGE OF MUSIC; Course/Program Title: Music Production and Engineering; 1140 Boylston St.; Boston, MA 02215; (617) 266-1400. **Chief Administrator:** Lee Eliot Bark, president. **Program:** The Music Technology division offers four-year degree/diploma programs focusing on professional production, engineering, music synthesis skills and extensive, hands-on training. Courses include analog/digital audio, automated mixing, digital/video post-production, maintenance, music business, sound reinforcement (MIDI/ SMPTE synchronization systems, sampling, sequencing, sound design, and computer-based synthesis, processing and editing). Internship program is available. The Berklee facilities include: seven fully equipped studios (three 24-track), digital/video post-production editing room, three synthesis labs with individual workstations and MIDI-equipped ensemble/recital rooms. Our graduates are employed at A&M, BMG, CBS, GRP and PolyGram Records; Capitol, Conway, Criteria, Masterdisk, Hit Factory, Power Station, Record Plant and Unique Studios; Korg, Kurzweil, New England Digital, Roland and Yamaha. Selected production projects are included in an annual CD release. We are proud to have received three consecutive TEC Awards.



CAREER INSTITUTES OF AMERICA
Miami Beach, FL

CAREER INSTITUTES OF AMERICA; Course/Program Title: Audio-Video Training Center; 1205 Washington Ave.; Miami Beach, FL 33139; (305) 531-3300; (800) 762-4466. **Program:** Learn audio recording and production. Train with Mert Paul, former VP, CBS Records. Intensive one-year program also includes video production; promotion, marketing and airplay; copyright law; contracts; artist management; music publishing; and concert production. Financial aid for those who qualify. Employment assistance. Housing available. Call for free brochure.

CAYUGA COMMUNITY COLLEGE; Course/Program Title: Telecommunications Technology—Audio Specialization; Franklin St.; Auburn, NY 13021; (315) 255-1743. **Chief Administrator:** Steven Keefer.

CENTER FOR THE MEDIA ARTS; Course/Program Title: Audio Arts; 226 W. 26th St.; New York, NY 10001; (212) 929-6999; (800) CMA-2297 (outside NYC). **Chief Administrator:** Michael Martin, vice president of admissions. **Program:** Supervised by an experienced team of recording industry professionals, students at CMA learn audio production through equipment-intensive training. The Basic Audio Recording Techniques core curriculum explores a broad range of areas within the audio and music industries, including music recording, mixing and editing, and business practices. Students then specialize in one of three areas: Audio Engineering (training for careers in recording studio engineering and management);

MIDI/Synthesizer Specialist (the study of synthesis techniques, digital sampling, sound design and its application to MIDI-sequenced music and video soundtracks); Music Producer (training in music production including composition, arranging and recording). All students receive hands-on training in the main 24-track studio as well as in our mixing, editing, post-production and MIDI suites. The Center for the Media Arts is accredited by the National Association of Trade and Technical Schools (NATTS) and licensed by the New York State Education Department.

COLLEGE OF ST. ROSE; Course/Program Title: BS in Music, concentration in Studio Music; 432 Western Ave.; Albany, NY 12203; (518) 454-5178. **Chief Administrator:** Mary Ann Nelson. **Program:** The College of Saint Rose's Studio Music program leads to a BS degree in music with a concentration in studio music. The studio music component focuses on strong musical performance, writing, arranging and improvisation, as well as studio production, recording technology and television production. Admission is by audition. Catalog and application information: CSR Admissions Office (518) 454-5150.

DARTMOUTH COLLEGE; Course/Program Title: Master of Arts in Electro-Acoustic Music; **Department of Music, Hopkins Center;** Hanover, NH 03755; (603) 646-2520. **Chief Administrator:** Jon Appleton. **Program:** A two-year program combining study in music, computer science and engineering for students with a bachelor's degree in one of these fields. Other requirements include ability to play musical instrument and knowledge of music history and theory. Intended for those who will work in the music industry as designers, producers, artists or consultants involved with new technology. Seminars in timbre, musical systems, computer music languages, acoustics, music cognition, history and analysis of electro-acoustic music and composition. Collaboration with New England Digital Corp. and Apple Inc. Three students admitted each year, all guaranteed fellowships and stipends. Faculty: Jon Appleton (director), Kathryn Alexander, Jamshed Bharucha, Larry Polansky, Michael Sturge. Not a recording arts program.

DUQUESNE UNIVERSITY—SCHOOL OF MUSIC; Course/Program Title: Bachelors of Music in Sound Recording Techniques; 600 Forbes Ave.; Pittsburgh, PA 15282; (412) 434-6081. **Chief Administrator:** Dean Michael Kumer, Tomas J. Kikta, Jr., dir. Rec. Arts. **Program:** Duquesne University's new four-year program fills a void in existing offerings elsewhere by combining the music and technical aspects of today's musical fields into a single, comprehensive package. In addition to their major instrument, students will gain exposure and hands-on expertise in such areas as electronics, recording theory, computerized music application, music production, acoustics and studio design and management. At the same time, student will complete traditional elements of the music curriculum such as piano, theory, solfège, eurhythmics, composition, conducting and music history and literature. All recording training takes place in Duquesne's new multitrack/synthesis facility. For additional information and equipment list, please contact the School of Music at (412) 434-6080.

DUTCHESS COMMUNITY COLLEGE; Course/Program Title: Communication and Media Arts; 53 Pendell Rd.; Poughkeepsie, NY 12601-1595; (914) 471-4500. **Chief Administrator:** Eric Somers. **Program:** Audio coursework is part of a larger audio/video production program leading to an AS degree. Facilities include 30 x 40 16-track recording studio, three radio production rooms, 40 x 60 television studio with high-end broadcast equipment, SMPTE editing, animation lab, etc. Open admissions policy. Scenic Hudson Valley location. Easy access by commuter train or car to NYC.



ELIZABETH CITY STATE UNIVERSITY
Elizabeth City, NC

ELIZABETH CITY STATE UNIVERSITY; Course/Program Title: BS in Music Industry Studies w/Music Engineering & Technology; ECSU Department of Music; Elizabeth City, NC 27909; (919) 335-3359. **Chief Administrator:** Dr. Willie Sullivan, Barry R. Hill. **Program:** As a rapidly expanding constituent of the University of North Carolina, Elizabeth City State University offers quality education within a small campus environ-

ment. With the music degree program, ECSU offers a BS in Music Industry Studies with a concentration in Music Engineering & Technology. Our newly completed 24-track facility features a Trident console with Otari multitrack and mastering tape machines, DAT mastering and remote recording, and an array of outboard gear and microphones by Lexicon, Neumann, AKG, etc. The curriculum involves studies in studio recording and production, acoustics and studio design, digital audio, MIDI, computer applications, electronics and sound reinforcement. Our MIDI/Electronic Music Laboratory, scheduled for completion by fall 1990, will facilitate studies in music synthesis and electronic music production. ECSU offers low in-state and out-of-state tuition (\$591/\$2,512 per semester) and is located within 60 miles of Norfolk, Virginia, and the North Carolina Outer Banks resort areas.

FIVE TOWNS COLLEGE; Course/Program Title: Audio Recording Technology; 2165 Seaford Ave.; Seaford, NY 11783; (516) 783-8800. **Chief Administrator:** Dr. Stanley Cohen. **Program:** The AAS degree program in business management with a concentration in audio recording technology is intended for those students who wish to enter the recording field directly after completion of their studies at the college. Students will acquire a knowledge of the technical equipment and processes used in recording studios; the ability to produce both an artistically and commercially acceptable master recording for a record company, publishing company, broadcasting company, etc.; and an understanding of the various financial aspects involved in establishing and operating a recording studio business. All courses are taught in the new state-of-the-art 24-track recording studio. The college also offers two-year degree programs in jazz/commercial music, music business, music instrument technology and video arts. It is fully accredited by the Middle States Association (MSA).

FRANKLIN INSTITUTE OF RECORDING SOUND TECHNOLOGY (F.I.R.S.T.); Course/Program Title: One-on-One Engineering Course (18 weeks); PO Box 1121; Franklin, TN 37065; (615) 794-3660. **Chief Administrator:** Danny M. Hilley.

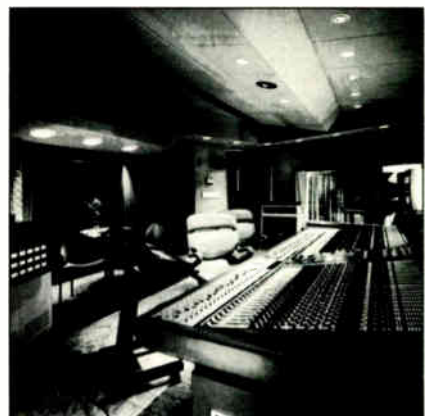

FULL SAIL CENTER FOR THE RECORDING ARTS
Winter Park, FL

FULL SAIL CENTER FOR THE RECORDING ARTS; Course/Program Title: Recording Arts Comprehensive Program/Video on Film Production; 3300 University Blvd.; Winter Park, FL 32792; (407) 679-0100; (800) 221-2747 (outside FL). **Chief Administrator:** Jon Phelps, Garry Jones. **Program:** Comprehensive programs in audio and/or video and film cover the major aspects of their respective industries including recording engineering, record production, post-production, the tapeless studio, digital recording, music video, concert sound and lighting, MIDI music business, video production, cinematography, set design and special effects. 2,613 contact hours are offered with over 1,350 hours of hands-on labs utilizing equipment including: Neve, SSL and Sony consoles; Studer, Otari and Ampex recorders; Synclavier and Direct-to-Disk™ digital recorders; and CMX, Chyron, Grass Valley and Ikegami video gear. Programs offer six-week externships where students choose the facilities/locations whenever possible. Short courses are available. Full Sail is the winner of the 1989 TEC Award for best audio school; the official training center for New England Digital and Neve; nationally accredited by NATTS; capable of offering financial aid to those who qualify. Call and tell us about your career goals. We take your dreams seriously.

GEORGIA STATE UNIVERSITY; Course/Program Title: Commercial Music/Recording Program; University Plaza; Atlanta, GA 30303; (404) 651-3513. **Chief Administrator:** Frederick J. Taylor. **Program:** The Department of Commercial Music/Recording offers the Bachelor of Science degree with a major in Commercial Music/Recording. Student may pursue a four-year program of study with a concentration in music business or engineering/production. The purpose of the program is to prepare students for entry positions in many areas of the music industry—such as record promoters, studio managers, copyright lawyers and recording engineers. Recording courses

—LISTING CONTINUED ON NEXT PAGE

CAREERS IN

music and video BUSINESS

Enter the exciting and lucrative world of the entertainment industry! Learn the business and the technical aspects of music & video production from top professionals! An 18 month degree program. Check choice of school location below.

CALL TOLL FREE, OR WRITE

1-800-424-2800

Atlanta Houston Seattle Ft Lauderdale
 Dallas Pittsburgh Colorado Philadelphia

YES, I would like information
about your Programs!

NAME _____ YR. H.S. GRAD _____

ADDRESS _____

CITY _____ STATE _____ ZIP _____

PHONE _____ SC49MX

The Art Institutes
626 Penn Ave., Pittsburgh, PA 15222

Circle #141 on Reader Service Card

GOLD LINE LOFT

NEW: LOFTECH TS-2 IMPEDANCE METER & AUDIO TEST SET



Impedance Meter, dB Meter
Audio Oscillator
& Frequency Counter

CONTRACTOR PRICES Send for free catalog:

Box 500, West Redding, CT 06896
PH (203) 938-2588 FAX (203) 939-8740
(800) 433-6373

Circle #181 on Reader Service Card

E A S T E R N

RECORDING SCHOOLS

SEMINARS & PROGRAMS

—LISTING CONTINUED FROM PREVIOUS PAGE

offer practical, hands-on experience in analog and digital technology at New Age Sight and Sound Studios (see February '90 Southeast Studio listing). Courses are also offered in MIDI and electronic music. The internship program places students at businesses such as record companies and studios throughout the nation. All instructors are active professionals in the music industry with a minimum of a master's degree. If interested please call or write for additional information.



INSTITUTE OF AUDIO RESEARCH
New York, NY

INSTITUTE OF AUDIO RESEARCH; Course/Program Title: Multitrack Recording Technology Program; 64 University Pl.; New York, NY 10003; (800) 544-2501; (212) 777-8550 (NY, NJ, CT). **Chief Administrator:** Albert B. Grundy, Miriam Friedman. **Program:** The 600-hour program features the techniques and technology of the multitrack recording studio. Students perform hands-on recording sessions with professional bands in IAR's studio complex with both analog and digital consoles and tape machines, outboard equipment, as well as a complete MIDI studio with 64-track digital sequencer. IAR offers a unique training opportunity through its cooperative program with Solid State Logic. IAR students receive special training in signal flow and console operation on the SSL 6000G. (Advanced SSL training is also available in both operations and maintenance for working engineers.) Each student can intern at one of the top recording studios in New York City and lifetime graduate placement assistance is available from the first job on up. IAR also offers a comprehensive Video Technology Program and an assortment of short courses, such as live sound reinforcement, advanced MIDI, maintenance engineering and more. IAR is fully accredited by NATTS and offers federal financial aid programs to eligible students, as well as veterans' benefits.

THE INTERNATIONAL FILM & TELEVISION WORKSHOPS; Course/Program Title: Workshops in Film Location, Sound and Music; Rockport, ME 04856; (207) 236-8581; FAX: (207) 236-8581. **Chief Administrator:** David H. Lyman. **Program:** The International Film Workshops: film's largest and most respected workshop program and center. Seven one-week summer workshops in: Location Sound Recording for Documentaries and Commercials, Feature Film Sound Recording workshops, Film Scoring workshops, Electronic Music for Video and Film. Tuition: \$800. Room and board begins at \$375. Write or call for a free 60-page catalog listing more than 100 workshops.

LEBANON VALLEY COLLEGE; College Ave.; Annville, PA 17003; (800) 223-6181 (PA); (800) 445-6181 (outside PA). Chief Administrator: John J. Uhl. **Program:** The Sound Recording Technology program at Lebanon Valley College is a comprehensive course of study combining the art, science and philosophy of recording. The students follow a variety of disciplines involved in the field of audio engineering including: recording technology, music, physics, electronics, mathemat-

ics, computer science, business administration and selected courses in the liberal arts. Emphasis is placed on student usage of equipment in laboratory and level 500 courses. All applicants to the program must pass a musical audition for acceptance. The degree conferred is a Bachelor of Music: Sound Recording Technology and meets NASM standards.



MEMPHIS STATE UNIVERSITY
Memphis, TN

MEMPHIS STATE UNIVERSITY; Course/Program Title: Commercial Music; CFA 232; Memphis, TN 38152; (901) 678-2559. **Chief Administrator:** Larry Lipman. **Program:** Bachelor of Music in Commercial Music with concentrations in recording technology and music business. Fully accredited by NASM. A thorough understanding of fundamental concepts and techniques is stressed within each concentration. Equal emphasis is placed upon developing the student's ability to adapt quickly to new practices, technologies and creative direction. Our faculty members have been carefully selected to ensure that students work with instructors who possess a broad knowledge of music industry practices and who are actively involved in today's commercial music industry. Modern production facilities include a comprehensive 24-track studio, video production suite, electronic music lab and Synclavier digital audio workstation. (See Southeast Studios Master Directory for complete equipment list.) The Memphis arts community offers diverse cultural opportunities and a rich assortment of internship possibilities. A commitment to personal attention and quality instruction requires that enrollment be limited and based on selective procedures.

MIAMI SUNSET SENIOR HIGH SCHOOL; Course/Program Title: TV Production/Electronic Music; 13125 SW 72nd St.; Miami, FL 33183; (305) 385-4255. **Chief Administrator:** Daniel B. Sell. **Program:** Sunset offers a three-year curriculum in television production and electronic music (recording engineering). Students in TV work in a four-camera color studio with computer-assisted editing, telecine and intermat; dubbing. Students produce commercials, live closed-circuit broadcasts and daily news, and record schoolwide events including four camera remotes. Students involved in audio use the eight-channel Tascam/Tapco studio complete with dbx and many outboard accessories. Students also study sound reinforcement using our Yamaha P.A. system. Most projects include combining the TV, recording and sound reinforcement equipment. These programs are open to all full-time students in the school.



MIDDLE TENNESSEE STATE UNIVERSITY
Murfreesboro, TN

MIDDLE TENNESSEE STATE UNIVERSITY; Course/Program Title: Recording Industry Management; PO Box 21, MTSU; Murfreesboro, TN 37132; (615) 898-2578. **Chief Administrator:** Geoffrey Hull. **Program:** Recording Industry Management (RIM) is a four-year Bachelor of Science degree pro-

gram in music business and audio engineering. RIM offers 64 semester hours of courses in audio and the recording industry, ranging from acoustics, maintenance and survey of the record industry to concert promotion. Audio students work in two studios on campus, a 24-track digital room and a 24-track analog room. Internships are available for senior-level students in audio and music business. Approved minors include mass communications, business, music, electronics and entertainment technology. Video instruction is available. Three MIDI/electronic music courses are offered. The School of Mass Communication is accredited by ACEJMC. A new building with video soundstage and two recording studios is planned for fall 1991. The program has eight full-time faculty and over 500 majors from 35 different states. Current tuition, full-time, \$616/semester in-state; \$2,093 out-of-state.

THE MUSIC FACTORY ENTERPRISES, INC.; Course/Program Title: Audio Engineering/The Recording Arts; Ste. 300, Ford & Washington Sts.; Norristown, PA 19401; (215) 277-9550. Chief Administrator: Jeffrey Calhoon.

MUSICATION MEDIA; Course/Program Title: Music Technology/Multimedia Applications; 1600 Broadway, Ste. 1000A; New York, NY 10019; (212) 957-9100. Chief Administrator: Jamie Blackman. Program: Musication offers individual instruction geared to the needs and interests of the performer, composer, arranger, producer and engineer. Special emphasis is placed on understanding the language of MIDI, music technology and multimedia applications. Participants can design their own curriculum and do individual study on state-of-the-art music, computer, video and audio equipment. For more information please contact or write. Rates are based on an hourly or course fees. For a free catalog please call or write.

NEW YORK UNIVERSITY; Course/Program Title: Music Business and Technology; Dept. of Music and Music Education; 35 W. 4th St., Rm. 777; New York, NY 10003; (212) 998-5432. Chief Administrator: Dr. Ken Peacock (tech.), Steve Engle (business manager). Program: New York University offers specialized courses in analog synthesis; computer music, FM synthesis, MIDI, electronic music composition, film scoring, studio production and audio engineering. Four-year programs lead to Bachelor of Music degrees in music business and technology, composition, performance, jazz studies and music education. Non-degree, special-student status is available to those wishing to enroll only in specific classes. Graduate studies leading to MA, DA, Ed.D. and PhD degrees are also offered. NYU recording and electronic music studios are continually being upgraded. Current facilities include a 16-track recording studio, three 8-track studios and two 4-track studios. All are MIDI-equipped with computers (IBM, Atari, Macintosh, Amiga, Yamaha) and a varied selection of synthesizers (Yamaha, Korg, Fairlight, Voyetra, McClavier, Arp, Buchla, Serge), mixers, monitoring systems and a wide assortment of outboard gear. Research laboratories provide opportunities for the application of computers and MIDI in music education and music therapy. Advanced techniques in digital synthesis and computer-aided composition are explored using the school's DEC PDP11-44 computer system.

JOSH NOLAND MUSIC STUDIO; Course/Program Title: Introduction to the Art of Recording; 760 W. Sample Rd.; Pompano Beach, FL 33064; (305) 943-9865. Chief Administrator: Josh Noland.

THE OMEGA STUDIOS' SCHOOL OF APPLIED RECORDING ARTS AND SCIENCES; Course/Program Title: Studio Techniques, Advertising Production, MIDI; 5609 Fishers Ln.; Rockville, MD 20852; (301) 230-9100; FAX: (301) 230-9103. Chief Administrator: W. Robert Yesbek. Program: The Omega Studios' School, presently in its 14th year, offers a Basic Program (32 hours, \$595), an Intermediate Program (32 hours, \$795), an Advanced Program (40 hours, \$995), an Advertising Production Program (24 hours, \$695), a Basic Electronic Music and MIDI program (32 hours, \$795) and an Advanced Electronic Music and MIDI program (40 hours, \$995). The courses include lectures and workshops covering acoustics; microphone, signal processor and tape machine theory; console operation (taught on SSL, API and Audiotronics consoles); computer sequencing; synthesizer operation and programming; audio-for-video; jingle production and voice-over techniques. All programs include extensive hands-on training in all four of Omega's control rooms and studios. Approved by the Maryland Higher Education Commission, approved for veterans' training, and certain courses are available for accreditation by The American University in Washington, D.C.

PEABODY INSTITUTE OF THE JOHNS HOPKINS UNIVERSITY; Course/Program Title: Bachelor of Recording Arts and Sciences; 1 East Mt. Vernon Pl.; Baltimore, MD 21202; (800) 368-2521. Chief Administrator: Alan P. Kefauver. Program: The Recording Arts and Sciences department of the Peabody Institute of The Johns Hopkins University offers a five-year program of training culminating in a Bachelor's of Music degree. The program combines the musical strengths of the world-famous Peabody Conservatory of Music with the technical expertise of the electrical engineering program at Johns Hopkins. Approximately ten students per year meet the qualifications for acceptance into this prestigious program, which requires a musical audition and high math SATs. Students are trained in the conservatory's automated analog/digital 24-track recording studio with a variety of music. From classical string

quartets through high-intensity techno-popular styles, hands-on training and in-studio lectures are combined with the classroom in music and engineering to produce highly qualified recording engineer/producers whose technical abilities match their musical expertise. Scholarship aid is available, and all students are employed by the studio during their course of study.

SCHOOL OF MODERN RECORDING; Course/Program Title: Recording Techniques; 753 Capitol Ave., Media Arts Center; Hartford, CT 06106; (203) 951-8175. Chief Administrator: Jack Stang.

SONY PROFESSIONAL AUDIO TRAINING GROUP; 1400 W. Commercial Blvd.; Ft. Lauderdale, FL 33309; (305) 491-0825. Chief Administrator: Raymond Callahan. Program: All courses are offered as either factory training in Fort Lauderdale or on-site at the customer's location. The curriculum is two-fold: 1. Technical service training classes designed to provide technical service engineers with knowledge and confidence to service and maintain Sony Professional Audio products in the field. A two-year electronics degree is required for this training. 2. Applications engineering classes designed to provide the sales/recording/service engineers with the knowledge necessary to effectively recommend, demonstrate and specify Sony Professional Audio equipment. All courses stress hands-on time, enabling students to become confident with operating and/or servicing the specific equipment. Call our

SONY®

SONY PROFESSIONAL AUDIO TRAINING GROUP
Ft. Lauderdale, FL

offices for course listings, prerequisites, tuition fees and latest schedule information.

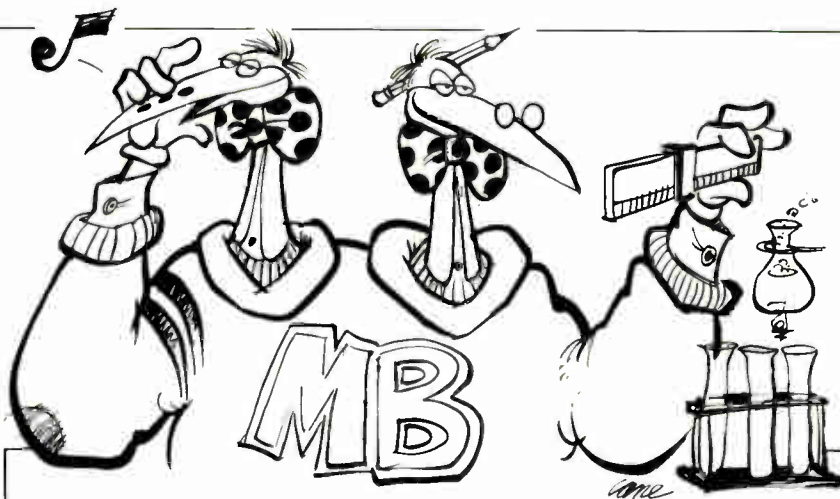

"Musica Brainious"

This rare, two-headed bird is a top-flight high school musician—good enough to enter a major conservatory. He (or she) is also a whiz at science and math—good enough to enter a highly selective liberal arts college.

Musica Brainious will thrive in the Recording Arts and Sciences degree

program at the Peabody Conservatory of Music. Here this bird migrates between the musical performance atmosphere of the conservatory and the electrical engineering territory of The Johns Hopkins University. When mature, he (or she) works anywhere music is performed, preserved or transmitted.

If you spot a Musica Brainious in your classroom, tell him (or her) about the Bachelor of Music in Recording Arts and Sciences at the Peabody Conservatory of The Johns Hopkins University.

A rare program for a rare bird.

For application and scholarship information, please contact:
David Lane, Director of Admissions

The Peabody Conservatory of Music
OF THE JOHNS HOPKINS UNIVERSITY

One East Mount Vernon Place
Baltimore, Maryland 21202
Toll Free 800/368-2521
in Maryland 301/659-8110

Peabody Conservatory / Fine Tuning

Circle #182 on Reader Service Card

CLEAN PATCH BAYS NO DOWN TIME

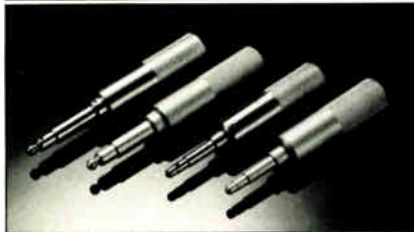

VERTIGO BURNISHERS AND INJECTORS RESTORE ORIGINAL PERFORMANCE TO YOUR PATCH BAYS

VERTIGO 1/4" TRS AND TT BURNISHERS:
Each used to eliminate noise caused by contamination of main contacts in normal patching situations.

VERTIGO 1/4" TRS AND TT INJECTORS:
Each allows injection of cleaning solvent in breaking contacts (normals), to eliminate intermittency that occurs when patch cord has been removed.

ONLY \$34.95 Ea. (Cont. USA) Please write for additional information and order form. Used by Professionals Worldwide. US Patent No. 4,733,678

VERTIGO RECORDING SERVICES
12115 Magnolia Blvd. #116
North Hollywood, CA 91607
Telephone: (818) 907-5161
Fax: (818) 784-3763

Circle #183 on Reader Service Card

DISC MAKERS

CD Replication

- Fast Delivery
- Small Quantities



**500 CDs and
500 Chrome
Cassettes for
'2990
COMPLETE
PACKAGE PRICE!**

Call today
for complete
details and our
FULL COLOR
CATALOG



1-800-468-9353
In PA (215) 232-4140

DISC MAKERS

1650 Broadway, Suite 1010
New York, NY 10019
(212) 265-6662

Circle #184 on Reader Service Card

E A S T E R N

RECORDING SCHOOLS

SEMINARS & PROGRAMS

STATE UNIVERSITY OF NEW YORK COLLEGE AT FREDONIA; Course/Program Title: Sound Recording Technology; c/o School of Music; Fredonia, NY 14063; (716) 673-3151. Chief Administrator: Ros Ritchie.

STATE UNIVERSITY OF NEW YORK AT OSWEGO; Course/Program Title: Radio-Audio Production/Broadcasting/Mass Communication; Lanigan Hall; Oswego, NY 13126; (315) 341-2357. Chief Administrator: Frank J. Messere.

UNITY GAIN RECORDING INSTITUTE; Course/Program Title: Audio Recording Comprehensive Program; 2976-F Cleveland Ave.; Fort Myers, FL 33901; (813) 332-4246. Chief Administrator: Anthony Iannucci. Program: Fort Myers' newest recording institute offers a 36-week program in Audio Recording. Classes are limited to five, providing each student with semiprivate instruction. Our 108-hour program includes over 70 hours hands-on time utilizing the institute's professional multitrack facility. The course is comprised of three levels: Introduction to Audio Engineering, Advanced Techniques in Audio Engineering and the Audio Recording Workshop. Throughout the course each student participates in recording 14 different musical groups. Equipment used in lab include: Soundtracs PC MIDI 24 console; Lexicon, Eventide, Korg, Aphex and dbx outboard gear; Mac SE, Professional Performer sequencer, Akai sampler and Roland D-50 synthesis, AKG, Sennheiser, Electro-Voice, Neumann and Shure microphones. Upon completion of course, each student receives a certificate of completion, a complete listing of all audio facilities nationwide and is provided with placement assistance in the area of his/her choice. For further information, or to receive a free catalog, please call or write.

UNIVERSITY OF LOWELL; Course/Program Title: Sound Recording Technology; College of Music; Lowell, MA 01854; (508) 934-3850. Chief Administrator: Dr. William Moylan. Program: The University of Lowell offers three degree programs in Sound Recording Technology: the Bachelor of Music degree with a major in Sound Recording Technology, and minors in SRT for Electrical Engineering and Computer Science majors. The program's facilities include: 24-track studio (automated and digital), video post-production and multitrack studios, concert recording and sound reinforcement facility, sound synthesis and MIDI studio, equipment design and maintenance laboratory. The Bachelor of Music degree in Sound Recording Technology is offered through the College of Music. The program produces musically sophisticated and sensitive professionals with sufficient technical knowledge to excel in the present production industry and to easily keep pace with the changing technology. The program combines studies in physics, electrical engineering, computer science and calculus with traditional studies in music, and at least nine courses in the art and technology of recording. The University of Lowell's interns have been placed from Tanglewood to Hollywood.

UNIVERSITY OF MIAMI; Course/Program Title: Music Engineering; School of Music; Coral Gables, FL 33124; (305) 284-2439. Chief Administrator: Ken Pohlmann. Program: The Music Engineering program at the University of Miami offers a four-year Bachelor of Music Engineering degree, with a minor in electrical engineering, as well as a two-year Master of Science, Audio Engineering degree. Courses in the undergraduate curriculum include recording engineering, digital audio, acoustics and studio design, studio maintenance, video production, computer programming, circuit theory, music business, music theory, arranging and performance. The graduate curriculum includes study in advanced digital audio, video, psychoacoustics, electrical engineering and a research thesis. Only students of the highest caliber are considered for admission to these programs. The principle recording studio houses an automated Sony MXP-3036 console, MCI 24-track and Sony 2-track recorders, 3M digital recorder, dbx digital audio processor, Audio Kinetics synchronization system, Sony 3/4-inch video recorders, a Synclavier system and other equipment. Our recent graduates enjoy the highest placement rate in the professional audio industry, and have engineered gold, platinum and Grammy-winning albums.

UNIVERSITY OF NEW HAVEN; Course/Program Title: BA/BS in Music & Sound Recording; 300 Orange Ave.; West Haven, CT 06516; (203) 932-7102. Chief Administrator: Michael G. Kaloyanides.

UNIVERSITY OF NORTH ALABAMA; Course/Program Title: Bachelor of Arts/Science in Commercial Music; Box 5040, Univ. of North Alabama; Florence, AL 35632-0001; (205) 760-4361. Chief Administrator: Dr. James K. Simpson. Program: General Studies: 44 to 55 semester hours. Music Core: Music Theory, 12 to 15 sem. hrs.; Music Literature & Music History, 9 sem. hrs.; Conducting, 2 sem. hrs.; Orchestration, 2 sem. hrs.; Musical Activities, 5 sem. hrs.; Class and/or Applied Music, 7 sem. hrs.; Music Electives, 4 sem. hrs. Prescribed Business Administration minor and supporting sources (24 semester hours): Accounting 291, 292 (6) Elementary Accounting, Business Law 280 (3) Business Law I, Management 330 (3) Principles of Management, Marketing 360 (3) Marketing 373 (3) Principles of Advertising, Math & Computer Science (6). Commercial Music (18 semester hours): Music Publishing (3), Record Company I & II (6), Studio Techniques (3), Production (3), Commercial Music Production (3). Music Dept. is a member of the National Assoc. of Schools of Music.

Music with Recording Arts



UNCA
University of North Carolina Asheville

UNIVERSITY OF NORTH CAROLINA-ASHEVILLE
Asheville, NC

UNIVERSITY OF NORTH CAROLINA-ASHEVILLE; Course/Program Title: Bachelor of Science in Music with Recording Arts; UNCA Department of Music; Asheville, NC 28804-3299; (704) 251-6432. Chief Administrator: Dr. Wayne J. Kirby. Program: Bachelor of Science in Music and Recording Arts or Bachelor of Arts in Music. Distinguished music faculty includes Dr. Robert Moog, the inventor of the Moog synthesizer. The BS degree program is designed for aspiring musicians interested in both the creative and technological aspects of music recording and production. This program includes practical experience in on-campus facilities, which house a multitrack recording studio, computer-based electronic music/digital synthesis laboratory, digital editing lab and maintenance/repair lab. Studies include MIDI, SMPTE, digital recording, sound reinforcement, synthesis, sound sampling, multitrack recording, acoustics, studio performance. Electives include: composition, jazz improvisation, arranging, music business and other profession-oriented courses. Minors are available in computer science, management, communications and theater. Internships are available to qualified students. In-state tuition and fees for one semester, approximately \$558; out-of-state, approximately \$2,551. Limited enrollment by audition.

PHILIP J. WEAVER EDUCATION CENTER; Course/Program Title: Electronic Music—high school students; 300 S. Spring St.; Greensboro, NC 27435; (919) 370-8282. Chief Administrator: Dr. Howard Braxton, Ronald W. Follas.

WIDENER UNIVERSITY; Course/Program Title: Musical Aspects of Recording; Widener University; Chester, PA 19013; (215) 499-4338. Chief Administrator: John Vanore.

CENTRAL

THE ART INSTITUTE OF DALLAS; Course/Program Title: Music and Video Business; 8080 Park Ln.; Dallas, TX 75231; (800) 441-1577. Chief Administrator: Terry Pope, program director. Program: The Music and Video Business program at The Art Institute of Dallas is an intensive, 18-month program in music and entertainment management. The program focuses on the specialized knowledge needed to begin a career in the business or technical side of the music, recording, video or entertainment industry. Musicians, songwriters and performers can redirect their careers with practical music-business knowledge. Other students who start with only a love for music soon develop marketable skills and explore new career directions. The MVB program is taught by an experienced, energetic group of industry professionals. Students become familiar with how professionals develop a hit record and produce a live concert or music video. Students also learn the marketing, sales, promotion, legal, financial and business management sides of the music industry. The Institute also assists graduates in their job search by helping them determine career goals and by offering assistance in preparing resumes, conducting interviews and establishing job leads. Financial aid



The Art Institute of Dallas

Two NorthPark • 8080 Park Lane
Dallas, Texas 75231-9959

THE ART INSTITUTE OF DALLAS
Dallas, TX

(if you qualify), part-time employment assistance and housing assistance are available. Call the institute at 1-800-441-1577 for more information.

AUDIO ENGINEERING INSTITUTE; Course/Program Title: Modern Recording Techniques I & II, 8535 Fairhaven; San Antonio, TX 78229; (512) 340-8776. **Chief Administrator:** Marius Perron III.

BOWLING GREEN STATE UNIVERSITY; Course/Program Title: Recording Technology Minor, College of Musical Arts; Bowling Green, OH 43403; (419) 372-2181. **Chief Administrator:** Dr. Robert Thayer. **Program:** The Recording Technology Minor is a supplementary program that provides students with classroom and lab experiences that familiarize them with the equipment and techniques used in a modern recording studio. By means of elective courses, students can emphasize either the business or technical aspects of the industry or create any combination of these. The studio houses 16 tracks, many of the most popular: sound processors, over 80 microphones, and the latest in computer-assisted digital editing and hard-disk recording.

BROWN INSTITUTE; 2225 E. Lake St.; Minneapolis, MN 55407; (612) 721-2481. Chief Administrator: Donald W. Swanson, electronics dept. chmn. **Program:** Brown Institute, a National Education Center, is a technical school that offers an associate degree program in electronics technology. We are accredited by the National Association of Trade and Technical Schools. Audio recording technology is one of several areas of specialization that students may choose to pursue after having completed five quarters (1,200 hours) of electronics fundamentals. Students in the audio program are trained in systems analysis, as well as component-level troubleshooting. Topics covered in the program include the following: 1) sound, hearing and acoustics, 2) audio amplifier design and troubleshooting, 3) studio/tape recorder maintenance and repair, 4) editing and master tape preparation, 5) mixing console operation, maintenance and troubleshooting, 6) signal processing equipment operation, maintenance and troubleshooting, 7) synchronization techniques, MIDI and SMPTE, 8) microphone types, applications and placement techniques, 9) digital audio media. NEC-Brown Institute's audio recording technology program combines operations training with equipment maintenance in order to meet the needs of the industry.

CAPITAL UNIVERSITY CONSERVATORY OF MUSIC; Course/Program Title: Music Industry; 2199 E. Main St.; Columbus, OH 43209; (614) 236-6411. **Chief Administrator:** Paul K. Formo, dean. **Program:** A bachelor's degree (four-year program) with elective options in music merchandising and music media. Designed to provide undergraduates with a solid base of traditional and contemporary musical training. Music study is supplemented with studio recording techniques taught in conjunction with The Recording Workshop in Chillicothe, Ohio. This degree can be combined with a second major (business, communication, etc.) or a minor in one of the liberal arts areas.

CEDAR VALLEY COMMUNITY COLLEGE; Course/Program Title: Commercial Music Recording Technology; 3030 N. Dallas Ave.; Lancaster, TX 75134; (214) 372-8127. **Chief Administrator:** Helen Spencer, Ph.D. **Program:** Commercial Music Recording Technology (two-year associate degree). This two-year program is designed to provide the technical and musical skills necessary in the field of recording technology. Musical skills include vocal, instrumental and MIDI-based, computer-driven synthesis. Technical skills include electronic and acoustical theory, multitrack recording, automated mixing, session planning, session procedure, digital recording and troubleshooting.

THE CLEVELAND INSTITUTE OF MUSIC; Course/Program Title: Audio Recording degree program; 11021 East Blvd.; Cleveland, OH 44106; (216) 791-5000. **Chief Administrator:** Tom Knab, department head. **Program:** The Cleveland Institute of Music offers a unique conservatory setting for learning audio/music production while pursuing a BM in Audio Recording. Courses cover a audio system design and operation, digital audio, advanced microphone techniques, multitrack recording, signal processing, audio for video production and post, and MIDI/synthesis. Internship, independent projects and four years professional experience in audio service round out the program. Classical music recording studies are done under the guidance of multiple Grammy-winner Jack Renner of Telarc International. Guest lecturers include Dr. Peter D'Antonio, John Earle and Shawn Murphy. The Institute offers excellent orchestras and top-quality musicians for collaboration. We emphasize musical and aural acuity development as well as technical excellence. Two well-equipped studios and limit of 16 majors allow for plenty of hands-on time and personalized instruction. Strong musical and academic entrance requirements. Minor in Electrical Engineering available through Case Western Reserve University.

COLUMBIA COLLEGE; Course/Program Title: Sound Engineering; 600 S. Michigan Ave.; Chicago, IL 60605; (312) 663-1600, ext. 354. **Chief Administrator:** Douglas R. Jones. **Program:** The Columbia College Sound Program is designed to educate tomorrow's professional sound person. Our classes include basic sound practices, electronics for audio, mix-down, sound system design, digital audio and the first Time Delay Spectrometry Lab anywhere, with six Tachron Tef 12 Plus computers. The dept. of Radio and Sound offers 53 credit hours in audio (14 classes) with an additional 50+ credit hours from other depts. in the college. Students can earn either a four-year Bachelor of Arts degree or a 36-credit hours, two-year certificate.

ELMHURST COLLEGE; Course/Program Title: Music Business Program; 190 Prospect; Elmhurst, IL 60126; (708) 617-3515. **Chief Administrator:** Tim Hays. **Program:** Located in the Chicago metropolitan area, Elmhurst College is a nationally accredited institution that offers both a BS and a BM in music business. In addition to classwork in music, business and business of music, students get hands-on industry experience through internships, industry speakers and course tours to locations as diverse as Los Angeles, New York City and West Germany. Resources include a 16-track studio with digital mastering that has just come online in the college's new Computer

—LISTING CONTINUED ON NEXT PAGE

The power that Pro's rely on

Discover why more professionals are switching over to the superior sound of Carvin's FET series amps than any other power amp made. It's not just reliability, but the pure sound of Carvin's MOSFET circuitry that makes the difference.

CARVIN sells FACTORY DIRECT giving you more performance for your dollar. Call toll-free 800-854-2235 for information or to order your FET amp today. You be the judge—all FET amps are sold on a money back guarantee!

Sound reinforcement / Studio users:

- Derrek Allen (Janet Jackson)
- Jay Azzolina (Spyro Gyra)
- Jennifer Batten
- Jason Becker (David Lee Roth)
- Bob Bradshaw
- Vito Bratta (White Lion)
- Oingo Boingo
- Craig Chaquico (Starship)
- Chris DeGarmo (Queensryche)
- Mick Fleetwood (Fleetwood Mac)
- George Lynch (Dokken)
- Lee Ritenour
- David Rosenthal (Robert Palmer)
- Dave Sabo (Skid Row)
- Steve Vai
- Frank Zappa

FACTORY
DIRECT

FET400 400 watts ~~\$895~~ **\$519**

FET900 900 watts ~~\$1195~~ **\$669**

Outside the USA: See your dealer

CARVIN

800-854-2235

Write for FREE full color catalog:
CARVIN, MX28, 1155 Industrial Ave.
Escondido, CA 92025



Hollywood Store: 7414 Sunset Blvd. (213) 851-4200

PERFORMANCE TESTED

"When you compare the performance of the FET power amplifier with that of other amplifiers having similar power output ratings and features you begin to realize just how much of a bargain that price represents... Internal layout of the amplifier was exemplary and was clearly the result of careful design and layout!"—Len Feldman db Magazine

MOVING?

FOR UNINTERRUPTED SERVICE
MAIL TO:
MIX PUBLICATIONS
PO BOX 3714
ESCONDIDO, CA 92025-3714

(PLEASE ATTACH OLD ADDRESS LABEL HERE)

(PLEASE PRINT NEW ADDRESS BELOW)

NAME

COMPANY

ADDRESS

CITY

STATE

ZIP

CENTRAL RECORDING SCHOOLS

SEMINARS & PROGRAMS

—LISTING CONTINUED FROM PREVIOUS PAGE

Science and Technology Center, courses ranging from Music Theory to MIDI, recently expanded practice and recital facilities and an artist faculty of over 30. Industry support is provided in the form of scholarships from trade organizations such as NAMM and NARAS, corporate sponsorship, a student chapter of MEIEA and an intern/job bank. Offering students individualized instruction in music business for over 18 years, Elmhurst provides a specialized career track integrated within a four-year degree.

HOUSTON COMMUNITY COLLEGE SYSTEM; Course/Program Title: Commercial Music, Audio Engineering Technology; **901 Yorkchester; Houston, TX 77079; (713) 468-6891. Chief Administrator:** Aubrey Tucker. **Program:** Fully accredited college offering two-year associate degree and certificate programs in audio engineering. Cost of instruction is extremely competitive in this field, consisting of normal tuition and fees. Great emphasis is placed on practical, hands-on experience. Two fully equipped studios. Studio A features MCI JH-536 automated console, MCI 24-track recorder with 24 channels of Dolby A noise reduction, two MCI 2-track recorders, Lexicon 200 and 224 digital reverb units, full Scamp rack and a wide variety of professional microphones. Studio B contains Tascam 520 20-channel mixing console, Fostex 16-track recorder and similar outboard equipment and microphones. New inventory of keyboards, synthesizers, drum machines and sequencers.

HUTCHINSON TECHNICAL COLLEGE; Course/Program Title: Audio Technology; **2 Century Ave.; Hutchinson, MN 55350; (800) 222-4424; (612) 587-3636 (in MN). Chief Administrator:** Dick Lennes, David Igl. **Program:** Two-year intensive technical audio program. Extensive, hands-on training in audio electronics (analog and digital), studio and remote recording systems design and installation, acoustics, signal processing and sound reinforcement for pro sound market. Heavy on lab and practical applications. Personalized instruction allows students to enter throughout year, receive credit for previous experience and work at accelerated pace. Students active in AES. State school, low tuition. Video training also available. Graduates available throughout year. Extensive cooperation with employers for internships and supervised work experience. Our graduates have the mix of technical and production skills for today's pro sound market.

INDIANA UNIVERSITY; Course/Program Title: Associate of Science in Audio Technology/Bachelor of Science in Audio Recording; **School of Music MU 4C; Bloomington, IN 47405; (812) 855-1613; (812) 855-1900. Chief Administrator:** David A. Pickett. **Program:** The Associate of Science in Audio Technology, lasting approximately five semesters, offers training in audio recording, reinforcement and media production, with emphasis on classical music recording techniques and multitrack studio. The Bachelor of Science in Audio Recording is a four-year program that offers training in audio recording and reinforcement with emphasis on classical music engineering and producing. Applicants must demonstrate a keen interest in classical music and aptitude for core music studies. Performance not required. Students record all official concerts ranging from solo and chamber music through symphony orchestras, jazz ensembles and opera. In total, about 1,000 performances are produced annually in a 500-seat recital hall and the 1,460-seat Musical Arts Center. Classes in recording techniques, electronics, acoustics, maintenance and musical styles. Professional equipment includes 2-track digital and up to 16-track analog. University financial aid and some work scholarships available. Departmental assistance offered in job placement.

LANSING COMMUNITY COLLEGE; Course/Program Title: Media Technology; **52-Media, PO Box 40010; Lansing, MI 48901-7210; (517) 483-1670. Chief Administrator:** Dr. James C. Greene, program director. **Program:** The Media Department at Lansing Community College offers a variety of courses in Audio Production, Audio Recording and Sound Reinforcement. These courses are geared toward developing entry-level skills for students interested in these fields. The courses are progressive and offer a balance between theory and practice. Lab facilities offer modern analog and digital processing equipment. A two-year degree in Media Technol-

ogy is available for students wishing to pursue an academic degree. The Media Department also offers courses in radio, video and photography (including film). Lansing Community College offers an open enrollment policy.

MCLENNAN COMMUNITY COLLEGE; Course/Program Title: Audio Technology/Commercial Music; **1400 College Dr.; Waco, TX 76708; (817) 750-3578. Chief Administrator:** David Hibbard. **Program:** Broad-based program offering three degrees (A.A.S.) in Audio Technology, Songwriting/Composition and Performance with a new degree pending in Music Industry Management. Full-time faculty are all active professionals in the areas of recording, performance and composition. About 100 student majors with over 20 ensembles actively performing and recording music in all styles of contemporary and traditional music.

MICHIGAN STATE UNIVERSITY, DEPARTMENT OF TELECOMMUNICATION; Course/Program Title: Telecommunication; **409 Comm. Arts & Sciences Bldg.; East Lansing, MI 48824; (517) 355-8372 (dept. office); (517) 353-9753. Chief Administrator:** Gary A. Reid, Bradley Greenberg. **Program:** An emphasis in audio production is available to students majoring in the Department of Telecommunication. Students must first complete a required sequence of core telecommunication courses. Upon completion of the core, students may opt into various areas of specialization. The production specialization area consists of advanced courses in both audio and video production. The audio sequence is based around three courses with content ranging from basic, radio-oriented production through full 24-track studio sessions. Emphasis is also placed on MIDI-based computer sequencing and SMPTE-based video sweetening. Independent study courses and internships are available to advanced students. A similar area is available for students specializing in video production. Students graduate with a BA in telecommunication. A master's-level production program is also available. The facilities include 2/4/8/24-track audio studios interfaced with two video production studios.

MIDLAND COLLEGE; Course/Program Title: Audio Technology; **16-track; 3600 N. Garfield; Midland, TX 79705; (915) 685-4500. Chief Administrator:** Jerry Tubb.



NORTHEAST COMMUNITY COLLEGE
Norfolk, NE

NORTHEAST COMMUNITY COLLEGE; Course/Program Title: Audio and Recording Technology; **801 E. Benjamin; Norfolk, NE 68701; (402) 644-0506. Chief Administrator:** Timothy Miller. **Program:** Northeast offers a two-year Associate of Art and/or Associate of Applied Science in Audio and Recording Technology. The Audio and Recording Technology program is a balanced mix of audio and electronic theory, concert lighting and sound reinforcement, music, MIDI, TEFT™, studio techniques, and hands-on experience with professional equipment and facilities. Northeast Community College is accredited by the North Central Association of Colleges and Schools and the Nebraska State Department of Education.

OBERLIN CONSERVATORY OF MUSIC; Course/Program Title: Technology in Music and Related Arts (TIMARA); **Oberlin College; Oberlin, OH 44074; (216) 775-8900. Chief Administrator:** Conrad Cummings, Gary Nelson. **Program:** Completed in spring 1989, TIMARA's new electronic and computer music studios are among the best equipped in the world, with technical resources that are often unavailable at the undergraduate level. This seven-studio complex holds equipment ranging from the earliest analog synthesizers to the most recent digital synthesis technology. Some of the equipment includes recording decks by Otari, Ampex, Scully, Sony and Revox; Macintosh microcomputers; synthesizers by Moog, Buchla, ARP, Putney, Korg, Yamaha, Ensoniq. The TIMARA program has two academic faculty members and a full-time music engineer. Through the TIMARA program the Oberlin Conservatory of Music offers a Bachelor of Music degree with a major in electronic and computer music. Our courses stress musical and technical fundamentals and individual creative projects.



San Francisco's Full-Service
Professional Audio Dealer

AUDIO Images

- SALES AND SERVICE
- DESIGN AND INSTALLATION
- AUDIO FOR FILM AND VIDEO
- MULTI-TRACK RECORDING
- DIGITAL AUDIO WORKSTATIONS
- SOUND REINFORCEMENT
- COMPUTER MUSIC SYSTEMS
- TAPE AND ACCESSORIES

70 Oak Grove Street
San Francisco, California 94107
Fax: (415) 957-1531

(415) 957-9131

Circle #187 on Reader Service Card

Student works range from popular idioms through jazz to "avant-garde" music with multimedia production and live performance encouraged.

OHIO UNIVERSITY; Course/Program Title: School of Telecommunications-Audio Production Sequence; 253 Radio-Television Bldg.; Athens, OH 45701-2979; (614) 593-4870. **Chief Administrator:** Jeff Redeper. **Program:** The four-year program in Telecommunications leads to the Bachelor of Science degree in Communications. This is a broadly based liberal arts curriculum with an emphasis on media studies. The Audio Production Sequence incorporates coursework in multi-track recording, music production, media production, music, electronics, film, hearing and speech sciences, computer applications in music, as well as many other related courses. Audio courses stress technical theories, practical skills (with much hands-on training), as well as artistic considerations. Teaching facilities include stereo production and 8-track studios, and a four-station audio editing studio. Other campus facilities include a Synclavier studio, film sound re-recording studio and a 16-track production studio. In addition to in-class experience, students gain experience through one of Ohio University's public radio stations and through an extensive internship program. Admission is highly competitive and financial aid is available to qualified students.

PRIVATE STUDIOS; Course/Program Title: Introduction to the Recording Studio, Advanced Recording Technique, Specialized Seminars; 705 W. Western Ave.; Urbana, IL 61801; (217) 367-3530. **Chief Administrator:** Rex Anderson.



RECORDING INSTITUTE OF DETROIT, INC.
East Detroit, MI

RECORDING INSTITUTE OF DETROIT, INC.; Course/Program Title: Recording Techniques; 14611 E. 9 Mile Rd.; East Detroit, MI 48021; (313) 779-1380. **Chief Administrator:** Robert Dennis. **Program:** Established in 1976, The Recording Institute of Detroit offers a licensed educational program in 24-track professional recording and related music theory that can be applied to recording engineering, production, songwriting, audio-for-video/film and live sound mixing. The program includes 270 hours of classes and interning that is taught in two 24-track automated studios. A third MIDI studio with 24-track recording and two MIDI workstations are available for the final phase of the program. State-of-the-art equipment is used including a Solid State Logic 4000G console and Mitsubishi digital recorder. Students complete courses in basic recording, applied music theory and advanced recording techniques. They then complete extensive additional training and hands-on experience in a specialty of their choice during a 100-hour internship; specialties can include studio recording, MIDI, live sound mixing, music production and audio-for-video/film. The program includes six recording projects during classes and additional second recording engineer experience on actual sessions. Twenty-one start dates per year; evening and weekend schedule. Job placement assistance and more. Call for info.

THE RECORDING WORKSHOP; Course/Program Title: Recording Engineering and Music Production Program; 455-X Massieville Rd.; Chillicothe, OH 45601; (800) 848-9900; (614) 663-2510. **Chief Administrator:** Jim Rosebrook, director. **Program:** An intensive, seven-week, 300-hour program designed to prepare entry-level recording personnel—the original "hands-on" school for students seeking concentrated training in the creative operation of professional recording equipment. Over 200 hours are spent in-studio. This experience includes session setup, miking technique, recording, mixing, studio etiquette, song production, commercial and audio-for-video production, editing and equipment maintenance. In lecture, students receive a broader study of audio engineering and music business practices. Our six-studio recording complex features two automated 24-track studios, two 16-track studios, an 8-track commercial/MIDI production studio, a hard disk digital editing/DAT mastering studio and a conventional editing lab. In-studio class size is three to six students, lecture class size is 48. We have internship and job

—LISTING CONTINUED ON NEXT PAGE



LEARN THE ART OF RECORDING

THE RECORDING WORKSHOP IS THE WORLD'S LEADING SCHOOL FOR "HANDS-ON" TRAINING IN MUSIC RECORDING TECHNOLOGY. IN OUR INTENSIVE, 5-WEEK PROGRAM, YOU'LL LEARN THE CREATIVE OPERATION OF PROFESSIONAL RECORDING EQUIPMENT. WE'LL TEACH YOU THE JOB SKILLS NEEDED TO SUCCESSFULLY START YOUR CAREER AS A RECORDING ENGINEER, PRODUCER OR STUDIO MUSICIAN.

- ▶ 6 STUDIOS FILLED WITH THE LATEST EQUIPMENT: DIGITAL RECORDING TO HARD DISK, DAT MASTERING, AUTOMATED MIXING, MIDI AND MUCH MORE
- ▶ INTENSIVE, 5-WEEK PROGRAM GIVES YOU MORE QUALITY, IN-STUDIO EXPERIENCE THAN MOST LONG-TERM SCHOOLS
- ▶ SMALL CLASSES, PERSONAL ATTENTION
- ▶ JOB/INTERNSHIP PLACEMENT ASSISTANCE
- ▶ NO PREVIOUS EXPERIENCE REQUIRED
- ▶ FINANCIAL AID AVAILABLE
- ▶ LOW-COST, ON CAMPUS HOUSING



FOR FREE BROCHURE, PLEASE CALL OR WRITE TODAY

THE RECORDING WORKSHOP

1-800-848-9900 1-614-663-2510

455-X MASSIEVILLE ROAD, CHILLICOTHE, OHIO 45601

OHIO STATE BOARD OF SCHOOL AND COLLEGE REGISTRATION #80-07-0696T

© 1989 THE RECORDING WORKSHOP

Circle #188 on Reader Service Card

Sound Advice from Schirmer Books

Sound Advice: The Musician's Guide to the Record Industry

Wayne Wadhams 1990 ISBN 0-02-872692-8 \$24.95

For songwriters, recording artists, and aspiring musicians.

Sound Advice: The Musician's Guide to the Recording Studio

Wayne Wadhams 1990 ISBN 0-02-872694-4 \$34.95

Basic techniques for recording and mixing in the studio designed for the musician.

Sound Advice: 2 Compact Disc Set

Wayne Wadhams 1990 ISBN 0-02-872693-6 \$29.95

Recording techniques, a complete mixdown session, and technical data.

On the Track: A Guide to Contemporary Film Scoring

Fred Karlin and Rayburn Wright 1990 ISBN 0-02-873310-X \$49.95

Foreword by John Williams

All the technical and creative aspects of composing film scores. Includes a complete click track book.

Available From:

SCHIRMER BOOKS 866 Third Avenue, New York, NY 10022
Or call toll-free 1-800-323-7445 to place your credit card order

Circle #189 on Reader Service Card

IF YOU'RE NOT USING IT.... SELL IT!

THE BERTECH ORGANIZATION

YOUR NATIONAL CLEARINGHOUSE FOR FINE USED AUDIO AND VIDEO

Our mailers reach thousands of professionals every month. We'll list your used equipment free of charge — or help you find that rare item you've been looking for.

THE BERTECH ORGANIZATION

Distributors, brokers and custom fabricators of quality audio and video equipment

14447 CALIFA STREET
VAN NUYS, CA 91401
(818) 909-0262
Toll Free Outside CA
(800) 992-2272

THINK BERTECH FIRST!

Circle #190 on Reader Service Card

C E N T R A L

RECORDING SCHOOLS

SEMINARS & PROGRAMS

—LISTING CONTINUED FROM PREVIOUS PAGE



THE RECORDING WORKSHOP
Chillicothe, OH

placement services. We offer low-cost, on-campus housing. Financial aid is available. T Workshop is a 1989 TEC Award nominee and is approved by State Board of Proprietary School Registration. Please call for a free brochure.

RED WING TECHNICAL COLLEGE; Course/Program Title: Band, Electronic and String Instrument Repair; 215 Pioneer Rd.; Red Wing, MN 55066-3999; (612) 388-8271 (call collect). Chief Administrator: Ed Dunn.

SMITH/LEE PRODUCTIONS MEDIA SCHOOL; Course/Program Title: Basic Recording Techniques, Advanced Recording Techniques; 7420 Manchester Rd.; St. Louis, MO 63143; (314) 647-3900. Chief Administrator: David Smith. Program: Smith/Lee Productions is a professional 24-track studio offering Basic Recording Techniques and Advanced Recording Techniques. The Basic Recording Techniques course is designed to prepare students with the proper theoretical foundation in audio and magnetic recording while providing key instruction in the operation of professional audio recording equipment. The Advanced Recording Techniques course provides continuing technical instruction and training preparing the student to successfully tackle more complex production situations in sound recording, mixing, A/V production, and audio for video. Smith/Lee Productions, Inc., offers courses quarterly for eight weeks, meeting once a week. These courses are excellent training for students, professionals, musicians, record producers and recording artists.

SOUND ARTS RECORDING SCHOOL; Course/Program Title: 24-Track Audio Engineering; 2036 Paskett; Houston, TX 77092; (713) 688-8067. Chief Administrator: Jeff Wells.

SOUTH PLAINS COLLEGE; Course/Program Title: Sound Technology, Performing Arts Production Technology; 1401 S. College Ave.; Levelland, TX 79336; (806) 894-9611. Chief Administrator: John Hartin. Program: Performing Arts Production Technology program trains you to work as production manager or technician of video production houses, entertainment and convention facilities, civic centers, and theaters. Program provides training in video and audio production, lighting, stage crafts and business management. Training facilities include 3,600 sq. ft. Tom T. Hall production studio and two other 900 sq. ft. TV studios. Equipment includes Grass Valley switcher, Sony A/B roll editor, Dubner character generator, Ampex ADO, Sony 3/4-inch SP tape recorders, Sony CCD cameras and computer-controlled Strand Century lighting system. Two-year program awards Associate of Applied Science degree. Contact: Pat McCutchin. Sound Technology program trains you for a career in the recording industry as a recording engineer, sound reinforcement specialist or studio technician. Training facilities include the Tom T. Hall studio with 36-track Sony automated console with synchronization-to-video, plus the Waylon Jennings studio with MCI 24-track

recording capabilities, and 8-track demo studio and synthesis/MIDI center. Multitrack and 2-track digital are the newest additions to the center.

SOUTHERN OHIO COLLEGE; Course/Program Title: Audio Video Production; 1055 Laidlaw Ave.; Cincinnati, OH 45237; (513) 242-3791. Chief Administrator: Mark R. Turner, department chairperson. Program: The Audio Video Production Department features four recording studios, two multitrack. Instruction includes: audio sweetening, ADR, Foley, digital audio editing, mixing techniques for voice and instruments, location audio, and audio for video. Video instruction includes: studio and location production, computerized A/B roll editing, 2-D and 3-D computer graphics and animation, chroma key, lighting, and set design. Facilities include: three edit rooms, three graphic workstations, four EFP packages and a 40' x 25' studio. Southern Ohio College offers an Associate Degree and is accredited by the North Central Association of Colleges and Schools and the Association of Independent Colleges and Schools.

TEXARKANA COLLEGE RECORDING AND MIDI STUDIOS; 2500 N. Robison Rd.; Texarkana, TX 75501; (214) 838-4541 x257/x360. Chief Administrator: Dr. Murry Alewine. Program: Two-year associate degree in commercial music; classes in MIDI, arranging and the recording studio. A state-sponsored college with two 16-track studios. Each 16-track studio has complete facilities with modern, up-to-date equipment. Professional-quality equipment with professional faculty. Classes begin each September, January and June. Fees/tuition schedule available on request. Hands-on instruction and lab time for all students beginning first semester. Fourth-semester students have access to professional 24-track studio in city. Many clubs, lounges, restaurants available in vicinity for employment. MIDI studio available. Three courses (Elementary/Intermediate/Advanced) in MIDI instruction. New program: Music Printing—two semester. Macintosh SE with 20MB hard disk, laser printer NTXII, Finale by Coda and Music Publisher graphic notes.

UNIVERSITY OF WISCONSIN—OSHKOSH; Course/Program Title: Music Merchandising—Recording Technology Emphasis; 800 Algoma Blvd.; Oshkosh, WI 54901; (414) 424-4224. Chief Administrator: John Minniear. Program: The recording technology emphasis is an option of the music merchandising program, one of the majors offered by the University of Wisconsin, Oshkosh. This is a four-year program covering all aspects of the recording process: mixing to mixdown, production and contractual agreements. The final semester is spent in the field as an intern at a professional recording studio. The music department is accredited by NASM. Early application for admission to the university is advised. Classes begin after Labor Day.

WEBSTER UNIVERSITY; Course/Program Title: Media Communications; 470 E. Lockwood Ave.; St. Louis, MO 63119; (314) 968-6924. Chief Administrator: Art Silverblatt.

WESTERN

ASPEN MUSIC FESTIVAL AND SCHOOL; Course/Program Title: Edgar Stanton Audio Recording Institute; Box AA; Aspen, CO 81612; (303) 925-3254. Chief Administrator: Daniel Craik, director.

BRIGHAM YOUNG UNIVERSITY; Course/Program Title: Sound Recording Technology; C-550 Harris Fine Arts Center; Provo, UT 84602; (801) 378-3083. Chief Administrator: Ron Simpson.

CALIFORNIA POLYTECHNIC STATE UNIVERSITY; Course/Program Title: (Music Department) Music Technology Program; Music Dept.; San Luis Obispo, CA 93407; (805) 756-2406. Chief Administrator: Dr. Antonio G. Barata.

CALIFORNIA RECORDING INSTITUTE; Course/Program Title: Recording Arts and Technology; PO Box 2693; Santa Cruz, CA 95063-2693; (408) 722-4658. Chief Administrator: David A. Gibson. Program: Weekend seminars, six-week classes, semester comprehensive courses and one-year programs at four campuses—Sonic Images 24-track automated audio/video studio in San Jose, MARS 24-track studio in Santa Cruz, VSO 16-track studio in Monterey and Gold Record, Inc., 16-track studio and record company in Gilroy. Classes in the Art of Recording/Mixing, The Structure of Mixes, Running Sessions, MIDI and computers in the Studio, Sound Reinforcement, Synthesizers/Drum Machines, Equipment Maintenance, The Music Business, Television Production, Computer Editing, Audio-for-Video and Computer Graphics. Facilities include a variety of multitracks and mixing boards with various automation systems, an impressive selection of processing and effects, MIDI studios with SMPTE Sync, a wide range of synthesizers/drum machines and complete video post-production. Labs are always open for extensive hands-on mixing time. By enrolling in one campus you may attend classes at any of the four campuses, gaining a perspective on a wide range of equipment, maximizing extra studio time and to repeat or make up classes! Internship programs and job placement assistance available. Call or write for brochure.

Financial Aid Available

Accredited by NATTS

Our Graduates Work

A practical education in audio and video recording arts and sciences for anyone who takes recording seriously.

Institute of Audio-Video Engineering

1831 Hyperion Ave., Hollywood, CA 90027

Call Toll-Free: National 1-800-551-8877
Local (213) 666-2380

Circle #191 on Reader Service Card

CALIFORNIA STATE UNIVERSITY, CHICO: Course/Program Title: Recording Arts (BA and minor); Department of Music; Chico, CA 95929; (916) 895-5152. Chief Administrator: Raymond Barker, Daniel Craik. Program: The Department of Music at California State University, Chico, offers two programs in recording arts: the Bachelor of Arts in Music with an option in Recording Arts, and the Minor in Recording Arts. These programs are being offered in newly constructed facilities in the west wing of the Performing Arts Center. These facilities include a 24-track control room, a performance studio and electronic music studio. A music major in the Recording Arts option will take courses in music history, music theory, composition with electronic media and audio recording, along with courses from other departments in electronics and physics of sound. The option in Recording Arts for music majors includes a capstone "internship" course that will provide the opportunity to record the major productions on this campus and to acquire experience in selected recording studios off campus.



CALIFORNIA STATE UNIVERSITY, DOMINGUEZ HILLS
Carson, CA

CALIFORNIA STATE UNIVERSITY, DOMINGUEZ HILLS; Course/Program Title: Audio Recording and Music Synthesis (ARMS); 1000 Victoria St.; Carson, CA 90747; (213) 516-

3543. Chief Administrator: David Champion, John Hill, David Bradford. Program: CSU, Dominguez Hills, offers four-year BA music degrees in Audio Recording and Music Synthesis and a certificate program in Audio Technology. The curriculum includes lecture and hands-on lab courses in audio engineering, music synthesis, music production, studio electronics and equipment maintenance. Elective studies in video production are available. Recording labs are conducted in an automated 24-track facility that includes a Soundcraft 2400 console, Sony/MCI JH-24 with Dolby SR, digital and analog 2-track machines for mixdown, and an assortment of state-of-the-art microphones and signal processors. The adjoining MIDI studio (with SMPTE lock) is configured around an 8MB Emulator III system. Students use an extensive software library for music sequencing, patch editing/storage, music printing, algorithmic composition, and visual sample editing on the Macintosh and Atari ST computers. Expander synthesizer modules include products by Yamaha, Roland, Oberheim, Casio, Alesis and Korg.

CITY COLLEGE OF SAN FRANCISCO; Course/Program Title: Broadcasting Dept.; 50 Phelan Ave.; San Francisco, CA 94112; (415) 239-3525. Chief Administrator: Phillip Brown, dept. chair.

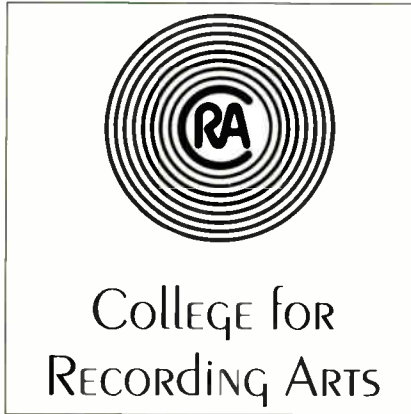

College for Recording Arts

COLLEGE FOR RECORDING ARTS
San Francisco, CA

COLLEGE FOR RECORDING ARTS; Bi-Cultural Foundation Inc.; 665 Harrison St.; San Francisco, CA 94107; (415) 781-6306. Chief Administrator: Leo De Gar Kalka. Program: One-year course for recording engineers and others intent on a career in the music/recording industry. C.R.A. is accredited by the National Association of Trade and Technical Schools (NATTS), approved for veteran training and authorized under federal law to enroll non-immigrant, alien students. Semesters start the first full week of June, October or February. Over 15 years of providing quality graduates to the music/recording industry.



CONSERVATORY OF RECORDING ARTS & SCIENCES
Phoenix, AZ

CONSERVATORY OF RECORDING ARTS & SCIENCES; Course/Program Title: Master Recording Program; 1110 E. Missouri, Ste. 400; Phoenix, AZ 85014; (800) 562-6383; (602) 493-9898. Chief Administrator: Jacqueline F. Vican. Program: Professional career training in audio recording and production. The Conservatory offers the Master Recording Program, a 320-hour intensive, 15-week course including audio recording and production; MIDI/computer/electronic recording, music business, sound reinforcement and troubleshooting. Emphasis is hands-on instruction in a 24-track
—LISTING CONTINUED ON NEXT PAGE



Never Blow A Punch Again.

Now add automatic punch-in
to any recording setup with
MIDI tape sync!

You can't be at your creative best when you're nervously waiting for the right instant to hit the Record button or the punch-in footswitch.

So relax and let the new CueCube™ give you perfect punches every time, automatically.

Feed the CueCube any kind of MIDI tape sync: Clock, Song Pointer, MIDI Time Code, or Direct Time Lock. Then simply patch it to your tape deck's Remote Punch-In jack.

To do a punch-in, you "teach" it to the CueCube by playing the track and flipping the switch at the "IN" and "OUT" points.

Now you can rehearse the punch, aided by flashing LEDs that give you a 4-beat countdown.

When you're ready to record, just flip the switch to "PERFORM." As the track plays, the CueCube automatically punches your deck in and out at the exact instants you've programmed.

You can concentrate totally on your performance—without wasting time on retakes, or worrying about accidentally erasing something.

Order Now for Special Introductory Discount.

The CueCube is normally \$169.00. But until July 31, you can add the incredible benefits of auto-punch to your system for only \$149.00 plus \$5.00 shipping.

**VISA & M/C orders, call toll-free:
1-800-888-0848, ext. 227X**

or send check or money order to Musonix.
Calif. residents add \$10.06 sales tax.
1-yr. warranty; 30-day money-back guarantee.



MUSONIX, LTD
2537 NORTH ONTARIO ST.
BURBANK, CALIFORNIA 91504-2592
818 845-9622 FAX: 818 841-5927
© 1990

Confused? We take the time to help you!

Specializing in MIDI Equipment by:

KURZWEIL
Music Systems

**900, 1000, & 1200 Series
K250, RMX, MIDIBOARD**

Sweetwater's K250 Editing program for the Macintosh
K250 Sample Network (over 300 QLS disks)
Sweetwater's own Resident Sound Blocks for the 250

Ask for our **FREE** famous Kurzweil Newsletter
&

E-mu Systems

EMAX II 16 Bit Samplers (regular and turbo)
PROTEUS I, II, & XR

New Sales • Support • Modifications • Service • Upgrades

Knowledgeable People • Great Prices

Other major brands, too!

Opcode • AKAI • Digidesign • Ramsa •
Passport • Mark of the Unicorn • TOA
JBL Studio Monitors • Fostex Recording
Lexicon • Coda • CMS

Mac, Atari, and IBM music software!

CALL NOW! 24 Hours a day!

We ship UPS & Federal Express or ...
You can receive it TODAY if
we ship by major airline!



NO SALES TAX (except IN)
VISA • MASTERCARD
AMEX • COD • TRADES

SWEETWATER SOUND, INC.

4821 Bass Road Fort Wayne, IN 46808
(219) 432-8176 FAX# (219) 432-1758

Circle #194 on Reader Service Card

Los Angeles To Little Rock

IN THE

September Mix

So. Cal/SW U. S. Recording

Sound for Film and Video

Synchronizers in the Field

Mix travels to Southern California and all through the Southwest to ask studios what is being done in the world of audio-for-film. Plus, Blair Jackson asks film sound designers how they created some of their favorite effects.

Also, we will bring you Paul Simon, Keith Cohen, the New Orleans Jazz & Heritage Festival and more! Directories of Southwest U.S. and Southern California/Hawaii recording studios.

**Ad Closing: July 6
Materials Due: July 16**

W E S T E R N RECORDING SCHOOLS SEMINARS & PROGRAMS

—LISTING CONTINUED FROM PREVIOUS PAGE

studio, a MIDI studio and on the SS_ console. Individual projects required. Selective enrollment policy enforced. Applicants judged on aptitude and attitude. Classes limited in size to eight to nine students. Internships available in commercial facilities around the country. Director of Education is Gold Album-winning engineer and a current working professional in the recording industry. Master Program awards a diploma and enrolls three times per year: winter, spring/summer, fall. Foreign students eligible.

FULLERTON COLLEGE; Course/Program Title: Music Recording/Production; 321 E. Chapman Ave., Music Dept.; Fullerton, CA 92634; (714) 992-7296. Chief Administrator: Alex Cima. Program: 1985 Mix TEC Award nominee. The college offers a one-year certificate in Music Recording/Production encompassing two semesters of audio recording, two semesters of electronic music, one semester of music business and other relevant music courses. The Music Dept. has a fully equipped 24-track studio w/automated board, digital reverb, digital mixdown and the usual complement of signal processors (harmonizer, compressors, etc.) and microphones. Fullerton College is a public California community college with minimal tuition for California residents. A great way to receive a college education and learn professional audio recording.



GOLDEN WEST COMMUNITY COLLEGE
Huntington Beach, CA

GOLDEN WEST COMMUNITY COLLEGE; Course/Program Title: Music Business and Technology; Recording Arts; 15744 Golden West St.; Huntington Beach, CA 92647; (714) 895-8780. Chief Administrator: David Anthony, Scott Steidinger, Evan Williams. Program: A well-deserved international reputation has brought students from around the world to this "model" program. The program is unique in the generous amount of hands-on time and experiences available in the three well-equipped studios and four workstation/labs. Studio A features: MCI 24-track recorder, 40-channel Neotek Elite automated console, Q-Lock synchronizer, Lexicon 224XL reverb, digital recording plus extensive outboard signal processing. Studio B features: Neve 16-channel mixer, MCI 16-track recorder, digital recording and editing, plus analog and digital signal processing. Studio C features: a mixing capacity of over 60 inputs, 16-track recorder, extensive signal processing and an array of over 60 MIDI-sequenced synthesizer channels (Yamaha TF modules, Kurzweil 250, Roland S-550 sampler, Roland D-110 Proteus, Yamaha controller keyboard, drum machines, plus much more!) controlled by Macintosh computer system and various software programs. A leader in music technology since 1972.

GROVE SCHOOL OF MUSIC; Course/Program Title: Recording Engineering Program; 14539 Sylvan St.; Van Nuys, CA 91411; (818) 904-9400. Chief Administrator: "Duke" Gore. Program: Grove School of Music's one-year Recording Engineering Program is based on a four-part philosophy: learn how to operate the technology of today; have a fundamental

music background; explore the variety of positions available in the audio field; and prepare students to obtain that first real-world, entry-level job. These goals are achieved using Grove's in-house studios for hands-on experience with professional and student recording sessions and with in-depth classes on recording techniques and music theory taught by a faculty of Los Angeles' working professionals.

INSTITUTE OF AUDIO-VIDEO ENGINEERING; Course/Program Title: Recording Engineering (Audio & Video); 1831 Hyperion Ave.; Hollywood, CA 90027; (213) 666-2380; (800) 551-8877. Chief Administrator: Dominic LaCasse. Program: The Institute of Audio-Video Engineering offers concise, expert instruction in audio and video engineering and is housed in a state-of-the-art recording studio, actively engaged in servicing the local community. The school is an accredited member of the National Association of Trade and Technical Schools. The eight-month, state-approved diploma program includes audio recording, video production, editing and studio maintenance. Elective classes offer students an opportunity to further their understanding and skills in specialized areas such as sound reinforcement, advanced mixing, advanced video editing and use of the Fairlight CMI music computer. New terms start approximately every ten weeks. The cost of the entire program ranges from \$5,000 to \$5,950, depending on electives selected. Approximately \$175 will be needed for books and supplies for the whole program. Classes are scheduled primarily during evening or weekend hours, since instructors are professionals currently active in the entertainment fields. Students are required to complete 560 clock hours of classes with 344 of those hours being hands-on experience. The Institute of Audio-Video Engineering has been established since 1980.

LONG BEACH CITY COLLEGE; 4901 E. Carson St.; Long Beach, CA 90808; (213) 420-4309; (213) 420-4517. Chief Administrator: Priscilla Remeta, Dr. George Shaw. Program: Facilities include 24-track, 16-track (TEAC and Fostex), 8-track and 4-track studios. A state-of-the-art MIDI classroom is comprised of 21 individual computer-controlled songwriting stations. Each station is equipped with Macintosh, synthesizers, drum machines, effects and recording equipment. Commercial music instructors are all professionals in the music recording and performance fields. Students are given hands-on training and receive certificates in record producer, recording engineer, songwriter/arranger, copyist, vocal, instrumental including MIDI applications.

LOS ANGELES CITY COLLEGE; Course/Program Title: Radio-Television-Film Department; 855 N. Vermont Ave.; Los Angeles, CA 90029; (213) 669-5545. Chief Administrator: Robert Stahley. Program: Study recording in a commercial-grade recording facility fully accredited by Western Association of Schools and Colleges. 4/8/24-track recording taught in a multimillion dollar communication complex. Two separate studios with separate control rooms offers hands-on experience. Program leads to a department certificate or an AA degree. Fundamentals of recording theory and practice with emphasis on pre-/post-production. Sound for film and video sweetening is also offered. Studio A is 46 x 29. Studio B is 25 x 29. Each studio equipped with upright and grand pianos as well as various electronic instruments. Mixing consoles: MCI, Yamaha, Tascam. Audio Recorders: MCI 24-track, 30 ips; 8-track, 30 ips; 2-track; Revox 2-track; Scully 2-track; Scully 8-track and Tascam 4-track w/Dolby. Outboard equipment: Yamaha, UREI, Orban and Dolby. Mics: AKG, Neumann, Beyer, Crown, Electro-Voice, Shure, RCA, Sennheiser. Monitor amps: Yamaha and Crown. California resident fee: maximum of \$50 per semester. Non-resident fee: \$112 per semester unit.

**LOS ANGELES
RECORDING
WORKSHOP**

**EXTENSIVE
HANDS-ON TRAINING
IN FOUR 24-TRACK
RECORDING STUDIOS**

LOS ANGELES RECORDING WORKSHOP
Studio City, CA

LOS ANGELES RECORDING WORKSHOP; Course/Program Title: 200-hour Recording Engineering Program; 300-hour 1st Engineer Program; 12268-X Ventura Blvd.; Studio City, CA 91604; (818) 763-7400. Chief Administrator: Christopher Knight. Program: The Los Angeles Recording Work-

shop offers 200-hour and 300-hour programs in Recording Engineering. These are intensive, hands-on training programs designed specifically to train students for jobs in the recording industry. Job placement assistance is included. Our students train in six different studios: four different 24-track studios, one 16-track SMPTE/MIDI lockup studio and one rehearsal studio that is used for the live engineering portion. Studies include analog and digital recording, mixing techniques, live engineering, MIDI sequencing and sampling, outboard gear, tape machine alignment and music business. Both full-time (five-week or ten-week) and part-time (ten-week or 15-week) schedules are available. We are fully accredited by ACCET, and financial aid is available to qualified students. Dorm-style housing is available. Call or write for our brochure and sound-sheet.



LOS MEDANOS COLLEGE
Pittsburg, CA

LOS MEDANOS COLLEGE; Course/Program Title: Recording Arts; 2700 E. Leland Rd.; Pittsburg, CA 94565; (415) 439-0200. Chief Administrator: Frank Cormie. Program: Los Medanos College in Pittsburg, California, offers a degree program in Recording Arts, including courses in multitrack recording, sound reinforcement, acoustics, MIDI sound synthesis, producing and troubleshooting. Theory, hands-on experience, a state-of-the-art recording studio and a faculty honored with two Grammy nominations make the Los Medanos Recording Arts program the finest in Northern California. Fees: California residents \$5 per unit (\$50 max. per semester), out-of-state \$92 per unit.

LOYOLA MARYMOUNT UNIVERSITY; Course/Program Title: Recording Arts; Communication Arts Dept.; Loyola Blvd. at W. 80th St.; Los Angeles, CA 90045; (213) 338-3033. Chief Administrator: Donald J. Zirpola, chair; John Michael Weaver, program coordinator. Program: LMU Recording Arts is a four-year program that offers students the opportunity to explore both the aesthetic and technical challenges of sound design and recording, through in-depth study and hands-on experience. Emphasis is placed on both the art of music recording and the creative use of sound in film and television. Students take classes in mass communications, the art of cinema, screen writing, film and television production, sound design, recording technology, acoustics, production and post-production sound, recording practices and techniques, contemporary issues, advanced recording and related music courses. Among LMU's recording facilities are a 16mm film recording studio, a video-assisted film and television post-production suite, and a 24-track recording studio containing equipment from AKG, Ampex, JBL, Lexicon, Neumann, Orban, Otari, Sennheiser, Sony, Trident and UREI. Classes are kept small to ensure that the needs of the individual student can be met.

MAY SCHOOLS; Course/Program Title: Recording Engineer and Radio/Television Broadcasting; 1320 Grand Ave.; Billings, MT 59102; (406) 259-7000. Chief Administrator: Michael May. Program: Students in the Recording Engineering course complete training in eight months with emphasis on hands-on training in a full 24-track studio plus three individual MIDI-equipped studios and four advertising production studios. Recording students also learn TV/video production using the school's main TV studio and three video editing studios. Radio/TV broadcasting students do all of the coursework in the Recording Engineering course plus an additional semester (four months) of study in Broadcast Journalism and Air Personality work. Accredited member of NATTS. Provides job-placement assistance, student financing professional staff. Classes start every eight weeks. Call or write for free catalog and financial aid information.

MILLS COLLEGE MUSIC DEPARTMENT; Course/Program Title: Center for Contemporary Music; 5000 MacArthur Blvd.; Oakland, CA 94613; (415) 430-2191. Chief Administrator: David Rosenbaum.

NEW MEXICO STATE UNIVERSITY; Course/Program Title: MUS 249/250 Audio Recording Techniques; NMSU Music Box 30001-3F; Las Cruces, NM 88003; (505) 646-

5215; (505) 521-4918. Chief Administrator: Dr. Warner Hutchison, Jim Archuleta, Stacy Parrish.

PORTLAND COMMUNITY COLLEGE, MUSIC DEPT., CASCADE; Course/Program Title: Recording Technologies; PO Box 19000; Portland, OR 97219-0990; (503) 244-6111, ext. 5226. Chief Administrator: Hal Lee. Program: The PCC Vocational Music Department offers excellent courses in recording, performance and composition. Designed by musicians for musicians, the two-year program leads to an Associate of Applied Science degree. The recording course seeks to integrate music and technology by emphasizing a comprehensive understanding of production skills. Topics covered include engineering fundamentals, microphone techniques, multitrack recording, mixing, audio-for-video sweetening, editing and MIDI recording applications. Additional classes cover histories of jazz, rock and folk, business for the musician and classes in basic instrumental improvisation. Whether you are just getting underway or are a practicing professional needing to polish skills, this program has something to offer you. Portland Community College's Cascade campus is located 15 minutes from downtown Portland, the live music capital of the Pacific Northwest. Tuition costs are reasonable, averaging approximately \$250 for in-district residents.

QUINCY STREET SOUND; Course/Program Title: Multitrack Recording Level I; 130 Quincy St. NE; Albuquerque, NM 87108; (505) 265-5689. Chief Administrator: Eric Larson.

RECORDING ASSOCIATES; Course/Program Title: Sound Recording and Mixing; 5821 SE Powell Blvd.; Portland, OR 97206; (503) 777-4621. Chief Administrator: Jay Webster. Program: Video programs available: two hours at \$39 answers beginners most often asked questions: connectors, connections, phasing, microphones, tone control, room tuning, mixing boards, sound mixing, band setup, recording, echo/effects and more. 12 hours at \$239 is a must for the pro or soon-to-be pro. Here's the relationship between theory and the choices you make operating equipment and effects: vocabulary, basic theory, adv. theory, connectors, connections, phasing, mic theory, mic application, adv. mic theory, tone theory, adv. tone theory, tone application, acoustics, room tuning, studio consoles, console operation, mix theory, adv. mix theory, compression, recorders, maintenance, echo, reverb, other effects, production and studio tips, glossary, and more. Students enrolled in the 12-hour course who complete the final quiz with a passing grade will be issued a certificate of completion. You may write or call for free assistance in answering test questions or questions in general regarding sound and recording.



RECORDING INSTITUTE
Van Nuys, CA

RECORDING INSTITUTE; Course/Program Title: Recording Engineer; 14511 Delano St.; Van Nuys, CA 91411; (818) 994-9976. Chief Administrator: Fred Much, Larry Cook. Program: Certificate program, 155 hours. Comprehensive hands-on training for recording engineers. 24-track in-house studio with over 20 gold/platinum records! All classes taught by professionals. 12 weeks, four classes per week, usually evenings and weekends. Through a combination of lectures, labs, workshops and professional experiences you will learn the skills required of a recording engineer and gain insight into the psychology of recording sessions. The course includes: 24-track recording and mixing, MIDI and possible internship. Extensive placement assistance. A personal interview/school tour is required for admission. At the interview you will be asked to discuss your educational objectives and professional goals. You will also be asked to take a hearing test and to participate in some ear training drills. We are located in Van Nuys, California, only a few minutes away by car from Los Angeles, Hollywood, Burbank and Beverly Hills. \$2,330 plus books. For a catalog and further information contact Recording Institute.

R.O.P. (REGIONAL OCCUPATIONAL PROGRAM) MENDOCINO COUNTY OFFICE; Course/Program Title: Radio/Recording Technician; PO Box 226; Mendocino, CA 95460; (707) 937-1200. Chief Administrator: Paul Tichinin, Bob

Evans. Program: Mendocino County Schools regional occupational program (ROP), audio recording studio for adult and high school students offers individualized instruction in recording techniques, sound reinforcement, introduction to MIDI, radio production, safety and studio etiquette. Equipment includes Tascam 16-track recording facility, 2/4-track mixdown, Panasonic SV-3500 DAT, Tascam multichannel mixing board, Yamaha SPX90, Korg DVP-1 digital voice processor, Macintosh Plus w/Opcode 2 Pro MIDI interface, Opcode 2.54 sequencer, DX-TX librarian, Deluxe Music Construction Set, Roland SDE-3000 digital delay, Yamaha DX7 Sequential Circuit MAX, Korg DS8, Casio CZ-100, Yamaha DX100, SDS9 digital drums. Mics: Sennheiser 421, AKG condensers, Shure SM57, Audio Technica Dynamics. Facility: drum isolation booth, large main tracking room, control room. No charge for training, although program requires a small materials fee for tapes, disks, books and equipment repair. Open entry/open exit, Sept.-June only. Certificate awarded to completers. 1,200 hours maximum. Contact Bob Evans, studio manager/instructor.

SAN DIEGO RECORDING WORKSHOP; Course/Program Title: Recording Theory "Hands-on"; PO Box 7632; San Diego, CA 92107; (619) 571-5965. Chief Administrator: Steve Grossman.

SAN FRANCISCO STATE UNIVERSITY EXTENDED EDUCATION; Course/Program Title: Music/Recording Industry Certificate Program; SFSU Downtown Center; 814 Mission St., Ste. 201; San Francisco, CA 94103; (415) 338-1372. Chief Administrator: Mary Pieratt. Program: The Music/Recording Industry Certificate Program (MRI) offered through San Francisco State University focuses on the music business and studio engineering. Classes offer academic credit and are taught by Bay Area professionals in the field. The program is designed for both students and professionals who want to gain experience and education in the music industry through a structured course of study. Musicians, managers, agents and engineers will benefit from courses that cover a wide range of topics. Courses include audio engineering (beginning, intermediate, advanced, mixing and MIDI), offered in all 24-track studios), artist management, studio management, publicity, promotion, tour management, music video, songwriting, industry history, legal aspects, career options, and concert booking and production. Expand skills with one or more workshops or earn the MRI certificate. Courses are offered evenings. Formal university application is not required.

SKE AUDIO PUBLISHING; Course/Program Title: Recording School Curriculum Service/Home-Study Course; PO Box 2519; Sedona, AZ 86336; (800) 284-1258. Program: We publish a complete curriculum for schools and recording studios wishing to teach sound engineering. Based on the book *Practical Techniques for the Recording Engineer*, these course materials are already in use at over 75 universities, colleges and studios throughout the world. The program includes the text (\$28.95), Teacher's Manual (\$45), Answer Key (n/c), Student's Workbook/Supplement (\$16.50) and three final exams (n/c). Suggested session content for hands-on studio work. Course features practical, useful content. Text covers techniques and skills while Workbook/Supplement covers conventional subjects. Write for more information. Sound Engineering Home Study Course. A fast, affordable way for the sound enthusiast to study high-powered sound engineering based on the college text *Practical Techniques for the Recording Engineer*. The home study cassette packages for Basic, Intermediate and Advanced contain 12 50-minute audio cassettes at \$99.99 each. Some of the course features are mics, recorders, session and stage setup and breakdown, alignments, noise reduction sound and audio theory, acoustics, editing, mixing.

SONOMA SOUND; Course/Program Title: Sound Engineering Classes; PO Box 1623; Sonoma, CA 95476; (707) 996-4363. Chief Administrator: Aron Johnson.



SONOMA STATE UNIVERSITY
Rohnert Park, CA

—LISTING CONTINUED ON NEXT PAGE

W E S T E R N RECORDING SCHOOLS

SEMINARS & PROGRAMS

—LISTING CONTINUED FROM PREVIOUS PAGE

SONOMA STATE UNIVERSITY; Course/Program Title: Recording & Electronic Music; 1801 E. Cotati Ave.; Rohnert Park, CA 94928; (707) 664-2324. **Chief Administrator:** Arthur Hills, Warren Dennis, Ron Pellegrino. **Program:** Three semesters of recording studio plus tutorial. Career minor in recording technology also includes internship. One-semester courses on studio performance and production, songwriting and live performance are also offered (Sound for Media course is in process). All programs incorporate hands-on use of a new, fully outfitted, 1-inch 8-track studio with two full isolation booths. **Electronic Music Studio:** courses in sound synthesis with computers and digital, hybrid and analog synthesizers; emphasis on fundamental principles and studio techniques, composition and performance. All courses have hands-on work with FM, sampling, phase distortion, linear/arithmetic, percussion and analog synthesis. Completely integrated MIDI/ SMPTE studio includes latest Macintosh-based software for sequencing, notation and voice editing, librarian functions for all studio synthesizers. Studio includes an 8-track and two 4-track tape machines, and multiple outboard processors for audio and MIDI signals.



SONY INSTITUTE OF APPLIED VIDEO TECHNOLOGY
Los Angeles, CA

SONY INSTITUTE OF APPLIED VIDEO TECHNOLOGY; Course/Program Title: Production Audio and Post-Production Audio for Video (and other related workshops); 2021 N. Western Ave.; PO Box 29906; Los Angeles, CA 90029; (213) 462-1987. **Chief Administrator:** Jeffrey Glasser, Stephen Gach. **Program:** Get your career on the fast track! Learn from the leaders. The Sony Institute offers the most comprehensive curriculum in professional video education today. Workshops are university-accredited, fully certified and carry an unconditional money-back guarantee if you're not delighted. More than 25 original workshops have been developed to meet your professional needs. Courses like Production Audio for Video and Post-Production Audio for Video, plus a wide range of other subjects including ENG: Capturing the live event and numerous courses in electronic field production, editing, lighting and more! The Sony Institute also offers a variety of top-notch products and production tools such as Shaping Your Sound, The Video Music Composer and more. Call for a free catalog and get your career headed in the right direction.

SOUTHWEST INSTITUTE OF RECORDING ARTS AND SCIENCES; Course/Program Title: Audio Recording Engineering; 4831 N. 11th St., Ste. C; Phoenix, AZ 85014; (602) 241-1019. **Chief Administrator:** Billy Moss. **Program:** A 16-week, 310 class-hour learning system designed to teach audio recording and engineering. Students will progress from a firm understanding of the most basic recording concepts through student-engineered sessions using the most sophisticated of modern recording equipment, thus gathering an academic and practical knowledge of all the most common aspects of audio recording. By starting with the basic (2-track date), then working through the fully automated mixdown (SSL 4040 E/G auto-

mated mixing desk) of a state-of-the-art, multitrack digital recording (Sony 3324 digital multitrack and Mitsubishi X-80 digital 2-track), this system will enable students to successfully compete in any audio recording environment as fully qualified, entry-level audio engineers. Seats in this class will be limited to ensure comprehensive work loads with a major emphasis on hands-on training. Cost of program is \$3,500, which includes all materials, fees and textbooks.



TREBAS INSTITUTE
Hollywood, CA

TREBAS INSTITUTE; Course/Program Title: Recording Arts & Sciences: Integrated Music Tech., Music Industry Management; 4664 Sunset Blvd., The Penthouse; Hollywood, CA 90028; (213) 467-6800. **Chief Administrator:** David P. Leonard. **Program:** Two-year programs in the Recording Arts and Sciences w/specialization options in Integrated Music Technology and Music Industry Management. More than 100 courses to choose from in 11 tracks of study: Music, Production, Synthesis and MIDI, Video, Computers, Digital, Audio Engineering Theory and Studio Recording, Electronics, Music Business, Management and General Education. Three majors available: Production/Engineering, Engineering/Electronics and Management. Diploma in Recording Arts & Sciences (w/ specialization in one of the two programs above). One entrance scholarship offered at each of five campus locations across North America, valued at \$6,000 each. Memorial scholarship for second-year studies at each location. Other awards of merit available. Consult admissions office. Transfer of credits between campuses. Facilities: professional multitrack recording studio, electronic music/synthesis/MIDI studio, electronics lab, computer labs, audio/video post-production mixing lab and analog/digital disc mastering rooms (at selected campuses). Resource Center, including library of several thousand volumes (books, magazines, articles) on the music business.



UCLA EXTENSION
Los Angeles, CA

UCLA EXTENSION; Course/Program Title: Certificate Program in Recording Engineering; 10995 Le Conte Ave., PO Box 24901; Los Angeles, CA 90024; (213) 825-9064. **Chief Administrator:** Ms. Ronnie Rubin, Van Webster, program coordinator. **Program:** The UCLA Extension Certificate Program in Recording Engineering is a rigorous training program that prepares the student in both the art and science of sound recording. Drawing on the talent and studio facilities of Los Angeles, one of the music industry capitals of the world, UCLA Extension has created a sequential curriculum of required and elective courses that covers both theory and practice in audio technology, equipment, musicianship and business practice. All classes are taught by working professionals in the recording industry. The objective is to enable future engineers to acquire vision and problem-solving techniques that meet the challenge of rapidly evolving technology and a dynamic sound recording market. Prerequisite courses include basic physics;

math and electronics, available through UCLA Extension, plus a music background. The Certificate Program in Recording Engineering is a state of California-approved program of significant educational accomplishment in a professional field. Additional certificate programs are offered in recording arts, songwriting, electronic music, film-scoring, and film/television video. Call or write for the professions in the Entertainment Industry catalog.

UNIVERSITY OF ARIZONA; Course/Program Title: School of Music; Tucson, AZ 85721; (602) 621-1655. **Chief Administrator:** Jeff Haskell. **Program:** A recording studio production class is offered to music and RTV students. The class includes a basic overview of studio equipment use and terminology, in addition to music production and music law. Courses in computer and MIDI applications are offered. The recording studio features an audiophile-quality 24-track facility with numerous signal processing equipment including: Lexicon PCM70, Drawmer gates, dbx 165A compressors, Pultec EQP-1A EQ, Prime Time delay, etc. The recording studio is very accessible to students for gaining experience writing, producing and performing in professional-quality recordings.

UNIVERSITY OF COLORADO, DENVER, COLLEGE OF MUSIC; Course/Program Title: Recording Technology & Sound Synthesis; 1200 Larimer St., Box 162; Denver, CO 80204; (303) 556-2727. **Chief Administrator:** David Magidson.



UNIVERSITY of DENVER

Lamont School of Music

UNIVERSITY OF DENVER,
LAMONT SCHOOL OF MUSIC
Denver, CO

UNIVERSITY OF DENVER, LAMONT SCHOOL OF MUSIC; Course/Program Title: Bachelor of Music in Commercial Music; 7111 Montview Blvd.; Denver, CO 80220; (303) 871-6400. **Chief Administrator:** David J. Genova. **Program:** This degree is for the student who wants to develop into a first-rate freelance or sessions player, and/or commercial arranger/composer, ready to enter the world of high-tech music. Within the structure of a Bachelor of Music degree, commercial music majors will participate in a well-rounded general education program, enhanced by special offerings appropriate to developing commercial musicians. Commercial music majors will take courses in commercial composition and arranging, applied commercially oriented harmony at the keyboard, business, law and contracts for commercial musicians, basic electronics, history of synthesis, synthesis programming, sampling and courses in sound recording in the home and professional studio. Sound reinforcement is included, and advanced students will intern as recording engineers and sessions players.

UNIVERSITY OF NEVADA, LAS VEGAS; Course/Program Title: Audio Engineering and MIDI; 4505 S. Maryland Pkwy.; Las Vegas, NV 89154; (702) 739-0819. **Chief Administrator:** Curt Miller. **Program:** The University of Nevada, Las Vegas, currently offers three courses in Audio Engineering and MIDI Environments. MUS180: A one-semester course in audio engineering theory and live stereo recording techniques. No prerequisites required. MUS280: A one-semester course in multitrack recording techniques; at least one project band will be used during the semester. Prerequisite: MUS180. MUS166: A one-semester course in advanced MIDI theory. Keyboard experience not necessary, the course is geared for engineers and musicians wishing to learn the MIDI language in detail with hands-on experience in synthesizers, sequencers, drum machines, samplers, etc. Prerequisites: none. The University recording studio features state-of-the-art equipment including MCI 24-track; Soundcraft 2400 28 x 24 x 2 console, disk-based recording by Digidesign, Macintosh-based sequencing. Outboard gear by UREI, Trident, Lexicon, Yamaha, etc. These courses are extremely popular so register early.

UNIVERSITY OF SOUND ARTS; Course/Program Title: Audio/Video Engineering Music/Video Bus. Management; 1645 N. Vine St., Ste. 609; Hollywood, CA 90028; (213) 467-5256; (213) 962-5100. **Chief Administrator:** Faghue Gadhok. **Program:** University of Sound Arts has been offering quality education and placement in the music, video and film industry



UNIVERSITY OF SOUND ARTS

UNIVERSITY OF SOUND ARTS
Hollywood, CA

since 1976. Situated in the heart of Hollywood, University of Sound Arts provides college education and work experience in recording engineering, audio/video engineering, music business management, record production, Synclavier programming, record label management, broadcasting arts, electronic music production, motion picture and television production, etc. Financial aid is available, and USA is approved for foreign students.

UNIVERSITY OF SOUTHERN CALIFORNIA; Course/Program Title: Bachelor of Science in Music Recording; **School of Music; MUS 212; Los Angeles, CA 90089-0851; (213) 743-2627. Chief Administrator:** Richard J. McIlvery. **Program:** The Recording Arts Program at USC offers a four-year Bachelor of Science Degree in Music Recording. Skills in both music and mathematics are required for entrance. A performance audition is also required on an acoustic instrument. Courses are taught by both university professors and industry professionals. Program is limited to 15 students per year. In addition, a Minor in Music Recording is offered to a limited number of students who are pursuing a Bachelor of Science in electrical or Mechanical Engineering. Call or write for information.

OUTSIDE U.S.



The Banff Centre

THE BANFF CENTRE FOR THE ARTS
Banff, Alberta, Canada

THE BANFF CENTRE FOR THE ARTS; Course/Program Title: Media Arts Audio Recording and Production Associate-ships; **Office of the Registrar; PO Box 1020; Banff, Alberta, T0L 0C0 Canada; (403) 762-6180; FAX: (403) 762-6444. Chief Administrator:** Kevin Elliott, head of audio recording and production. **Program:** Professional development associate-ships are available to individuals with rigorous training or significant experience. Those accepted receive full scholarship, room and board, and stipend. Functioning as staff engineers, associates work in the digital multitrack and MIDI studios, digital audio workstations, etc., pursuing their own development/research aims and production projects. Duties include multitrack production stereo recording (classical/jazz), audio-for-video, support for artists working in electroacoustics, multimedia and hypermedia, studio management, etc. Applicants are required to have strong credentials in at least one of these areas. The program strives to foster production projects of a fine arts and experimental nature generated from within and outside The Banff Centre. It aims to provide professional development experience in audio recording and production, and foster research within an artist-driven production environment. Residences available from three months and up; please inquire. Direct telephone number to program head: (403) 762-6407.

BULLFROG RECORDING SCHOOL; Course/Program Title: Sound and Recording Engineering; 2475 Dunbar St.; Vancouver, BC, V6R 3N2 Canada; (604) 734-4617. Chief Administrator: Maggie Scherf.

COLUMBIA ACADEMY OF RADIO, TELEVISION AND RECORDING ARTS; 1295 W. Broadway; Vancouver, BC, V6H 3X8 Canada; (604) 736-3316. Chief Administrator: Marty Hasselbach. **Program:** For well over two decades, Columbia Academy has been offering realistic and practical media arts training. Full-time programs include Broadcast Performing Arts, Recording Arts and Music Production, Digital Automated Recording Arts, Music Mastering, Marketing & Management, and Video and Television Production. With three large state-of-the-art training campuses in Western Canada, students are guaranteed to get the practical "hands-on" skills they need. Facilities include audio/visual equipped classrooms, 24-track analog recording studios, 48-track fully automated digital recording/film post-production studios, editing and production rooms, multistation MIDI/8-track production studios, complete television sound stages, online television control room, offline editing suites and complete "in-house" radio stations. Government registered training programs. Day and evening classes. Financial assistance for qualified applicants. Call for free information.

I.C.A. INSTITUTE OF COMMUNICATION ARTS; 5787 Marine Dr.; Burnaby, BC, V5J 3H1 Canada; (604) 430-4092. Chief Administrator: Niels Hartvig-Nielsen. **Program:** Programs are one to three years in length. Part-time studies are available. Subjects include: Recording Studio Operations, Record Production, Digital Music Technology, Audio-for-Video, Music Arranging, Songwriting and Composition, Entertainment Business, Video Production, Computer Graphics, etc. Student financing available. Semesters commence Oct./Feb./April/June. I.C.A. is recognized by the United States Department of Education and therefore eligible to participate in the U.S. Guaranteed Student Loan program. (G.S.L. #025403). Call or write for more information.

MCGILL UNIVERSITY, FACULTY OF MUSIC; Course/Program Title: Master's of Music in Sound Recording; 555 Sherbrooke St. W.; Montreal, Quebec, H3A 1E3 Canada; (514) 398-4538. Chief Administrator: John Rea. **Program:** Master's of Music in Sound Recording degree. Duration: one preparatory undergraduate year plus two years graduate. Course titles: Sound Recording (Theory and Practice), Analy-

sis of Recordings, Technical Ear-Training, Analog and Digital Audio Editing, Audio with Vision, Studio Equipment Maintenance, Digital Studio Technology, Computer Music/Sampling/MIDI, Classical Music Production. Facilities: Two concert halls, one recital hall, two control rooms, one two-room studio, 24-track and 2-track recording, computer-assisted mixing, digital and analog recording and editing, computer/MIDI/electronic repair shop. Costs/tuition: Canadian citizens \$1,350 CDN/year, foreign students \$9,000 CDN/year tuition and student services. General information: program established in 1979. Admits four or five students per year (competitive). Bachelor of Music degree is required for admission. Non-McGill applicants are admitted to a prerequisite undergraduate year to do preparatory work in sound recording, electronic music, physics and psychophysics of music, musical acoustics, electroacoustics, mathematics, orchestration and computer.

ONTARIO INSTITUTE OF AUDIO RECORDING TECHNOLOGY; Course/Program Title: Audio Engineering; 500 Newbold St.; London, Ontario, N6E 1K6 Canada; (519) 686-5010. Chief Administrator: Paul Steenhaus, Geoff Keymer. **Program:** An intensely focused, full-time program of study, one academic year in length, (Sept. -April), designed to prepare the student for a career in the audio and music recording industry. Course headings: Recording Technology, Recording Practical Labs, Studio Electronics, Equipment Alignment, Digital Technology, Acoustics, Music, Music Business, Music Production, Audio for Visuals and more. Courses begin at introductory levels and accelerate rapidly, combining to provide the student with knowledge and practical skills in all aspects of audio recording. The program is a "step through" process with smaller concepts and skills building on each other until, within five months, our students are responsibly operating a \$350,000 recording facility. Theoretical material is strongly supported with practical labs, each lab having a maximum of three students per instructor. Lab time: 200+ hours. Classes held in studios: 400+. Studio equipment: Mitsubishi, Studer, Lexicon, JVC, Sony, Roland, MCI, ADAP, Adams-Smith, Fairlight III, etc. Seven full-time instructors and a maximum enrollment of 50 students ensure individual attention. Registered and approved by the Canadian Ministry of Education and U.S. Department of Education.

RECORDING ARTS PROGRAM OF CANADA; 28 Valrose Dr., Stoney Creek, ON L8T 3T4, Canada; 34 Chemin Des Ormes; Ste. Anne des Lacs, Quebec, J0R 1B0 Canada; (416) 662-2666 (Ontario); (514) 224-8363 (Quebec). Chief Administrator: John Keca.

Required Reading

The new 1990 Mix Bookshelf Catalog is now available! We've added 200 new products to the world's most complete collection of books, videos, tape courses, sounds and software for audio professionals. Write or call now for your FREE copy.

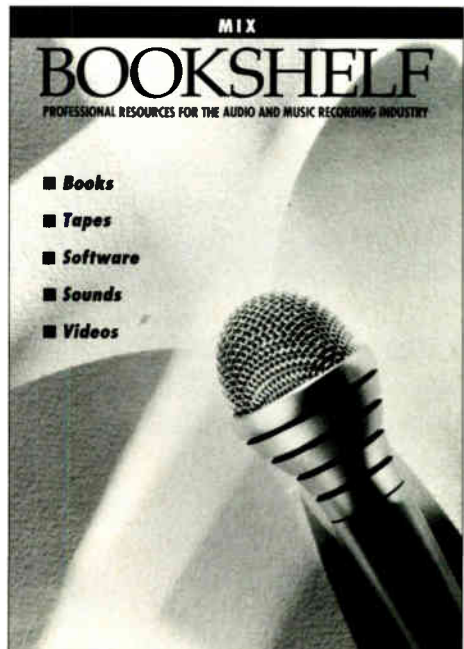

MIX BOOKSHELF

6400 Hollis Street #12
Emeryville, CA 94608

Call Toll-Free:
(800) 233-9604
(415) 653-3307
FAX: (415) 653-5142

O U T S I D E U . S .

RECORDING SCHOOLS

SEMINARS & PROGRAMS



TREBAS INSTITUTE

Montreal, Ottawa, Toronto, Vancouver, Canada

TREBAS INSTITUTE; Course/Program Title: Recording Arts & Sciences: Integrated Music Tech., Music Ind. Mgmt; 451 St. Jean St.; Montreal, Quebec, H2Y 2R5 Canada; (514) 845-4141. Chief Administrator: David P. Leonard. Program: Two-

year program in the Recording Arts & Sciences w/specialization options in Integrated Music Technology and Music Industry Management. More than 100 courses to choose from in 11 tracks of study, including: music, production, synthesis and MIDI, video computers, digital, audio engineering theory and studio recording, electronics, music business, management, and general education. Three majors available: production/engineering, engineering/electronics and management. Diploma in Recording Arts & Sciences (w/specialization in one of the two programs above). One entrance scholarship offered at each of five campus locations across North America, valued at \$5,000 each. Memorial scholarship for second-year studies at each location. Other Awards of Merit available. Consult admissions office. Transfer of credits between campuses. Facilities: professional multitrack recording studio, electronic music/synthesis/MIDI studios, electronics lab, computer labs, audio/video post-production mixing lab and analog/digital disc mastering rooms (at selected campuses). Resource Center including library of several thousand volumes (books, magazines, articles) on the music business, audio, video, recording and music production. Accredited by ACCET.

TREBAS INSTITUTE; Course/Program Title: Recording Arts & Sciences: Integrated Music Tech., Music Industry Management; 290 Nepean St.; Ottawa, Ontario, K1R 5G3 Canada; (613) 232-7104. Chief Administrator: David P. Leonard. Program: Two-year program in the Recording Arts & Sciences w/specialization options in Integrated Music Technology and Music Industry Management. More than 100 courses to choose from in 11 tracks of study, including: music production, synthesis and MIDI, video computers, digital, audio engineering theory and studio recording, electronics, music business, management, and general education. Three majors available: production/engineering, engineering/electronics and management. Diploma in Recording Arts & Sciences (w/specialization in one of the two programs above). One entrance scholarship offered at each of five campus locations across North America, valued at \$5,000 each. Memorial scholarship for second-year studies at each location. Other Awards of Merit available. Consult admissions office. Transfer of credits between campuses. Facilities: professional multitrack recording studio, electronic music/synthesis/MIDI studios, electronics lab, computer labs, audio/video post-production mixing lab and analog/digital disc mastering rooms (at selected campuses). Resource Center including library of several thousand volumes (books, magazines, articles) on the music business, audio, video, recording and music production. Accredited by ACCET.

TREBAS INSTITUTE; Course/Program Title: Recording Arts & Sciences: Integrated Music Tech., Music Industry Manage-

ment; 410 Dundas St. E.; Toronto, Ontario, M5A 2A8 Canada; (416) 966-3066. Chief Administrator: David P. Leonard. Program: Two-year program in the Recording Arts & Sciences w/specialization options in Integrated Music Technology and Music Industry Management. More than 100 courses to choose from in 11 tracks of study, including: music, production, synthesis and MIDI, video computers, digital, audio engineering theory and studio recording, electronics, music business, management and general education. Three majors available: production/engineering, engineering/electronics and management. Diploma in Recording Arts & Sciences (w/specialization in one of the two programs above). One entrance scholarship offered at each of five campus locations across North America, valued at \$5,000 each. Memorial scholarship for second-year studies at each location. Other Awards of Merit available. Consult admissions office. Transfer of credits between campuses. Facilities: professional multitrack recording studio, electronic music/synthesis/MIDI studios, electronics labs, computer labs, audio/video post-production mixing lab and analog/digital disc mastering rooms (at selected campuses). Resource Center including library of several thousand volumes (books, magazines, articles) on music business, audio, video, recording and music production. Accredited by ACCET.

TREBAS INSTITUTE; Course/Program Title: Recording Arts & Sciences: Integrated Music Tech., Music Industry Management; 112 E. 3rd Ave.; Vancouver BC, V5T 1C8 Canada; (604) 872-2666. Chief Administrator: David P. Leonard. Program: Two-year program in the Recording Arts & Sciences w/specialization options in Integrated Music Technology and Music Industry Management. More than 100 courses to choose from in 11 tracks of study, including: music, production, synthesis and MIDI, video computers, digital, audio engineering theory and studio recording, electronics, music business, management and general education. Three majors available: production/engineering, engineering/electronics and management. Diploma in Recording Arts & Sciences (w/specialization in one of the two programs above). One entrance scholarship offered at each of five campus locations across North America, valued at \$5,000 each. Memorial scholarship for second-year studies at each location. Other Awards of Merit available. Consult admissions office. Transfer of credits between campuses. Facilities: professional multitrack recording studio, electronic music/synthesis/MIDI studios, electronics lab, computer labs, audio/video post-production mixing lab and analog/digital disc mastering rooms (at selected campuses). Resource Center including library of several thousand volumes (books, magazines, articles) on the music business, audio, video, recording and music production. Accredited by ACCET.



SAVE YOUR MIX!

Mix magazine is the most handy reference tool serving the professional audio industry. Keep your issues protected for the next millennium in our custom-made magazine cases and binders.

Each holds a year's worth of *Mix* and is bound in a leather-like crimson material with the *Mix* logo hot-stamped in gold.

Magazine Cases

\$7.95 each; 3 for \$21.95; 6 for \$39.95

Binders

\$9.95 each; 3 for \$27.95; 6 for \$52.95

Please send me _____ cases and/or _____ binders (add \$1 per unit for postage & handling, \$2.50 outside U.S. PA residents add 6% sales tax).

Check enclosed for _____. Check # _____. (Make check payable to Jesse Jones Industries)

For credit card purchases, call toll-free: (800) 972-5858

Print Name _____

Address (no PO Boxes) _____

City/State/ZIP _____

Mail to: Jesse Jones Industries, Dept. Mix, 499 East Erie Avenue, Philadelphia, PA 19134

—CONTINUED FROM PAGE 99, PHILIPPINES

The local recording facilities take an active role in the development of this Filipino talent, not to mention clients from Australia, China, Japan and Guam. Several 24- and 16-track analog studios produce crisp, clear masters that are put onto cassettes as final products. One of these is Greenhill Sound Studios, which boasts two 24-track rooms, two 16-track rooms and an 8-track copy room. The equipment is mostly Soundcraft consoles, MCI JH-24 and Ampex 1200 recorders, and the usual array of outboard processing gear by Lexicon, Yamaha, UREI and others.

Cinema Audio is one of the country's oldest recording studios. It has produced various local and international hit records, and features the country's only Tom Hidley-designed room. Consoles are from MCI and API, multitrack recorders are again JH-24s and Ampex, while ATRs and MCIs do the 2-track mastering chores. A selection of digital reverbs, outboard gear and monitoring systems are also available, along with a variety of tube-type equipment such as old Neumann mics, Fairchild compressors and limiters, and some plate reverbs.

The increasing demand for studios catering to both music and advertising clients has spawned a generation of newer facilities. TRACKstudios has Soundcraft TS12 and 6000 consoles as its centerpieces. The facility houses two 24-track rooms and a dubbing/copy room. A MIDI scoring system complete with audio-video synchronization is in one of the rooms. Multi-tracking is handled by Otari MX-80 and Soundcraft SCM-762 machines. A Studer 807 and a Sony R-DAT are used for 2-track mastering. The control rooms are fashioned after LEDE®-type designs, and the studios have variable acoustics.

Works Avenue belongs to a communications group that operates radio and television stations, audio and video post-production studios, and an equipment rental facility. The audio facilities are centered around a Soundcraft TS12 console, a Soundcraft SCM-762 III 24-track, Studer Revoxes and a Sony 2500 R-DAT.

A dedicated room—used mainly as a music and audio-for-video studio—is equipped with Sony video switchers, Abekas, Chyron and several other

video effects for post use. This video suite has a Soundcraft 200 BVE for an audio-follow-video capability. Recorders are Sony BVU 5000 Series.

ABS-CBN is the biggest studio in

the country (it can fit a 30-piece orchestra under its cathedral-like ceilings). Owned by a television network, it is used primarily to record music for broadcast. Equipment includes a Soundcraft TS12 console, a Saturn 24-track tape recorder, a host of outboard gear and an audio-for-video synchronization system by Applied Microsystems of England. ABS-CBN broadcasts nationwide via satellite.

Vicor Music Studios is a record company-owned MIDI facility. Designed mainly for in-house use, it is equipped with an AMR 24 console, Studer 820 24-track recorder and several effects and peripherals.

Charo Unite Productions specializes in jingle work. (Its owner, Charo Unite, controls about 75 percent of all advertising music requirements in the country.) Recording duties are handled by an Otari MX-80, a Soundcraft 600, and Fostex and Tascam equipment.

Located in the Philippines' business town of Makati, Audio Captain features a newly acquired Otari MX-80 and a Soundcraft 6000. The facility is the favorite among the young artists in the country. It is fully MIDI-fied, and all the rooms are accessible via tielines. Audio Captain has nearly finished a dedicated mix/dubbing room, as well.

Positioning itself toward the lucrative advertising market, Audio Post is one of the newer studios in the Philippines. It is the first facility in the country to be equipped with an AMS Audiofile system, with video synchronization. Audio Post also uses a comprehensive sound FX library on a Sony CD jukebox controlled via Leonardo software. Ever since it opened, the facility has been busy with advertising work and industrial A/V.

Americans working in the Philippines find that communication with local musicians and engineers is generally not a problem because most of the population speak English. As benefits this tropical climate, the pace of life and work is slower here than in the urban recording centers in the United States, so expect to devote time to fun and relaxation if you work here. Bring your ears for work, but don't forget your swimsuit, either. ■

Mike N. Pedero designs studios, programs a radiostation, owns a 24-track recording studio, produces, and occasionally bums around the beaches near Manila.



ILLUSTRATION: CHARLIE POWELL

Hal Blaine and The Wrecking Crew

The Story of the World's Most Recorded Musician

Exclusive stories from the musician who recorded over 350 Top Ten hits and became the heartbeat and backbone of pop music's golden age. Twenty-four pages of scrapbook photos provide a rare glimpse into Hal's unique musical history. An entertaining and educating book for musicians and fans alike.

"Hal Blaine set the standard for creative and inventive drum sounds in the '60s."

Herb Alpert

"Hal Blaine is an original." **Neil Diamond**

"Thanks, Hal, for the tom tom tom toms!" **Ringo Starr**

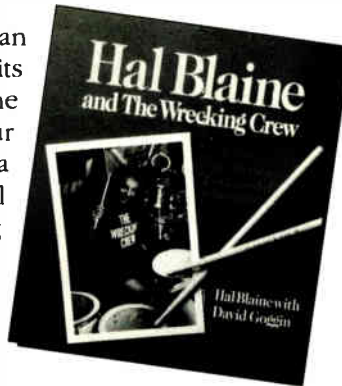

192 pages
\$19.95

Published by

MIXBOOKS

To order:

Call or write Mix Bookshelf, 6400 Hollis St. #12, Emeryville, CA 94608 (415) 653-3307 **Toll Free (800) 233-9604**. Include \$3 for UPS shipping. NY, CA, IL residents add appropriate tax. Free catalog available.

Circle #133 on Reader Service Card

If You Supply A Product or Service...

MIX CLASSIFIEDS

are the best way to reach thousands of professionals in the audio-video industry! Find out why Mix Classifieds are the most cost-effective way to advertise—see the Classified section in the back of this issue for categories and complete details.

**FOR MORE INFORMATION,
OR TO PLACE A MIX CLASSIFIED AD,
CALL (415) 653-3307. DEADLINE: 15TH OF MONTH,
SIX WEEKS PRIOR TO PUBLICATION.**

— FROM PAGE 55

know this is all beta, and it might not all work the way it's supposed to." While I found that some features were not yet implemented, the program was 90 percent functional. What's more, I experienced no crashes from any of the Digidesign software all day. And, based on past experience with this company, I feel pretty confident when I predict that by the time you read this, Deck will be available in all its glory. At \$349 this is an elegant and valuable piece of software. Wait'll they hear about this in Mayberry!

Meanwhile, in Other Digidesign News...

Q-Sheet A/V 2.0, an upgrade to this popular MIDI/SMPTE automation program, was recently released. The upgrade allows Q-Sheet A/V to be integrated with Sound Tools. With Version 2.0 and Sound Tools, you can add two independent tracks of digital audio to MIDI events, such as sequences or sampled sound effects, all synchronized to SMPTE. Suggested retail price is \$995, with upgrades to registered users offered at \$50.

A Sound Tools Utility Disk has been released. It contains Master List, Live List and DATa. Master List (mentioned in this space in April) allows a Sound Tools user to create a master playlist of soundfiles, playlists or playlist regions. Live List is a performance application, enabling the user to trigger Sound Tools soundfiles, playlists or regions from any MIDI event or Mac keystroke. DATa allows you to back up your soundfiles to DAT and is also included free of charge with every DAT I/O.

And finally, the company is targeting a June shipping date for PRO I/O, a new hardware option for Sound Tools. Priced at \$2,995, it is intended for users requiring audiophile quality A/D and D/A conversion. The 19-inch rack-mount converter uses Apogee filters, digital meters, +4 balanced XLR ins/outs, 18-bit resolution, "house sync" capability, and 8-times oversampling D/A and 64-times oversampling A/D. Owners of AD IN will be offered a "generous" trade-in for PRO I/O. Digidesign, Menlo Park, Calif., (415) 327-8811.

Chip Shots

Hybrid Arts recently released its

SMPTEmate II™ interface card for the ADAP II digital audio recorder and editor. The interface gives the ADAP II system full chase-lock capabilities to time code with subframe accuracy. Suggested retail price for SMPTEmate II is \$1,095.

Also announced was the release of TIME Page™ time compression and expansion software for its ADAP II system. TIME Page, which retails for \$695, allows ADAP II to stretch or shrink recordings by as much as 50 percent with no degradation of audio quality. Hybrid Arts, Culver City, Calif., (213) 841-0340.

For those MIDI-based engineer/player/composer types, Articulate Systems has come up with VoiceWaves/MIDI. Together with its Voice Navigator for the Macintosh, Voice-

*Before
the end
of the year
Digidesign will
introduce
a new multitrack
version of Sound
Tools with new
hardware and
software.*

Waves/MIDI gives you voice control of music software while at a MIDI keyboard or mixing-console. While Voice Navigator alone allows users to use their voice to control any Mac software application, VoiceWaves/MIDI has customized templates for the most popular MIDI programs to make that task much less difficult and time-consuming. Articulate Systems, Cambridge, Mass., (617) 876-5236.

Dr. T's Music Software is now publishing Intelligent Music Software products for the Macintosh, Amiga and Atari computers. All customer service, including upgrades, backups, and technical support for Intelligent Music products, will now be handled through Dr. T's. Registered users should contact Dr. T's for more infor-

mation. Dr. T's Music Software, Chestnut Hill, Mass., (617) 244-6954 (technical support: (617) 244-1542).

Opcode Systems, Inc., has released an updated version of its powerful sequencing software package for the Macintosh. Vision 1.1 has many new features, including automated moving faders, scrolling edit windows and "scrubbing" control in the graphic editing window. Vision also has the ability to work with patch names interactively with Galaxy, Opcode's newly released universal librarian. Vision 1.1 is a free update to all registered owners and \$495 to others. Galaxy is available for \$249. Opcode Systems, Menlo Park, Calif., (415) 369-8131.

MIDIQuest is a universal editor/librarian from Sound Quest Inc. It's available for the Mac, PC, Atari and Amiga systems, and offers a flexible way to combine, sort and edit data for existing as well as future MIDI devices. Sound Quest Inc., Toronto, Ont., (800) 387-8720.

Coda Music Software is now shipping an IBM PC-compatible version of its music notation software, Finale. It operates in a Microsoft Windows environment and has most of the features in Finale 2.0 for the Macintosh. Minimum requirements are 1 MB RAM (2 MB recommended), 80286 processor and a hard disk. The suggested retail price is \$599. Coda Music Software, Bloomington, Minn., (612) 854-1288.

Now shipping is Version 3.3 of Jim Miller's Personal Composer MIDI sequencing and transcription software for the IBM PC and compatibles. Among the new features are: a mouse-driven user interface with extensive pull-down menus; support for all PostScript printers and typesetters; an integrated text editor; and standard MIDI file format compatibility. Personal Composer 3.3 is \$595, and owners of Version 2.0 or higher can upgrade for \$75. Personal Composer, Mercer Island, Wash., (800) 446-8088.

Sound Globes, the interactive composition software for IBM PC, is now being published by Cool Shoes Software. Previously, Twelve Tone Systems had exclusive publishing rights for the Sound Globes. Cool Shoes Software, Boston, Mass., (617) 229-9942. ■

Paul Potyen is associate editor of Mix and a veteran musician, composer, arranger and producer.

ONE STEP AHEAD

**Coming in Mix:
August 1990**

Facility Design & Acoustics

- **Studio Designer's Forum:** The Monitoring Environment—A Systems Approach; with a sidebar on computer analysis
- **Special Feature:** Testing Control Room Acoustics; with a sidebar on acoustical materials
- **Special Feature:** Patch Bays—Planning a Design for Commercial Facilities
- **Class of 1990:** The Hottest New Rooms from Across the United States
- **Equipment Field Test:** CAD Equitek II Microphone reviewed by Stephen Paul
- **The Byte Beat:** Mark of the Unicorn's TimePiece
- **Sound Reinforcement:** Starplex Amphitheater; Sound Reinforcement News and Tour Update
- **Directories:** Facility Designers & Suppliers

PLUS!

Vincent Van Haaff, James Jamerson, Shel Talmy, Mike Hedges, Harry Connick and Toscanini!

ATTENTION ADVERTISERS:

Deadline for ad placement is the seventh of the month, two months prior to publication. Call (415) 653-3307 for a 1990 Mix Editorial Calendar, space reservations and complete advertising information.

MIX THE
RECORDING
INDUSTRY
MAGAZINE

CLASSIFIEDS

Business Opportunities

LET THE GOVERNMENT FINANCE your new or existing small business. Grants/loans to \$500,000. Free recorded message: (707) 448-0270. (NL3).

Portland, Maine, studio seeks partner/investor

successful, 24-4k residential, fine staff, sep. MIDI suite. Will expand w/ your industry exp. and investment. (207) 854-8863.

Employment Offered

"Fast-growing" pro speaker company seeks a sales & marketing manager. If you have pro audio experience, a sales background, a high energy level and love a challenge, send us your resume. Smithline Audio, 15406 Cabrito Road, #11, Van Nuys, CA 91406

Audio Engineer - A/V midtown music mix facility/prod. co. seeks engr w/ exper in SMPTE interlock mixing 24-tk to 1" video. \$25-40k+ comm. commen w/ skill & exper. Studio Mgr., \$20-27k+ comm. A/V Maint. Engr., \$30k. Sales rep., salary plus comm. Resume: PO Box 31, 314 West 52nd St., New York, NY 10019.

Music Production Company seeking motivatec engineer/producer with experience in all areas of modern production as well as commercial writing. Cooperative, positive attitude and intense creativity are essential to our A-level team. Sour grapes need not apply. Send demos and resume to: LaBov & Beyond, PO Box 5533, Ft. Wayne, IN 46895. Attn: Linda.

THE BEST AUDIO SCHOOLS

are in New Ears: A Guide to Education in Audio & the Recording Sciences. 84 profiled, 324 listed, 208 pages of reference & info. \$11.95 U.S., \$15.95 air, NE Productions, 1033 Euclid, Syracuse, NY 13210, ph: (315) 425-0048.

AUDIO ENGINEER

Major NYC video/audio facility seeks audio engineer with experience in SMPTE Interlock mixing. Send resume to PO Box 2258, Dept. Audio, Times Square Station, NY, NY 10108.

Audio Technician needed for AVR New England Studio Store. Self-starter with experience, good customer relations and positive attitude. Call Mr. Brito (617) 924-0660.

Employment Wanted

Sound Reinforcement Engineer

F.O.H. & monitors, specializing in monitors, 8 yrs. prof. experience. National one-offs & touring. Seeking employment w/ touring sound/production comp. w/ reputable mngment. Ross Hindman, 38 Magdelina St., Pittsburgh, PA 15203. (412) 736-8186/431-1883.

Equipment For Sale

Sony APR 24, \$37.5k,
(717) 569-8474.

(2) MIDAS CONSOLES
Pro 4 monitor, 30 ch
Pro 5 House, 38 ch
Excellent Condition
Half Nelson Systems, Inc.
(705) 674-1450



Request our new "DATAFILE." Equipment reviews & buying guide. NEW & USED DEALS. Delivering: PRODISK Hard Disk Recorder; SOUNDCRAFT 3200 Mega-Mixer; OTARI DTR-900, MTR-100, MX-80; Sony & Panasonic DATs, Tannoy; Chicago's leading Pro Audio Dealer. (312) 339-8014.

SOUNDCRAFT 24-TRACK recorder 760 mk3 with remote. 4 yrs old. \$15,000. (606) 292-8428.

The Best Audio Transformers!

- Wide bandwidth
- No overshoot
- Flat group delay
- or ringing

Free applications assistance
(M-Th, 9am-5pm Pacific time)

jensen transformers

10735 Burbank Bl. • N. Hollywood, CA 91601
FAX (818) 763-4574 Phone (213) 876-0059
TELEX 6502919207 MCI UW

American Pro Audio

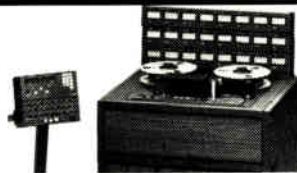

- Sony/MCI • Trident •
- Tannoy • Eventide •
- Yamaha • Tubetech •
- Fostex • Soundtracs •
- Beyer • Roland • Akai •
- Ramsa • Panasonic •

Mini Lease Program

New or used, trade-ins 24-60 months with buyout option \$5K-25K **no** financials required min. 2 yrs in business.

1-800-333-2172

BUY-SELL-TRADE
NEW & USED EQUIPMENT

- RECORDERS
- CONSOLES
- DIGITAL RECORDERS
- MICROPHONES
- MONITORS
- TAPES & ACCESSORIES

CALL FOR THE LATEST
LIST & FREE
CATALOGS.

OPUS

Recording & Equipment Co.
4262 Grand Ave.
Gurnee, IL 60031
1-(800) 522-(OPUS)-6787
FAX: (708) 336-6895

TIMELINE SYNCHRONIZERS

Drawmer Gates & Compressors
Audio Kinetics Automation
Tape Machine Rentals
Lots of used equipment available
Call for free list
SG AUDIO
(312) 266-1901
FAX (312) 266-1904

NEW, USED, DEMO SALE

RECORDERS, CONSOLES,
OUTBOARD EQUIPMENT
Trident consoles, Akai A-DAM,
TAC Scorpion II, Drawmer,
Tascam MSR-24, Digidesign
Sound Tools, Sony/Panasonic
DATs, Apogee A/D converters/
filters, Tascam DA-30 DAT,
Studer Dyaxis, CAD consoles,
Otari MX-70, Adams-Smith
Zeta-3, Roland/Akai samplers.
Equipment leasing specialists—
experienced staff/unequaled
service.

E.A.R. PROFESSIONAL AUDIO
(602) 267-0600

Otari MTR-12 1/2" 2-track, exc. condition \$7,000; B&K 1560 60 MHz Triple Trace Scope \$650; Mellotron Model M400S \$650. Call George: (916) 392-5640.

AMS AUDIOFILE IV

9 mos. old, immaculate cond., latest software, 1630 option. Call (212) 333-2206.

Portable Sound Panels



- Isolate specific areas
- Many sizes and options
- Panels start at \$19.95/ea
- Complete w/foam

Write for free catalog

Island Cases

1121-1 Lincoln Ave., Holbrook, N.Y. 11741
800-343-1433 • In N.Y. 516-563-0633

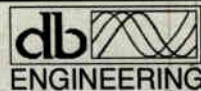

The oldest broker on the East Coast !!

PHONE (617) 782-4838

FAX (617) 782-4935

214 Lincoln St., 103C, Boston, MA 02134

WE NEED YOUR CLEAN USED 24 TRACK !!!

SSL 4064G, 3yr, mint, call; 4056E/G LH patch, call; 6064E/G VU, \$275K; 4048 w/32, recall ready, \$165K; Neve 8128, 48 in 56fr w/Necam \$175K; 4000E Modules, \$3.3K. **Amek API, Neve, Trident, Call. 24+Tracks:** Studer A800 MkIII \$48K; MCI JH24 lo hrs, \$20K; Mitsubishi X-850, call; 3M dig 32, \$40K; Otari MTR90, MX-80 many, call. Otari 5050B \$1.5K; Pultec Mavec, \$1.4K; EQP1A, \$1.8K; Neumann U87 \$1.2K; VF-14 tube \$425; Telefunken 251 mint, CALL; AKG C12A (tube), \$1.5K; C414B, \$650. We have dbx in stock.

List Your For-Sale Items With Us Free!!

db ENGINEERING now offers new specials !
Tannoy, Aphex, Adams-Smith, Ashly, Eventide,
Beyer, Klipsch, Sennheiser, Studiomaster, Neumann,
AKG & most major brands. Now offering GML, Jensen,
TubeTec, Sontec. Tube compressor coming soon.

VELCRO CABLE WRAPS



6 Sizes, 10 Colors
Custom logo printing available

Seam Tech

(415) 861-6011
P.O. Box 77394
San Francisco, CA 94107

All rights reserved. Patent #4700432

Sounds Incredible, Inc.
PO Box 796054, Dallas, TX 75379-6054. Sound & recording gear delivered to your doorstep. From cables to mics and power amps to tape decks: all major brands. Write for catalog & monthly mailer or call
(214) 238-9393.

PROFESSIONAL CABLE PRODUCTS

We've been providing high-quality cable products to the industry for over 5 years. Hard to find or make adapter cables and snakes. Bantam cables a specialty. Patch bays and custom harnessing—no problem.

CALL: (800) 446-3146
T L Industries, Inc.

PANASONIC PROFESSIONAL VIDEO

- VCRs
- CAMERAS
- CAMCORDERS
- MONITORS
- MIXERS
- PROJECTORS & AUDIO FOR VIDEO

OPUS RECORDING & EQUIPMENT
•1-(800) 522-6787

IF YOU'RE NOT USING IT —SELL IT!
Your national clearinghouse for used audio and video! Call for free copy of our latest listings, or to list your used gear free. The Bertech Organization. Call toll-free: (800) 992-2272. In Calif. call: (818) 909-0262. **THINK BERTECH FIRST!**

FOR OVER 10 YEARS YOUR BEST BUY IS USED RECORDING EQUIPMENT
SYE MITCHELL SOUND
22301 CASS AVE.
WOODLAND HILLS, CA 91364
(818) 348-4977
FAX: (818) 704-7031

MODULAR TECHNOLOGIES

HIGH PERFORMANCE SPEAKERS

FULLY LOADED
3 WAY 15" P.A. OR MONITOR

LIST \$479

FOR DEALERS OR INFORMATION CALL:
(215) 736-0811

CUSTOM MIDAS CONSOLE
Ex-Oscar Peterson, 16 x 8 recording, 8 PRO5, 8 PRO3 w/ updated amps, Remix option, 6 LED option, NTP peak meter, patch bay, flight case. \$9,500. Hank, (916) 284-6929.

TUBE MICS

The best tube mics bought/sold. New power supplies for old mics.
Bill Bradley
(312) 751-1216
FAX (312) 751-1217

AMS AUDIOFILE

As-new condition. Latest software/hardware updates.
(212) 582-5473,
Tom Steele.

MERCENARY AUDIO

WE HAVE HUNDREDS OF LISTINGS ON:
SSLs, NEVEs, TRIDENTs, STUDERS, OTARIS, MCIs, COMPRESSORS, EOs, MIC-PRES, MICROPHONES, ETC.
WE BUY, SELL, & TRADE VINTAGE EQUIPMENT
CALL FOR LISTS !!!

in stock:
TELETRONIX LA-2A, LA-3A
NEUMANN 48, 49, 67, 86, 87
NEUMANN 48a w/1-micron cap
AKG C-12B, C-12
FOCUSRITE ISA-115HD
PULTEC EQP-1, H-2, MEQs
NEVE 2254A, 1073, 1081
TRIDENT A-RANGE MODULES
"this is not a problem"
(617) 784-7610 TEL
(617) 784-9244 FAX

STUDIOWORKS

Sony used and demo sale. Sony 3036 loaded 32/non-auto, \$57.7k. Full manufacturer warranty. Sony 3036 loaded 36 w/auto, \$81k.
(800) 438-5921 (704) 375-1053
STUDIOWORKS sells over 70 pro lines: AKG, E-V, Hafler, JBL, Lexicon, Soundtracs, Allen & Heath, Sony, Sennheiser, Neumann, Otari, Ramsa, UREI and many others.
Factory-direct prices for 3M and Ampex.

DON'T MISS YOUR MIX DIRECTORY LISTING!

Mix Directories are the most authoritative guides to facilities and services for the audio and video production industries. When production professionals need equipment, studios or other services, they consult *Mix* first.

To receive a free questionnaire for your Directory listing and to get the details on placing low-cost advertising in these special issues, call us—now!

**Toll-free Mix Directories number:
(800) 344-LIST.**

UPCOMING ISSUES & QUESTIONNAIRE DEADLINES

OCTOBER

**New Products For 1991
(AES Issue)
DEADLINE: JULY 17**

NOVEMBER

**North Central U.S. Studios
& Canadian Studios
DEADLINE: AUGUST 16**

DECEMBER

**Mastering, Pressing &
Tape Duplicating
DEADLINE: SEPTEMBER 17**

THIS IS THE 90'S..... DO YOU NEED DIGITAL ?

anything audio offers a full range of professional Digital Audio products for every application and budget. Let our staff of sales engineers and technicians design a system to meet your facilities needs, from R-DAT to multi-track digital, new or used we have what you need to get the job done easily & cost-effectively. We carry a complete line of new & used audio and video equipment with prices and services unmatched nationwide. Call today and start saving time and money now!

Take a look at some of our quality product lines...
ALPHA AUDIO DR-2 Hard Disk Recorder & Bose-2 Editing System • AUDIOMATION Moving Fader automation • Digital Designs • AUDIO-KINETICS MASTER MIX II Automation • Eventide • AMS • T.C. Electronic • API • BSS • Klark-Teknik • Neotek • USED SPECIALS - SSL-4048G/E, recall 170k-Otari MTR-90/1 \$18.5k- AKG Tube \$1.7k • 2-Panasonic SV3500 \$1.5k ea. • Sony APR-24 Like-new \$37.9k • Mts X-850 \$87k • 2-Neumann U47 Tube \$1.7k ea. also 2-U67 \$1.9k ea. • Fostex B16D 30ips \$3.6k • AMS RMX16 \$4.6k • 3-Tascam MS-16 \$4.7k • MCI JH-24 \$19k • API 4-550b \$2k • Neve 24x8x2 \$15k • MCI JH-636, auto \$23.5k • AKG 414EB \$675 • Otari MX-80 24 \$19k • Ashly FET 500 \$350 • Otari MTR-10c (10hrs) \$4.5k • A&H Saber 24x16 \$10k • Sony C48 \$700 • 2-Pultec PEO1A \$1.9k • Tascam M-520 \$3.8k • List your 4-sale equip w/US FREE!!

anything audio

professional audio and video systems
 Equipment Sales System Design Installation

THE DIGITAL AUDIO SOURCE
 NEW • USED • RARE • BUY • SELL • TRADE
 PHONE 617-426-2875 FAX 617-426-2763
 63 MELCHER STREET BOSTON, MA 02210

ICB AUDIO

2036 Reading Road
 Cincinnati, OH 45202
 Call us for over 100 lines of
 Professional Audio and Video
 (513) 651-0800

Necam I mvg fdr auto sys w/2nd
 Necam cmprtr, 40 faders, spr pts.
 100 new Aphex 500A VCAs. Studer
 A80 1" 8-trk. 24-ch Dliby A CAT-22/
 44 cds in MH racks. BTX Cypher.
 Prophet 600, 6-trk, Pro-1. Sound-
 craft 400B cnsl. Mac II setup. (212)
 645-6319.

AVR

106 Main St.
 Watertown, MA 02172
 (617) 924-0660

The widest selection of used gear. The best prices on new equipment. In stock: AKG 466/CK22: \$400; Ampex AG440: call; Ampex ATR-102 in stock (many available): \$5.5k to \$7.5k; Crown PZM 31 w/x18: \$200; Fairlight 2x w/MIDI, SMPTE, Voicetracker, cases: \$5k; Fostex 4030/4035 synchronizers: call; Fostex 80: \$1,375; Fostex E16 (30 IPS): \$5k; Fostex E22: \$2,650; Lang PEQ-2: \$750; MCI JH-24: \$19k; Macintosh MC40 tube amp: call; Mitsubishi X850 (mint): call; Neotek Series I 16x16: \$8k; Neumann U87 \$1,250; Orban 516C de-esser: \$325; Otari MKII E8: \$3.7k; Otari MTR-90 II (many available): call; Otari MX-80 24: call; Pultec EQP-1A, EQH-2: call; Ramsa T820: \$2,900; Tascam MS-16: call; TC Electronic 2290-S1: \$1.9k.

WE BUY AND TRADE!!

We list your items for free. All used equip. warranted and calib. to factory spec or your \$ back.

(617) 924-0660
 AVR

CONSOLES FOR SALE

Classic Neve 80 Series 24x16x24; \$40k; DNR 4000 Series 28x8x28 w/ extensive upgrades including 576 pt. custom patch bay; \$16k. Call (416) 279-4008 or Fax (416) 279-4006.

MacIntosh II with 140-meg hard drive, absolute perfect condition. Marshall Electronic (301) 484-2220.

HELP!

We're overstocked!

We guarantee the best deal on recording equipment, keyboards, MIDI devices and all musical equipment. All major brands. Ask for Ted; the call is free. Music Makers, 1-(800) 395-1005.

FOR IMMEDIATE SALE as package only. 1988 Neumann disc cutting system, VMS 80, SAL 74b, SP 79b, Studer A80, MKII prev. 1/4" 2-track, Studer B67 1/4" 2-track, five Aiwa F-770 cassette decks, two White 4400 EQs, one Yamaha P-2201 amplifier, EMT 445 delay, two UREI 811s, two Yamaha NS-10Ms, two Valley People HH2x2B level matching interface, one Elenco 35 MHz oscilloscope. Buyer is responsible for packing and shipping. All equipment in excellent condition and presently in use. Inspections are welcomed. Price: \$185k. Contact Christine Zack (312) 242-3434.

FOR OVER 10 YEARS
 YOUR BEST BUY IS USED
 RECORDING EQUIPMENT
 SYE MITCHELL SOUND
 22301 CASS AVE.
 WOODLAND HILLS, CA 91364
 (818) 348-4977
 FAX: (818) 704-7031

Fostex: 4030/4035 \$1,250; 8700 \$110; (2) 8785 \$200 ea; Tascam 58 w/remote \$4,200; Panasonic AG68 10 VHS \$1,100. Yamaha MCS-2 \$100; Synhance MTS-1 MIDI sync \$120; Otari MX-5050B 1/2-track recorder \$1,200. Tascam M512 \$2,950. All equipment in new condition. The Process (919) 855-1941.

GREAT DEAL!

ACES 32x24 recording console and 24-track recorder; includes all wiring, cable and patch bay. One year old and in excellent condition. Complete package \$32.5k. Call Gene at (216) 845-1937.

Harrison MR3, Soundcraft 600, Steinway M (1927), RX5, DPX1, MSB+, Masterbeat, Crown DC-300, DC-150, E-V Sentry 100 As, JBL 4401s, Bel BD80, Orange County comp/lmtr, dbx 161, Ampex 350/Inovonics 2tk, Pioneer RT1050 2-tk, Crown PZM, MXR ddl... (212) 362-7840.

Home studio: Soundtracs CM-4400 w/ CMS2 auto, 32x12x24, Akai MG14D w/ autolocator, Klark-Teknik DN780 rev w/ remote, Otari 5050B, Nakamichi MR-2, EPS, Kawai R-100DM + more. Call David, (813) 264-0105.

Neve 8058 28 mainframe. All Bus modules. 24 EQs w/mic pres, 2 limiters; 16 buses—8 auxes, 24 faders; 2 stereo faders—all meters; 1/4" patch bay, lose. 4 echo returns. Immaculate condition. \$56,000. Clay, (516) 759-9110; FAX: (516) 674-4204.

NEVE 8058MKII

PRISTINE 32 INPUT, 16 GROUP, 8 AUX W/ MATRIX, A/B CUT, P/BAY. ONE OWNER, PRIVATE USE. (415) 662-2046.



Reliable

No Fancy Ads
 Just Good Service
 & Prices.
 All Major Lines.

704 375 8662
Ext. 649

Otari 7300 1" 8-track professional tape machine. Remote. \$5,500. Soundworkshop 1280 B console. Perfect condition. 12 in 8 out. Both barely used; home use only. \$1,400. Kawai KG2C 5' 9" classic grand piano. Perfect and beautiful. Ebony finish. \$9,950. John, (615) 797-3016.

Otari MTR-12H 1/2" 1/2-trk 30 ips demo, \$6,995. Sony 3202 dgtl mstrng dck, lists: \$18.5k sell: \$11.7k. Mstr 5002 1/4" 30 ips 1/2-trk, 2 yrs, \$4,800. Neumann U-47 w/ pwr sply exlnt cond, \$2.4k. Eventide 969 Harmonizer delay lists: \$5,995, sell: \$2,800. Rob (804) 499-0000.

Recording consoles for sale from my personal studio. Neotec 12x8x2, excellent condition, \$4,500. Ramsa WR-T812 12x8x2, excellent condition, \$2,500. DeltaLab effects, \$200. Space Station digital reverb, \$300. All have low hours and used only in personal studio. Ask for Chuck (405) 324-5311 office; (405) 341-8445 after 6 p.m.

SONY PCM 1610 Digital Processor (2) \$19,000 ea. SONY DAE 1100A Digital Editor with Anvil cases, \$23,000. 1610/DAE 1100A Package with Anvil Cases, \$37,000. (713) 664-5258 Studio.

SOUND CRAFT 600 CONSOLE.

24-in, 32-mod frame. External patch bay (3 x 96), rdcase, all harnesses, exc cond. Configure to suit or sell separately.

DAVID CARROLL ELECTRONICS
 (415) 528-8054.

MILAM AUDIO

"THE SOURCE"

SINCE 1967

SPECIALIZING IN
 ALL TYPES OF RECORDING
 EQUIPMENT, SUPPLIES,
 DESIGN, INSTALLATION,
 AND CONSULTATION

CONSOLES ■ D.A.T. ■ MICS
 MULTI-TRACKS
 MONITORS ■ AMPS

CALL US TODAY

MILAM AUDIO

1470 Valle Vista Blvd.
 Pekin, IL 61554
 (309) 346-3161
 ORDER HOT LINE:
 800-334-8187
 FAX 309-346-6431

SSL 4000E/total recall/3 mach. A/S sync/Extra patch bays/lots of xtras, dbx multitrack N.R. units, Omnicraft production mixer, 16-4-2 patch bays, MCI JH24s, MCI 4-track, Kexpex frames/gates/comps, Scully 4-tk/mono, UREI 813a spkrs 3M 79 spare parts, Harrison 4032. Call Warren at (312) 644-1666.

State-of-the-art sound reinforcement. Soundcraft 200 Delta 24-channel console; Apogee AE-5 mains with AE-10 subs; Klark-Tekniks EQ; 2 Crown 600 amps; 2 Crown 1200s; Pro-Co 150-foot snake; Shure mics; JBL monitors and Rane EQs; Art SGE effects plus mic cabling and stands. Call (505) 266-9388.

TAC Scorpion console 28/12/24/2 w/4 patch bays wired w/Mogami cable in custom desk w/12 single rackspace equally spaced above meter bridge. Otari MX-80 and Otari MTR-10. Less than 50 hrs., Hafler P-500 power amp. Call Bob, (805) 251-2599.

db ENGINEERING Call and ask why ARIES consoles are the industry's best buy !!

English quality & Great sound for less \$\$\$ than Trident, Soundcraft or TAC !! Prices for 16/8/16 start under \$5,000. New modular range 24/8/16 w/meters, 4 band EQ and 8 sends from \$12,500. Call for 8/12 buss, 16/24 monitor pricing up to 40 x 12 x 24.

Phone 617 782-4838
 Fax 617 782-4935

DYAXIS DIGITAL SYSTEM

320-meg hard disk, \$6,000

Orig. cost over \$12,000, less Mac. Call Paul, Schafer Digital, (619) 456-8000.

SOUND POWER

Protect your sensitive equipment with power conditioners & uninterruptible power systems from Oneac, Toshiba/Houston & Clary. (800) 288-9807

POWERCOM

WANTED: DEAD OR ALIVE! Pultec EQs; Fairchild & Teletronix Limiters; Neumann, Telefunken, AKG, RCA, & Schoeps microphones. Tube McIntosh or Marantz amps & pre-amps. Sontec, ITI, & Lang EQs. Neve or API equipment. Boxes of old tubes; UREI, Orban, United Audio, dbx, & other outboard gear. Ampex ATR-102s or 104s. Parts for MCI JH-110/114 recorders. Altec 604s/crossovers/Tannoy speakers, JBL 2231; Altec 288h drivers; misc. equipment of all types. Please call Dan Alexander, 2944 San Pablo Ave., Berkeley, CA 94702. (415) 644-2363. Fax: (415) 644-1848.



THE LAST CALL YOU WILL EVER HAVE TO MAKE FOR THE BEST DEAL ON PRO AUDIO GEAR

215-426-6700

TekCom carries a full line of professional sound reinforcement, recording and midi equipment by Otari, Crown, JBL, Fostex, Tascam, Kurzweil and Roland among others. Our qualified sales staff and factory trained technicians are waiting to assist you.

TekCom Corporation

1020 N. Delaware Ave. Phila., PA 19125

USED EQUIPMENT Bought & Sold



Summit Audio Inc.
P.O. Box 1678
Los Gatos
CA 95031
408-395-2448

FAX: (408) 395-1403

Mix Classifieds are the easiest and fastest means of reaching a buyer for your product. One phone call is all it takes. (800) 747-3703.

Equipment Rentals

!!!! API 16x4 mixer !!!!

550-A EQs, Jensen mic pres. Other cool mods. \$300 per day, \$1,200 per week, \$3,600 per month. Call Swirling Vortex Music, (213) 656-0854. Warmth - punch - quality for those who know.



ADVANCED AUDIO

Pro Audio Rentals

- Digital Recorders
- Analog Recorders
- Dolby Noise Reduction
- Outboard Processing Gear

- Competitive Rates
- Well-Maintained Equipment
- Exceptional Service & Support

(818) 985-6882
11120 Weddington St., N Hollywood, CA 91601

Check this Out

Rack Attack™

Audio Processing Systems

Lexicon 480L
Lexicon PCM-70
Lexicon PCM-42
Eventide H-3000
Yamaha SPX-1000
Yamaha REV-5
T.C. 2290

All 7 devices
\$165/day

All systems include remote patchbay

Outboard Rentals

(818) 998-1024
Hollywood, CA

DESIGN FX AUDIO

DIGITAL AUDIO RENTALS
Specializing in digital tape machines, reverbs and effects processors. Technical consultation included.
213/838-6555
800/441-4415
P.O. Box 491087
Los Angeles, CA 90049

Pro Sound Reinforcement Mixing Console Rentals:

Gamble, Yamaha
Soundcraft, Audioarts,
Studiomaster,
Ramsa, Toa.

Hi-Tech Audio Systems Inc.

Long- and short-term rentals
Good Rates—New Equipment
(415) 726-2428

UNDERGROUND SOUND

PRO AUDIO RENTALS

MITSUBISHI X-850 (Apogee Enhanced)
\$500 per day / \$2,000 per week

REVERB RACK

2-AMS RMX16
1-AMS DMX-15
2-480-L Lexicon
1-Lex PCM70
1-T.C. Elect.
2-Yamaha SPX-9011
\$225/day

ALSO VINTAGE TUBE GEAR

• NEW RACK CONFIGURATION
Call For New Rate Card

• SONY 3348 DIGITAL MACHINES

Prices do not include sales tax or cartage. All prices subject to change

(615) 347-0243 • (615) 327-2900

EQ RACK

Focusrite 115
Massenburg EQ
(2)-Pultec EQP-1A3
(2)-LA-2A
(4)-Aphex E.Q.
(6)-Aphex Comp
L.T. Sound
(2)-DBX 160 lim.
DBX Boom Box
\$195/day

Equipment Wanted

MERCENARY AUDIO NEEDS YOUR CONSOLES

SSL/NEVE/TRIDENT
MULTITRACKS

A800/MTR-90/JH-24

MICROPHONES

NEUMANN/AGK/B&K

COMPRESSORS

UREI/FAIRCHILD/NEVE

EQUALIZERS

API/NEVE/PULTEC

MIC-PREAMPS

SUMMIT/JENSEN/HARDY

—ANYTHING—

of Exceptional Audio Quality

"this is not a problem"

(617) 784-7610 TEL

(617) 784-9244 FAX

Recording studio wanted.

Looking to buy large package of studio equipment for one or more studios. All-cash offer. Also looking for individual pieces: consoles, multi-tracks, outboards, any tube equipment, etc. Ask for Dave (818) 346-9007.

Instruction

EDUCATIONAL VIDEOS

12-hour sound mixing/recording course: \$239, 2-hour course: \$39; 2-hour MIDI course: \$39; plus shipping/handling. Visa/MC/check. For brochure: RECORDING ASSOCIATES, 5821 SE POWELL, PORTLAND, OR 97206. (503) 777-4621.

The NEW 1990 Mix Bookshelf Catalog is now available! We've added over 150 new products to the world's most complete collection of books, tape courses, videos, sounds and software for audio professionals. Write or call now for your FREE copy.

MIX BOOKSHELF
6400 HOLLIS STREET #12
EMERYVILLE, CA 94608
Call Toll-Free: (800) 233-9604
or (415) 653-3307

Maintenance Services

MAGNETIC RECORDING HEADS

—RELAP/REPLACEMENT for Audio, Video, Time Code, Duplication. 30 years of head design experience. IEM, 350 N. Eric Dr., Palatine, IL 60067; tel. (708) 358-4622.

RCA Microphones — Repair service on all models. Complete sound and cosmetic restoration. 35 yrs. experience with RCA. ENAK Microphone Repair, 420 Carew Avenue, Pitman, NJ 08071. (609) 589-6186.

DAT MODIFICATIONS

For Sony TCD10 Pro. MOD #1: SPDIF digital In at 44.1 k. MOD #2: Fix problem with non-monotonic and non-linear digital output, presently preventing perfect clones. Cost: \$200 (either mod), \$300 (both mods) incl. retr. ins. FED EX. Other DAT mods avail. By DIGITAL DOMAIN, Bob Katz, prop. East (212) 369-2932. West (408) 238-6062.

DAT Repairs & Mods.

Expert repairs on all models of Sony, Aiwa, Technic...DATs. Home/Portable/Studio Models. 44.1 MODs at reasonable prices. Fast service. UPS/Fed Ex. Free est. All work guaranteed. F.E.T. Electronics (818) 345-8565.

Music Products/ Software

IBM PC MUSIC FEATURE!

Option card with 8-voice, multitimbral MIDI synthesizer onboard. Includes 240 pre-programmed Yamaha sounds, 96 programmable patches and a MIDI in/out/thru interface. Use two cards to double capacities. An all-in-one MIDI studio for IBM and compatibles for only \$425. Software available for recording, arranging and educational needs. Packages recommended. Dealers, catalogers & VARs call for discount schedule. **Distributed by: Mix Bookshelf**, 6400 Hollis St. #12, Emeryville, CA 94608, (415) 653-3307, (800) 233-9604.

Records, Tapes & CD Services and Supplies

Disc Mastering and Record Production. CDs, LPs, 45s.
**CASSETTE DUPLICATION
THE CUTTING EDGE**
Box 217M
Ferndale, NY 12734
(914) 292-5965

TRAXX RECORDING PRODUCTS
 24 Crestway - KC
 New Fairfield, CT 06812

- Real-time dup. & full-svc. pkg.
- Custom-loaded cassettes & sup.
- High-quality, fast turnaround

For Free Catalog call:
 (203) 746-3561.

REAL TIME
 Best Quality Cassettes using Nakamichi decks only. Custom-loaded Agfa or BASF Chrome. Label and insert printing, shrinkwrap, blank tapes.

SUPERB QUALITY AT LOW PRICES
 Uni-Sette, Inc.
 1852 Fulton Ave.
 Sacramento, CA 95825
 (916) 485-9534

PROFESSIONAL RECORDING SUPPLIES

We are a major wholesale distributor of Ampex, Agfa & 3M reel-to-reel mastering tape (1/4" to 2"). We also stock broadcast videotape, assorted reels and boxes, splicing/leader tape and pre-packaged cassettes. We load bulk cassettes in custom lengths using a variety of tape brands. Please call or write for our FREE catalog.

Advance Recording Products
 7190 Clairemont Mesa Blvd.
 San Diego, CA 92111
 (619) 277-2540
 Inside CA: (800) 858-1061
 Outside CA: (800) 854-1061
 Visa/MC Accepted

SoundSpace Inc.

Real-time cassette duplication.
 Full printing and packaging
 (513) 767-7353
 Custom-length cassettes and supplies: Agfa, BASF, Sunkyong
 (513) 767-7354
 126 Dayton St., Yellow Springs, OH 45387.

CHROME BLANK TAPES

100/Quantity • Clear Shells
 30 min. 60 min. 90 min.
 .61 .78 \$1.06
 Custom lengths available
BEST SERVICES UNLIMITED
 Free samples. Visa/MC.
 (800) 627-7365/(415) 547-5272

REAL TIME DUPLICATION

BLANK CASSETTES

Custom length
 Chrome or low noise
 Choice of shells

Full production/graphics; packaging/sweetening. Call us for QUALITY first. McIver Recording, (518) 374-4339.

CASSETTE DUPLICATION

One to a Million

High Speed-Real Time-Blank Cassettes
 Recording Tape & Supplies

Jackson Sound Productions

3897 So. Jason, Englewood, Colorado 80110
 1-800-621-6773 (303) 761-7940
 Fax (303) 789-0557

CD'S LP'S 45'S CASSETTES
1-800-527-3472

Custom/Packaging
A + R RECORD & TAPE MFG. CO.
 902 North Industrial Blvd.
 Dallas, Texas 75207
 214-741-2027
 Visa MC Accepted

AUDIO/VIDEO DUPLICATION

Complete Packaging Service
(800) 525-0100
 phylco audio
 Satisfaction Assured • Since 1974



REAL TIME DUPLICATION

Top quality cassette duplication on 56 Nakamichi decks. Custom labels, and inserts with complete packaging. Custom loading—CD premastering Digital DAT to DAT Transfers.
 call toll free 1-800-783-7372
 10650 East Bethany Drive, Suite B
 Aurora, CO 80014 303/755-9978

DISC MAKERS

MONEY SAVING PACKAGES

COMPLETE MANUFACTURING



PROFESSIONAL DESIGN DEPT.
 CALL FOR CATALOG

1-800-468-9353

STUDIOS SONGWRITERS MUSICIANS B & L SALES

Stocks
TDK Short Length and Studio Quality Blank Cassettes
 Now Available in C-10.

C-20 and C-30 Formats
 Complete line of TDK and Maxell Cassettes Available in DATS

B & L SALES
(818) 985-1792

10812 1/2 Magnolia Boulevard
 North Hollywood, CA 91601

3M AGFA AMPEX SONY

Audio, video & digital tapes
 Full line of accessories
 DAT recorders.
 Orders shipped within 24 hours.
R & M PRO AUDIO
 1080 Pacheco, S.F., CA 94116
 (415) 665-8480

Mix Classifieds are the easiest and fastest means of reaching a buyer for your product. One phone call is all it takes: (800) 747-3703.

Cassettes AS EASY AS . . .

- 1 REAL TIME DUPLICATION
- 2 HIGH SPEED DUPLICATION
- 3 CUSTOM BLANKS

INTRODUCING:

Full Service Digital Editing and CD Compilation

ESP Means Quality Full Service Printing and Packaging, Friendly Professional Service, Competitive Prices, Fast Turn-Around and Highest Quality Raw Materials.

ESP EASTERN STANDARD PRODUCTIONS, INC.
 26 BAXTER STREET
 BUFFALO, NY 14207
 1-716-876-1454

1-800-527-9225

TIRED OF PAPER LABELS ?

INTRODUCING

AN AFFORDABLE
 ON-CASSETTE PRINTER
 The
 ARCOSET MINI PRINTER

\$1800
 (Options Available)

For Sample CASSETTE & ordering Info
 CALL OR WRITE:

THE ARCHON CORP.
(508) 777-8836
 43 Cherry St.
 Danvers, MA 01923



INCREDIBLE CD DUPLICATION PACKAGES!
 500 CD'S ONLY \$2395.00 COMPLETE!
 1000 CD'S ONLY \$2795.00 COMPLETE!

- AD / DD conversion
- Mastering and Plating
- 1000 full color booklets
- 3 inside typeset panels
- Print on CD
- Personal Service
- Quick Turn-Around
- Proofs within 24 hours
- Packaging and Shrink Wrap

FOR MORE INFORMATION ON CD AND OTHER DUPLICATION SERVICES CALL OUR NATIONAL TOLL FREE HOTLINE

TODAY!
1-800-386-DISC
 1-800-386-3472

AAPEX

ULTIMATE FIDELITY

The world's largest Nakamichi real-time cassette duplication system. Full-service packaging. 50 to 50,000 qty. Outside CA, call toll free (800) 323-AAPEX or (415) 492-1300
 —Call AAPEX today!

Recording Services

WAREHOUSE RECORDING STUDIO

Quality Cassette Duplication — BASF tape. Complete services and fast delivery from studio to fulfillment. Call (904) 399-0424 or write 2071-20MX Emerson St., Jacksonville, FL 32207.



DIGITAL TRANSFERS

CD MASTERING

DIGITAL EDITING

CD PRODUCTION

db PLUS

DIGITAL SERVICES INC.

BOX 694 LYNBROOK, N.Y. 11563
 (516) 872-2325

TAPE DUPLICATION
REAL TIME & HIGH SPEED
1/4" DISTRIBUTION & RUSH SERVICE

DUPLICATION SPECIALISTS
 (N.Y.) 516-432-7107

Studios For Sale

PROFITABLE MIDTOWN N.Y. RECORDING AND AUDIO-FOR-VIDEO POST-PRODUCTION FACILITY FOR SALE. Several rooms, 24-tk to 1" and 3/4" interlock. Call (212) 865-9166.

AUDIO/VIDEO RECORDING FACILITY. DRIVE-IN AUDIO/VIDEO SOUNDSTAGE 25x30, 16-track, 2" audio w/ many outboard effects, 3/4" VIDEO EDITING w/ broadcast cameras, 2,000-track MIDI setup w/ many keyboards. Offices on premises. In business for 18 years w/ built-in client base. (201) 646-0416.

INVESTMENT OPPORTUNITY.
 PHILA. 24-TR STUDIO FOR SALE. Prestigious location. 1 24-tr., and 2 production suites. Designed for VAPP and music prod. Established client base. 3,000 sq. ft. (215) 642-2346.

MIAMI, FLORIDA RECORDING STUDIO FOR SALE

3,300 sq.ft. facility

designed for full production services. Complete isolation between studios. Located in the heart of Kendall. Spacious, comfortable, new. Tel: (305) 235-1435. 24 hrs.

WORLD-CLASS 48-TRACK MIDI room, audio/video. Neve/Studer. Ton o' synths. Heart of Hollywood, charting records. Loaded and beautiful. Eric (213) 461-0734.

Manhattan Recording Studio and Luxury Apt. For Sale.

Established studio, 24-tracks+. Excellent acoustics, looks great, wired and ready to go. Also has MIDI room, office, shop, lounge and storage. With or w/o equipment. **Four Bedroom, 2.5 bthrm apartment in same building.** Spacious living rm and dining rm. Sunny. Sold separately or together. Qualified buyers only. (212) 362-7840.

Time to upgrade your equipment? Look in the Equipment for Sale category or place an ad under Equipment Wanted. Mix Classifieds work! Call Robin at (800) 747-3703.

Miscellaneous

ADVERTISING/PR SERVICES
Former Director of Advertising for Studer/Revox America and writer for *PSN*, *MIX*, and *RE/P*. Ad copy, PR releases, feature articles, brochures and manuals at very reasonable rates. Call Bruce Borgerson, (503) 488-5542.

MASTERING
REPLICATION **PRINTING**
COMPLETE CD AND CASSETTE PRODUCTION
DIGITAL HOUSE
FOR THOSE WHO HEAR THE DIFFERENCE
GRAPHIC DESIGN ART STUDIO
TOTAL PACKAGING
PERSONALIZED EXPERT SERVICE
212-333-5950
101 WEST 57th STREET, NEW YORK, N.Y. 10019

POP FILTERS
An absolute necessity for every studio
\$49.95 includes screen, clamp, gooseneck and shipping
Call or Write for Free Brochure
Outside CA (800) 446-7677
Inside CA (818) 788-3635
POPPER STOPPERS
P.O. Box 6010—658 Sherman Oaks, CA 91413
DEALER INQUIRIES WELCOME
SATISFACTION GUARANTEED
Mix Classifieds work! (800) 747-3703.

Le Cover™
CUSTOM COVERS...
CALL NOW!
1 800-228-DUST



**Best Prices
Best Service
Best Names...**
AMPEX AGFA
GANARE
FOSTEX maxell
NEUTRIK Switchcraft
LEADER 3M
Call for our FREE Catalog filled with Professional Tape, Equipment, Accessories and Supplies.

309 Power Ave., Hudson, NY 12534
800-999-HAVE • 518-828-2000 (NYS)

How to Place a *Mix* Classified Ad

Please print or type in CAPITAL LETTERS and lowercase. There are 8 lines to the inch and approximately 24 CAPITAL letters or 32 lowercase letters per line. \$80 per inch—1" minimum. Additional lines \$10 per line. **BOLD TYPE** or Black Border \$10 per line. Gray screen \$15 extra. Logos or display advertising up to 4" will be charged at \$100/inch. Logos or display advertising must be camera-ready (width is 1-5/8" or 10 picas). Frequency discount rates available. Call for information. **Payment by check, money order or charge must accompany ad. DEADLINE is the 15th of the month, 6 weeks prior to publication.**

Categories Available (check one):

- | | | |
|---|--|--|
| <input type="checkbox"/> Acoustic Consulting | <input type="checkbox"/> Equipment Rentals | <input type="checkbox"/> Records, Tapes & CD Services & Supplies |
| <input type="checkbox"/> Business Opportunities | <input type="checkbox"/> Equipment Wanted | <input type="checkbox"/> Recording Services |
| <input type="checkbox"/> Employment Offered | <input type="checkbox"/> Instruction | <input type="checkbox"/> Studios for Sale |
| <input type="checkbox"/> Employment Wanted | <input type="checkbox"/> Maintenance Services | <input type="checkbox"/> Miscellaneous |
| <input type="checkbox"/> Equipment for Sale | <input type="checkbox"/> Music Products/Software | |

Co. Name _____

Name _____

Address _____

Phone _____

I am paying by (check one): VISA MASTERCARD AMERICAN EXPRESS

Card #: _____ Expiration Date: _____

Signature: _____

Check or Money Order #: _____ Amount Enclosed: \$ _____

MAIL TO:

Mix Classifieds, Attn: Robin Boyce, 6400 Hollis St. #12, Emeryville, CA 94608
Toll-Free Order Line: **(800) 747-3703** (415) 653-3307 FAX: (415) 653-5142

Ad Copy: _____

ADVERTISERS INDEX

PAGE	ADVERTISER	ActionFax #	PAGE	ADVERTISER	ActionFax #	PAGE	ADVERTISER	ActionFax #
80	Ace Music Center		71	DigiTech		51	Opcodes Systems	
160	Act III Publishing		60, 188	Disc Makers		178	Optical Media International	
31	Agfa		58	Dolby Laboratories		143	Orban	(415) 957-1070
101	Akai Digital		46	Dr. T's Music Software		7	Otari	(415) 341-7200
19, 85	Alesis Studio Electronics		166	EAR Professional Audio/Video		187	Peabody Conservatory of Music	
145	Alpha Audio Acoustics		72	Echo Sound Recording		IBC	Peavey Electronics	
175	American Helix Technology		67	Electric Sound & Picture		59	Personal Composer	
12-13	Ampex		129	Electro-Voice		173	Polyline	
42	AMP Services		52-53	E-mu Systems		111	Professional Audio Services & Supply	
28, 159	AMS Industries		174	Europadisk				(818) 843-5754
110	Anvil Cases		146	Eventide		27	Prosonus	(213) 462-7036
150	Apex Machine Company	(305) 563-2844	179	First Light Video Publishing		123	QSC Audio Products	
61	API Audio Products		156	Fostex		35	Radian	
118	Apogee Sound		50	Full Compass Systems		66	Rane	
40	Applied Research & Technology (ART)	(716) 436-3942	87	Fullersound		191	The Recording Workshop	
			34	Full Sail Center for the Recording Arts	(407) 671-1112	172	Rhythm City	(404) 233-1581
186	The Art Institutes				(203) 938-8740	20-21, 102-103	RolandCorp US	
113	Sam Ash Professional		186	Gold Line/Loff		62	Saki Magnetics	
190	Audio Images	(415) 957-1531	151	Gotham Audio		191	Schirmer Books	
79	Audio Intervisual Design		30	Grove School of Music		29	Sennheiser	
39	Audio Precision		147	The John Hardy Company		107	Simon Systems Engineering	
140	Audio Services Corp. (ASC)		142	Head Water		11, 78	Solid State Logic (SSL)	
121	Australian Monitor		172	HRC Magnetics		162	Sony Audio Visual Products	
171, 173, 175	B.A.S.E.	(818) 244-6664	25	illbruck		8, 74	Sony Professional Audio	
192	The Bertech Organization		147	Imperial Tape		177	Sound Code Systems (SCS)	
126	BGW Systems		38	Institute of Audio Research	(212) 677-6549	125	Soundcraft	
104	Biamp		192	Institute of Audio-Video Engineering		163	Sound Ideas	
60	Brainstorm Electronics	(213) 475-7570	122	Intersonics		55	Spectral Synthesis	
17	Bruel & Kjaer	(508) 485-0519	115, 117, BC	JBL Professional		55	Sprague Magnetics	
141	Bryston		36	Jensen Transformers		109	Steinberg/Jones	
161	Burlington Audio/Video Tapes	(516) 678-8959	41	JRF Magnetic Sciences	(201) 579-6021	100	John M. Storyk Design	
			171	KABA Research & Development		4-5	Studer Revox	
136	Carver Professional		48	K-disc Mastering		167	Studio Consultants	
189	Carvin		73	Klarity Cassette	(207) 873-3924	54	Studiomaster	(714) 524-5096
149	CCS Printing		155, 157	Korg		176	StudioTECH '90	
170	Center for the Media Arts		130	Lexicon		194	Sweetwater Sound	(519) 745-2364
84	Cipher Digital		86	Lone Wolf		63	Tannoy	
120	Community	(215) 874-0190	73	LT Sound		106	Target Technology	
137	Conneaut Audio Devices		149	Manhattan Production Music		180-183	TASCAM	
48	Conservatory of Recording Arts & Sciences	(602) 277-6552	140	Markertek Video Supply	(914) 246-1757	177	Thoroughbred Music	
75	J.L. Cooper Electronics	(213) 822-2252	64-65	Maxell		37	The Toy Specialists	
134	Crest Audio		138	Meyer Sound Laboratories	(415) 486-8356	83	Trebas Institute of Recording Arts	
135	Crown	(219) 294-8329	41	Middle Tennessee State University		57	Trident	
87	CRT Custom Products		200	Mix Books/Hal Blaine		121	UltraSound	
16	D & R Electronics USA		197	Mix Bookshelf		82	Universal Entertainment Group	
80	D.A.T. - Audio Gallery	(213) 829-0304	170	MusiCity		188	Vertigo Recording Services	
18	The DAT Store	(213) 470-6176	167	Musicmakers		15	Wadia Digital	(715) 386-8116
43	dbx	(415) 957-1070	193	Musonix		23	WaveFrame	
144	DDA/Klark-Teknik		IFC-1	Neve		81	Westwood One	
97	Digital Dynamics		42	Northeast Community College		124	Yorkville Sound	

MIX THE RECORDING INDUSTRY MAGAZINE

ACTIONFAX

Advertiser _____ Adv. Fax # () _____

Name _____ Title _____

Company _____

Address _____

City _____ State _____ ZIP _____

Tel# () _____ Fax # () _____

Use this form to immediately contact advertisers in this issue. All advertisers with a Fax number are listed in the Ad Index above. Photocopy this page if you need additional copies of this form.

Please send additional information about _____

as seen in _____ Mix. Please send this information by Return Fax Mail

Please have a salesperson contact me.

DPM™ 3

"Even under the microscope, the Peavey (DPM 3) sounds are uniformly excellent." — Craig Anderton, *Electronic Musician Magazine*

"...a powerful contemporary sound."
— *Keyboard Magazine*

"...Most Innovative Keyboard" 1990
— *Music & Sound*

- **Totally DIGITAL PHASE MODULATION SYNTHESIS (DPM)**
- **Software-based voice/program generation**
- **Dual Multi-Effects Processors**
- **16-voice Polyphonic/16-voice Multi-Timbral Dual Oscillator Program Architecture**
- **4 Megabytes of 16-Bit PCM Wavesample ROM**
- **27 Megahertz DSP sound generation eliminates dedicated hardware approach**

- **720K byte/3.5" PC-compatible floppy disk drive**
- **Software upgradable — Only a software update away from next year's model**
- **MIDI or Disk loadable PCM Wavesample RAM expandable to 512K**
- **"Tape Deck" — Like 9-track 20,000 note MIDI Sequencer**
- **"Up-Front" studio quality 16-bit PCM Wavesamples**
- **61-key dynamic keybed with "aftertouch" and velocity sensitivity**
- **5 totally programmable 32-piece Drum Kits**
- **100 Internal Programs (Expandable to 200 with Peavey Cache™ Card)**
- **Capable of operation as a MIDI Master Controller via Global Data Storage and Multiple Channel control**
- **Diagnostic Disk runs complete system check on internal functions**

**For further information, call the DPM™ 3 Hotline
1-601-483-5370**



Puts The Music Back In Your Hands.

Peavey Electronics Corp.
Meridian, MS 39302-2898
(601) 483-5365 Telex: 504115
©1990

World Radio History

Circle #047 on Reader Service Card

Super. Natural. Power.



The JBL/UREI SR Series is an artful achievement in sound reinforcement electronics, putting pro-caliber power amplification into a super small super lightweight package. The 500 watt model, for example, is a mere 2 rack units tall and weighs only 42 pounds.

SR Series circuitry capitalizes on the natural benefits of high-speed complimentary symmetry, giving you an amplifier that naturally cancels distortion and lets every nuance of your music come through.

And, powerful. Responding the instant you need it, the dual 150 watt model 6615, dual 300 watt model 6630 and dual 500 watt model 6650 all come with switch-selectable stereo, dual mono or bridged mono operation.

Plus, The SR Series uses an ultra-quiet cooling fan that alters its speed as it senses subtle variations in the heat sink temperature. With a rear-to-front airflow across the components, your racks stay cool while your music heats up.

SR Series Power Amplifiers can be found at your local authorized JBL Professional dealer. Drop by today, give them a good listen and put some super natural JBL power into your sound system.



JBL Professional
8500 Balboa Boulevard, Northridge, CA 91329
A Harman International Company