

SEPTEMBER 1984
U.S. \$2.50
CANADA \$2.95
Bipad No. 71613

THE RECORDING INDUSTRY MAGAZINE

Mix[®]

Interview: Jeff Beck

FILM SOUND '85
Southern California
Studio Listings

Digital Supplement
Low Cost Digital
Lucasfilm ASP
Interactive Disks
Digital Resource Guide

Three hundred years ago, it took the hand of a master craftsman to create a concert violin. It also took commitment—a commitment to producing the highest quality, purest possible sound.

Today, at the new Harrison, we still follow the craftsman's tradition—and we share that unwavering commitment. We realize that, even today, there is no substitute for the enduring quality and value of precision craftsmanship. That's why we take the time to listen to your ideas and needs, and why we use that input to build every Harrison console with the same painstaking care that the master violinmaker devoted to his craft.

For the future, we'll continue to bring you the best possible workmanship, technology and service. Yet, even as we engineer for the future, we're also committed to the careful tradition of the past. We know that's where our best example lies.

THE NEW
Harrison

P.O. Box 22964, Nashville, Tennessee 37202
(615) 834-1184, Telex 555133



C O M M I T T E D T O A S O U N D F U T U R E

Circle #001 on Reader Service Card

World Radio History



Cover: Ground Control Studios, Santa Monica, CA
Photo: Mark Rice
Corner photo of Jeff Beck by Richard MacCaffrey

Opened one and a half years ago by owner/producer/engineer Paul Ratajczak, Ground Control has recently added a Studer 800 Mk III multitrack and a TAD TSM One monitoring system. Recent clients have included the Hollies, Dolly Parton, and Oingo Boingo.



The irrepressible Mr. Bonzai travels all over Los Angeles for this issue's feature on film sound. In the course of his journeys, Bonzai visits Glen Glenn Sound, Paramount Studios, SMPTE and much, much more. Bonzai's odyssey begins on page 14.

DEPARTMENTS

- 5 FEEDBACK
- 6 CURRENT
- 8 SESSIONS/STUDIO NEWS
- 153 BOOKSHELF
- 159 PREVIEW
- 214 CLASSIFIEDS
- 218 ADVERTISERS' INDEX

LISTINGS

- 102 STUDIOS OF SO. CALIFORNIA
- 106 4 & 8 TRACK
- 114 16 TRACK
- 117 24+ TRACK

AUDIO

- 14 MR. BONZAI GOES TO THE MOVIES by Mr. Bonzai
- 35 MIX DIGITAL SUPPLEMENT (Contents on Page 37)
 - SPARS President Speaks Out
 - Low Cost Digital
 - Optical Disk Technology
 - New England Digital Corporation
 - Digital at Lucasfilm
 - Video & The Compact Disc
 - Sony Digital Mixer
 - Digital Update
 - Digital Resource Guide

AUDIO (cont.)

- 93 SOUTHERN CALIFORNIA STUDIO ROUNDUP by Blair Jackson
- 141 NEWS FROM APRS by Ron Neilson
- 151 CES REPORT by Neal Weinstock
- 156 SOUND ON STAGE: THE DEMOCRATIC CONVENTION by George Petersen
- 164 FIELD TEST: AKG'S "THE TUBE" by Robert Missbach

MUSIC

- 154 SESSION PLAYER by Carol Kaye
- 168 JEFF BECK by Iain Blair
- 174 MUSIC NOTES
- 192 PLAYBACK

VIDEO

- 196 MUSIC VIDEO PRODUCTION by Lou CasaBianca
- 199 SOUND FOR "SOLID GOLD" by Tony Thomas
- 204 VIDEO INTERFACE by Neal Weinstock & Lon McQuillin
- 212 VIDEO NEWS by Mia Amato

In our continuing commitment to stay on top of the latest in digital technology, we offer a meaty section that includes a digital resource guide, and articles on Lucasfilm, New England Digital, optical disk technology, SPARS president Jerry Barnes and more. See page 35.



The focus of our listings section this issue is Southern California. Those listings start on page 102, and are preceded by a look at the music and studio scene in that region (page 93).

Transforming the cavernous Moscone Center in San Francisco from an empty concrete shell to the colorful site of the 1984 Democratic Convention was no small feat. George Petersen takes a look at the complicated audio preparations that were necessary to make the convention sound as good as it looked. Page 156.

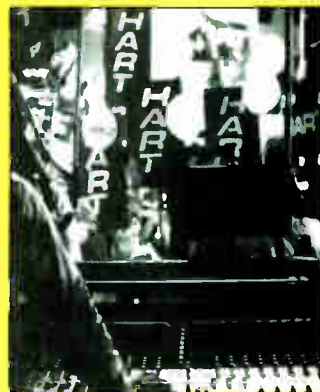

First we proved it. Then we improved it.



Over the past four years we've installed over 500 Studer A800 multi-track recorders in studios all around the world. We've proven this machine on all counts—reliability, sonic performance, production versatility, and total client satisfaction. No other recorder has earned such widespread admiration among recording professionals.

And now, with the introduction of the A800 MKIII, we've improved on the proven standard. We've removed all transformers from the record and reproduce paths. We've added interfaces for Solid State Logic and

Neve/Necam automation, and for all SMPTE/EBU synchronizing and editing systems. We've also updated the software for the microprocessor controls to meet the most demanding industry requirements.

Improving the A800 was not an easy assignment, but at Studer the pursuit of perfection has become an ingrained habit. Discover the difference yourself. Call your Studer representative and ask for details on our new A800 MKIII...now, more than ever, the proven standard for impeccable performance.

STUDER REVOX

Studer Revox America, Inc. • 1425 Elm Hill Pike, Nashville, TN 37210 (615) 254-5651
Offices: Los Angeles (213) 780-4234 • New York (212) 255-4462 • Dallas (214) 760-8647 • Canada: Studer Revox Canada, Ltd.

Circle #002 on Reader Service Card

World Radio History

Mix

PUBLISHER/
EDITOR
David M. Schwartz

PUBLISHER/
GENERAL MANAGER
Penny Riker Jacob

ASSOCIATE PUBLISHER/
ADVERTISING DIRECTOR
Hillel Resner

MANAGING EDITOR
Blair Jackson

ASSISTANT EDITOR
George Petersen

ASSOCIATE EDITOR
Ken Pohlman

MUSIC EDITOR
David Gans

EDITOR AT LARGE
Mr. Bonzai

EDITORIAL ASSISTANT
Elizabeth Rollins

CONTRIBUTING EDITORS
Mia Amato
Lou CasaBianca
Bruce Pilato
James Riordan
Neal Weinstock

ADVERTISING DEPARTMENT
ACCOUNT EXECUTIVES
Jeffrey Turner
Kathy Arnold

DIRECTORIES/CLASSIFIED MANAGER
Lauri Newman

ART DIRECTOR
Tim Gleason

ASSISTANT ART DIRECTOR
Bonnie Blair Ofshe

DESIGN & PRODUCTION
Dave Marrs Andrew Boettcher

TYPESETTING
Linda Dierking

PRODUCTION MANAGER
Anne Letsch

CIRCULATION MANAGER
Mary Holland

CIRCULATION ASSISTANT
Allison Hershey

ACCOUNTING DEPARTMENT:
Mark Elsberg
Linda Simpson
Cathy Boyum

TRAFFIC MANAGER
Ron Ward

PROJECTS DIRECTOR
Craig Wingate

OFFICE MANAGER
Patsy Messerer

Mix Magazine is published at 2608 9th St., Berkeley, CA 94710 and is ©1984 by Mix Publications, Inc. This is Volume Eight, Number Nine, September, 1984. Mix (ISSN 0164-9957) is published monthly. Subscriptions are available for \$24.00 per year. Single or back issue price is \$3.50. Subscriptions outside USA are \$42.00. Please address all correspondence and changes of address to Mix Magazine, 2608 Ninth St., Berkeley, CA 94710 (415) 843-7901. Controlled circulation postage paid at Berkeley, CA and additional mailing offices. Mix Magazine is distributed in recording studios, pro-audio stores, music stores and other related businesses. If you have a recording or music related business and would like to distribute Mix, please give us a call. Display advertising rates, specs and closing dates are available upon request. This publication may not be reproduced or quoted in whole or in part by mimeograph or any other printed means, without written permission of the publishers.



Dear Mix:

Concerning the Field Test of the ANT Telcom noise reduction system, July 1984, there are a number of points we would like to discuss, some commercial and some technical.

Telcom C4 noise reduction was introduced as long ago as 1975, and, being German, is indeed becoming the standard system in BCN video tape recorders in Germany and Austria. In addition it is used by many of the broadcasters in those countries. However, it is our belief that there is not much use in Europe outside of these countries, and certainly not in the USA or elsewhere. The great majority of BCN machines at present in use worldwide use Dolby A-type NR system.

In C-format video tape recorders the Dolby A-type NR system is used worldwide whenever noise reduction is required (for example, the independent television companies in England have standardized 100 percent on A-type for all recordings). There is absolutely no validity in the statement that the C4 system is becoming a standard in Europe for C-format machines, and there is no use of C4 in the USA with this format of which we are aware.

On the technical side, we query the assertion that fast attack times are essential during noise reduction. On the contrary; slow attack times are to be preferred where at all possible. Fast attack times lead to control frequencies which cannot be passed by the recording medium—it may sound satisfactory on a simple back-to-back test, but a real live tape recorder between encoder and decoder produces dispersion which results in muffled transients—which indeed may have been observed by your tester who noted elsewhere in the review that "Telcom may be inferior to Dolby in high frequency clarity."

However, our more serious comments relate to the testing and evaluation section. It should have been next to impossible to hear any noise difference between a master without noise reduction and 1:1 copies made from this master with the three systems using the quoted figures for the noise reduction effects of the three systems, and assuming a 55 dB signal-to-noise ratio for the source, the copy would have increased its noise level by 0.35 dB, 0 dB and 0.01 dB for Dolby, dbx, and Telcom respectively.

These changes are pretty insignificant, and I doubt if they are audible. Similarly, it is claimed the Telefunken system improved the bass clarity and the Dolby system increased the high frequency content. By definition, a noise reduction system should be transparent, and any change in the sound means a failure of the system, even if the reviewer likes the new sound. All of this points to either faults in equipment or incorrect calibration, and therefore leads us to suspect all the tests.

This suspicion is re-inforced by the next paragraph, which states the Telcom system appears to reduce the original source noise after encoding and decoding. Just how is this meant to happen—or if it does, how does it not effect the high frequency program content? All three systems are theoretically incapable of removing noise already in a source—they cannot distinguish between program and noise, and thus any reduction in noise (due to either mal-function, mis-calibration of system or recorder, or limited bandwidth between encoder and decoder) must also be accompanied by a similar reduction in high frequency program, which should be just as audible as the (incorrect) reduction in noise. Thus a change to the sound is not a good feature as implied, but in fact an indication of a problem in the unit—either in the fundamental design, or by virtue of a fault.

We would be interested in your reviewer's comments on the above.

Sincerely,
David P. Robinson
vice president,
Advanced Development
Dolby Laboratories
San Francisco, CA

Dear Mr. Robinson,

With regard to your questions concerning the Field Test of the Telcom C4, in addition to being the standard noise reduction system of West German radio stations and standard equipment in BCN videotape recorders in Austria and Germany, Telcom is also the standard for all B type VTRs in Sweden, East Germany, West Germany, Austria and Switzerland, with the Netherlands expected to follow suit, according to the manufacturer. Bosch, the largest supplier of B format VTRs uses Telcom exclusively on these machines. Telcom is also standard for noise reduction in C type machines in Denmark, Switzerland and Finland using either the Telcom "X" system or C4DM cards with the VTRs. Type C VTRs are used on a large scale in England and the USA and it is true that at present Dolby A is the accepted standard for these systems.

—PAGE 116

CURRENT

AES Sets Fall Meet

The 76th Convention of the Audio Engineering Convention has been set for October 8 through 11 at the New York Hilton. Among other events will be the installation of officers for the coming year. The annual election will be held on October 1st at noon, when election officers count the ballots of AES members. The nominations committee has proposed the following slate of candidates for office: president-elect, Bart Locanthi, Robert Schulein; governors (three to be elected), Greg Bogantz, Jerry Bruck, Kevin Dauphinee, Robert Trabue Davis, Daniel Gravereaux, Stanley Lipshitz; secretary, John Bubbers; treasurer, Arthur Gruber. For more information, contact AES at (212) 661-8528.

Sony to Build U.S. Plant

The Sony Corporation has announced plans to build a 40,000-square laser video disk manufacturing plant at a site to be announced somewhere in the state of Indiana. Intending for the facility

to be operational in 1985, Sony is building the operation to provide replication services mainly for government, industry and educational customers. The plant is expected to have initial production capacity of one million disks annually, and expand to a yearly capacity of three million units.

The choice of Indiana was partly based on the positive experience of CBS/Sony's Digital Audio Disc Corporation in Terre Haute, Indiana. That facility, which will manufacture Compact Disc laser software, is expected to be fully operational by early Fall 1984.

NAMM Attendance Record

The National Association of Music Merchants International Expo, held at Chicago's McCormick Place June 23 through 26, set an all-time record, with 23,587 attendees showing up to view the latest in musical instruments as exhibited by 515 manufacturers and distributors.

Elections for NAMM's Executive Committee for 1984-85 resulted in the following: president, Jim Kleeman, Karnes Music Co., Elk Grove, IL; vice president, Alfredo Flores, Jr., Alamo Music Center, San Antonio, TX; treasurer,

Don Griffin, West L.A. Music, Los Angeles; and secretary, Lee Donais, Vienna, VA.

RIAA CD/Video Music Workshop

The Recording Industry Association of America (RIAA) sponsored a series of meetings, July 17 through 19, to exchange information between member companies and independent engineers and producers, and to discuss the creation of suggested standards for the production of compact discs and music videos. In the first session, held at CBS Records in New York City, the RIAA engineering committee outlined the need for a "White Paper" detailing suggested sound transfer requirements of CD's and music videos. The following day, at RCA Studio A, CD transferring techniques were demonstrated. The final day of the workshop centered on the sound for music videos. Hosted by Warner Communications, this event brought together representatives from home video, cable and broadcast television, video producers and engineers as well as promotional personnel to talk about maintaining sound quality in music videos.

notes

Solid State Logic (USA) Inc. has opened a new sales and service office, headed by *Piers Plaskitt*, at 200 West 57th St., Suite 1210, in New York City, 10019. *Lance Korthals*, former *dbx* marketing manager, has moved to a similar position at *Lexicon*. *Keith Worsley* has left *Lexicon* and joined *Klark-Teknik* as U.S. marketing director. *Larry Nicholas* has been appointed to the new position of public relations manager of *Ampex Corporation's* audio-video systems division. *Neotek Corporation* has announced the appointment of *Gregory G. Davis* as vice president of manufacturing. *Auditronics* has appointed *Michael Uhl* national sales manager. A four-day video production workshop is being offered by *Audio Visual Consultants* October 9 through 12 in Berkeley, CA. Call (415) 839-9745 for details. *Bigg Electronics* has purchased

GLI/Integrated Sound Systems, Inc., which will become a wholly-owned subsidiary of Bigg Electronics. *Victor Duncan, Inc.* has announced the additions of *Ben Everett* as district sales manager for the Detroit region and *John White* as southwest broadcast sales representative. *Barcus-Berry, Inc.* has formed a new affiliate, *Barcus-Berry Electronics, Inc.*, to market a new line of audio components for commercial and consumer applications for both video and audio products. *Mark O. Russel* has joined *Manhattan Transfer/Edit*, of New York City, as director of videotape operations. *Douglas G. Booth* has been named national sales manager of industrial products for *TDK Electronics Corporation*. *Glenn H. Derringer* has been named vice president for sales and marketing at *Kurzweil Music Systems*. *George Heywood* has been appointed

vice-president and general manager of *Omnibus Computer Graphics Center, Inc.*, in New York City. *Celestion Industries, Inc.* has recently appointed *Jeffrey L. Nagel* national field sales manager. *Rolling Stone Magazine* is expecting to attract as many as 500,000 students to a series of 50 two-day on campus electronics shows featuring high fidelity components, video, musical instruments and computers, beginning in September and running through Spring 1985. *Guitar Center* has promoted *Dave Weideman* to the post of manager of their Sherman Oaks, CA operation. *Algis Renkus* of *Emilar* reports that *Malcolm Hill* of England has purchased fifty EC 320/EH 820 HF driver/horn combinations for use with the European AC/DC tour.



BRUCE SANDERS

Enter the Space Age

With the coming of the Space Age, sound engineers will finally acquire power over acoustic space and time. They will create reverberant spaces of almost limitless variety, from tiny chambers to vast echoing canyons. They will tune their effects to achieve a richness and realism that once seemed beyond the reach of any technology. And they will command equipment so easy to use, it becomes an extension of their own creative abilities.

Now, with StarGate 323 from Ursa Major, you can bring the Space Age into your own studio. StarGate 323 is a high performance digital reverberation system whose sound quality and features match those of much higher-priced

systems. Eight pre-tuned Rooms let you simulate (and modify) a wide range of acoustic environments; the superbly designed panel controls let you independently adjust all important reverb parameters, with full simultaneous display of settings.

To see what Space Age technology can do for you, ask for a hands-on demonstration of StarGate 323 at any Ursa Major dealer. And enter a new dimension of sound.

STARGATE 323



URSA MAJOR, Inc.

Box 18, Belmont, MA 02178 USA • Telephone (617) 489-0303
Telex: 921405 URSAMAJOR BELM

SESSIONS

NORTHWEST

At *The Automatt* in San Francisco, MCA recording artists *Atlanta* recorded a promotional spot for the city of Atlanta, with *Milan Bogdan* producing and engineering, with *Ray Pyle* assisting. Also *Sylvester* cut a new LP for Megatone Records with *Tip Werrick* and *Ken Kessie* producing and Kessie engineering. Current projects from top Northern California studios recently mastered to disk at San Francisco's *Sonic Arts* by president/chief engineer *Leo Kulka* include a single by *John Mabry & Falling Dark*, "Steel City" b/w "Love Torn Man," recorded at Bammie Award Winner *Felton* (of *Confunkshun*) *Pilate's Felstar Studios*, located in Vallejo. Also recorded at Felstar and mastered at Sonic Arts is the fourth release from San Francisco's own *Champions*. Four wheelin' through *Espresso Productions'* ¼ on-line suite in Emeryville, CA was the Western Media Group of *AT&T*. AT&T was at Espresso to finish a half-hour training tape on four wheel drive vehicles. *Ron Keel* (former Steel-er lead vocalist) was in at Cotati, CA's *Prairie Sun* producing his band's—Keel—debut album on Shrapnel Records, with *Mike Davis* engineering, and *John Volaitis* assisting. Also at Prairie Sun, *The Drive* cut tracks with *Neal Schon* producing the project and *Allen Sudduth* engineering. *The Plant Studios* in Sausalito, CA announced that their chief engineer, *Jim Gaines*, is expanding his role at the studio and taking over as the new general manager. Gaines replaces former general manager and current sales manager Paul Broucek. At *Montage Recording Company*, Newark, CA, recent projects included a 45 for the *California Sun Band* engineered by *David Hartzheim* and *Chuck Coke* in with *Derrick Hughes*, producing a new EP. Berkeley-based ska punk-funkers, the *Freaky Executives* have been recording at *Starlight Sound Studio* in Richmond. Also at Starlight was *Mike Molenda* working with producer *Norman Kerner* on his video rock theater *Streetbeat* for movie theater release in the fall. Among the recent sessions at *Nightsore Studios* in San Francisco were *El Shaw*, working on a new demo, *Repeat Offenders* (album project) and surfrockers *New Tarzans*. From a dance score for the feature *Breakin'* produced by *Gary Remal* and *Michael Boyd*, Remal Music Design; to ADR sessions for *On the Edge* and the recording of the score and film mixes for the independent film entitled *Juggling* (*Kim Hoeg* and *Bob Crossley* of Strider Productions) Russian Hill Recording in San Francisco has been busy. At the *Music Annex* in Menlo Park *Ronnie Montrose* produced three new projects; an album for *Gary Hull* and *Marc Bonilla*, a four song demo for

John Smith, sax player for *Toto*, and a new album for himself. The Annex's chief engineer, *Roger Wiersema*, was the engineer on all three projects. Recent studio activity at *Rhythmic River Productions* includes a new 24 track album project by *Crawl Away Machine* produced by *Bill Cutler* and engineered by *Gary Mankin*. Sax wizard *Norman Salant's* long-awaited album *Saxtalk* will be released sometime this fall, but in the meantime he is doing final mixdown at *T & B Audiolabs* in San Francisco on a 12-inch dance version of the title song. Roy Sablosky is engineering on this project. At *Beggar's Banquet*, in Santa Rosa, CA *Scanner* completed a four-song EP produced and engineered by Mark Lyon. Bringing hot sounds from the Frozen North to San Rafael, CA's *Patchbay Studios* was *Montag* the Juneau, Alaska based songwriting team of *Mike Mongiello* and *Tag Eckles*. They cut a six-song EP to be released on the Flat Donut label. *Gordon Elliot* engineered the project. *The Sheets* have completed their second recording session at *Dragon Studios* in Menlo Park, CA. *Charlie Albert* did the mix

SOUTHWEST

The first annual Texas Music Video Awards were held at the Mistral Club in Dallas, TX, and of the four top winners, *Omega Audio* was responsible for the audio mix and sweetening on two of them: *Pamela Stanley's* "Comin' Out of Hidin'," directed by Ken Mandell, and *The Nelsons'* "I Don't Mind," directed by Steve Moss. *David Buell*, chief engineer at Omega Audio mixed both cuts. Recording and mixing has been completed on a new album for *Mazz*, one of the premier Hispanic bands in Texas, at *The Studio*, San Antonio. The Studio's *Sal Monistere* engineered and mixed the album with *Mazz's Jimmy Gonzales* and *Joe Lopez* acting as co-producers. *Z.Z. Top* and manager *Bill Ham* were at Sumet-Bernet's Studio "D" in Dallas to view a rough cut of an Aaron Russo film "Teacher" starring Nick Nolte. Negotiations were under way to get the Top to write and perform the title song. Sumet also put the finishing touches on the *NTSU Lab Band's* Lab '84 album. At *Rivendell Records*, Pasadena, TX, Austins' *Lee Roy Parnell* worked with *Kerry Prior* on their album project. *Paul Mills* was behind the board engineering *Dove & Note Recording Company* of Houston, TX recently completed recording sessions with the *Houston Symphony Orchestra*. Album release is expected this month. *Ray Benson*, leader of *Asleep at the Wheel*, was recently in Willie Nelson's *Pendernales Recording Studio* cutting tracks with Nelson and Robert Duvall. The three songs cut by the duet are World War I vin-

tage songs to be used in the soon to be released movie *1918*, written by Horton Foote starring Barbara Halle and Matthew Broderick. Foote wrote the Academy Award winning *Tender Mercies*. Benson is now completing the score for the movie in Austin. Austin's *Reelsound* had its remote trucked called in to provide audio support for a video shoot on the Marlboro country music festival in San Antonio. Featured on the show produced by Entertainment Services Group, Ltd. were *Ricky Skaggs*, *Merle Haggard* and *Ronnie Milsap*. *Buford Jones* engineered with assistance from *Harper, Harlow & Garrison*. *Dave* and *Dale Garrett* of New Zealand were at Fort Worth's *Sierra Recording* recording tracks for their next release. *Fletch Wiley* produced, with *Randy Adams* engineering, assisted by *Tim Hood*. Producer/engineer *Jon Early-Liqon* was very busy lately working with new music group *Edge of the Wedge* from Louisiana, local singer/songwriter *Billy White*, *Jimmy Wallace & The Clue*, R & B singer *Kim Farmer*, all at *Studio Southwest*.

NORTH CENTRAL

Model Citizen has been recording at *Pearl Sound Studios* in Detroit, with *Ben Grosse* producing and engineering the EP, the band's first. Recording activity at *Studio A*, Dearborn Heights, MI included rockers *Rough Cut*, featuring vocalist *Carolynne*, laying down tracks for an EP with producer *Freddie Brooks*, engineered by *Eric Morgeson*. *Streeterville Studios* in Chicago provided their multitrack recording and audio post-production for video facilities to Comtrack for an internal presentation celebrating Sears' 100th year anniversary featuring grammy-nominee *Patty Austin*. Comtrack scored the song "Brand New Day" for a 38-piece orchestra, which was recorded 48 track on dual MCI 24 tracks in Streeterville's Music I by *Gus Mossler*. At *Sweetwater Studio* in Fort Wayne, IN *Jimmy Mudd* and *Steve Manus* recorded and mixed songs for their video "What's Your Name," and their live TV appearances. *Buzzy Feiten* was in at *Paragon Recording* in Chicago producing vocals for *Bill Quateman's* latest project. And Paragon owner *Marty Feldman* and close friend *Ben Sidran* completed the new single of "Kid Leo and the Superheroes."

NORTHEAST

At *Sheffield Recordings Ltd.* in Phoenix, MD *John Palumbo* finished up his new album for HME Records. Palumbo produced and *Victor Giordano* was engineer. At *Evergreen Re-*

AFFORDABLE PERFORMANCE

Since the introduction of the Model 1000B and Model 1500, audio professionals throughout the world have consistently acknowledged both units as unequalled in both low noise and unmeasurable distortion. In an industry that relates cost to performance, SPECTRA SOUND equalizers stand alone. The cost of both units is far below lesser performing equalizers, an important consideration when selecting your next equalization device.

For further information on the affordable performance of SPECTRA SOUND equalizers, see your local professional audio dealer, or contact SPECTRA SOUND, 3750 Airport Road, Ogden, Utah 84405 (801) 392-7531.

SPECIFICATIONS, 1000B/1500

DISTORTION: Unmeasurable, THD less than .0012%, IM less than .0018% (20Hz to 20kHz, -22dB)

SIGNAL/NOISE RATIO: 116dB below +4dB, 20kHz bandwidth

OUTPUT IMPEDANCE: Less than 1 ohm, typically .3 ohm



3750 Airport Road
Ogden, Utah 84405
(801) 392-7531

Spectra Sound is a wholly owned subsidiary of Spectra Dynamics

Circle 4004 on Reader Service Card



Recording in New York, **Rob Stevens** mixed the **Anne Haigis** LP for EMI Germany, **Edo Zanki** producing, **Lothar Segeler** assisting. Recording in Bearsville Studios were **The Reddings**, produced by **Hubert Eaves** for Polygram Records. Engineering was **Mark McKenna**, assisting **Caryl Wheeler**. At **Planet Sound** in New York City, **Chaka Khan** completed vocals with **Arif Mardin** producing and **Lew Hahn** engineering.

CBS artists **The Manhattanans** cut at **Celestial Sound** in New York City with **John "Skip" Anderson**, **Morrie Brown**, **Steve Williams** producing. **Steve Goldman** engineered with **Ron Banks**, **Larry DeCarmine**, **Kurt Upper**, and **Dean Cochren** assisting. Recent sessions at **39th Street Music** in Manhattan included Capitol artists **Ashford & Simpson** working on new tracks with **Tim Cox** engineering; EMI-America artist **Jules Shear** self-producing new material with **Richard Kaye** engineering; and **Fred Munao** producing upcoming releases for Select/Atlantic artist **Gary Private** and Select artist **Crystal**, **Richard Kaye** engineering. **Lillo Thomas** was in New York City's **First Choice Studio** working on the title track for his upcoming album on Capitol Records, **All of You**. At **EARS** in East Orange, NJ arranger/writer/producer **Bill Galanty** wrapped up a track for Jane Fonda's "Workout." The song, entitled "Do It," was engineered by **John Rollo**. Also at EARS, artist/producer **James Mtume** put finishing touches on his latest album. **David Dachinger** engineered the album. At **Secret Sound Studio** in New York City, **David Hasselhoff**, star of NBC's TV hit **Knightrider** overdubbed and mixed his first single for Silver Blue Records. **Joel Diamond** produced with **Scott Noll** engineering and **Warren Bruleigh** assisting. **Dennis Scott** is producing a Sesame Street Christmas album, tentatively titled **Sesame Christmas Sing-Along**. The recording is being done at **Delta Recording Studio** in New York City. The album features the Jim Henson/Sesame Street Muppets as well as members of the TV show cast **Blacksheep**, the exciting international reggae group from Washington, D.C. has wrapped up their second album project, **Homeland**, at **Lion & Fox Recording**. Engineer/producer **Jim Fox** expected the album to be out in late summer. At **Greene Street Recording** in New York City, CBS recording artist **Philip Glass** was in recording his new album **Glasspieces**, music written for the world tour of the New York City Ballet. **Kurt Munkasci** and **Glass** produced, **Michael Reisman** engineered, and **Audrey Veblaitis** assisted. **The Ordinaires** returned to **The Power House**, Camden, NJ, to cut tracks for their new album, **The Real Deal**.

Edgar Winter, **Jerry La Croix**, and **John Pati** producing material for a forthcoming release entitled, appropriately enough, **Winter, La Croix, & Pati**. Engineer and associate producer **Jeffrey Kawalek** ran the board while **Chris Isca** ran the Necam automation with no display. The **ASL Mobile Audio Unit** was the production facility for three more live lunchtime concert broadcasts on WNEW-FM, New York City. **Steven Remote** recorded, mixed and engineered **Icicle Works**, **Colour Radio** featuring **Rick Denninger**, and the **Earl Scooter Band** live from the Ritz, NY. **Elvin Jones'** new live album from Palo Alto Records was recorded via **Aura Sonic's** mo-

bile unit from the Village Vanguard. **Gene Perla** engineered and mixed the performance while **Steven Remote** was the second engineer. At **Unique Recording Studios**, in New York City, **Diana Ross** was in mixing her next single and 12-inch release, "Swept Away," for RCA Records with producer **Arthur Baker**, **Chris Lord Alge** engineering and **Tom Lord Alge** assisting. At **Duplex Sound** in New York City, **Chuck Mangione** finished his new album for CBS Records, **Disguise**. It was produced by **Eumir Deodato** and **Mangione**, engineered by **Mallory Earl**. At **Blank Tapes** in New York City, **John Morales** & **Sergio Munzibai** of M&M Mix Productions were in re-mixing **Modern Romance** for RCA Records. **Joe Arlotta** engineered. **David Bowie** finished recording his much awaited new album, recorded in its entirety at **Le Studio**, Morin Heights, Quebec and mixed on the new JVC BP900 digital system. **Hugh Padgham** engineered.

SOUTHEAST

Atlantic recording artist **John Parr** has finished his debut album in Studio E at **Criteria Recording Studios** in Miami. The album, untitled at present, was produced by **Peter Solley**. Solley, and Criteria engineer **Jim Sessody** handled the engineering chores. Sessions at **A.M.I. Studio** in Hendersonville, TN included: **Roger Gore** working on an album and new single with producer **Michael Radford**; producer **Brien Fisher** working on an album with **Joe Sun**, with **Bernie Vaughn** engineering, **Jimmy Lee Huff** and producer **Jack Eubanks** working on new material.

Mobile Audio based in Rome, GA has been busy with various projects including spinning multitrack tape on **Dwight Twilley** for King Biscuit Flower Hour and live radio broadcast with artists **Jerry Reed**, **Bandana**, **Billy Swann**, **Kris Kristofferson**, **Mac McAnally** and **Ray Stevens**. **Al Craig** and **Kevin Burgart** engineered **Suzy Saxon & The Anglos** have begun work at **Alpha Audio Recording Studios** in Richmond, VA to complete their debut album for Brat Records. The tracks are being produced by **Barry Gottlieb**, engineered by **Joe Horner**. Recording at Island's **Compass Point Studios** in Nassau, the Bahamas were **Delite/Polygram** recording artists **Kool & The Gang**, and **Sheila**, a French artist on Carrere Records. At **Lamon Sound Studio** in Charlotte, NC, **Billy Scott** finished tracks for his latest release on Lamon Records. **Carlton Moody** and **David Moody** produced. Christmas time came a little early this year at **Woodland Sound Studios** in Nashville with **Barbara Mandrell** cutting her new Christmas album. A Christmas tree was set up to give the studio that holiday feeling along with the traditional Christmas dinner. **Tom Collins** produced the album with independent engineer **Les Ladd** behind the controls and **Tim Farmer** assisting. At **Scruggs Studio** in Nashville, **Randy Scruggs** produced **Star Search** winners **Sawyer Brown** on their first album for Capital-Curb Records. **Tom Brown** engineered the session. **Songbird Studio** in Atlanta sponsored a seminar for the Synclavier II digital synthesizer with **Pat Metheny** hosting. **Songbird** is now the southern

distributor for the Synclavier II. Also at **Songbird**, **Jimmy O'Neill** recorded an album for Artists Music Corporation with **Bryan Cole**, **Jimmy O'Neill**, and **Mark Pinske** producing. **Mark** is **Frank Zappa's** main engineer. In production at **Bullet Recording** in Nashville: **Shelley West** and **David Frizzell** teaming up on a project for Warner Bros. Records; **Anne Murray** worked on overdubs for her upcoming album—both projects were produced by **Jim Ed Norman** and engineered by **Scott Hendricks**; and **Lynn Anderson** finished her next album with **Michael Clark** producing and **Willie Pevear** at the board.

STUDIO NEWS

Midcom Incorporated will move into a new space at Las Colinas' Dallas Communications Complex sometime early in September. The new address is Three Dallas Communications Complex, Suite 108, 6311 N. O'Connor Road, Irving, TX 75039-3510. The new phone number is (214) 869-2144. In addition to the move, **Midcom** will now handle all sales and service for Otari's MTR-90 series of professional multitrack tape recorders. **Studer Revox America** has delivered another new A800 24 track recorder to the **Power Station** recording studios, making a grand total of six A800s at the New York City facility. "To our knowledge, the Power Station now owns more A800 24 track machines than any other single facility in the world," stated **Sam Borgeson**, director of public relations for **Studer Revox America**.

Star Track Studios of Tulsa, hosted an open house to demonstrate all the features and uses of the Adams-Smith 2600 SMPTE synchronizer system. The presentation consisted of a five minute science-fiction music video, written and produced by **Star Track** owner/engineer, **Rod Slane**. Guests included independent film makers, video producers, composers, a/v companies and advertising agencies. Former **Doobie Brother Michael Hossack** and independent engineer/producer **John Early-Ligon** have formed **Musique Production Associates**. **Musique** is committed to world class production in the southwest area. All sessions will be recorded at **Studio Southwest**, which will be home base for **Musique**. For more information contact **Michael Hossack** or **Jon Early** at (214) 226-1789. **Ron Cote**, a native Canadian, brings his years of experience as an engineer to Dallas by joining the staff of **Dallas Sound Lab**. **Womach Recording Studio**, Spokane, WA, has added an MCI two track recorder, **Ursa Major** digital reverb, **DeltaLab** digital delays, **Gatex** noise gate/expanders, and mikes by **Shure** and **Sennheiser**. **Prairie Sun Recording** in Cotati now owns an **AMS Digital Delay & Reverb Line**. Two new **Auditronics** consoles have been added at **San Francisco's Studio C**. **Studio 2** now has a 24 x 8 board, 16 film playback channels and a 2:16 track recorder with time code synchronization. **Studio 2** has also been re-equalized to match the new ISO curve for theatrical mixes. **Mincey Productions, Inc./The Edit Suite** welcomes **David Fallon**, CPA, to their staff. In addition, **Margaret Quaring** formerly of **KATU** and **John Rollo** from **Rockchester, NY**, have joined the **Edit Suite** staff.

AMPEX GRAND MASTER® 456

Success in the professional recording business comes from using the best—the best talent, the best music, and the best tape.

That's why more of today's top recording studios have the confidence to choose Ampex 2" tape over all other professional studio mastering tapes. Combined.

Confidence that comes from consistency.

Proven consistency. Proven by testing every reel of Ampex Grand Master® 456 end-to-end and edge-to-edge, to make certain you get virtually no

tape-induced level variations from reel-to-reel, or case-to-case. And we even include a strip chart in every box of 2" 456 to prove it.

With Ampex Studio Mastering Tape you also get consistency of delivery. Because we stock our tape inventory in the field, we're always there when you need us.

If the ultimate success in a studio mastering tape is measured by more hit records from more top recording stars, then Ampex professional studio mastering tape is the most successful tape in the world.

AMPEX

Ampex Corporation • One of The Signal Companies



Ampex Corporation, Magnetic Tape Division, 401 Broadway, Redwood City, CA 94063 (415) 367-3809

Circle #005 on Reader Service Card

World Radio History

AKAI

Micro Studio System

MG1212

- Programmable Digital Matrix 12-Track Recorder/Mixer
- DBX — Type 1
- Computerized Multi Function Locator

World Radio History



REFROLL

Akai Professional Musical Products Distributed by  P.O. Box 2344 Ft. Worth Texas 76102 817-336-5114

Akai—Creative At Heart.



Akai, through the use of advanced micro technology has developed a system that has revolutionized the compact mixer/recorder. The MG1212, the world's first affordable programmable 12 channel mixer 12 track recorder with 1/2 inch cassette tape format. The MG1212 delivers professional quality recordings using computerized digital features found only in major recording facilities. The Akai MG1212, a revolutionary sound creation system for tomorrow's market today.

Suggested List \$6995.00

REVOLUTIONARY

.....
Please Send Me Complete Data On The Akai MG1212
Name _____
Address _____
City _____
State _____

MR. BONZAI GOES

by Mr. Bonzai

OK, film fans, grab your popcorn and put on your thinking caps! We are about to embark on one reporter's multi-path journey behind the scenes in Hollywood. This started out as a simple investigation into the creation of sound for motion pictures, but soon grew into a zig-zag search in a cinematic labyrinth. I never found an end point, but I think you'll enjoy wandering around with me as I point out some of the curious ways in which we humans attempt to recreate reality.

We'll briefly go over the traditional methods of joining sound to picture. We will note how the film recording environment is different from the record studio. We'll praise the oldtimers for their ingenuity with primitive technology and try to understand why the significant innovations of recording artists, engineers and producers are so slow to be accepted by the film world. We'll also meet some of the characters in this volatile scene: the old guard, the rock and rollers who have made the transition to filmland, and the whiz-kids who are rethinking the entire methodology.

I love the movies and I love learning their secrets. I live in Hollywood,



(Above, Right) Glen Glenn Sound's PAP IV. (Right) Crew of "Digital Dream" prepare to shoot Glen Glenn's Computerized console in Studio 1 with pitching lens camera.



right underneath that big sign on the hill, so it is very common to find a street suddenly barricaded and lined with film trucks, mobile homes, camera cranes, porta-potties and rent-a-cops. I've worked as a film extra and I have experienced the "hurry up and wait" aspect of film

production. We may see two people chatting on the screen, but there were hundreds on the other side of the camera. The director must act like a military commander—calling the shots, timing the charge, feeding the troops with inspiration, shaping the campaign, and

cleaning up the mess.

First of all, the only thing that makes universal sense in Hollywood is money. Everything is immediately translated into economic terms. This is a natural principle, and when applied correctly can result in enhanced creativity.

The big news in audio post-production can be broken down into three categories: video technology applied to the film medium, computers put online to eliminate some of the drudgery, and electronic means for producing music and "sound sculpture."

Until recently, sound was an extremely secondary consideration in film production. The advent of such reproduction techniques as Dolby Stereo boosted ticket sales and woke up the film industry. Money. Chris Stone, president of LA's Record Plant, cites *Urban Cowboy* as a landmark in audio awareness. The film did OK, but the soundtrack al-

TO THE MOVIES

bum was a monster. Money again. Film producers are paying attention. The good news is that the audio people from both worlds are now communicating, and we are hearing some great soundtracks.

The SMPTE Tour

Our journey begins with a seminar sponsored by the Hollywood section of SMPTE, the Society of Motion Picture and Television Engineers. Many deserved thanks to Jack Spring, chairman of the tutorial committee for coordinating Paramount Studios, Glen Glenn Sound and Warner Hollywood Studios, providing an excellent team of technician/tutors, and putting up with 300 curious visitors.

After registering, grabbing donuts, and gulping some coffee, we assembled in a screening theater on the Paramount lot. Joe Kelly, who stepped down this year as president of Glen Glenn Sound, gave us a brief rundown on where we were, how we got there, and where we were going. (To see someone with 40 years in the business, and still showing such enthusiasm about motion picture sound, was a great inspiration.) He continues as a consultant to Glen Glenn Sound, and seems to be enjoying his new freedom as an audio guardian angel.

Joe pointed out how slowly changes are made in the film industry. As

an example, 1/4-inch magnetic tape was first used for film production around 1950, but took almost 20 years to be fully accepted. In the recent evolution of audio for motion pictures, the decade of the '50s was the period during which magnetic film (as opposed to optical recording) and tape recorders were adopted.

audio and permitted the assemblage of highly complex soundtracks. During the '70s, solid state technology progressed the audio consoles beyond the vacuum tube stage, and electronic signal processing devices became common in the post-production process. According to Joe, the '80s is the decade in which



In the '60s, reversible update recording was introduced in the dubbing room. Known as "rock and roll," the ability to shuttle the magnetic film back and forth, and to punch-in and -out (insert) gave new flexibility to the rerecording of

digital technology will alter both the recording and control procedures. As a final note, he pointed out the challenge and the frustration of working in the film industry, but added that if he could do it all over again, he would. —PAGE 19

A Few Film Sound Formats

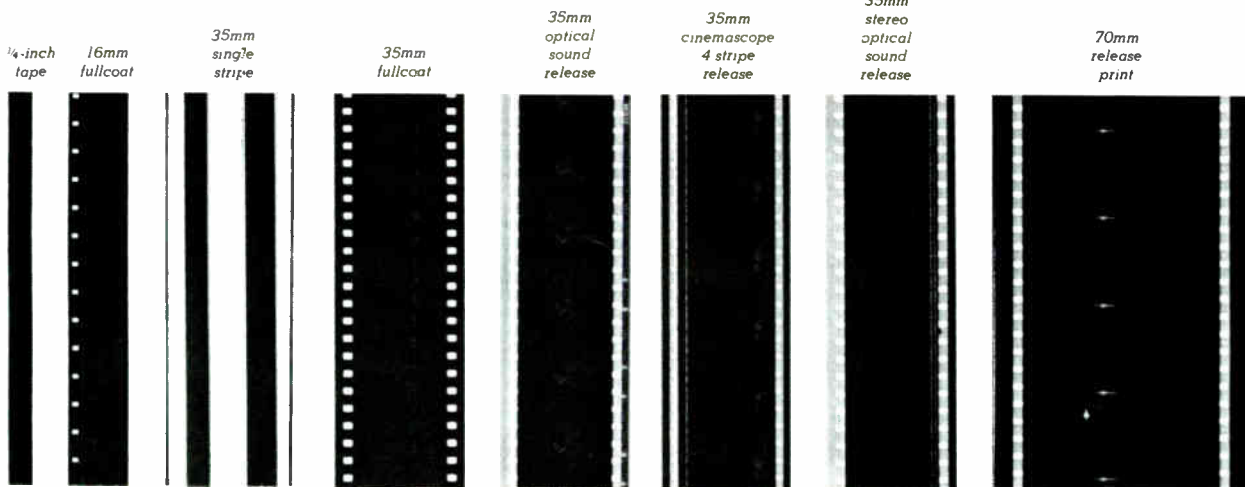

NOTE: THESE FILM EXAMPLES ARE NOT ACTUAL SIZE

Creative choice is what TASCAM's broad line of professional mixing consoles is all about. Whether you're polishing your musical skills or polishing your fourth gold album, opening up your audio to video, or opening up your own studio, TASCAM's comprehensive mixer selection lets you focus on your specific music needs.

Starting with our M-30, we've packed more artistic choice into a modestly-priced package than any console in the industry. This versatile 8x4 is ideal for everything from basic recording to video production and comprehensive small studio applications.

Increased flexibility highlights the M-30's big brother, our M-35. This durable 8x4 combines wide-ranging function capabilities with operating ease. The M-35 features 4 separate sub groups, solo, independent monitoring, built-in effects loop, and much more.

For more elaborate production demands, our rugged new M-520 console gives exceptional precision and complete control of your 8 and 16 track recording, overdubbing and mix down. The M-520's creative options include multiple inputs per channel, 8 independent subgroups, stereo solo-in-place, PFL, balanced and unbalanced inputs and outputs, multiple auxiliary mixes, and long-throw faders.

And if you're recording needs are met by 8 tracks, our M-512 console gives you the sophisticated functions, easy operation, and technical quality of the M-520, with fewer input channels.

See your TASCAM dealer today. He'll tell you about these and a wide range of other professional TASCAM mixers, and get you hands-on with the console that was built for you. Or write for more information to TASCAM, TEAC Professional Division, 7733 Telegraph Road, Montebello, CA 90640, (213) 726-0303.

Copyright 1984 TEAC Corporation of America

Circle #006 on Reader Service Card

Wherever you want to go with your music, TASCAM's extensive console line has the mixer to take you there.

Tascam Recording Consoles. Mix With The Professionals.



BUCKEROO BANZAI: A Case History

Buckeroo Banzai (no relation) is a 20th Century Fox film with a hero of Asian-American lineage who is a brain surgeon, martial arts champ, physicist, and among other things, a rock and roll musician. It's an action movie set in present time with a sci-fi edge and a modest theme: "Save the Earth." There are outer space aliens (good ones and bad ones), travel to other dimensions, organic spaceships, and concepts of relativity that bubble the imagination.

I first heard about the adventuresome soundtrack through Bones Howe, the music supervisor and sound designer for the film. Bones made the leap from the record biz to films when he landed the job of music supervisor for *Roadie* a few years back. Since then he has proven himself in such films as *One From the Heart*, *Man, Woman and Child* and *Top Secret*. He told me they were doing things for *Buckeroo* that had never been done before.

The director, Rick Richter, explained the soundtrack rationale: "The design for the sound had to be a very real part of the bizarre world of this movie." The setting moves from contemporary scenes to other dimensions, and includes very weird contraptions and characters. John Lithgow is superb as a human scientist possessed by alien mentality.

Bones' first move was to steer the music away from the lush symphonic scores that had beaten the grandeur of *Star Wars* to death. He also advised against a standard rock and roll score as unsuitable for this action flick.

"I wanted to be able to create a unified soundtrack so that the difference between the sound effects and the music score would be as small as possible. That is, that at some times the film audience would not be able to tell if the sound it was hearing was music or sound effects," says Bones.

The answer lay in synthesizers and Michael Boddicker was his choice for composer. "As far as I'm concerned, he was the only person in this country who was competent to do an entire electronic music score," he explained. There are a few organic musical numbers, but only when Buckeroo's band, "The Hong Kong Cavaliers," are playing. Boddicker has contributed music to *Flashdance* (Grammy '83), a number of other films, television shows, records, and

commercials, but this was his first gig as sole composer for a film.

(L) Michael Boddicker (composer) and Bones Howe (music supervisor and sound designer) in Studio "B", the synthesizer shop at Boddifications, Inc.



Synthesizers have radically altered the creation of film scores. Until recently, the music was typically recorded at the end of the film project. The composer viewed the edited film on a cumbersome upright Moviola and wrote the meticulously timed music. The orchestra performed en masse and there was virtually no room for creative flexibility. Today, a composer can work simultaneously with the film production, supplying fully realized musical ideas, easily synchronized and easily altered to fit changes as the film takes shape.

Michael's studio, Boddifications, Inc., specializes in synthesized music

and also electronic sound effects. This made for a perfect marriage between other worldly music and alien sounds. One of Michael's many toys is the new PPG digital synthesizer. Any sound, or musical instrument can be digitally sampled and then played on the PPG keyboard. Michael explained that he has found the PPG to be a very fast instrument, because the computer keypad and light pencils can be done away with. Internal programming results in simple knob adjustments for altering the sound,

as in analog synthesizers.

The resulting score is a stunning and creepy blend of music, with sometimes imperceptible transitions to altered sounds. One ominous alien sound was achieved by sampling the sound of bees, and then dropping the frequency three octaves. There are pulsing biological sounds, hollow grating sounds and metallic percussions woven into sweeping musical landscapes.

For additional audio surprises, Bones enlisted the services of Alan Howarth, who created the sound sculpture for the 8th dimension, and reprocessed every line of alien dialogue to give a further departure from the norm. To get away from the familiar "bleeps" and "bloops" of computer sounds, Bones himself created new chip "computerese" sounds on his Commodore C-64 and Otrona "Attache" computers.

—PAGE 28



Peter Weller as Buckaroo Banzai with his amazing hand-made jet car.

As designed for Motionpicture Recording, Inc. in Hollywood, the AMEK M-4000 CINEMA console offers simultaneous dubbing to mono, stereo 3 track, 3 into 5, 4 track, 6 track Dolby stereo, and 8 track Omnivision, with additional 24 track output assigns and mic inputs for Foley recording.

Dialog, music, and effect sections are three separate consoles with any section having the ability to control all three in any combination. Metering is a combination of 46 segment three-color LED light meters and true ballistic-reading VU meters; light meters reading all inputs and VU meters reading all outputs per each section.

Full automation functions include: Fader level, 10 subgroups per section

with sectional link capabilities (D, M, Fx), auto mute, aux send/return levels, and auto-graph equalizers in pre or final dub mode (controllable via a DEC 16-bit twelve-inch hard disk micro-processor with dual floppy back-up).

Other exclusive features include: Variable divergence panning, variable bandwidth parametric equalization, high and low pass parametric filters, a unique tri-color calibrated LED-ramp adjacent channel faders for VCA level indication while in automated mix mode, and totally comprehensive LED routing matrix indicating the exact signal path of the entire console at a glance. Optionally available: a compressor, limiter, expander noise gate may be fitted on each input and output.

AMEK SYSTEMS AND CONTROLS has been building major project one-off consoles since 1970. We build consoles for motion picture dubbing, video post-production (off-line or on-line), and on-the-air audio for television. We can build a custom console in any configuration to precisely suit your mixing and dubbing needs.

Motionpicture
Recording, Inc.
Hollywood, CA
(213) 462-6897

For 35 / 70 mm Dubbing
and Video Sweetening

AMEK CINEMA

MIXING CONSOLES

In the US:

AMEK CONSOLES, Inc.
11540 Ventura Boulevard
Studio City, California 91604
(213) 508-9788

In the UK:

AMEK SYSTEMS & CONTROLS, Ltd.
Islington Mill, James Street
Salford M3, 5HW, England
061-834-6747

The Scoring Stage

Our second stop was Studio M on the Paramount lot, one of the most elaborate scoring facilities in the world. "M" is leased by Glen Glenn and operated by the LA Record Plant. Chris Stone has been in the studio business for 16 years, remote recording for 13, and film scoring for five. He took over the operation of "M" last year and brought along the state-of-the-art technology of record recording. Extensive acoustical reconstruction resulted in a versatile system of sound traps and adjustable louvers permitting virtually any kind of sound environment. The room is 68 feet wide by 78 feet long, with a ceiling that was dropped from 50 down to 32 feet. To build the studio and equip it from scratch would cost about \$2 million in today's dollars. For that really big sound, "A lot of our record clients would die to do drums in this room," remarked Chris.

The control room at "M" houses a 40 input, 32 output SSL-4000E Solid State Logic console, with four-band parametric equalizer, limiter/compressors and noise gates on each input module. Audio can be mixed to mag film in six track, four, three, stereo, or mono formats, with recorders ranging from single track 35mm magnetic recorders to the Sony PCM-3324 digital multitrack or traditional 24 track 2-inch tape (analog).

Also available are live echo chambers, an EMT 140, EMT 250, EMT 251, and an AKG BX-20 for reverb. The monitors are a two-way system (for fewer phase problems) consisting of JBL 2235 woofers and 2441 compression drivers. It takes a seven man union crew to run the operation and the cost is \$475 an hour. According to Chris, because of the high operating costs, the profit margin is virtually the same as for a conventional recording studio.

For a recent *Star Trek III* date, 102 musicians were assembled at "M" for six days. Musician costs alone came to \$260,000. At \$125 a minute, it costs about \$375 just for a playback. The pressure is incredible and where a rock engineer might take a day to get a drum sound, in studio scoring you have about five minutes. Almost all sessions are recorded live, with very few overdubs, and inter-communication among the engineering team is crucial.

At a typical scoring date, the film is projected to a screen on the back wall of the main room so the conductor can view the film while directing the orchestra. The segments of music, or cues, as they are known, are of varying lengths and may have very odd time signatures to fit the movement of the film. Click tracks are used to maintain frame-accurate timings, but some composers, such as

John Williams, choose to conduct without this safety net.

Tim Boyle, of the "M" staff, explained that the music editor is the key liaison between the film people and the recording folks. The editor is the person who must walk away from the session with the reels of mag film that will be actually cut to match the picture. Multitracks synchronized to film may be employed, but everything eventually ends up on mag film.

The Music Design Group

A good example of video technology being integrated into the film world was shown to me by Curt Roush, of the Music Design Group. MDG is a music editorial facility formed two-and-a-half years ago by Curt, Merelyn Davis, and president Roy Pendergast. They have developed what they call Video-Score, a computer-assisted, video-based system for scoring. Basically they have taken the film and put it on videotape, with a synchronization scheme translating feet and frames to standard SMPTE time code. Picture is electronically synchronized with multitrack recorders, eliminating the mechanical sprocketed recorders. An immediate advantage is in shuttling time—videotape and audio recorders can move a lot faster than sprocketed film chains. The computer

SMPTE Seminar Attendees at Studio M



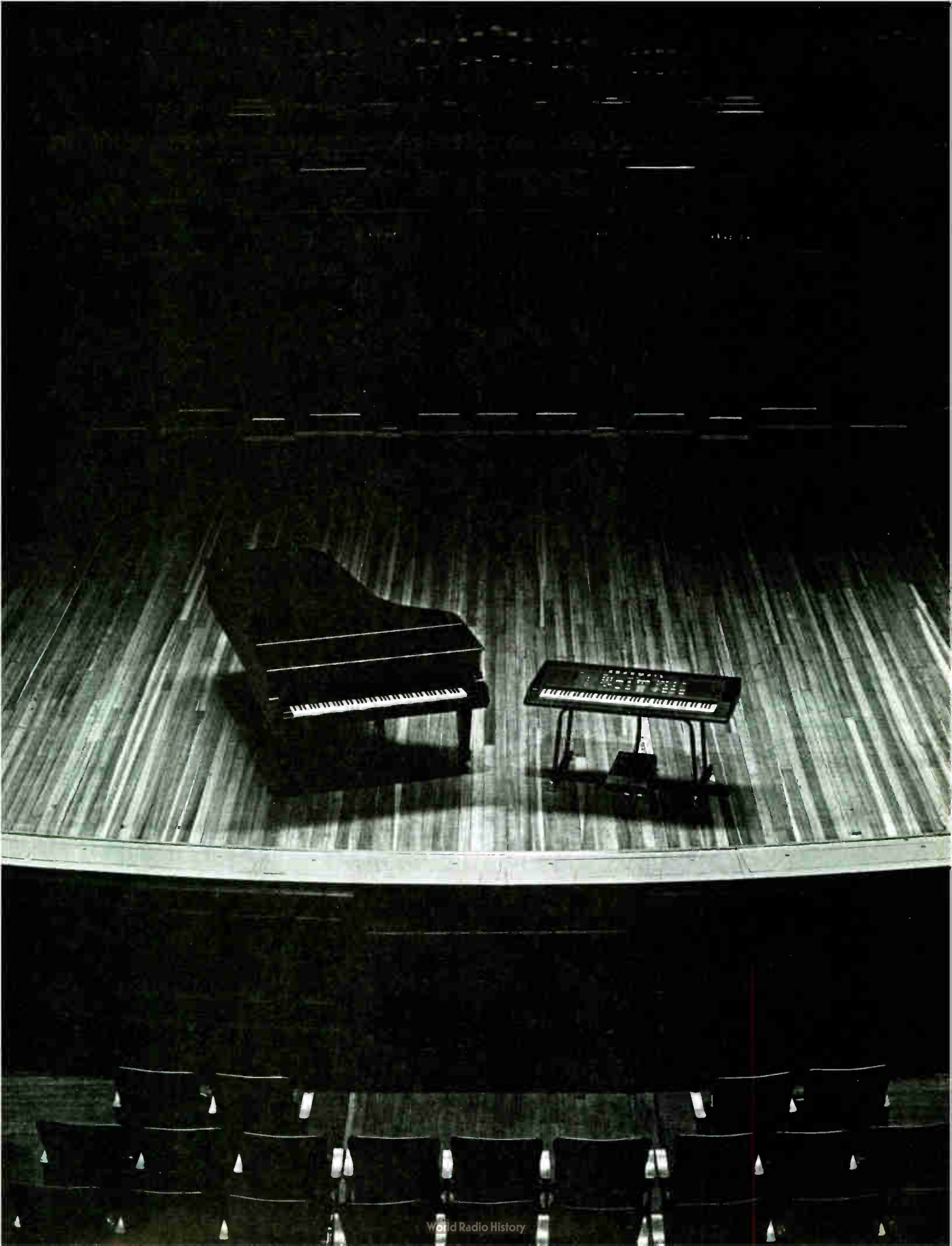

NO OTHER ELECTRONIC KEYBOARD WOULD DARE MAKE THIS COMPARISON.

In July of 1983, *High Technology* magazine, reporting on the new Kurzweil 250, said it "emulates with unprecedented fidelity the sound and feel of an acoustic piano." And *Musician* said it "could set the field on its collective ear."

Because while other electronic keyboards sound similar to pianos, only one duplicates the richness of tone of a \$35,000 concert grand—in all registers, at all loudnesses—from the initial attack of each note until its eventual decay.

And what this remarkable new keyboard does with the concert grand, it does with every other instrument as well: brass, strings, woodwinds, percussion, vocal chorus—even sound effects.

The Kurzweil 250's astonishing sound is the result of new technology developed by Raymond Kurzweil, one of the world's leading authorities on Artificial Intelligence and Pattern Recognition. Using insights gained from these fields, Kurzweil and his team of engineers developed Contoured Sound Modeling,[™] an exclusive approach to sound synthesis that enables the Model 250 to preserve all the complexities of acoustic sound.

For example, a middle C on the piano activates a very different set of overtones than an F# two octaves above it. The Kurzweil 250 takes this into account and accurately duplicates this changing harmonic structure across its entire keyboard.

And unlike other electronic keyboards, which cut the duration of each note in half at each higher octave, the Kurzweil 250 has Independent Pitch Duration Control,[™] which controls independently the length of time each note is heard, regardless of its pitch.

Also, through the use of Artificial Intelligence technology, the Kurzweil 250 "knows" that changes in loudness affect the timbre of a note. This means that notes played softly on the Model 250 sound mellow; the same notes played loudly sound bright. (And the Model 250's exclusive, velocity-sensitive keyboard action further helps you capture the feel and dynamic response of a grand piano.)

So if you want sound that's so realistic, it's virtually impossible to distinguish from the original, go to an authorized Kurzweil dealer and listen to our Model 250.

In the world of electronic keyboards, there is no comparison.

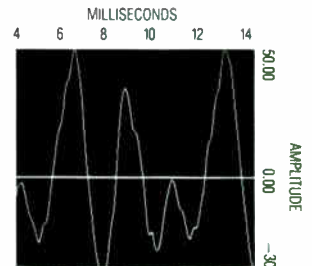

Section of waveform produced at middle "C" by a \$35,000 concert grand piano.

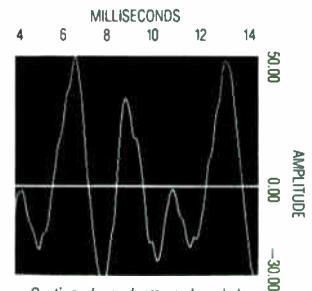

Section of waveform produced at middle "C" by a Kurzweil 250.[™]



KURZWEIL[™]

YOU CAN'T TELL THE DIFFERENCE.

Circle #008 on Reader Service Card

© 1984, Kurzweil Music Systems, Inc., 411 Waverly Oaks Road, Waltham, MA 02154, (617) 893-5900
Photographed in Jordan Hall, New England Conservatory of Music, Boston, MA

also provides easy updating of timing changes. If the director chooses to chop out a few feet of film, the computer ripples the data, and recalculates all the ensuing cues. To make the film director's transition easy, VideoScore employs the customary visual timing cues that are common in the film medium—the "streamers" and "punches." Streamers are diagonal lines that move horizontally across the moving picture, alerting the conductor that a downbeat is approaching. The effect is created by the sound editor, who physically scrapes the emulsion off the work print. Punches are holes poked in the film to create a strobing effect to indicate timing. VideoScore creates these effects by video overlay, which allows for instantaneous changes to be made. Large video projection systems replace

film playback. The entire system is marketed by Audio Intervisual Design, a systems facilitator company formed by Chris Stone (does this guy get around?), with Jim Pace as vice president in charge of operations.

Audio Intervisual Design

Jim Pace worked for years as off-road manager and concert mixer for Kenny Loggins, and supervised the logistics of his recording sessions. A few years back, he joined Bruce Botnick (Loggins' producer) when he established Digital Magnetics with engineer emeritus Armin Steiner. Jim engineered on a number of major film scoring dates and became an expert in digital procedures. "The Pacer" is a good example of a rock and roller who can't stand still, technolo-

gically speaking. As VP of AID, he is kept busy designing systems that integrate digital recording, computers, and videotape recorders. Through an OEM arrangement with Sony, AID is taking off-the-shelf equipment from various Sony divisions, adding custom proprietary interfaces, writing software programs, and supervising the hybrid installations.

Glen Glenn Sound

Our next stop was Glen Glenn's new multimillion dollar film and TV post-production facility: a "silent fortress." This 40,000 square foot building incorporates construction techniques that have never before been taken to such isolating extremes. Six-inch concrete walls, multiple foundations, elaborate air-handling systems, and plumbing hung from rubber grommets are a few examples of the attention paid to silence.

Glenn has seven studios for various aspects of postproduction. For the seminar, we were introduced to their PAP (Post Audio Processing) system. This is how music, dialogue and sound effects are edited and assembled in sync on multitrack tape. The unique system is operated by a computer developed by The Digital Sound Corporation in association with Glenn's engineers. The multitrack (in this case an old reliable Ampex MM-1000 chosen for its durability) is synchronized with a video workprint of the visuals. Audio material is rolled in from ¼-inch tape and from a library of prepared audio cartridges. We observed as the engineer, Doug Gray, explained the hand-built procedures for the layering of sound effects. When sounds from the library don't quite work, Doug may go off with a Nagra portable and record in the field. For the violent door crashing sequence we saw, he had a remodeling party at his home and invited friends to come over and smash his house up for the fresh sound effects. Unlike album recording, film sound calls for constant improvisation. After programming for the assembly of the individual sound units, the computer automatically adjusts for the various pre-roll times of the hardware, allowing for proper operating speed and full bias of current. The unmixed multitrack tape is then taken to the VTR sweetening room for equalization, reverb and the final mix to video master.

The mag recorders used in film postproduction are either three, four or six track machines interlocked to film by electronic stepping motor drives with the reference points being sprocket holes. In VTR sweetening at Glenn, the sound-



Joe Kelly of Glen Glenn Sound.

Warner Studios Re-Recording Room A.

tracks are assembled on 2-inch multi-track tape with servo motor drive for interlock controlled by BTX Shadow synchronizers. Rick Larson, VP of Glen Glenn, demonstrated a typical session where first dialogue, then sound effects, and finally music were mixed for one of the next season's cop shows. It's fascinating to see a show come to life, as ambient sound is added to dialogue, then the hard effects such as footsteps and punches appear, then the hubba-hubba of the "walla" group (actors who specialize in mumbling the background chatter) drifts in and finally the music is joined to picture for the final mix.

Digital Dream

One of the highlights of the tour was the screening of *Digital Dream*, a 70mm demonstration film with an all-digital soundtrack for theatrical release (the film was screened in movie theaters for consideration by A.M.P.A.S. for an Oscar). To convince the industry of the feasibility of digital recording, Glenn adapted all of the tried and true methods of soundtrack production to the digital medium—no simple feat. Dual multi-

tracks were synchronized at Studio M for the lavish orchestral score. Dialogue and Foley were recorded digitally, and location sound effects utilized Sony PCM-F1 portable digital recorders. Because there are so many transfers and re-

recordings required in film postproduction, the immediate advantage of digital is that every dub is clone-perfect and suffers no signal degeneration. The results are spectacular—from the thundering blast of a jet flying overhead to the close-

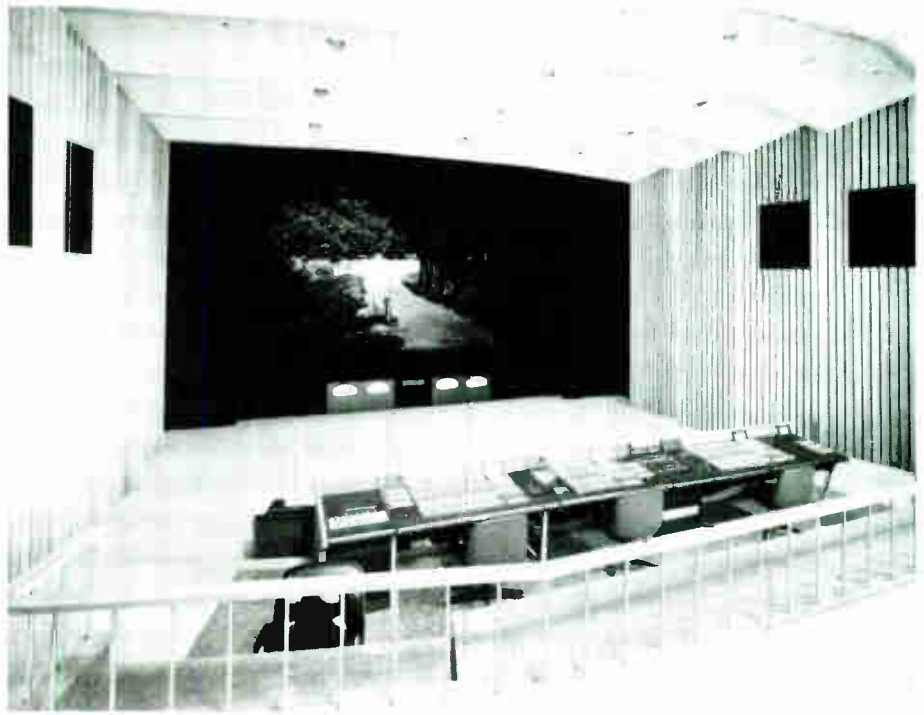

Expand your horizons



The new modular **bimix** mixing console from Biamp is a board you're never likely to outgrow. It has the built-in flexibility to fulfill all your current studio requirements – with a unique system upgrade capability to handle expanded

applications as your needs change. **bimix** is the only board in its class with fully modular inputs outputs, providing any combination of 1 to 24 outputs and 8 to 32 inputs. Write or call us for further information, or see your local Biamp

dealer today – and expand your horizons.

Biamp Systems Inc.

P.O. Box 728
Beaverton,
Oregon 97075
(503) 641-6767



Circle #009 on Reader Service Card



Engineer Tim Sadler at the TAJ console with assistant Greg Orloff at the computer terminal during the Foley sessions.

used to create the sound of walking on grass. Listen carefully to the individual sounds in a film and you will realize how much behind-the-scenes work goes into producing a life-like soundtrack.

On the dubbing stage (a studio set up exactly as a motion picture theater), we were treated to a mixing session with Bill Varney, the supervising re-recording mixer at Warner Hollywood. This is where all the elements are blended together, as Bill has done for such films as *The Empire Strikes Back* and *Raiders of the Lost Ark* (Academy Awards two years in a row). The consoles are gargantuan, and divided into three sections. Each one is operated by the individual sound effects, dialogue, and music mixers. In the machine room can be found the scores of mag film reproducers running in sprocketed synch with picture material.

Screen Sound— Molding the Technology

Steve Waldman, president of Screen Sound, is well known in the audio industry for having secured the American rights to Audio Kinetics. In five years, he took the Q-lock synchronizer and adapted its use to a multitude of purposes, among them being automated

miked sound of an egg trying. And when it's supposed to be quiet, it's *really* quiet. Digital audio may have a more profound effect on the film industry than it has on the record industry.

In the words of Tom Kobayashi, president of Glen Glenn, "While we don't yet have digital playback in theaters, the value is that a digitally-produced soundtrack can be transferred easily to any of the standard release formats, creating a vastly improved finished product."

As for actual digital playback in theaters, the speculation is that we might hear audio reproduced through ultraviolet readers reproducing digital info from the encoded film print, or perhaps through dual systems incorporating CDs or synchronized laser videodiscs.

Warner Hollywood Studios

Our next step took us to Warner Hollywood Studios' Goldwyn Sound Facilities for a demonstration of ADR (Automated Dialogue Replacement), Foley, and the re-recording of a final film soundtrack.

While dialogue, sound effects, and ambience is recorded on location (called "production sound"), the results are often unacceptable. Airplanes might have flown over during a take, or the director may choose to re-record audio for aesthetic reasons, as in calling for a different vocal performance by an actor. ADR is still referred to as "looping," a reminder of the days when each piece of film was actually edited into a loop whereby the actor could lip sync the line over and over again until a satisfactory reading was achieved. Today, the ADR process involves sprocketed three track mag recorders run in sync to picture with reversible update recording and multiple takes available to the director.

On the Foley stage, we observed

Joan Rowe, one of the film industry's most respected Foley "walkers," in action. The name comes from its originator, Jack Foley, who began his career as an offstage sound effects man in theater, and applied his synchronized walking, slapping, punching and door slamming to film production in 1930. We watched as Joan recreated the sounds in a bar room scene, complete with scraping bar stools, clinking glasses, and the convincing thud of someone's head being smashed on a tabletop. As an example, walking on piles of crumpled recording tape is



Foley walkers Joan Rowe and John Roesch at TAJ Soundworks creating the water sound effects for the upcoming Universal release, "The River." (further background: they hooked up a fire hose from the street to get the massive amounts of water needed to recreate the sounds of the flood scenes in the film. They stationed a guy down on the street with a walkie-talkie and had him regulate the water flow that came up to the second story of the studio and into the swimming pool. You might want to play around a little with something like, "Can you believe people making a living doing this sort of thing?" Tim remarked.

be SYNTHABLE

The software wizards stuck a 9-foot concert grand onto a tiny silicon chip . . . a world-class speaker is the way to hear it. Because a system designed only for "traditional" sounds can't live up to the powerful levels and complex timbres of electronically-created music.

That's why we created the 380SE.

Total Transparency—and Psychoacoustic Satisfaction, too.

The 380SE is a clean and powerful three-way speaker system. Electronic reeds and strings, flutey and brassy tones, percussive accents, special effects . . . all sounds at all levels come through with exacting sonic accuracy. The 380SE illuminates subtle variations in pitch and level, whether handling one note at a time or a full synthesized chorus.

Attention to Detail

The digital wizards must master every detail of their technology. A speaker designed for electronic music gives them the freedom to concentrate on sound creation rather than sound reproduction.

So we paid attention to every detail of the sound system. That's why the 380SE is constructed entirely from our own high-quality components. With continuous power handling of 360 watts. Full range inputs. Bi-amp and tri-amp connectors. Four bridging connectors. Mid- and high-frequency level controls, flush-mounted where you can get right to them.

And as you can see, we didn't overlook the visual details. The 380SE's appearance is visual confirmation of its class. The 380SE's performance proves its ability to handle electronic music.

That's what being synthable is all about.

For complete technical data, call or write:



TCA Electronics, Inc.
480 Carlton Court
So. San Francisco, CA 94080
(415) 588-2538
In Canada: TOA Electronics, Inc.
10712-181 Street
Edmonton, Alberta T5S 1K8
(403) 489-5511

©1984 TOA Electronics, Inc.





ADR, sound effects assembly and audio sweetening. His innovations have been absorbed by such leading-edge filmmakers as Lucas and Coppola. Audio Kinetics was sold this year at a handsome

Steve Waldman of Screen Sound holds a reel of 2-inch tape and a laser videodisc. "This is where we were and this is where we are going," he indicates. Pictured are two Sony SMC-70 microcomputers used in his various systems. Atop the monitor is the Video Streamer rock module. (Things were in a bit of disarray because I caught him when the company was about to move to new facilities.)

profit, but Screen Sound continues to grab off-the-shelf technology and adapt it to new purposes.

Their Mediacalc Calculator is a new hand-held pocket unit that computes conversions between the various SMPTE time codes and the feet and frames of the film world. The Video Streamer is like an electronic grease pencil that superimposes timing cues in film fashion onto videotape. The Edit Decision List Management System (EDL) takes the concept of automated video editing systems and applies it to audio post-production. The system incorporates standard synchronizers such as Adams-Smith, Audio Kinetics, BTX, EECO or Sony. It provides auto assembly and list management, producing a standard CMX compatible list.

The Laserdisc Sound Access System replaces audio tape with laserdiscs for both drastic reduction in library space and greatly increased access time. A Sony SMC-70 microcomputer and laser videodisc player provide the modern alternative to bulky and awkward SFX libraries. The cost for tape conversion to disc is getting relatively inexpensive—about \$300 per disc. Sounds called up on the system can be easily modified with the addition of such sampling devices as the Emulator.

Screen Sound specializes in finding the available components, writing custom software programs, and creating new products. "We don't sell boxes to people," explains Steve, "we address their particular needs to solve their problems."

New Visions—Douglas Trumbull's "Showscan"

Douglas Trumbull gained worldwide recognition in 1970 for creating the special effects for *2001: A Space Odyssey*. He has since directed such futuristic features as *Silent Running* and *Brainstorm*. Now, most of his time is spent with "Showscan" a revolutionary new film process that he developed. Unlike the conventional 24 frames-per-second rate of film (with each frame projected twice, resulting in 48 images per second), Showscan is shot and projected at 60 frames a second, producing stunningly realistic high resolution movies.

The Showscan 70mm films are shown only in specially designed theaters with wraparound screens and six channel sound systems. Four Showscan theaters are now up and running with 30 more to be built by the end of the year. So far, they have produced two 22-minute films, and are gearing up to produce ten a year, as well as going into theatrical exhibition with feature length films.

Trumbull arrived at the 60 frames-per-second rate by engaging in extensive psychological testing. Viewers were shown films shot and projected at

multimax

16:2:1 12:4:2:1 16:4:2:1

All from one 19" rack mount console

- 3 band Equalisation
- 2 auxiliary sends
- 90mm smooth action faders
- Mic and Line inputs
- Subgroup direct outputs
- RIAA equalised inputs
- Peak LED on inputs
- 12 way LED displays on masters
- Phantom power on every input
- 5532 Op-amps throughout



Hill Audio, Inc.
231 Marquis Court
Lilburn, GA 30247 USA
(404) 923-3193
TLX 293827 HLAD

Headwater Industries
635 Caron Avenue
Windsor, Ontario N9E 5B8, Canada
(519) 256-2454

Hill Audio, Ltd.
Hollingbourne House
Hollingbourne, Kent ME17 1QJ, England
(062 780) 555
TLX 966641 HILL



Circle #010 on Reader Service Card

DIGITAL DELAY DIGITAL CHORUS DIGITAL FLANGER



The new 900 series Digital Delay systems from DOD can do much more than just echo effects. ONLY with DOD do you truly get all three delay functions in one unit. The DOD R-908, R-909, and R-910 all have sweep widths of 10 to 1; this allows each unit to flange and chorus like no other digital delay system.

R-908 Digital Delay: PCM (900 ms.-30-8KHZ)
R-909 Digital Delay: PCM (450 ms.-30-15KHZ)
R-910 Digital Delay: PCM (1900 ms.-30-15KHZ)

*When comparing digital delay systems, check the specifications—you will find that the effect specialists at DOD have developed the only full function digital delay systems available today.

*Note: Most other digital delays have sweep widths of less than 6 to 1.



DOD Electronics, Manufactured in the U.S.A.
2953 South 300 West, Salt Lake City, Utah 84115
Telephone (801) 485-8534

—FROM PAGE 17, *BUCKEROO BANZAI*

The Foley, or synchronized footsteps and other sound effects were created at TAJ Soundworks. TAJ was formed in 1983 by Tim Sadler (a former record and radio engineer who had begun working in films) in partnership with John Roesch (one of a handful of the industry's top Foley artists), Alan Goodman (studio owner), and Ed Bannon (a state-of-the-art technical engineering crusader). Together, they have transformed a conventional recording studio, integrating computers, video technology, and multitrack recording techniques

Scene from Buckeroo Banzai.



for highly efficient film work, such as *Footloose*, *Gremlins*, *Trading Places* and *Thriller*.

The computer at TAJ keeps a record of the hundreds of sound effects that may be recorded for even the simplest of scenes. For the sessions, film is transferred to video and played on a Sony Beta I VTR with a Sony SLO-383 editor. Its real-time reverse mode is invaluable in back-stepping, timing, and setting up SFX sequences for incoming cues. Unlike most film Foley work, TAJ works with a color transfer of the picture material as opposed to a B&W workprint, another innovation. This is an advantage when, say, the actor on the screen is walking from a grassy surface to asphalt.

An Audio Kinetics Q-lock synchronizer locks up picture with multitrack, and slaves a 35mm mag recorder for the finished outgoing SFX tracks. Bannon has installed Monster Cable throughout the studio, for what he feels is a revolutionary breakthrough in high performance wire technology. "Normal cable is like a freeway with corners when compared with the frequency response of Monster Cable," he remarked.

Tim explained, "We don't synthesize sounds here, but we don't leave them alone either." His background as a record engineer prepared him for the creative use of familiar studio processing gadgets: flangers, phasers, DDLs, VSOs,

etc. Recreating sounds is a challenge, and among other things, TAJ has done pioneering work in finding new uses for Crown PZM (pressure zone) mikes and tiny Sony ECM-50 lavalier mikes.

Bones is emphatic in pointing out the pivotal role of Gordon Ecker, the supervising sound editor on *Buckaroo*. A lot of the "wild" or non-synchronous sound effects were pulled from Ecker's vast library, while others were recorded in the field using Nagras, the industry standard for location work. His immense job was to coordinate all of the various audio elements and get them on 35mm mag for the final assemblage.

For the filming of *Buckaroo*, Bones asked that the audio recording (production sound) be done at 15 ips as opposed to the standard 7½—an outrageous request that added \$1200 to the multimillion dollar budget. As a result, the improved transient response of recording at double speed permitted the use of many production effects tracks

duction, Compact has a reputation for being a comfy place to work. This is largely due to Tex Rudloff, the director of the facility. He paid his dues behind Hollywood's consoles for decades, and is sensitive to the position of every audio ranchhand under his command.

The re-recording theater is where it all comes together. In the machine room, the pre-mixes of music, dialogue, and sound effects are racked up. Rick Richter (director), Neil Canton (producer), Richard Marks (film editor) and Dan Lupovitz (production coordinator), joined John Reitz (dialogue mixer) and Bones, of course, for the lengthy final mixdown sessions. The mix for a film can easily take a month-and-a-half, often longer. And if the picture is re-edited (which is typical following preview screenings), the sound must be redone.

This case history would have become a book if I had covered every detail of the soundtrack, but it should be mentioned that there were many more

Rick Richter (director), Neil Canton (producer), Bones Howe (music supervisor and sound designer), and Dan Lupovitz (production coordinator) (from left to right) in the machine room of Studio E at Compact Sound Services during the re-recording sessions for Buckeroo Banzai.



that would have been otherwise unacceptable. ADR for the film was done at Warner Hollywood, an older facility that still commands solid respect throughout the industry. For the final mix, "Team Banzai" chose the Studio E dubbing theater at Compact Sound Services, a subsidiary of Compact Video. In addition to pioneering the use of multitracks in conjunction with mag recorders in post-pro-

folks and facilities that participated wholeheartedly in the creation of *Buckaroo Banzai*. It takes a lot of collaboration to make a film, and one of the endearing qualities of the industry is the ongoing formation of new teams that depend on incredibly tight-knit camaraderie and rapport for fun and profit. *Buckaroo Banzai* exemplifies this team spirit in action.

—Mr. Bonzai

COME WITH US TO AES!

7TH ANNUAL

AES/NEW PRODUCTS ISSUE

OCTOBER 1984

This special issue of Mix, to be distributed at the 76th Convention of the AES in New York City, will be our biggest ever! Containing more than 60 pages of new product listings, plus over 200 pages of special features and exclusive inter-

views, this issue of Mix will be saved and referred to during the year ahead.

Don't miss this milestone in audio publishing! Look for it October 1st, wherever Mix is distributed or sold.

Mix

"THE #1 PRO AUDIO MAGAZINE"

Matchless skill in equalisation

Klark-Teknik Research is setting a new standard for equaliser stability — and now the company's diverse experience of world markets has produced very different versions for very different needs, all using the same five-year warranted, state-of-the-art thick-film-engineered microcircuit filters.

Typical is the DN360 with thirty 1/3 octave filters to each channel for the most exacting applications, while the DN332, with sixteen 1/3 octave filters per channel, is a perfect match for many good modern sound systems — without outstretching most budgets.

Both are built to the same high standard with features such as electronically balanced inputs and subsonic filters as standard.

Frequency response $\pm 0.5\text{dB}$
20Hz-20kHz
Equivalent noise $< -90\text{dBm}$
Distortion $< 0.01\%$ THD @ 1kHz



KLARK TEKNIK



British designed, British made

The reliability of MELT micro-electronic filters gains a 5-year solid-state parts warranty for all Series 300 equalisers.

For full colour brochure contact Klark-Teknik or your nearest distributor (list available on request).

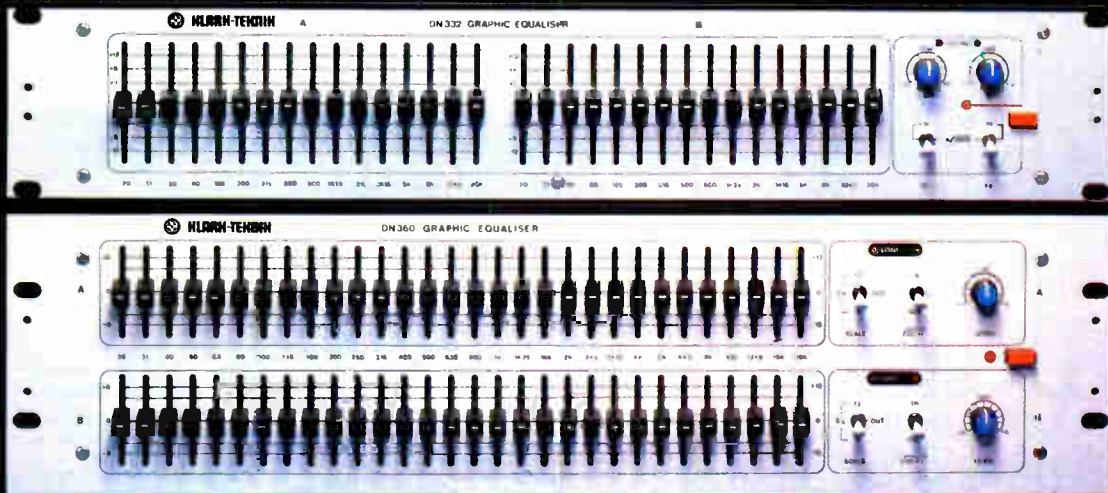

Manufactured by Klark-Teknik Research Limited
Coppice Trading Estate, Kidderminster DY11 7HJ,
England. Telephone: (0562) 741515 Telex: 339821

Klark-Teknik Electronics Inc.
262a Eastern Parkway, Farmingdale,
NY 11735, USA. Telephone: (516) 249-3660

Omnimedia Corporation Limited
9653 Côte de Liesse/Dorval, Quebec H9P 1A3,
Canada. Telephone: (514) 636 9971

Circle #012 or Reader Service Card

World Radio History



PHOTO BY BONZAI

Randy Bishop at Pasha recording studio in Los Angeles working on songs for film soundtrack ("Up the Creek.")

8,000, which is a high mid-range. You must record and mix accordingly.

Bonzai: What was it like working on *Stayin' Alive*?

Bishop: I composed a song with Tommy Faragher, "So Close to the Fire," and produced it to existing footage. The dance number had been choreographed to someone else's song and at a later date, Sly Stallone decided to use our song. We had to restructure the music, change the tempo and fit it to the action. We used sequencing synthesizers to automatically sync it to picture. Then they re-edited the scene and we had to do it all over again.

Bonzai: What was your contribution to *Up the Creek*?

Bishop: I was involved as a composer on five of the songs for the film and collaborated with The Beach Boys, Cheap Trick, Heart, and Danny Spanos. It's semi-realistic in this day and age to re-

cord a master record in two days, but that's typical in the film business. We just approached going into the studio like we were going to summer camp and spent a very intimate 48 hours together for each song. It ended up being a lot of work and a lot of fun.

Bonzai: Do you think it's easier these days for a rock musician to enter the film field?

Bishop: Yes, because there is a financial incentive on the part of the producers.

Bonzai: Do you have to have a big name to get into films?

Bishop: No, not necessarily. I don't think that Michael Sembello was that well known when he became involved with *Flashdance*. I'm certainly not a rock celebrity, but I have the advantage of having proven myself in a number of capacities—as performer, composer and producer. If you have the right vehicle and the movie is good and touches

the hearts of people and the song is commercial, you can end up scoring. It can be a good breakthrough for people who aren't that well known.

Bonzai: How have things changed since you first worked in films?

Bishop: When I began, the film sound people were an entirely different and alienated group of people, totally separated from those who made records. They didn't speak to each other at all; there was no dialogue. That has changed to a great degree.

Bonzai: Does film work offer more freedom in terms of style?

Bishop: Yes. To make progress in the record industry you have to stick with one thing and be easily identifiable. You package yourself specifically for a certain type of record appeal and hope that you'll cross over to other markets to widen your base of sales. In film, whatever works for the picture, whatever works in terms of the emotional context of the movie, is going to work for the soundtrack. The fundamental thing in films, as in records, is the ability to construct music and lyrics from beginning to end with all the components that make a good pop song. In many cases, it's easier to write from a character's perspective than it is from your own. It's easier for me to articulate somebody else's situation in a dramatic context. It's almost like playing a role.

Bonzai: Have you ever been entirely responsible for the complete score?

Bishop: I just finished my first job in that capacity. It's a theatrical short that was produced for the benefit of the Women's Clinic in Los Angeles, called *The Last Seduction*. It was a more alien territory than I have ever encountered, but I was very pleased with the results, and it's something I've always wanted to do.

Bonzai: I imagine that even for a small film, all the rules still apply.

Bishop: Absolutely. The technical side, the synchronization, the creative work, the composing and the performing, and the budgeting are exactly the same. You have to realize that there are only a handful of people who score the major films, and to make progress you have to keep acquiring credits wherever you can get them.

Bonzai: What advice would you give to someone who was interested in getting into this field?

Bishop: Get a credit any way you can. Work on a student film project; contribute to a documentary for PBS; write music for an industrial or corporate film. There are many paths that will provide the necessary discipline and can lead to feature films. ■

It's here at last!

...the book the recording industry never knew it needed

"This book could quickly become the New and Improved Testament for recording studios, the quintessential handbook for studio dwellers, a reference tome and tour book for what really goes on behind closed double doors...an upthrusting plea for insanity in a sane world."

—Ken Pohlmann

Music Engineering Department Head, University of Miami

"Mr. Bonzai has captured the true meaning of *Studio Life* in this incisive satire of what really happens in a recording studio. I could not stop laughing. All my friends will definitely get this book from me for Christmas."

—Chris Stone, President
Record Plant, Los Angeles

"(Mr. Bonzai) has carefully split the difference between riotous comedy and real information and the result is a book that can be read with pleasure by anyone, whether they be studio moles or real human beings. You'll learn a lot and you'll laugh even more."

—Phil Austin
Firesign Theatre

"I hope you enjoy your copy of *Studio Life* as much as I did mine. I boiled mine for dinner." —Stan Freberg, *Humorist/Recording Artist*

"...a must for anyone who is in the industry. It's comforting to know that all the insanities and extraterrestrial experiences affiliated with the record industry didn't just happen to me. *Studio Life* should be the new Bible for all studios."

—Michael Sembello
Recording Artist

\$7.95 160pp. Quality paperback
ISBN 0-918371-00-7
©1984 Mix Publications

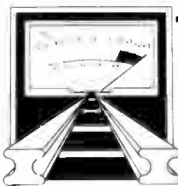

STUDIO LIFE: *The Other Side of the Tracks* by Mr. Bonzai

YES! Please send me _____
copies of STUDIO LIFE.

Enclosed is my payment @\$7.95
per copy plus \$1.00 postage, or

Bill to: VISA Mastercharge

Credit Card Number _____

Expiration Date _____

Signature _____ **World Radio History**

Name _____

Address _____

City _____

State _____

Zip _____

PAYMENT MUST ACCOMPANY ORDER.

Quantity Discounts, Inquiries Welcome

Mail to: Studio Life, c/o Mix Magazine,
2608 Ninth St., Berkeley, CA 94710
(415) 843-7901

When you're used to the best there is...



"You would choose a Soundcraft, too". That's what producer/songwriter Pete Bellotte told us.

And he certainly is used to the best. While he was co-writing and producing most of Donna Summer's hits he chose Soundcraft for his own studio.

"When we were recording Donna's 'Macarthur Park' and 'Bad Girls' we were amazed at the flexibility of the Soundcraft and in particular, the EQ. You get all the control you need out of a Soundcraft EQ without any harshness or distortion. The choice was simple.

"My major guidelines in selecting the equipment were space and quality. The Soundcraft 2400 and SCM tape machine met those criteria. With the split configuration of the 2400, it performs like a much bigger console. When I mix down I can use the monitor section of the console to return more tracks. I've got the capability of mixing down

up to 52 tracks simultaneously and I don't have to stand up to get to the controls – they're all within easy reach.

"Once you're used to the best there is, you'll never want to compromise. And that's why I chose Soundcraft".

Soundcraft The Producer's choice

Soundcraft Electronics Limited, 5-8 Great Sutton Street,
London, EC1V 0BX, England. Tel: 01-251 3631. Telex: 21198.

Soundcraft Electronics USA, 1517 20th. Street,
Santa Monica, California 90404. Tel: (213) 453 4591. Telex: 664923.

Soundcraft Canada Inc. 1444 Hymus Blvd. Dorval,
Quebec Canada H9P 1J6. Tel: (514) 685 1610 Telex: 05 822582.



DIGITAL 85

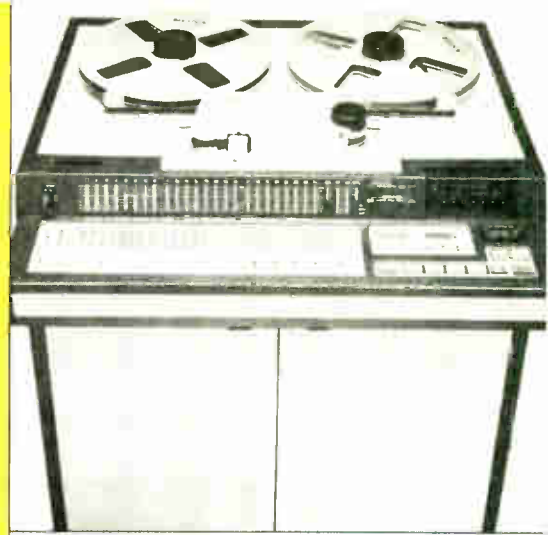

A SPECIAL MIX SUPPLEMENT

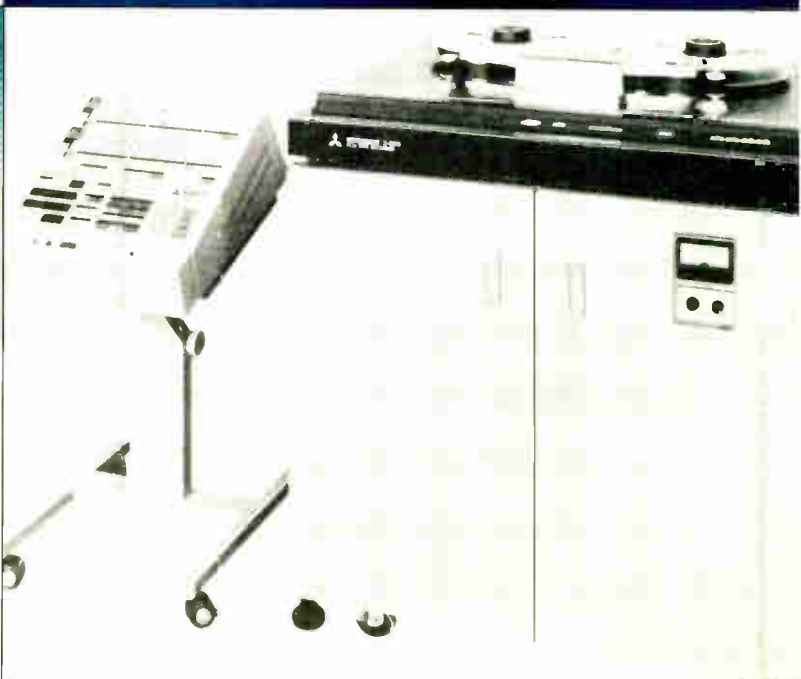
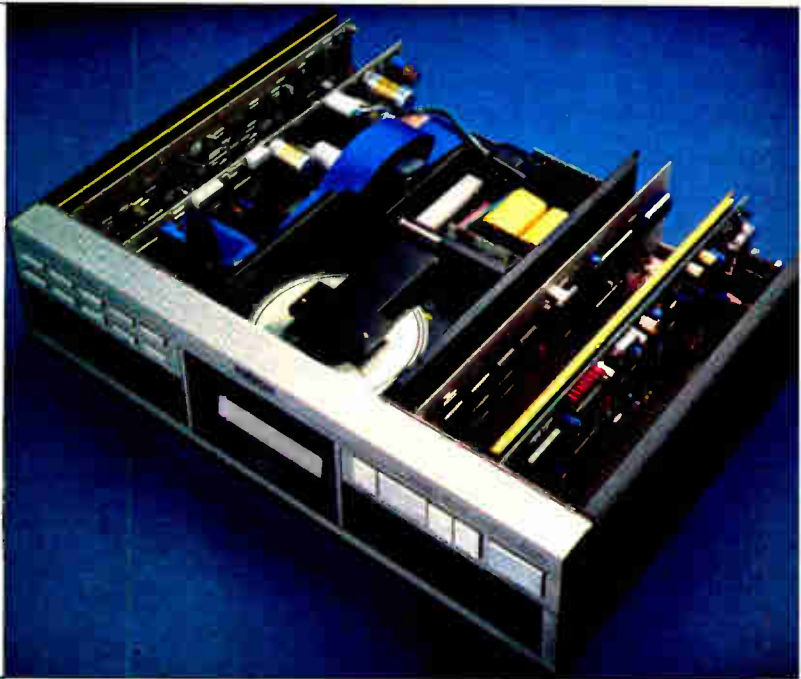

World Radio History

DIGITAL REALITY EXTENDS SUCCESS

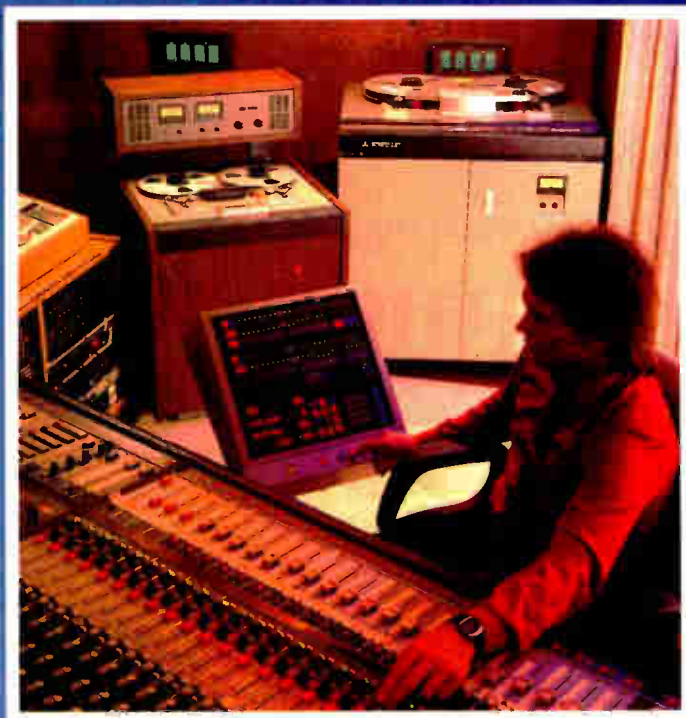

LION SHARE

RECORDING STUDIOS Tel. (213) 658-5990

Leadership Pays Off

Lion Share Recording Studios found the special formula early on, how to satisfy the leading artists and producers and keep them as long term clients. The primary ingredient for success over the years is Leadership. Leadership in studio design and acoustics, in technical support and equipment, in client relationship, and in studio atmosphere. But any leader must continuously review its facilities, approaches and client desires in order to maintain the leadership position.

A Commitment To Digital Recorders

In 1983, Lion Share realized the digital era was fast approaching and that their World Class clients would soon require digital multi-track and mixdown facilities. After exhaustive investigation into the sound quality and technical performance of studio quality digital recording and processing systems, Lion Share selected the complete Mitsubishi digital system. Why Mitsubishi? A major factor was the 32-Track Standard: 24-Track is just not enough. And in digital processing? The decision was to continue to go with a new major analog console rather than digital. Their reasoning? The digital recorders improve performance over analog by more than 20 dB. The digital console does not improve the dynamic range nor the sound over top analog consoles.

The Digital-Analog Combination

Lion Share's direction is clear. Digital recorders and analog consoles. Lion Share has continued its success by making the right decisions, solidifying its leadership position with the top artists and producers. As in 1983, the Mitsubishi X-800 32-Track and X-802 2-Track Digital Recorders are the obvious choices for Lion Share in 1984.

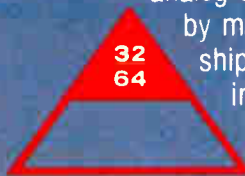

DIGITAL ENTERTAINMENT CORPORATION • A SUBSIDIARY OF MITSUBISHI ELECTRIC SALES AMERICA INC.

Headquarters: 69 North Street, Danbury, Connecticut 06810, Tel. (203) 743-0000. Telex: 703547 • New York City: Suite 1530, 555 W. 57th Street, New York, NY 10019, Tel. (212) 581-6100 • Nashville: 2200 Hillsboro Road, Nashville, TN 37212, Tel. (615) 298-6613 • Los Angeles: 8255 Beverly Blvd., Hollywood, CA 90046, Tel. (213) 651-1699



D I G I T A L 8 5 S U P P L E M E N T

After several years of telling ourselves that digital was just around the corner, all of a sudden something has pulled up in front of the studio. But is it really here, or are we just being test marketed with the bells and whistles to come?

to look a little more at the periphery, at how digital audio is gaining momentum in the less obvious areas, as well as new applications and related technologies that will soon be available to professionals and consumers.

To get a better picture of the status of digital, as it relates to professional audio applications, we looked around for significant developments and signs of real progress. Of course we've been keeping tabs on the latest pro recorders and standards developments for many years now, and have been in close touch with the pioneering manufacturers and studios who have launched the first generation of technology. In this special supplement we wanted

"Digital 85" is part of our ongoing commitment to give Mix readers the latest information, advice and

experience to take advantage of the tremendous opportunities generated by the digital revolution. We hope you find it of value and, as always, we welcome your suggestions and comments.



Digital cover photos (clockwise from top right): Sony 3324, Revox B225, Mitsubishi X-800, Sony K-1105, dbx 700, and the Neve DSP.

CONTENTS

39	SPARS and Digital	by George Petersen
42	Audio Applications: Low Cost Digital . . .	by Ken Pohlmann
48	Interactive Disk Technology	by Greg Badger and Elizabeth Rollins
58	Interview: NED's Sidney Alonso	by David Gans
62	Lucasfilm's ASP	by Larry Oppenheimer
72	The CD and Video	by Ken Pohlmann
76	Digital Discussions: Sony's Digital Mixer	by Curtis Chan
80	Digital News and Products	
83	Digital Resource Guide	

FANTASY IS DIGITAL REALITY.



Fantasy Studios
Tenth & Parker
Berkeley, CA 94710
Tel. (415) 549-2500

Complete Digital Services

- 32-Track X-800 Digital Recording and Mixing
- 2-Track X-80 Digital Mastering
- Digital Source Analog Disc Mastering
- Compact Disc Digital Master Assembly
- Digital First Generation Master Copying
- Digital Transfers to X-80 Format for Cut-and-Splice Editing
- Digital Audio Production for Film and Video

Fantasy Studios

In the San Francisco Bay area, there is a magnificent studio complex where digital audio recording and mastering is no big deal. They've been doing it for years. Fantasy Studios is truly World Class. The four sound studios, custom mastering room, and film scoring facilities are all outfitted with State-of-the-Art equipment, including a full complement of Mitsubishi digital recorders. In 1981, Fantasy was the first major studio in the world to commit to the Mitsubishi X-80 format. In 1983, Fantasy selected the Mitsubishi X-800 32-Channel machine for digital multi-track recording and mixing. No other studio is better equipped and has more experience in digital than Fantasy.

Digital Disc Mastering

Fantasy offers one of the most advanced disc mastering facilities anywhere. With their 2 Mitsubishi X-80 Digital Master machines (with DDL-1), the Zuma Audio Computer, and Neumann Disc Cutting System, Fantasy has, since 1981, mastered more than 50 digital albums (in addition to numerous successful analog products) with incomparable musical clarity and levels previously unattainable (without limiters, if you choose). In other words: the hottest, cleanest masters possible.

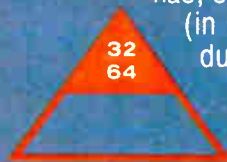

DIGITAL

DIGITAL ENTERTAINMENT CORPORATION • A SUBSIDIARY OF MITSUBISHI ELECTRIC SALES AMERICA INC.

Headquarters: 69 North Street, Danbury, Connecticut 06810, Tel. (203) 743-0000. Telex: 703547 • New York City: Suite 1530, 555 W. 57th Street, New York, NY 10019, Tel. (212) 581-6100 • Nashville: 2200 Hillsboro Road, Nashville, TN 37212, Tel. (615) 298-6613 • Los Angeles: 8255 Beverly Blvd., Hollywood, CA 90046, Tel. (213) 651-1699

MITSUBISHI
DIGITAL AUDIO SYSTEMS

STUDIOSCOPE

A CONVERSATION WITH SPARS PRESIDENT JERRY BARNES

by George Petersen

It's 1984, and whether we like it or not, we are currently immersed in the much-ballyhooed "age of digital." Times have changed, and one only has to look at a slide rule, rectifier tube, or wind-up alarm clock to realize that we now live in a world which is entirely different from that of a decade or so ago.

And while breakthroughs in digital audio have brought the industry to the brink of near-perfect sound reproduction, few studios have taken advantage of the new technology, primarily due to the costs involved, particularly when one contemplates the price of a digital console and multi-track combination. Yet in spite of the economic factors, a growing number of facilities are gearing up for digital and have successfully dealt with the problems of raising the required capital, deciding when (and *what*) to buy, maintaining digital equipment, the lack of a universal standard and the uncertainties of the new medium.

We talked about a few of these topics with Jerry Barnes, who is not only the manager of United Western (a multi-track digital/analog studio complex in Hollywood, California) but also the current president of SPARS, the Society of Professional Audio Recording Studios.

Mix: How does a studio decide when it is ready for digital?

Barnes: Many studios are starting with a two track, and later working up to a digital multitrack, which proves that digital is certainly a viable medium. And while a lot of studios are still intimidated by the costs, it's just a big roll of the dice: at some point you're going to take the plunge or step out on that tiny limb if you're going to do it. If a studio feels they have to wait until they are sure that they can afford it first, then they probably won't ever get into digital.

We started seriously contemplating it late last year. We were considering two manufacturers, but we didn't actually de-

cide on the Mitsubishi system until we put it to a very strenuous project.

Mix: What did that involve?

Barnes: We were working on a 32 track orchestral digital project in London, at Abbey Road Studios, and we brought the tape back to United Western and used a different X-800 to mix on, and it worked perfectly. I had heard all the horror stories about digital, where material recorded on one machine was not retrievable on another, but fortunately none of it was true, and it turned out to be a very good business move.

Mix: Did the move to digital change the way you market the studio?

Barnes: Not really, other than getting the word out that the equipment is available. We do however, in some cases, have to spend some time with potential users to overcome some of their "early-digital fears," which came about four or five years ago. At the time, a lot of people picked up on various buzzwords that were fun to say, like, "I can hear the quantizing noise...or I can hear the anti-aliasing filters." These weren't altogether false, but they sounded good rolling off the tongue, and many people were influ-

DIGITAL

THE STUDIOS' VIEWPOINT

"If a studio feels they have to wait until they are sure they can afford it first, then they probably won't ever get into digital."

enced by both that and by some of the early digital failures. Now we need time to undo some of that, although today it's a lot easier to excite people about digital.

The excuse of waiting until it's cheaper, or waiting for the next breakthrough is a thin one, because we are now able to do things digitally that we could never do in the analog domain. We are only cheating ourselves if we wait. I don't look at a piece of equipment and ask whether it would be useful five years from now, because the answer is probably "no." I look to see whether it will be useful *now*, and over the next year. I have to be a little bit daring that way—we all have to be.

One mistake we often make is assuming that digital audio only refers to making better records. I see enormous digital possibilities for agency people doing commercials and jingles; film scoring people; anyone who continually has to go back to the master and make alterations or add to it. Digital, especially in the 32 track format, is extremely useful in these applications, and with stereo TV becoming a reality, these people want their product to sound as good as it can.

Another exciting aspect of the digital medium is archival storage, and we have done a lot of digital copies of analog masters for clients. While the aging pro-

cess does not totally correct itself in the digital domain, it does extend the life for an indefinite period, and masters are put into a state where we can later convert them to a better technology when and if it comes along. Think of what a wealth we would have now if this would have been available 50 years ago—not only for music, but also for dialog, speeches, and recordings of historical events.

Mix: Does the maintenance of digital gear, whether a multitrack recorder or a programmable reverb, pose a problem for studios today?

Barnes: Well, a basic prerequisite to working as a maintenance person in a major studio today is a familiarity with digital—you've got to be up on technology. But we have found that our digital equipment is the most reliable of any gear we have—there's no alignment, we turn it on and it runs. So far, after six or eight months, we've had no problems with our recorders.

Studios with digital gear are going to need to get maintenance engineers who can relate to digital technology, and that is precisely why SPARS is so excited about the need for a testing program for

people who are entering the audio industry—whether they are entry-level or people with some experience.

The SPARS testing program is in formation now and we target that by spring 1985, we will begin testing in major universities around the country, open to anyone who wants to take the test. This will be a useful evaluation of one's prior experience or school training. It will also serve as a good primer and refresher for those who intend to stay in this business and grow with it, and know where they are technically, without embarrassing themselves in the middle of a session. SPARS will not administer the test; it will be given by an educational service which is totally independent, however it is our concept and we are sponsoring it.

We hope to see the next generation of engineers, technicians, and studio administrative people come through this process. Getting jobs in this industry has, almost by design, been very helter-skelter, but the days of walking in off the street and getting a job are over. To start out today, you need to know much more than you did ten years ago. We did recognize this and we owe a debt to the whole industry to lead the quality of our labor force to a higher level.

Mix: How important is digital standardization to the industry today?

Barnes: I don't think it's very important, frankly. There's no question that a lot of problems would be solved if everybody got together in a room today and decided on a single standard, but we're always going to be faced with different standards. I'm not sure we're ready for standards. We do have a standard in mastering for the Compact Disc—I kind of object that it's a 1610 standard, and it requires more conversions if you're using a different format. In that regard, I'm against standardization.

I think that people who are making Compact Discs are capable of expanding their mastering requirements to accept other formats, and I'm sure this can be worked out somehow.

Mix: What are some of your feelings about the Compact Disc?

Barnes: The CD is truly spectacular, even if one is somewhat critical of the medium. I sit down in my home and listen to music again—something I stopped doing years ago due to the poor quality of vinyl. I can sit down with a well-recorded Compact Disc and get a thrill out of listening to music that I haven't felt in years. The quality of the medium keeps improving, but it always boils down to the quality of the engineering in the first place. Digital exposes all the strengths and weaknesses of a production, so we all have to keep working harder to make it better. It's a good challenge for us. ■

*Just what you'd expect:
Innovation in Digital Audio.*

TC-5 INDUSTRIAL DIGITAL PROCESSOR
TC-4 BROADCAST DIGITAL PROCESSOR
TC-3 PRE-REVERB DIGITAL PROCESSOR

- PRODUCT DIVERSITY
- NO COMPROMISE QUALITY
- PRICE

audio digital INC.

1000 S. BERTELSEN ROAD • SUITE 4
EUGENE, OR 97402 • (503) 687-8412

The greatest innovation in audio mixing has just gotten better: Necam 96.

Picture courtesy
Atlantic Studios, N.Y.



The challenge: Take a technological triumph, Necam II, a computer-assisted audio mixing system, and make it better by making it faster, more informative, more intelligent and loaded with exciting features.

The result: Necam-96

- **Incredible speed:** Feather-touch sensitive faders eliminate hundreds of intermediate steps for lightning-fast operation.
- **Total Information Color Video Display:** Our high-resolution display tells where you are at a glance, including time code, mix names, event times, scene changes and more: all labels, mutes, stores and events can be rapidly changed.

NECAM 96

- **Unique Intelligent Rollback:** With or without updates. The faders move to where they need to be automatically—no FEC/Direct comparison needed. Sophisticated effects build up a snap.

- **Smart Keys:** Our human-engineered software is the fastest ever developed to eliminate repetitive keystrokes.

- **Technological Sophistication:** Necam 96 will interface with any synchronizer as master or slave; read SMPTE time code, foot/frame counts, or even tacho pulses.

Take the next step. For further information call Neve at (203) 744-6230 or write:

Demand Neve

RUPERT NEVE INCORPORATED: Berkshire Industrial Park, Bethel, CT 06801 (203) 744-6230 Telex 969638 • 7533 Sunset Blvd., Hollywood, CA 90046 (213) 874-8124 • RUPERT NEVE OF CANADA, LTD. represented by: Sonotechnique, 2585 Bates, Suite 304, Montreal, P.Q. H3S 1A9 Canada (514) 739-3368 Telex 055-62171 • NEVE ELECTRONICS INTERNATIONAL, LTD. Cambridge House, Melbourn, Royston, Hertfordshire, SG86AU England Phone (0763) 60776 • RUPERT NEVE GmbH: 6100 Darmstadt Bismarckstrasse 114, West Germany Phone (06151) 81764.

AUDIO-APPLICATIONS

I'm very impressed with the potential of digital processors to bring many more people into the digital arena. I think we will all be surprised by the quality of the work and the innovativeness of the applications.



Hamilton H. Brosious of Audiotechniques, Inc.

than in going out and recording their own material. I would say that more of them are used for professional applications, even though Sony has taken a strong position, contending that the F1 and the 701 are consumer items.

Mix: That raises the inevitable question: why pay \$20,000 for a digital open reel recorder when \$2,000 processor might do the job?

Brosious: It's a question of performance and application. As you know, the processors operate in 14 or 16 bit modes and in the 16 bit mode they borrow from the error concealment processing, approximately 50 percent of the power of the error concealment; the PCM-F1 was never conceived as a professional unit. Incidentally, I should mention that the PCM-F1 and the 701 are electrically identical, however the board architecture is a little less crowded in the 701. Despite their intended purpose, both processors have been used in professional applications with what I would call stunning results. A number of people have done video shoots, documentaries, and music recordings released on Compact Disc which have been excellent. And I have yet to hear any of the people who work with it all the time complain of any drop-outs.

Low Cost Digital

AN INTERVIEW WITH HAMILTON BROSIOUS

by Ken Pohlmann

Digital technology has changed all the rules in recording, both in terms of sound quality and equipment economics. In particular, the introduction of low cost digital audio processors has blurred the distinction between professional and consumer recording equipment, and opened digital doors to tremendous recording opportunities. In an effort to understand the current status of the low cost digital explosion, and estimate its potential impact, I talked to Hamilton Brosious, who is both the president of Audiotechniques, a New York City/Stamford, Connecticut company involved with digital sales and service, and the editor of *The Digital Recording Report*, a newsletter devoted to late-breaking digital recording news.

Mix: By way of introduction, exactly why are you such an expert on digital audio?

Brosious: Well, I don't consider myself an expert, more of a clearing house for digital information. With Audiotechniques, over the years I have inherited the mantle of the communicator of digital

technology, mainly trying to answer clients' questions. There seems to be a lot of misinformation around, but my approach has been to stick to the applications side of things and try to explain how recording studios, video houses, and television stations can deal with the Compact Disc and other innovations coming along. As I got into this, I found that there was a need for a forum for people to exchange ideas, and a need for commentary on what was going on, as opposed to relying solely on manufacturer's press releases. So I started a new publication, *The Digital Recording Report*, circulating to about 500 subscribers. We are looking to become one of the leaders in presenting information about digital recording equipment. Of course, the field is changing so very fast that it is quite difficult to keep up.

Mix: Let's talk about the PCM-F1 and 701 phenomenon. Who is using these processors, advanced consumers, semipro, pros?

Brosious: As near as I can tell, it isn't used much by consumers. By nature, consumers are more interested in a sound system, and its excellence, rather

Mix: The gap between consumer and professional digital equipment seems to be narrowing.

Brosious: I think the gap was closed with the introduction of the F1, now they are beginning to exploit it by providing a whole family of digital peripherals which will extend the capability of the 701. Also, the 701 is much easier to modify.

Mix: How?

Brosious: Audio + Design has come out with a modification to the 701 which gives you balanced +4 level, coincident time correction between channels to avoid the 11.34 microsecond difference, PAL and NTSC switching, pre-emphasis, copy prohibit, and serial digital in and out which means you can go directly into a 1610 or from 1610 to 701 if the client wants a copy to listen to. Their digital mixer also lets you bounce between processors, and in a multitrack mode for two tracks, you can keep adding things onto a two track from a 701 external signal.

Another English company called HHB has shown an editing system for the 701 which is very sophisticated. A well-known engineer in New York, David

THE dbx 700 DIGITAL AUDIO PROCESSOR IS HERE!



Celebrate the Triumph of Music & Song.

Now there's a digital audio processor for people who'd rather listen to music. The dbx 700.

The dbx 700 and a professional-quality VCR let you reproduce sound that's more musical than any other digital system. And you can buy it for a song.

The secret? A new technology called Companded Predictive Delta Modulation (CPDM)—a digital encoding technique that solves the problems inherent in existing digital systems.

What's more, the dbx 700 has an incredible 110 dB dynamic range.

Of course, the only true test is how the 700 sounds to you. We invite you to visit your nearest dbx digital dealer. And let your ears decide.

dbx[®]

dbx Inc., Professional Products Division, 71 Chapel Street, Newton, Massachusetts 02195, USA, Tel. (617) 964-3210, Telex: 92-2522



SHOWN WITH OPTIONAL MODEL 710 MICROPHONE PREAMPS.

World Radio History

“DIGITAL AUDIO IS TRANSFORMING US ALL.”

—*Giorgio Moroder*

“I’ve heard people say they really wanted to hate digital audio. But, of course, they couldn’t. Because nothing sounds as real as digital.” So begins Giorgio Moroder, the award-winning composer/producer and owner of one of the world’s most extensive Sony digital installations—three 24-track digital recorders and one PCM-1610 mastering system.

“Listening to digital is truly an ear-opening experience. You can’t even tell if what you’re hearing is a first generation track or a tenth. The fidelity is absolutely incredible.”

And these are just a few of the reasons why so many top recording artists and producers, like Moroder, Phil Ramone, Neil Young, Elliot Mazer, Frank Zappa and Nile Rodgers now own or use Sony DASH-standard digital equipment.

“After all,” Moroder explains, “I want my studio to be compatible with studios the world over and Sony has set the standard. And, of course, Sony has led this transformation right from the start.”

We couldn’t have said it better ourselves.

SONY
The Leader in Digital Audio.

© 1984 Sony Corporation of America. Sony is a registered trademark of the Sony Corporation. Sony Communications Products Company, Sony Drive, Park Ridge, New Jersey 07656.



A scene from Giorgio Moroder's rescored version of Fritz Lang's 1926 film classic, "Metropolis," which includes the world's first totally digital sound track.

Smith of Editel, has a device which allows you to bounce among several processors. Similarly, Ken Haman, an engineer in Cleveland, working with Jack Renner at Telarc, has developed an editing system. People are recognizing that a processor like the 701, which is priced at \$1,200, but can be bought at \$1,050, is becoming a nucleus for a near-professional system.

By June of 1985 you should be able to buy a couple of processors, three cassette decks, an editor, and a synchronizer—a whole two track editing system for about \$12,000 to \$15,000—going directly to a 1610 and then to Compact Disc.

The whole field will become even more elevated just by the nature of the accessories and peripherals becoming available. It will have a closer position to professional status. When Editel goes out on a video shoot and uses a processor for all of the audio, one has to say that the product and the results are professional.

Mix: Are we pressing the product too much? If 50 percent of the error concealment is gone when using 16 bit quantization, can we start to get audible degradation on CDs?

Brosious: Peter Jensen, of American Compact Disc Company, is a real veteran of the F1 scheme; he has told me that whether or not you use 14 or 16 bit doesn't really much matter. He has standardized on 16 bit but he has found that the quality of the tape itself and cleanliness of the transport is much more important than choice of mode. In addition it is necessary to use tape which is configured for audio recording, instead of low cost video tape.

Mix: Do you anticipate that companies will optimize videotape and transports for audio applications?

Brosious: That's hard to say. This gets out of my realm. All I can say is that you are seeing an explosion of digital technology at all levels and areas.

Mix: What's the next breakthrough?

Brosious: In the next one to three years, the most significant piece of equipment that many recording studios will purchase is a two track digital reel to reel machine. They'll have the choice between analog and digital, but I think we'll be seeing most mix-downs being done on digital machines, even though purists might prefer a half-inch analog machine. With the assimilation of digital two tracks into the studio, clients will begin to ask for a copy, but what they really want to know is how it will sound at home, on a CD. You will be able to take a 1610 mix, record it directly on a 701, and give it the A&R person or record label executive, or demo client, and they can take it home

and hear the same data they'll be hearing on the CD release.

Mix: You foresee coexistence between the three formats?

Brosious: I do. The reel-to-reel will have its place, as will the 1610, and the 701, or whatever the new product numbers will be.

Mix: How about new formats such as the digital audio cassette?

Brosious: You and I were both at the SPARS digital audio seminar at the University of Miami, and we heard Almon Clegg of Matsushita describe the digital cassette. According to Almon the standard will be established in Japan by the end of the year, and preliminary information indicates three hour playing time, and as of now no one is certain whether it will be a stationary or rotary head design. They are looking for a \$1,200 initial price, about what the Compact Disc was initially, then going down to the \$500 figure. The digital cassette is an answer, but also a problem. Because of the data density, it appears that the tapes will be difficult to duplicate. And there are those who feel that the analog music cassette will be with us for a long time. Doug Sax of Sheffield Labs tells me that he is confident that the LP is going to disappear, but not entirely because of the CD; rather because of the analog cassette. Fifty-two percent of the pre-recorded music to be sold in 1984 is on cassette and seven or eight million cars are sold each year equipped with cassette players. That's quite an army of analog cassettes, when you consider that the sales of CDs is numbered in the hundreds of thousands. The cassette, in one form or another, is here to stay.

Mix: So you see a future market split between CDs and digital cassettes?

Brosious: Almon Clegg seemed to feel that going into the mid 1990s we would be seeing Compact Discs and digital cassettes with the lion's share of the pre-recorded market. I personally think that market might be divided three ways, with analog cassettes still holding a large share of the market.

Mix: I didn't realize there was such life expectancy for the analog cassette.

Brosious: I didn't either, but Doug sent me some information on work being done by Nakamichi in which they get 20 to 20,000 Hertz frequency response at zero level, not at minus 20 with a plus 13 boost at the middle. He feels there are some incredible things still to come, but it will be very difficult to achieve that with high speed duplication.

Mix: There's one topic we haven't talked about, and that's the dbx delta modulation processor. Any opinions?

Brosious: I'm told by a number of people whose ears I respect that it "sounds better than PCM" however I don't know what "sounds better" really means. I sometimes wonder if that doesn't mean it sounds a little more like analog. Maybe if one could add a little third harmonic distortion to Compact Discs, the analog buffs would be happy. Back to the delta modulation processor, I am told they use a standard editor which gives them about frame accuracy and no music editor is going to accept frame accuracy which is a thirtieth of a second as being accurate enough to make cuts between notes and things of that nature. For sub-frame accuracy, such as a hundredth of a frame, then the cost is virtually the same as a 1610 system—you're talking \$70,000 to \$80,000 cost.

Mix: One idea is to take the "better sounding" delta modulation method and use it with reel-to-reel...

Brosious: dbx has said that they expect one of the major makers to announce shortly that they are doing this. I don't think it's going to be Sony or Studer because they have DASH, and it won't be Mitsubishi, because if they do anything, it will be toward DASH. If 3M comes back, it will be with their own system, so that pretty much leaves Otari. I am told that it was under active consideration by Otari, however, that it is no longer being considered, although information from my sources is frequently known to be incorrect! Maybe delta modulation is like saying the brake pedal should be to the right of the accelerator instead of the left, and you can really prove that the right is the best place. But if you ever go to put it there in a car...

Mix: Interesting analogy. Anything else to be said in summary?

Brosious: I am very impressed with the potential of digital processors to bring many more people into the digital arena. I think that in the next few years we will all be surprised by the quality of the work and the innovativeness of the applications made with these processors. And I think we'll be overwhelmed with the product developments pushing us more and more into the professional camp. The inevitability of it is dictated by cost considerations. You know, for a long time the industry has been myopic and looking for direction, and I think the panacea is now at hand. The demand for recorded sound has never been greater than it is now; it's our opportunity to capitalize on it with this medium.

The Digital Recording Report can be contacted at 195 Willowbrook Avenue, Stamford, CT 06902. Telephone (203) 325-2792. ■

A man with a mustache and dark hair, wearing a black shirt and white sneakers, is sitting on a stool in a music studio. He is smiling and looking towards the camera. In front of him is a large, white and black Synclavier keyboard. Behind him, there is a black Synclavier keyboard on a desk. The studio walls are decorated with framed pictures and posters, including one that says "SECRET SOUNDS".

A studio without a Synclavier? I don't record there.

Where I go, my Synclavier goes. To me, it is a mandatory piece of studio equipment. For example, the Sample-to-Disk Option has allowed me to record complete background vocal passages more effectively and has also reduced my cost by at least 4 times. After getting a perfect performance on tape, I then transfer the vocal track to the Synclavier's Winchester Disk where I can single-handedly become a complete choir. Plus, when I perform live, I can call the tracks up and perform them in concert; it's extremely effective.

This is, without a doubt, the best investment for a studio product that I have ever made. Believe me, the production of music is changing, and change is spelled SYNCLAVIER.

Kashif

Producer/Synthesist for: George Benson
Melba Moore
Hall & Oates
and more!

For more information or a personal demonstration of the Synclavier Computer Music System, please call New England Digital or one of our authorized distributors.



New England Digital Corporation
Box 546
White River Junction, VT 05001
802/295-5800

New York Digital Sound Inc. 212/977-4510
Los Angeles New England Digital 8453 Beverly Blvd.
(next to Westlake Studios)

Atlanta Songbird Studios 404/351-5955
Dallas Lightning Music & Sound Inc. 214/387-1198
Montreal Digital Music Systems 514/284-0609
Toronto Gerr Electro Acoustics Ltd. 416/868-0528
London Turnkey 202-4366

Synclavier and Sample-to-Disk are registered trademarks of New England Digital Corporation.
Copyright 1988 New England Digital Corporation.

World Radio History

Circle #019 on Reader Service Card

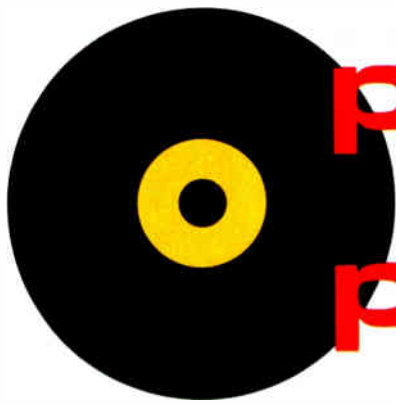

Optical and magneto-optical DATA DISK TECHNOLOGY

by Greg Badger

The field of data storage technology is rapidly advancing as more companies announce the details of their approaches to permanent data storage using optical and magneto-optical disk-based techniques. This article will focus on several aspects of these emerging technologies.

The applications for optical based data storage are virtually endless. They include educational and point of purchase systems, office automation of document and graphic storage and retrieval, software distribution, electronic publishing, security and backup files, cartography, computer aided design (CAD), and film/video editing systems.

Requirements for Digital Data Storage

One of the advantages of optical data disk storage is the excellent long-term archivability of a glass or plastic disk. Whereas standard magnetic storage media exhibit increased reliability problems and higher bit error rates after three years, all signs point to a life expectancy well in excess of ten years when optical disks are stored under normal environmental conditions.

In most optical disk systems, the digital data is stored as a track of pits or bumps in a thin reflective metallic layer sandwiched between two layers of plastic which are relatively impervious to damage and minor surface scratches encountered during normal handling.

The disk is inherently suited to high speed random access of data since the readout head can move across the signal surface at high speeds and can repeat any segment endlessly without disk wear.

Digital data storage requires that the bit error rate after correction be on the order of 10 to 12. In Compact Disc digital audio applications, a higher bit error rate is tolerated to allow cost effective replication of large numbers of disks.

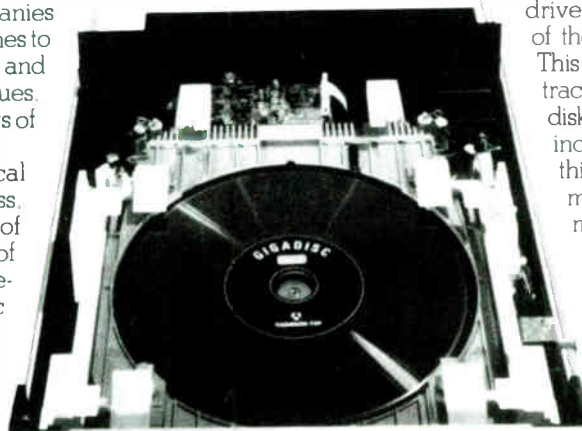

The Thompson-CSF GD 1001 DRAW system can record a gigabyte of data per side of a 12-inch optical disk.

The Compact Disc format takes advantage of data interpolation and muting techniques during playback when disk damage exceeds the correction capabilities of the CIRC error correction system.

Physical Formats for Digital Data Disks

Magnetic and optical based disk systems use one of three methods to control the rotational speed of the disk and thus, the linear velocity at which the data track is recorded and played back. These are CAV (constant angular velocity), CLV (constant linear velocity), and CAA (constant angular acceleration).

Regular LP records and many magnetic disk drives for computers record the data at a constant angular velocity (CAV). That is, the turntable or disk drive rotates at a constant speed regardless of the point being accessed on the disk.

This means the readout device or stylus traces a shorter path near the center of the disk than at the outer diameters. Most 5¼-inch and 8-inch floppy disk drives use this technique to allow the disk to be formatted into tracks and sectors for minimum access time.

The second method of rotational control is CLV (constant linear velocity). Here the relative linear velocity of the read/write head is maintained by decreasing the rotational speed of the disk with increasing radius of the track currently being accessed. Since most optical formats begin recording at the inner diameter of the disk, the disk rotation speed is fastest at the beginning and slowest near the end of the side. Typically this allows a doubling of information storage capacity per disk side over the CAV approach.

The format requires special servo systems for controlling rotational speed and access to individual records on densities on magnetic disk drives for minicomputers.

A third method for rotational speed control is known as CAA (constant angular acceleration). It is used by Pioneer Video for long play format video disks to reduce the effects of inter-track crosstalk. On normal CLV disks, there will be visible interference from the video synchronizing pulses which are part of the adjacent tracks. This is manifested as a wavy pattern moving horizontally across the video screen during playback of slightly warped disks.

The disk begins rotation at 1,800 rpm like a standard CLV video-disk. The rotational speed is stepped down in increments which form bands on the disk recorded at nearly constant angular velocity. This allows the synchronizing information of the adjacent

tracks to remain at a constant physical relationship with the track being played back. The side effects of intertrack crosstalk are thus minimized. The stepping down of the disk rotational speed is performed within the tracking range of the CLV spindle servo and is totally transparent to the player.

The Basics of Playback-Only Optical Systems

By now most *Mix* readers are at least casually aware of the basic concepts used in optical reflective recording. The Laservision videodisk stores the audio and video signals in a frequency modulation scheme where the pit length and spacing are continuously variable over a range of values. In the Compact Disc system there are a finite number of acceptable pit lengths and spacings between pits which are allowed. This modulation format reduces the susceptibility of the system to irregularities in the surface of the disk.

The "pits" in the Laservision and Compact Disc formats are molded depressions or bumps in the metallic coating deposited on the back of the PMMA (polymethylmethacrylate) or similar material which is molded to produce the actual disk. The pit depth is one-quarter wavelength of the laser light used to read the disk back.

As the spiral of pits moves under the laser readout, constructive and destructive interference occurs as the light is reflected off of the metallic in-

ner program surface. This forms an eye pattern in which the data is encoded as a series of high-low transitions. In the Laservision system, each transition represents a swing of the FM carrier, whereas in the Compact Disc there is an eight to 14 relationship between data and channel bits.



ODC Model 610—Optical Disc Corporation offers a DRAW optical recording system which uses a 12-inch disk. Recorded motion and still-frame video can be played back on any LaserVision system.

Laser Video Disk Formats for Optical Data Storage

There are several methods available for storing digital data on an optical disk. Many systems such as that available from Laser Data and Optical Disc Corporation have been developed to carry analog or TTL data in an NTSC compatible format which may be recorded on a Laservision videodisk. These systems store the digital data as a series of black-white transitions or changes in the grey scale of the video luminance signal. This is similar to the techniques used to store still frame audio narration for playback over still frames of a videodisk.

3M/ECCO and Sony, among others sell these still frame audio adapters where there is a justification for speech compression for certain kinds of educational programs. This is useful when large numbers of still frames with narration are present. Playing times for a standard half-hour CAV videodisk using still frame audio may be increased dramatically as the audio for a still frame with ten seconds of narration uses 15 or 20 video frames instead of 450 or more frames if done in real time.

The two analog FM encoded audio carriers of the Laserdisk may also be used to carry low speed digital data streams similar to SMPTE timecode. In these systems, the data is transmitted as a series of 1 kHz and 5 kHz tones where the transitions between the frequencies represents a data bit. Disks using this tech-

Interactive Laser Disk Applications

This year, laser technology has emerged as the victor over RCA's CED format in the consumer video disk competition, and in broader terms, as a budding challenger to magnetic recording technology. So far, most people have been acquainted with only the simplest applications: the Compact Disc for audio playback, and the laser disk which, in its common consumer form, plays back linear programming in much the same way a VTR does.

The laser disk, however, offers inherent capabilities that can completely change our ways of receiving information. Interactivity requires involvement. It is fundamentally different from the authoritarian linear program design.

SPEED OF LIGHT

Instantaneous random access to any address on disk turns a viewer into a user—a recipient into a participant. An interactive video system supplies tools to react to programming. Computer keyboards, keypads, monitor touch-screens, joysticks and lightpens can be used in various configurations.

Level 1: This is the simplest of the four programming configurations. Most consumer disks are made with elementary freeze-frame, variable speed control, and some random access functions in mind.

Level 2: This is when "branching" comes into play. The program is designed with junctures where the user determines which branch of many could be followed. A level 2 configuration uses a keypad for commands, and a playback machine with an internal microprocessor. Digital programming information is buried

on the disk, and dumped into the microprocessor as needed. Level 2 is limited because the digital information dumps occupy space that could be used for video or audio, and also because once a disk is mastered, the program cannot be changed.

Level 3: A level 3 disk acts as a data base. Therefore, a variety of programs designed for different levels on the learning curve could be used by biology students in different grades. In a business application, a product line could be stored on disk, and prices and features could be updated every few months with a new program. This extends the life expectancy of a non-erasable disk.

Level 4: In May, 1984 the Videotape Production Association (VPA) sponsored a meeting in New York devoted to interactive video applications. Producer Jean-Pierre Isabouls of Advanced Image Technology spoke about the most sophisticated

—PAGE 50

—FROM PAGE 49, APPLICATIONS programming configuration: level 4.

As with level 3, this is externally controlled. The difference is that playback is driven by a computer with more memory than a micro. Isabouts simply calls his company's proprietary design a "data base manager system."

This is a sorting-out method. With thousands of images, motion sequences and bits of audio stored anonymously in pits on disk, systematic retrieval takes on new importance.

Isabouts described an application for which his level 4 data base manager is well suited: advertising. Laser disk is the first medium to store everything an agency produces for TV, print, and radio campaigns. If an executive wanted to see a list of all the television spots and print ads for one particular client, he could command a print-out list. Then, he could ask to actually see, for example, wild footage from all those spots shot in Hawaii. An alternate authorization entry code could retrieve budget information. Level 4 is reminiscent of the flexible software programs we are accustomed to using with computers.

TALKING BACK TO YOUR TV:

Three fascinating language training laser disks have recently been designed by The David O. McKay Institute of Brigham Young University at Provo, Utah. Following the sage advice that you can best learn a foreign language if you go to the country and speak with the natives, the "Montevideo" courseware trans-

ports the student of Spanish to Hermosillo, Mexico. Punching instructions into a modified level 3 system allows the user to assume one of several identities: an American tourist, a Mexican student, even a Russian sailor. Larry Gale, co-ordinator of research at the McKay Institute, notes that, "This is the spicy role. Naturally, a Russian sailor would go to different places, and perhaps do quite different things..."

At the beginning of the course, while he's strolling through the Hermosillo plaza, a character might walk up and say, "Hey, you're an American tourist, aren't you?" in Spanish. The user then answers in Spanish into a microphone jacked into a tape recorder. An audio interface with the controlling computer means his response is evaluated. If he answers incorrectly or inappropriately, there are many possibilities. In fact, there are 1,100 branches designed into this conversation simulation program. Because Spanish is a gender-specific language, there are also two separate programs for male and female roles. Very different from the language records that teach how to ask where the men's room is, and how much for the chicken mole!

Another language course designed by the McKay Institute at BYU is called "Flight 505." This is targeted at Japanese businessmen who want to develop English conversational skills. Although the Japanese concentrate on learning foreign languages far more than do Americans,

—PAGE 52

nique have been made for a variety of applications including control of the videodisk player when used in conjunction with the video recorded on the disk and for audio animation systems where the digital data tracks control various parameters of the equipment in the exhibit. Unused portions of the video may be used for slow speed data transmission in videogame or simulator applications.

The video luminance signal may be encoded with any standard NTSC format digital audio processor such as the Sony PCM-F1 or the Sansui Tricode system using the 14 bit EIAJ or 16 bit linear PCM format. However, it must be noted that this will produce a non-standard disk which requires certain changes to the vertical interval encoding and minor modifications to the player. The disk produced will not play on certain players, so consult the disk and player manufacturers before attempting this format.

In passing, it should be mentioned that there are now random access jukebox machines available for Laserdisks such as the unit made by Mitomo. While this system provides true random access to a large number of disks, there may still be disk handling problems which cause scratches, thereby degrading signal quality and increasing drop-outs.

Compact Disc Based Digital Data Storage

The standard Compact Disc format includes eight digital data channels with a transmission rate of approximately 7 Kbits/second. These are designated P, Q, R, S, T, U, V, and W. At the present time, only the P and Q channels are used for pause flags between tracks,

Typical Application of the EECO VAC-300 Still-Frame Decoder

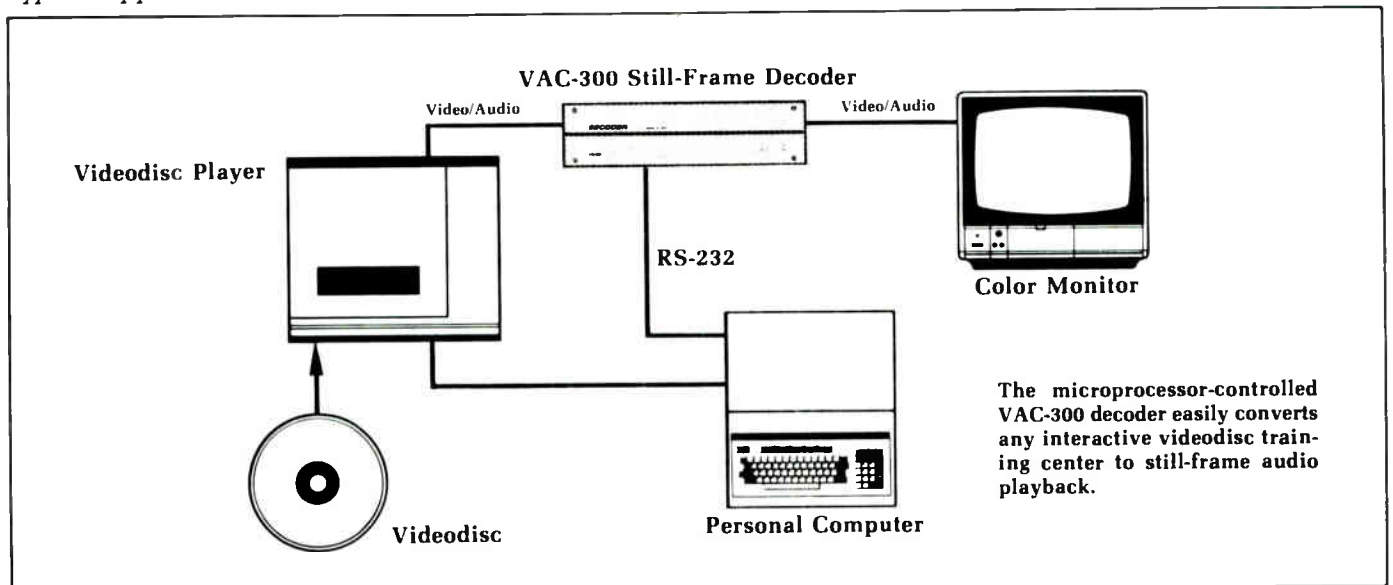

INSTANT

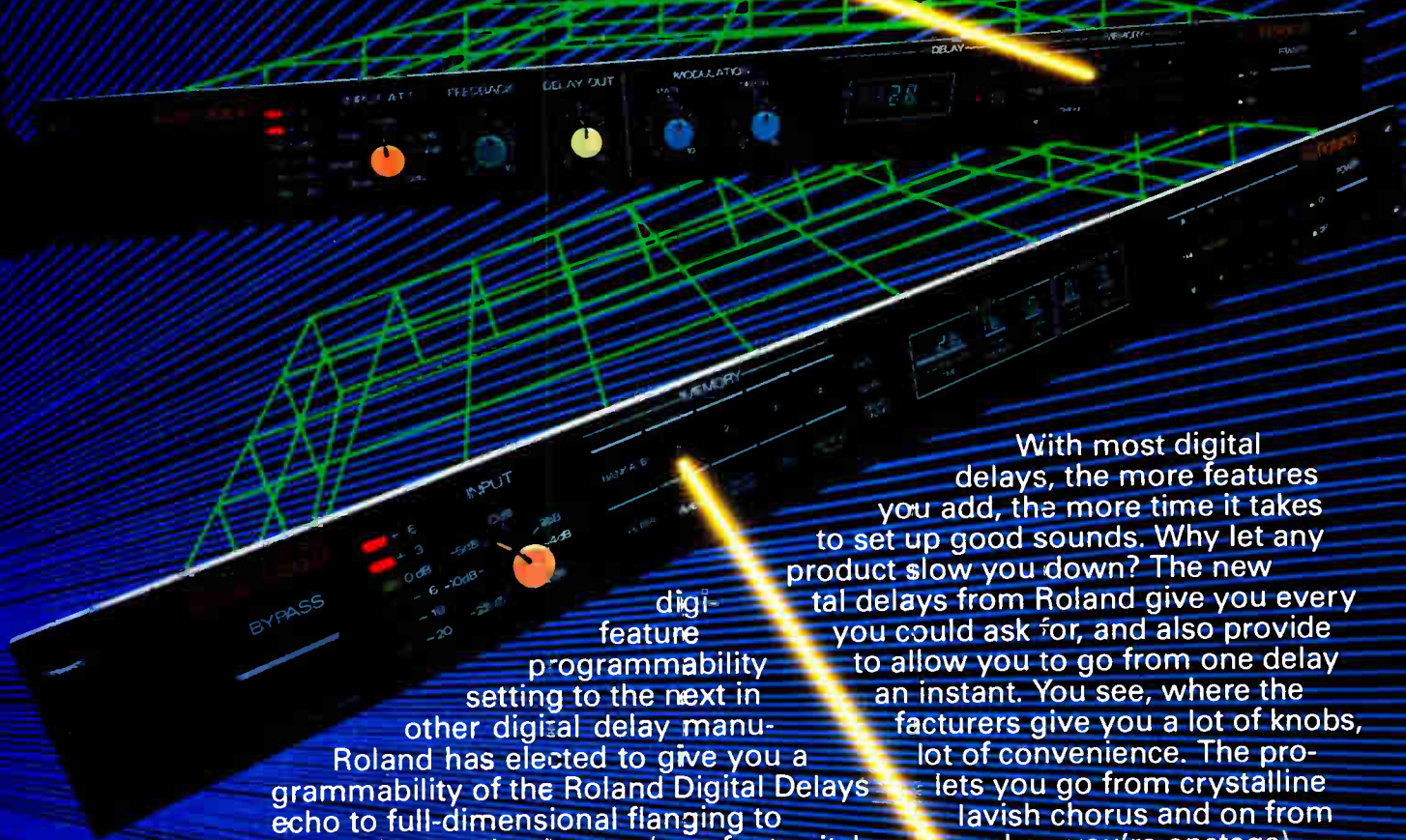

With most digital delays, the more features you add, the more time it takes to set up good sounds. Why let any product slow you down? The new digital delays from Roland give you every feature you could ask for, and also provide you with the convenience of allowing you to go from one delay setting to the next in an instant. You see, where other manufacturers give you a lot of knobs, a lot of convenience. The programmability of the Roland Digital Delays lets you go from crystalline echo to full-dimensional flanging to there... just push a button (or a footswitch). What's more, Roland has provided program- higher resolution and more delay time per dollar than any product on the market. The features speak for themselves:

Both Units: Four convenient footswitches: Delay switch between Memory Channels), Playmate (to switch time), and Hold. Precision control of Delay Settings: to 10 mSec in 1 mSec steps. Wide Frequency Response: Digital Companding and Pulse Code Modulation (16 bit A/D converter) increase frequency response, to effective dynamic range of 100 dB with only .03% THD.

SDE-1000: Four channels of microprocessor-based memory, 1.125 Sec. of Delay and LED readouts for Delay time for \$499.00.

SDE-3000: Eight channels of memory, 1 mS to 4.5 Sec. of Delay Time, Feedback Level, Output Level, Modulation Rate, and Modulation Depth—all for \$1099.00.

Instant Delay. Once you've experienced it, you won't be able to settle for less.

On/Off, Preset (to remotely set delay adjustable from 1 mSec to 10 mSec), Response/Low (equivalent to a give an effective

1 mSec to

Delay, Mod-

 **Roland** RolandCorp US, 7200 Dominion Circle, LA, CA 90040.

DELAY

—FROM PAGE 50, APPLICATIONS

they have few people to practice with since the population is 94 percent native Japanese. In "Flight 505" the businessman is on his way to a conference in the United States. He may encounter some cultural, as well as language differences. For example, an American female executive meets him at the airport. A woman in such a position is almost unheard of in Japan.

There are educational disks that have been developed at BYU which use existing footage, as well. "Raiders of the Lost Ark" provides an entertaining way to learn English as a second language. Grade school children can interact with the Robert Redford movie, "The Great Waldo Pepper" to learn Social Studies.

COMMERCIAL APPLICATIONS

Laser disk technology is a boon to point-of-purchase marketing. Here are three examples of companies who are using kiosks equipped with interactive disk systems:

By-Video: Nolan Bushnell, the man who invented the first coin-operated video game, and founded Atari, has a new company. You'll probably see one of these "By-Video" kiosks soon in an airport or office complex. It's designed to give you information about a number of products, and then, let you buy your choice with your credit card. The target consumer group is the executive who doesn't have time to shop, and wants to efficiently use airport captivity time.

Interac: This company uses the same general approach, but it's narrowing the demographic. Interac kiosks are planted in or close to computer stores. They give "infomercials" about various lines of software and hardware. The advantages here are: no misinformation from a computer salesperson who used to sell real estate; the flexibility to be able to skip over material you already know, and to dwell on concepts that you don't yet understand; level 3 program updates that can keep you current with a rapidly changing field. The disadvantages could be that the "infomercial" may not tell the whole story from a user's perspective. It's a marketing commercial, after all. The truly good salesperson will always be worth his commission!

SRO Music Video: Life-size cut-outs of Michael Jackson and Olivia Newton-John can only go so far. SRO Music Video is really more of a

jukebox that lets record store patrons program music videos they'd like to watch on a 25-inch monitor. One hundred jukeboxes are scheduled to be on location before the end of the year. The concept is a joint venture of H&H Movie Score, the marketing firm of Rip Pelley and Marv Helfer, and a Hollywood commercial production company, Cimarron Productions.

THE CLASSICS

There are too many ingenious disks to enumerate in one article, but here are some that have already achieved "classic" status in the last two years:

The Cardiopulmonary resuscitation (CPR) disk. David Hon designed this program for the American Heart Association. Here is an excellent example of how interactive technology can do things no other medium has ever done.

Three-hundred-and-fifty-thousand Americans who die of heart attacks each year never make it to emergency care. CPR training and certification is an outreach program to teach lay people how to keep a victim's heart and lungs going until medical help arrives.

The modified level 3 system to teach CPR includes light pen control of a touch-screen, "talk along" instruction by random access audio to accompany freeze-frames, and a life-size dummy with electrical connections to the controlling computer. This means that, not only can the user spell out answers to questions with the light pen, but he can actually manipulate the dummy in the same way he would a human. The computer will evaluate if the student is using his hands correctly to apply pressure to the chest, or if he's going about the procedure in the correct sequence. Hon's CPR disk and hardware design shows one of the most advanced, humanistic applications of interactive technology.

Some other classic examples are: the surrogate travel disks developed at MIT, where a user can explore an entire town as if he were driving down each street; the Disco-Vision Associates disk which enabled garment buyers at the 1982 "World Buyers Week" in New York to review 1500 slides of various designer's fashions; the very successful "Murder, Anyone?" game developed by Vidmax, which uses a cast of ten characters to take you through 16 separate who-done-it scenarios.

—Elizabeth Rollins

time code, and disk identification. No firm proposals have yet been advanced utilizing the unused data channels, but possible uses include slow scan video graphics, lyrics, and control data.

It is possible to configure digital data for encoding on CD if the parameters of the EFM and CIRC systems are taken into account. Both Sony and Phillips have proposed formats for CD-ROM's which offer one-half gigabyte of digital information storage on a regular Compact Disc. Suggested applications for the CD-ROM include videogames, electronic publishing (dictionaries, encyclopedias, etc.) where low cost storage and mass distribution of programs and data bases are required.

Several manufacturers have announced changers and jukebox style CD players. These systems will allow CD digital data storage of 25 to 50 gigabytes of information with rapid access times.

The Basics of Draw Systems

A typical one-time recordable DRAW (direct read after write) disk consists of a heat sensitive layer sandwiched between air and/or the outer protective surface. When the recording material is heated to a certain temperature by the write laser, the surface will form pits or bubbles which change its reflectivity when played back with a low power laser.

The trick here is to find a material which is stable under normal environmental conditions and changes its state over a narrow band of temperatures around 230 degrees Fahrenheit. When this permanent phase transition occurs, the alloy material is changed from its unrecorded amorphous state to a crystalline structure. This causes a three or four fold increase in surface reflectivity and provides sharp delineation of the edges and lengths of the recorded pits.

Typical recording materials include antimony-selenide metallic film or other polymeric DRAW material with a heat absorbent layer of bismuth telluride or similar alloy.

Several manufacturers now offer or soon will offer one time DRAW systems for Compact Disc and laser videodisk including Optical Disc Corporation, Laser Video, Phillips, Sony, Hitachi, Toshiba, and Matsushita/Panasonic. Thomson CSF/Xerox and 3M offer dedicated DRAW digital data systems not based on videodisk or Compact Disc technology.

At the present time, Optical Disc Corporation, Laser Video, Thomson CSF, 3M, and Panasonic have DRAW systems on the market. The Optical Disc Corporation is placing their Model 610 Laservision compatible DRAW recording system in several facilities around the country. Spectra Image of Burbank is using the system to pro-

PRODUCTION

Heightened consumer awareness, the success of music video, and the resurgence of live programming challenge broadcasters to achieve new standards of audio performance. The quality of new source material, such as the Compact Disk, places exceptional demands on the audio chain. Production consoles must meet these demands as well as provide systems unique to the broadcast environment.

NEOTEK Production consoles enable broadcasters to meet this challenge. Designed with the circuits that make NEOTEK recording consoles the industry standard for sonic quality, they produce outstanding technical specifications.

Distortion	below .005%
Bandwidth	greater than 40kHz
Output Noise	less than -96dB
Crosstalk	less than -80dB

Combine this performance with features essential to broadcasters: mic/line input modules with live mic sensing and individually programmable studio/control room mute, start pulses, and overpress cue; stereo line input modules with remote logic interface; and a master section with cue, solo, headphone amp, twelve stereo inputs, slate oscillator, talkback, and a host of additional functions. P&G faders and high resolution meters are standard, many frame formats are available, and there is an extensive list of options and accessories.

NEOTEK manufactures console systems for recording, broadcast production, sound reinforcement, theater, and TV/film. Each is built to individual order in the United States, and brings to every unique application the highest standard of quality.



NEOTEK

1154 West Belmont Avenue

Chicago, Illinois 60657 U.S.A.
312-929-6699

Circle #021 on Reader Service Card

duce one-off replicas of programs for \$300 per half hour side. The cost of a complete ODC-DRAW system with playback VTR's, encoders, and associated facilities will run well over a quarter-of-a-million dollars, so this is not for consumer applications.

3M has announced that several facilities around the country offer digital data encoding for 3M produced Laserdisks in the NTSC format. These facilities include Matrox Electronic Systems in Quebec; Fields Video and Perceptronics in Virginia; Ixion and Intermedia in Seattle, WA; Global Interactive Video in

Florida; and Reference Technology in Colorado.

Laser Video of Anaheim, California offers a photolithographic disk reproduction process for manufacturing small quantities of Laservision or compact digital audio disks. The system records a standard laser optical master which is converted into a mask used to contact print the pits with an ultraviolet sensitive photoresist process onto a plastic substrate coated with a thin film of metal. The technique used is similar to the one employed in the manufacturing of integrated circuits.

An alternative laser optical videodisk recording system is being offered by Panasonic as the TQ-2023F recorder and TQ-2024 player. The recorder is priced around \$35,000 and the companion player is about \$4,000. Disks are on the order of \$175 each. Although the disks look similar to regular Laservision video disks, the system is not compatible with Laservision players since it uses different carrier frequencies for audio and video. The chrominance information is recorded using color under heterodyning techniques similar to those used in videocassette recorders.

The 8-inch plastic disk rotates at 1,800 rpm which will store 24,000 NTSC video still frames or 15,000 motion frames with audio. The recorder and player may be controlled via an RS-232 computer interface with access times in the neighborhood of one-half second. An erasable version is expected next year.

Initial applications for these video DRAW systems include data archival and storage as well as video and film editing systems such as Lucasfilm/Convergence Corporation's EditDroid or Spectra Image's Laser Edit. Spectra Image also offers videotape editing facilities and CX audio noise reduction to prepare the tape masters to produce the disks required for these systems.

Spectra Image will offer same day or overnight turnaround of disks with adequate notice for check disk and video editing applications as well as complete video post production facilities. With their facilities it will be possible to simulate inaccessible environments such as the inside of a nuclear reactor, undersea drilling sites, foreign terrain for flight simulators and proposed real estate developments. They will also be offering a disk based video editing system using a dual optical head player for simulating complex editing of scenes on the same disk.

Thomson-CSF and Xerox have prototypes of their Gigadisc optical based digital data disk system in the field for testing and evaluation. This format offers one gigabyte of storage on one side of a 12-inch optically transmissive glass disk housed in a protective caddy. The system is based on Thomson's earlier work with transmissive laser optical technology for videodisk applications. The information is stored on the surface of the disk and alters the transmission of the laser light through the disk to recover the data. Because the data is stored on the surface of the disk, it must be protected from dust and handling.

3M has also announced the availability of 12-inch glass disk based optical DRAW data storage system with a capacity of one gigabyte per side. It may

DOES YOUR COMPACT DISK SOUND LIKE JUST ANOTHER RECORD?

DISCOVER THE LOST 10-12 ANALOG GENERATIONS ON VIDEOS

**THANK YOU FOR PREFERRING TO CAPTURE RECENT
PERFORMANCES ON PURE DIGITAL MASTERS,
AND FOR CAREFULLY SELECTING
THE NATURAL SOUND OF 3M OR JVC...**

- STEVIE AND LON NEUMANN •
"STEVIE WONDER COMES HOME"
CABLE VIDEO PURE DIGITAL TO SIMULCAST
- DAVID KERSHENBAUM AND JOE JACKSON •
"BODY AND SOUL"
- KURT MUNKACSI "SATYAGRAHA" •
PHILIP GLASS OPERA
- JEFF ROSEN AND BOB DYLAN "INFIDELS" •
• KASHIF "SEND ME YOUR LOVE" •
- TOM SHEPARD "SUNDAY IN THE PARK WITH GEORGE"
AND "LA CAGE AUX FOLLES"
- LARRY ROSEN AND DAVE GRUSIN "NIGHT-LINES" •
• MARK AUBORT AND JOANNA NICKRENZ •
1984 GRAMMY BEST CLASSICAL PRODUCERS

**FOUR YEARS AND HUNDREDS
OF DIGITAL ALBUMS LATER...**

**DIGITAL BY
Dickinson**
OWNER-ENGINEER

201-429-8996
NEW, ON PREMISES STUDIO

Circle #022 on Reader Service Card

How important is microphone phase response?

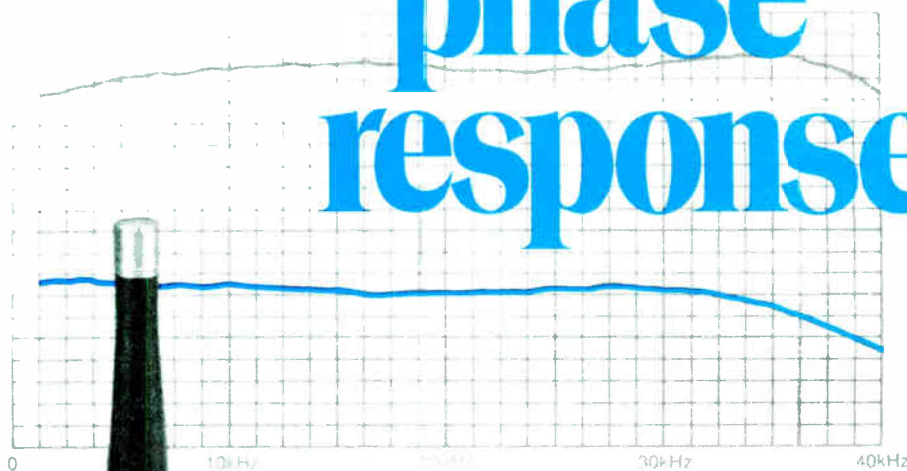

The ability of a microphone to reproduce transients without smearing is directly proportional to the uniformity of its phase response. Yet, few manufacturers measure the phase performance of their microphones, and fewer still publish these data.

Brüel & Kjær designed its 4000 series to exhibit uniform phase response across the entire audio spectrum not only on-axis but off-axis. These phase response characteristics are matched within 10° (5° on some models) to assure a stable, undistorted image when you work in stereo. And we publish them in our brochure so you know what you're getting before you purchase.

If you like to read response curves, request our literature. If you like to hear clean transients, call us for a demonstration of B&K 4000 series microphones in your space.



Brüel & Kjær Instruments, Inc.

185 Forest Street, Marlborough, Massachusetts 01752 • (617) 481-7000 • TWX 710-347-1187

Regional offices: NJ-201-526-2284; MD-301-948-0494; GA-404-951-0115; MI-313-522-8600; IL-312-358-7582; TX-713-645-0167; CA-714-978-8066; CA-415-574-8100

World Headquarters: Naerum, Denmark. Sales and service in principal US cities and 55 countries around the world.

1843

Circle #023 on Reader Service Card

ON SALE NOW!



Please sign me up for a one-year subscription (twelve issues) to *Digital Audio* magazine at \$19.97, a 43% savings over the newsstand price.

- Check enclosed
 MC VISA AE
 Bill me

Card no. _____
Exp. date _____
Name _____
Address _____
City _____
State _____ Zip _____

749113

Send Coupon or a Photocopy to:

Digital Audio Magazine
P.O. Box 976
Farmingdale, NY 11737

or call toll free **1-800-227-1053**

DIGITAL AUDIO

MAGAZINE

A WGE PUBLICATION

be custom formatted for almost any customer specified track/sector format.

Phillips and CDC are field testing a data archival system known as Megadoc. It will be available in 1985.

Another data disk system known as Sophomation uses an optical scanner to store thousands of A-4 pages per disk side and uses a random access jukebox for extensive on-line databases.

Mnemos of Lawrenceville, New Jersey is working on an electron beam writing system which records 6000 A-4 pages on a 12-inch disk.

Magneto-Optical EDRAW Systems

Sony, in conjunction with Kokusai Denshin Denwa plans to market an erasable magneto-optical DRAW disk system for digital audio, video, or data. It is recorded on an eight-inch disk revolving at 1,800 rpm. This and similar systems use a magnetic bias field in the laser light path to alter the polarity of the signal pits in one of 28,000 tracks across the disk. The recording layer is an amorphous vertically aligned magnetic alloy of terbium, iron, and cobalt.

The disk is played using a laser diode assembly similar to that used for reproducing Compact Discs. Each disk will store 2,000 to 3,000 NTSC video frames or one-and-a-half gigabytes of digital data.

Magnetic Disk Based Digital Audio Storage Systems

Compusonics of Cambridge, Massachusetts is now offering a professional digital audio recording system using hard disk drives. Early in 1985 they will offer a consumer version which uses the Kodak/Spin Physics system of vertical magnetic recording on 5¼-inch floppy disks to store an hour of stereo digital audio using an advanced data compression technique.

Gotham Audio also sells the Systex 300 hard disk based digital audio recording system for audio professional applications.

This article is not intended to be an exhaustive treatment of the field of digital data disk storage techniques. To facilitate further research on the subject, below are listed several of the firms involved in this field. This will allow further research into areas of interest to the reader.

Compusonics
One Arnold Circle
Cambridge, MA 02139
(800) 223-1821

Convergence Corporation
1641 McGaw
Irvine, CA 92714
(714) 250-1641

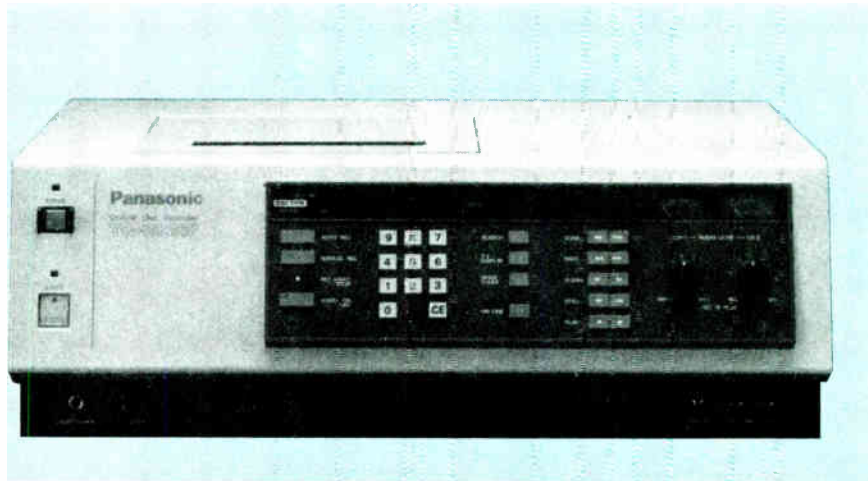

Panasonic's TQ-2023F DRAW optical disk recorder was introduced at the April NAB. It can record up to 24,000 still frames, or up to 13 minutes of motion video per side of an 8-inch disk.

Fields Video
8027 Leesburg Pike
Vienna, VA 22180
(703) 556-9700

Global Interactive Video
100 West South Street
Orlando, FL 32803
(305) 423-8356

Gotham Audio
741 Washington Street
New York, New York 10014
(212) 741-7411

Hitachi Sales Corporation
401 West Artesia Boulevard
Compton, CA 90220
(213) 935-8980

Intermedia
1600 Dexter Avenue North
Seattle, WA 98109
(206) 282-7262

Ixion
1216 6th Avenue West
Seattle, WA 98119
(206) 282-5657

Laser Video
1120 Cosby Way
Anaheim, CA 92806
(714) 630-6700

Matrox Electronic Systems
5800 Andover Avenue
Town of Mount Royal, Quebec
H4T 1H4
(514) 258-9008

Mitomo Company, Ltd.
1-8-11 Jinnan, Shibuya-ku
Tokyo 150 JAPAN
Telephone: 03-463-1601

Optical Disc Corporation
17517-H Fabrica Way
Cerritos, CA 90717
(714) 522-2370

Panasonic
One Panasonic Way
Seacaucus, NJ 07094
(201) 348-7000

Perceptronics
1911 N. For. Mever Drive
Arlington, VA 22209
(703) 525-0184

Phillips Television Systems
900 Corporate Drive
Mahwah, NJ 0743C
(201) 529-1550

Pioneer Video
5150 E. Pacific Coast Hwy., Suite 300
Long Beach, CA 90804
(213) 498-0300

Reference Technology
1832 N. 55th Street
Boulder, CO 80301
(303) 449-4157

Spectra Image
540 N. Hollywood Way
Burbank, CA 91505
(818) 842-1111

Thomson CSF
360 N. Sepulveda Blvd., Suite 2080
El Segundo, CA 90245
(213) 615-1881

3M Optical Disc Recording Project
223-5S 3M Center
St. Paul, MN 55144
(612) 736-2671

by David Gans

In his lecture to the students at the Synclavier Summer Seminar at Dartmouth College last June (see story and photos in Music Notes), New England Digital president Sydney Alonso talked about his ideal for the "musical instrumentness" of his company's product, the Synclavier. "The thing should be able to create or reproduce any sound that has been musically useful to people up to now—extremely well." Furthermore, he said, the knowledge behind the instrument should be sufficient "so that if you tell me you'd like to change that sound in some way, I can do it really easily." It also should be capable of connection with "every kind of transducer to the human body that has ever been useful in musical history."

Music comes from the mind *and* body, Alonso noted, "so forget about implanting electrodes and thinking the music." That said, he went on to conduct a lively discussion of how synthesizers in general—and the Synclavier in particular—should interface with the human body and the human mind. "This is just my vision of where it's going to go," he cautioned, "so be as vociferous in your approval or disapproval of my remarks as you please."

Throughout the week-long seminar, Alonso sat in on other lectures and question-answer sessions, listening and occasionally contributing a comment. His open-minded, undogmatic attitude seems to be an attribute of New England Digital in general; further evidence is found in the fact that the name of the instrument was pronounced several different ways by employees and players (though most of the NED people seem to favor SYN-cluh-veer) and nobody from the company made a big deal of it.

Maybe some of NED's undogmatic attitude stems from the fact that its president isn't himself a synthesist. Alonso played jazz bass in high school but now favors country fiddle. "My favorites are French-Canadian fiddle tunes, really sort of backward, old-timey stuff. The Synclavier will never invade that," he concedes, "although some of the people I've run into have electric fiddles, which are really good at noisy parties."

A West Virginia native, Alonso studied geology at MIT before moving to New York City to try and become a painter. He'd been a ham radio enthusiast in his youth, and after moving to Dartmouth College in the mid-'60s he got in-

New England Digital looks forward



PHOTO: DAVID GANS

An interview with Sydney Alonso

terested in computers. He was a programmer at first, and "then I found out I was pretty good at hardware design." Dartmouth at the time was a hot locale in the field. "They had the first really practical timesharing system, and BASIC was developed there."

At the behest of music professor and electro-acoustic composer Jon Appleton, Alonso and his boss, Tom Piatkowski, explored the possibility of controlling a Moog synthesizer with the big timesharing system. Piatkowski decided it would make more sense to get started on a digital synthesizer that would be easy to control with a computer.

Alonso eventually became a

student at Dartmouth's Thayer School of Engineering, in the master's program in electrical engineering. "My thesis was the digital synthesizer. Rather than publish it, we patented it," he says. "It just didn't work out that I got a degree."

The first product developed by Alonso and his associates was a CAI (Computer-Aided Instruction) device, which taught ear training, harmonic dictation, rhythm pattern recognition, etc. to several students at once. Norlin Corporation bought it, but Dartmouth "could not indulge in making the prototypes," Alonso explains, "so a company had to be formed to do it." That was New England Digital.



A NEW CHAMPION

The Electro-Voice

BLACK KNIGHT

As the Black Knight settles comfortably in your hand, something remarkable happens. You immediately wield the power and authority to give the sonic performance of your career.

What you'd swear was the magic of Merlin is really the Black Knight's invincible power. Acting like a vocal sword, it thrusts your voice through noise barriers that would soundly suppress other brands of microphones.

A true Road Warrior, with both Phantom and battery power, the Black Knight will ride with you anywhere—including to the top

of the charts. And its smooth, peak-free frequency response and cardioid polar pattern minimize annoying feedback problems.

So why fight a losing battle with other mikes. Command the power of the Black Knight and conquer your audience. With the best sound, best warranty and best price in its domain, nobody beats the Black Knight.

See your nearest EV dealer, or write to: Greg Hockman, Product Manager, Music Products Division, Electro-Voice, Inc., 600 Cecil St., Buchanan, MI 49107.

EV Electro-Voice[®]
SOUND IN ACTION™

a gulton company

World Radio History

© 1995 Electro-Voice, Inc.

After Norlin abandoned the CAI project, NED decided to go to work on a musical instrument. By then, Alonso notes, "the mini-floppy disk was a reality." NED also had its own computer, "a home-brew MIS 16-bit machine that happens to be very, very fast. These two developments made it feasible to mount such a project."

The Synclavier I "didn't have the modularity of the Synclavier II," Alonso notes. "It didn't have the expandability. It was missing a lot of features." But it did attract some attention. Some professionals saw the instrument's potential and came to New England Digital with suggestions on how to improve it. "Next thing we knew we were rebuilding it, and that's the Synclavier II."

Naming that instrument "II" has proved a troublesome decision, Alonso comments. "Now everyone wants to know where the Synclavier III is." But NED is up to the ninth release of the software, "and we've had multiple editions of some of the releases. So the III really came out a long time ago."

A prototype of a new Synclavier was shown at the summer seminar. It's not clear whether it will be called

Synclavier III, but it does sport several hardware changes. Alonso took a few minutes to explain to *Mix* some of the features of the new machine, and in the process he discussed his company's plans as well as his own views of the future of music in the digital realm.

Alonso: We're going to a velocity and pressure keyboard, using the Prophet T-8 keyboard. Everybody says they love the feel of it. For a person who's about to introduce a keyboard product that's supposed to be an improvement on what they have already, one of the most hair-raising decisions is which keyboard feels good. The news of the T-8's feel was so good that rather than try to invent one ourselves, we opted to intrument that one. We buy the raw thing from [SCI], put some electronics in that adapt it to our purposes...

Mix: That takes the keyboard beyond the realm of an array of switches and puts it into something else entirely. How much more memory do you need? What are the benefits and the costs?

Alonso: It's a 76-note keyboard, and [Synclavier II] is 61. So the box is bigger just by virtue of more keys. Also, the keys

are deeper; it's a double-acting mechanism, 16 inches deep or so. With a bigger cabinet volume and a bigger panel, we have room for some more buttons and an expanded display. So it's almost irresistible to put those in, because of one of our problems before was that the number of buttons was fixed but the number of things we wanted to do with them was always increasing. We had to go to weird modes, like blink mode or double-depress mode. Some of the original clarity of having lighted buttons is lost if their operation gets too complicated; this can only be solved by having more buttons.

We've thought of getting rid of the concept of buttons altogether and going to something like a CRT, but those buttons do something that can't be done any other way. When you swipe across a whole bunch of buttons—meaning you want to do a whole bunch of things at once—it picks up on that very efficiently. If you had to describe that, even into a voice response system, you'd be there all day saying, "Increase this, decrease that..." So for some purposes the buttons are pretty nice; for other purposes—editing a recording, for example, moving a block of data from here to there—the buttons might start to be more cumbersome than doing it with the tube. But for some things it's pretty nice, so we added 32 more buttons, bringing the total up to 150.

We expanded the alphanumeric display so we don't have to encrypt the messages just to fit into the four-character format. We now have 32 full 7x5 characters, easily read. We can put a certain amount of the English language in that window, and it doesn't have to be super abbreviated. We can start giving the timbres names, without a computer terminal.

Mix: Can you make it more self-documenting now?

Alonso: It's possible that it can communicate a lot of information. We're probably a little remiss in not going into greater and more painstaking detail about the differences between this kind of synthesis and analog synthesis. But judged on its own merits, for even an experienced user to get messages like "Err4" is really not a very hip way to tell you something—"Wrong Disk" would be better.

Each key now has two parameters connected to it. It has ten bits of velocity information, eight bits of pressure information, and it also has a little thing that tells us the time of day at which the key was pressed. That sounds a little funny, but we're going to put that to really good use.

The load on the computer in the musical instrument environment is in bursts. Most of the time it's not doing anything,

—PAGE 206

SONY
THE LEADER IN
DIGITAL AUDIO



**AUDIO
INTERVISUAL
DESIGN**
LOS ANGELES

**IF YOU TAKE THE TIME
TO COMPARE DIGITAL
MULTITRACK RECORDERS...
...SONY IS THE ONLY CHOICE!**

- Village Recorders did—
... and *bought two*.
- Neil Young Studios did—
... and *bought two*.
- Seven other studios did—
... and *bought twelve*.

• *Quality* • *Reliability* • *Local Service*

Contact Jim Pace • (213) 653-0240
FOR INFORMATION

Circle #026 on Reader Service Card

Just The Right Mix

601R[™]/701R[™]/R6M[™] RACK MOUNT MIXERS

Peavey introduces the R Series, a professional line of Rack Mount Mixers capable of providing the musician and sound technician with performance levels that most console-type mixers costing twice the price cannot achieve.

No longer does the industry standard of 19" dictate what you get in terms of features and price. The 601R, 701R and R6M offer

versatility and choice... whether it be monaural or stereo configuration, 3 or 4 band equalization, balanced inputs, RIAA capability, upfront mixing, monitor mixing, specialized mixing such as keyboards, drums, etc. and even four track recording.

For the complete run down, write for our new Monitor magazine or contact your nearest authorized Peavey Dealer.

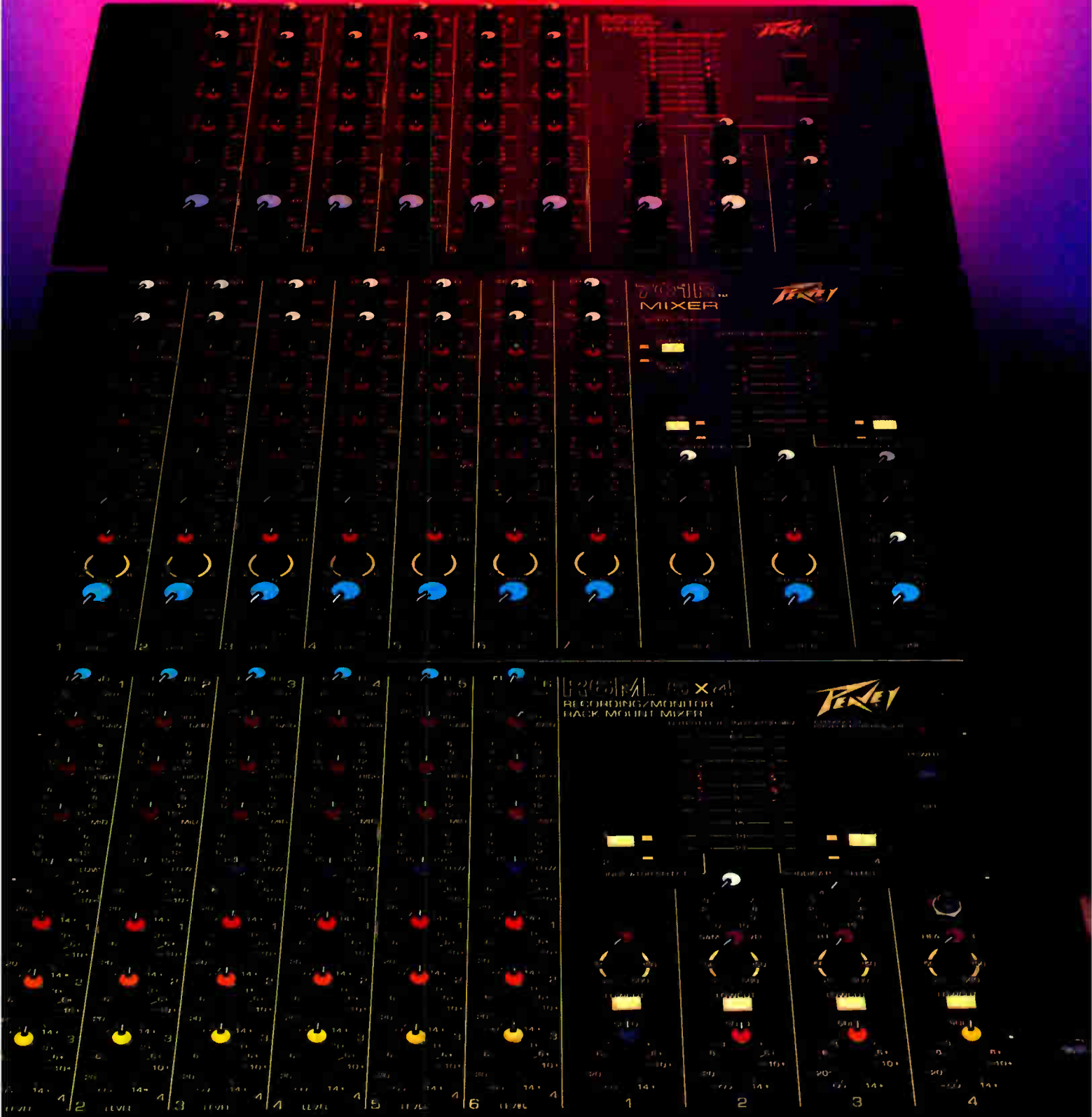

The Lucasfilm ASP

Digital audio comes of age.

by Larry Oppenheimer

In the early days of electrical recording, much of the pioneering work was done in the motion picture industry. Time passed, music recording blossomed into a major industry of its own, recording machinery and techniques progressed, and the art and science of recording matured into their current close-miked, multitracked, flanged, reverberated, SMPTE-synchronized state of affairs. Meanwhile, film sound languished by comparison, continuing to use processes which began increasingly to appear cumbersome and even antiquated. Today, through the vision (and money) of maverick filmmaker George Lucas, and the efforts of a small but very select team of engineers, film sound is once again surging into the technological lead in the form of a machine called the Lucasfilm Audio Signal Processor, more commonly known as the ASP.

The ASP is an extraordinarily fast and powerful digital signal processing system, configured specifically for the needs of audio in general, and film production in particular. It is the brainchild of the Digital Audio group at Lucasfilm, one of three groups formed in late 1979 by Lucas to avail film production of the technologies available in the late 20th century. (The other groups were: Computer Graphics—the largest group, and Video Editing. A Computer Games group, representing an interest of Lucas' outside of film, was added later.)

"The character of the group is to revolutionize, wherever possible, all aspects of film sound production," states director of digital audio research James A. (Andy) Moorer. It would be exceedingly difficult to find a better qualified candidate for such a challenge than Andy Moorer.

Moorer was recruited by Ed Catmull (now a Lucasfilm vice-president heading up the computer research and development arm of the company) from Stanford's center for computer research in music and acoustics (which Moorer co-founded; see *Mix* June '84), to which he had recently returned after a two year residence at France's IRCAM. During this time at those institutions, Moorer worked closely on the implementation of several digital synthesis/processing machines; including the systems concepts digital synthesizer (the Samson Box) and his own Polycephalous processor at Stanford, plus the 4B and 4C digital synthesizers at IRCAM. Additionally, he has published numerous landmark papers on a

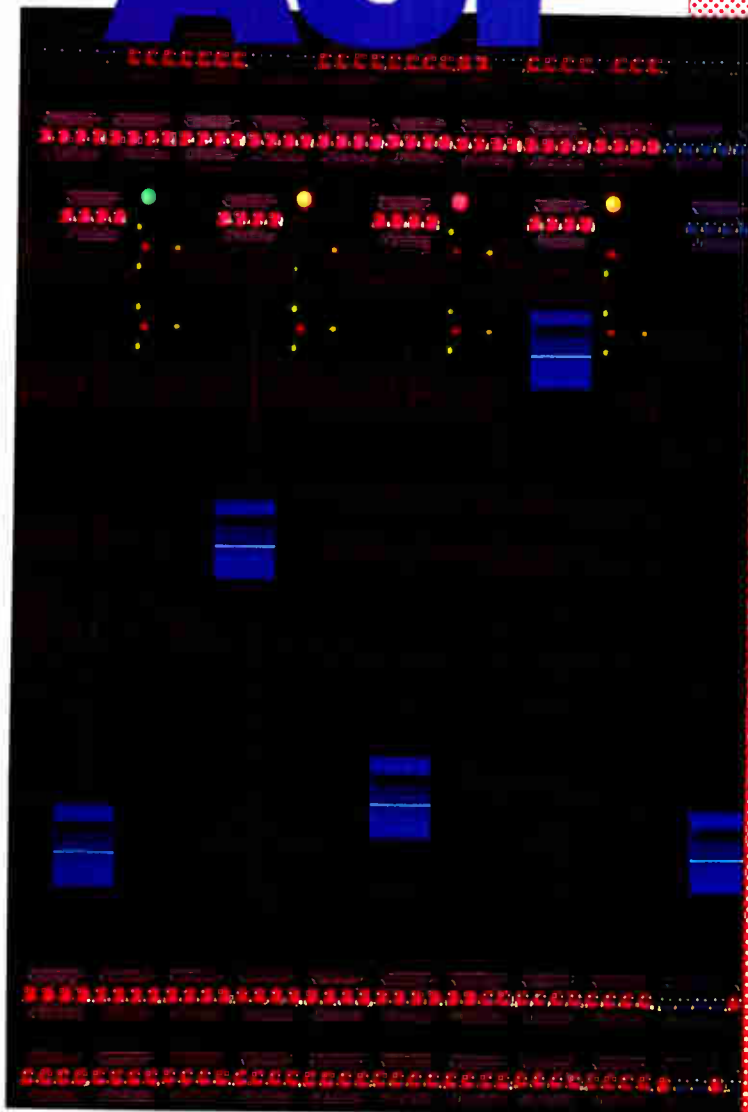

Above: Detail of the Lucasfilm digital console's slider module with programmable alphanumeric displays (no tape name tags here!) and user-assignable colored LEDs and pushbuttons. At left: Andy Moorer, Lucasfilm's Director of Digital Audio Research.

variety of research topics; including computer analysis/resynthesis of musical instrument tones, digital reverberation, and digital signal processing for computer music.

Moorer quickly formed his crew, enlisting John Snell, Curtis Abbott, and Jim Lawson, all top names in the computer music field. Lawson has since moved into Lucasfilm's systems software group and Alan Mari added to Moorer's group, but the only other personnel changes have been the recent additions of Peter Nye and Mike Holly.

Long before Moorer and his team created the ASP, it had become obvious to them individually that the high computational and input/output demands of digital audio far outstripped the abilities of general-purpose computers, and that a special-purpose machine was needed, with a very high speed computational "engine," and extensive interfacing to

Digital Services

48 Track Digital Recording—Nationwide
Rentals • Consulting • Engineering

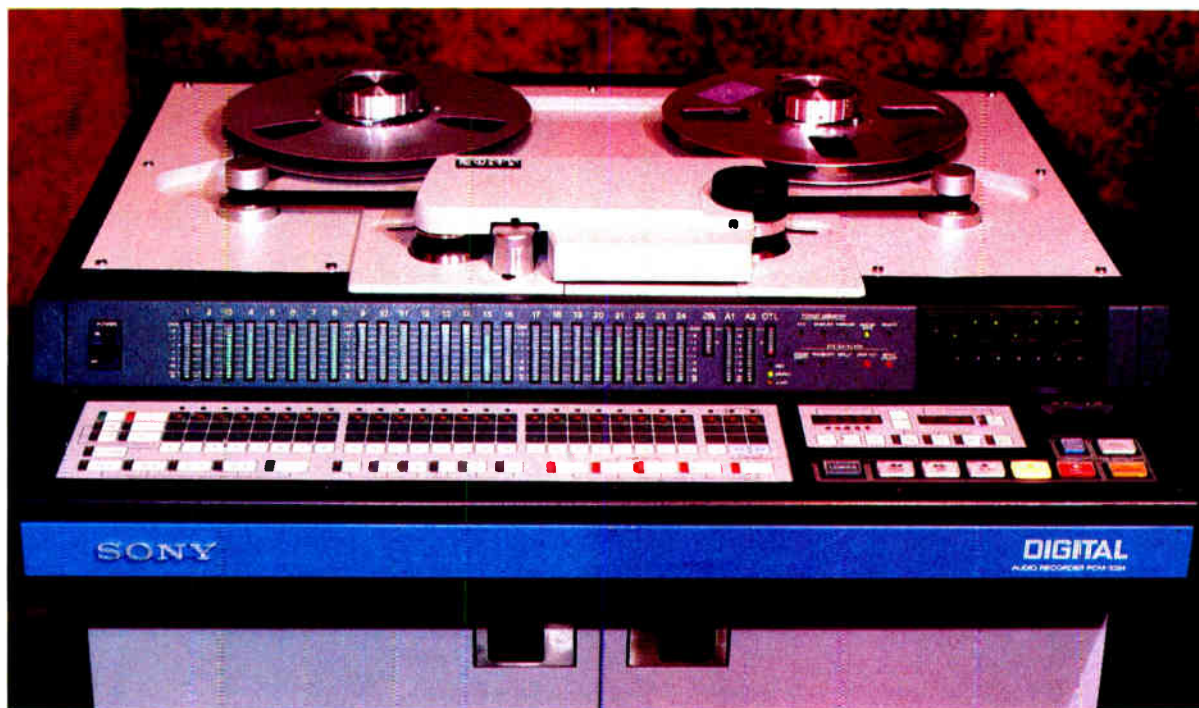

The Digitals: 4 Sony PCM 3324 Digital Multitracks • Complete PCM 1610/DAE 1100 Electronic Editing System • RTW/F1 Portable Digital Recorders and Format Transferring

The Facilities: Any studio, remote, or post production facility your project may use. Our Remote Truck and Studios offer complete Digital or Analog multitrack production with automated mixing and SMPTE interlock.

The Experience: First Sony multitrack owner/operator • First Digital Audio to Film Optical Transfer for Movie Sound • Our clients include Neil Young, Frank Zappa, Neil Diamond, Barbra Streisand, CBS Masterworks, Telarc Records, Talking Heads, Texas Chamber Orchestra, plus many others.

John Moran	(713) 520-0201	Houston, TX
David Hewitt	(914) 425-8569	New York, NY
Elliot Mazer	(415) 644-4321	San Francisco, CA
Mark Wolfson	(818) 506-5467	Los Angeles, CA

Digital Services

2001 Kirby Dr., Suite 1001, Houston, TX 77019 Telex 790202

Circle #028 on Reader Service Card

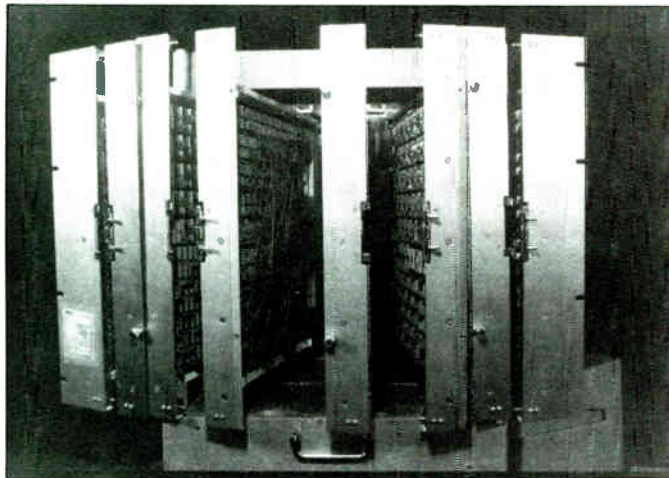

(Left) One digital signal processor (out of eight possible) in the Audio Signal Processor (ASP), pulled out of rack and opened to expose circuits and wiring; (right) Lucasfilm's prototype digital mixing console.

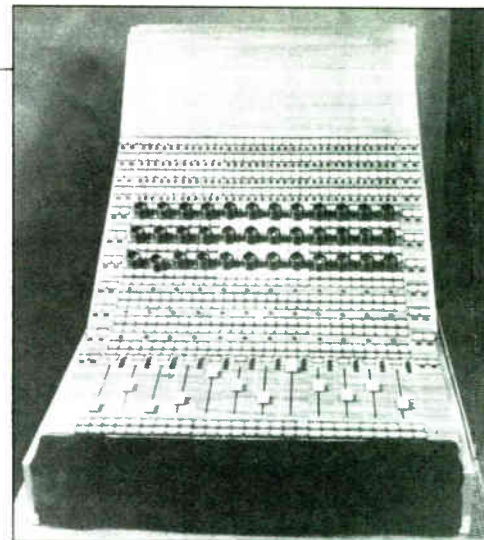

the user. Thus, many of the concepts embodied in the ASP had been formulated well in advance of the project itself. It is nonetheless remarkable that Moorer took only a year to design the prototype (with some hardware design by Snell); that's a fast piece of work for a machine of such complexity. Achieving large amounts of work in small amounts of time through very intensive effort seems to be Moorer's style.

At the same time that Moorer was cranking out the hardware design, Curtis Abbott was writing software for the system. This parallel effort enabled the team to build and debug the prototype in less than a year, and the ASP went on-line in April of 1982.

The ASP is exceptional in many respects, both technically and operationally, but from a functional standpoint the first striking impression is simply how many things it can do. Dr. Moorer elaborates: "The ASP is capable of storage and retrieval [recording and playback], including random-access playback; that is, assembling large quantities of very short sounds into any desired order and changing that order very, very easily. It is capable of mixing and all the processing that mixing desks do, including equalization, compression/limiting, and summing, plus a lot of the outboard processing that is used, such as reverberation, pitch shifting, spatialization, flanging and phasing. It is also capable of sound synthesis. Sound designer Ben Burtt has likened the ASP to a blank 19-inch rack: when you want a filter, you go to the equipment room, check out a filter, and mount it in a rack. On the ASP, this means calling a program, that is, a piece of microcode, and loading it into the instruction memory. You can keep loading programs like that until you fill up the memory."

This chameleon-like performance arises from the generality of the ASP's design. "The machine is a blank slate," says Moorer, and indeed many ASP programs are "made-to-order" when Ben Burtt calls with a specific need.

GE 27 STATE VARIABLE THIRD OCTAVE EQUALIZER

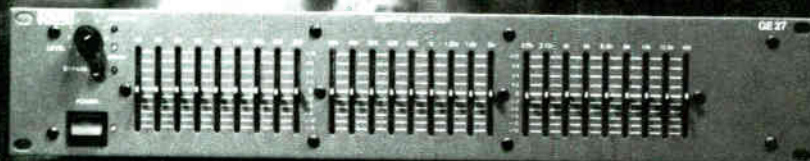

THE NEW STANDARD IN GRAPHICS

The GE 27 State Variable filters maintain a constant $\frac{1}{3}$ octave bandwidth at all slider positions, unlike all other graphic designs which suffer increasing bandwidth with decreasing amounts of boost or cut. The consistent precision of the GE 27 allows significantly greater feedback control without adverse effect on overall sound quality. And it yields a much higher degree of system accuracy in less time, due to reduced adjacent filter overlap at moderate amounts of boost/cut...a difference you can hear and appreciate.

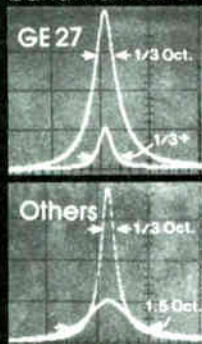

The GE 27 State Variable design has indeed revolutionized the $\frac{1}{3}$ octave format, creating a new standard against which all other graphic equalizers will be compared, regardless of cost. And yet the GE 27 is only \$449 suggested list price.

Which proves that smart technology doesn't have to be expensive.

RANE
CORPORATION

6510 D 216th SW
Mountlake Terrace
WA 98043 (206) 774-7309

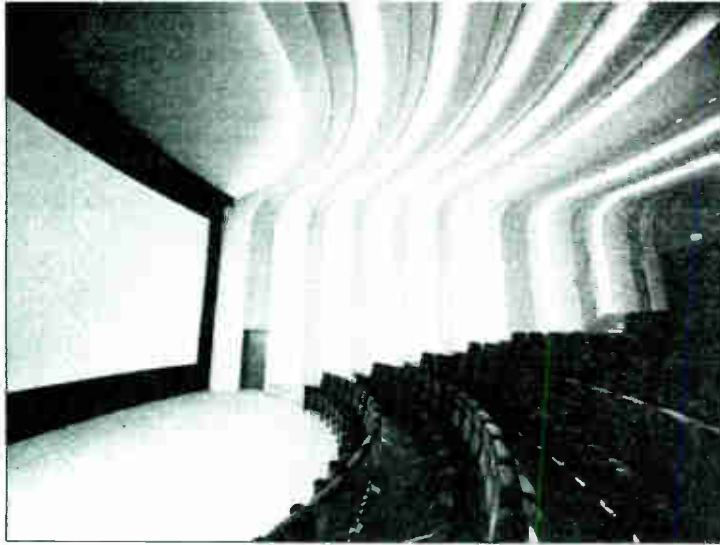

The Jeff Cooper-designed Lucasfilm dubbing theater. Foley pits are concealed under the carpeting in front of the screen.

What makes this machine more than a glorified combination of a Synclavier and a 224X is its ability to perform several of these functions simultaneously. This is well illustrated in one demonstration of the ASP which consists of a Bach piece played from 88 piano tones stored in memory and sequenced in the proper order. In addition to the sequencing, which is complicated by overlapping notes, the ASP is also acting as a six-band equalizer, a six channel mixer, and a stereo reverberator. All of this uses only a fraction of the processing power

in a full-blown ASP system.

Now, as any Hollywood mad scientist can tell you, once you've built the monster, the question then becomes, "How does one control the beast?" For the Lucasfilm group, as with the rest of the computer field, this has proved to be a considerable challenge of an evolutionary nature. "We have a lot of experience with number-crunching, and not as much with console-handling," says Moorer. Thus, console computer design is the least resolved aspect of the ASP system.

Currently, the ASP is controlled through the use of two kinds of console computers. One is a standard computer terminal setup, typically running an interactive program based on high-powered graphics. Alan Marr's Cue Sheet Editor is a good example: the screen displays a representation of the familiar sound editor's cue sheet (showing the occurrence of sound events in time). Individual sounds or groups of sounds can be manipulated in time with simple commands, and the results are displayed on the screen, and available for auditioning immediately. When used in conjunction with a video editor, this system allows free exploration without tedious and potentially dangerous copying and splicing of source material on tape or film.

The second console computer is "soft" console—a collection of sliders, buttons, switches, and rotary pots (all familiar tactile controllers) which are completely assignable in function, and have displays to indicate the current function. Peter Nye is currently working on a new console which will allow an operator to merely touch the appropriate part of a screen display showing functions, and then touch the desired controller (slider, button, etc.), instantaneously.

SOUNDWORKS™

Digital Audio/Video Studios, Ltd.

WHERE THE FUTURE OF CREATIVE TECHNOLOGY BEGINS.

254 West 54th Street, New York City 10019 For information, contact Charles Benanty at 212-247-3691

Circle #030 on Reader Service Card



MUSIC SOFTWARE

SOUNDWARE®

FOR MIDI

MIDI/4 – The First \$99 Digital Recording Studio for all MIDI Synthesizers.

MIDI/4 is the only MIDI music software on disk that lets you custom design your own recording studio. Now you can interface all MIDI synthesizers and any drum machine to today's most popular personal computers. Multi-track recording with unlimited overdubs, real-time editing, transposition, external sync, and tempo control has never been so easy and affordable.

MIDI/4's incredible speed and ease of use will make you much more productive in a lot less time. In fact, MIDI/4 is so easy to use you'll probably have it mastered before you leave the store!

Four independent MIDI channels and a variable drum clock let you record and playback on four or more different MIDI synthesizers all in perfect sync with your drum machine. Each channel has the capacity to digitally record and merge as many MIDI tracks as you wish giving you an unlimited number of overdubs with no loss in fidelity (up to 5500 notes). MIDI/4 captures every nuance of your performance including key velocity, pitch bend, aftertouch, modulation, foot pedals, breath controls, and more.

Visit your local dealer to see why MIDI/4 is the best selling music software for MIDI. Unbelievable power, simplicity and flexibility made available to you by Passport at an unbeatable price.....\$99

POLYWRITER – Polyphonic music printing software for MIDI.

Polywriter is a musician's dream come true. Software so sophisticated and powerful that you have to see it to believe it. Polywriter translates your musical performances into standard music notation and prints out perfect hardcopy. Combining full polyphonic notation with accurate, autocorrected transcription, Polywriter lets you print out anything that you can play.

Polywriter lets anyone who can play music, write music. Whether you're writing simple lead sheets, piano concertos, choral scores, jingles, vocals, individual instruments, or full orchestral scores, Polywriter can save you tremendous time and effort. Polywriter includes a full screen editor which lets you add notes and correct errors. Correct beaming, split stemming, and ties are all handled automatically. You can save every piece you ever write on disk for instant recall. Transpose to any key any time at will.

Polywriter is the most advanced music printing and editing software ever offered for less than your life's savings. Polywriter is an unbelievable bargain for \$299. The only system comparable to Polywriter is Synclavier's Music Printing Option* which costs more than ten times as much! Plus Polywriter will transcribe directly from any MIDI instrument in real-time with auto-correction, full screen editing, and final hardcopy of exceptional quality.....\$299

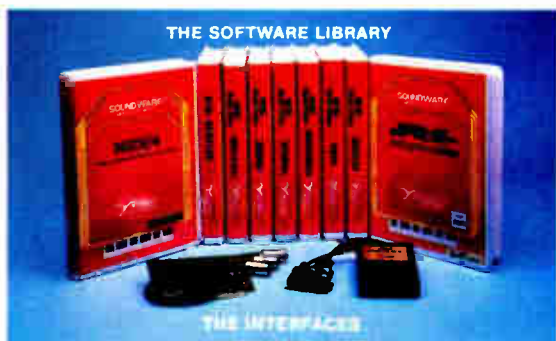

The Passport MIDI Interface and SOUNDWARE® Music Software for MIDI are available at better music stores everywhere and are distributed in the U.S. by Kaman, Coast Wholesale, and C. Bruno and Sons.

For more information see your local Passport dealer or contact us for the one nearest you.



PASSPORT
"The Music Software Source"

625 Miramontes Street • Half Moon Bay, CA 94019 U.S.A. (415) 726-0280
FAX: (415) 726-2254

THE INTERFACES

The Passport MIDI Interface for Apple II and Commodore 64 computers gives any MIDI keyboard access to the SOUNDWARE® Library. Each interface gives you MIDI IN, MIDI OUT, and Drum Sync connections. The Passport MIDI Interface is becoming the industry standard. In fact, it has been selected by Yamaha for use with the DX Synthesizers.

The Passport MIDI Interface is supported by more music software than any other. With our MIDI GUIDE containing complete interfacing specifications, you can even write your own software. All this at a very reasonable price \$195

SOUNDWARE® MUSIC SOFTWARE LIBRARY

The SOUNDWARE® Music Software Library is the fastest growing collection of software for MIDI. It's the first Music Software line to include Education, Performance, Recording, Music Printing and Storage. SOUNDWARE® is modular, inexpensive and so hot, that major synthesizer manufacturers are licensing it. Each SOUNDWARE® program comes on 5 1/4" floppy diskettes with easy to read users manuals, all packaged in sturdy binders for maximum software protection.

Polywriter, MIDI/4, MIDI Interface, Soundware, and Passport are all trademarks of Passport Designs, Inc.

Apple is a registered trademark of Apple Computer, Inc.

Commodore 64 is a registered trademark of Commodore Business Machines.

Synclavier Music Printing Option is a trademark of New England Digital.

neously linking the two.

The ASP is designed to interface up to eight console computers, so that numerous types of control schemes can be tried. Further flexibility is added through the use of the ASPnet, a private Ethernet (a type of high-speed digital interface) through which the console computers communicate. A console computer can use any type of hardware and/or software approach, as long as the ASPnet protocol is agreed upon. This means that the designers can have the freedom to create in any style that they please and still maintain compatibility with the rest of the system. It also means that creating a new console "front-end" need not entail a knowledge of the nitty-gritty in ASP software, only the hundred or so ASPnet commands.

In contrast to the open-ended approach of the console computers is the design of the ASP itself, which is considered final enough that Moorer is currently reimplementing it into a version suitable for production and marketing. As

mentioned above, the science of building number-crunching machines is relatively mature, which means less that solutions have been well defined than that the problems have been well defined. The design of the ASP displays some interesting solutions.

As shown in Figure 1, the ASP system consists of three basic parts: the ASP itself, the console computers, and the master computer which mediates activity throughout the system.

The ASP itself contains the 16-bit A/D and D/A converters, up to eight digital signal processing units (DSP) which do the actual data processing, and a high-speed controller which acts like a switchboard for the DSPs. Each DSP is capable of processing up to eight channels of audio at a 48 kHz sampling rate, for a total of 64 channels in a fully loaded ASP. The Bach demo described above could be run on a single DSP.

There are several problems to be dealt with in the design of this type of machine, but speed and mass storage, in

that order, are probably the primary ones. For mass storage the ASP currently uses standard 300 Mbyte removable pack disk drives. These have the advantage of being relatively inexpensive, and easily available, but with eight channels of 48 kHz audio on them, they can only hold ten minutes or so of sound. Investigation into Winchester disks for short term storage and optical disks for archival purposes is currently in progress.

The problem of speed is in many ways more crucial to a machine such as this. Consider the tasks that the machine must perform simultaneously: A/D and D/A conversion, storage and retrieval of information (often sounds only milliseconds long) to and from disks, receiving input from users through the console computers (and making the indicated parameter changes), plus all the processing that is the machine's *raison d'être*. The question of speed is addressed in the ASP by using a number of methods to optimize performance at every level. The architecture is based on a combina-

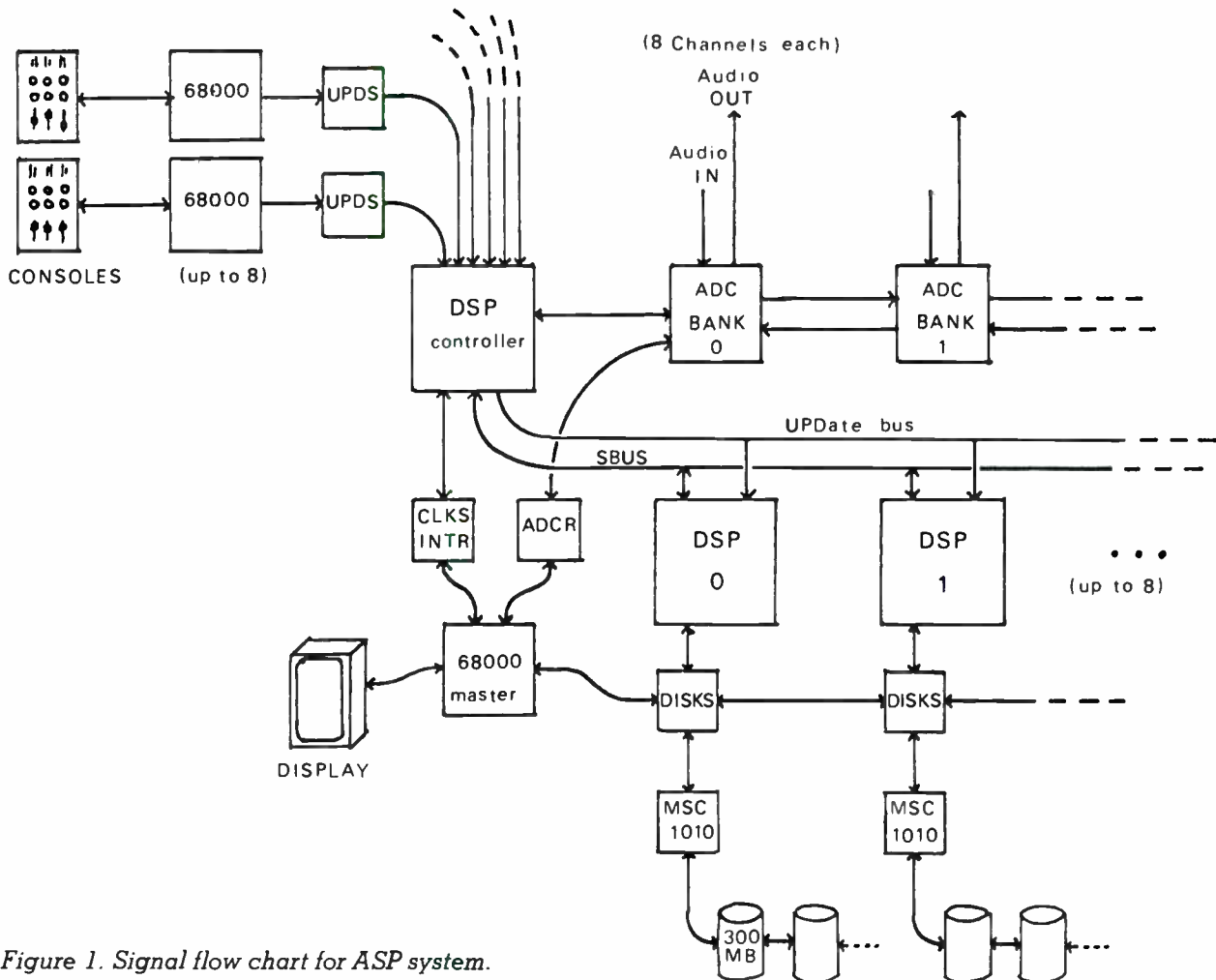

Figure 1. Signal flow chart for ASP system.

tion of brute force and clever twists.

Moorer started with raw speed. The ASP master clock runs at 160 MHz (a typical 8-bit microprocessor such as in a personal computer will rarely run faster than 2.6 MHz), enabling it to perform some 20 million instructions per second. The console computers are based on Motorola 68000 microprocessors which run at a fraction of that rate. This means that the ASP can do a great deal of processing on a sample, output a sample to the D/A converters, and make parameter changes as indicated by the console computers, finishing all of that work so fast that the 68000s perceive the updates as instantaneous. Further, the ASP is a "lock-step" machine, with no program branching (subroutine calls) to slow things down. Decision-making is done through instructions which are executed or not according to the results of conditional tests.

Potential bottlenecks which may be caused by I/O operations have also been addressed. For eight channels of 48 kHz audio a steady disk transfer rate approaching 800 kbytes/second is required. This can be difficult to achieve when it is considered that film work often calls for sounds a quarter of a second or less in length which are made up of sequenced small portions (perhaps only tens of milliseconds long) of several different sounds. Accessing these small pieces of sounds, which may be stored in random places on a disk, can require a great deal of time-consuming head movement if done in the order the segments are needed. The solution on the ASP is to provide each DSP with a board containing up to 6 Mbytes of solid-state memory (the current system at Lucasfilm uses only 3 Mbytes), which is used largely as a giant disk buffer, in addition to storing oscillator wavetables and a few other functions. The segments are read from the disk in the order they are encountered and transferred to the DSP memory, from which they are read in the desired sequence. This allows the disks to operate continuously "with the throttle wide open," yielding a sustained transfer rate of nearly 1 Mbyte/second. Disk-based random-access storage also allows playback and editing of any given segment without shuttling, and reuse of a segment without degradation from copying or repeated playing.

Similarly, there are buffers between the ASP and the converters, so that each can operate at its own pace.

The computational engine which is the heart of ASP is the DSP multiply/accumulate unit. Several ideas have been employed in making this unit very fast and accurate. One is the use of dual data buses, which means that the multiplier and multiplicand can be fetch-

ed simultaneously instead of sequential fetching and latching. Each databus is 24 bits wide, and the accumulator develops a full 48-bit product. This is crucial in developing the accuracy necessary to implement high-order filters, often required in sophisticated applications like linear predictive synthesis (also known as linear predictive coding, or LPC).

The multiply unit is also pipelined, a common design strategy in which processing of adjacent samples is interleaved. The multiplication is broken down into several steps, with the current sample's second step coinciding with the following sample's first step. The DSP's thoughtful design allows it to perform some 18 million integer multiply/adds per second.

It may seem to the reader that this writer is throwing out large numbers to make an impression. To some extent this is, in fact, the case. A little research into typical numbers for a computer system will show that these figures are indeed quite impressive.

The design of the console computers gives them a much larger role than simple controllers, so that they might spare the ASP some effort in "overload." Besides communicating over a high-speed data link, the console computers use direct memory access to pass data to the ASP, using memory locations as "mailboxes." Update commands are placed by the consoles into a queue, which the ASP (with its blinding speed) empties and executes between completion of processing on one sample and beginning the next. The commands can be placed anywhere in the queue and be made conditional. Similarly to the aforementioned buffering systems, these aspects of the consoles are designed to allow the parts of the system to operate at their own speeds, without slowing the other parts (mainly the DSP).

The structure of the software also uses a division of labor. The burden of administration within the machine is handled by Curtis Abbott's multifaceted FMX (for Film MiX), a rather lengthy program which runs on the control computer and is written in "C" (as is all the ASP software except the actual processing microcode). The DSP runs microcode which is written in a mid-level assembly language, and this is where the actual processing functions occur. The console computers contain all the "front-end" software, which includes automation functions, receiving and processing of user input, and Cue Sheet software which allows the user to construct sequences of changes and commands into a sort of program. Currently, FMX is by far the longest program, but as the console software grows in sophistication, it also grows in length. The ASP system,

then, is an integrated whole made up of components optimized to do specific and separate functions, but with the ability to communicate easily with the other parts. It appears that the ASP is the first realization of the true digital studio.

Lucasfilm has not yet produced a complete film soundtrack using only the ASP, and it is difficult to say when that will happen. Most recently, the ASP was used to achieve a number of different effects for *Indiana Jones and the Temple of Doom*, ranging from simple digital "tape loops" to complex speech processing. "The ASP was used as a regular tool in the daily operation," explains Moorer, "exclusively for special effects and ambient sounds." Ambient sounds in films (motors, crowd noise, traffic sounds, etc.) are often created by splicing a short tape section of the sound into a loop. The ASP team wrote a program which allows Ben Burtt to enter a sound and determine start, end, and crossfade time for the loop. "It allowed him to set up these 'tape loops' just as fast as he could feed the sound in. Consequently, most of the background sounds in that film were processed using the ASP."

The ASP was also used to provide the necessary overdramatics required in Lucas' films. "for this kind of 'black-hat/white-hat western' you don't want subtlety," notes Moorer, and so screams, arrows, and plane crashes are treated to produced sufficiently exaggerated sound effects.

Real arrows flying by are only heard as a quick whoosh. For "Indy II," 25 milliseconds of a real arrow fly-by were analyzed and resynthesized (using LPC, a particularly complex form of synthesis which Moorer has worked with extensively), then fed into the "tape-loop" program, followed by a Doppler-shift based "fly-by" program. Burtt was able to make arrow fly-bys of any length, and freely intermix real and synthesized fly-bys.

The same process was used to create the sound of the plane dive and crash which occurs early in the film. "The problem is that it's very hard to get the sound of an airplane doing a vertical dive, and shut off their engines. They don't like to do that." With daredevils (read "maniacs") few and far between, Moorer turned to the ASP. Starting with an old and decrepit optical track from a genuine Nazi film, he located twenty-five milliseconds of usable plane dive and crash, then performed the analysis, LPC, "tape loop", and "fly-by" processing. The rate of descent could then be altered to fit the picture, since "in the film they typically drag it out much, much longer than it actually takes a plane to crash."

One other interesting use of LPC was in manipulating screams.

THE NEW ADVANCED GENERATION OF The Tom Hidley Control Room Design

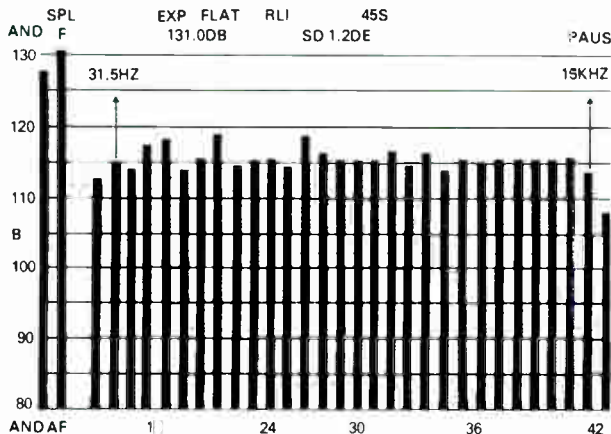

STEREO SUMMATION: 31.5 Hz-16KHz = +6 S
FREQUENCY RESPONSE: 31.5 Hz-16KHz = ±2d

C.B.S./SONY -
HONG KONG
C.R.I. - L & R
FEB. 1984
RELEASE

WITH NO MONITOR EQ

Finally, a natural C.R. sound with honesty and clarity never before attained
Natural and smooth reverberation times: Your choice .2 to .3 seconds

Advanced Control Room Design

- * No monitor EQ. required (± 2 D.B. 31.5 Hz to 16 KHz)
- * Reduced ear fatigue — reduced acoustical phase distortion
- * Controlled reverb times as required from .2 to .3 sec (20 Hz to 8 KHz)
- * 20 Hz Linear response (20 Hz to 16 KHz) with 20 Hz monitor

Advanced Studio Design

- * Variable acoustics with reverb times from .3 to 1 second (250 Hz = 8 KHz)

New Monitors

- * New 20 Hz monitoring avail ± 3 D.B. 20 Hz to 16 KHz (2-way system)
- * New 30 Hz Monitoring avail ± 2 D.B. 30 Hz to 16 KHz (2-way system)
- * New wood horn — no cellular effect as with the older Hidley horn.

WITH THE HIDLEY STUDIO DESIGN, YOU GET EXPERIENCE
- NOW OVER 300 ROOMS -

INTERNATIONAL REPRESENTATIVE:



Sierra Audio Acoustics LTD.

Kent Duncan, President ■ P.O. Box 7736 ■ Burbank, California 91510 ■ (818) 843-8200 ■ TELEX 662745 (K DUNCAN BUBK)

OUR UNITED STATES DEALERS ARE:

Audiotechniques
Ham Brosius, president
652 Glenbrook Road
Stamford, Connecticut 06906
Telephone (203) 359-2312
Telex 996519 (HAMB0B)

Studio Supply
Thomas Irby, president
1717 Elm Hill Pike, Suite B-9
Nashville, Tennessee 37210
Telephone (615) 366-1890

Audiotechniques
Gene Perry, general manager
1619 Broadway
New York, New York 10019
Telephone (212) 586-5989
Telex 996519 (HAMB0B)

Southwest Pro Audio
Dennis Lowe, vice president
3341 Towerwood Drive, Suite 206
Dallas, Texas 75234
Telephone (214) 243-4477

Audio Industries Corporation
Ike Benoun, president
1419 No. La Brea Avenue
Hollywood, California 90028
Telephone (213) 851-4111
Telex 677363 (AIC)

Southwest Pro Audio
Greg Klingensmith, president
1500 Summit Street
Austin, Texas 78741
Telephone (512) 443-4567

"There's a place (in the film) where the thuggy vassals—the bad guys who have been drugged horribly into blind submission—scream in the background. [Burt] wanted some way to distinguish the screams of one of these drugged, mindless people from those of just the regular torture victims. So I had some of the guys come in and told them to scream as loud as they could, and then applied Linear Prediction to make it more of a growling, hoarse, sandpapery sound. There's one scream in a very prominent place that makes everyone in the theatre jump out of their seats, so I guess it's successful." Moorer's humor tends to be on the dry side, and he seems

to find it amusing and in some odd way appropriate that all of this Big Science is brought to bear on making weird screams and drawn-out plane crashes.

The ASP is being used to change even the most basic suspense flick tricks. "There's this classic sound that's in every horror movie in the world when the hand comes from behind the door and grabs the girl's shoulder; typically high, suspended strings. Ben wanted something to generate that sound, so I set up a little synthesis program with string-like sounds, lots of vibrato, lots of reverb, lots of echo, so it sounded like the Mantovani 101 strings. Then I put that on the 'pot box' [soft con-

sole] so that he could control the pitch, vibrato depth, etc." It is interesting to note that the majority of this fancy-pants processing is intended to go virtually unnoticed as part of the background, with an almost subliminal effect. It is likely that the ASP would be used in quite a different way were it to fall into the hands of a rock-and-roll record producer.

In less than two years, we may get the chance to find out. As previously mentioned, Moorer is currently working on a production version of the ASP, which will hopefully see release in 12 to 18 months. As basic ASP station with editing capabilities is projected to cost somewhere between \$100,000 and \$200,000. This will give random-access editing and some simple processing for eight channels of audio, with the amount of time being limited only by the purchaser's ability to buy disk drives. The rest of the ASP's functions will be made available in chunks as the product develops in the market. Film, video, and television production houses are the expected market, although the ASP will undoubtedly find its way into some music production studios.

The ASP is not the first fruit of Lucas' dream to reach the public. A Computer-Aided Printed Circuit Design program called CADroid is on the market. It runs on 68000 based systems, and was written by Andy Moorer (surprise!) to simplify design of the ASP. The most recent NAB show in Las Vegas saw the introduction of the Video Editing group's project: EditDroid, a 68000 based video editor which uses Laser Discs in addition to video tape to provide very sophisticated and fast-access editing. The ASP is intended to work intimately with EditDroid, which will allow picture and sound editors to be friends. Several computer games were recently introduced in conjunction with Atari. And a number of graphics packages, both hardware and software, are also forthcoming.

In the last decade or so, computers have moved into the entertainment industry in a big way. The rate of technological development has been staggering; it seems that as soon as a machine is purchased, something better comes out. This is expressed by the computer industry adage, "Anything which you can buy is either experimental or obsolete." The design of the ASP is an attempt to accommodate this syndrome in a relatively stable framework. In fact, Andy Moorer feels confident enough to make this dangerous statement, "With the ASP, you never have to buy another piece of equipment. You may have to buy some programming talent, but you never have to change the wiring of the machine to get another function." We can only hope this comes true. ■

CMS Rentals makes digital affordable!

Now offering complete service:

- * Format conversion
- * The JVC DAS-900 processor/recorder
- * The Sony PCM 1610 processor/recorder
- * The ease of electronic editing
- * The ability to go direct to CD without further format conversion
- * 40% more dynamic range, 75% saving on tape costs

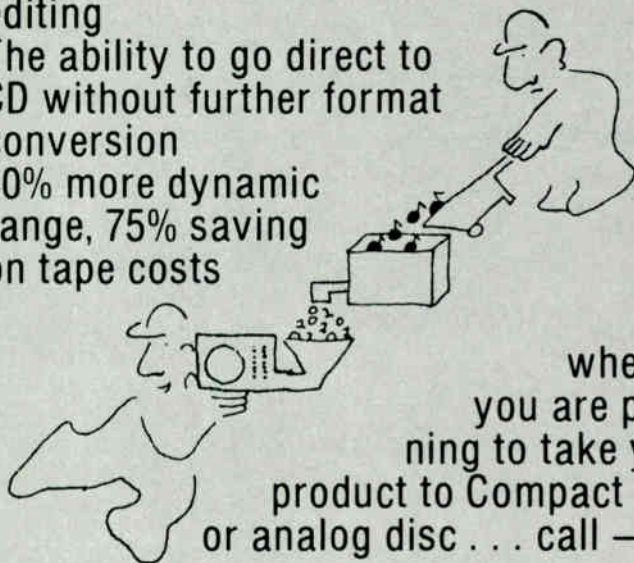

So, whether you are planning to take your product to Compact Disc or analog disc . . . call —

CMS DIGITAL RENTALS
(818) 797-3046

The company that Rents you the highest technology at a price that's not.

power TOBOR

computer jingle machine

Start time
0.03 sec

Spooling time
60 sec (cassettes C 60)

Frequency response
25 Hz/23 kHz
(± 3 db)
record + replay
(metal - 20 db)

S/N ratio
58.5 db A
(comp. off)
more than 80 db A
(comp. on)
reference 0 db (250 nW)

Wow and flutter
DIN 45507
less than ± 0.1%

Speed
4.75 cm



Programming
Jingles coding and
automated search
**Fast search and
automated cueing**
Random program play
Edit function

**TBR 01 module
(optional)**

- Cancellation
- Insertion
- By-Pass

**Real time features
TBX 310 (optional)**

Coding/decoding interface
module provides for the
control of motion and play
commands of three spare
recorders

**RS 232 interface
(optional)**

TOBOR offers RS 232
interfacing facility to be
driven by any computer either
directly or either remotely
via a phone modem

PWM
Audio Amplifiers

COMELTRIC
Electronic Crossovers

TRIPHONIC
Superbass Synthesizers



power
COMEL

Paris, France
Tel: 793.65.12
Telex: 630504 F

See us at
**Room 517,
New York
AES Convention**

power U.S.A.
ALAGATRONICS INC. N.Y.C.

11 Avenue of the Americas
New York, New York 10013
(212) 219-0988

by Ken Pohlmann

The Compact Disc is a now-familiar audio reproduction system, with almost 200,000 players in US households, reading musical data from some four million discs. The production of sonically superb discs has validated the 16 bit, 44.1 kHz standard and the technique in general. As with any new technology the inevitable learning curve must be experienced to properly educate those involved in the production of recordings destined for CD release to insure that the

an outer diameter of 120 millimeters, a center hole 15 millimeters across, a thickness of 1.2 millimeters, and a weight of 14 grams. Track pitch is 1.6 micrometers, reflection and substrate transmission is 70 to 90 percent, and scanning velocity is 1.2 to 1.4 meters per second. Its specifications call for a maximum eccentricity of track radius of 70 micrometers, and a maximum angular deviation (skew) of 0.6 degrees. Data is contained in a spiral necklace of pits running from the inside of the disc to the outside. Each pit is about 0.5 micrometers wide and its length and the length of the land separating each pit varies incrementally from 0.833 to 3.56 micrometers. It is that varying ratio of pit and land which encodes the data itself. A laser beam, output from a semiconductor device, strikes the underside of the disc. As it travels through the disc thickness, the 1.5 refractive index of the substrate causes the beam diameter to focus from its 0.8 millimeter width at the substrate surface to a focal spot of 1.7 micrometers at the reflective pit surface. This focusing causes any substrate imperfections such as scratches or fingerprints to appear to be out of focus; its shadow is a small fraction of its original size when it reaches the disc surface thus its effect is minimized. As the laser beam strikes pits and the reflective areas between, the varying intensity returning beam carries the information on the disk back to a photodiode reacer and then to an EFM demodulator where the original binary signal is restores for D/A conversion and output as an analog voltage.

The CD hardware thus comprises a fairly straightforward system. What is not so apparent is the data format contained on each disc. The spiral pit track contains a sophisticated ordering of data which carefully distinguishes between audio data and its parity, sync information, and the subcode. The figure illustrates the smallest complete piece of information contained on a Compact Disc. As you can see, the bit stream on the spiral track is divided into frames which are further divided into the various kinds of data. Each frame incorporates six sampling periods; each sampling period giving 32 bits (16 for each of the two audio channels) with a total of two 96 bit audio data blocks. These 32 bits are divided to make four symbols in the audio bit stream. To scatter possible errors, the symbols of the different frames are interleaved so that the audio signals in one frame originate from different frames. The modulation translates the eight data bits of a symbol into fourteen channel bits (hence eight-to-fourteen EFM modulation). Parity bits are added twice for each frame for a total of

COMPACT DISC VIDEO

The Compact Disc is more than a replacement for the vinyl LP record. It represents an entirely new technology of information dissemination.

vast majority of recordings achieve the maximum fidelity offered by the CD medium. When that learning curve flattens out the complaints will be gone and all CD's will sound as excellent as the medium's ideal. Now that artisans such as Tom Jung and Bob Ludwig, and audiophile companies such as Mobile Fidelity Sound Labs are actively involved in the preparation of CD recordings, it is clear that the challenge to master the new medium is being met. But technology moves faster than any of us can absorb. Just when you thought they had perfected the task of making high fidelity audio CD recordings, another artistic challenge is about to appear.

The CD holds a staggering amount of information; audio recording playback requires two channels of 16 bits at a rate of 44.1 kHz, or 1.4 million bits per second of audio data to be read off the disc, as well as parity, etc. A 60-minute disc would hold 500 million bits of audio data. But there is still a lot of storage space (320 million bits) for video information. Thus an ordinary CD with a standard 60-minute music program can also hold about 900 still video images, drawing from the disc at a rate of one every five seconds. Pictures? That's right. Get ready to add another album credit, that of session photographer. Exactly how will all this extra information be added to audio CD's? The answer lies buried in the subcode...

First let's consider the physical characteristics of a Compact Disc. It has

If It's Worth Doing, It's Worth Doing Right!

FLANNER'S PRO AUDIO, INC.

2323C Bluemound Road • Waukesha, Wisconsin 53186

(414) 785-9166 (Outside WI, call) 800-558-0880

For the past seven years Flanner's Pro Audio, Inc. has been quietly growing. In that relatively short period of time, we have been one of the major suppliers of professional audio equipment to Recording Studios, Video Production Houses, Radio and Television Broadcasters, major Corpor-

ations, and Universities. The reasons are simple: knowledgeable people, the right products, and affordable prices. Whether you need tape or small goods to complete design, installation and construction of your facility, we can do it for you. Give us a call. Let us prove we do it right!

NOW DIGITAL REVERB UNDER \$1,500.00

New
Lexicon
PCM-60



Lexicon's NEW PCM-60 Digital Reverb, a high-performance, low-cost digital reverb. Designed for high-quality reverberation, the PCM-60 incorporates the most advanced digital audio processing circuitry available for natural sounding reverberation. The PCM-60 features two main reverb pro-

grams: Room and Plate. Users tailor reverberation characteristics on the basis of size, reverb time, and bass and treble contouring, to produce a wide variety of reverb effects. Lexicon PCM-60's are now available at Flanner's Pro Audio, but promise to be a hard to get item!

☆ CALL NOW - QUANTITIES LIMITED ☆

MCI JH-24 SERIES

24 TRACKS AT AN AFFORDABLE PRICE!

Known for its reliability, performance, and reputation as the producer's and engineer's choice, the MCI JH-24 Series recorders are available at Flanner's Pro Audio. There have been more gold records cut on MCI tape equipment than any other. If you are searching for gold, let Flanner's show you the MCI machines that will make it easy.

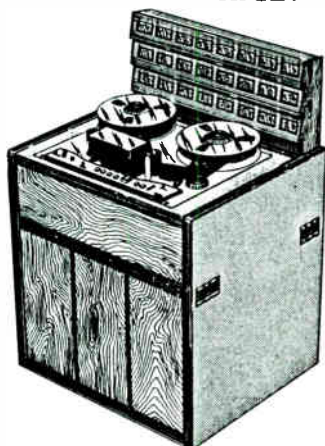

PRICES START AT \$17,000

JH-24-8

NEOTEK CORP

Production Console

Flanner's Pro Audio, Inc. has been representing NEOTEK consoles for over seven years. The newest product from NEOTEK is the production console, developed in response to specific demands of production engineers and broadcasters. The console can be fitted with a variety of input modules and configured from 4 to 8 outputs with multiple inputs. Call us. Let's put you into a NEOTEK today!

Prices Start
at \$9,100

12 x 4

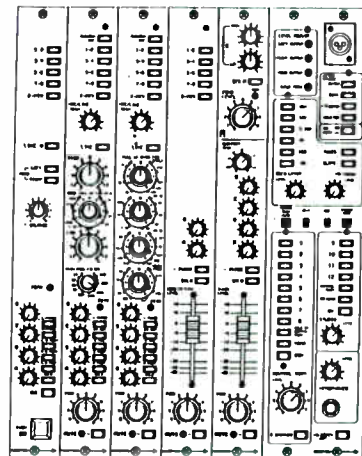

Circle #034 on Reader Service Card

64 bits. The frames are marked with a synchronization signal uniquely identifiable from any other possible data configuration (specifically the sync word is 10000000000100000000010). Thus most of the CD audio disc format is devoted to audio data, its parity, and sync for the frame.

However an 8 bit subcode of user bits remains in each frame; they are designated P, Q, R, S, T, U, V, and W, usually referred to as the PQ code. Presently only the P and Q bits are used in audio Compact Discs; this subcode information contains data detailing the total number of selections on the disc, their beginning and ending points, index points within selections, pre-emphasis on/off, and end point of the disc. The other six bits are presently unused and available for video information. Since the number of bits available in each frame is small, the entire number of subcode bits available over 98 frames are collected to form a subcode block, complete with its own 16 bit sync word, instruction and data, commands and parity. For video, the data may be collected over 20 to 30 thousand frames to form a video image. Given the velocity of the disc, a new image could be drawn from the disc every five seconds.

The possibilities are varied for such a CD format; using an I/O accessory port on the CD player (already present on some players) an adapter could connect the player to a television, and the images could be viewed as the music is reproduced. Still pictures relating directly or conceptually to the material could be displayed, as could lyrics or other alphanumeric information. Either video camera images or computer generated still images could be stored on the music disc. Smart producers are reportedly already enlisting the aid of photographers during recording sessions to visually document the recording; those pictures will later appear on future CD releases of the music.

What is required to actualize such an audio/video CD system? Only a few points need to be agreed upon. The format of the data storage in the subcode bits needs to be standardized, in other words, the many manufacturers with vested interest in the Compact Disc will have to agree on a common format. Once that occurs, existing CD mastering equipment will be able to encode that video information in the subcode. The U-matic track format could be adapted from a two audio track system (presently used for SMPTE and PQ code) to a three track

format (the third track for R-W code). The only additional hardware would be a RW editor, required to input the image from a camera, or keyboard. The actual transfer of data is facilitated because the EBU/AES standard digital I/O format has full capability to transfer CD subcode data. This format could be used to establish the CD player digital output format for video images. The accessory port on players could be used for this purpose, only an adapter would be required to provide modulation for the television. Thus video playback could be included in the CD audio reproduction system with relatively little difficulty.

Of course, hard on the heels of audio CD's with still images is the logical transition toward a marrying of CD audio and video disc systems. As you might expect, plans have already been laid for a CD ROM system, in which the Compact Disc is treated as a Read Only Memory system, useful for storage of any kind of information. If the storage area presently devoted to audio is given to other information, moving video could be encoded, as could libraries of still pictures, computer software, etc. A CD ROM disc would identify itself as differing from an audio CD and the modified player with digital outputs would handle the rest. A CD ROM disc could hold 550 M Bytes of digital information, which is equivalent of 500 to 1,000 floppy disks. According to Sony engineers, one CD ROM disc could hold 270,000 pages of alphanumerics, or 18,000 pieces of computer graphics, or 9,000 pieces of graphics and two channel sound, or 3,600 still pictures. In other words, the CD ROM would form the basis for a new publishing medium applicable to book publishing, dictionaries, encyclopedias, technical manuals, shopping catalogs, computer storage, video games, aircraft and automobile navigation systems, and so on. And don't forget that the CD format is compatible with cable television and satellite distribution formats. A totally unsubstantiated but highly believable rumor making the rounds is that one giant American computer company has contracted for one-and-a-half million CD players from a giant Japanese manufacturer for inclusion in its next generation of personal computers.

The Compact Disc is more than a replacement for the vinyl LP record. It represents an entirely new technology of information dissemination. For recording engineers, it represents another artistic challenge, the art of audio recording requires adaptation to the new medium both in terms of sonic consideration, and soon, visual considerations. Engineers, clean your ears! Photographers, clean your lenses!



The Link

PROPAK™1 provides a high performance, two way interface between the line level signals required by professional audio equipment and the unbalanced, low signal levels of consumer or semi-pro equipment.

PROPAK 2 also compensates for the inherent time delay between left and right channels of the EIAJ digital audio format (and certain CD players). Although this delay is corrected at the analog output of the processor (such as the Sony PCM F1), Coincident Time Correction (CTC™) in the Propak 2 will allow conversion to 1610 or CD formats without leaving the digital domain.

Both Propak models offer immaculate audio performance at an attractive price. Other features, including electronic or (optional) transformer balanced inputs/outputs with gain adjustment trimmers, and gold plated RCA sockets will make Propak the strong link in your audio chain.

AUDIO + DESIGN/CALREC, INC.
P.O. Box 786 • Bremerton, WA 98310 • Phone 206-275-5009, 206-275-5010
Telex 15-2426

AUDIO + DESIGN RECORDING, LTD.
Unit 3 Horseshoe Park • Pangbourne, Reading RG8 7JW, England
Phone (0734) 861088 • UK Telex 848722

Audio + Design

FOR THE DIGITAL ERA

©1984 by Audio + Design/Calrec, Inc

Family Portrait

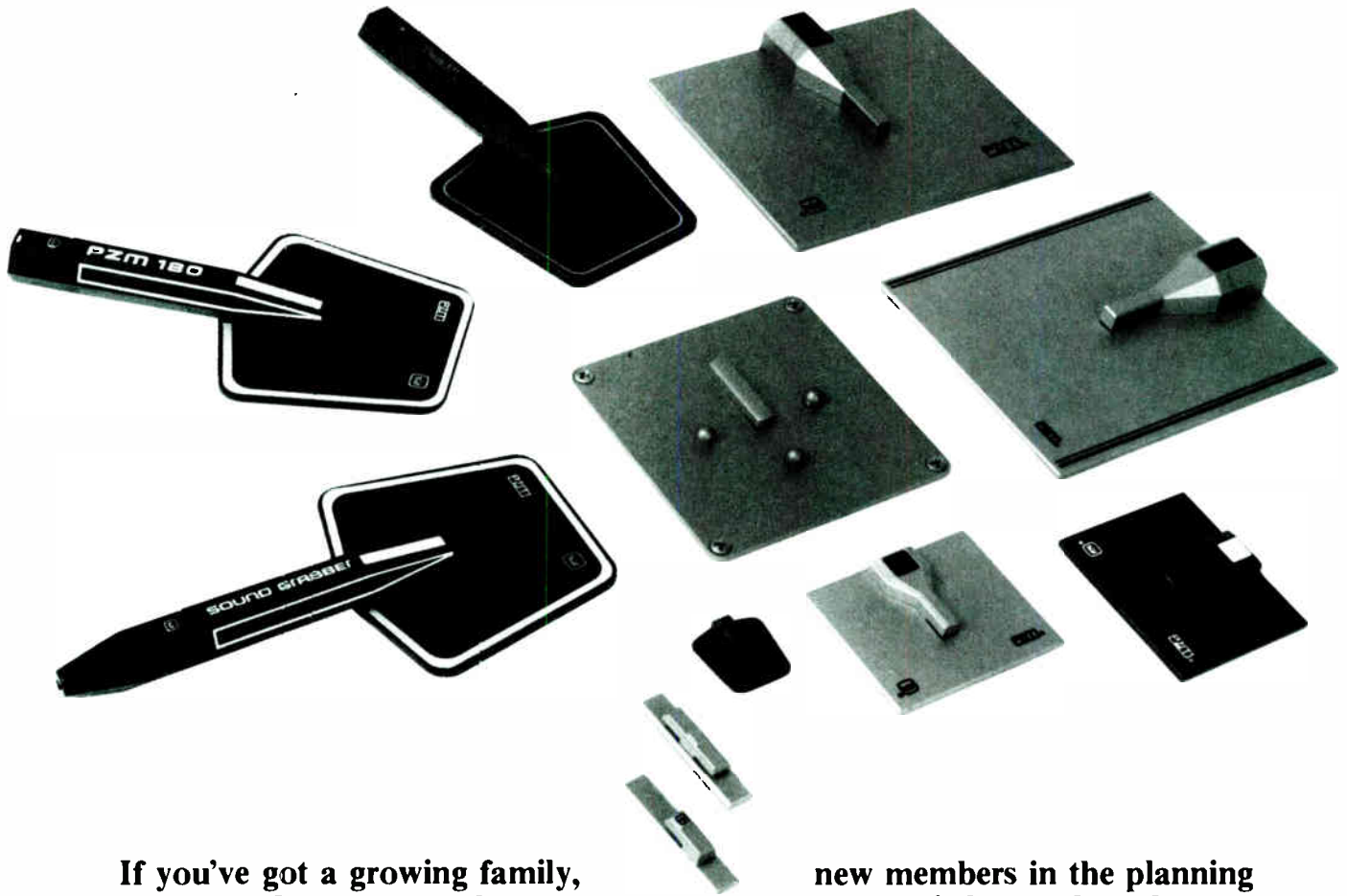

If you've got a growing family, sooner or later you need a picture with everybody in it. It's a statement of family pride, and we humbly admit that we are pretty proud of this group.

There was a time when most people didn't recognize a Crown PZM® as a microphone - even when they looked at one. Times have changed. Billboard Magazine reports in their most recent brand usage survey that 37.5% of U.S. recording studios use Crown PZMs.

This sort of demand, multiplied by many other applications, has made the family grow, with new microphones tailored for new users. In fact, the number of

new members in the planning process is larger than the number in the picture. Since a lot of our friends have only used one or two models so far, we thought we'd better introduce the family. The next time we may not be able to get them all in one picture.

Keep an eye on this family. Right now it's one of the newest and best. It just might get to be the biggest.

PZMs from Crown. Call or write for your family tree.



CROWN®

1718 W. Mishawaka Rd.
Elkhart, IN 46517
(219) 294-5571

DIGITAL DISCUSSIONS

THE SONY K-1105 8-CHANNEL MIXING SYSTEM

by Curtis Chan
Senior Engineering Manager/Digital
Audio, Sony Professional Audio
Division

By now, digital audio technology has achieved widespread acceptance of the K-1105 eight channel digital mixing system, Sony has significantly expanded the application of digital techniques in audio production. The new console is designed to mix 16-bit linear quantized digital signals in a fashion identical to conventional analog consoles. Utilizing the familiar slide-type fader controls and LED meter displays, the console provides comprehensive digital mixing and equalization capabilities.

There are a number of applications where a digital console offers immediate advantages. In Compact Disc mastering, the artist and producer can have true digital equalization and bypass all analog stages. For location broadcasting and recording, an eight channel mixer is often perfectly adequate, as in classical music settings. In motion picture soundtrack applications, eight channels can

handle all of the standard release formats. In conjunction with the Sony PCM-3324 digital multitrack, the K-1105 can be used for pre-mixing and combining of tracks, or it can be cascaded with additional mixers to form a 24 channel digital mixing configuration.

The first Sony digital mixer was purchased by CBS/Sony Studios in Tokyo. The results were so favorable that two more were immediately installed. The equalization is purely digital, therefore a completely mathematical process. Although today's state-of-the-art analog consoles offer excellent equalization, a number of sophisticated electronic processes have been devised to achieve these results. None of these compensations developed for analog are necessary in digital equalization. If you choose a 15 kHz boost, that is precisely what you get. Digital recording has proven itself; digital mixing is now a reality. The benefits can put the recording studio, the pro-

duction company, or the rental house in the spotlight and more than just step ahead of the competition.

The K-1105 was designed to be highly flexible in today's recording environment. The complete mixing system consists of four modular components: a desk-top control unit console, a separate rack-mountable signal processor unit, and rack-mounted A/D and D/A conversion units.

The signal processing unit and the mixing control unit comprise the basic system. The signal processor has eight digital input ports and provides three types of digital outputs: 1) two channel main outputs, 2) two channel sub outputs and 3) eight channel direct outputs. The mixing control unit consists of an eight channel meter bridge, eight channel modules and the master module. By coupling the processing unit with the mixing control unit, up to eight digital signals can be mixed and equalized.

With system flexibility in mind, the addition of the A/D and D/A conversion units provides for the digital mixing of analog signal sources. The analog inputs and outputs utilize common Cannon XLR connections. In addition, the A/D and D/A conversion units have separate digital outputs and inputs respectively.



The Sony K-1105 System

The basic signal processor/mixing control unit combination is intended for pure digital mixing applications. In conjunction with the PCM-1610 digital audio processor, the DAE-1100 digital editor, and the DAQ-1000 cue editor, the processor/control unit mixer completes a mastering system and cutting equalizer for CD production. With the addition of the A/D and D/A conversion



Back Panel Assembly for all units.

In the eastern United States Audiotechniques, Inc. is ...

SONY DIGITAL

Audiotechniques, Inc., is proud to be the Sony Digital Audio Sales Representative center in the eastern U.S. As you make the transition into digital audio, we can help answer the questions you'll have. And we'll be able to recommend, sell and install the Sony Digital equipment that will best fit your needs. We have them all . . . from the low cost PCM 701ES processors to the remarkable 3324 digital multi track recorder. Digital audio is the fastest growing segment of the professional recording industry. Digital will become a must for recording studios, video location, post production operations and film recording. Visit our newly remodeled facilities in New York City and talk digital with us.

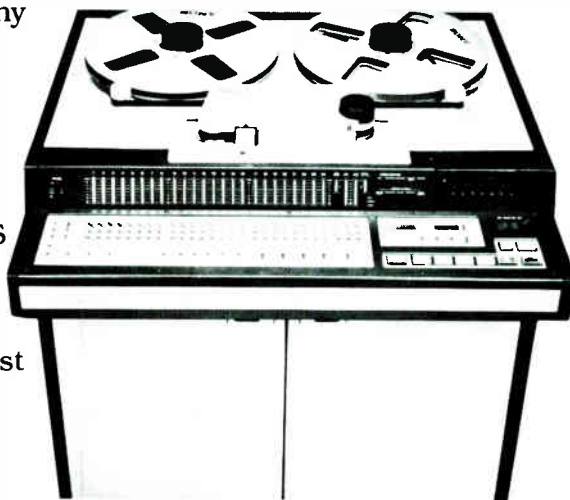

PCM 701ES PROFESSIONAL MODIFICATION SPECIAL!

Audiotechniques, Inc., is the exclusive eastern U.S. sales and installation agent for Audio & Design's acclaimed professional modification for Sony's PCM 701ES. Installation and system check is supervised by our technical manager who received factory training on this product at Audio & Design in England.

Sony PCM 701ES.....	list price	*1,200	Audiotechniques'
A & D professional modification ...	price	*1,850	Special
Total price.....		*3,050	*2,750

CALL AUDIOTECHNIQUES FOR APPLICATION, PRICE AND DELIVERY INFORMATION ON . . .

- Sony PCM 3324 Digital Multitrack
- Sony 3210 DASH 2 Track Recorder
- Sony DAE 1100 Digital Editor
- Sony PCM-F1 Digital Processor
- Sony Betamax Videotape Recorders
- BVU 800D U-Matic Video/Digital Recorder
- Sony PCM 701ES Digital Processor
- Sony CDP 3000 Compact Disc System
- Sony DRE2000A Digital Reverb
- Sony DDU 1520 Mastering Digital Delay
- Sony PCM 1610 2 Track Digital Audio Processor

SONY DIGITAL RECORDING TAPE AT BEST PRICES . . .

KCSBRD (1 hr) \$29.75 ea. in 12 piece case lot • D 1/2 2920 (1 hr) & D 1/2 1460 (1/2 hr) for PCM 3324 • L-500HG (1 hr) Betamax digital tape \$8.15 ea.

audiotechniques

1619 Broadway, New York, NY 10019 Telephone: (212) 586 5989
652 Glenbrook Road, Stamford, CT 06906 Telephone: (203) 359 2312

Circle #037 on Reader Service Card

RED

NOW MANUFACTURED IN THE USA

...TAKING THE LOUDSPEAKER SYSTEM INTO ITS NEXT ERA...

PSYCHOACOUSTICS

Because we believe the true measure of music quality is in the ear.

Pioneered by acoustic designer Borjan Kostic, the compact driver-matched, power amplified RED Psychoacoustic active system increases listening pleasure by surrounding the listener with a perfectly balanced sound. Actually developed in predigital times, this digital era design, complemented with sophisticated electronics, allows complete protection whatever the dynamic range.

See us at AES, October 8-11, New York Hilton — sixth floor.
Meet Borjan Kostic and hear the difference.

Dramatically responding to sound!

RED Acoustics (USA) Ltd.

Professional Audio Equipment

1231 Roth Drive

Lansing, MI 48910

517 694-3618

units, analog disc mastering can be readily accomplished.

TECHNICAL DESCRIPTION

The photograph of the rear panels shows the connections for interfacing the signal processing unit, the control unit, and the A/D and D/A conversion units. Each unit is connected via a single I/O connector for quick and simple interface. As an added convenience, the mixing control unit can be located remotely from the rack units for ease of operation.

Referring again to the rear panel photograph, eight channels of analog information are input to the A/D conversion unit, converted to digital form and output to the signal processing unit. The eight digital channels are then processed by the signal processing unit with control information (i.e. mixing, level changes, equalization and routing) derived from the mixing control unit. The digital output is then fed to the D/A conversion unit, whereby the signals are converted back to eight discrete analog channels. Digital input and output signals are also available for interface with peripheral signal processing devices.

FEATURES AND FUNCTIONS

The processing unit performs digital equalization and mixing of the signals. Because the signals are routed digitally through the various units, signal degradation is eliminated. The signal processor houses all of the digital ports needed to interface to the various units, as well as providing the three types of digital outputs previously mentioned.

The mixing console is designed as an independent unit, separate from the processor, to allow flexible remote operation. The unit is comprised of eight input modules and a master module. Each input module has a 16-segment LED program meter capable of peak holding status. In addition, each input module has a full complement of digital controls for signal processing. Digital equalization is possible with separate variable controls for hi cut, low cut, high, high mid, low mid and low sections. High/low pass, peaking (boosting) and shelving (attenuating) of specific frequency ranges are also selectable. Signal routing, phase reversal and meter selection are provided. Mixing operations are facilitated by the use of the two AUX level controls and pre and post fader selections to the auxiliary busses. Prefade, pan and gain trim controls are standard for each module while the channel fader provides continuously variable adjustment of the signal output.

Because the system is designed for CD mastering, automatic emphasis control is also incorporated. Emphasis

refers to the noise reduction scheme used in digital audio processing. If the signal has pre-emphasis, the system will not add further emphasis information to the signal. However, pre-emphasis can be manually selected and added to the output.

Another useful feature of the mixing system is the Gang Control and A/B roll function. By setting the gang switches on the input modules, signals assigned to both Group A and Group B can be controlled simultaneously. Using the A/B roll assign switch on the master module, it becomes possible to switch equalization between Group A and Group B.

The master module incorporates a stereo LED 24-segment display for the reading of output signal levels. Sampling frequency detection is automatic and LED readouts for 44.1 kHz, 48 kHz and mismatch are provided. Mismatch indicates that the signal being processed has a non-standard sampling rate. Emphasis control, A/B roll, AUX 1 and AUX 2 master controls, and the master fader are used to control the signals to be sent out via the back panel of the processor.

The A/D conversion unit accepts eight channels of audio and provides the processing to convert the analog information to digital form. The unit outputs both parallel and serial formats. To meet needs in different system configurations, the A/D conversion unit is designed as a single, independent unit with many practical features. Any of four headroom settings (6, 12, 18 and 24 dB) can be selected to achieve the widest dynamic range. In addition, the input sensitivity can be varied in a range from -24 dB to 10 dB. Emphasis and sampling frequency are selectable and input level indications for low, ref, and over are standard for each of the eight modules to show the relationship between the input signal and the chosen zero dB reference level.

The D/A conversion unit is similar in design to the A/D conversion unit. The two units share the same features, with their functions reversed. The D/A unit reconverts the digital information back to analog form and provides both parallel and serial inputs for processing. Both rack units are interfaced with the main processor via a single multiwire cable.

CONCLUSION

Digital signal processing techniques have already had a profound effect on the professional audio industry. Sony's new eight channel digital mixing console will accelerate the practical implementation of digital techniques by providing a flexible system for a wide range of applications. The standard characteristics of conventional analog consoles have been employed to make the engineer's transition from analog to digital a comfortable A/D conversion. ■

**Time-code-based
EVENT/EDIT CONTROL
for audio-for-video**



*two more
SYSTEM 2600
building blocks*

Two new complementary products which expand **SYSTEM 2600** to full television sound editing capability.

Use them to both rehearse and record audio-for-video edits. Save audio tracks. Reduce cut-and-try time. Synchronize audio and video cues with sub-millisecond precision. Turn "wild" sources on and off. Cue talent. Cue automated switchers and mixers. And more!



EVENT EXECUTIVE MODULE
SMPTE/EBU time-code-based with LTC reader and six user-settable event commands. Pre-sets each event to 1/100 of a TV frame, with ten pairs of time code addresses — 120 on-off commands in all. Compensates for erase head offset and record command delays with sub-millisecond-adjustable advance operation of each output. Uses your computer, terminal or keyboard for control, or our new Event/Edit Controller.



EVENT/EDIT CONTROLLER
Modular remote control panel. Sets, trims and controls events. Captures addresses from incoming time code. Use to both rehearse and record edits.



Building-block design. Use EE and E/EC alone, or to add precision audio-for-video event editing to any **SYSTEM 2600** synchronizing configuration.

FOR DETAILS ABOUT **SYSTEM 2600 BUILDING BLOCKS**, CALL, WRITE OR WIRE:

ADAMS•SMITH

34 Tower Street
Hudson, MA 07149 USA
Tel.: 617-562-3801
NYC.: 516-352-2341
TWX: 710-347-0096

Circle #039 on Reader Service Card

2000 CD Titles by Year End

Virtually all of PolyGram Records' accounts now carry Compact Discs and "manufacturers are adding titles to the total Compact Disc catalog at a rate unprecedented for any home entertainment software introduction," according to Emiel Petrone, senior vice president of PolyGram Records and chairman of the Compact Disc group.

PolyGram Records, which distributes about one-third of all CD titles, "is presently selling Compact Discs to more than 2,700 outlets nationwide, including retailers, one-stops and rack jobbers," Petrone revealed.

"There are far more titles available now on Compact Disc than were available on audio cassettes, video cassettes and discs, and video games nine months after their respective introductions," he pointed out.

Among the titles PolyGram is adding to the Compact Disc catalog are older, classic recordings. "The recording quality of these titles may be judged crude by today's standards, but the performances are timeless. These releases will clearly demonstrate the value of the Compact Disc format as a medium for **preserving** music," Petrone emphasized.

At the other end of the spectrum, manufacturers will strive to release new recordings on Compact Disc as near as possible to the release date of the album and cassette versions. "We believe it is a reasonable objective to have the Compact Disc version available within 30 days of release of the album and cassette," he said.

Tokyo Report: Japan's Move Toward Digital in Consumer Products

Digital audio and video technology in Japan has emerged from the laboratory and quickly filtered down from strictly professional applications to the broadbased consumer. The Compact Disc is only the first example of digital technology in the consumer market; and the CD itself as a music storage medium will soon be followed by CD ROM, a read-only storage system suitable for video images, computer software, and any alphanumeric information.

A second major development is the digital audio cassette. Manufacturers have prototyped both fixed and rotary head systems, using 16 bit, 44.1 kHz circuitry, with one compact cassette holding up to four hours of recording time. A standard format is expected by year's end, following manufacturers' meetings. Price of a CD-quality tape recorder should be around \$1,000 at introduction, soon dropping to \$500.

Digital News & Products



DMP artists Flim & the BB's with producer/engineer Tom Jung at Minot Sound, New York. Pictured from left to right are Bill Berg, Tom Jung, Billy Barber and Flim Johnson.

Consumer video markets will increasingly feel the impact of digital technology. The videocassette recorder will be replaced by a digital VCR, and CCD video cameras will gain a large market share. Digital television receivers have been developed, with double the number of scanning lines for increased resolution, freeze-frame projection, and multiple channel viewing, one prototyped system projects nine channels simultaneously on the CRT. Also, be on the lookout for flat screen displays and hard-copy televisions in the near future.

Personal satellite down-links are already available in Japan. Parabolic dishes as small as a half meter in diameter can be attached to the roof by the consumer and aligned in a matter of minutes. Direct broadcast satellite programming of both video and digital audio can thus be received from geostationary satellites such as the Japanese broadcast network's BS-IIa satellite.

The list goes on. It is clear that digital technology will be prevalent in consumer products. The reason, of course, follows the Japanese formula for success: higher performance at a lower relative cost. Digital technology permits the perfect exercise of that formula as sophisticated circuitry is integrated and manufactured at a low cost through mass production. The economics of audio/video are thus re-defined and the perfor-

mance of digital consumer products, better able to take advantage of the high volume/low cost ratio, will increasingly challenge the performance of professional equipment, at a disadvantage because of low volume/high cost.

—Ken Pohlmann

All Digital Label Formed

A New York-based jazz-oriented record label has recently been formed dedicated solely to digital recording of music for release on Compact Disc. Established by producer/engineer Tom Jung, Digital Music Products, Inc. (DMP) was organized around a desire to release well-recorded music by top session musicians who were looking for alternative ways to showcase their work. DMP is currently recording their artists direct to a Mitsubishi digital two-channel recorder, and plans a release pace of one CD title per month for the near future. Contact: DMP, Rockefeller Center Station, P.O. Box 2317, New York, NY 10185.

Optical Memory Conference

The second annual Technology Opportunity Conference on "The Future of Optical Memories, Videodisks and Compact Discs to the Year 2000" will be held at Loew's Summit Hotel in New York City, October 15 through 17, 1984. Among the programs featured will be a tutorial on the technology by Leon

ard J. Laub of Vision Three, Inc. Edward S. Rothchild, editor and publisher of Optical Memory News and the Optical Memory Report, will review the status of optical memory developments worldwide, and offer U.S. market forecasts to 1990. The conference will feature demonstrations of optical memory, videodisk and Compact Disc products.

For more information, contact Technology Opportunity Conference, P.O. Box 14817, San Francisco, CA 94114-0817.

Digital Rental House Opens in Nashville

A digital audio equipment rental facility, founded by veteran recording engineers Mike Poston and Rick Horton, has recently been opened to serve the Nashville music community. Digital Associates have chosen Mitsubishi X-800 32 track and X-80 two track exclusively for their digital audio recorders. According to Horton, "In order for the Nashville studios and production houses to maintain their status within the industry, we feel a vital need for digital technology to be more readily available." Contact: Digital Associates, P.O. Box 422, Spring Hill, TN 37174.

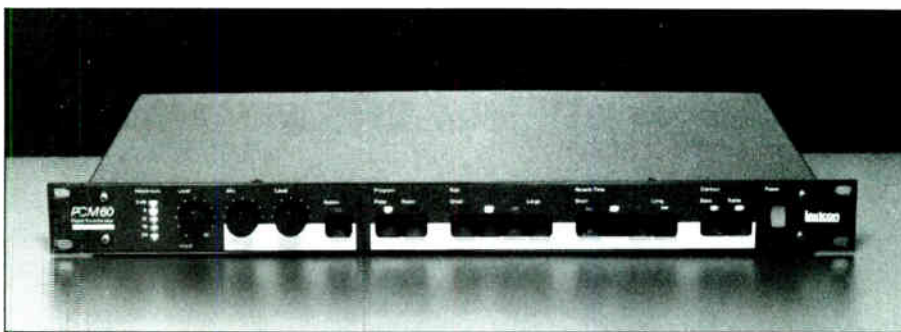

Lexicon's PCM-60 offers two adjustable digital reverberation programs and lists under \$1500.

Lexicon PCM 60 Reverb

Lexicon, Inc. has introduced a low-cost, high performance digital reverb dubbed the PCM 60 digital reverb. Designed for small studios and on-stage applications, the PCM 60 features two main reverb programs: room and plate, with variable size, reverb time and bass and treble contouring. The unit has a balanced/unbalanced audio input two unbalanced (single-ended) audio outputs and an effects loop, all employing 1/4-inch phone jacks. Input and output sensitivity select pushbuttons

on the rear panel can be set for high or low-level inputs and high or low-level outputs. List price is \$1,495. For information contact Lexicon Inc., 60 Turner St., Waltham, MA 02154.

Gotham Unveils SYSTEX™

Gotham Audio Corporation has recently introduced SYSTEX, a 330 Megabyte hard disk storage system that digitally records, plays back and locates audio information. The system is designed for broadcast, TV, film and recording studio applications where instant random access to a large library of



HY JAMES and dbx digital

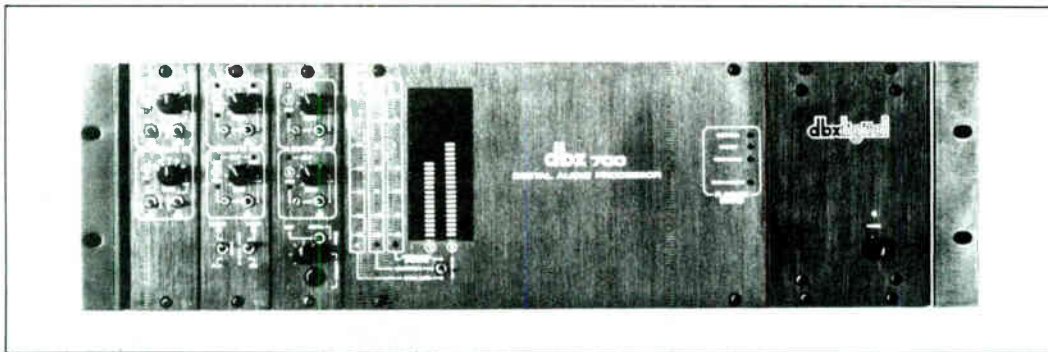

You know about the sonic quality of the dbx 700 Digital Processor. Call Tom or Henry at Hy James for information on their frame accurate editor and the dbx disc transfer delay line.

HY JAMES The Audio Professionals

24166 Haggerty Road, Farmington Hills, Michigan 48018 U.S.A.
(313) 471-0027 - from Ann Arbor 994-0934



Audio + Design is now offering a "professionalized" version of the Sony 701 ES digital processor. The unit now features balanced XLR inputs/outputs, an RS-232 interface and more.

high quality audio material is needed. At a sampling rate of 48 kHz, the single disk drive unit can store and reproduce 60 minutes of mono recording time or thirty minutes of stereo per disk. However, the system can be expanded to accommodate as many as 60 separate disk drives. The price for the basic SYSTEX dual-

rack mounted system, including CPU, single hard disk and sequencer, is \$125,000. Additional sequencers are \$35,000 and the 330 MByte Winchester disk drives are approximately \$10,000 each. Contact: Gotham Audio Corporation, 741 Washington St., New York, NY 10014-2070.

Retrofit Professional Upgrade Available for Sony 701 ES Digital Processors

Audio + Design, of Bremerton, Oregon, and Audiotechniques of New York City are now offering "professionalized" upgrade versions of the popular Sony 701 16 bit digital audio processors. Dubbed the PRO 701, the modified units feature XLR connectors, are fully balanced with operating levels of up to +22 dBm, and incorporate A+D's patented Coincident Time Correction (CTC™) circuitry which yields a coincident output in both analog and digital domains.

Input level controls are replaced with a 12 position input/output unity gain control that sets the operating in two decibel steps from -2 dBm to +20 dBm. The position of this control indicates the "0" peak operating level on the processor and can be used to establish any in-house headroom standard. The modification also includes removing the 14/16 bit push button tops (which are prone to accidental switching). Bit selection can then be easily accomplished by inserting a matchstick or small screwdriver through two front panel holes, and status is indicated on the main 701 display.

Other alterations, which are available at extra cost over the basic upgrade package include: copy prohibit, record emphasis and NTSC/PAL switching; function remoting; and several digital interface options, including a PCM 1610 I/O interface.

Modification prices range from \$480 to \$975, return postage paid, and arrangements can be made to supply a new 701 processor if the customer does not already own one.

"Cotton Club" Goes Digital

According to the Digital Report, a monthly newsletter for the digital recording industry published by the Technical Systems Group of Stamford, Connecticut, Orion Films' high budget film about the famed Harlem nightspot of the 1920's, "Cotton Club," is digital all the way. The soundtrack, being recorded at A & R Recording in New York City, is employing a pair of Sony 3324 multi-track recorders. Other principal equipment on the project includes a Calrec Soundfield Microphone for the brass and reed recording and a Quantec Reverbator for room environment simulation. John Barry, famed British movie music composer, is musical director for the project, with arrangements by Bob Wilbur. There are more than 30 musical numbers in the film, occupying over two hours of the total two hours and twenty-five minutes of the film. ■

df first...

AUDIO FOR FILM & VIDEO

- SWEETENING
- SCORING
- MIXING

COMPACT DISC & RECORD MASTERS

- 24 TR. ANALOG
- SONY DIGITAL
- REALTIME DUP.

COMFORTABLE WORKING ATMOSPHERE • SOLID SOUND • EFFICIENT PRO SERVICE

DIGITAL SOUND RECORDING

607 NORTH AVENUE 64
LOS ANGELES, CA. 90042
(213) 258-6741

Circle #041 on Reader Service Card

DIGITAL RESOURCE

GUIDE

The following guide is a listing of digital recorder manufacturers, studios, mastering houses and rental facilities in the United States and throughout the world. This guide is based on the fourth edition of the "RIAA Digital Recording Facilities Directory," published by the Recording Industry Association of America (888 Seventh Avenue, 9th Floor, New York City, NY 10106), with some recent additions compiled by the Mix staff. We encourage other commercial digital audio facilities to contact us, to be included in our next update. Companies marked with a • have digital multitrack systems.

COMPUSONICS CORPORATION

323 Acoma Street
Denver, CO 80223
(303) 698-0060 or (800) 223-1821
David Schwartz, president

DIGITAL ENTERTAINMENT CORPORATION (headquarters)

Subsidiary of Mitsubishi
Electric Sales America
69 North Street
Danbury, CT 06810
(203) 744-3226; Telex: 703547
Lou Dollenger, marketing manager;
Tore Nordahl, president

555 West 57th Street, Suite 1530
(NY Branch Office)
New York, NY 10019
(212) 581-6100
Lou Dollenger, marketing manager

8255 Beverly Boulevard
(LA Branch Office)
Los Angeles, CA 90046
(213) 658-6881
Bill Van Doren, western area manager

MITSUBISHI DIGITAL STUDIOS, (U.S.A.)

- Alivity Productions
14755 Ventura Blvd. #1715
Sherman Oaks, CA 91403
Craig Hundley, president
(213) 872-3033

Audioforce, Inc.
147 W. 24th Street
New York, NY 10011
Sid Zimet, president
(212) 741-0919

- The Burbank Studios
4000 Warner Blvd.
Burbank, CA 91505
Tom McCormack, manager
(213) 954-6000

- Clinton Recording
653 10th Avenue
New York, NY 10036
Bruce Merley, president
(212) 246-2444

Criteria Recording Corp.
1755 NE 149th Street
Miami, FL 33181
Mack Emerman, president
(305) 947-5611

- Digital Associates
PO Box 422
Spring Hill, TN 37174
Rick Horton
(615) 256-4487

Digital Music Products
44 Farley Road
Scarsdale, NY 10583
Tom Jung, president
(914) 725-4135

Editel
301 East Erie Street
Chicago, IL 60611
Lenard Pearlman, vice president
(312) 440-2360

ERAS Recording
226 E. 54th Street
New York, NY 10022
Boris Midney, president
(212) 832-8020

- Fantasy Studios
10th at Parker
Berkeley, CA 94710
Roy Segal, vice president
(415) 549-2500

Future Disc Systems
3475 Cahuenga Blvd. W.
Hollywood, CA 90068
Gary Rice/Steve Hall
(213) 876-8733

Larrabee Sound
8811 Santa Monica Blvd.
Los Angeles, CA 90069
David Mills, manager
(213) 657-6750

Legonks W. Recording Studio
5430 Sunset Blvd. #1500
Hollywood, CA 90028
George Duke, president
(213) 461-3277

- Lion Share Studios
8255 Beverly Blvd.
Los Angeles, CA 90048
Terry Williams, studio director
(213) 658-5990

Muscle Shoals Sound Studios
100 Alabama Avenue
Sheffield, AL 35660
Jimmy Johnson, president
(205) 381-2060

Soundcastle Recording
2840 Rowena Avenue
Los Angeles, CA 90039
Buddy King, president
(213) 665-5201

Sound Summit Studio
Americana Lake Geneva Resort
Highway 50
Lake Geneva, WI 53147
Phil Bonnano, vice president
(714) 640-3587

- Soundworks Recording
254 W. 54th Street
New York, NY 10019
Charles Benanty, president
(212) 247-3690

The New
**Bernie Grundman
 Mastering Studio**
 6054 Sunset Blvd., Hollywood, CA 90028
 (213) 465-6264

- Complete Disc Cutting Services
- Analog and Digital Sub Masters for:
 Compact Discs
 Cassette Duplication



Circle #042 on Reader Service Card

API CONSOLE UPDATE:

Wolff Associates is now an authorized dealer for API and Datatronix audio products. We can supply your facility with anything from a used equalizer to a complete new recording console.

Wolff Associates will also keep your present API/Datatronix equipment running with factory replacement parts. We do on-location repair of control room grounding and signal flow problems, etc.

USED EQUIPMENT FOR SALE:

24 X 16 API Console; (2) 1604 API Consoles; (2) API console frames; 550A EQs; 440 Series faders; 3M M-79 w/16- and 24-track heads.

WOLFF ASSOCIATES
 1378 NORTHGATE SQUARE
 RESTON, VA 22090
 (703) 689-0448

Circle #043 on Reader Service Card

Sterling Sound, Inc.
 1790 Broadway
 New York, NY 10019
 Lee Hulko, president
 (212) 757-8519

• The Village Recorder
 1616 Butler Avenue
 Los Angeles, CA 90025
 Michael Geller, studio director
 (213) 478-8227

• United Western Studios
 6000 Sunset Blvd.
 Hollywood, CA 90028
 Jerry Barnes, president
 (213) 469-3983

• Universal Recording
 46 East Walton Street
 Chicago, IL 60611
 Murray Allen, president
 (312) 642-6465

Thomas Vicari
 15247 Rayneta Drive
 Sherman Oaks, CA 90039
 (213) 757-8519

Woodland Sound Studios
 1011 Woodland Street
 Nashville, TN 37206
 Glenn Snoddy, president
 (615) 227-5027

MITSUBISHI ELECTRIC SALES AMERICA, INC.

(International headquarters)
 110 New England Avenue, West
 Piscataway, NJ 08854
 (800) 631-5377 or (201) 981-1414
 Sonny Kawakami, vice president

European Distributor:

AEG-Telefunken
 Bueklestrasse 105, D-7750 Konstanz
 Federal Republic of Germany
 (0 75 31) 86-1.

Ingo Joch, manager, professional tape recorder department

England:

British Broadcasting Corporation (BBC)
 Broadcasting House
 London, W1A 1AA
 (01) 580-4468 Telex: 265781

Federal Republic of Germany:

Miller International
 Schallplatten GMBH (Miller International Record Company)
 Justus-Von-Liebig-Ring 203.
 2036 Quickborn
 (04) 106-5001 Telex: 212 386

• Soundstudio "N"
 Unter Kirschen 8, 5000 Cologne 30
 (02) 215-3406 1-63

Tennessee Tonstudios GMBH
 (Tennessee Recording Studios)

Wandsbecker Zollstrasse, 87-89
 200 Hamburg 70

Japan:

Mitsubishi Electric Corporation
 Mitsubishi Denki Building
 2-3 Marunouchi, 2-chome
 Chiyoda-ku, Tokyo 100
 (03) 218-2111 Telex: J24532
 Cable: Melco Tokyo
 Mr. Awazu

Itokuchizaka Studios
 4-3-31 Kudan, Chiyoda-Ku, Tokyo
 (03) 263-1097
 Mr. Ono, manager

King Records

2-12-13 Otowa, Bunkyo-ku, Tokyo
 (03) 945-2116 Mr. Kikuta, manager

• Nippon Columbia Records
 (Denon)

4-14-14 Akasaka, Minato-ku, Tokyo
 (03) 584-8111 Mr. Takasu, manager

• Toshiba-EMI Records
 2-2-17 Akasaka, Minato-ku, Tokyo
 (03) 587-9188 Mr. Moriwaki, manager

Norway:

Grieghallen Bergen
 (Edvard Grieg Auditorium)
 N-500, Bergen
 22 00 10, Lars Hillesgt. 3A

Switzerland:

Mr. Patrick Mimran
 32, Chemin Des Princes
 1253 Vandoeuvres/GE
 52 47 17 Telex: 22679

U.S.S.R.:

Melodija Moskau
 (Melodia Moscow) VIA
 Maschpriborintorg, Smolenskaja-Pl.
 32-34 Moscow
 244-2775 Telex: 7235, 7236

JVC COMPANY OF AMERICA

41 Slater Drive
 Elmwood Park, NJ 07407
 (201) 794-3900
 Larry Boden,
 special products manager
 West Coast Office:
 1111 West Artesia
 Compton, CA 90220
 (213) 537-6020

JVC DIGITAL STUDIOS (U.S.A.)

American Multimedia
 Route 8, Box 215-A
 Burlington, NC 27215
 (919) 229-5554
 Richard Clark

Capitol Records Studios
 1750 North Vine Street
 Hollywood, CA 90028
 (213) 462-6252
 Charles Comelli

"The sonic quality of Saki heads, makes them the #1 choice on all our multitracks"



CMS Digital Rentals
453 East Wapello
Altadena, CA 91001
(818) 797-3046
Fred Mitchell

Digital by Dickinson
9 Westinghouse Plaza
Bloomfield, NJ 07003
(201) 429-8996
Frank Dickinson

JVC Cutting Center
RCA Building, Suite 500
6363 Sunset Boulevard
Hollywood, CA 90028
(213) 467-1166

Master Technologies
28 Music Square East
Nashville, TN 37203
(615) 327-4533
Glenn Meadows

Treasure Isle Recording
2808 Azalea Place
Nashville, TN 37204
(615) 327-2580
Fred Vail

Canada:
Le Studio
201 Perry Road, Morin Heights
Quebec JOR 1HO
(514) 226-2419
Yael Brandeis

England:
Abbey Road Studios
3 Abbey Road, St. John's Wood
London, NW8 9AY

France:
Disque Erato
60 Rue de Chausse D'antini
Paris, France 75009
Mr. P. Lavoix

Japan:
JVC Adyama Studios
2-21-1 Jingu-mae, Shibuya-ku
Tokyo 150
(03) 403-0111
Mr. Kiyoshi Okumura
JVC Yokohama Cutting Center
3-12 Moriya-Cho
Kanagawa-ku, Yokohama
(045) 453-1111
Mr. Niimi

Camerata Tokyo
4-26-32 Jingu-mae
Shibuya-ku, Tokyo
(03) 405-6081
Hiroshi Isaka

Nippon Phonogram
Wako Building, 4-8-5 Roppongi
Minato-ku, Tokyo
(03) 479-3713
Mr. T. Atarashi

-PAGE 218



Chief Engineer Cary Fischer
United Western receives no compensation for this endorsement

SAKI MCI 24 Track

After 16 years of technological leadership in one of the most demanding and ever-changing fields, you can depend on Saki's commitment to service your future needs long after the competition is gone.

SAKI heads are made in the USA



SAKI MAGNETICS, INC.

A California Corporation Since 1968

8650 Hayden Place, Culver City, CA 90230 213 / 559-6704 (TWX-910-328-6100)

Circle #044 on Reader Service Card

WHERE DISC MASTERING QUALITY REALLY COUNTS

THANK YOU:	AL JARREAU	DONNA SUMMER	PAT BENATAR
JEAN-LUC PONTY	SHEENA EASTON	ONE WAY	GEORGE HOWARD
MR. MISTER	BERLIN	KOINONIA	ROD STEWART
DWIGHT TWILLEY	SLIDER-GLENN	JERMAINE JACKSON	PATTI AUSTIN



FUTURE DISC SYSTEMS

3475 Cahuenga Boulevard West
Hollywood, California 90068
(213) 876-8733

MASTERING ENGINEER:

STEVE HALL

EQUIPMENT:

ORTOFON DSS82; (GREEN)
CUTTING SYSTEM
CYBERSONICS MC2003 FULLY
AUTOMATED MASTERING CONSOLE
ATR 1/2"-1/4" MASTERING
MACHINE
MITSUBISHI X-80A/DDL-1
DIGITAL MASTERING SYSTEM
SONTEC EQUALIZER AND
LIMITER/COMPRESSOR

Circle #045 on Reader Service Card

Mexico:

Universidad Veracruzana
Teatro Del Estado
Xalapa, Veracruz
(281) 8-08-34
Jonathan Wearn

SONY PROFESSIONAL AUDIO PRODUCTS DIVISION

Sony Drive
Park Ridge, NJ 07656
(201) 930-1000
George Currie, general manager

SONY PROFESSIONAL AUDIO PRODUCTS DIVISION

700 West Artesia Boulevard
Compton, CA 90220
(213) 537-4300
Rick Plushner, national sales manager

SONY DIGITAL STUDIOS (USA)

American Gramophone
206 South 44th Street
Omaha, NB 68131
(402) 553-1164
Don Sears

• Atlantic Recording Studios

1841 Broadway
New York, NY 10023
(212) 484-6093
Paul Sloman

• Audio Intervisual Design

8474 West Third Street
Los Angeles, CA 90048
(213) 653-0240
Jim Pace

Audiotechniques
1619 Broadway
New York City, NY 10019
(212) 586-5989
Jim Flynn or Gene Perry

Capitol Records, Inc.
1750 North Vine Street
Hollywood, CA 90028
(213) 462-6252
Charles Comelli

CBS Recording Studios
49 East 52nd Street
New York City, NY 10022
(212) 975-2958
William Townley

Clover Recording Studios
6232 Santa Monica Boulevard
Hollywood, CA 90038
(213) 463-2371
Dan Moorehouse

CMS Digital Rentals
453 East Wapello
Altadena, CA 91001
(818) 797-3046
Fred Mitchell

Digital Audio Disc Corporation
1800 North Fruitridge
Terre Haute, IN 47804
(812) 466-6821
Alan Ater

Digital by Dickinson
9 Westinghouse Plaza, Box 547
Bloomfield, NJ 07003
(201) 429-8996
Erin Ohlsen

Digital Magnetics
1800 North Argyle Avenue #310
Hollywood, CA 90028
(213) 463-0279
Stewart Whitmore

• Digital Services Recording

1001 River Oaks Bank Tower
2001 Kirby Drive
Houston, TX 77019
(713) 520-0201
John Moran

Digital Sound Recording
607 North Avenue 64
Los Angeles, CA 90042
(213) 258-0048
Van Webster

Everything Audio
16055 Ventura Blvd., #1001
Encino, CA 91436
(213) 995-4175
Brian Cornfield

Frankford/Wayne Mastering Labs, Inc.
1697 Broadway, 14th Floor
New York, NY 10019
(212) 582-5473
Tom Steele

M & K Sound
10391 Jefferson Boulevard
Culver City, CA 90230
(213) 204-2854

Master Digital
202 Main Street
Venice, CA 90291
(213) 399-7764
Roger Pryor

Masterdisk
16 West 61st Street
New York, NY 10023
(212) 541-5022
Doug Levine

• Elliot Mazer

Digital Audio Consultant
Fantasy Studio Building
10th & Parker
Berkeley, CA 94710
(415) 644-4321

Middle Ear Recording Studios
1801 Bay Road
Miami Beach, FL 33139
(305) 672-2390
Dale Peterson

Miller & Kreisel Sound Corporation
10391 Jefferson Boulevard
Culver City, CA 90230
(213) 204-2854
Ken Kreisel

Motown/Hitsville USA
7317 Romaine Street
Hollywood, CA 90046
(213) 850-1510
Guy Costa

New York Digital Recording Inc.
200 Varick Street
New York, NY 10014
(212) 553-1164
MacDonald Moore

• Power Station (Nile Rogers)

441 West 53rd Street
New York City, NY 10019
(212) 246-2900
Dianna Alleyne

• Record Plant

8474 West Third Street
Los Angeles, CA 90048
(213) 653-0240
Rose Mann

• Soundworks

254 West 54th Street
New York City, NY 10019
(212) 247-3690
Charles Benanty

Sterling Sound
1790 Broadway, 9th Floor
New York, NY 10019
(212) 757-8519
Lee Hulko

Telarc Records
23307 Commerce Park Road
Cleveland, OH 44122
(216) 464-2313
Jack Renner

• The Village Recorder

1616 Butler Avenue
West Los Angeles, CA 90025
(213) 478-8227
Kathy Konop

Wakefield Manufacturing
PO Box 6073, 1745 West Linden St.
Phoenix, AZ 85005
(602) 252-5644
Mary Ann Miller

Allen Zentz Mastering
7083 Hollywood Boulevard, Suite 302
Hollywood, CA 90028
(213) 851-8300
Nancie Boykiss, manager

SONY DIGITAL STUDIOS (International)**Canada:**

McClea Place
225 Mutual, TST
Toronto, Ontario
(416) 977-9740
Phil Sheridan

Note: Data indicating which of the following have 3324 multitrack systems was not available at press time.

Sounds Interchange
506 Adelaide Street, East
Toronto, Ontario M5A 1N
(416) 364-8512

Czechoslovakia:

Suphophon
Praha 1, Palacheho 1
Telex: 121218
M. Kulhan

England:

Abbey Road Studios
1 Abbey Road, St. John Woods
London, NW8 9AY
(01) 286-1161
Ken Townsend

Air Studios
214 Oxford Street
London, W1
(01) 637-2758
Dave Harries

Britannia Row
35 Britannia Row, Islington
London, N1 8QH
(01) 226-3377
Richard Kelly

CBS Studios
31-37 Whitfield Street

London, W1
(01) 636-3434
Roger Bain

CTS Studios
The Music Centre, Engineers Way
Wembley, Middx., HA9 ODR
(01) 903-4611
Peter Harris

Chandos Records
41 Charing Cross Road
London WC2
(01) 437-1448
Brian Couzens

Do Not Erase Productions
Flat 2, 18 Priory Terrace
London NW 6
(01) 328-9003
Steve Levine

Feldon Audio
126 Great Portland Street
London, W1
(01) 580-4314
Roger Cameron

Fisher Lane Studios
Fisher Lane Farm
Chiddingfold, Surrey
(01) 439-8451
Geoff Callingham

HJB Sales and Hire
Unit F, New Crescent Works
Nicholl Road, London NW10 9AX
(01) 961-3295
Ian Jones

Marquee Studios/NJF
10 Richmond Mews, Dean Street
London W1
(01) 437-6731
Simon White

Nimbus Records
Wyastone Leys, Monmouth
06-600 890682
Gerald Reynolds

Queen Productions
46 Pembroke Road
London W11
(01) 486-0597
Jim Beech

Peter Self/Digital Audio Systems
Unit A, Coburg House, Western Road
Wood Green, London N22 6UH

Tape One/Mobile One
27/28 Windmill Street
London W1
(01) 580-0444
Bill Foster



A Recording Legend in the Making The Bruel & Kjaer Studio Microphones

The major contributor to a microphone's fidelity to the original acoustical event is the uniformity of its amplitude response over frequency. Indeed, the anomalies that give most popular microphones their characteristic coloration show themselves upon careful analysis to be variations from flat amplitude and phase response, especially those occurring in the middle and high frequencies.

Believing the best microphone must be an accurate one, Bruel & Kjaer designed the 4000 series of professional condensers to have virtually



ruler-flat response through the middle frequencies, and worst-case deviation of ± 2 dB from 10 Hz to 40 kHz. Not only are the amplitude and phase response uniform on-axis, but they remain remarkably uniform even off-axis.

Get ready for digital recording with the B&K 4000 series. Maximum peak sound pressure level is 168 dB with the model 4004; equivalent input noise is 24 dB(A)! The frequency response is 5 Hz to 150 kHz ± 3 dB! Order yours today!!! Call Tom or Henry.

Available from

HY JAMES *The Audio Professionals*

24166 Haggerty Road, Farmington Hills, Michigan 48018 U.S.A.
(313) 471-0027 - from Ann Arbor 994-0934

Circle #046 on Reader Service Card

We Just Sound Better!

**NEVE NECAM • SSL
3M and MITSUBISHI
DIGITAL**

Film Mixing • Music • Video Sweetening



*Murray Allen - president
Foote Kirkpatrick - studio manager*



UNIVERSAL RECORDING CORPORATION

46 East Walton Street • Chicago, Illinois 60611 • 312/642-6465

Townhouse Studios
150 Goldhawk Road
London W12
(01) 743-9313
Brian Collins

Unicorn Records
7 Hillgate Place
London W8
(01) 727-2893
Nigel Brandt

Federal Republic of Germany:
EMI Electrola GMBH
Maarweg 149, 5000 Kohn 41
0221-4902/1
Mr. Rotha

Harmonia Mundi Acustica GMBH
Inden Sigristmatten 6
7800 Freiburg 0761-491506
Mr. Benjamin Bernfeld

Suedwest-Tonstudio GMBH
Liederkrantzhalde, Lortzingstr. 25
7000 Stuttgart 0711-69130
Mr. Neubronner

Teldec Telefunken-Decca, Schallplatten
GMBH
Heussweg 25, 030-833103
Mr. Fouque

Tonstudio Bauer GMBH and Co. KG
Markgroeningenstr. 46
7140 Ludwigsburg-Eglosch
07141-31098
Mr. T. Bauer

Tonstudio Ulrich Kraus
Inderstorferstr. 60
8000 Muenchen 21
Mr. Kraus

Tonstudio, Bernhard Mahne
Thierschstr. 31
8000 Muenchen 22 089-227639
Mr. Mahne

Tonstudio, Teije Van Geest
Mkkensturmerstrs. 24
6805 Heddagheim 06203 43185
Mr. Van Geest

France:
Erato
60 Rue de la Chaussee
d'Aupin 7500g
(01) 280-6919
M. Laroix

Pathe Marconi-EMI
62 Rue de Sevres
F-92100 Boulogne
(331) 603.17.11
Claude Lamy, studio manager

Studio d'Enregistrement Itinerant
82 Rue St. Fiagre
F-91580 Auvers-St. Georges, Etrechy
(1) 080 44.69
Gilbert Preneron, owner

THIS LITTLE PIECE OF MUSIC
CAN MAKE YOU, OR BREAK YOU...

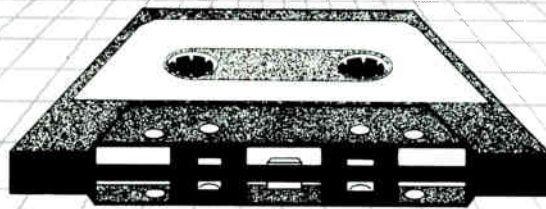

LET'S FACE IT! NOBODY HEARS YOUR MASTER TAPES! That's why most major record labels, managers, producers, artists, and ad agencies continually choose us to master their advance audio cassettes. They require the absolute best — **a precise duplicate of their masters.** That's why they use **MASTER DIGITAL®.** Look over the following facts and decide for yourself...

- Your analog masters are transferred to a 16-bit digital audio format — no noise introduced — no deterioration of your master.
- Our passive distribution network is greater than 100db, and transformerless.
- We custom load the best — SONY UCXS tape to your required length — no excess blank tape to rewind through.
- All cassettes are run in real-time.
- We maintain our state-of-the-art equipment with the strictest standards in the industry.
- Your product goes through numerous quality control checks.
- We deliver a finished, packaged product which includes color stock printed j-cards, A & B side labels and Norelco storage boxes, usually in 48 hours or less.

NOBODY MAKES CASSETTES LIKE MASTER DIGITAL, Inc....PERIOD !

MASTER DIGITAL®

THE ULTIMATE IN REAL-TIME CASSETTE MASTERING
213-399-7764

NOW CALL US FOR ALL YOUR VHS, BETA & 3/4 VIDEO DUPLICATION NEEDS.

Circle #047 on Reader Service Card

best (best) adj. 1. Surpassing
all others in quality, most excellent.

sonicarts
The Mastering Room

**NOW FEATURING DIGITAL AND ½-INCH
HALF-TRACK MASTERING**

**"THE BEST CUSTOM RECORD
MANUFACTURING IN THE WORLD."**

FOR MORE INFORMATION ABOUT DISK
MASTERING, MANUFACTURING & JACKET
PRINTING, CALL OR WRITE TODAY.

SONIC ARTS

665 HARRISON STREET • SAN FRANCISCO, CA 94107 • (415) 957-9471 • TELEX 176-123

Circle #048 on Reader Service Card

Translab
12-14 Boulevard de l'Hospital
Paris 75005
(01) 707-5486
Christian Oysiui

Holland:

CBS, Manufacturing Service Centre
Nijoorheidsweg
32-26, 2031 CP, Haarlem
023-319419 ext. 331
Mr. H. Niggebrugge

Polygram Record Operations
PO Box 23, 3740 AA
Baarn, The Netherlands
02154 19338
Mr. B. Scoothaak

Hungary:

Hungaroton Qualiton
H-1051 Budapest
Vorosmarty Ter. 1
428 546
Dr. F. Takacs

Japan:

Canion Records, Inc.
4-3-31, Kudankita
Chiyoda-Ku, Tokyo
(03) 265-6484
Mr. Kuroda

CBS/Sony Shinanomachi Studio
6-8 Minamimotomachi
Shinjuku-ku, Tokyo
(03) 358-8071
Mr. K. Hazama

King Record Company Ltd.
12-13, 2-Chome, Otowa
Bunkyo-Ku, Tokyo
(03) 945-2116
Mr. S. Chiba

Nippon Columbia Co., Ltd.
14-14, 4-Chome, Akaska
Minato-Ku, Tokyo
(03) 584-8111
Mr. A. Takasu

Polydor, Inc.
1-8-4, Ohhashi
Meguro-Ku, Tokyo
(03) 462-5131
Mr. Takahashi

Toshiba EMI Inc.
2-2-17, Akasaka
Minato-Ku, Tokyo
(03) 585-1111
Mr. Furusawa

Warner-Pioneer Inc.
Roppongi Fuji Building

4-11-10, Roppongi
Minato-Ku, Tokyo
(03) 479-1131
Mr. Matsumoto

Yamaha Ongaku Shinkohkai Epiculous
Studio
8-27, Sakuragaoka
Shibuya-Ku, Tokyo
(03) 476-3261
Mr. Kaminari

Sweden:

Swedish Radio
Oxenstiernsgatan 20
S-105 10 Stockholm
Mr. Christer Grewin

3M DIGITAL AUDIO SYSTEMS

3M Center, Building 223-55
St. Paul, MN 55144
(612) 736-1149
Tom Kenny, market development
manager

3M DIGITAL STUDIOS (U.S.A.)

- Castle Recording Studio
Route #11 Old Hillsboro Road
Franklin, TN 37064
(615) 791-0810
Jozef Nuyens

- SYNCNS ANY * DRUM COMPUTER OR SEQUENZER TO SMPTE
- REMEMBERS START AND CUES

SRC

SMPTE READING CLOCK

- UNIVERSAL MODULAR SYSTEM
- SOLVES ANY SYNC PROBLEM NOW AND IN THE FUTURE



* AMDEK, DRUMULATOR, FAIRLIGHT, KORG, LINN, MICROCOMPOSER, MOOG, OBERHEIM, PPG WAVE 2.2, ROLAND, SEQUENTIAL CIRCUITS, SIMMONS, SYNCLAVIER II - - - AND ALL OTHERS ! MIDI SYSTEM CLOCK !

FRIEND-CHIP

Europa
EUROPA TECHNOLOGY, INC.

1638 WEST WASHINGTON BLVD. VENICE CA 90291 213 392-4985

- Digital by Dickinson
9 Westinghouse Plaza
Bloomfield, NH 07003
(201) 429-8996
Frank Dickinson
- Soundworks Digital Audio/Video
Recording Studios, Ltd.
254 W. 54th Street
New York, NY 10019
(212) 247-3690
Charles Benanty
- Studio M, Minnesota Public Radio
45 E. 8th Street
St. Paul, MN 55101
(612) 221-1500
Tom Voegeli, Tom Mudge
- Treasure Isle Recording Studio
2808 Azalea Place
Nashville, TN 37204
(615) 327-2580
Fred Vail
- Universal Recording Corporation
46 E. Walton Street
Chicago, IL 60611
(312) 642-6465
Murray Allen
- Warner Bros. Records
1114 Cumpston Avenue
North Hollywood, CA 91601
(213) 980-5605
Lee Herschberg
- Westlake Audio
7265 Santa Monica Boulevard
Los Angeles, CA 90046
(213) 851-9800
Glenn Phoenix

England:

- Decca Recording Services Ltd.
254 Belsize Road
London, NW6 4BT
(01) 625-4481
David Frost
- Jacobs Studios
Ridgeway House, Runwick Lane
Farnham, Surrey T23518
Andy Fernbach
- Roundhouse Recording Studios
100 Chalk Farm Road
London NW1 8EH
(01) 485-0131
Mark Darnley
- Townhouse Studios Ltd.
150 Goldhawk Road
London W12 8E1
(01) 743-9313
Geoffrey Atter

Federal Republic of Germany:

Avrophon Schall-Platten
Hauptstr. 41
7813 Stauffen
(07) 633-7171
M. Ullmann



HERE'S π IN YOUR EYE

In any monitor, especially a near-field type, response will vary from a 2π (wall/soffit) to a 4π (free field/console) environment.

The better the performance, the more noticeable the phenomenon. In our case, with more than 20 international patents so far, this field select switch was absolutely necessary.

So that you could have the same flat response in either field or both fields.

These are Point Source reference monitors. Coaxial, and time compensation adjusted in a true concentric design. Stereo imaging the way it happens in nature.

They also take lots of power without distortion or complaint. They are stunning.

Audition the Near-Field Point Source Reference Monitors. From Fostex. RM-765 (6½" woofer) and RM-780 (8" woofer). Both with patented RP Technology. For flat response in both 2π and 4π environments.



RM765

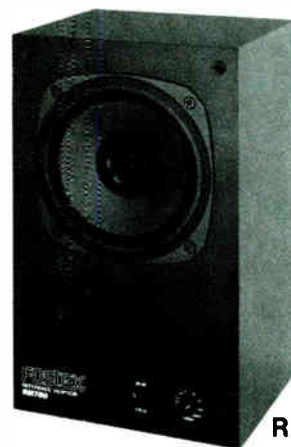

RM780

FOSTEX[®]

Pro Sound Division

FOSTEX CORPORATION OF AMERICA
15431 Blackburn Avenue, Norwalk, CA 90650 (213) 921-1112

Circle #050 on Reader Service Card

The proof is in the listening.

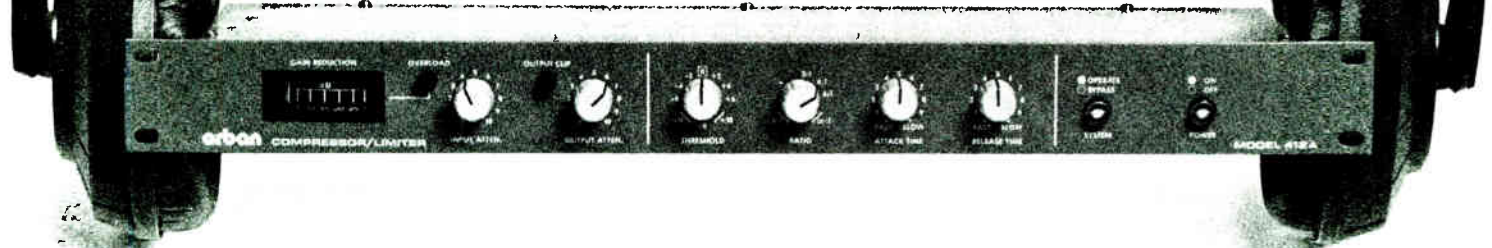

The surprise is in the price. \$425.

The New Orban Model 412A Compressor/Limiter

The new 412A Compressor/Limiter is Orban's entry into the general-purpose level control sweepstakes—it's designed to make you, the audio professional, the winner! Available in mono (412A) and stereo (414A) versions, it's loaded with features that most other low-cost units don't offer—but the real proof is in the *listening*. We invite you to compare its natural, transparent sound to any other compressor/limiter you might know or use. After you do, we feel confident you'll make it *your* essential AGC. Contact your Orban dealer for a demonstration, and find out how affordable Orban-quality processing can be!

Performance Highlights

- Streamlined, straightforward front panel offers the most-demanded user controls, including ATTACK TIME, RELEASE TIME, RATIO, and THRESHOLD. These wide range controls permit extremely natural sound or special effects.
- Exclusive Orban feedback control circuitry (adapted from our popular 424A Gated Compressor/Limiter/De-Esser) achieves remarkably transparent sound.
- User controls interact intelligently to simplify and speed setup, and to prevent errors.
- Peak limiting and compressor functions are crosscoupled to eliminate potential pumping and modulation effects.
- THRESHOLD control with 20dB range allows user to determine the level at which gain reduction first occurs, without changing below-threshold gain. Ideal for sound reinforcement applications.
- Proprietary circuitry achieves optimum headroom and signal-to-noise regardless of THRESHOLD control setting.
- Front-panel OUTPUT ATTENUATOR control with OUTPUT CLIP LED to indicate line amplifier clipping.
- Illuminated, true peak-reading GAIN REDUCTION meter is more accurate and readable than LED displays.
- GAIN REDUCTION OVERLOAD lamp warns of control circuit overload due to a demand for G/R which exceeds the range of the VCA.
- Hard-wired system bypass switch for fail-safe protection.
- Side-chain externally accessible for special effects such as frequency-selective limiting.
- Active-balanced, floating input and output interfaces easily to any system, balanced or unbalanced.
- Proprietary Class-A Orban VCA features very low distortion and noise.
- Stereo 414A has STEREO COUPLING switch to permit either stereo or dual-mono operation; an unlimited number of units can be wire-coupled to track ± 0.5 dB.
- All-metal chassis with RFI suppression on input, output, and AC leads.

Suggested List Prices:
Model 412A (Mono), \$425.
Model 414A (Dual Channel/Stereo), \$799.

orban

Orban Associates Inc.
645 Bryant St.
San Francisco, CA 94107
(415) 957-1067
Telex: 17-1480

Southern California

Recording

BOOM • DAYS ON THE COAST

by Blair Jackson

Even during the lowest ebb of the recession, Los Angeles had a vital recording scene. True, the big 24 track studios didn't attract as many clients as they had in the late '70s, when it looked like the record business could do no wrong, but the city itself had a vibrant rock scene and the number of small, local groups (most of them in one of the new wave's many offshoots) who did demo and independent recording work in four, eight and 16 track studios increased dramatically. Still, it has taken a tentative nationwide economic recovery and the rebounding of the big-time record industry (thanks in large part to video's ascension to a position of importance) to get the owners of the major studios smiling again.

The clubs are no longer producing the great bands they did just a few years ago, when groups like Wall of Voodoo, X, The Blasters, The Go-Gos, Gary Myrick & the Figures and the

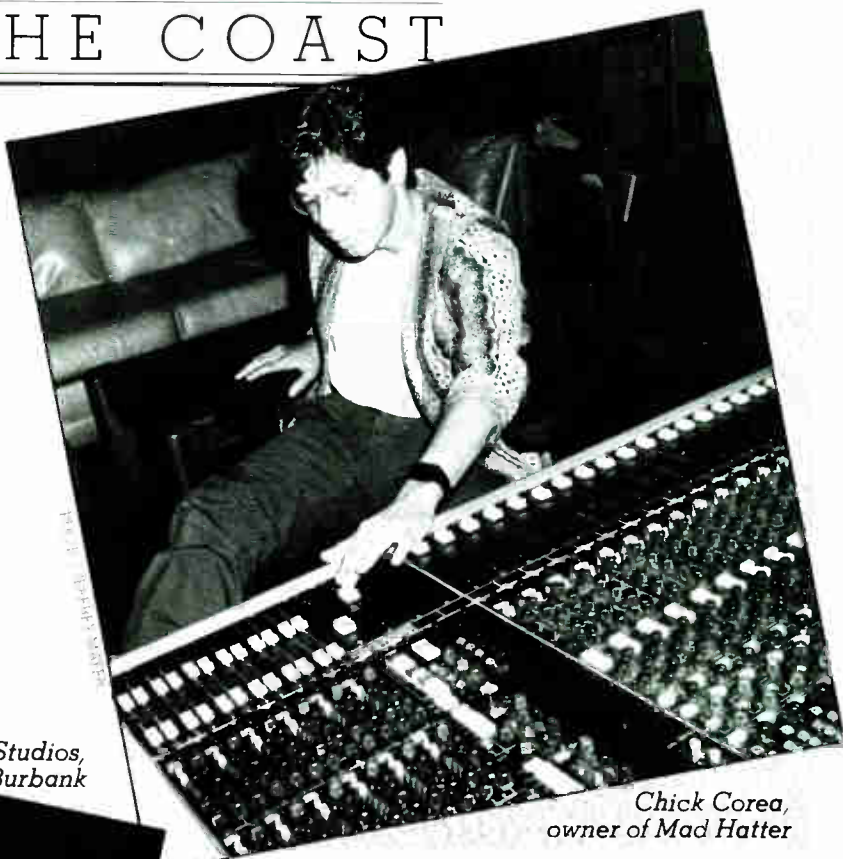

*Chick Corea,
owner of Mad Hatter*

*Evergreen Studios,
Burbank*

very underrated Knack burst upon the scene, but L.A. is still a hotbed of musical activity, and local bands are still being signed, almost daily. When the record companies didn't find hit bands in the city's varied new wave scene (which, despite the lame protestations you might hear from New Yorkers, was unmatched in this country) they turned to other genres, finally scoring with a succession of heavy metal bands of varying quality, including Ratt, Great White, Quiet Riot, and Motley Crue.

The neo-psychedelic underground continues to grow, and bands like Dream Syndicate, Rain Parade, the Long Ryders and Bangles have all put out fine records in the past few months, proof positive that the club scene is still healthy.

But of course the major studio activity area-wide is still in more commercial aspects of the business, ranging from film score work to commercials to sessions with top pop, soul and adult contemporary acts. As one record industry person told us, "A lot of people are doing **very** well right now. It's not like '77, but it'll never be like that again. It's a different time and a different buying audience." Our calls to various studios around Southern California recently confirmed that the industry is on the upswing still and that confidence is running high. The



champagne corks aren't exactly popping all over L.A. quite yet, but at least the bottle is paid for, on ice and waiting.

They'd be celebrating at Glendale-based Tim Pinch Recording except that they're so busy. The TPR remote truck has seen almost constant activity of late, including stints at Disneyland, where Pinch recorded some Big Bands for the Disney Channel, and, more impressive, the recent Olympics. Pinch was hired to mix both the opening and closing ceremonies, which were both massive undertakings. The opening ceremonies involved a 2,000 voice choir, some 85 grand pianos and a multiplicity of other complicating elements that taxed their 52-input Yamaha M406 sub-mixers to the limit.

Over at the Record Plant, Jim Pace tells us that "The digital age is not only coming, but it's here," and that in part explains why the facility purchased Sony digital recording equipment—the PCM 3324—in March. "They're real quality machines," Pace enthuses, "and since they're in the DASH format, they have a future." The studios have been very busy of late with a good combination of different clients. The scoring of this fall's episodes of *Fame* was done there, and such up-and-coming major label acts as Sky Talk, Autograph and Angel City worked there. Devo checked in to do some work, and the *Live from the Record Plant* radio program found the likes of Roger Taylor, Rockwell and Mr. Ghostbusters himself, Ray Parker, Jr., passing through. In addition, Steve Miller used Record Plant equipment for nearly two months of work across town at Capitol. Also of note is that Record Plant's special film/TV scoring facility, dubbed Studio M, on Paramount's Melrose Avenue lot, has been doing quite well.

At Evergreen Studios in Burbank, Studio B has been expanded with the addition of a 14 x 27 iso booth.

Alpha Studios Opens

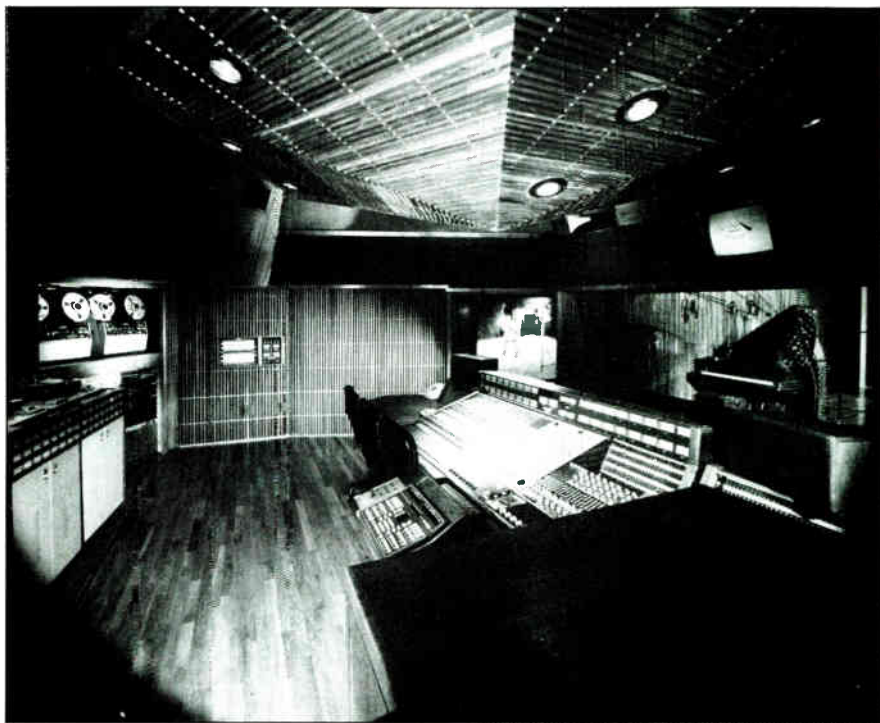

Alpha Studios' control room, live action stage and main studio.

There's been film scoring galore going on at the studio, with clients including Universal, Columbia, CBS-TV, Lorimar Productions and MTM Productions. Recent record dates have featured such "name" acts as The Jacksons (who worked on their *Victory* album there), soul singer Peabo Bryson, Crystal Gayle, Rod Stewart, Rickie Lee Jones, and Harry Nilsson, who's recording an album of Yoko Ono's songs.

Crystal Sound Recording Studios in Hollywood has been enjoying a

—PAGE 96

Alpha Studios in Burbank are sure to create a stir when they re-open as a major 24 track audio and video production and postproduction studio this month. Designed by Gary Brandt and former Warner Bros. Studios man Denny Shaw, Alpha boasts a custom API/Alpha board that features 32 inputs with eight sub-groups, four echo returns and a monitor panel that subceeds; Ampex Series 1200 recorders and ATR 1/2-inch two track; Ampex VPR-2 with TBC; a IVC 8250 for utility; two Panasonic VHS machines; a complete BTX Softouch system and the brand new Pioneer TSM-1 monitors (the second pair made, in fact). The studio is 42x22x12, plus there is a 10x12 iso booth and a full, live-action stage that measures 48x45x12. That stage also has an adjacent control room that can be used for any number of functions and an upstairs lighting booth controls a 1000 amp grid. In addition, Alpha has a lounge, with audio and video playback capabilities, a patio and a separate production room. For more information on rates and particulars call (213) 506-7443.

The Record Plant's massive scoring stage, Studio M, on the Paramount lot.



OUR STUDIOS TOWER OVER EVERYBODY!

- NEVE 8068 and 8108 NECAM
- 2 STUDER A-800 24 TRK
- STUDER A-80 VU MK-III 24 TRK
- Q-LOCK SYNCHRONIZER
- AMPEX ATR 102-104½"
- DIGITAL 2 TRK SONY AND JVC
- DIGITAL 2 TRK MASTERING
- 8 LIVE CHAMBERS
- EMT PLATE • EMT 250



- AMS REVERB & DDL • SUPER PRIME TIME • LARGE ASSORTMENT OF NEW & CLASSIC OUTBOARD EQUIPMENT AND MICROPHONES • DIRECT TO DISC MASTERING • CUSTOM LACQUER AND XDR CASSETTE MASTERING • STUDIO A (60 x 45)



STUDIO B ▲

THE PERFECT COUPLE

▼ MIXDOWN C



Member of EMI World Music Group which includes such well known studios as Abbey Road (England), 301 (Australia) and Toshiba EMI (Japan).



Capitol Studios, 1750 N. Vine Street, Hollywood, California 90028 (213) 462-6252, Ext. 442

©1984 CAPITOL RECORDS INC

Circle #052 on Reader Service Card

prosperous year under its relatively new ownership, according to studio manager engineer/producer Robert Margouleff. "We've had more business the past 14 weeks than all last year," he says. Among the projects handled by the studio were album sessions for Bobby DeBarge, of the Motown family The DeBarges, the English soul-wave group ABC, Epic Records' Bang Bang, various mixing chores for D.I.R. broadcasting, including concerts by Billy Idol, Australia's Midnight Oil, and the Margouleff-produced sessions for Gary Myrick, the talented LA-based rocker who put out three outstanding but generally ignored records for Epic. "This is his best material yet," Margouleff says. "I love working with Gary. He's talented in so many ways." Another project worth mentioning is Alan Douglas' forthcoming film about Jimi Hendrix. Douglas, you may recall, was responsible for a series of controversial Hendrix albums put out by Warner Bros. after Jimi's death featuring contemporary musicians playing along to unreleased vocal and guitar tracks by the axe slinger.

Pasadena's Audio Engineering Associates have kept busy with a wide variety of different clients, ranging from commercial airlines, to corporations to the Los Angeles Philharmonic and the Museum of Contemporary Art. According to studio manager Janet Dodson, one type of session that is definitely on the upswing is demo tapes for classical musicians. The players use the tapes for long distance auditions frequently.

Harlequin Studios in Northridge is among the studios that have upgraded from 16 to 24 tracks since our last Southern California update. To make the switch, owners Paul and Jeff Stillman purchased a Stephens 824B recorder, the last model made by that company, and a customized Tangent 3216 console. Paul Stillman says he sees the upgrading as a natural step in the evolution of Harlequin, as well as an insurance against hard times. "If the economy goes down again, I don't want to go down with it," he says, adding that the switch to 24 track has already changed the sort of clients the studio is attracting. "I'd heard all sorts of things, like 'You'll have trouble matching the punchiness of 16 track,' but that hasn't been the case so far. We're delighted with the way things are going," he says. Harlequin has played host to rock, rap and adult contemporary musicians since making the switch—clients include numerous players, from Jam Power Productions to *Star Trek's* Michelle Nichols, members of Robert Palmer's band, and heavy metal guitar ace Yngwie Malmsteen. Harlequin has also done a considerable amount of work for both cable radio and TV.

—PAGE 98

Southern California **Sessions**

Warner Bros. recording act Zill was at *Skip Saylor Recording* in L.A. mixing an EP. *Guy Spells*, *Michael Lee Remedés*, and *Michael Wells* were the production team with *Skip Saylor* engineering. Also, the group *Crosson* was in cutting tracks with producers *Manny Freiser* and *John Crosson*. . . . Recent projects recording at One On One Studios in North Hollywood included *Andy Johns* producing/engineering debut album for MCA recording artists *Fury*, with *Dave Ahlert* assisting, and *Gerard McMahon* producing, *Joel Soifer* co-producing and engineering MCA artist *Winston Ford's* album, with *Jeff Bennett* assisting. . . . Recently, *Starfax* of North Hollywood took their cameras, crews and equipment out on location with Dick Clark Productions to videotape *Rock Rolls On*, a two-hour syndicated special which currently is sold to 67 stations across the country including KHJ Los Angeles, WOR New York, and WGN Chicago. *Elizabeth Myers* and *Jill Fraser* composed original music for three Nike "Sweats" spots depicting amateur sports at its dripping best. The sessions were recorded by *Mark Howlett* at *EFX Systems* in Burbank, California. *Sacred Nick*, featuring former Quiet Riot and Dokken guitarist *Greg Leon*, has been recording at *Track Record Studios* in Hollywood. The sessions have been produced by Canadian *Eric "Griffy" Greif*. Greif is also producing the first American release for Canadian pop band *Braidy Lace* at *Juniper Recording* in Burbank for Kansas City-based Kondor Records. *Albhy Galuten* produced three sides on *Barbra Streisand's* upcoming album at *Bill Schnee Studios* in North Hollywood. *Jack Joseph Puig* engineered *The Post Group* in L.A. completed postproduction on the first music video for *Glenn Frey's* new album, *All Nighter*; the hit song "Sexy Girl" was shot on film and transferred to tape at The Post Group by Howard Sisko. *The Complex* in West L.A. had its stages one and two utilized for five days for Prince's film *Purple Rain*. The new stage two was also used for *Condor*, an Orion Pictures pilot, when special effects and robotics sequences were lensed at The Complex. Private Eye recording artist *Matthew Wilder* was in at *Conway Recording Studios*, Hollywood doing his new LP. *Peter Bunetta* and *Rick Chudacoff* are producers. *Csaba Petocz* is the engineer with assistance from *Jeff Stebbins* and Rick Clifford. A theme song for the just-passed Summer Olympics was re-

corded at *Sound Affair* studios in Santa Ana. The song "Reaching for the Gold" was used on Olympic telecasts. Arista Records released the single by *Tom Player* for promotion and distribution. *Shandi* (*Mark Walton* producing, *Steve McDonald* engineering) is currently working on a new project at *Brookhill* in Sherman Oaks. Engineer *Rick Riccio* was in at the *Village Recorder* working on tracks for an upcoming CBS Masterworks album featuring *Placido Domingo* with producer *Milt Okun*. Also at the Village Recorder was *Barbra Streisand*, working with producer *Jim Steinman*, engineer *Neil Dorfsman* and assistant *Steve Hirsch*; and *George Benson*, in with producer *Russ Tittleman*, engineer *Gary Ladinsky* and assistants *Jay Willis* and *Clif Jones*. . . . *Emerald City Recording* in Grover City has been busy with varying projects done by: *911*, *Nic Scatena*, *Comission International*, *Danny Hillstock*, *Strictrnine* and *The Next Tyme Band*. *Lumpy* and *Jake* shared the engineering responsibilities for these projects. . . . At *Group IV Recording* in Hollywood *Shadow Fax* layed tracks for their new Windham Hill LP with producer *Chuck Greenberg* and engineer *Harry Andronis*, assisted by *Andy D'Addario*. . . . *JVC Cutting Center's* chief mastering engineer, *Joe Gastwirt*, finished the following LP projects recently: *Top Secret* and *Promised Valley* soundtracks for Varese/Sarabande Records; *The Last Starfighter* and *King Kong* for Southern Cross Records; *Kittyhawk*, for Zebra Records, and a jazz sampler featuring Miles Davis, Branford Marsalis, and Steve Smith for CBS Records. . . . Plenty of action at *Studio Orange* in Santa Ana with *Tiger Lily* working on an EP with producer *Ted Vegvari* and engineer *Tim Vegvari*; *Christos* cutting tracks with producer/engineer *James Melonakos*; and country rockers T.I.C. working on an album with producer *Mark Daniel Jones* and engineer Melonakos. At *Your Recording Studio* (Van Nuys) *Cathy Wyatt* was in recording a new LP with producer *Alan Hart* for an upcoming release on Zanzibar Records. *Alan Hart* and *Tim Bowman* engineered. At *Soundcastle Studios* in Los Angeles, CBS artist *Placido Domingo* was in mixing with producer *Milt Okun*. *Ric Riccio* was at the board with *Mitch Gibson* assisting. Also at Soundcastle, *Thelma Houston* was in working on her latest for MCA. *Dennis Lambert* produced, *Gabe Velti* engineered with *Bino Espinoza* assisting.



More Bass, More Output, More Value. The New KLIPSCH KSM-2.®

The new KLIPSCH KSM-2 is an outstanding monitor value. Its horizontal, slant configuration makes it ideal for use as a stage monitor, yet it can be turned upright for use as a front system in small clubs. Polars remain essentially smooth and constant, either way.

It's a ported two-way system with a 15" woofer and horn loaded tweeter. The measured frequency response of 45 Hz to 14 kHz provides plenty of bass for the monitoring needs of keyboard and drums.

The special input panel allows

easy field change from a parallel wiring configuration to a bi-amp configuration. Separate filters for each driver eliminate the need for an additional electronic crossover network – you can feed full bandwidth into both the tweeter and the woofer without undue problems. And the speaker is conservatively rated at 200 watts power handling.

Yet if you do blow a driver, you don't have to replace a driver. Now driver diaphragms are easily replaced in the field. This feature saves you time, money, and headaches.

Hear the new KLIPSCH KSM-2 at your nearest dealer for KLIPSCH® Professional Products. He's in the Yellow Pages. You'll find a rugged box that arrives on time, ready to go to work.

You'll love this monitor. And you'll love its price.



klipsch®

A Legend In Sound.™

P.O. Box 688 • Hope, Arkansas 71801
(501) 777-6751

Circle #053 on Reader Service Card



Below Dealer Cost! LA Summer Games Special

Available September first. 36 PR 99's with monitor panels below dealer cost. These 15 ips machines are in consoles, carrying cases and rack mounted.

The PR 99's are being used at ABC's International Broadcast Facility. If ABC entrusts international Olympic coverage to Revox, you know you can count on the PR99's for performance and reliability.

The PR 99's will be completely checked out before purchase and include the full one year warranty. So join a winning team this summer, by choosing Revox.

	List	Your Price
PR 99 with monitor panel	\$2,225	\$1,495*
Roll around console and carrying cases available.		
Call for package prices.		

All prices include shipping in the U.S. *Discounts on multiple machine purchase

Remember, this quantity is limited. To secure your machines, a 10% deposit should be sent in immediately to:



audio engineering associates
1029 north allen avenue pasadena, ca. 91104
(818) 798-9127

Circle #054 on Reader Service Card

GRD
AMERICA'S MOST EXPERIENCED REAL TIME DUPLICATOR

The world's largest state-of-the-art cassette duplication facility continues to give you incredible sonic excellence. GRD was first to introduce Real-Time cassette duplication at a reasonable cost, and elevated the cassette to audiophile quality. This year GRD has taken the next step into the future with Digital Duplicating, AGFA's super-extended normal bias 612 tape and high bias 627 tape. GRD will faithfully reproduce your most demanding programs without compromise... in Real-Time at unreal prices.

HIGH QUALITY PRINTING AND ASSEMBLY
CUSTOM LOADED BLANK AGFA CASSETTES, CHROME, 612

(602) 252-0077
P.O. BOX 13054
PHX., AZ 85002

THE RECORDERS Quartz-lock, Auto Bias 30-20,000 Hz, 0.25% w/r.m.s., Dolby B - more than 67 db S/N ratio

Circle #055 on Reader Service Card

—FROM PAGE 96, SO. CALIFORNIA

Recent purchases at the ever-expanding Rocshire Studios in Anaheim include a Quantec Room Simulator, a selection of Charvel guitars ("A lot of guitarists like the variety they offer," notes Rocshire's Lester Claypool), a PPG Wave synth, and on order is a Kurzweil. The studio has been booked heavily of late with sessions by Yngwie Malsteen, the one-time lead guitarist of Rocshire Records' Alcatrazz, Citizen Kane and The Suttons, whose song "Live It Up" was a summer soul hit. Claypool says that recently some clients have enjoyed using the Rocshire remote truck hooked up to the studio facility's giant soundstage: "It's a big room and it hasn't been treated by studio standards. It's got great natural ambience and it's fantastic for loud rock and roll." That's something Rocshire knows a lot about. To help develop their already strong keyboard/synthesizer room, Rocshire has hired producer/composer Ed Freeman as a full-time consultant. According to Claypool, Rocshire is committed to "interfacing computers, video, synthesizers and 24 track automated mixing for film scoring and jingles. This is going to produce some major breakthroughs in scoring technology."

Activity at Rusk Sound Studios in Hollywood has been brisk. Audio post production for visual has run the gamut from a Showtime/PBS Jessica Lange/Rip Torn version of *Cat on a Hot Tin Roof* with Tom Scott scoring, Hank Cicala engineering and Kevin Beauchamp seconding, to *Voyage of the Rock Aliens* with star Pia Zadora doing vocals for a duet with Jermaine Jackson, and the score produced by Jack White with Juergen Koppers engineering. Projects ranging from arena rockers Xeron to HLC doing advertising spots for Wheaties and others (Dick Hart engineering, Frank Nadasy seconding), with Polygram artists Darwun (with producer Koz and engineer Gabe Veltri) and Christian rock band The Goats (engineered by Bill Smith and Bill Poppy for Gabriel Records) fill out the spectrum.

Down in San Diego, New World Audio's Bob Goold tells us that business has been quite good recently with clients coming from a variety of different fields. Aside from work with local musical groups like The Monroes, Color TV and Opal, they did work with both Roger Miller and Randy Newman, both of whom were involved with local stage productions this summer, instructional programs for Kaypro computers, and some recording work for American Airlines.

It was just three years ago that Yamaha built its state-of-the-art recording and R&D studio in Glendale. A single-story brick building designed by Peter Creamer, it is one of the few studios in the area that was built from the ground



The Neotek board at Advanced Media Systems.

up specifically to be a recording studio. Acoustic design was by George Augspurger "to work in the digital age, where ultra quiet recordings are creating new demands for lower studio noise levels." Although it is used frequently as a testing ground for Yamaha the studio is increasingly trying to compete in the commercial arena and has hosted such artists as

Jermaine Jackson, Bil. Withers, Chicago and Fat Boone.

One of the area's newest 24 track facilities is Advanced Media Systems in Orange, owned by former Berlin producer/engineer Dan Van Patten. (In addition, he is a seasoned synthesist and drummer who has worked in those capacities for Berlin and others.) As Van Pat-

ten tells the story, he was working in England last year with Nicky Chinn (of Chinn-Chapman fame) at The Music Works studio as an engineer. He came back to Los Angeles on vacation and was driving around one day when he saw a building that had a "Studio For Lease" sign on it. He'd wanted to open his own studio for some time and when he saw this one he jumped immediately. "Someone had built a Westlake design room but then torn out everything but the frame. So I used the frame and then modified the control room to incorporate Eastlake specs. We just opened in June and business has been great." Equipment in Van Patten's studio includes a Neotek Series IIC 40x24 console, Studer A-80 recorder, an Otari 1/2-inch two track, and lots of outboard equipment and, of course, synthesizers, which remain a specialty of his. Among the groups who have taken advantage of the new studio are his old bandmates in Berlin, who recently used Advanced Media Systems to cut demos for their next Geffen LP, the local band Bachelors Even, an EMI Records group called SFQ, and LA's popular surf/punk/psychedelic rockers Agent Orange. "I've never been busier," Van Patten says, "and so far everything's worked just great. The Neotek console has all the features I wanted. Every day I use it I love it more and more."

SHAPE IT UP

As a professional you don't have time to fool around. With seven years experience in equalizer design, we know what's needed and how to do it.

Our Model 2700 is a precision third octave equalizer employing a fresh approach in its electronic design. The result is a truly superior sounding filter set non-interacting in its control settings and accurate in its calibration.

Our Model 4200A stereo four-band parametric equalizer is an achievement in tuneable filter design. Its multi-range filter banks provide the engineer with a degree of precision control and range of effects available on no other equalizer today.

If technical excellence, sonic performance and dependability are of prime importance to you then depend on AUDIOARTS ENGINEERING, the people with the experience and the know-how.



AUDIOARTS[®] ENGINEERING

5 COLLINS ROAD, BETHANY, CT. 06525 (203) 393-0887

Circle #056 on Reader Service Card

Sunset Sound in Hollywood must be one of the busiest studios in America currently: "We're booked 24 hours a day, seven days a week," bubbles general manager Craig Hubler. "We're having the best year we've had in a few years and we're really close to the levels we hit in the mid-'70s before the recession." Since late Spring, Sunset's newly renovated Studio One (which was their original studio when the facility opened in 1961) has been occupied by a steady stream of industry biggies, all attracted by the large, Augspurger-designed control room "which is the largest one we've ever had. It's equipped with

the latest in a long line of custom Necam-automated consoles. "It's got 68 in, 68 direct out, but it's more like 156 out," Hubler says. "It's designed to accommodate double 24 track mixdown, which is a lot of the work we get. Actually, though, it can accommodate three 24 tracks, but we're usually dealing with 48 tracks. Two recent visitors to Studio One were Kenny Rogers, who cut a Christmas album with engineer Humberto Gatica featuring a slew of celebrities including Olivia Newton-John, Dolly Parton and Laura Branigan; and lead Tube Fee Waybill, in cutting a solo LP with producer David Foster. Other clients of the

studio complex lately have included America, working with producer Matthew McCauley and engineer Mark Linnett, Sheena Easton (producer Greg Mathieson and engineer David Leonard) and Kenny Loggins (producing himself with engineer Terry Christian).

That Studio in North Hollywood is another facility that recently made the jump from 16 to 24 track, with the acquisition of an Otari MTR 90 recorder and a Harrison MR-4 automated board. Explaining the switch, studio manager Richard Holbrook commented, "We had a little money to work with and a lot more work to do, so it made sense." Holbrook says That Studio does a lot of jingle work and regular music sessions, but much of the studio's time is used for in-house projects, notably publishing demos.

At Master Control in Burbank, work is just about complete on the new 24 track studio, which features Studer recorders and a Trident Series 80B custom console, in addition to JBL and Yamaha monitors and outboard gear ranging from AMS and Lexicon digital reverb units to UREI limiters, an Eventide Harmonizer and much more. Co-owner/studio manager/engineer Steve Catania says that he's particularly delighted with the AMS digital reverb: "It's proving to be very popular. We might even buy another one just to be able to rent it out to all the people who want to use it." Commenting on the recording scene around Los Angeles currently, Catania says, "A lot of studios are expanding right now and it seems very healthy. The reason that for the first time in a long time, the budgets are there. It's not quite like a few years ago, but it's way up over the recession period. We're getting a lot of calls." Master Control was designed by Everything Audio's Brian Cornfield and equipped by that outfit, as well. It has a very large control room (21 x 24) and main room (24 x 58 with a 12-foot ceiling), as well as a 14 x 18 iso room. Catania says "The control room is somewhat unique in that we have the monitors at ear level rather than overhead, so you don't have the same kind of problems with reflections." The studio expects to be open by September 1.

Chick Corea's Mad Hatter Studios in LA have been buzzing with nearly constant activity. Although it has been a public studio for a few years now, Ron Moss tells us that the studio is "still trying to escape the stigma of being exclusively a 'jazz' studio. In fact we do a lot of other work here. John Hug has been in producing a group called Fast Forward that is the loudest rock and roll band I've heard in years!" Other unmistakably non-jazz musicians who've used Mad Hatter lately include Windham Hill Records pianist Liz Story, who was in re-

—PAGE 217

Insure Your Studio's Reputation for Great Sound Quality- Use Sound Tech's 1510A!

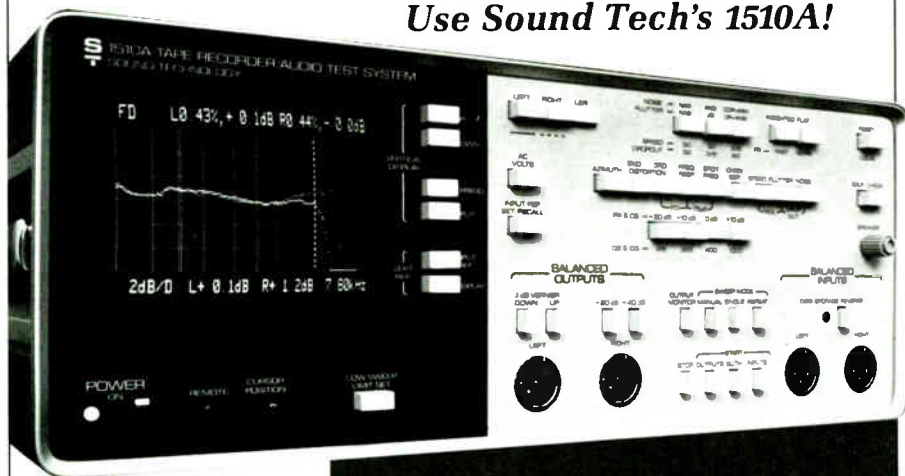

WHY?

Because the 1510A is:

- an in-house maintenance department
- a fast and accurate problem-solver, complete with hardcopy documentation
- a complete test and measurement system for your entire audio chain: ATRs, VTRs, film recorders, signal processing, and room response

**Leaders in Test
and Measurement
for over a Decade**

**SOUND
TECHNOLOGY**

1400 Dell Avenue
Campbell, CA 95008
(408) 378-6540
Telex: 357445

© Sound Technology, 1984

GIVES YOU THE COMPLETE PICTURE

The 1510A is the only two-channel audio test system available today. As a result, it's the only instrument able to perform phasing, channel separation, and many more two-channel comparison tests.

The 1510A's intelligent I/O operation also allows for analysis of test data *regardless* of source (its own internal generator, test records, test tapes, external oscillators). PLUS—all tests are displayed in "real time" on the integral CRT!

THE ULTIMATE INSURANCE POLICY

Got just five minutes in between clients? With the 1510A, you can take that time to increase your confidence factor in solving these on-going problems: verifying tape drop-outs, rebiasing for different tape types, last-minute monitor changes, and unexpected electronic failures.

DESIGNED WITH THE AUDIO PRO IN MIND

Microprocessor control, 14 different on-board tests, differential inputs, electronically-balanced outputs with a clean, low-distortion signal source (typically .005%) from +30 to -70 dBm/600 ohms . . . all contribute to the 1510A's ability to precisely fulfill ALL your audio requirements.

PROTECT YOUR INVESTMENT

Why pay expensive maintenance fees for routine check-ups—why wait for a session-ending electronic failure before you call for *help*—when the 1510A can protect your investment *and* your reputation? Call Sound Technology today to find out more about the 1510A!

Back Issues

- 1981 July, **SOLD OUT** Listings. Please Make Another Selection. Recorder Maintenance. Recording.
- 1981 August, Studio Design Listings. Dealing with the Bldg. Dept., Building Materials. Monitor Field.
- 1981 September, **SOLD OUT** Listings. Please Make Another Selection. Editing. Tape.
- 1981 October, North Central Listings. Digital Reverberation Survey. Chicago Music History.
- 1981 November, 1982 New Products. Studio Monitor Report. Synthesized Drums. Larry Carlton. Al Kooper.
- 1981 December, **SOLD OUT** Listings. Please Make Another Selection. Ritenour. Disc. High Speed.
- 1982 January, Northwest Listings. Mixing Consoles. Grateful Dead's Studio. Lindsey Buckingham.
- 1982 February, Southeast Listings. Digital Synthesizers. Dave Edmunds. John Meyer.
- 1982 March, Northeast Listings. Car's Studio. Microphones. Phil Ramone.
- 1982 April, Video Focus. A/V Studio Listings. Video Music Satellite. Mike Nesmith. Legal Issues in Video. John Boylan.
- 1982 May, Southwest Studios. Quarterflash. Charlie Pride's Studio. Digital Recording. Fantasia Digital Soundtrack.
- 1982 June, Concert Sound & Remote Recording. Drum Machines, Pt. 2. Keyboard Artists Forum. Video Legal Issues. Bones Howe.
- 1982 July, **SOLD OUT** Listings. Please Make Another Selection. ers, Supp. Jones. W.
- 1982 August, 5th Anniv. Issue. History of Recording. Asia. Oscar Peterson. Bill Porter. Beatles' Console.
- 1982 September, S. Cal. Listings. Film Sound. The Dregs. Video Synchronizer Survey. Digital Discussions, I. Supertramp Studio.
- 1982 October, N. Central Listings. Studio Monitors. John Cougar. Digital Discussions, II.
- 1982 November — SOLD OUT. 1982 December — SOLD OUT.
- 1983 January, Northwest Listings. Multi-track Analog Tape Recorders. Record Restoration. Michael Palin. Narada Michael Walden.
- 1983 February — SOLD OUT.
- 1983 March, Southeast Studios. Echo, Reverb & Delay, I. Buddy Buie. Electronic Religion. Phil Dunne.
- 1983 April, Music Video. Video Production, Post Production Listings. Missing Persons. Echo, Reverb & Delay, II. Toto.
- 1983 May, Northeast Listings. Donald Fagen, Mixing Console Forum. Echo, Reverb & Delay, III. Harry Nilsson. Randy Newman.
- 1983 June, Sound Reinforcement/Remote Recording. Showco. Frank Zappa. Mixing Console Forum, II. Papa John Creach.
- 1983 July, Southwest Listings/Recording School Listings. Audio Special Effects. Josef Zawinul. Education Update.
- 1983 August, Studio Design, Designers & Suppliers Listings. Bill Putnam. Phil Collins. Bee Gees' Studio.
- 1984 February, Independent Engineers & Producers. NAAM Show. Ronnie Lane. Keyboard Artists Forum. Allan Holdsworth.
- 1984 March, Southwest Studios. Microphone Special Report. Religious Recording. Oak Ridge Boys. Sound in Australia.
- 1984 April, Video Production & Post-Production. Video Production Supplement. Time Code Special. Jeff Baxter and Brian Setzer.
- 1984 May, Northeast Recording Studios. Studio Computers. NASA Sound. Robert Moog. Billy Joel and Jim Boyer. Roger Nichols.
- 1984 June, Remote Recording & Sound Reinforcement. George Benson's Studio. Computer Music. Pretenders' Chrissie Hynde.
- 1984 July, Southwest Studios, Recording Schools & Programs. Cassette Multitracks Jobs in Recording. King Crimson. Booker T. Jones.

CHECK THE ISSUES YOU'RE INTERESTED IN.

of BACK ISSUES CHECKED ABOVE at \$3.50 each (\$4.50 outside U.S.) _____

CHECK ENCLOSED FOR TOTAL (U.S. Funds) \$ _____

NAME _____

ADDRESS _____

CITY _____ STATE _____ ZIP _____

MAIL TO: Mix Back Issues, 2608 Ninth Street, Berkeley, CA 94710. Make checks payable to Mix Publications; allow four weeks for delivery.



Binders

MIX MAGAZINE is a year-round reference tool. Keep your issues protected, ordered, and readily accessible.

Both handcrafted styles are bound in textured crimson leatherette, embossed with the gold-leaf embossed MIX logo and gold transfer slips for indexing volume and year.

SATISFACTION GUARANTEED OR YOUR MONEY REFUNDED!

LIBRARY FILES: 12 issues are organized for storage and slide out individually for use.

BINDERS: 12 issues are bound for protection and open flat for easy reference.

MAIL TO: Jesse Jones Box Corp., P.O. Box 5120, Dept. MIX, Philadelphia, PA 19141. Make check payable to Jesse Jones Box Corp.; allow six weeks for delivery.

Quantity _____ Please send me:
 _____ **LIBRARY FILES @ \$5.95, 3 for \$17.00,** \$ _____
 6 for \$30.00
 _____ **BINDERS @ \$7.50, 3 for \$21.75,** \$ _____
 6 for \$42.00
CHECK ENCLOSED FOR TOTAL \$ _____
 (U.S. Funds)

NAME _____

ADDRESS _____

CITY _____ STATE _____ ZIP _____

Southern California

Studio Location Index

All studio information listed has been supplied to the Mix by studios responding to questionnaires mailed in April 1984. People, equipment and locations change, so please verify critical information with the studios directly. The Mix does not take responsibility for the accuracy of the information supplied to use by the studios.

Number of Tracks	Page	Number of Tracks	Page	Number of Tracks	Page
ALHAMBRA		CAPISTRANO BEACH		24 Tim Pinch Recording	126
24 Martinsound Recording	124	4 Incidental Sound	108	24 Studio on Wheels	133
ANAHEIM		CARDIFF-BY-THE-SEA		24 The Truck	136
24 Rocshire Studios	128	8 Maxtrax Recording	108	24 Yamaha Rec. Studios	138
ARCADIA		CARSON		GOLETA	
8 Impact Audio	108	24 Piper Recording	126	4 Crystal Ship Recording	107
ARROYO GRANDE		CLAREMONT		8 J.E.R. Studio	108
8 Central Coast Recording	106	8 The Attic	106	GROVER CITY	
ATASCADERO		24 Winetree Village Recording	138	8 Emerald City Recording	107
16 Sutton Sound Studio	116	CLOVIS		HEMET	
BAKERSFIELD		8 New Jerusalem Records	108	4 McCay Mobile Audio	108
8 Chase Music Productions	106	COSTA MESA		HOLLYWOOD	
4 Creative Media	107	24 Front Page Recorders	122	24 A & M Recording	117
8 Custom Audio Recording	107	24 Golden Goose Recording	122	24 Artisan Sound Recorders	117
BALDWIN PARK		8 Mad-den Studio	108	8 Ascot Recording	106
24 Morning Star Sound Recording	124	4 Moffett Manor Recorders	108	24 Baby 'O Recorders	117
BEVERLY HILLS		CULVER CITY		24 Bell Sound Inc.	117
24 Audio Affects	117	8 John Barr Productions	106	24 Blue Dolphin	117
BUENA PARK		24 Studio II	133	24 Britannia Studios	117
8 Hot Mix Recording	107	8 Sunburst Recording & Prodns.	110	24 California Recording	118
8 JSL Recorders	108	24 Westwood One	138	24 Capitol Records	118
16 Apollo Recording	114	DOWNNEY		24 Classic Sound	119
BURBANK		4 Jay Staggs	110	24 Clover Recording	119
16 B & B Sound Studios	114	EL CAJON		24 Conway Recording	119
24 Channel Recording	119	24 Fanfare Recording	120	24 Crystal Sound Recording	119
24 Compact Sound Services	119	EL CENTRO		24 Doctor Musix	120
24 EFX Systems	120	16 Rose Studios	115	24 Fast Forward Rec.	120
24 Evergreen Recording	120	ENCINITAS		4 Golden Era Studios	107
16 Fattrax Studios	114	8 Padded Cell Studio	110	24 Group IV Recording	122
24 Juniper Recording	123	ENCINO		24 Image Recording	123
24 Kendun Recorders	123	4 Mr. Mess Rec.	108	24 Fred Jones Recording Services	123
4 Koala Studio	108	FRESNO		16 Kitchen Sync	115
24 Master Control	124	16 Kenio Audio Inc.	115	24 KSR Studios	123
24 RSC	124	16 Studio B Prodns.	116	24 L. A. Studios	123
8 Synapse Recording	111	24 Trac Record Co.	136	24 Motown/Hitsville	124
24 Synth Room	134	24 Triad Recorders	136	24 Music Lab	124
CAMARILLO		FULLERTON		16 Original Sound Recording	115
8 R. E. Copsey Recording	107	16 Casbah Recording	114	24 Pasha Music House	126
24 Poiema Studios	126	GARDEN GROVE		24 Present Time Recorders	127
CANOGA PARK		4 Creative Media	107	24 Producers Workshop	128
24 Rumbo Recorders	129	GLENDALE		16 Remote Recorders	115
CANYON COUNTRY		4 Berkens Sound Recording Labs	106	24 G. Nash's Rudy Records	124
24 Custom Sound Recording	119	24 MCA Whitney Recording	124	24 Rusk Sound Studios	129
				24 Sage & Sound Recorders	130

SYSTEMS OF THE 80'S



*ITAM model 1610
1"-16 track,
7½, 15 & 30 ips,
+ 4 in/out, full
function remote
standard.

Whether you're building an 8 or 16 track studio, these Professional Performers from Allen & Heath, Otari and Itam will give you master quality results for the price of a semi-pro - 10 dBm system.



*Allen & Heath's
amazing #1616,
16 track recording
console with full 16
track monitoring, + 4
in/out.

Both as shown above for under \$17,000.

*Both Consoles Feature:

- External power supply with phantom power
- 3-band EQ with mid-sweep and selectable shelving
- Smooth long travel fader
- Peak LED on all inputs
- Insert points on inputs and outputs
- EQ cut switch
- Line inputs normal to monitor section.



*Otari #MK III-8,
½"-8 track,
+ 4 in/out



*Allen
& Heath
#168,
8 track
recording
console with
full 8 track
monitoring,
+ 4 in/out.

Both as shown above
for under \$9000

At Professional Audio, we sell quality recording systems to fit your budget and your needs. Stop by today for a *FREE* "Hands On" demonstration with a qualified professional.

**PROFESSIONAL
AUDIO SERVICES
AND SUPPLY CO.**

4628 West Magnolia Blvd. • Burbank, CA 91505 • 818/843-6320

Number of Tracks	Page	Number of Tracks	Page	Number of Tracks	Page
24 Sound Labs	132	8 Positive Media	110	16 Spectrum Studio	115
8 Studiohouse	110	24 Present Time Recorders	128	4 Stratosound	110
16 Studio 9 A/V Labs	116	24 Prime Track	128	SANTA MONICA	
24 Sunset Sound	134	24 Sound Master A/V Recording	132	24 Ground Control	122
24 Sunset Sound Factory	134	16 Studio A	115	16 Scottsound	115
24 Sunwest Studio	134	24 Studio Sound Recorders	134	24 Sound Solution	133
24 Taj Soundworks	134	24 That Studio	135	8 The Studio	110
24 T.A.P.E. Recorders	135	24 J. Thomas Studios	135	8 Zacuto Audio	112
24 Track Record	136	24 Valentine Recording	137	SAUGUS	
24 United/Western	136	16 Watermark Studios	116	16 E.D.B.	114
4 Howard Valentine	112	24 Weddington Studio	137	SEASIDE	
HUNTINGTON BEACH		24 Wizard Recording	138	8 Bard Recording	106
24 Adamo's Recording	117	NORTHRIDGE		SHERMAN OAKS	
24 Sound Advice	131	24 Harlequin Sound/Recording	122	24 Brookhill	118
INGLEWOOD		24 Precision Recorder	127	24 Footprint Sound	122
8 Underground Studio	112	OCEANSIDE		24 Record One	128
IRVINE		8 Exxel Recording Studios	107	16 K. Stevens Enterprises	115
24 Soundome	131	OJAI		8 VCA Audio	112
LAGUNA BEACH		24 Zero Studios	140	16 Woodcliff Studios	116
8 Laguna Sound Stage	108	ONTARIO		SIERRA MADRE	
LA MANANA		8 The Reel Thing	110	8 Southwest Recording	110
24 Ryan Recording	130	ORANGE		SIMI VALLEY	
LONG BEACH		24 Advanced Media Systems	117	4 Audio & Video Arts	106
8 Cantrax Recorders	106	24 Studio Orange	134	STUDIO CITY	
8 db Productions	107	OXNARD		8 Digisis Studio	107
24 Trianon Recording	136	8 King Recording	108	24 Fidelity Recording Studios	121
LOS ANGELES		PALM SPRINGS		24 Sound Connection	131
16 Acrasound Recording	114	16 Merchantile Recording	115	24 Sunswep Studios	134
8 Amp Records	106	PASADENA		8 Rick Lee Vinson Ent.	108
4 Big Ween Studios	106	24 Audio Engineering Assoc.	117	SUNLAND	
16 Buzzy's Recording Services	114	24 Fifty-Four East Sound Recorders	122	24 Sound Vault Studios	133
4 California Communications	106	4 Milan's Audio Services	108	SUN VALLEY	
8 Cantrax Recorders	106	24 Pasadena (Sound) Recorders	126	24 Perspective Sound	126
8 Chalet Studios	106	24 Sound Chamber Recorders	131	TARZANA	
8 Control Center	106	PLAYA DEL REY		24 Can-Am Recorders	118
24 Detroit Sound Studio	119	4 Rag Recording	110	THOUSAND OAKS	
24 Digital Sound Recording	119	POWAY		16 Dreammaker Recording	114
24 Fiddlers Rec. Studio	121	8 Southland	110	16 Future Sound	115
24 Fiesta Sound & Video	121	RANCHO MIRAGE		TOPANGA	
8 Fullersound A.V. Recording	107	24 A&R Recording Services	117	24 Skyline Recording Co.	131
24 Hit City West	122	RIVERSIDE		TORRANCE	
24 Hit Man Recording	123	8 George's Recording	107	8 Donovan Sound	107
4 Lane Audio & Records	108	REDONDO BEACH		24 Dynasty Studio	120
24 Larrabee Sound	123	24 Total Access Recording	135	16 Travel Tracs	116
24 Lion Share Recording	123	8 Beach Recording & Filmworks	106	TUJUNGA	
24 Mad Hatter Studios	124	RESEDA		24 Promise Productions	128
8 Music Box Recording	108	8 Harpaz Recording Studio	107	VAN NUYS	
24 Music Grinder Studios	124	8 Superior Sonics	111	16 Denton Studio	114
16 Muzic Trak	115	SAN DIEGO		16 Kingsound Studios	115
24 Odd E/O Engineering	126	16 Accusound & Video Studios	114	24 Salty Dog Recording	130
24 Quad Teck Studios	128	4 Advent Studios	106	24 Sound City Inc.	131
24 Record Plant	128	8 Audio Recorders	106	24 Westworld Recorders	138
24 Skip Saylor Recording	130	8 Audiovision	106	8 Your Recording Studio	112
24 Sound Arts	131	24 Circle Sound	119	VENICE	
24 Soundcastle Recording	131	8 M. Ewing's Soundtech Recording	107	8 Imaginary Studios	108
24 Studio 55	133	16 Hit Single Recording Services	115	24 Mad Dog Studio	124
24 Studio Masters	133	16 Lightning Corp.	115	VENTURA	
8 Supersound Studio	110	24 New World Recording	124	8 Catalina Recording	106
8 Theta Sound Studio	112	8 Night Vision Studios	108	8 Eight Ball	107
16 Trax Sound Recording	116	24 Seacoast Recording	130	24 Goldmine Recording	122
24 Village Recorders	137	16 Soundtrax Recording	115	VISALIA	
24 Westlake Audio Studios	137	24 Studio West	134	8 Power House Recording	110
24 Wilder Bros. Recording	138	24 Sunsound Studio	134	8 Sierra Recording	110
LYNWOOD		24 Western Audio Recording Studios	137	WEST COVINA	
24 NSP Studios	126	SAN GABRIEL		8 Garage Audio & Video	107
MALIBU		8 Syntrax Productions	111	WEST LOS ANGELES	
24 Indigo Ranch	123	SAN PEDRO		24 The Complex	119
NEWPORT BEACH		4 Joel Productions	108	WESTLAKE VILLAGE	
4 Phusion	110	SANTA ANA		24 Westwind	138
16 J.E.L. Recording	115	8 Moser Sound Prodn.	108	WESTMINSTER	
NORTH HOLLYWOOD		16 New South Communications	115	16 Gopher Baroque Prodn.	115
24 Amigo Studios	117	8 South Coast Recording	110	8 Selah Recording Studio	110
24 Best Audio/Best Scoring	117	24 Sound Affair	131	WHITTIER	
4 Customcraft Recordings	107	24 White Field Studio	138	16 Duchess Studios	114
24 Devonshire Sound	119	16 Evan Williams Recording	114	WOODLAND HILLS	
24 Enactron Truck/Magnolia Sound	120	SANTA BARBARA		24 Preferred Sound	127
24 Flores Rec. Studios	122	8 Master Tracks Rec. & Multimedia	108	4 Studio 23	110
24 Monterey Sound Studios	124	4 Don Messick Sound Studio	108	YORBA LINDA	
24 One on One Studios	126	24 S.B. Sound Recording	130	24 Foss Sound & Video	122

CALL FOR PRODUCTION
CONSULTATION AND STUDIO VISIT

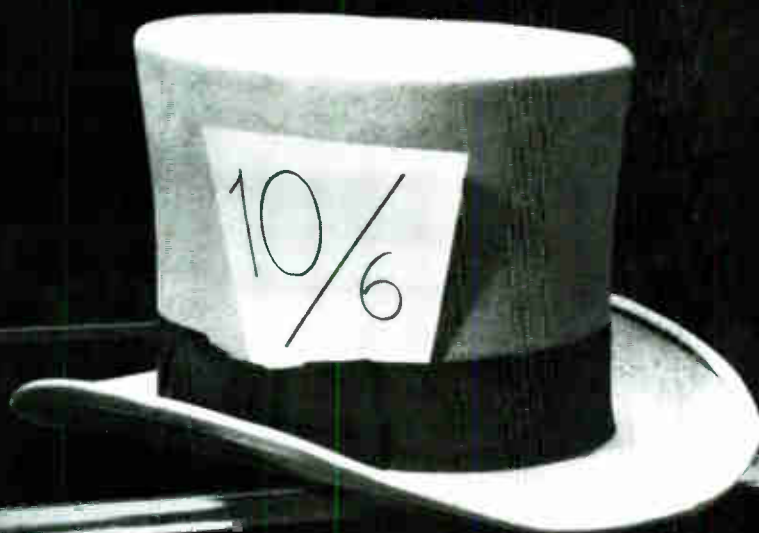

MAD HATTER

RECORDING STUDIOS

"The building of Mad Hatter Studios is the realization of an old dream of having a place where musicians could make music in a free, easy atmosphere.

Our technical concept is: clarity of sound -
Our musical concept is: the artist's vision realised."

- *Chick Corea*

CONTACT: RON MOSS, STUDIO MANAGER - BERNIE KIRSH, CHIEF ENGINEER

MAD HATTER RECORDING STUDIOS, 2635 GRIFFITH PARK BOULEVARD, LOS ANGELES, CALIFORNIA 90039 (213) 664-5766

World Radio History
Circle #060 on Reader Service Card

Southern California



4&8 Track

• **ADVENT STUDIOS**
4304 Randolph Terrace, San Diego, CA 92103
(619) 296-7599

Owner: Jim Morlino
Studio Manager: Jim Morlino
Engineers: Jim Morlino, Ken Robertson, Tim Reid
Dimensions of Studio(s): 30 x 12
Dimensions of Control Room(s): 15' x 7'
Tape Recorders: TEAC 3440 4 track, TEAC X3 2 track, TEAC C-3HX Cassette, (2) Technics M245X Cassette
Mixing Consoles: Carvin MX1202 12, 12, Carvin MX 1688 16 8
Monitor Amplifiers: QSC, Yamaha, Kenwood
Monitor Speakers: Advent, Cannon
Echo, Reverb & Delay Systems: Live Chamber, Furman RV-1, Delta Lab, Digital Delay, Various Tape Delay, Roland Analog Delay, DDD Digital Delay.

Other Outboard Equipment: Furman compressor/limiter, dbx noise reduction on all machines; Roland stereo chorus and assorted effects; Carvin and Roland EQ's; Technics turntable
Microphones: AKG, Beyer, Shure, Sony
Instruments Available: Steinway Grand and Gulbransen upright pianos, Fender Rhodes, Yamaha DX 7; Sequential Circuits PRO1, Prophet 5 Fender Jazz bass, Gibson 335, Yamaha acoustic, Music Man, Fender and Roland amps. Drums, congas, and lots of percussion
Rates: \$15/hour (block rates available)

• **AMP STUDIOS**
also *Remote Recording*
7188 Sunset Blvd., Suite 204, Los Angeles, CA 90046
(213) 876-2552
Owner: Alternative Music Productions, Inc. (aka AMP Records)
Studio Manager: John Brock

• **ASCOT RECORDING STUDIO**
5904 Sunset Blvd., Hollywood, CA 90028
(213) 466-8355
Owner: James Hayton
Studio Manager: James Rayton
Engineers: James Rayton
Dimensions of Studio(s): 18 x 25
Dimensions of Control Room(s): 12 x 15
Tape Recorders: Stephens 8 track, Ampex 4 track, 3M & Tascam 2 tracks, Pioneer 1/2 & 1/4 stereo, TEAC & Pioneer cassettes (4).
Mixing Consoles: Opamp Labs 1204, 12 in x 4 out plus 12 direct
Monitor Amplifiers: Opamp 423s
Monitor Speakers: Altec 604Es w/Mastering Lab crossovers
Echo, Reverb, and Delay Systems: Fairchild reverb, Lexicon Prime Time, Eventide H910 Harmonizer
Other Outboard Equipment: Orban parametric EQ, Orban stereo synthesizer, UREI tube limiters, Teletronix LA3A leveling amps, Gramham/Gotham disk cutting system
Microphones: AKG, Neumann, PML Condensers, E-V & Shure dynamics, HCA, Shure, Altec ribbons, mix direct boxes
Instruments Available: Grand piano, Lowrey organ w/synthesizer and strings
Rates: \$24/hr 2 track, \$30/hr 4 and 8 track, add 1/2 after 6 pm

• **THE ATTIC**
678 California Dr., Claremont, CA 91711
(714) 621-7768
Owner: Dr. A. John Mallinckrodt
Studio Manager: Dr. A. John Mallinckrodt

• **AUDIO RECORDERS**
3843 Richmond, San Diego, CA 92103
(619) 296-6355
Owner: John A. Mullen
Studio Manager: John A. Mullen

• **AUDIO & VIDEO ARTS**
PO Box 398, Simi Valley, CA 93062
(805) 583-0540
Owner: Paul Gardocki
Studio Manager: Paul Gardocki

• **AUDIOVISION**
3191 Adams, Ave., San Diego, CA 92116
(619) 280-7941
Owner: Jon A. Cline
Studio Manager: John P. Thompson

• **BARD RECORDING**
also *REMOTE RECORDING*
1760 Fremont Blvd., Seaside, CA 93955
(408) 394-9170
Owner: Viktor Klincker, Walter Vicjan, Guy Powell
Studio Manager: Viktor Klincker, Walter Vicjan, Guy Powell

• **JOHN BARE PRODUCTIONS**
PO Box 4988, Culver City, CA 90231
(213) 390-5081
Owner: John Bare
Studio Manager: John Bare

• **BARR RECORDERS**
5238 Laurel Canyon Blvd., N. Hollywood, CA 91607
(818) 506-0100
Owner: Barron Abramovitch
Studio Manager: Barron Abramovitch

• **BEACH RECORDING AND FILMWORKS**
also *REMOTE RECORDING*
16119 Inglewood Ave., Redondo Beach, CA 90278
(213) 371-5793
Owner: David Harms, Geoff Emery and Mike Colton
Studio Manager: Geoff Emery

• **BERKENS SOUND RECORDING LABS**
also *REMOTE RECORDING*
1616 W. Victory Blvd., Glendale, CA 91201
(818) 246-6583
Owner: William Berkuta, Richard P. Stevens, II
Studio Manager: William Berkuta

• **BIG WEEN STUDIOS**
922 San Vicente Blvd., Los Angeles, CA 90069
(213) 659-9569
Owner: Jim Herter
Studio Manager: Jim Herter

• **CALIFORNIA COMMUNICATIONS**
6900 Santa Monica Blvd., Los Angeles, CA 90038
(213) 466-8511
Owner: Bill Muster
Studio Manager: Daryl Fredrick

• **CANTRAX RECORDERS**
also *REMOTE RECORDING*
2119 Fidler Ave., Long Beach, CA 90815
(213) 498-6492
Owner: Richard J. Cannata
Studio Manager: Nancy Cannata

• **CATALINA STUDIO**
6003 Fiesta St., Ventura, CA 93003
(805) 644-2618
Owner: Lyndon Turner
Studio Manager: Michael Lusa

• **CENTRAL COAST RECORDING**
also *REMOTE RECORDING*
684 Stagecoach Rd., Arroyo Grande, CA 93420
(805) 489-7861
Owner: Robert and Ruth Montano, Louie Arduini, Paul Stanton, Herbert Barr
Studio Manager: Herbert Barr
Engineers: Woodrow Barr, Robert Barr
Dimensions of Studio(s): Small
Dimensions of Control Room(s): Small
Tape Recorders: Tascam 38 8 track, Revox A77 2 track, Reeper 707, 1 track Various cassette deck
Mixing Consoles: Carvin 1608 16 8
Monitor Amplifiers: Dyna, Harmon Karson
Monitor Speakers: JBL, Auratones
Echo, Reverb & Delay Systems: Barr Plate Reverb, Sonar Concepts D.D., Ibanez D.D.
Other Outboard Equipment: Eight channel dbx, Ibanez multi-effects
Microphones: Neumann U 87, KM 84 Various Shures, E-V, AKG, Beyer, Sony, Sennheiser
Instruments Available: 1895 Ivers and Pond acoustic piano, Wuritzer electric piano, Hohner clavinet, Fender precision bass, various acoustic and electric guitars, selection of amps
Rates: Upon request

• **CHALET STUDIOS**
3247 Shasta Circle North, Los Angeles, CA 90065
(213) 256-5350
Owner: Greg Tiner
Studio Manager: Greg Tiner

• **CHASE MUSIC PRODUCTIONS**
also *REMOTE RECORDING*
6501 Bronson Lane, Bakersfield, CA 93309
(805) 832-0910
Owner: Don & Nancy Chase
Studio Manager: Don Chase



AUDIOVISION
San Diego, CA

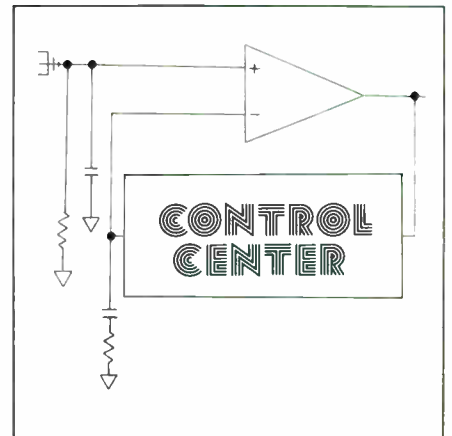

THE CONTROL CENTER
Los Angeles, CA

• **THE CONTROL CENTER**
128 No. Western St., Los Angeles, CA 90004
(213) 462-4300 & (213) 413-2522
Owner: Aseley Otton, Rick Altshuler
Studio Manager: Rick Novak
Engineers: Aseley Otton, Rick Altshuler, Rick Novak, Steve Catania, Frank E. Blew, Curt Wilson

Dimensions of Studio(s): 18 x 24 main room, 7 x 12 live room
 Dimensions of Control Room(s): 12 x 16
Tape Recorders: Otari 5050 8 track w/VSO, Otari 50 50B 2 track w/VSO, TEAC A4010S ¼ track, Technics M-45 cassette, Sony TC FX44
Mixing Consoles: Sound Workshop 1280, 12 in x 8 out, w/super EQ and meter bridge
Monitor Amplifiers: KGW, Crown
Monitor Speakers: JBL 4312, Auratone 5C
Echo, Reverb, and Delay Systems: Ursula Major Space Station, Digital reverb and delay, MXR digital delays (2), Tape delay, Eventide 910 harmonizer and delay
Other Outboard Equipment: dbx 161 compressors (2), stereo chorus, MXR flanger, DOD flanger, URF-11.N1 176 limiter patch bay, pinball game!
Microphones: AKG 414 ER, 452 Neumann U-87, Sennheiser 441, 421, Shure SM 57, SM 77, Sony ECM 22 P
Instruments Available: Howard baby grand piano, Hammond B-3 w/Leslie, Rogers drum, Precision bass, LinnDrum
Rates: Call for rates

•• R.E. COPSEY RECORDING
 also REMOTE RECORDING
 PO Box 367, Camarillo, CA 93011
 (805) 484-2415
 Owner: Reese E. Copsey
 Studio Manager: Reese E. Copsey

• CREATIVE MEDIA
 7271 Garden Grove Blvd., Suite E, Garden Grove, CA 92641
 (714) 892-9469
 Owner: Tim Keenan
 Studio Manager: Tim Keenan

•• CREATIVE PRODUCTIONS
 3128 Linden Ave., Bakerfield, CA 93305
 (805) 325-3676
 Owner: Roger Thiesen
 Studio Manager: Roger Thiesen



CRYSTAL SHIP RECORDING
 Goleta, CA

• CRYSTAL SHIP RECORDING
 PO Box 1534, Goleta, CA 93116
 (805) 687-8660
 Owner: Ray Greene, Craig Padgett
 Studio Manager: Ray Greene

•• CUSTOM AUDIO RECORDING
 also REMOTE RECORDING
 929 Calif. Ave., Bakerfield, CA 93309
 (805) 324-0736
 Owner: Trenton Houston
 Studio Manager: Trenton & Kenneth Houston

• CUSTOMCRAFT RECORDINGS
 also REMOTE RECORDING
 5440 Ben Ave., N. Hollywood, CA 91607
 (818) 509-9649
 Owner: Dean Talley
 Studio Manager: Thomas D. Talley

•• db Productions
 also REMOTE RECORDING
 PO Box 21273, Long Beach, CA 90801
 (213) 433-7727
 Owner: Dan Brown, Bruce Crook
 Studio Manager: Mary Crook

Engineers: Dan Brown, Bruce Crook, Arthur Wright
 (Maintenance)
Dimensions of Studio(s): 10 x 20
Dimensions of Control Room(s): 10 x 5
Tape Recorders: Ampex AG 440 8, Revox A77 Pro w/VSO 2-½ track, Sony TC FX44 Cassette
Mixing Consoles: NSP 84 B 16x8x2
Monitor Amplifiers: Sony
Monitor Speakers: Yamaha NS-10M, Realistic Minimals, 3 AKG Headphones
Echo, Reverb & Delay Systems: NSP Concert-1 Stereo Reverb Roland digital delay SD1000
Other Outboard Equipment: NSP 114-A Stereo Limiter, NSP Quadrate Noiseate, MXR Graphic EQ
Microphones: Neumann, ATM, AKG, PZM, Sony, Shure, NSP Direct Boxes
Instruments Available: Assorted guitars and keyboards
Rates: \$40 per hour plus tape/8 track (block rates available) \$35 per hour plus tape and mileage 2 track remote

•• DIGISIS STUDIO
 3888 Alta Mesa Dr., Studio City, CA 91604
 (818) 761-0275
 Owner: Peter and Karen Schless
 Studio Manager: Karen Schless
Dimensions of Studio(s): 18 x 22
Tape Recorders: Otari MX5050 MkIII 8 track w/Otari CP116 Auto Locator, Technics SV1100 digital 2 track, Otari 5050B MkIII ¼" 2 track, (2) IVC DD66 cassette decks
Mixing Consoles: Amek Tac console 16x8x2
Monitor Amplifiers: Haller DH500W, Haller DH2:0W
Monitor Speakers: Yamaha NS 10Ms, Auratones
Echo, Reverb & Delay Systems: Ursula Major 8x32 digital reverb, Korti DP 3000 programmable digital delay, Eventide 949 Har monitor
Other Outboard Equipment: dbx 160 compressor, ADS Vocal Stessor, Dyno My Tri Stereo Chorus, (2) PB64 patch bays, necessary support equipment
Microphones: AKG 414 ER, Shure SM57, SM58, E-V DS35
Instruments Available: (2) Mid-d digital synthesizers - (4) Yamaha DX 7s, Yamaha CE 20, Yamaha CE 25, Yamaha GS 2, IBM PC computer, Apple 2E computer, Prophet V analog synthesizer w/L Cooper sequencer, Simmons Drums Brain, Emu Drumulator custom built Fender Stratocaster guitar w/hand wound Seymour Duncan pickups, Hohner Clavinet w/Castlebar modification
Video Equipment & Services: BTX Shadow, BTX 5300 video display, Sony 5850 Umatic video ¼" cassette recorder, Sony 5800 Umatic playback machine, Sony Trinitron 20" color monitor, JVC 12" color monitor

Extras: A secluded studio in a private medieval castle on a mountain top with a panoramic view, hot tub, and guest quarters available. Five acres of hillside and hiking. Graphic arts department, secretarial service, and catering available on premises
Direction: Digisis is a "new school music" studio with all direct recording and main emphasis on midi controlled computerized digital synthesis. On full time staff are Peter Schless, producer/composer/synthesist, Bo Tomlin, sound designer/composer/producer and two additional writers and synthesists. This studio is designed for motion picture and video soundtrack productions, artist pre-production, and TV and radio commercial applications

•• DONOVAN SOUND ENGINEERING
 also REMOTE RECORDING
 1327 Cabrillo Ave., Torrance, CA 90501
 (213) 533-9531
 Owner: Audio Achievements Int'l. Cal Corp
 Studio Manager: Donovan Smith

•• EIGHT BALL
 414 S. Arcade, Ventura, CA 93003
 (805) 648-5613
 Owner: Steve Dingle
 Studio Manager: Steve Dingle

•• MIKE EWING'S SOUNDTECH RECORDING STUDIOS
 (619) 296-3451

•• EXXEL RECORDING STUDIOS
 102 North Ditmar Street, Oceanside, CA 92054
 (619) 722-8284
 Owner: J. Richard Lee Inc.
 Studio Manager: Bill Kottkamp
Engineers: Ron Jakeway, Bill Berry
Dimensions of Studio(s): A 20 x 14 B 12 x 6
Dimensions of Control Room(s): A 20 x 8 B 12 x 9
Tape Recorders: Otari 5050 MkIII 8 w Auto Locator 8-track, Otari 5050 BII 2-track, Ampex (2) AG-440B 2,1 track, Revox A700 2 track, Ampex ATR700 2-track
Mixing Consoles: BIMIX 1280, 12/8, EV TAPCO 5208, 8/2
Monitor Amplifiers: Haller, Crown, BGW, JBL
Monitor Speakers: JBL 4311, 4313, Yamaha NS-10, Auratones
Echo, Reverb & Delay Systems: Orban Stereo Reverb

Other Outboard Equipment: Valley People Dyna-Mite 430, EXR SP11 Projector, 1/3 Octave Equalizers, Sony 3-head cassette decks, dbx Noise Reduction on all channels, Turntables, tape transports
Microphones: AKG 414(2), Electro-Voice, Shure, Sennheiser, Audio Technica, others
Instruments Available: New Yamaha U 4 Piano, Yamaha DX-7, Celebration Organ, any instrument available upon request
Rates: Please call for a pleasant surprise!
Extras: Complete post production services available including cassette duplication, reel duplication, packaging and mailing. If you like we can provide you with a producer, an arranger, and musicians and singers. We also have our own record label and we offer excellent album packages including hundreds of soundtracks of gospel and sacred songs to choose from. We'll take care of all the details including copyright negotiation, the ordering of soundtracks (if you want to use them), and the acquisition of mechanical licenses
Direction: We are dedicated to clean, pure, natural sound and our professional staff will make every accommodation possible to give every client just that. Our equipment is new, set up for fully professional levels, and impeccably maintained and operated by experienced engineers. Choose EXXEL for the sound of excellence.



EMERALD CITY RECORDING
 Grover City, CA

•• EMERALD CITY RECORDING
 1050 Griffin, Grover City, CA 93433
 (805) 489-9455
 Owner: B. Sahroian, J. Dunn, T. Martin
 Studio Manager: Lumpy

•• FULLER SOUND A.V. RECORDING
 P.O. Box 65051, Los Angeles, CA 90065
 (213) 660-4914
 Owner: A Division of Creative Support Services Advertising Agency
 Studio Manager: Michael J. Fulton, Jr.

•• THE GARAGE AUDIO AND VIDEO
 West Covina, CA 91790
 (818) 337-7943
 Owner: Patrick E. Woertink
 Studio Manager: Alan Clark

•• GEORGE'S RECORDING STUDIO
 also REMOTE RECORDING
 4375 Highland Place, Riverside, CA 92506
 (714) 682-8942
 Owner: George Williams

•• GOLDEN ERA STUDIOS
 1404 N. Catalina, Hollywood, CA 90027
 (213) 668-1590
 Owner: Church of Scientology
 Studio Manager: Sheldon Mousell

•• HARPAZ RECORDING STUDIO
 19559 Valerio St., Reseda, CA 91335
 (818) 993-3272
 Owner: Yair Harpaz
 Studio Manager: Yair Harpaz

•• HOT MIX RECORDING
 5892 Los Molinos, Buena Park, CA 90620
 (714) 761-2621
 Owner: Bob Chance
 Studio Manager: Bob Chance

•• **IMAGINARY STUDIOS**
 971 Indiana Ave., Venice, CA 90291
 (213) 396-3973
 Owner: Steven B. Torlizzi
 Studio Manager: The Imaginary Man

•• **IMPACT AUDIO**
 5200 Gary Park Ave., Arcadia, CA 91006
 (818) 575-0878
 Owner: Jay Barbea, Steve Martin
 Studio Manager: Jay Barbea

• **INCIDENTAL SOUND**
 34502 Calle Naranha, Capistrano Beach, CA 92624
 (714) 496-2370
 Owner: Fredrick B. Hodshon
 Studio Manager: Fredrick B. Hodshon

•• **J.E.R. STUDIO**
 485 South Kellogg Way, Goleta, CA 93117
 (805) 964-1512
 Owner: J.E.H. Enterprises
 Studio Manager: Debra and John Esparaco

• **JOEL PRODUCTIONS**
 29613 Trotwood Ave., San Pedro, CA 90732
 (213) 833-8647

Owner: Rick Crowell, Hayden Jones
 Studio Manager: Hayden Jones
 Engineers: Rick Crowell, Hayden Jones
 Dimensions of Studio(s): 25 x 15
 Dimensions of Control Room(s): 11 x 11
 Tape Recorders: TEAC 3440 4 track, Revox A77 2 track, TEAC A1106 cassette
 Mixing Consoles: Tascam Model 10 8 in x 4 out
 Monitor Amplifiers: Marantz, Philips (built into control room monitors)
 Monitor Speakers: Altec, Philips 542s (motion feedback by speaker)
 Echo, Reverb, and Delay Systems: Sound Workshop 242 stereo
 Other Outboard Equipment: dbx RM 157 noise reduction, MXR compressor dx 161 comp/limiter, MXR noise gate, MXR stereo chorus, Avidion's 4200 parametric equalizer
 Microphones: AKG 451 E, Shure SM 7, SM 54, SM 57
 Instruments Available: Chattering baby brand, (2) Martin D 18s, Fender Precision bass, Ibanez musician electric guitar, solo drums—six mixers and other instruments available on request
 Video Equipment & Service: Available upon request
 Rates: \$15/hr



*JSL RECORDERS
 Buena Park, CA*

•• **JSL RECORDERS**
 6179 San Ramon, Buena Park, CA 90620
 (714) 995-8818
 Owner: Jeff S. Landgraf, Joannette E. Landgraf
 Studio Manager: Joannette Landgraf
 Engineers: Jeffrey Landgraf
 Dimensions of Studio(s): 19 x 19 with vocal isolation booth
 Dimensions of Control Room(s): 10 x 14
 Tape Recorders: Tascam 80 8 track, Teac 3440 4 track, Sony PCM F 12 track
 Mixing Consoles: Tascam C 12, 12 4
 Monitor Amplifiers: Yamaha Pz200, SAE P50
 Monitor Speakers: JBL 4315, Auratone
 Echo, Reverb & Delay Systems: (2) Doherty 1024 DDL, Masberkorn stereo reverb, custom plate reverb
 Other Outboard Equipment: UREI LA 4, Symetrix noise gates,

S. Ca. 4&8 Track

8 channel dbx noise reduction, DOD direct boxes
 Microphones: AKG C 451's, EV RE 20, Shure SM 57's, SM 59's, Sennheiser, and Sony
 Rates: Call for rates

•• **KING RECORDING STUDIO (KRS)**
 PO Box 883, Somis, CA 93066
 (805) 987-2424
 Owner: Don King
 Studio Manager: Geoff King

• **KOALA STUDIO**
 601 N. Buena Vista, Burbank, CA 91505
 (818) 848-1569
 Owner: Jack Adams
 Studio Manager: Shirley Adams

•• **LAGUNA SOUND STAGE**
 2147 Laguna Canyon Rd., Laguna Beach, CA 92651
 (714) 497-5530

Owner: Don Whitman, Dennis Keary
 Studio Manager: Don Whitlatch
 Engineers: Michael Cripe, Philip Morrison, Jim Cochran
 Dimensions of Studio(s): Main studio 15 x 20, isolation booths 4 x 6 and 7 x 10
 Dimensions of Control Room(s): 15 x 16
 Tape Recorders: TEAC B 8 track, TEAC A 3440S 4 track, TEAC 124 Syn-assoc 2 track, Optonica RT-660S 2 track, Pioneer Hi-Fi track
 Mixing Consoles: Sound Workshop 1240B 12 in x 8 out
 Monitor Amplifiers: Phase Linear, Crest Marantz
 Monitor Speakers: Altec, JBL, Cerwin Vega
 Echo, Reverb & Delay Systems: Space Echo, MXR digital delay, Sound Workshop stereo reverb, Furman limiter/compressor, Furman parametric EQ, Soundcraft 8 in EQ
 Other Outboard Equipment: 8 channel mix, various amplifiers
 Microphones: Shure, Sennheiser, Electro Voice
 Instruments Available: Drum set, Hammond organ with Leslie, Prophet 600
 Video Equipment & Services: Prints, colorizers, contrast video service
 Rates: Behaviors do not insist to accept more \$10 per \$8 block, Beer and \$25 per hour, \$20 block
 Direction: As any musician will tell you, how music comes not from the instruments you play but how you use them. At Laguna Sound Stage our engineers know their equipment inside and out. Their years of experience as accomplished musicians and engineers, combined with your songs and arrangements, can produce for you a great track, master or demo tape you'll be proud of. Pressing plants that receive our masters are always amazed that they are an excellent production. This quality is available to you at our reasonable rates. Give us a chance. Come by and hear for yourself.

• **LAND AUDIO & RECORDS**
 (Sonic Restorations Only)
 Box 29171, Los Angeles, CA 90029
 (213) 469-8007
 Owner: Michael R. Lane
 Studio Manager: Michael R. Lane

•• **RICK LEE VINSON ENT.**
 12535 Kling St., Studio City, CA 91604
 (818) 508-0164
 Owner: Rick Lee Vinson
 Studio Manager: Richard Levinson

•• **MAD-DEN STUDIO**
 1999 Anaheim Ave., #B, Costa Mesa, CA 92627
 (714) 631-4098
 Owner: Mark Madden
 Studio Manager: Mark Madden
 Engineers: Mark Madden, John Munsterman, David Wheeler
 Dimensions of Studio(s): 17 5 x 20
 Dimensions of Control Room(s): 8 x 20
 Tape Recorders: Heider 3M 400 81 15+30 ops, Otari 5050B II 2 track, JVC KD A7 2 cass, Sansa D 470 2 cass
 Mixing Consoles: Carvin MX1688 16 B
 Monitor Amplifiers: Carvin KCA 800, QSC 1400
 Monitor Speakers: Fisher ST 750, KLH 4, Bose 901 III

Echo, Reverb & Delay Systems: Lexicon Prime Time 93 Digital Delay, Eventide 949 Harmonizer, Yamaha E1010 Analog Delay, Roland RE 201 Space Echo
 Other Outboard Equipment: Furman LC 2 Limiter/compressor, MXR Stereo 15 band EQ, ADC Stereo 12 band EQ, (4) MXR Noise Gates
 Microphones: Neumann TLM 170, Electro Voice PL20, (2) Sennheiser 421's, (2) AKG D1000 E's (2) EV PL881's, Shure SM 58, SM10A, (4) Audio Technica's, FR
 Instruments Available: 7 Piece Ludwig drum set with cymbals, Oberheim DX, Acoustic upright piano, Roland IX 4P with sequencer, Roland SH-1000 mono-synth, electronic organ; various bass and guitar amps, various foot effects, Country Man direct boxes, various percussion instruments
 Rates: \$25 hour, block rates available. Please call for full information

•• **MASTER TRACKS RECORDING AND MULTI-MEDIA**
 also REMOTE RECORDING
 402 Loma Alta Drive, Santa Barbara, CA 93109
 (805) 966-6374
 Owner: T. David Sommers
 Studio Manager: T. David Sommers

•• **MAXTRAX RECORDING STUDIOS**
 1303 Belleview Ave., Cardiff-By-The-Sea, CA 92007
 (619) 942-9817
 Owner: Jeff Stein
 Studio Manager: Frank Uberti

• **McCAY MOBILE AUDIO & CASSETTE DUPLICATION**
 also REMOTE RECORDING
 614 E. Date St., Hemet, CA 92343
 (714) 652-5110
 Owner: Steve McCay
 Studio Manager: Steve McCay

• **DON MESSICK SOUND STUDIO**
 PO Box 5426, Santa Barbara, CA 93108
 (805) 969-6926
 Owner: Don Messick
 Studio Manager: Don Messick

• **MILAN'S AUDIO SERVICES**
 CASSETTE DUPLICATING
 1378 Rutan Way, Pasadena, CA 91104
 (818) 797-2629
 Owner: Milan W. Ubovich

• **MOFFETT MANOR RECORDERS**
 2154 Canyon Dr., Costa Mesa, CA 92627
 (714) 646-3838
 Owner: Robert Moffett
 Studio Manager: Robert Moffett

•• **MOSER SOUND PRODUCTION**
 1923 W. 17th St., Santa Ana, CA 92706
 (714) 541-6801
 Owner: Richard Moser
 Studio Manager: Richard Moser

• **MR. MESS RECORDING**
 Encino, CA 91316
 (818) 343-3547
 Owner: Allen Bacc
 Studio Manager: Allan Bacc, Karen Fielts

•• **MUSIC BOX RECORDING STUDIO**
 1146 N. Western Ave., Hollywood, CA 90029
 (213) 462-7761
 Owner: Edward Perry
 Studio Manager: Sonorro Lutzas

•• **NEW JERUSALEM RECORDS**
 also REMOTE RECORDING
 PO Box 1103, Clovis, CA 93613
 (209) 292-8438
 Owner: Mark Seibert, Ron Elms, Dave Noe
 Studio Manager: Mark Seibert, Ron Elm.

•• **NIGHT VISION STUDIOS**
 8695 Hebrides Dr., San Diego, CA 92126
 (619) 566-8989
 Owner: Donald V. Phillips
 Studio Manager: Marianne Balabuch

A system designed to offer you the ultimate satisfaction.



ProAudioSystems

"From architectural planning to the top of the charts."

243 Azusa Ave, West Covina, CA 91791
818 966-1781 · Toll Free 800 423-6582
Another commitment within the Hanich Music complex.

Circle #061 on Reader Service Card

•• **PADDED CELL**
1938 Parkdale Lane, Encinitas, CA 92024
(619) 436-7443
Owner: George Sack
Studio Manager: George Sack

• **PHUSION**
REMOTE RECORDING ONLY
P.O. Box 7981, Newport Beach, CA 92660
(714) 751-6670
Owner: Mark Paul

Studio Manager: Mark Paul, Sylvia Waack
Engineers: Mark Paul
Dimensions of Control Room(s): 20 x 12
Tape Recorders: TEAC A3440 4 track, Technics RSM 65 cassette, Sony 1/4 track
Mixing Consoles: TEAC/Tascam Model 3, 8 in x 4 out, 8 in x 2 out, 4 in x 2 out
Monitor Amplifiers: Carver/M 400 (magnetic field power amp)
Monitor Speakers: (4) JBL 4311 (mix down)
Other Outboard Equipment: Soundcraftsman Model RP2201R graphic EQ, dbx Model 124 noise reduction, Korq Model SD-400 analog delay
Microphones: Sennheiser MK-402U, Shure SM 57, SM-59, AKG D 1000Es, D 190E, Pearl CM 4000 condenser, Peavey, Sony F 100s
Instruments Available: ARP Odyssey, acoustic 150 guitar amp, drums, MESA Boogie
Rates: Reasonable rates will be tailored to suit your personal/project needs

•• **POSITIVE MEDIA**
also REMOTE RECORDING
5422-A Fair Ave., North Hollywood, CA 91601
(818) 761-5192

Owner: Paul Holman
Studio Manager: Paul Holman
Engineers: Roger Masson, Mike Martin, Hessel Helm
Dimensions of Studio(s): 25 x 50 Stage with lighting grid
Dimensions of Control Room(s): 12 x 20
Tape Recorders: Sony 5850 2 track, Studer A-77 2-track, TEAC 80 8 8 track
Mixing Consoles: TEAC
Monitor Amplifiers: Phase Linear
Monitor Speakers: JBL
Echo, Reverb & Delay Systems: Natural Room
Other Outboard Equipment: We specialize in video production and editing. Single camera to 5 cam shoots 1-inch, 3/4-inch or the new Beta Cam 650 line resolution mini-cams with portable recorders chroma key switcher with Tek test equipment. SMPTE time code, Sony editing equipment
Microphones: Crown P2Ms, Sony ECM 505, HE 20, RE 55, Shure 57s
Instruments Available: Sony cross pulse color monitors all equipment is available for rent. Large screen video specialists
Video Equipment and Services: 2 Sony 3/4 inch editing systems. One is for carryout rental. Sony 2 tube cameras JVC KM-2000 Seq., Sony broadcast time code gen., Beta Cam, Tektronix 528A and 1420 Shintron character gen. We also do large screen video projection using V-Star 5's, 16-foot picture
Rates: Editing \$20 per hour, cameras \$200 per day, editing system \$150 per day, Beta Cam \$350 per day, video projection \$550 per day

•• **POWER HOUSE RECORDING**
also REMOTE RECORDING
1801 N. Divisadero, Visalia, CA 93291
(209) 732-0976

Owner: Reid Power
Studio Manager: Reid Power
Engineers: Reid Power, Dave Johnson
Dimensions of Studio(s): 20 x 20 x 10
Dimensions of Control Room(s): 8 x 13
Tape Recorders: Tascam 80-8 8-track, Teac 3340 4-track, Tascam 32 2 track, Onkyo TA2066 Hitachi D-850, Hitachi D-EII cassettes
Mixing Consoles: Ramsa 8210 10 x 4, Kelsey 8 plus 2 8 x 2
Monitor Amplifiers: Kenwood KA6006, Roland SPA 120
Monitor Speakers: JBL-L100, Sansui AA4900, Radio Shack Minis
Echo, Reverb & Delay Systems: Orban 111b stereo reverb DeltaLab ADM 1024, DeltaLab ADM 256
Other Outboard Equipment: Full 8 channels dbx noise reduction, dbx 163 comp/limiters (2), dbx 117 stereo comp/expander, Audioarts 4100 parametric eq, Symetrix 522 comp./limiter/noise gate (stereo)
Microphones: AKG451, AKGD12E, Sony ECM-56F, Sony ECM 231, Beyers M 201, Ev D054, Jensen and Whirlwind direct boxes
Instruments Available: Wurlitzer upright piano, Rhodes 73, Roland JX'3P polyphonic synth, Moog Rogue, Fender Jazz bass, Martin D 28 acoustic guitar, Ibanez electric guitar, Fender 75 amp, Rogers drums w/Synare, Morley, MXR and Roland effects, etc.
Video Equipment & Services: Available on request
Rates: \$25 hr., block discounts available



• **RAG RECORDING**
8152 Manitoba St., #6, Playa del Rey, CA 90293
(213) 822-7543
Owner: Richard A. Grea
Studio Manager: Billy Scooter

•• **THE REEL THING**
11197 Tudor, Ontario, CA 91761
(714) 628-3024
Owner: Robert M. Hill and Georgia V. Hill
Studio Manager: Robert M. Hill
Engineers: Robert M. Hill
Dimensions of Studio(s): 12 x 19 x 8
Dimensions of Control Room(s): 8 x 6 x 8
Tape Recorders: Tascam/TEAC 80-8 8 track, Tascam/TEAC 35-2 2 track, TEAC A601R cassette
Mixing Consoles: Tascam/TEAC 35, 8 in x 4 out
Monitor Amplifiers: Spectro Acoustics 200R
Monitor Speakers: JBL 4311b, Auratone Cubes
Echo, Reverb & Delay Systems: Fostex digital delay, Master Room reverb XL 405 (MICMIX)
Other Outboard Equipment: Tascam TEAC model 1, MXH noise gate, MXR phase 90, MXR distortion Plus, Spectro Acoustics graphic EQ 210H, dbx 161 limiter/compressor, Tube-cube direct box, Aphex system 602B Aural Exciter
Microphones: Beyers 500, Shure SM57 SM58, SM56, E V HE20, Sony ECM 56F, Sennheiser 421
Instruments Available: Fender twin reverb amplifier, Roland Juno 60 synthesizer, Peavey 30 amplifier, Fender Precision bass guitar, Epiphone guitar, Fender 12 string guitar, Fender electric 12 string guitar, Fender Stratocaster guitar, Ludwig drums, piano
Rates: \$20/hr 8 track, \$15/hr 2 track. Block rates available

•• **SELAH RECORDING STUDIO**
9190 Poppy Circle, Westminster, CA 92683
(714) 898-5220
Owner: David Gehlhar
Studio Manager: David Gehlhar

•• **SIERRA RECORDING**
also REMOTE RECORDING
31585 Rd. 228, Exeter, CA 93221
(209) 592-4337
Owner: Manuel "Manny" Alvarez
Studio Manager: Clark De'Coux

•• **SOUTH COAST RECORDING**
401 E. Washington, Santa Ana, CA 92701
(714) 953-9923
Owner: Jim Dotson
Studio Manager: Jim Dotson

•• **SOUTHLAND - MULTITRACK**
P.O. Box 632, Poway, CA 92064
(619) 748-2050
Owner: The Memphis Lee Organization
Studio Manager: Norman K. Elder

•• **SOUTHWEST SOUND**
also REMOTE RECORDING
14 N. Baldwin Ave., Sierra Madre, CA 91024
(818) 791-7978
Owner: Thomas Mehren
Studio Manager: Devin Thomas

• **JAY STAGGS CASSETTE DUPLICATION**
also REMOTE RECORDING
7332 Florence Ave. Suite D, Downey, CA 90240
(213) 928-7516
Owner: Jay Staggs
Studio Manager: Jay Staggs

• **STRATOSOUND**
812 Chelham Way, Santa Barbara, CA 93108
(805) 969-4131
Owner: Neil Mietus
Studio Manager: Neil Mietus

•• **THE STUDIO**
1612 Ocean Park Blvd., Santa Monica, CA 90405
(213) 452-3930
Owner: Vincent Fazzan
Studio Manager: Rhonda Talsky

•• **STUDIOHOUSE**
6363 Sunset Blvd. Suite 716, Hollywood, CA 90028
(213) 464-1133
Owner: Mr. George Gilbreath
Studio Manager: Mr. George Gilbreath

• **STUDIO 23**
22725 Califa St., Woodland Hills, CA 91367
(818) 704-8634
Owner: Bryan Cumming
Studio Manager: Bryan Cumming

•• **SUNBURST RECORDING AND PRODUCTIONS**
10313 West Jefferson Blvd., Culver City, CA 90230
(213) 204-2222

Owner: Bob Wayne
Studio Manager: Bob Wayne
Engineers: Bob Wayne, Dave Starns, independents
Dimensions of Studio(s): 22 x 18, ceiling 12-14'
Dimensions of Control Room(s): 18 x 15, ceiling 10-12'
Tape Recorders: Tascam 80-8 1/2" 8 track VSO 20%, Tascam 25-2 1/4" (hall track) 2 track VSO 5%, TEAC A-7030 (hall track) 2 track, TEAC C-3 cassette 2 track (2 machines), Marantz C-205 cassette 1 track VSO 20%
Mixing Consoles: Sound Workshop 1280-8 EQ with expander 24 in 24 direct out 8 buss out
Monitor Amplifiers: BGW, Dynaco, Sony, Marantz
Monitor Speakers: Control room Electro-Voice Sentry 5s, Auratones, Recording room Bose 800s
Echo, Reverb, and Delay Systems: Lexicon 200 Digital Reverb, Orban 111B stereo reverb with parametric EQ, MXR digital delay—all four delay modules
Other Outboard Equipment: Tom Scholz's Rockman; dbx: noise reduction (ten channels), 165 compressors, 161 compressor; MXR: Stereo Chorus, 31 band graphic EQs, noise gates, flanger, Phase 90, Distortion +; Mutron III; 5 direct boxes, Dual turntable, electronic metronome
Microphones: Neumann U-87, KM-84, AKG 414, 451s, 100s; Electro-Voice RE-20s, RE-15s, 676; Crown P2M 30 GP; Sony ECM 33P, ECM 21, Sennheiser 421; Shure SM-81, 565.
Instruments Available: Keyboards: Kawai 74" grand piano—Model KG 6C, Hammond 1958 B-3 organ w/Leslie 122, Roland Juno 60 programmable polyphonic synthesizer, Mini-Moog, Fender Rhodes 73, ARP String Ensemble, Casio MT30 organ, Yamaha C-5 15 synthesizer, Hohner D-6 clavinet; Drums: Complete studio trap set; Amps: Fender Pro-reverb and Pignose; Misc: Various percussion and misc. instruments.
Rates: \$25/hr—Includes engineer and all equipment.
Extras: Full central air-conditioning; rear 10' x 10' loading door—no steps, complete lounge facilities with refrigerator, coffee maker, oven, hot plate, and Sparklets water. Lounge overlooks control room from rear window and is "wired" for headphone and microphone inputs.
Direction: Founded in 1976, Sunburst will be expanding to 2" 16-tracks by July of 1984 to further provide for the needs of our growing client list.



SUPERSOUND STUDIO
Los Angeles, CA

•• **SUPERSOUND STUDIO**
also REMOTE RECORDING
8946 Ellis Ave., Los Angeles, CA 90034
(213) 836-4028
Owner: Morris D. Golodner
Studio Manager: Morris D. Golodner

•• SUPERIOR SONICS
 also REMOTE RECORDING
 19516 Hemmingway St., Reseda, CA 91335
 (818) 701-5253
 Owner: Richard Peden, Kevin Vincent



SYNAPSE RECORDING
 Burbank, CA

•• SYNAPSE RECORDING (ELECTRONIC MUSIC STUDIO)
 444 South Victory Boulevard, Burbank, CA 91502
 (818) 661-7777
 Owner: Nicholas Simone
 Studio Manager: Mitch Aiken
 Engineers: Andrew Horvath, Nicholas Simone
 Dimensions of Studio(s): 12 x 24
 Tape Recorders: 8-track Otari 1/2-inch MK III/8 8-track, 2 track Otari 1/4-inch MK III/2 2-track; Cassette Tascam 122 Synclavier II 16-track Digital Memory Recorder, PCM-F 1-2 track Digital Sony; Sony 2 tr 3/4-inch recorder, Mitsubishi monitor
 Mixing Consoles: Ramsa/Mitsubishi/Panasonic WR 8112 12 x 8
 Monitor Amplifiers: Haller 500w
 Monitor Speakers: JBL 4411's Auratones
 Echo, Reverb & Delay Systems: Master Room XL-305
 Instruments Available: Synclavier, LinnDrum, Yamaha DX-7
 Video Equipment & Services: Full video and 16mm film production company services, equipment usually subcontracted. Full rock video production offered
 Rates: Electronic music studio rate \$75 per hour. Rock video production between \$20,000-\$50,000

•• SYNTRAX PRODUCTIONS
 San Gabriel, CA
 (818) 285-3698
 Owner: Bill Pearson
 Studio Manager: Bill Pearson
 Engineers: Bill Pearson
 Dimensions of Studio(s): 11 x 13
 Tape Recorders: Tascam 38 8-track, Revox B77 2-track, TEAC A33405 4-track, Technics M224 Cassette
 Mixing Consoles: Ramsa 8210 10 x 4 x 2
 Monitor Amplifiers: BGW
 Monitor Speakers: JBL, Auratone, Yamaha
 Echo, Reverb & Delay Systems: Yamaha Digital Reverb, Yamaha E1010 Analog delay, (2) Ibanez DM 2000 digital delays, custom reverb system
 Other Outboard Equipment: 8 channels of dbx noise reduction, 4 channels, parametric EQ, MXR 2 channel limiter, Keyboard synchronizer, Roland SVC 350 Vocoder hyperflange unit.
 Microphones: Shure, EV, Audio Technica.
 Instruments Available: Yamaha DX-7, Prophet 5 with digital poly-sequencer, Roland Jupiter 6, Rhodes, E-MV Drumulator, Roland VK-1, ARP Odyssey, Casio, Roland MSQ-700 MIP I. Digital Sequencer (8 tracks); Emulator II (on order), Ibanez artist and Telecaster guitars, Paul Rivera custom delux reverb amp, Kranich & Bach, 6 foot Baby Grand piano. Also available on request Roland GR700 MIDI guitar synthesizer
 Rates: \$19.50 per hour
 Extras: Synth. programming, arranging and production services available for in house or outside productions. In house jingle company available for commercials. Comfortable atmosphere; competent, knowledgeable staff; and great sound!
 Direction: Commercials and background music for TV and radio, album production and pre-production, publishing demos. Partial client list: ABC TV, CBS TV, Sparrow Records, C.A. Music, Star-song Records, Walker & Associates Advertising, Estey-Hoover, Ron Harris Music, Bigfish Music, Filmboys Productions, and Hugh Heller Corp. Special direction: High class synthesizer productions

IN STOCK!

Saki heads are the finest in the industry. Every head is dynamically tested and guaranteed.

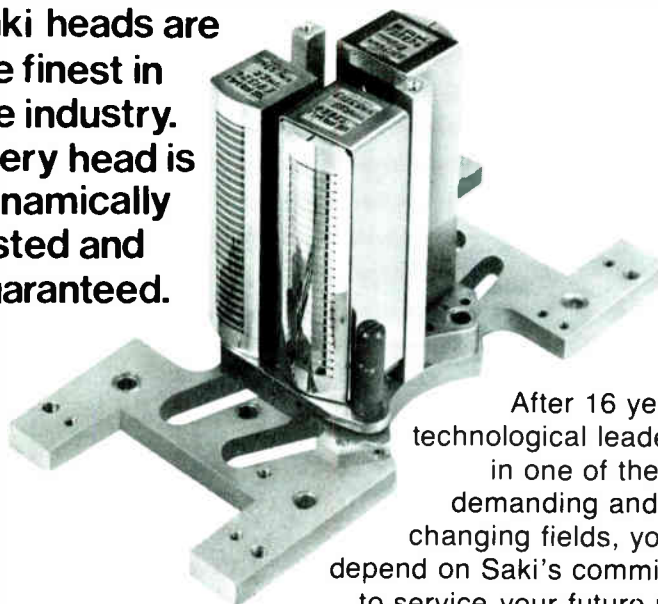

After 16 years of technological leadership in one of the most demanding and ever-changing fields, you can depend on Saki's commitment to service your future needs long after the competition is gone.



SAKI MAGNETICS, INC.

A California Corporation Since 1968

8650 Hayden Place, Culver City, CA 90230 213 / 559-6704 (TWX-910-328-6100)

Circle #062 on Reader Service Card

Audiophile Quality and Service

The people at KM Records are masters at their craft and treat each recording as "solid gold." From tape to record the cost-effective way, because we do it all in-house: mastering, matrix electroforming, record pressing, label and jacket graphics and printing.

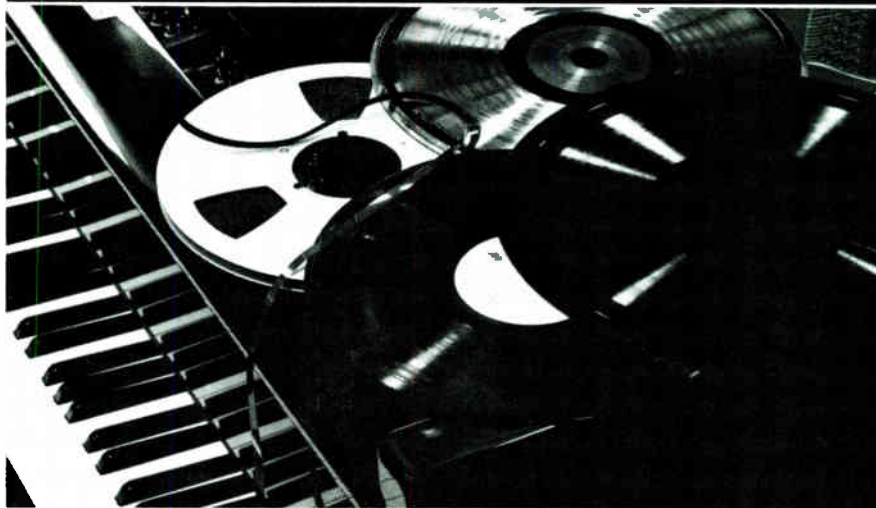

KM Records — always a sound choice.

2980 N. Ontario Street, Burbank, CA 91504
 Tel. 213 841-3400 or TWX No. 910-498-5700

Circle #063 on Reader Service Card

• **TARGET RECORDERS**
 1123 Rosewood Ave., Inglewood, CA 90301
 (213) 419-4017
 Owner: A R Thomas
 Studio Manager: A R Thomas



THETA SOUND STUDIO
 Los Angeles, CA

•• **THETA SOUND STUDIO**
 Los Angeles, CA
 (213) 669-2772
 Owner: Randy Tobin
 Studio Manager: Cyndie Tobin
 Engineers: Randy Tobin, Wally August, Rick Stone
 Dimensions of Studio(s): 13 x 14 w/drum booth
 Dimensions of Control Room(s): 10 x 12
 Tape Recorders: Tascam 38 1/2" 8 track; Tascam 34 4 track,
 Technics 1520 2-track TEAC A 3340 4 track Onkyo (4) 630D
 cassette decks (4), Advent 201 cassette deck
 Mixing Consoles: Roland RM 600 16 x 16 x 5, console Tapco
 6100RB/EB, 14 x 9

Monitor Amplifiers: Kenwood high speed amp; RANE HC-6
 headphone amp
 Monitor Speakers: JBL 4301B, Auratone 5C
 Echo, Reverb, & Delay Systems: LT Sound TAD-4 stereo
 echo/delay, Yamaha R1000 Digital Reverb (2), MXR DDL, reverb
 in Tapco 6100
 Other Outboard Equipment: Full dbx noise reduction, dbx 163
 compressor/limiter, Symetrix CL-100 compressor/limiter, MXR
 dual limiter, 4 channel custom parametric EQ, Soundcraftsman 10
 band graphic EQ (2 units), Symetrix Sound systems 24 channel
 graphic EQ (2 units), Ibanez Harmonics Delay, Inter City Aural
 Exciter, Dual 1229 turntable with Shure V15 type III cartridge
 Microphones: Countryman EC 101 (2), Countryman Isomax II,
 AKG 414EB, D1000, Shure SM57, Beyer M160, M500
 Instruments Available: Yamaha 66" conservatory grand piano,
 Yamaha DX7 Synthesizer, Roland Jupiter 8 Synthesizer, SCI
 Drumtraks, Roland SMO 700 Sequencer, Fender/Rhodes piano
 (1972) ARP Omni, Slingerland drum kit with Tama hardware and
 cymbal assortment, Gibson Ripper bass, congas and assorted per-
 cussion, Fender and Sunn instrument amplifiers
 Video Equipment & Services: Sony SL2710 Beta HiFi VCR,
 Toshiba Monitor
 Rates: 8 track - \$25/hr, 4/6 track - \$18/hr (includes engineer)
 Tape copies - \$15/hr
 Extras: Record production, packaging, art and graphics, photog-
 raphy, radio spots, jingles, voice elimination (for budget demos),
 cassette deck tune ups, recording classes for musicians
 Direction: Our philosophy has been for the past 6 years, "Back to
 the Real Sound!" We have been providing excellent quality
 demos and masters to a talented but budget minded clientele.
 With our steady growth, we continue our commitment to the idea
 that a great place to create and record need not be too expensive
 in this day and age

•• **UNDERGROUND STUDIO**
 also **REMOTE RECORDING**
 652 West Arbor Vitae, Inglewood, CA 90301
 (213) 671-6108
 Owner: Tom Cherry
 Studio Manager: Richard Sandford
 Engineers: Richard Sandford, Richard Jallis, Dave Levine,
 Eddie Call
 Dimensions of Studio(s): main room 15 x 20, isolation booth
 7 x 5
 Dimensions of Control Room(s): 9 x 13
 Tape Recorders: Otari 5050 8 Mk III 8 track, TEAC (2) A 3340S
 4 track Technics RS1500US 2 track Sony TCK81 cassette, San
 sui SC 3110 cassette
 Mixing Consoles: Studiomaster 1608 16/8 2, Studiomaster
 1604, 16/4 2, Shure M68, 5 1
 Monitor Amplifiers: Marantz BWG Crest
 Monitor Speakers: JBL, Auratones, custom
 Echo, Reverb & Delay Systems: MasterRoom MICMIX XL305
 stereo reverb, Eventide digital delay, Ellectron digital delay, (2)
 Roland RE501 chorus echo
 Other Outboard Equipment: Eventide Omnipressor, UREI lim-
 iter/compressors Audio Arts stereo parametric EQ, dbx 160x
 compressor/limiters, professional series dbx noise reduction,
 Technics turntable
 Microphones: Neumann, AKG, Sennheiser, Sony, Beyer, E.V.,
 Shure, direct boxes (Westlake and Jensen)
 Instruments Available: Ludwig and Gretsch drums, Sequential
 Circuits Prophet 5 and 10 Oberheim OBX A piano (acoustic),
 ARP Omni 2, ARP string ensemble, Farfisa VIP34S, Ampex, Mar-
 shall, Fender amps, Rockman 1 & 2 Musser orchestra bells,
 assorted percussion, sound effects records, LinnDrum machine,
 electric acoustic and bass guitars, Prophet 600, Juno 60 DX-7
 Rates: 8 track \$20/hr, \$150 for 10 hour block 4 track \$13/hr
 Rehearsals 55 hr

• **HOWARD VALENTINE SOUND SERVICES**
 6263 Leland Way, Hollywood, CA 90028
 (213) 464-8888
 Owner: Howard Valentine
 Studio Manager: Howard Valentine

•• **VCA STUDIOS**
 4436 Katherine Ave., Sherman Oaks, CA 91423
 (818) 783-0386
 Studio Manager: Michael Sullivan

•• **YOUR RECORDING STUDIO**
 16824 Satcoy St., Van Nuys, CA 91406
 (818) 780-6958
 Owner: David Lee
 Studio Manager: Russ Mitchell

•• **ZACUTO AUDIO**
 1653 18th St., Santa Monica, CA 90404
 (213) 828-8702
 Owner: Gary Zacuto
 Studio Manager: Gary Zacuto
 Direction: Commercial and industrial soundtrack production.
 Services include: Studio, narrators, pre-recorded and original
 score music tracks, original sound effects, copywriting and con-
 sultation. Our track record includes a number of national and local
 advertisers, and corporate marketing divisions

The art of shaping sound.

SONEX is a high-performance acoustical foam that upgrades your studio inexpensively. Ideal for a temporary isolation booth, it can also eliminate slap echo and harsh resonances in the main room or silence noisy tape equipment in the control booth. Write for our color brochure today.



**Alpha
 Audio**

2049 West Broad St. • Richmond, VA 23220 • (804) 358-3852

Circle #064 on Reader Service Card

**HAVE A
 RECORDING STUDIO
 PROBLEM?
 Call DataLine
 (213) 651-4944**

The Society of Professional Audio Recording Studios, a non-profit organization, offers SPARS members, and non-members referred by a SPARS member, a national telephone 'hot-line.'

Questions regarding any area of recording studio operations including business practices, audio engineering, and technical maintenance will be answered by SPARS-approved sources at no charge.

Want a problem solved?
 Call SPARS—
(213) 651-4944

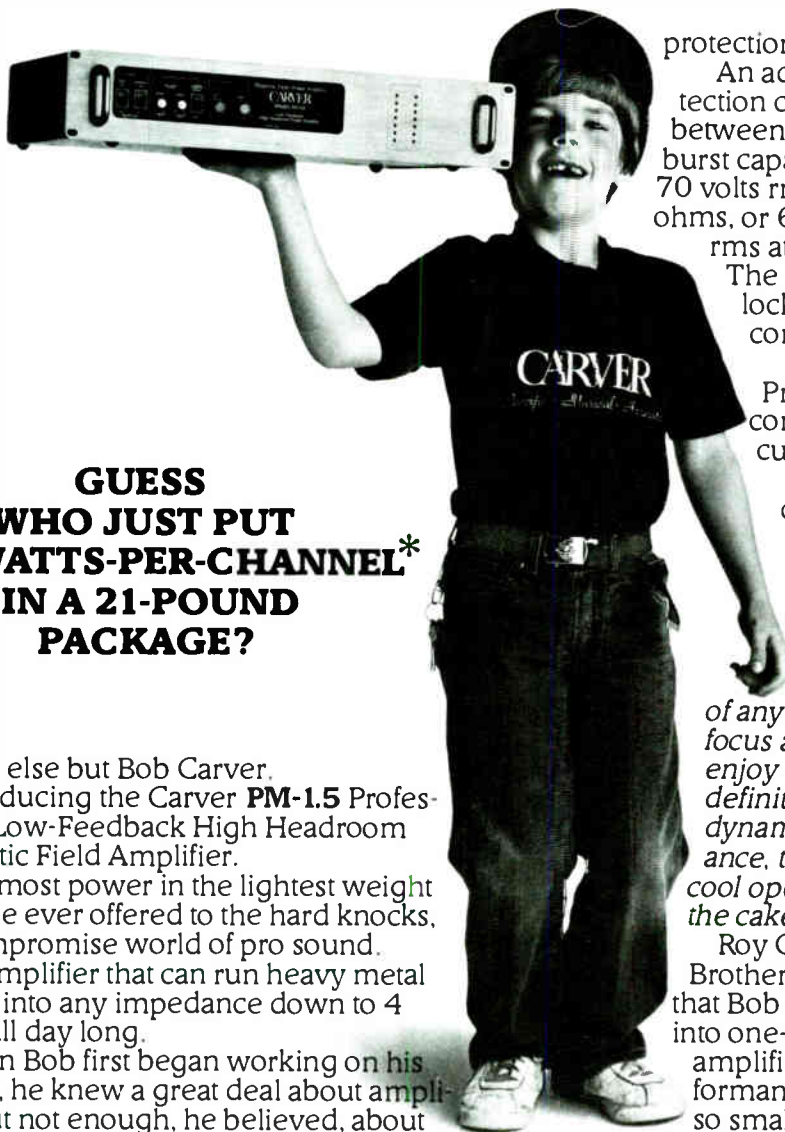

**GUESS
WHO JUST PUT
450 WATTS-PER-CHANNEL*
IN A 21-POUND
PACKAGE?**

Who else but Bob Carver.
Introducing the Carver **PM-1.5** Professional Low-Feedback High Headroom Magnetic Field Amplifier.

The most power in the lightest weight package ever offered to the hard knocks, no-compromise world of pro sound.

An amplifier that can run heavy metal flat-out into any impedance down to 4 ohms all day long.

When Bob first began working on his PM-1.5, he knew a great deal about amplifiers but not enough, he believed, about the night-in night-out requirements (and wish dreams) of the pro sound world. And so he spent much time consulting with a large number of sound reinforcement professionals, including the "pros' pro," Clair Brothers.

Clair Brothers asked for lower input ac line current, greater transformer thermal capacity, dual modes of precision balanced inputs with 1% resistors, back-to-front cooling with a fully proportional fan system that can just tick over at idle or blast 1000 ft/min. to keep output transistor temperatures constant. They wanted greater noise immunity and unbelievable long-term, high-power operation, as well as a 3/16" front panel with deep-recessed controls.

Others wanted rear rack-mounts, adjustable protection circuit thresholds, front panel selectable clipping eliminator, and even a sequential, soft-start power-up mode.

Now that the PM-1.5 has undergone thousands of lab test hours and seven months of hard road testing, Clair Brothers, Bob, and you get all that and more.

The PM-1.5 is designed to run balls-to-the-wall, even into 4 ohms day and night without compromising itself or your drivers. Because the PM-1.5 has three special adjustable speaker

protection circuits.

An adjustable Short-Term Speaker Protection circuit adjusts dynamic headroom between 60 and 77 volts with a short term burst capability of 70 volts rms at 8 ohms, or 60 volts rms at 4 ohms.



Front-panel-adjustable protection circuits.

The circuit locks-in to the control setting after 0.5 seconds.

An adjustable Long-Term Speaker Protection circuit matches the time constant of the output shutdown circuit to your PA or monitor system.

Finally, the Clipping Eliminator detects clipping lasting longer than 30 milliseconds and attenuates the input signal just enough to pull the PM-1.5 out of clipping.

As for sound quality, consider this quote from **The Audio Critic Magazine**, "...the equal of any power amplifier in transparency, focus and smoothness. We especially enjoy hearing spatial detail, instrumental definition and completely natural dynamics. At this level of sonic performance, the astoundingly small size and cool operation become icing on the cake..."

Roy Clair and Ron Borthwick of Clair Brothers said it this way, "We are amazed that Bob was able to put the same wattage into one-fourth the volume of conventional amplifiers without sacrificing audio performance. It's hard to believe that an amp so small and lightweight can put out so much clean power. But it does!"

Whether you run a megawatt sound company, a struggling bar band, or a recording studio gearing up for digital, the PM-1.5 will pay you. In increased portability and reduced freight costs. In freedom from expensive blown drivers. In sheer sonic excellence.

Write for a detailed brochure today or give your local pro store no peace until they order you 21 pounds of pure power.

*Power: 8 ohms, 450 watts/chan 20 Hz-20 kHz both channels driven with less than 0.1% THD. 4 ohms, 600 watts/chan rms 20 Hz-20 kHz both channels driven with less than 0.1% THD. 16 ohms, 300 watts/chan 20 Hz-20 kHz both channels driven with less than 0.1% THD. 2 ohms, 525 watts/chan. at clipping, 1 kHz, with less than 0.2% THD. Note: 2-ohm specification for information purposes only. Operation at 2 ohms is permissible but not recommended. **IM Distortion:** Less than 0.1% SMPTE **Frequency Response:** -3 dB at 3 Hz, -3 dB at 80 kHz. **Damping:** 200 at 1 kHz. **Gain:** 26 dB. **Noise:** Better than 115 dB below 450W A-weighted. **Input:** Balanced to ground. XLR or phone. **Impedance:** 15k-ohm each leg, balanced to ground. **Bridging:** 1200W into 8 ohms, 1000W into 16 ohms, accessed through rear-panel recessed switch. **Dimensions:** 19 in wide, 3 1/2 in high, 10 1/2 in deep. Weight: 21 lbs.



CARVER

(206) 775-1202 P.O. Box 1237 Lynnwood, WA 98036

Circle #065 on Reader Service Card

Southern California



16 Track

••• ACCU-SOUND & VIDEO STUDIOS

also REMOTE RECORDING

Audio: 4274 1/2 El Cajon Blvd., Video: 4276 El Cajon Blvd., San Diego, CA 92105

(619) 281-6693 (audio);
(619) 280-6098 (video)

Owner: John A. Meiner

Studio Manager: Brian Cantarini

Engineers: John Hildebrand (chief engineer), Brian Cantarini,

Grant Stewart. Independent studios welcome

Dimensions of Studio(s): A 21 x 26, B 12 x 16

Dimensions of Control Room(s): A 10 x 21, B 11 x 12

Tape Recorders: Analog: Ampex MM 1100 16 track, (2) Tascam

80 B w dbx & VSO 8 track, Tascam 40 4 w dbx 4 track, TEAC

440S 4 track, Otari 5050 2 track; JVC, Sony, TEAC & Aiwa

synthesizer track

Mixing Consoles: Tascam 4216 16x16, Tascam 10B (modified)

12x8 Tascam 2A (modified) 6x4

Monitor Amplifiers: BGW, Crown

Monitor Speakers: JBL Custom JBL 4 411 various mini monitors

and consumer style speakers

Echo, Reverb & Delay Systems: (2) Lexicon 93 Prime Times

Master Room, Bamp, & Tapco reverbs

Other Outboard Equipment: Aphex Aural Exciter UREI LA

4As (modified), Allison Gain Brains & Kepex's, Bamp and Shure

EQs, SAE Impulse noise filter, Dual turntable w/Shure cartridge &

compressor plays /hrs, much more on request

Microphones: Versatile selection by Neumann, AKG, Senn

heiser, Sony, Beyer & Shure

Instruments Available: Pearl Drums, Zildjian cymbals, Ham

mond B 3 w Leslie Cable baby grand piano, Fender Rhodes

Shure 88 Yamaha CP70 electric grand piano, Hohner C II

Clavier Gon Hop timbales Ludwig timbales Art Omni syn

thesizer Much more available from adjacent music store

Video Equipment & Services: Full service production house

with facilities for multi-camera studio or location shoots, editing

suite and duplication to your choice of formats. Overseas stan

dards conversions available. Call our Video Department for detail

ed information

Rates: Contact Brian Cantarini for further studio information

••• ACRASOUND RECORDING STUDIO

5951 Venice Blvd., Los Angeles, CA 90034

(213) 936-7788

Owner: Steve Zinkow and Edward Zinkow

Studio Manager: Steve Zinkow and Edward Zinkow

••• APOLLO RECORDING STUDIO

6142 Beach Blvd., Buena Park, CA 90621

(714) 994-3761

Owner: Ace Simpson Ron Brady, Tom Chisholm

Engineers: Ace Simpson (chief), Ron Brady, Sam Burke, and

Jim Goodwin

Dimensions of Studio(s): 24 x 20

Dimensions of Control Room(s): 12 x 20

Tape Recorders: 3M 16 track 3M 8 track, Tascam 25-2, TEAC

440 4 track discrete, TEAC 450 stereo cassette

Mixing Consoles: Tascam Series 16 (expanded)

Monitor Amplifiers: Marantz 1050 & 1070 plus cue boost

amplifier

Monitor Speakers: JBL 4 411s control room, JBL L100s studio,

Autonote Mixing Cables

Echo, Reverb, and Delay Systems: Tapco 4400 reverb, varia-

ble pitch time delay tape phasing (VSO), Ibanez DM 1000 digital

delay

Other Outboard Equipment: Teletronix compressor/limiter,

SF 40 compressor ADX graphic EQ, Moog parametric EQ,

stereo synthesizer Ibanez HD 1000 harmonizer, Vokal eliminator

Microphones: AKG D 200E D-190, D 119, Sennheiser

MD 421H Altek 654 A, Shure SM-57, Electro-Voice 627 B,

HCA 77 D BX 11A Sony F 121, various quadres of each, direct

boxes

Instruments Available: Acoustic piano (no tee), baby grand

piano Fender Rhodes, bass guitar, electric guitar, 25W Fender

tuba amp Wah Wah pedal and various percussion, large set of

Rodgers drums, also synthesizer and Wuritzer electric piano

available by special arrangement. Yamaha D80 organ and Crum

phar string machine

Video Equipment & Services: Recording, editing and dub serv

ice up to 1/4" format

Rates: 16 track \$35/hr, 8 track \$30/hr basic. Negotiable

depending on requirements. Dubbing or copying \$20/hr. Special

rates for block time (50 hrs minimum)

••• B & B SOUND STUDIOS

3610 W. Magnolia Blvd., Burbank, CA 91505

(818) 848-4496

Owner: Ron Berger

Dimensions of Studio(s): 100 x 50 (studio A), 75 x 20 (studio

B), 50 x 20 (studio C)

Dimensions of Control Room(s): 15 x 20

Tape Recorders: MC1 JH 16 16 track; Ampex 440 8 track,

Ampex 440C 4 track

Mixing Console: Opamp Labs, 16 in x 16 out, Opamp Labs "A"

board and "B" board, 20 in x 20 out, Quantum, Soundcraft

Monitor Amplifiers: McIntosh, Opamps, Crowns, Yamaha

Monitor Speakers: JBL

Echo, Reverb, and Delay Systems: Opamp

Microphones: Neumann U 47, AKG 202-E1, E V RE-15 16

Sennheiser

Video Equipment & Services: JVC & Sony 1/4" video cassettes

Audio Kinetics Q lock synchronizer, MC1 50" TV, Sharp & Sony

color monitors Macnasyne/Moviola, 3 track insert recorders

Video tape sweetening, 16mm and 35mm dubbing, live record-

ing ADR and 35 & 16mm film chain Foley Stage 3M NEC

1 inch videotape machine

Rates: Call for rates

••• BUZZY'S RECORDING SERVICES

6900 Melrose Ave., Los Angeles, CA 90038

(213) 931-1867

Owner: John W. Britt

Studio Manager: Larry Lantz

••• CASBAH RECORDING

1895 Commonwealth Ave., Suite N, Fullerton, CA 92632

(714) 738-9240

Owner: Chaz Ramirez Jon St James

Studio Manager: Lisa Black

••• DENTON STUDIO

15350 Cohasset St., Van Nuys, CA 91406

(818) 786-2402

Owner: Gary Denton

Studio Manager: Melody Carpenter



DREAMMAKER RECORDING
Thousand Oaks, CA

••• DREAMMAKER RECORDING

2509 Thousand Oaks Blvd., #379, Thousand Oaks, CA

91362

(805) 529-5148

Owner: Dan Hillard, Jim Nucifora

Studio Manager: Dan Hillard

Engineers: Dan Hillard, John Sisti, Michael George

Dimensions of Studio(s): 22 x 20, Isolation booth 10 x 6

Dimensions of Control Room(s): 14 x 12

Tape Recorders: Otari MTR 90 16 track, TEAC Tascam 85-16

with dbx 16 track, Otari MX 5050 BII 2 track, Tascam 122 B

cassette, Sansui SC 5100 cassette

Mixing Consoles: Soundcraft 1600 producers Model 24 x 24

Monitor Amplifiers: Yamaha P 2200 Cerwin Vega M 200, SAE

4100

Monitor Speakers: Control Room Westlake BBSM 10s, Aural

tones Studio Altek Lansing MDL-8s

Echo, Reverb & Delay Systems: Echo Plate III, Lexicon Prime

time II, Eventide 910 harmonizer, DeltaLab 1024 Effectron, Delta-

Lab 2048 Supertime Line

Other Outboard Equipment: dbx 165A compressor/limiter (2),

Gainbrains II, (2) Kepex II, Orban 622 B Parametric EQ, Denon

DP 602 turntable

Microphones: Neumann U-87, AKG 414EBs, 451s, 190 E, D-12,

D 1000E, Sennheiser MD421, Shure SM 57s.

Instruments Available: Yamaha Baby Grand Piano, Oberheim

OB8, Oberheim DX drum machine, Roland Juno 60, 5 piece

Tama drums, Roto Toms

Rates: Believe it or not, \$25 00 per hour

••• DUCHESS STUDIOS

also REMOTE RECORDING

7923 Duchess Dr., Whittier, CA 90606

(213) 695-7715 or 696-5503

Owner: Chuck & Madeline Minear

Studio Manager: Tim Minear

Engineers: Chuck Minear, Chuck Mitchell, Chuck Minear Jr

Dimensions of Studio(s): Studio "A" 18 x 23, "B" 12 x 10

vocal booth, Studio "C" 10 x 8 production booth

Dimensions of Control Room(s): A & B 17 x 13, C, 10 x 8.

Tape Recorders: Ampex 1100 16 track, Ampex AG 350 2 track,

(2) Revox B 77 (1/4) (1/2), (2) Revox A-700 2 track, (2) Revox B-77

(1) (2), Revox B-700 cassette, TEAC 80-8 8 track.

Mixing Consoles: Amek 2000A 20/20, TEAC model 5 8/4

Monitor Amplifiers: McIntosh 2100, OpAmp

Monitor Speakers: UREI 811s, Philips 545, Auralone

Echo, Reverb & Delay Systems: Lexicon 200 reverb &

PCM 42, AKG-BX-10, Klark-Teknik DN-36, EXR-3

Other Outboard Equipment: Limiters dbx 160, UREI 1176,

Electrodyne, Symetrix gates, Mighty Mike

Microphones: AKG, Beyer, Neumann, Shure, PZM, Sennheiser,

HCA, QTC

Instruments Available: Kawai 7' 4" Grand piano, Rhodes, Ham

mond organ, various guitars and synthesizers available

Rates: \$55 16 track, \$35 8 track, 1st block rate \$40 hour

EDB Audio & Video Recording

E.D.B AUDIO & VIDEO RECORDING
Sangus, CA

••• E.D.B. AUDIO & VIDEO RECORDING

27417 Onlec Ave., Sangus, CA 91350

(805) 259-0828

Owner: Eric Di Berado

Studio Manager: Eric Di Berado

••• EVAN WILLIAMS RECORDING

1519 S. Grand Ave., Santa Ana, CA 92706

(714) 543-6155

Owner: Evan Williams

Studio Manager: Evan Williams

••• FATTRAX STUDIOS

4108 Burbank Blvd., Burbank, CA 91505

(818) 841-6423

Owner: Chris Brosius, Craig Fall

Studio Manager: Chris Brosius

••• **FUTURE SOUND**
1842 Burleson, Thousand Oaks, CA 91360
(805) 496-2585
Owner: Handy Dew
Studio Manager: Randy Dew

••• **GOPHER BAROQUE PRODUCTIONS**
7560 Garden Grove Blvd., Westminster, CA 92683
(714) 893-3457
Owner: Michael Mikulka/Steve McCintock
Studio Manager: Michael Mikulka
Engineers: Michael Mikulka, Steve Kempster, independents welcome
Dimensions of Studio(s): 45 x 22 with 18-foot ceiling, including 4 separate isolation areas
Dimensions of Control Room(s): 18 x 15
Tape Recorders: Tascam 85-16B, 80-8, 25-2 all with dbx and VSO; Tear X10 1/4 track and Technics M85 cass
Mixing Consoles: Tascam Model 16, 22x8x2 with stereo subgroups
Monitor Amplifiers: Hill, Crown
Monitor Speakers: JBL 4435s, Yamaha NS-10s, Auratones
Echo, Reverb, and Delay Systems: Mic Mix 305 MXR Digital reverb, 5 DDL's
Other Outboard Equipment: 6 Limiters, DynaMite noise gates, parametric EQ, Aphex
Microphones: Neumann, Telefunken, AKG; Sennheiser, EV, Shure, Sony, PML
Instruments Available: Yamaha C7 Fiano B 3 with 900 series Leslie, Fender Rhodes, String synth, Pearl drum kit, misc percussive
Rates: All types of studio rates inc. Block (15 hrs.) Day Block (10 hrs. in a single day) Late Night and Ind. Producer/Engineer Special!

••• **HIT SINGLE RECORDING SERVICES**
College Grove Center, Lower Ct. #4,
San Diego, CA 92115
(619) 265-0524
Owner: Scottman Ltd. a California Corporation
Studio Manager: Rick Bohman



JEL RECORDING STUDIOS
Newport Beach, CA

••• **JEL RECORDING STUDIOS**
6100 W. Pacific Coast Hwy, Newport Beach, CA 92663
(714) 646-5134
Owner: Edo Giudotti
Studio Manager: Sandra Gentosi
Engineers: Edo Giudotti, Bill Trousdale, Don Harper, Bob La Masney
Dimensions of Studio(s): Studio A 40 x 35, B 15 x 18
Dimensions of Control Room(s): A 16 x 18, B 16 x 16
Tape Recorders: Studer A80 MK III, Tascam 80 B 8 track, (2) Otari 5050B 2 track, Studer B 67 2 track, Otari 5050 MK III 8 track
Mixing Consoles: Sound Workshop 1600 20 in x 16 out, Sound Workshop Logex 8, 12 in x 8 out
Monitor Amplifiers: BGW, Crown
Monitor Speakers: F.V. JBL, Auratones
Echo, Reverb, and Delay Systems: Echo Plate III MICMIX reverb, Eventide Harmonizer, Marshall Time Modulator
Other Outboard Equipment: dbx limiters, Gain Brains, Kepexes, UREI 1176s
Microphones: Neumann, Sony, RCA, Shure, AKG, etc
Instruments Available: (2) Kawai grand pianos, Sequential Circuits Prophet 5, Hammond B 3, ARP 2600
Video Equipment & Services: JVC 1/4 inch VCR, BIX Shadow Synchronizer
Rates: Video Sweetening: \$110/hr. 16 track, \$75/hr. 2 & 8 track \$45/hr.

••• **KENJO AUDIO INC.**
also **REMOTE RECORDING**
607 E. Belmont, Fresno, CA 93701
(209) 266-9681
Owner: Jim Clymer, Jr.
Studio Manager: Jim Clymer, Jr.

••• **KINGSOUND STUDIOS**
7538 1/2 Woodley Ave., Van Nuys, CA 91406
(818) 997-1353
Owner: Eddie and Mari King
Studio Manager: Mari King

••• **KITCHEN SYNC RECORDING**
5325 Sunset Blvd., Hollywood, CA 90027
(213) 463-2375
Owner: Michael Hamilton, Larry Menshek, Jeff Snyder
Engineers: Michael Hamilton, Larry Menshek, Jeff Snyder
Dimensions of Studio(s): 16 x 14, isolation booth: 5 x 5
Dimensions of Control Room(s): 13 x 13
Tape Recorders: MCI JH 114 16 16 track, TEAC 60-8 width 8 track, Ampex ATH 100 2 track, Otari 5050B 2 track, TEAC 1/4-tracks (2), Sony cassette decks (5)
Mixing Consoles: Sound Workshop 1600, 20 in x 16 out
Monitor Amplifiers: Haller, Crown D-60s
Monitor Speakers: UREI 811 Time Align, Auratone 5Cs JBL 4411
Echo, Reverb, and Delay Systems: MIC MIX Super C reverb, MXR digital delay, Echoplate stereo plate reverb
Other Outboard Equipment: Eventide Harmonizer, MXR flanger/doubler, dbx 161 compressors, Kepex graphic EQs, 16 channels parametric EQ, Roland stereo flanger/chorus, Valley People DynaMite limiters, Symetrix phone interface
Microphones: Neumann, AKG, Sennheiser, Shure, Sony, Crown PZMs
Instruments Available: Kawai 6' grand piano, ARP Omni, Fender Rhodes
Rates: Call for rates

••• **LIGHTNING CORP.**
7854 Ronson Rd., San Diego, 92111
(619) 565-6494
Studio Manager: Mike Larsen

••• **MERCANTILE MOBILE RECORDING**
also **REMOTE RECORDING**
PO Box 2271, Palm Springs, CA 92263
(619) 320-4848
Owner: Kent Fox
Studio Manager: Kent Fox

••• **MUZIC TRAK**
2227 Alsace Ave., West Los Angeles, CA 90016
Owner: Courtney Branch, Randy Branch
Studio Manager: Courtney Branch, Randy Branch

••• **NEW SOUTH COMMUNICATIONS**
also **REMOTE RECORDING**
1720 E. Garry St., Suite 117, Santa Ana, CA 92705
(714) 250-1866
Owner: David Lubetkin
Studio Manager: Larry Travis

••• **ORIGINAL SOUND RECORDING STUDIOS**
7120 Sunset Blvd., N. Hollywood, CA 91607
(818) 766-9164 & 760-9393
Owner: Helen J. Levine
Studio Manager: Robert Groom

••• **REMOTE RECORDERS**
6124 Selma Ave., Hollywood, CA 90028
(213) 469-1002
Owner: Criterion Music Corp.
Studio Manager: Lawrence W. Wendelken

••• **ROSE STUDIOS**
1098 Rose Ave., El Centro, CA 92243
(619) 352-5774
Owner: Danny Berg
Studio Manager: Danny Berg/Domingo Ulloa
(SEE LOGO NEXT COLUMN)



ROSE STUDIOS
El Centro, CA

••• **SCOTTSOUND**
6110 Santa Monica Blvd., Santa Monica, CA 90408
(213) 462-6981
Owner: Bruce L. Scott
Studio Manager: Bruce L. Scott

••• **SOUNDTRAX RECORDING STUDIOS, INC.**
8170-U Ronson Rd., San Diego, CA 92111
(619) 560-8449
Owner: James B. PapaGeorge
Studio Manager: Christine Burobin

••• **SPECTRUM STUDIO (by appointment only)**
also **REMOTE RECORDING**
664 Camino Campana, Santa Barbara, CA 93111
(805) 967-9494, 967-1526, 963-7065
Owner: Don Ollis
Studio Manager: Don Ollis
Engineers: Don Ollis
Dimensions of Studio(s): 27 x 23 x 8, 14 x 12 x 8, 12 x 10 x 8
Dimensions of Control Room(s): 20 x 17 x 13
Tape Recorders: Ampex MM1000 w/VSO 2" 16 track, 1" 8 track, Ampex 440B 2 track, 15 & 30 ips, Revox A77 w/VSO 2 track, TEAC 3340S 4 track
Mixing Consoles: Custom, 18 in x 16 out
Monitor Amplifiers: Phase Linear 700As
Monitor Speakers: JBL 4311, 4301, Auratones
Echo, Reverb, and Delay Systems: Echoplate reverb, Marshall Time Modulator delay, Eventide H949 digital delays, also 15 and 30 ips tape delay
Other Outboard Equipment: Limiters Teletronix LA2As, RCA BA6s, dbx 161s Spectra Sonics 610 complementer, Marshall Time Modulator, Eventide H949 Harmonizer, EQs, Pultec EQP1A, MEQ5, Lang PEQ1s, Cassette decks (2) Sony TCK81s, (2) Hitachi D850s, Technics M260, (8 channel) Omnicraft GT 4 noise gates, Korg Vocoder
Microphones: Telefunken 250, 251s, Neumann M49, U67s, KM56, U87s, AKG C12, C12A, C2B, C28A, 414s, 452, 451s, Sennheiser 441, 421s, E.V. CO-90, Sony C500, ECM377, 22P, 33P, ECM50s, Altec M11s, 633As, HCA 44Bx, 44As, 77DXs, 74B, Shure 545s, SM56, SM57s, PE50SP
Instruments Available: LinnDrum II with large chip library, Korg Polysix, Korg Mono Poly, Korg Signal Processor, AlphaSyntra digital synthesizer, vintage 7' Steinway B grand piano, ARP String Ensemble, Fender Rhodes electric piano, Fender Jazz Bass, '57 Strat, Pre-CBS deluxe, twin, Ludwig drum set with 7 Roto toms, Guild 025 Comina soon, Yamaha DX7, Simmons Drums, Mini Moog
Video Equipment & Services: JVC pro video monitor (19-inch), Sony SL 5800 1/2 inch Beta Recorder/Player
Rates: \$45/hr. 16 track, 8 hour block \$45/hr., \$35/hr. 1" 8 track, \$30/hr. 2/4 track

••• **KRIS STEVENS ENTERPRISES INC.**
14241 Ventura Blvd., Suite 204,
Sherman Oaks, CA 91423
(818) 981-8255
Owner: Kris Erik Stevens
Studio Manager: Marc Grave

••• **STUDIO A**
11334 Burbank Blvd., N. Hollywood, CA 91601
(818) 761-1303
Owner: Gene Rabbai
Studio Manager: Gene Rabbai

Our 45th Year

Park on the roof



Since 1939

RAINBO RECORDS

1738 Berkeley Street
Santa Monica, California 90404
(213) 829-0355 (213) 829-3476
TWX 910-343-6862

**The ONE STOP
Center for Complete
Duplicating &
Total Custom Record
Pressing**

Any Size

Any Shape

Any Picture

Any Color

In-House Labels

Record Jackets

Mastering

Picture Sleeves

Processing



**No Order Too Large
No Order Too Small
10-Day Turn Around**

Circle #066 on Reader Service Card

S. Ca. 16 Track

••• **STUDIO AMERICA, INC**
50 N. Mentor, Pasadena, CA 91106
(818) 440-9919

Owner: Denny Dooley, Roy Ottopalio, Joe Pollard
Studio Manager: Joe Pollard

••• **STUDIO B PRODUCTIONS**
1365 N. Van Ness, Fresno, CA 93728
(209) 268-4010

Owner: Marv Allen
Studio Manager: Marv Allen

••• **STUDIO 9 AUDIO/VIDEO LABS**
5504 Hollywood Blvd., Hollywood, CA 90068
(818) 871-2060, 353-7087

Owner: John Gillies

Studio Manager: John Gillies

Engineers: John Gillies, Ron Wenick, Steve Blazina, Bill Smith

Dimensions of Studio(s): 20 x 20, Iso Booth 8 x 5

Dimensions of Control Room(s): Audio 20 x 15, Video editing and screening room 20 x 12

Tape Recorders: 3M 2 inch 79 16 track, Tascam with dbx 80-88 track, Tascam with dbx 3440 4 track, Teac with dbx 3300 2 track, 4 Sansui 1110 cassette decks

Mixing Consoles: Quantum Concept 118 in 8 out

Monitor Amplifiers: Marantz

Monitor Speakers: JBL 4311s and Auratones

Echo, Reverb & Delay Systems: 2 Furman Reverb Chambers both with limiters, MXR digital delay, MXR pitch transposer, MXR flanger doubler, tape delay, and Echoplex

Other Outboard Equipment: Symetrix stereo noise gate, Furman stereo parametric equalizer, dbx limiters compressors, Technics turntable and electronic metronome

Microphones: 3 Electrovoice RE 20s, RE 50, Sennheiser 441 and 421, Shure (5) SM57s, (4) SM 58s, Sony condenser EM, (4) Audio Technica condenser

Instruments Available: Baby grand upright piano, Fender deluxe reverb, At small additional cost, DMX and LinnDrum machine, Prophet 5, Chroma, Vocorder, and complete list of studio musicians. Plus complete demo packages

Video Equipment & Services: 1/2 inch video editing, 1/2 inch and 1/4 inch copying, giant screen viewing room with JBL monitor

Rates: 4 track \$15/hour, 8 track \$18/hour, 16 track \$24/hour, Video editing \$24/hour, Screening and video copies \$18/hour. All rates include engineer

••• **SUTTON SOUND STUDIO**
8390 Curbaril, Atascadero, CA 93422
(805) 466-1833

Owner: Rick Sutton
Manager: Rick Sutton

••• **TRAVEL TRACS RECORDING CO.**
also **REMOTE RECORDING**
1605 W. 221st St., Torrance, CA 90501
(213) 320-8664

Owner: Double T Enterprises
Studio Manager: Don Briggs

••• **TRAX SOUND RECORDING**
1916 Manning Ave., Los Angeles, CA 90025
(213) 470-8180

Owner: Michael McDonald

Engineers: Michael McDonald

Dimensions of Studio(s): 12 x 24, two isolation rooms 6 x 8 and 7 x 9

Dimensions of Control Room(s): 9 x 15

Tape Recorders: Tascam 90 16 16 track, Otari MX5050B 2 track, Pioneer RT 1050 2 track, Tandberg 10X 2 track, Hitachi, Superscope cassette decks

Mixing Consoles: AudioArts R-16, 24 x 8 x 2

Monitor Amplifiers: AB Systems Model 410C, G.A.S., Crown, Nakamichi

Monitor Speakers: UREI 811 Time Aligned, Auratones

Echo, Reverb & Delay Systems: Echoplex III plate reverb, MXR 01 digital reverb, 2 DeltaLab DL 4 delays

Other Outboard Equipment: Eventide 910 Harmonizer, (2)

AudioArts limiters/de-essers, dbx 164 limiter, (2) dbx 160 limiters, Valley People Dynamite, EXR Exciter, Omni-Craft GT 4 noise gates, MICMIX Dynallex, UREI 527 27 band EQ, (2) Klark Teknik 27 band EQ's, innovative audio tube mic pre-amp, innovative audio tube direct boxes

Microphones: Neumann U 87, Foxtex M83RP Ribbon; (2) AKG 414's, (4) AKG 452's, AKG D12E (1+4), (2) Sennheiser 421's, (2) Crown PZMs, EV RE 20, RE 15, FL 76, Smau SM 57, SM 58, SM 59

Instruments Available: Steinway grand piano, guitars, amps, effects

Rates: \$40/hr. (All equipment and engineer included) Block rates available

Direction: For the last five years Trax has recorded many album E.P. and single releases, national commercials for radio and television, and music scores for feature films, film trailers and television. Our clients include Columbia pictures, Walt Disney Productions, Glen Larson Productions, Warner Bros., Hanna-Barbera, Screen Gems, Disneyland, Budweiser, and many others.



TRAX SOUND RECORDING
Los Angeles, CA

••• **WATERMARK STUDIOS**
10700 Ventura Blvd., N. Hollywood, CA 91604
(818) 980-9490

Owner: ABC Radio Enterprises, Inc.
Studio Manager: Joel Saikowitz

••• **WOODCLIFF STUDIOS**
Sherman Oaks, CA 91423
(818) 784-7259

Owner: Michael Rosato
Studio Manager: Frank Rosato

—FROM PAGE 5, FEEDBACK

Fast attack times of the compressor reduce the signal peaks of the compressor output level, and thus distortion. This should be an important consideration in noise reduction design since it allows for better overall response. Ideally, any type of noise reduction should be transparent with no signal coloration. However, all of the noise reduction units tested colored the reproduction in one way or another. None of the systems tested, Telcom, Dolby or dbx, could actually improve the sound quality, but in our tests, results showed that the program rerecorded with Telcom gave the most accurate representation of the prerecorded material with the least coloration. Thank you for your comments.

Sincerely,
Karen Ensor
Mix Field Test Engineer

Southern California



24 Track

ADAMO'S RECORDING

16571 Higgins Circle, Huntington Beach, CA 92647
(714) 842-2668
Owner: Jerry Adamowicz

ADVANCED MEDIA SYSTEMS

833 W. Collins Ave., Orange, CA 92667
(714) 771-1410
Owner: Daniel R. Van Patten
Studio Manager: Cheryl Thiele

AMIGO STUDIOS

1114 Cumpston St., N. Hollywood, CA 91601
(818) 980-5605
Owner: Chet Humes, Steve Shields, Barry Wilson
Studio Manager: Bob Carroll

A&M RECORDING STUDIOS

1416 N. La Brea Ave., Hollywood, CA 90028
(213) 469-2411

Owner: A&M Records

Studio Manager: Director of Operations Don Hahn, Studio Manager Thomas "Ben" May, Traffic Manager Mimi Thomas
Engineers: Staff or bring your own

Dimensions of Studio(s): A 44 x 36 x 25 and vocal booth; B 22 x 31 1/2 x 15 and vocal booth; C 26 x 19 x 9, D 29 x 32 x 24, three isolation rooms. All studios capable for tie in to A&M's Chaplin sound stage

Tape Recorders: MCI JH 24-24 24 track; MCI JH-114 24/16 track, Scully 280 16/8/4/2/1 track, Ampex ATR 2 track, Tandberg, Eumig, Pioneer cassette decks

Mixing Consoles: A. Trident TSM custom, 40/24/32, D. Trident with Melquist Computer TSM custom, 48/24/32; B&C API custom, 32/16/24

Monitor Amplifiers: UREI, H&H, McIntosh

Monitor Speakers: Custom system & Altec 604E with subwoofer and Mastering Lab crossover

Echo, Reverb, and Delay Systems: Live chambers, EMT 140s, Lexicon 224, Lexicon Prime Time, Eventide DDL, Klark Teknik, DDL, Cooper Time Cube, Echoplate

Other Outboard Equipment: EQs Orban parametric, Pultec, Lana, Quad Eight, API, Aphex Filters Langlevin, UREI, UA, Haeco Limiters: UREI 1176, LA2A, Kexex, Aphex, Gain Brain, Fairchild Other Dolby, dbx, Harmonizers, phasers, de-essers, BTX interlock and more

Microphones: Telefunken, Neumann, AKG, RCA, Sennheiser, Shure, Electro-Voice, Sony, Norelco, Altec, Beyer. Full complement of tube, solid state, condenser, dynamic and ribbon microphones

Instruments Available: 4 Steinway 7' pianos, 2 Hammond B-3 organs, 2 Celeste, Tack piano, Fender Rhodes
Rates: Call for rates

A&R RECORDING SERVICES

also REMOTE RECORDING

71906 Highway 111, Rancho Mirage, CA 92270
(619) 346-0075

Owner: Scott B. Seely

Studio Manager: Nick Mandala Scott Seely

Engineers: Nick Mandala, Scott Seely

Dimensions of Studio(s): 30 x 18

Dimensions of Control Rooms: 12 x 12

Tape Recorders: Soundcraft 382 24 track, Ampex ATR-102 2 track; Revox A77 2 track

Mixing Consoles: Neotek Series 2, 24 out x 24 in

Monitor Amplifiers: BGW 700, Crown 60, Crown D-150s.

Monitor Speakers: JBL 4311s, Altec 604s, Auratone 9Cs

Echo, Reverb, and Delay Systems: MasterRoom XL-210, Acoustic Computer MXL-305

Other Outboard Equipment: dbx 160, Orban 424A, DeltaLab DL-2, Kexex, Denon and Akai GX-M50 cassette decks, Ashly Sc-66As, Clap Trap

Microphones: Neumann U47 tube, AKG P48s & 414, E-V RE-20s, SM-58s

Instruments Available: Steinway A grand piano ARP String Ensemble, Prophet 5 1000, Mini-Mooq, Mini-Korg, Rhodes Pro piano modified

Video Equipment & Services: Available in house or remote location 2 cameras available

Rates: On request

ARTISAN SOUND RECORDERS

1600 North Wilcox, Hollywood, CA 90028
(213) 461-2070

Owner: Kent R. Duncan

Studio Manager: Greg Fulbright

AUDIO AFFECTS

P.O. Box 6327, Beverly Hills, CA 90212
(213) 986-9902

Owner: Craig Hundley

Studio Manager: Derra Shelley

AUDIO ENGINEERING ASSOCIATES

also REMOTE RECORDING

1029 N. Allen Avenue, Pasadena, CA 91104
(818) 798-9127 also (818) 684-4461

Owner: Wes Dooley and Sara Beebe

Studio Manager: Janet Dodson

Engineers: Ron Streicher, Janet Dodson Pitt Kinsolving, Wes Dooley, Richard Knoppow

Dimensions of Studio(s): 30 x 23 x 14, isolation booth 10 x 7 x 8

Dimensions of Control Rooms: 17 x 13 x 12

Tape Recorders: Studer A80RC II 1/2" 2 track, Studer A810 1/4" 2 track, Otari MX5050 MkIII 8 1/2" 8 track, Soundcraft 760 2" 24 track, Sony PCM-F1/SL2000 2 track digital, Otari MX5050B MkII 1/4" 2 track, Tascam 16 track 1", misc. other recorders by Revox and Sony 1/4 track cassette

Mixing Consoles: Soundcraft 1600, 24x8x2 and 800, 18x8x2, Soundcraft 400B, 16x4x2, Quantum 12A custom modified, 12 in x 4 out. Custom built 6x2 portable consoles

Monitor Amplifiers: Hafler, Ashly, Fostex, UREI

Monitor Speakers: KEF, JBL, UREI, Auratone; headphones by Beyer, Fostex, Yamaha, Koss, AKG

Echo, Reverb, and Delay Systems: Echoplate (all three size units), Lexicon and DeltaLab, Fostex, AKG; MICMIX and others

Other Outboard Equipment: Wide variety of equipment by AKG, dbx, UREI, Lexicon, Ashly, Klark Teknik, Fostex, DeltaLab and others

Microphones: AKG, Schoeps, Neumann, Crown PZM Shure, RCA ribbon, Beyer, E-V, Sennheiser

Instruments Available: Steinway model M grand piano

Rates: 2 track rate: \$50/hr., 8 track rate \$60/hr. Remote rates and special rates by quotation

BABY 'O RECORDERS, INC.

6525 Sunset Blvd., Hollywood, CA 90028

(213) 464-1330

Owner: Rafael Villalane, Enrique Senker, Rick Perrotta



BELL SOUND INC
Hollywood, CA

BELL SOUND INC.

also REMOTE RECORDING

916 N. Citrus Ave., Hollywood, CA 90038
(213) 461-3036

Owner: Sandra Marshall, John Francis, Don Piestrup

Studio Manager: Chris Smith

Engineers: John Osiecki (chief engineer), Doug Rutherford, Robb (Lightning) Holt, Steve Skinder, Scott Nevland

Dimensions of Studio(s): A 34 x 24 B 29 x 16

Dimensions of Control Rooms: A: 18 x 24, B 21 x 16
Tape Recorders: Analog Ampex MM 1200 24 track, MCI JH24 24 track, 3M M79 4 track, (2) 3M M79 2 track, (2) Studer A810 2 track, (2) MCI JH110 2 track, Ampex 440 full track (8) Ampex 351 full track

Mixing Consoles: Quad Eight Coronado 36 in x 36 out, Audiotronics 501 26 in x 26 out, Soundcraft 200 8 in x 4 out

Monitor Amplifiers: UREI, H&H, Crown, SAE P S

Monitor Speakers: UREI, Altec, Auratone, Yamaha Echo, Reverb, and Delay Systems: EMT 140 stereo plate, EMT 251, Lexicon Prime Time, Lexicon 224X, Lexicon Super Prime Time

Other Outboard Equipment: Kexex, Kexex II, UREI limiters, Gain Brains, Berwin noise eliminator, Little Dipper, UREI 526 EQs, Dolby 26, Harmonizer, EXR Exciters.

Microphones: Sennheiser, Neumann AKG Telefunken, Shure Altec, RCA, E-V

Instruments Available: (2) Yamaha grand pianos 9 piece Gretsch drum set, 7 piece Yamaha drum set

Video Equipment & Services: Sony 2860 A, Sony 5800, EECO MQS 100, 24 track 1/4" lockup

Rates: Upon request

BEST AUDIO/BEST SERVICE

ONLY REMOTE RECORDING

5422 Fair Ave., No. Hollywood, CA 91601

(818) 763-2378

Owner: Estrin Associates, Inc

Studio Manager: Bob Huntley

BLUE DOLPHIN

650 N. Browson Ave., Hollywood, CA 9004

(213) 467-7660

Owner: Bruce Langhorne, Morgan Cavett, Stan Young

Studio Manager: Morgan Cavett

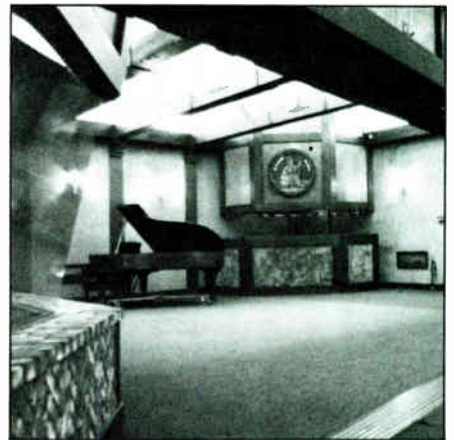

BRITANNIA STUDIOS
Hollywood, CA

BRITANNIA STUDIOS INC.

3249 Cahuenga Blvd. West, Hollywood, CA 90068

(213) 851-1244

Owner: Gordon Mills, Tom Jones

Studio Manager: Greg Venable

Engineers: Greg Venable, Gary Singleman

Dimensions of Studio(s): 32 x 45, separate string room

Dimensions of Control Room(s): 18 x 18

Tape Recorders: MCI JH-110-A 2 track, MCI JH-110 4 track, MCI JH 114 24 24 track

Mixing Consoles: MCI JH 536, 36 in x 36 out

Monitor Amplifiers: BGW

Monitor Speakers: JBL custom, Bi-Amp 2 way, JBL 4311, Auratone

Echo, Reverb, and Delay Systems: Two MICMIX III, two live stereo acoustic chambers with pan send capabilities

Other Outboard Equipment: Harmonizer with DDL, (6) UREI limiters: Orban parametric EQ, Orban De Esser, phasers, etc., 28 channels Dolby, 2 channels dbx

Microphones: Neumann U-87, KM-84; AKG 452; E-V RE-20, RE-15, 667, 666, Shure SM-57, Sennheiser

Instruments Available: Steinway B grand piano, Fender Rhodes, clavinet

Rates: \$160/hr includes two engineers, 24 hours per day, 7 days

(LISTING CONTINUED ON PAGE 118)

- 2500 & 600 Square Foot Sound Stages
- 1-Inch A/B Roll, 24-Track Audio Sweetening
- In-House or Location Shooting

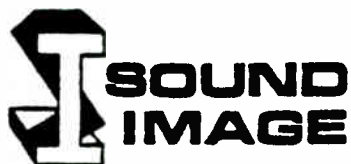

Professional Audio & Video Services

1945 Diamond Street
San Marcos, California 92069
(619) 744-8460

Circle #067 on Reader Service Card

The New
**Bernie Grundman
Mastering Studio**
6054 Sunset Blvd., Hollywood, CA 90028
(213) 465-6264

- Complete Disc Cutting Services
- Analog and Digital Sub Masters for:
Compact Discs
Cassette Duplication

Circle #068 on Reader Service Card

(FROM PAGE 117)

a week. Also includes all equipment and Dobys \$135/hr less first engineer.

Extras: Large lounge with full kitchen and TV. Warm old English Tudor atmosphere.

Direction: We are now a member of the IATSE and offer video lock up for film scoring. Call for rates.

◆◆◆ BROOKHILL

13715-A Ventura Blvd., Sherman Oaks, CA 91423
(818) 788-0300

Owner: Tim O'Brien

Studio Manager: Steve McDonald

Engineers: Steve McDonald, Bill Jenkins

Tape Recorders: Analog Ampex MM1100 24 track, Hevox B77 2 track; TEAC 3300 2 track; Studer B67 2 track

Mixing Consoles: Dynamix 3000 32x8

Monitor Amplifiers: Marantz 250

Monitor Speakers: JBL, Visonik, Auratone

Echo, Reverb, and Delay Systems: MasterRoom XI, 405, DeltaLab Super Time Line, 224 Lexicon

Other Outboard Equipment: Aphex Aural Exciter, dbx 160x compressors, Valley People Dyna Mite, Eventide Harmonizer, Soundcraftsman EQ

Microphones: AKG 202, Altec N21 (tube), Beyr M88, M101, E-V 666 Neumann U-47, Sennheiser 421 (5) Sony C-500, ECM 50, Countryman and Sennheiser direct boxes

Instruments Available: LinnDrum, Fender Rhodes, Memorymoog, Farlight CMI (extra)



CALIFORNIA RECORDING
Hollywood, CA

◆◆◆ CALIFORNIA RECORDING

5203 Sunset Blvd., Hollywood, CA 90027
(213) 666-1244

Owner: American Music Industries Inc.

Studio Manager: John Brady

Engineers: John Brady, Tim Garrity

Dimensions of Studio(s): Studio A 45 x 40, Studio B Dubbing and Production

Dimensions of Control Room(s): 20 x 18

Tape Recorders: MCI JH 24 24 track, Ampex AG 440 2 track, Ampex 1/2 4 track, Ampex ATR 102, cassette machines by Technics, TEAC, Pioneer, and Aka;

Mixing Consoles: Neotek Series III (totally transformerless), 28 in x 24 out

Monitor Amplifiers: Yamaha, Crown, BGW, and SAE

Monitor Speakers: Altec 604Es with Mastering Lab Crossovers in De Medio cabinets, Auratones

Echo, Reverb, and Delay Systems: EMT 140 Lexicon Prime Time, Harmonizer

Other Outboard Equipment: LA-2A, 1176, dbx 161 limiter, Kexex, Pultec EQ; Digital Metronome, Roland flanger, 224X w Larc head, (2) Lexicon PCM 442 DDLs and Valley People Kexex noise gates.

Microphones: Telefunken M-251, Neumann U 48 tube, U 87, KM-84, RCA 77-DX, 44, AKG 414-EB, 451; Sony C-17 A tube C-37 FET, E-V RE 20, RE 15, 665, Sennheiser 421, Beyr M 160, Shure 545, 57, etc

Instruments Available: Steinway B grand piano, Rhodes, guitar amps, Leslie speaker

Video Equipment & Services: Complete Audio/Video interlock for audio sweetening for TV shows, commercials and film production

Rates: Please call for rates

◆◆◆ CAN-AM RECORDERS, INC

18730 Oxnard St., Tarzana, CA 91356
(818) 342-2626

Owner: Can Am Corp

Studio Manager: Larry A. Cummins

Engineers: Brian Malouf, Ann Calnan, Bill Stanbridge

Dimensions of Studios: 25 x 40 x 14 w/2 live iso booths

Dimensions of Control Rooms: 20 x 25

Tape Recorders: Analog Ampex ATR 124 24 track, ATR 102 2 track (1/2 x 1/4), MCI JH10A 2 & 4 track, Pioneer Technics RT 701 & RS M85 1/4 track cassette

Mixing Consoles: Quad Eight Coronado 40x40

Monitor Amplifiers: Crown PSA 2, IX-800 IX-150, Yamaha, Technics

Monitor Speakers: JBL, Yamaha, Visonik, Auratone

Echo, Reverb, and Delay Systems: EMT stereo tube 140, 240 gold foil, Lexicon 224X, Lexicon Prime Time I & II, Eventide H944 & H910 Harmonizers, DeltaLab delays, Klark Teknik DN 44

Other Outboard Equipment: UREI L4 4, 1176, dbx 165, 160X, 48X, Quad Eight CL22, Kexex II, Orban 622B parametrics, EXH, MICMIX Dynalander, Dolby, MXR phasers and flangers, autotune

Microphones: Neumann, AKG, Sennheiser, Beyr, Shure, Crown P2M, Sony Superscope, E-V AT Foster

Instruments Available: Studio grand, Rhodes, Artstrings, drum set, guitar & bass amp, LinnDrum, Simmons

Rates: Available upon request



CAPITOL RECORDING STUDIO
Hollywood, CA

◆◆◆ CAPITOL RECORDING STUDIO

1750 No. Vine St., Hollywood, CA 90028
(213) 462-6252

Studio Manager: General Manager Charles Cornelli Bookings Barbara Hon

Engineers: Davis Cole, Gene Woolley, Hugh Davies, Bob Norling, Jay Bonelluca, Gary Hollis, Disc Mastering Engineers: Wally Truitt, Eddy Schroyer, Gene Thompson

Dimensions of Studios: A 60 x 45, B 44 x 41, C 10 x 12 (D) 10

Dimensions of Control Rooms: A 15 x 20, B 20 x 22, C 18 x 22

Tape Recorders: Analog (2) Studer A800 24 track, Studer A80 24 track (8) Ampex ATR 100 2 & 4 1/4" & 1/2" (2) Studer A80 2 track, Digital (2) Sony BVU 800 PCM 1610 2 track, (2) IVC 8200 2 w Editor

Mixing Consoles: Neve 8008 32x16, Neve 8108 48x32, Quad B Custom 32x16

Monitor Amplifiers: David Haller's P 500s modified

Monitor Speakers: UREI system in C, Acoustic-r system in B, JBL 4420 custom in A

Echo, Reverb, and Delay Systems: (8) live chambers, AMS digital, AMS reverb, EMT 140 (stereo), Cooper Time cube, Prime Time Super Prime Time, Roland 3000 & Klark Tek analog delay, EMT 250

Other Outboard Equipment: dbx limiters (160) Trident parametric EQs, Kexex II, (10 channels) Q Lock Synchronizer system, ITI parametric EQ, UREI 1176 Eventide 949 Harmonizers, Fairchild limiters

Microphones: 200 plus microphones. All popular makes and models

Instruments Available: Steinway grand piano, 9 Yamaha concert grand, Fender Rhodes 73 & 88 Wuritzer electric, celeste, vibes, Hammond B 3

Rates: Studio A (days) \$125/hr., (nights) \$135/hr. Disc Room

\$110/hr Studio B (days) \$135/hr; (nights) \$150/hr EQ, Run-down, Studio C (days) \$135/hr; (nights) \$150/hr
Extras: XDR cassette mastering Featuring digital mastering for Capitol's highly acclaimed, high quality XDR cassettes. Library of sound effects. Private Artist's lounge, 1/2" 2-track recording & mastering Two mastering rooms, mixdown suite 48 track. Digital 2 track recording & mastering Zuma cutting system, Q-LoKk Sync System Facility tie lines for interconnecting studios
Direction: Complete in-house facility from tracking to mastering with (4) Neve consoles and (2) Neumann SAL 74 mastering systems, both with Studer 2 track playback We have been chosen by Great American Gramophone Co and others for the major Direct-to-Disk session on the West Coast Superior studio acoustics and the wide variety of equipment available to draw clients from all major record labels as well as Capitol Let us help make your next hit record

**** CHANNEL RECORDING
 2201 W. Burbank Blvd., Burbank, CA 91506
 (818) 846-3003
 Studio Manager: Michael Verdick

**** CIRCLE SOUND
 3465 El Cajon Blvd., San Diego, CA 92104
 (619) 280-7310
 Owner: R&B Music Corp
 Studio Manager: Richard Bowen



CLASSIC SOUND
 Hollywood, CA

**** CLASSIC SOUND
 6362 Hollywood Blvd., Ste. 214/216, Hollywood, CA 90028
 (213) 664-7622
Owner: Tony Rockliff, Patti Nicklaus, Ron Fitzgerrel
Studio Manager: Tony Rockliff, Patti Nicklaus
Engineers: Mark Coffin, Frank Orlando
Dimensions of Studios: 23 x 13 and (2) booths
Dimensions of Control Rooms: 16 x 14
Tape Recorders: Analog: Stephens H21 B w/QII & video sync 24 track, Otari 5050 MkII 2 track; TEAC 3300SX 2 track, Aiwa 3500A11 cassette
Mixing Consoles: Tancent 2402 24/2, Bamp 1642 16/16
Monitor Amplifiers: Acuphase P200
Monitor Speakers: Tannoy SRM 12 B, Auratone, Sixx Electrostats
Echo, Reverb, and Delay Systems: Echoplate, MasterRoom, OrbanPhase Linear auto-correlator
Other Outboard Equipment: Eventide H949 harmonizer w/keyboard, DeltaLabs Effectron, MXR digital delay, EXR Aural Exciter, Kepex & Roger Meyer gates, Valley People stereo Dyna Mile, dbx 165 compressor, Eventide Omnipressor, Orban stereo parametric EQ, SAE 20 band stereo graphic EQ, Spectro Acoustic stereo 10 band graphic EQ, Pultec tube EQ, dbx 155 noise reduction, Orban mono/stereo synth
Microphones: AKG 414 (3), AKG 401 (2), PZM, Audio Technica 813, Sennheiser 421 & 441, Electro Voice RE11 & RE15, Shure SM59 & SM56, several other assorted mikes
Instruments Available: Steinway grand piano, 360 systems digital keyboard, Sequential Circuits 6 track, Sequential Circuits drum traks, clavinet, Koru guitar synth, Casios, Les Paul and many effects
Video Equipment & Services: Video sync on 24 track
Rates: First 3 hours (intro special) \$25/hr including synths, under 10 hr = \$40/hr Average rate = \$35/hr (10 hrs and more) Larger block rate = \$30/hr (50 hrs and more).
Extras: We have a full service record production division for our clients and also do in-house production for European record deals. We also feature a unique studio time-sharing plan, now in its second successful year. Another major feature is the accuracy of our control room monitoring
Direction: The studio does mainly albums, singles, EPs and

soundtracks. Regular clients include Kim Fowley & David Campbell. We place a tremendous emphasis on the relationship between our engineers and our clients as we feel that the engineer's attitude is at least as important as his technical expertise. We keep in very close touch with our clients to ensure that they have fun, productive sessions in a very comfortable atmosphere and get what they want. A lot of previously unsigned people have obtained deals with tapes done at our studio.

**** CLOVER RECORDING STUDIO
 6232 Santa Monica Blvd., Hollywood, CA 90038
 (213) 463-2371
Owner: Chuck Plotkin
Studio Manager: Catharina Masters-Bunch
Engineers: Catharina Masters-Bunch, Todd Prepsky, Assistant Engineer, Dave Pearce, Maintenance. Independent engineers available
Dimensions of Studio(s): 26 x 23 x 10'; isolation booth 15 x 16 x 10'; vocal booth 5 x 6 x 10'
Dimensions of Control Room(s): 15 x 15
Tape Recorders: MCI 24 track w Autolocator III, Studer A80 2 track, Studer B67 2 track, Ampex ATR100 2 track, Otari 2 track 1/4" Revox 2 track, Sony digital cassette PCM F-1, Technics cassette, Aiwa cassette
Mixing Consoles: API/Jensen 2488, 32x24x2 w/computer mixing matrix
Monitor Amplifiers: Haller DH220, ESS 500A, Crown DC150
Monitor Speakers: IREI Time Aliqns, Altec 604Es with Mastering Lab crossovers, IRL 4311s, Auratones, Yamaha NS 10-M's, Advent
Echo, Reverb & Delay Systems: EMT 250, Echoplate, (2) EMT 140s (stereo units)
Other Outboard Equipment: LA2A compressor/limiter, (2) LA2A compressor/limiters, (3) 1176LN limiters, (2) EMT PDM compressors, Eventide Omnipressor, (4) Kepex noise gates, (2) Roger Meyer noise gates, (2) Gain Brauns, Lang parametric EQ, (2) Pultec filters, Orban parametric EQ, SAE stereo EQ, Publison Gleichless Harmonizer dual digital delay, Orban Sibilance control, Eventide instant flanger, B.E.L. flanger, (2) Marshall tube modulators, Eventide Harmonizer, Eventide digital delay
Microphones: full complement of dynamic and condenser mikes including older tube types
Instruments Available: Steinway model B grand piano
Rates: Please call

**** COMPACT SOUND SERVICES
 2813 W. Alameda Ave., Burbank, CA 91505
 (818) 840-7000
Owner: Compact Video Inc
Studio Manager: Terry Averbach/Vide, Tex Hudlott/Film

**** THE COMPLEX
 2323 Corinth Ave., West Los Angeles, CA 90064
 (213) 477-1938
Owner: The Complex Inc
Studio Manager: Richard Salvato



CONWAY RECORDING STUDIO
 Hollywood, CA

**** CONWAY RECORDING STUDIO
 655 N. St. Andrews Place, Hollywood, CA 90004
 (213) 463-2175
Owner: Buddy and Susan Brundo
Studio Manager: Nadine White
Engineers: Csaba Petocz, Jeff Stebbins
Dimensions of Studios: 20 x 60 x 16
Dimensions of Control Rooms: 18 x 30
Tape Recorders: Analog: Studer A800 24 track, Studer A80 RC 1/2" 2 track, Studer A80 RC 1/4" 2 track
Mixing Consoles: Neve 8108, 48 inputs
Monitor Amplifiers: Perreaux

Monitor Speakers: George Augspurger, JBL, TAD, Yamaha NS-10, JBL 4311, Auratone
Echo, Reverb, and Delay Systems: EMT 250, Echoplate, 949 910, DeltaLab stereo DDL, Prime Time, etc
Other Outboard Equipment: Q-LoKk, (8) Kepex II, dbx rack w/EQ & de-esser, (2) Marshall A300 tape deck eliminator, loit flanger, AMS flanger, 10 limiters, etc
Microphones: All AKG, all Neumann, U-47
 Yamaha 9' concert grand, GML movable fader automation (George Massenburg labs).
Rates: Call

**** CRYSTAL SOUND RECORDING STUDIOS
 1014 N. Vine St., Hollywood, CA 90038
 (213) 466-6452
Owner: Andrew Berliner, President
Studio Manager: Robert Marcoulet
Dimensions of Studio(s): 40 x 50 x 15, fully adjustable acoustics on wall and ceiling. Drum platform and vocal booth
Dimensions of Control Room(s): Studio A: 27 x 30 x 16
Tape Recorders: Studer tape machines
Mixing Consoles: 48 in/24 out/32 monitor Crystal Lab system console; Crystalab model 2424, 40 in x 24 out, Mastering Room, Neumann Lahe 5X74 head and Crystalab electronics
Microphones: Extensive microphone selection many tube mikes
Instruments Available: Yamaha 9' concert grand, Hammond B3 organ w Leslie, Fender Rhodes electric piano, ARP String synthesizer
Rates: Available on request

**** CUSTOM SOUND RECORDING
 also REMOTE RECORDING
 16507 C Soledad Canyon Rd., P.O. Box 2036,
 Canyon Country, CA 91351
 (805) 251-4311
Owner: R.S. Mintz, Esq
Studio Manager: Estrella Antares

**** DETROIT SOUND STUDIO
 also REMOTE RECORDING
 P.O. Box 43609, Los Angeles, CA 90043
 (213) 299-5002
Owner: Frank H. Jackson
Studio Manager: Frank H. Jackson

**** DEVONSHIRE SOUND
 10729 Magnolia Blvd., N. Hollywood, CA 91601
 (818) 985-1945
Owner: David K. Mancini
Studio Manager: Dee Mancini



DIGITAL SOUND RECORDING
 Los Angeles, CA

**** DIGITAL SOUND RECORDING
 (Formerly THE HOPE STREET STUDIO)
 also REMOTE RECORDING
 607 N. Ave. 64, Los Angeles, CA 90042
 (213) 258-6741, 258-0048
Owner: Van Webster
Studio Manager: Mariellen Urban
Engineers: Van Webster, George Sanger, Mariellen Urban
Dimensions of Studios: Studio A: 40 x 32 x 11, plus 7 x 12 x 11 vocal booth
Dimensions of Control Rooms: 16 x 16 x 10
Tape Recorders: Analog: 3M Minicom 79 24 track, Studer 67 2 track, Ampex 440 2 track, Trac 3300 2 track, Sony PCM 1600/1610 2 track
Mixing Consoles: MCI 428B, 28 in x 24 out
Monitor Amplifiers: SAE 24001, SAE 2600 bamped w SAE
 (LISTING CONTINUED ON NEXT PAGE)

(FROM PAGE 119)

Crossovers: McIntosh 275, Dyna JBL
Monitor Speakers: JBL, Auralone, RSI
Echo, Reverb, and Delay Systems: Digital reverb, live chamber, Eventide Phaser and Harmonizer, Marshall Time Modulator, Sound Workshop time delay, Master Room Stereo Super C, tape delay Stamp

Other Outboard Equipment: Adams Smith 2600 synchronizer system, Scamp rack, Burwen DNF/1000 noise filter, Limiters Stamp, UREI, Teletronix LA2A Inovonics, dbx, Expanders 3BX, Kepex, Scamp, Pultec filters, Orban stereo synthesizer and sibilance controller, VXC, parametric EQ, 4M Selectake II

Microphones: Neumann SM2 (tube), UM 64 (tube) Neumann U 47 FE1, & U 47 tube, U-87, IM-84, AKG 451, 452, 224E, C 60 (tube type), Electro Voice RE-20, RE-15 666, Sennheiser 421, 401, RCA 77DX, Shure 545-SD, SM-5H, PE 54D, Sony F 121, direct boxes

Instruments Available: Steinway Model B grand piano, Oberheim OB-X Roland Jupiter 4, Sequential Circuits Prophet 5, Mini Moog, Roland SH 5, Wavemaker 6, Serge Modular System, Synthi AKS, Fender amps, Gulbransen upright piano

Video Equipment & Services: 1/4" off line editing, BVU 200A recorders. Digital audio services for Beta hi fi masters. Full video production broadcast & industrial

Rates: Call for rates

Direction: Digital Sound Recording is a source for compact disc master tape preparation and analog to digital transfers. We also are the best source of digital audio services for video production. Our pioneering digital audio work includes artists like Bruce Springsteen, Peter Gabriel, Berlin, The Blisters, Ray Price, and the first Beta hi fi singles from Sony. Call us to answer any of your digital questions

•••• DOCTOR MUSIX

6715-17 Melrose Ave., Hollywood, CA 90038
(213) 930-2501

Owner: Peter and Cindy Hirsh
Studio Manager: Cindy Hirsh

•••• DYNASTY STUDIO

1614 Cabrillo Ave., Torrance, CA 90501
(213) 328-6836

Owner: Phil Kachaturian
Studio Manager: Phil Kachaturian

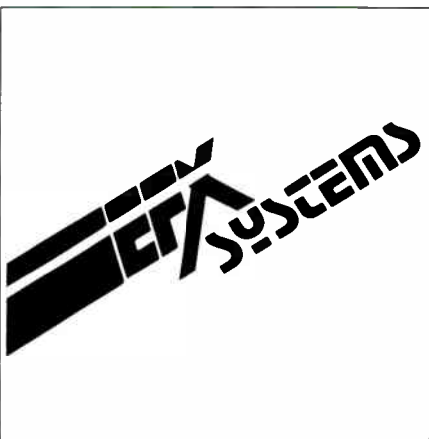

EFX SYSTEMS
Burbank, CA

•••• EFX SYSTEMS

919 N. Victory Blvd., Burbank, CA 91502
(818) 843-4762

Owner: partnership

Studio Manager: Roberta Liebreich

Dimensions of Studio(s): M 35 x 47 x 20, S 14 x 14 x 10

Dimensions of Control Room(s): M 22 x 26, S 14 x 14

Tape Recorders: MCI JH24 24/16 track, (2) MCI JH14 24/16 track, Scully 280H 24 16 track, 4M 79 16 B track, 3M 56 B track, Studer A80VI 4/2 track, Ampex ATH100 2 track, MCI JH110 2 track

Mixing Consoles: Amek 2000A 2500, 36 in x 24 out, B&B 1624, 28 in x 16 out, WA 800, 24 in x 16 out

Monitor Amplifiers: Times One, Yamaha, QSC, Haller, McIntosh, Crown AB Systems

Monitor Speakers: Altec, JBL, Yamaha, Tannoy, Electro Voice, Auralone, Visonik

Echo, Reverb & Delay Systems: EMT 240, Studio Technologies, Lexicon 224, Ursal Major 8x32, GBS, Brick Audio, Eventide 1745M, 949, 910 Harmonizers, Lexicon Super Prime Time, Audio Digital TC 2

Other Outboard Equipment: 26 compressors featuring LA2As, 32 equalizers featuring Lang Pultec and Massenburg, 26 noise gates featuring dbx 900, Allison and Rebs, Orban De-esser, Haeco CSK 2, Burwen, Dolby, dbx noise reduction

S. Ca. 24 Track

Microphones: Everything from vintage tube models (U47, KM56, C12, etc.) to modern esoterics (AKG P48, PML DC63, Schoeps, Neumann U89) and all those in between. 168 microphones available

Instruments Available: Steinway grand, Mason Hamlin grand, Rhodes RH, Hammond B3, Emulator, 12 synthesizers, including Yamaha, MemoryMoog, Sequential Circuits Prophet, and alpha-Syntauri Drumulator, various percussion instruments, guitar amps, guitars, keyboards, etc

Video Equipment & Services: Full video services, including CMX editing, layback to 1" video synchronization of video to any format. Audio via Adams Smith or BTX time code synchronizers, Sony BVP 430 broadcast cameras

Rates: Reasonable! Call for rate card.

Extras: Full audio post production planning for record production, music video, film, and television. Our experienced associates can guide you through all stages of production and post production budgeting and scheduling. Let us help you find out how to cut the budget without sacrificing quality

Direction: This facility was designed from the ground up to serve the modern recording artist and independent production company. Our high ceiling recording rooms and first quality equipment reflect our commitment to high fidelity. Our rate card reflects our commitment to being cost-effective. Our largest recording room can handle a 60-piece orchestra or get a truly live rock sound. Our smallest 24 track room is packed with the latest synthesizer gear. All rooms are video interlaced for the future. If you are tired of working in a conventional studio, try something extraordinary

•••• THE ENACTRON TRUCK/MAGNOLIA SOUND
also REMOTE RECORDING

5102 Vineland Ave., N. Hollywood, CA 91601
(818) 761-0511

Owner: Brian Ahern

Studio Manager: Stuart Taylor

Engineers: Stuart Taylor, Donovan Cowart

Dimensions of Studio: Truck: Has overdub room, Studio: 40 x 30 + isolation booths

Dimensions of Control Rooms: Truck 40 x 8, Studio 20 x 23

Tape Recorders: Stephens, MCI, Ampex, Scully
Mixing Consoles: Truck Neve, 28 in x 16 out, Yamaha PM1000, 16 in x 24 out Studio Sphere, 40 in x 24 out, fully automated (Allison)

Monitor Amplifiers: BGW, SAE, Bryston Pro 2

Monitor Speakers: JBL 4435, UREI 815, Chartwell, Klipsch (Belle & La Scala), Auralones

Echo, Reverb, and Delay Systems: AKG BX-20, AMS Digital Harmonizer, Eventide DDL, Lexicon Prime Time, Space Station, Lexicon 224, acoustic chamber

Other Outboard Equipment: Pultec midrange EQs, dbx compressors, Orban De-esser, UREI graphic EQ, UREI 1176s, Teletronix LA 2As, Kepexes, MXR flanger, MXR dual limiter, Ashly stereo noise gate

Microphones: We have a selection of more than 50 mics, including Neumann, PML, AKG, Reslo, Electro-Voice, Shure and Sennheiser

Instruments Available: Yamaha C 7, Hammond B-3, various amps

Rates: Call

Direction: REMOTES: Black Sabbath, Jimmy Buffet, Dan Fogelberg, Peter Frampton, Emmy Lou Harris, Waylon Jennings, Quincy Jones, Gladys Knight, Willie Nelson, Bonnie Raitt, STYX, Joe Walsh MOVIES: A Star is Born, The Rose, Honeysuckle Rose, The Last Waltz

•••• EVERGREEN RECORDING STUDIOS, INC.
4403 W. Magnolia Blvd., Burbank, CA 91505
(818) 841-6800

Owner: Charles Fox, Arto Butler

Studio Manager: Sandra Smart

Engineers: Rick Rivco, Chief Engineer, Murray McFadden, Mike Hatcher, Gary Luchs, Kevin Erickson, John Richards, Kathy Kurash, Record Project Coordinator, Theresa Hogan, Traffic Manager

Dimensions of Studio(s): Studio A 46 x 70, overdub room 12 x 17, rhythm stage 16 x 8 Studio B: 35 x 35 and drum booth, Iso room 14 x 27

Dimensions of Control Room(s): Studios A & B 20 x 26

Tape Recorders: Ampex (3) w/48 trk record and mix capability MM1200 24 track, Ampex (5) ATH104 4 track, Ampex (5) ATH102 2 track, Maximator (6) single, three, four, and 6 track w/Sel sync punch-in capability

Mixing Consoles: Harrison (custom) Studio A 4832 48 in x 32

out, Harrison (custom) Studio B 4032, 40 in x 32 out
Monitor Amplifiers: Crown PSA 2 in control rooms and for play back in studios

Monitor Speakers: UREI Time Aligned, JBL 4311s, Hitachi's, Auralones

Echo, Reverb & Delay Systems: (2) live chambers, (2) EMT stereo 140, (2) BX-20 stereo, 224 Lexicon, echo plate

Other Outboard Equipment: Marshall Time Modulators, Eventide Harmonizers, UREI, Inovonics, Lexicons, Dolbys, dbx, Adams-Smith, EECOM Time Code w/SMPTe

Microphones: Neumann, AKG, Shure, Sony E V, Sennheiser Instruments Available: Yamaha grands in each studio

Other Services: Complete transfer facilities mag, reel to reel, cassettes

Rates: Record and film scoring rates, call for information



FANFARE RECORDING STUDIOS
El Cajon, CA

•••• FANFARE RECORDING STUDIOS
(div. of Rondel Audio Ent. Inc.)

Studio: 120 E. Main St., El Cajon, CA 92020
(619) 447-2555

Owner: Ronald L. Compton

Studio Manager: Carol A. Compton

Dimensions of Studio(s): 25 x 30, Isolation room #1: 10 x 12, Isolation room #2: 7 x 7

Dimensions of Control Room(s): 17 x 20

Tape Recorders: MCI JH 24 24 track, MCI JH-16 16 track, MCI JH 100 2 track, Ampex 440B 1 track, Ampex 440B 4 & 2 track, (2) Revox A77 2 & 1/4 track, Nakamichi 700 B cassette

Mixing Consoles: MCI 636 (full mixing automation, trans amp inputs), 36 in x 36 out

Monitor Amplifiers: BGW & Crown

Monitor Speakers: JBL, Auralones, Altec, Sennheiser, AKG headphones

Echo, Reverb, and Delay Systems: EMT Stereo Plate, Lexicon 224 with all programs and non-volatile memory, Eventide Harmonizer, DeltaLab digital delay

Other Outboard Equipment: (4) Orban parametric EQs, (4) UREI LA4A compressors, 1176 LN limiters, (2) Gain Brains, (4) Kepexes, Orban Sibilance controller, UREI digital metronome, Pultec EQ, Orban stereo synthesizer, EXH Exciter, (2) dbx 124 compressors, Dolby noise reduction

Microphones: Neumann U-87, KM-86, KM 84, U-47, AKG 414, 202E, 119, Shure SM-56, Electro-Voice RE 15, RE 10, Sony 337 (4), Altec 19B, RCA 44BX

Instruments Available: 7 Yamaha conservatory grand piano, Hammond B-3 organ with tube type Leslie speaker, Fender Rhodes electric piano, Ludwig drums w/concert toms Syn-drums, ARP Omni and ARP Odyssey synthesizers, congas, orchestra bells, chimes, percussion devices

Rates: 40 track 1/24 & 16 synced \$95/hr, 24 track \$85 hr, 16 track \$75/hr

•••• FAST FORWARD RECORDING
6428 Selma Ave., Hollywood, CA 90028
(213) 465-3457

Owner: Shepherd Ginzburg, Jill Leiberg

Dimensions of Studio(s): 11 x 17 x 11, 17 x 10 x 11

Dimensions of Control Rooms: 12 x 14 x 11

Tape Recorders: ACES ACTR 24 track, ACES ACTR-2 1/2", 30 IPS, Ampex 354, 1/4" 2 track, Tandberg 1/4 track, Sony ITC-FX 66 cassette

Mixing Consoles: ACES ACML 26/24

Monitor Amplifiers: Adcom GFA I, McIntosh 50

Monitor Speakers: Altec 9342 A JBL 6

Echo, Reverb, and Delay Systems: Studio Technologies Echo-plate III, DeltaLab 1024, Paia Hyperflange & chorus

Other Outboard Equipment: CBS Labs AGC, Paia dual limiter, US Audio gates, MXH graphic EQ

Microphones: E V RE20, RE55, P15, AKG 414, D 12, D 200E,

Shure SM 57, Audio Technica ATM 41, ATM 10
Instruments Available: Call for current list
Rates: 24 track \$26/hr. all inclusive
Direction: We are a brand new facility and will be expanding our
 complement of equipment as time goes on. If you don't see a piece
 of equipment that you feel you need, call us anyway. We might
 already have it! We are an ideal studio to produce new acts in.
 We can supply true professional quality at a bargain price. Independent
 engineers are welcome.



FAST FORWARD RECORDING
 Hollywood, CA

**** FIDDLER'S RECORDING STUDIO
 7430 Melrose, Los Angeles, CA 90046
 (213) 655-6087
Owner: Michael Clausen
Engineers: 1 full time, 2 session
Dimensions of Studios: 40 x 46 includes vocal booth, piano
 room, drum booth 18 x 26 x 14

Dimensions of Control Rooms: 22 x 26 w/separate machine
 room
Tape Recorders: Analog Studer A-80 24 track, Studer A-80 2
 track, 1/4" & 1/2", Ampex 440 4 track 1/2", Technics M85 cassette,
 Technics 2 track
Mixing Consoles: Trident TSM 40x24x32
Monitor Amplifiers: H&H "Mostets" with White EQ tuned by
 George Augspurger
Monitor Speakers: JBL 4350s, Yamaha NS-10s, Auratones, JBL
 431 s
Echo, Reverb, and Delay Systems: EMT 251 plate, AKG BX20,
 Lexicon 93s, Prime Time, Eventide 910 Harmonizer, Lexicon
 PCM 41, Delta Acoustic Computer
Other Outboard Equipment: Kepex II & Gain Brain, dbx 165 &
 162, UREI 1176, Orban stereo parametric EQ, UREI LA3As,
 digital metronome, etc.
Microphones: Neumann U47, U87s, KM86 and 84, U67 tube;
 AKG 414s, 452s, 224, Beyer 500s, PZMs, Shure 57s, 58s, Sen-
 nheiser 421, 405, Electro-Voice RE15, RE20, Sony C37A, plus
Instruments Available: Linn II & DX drum machines, Schummel
 7" grand piano
Rates: \$500 days, 10-6 (8 hrs) or \$80/hr, 4 hr minimum, \$600
 nights, 7-7 (12 hrs) or \$90/hr, 4 hr minimum
Extras: Private producers lounge w/TV and phone, players
 lounge, kitchen, vending machines and equipment storage
Credits: Ten top ten records for CBS, RCA, Warners, etc

**** FIDELITY RECORDING STUDIO
 4412 Whittett Ave., Studio City, CA 91604
 (818) 763-6323
Owner: Artie Ripp
Studio Manager: Cliff Zellman
Engineers: Cliff Zellman, Steve Lang, Bernard Frings, Larry
 Elliott
Dimensions of Studios: Studio A: 19 x 30 x 9; Studio B: 20 x
 27
Dimensions of Control Rooms: Studio A: 14 1/2 x 17; Studio
 B: 16 x 12
Tape Recorders: Analog Studio A: Ampex MM1200 24 track
 Studio B: Stephens 821 B 40 24/32; (3) Ampex ATR 2/4, (3)
 Otari MX5050B 2/4
Mixing Consoles: Studio A: MCI JH500 42/32, Studio B: Custom
 Aengus B&B/API 24 B

Monitor Amplifiers: Studio A: Haller 500, 250, BGW, McIntosh;
 Studio B: Haller 250, Phase Linear 400
Monitor Speakers: Studio A: UREI 838 Time Align, Yamaha
 NS10 Auratones, Studio B: Tannoy Little Reds, Yamaha NS10,
 Auratones
Echo, Reverb, and Delay Systems: EMT 250, AMS 805, Lex-
 icon 224, (2) EMT 140 stereo plates, Lexicon Prime Time, BX 20
Other Outboard Equipment: Limiters: UREI (2) LA2A, (6)
 LA3A, (3) 1176N, (2) dbx 160, (2) Eventide Harmonizer 910,
 vocal stressor, Marshall time modulator, RM stereo limiter, Pultec
 and B&B EQs, Kepex
Microphones: Neumann U87, 67, M49, KM56, KM84, AKG
 C 12, C 24, C 451, C-60, Sony C500, C37A, C38 ECM 22P,
 Shure SM56, 57; Sennheiser 441, 421, P2M, Frap, and many
 more
Instruments Available: Studio A: Yamaha 7' grand, Studio B:
 Mason & Hamlin 7' grand, Fender Rhodes, Hammond B-3
 w/Leslie
Rates: Starting at \$30/hr. Call for block rates

**** FIESTA SOUND & VIDEO
 also REMOTE RECORDING
 1655 S. Compton Ave., Los Angeles, CA 90021
 (213) 748-2057
Owner: H.G. Hebeson
Studio Manager: Irma Lopez
Engineers: Enrique Elizondo, Oscar Ventura Brian Levin
 Octavio Villa
Dimensions of Studio(s): 50 x 60 plus isolation room
Dimensions of Control Room(s): 25 x 15
Tape Recorders: MCI 24 track, MCI 2 track, Otari 2 track
Mixing Consoles: MCI 428 24 in x 24 out
Monitor Amplifiers: Crown LC-800
Monitor Speakers: JBL 433 s
Echo, Reverb & Delay Systems: Master Room III echo
Other Outboard Equipment: UREI graphic EQs, 41 band EQ,
 Dodsys 1176 and dbx 160 compressor limiters, Lexicon DDL
Microphones: Neumann U 87 s, KM 84 s, AKG C 452 s,
 C 414 s, Sennheiser MD 421 s, Shure SM 57 s, SM 7 s, Sony
 ECM 33 F's, FV RE 20's
Instruments Available: Steinway upright grand piano, Fender
 Rhodes electric piano, D6 clavinet, ARP Omni, ARP Odyssey
 syn, Fender Twin Haverb amp
Rates: Call for rates. We encourage block booking.

Question:

What Has:
 A 60-Piece Orchestra
 An 800-Piece Marching Band
 120 Fanfare Trumpeters
 84 Grand Pianos
 A 1,000-Piece Choir
 8 Separate Multitrack Playbacks
 A Cast of 12,000 Performers
 And is carried live to
 every nation on earth?

Answer:

The XXIII Olympiad opening and
 closing ceremonies live from the
 Coliseum. The largest live show
 ever produced. And **Tim Pinch
 Recording** is proud to have been
 chosen to handle the final live
 broadcast audio mix for both the
 opening and closing ceremonies.
 If we handle an event of this
 magnitude and importance, just
 think of what we can do for you!
 For more information and rates,
 please call (818) 841-8247

TIM PINCH RECORDING

**** FIFTY FOUR EAST SOUND RECORDING
54 East Colorado Blvd., Pasadena, CA 91105
(818) 356-9308
Owner: 54 East Limited
Studio Manager: Russ

**** FLORES RECORDING STUDIOS
11115 Magnolia Blvd., N. Hollywood, CA 91601
(818) 508-5216
Owner: Flores Productions, Inc.; David Flores, president
Studio Manager: Gloria Williams
Engineers: David Flores, Victor M. Sanchez, Bobby Macias, Rick Clifford, independents
Dimensions of Studios: A 37 x 25, B 13 x 28
Dimensions of Control Rooms: A 19 x 25; B 19 x 25
Tape Recorders: Analog, Studer A80 VU MkII 24 track, Studer A80 VU MkII 2 track; (2) 3M M79 24 track, (5) 3M M79 2 track
Mixing Consoles: (2) Harrison 3232 32x24
Monitor Amplifiers: IBL 6243, Crown, Studer
Monitor Speakers: UREI 813, Yamaha NS10, Auratone
Echo, Reverb, and Delay Systems: (4) EMT 140 echo chamber, Lexicon 224XL, AKG BX10, DeltaLab DL-2, Eventide 1745 digital delay
Other Outboard Equipment: (8) Kexex II, (10) Kexex 500, (4) UREI LA4, (8) UREI 1176, (4) Eventide 2830 Compressor, (2) LA 2 tube type limiters, (4) Maxi Qs, (4) Gain Brains, (2) Spectrasonic limiters
Microphones: Telefunken U47 tube type, Telefunken Elm 251, Neumann U87, U47 FET, KM84, AKG 414EB, Sennheiser 421U, MD 402U, Electro-Voice RE20, RE15, C915, Shure SM56, SM7
Instruments Available: 9' concert grand piano Yamaha (Studio A), 6' concert grand piano Yamaha (Studio B)
Video Equipment & Services: Please call for details
Rates: Available upon request

**** FOOTPRINT SOUND STUDIOS
13216 Bloomfield St., Sherman Oaks, CA 91423
(818) 872-1854
Owner: Jerry Fuller
Studio Manager: Annette Fuller
Engineers: Engineers on call Marc Piscitelli, Linda Corbin, Brian Friedman Technician Neil Hopper
Dimensions of Studio(s): 27' x 16 1/2' w/20' high string room plus isolation booth, drum booth and projection room/loft
Dimensions of Control Room(s): 10 x 12
Tape Recorders: Ampex MM1200 24/16 track, ATR-100, Ampex 350 2 track w/VSO, Sony 2 various 1/4 track; Technics cassette (2)
Mixing Consoles: Trident "Series 80" w/mixing capabilities up to 56 tracks
Monitor Amplifiers: SAF, Crown, Yamaha P2100, Haller 225 (2)
Monitor Speakers: MDM 4s Time Aligned, JBL 4311s, Auratones, Yamaha NS10M
Echo, Reverb, and Delay Systems: AKG BX-10, Orban dual reverb, Quad/Eight reverb, Eventide DDL, Harmonizer, Lexicon Prime Time, Echoplate.
Other Outboard Equipment: UREI 1176, LA3A, dbx 160 comp/limiters, GT 4 noise gates, UREI 527-A and Spec Acoustics graphics EQ, Orban parametrics EQ, UREI digital metronome, Orban De-esser
Microphones: Neumann, AKG, Electro-Voice, Shure, Sony, Sennheiser, Crown PZM
Instruments Available: Complete 7 piece drum set, Yamaha 6' grand piano, grand piano, Iso-Box, Fender bass/guitar amps, Rockman amps, percussion
Rates: 24 track from \$55/hr to \$95/hr plus special rates (all equipment plus 2nd engineer included)
Extras: Production assistance available. Musicians lounge, coffee, tea, refreshments, swimming pool, basketball, nearby restaurants, liquor store/market, quest room available
Direction: Quality, affordable product in relaxed environment. Clientele: Glen Campbell, Tanya Tucker, Bobby Goldsboro, Toby Beau, Bobbie Gentry, Jerry Fuller, Johnny Mathis, Carl Weathers, Al Wilson, Kimberley Springs, etc

**** FOSS SOUND & VIDEO PRODUCTION
also REMOTE RECORDING
P.O. Box 414, Yorba Linda, CA 92686
Owner: Thomas A Foss
Studio Manager: R Daily

**** FRONT PAGE RECORDING
(714) 548-9127
Owner: Front Page Recording
Studio Manager: Bill Vincent

**** GOLDEN GOOSE RECORDING
2074 Pomona Ave., Costa Mesa, CA 92627
(714) 548-3694
Owner: Dennis Rose
Studio Manager: Dennis Rose

S. Ca. 24 Track

**** GOLDMINE RECORDING STUDIO
1393 Callens Rd., Ventura, CA 93003
(805)644-8341
Owner: Goldmine Productions
Studio Manager: Tim Nelson
Engineers: Jeff Coyle, Ken Felton, Tim Nelson
Dimensions of Studios: 40 x 26 x 12, 26 x 16 x 12, iso, 4 x 10 x 12 iso
Dimensions of Control Rooms: 18 x 16
Tape Recorders: Analog Otari MTR 90 24 track, TEAC 80-8 8 track, Otari 5050 2 track, Technics 1506 2 track
Mixing Consoles: Neotek Series II 28 x 24
Monitor Amplifiers: Haller DH500, Phase Linear 700B
Monitor Speakers: UREI 813, Yamaha NS-10
Echo, Reverb, and Delay Systems: Echoplate II, DeltaLab Efectron, MXR DDL, H910 Harmonizer
Other Outboard Equipment: LA2A limiters, UA175 limiter, dbx 161 limiters, Omnidirect noise gates
Microphones: Neumann, AKG, E.V., Sennheiser, Shure, PZM
Instruments Available: Yamaha CP80, LinnDrum, Kimbal 6'6" grand, Yamaha PF15 piano
Rates: 24 track, \$40, 8 track, \$25, 2 track, \$20



GROUND CONTROL
Santa Monica, CA

**** GROUND CONTROL
1602 Montana Ave., Santa Monica, CA 90403
(213) 453-1255
Owner: Paul Batajczak
Studio Manager: Lisa Hoy
Engineers: Chief engineer Paul Batajczak
Dimensions of Studio(s): 40 x 30 w/16 ceilings, w/isolation rooms 10 x 7 and 12 x 10
Dimensions of Control Room(s): 15 x 22
Tape Recorders: Studer A-800 MkIII 24 track, Lyrec (Denmark) 24 track, Ampex ATR 102 2 track, 440B 2 track, Sony cassette TCK 777, TEAC cassette C-1
Mixing Consoles: Amek (England) M3000, 36x24x4, 8 returns
Monitor Amplifiers: PMF 2150B Perreux, Carver PM 1, 5
Monitor Speakers: TAD TSM 1, Sony APM 700, Yamaha NS-10s, Auratone, along w/Stax electrostatic headphones and Dahlquist DQ-10s for additional reference
Echo, Reverb & Delay Systems: EMT 140 plate (tube), 7 Echo Plate, AKG BX-20E, a live room chamber and for electronic digital reverberation the new AMS HMX16 Delay systems include Eventide 949, MXR Delay IIs, MXR Delay I phaser and flangers, Marshall Time Modulator, AMS dmx 15-80S, Lexicon 224XL
Other Outboard Equipment: Compression/limiter selections include UREI LA2A, LA3A, dbx 165, Spectrasonics 610, Allison Gain Brains, and for noise gates and key effects, Allison Kexex II system
Microphones: Neumann U67 and U87, KM84, U47F, Cine Churrh, AKG G12, D12E, 451s, P87, DC'63 414s, C60s, Telefunken 251, RCA 77, E.V 666; Sennheiser 421, Altec 145, Shure SM57s
Instruments Available: Yamaha grand (7'4"), ARP 2800 selection of acoustic and electric guitars
Video Equipment & Services: Available upon request
Rates: Please call

**** GROUP IV RECORDING
1541 N. Wilcox, Hollywood, CA 90028
(213) 466-6444
Owner: Angel L. Balester, Dennis S. Sands
Studio Manager: Angel L. Balester

**** HARLEQUIN STUDIOS
also REMOTE RECORDING
19347 Londelius St., Northridge, CA 91324
(818) 993-4778
Owner: Paul and Jeff Stillman
Studio Manager: Audio Anthony Sorrentino, Video, Paul Stillman
Engineers: Anthony Sorrentino, Gary DuLac, Brian McLaughlin, Dave Hoxan & outside engineers
Dimensions of Studios: Audio, 20 x 30 x 16 (live), iso booth 12 x 12 x 15, Video soundstage 42 x 35 x 16
Dimensions of Control Rooms: Audio, 14 x 22 x 12, Video, 20 x 12 x 8
Tape Recorders: Analog Stephens 824B w/audio locator 24 track, Tascam 48 8 track, 3M M64 2 track, Otari 5050B 2 track, TEAC 4440 4 track (6) Kenwood 630s 2 track, Nakamichi 1000II cassette, B Dural dbx 700 2 track
Mixing Consoles: Customized Tangent 4216 32
Monitor Amplifiers: Audio Research D150, Yamaha P2200, P2100, BGW 500II
Monitor Speakers: IBL 4445 (bi radials), UREI 813s, JBL 4311s, Yamaha NS10s, Auratones
Echo, Reverb, and Delay Systems: Lexicon 200 digital, Williams reverb, Eventide Harmonizer 910, DeltaLab DL 2, AAD 250 digital, MXR digital, Roland Echo 301
Other Outboard Equipment: dbx 160X 161 164, UREI 1176, Audio Arts 4100 parametric, Bi Amp 27 & 10 band, Delta Graph 10 bus is, noise gates, EXR Exciter
Microphones: Neumann's, AKG's, Sennheiser, etc
Instruments Available: Fairlight, Emulator, Chamberlin, OBX, Photograph 57 grand, drums, Simmons, Linn, assorted percussion
Video Equipment & Services: Complete soundstage lighting and w lights, 2 scene (24K) board, 2 wall eye, staining, velvet curtains, dressing room. Full production staff w/ numerous credits, JVC KY310 cameras (others available), 8 Cam switcher w/effects Full edit in
Rates: Call for rates



HIT CITY WEST
Los Angeles, CA

**** HIT CITY WEST
6146 W. Pilo Blvd., Los Angeles, CA 90035
(213) 852-0186
Owner: Jason Bell
Studio Manager: Jason Bell
Engineers: Avi Kipper (chief), Susan Whipple, Bruce Rockwell
Dimensions of Studios: Studio A 18 x 30, Studio B 12 x 12
Dimensions of Control Rooms: Studio A: 16 x 15, Studio B 12 x 12
Tape Recorders: Analog MCI JH 114 (transformerless) w/audio locator 24 16 track, Ampex ATR 102 2 track, Ampex 440X 2 track, Akai CX625 1/4 track, NAD/Ativa cassettes
Mixing Consoles: Soundcraft Series 2400 w/Bargraph and 28 mks in x 52 line in x 24 out
Monitor Amplifiers: Crown, SAF, Technics White
Monitor Speakers: Custom Time Alcon JBL, Yamaha NS10, Auratone 5C, JBL 4313
Echo, Reverb, and Delay Systems: Lexicon 224-X, EMT 240, Ureia Major SST282 Space Station, MIC MIX, Master Room Super Comber, MXR digital reverb, Lexicon Prime II, Lexicon Super Time DDL, DeltaLab Acousticcomputer DL2, Eventide 949 Harmonizer
Other Outboard Equipment: Eventide instant flanger, Countryman 968 phase shifter, ADP vocal stresser, EXR Exciter, Technics live band stereo compressor EQs, UREI parametric EQs, UREI 27 band graphic stereo EQs, dbx 165 Overeasy comp/limiter, dbx 160 comp/limiters, UREI 1176 limiter, Allison Gain Brains, Drummer stereo noise gates, Kexex, 5 channels Orban de-

esser, UREI digital metronome.
Microphones: Telefunken, Neumann, AKG, Sennheiser, Electro-Voice, Beyer, Shure, RCA, Countryman (Isomec), Crown PZM
Instruments Available: Steinway grand piano, Hammond organ w/Leslie, Cable & Sons upright piano, all other instruments available as rentals
Rates: Please call for information
Extras: Editing suite with full tape copy service and rehearsal room with piano Lounge with all the comforts
Direction: Clients include: Bobby Womack, Wall of Voodoo, Motley Crue, Beach Boys, Josie Cotten, Freddie Hubbard, Sly Stone, Jan & Dean, Onco Boingo, Fleshtones, Dillards, John Hartford, etc

•••• **HIT MAN RECORDING STUDIOS**
 815 N. Fairfax Ave., Los Angeles, CA 90048
 (213) 852-1961
 Owner: Jerry Wallace
 Studio Manager: Debbie Johnson

•••• **INDIGO RANCH RECORDING STUDIO, MALIBU**
 P.O. Box 24A-14, Los Angeles, CA 90024
 (213) 456-9277
 Owner: Richard Kaplan, Michael Hoffman
 Engineers: Chris Brunt, Richard Kaplan
 Dimensions of Studio(s): 25 x 20 plus isolation room
 Dimensions of Control Room(s): 18 x 20
Tape Recorders: 3M M79 24 track, 1M M79 2 track, Studer Bvox 2 track
Mixing Consoles: Aconus Jensen custom, 32 in x 24 out fully automated (Allison 65K System)
Monitor Amplifiers: McIntosh Crown, E.A
Monitor Speakers: Custom JBLs, Visonik Little Davids, Auratones Braun
Other Outboard Equipment: 32 channels of dbx noise reduction, dbx 160s, UHF1 1176 LN, 11A 175s, 176s, Altoc 46C limiter, Teletronix LA1, LA2, LA2As, Kepexes, Harmonizers, phasers, UREI 550 Little Dipper, Orban Par sound parametric EQ, EMT echo, MXR digital delay, ADR stereo Compex limiters, Marshall Time Modulator, Pultec and Lund EQs all models, Selektor EMT 250, Lexicon 224A and much more
Microphones: Over 250 to choose from including: AKG, Altec, Beyer, Calrec, Electro-Voice, Neumann, RCA, Sennheiser, Sony, Shure, etc., with over 100 tube type condensers and unusuals
Instruments Available: Steinway grand piano, Fender Rhodes 88, clavinet D6, Farfisa Mini, guitar amps, and accessories
Rates: Please call for rates.
Extras: 60 acre mountain lot with kitchen and 3 bedrooms
Direction: Indigo Ranch provides a unique environment conducive to musical creativity in a home like but professional setting. Located in the Malibu Hills overlooking the Pacific Ocean, Indigo services top recording artists from all over the world. The sixty acre ranch offers sleeping accommodations, kitchen facilities, and a gourmet cook (on request). The ranch and its fully equipped, state of the art studio are beautifully maintained by an experienced and conscientious staff doing its utmost to make clients feel welcome and comfortable.

•••• **KENDUN RECORDERS**
 619 and 721 S. Glenwood Place, Burbank, CA 91506
 (818) 843-5900
 Owner: Kent R Duncan
 Studio Manager: William E Rogers
 Engineers: Chief Engineer: Jeff Sanders, Barney Perkins, Jeff De Morris, Dan Marmen, Russ Bracher, Lindy Griffin
 Dimensions of Studio: Studio 1 40 x 60, Studio D 25 x 40
 Dimensions of Control Rooms: Studios D, 1 & 5 26 x 26
Tape Recorders: Analog: Studer (2 in each studio) A-800 24 track, Studio A 80 24, 2 and 1/2" 2 tracks, Studer custom previews 2 track, MCI JH110 4 track, Pearl drum kit, Roland drum machine, Jupiter 8 keyboard, DX-7 Yamaha synth
Mixing Consoles: Studio 1 SSL SL4000E 40 in x 32 out, Studio C & D SSL SL4000B 40 in x 32 out, Studio 5 Sierra Audio Disk Mastering, Studio A Neumann disk mastering
Monitor Amplifiers: Studer A68
Monitor Speakers: Sierra/Hidley TM 8 biamped monitor system.
Echo, Reverb, and Delay Systems: Live stereo echo chamber, (4) EMT 140 Echo Plates, EMT 251, Lexicon 224.
Other Outboard Equipment: Studer TIS tape lock system, AMS digital reverb, Audio Kinetics lock system
Video Equipment & Services: 1/4" BVU mix to screen

•••• **KSR STUDIOS**
 1680 Vine St., Ste. 515, Hollywood, CA 90028
 (213) 467-0768
 Owner: Kenneth Story
 Studio Manager: Michael Perricone

•••• **IMAGE RECORDING, INC.**
 1020 N. Sycamore Ave., Hollywood, CA 90038
 (213) 850-1030
 Owner: Harry Maslin, John Van Nest
 Studio Manager: John Van Nest
 Engineers: John Van Nest, Steve Krause
 Dimensions of Studio(s): 20 x 40 x 20
 Dimensions of Control Rooms: 14 x 20 x 10
Tape Recorders: Analog: MCI JH 24 48 track; Ampex ATR-102 1/2" 2 track, Ampex ATR-102 1/4" 2 track, Digital: Sony PCM-F1 2 track
Mixing Consoles: Harrison 3232C 40 in x 32 out; Neve input modules
Monitor Amplifiers: McIntosh 2300, Nakamichi 100W
Monitor Speakers: UREI Time Aligned monitors, Yamaha NS10M, Auratones
Echo, Reverb, and Delay Systems: AMS digital reverb, EMT 140 plate, AMS DM80S stereo harmonizer/digital delay, Lexicon Prime Time, Lexicon Delta T, Marshall Tape Eliminator
Other Outboard Equipment: Eventide Harmonizer, Eventide flangers, AMS flangers, ADR Panscan, dbx noise gates, de-essers, limiters, Kepex noise gates, Drawmer noise gates, limiters by UREI, Inovonics, Kepex noise gates, Drawmer noise gates, limiters by UREI, Inovonics, Teletronix Dolby noise reduction, Doctor Click Mini-Doc
Microphones: Over sixty available, including 30 Neumann
Instruments Available: Yamaha C7 7 grand piano, Hammond organ, Simmons drums, Roland vocoder, Vox amp
Video Equipment & Services: Sony Syncmaster synchronizer, Sony 1/4" video cassette recorder
Rates: On request

•••• **FRED JONES RECORDING**
 6515 Sunset Blvd., Ste. 205, Hollywood, CA 90028
 (213) 467-4122
 Owner: Fred L Jones

•••• **JUNIPER RECORDING**
 719 Main St., Burbank, CA 91506
 (818) 841-1249
 Owner: Geoff Levin, Stephen Sharp
 Studio Manager: Jane Boltinhouse
 Engineers: Stephen Sharp (chief), Jim Emrich, James Stewart, Brian Vessa
 Dimensions of Studios: Main room 24 x 12 x 16, drum booth 7 x 9; iso room: 18 x 11, piano iso: 13 x 5 x 8
 Dimensions of Control Rooms: 19 x 19
Tape Recorders: MCI JH-116 w/Autolocator II, 24/16 track; Otari 5050B 2 track, TEAC A3340S 4 track, TEAC A3300SX 2 track. Aka: cassette decks
Mixing Consoles: Amek-PAC matchless MCD5 32/32, Valley People "Trans-amp" (transformerless preamps), 9 in x 9 out
Monitor Amplifiers: Accuphase 180; Nikko Dyna Kit, BGW
Monitor Speakers: Tannoy "Golds", Auratone
Echo, Reverb, and Delay Systems: Lexicon 224X digital reverb, DeltaLabs Ellectron
Other Outboard Equipment: Apex Aural Exciter, MXR Pitch Transposer, UREI LA3A limiters, Audioarts limiter/De-esser, Burwen noise filter, UREI digital metronome, Valley People "Dyna-Mite" limiter/gates, Nikko 10-band graphic EQs, Moog parametric EQ, Omnicraft noise gates, Korg programmable DDL, Eventide Harmonizer, Yamaha NS 10 speakers, E-V Sentry 100 speakers
Microphones: Neumann U-87, AKG 414, 451, 414EB, D25, Sennheiser 421, 441, Electro-Voice 666, Sony C37P, 56P, ECM 50P, ECM33P, 22P, 9P, Crown PZM, Shure SM-81, SM-56, SM-57
Instruments Available: Mini Moog synthesizer, Crumar Orchestrator, Steinway "A" grand piano, Pearl drum kit, Roland drum machine, Jupiter 8 keyboard, DX-7 Yamaha synth
Rates: 24 track, \$36/hr, 16 track, \$31/hr. Includes engineer

•••• **LARRABEE SOUND**
 8811 Santa Monica Blvd, Los Angeles, CA 90069
 (213) 657-6750
 Owner: Dolores Kaniger, Jackie Mills
 Studio Manager: David Mills
 Engineers: Steve Hodge, Barry Rudolph, Gerry Brown, Randy Tomina, Taavi Mote, Sabrina Buchanek, Chief Tech., Scott Pithell
 Dimensions of Studios: Studio A 27 x 42, Studio B 20 x 30
 Dimensions of Control Rooms: Studio A 18 x 30, Studio B 12 x 26
Tape Recorders: Analog: Studer A 800 24 track, (2) Studer A-80 24 track, (8) Ampex ATR 102 2 track, Ampex ATR 104 4 track, (4) 1/2" head stacks for ATR's
Mixing Consoles: Solid State Logic Series E, API 3232 32/24
Monitor Amplifiers: Bryson amp-high end, (2) BGW amps-low end, White EQs and crossovers
Monitor Speakers: Custom George Augspurger with Ceteq drivers. Also Yamaha NS10s, Auratones, 4312 JBLs
Echo, Reverb, and Delay Systems: (4) live stereo chambers, (2) EMT reverb units, AMS DM X 15 805, Lexicon 224, (2) Eventide digital delays, Lexicon Prime Time, (2) Eventide Harmonizers
Other Outboard Equipment: Audio Kinetics Q-Lock 310, (2) Technics 1700s 1/4 track reel to reel, (7) Technics M85 cassette decks, Flanger, phaser, Compressor, UREI LA 2As, LA 4As, 1170s, Inovonics limiters, Graphic 527 A EQs, Pultec EQs, Roqer Mayer noise gates, 30 channels of Dolbys, (8) API 550A EQs
Microphones: Large selection of Neumann, AKG, Sony, Shure, Sennheiser, Beyer and tube microphones.
Instruments Available: (2) Kawai grand pianos, Wurliitzer electric piano, clavinet
Rates: Upon request

•••• **LION SHARE RECORDING STUDIO, INC.**
 8255 Beverly Blvd., Los Angeles, CA 90048
 (213) 658-5990
 Owner: Ken Y Rogers
 Studio Manager: Terry Williams
 Engineers: Larry Larousson, Glenn Schmitt, Tom Fouca, Jay Artista (chief engineer), Paul Bassett, Howard Weiss
 Dimensions of Studios: Studio A 20 x 36, Studio B 17 x 18, Studio C 16 x 20
 Dimensions of Control Rooms: Studio A 18 x 13, Studio B 13 x 15, Studio C 17 x 20
Tape Recorders: Analog: Studer A800 24 track, Studio A80 HC 1/2 & 1/4 2 track, Studer A80 TU 1/2 & 1/4 2 track, 3M 79 24 & 2 track, Digital: Mitsubishi X800 32 track, Mitsubishi X800 4 track, Mitsubishi X40 2 track
Mixing Consoles: Neve 8108 46 in x 48 out, Neve 81 8 48 in x 32 out, API DeMedio 36 in x 24 out
(LISTING CONTINUED ON NEXT PAGE)



THE L.A. STUDIOS
 Hollywood, CA

•••• **THE L.A. STUDIOS**
 3453 Cahuena Blvd. West, Hollywood, CA 90068
 (213) 851-6351
 Owner: Sidney Blueskyes and Jim Bertout
 Studio Manager: Jim Bredow
 Engineers: Bob Guarino, Tim Berni, Charles Thompson, Patrick McDonald, Jimmy Hite, Jim Bredow, Glenn Sparks, and Jimmy Tomlinson. Sencods: Newie Kirkpatrick and Keya Goleosorkh
 Dimensions of Studio(s): Studio A BIG; Studio B: small; Studio C: Medium
 Dimensions of Control Room(s): See above
Tape Recorders: (7) MCI JH 110B 2 track, (3) MCI JH 24 24 track, (5) Ampex ATR-700 fullflat tracks, (5) Technics M-85 cassette decks, TEAC A-3300FX quarter track, Magmatex MR-40: 8.55mm snaz stripe mag machine
Mixing Consoles: MCI automax 3 36, 36 in x 24 out, MCI automax 6 36 32 in x 24 out, MCI 6 36 16 in x 12 out
Monitor Amplifiers: (6) Times Cps 400/200 watt amps
Monitor Speakers: Custom w/2; Gauss 15" and TAD 4001 woofer per monitor. Also Tannoy 9in Revs, JBL 4301s, JBL 4315s, MDM-4s, and, of course, the speaker w/ the winning personality, Auratones
Echo, Reverb & Delay Systems: (2) EMT Gof-Foi 240s; Lexicon 224 and MICHIX Super C. Also Eventide Harmonizer 4994 and Lexicon Prime Time
Other Outboard Equipment: We have 68 channels of Dolby and 9 channels of dbx. Also (8) Kepex (8) Gain Brans, (6) UREI 1176s, (4) dbx Ovarbasys, (6) UREI LA4s, (2) UREI digital metronomes, (3) Orban De esser, and (6) O-ban parametrics. Also Apex Aural Exciter and ph-noise filter
Microphones: Neumann 87s, 47s, 4 KM-84s, Shure SM 56s & 57s, RCA: 77 and 44s, Sennheiser 44-1s, 421s, MKH 416s, 4167Es, Sony ECM-50PSs, PML DC-63, AKG 414s, 451s 452; Crown PZMs, Telefunken U 47
Instruments Available: 9' Steinway grand, Rogers drum, Eddie Reynolds modified Fender Rhodes
Video Equipment & Services: Complete sweetening services w/ Sony 3/4" 100A 1" deck, Sony BVU 800 3/4" deck, 1/2" VHS dubbing, wave form monitor, wave scope, Keivami monitoring, ADF, S.K. Assembly, and to synchronize the whole damn thing together. Audio Kinetics system
Rates: \$85-\$250/hr. Call for criteria
Extras: Real time dubbing w/multiple machines including 35mm mag. Fully loaded kitchen. Steam room
Direction: With a client list that includes Russ Kunkel, Mel Brooks, CBS, Warner Brothers, Stephen Bishop, Atlantic Records, and most major advertising agencies, you can see #1 at our appeal isn't limited to one type of client. Instead, an appreciation for high quality without pretense, competent staffing without arrogance, and great, well-maintained gear without hidden additions (\$) seem to be our main attractions. Our look is high tech and hi brow, our work is fast and efficient. Our vibe is friendly and relaxed. Our motto is "No adults to spoil the fun."

(FROM PAGE 123)

Monitor Amplifiers: Bryston 4B, 2B, H&H V800, V500, Studer A68

Monitor Speakers: JBL (custom), JBL TAD (custom), Yamaha 1000, Auratones T66, T6

Echo, Reverb, and Delay Systems: (3) live stereo echo chambers, (6) EMT 140s, (3) Lexicon 224X LARC, (3) AMS RMX 16 reverb, (3) AMS DMX 15-80s DDL, EMT 250 reverb, Quantec room simulator

Other Outboard Equipment: Pubison DHM 89-B2 Harmonizers, ADR Vocal Stressor, (3) Lexicon Prime Time, Super Prime Time, Aphex II Aural Exciter, Eventide DDL lines and compressors, Harmonizers, phasers and flangers, Scamp rack, 48 track of Dolby, Limiters Neve, (3) Massenberg dual limiters, Teletronix LA2As, Inovonics, dbx 160, 160X, 165, 162 stereo, UREI LA3As, (3) Massenberg dual parametric EQs.

Microphones: Neumann M-49 tube, U48 tube, U47 tube, U67 tube, U87, U47, KM84, KM86, KM88, Shure SM81, SM7, 546, SM57, SM56, Sennheiser 416, 435, Binaural 2002, 421, AKG 412, 414, 452, C24 tube; E-V RE20, RE15; Telefunken 250 tube

Instruments Available: Sequential Circuits Prophet-10 synthesizer, LMI drum machine, Bosendorfer grand piano, (2) Steinway grand piano, Eddy Renolds Rhodes 88, Hammond B-3.

Video Equipment & Services: Ampex VPR 2B, Sony BVU 800, BVU 200, Beta & VHS 1/2" recorders, BTX synchronizer, Studer TLs 2000 Post production sweetening and mixing using Necam Automation with 48 track analog and/or 32 track digital to picture Sound EFX included

Rates: Open Upon request

**** MAD DOG STUDIO

1715 Lincoln Blvd., Venice, CA 90291
(213) 306-0950

Owner: M D Productions

Studio Manager: Mark Avnet

Engineers: Dusty Wakeman, Mark Avnet, Philip Celia, Stuart Schonwetter, Don Tittle

Dimensions of Studios: 25 x 18, 10 x 5 iso

Dimensions of Control Rooms: 20 x 15

Tape Recorders: Otari MTR-90 24/16 track; Ampex ATR-102 2 track, Technics 1500 2 track, Sony TC-K777 cassette

Mixing Consoles: Amek Angela 28 x 24 with parametric EQ, 6 echo sends, 4 stereo subgroups

Monitor Amplifiers: Crown, BGW, HH

Monitor Speakers: Westlake BBSM-12, Auratone 5C, JBL 4311, Yamaha NS-10

Echo, Reverb, and Delay Systems: Lexicon 224 digital reverb with lever 4 3 programs, MICMIX Master-Room XL-305, Delta-Labs DL-2 Acousticcomputer, Eventide Harmonizer, MXR digital delay with all cards, Sequential Circuits Pro-FX programmable digital delay

Other Outboard Equipment: Limiters: dbx 165, dbx 161, UREI LA-4A, UA 175 tube Misc.: EXR 4 exciter, EXR SP exciter, Kepex II, Symetrix keyable gates, Roland stereo flange/Chorus, White EQ, Biamp EO, Orban stereo synthesizer, triggerable Simmons-like drum synthesizer

Microphones: Neumann U87, U67 tube, PLM, AKG 414, 452; Shure 57, 58, 81, 33, SM7, Electro-Voice; Beyer, Sennheiser, more

Instruments Available: LinnDrum, Alembic basses (fretted and fretless), Guild and Martin acoustic guitars (6 and 12 string), Gibson and Fender electric guitars (6 and 12 string), synthesizers and programmers, Yamaha grand piano

Video Equipment & Services: On request

Rates: On request



MAD HATTER STUDIOS
Los Angeles, CA

**** MAD HATTER STUDIOS

2635 Griffith Park Blvd., Los Angeles, CA 90039
(213) 664-5766

Owner: Chick Corea

Studio Manager: Susan Garson

Engineers: Bernie Kirsh, Eric Westfall

S. Ca. 24 Track

Dimensions of Studio(s): Studio A 35 x 30; Isolation room 16 x 10

Dimensions of Control Room(s): 25 x 20

Tape Recorders: Studer A-80 Mk II 24 track, (2) Studer A80 RC stereo mastering recorders (modified by Mark Levinson Audio Systems), Otari 8080 4 track, (2) Nakamichi 582 cassette decks

Mixing Consoles: Trident modified series 80, 40 in x 24 out

Monitor Amplifiers: John Meyer

Monitor Speakers: John Meyer ACD system, Auratones, Yamaha

Echo, Reverb & Delay Systems: (2) EMT 140 stereo plates, EMT 240 Gold Foil, Lexicon 224X digital reverb, Lexicon Super Prime Time, Lexicon Prime Time.

Other Outboard Equipment: Teletronix LA2A limiters, UREI 1176LN limiters, Klark Teknik graphic EQs, Sontec parametric EQs, Kepexes, Eventide instant phaser/flanger, Eventide 9494 Harmonizer.

Microphones: Neumann, Schoeps, Bruel & Kjaer, AKG, Sennheiser, Shure, Sanken.

Instruments Available: Steinway D Hamburg 9' concert grand, Bosendorfer 9' concert grand, Yamaha GS-1, Rhodes 88, Rhodes EK 10, OBY A, Clavinet, Yamaha CP 80, Poly Moog, Mini Moog, Twin reverb, Yamaha combo organ YC-45, Oberheim DMX drum machine, Oberheim 8 Voice

Rates: Rate available on request.

**** MARTINSOUND RECORDING STUDIOS

1151 W. Valley Blvd., Alhambra, CA 91803-2493
(818) 281-3555

Owner: Joe Martinson

Studio Manager: Annette



MASTER CONTROL
Burbank, CA

**** MASTER CONTROL

3401 W. Burbank Blvd., Burbank, CA 91505
(818) 842-0800

Owner: Aseley Otten, Steve Catania

Studio Manager: Aseley Otten, Steve Catania

Engineers: Steve Catania, Aseley Otten, independents

Dimensions of Studios: Main room 58 x 24, Iso room 14 x 18, Vocal booth 7 x 8

Dimensions of Control Rooms: 20 x 24

Tape Recorders: Analog Studer A80 VU-Mk III 24 track, Studer A80 RC-Mk II (1/4" & 1/2") 2 track, Revox PR-99, Studer A710 cassette deck

Mixing Consoles: Trident custom 80B 32x24x24

Monitor Amplifiers: Crown PSA-2, Studer A-68

Monitor Speakers: JBL 4435, JBL 4311, Tannoy SRM 12B, Yamaha NS-10M, Auratones 5C, Realistic Minimus 7

Echo, Reverb, and Delay Systems: AMS RMX 16 digital reverb, Lexicon 200 digital reverb, Great British Spring reverb, Delta Lab 1024 Ellection II

Other Outboard Equipment: UREI LA2A, 1176 limiters, Trident outboard parametric EQ, Eventide 949 Harmonizer w/de glitch, dbx 160X limiter/compressors, Valley People 430, Dynamite limiter/gate

Microphones: AKG 414 EB-P48, "The Tube", Beyer M160,

Neumann U87, U47, KM84, KM85 Sennheiser MD421 441 Shure SM57, SM77, Crown P2M, RCA 77DX, American DR 332.

Instruments Available: LinnDrum and others upon request
Rates: Very competitive, call for specifics

**** MCA WHITNEY RECORDING STUDIO

1516 W. Glenoaks Blvd., Glendale, CA 91201
(213) 245-6801; (818) 507-1041

Owner: MCA Records

Engineers: Tom Baker, Chris Belman, Tim Ellis, Paul Elmore, Ron Garrett, Dave Hernandez, Frank Keemar

Dimensions of Studios: 35 x 60, 25 x 35, 18 x 20

Dimensions of Control Rooms: 24 x 24, 20 x 20, 18 x 20

Tape Recorders: Anaog, (2) Studer A800 Mk III 24 track, (2) MCI JH24 24 track, (14) ATH 102 104 2 & 4 track, (38) Tandberg 3014 cassettes

Mixing Consoles: Neve 094 36 24, Neve 1085 24 24, Neve 10/2

Monitor Amplifiers: Hatler, Bryston, Crown, Cerwin Vega, Yamaha, Sony McIntosh

Monitor Speakers: John Meyer 833, UREI 813, 813B, JBL 4401, 4411, 4311, 4313, Auratone T6

Echo, Reverb, and Delay Systems: (2) EMT 251s, (2) EMT 140s, (2) live chambers

Other Outboard Equipment: Limiters LA2 1176 Neve dbx, Aphex Compeller EQ, Neve Pulser, Sphere, Trident parametric API Kepex II, Eventide Harmonizer, DDL Phaser Roland Chorus Echo, noise reduction, Dolby, dbx Digital metronome, Orban de-esser EXR Exciter, Aphex Mike preamps, 990 Two Servo Mike preamps

Microphones: AKG C12 C24, C414 451, E-V RE15 RE20, Neumann U67, U87, KM83, IM84, IM86, M49, U45, FET 47, RCA 77DX, 44BX, Sennheiser MD421 MD441, Shure SM57 SM58, Sony C500, Telefunken 251

Instruments Available: Steinway baby grand, Yamaha C7 grand, Hammond w/Leslie, Baldwin 3 manual organ, Celeste, electric piano

Rates: Please call for rates

**** MONTEREY SOUND STUDIOS

230 S. Orange St., Glendale, CA 91204
(818) 240-9046

Owner: Jack Daugherty

Studio Manager: Dana Papazian

**** MORNING STAR SOUND RECORDERS

4115 N. Main Ave., Baldwin Park, CA 91706
(818) 960-7308

Owner: Steve and Becky Brown

Studio Manager: Steve Brown

**** MOTOWN/HITSVILLE RECORDING STUDIO

7317 Romaine St., Los Angeles, CA 90046
(213) 850-1510

Owner: Motown Record Corporation

Studio Manager: Guy Costa

**** MUSIC GRINDER

7460 Melrose Ave., Los Angeles, CA 90046
(213) 655-2996

Owner: Ron Fiecca, Gary P. Skaraina

Studio Manager: Ron Fiecca, Rody Hassano, Traffic Manager

**** MUSIC LAB

also REMOTE RECORDING

1831 Hyperion Ave., Hollywood, CA 90027
(213) 666-3003

Owner: Chaba Mehesh

Studio Manager: Tony Meederes

**** GRAHAM NASH'S RUDY RECORDS

1522 Crossroads of the World, Hollywood, CA 90028
(213) 467-6000

Owner: Graham Nash

Studio Manager: Marcy Giensic

**** NEW WORLD RECORDING STUDIOS

also REMOTE RECORDING

4877 Mercury St., San Diego, CA 92111
(619) 569-7367

Owner: New World Audio, Inc

Studio Manager: Bob Goold

Engineers: Bob Goold, Jim Scott, Charles Defazio, Garth Hedin, independents

Dimensions of Studios: 27 x 27

Dimensions of Control Rooms: 19 x 16

Tape Recorders: Otari MTR-90 II 24/16 track, Otari MTR-12 2 track, Otari MTR-10 2 2 full track, Otari Mk III 8 track

Mixing Consoles: Quantum Audio Labs QR-1010 (modified) 27 x 24

(LISTING CONTINUED ON PAGE 126)

THAT BRITISH SOUND



ACES TR-24: 2" 24 track Recorder/Reproducer \$19,300.00 (2" 16trk., pre-wired 24trk. available)

BOTH TAPE MACHINES FEATURE: +4dbm IN/OUT • 15/30ips • Full-function 9 cue position remote-autolocator • Stand • 50% range vari-speed •



ITAM #1610: 1" 16 track Recorder/Reproducer \$12,999.00 (1" 8trk., pre-wired available)



ACES ML24: I/O console, 32 in x 24 buss, Wired patch bay. \$16,800.00

ACES SM16: Split console, 32 in x 16 buss \$14,400.00

BOTH CONSOLES FEATURE: Fully modular • +4dbm IN/OUT • AudioFad long-throw conductive plastic faders • 5 Aux sends • 5 band switchable EQ • Input LED PPM'S • Stand • +48v phantom power • LED display (optional) • Two year parts warranty • Other frame sizes available •

EAST COAST DEALER:

AUDIOTEK

182-35 Jamaica Avenue
Hollis, New York 11423
(212) 526-1456

WEST COAST DEALER:

**PROFESSIONAL
AUDIO SERVICES
AND
SUPPLY CO.**

4628 West Magnolia Blvd.
Burbank, CA 91505
(818) 843-6320

(FROM PAGE 124)

Monitor Amplifiers: Crown PS 200, Crown PS 400, Crown DC-300, Crown D-75, Haller 500, QSC 1400.

Monitor Speakers: JBL 4435s, JBL 4312s, JBL 4401s, MDM-4s, Tannoy SRM 12Bs, Auratones

Echo, Reverb, and Delay Systems: Lexicon 224, Lexicon Super Prime Time, Lexicon Prime Time II, DeltaLab Super Time Line. **Other Outboard Equipment:** Eventide Harmonizer, MXR pitch transposer, (2) dbx 160X compressors, (2) Valley People Gain Brains, (2) Valley People Kepexes, Klark Teknik On3030, UREI digital metronome, Orban Parametric EQ, Orban compressor/de-esser, Tascam 122B cassette decks.

Microphones: Neumann U87, U47, U89, KM84s, KM86, Sennheiser MD421, MD441s, AKG C414, C452, C535, C460, Shure SM81, SM57, SM85, E-V RE20, Countryman, Crown P2Ms, Beyer, AKG tube mikes

Instruments Available: Yamaha C7 7'4" grand emulator digital synth, Drumulator, Fender Rhodes, Fender bass, Fender bass amps, Hammond B-3, Leslie

Video Equipment & Services: BTX Shadow, BTX Cypher, BTX soft touch, Sony 5850 3/4 recorder, 1/2 VHS & Beta formats available

**** NSP STUDIOS

3320 E. Century Blvd., Lynwood, CA 90262
(213) 636-2573

Owner: Nonstop Productions, Inc.
Studio Manager: Marlene Wright

**** ODD E O ENGINEERING

1740 N. Gramercy Place, Los Angeles, CA 90028
(213) 465-1762

Owner: Jeff McLane
Studio Manager: D. Moody

**** ONE ON ONE STUDIOS

5253 Lankershim Blvd., N. Hollywood, CA 91601-3111
(818) 761-3882

Owner: Jim David

Studio Manager: Jim David

Engineers: Joel Sotler, chief engineer; Jeff Bennett, Peter Lewis, Joey Wolpert

Tape Recorders: Analog: Studer A 800 Mk III 24 track, Ampex ATR-100 4 track, Ampex ATR 100 2 track, (5) Sony TC-K777 cassette; Technics 1506 reel-to-reel

Mixing Consoles: Trident Series 80 40

Monitor Amplifiers: Haller

Monitor Speakers: JBL - TADS, Auratones, Yamaha NS-10

Echo, Reverb, and Delay Systems: (2) EMT 140 plates, Lexicon 224 XL, AMS stereo DDL w/locking and 3.2 capability, (2) Roland SDE-3000, Eventide signal processor, Lexicon Prime Time.

Other Outboard Equipment: (2) Eventide H949 Harmonizer, (5) Kepex IIs, (2) Inovonic 201 limiters, (2) UREI LA3A, (2) UREI LA4A, (2) UREI 1176 limiters, UREI 530 graphic stereo graphic EQ, B&B parametric EQ, Orban silbance controller

Microphones: AKG C12, C12A, 414EB, 451; Beyer M500; Electro-Voice RE20, Neumann KM84, M49B, U87, U67, U47, U47FET; P2M; RCA 77DX, Sennheiser 421, 441; Shure SM57; Sony 33FP, C500

Instruments Available: 9' Yamaha grand & Yamaha upright acoustic pianos, LinnDrum machine

Video Equipment & Services: JVC 8250 3/4", BTX Softouch, Shadow & Cypher, 10' Kloss Nova Beam

Rates: Call for rates.

**** PASADENA SOUND

276 N. Raymond Ave., Pasadena, CA 91103
(818) 796-3077

Owner: James Jones

Studio Manager: Gil Jones

**** THE PASHA MUSIC HOUSE

5615 Melrose Ave., Hollywood, CA 90038
(213) 466-3507

Owner: Spencer Profler

Studio Manager: Hanspeter Huber

**** PERSPECTIVE SOUND

11176 Penrose St. #4, Sun Valley, CA 91352
(818) 767-8335

Owner: Vince Devon

Studio Manager: Gene Nash

**** TIM PINCH RECORDING

also REMOTE RECORDING

6600 San Fernando Rd., Glendale, CA 91201
(818) 507-9537

Owner: Tim Pinch

Studio Manager: Rex Olson

Engineers: Tim Pinch, Rex Olson

Dimensions of Studio(s): 15 x 20 remote truck, 15 x 15 studio

Dimensions of Control Room(s): 8 x 8 x 16

Tape Recorders: Ampex MM1200 24 track, Ampex A6 440C 4

S. Ca. 24 Track

track; Ampex A6 440C 2 track

Mixing Consoles: Amek 28 x 24 console with grouping, lader reverse, trans-amp mike preamps, Dean Jensen line amps Two 8 input outboard mixers for a total of 44 inputs.

Monitor Amplifiers: BGW 250B, BGW 100, BGW 750A

Monitor Speakers: Remote truck, Altec 604E w/Mastering Lab crossovers, Auratones, studio: 813 Time Align

Echo, Reverb, and Delay Systems: Echoplex

Other Outboard Equipment: (4) dbx 160 limiters, 1176 limiter, LA2A limiter, RTS and Clear-Com comm

Microphones: AKG 414s, 451EBs, C61; Neumann U87, U47; Sennheiser MD421, K2U shotguns. All others available.

Instruments: Kawai upright piano, Fender Rhodes stereo piano.

Video Equipment & Services: Video sweetening and mix to picture Color video monitor and camera

Rates: Please call for rates.

Extras: Our remote recording truck is specifically designed for live 24 track recording, Video & Film production, live broadcasts, stationary album production and anywhere there is a need for high quality audio on location.

Direction: We have high standards of quality in addition to reasonable rates, the same quality that is demanded by such clients as Al DiMeola, John McLaughlin and Paco DeLucia, Merle Haggard, Humble Pie, The Jacksons, The Go-Go's, Little Feat, DEVO, The Police, Roseanne Cash, Johnny Van Zant, Quiet Riot, Modern English, People's Choice Awards, King Biscuit Flour Hour, BBC Rock Hour. We have recorded everything from small night club acts and television specials to major outdoor festivals

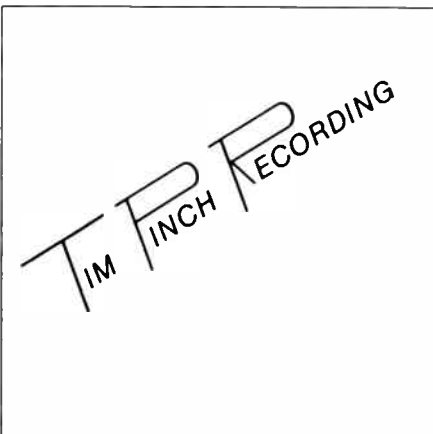

TIM PINCH RECORDING
Glendale, CA

**** PIPER RECORDING STUDIO

1425 Marcelina Ave., Torrance, CA 90501
(213) 328-8208

Owner: Ben Piper

Studio Manager: Allen Kaufman

Engineers: Allen Kaufman, Ben Piper, qualified engineers on call

Dimensions of Studios: 25 x 25, main room including drum booth (6 x 8), isolation booth (live ambience) (12 x 12), also 6 x 12 isolated room

Dimensions of Control Rooms: 20 x 24 (with lots of working space)

Tape Recorders: Analog MCI JH-16 24 track, Tascam 80-8 8 track, Scully 280 2 track, (3) Ampex 440 2 track, TEAC 3340 4 track, Marantz 5030B cassette, TEAC 25-2 2 track

Mixing Consoles: Sound Workshop 1280 24x24

Monitor Amplifiers: Crown DC-300s, Crown DC-150, Marantz 300DC, Dynaco

Monitor Speakers: JBL 4344s, Auratones.

Echo, Reverb, and Delay Systems: AKG BX10, Cooper Time Cube, DeltaLab Super Time Line 2048.

Other Outboard Equipment: UREI 1176s, LA3As, Compressor, Quantum limiters, Kepex, noise gates, Eventide instant flanger, Moog parametric EQ, Orban Parasound de-esser, UREI HF filter.

Microphones: Neumann U47, U87, KM84, AKG 414, 452, 451; Sennheiser 421; Shure SM57, SM57, (more than one of each - plus others)

Instruments Available: Kawai Classic grand piano, Ovation guitar, Gibson 1200 acoustic guitar, synthesizers, drums, Simmons drums, Hammond organ, etc.

Rates: 24 track, \$45/hr.; 8 track, \$30/hr.; 2 track, 4 track, \$25/hr. Prices subject to change. Rock rates negotiable.



PIPER RECORDING STUDIO
Torrance, CA

**** POIEMA STUDIOS

also REMOTE RECORDING

P.O. Box 651, Camarillo, CA 93010
(805) 482-7495

Owner: Bill and Marsha Cobb

Studio Manager: Marsha Cobb

Engineers: Bill Cobb and independents

Dimensions of Studio(s): 17 x 18 use booth 8 x 9

Dimensions of Control Room(s): 12 x 11

Tape Recorders: Analog: Stephens 821B 1/2" & 24 track with Autolocator; Ampex ATR 100 with 1/2" and 1/4" head assemblies, Scully 280 4 and 2 tracks, Technics 1520 2 and 1/4 tracks; Technics RM 85 cassette deck; Digital: Sony PCM Pro 702 with Auto Design & recording modifications

Mixing Consoles: Soundcraft Flexcom's Series 2400, 28 in x 24 out, fully automated, transformerless with 52 mp mix capability

Monitor Amplifiers: AF Systems Series 710, 410, 730, Spectra Sonics 700, 840 wats (1/4 car ls)

Monitor Speakers: JBL 433As, JBL 433As, JBL 4411s, Westlake Audio PB SM6Bs, Neutronics Yamaha NS 10s, Auratones

Echo, Reverb, and Delay Systems: Lexicon 224 digital reverb system, EMT 140 plate reverb, Lexicon Prime Time digital delay, DeltaLab A microcomputer, Marshall Time Modulator, Kora SDD 3000 digital delays (2), Howard SDE 3000 digital delays (2), MXR digital delay

Other Outboard Equipment: dbx 300 Series noise gates, compressors & de-essers, Eventide Harmonizer/DDI, Eventide Instant Flanger, AER Vocal Stressor, AIR Express limiter, SpectraSonics compressor/limiter, Aphex Analog Exciter, dbx 160 compressor/limiter, Orban/Parasound 522B parametric EQ, Orban stereo synthesizer, multi sync V30

Microphones: Neumann U 87, Telefunken 251, AKGs 414s, 451s, 571s, 402s, Sennheiser 421Us, Shure SM57, SM53, SM81s, Electro-Voice RE 20, Crown P2Ms, Sony E-M 22P

Instruments Available: Mason & Hamlin 7' grand piano, Kora Poly 61 1/4" synth, 2 Polytone Minibrute II guitar amps

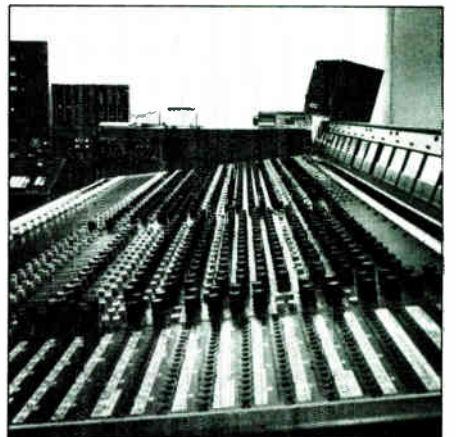

POIEMA STUDIOS
Camarillo, CA

Coon strobe tuner

Rates: Rates available upon request

Extras: Full kitchen facilities, overnight accommodations easily arranged. Sync interface to 46 tracks available by special arrangement.

Direction: Poema Studios provides an alternative to the hustle and high pressure of the city, but we maintains a state of the art recording environment. Situated on a half acre in the countryside, just 45 minutes north of L.A., the studio provides a relaxed & creative atmosphere. We desire to serve artists and producers with affordable rates without compromise to quality.

•••• PRECISION RECORDER

Northridge, CA
(818) 787-7778

Owner: Drew Dwyer - 1981-84 Chairman Audio Engineering Society - Los Angeles section



PREFERRED SOUND
Woodland Hills, CA

•••• PREFERRED SOUND

22700 Margarita Dr., Woodland Hills, CA 91364
(818) 883-9733

Owner: Scott Berden

Studio Manager: Meryl Stabin

Engineers: Robert Stamps - chief engineer, house engineer available upon request

Dimensions of Studio(s): 25 x 20, isolation booth #1: 10 x 10; isolation booth #2: 12 x 12

Dimensions of Control Room(s): 18 x 16

Tape Recorders: Studer A80 1/2 track (2) Hitachi cassettes

Mixing Consoles: Amek 20 (2), 2B in x 24 out

Monitor Amplifiers: Acoustat, K&W, Crown

Monitor Speakers: JREI 811s Time Aligned with White EQs, JBL 4401s Auratons

Echo, Reverb, and Delay Systems: Lexicon 224 digital reverb, EchoPlate II, MasterRoom XL-65 reverb, (2) Lexicon Prime Time

Other Outboard Equipment: (2) Lexicon Prime Time, Eventide Harmonizer, Howard stereo chorus/vanger, MXR flanger, (4) Kepex noise gates, (2) dbx -65, (2) JREI LA4s, LA2, (2) JREI 117bs, peak meter, Ross graphic EQ, digital metronome, JREI universal filter set - Urban de-esser

Microphones: Neumann U47 (tube), BMS6 (tube), U87s, EM84s, AKG 414EBs, 452, 451, RCA 771Xs, Sony C-7As (tube), ECM50s, E-V BE20s, Beyers M500s, M88, Shure SM56s, 57s, 58s, 81s, Sennheiser 42's, 441s MKH405s, MKH 105, MD402U

Instruments Available: Grand piano (Kawai GS 40), Fender Rhodes - Hamilton B3 organ, w/Leslie, and vintage guitars available through Norm's Fine Guitars - Ampex B 15, full selection of vintage Fender amp

Video Equipment and Services: Sony U-Matic 3" video machine - Full video services upon request.

Rates: Upon request

•••• PRESENT TIME RECORDERS

5154 Vineland Ave., N. Hollywood, CA 91601
(818) 762-5474

Owner: Bob & Grace Winters

Studio Manager: Bob Winters

Engineers: Bob Winters - Prince Able - Irvin Kramer

Dimensions of Studio(s) 76 x 17

Dimensions of Control Room(s) 17 x 14

Tape Recorders: MCI Autostocor 1-1100 w/VS 2/2418 tracks, Teac 8080 1/2 track, Technics 1001, track 5 Hitachi cassette deck

Mixing Consoles: Quantum QA-8000 w/full patch bay 24 in x 24 out

Monitor Amplifiers: S A F

Monitor Speakers: Altec 6440s x 2 04E with Motor Lab cross over - Auratons

(LISTING CONTINUED ON NEXT PAGE)

UNIVERSITY OF SOUND ARTS

EDUCATION PUTS YOU IN CONTROL

Education thru Hands On Training:
Recording Engineering
Outboard Equipment
Tape Editing
Music Theory
Music Business Mgmt.
Electronics
Sound Reinforcement

Classes start Sept. 3rd, Oct. 29th and Jan. 7th, 1985
Request Catalog and Open House Information
Call 467-5256

University of Sound
6525 Sunset, G-7
Hollywood, CA 90028

FOR THE FUTURE

Circle #071 on Reader Service Card

WE'VE GOT IT!

LIVINGSTONE

EXOTIC MICROPHONES & EQUIPMENT
FOR HIRE

Livingstone Audio is pleased to announce our new arrival:

SONY PCM3324

24 TRACK DIGITAL MACHINE

AVAILABLE FOR RENTAL!

Your prescription for painless digital

\$1,000/day • \$4,000/week • \$12,000/month

(213) 653-0270

Circle #072 on Reader Service Card

(FROM PAGE 127)

Echo, Reverb, and Delay Systems: Custom built stereo reverb, Yamaha delay, MXR doubler, Lexicon Prime Time and plate echo

Other Outboard Equipment: dbx limiters, MXR flanger, Fatch Transposer, Kepex, outboard EQ, direct boxes

Microphones: Neumann U87, AKG 414, 451, 2000, 1000, 202, Sennheiser 421, 416, Beyer 500, Electro-Voice RE-20, RE-15, Shure SM-57

Instruments Available: Steinway grand piano & ARP quartet
Rates: 24 track, 5 hr block \$30/hr, 16 track, 5 hr block \$25/hr, 8 track, \$22/hr

***** PRESENT TIME RECORDERS

5154 Vineland Ave., N. Hollywood, CA 91601
(213) 762-5474

Owner: Bob & Grace Wurster

Studio Manager: Bob Wurster

Engineers: Bob Wurster, Bruce Ablin, Irvin Kramer

Dimensions of Studio(s): 26 x 17

Dimensions of Control Room(s): 17 x 14

Tape Recorders: MCI Autolocator JH-100 w/VSO 24/16 tracks; Tascam 80-8 track, Technics 1500-2 tracks; (5) Hitachi cassette decks

Mixing Consoles: Quantum QA3000 w/full patch bay, 24 in x 24 out

Monitor Amplifiers: S A E

Monitor Speakers: Altec (balanced) 604E with Master Lab crossover, Auratones

Echo, Reverb, and Delay Systems: Custom built stereo reverb, Yamaha delay, MXR doubler, Lexicon Prime Time and plate echo

Other Outboard Equipment: dbx limiters, MXR flanger, Pitch Transposer, Kepex, outboard EQ, direct boxes

Microphones: Neumann U-87, AKG 414, 451, 2000, 1000, 202, Sennheiser 421, 416, Beyer 500, Electro-Voice RE-20, RE-15; Shure SM-57

Instruments Available: Steinway grand piano & ARP quartet
Rates: 24 track, 5 hr block \$30/hr, 16 track, 5 hr block \$25/hr, 8 track, \$22/hr

***** PRIME TRACK STUDIO

7437 Laurel Canyon Blvd., N. Hollywood, CA 91605
(818) 765-1151

Owner: Danny Tarsha

Studio Manager: Daniel Chance

***** PRODUCERS WORKSHOP

6035 Hollywood Blvd., Hollywood, CA 90028
(213) 466-7766

Owner: American Variety International

Studio Manager: Annie Butkiewicz

***** PROMISE PRODUCTIONS

9834 Marcus Ave., Tujunga, CA 91042
(818) 353-1255

Owner: Danny Watson

Studio Manager: Danny Watson

***** QUAD TECK STUDIOS LTD.

4007 W. 6th St., Los Angeles, CA 90020
(213) 383-2155

Studio Manager: Hank Waring, Joani Waring

***** RECORD ONE

13849 Ventura Blvd., Sherman Oaks, CA 91423
Owner: Val Garay

Studio Manager: D. Sommer

***** RECORD PLANT

also REMOTE RECORDING & FILM SCORING
8456 West Third St., Los Angeles, CA 90048
(213) 653-0240

Owner: Chris Stone

Studio Manager: Rose Mann

Engineers: Michael Stone (Chief Engineer), Mike Berger, Phil Jamtaas, Ricky Delena, David Bianco, Dan Wallin (Scoring Mixer)

Dimensions of Studio(s): A: 40 x 20 x 15, with isolation booth; B: 8 x 15 x 20, C: 50 x 35 x 23, with stage & 2 iso booths, D: 23 x 46 1/2 x 22; M: 70 x 80

Dimensions of Control Room(s): A: 15 x 15, B: 16 x 16, C: 16 x 20; D: 19 x 22, M: 35 x 45

Tape Recorders: Sony 24 track digital; Studer Mark III 24 track, 3M 79 4 track; 3M 79 24 track, 3M 64 2 track, 3M 64 4 track, Ampex 440 C 4 track; Ampex ATR-100 2 track, Technics RMS280 cassette decks

Mixing Consoles: Solid State Logic E Series, 48 in x 32 out; Solid State Logic 4000E, 40 in x 32 out w/Record Plant custom, 32 in x 8 out (film submix console), SSL E Series 48 in x 32 out; custom designed consoles, all have automated mixdown and groupers

Monitor Amplifiers: Studer A68, Crown DC 300A, Phase Linear 700B, Haller DH200, BGW 750

Monitor Speakers: Westlake TM-1, Altec 604Es with Mastering Lab crossovers, JBL 4312s, Record Plant custom JBL BM3,

S. Ca. 24 Track

Klipsch M1900, Auratone 5Cs, anything available by request; TAD 2 way system available

Other Outboard Equipment: Any Eventide, UREI, Pultec, EMT, ADR, dbx, Dolby, Allison (inc Allison 65K computers) units in house, including live chamber, EMT 251 digital echo, EMT 140ST and 240, plus AKG BX-20. Any item on request

Microphones: Neumann, AKG, Shure, Electro-Voice, Altec, Sony, Sennheiser, Studer, Telefunken, etc. Any mike on request.

Instruments Available: Hammond B-3 organ and Leslie, Yamaha piano and grand piano (Piano and organ included in rates). Synclavier (call for rates).

Rates: Call studio manager for rates

Extras: Two game rooms, Jacuzzi, sauna, Private band living room with full bath and TV. Private bedrooms with full bath. Projection with multi track magnetic film chain fully equipped. Record Plant has opened a new scoring facility, Studio M on the Paramount lot at 5555 Melrose Avenue

Direction: Record Plant Studios has diversified music recording into 3 divisions: Scoring, records & remote. We feel in this way we can best service our segment of the video & film audio industry. We remain the premier state of the art music studio with 5 studios, digital re-cording, new 35 mm film chain & 2 recording trucks



RECORD PLANT
Los Angeles, CA

***** ROCSHIRE STUDIOS

4091 E. La Palma, Suite S, Anaheim, CA 92807
(714) 632-9452

Owner: Clyde L. Davis, Shirley J. Davis

Studio Manager: Mark Goodman

Engineers: Lester Claypool, Willie Harlan, Rick DeLong, Clyde Davis, Peter Vargo, Jimmy Sandweiss, Tech. Maintenance

Dimensions of Studio(s): 30 x 21 x 14' ceiling

Dimensions of Control Room(s): control room 20 x 12, additional machine room: 16 x 8

Tape Recorders: Studer A80 VU Mark III 24 track 1/2" and 1/4"; Studer A80 VU Mark III 2 track 1/2" and 1/4"; Studer A62s, Studer Revox PR-99, digital Sony PCM 1610; 2 track available on request

Mixing Consoles: Neve 8128, 32 inputs, 8128, 64 line inputs, 8128, 24 inputs

Monitor Amplifiers: Conrad Johnson MV45A-MR75A

Monitor Speakers: Available at push button control from console desk UREI Time Align 813s, 3-way Time Align TAD system, Tannoy 12" Time Align speakers, Yamaha NS10s M&K satellites, Yamaha MS10s, Auratone 5Cs

Echo, Reverb & Delay Systems: PCM42 digital delay with 3 second delay and additional memory capability, Super Prime Time with 3 second delay, Quantec room simulator

Other Outboard Equipment: EMT 140 echo plate, Eventide Harmonizer Model 910, Marshall AR300 tape eliminator, Publication 89B2 w/keyboard expander and 5 second delay capability, Lexicon 224X digital reverb

Microphones: AKG C414Es, C451Es, 452s, C452EBs, D58E/200s, E-V PL80s, RE15s, RE20s, Milab LC25s, Neumann U47 tubes (6), M49 tubes (4), SM69 stereo (2), KM85s (2), UB7s (2), U67s (2), M269Cs (4) PML ST-8 stereo; Shure SM7s, SM57s, Sony C37As, C37Ps; Sennheiser MD421s (6); Telefunken ELAM 251s (6).

Instruments Available: Double bass set of Simmons drums, Moog Prodigy synthesizer, 1910 Steinway B acoustic piano, 1957 Martin acoustic guitar, 1959 Martin acoustic guitar, Rockman guitar amps, Roland guitar amps, custom Charvel/Jackson electric guitars/bass available, assorted percussion instruments also available upon request.

Rates: Studio rates available upon request - call (714) 632-5046 Rocshire Studios or (714) 632-9452 Rocshire Records

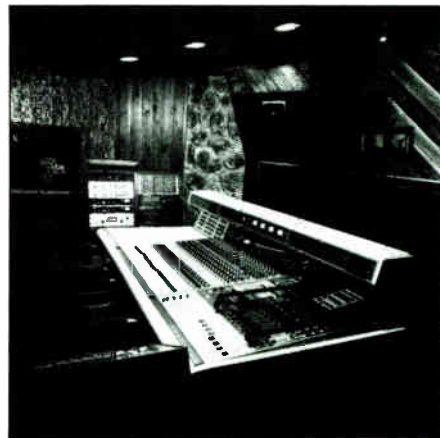

ROCSHIRE STUDIOS
Anaheim, CA

***** RSC

also REMOTE RECORDING
2414 W. Olive Ave., Burbank, CA 91506
(818) 843-8640

Owner: Recording Services Company, Inc.

Studio Manager: Ken Dahlinger

Dimensions of Studio(s): Vocal booth 8 x 10

Dimensions of Control Room(s): 14 x 20 control room, 13 x 8 machine truck control room

Tape Recorders: Ampex MM-1200 24 track; Fmpex MM-1200 16 track; Ampex MM-1200 8 track; Ampex ATR-100 4 track; Ampex ATR-100 1/2-inch 2 track; Ampex ATR-100 1/4-inch 2 track; Qlar: MX-5050 4 track and 3 track; Stephens 821 A 16 track; and 24 track

Mixing Consoles: Audionics 50, 26 x 16 x 24; Audionics 103 24 x 8

Monitor Amplifiers: BGW-750, BGW-25C, Crown D-6C

Monitor Speakers: UREI 813A; JBL-4311, Auratones

Echo, Reverb & Delay Systems: AMS RVS-16, AMS 1580S, AKG BX 10, Eventide 910; Lexicon 224X Larc; Eventide 949; Lexicon Super Frimetime

Other Outboard Equipment: Q-Link 310 Synchronizer; BTX shadow synchronizer; Dolby MH-24 noise reduction; Dolby SP-24 noise reduction; Orban 622 parametric; UREI LA-2, LA-3A LA-4, 1176LN, dbx 160, Reverb 500 noise gate; dbx 902; Orban 516A (De-essers)

Microphones: Well rounded choice of professional dynamic and condenser microphones

Instruments Available: Emulator II

Video Equipment & Services: Video laydowns and laybacks in all formats 2-inch, 1 inch, 3/4-inch, 1/2-inch. Mix to picture with customer choice of synchronizers SMPTE, burn in and tape transfers

Rates: On request.

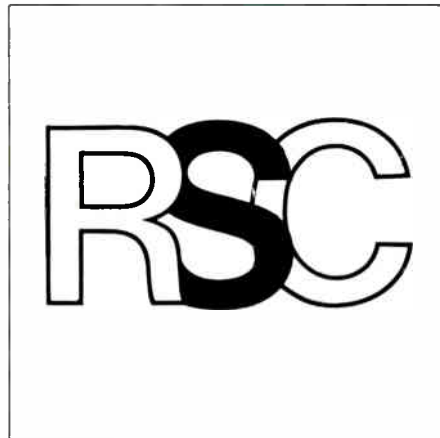

RSC
Burbank, CA



RUMBO RECORDERS
Canoa Park, CA

•••• RUMBO RECORDERS

20215 Saticoy St., Canoga Park, CA 91306
(818) 709-8080

Owner: Daryl Dragon

Studio Manager: Greg Edward

Engineers: Greg Edward, Chief Engineer, Ian Minns, Chief Maintenance, Julian Stoll, Greg Droman

Dimensions of Studio(s): Studio A 2500 sq ft., Studio B 2000 sq ft.

Dimensions of Control Room(s): Studio A 500 sq ft., Studio B: 450 sq ft.

Tape Recorders: (2) Studer A-800 48 tracks, Otari MT8-80 24 track

Mixing Consoles: Studio A: Neve 8088, 52 in x 48 out; Studio B: Trident TRS-80, 32 in x 24 out

Monitor Amplifiers: Yamaha—all studios

Monitor Speakers: Studio A: 2 way custom, Studio B: Fostex LS-4s

Echo, Reverb, and Delay Systems: Echoplate, EMT 140, live

chamber, Lexicon 224 digital reverb, (3) Lexicon Prime Times AKG BX-20 AMS phase

Other Outboard Equipment: (2) UREI LA4, (4) UREI 117E Teletronix LA2A (tube), (4) dbx 160, Orban De-Esser, Harmonizer, Q-Link synchronizer, vocal Stresser, Neve compressor/limiters, (2) Scamp racks

Microphones: A full complement of microphones available with up to 70 to "choose from"

Instruments Available: The keyboards of Daryl Dragon of "The Captain & Tennille" are available upon request

Rates: Call for rates



RUSK SOUND STUDIOS
Hollywood, CA

•••• RUSK SOUND STUDIOS

1556 N. La Brea Ave., Hollywood, CA 90028
(213) 462-6477

Studio Manager: Ganapath

Engineers: Independents

Dimensions of Studio(s): Approximately 1500 sq ft. Several areas may be isolated by sliding glass doors if desired

Dimensions of Control Room(s): 500 sq ft. Eastlake type

Tape Recorders: Ampex MM 1200 with XI 24 24 track Stephens 821 24 track, Ampex ATH104 4 track, 2 Ampex ATH102 1/4 inch and 1/2 inch 2 track, Revox HS77 2 track, Sony and Dacorler 1/4 track 4 channel, Yamaha cassette

Mixing Consoles: Harrison 32 42 B.C. automated with some improvements and extra sends 42 input plus 8 stereo returns

Monitor Amplifiers: BGW, Crown etc. with Wham 27 B and EQ

Monitor Speakers: Sierra/Eastlake, 604Es JBL 4311s and 1100s, Yamaha NS10, Auratones

Echo, Reverb & Delay Systems: Lexicon 224 X1 ABC, Echoplate I (large EMT 140s type) classic live chamber, AKG BX10, small plate, Eventide 949 and H910 Harmonizers, Prime Time, Roland SDE, 4000 programmable delay, DeltaLab 1024 and Di-1 (3 out) delays, Roland Space Echo and tape delays

Other Outboard Equipment: Teletronix LA2 (tube) limiter, (2) UREI 1176LN, (2) dbx 161 (1) dbx 160, 2 channels of word gates, (4) Valley People Dynamos, 4 channels Omnecraft gates, Dolby 361's, dbx 154, Eventide instant flanger, MXR doubler/flanger, MXR pitch changer, MXR auto flanger, SAF stereo 20 and 10 band graphic EQ, Furman parametric, Aphex Aural Exciter, Phase Linear 1000 autocorrelator, Orban 3 channel De-esser, UREI LA3A

Microphones: Telefunken 251E, Neumann U67 (5), U87 (3), U47 FET, KM84 (4), KM 85, AKG 414EB (2), 451EB (4), D1000E, D190, RCA 77DX, Sony C12A, ECM 22P (2), Sennheiser 441, Sennheiser 421, MK40, F V HF20, RE15 (2), 666, Crown PZMs (2), Shure 57s (5), SM 54

Instruments Available: Steinway grand piano, ARP 2600 synthesizer, Farfisa organ, various percussion, various guitars and amplifiers available on request

Video Equipment & Services: Wired for video loop throughs throughout studios, video lockup available, BTX 4500 synchronizer and BTX 4200 SMPTE reader/repeater

Rates: Please phone, we will try to work out the best value for your project

Extras: Any equipment available on request. We have a comfortable private lounge with video games, coffee, etc.

Direction: Rusk is a fully equipped world class recording studio that recognizes the importance of service, comfort and privacy to our clients. Rusk has been used to record platinum and #1 records for artists such as Donna Summers, Bonnie Steel, Breeze, Billy Idol, The Sylvers, Giorgio Moroder, Laura Branigan, Elton John, John Cougar and also film scores, jingles and radio and TV spots

REAL TIME DUPLICATION

Cut to: 1/2 the TIME
1/2 the number of DECKS
1/2 the SPACE

KABA's new, professional 4 track Real Time Duplication System

AVAILABLE THIS FALL
SPECIAL OFFER FOR CHARTER USERS

Call or write
for specifications & details

- Master-Slave configuration reduces system cost
- Dual position slaves give 4 times the production (per deck)
- 10,000 hour transport for long trouble-free life
- Send-Receive busses on master deck allow external signal processing
- Optional 3 1/4 ips operation for 8 times the production (per deck)
- 4-track recording makes possible audiophile quality stereo A/V sync-masters

EVERYTHING FOR THE CASSETTE PRODUCER AND USER

KENNETH A. BACON ASSOCIATES 24 COMMERCIAL BLVD., SUITE E, NOVATO, CA 94947 (415) 883-5041



WHEN YOU'RE
READY
TO CUT

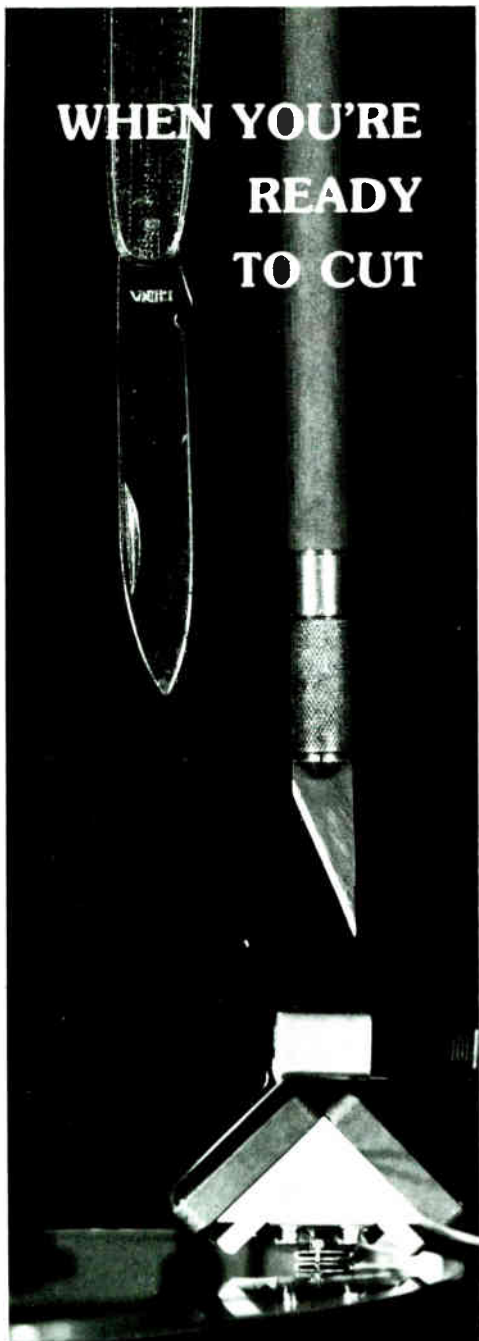

WE
KNOW THE
RIGHT WAY

**Kdisc
mastering**

6550 Sunset Blvd.
Hollywood, CA 90028
(213) 466-1323

Circle #074 on Reader Service Card

S. Ca.
24 Track



RYAN RECORDING
La Manana, CA

•••• **RYAN RECORDING**
3324 Cornerstone Circle Dr., La Manana, CA
(call information for current phone listing)
Owner: Cart Ryan
Studio Manager: Mr. Bonza
Engineers: Cart Ryan, Smilin' Deal Eddie Edwards, Layla Lane
Dimensions of Studio(s): 8 x 15 x 47
Dimensions of Control Room(s): 10 x 12 x 15, Kent Korn-kooper Live Head/Dead Head Design
Tape Recorders: Custom Stanley 32 track; Atrax 2 track, Lantz 8 track cartridge; Authentic cassette machine
Mixing Consoles: SuperSonic II w/Plasma Vue, Pneumatic Semi-automation, 48 x 5-foot-2
Monitor Amplifiers: Modzalla Cube Loops
Monitor Speakers: Lektron Time Designs, PermaSonic "Little Dippers," and Oralphones
Other Outboard Equipment: Evinrude DeFiatter, S-X Slap Master, Omega Labs Digital Flanger/Fuzzier, Abba Dabba Drum Exciter, and 3D Noise Gates
Microphones: RKO, EEG, Erlichmanns, and vintage tubes
Instruments Available: Phaser "Stundrums," nose harmonica, Deussenorfer 13-foot grand piano, Clavinator II
Rates: Our book rate is \$220/hr but we have, on occasion, negotiated as low as \$15/hr. Please call
Extras: Chase lounge, unicycle, motel accommodations, vegetarian catering, mini-limousine service, 24-hour medical supervision. Telephones nearby
Direction: We are very sensitive to the incredible pressures that musicians are subjected to. We maintain our equipment and recreational activities at a highly professional level. Credits: Johnny Terrific, Lorne Rogers, Morris Edward and many others whose attorneys requested they remain unnamed

•••• **SAGE & SOUND RECORDING**
1511 Gordon, Hollywood, CA 90028
(213) 469-1527
Owner: Jim Mooney
Studio Manager: La Verne

•••• **SALTY DOG RECORDING**
14511 Delano St., Van Nuys, CA 91411
(818) 994-9973
Owner: David Cox
Studio Manager: Tina Campbell
Engineers: Patrick Cyclone and various independents
Dimensions of Studio(s): 50 x 40
Dimensions of Control Room(s): 20 x 25
Tape Recorders: 4M 79 24 track, 4M 79 2 track, (2) Ampex 440B 24 track (1 1/2 inch and 1 1/4 inch head assemblies), Sony 654 4 2 1/4 track
Mixing Consoles: MCI 152H 28 in x 28 out with many sonic improvements
Monitor Amplifiers: SAE Crown Mirant Bryson
Monitor Speakers: UREI 813 Time Aligned, Auratones, IBL 411
Echo, Reverb & Delay Systems: 2 EMT 140 stereo, Lexicon

Prime Time, Cooper Time Cube, Marshall Time Modulator, MXR Digital Delay
Other Outboard Equipment: UREI 1176 LN limiters, UREI LA4A's, Invoconics 201 limiters, Furchild stereo compressor, UREI notch filters, Haeco CSG 4, MXR Phasor, MXR Flanger, Orban 516 De-esser, disc playback, Kopyex Gain Brains dual cassette, line level mics, Vocal Stressor, Harmonizer and more
Microphones: Neumann KM 84's, U 87's, U 47's (tube), U 48 (tube), AKG 414's, 451's, 452's, Sennheiser 421's, 441's, Sony C 7A's, ECM 2/P's, Shure 57's, 58's, RCA 44, F-V R1, HF, and more
Instruments Available: Yamaha C5 grand piano, AB Chase upright piano with tack strip, Hammond C3 with Leslie speaker included in studio rate

•••• **SANTA BARBARA SOUND RECORDING**
33 W. Haley St., Santa Barbara, CA 93101
(805) 963-4425
Owner: Santa Barbara Sound Recording, Inc.
Studio Manager: Daniel Protheroe, Landa Silva
Engineers: Terry Nelson, Daniel Protheroe, Paul Durro
Dimensions of Studio(s): 400 sq ft
Dimensions of Control Room(s): 450 sq ft
Tape Recorders: Studer A80 V 2 24 track, Studer A80 H 2 2 track, Ampex MH 70 2 track
Mixing Consoles: MCI 1H52H 28
Monitor Amplifiers: Phase Linear, Accophase
Monitor Speakers: UREI 813, Altec 604, JBL, Yamaha
Echo, Reverb & Delay Systems: EMT 140, AKG BX10. Misc delays and digital effects
Microphones: Complete selection of standard studio mics, plus a good supply of various tube mics
Instruments Available: Yamaha C7 Grand Piano, Hammond B3 with Leslie
Rates: Call for rates

•••• **SEACOAST RECORDING STUDIO**
926 Turquoise Street, San Diego, CA 92109
(619) 270-7664
Owner: Elliott Audio Enterprises
Studio Manager: Jack Elliott

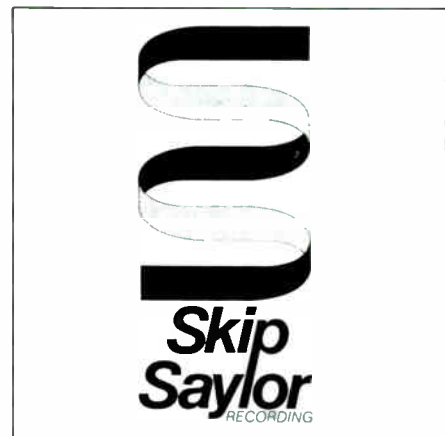

SKIP SAYLOR RECORDING
Los Angeles, CA

•••• **SKIP SAYLOR RECORDING**
506 N. Larchmont Blvd., Los Angeles, CA 90004
(213) 467-3515
Owner: Skip Saylor
Studio Manager: Skip Saylor
Engineers: Skip Saylor, Tom M. Cauley and various independent engineers
Dimensions of Studio(s): 22 x 20 main room, Isolation rooms 15 x 10 and 17 x 4
Dimensions of Control Room(s): 17 x 11
Tape Recorders: Ampex MM1200 24 track, Ampex ATR 102 2 track 1/2 inch and 1/4 inch headstack, Ampex ATR 104 4 track 1/2 inch headstack, Ampex ATR 800 2 track 7 1/2, 15 and 30 ft, rental equipment available
Mixing Consoles: Trident Spectra Sonics customized 48 in x 24 out
Monitor Amplifiers: Crown
Monitor Speakers: Control room tuned by George Anagnostopoulos, IBL's, Yamaha NS 100Ms, Auratone Tubs and Cubes, and Hemispheres
Echo, Reverb & Delay Systems: Lexicon 224X Large (3 Stereo Envelopes, 2 Studio Technologies Reverb Processors, Eventide Harmonizer 910, Eventide DDL 1745M, Lexicon Prime Time Roland Chorus Echo SH 555, Roland Digital Delay SDE 2000
Other Outboard Equipment: 10 UREI 555/A Equalizers, Teletronix LA 2A tube limiter, (2) UREI 1176LN (2) dbx 160X (stereo) UREI LA 4A, (2) Kopyex (4) Drawmer Noise Gate, Roland Phase Shifter SPH 324, Roland Stereo Flanger SH 325

Holand Dimension-D SDD 420, Orban Parametric EQs, (4) Orban De-essers, Furman Parametric EQs, UREI Little Dipper, UREI 550A Hi Lo Pass Filters, Studio Technologies, Stereo Simulator, SMPTE and 60 Hz Sync, UREI Digital Metronome, VSO AKG and Koss Headphones

Microphones: AKG "The Tube", 414s, 452s, D12E, Neumann U87, Sennheiser 441 and 421's, Beyer M400's, E-V RE-20, HE-15s, Shure SM 57s and more

Instruments Available: Yamaha grand piano and Mini-Moog

Video Equipment & Services: Rental equipment available

Rates: Please call for rates

**** SKYLINE RECORDING CO.

1402 Old Topanga Canyon Rd., Topanga Park, CA 91290
(213) 455-2044

Owner: Ron Bacon

Studio Manager: Lisa Bacon

**** SOUND ADVICE

7611 Slater Ave., Ste. N, Huntington Beach, CA 92647
(714) 842-2213

Owner: Ron J. Leeper

Studio Manager: Virginia Leeper

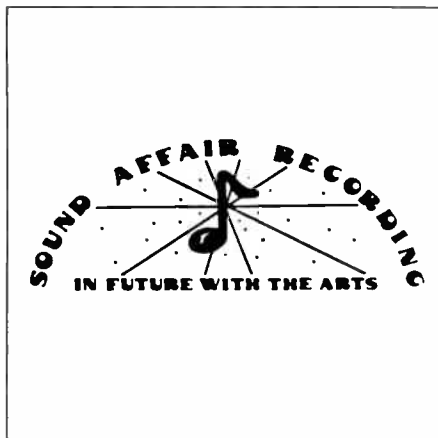

SOUND AFFAIR
Santa Ana, CA

**** SOUND AFFAIR

2727 Craddy Way, Santa Ana, CA 92704
(714) 546-0063

Owner: Ron Leeper

Studio Manager: V. Leeper, Cheryl Sullivan

Engineers: Ron Leeper, David Jones, John Tomlinson

Dimensions of Studio(s): A- 36 x 30, drum booth 12 x 10, vocal booth 7 x 6, B. 26 x 24 x 16, drum booth 11 x 9, A Piano trap 12, C: 18 x 12

Dimensions of Control Room(s): A: 20 x 18, B: 18 x 14

Tape Recorders: Analog: Ampex MM 1200 24 track w/locator, Ampex MM 1200 16 track w/locator, Ampex ATR 100 1/2 & 1/4" 2 track, Ampex 440 2 track; Otari 50-50 2 track

Mixing Consoles: MCI JH600 automated 36/24, Sound Workshop 1600 20/16.

Monitor Amplifiers: Crown DC 300A, Crown D175, BGW 100, BGW 210 (2), UREI 6500, UREI 6150.

Monitor Speakers: JBL 4430 and 4311, Tannoy SRM-12B, Yamaha NS10M, Auratones 5-C

Echo, Reverb & Delay Systems: Lexicon 224 digital reverb Echoplate, Super Prime Time, Eventide Harmonizer 949, MIC-MIX Super C, DeltaLab Effectron DL2, Acousticcomputer, Lexicon Prime Time, Sound Workshop Vocal Doubler, Eventide SP-2016

Other Outboard Equipment: UREI 1176, LA2A, LA4A, 535 graphic EQs, ADR Voice Stressor, dbx 161 limiter, EXR Exciter, HPXX display, full Scamp rack, White 4001 EQs, Furman Parametric EQs, Eventide Phasers, ADR auto panner, Gold Line RTA.

Microphones: AKG S, The Tube, 414, 451, 452, Neumann's U47, U87, KM84, Electro-Voice RE20, PL95, DS35, Sennheiser MD 421, MD 441, MKH 405, Crown PZM, Calrec CB21C, Altec 195-A, RCA DXFF, Shure SM56, 57

Instruments Available: (2) grand pianos, drums, electric piano, organ, sound effects and library

Video Equipment & Services: We are currently expanding for in-house video production and remote, color effects, editing, interlock.

Rates: Please call.

Extras: High ceiling acoustic string room, (3) freeways close by and major airport. Tape duplication, high speed cassette, tape vault, kitchen, house accommodation available.

Direction: Our goal has been to Sound Affair to be one of Southern California's finest studios. We are proud of our steady growth in many directions. This has been our most busy year.



SOUND ARTS
Los Angeles, CA

**** SOUND ARTS

2825 Hyans St., Los Angeles, CA 90026
(213) 487-5148

Owner: Bob Walter, Jim Cypherd, John Berkman, Rick Johnston, Aseley Otten

Studio Manager: Bob Walter and Aseley Otten

Engineers: Jim Cypherd, Aseley Otten, Rick Bow's Resident

Synthesists: Rick Johnston, Jim Cypherd.

Dimensions of Studio(s): 36 x 22

Dimensions of Control Room(s): 24 x 22

Tape Recorders: Ampex MM-1200 24 track, ATTI: 104 4 track, Ampex ATR-102 2 track

Mixing Consoles: Trident Series 80, 32 in x 24 out

Monitor Amplifiers: Crown DC-300s DC-150s, 9GW 25GB

Monitor Speakers: Sierra Hadley JII's, JBL 4315s, 4311s, Auratone 5Cs

Echo, Reverb, and Delay Systems: Lexicon 224, AKG BX-10, Eventide DDL and Lexicon Prime Time

Other Outboard Equipment: Orban Parametric EQs, JREI 1176, LA3A, LA2A; digital metronome, Eventide 949 Harmonizer, Alison Gain Brains and Kepexes, Orban Sibilance Controller, Moog Vocoder, dbx 162 comp/limiter, Ampex VSO, 360 Systems and Bode frequency shifters, Roland Space Echo w/chorus, Dr. Click, Adams Smith Synchronizer

Microphones: PML DC-63s, Neumann U-87s, KM-84s; E-V RE-20, RE-15s, AKG 451s, 124E, D 1000E; RCA 77Ds; Shure SM-77s, SM-54s, SM-57s, SM-58s; Sony C-55Ps; Sennheiser 421s, 441s

Instruments Available: Fair-light CMI, Yamaha DX-7, Memory Moog, Roland Jupiter 8, Moog Model 55C expanded modular system, Prophet 10 & 5 voices, Yamaha CS90 Oberheim 4-voice, Polytrig, Mini Moog, ARP String Ensemble, Roland SH 1000, Sequential Circuits digital sequencer, Baldwin electric harp/hurdy; Hammond B-3, Steinway grand piano.

Rates: Call for rates.



SOUNDCASTLE RECORDING STUDIOS
Los Angeles, CA

**** SOUNDCASTLE RECORDING STUDIOS

2840 Rowena Ave., Los Angeles, CA 90039
(213) 665-5201

Owner: Buddy King

Studio Manager: Darryl Casene, Marianne Fellicci, Art

**** SOUND CHAMBER RECORDERS

27 So. El Molino Ave., Pasadena, CA 91101
(818) 449-8133

Owner: Richard McIlwery, Randy Farrar, Tim Kenefick

Studio Manager: Richard McIlwery

Engineers: Richard McIlwery, Handy Farrar, Tim Kenefick, independents

Dimensions of Studio(s): 18 x 40 x 18 ceiling, 12 x 12 drum booth

Dimensions of Control Room(s): 18 x 17

Tape Recorders: Analog: Stephens B21 24 track, Ampex ATR 102 2 track, 1/4 & 1/2", Technics 1500 2 track, TEAC cassette.

Mixing Consoles: Trident Series 80B 32 x 24

Monitor Amplifiers: Metron, Corwin-Vega, BGW

Monitor Speakers: UREI 813, JBL 4311, Yamaha NS10M, Auratone 5C

Echo, Reverb & Delay Systems: Lexicon 224X w/LAHC, EMT 140s (tube), Echoplate I, Lexicon Prime Time II, Eventide 949 Harmonizer

Other Outboard Equipment: UREI 1176 I/II's, UREI LA4s, dbx 162 comp/limiter, Orban stereo parametric EQ, Gates gates, Aphex gate compressors, UREI digital metronome

Microphones: Neumann U87, U47 (tube), KM84, AKG C414, C452, Sennheiser MD421, Shure SM57, 54, 54b

Instruments Available: Yamaha C7 "74" grand piano, Hammond B3 organ w/Leslie, Yamaha DX7 synthesizer, Fender Rhoxes Prophet 5, Lundrum

Rates: Please call



SOUND CHAMBER RECORDERS
Pasadena, CA

**** SOUND CITY INC

15456 Cabrito Road, Van Nuys, CA 91406
(818) 787-3722, 873-2842

Owner: Joe Gottfried, Tom Skeeter

Studio Manager: Paula Salvatore

Engineers: Richard Polakow, Ray Leonard, Bruce Barris, Tom Swenson, Maintenance: William Elswick, Jimmy Hobson

Dimensions of Studio(s): Studio A: 40 x 50, Studio B: 40 x 30
Dimensions of Control Room(s): Studio A: 26 x 20, Studio B: 20 x 20

Tape Recorders: Studer A800 24 track, Studer A80 MK II 24 track, Studer A80 I, Studer A80 I+, (2) B67 2 tracks, Revox Sony 14 track

Mixing Consoles: Neve (Studio A) w/Ne-tam computer mix 26 in x 42 out, Neve (Studio B) 28 in x 42 out

Monitor Amplifiers: Crown DC-300, for the Q system, Yamaha P-2200

Monitor Speakers: A & B JBL (custom designed and tuned by George Auspurgner)

Echo, Reverb, and Delay Systems: EMT, AKG, Lexicon Delta-T digital delay, (2) Harmonizer, 949, Eventide flanger, Orban De-esser, Eventide digital delay, AMS BMX 16 digital reverb

Other Outboard Equipment: Parametric EQ, dbx 165a's, Pultec EQs, filters, Teletronix LA2A limiters, Neve limiters, UA 1176, Dolby's

Microphones: Neumann U 47, U 67, U-47 FET, U-84, U-86, U-87, KM 84, KM 86, M 49, AKG 541Es, C-451E, C-24, C-12A, 460s, M49, Electro-Voice RE 20, E-15, 635s, Shure 545s, SM 57, SM-58, Sennheiser MD 421, Sony C-37s, EC 50

Instruments Available: Hammond C 3 organ with Leslie, two Steinway grand pianos

Rates: Call for rates

**** SOUND CONNECTION

11724 Ventura Blvd., Studio City, CA 91604
(818) 985-3805

Owner: Ham Saban, Shuki Levy

Studio Manager: Theresa Abrock

**** SOUNDOME

17422 Murphy Ave., Irvine, CA 92714
(714) 474-2015

Studio Manager: Richard Donaldson

ator 4, Prime Time, Lexicon PCM 41, Harmonizer Eventide, D250 Advanced Audio Design, 265 Dynaliner Limiters dbx 16's, UREI 1176's, dbx 161's Quad/Eight compressor/expander, Quad/Eight De-Essers Noise gates 16 Quad/Eight and Kepex Orban parametric UREI 527A MXR phaser, Eventide Instant Phaser Marshall Time Modulator, Eventide DDL 1745

Microphones: Shure Bros complete line, Electro-Voice, Audio Technica PZMs AKG, Sony, Beyer Neumann, Altec, RCA, Sennheiser, Vega wireless, Eddor wireless, over 350 microphones including old tube types

Instruments Available: Steinway 77" grand piano, Yamaha 6'6" grand, H-3 with Leslie, Linn LM 1 computerized drum machine, timbales, orchestra chimes string synthesizer, and varied array of hand percussion instruments

Video Equipment & Services: Full video production house on-site. Video studio dimensions 30' x 40'. Computerized post production editing with Chromakey character generator, digital special effects, freeze-frame and frame store, Ikegami and JVC color cameras, also ENG Program pre-planning, design script writing, and in house tape duplication

Rates: Available on request

Extras: On site disc mastering studio equipped with Tandem Cyberonics disc cutting lathes with Orton heads, and computerized digital Cyberonics console. Also, three mobile trucks, Remote Recording, Sound Reinforcement and Video

Direction: Looking ahead to the future, Sound Master has incorporated full color video capabilities into a state of the art recording studio facility to accommodate the current growing audio/video fusion in the recording industry. Our aim is to provide you with technical sophistication as well as personal attention.



THE SOUND SOLUTION
Santa Monica, CA

•••• THE SOUND SOLUTION
1211 Fourth St., Santa Monica, CA 90401
(213) 393-5332

Owner: David Epstein

Studio Manager: Xtina Bek

Engineers: Keith Wechsle, Steve Barnard (staff producer), Robin Lambie, Rod Clark, David Fowler (maintenance), Lori Kolem

Dimensions of Studio(s): 32' x 14' plus iso booth 4' x 8'
Dimensions of Control Room(s): 14' x 16'

Tape Recorders: MCI JH 114 24 16 8 track w/AutoLocator & VSO, EM 56 16 8 track w/locator, (2) MCI JH 110 2 tracks, Ampex AG 440B 2 track, Technics 1500 2 track, Sony TC 854 4 track, Sony TC K777 cassette decks, Otari 1/2 8 track recorder available

Mixing Consoles: MCI 428 28 in x 24 out, modified

Monitor Amplifiers: Haller P 500, QSC P 500, BGW 250D, BGW 100B, AB Systems 205, Uni-syn 50s

Monitor Speakers: Altec 604Es with Mastering Labs crossovers, Sony APM 700s, Yamaha NS 10Ms, Auratones

Echo, Reverb & Delay Systems: Lexicon 224X1, "LARC" digital reverb, EMI 140S, Echoplex III & AKG BX 10k reverb systems, Lexicon M 97 Super Prime Time, (2) Lexicon M 93 Prime time digital delays, Dattalab ADM 10/4 Electron II digital delay, Eventide H 910 Harmonizer, Roland SHE 555 tape echo with chorus

Other Outboard Equipment: (6) UREI 1176 LN limiters, (2) LA 3A limiters, (2) dbx 165A limiters, (3) dbx 163 compressor limiters, (2) Allison Gain Brain limiters, (8) Allison Kepex noise gates, (2) Orban 622B dual channel parametric EQs, Klark Teknik DN 40 30, DN 27, DN 22 graphic EQs, Systech 7012 flanger

Microphones: Over 100 mikes including Neumann, Sennheiser, AKG, Shure, Sony, Beyer, E.V. RCA

Instruments Available: Yamaha ("774" grand piano, Yamaha DX 7 digital programmable synthesizer, Fender Rhodes, Prophet 5 synth, Mini moog, LinnDrum computer Premier drums with Zildjian cymbals, Yamaha and Fender guitars and bass, misc amplifiers, pedals and effects

Rates: Hourly rate includes all equipment and engineer. Please call for specific quote

Extras: Musicians, arrangers, composers and rentals of any in-

struments or equipment available. (air conditioning and digital color machine) Producer Steve Barnard available on a project basis. The studio has nearby parking and restaurants and is located 4 blocks from the beach in sunny smog free Santa Monica. So beat the heat and move your feet on down to The Sound Solution

Direction: The purpose of The Sound Solution is to create an environment where people are inspired to perform to their absolute limits, and beyond. Effortlessly. Recent clients have included Hoyt Axton, Dudley Moore, Free Flight, Carl Anderson, Henry Lowmy, Bruce Johnston, CBS Records, Arista, and numerous TV and radio commercials and identities.

•••• SOUND VAULT STUDIOS
8134 Foothill Blvd., Sunland, CA 91046
(818) 353-7121

Owner: William Hawkins

•••• STUDIO II
(affiliate of Indigo Ranch)
9733 Culver Blvd., Culver City, CA 90230
(213) 558-8832

Owner: Richard Kaplan, Jason Wolchin

Studio Manager: Jason Wolchin

Engineers: Richard Kaplan, Carl Lancia, Jason Wolchin

Dimensions of Studio(s): 18 x 45, designed by Jeff Cooper

Dimensions of Control Room(s): 12 x 12, designed by Jeff Cooper

Tape Recorders: Stephen: 821A 24 track, Scully 280B 2 track, 3M 79 2 track transformerless, (3) Sony 777 cassette decks, (3) Ampex 450 2 tracks

Mixing Consoles: Aenous Jensen, the only other Indigo Ranch type console, 32 in x 24 out

Monitor Amplifiers: BGW 750C, Crown DE 400A, Mates 100, Technics Class A, McIntosh, etc.

Monitor Speakers: custom JBL (bumped)

Echo, Reverb & Delay Systems: Live chamber, Echoplex MasterRoom, Sennheiser reverb, (1) Telefunken reverb, (2) Eventide 1745As, Eventide 1745M, (1) Eventide Harmonizers, Marshall Time Modulator, (2) Cooper Time Cubes, and EMT 250 is available, (2) EMT stereo plates, Yamaha digital reverb, Lexicon Prime Time 10ET 440 stereo delay flanger, (3) MXR DDLs w/4 card memory, MXR flanger/doubler, MXR pitch shift doubler

Other Outboard Equipment: Limiter: 1A1 tube, 1A2 tube, LA2A tube, dbx 162, UA 175 tube, UA 176 tube, Altec 436C tube, Fuchsli 602 tube, EQ: Pultec SAF graphic, API: B&B, Aenous Graphics, Cincom Engineering EQs with Pultec boosters

Orban de-esser, (8) Kepex, (2) Gain Brain, Collins tube limiter, RCA BA6A tube limiter, (4) RM noise gate, Audio Design Recording F 500 RS selective processor, White 140 sound analyzer, and much more!

Microphones: AKG C12A, C60, C61, C28, C451, C452, 414, Neumann U47, M59, KM54, KM54, KM54, KM64, U64, SM69 stereo, KM84, KM86, U87, E.V. RE20, 666, CS15, 741, 670, Calson 1050, Altec 22, 29A, 150A, 175A, Sony C47A, C220, ECM 16, ECM 22, ECM56, ECM65, ECM 54, Shure SM56, SM57, 545, 565, Telefunken ELAM251 (tube), Neumann M269 (tube) H 47 (tube) H 67 (tube), Sony 47E

Video Equipment & Services: Available

Rates: Please call

•••• STUDIO 55
5505 Melrose Ave., Los Angeles, CA 90038
(213) 467-5505

Studio Manager: David Dubey

•••• STUDIO ON WHEELS
ONLY REMOTE RECORDING
6600 San Fernando Rd., Glendale, CA 91201
(213) 506-9537

Owner: John Falzarano

•••• STUDIO MASTERS
8312 Beverly Blvd., Los Angeles, CA 90048
(213) 653-1988

Owner: Randolph C. Wood

Studio Manager: Larry Wood

Engineers: Don Blake, Robert Brown, Tim Jaquette, Taavi Mole

Dimensions of Studio(s): Studio A, 30 x 40 w/20 x 18 isolation room

Dimensions of Control Room(s): 20 x 15

Tape Recorders: Ampex (2) MM1200 24 track, Studer (3) A-80 2 track

Mixing Consoles: Harrison 46x24 36 in x 24 out

Monitor Amplifiers: Crown 400A

Monitor Speakers: Westlake Audio TM 1

Echo, Reverb & Delay Systems: Eventide DDL, EMT Master Room, AMS digital reverb RMX 16

Other Outboard Equipment: 1176 limiters, Eventide Harmonizer, Prime Time digital delay, Audio Kinetic, Q Lock 68 track recording, Neumann disk mastering, Allison & Kepex, dbx 165A compressor limiter, Orban parametric EQ

Microphones: All types

Rates: Please call for rates

360 Systems

DIGITAL KEYBOARD
WITH REAL ACOUSTIC
INSTRUMENT SOUNDS
**RENTALS AVAILABLE
FOR SESSIONS**

COMPLETE SOUNDS
LIBRARY INCLUDES:
26 VIOLINS, BRASS,
WOODWINDS, GUITARS,
MALLETS, GRAND PIANO,
ETC.

RECENT CLIENTS INCLUDE:
MICHAEL OMARTIAN,
NEIL DIAMOND,
SMOKEY ROBINSON,
BOBBY KING

WAVE PPG. 2.3 AND OTHER
KEYBOARDS IN CARTAGE

STEVE WILLIAMS
STUDIO KEYBOARDIST
IN SOUTHERN CALIFORNIA CALL
(818) 891-6498

Circle #077 on Reader Service Card

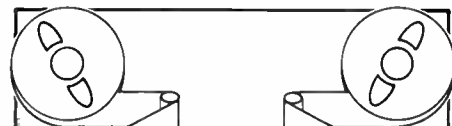

ADVANCE
RECORDING PRODUCTS

Pro Audio
Dealers
for 3M, Agfa,
Ampex

We Also Load
Custom Cassettes

Call Toll Free
Inside CA
1-800-858-1061
Outside CA
1-800-854-1061

7190 Clairemont Mesa
Bldg.
San Diego, CA 92111
(619) 277-2540

Circle #078 on Reader Service Card

◆◆◆◆ STUDIO ORANGE
1509 North Main, Ste. F, Santa Ana, CA 92701
(714) 953-2999
Owner: Ted Vecovick, Jim Melnick
Studio Manager: Jim Melnick



STUDIO SOUND RECORDERS
North Hollywood, CA

◆◆◆◆ STUDIO SOUND RECORDERS
11337 Burbank Blvd., N. Hollywood, CA 91601
(818) 506-4487 (506-HITS)
Owner: George Tahir Productions, Inc.
Studio Manager: Brad Schmidt
Engineers: Staff: Les Brockmann, Alan Hirshberg, Carl Fruthe, David Koenig, Paul Larson, Independents: Howard Lee Wolfen, Bryan Stott, Steve Mitchell, Cassio De Luna, Sheridan Eldridge
Dimensions of Studio(s): Studio A, 45 x 25 w/25 isolation booths approx. 10 x 12 each, Studio B, 30 x 15
Dimensions of Control Room(s): 20 x 20 each (both control rooms were built to identical specs)
Tape Recorders: Ampex MM1200 24 track (2), Ampex ATP 122 2 track, 1/2" and 1/4"
Mixing Consoles: Harrison 3624 w/Allison 65K automation, Studio A 30 in x 24 out, Studio B 28 in x 24 out
Monitor Amplifiers: Phase Linear, HGW, H&H M9C
Monitor Speakers: UREI 814 Time Alkan, JBL 4313, Auratones, Yamaha NS10
Other Outboard Equipment: EMT 251 digital reverb, Lexicon 224 digital reverbs, (2) Lexicon Prime Time, EMT 240 Gold Foil, AKG FX 10, (2) Eventide 949 Harmonizers, 910 Harmonizer Pulser, EQH 2, MEQ-5 and Lana PEQ 2 equalizers, Allison Brain Brains and Kopyex, (1) 70 compressor/limiters, dbx 155 limiters, ADR Vocal Stressor, (2) EXB Exciters, Orban De Esser, Clark Teknik graphic EQ, AMS reverb
Microphones: Telefunken 251 tube, Neumann U 47 tube, U 67 tube, U 87, KM 8c, KM 84, AKG 452EB, D-12, Sennheiser 406, MD 41c, 421, 441; E 7 RE 20, RE 15, HE 10, HE 11, 6-5A, BCA 77, Sony EC 9P, etc.
Instruments Available: Kawai acoustic grand piano, Hammond organ, Rhodes, Wurliizer, Sequential Circuits Prophet, Pro 1, LinnDrum machine, Jupiter 6
Rates: \$135/hr. Negotiable. Please call for quotes.

◆◆◆◆ STUDIO WEST
5042 Ruffner St., San Diego, CA 92111
(619) 277-4714
Owner: Leroy Carroll, David Johnson
Studio Manager: Dan Miner

◆◆◆◆ SUNSET SOUND
also REMOTE RECORDING
6650 Sunset Blvd., Hollywood, CA 90028
(213) 469-1186
Owner: Paul Camarata
Studio Manager: Craig Hubler, general manager
Engineers: Eric Benton chief technical engineer, Peggy McCreary, Terry Christian, Bill Jackson, Stuart Furusho, Dick Cauchron, Steven Shelton, Murray Kunis
Dimensions of Studio(s): Studio 1, 22 x 36 w/separate strippin room, Studio 2, 30 x 40, Studio 3, 20 x 50 w/2 isolation rooms
Dimensions of Control Room(s): Studio 1, 19 x 20, Studio 2, 16 x 23, Studio 3, 18 x 21
Tape Recorders: Analog: Ampex MM 1200 16/24 track, Ampex ATH 100 2/4 track; Nakamichi 1000 II cassette; Studer A 710 cassette. Digital: Most formats available upon request.
Mixing Consoles: Consoles in Studios 1 & 2 feature NECAM automation, Studio 1, Custom/Sunset Industries 68 in x 68 out; Studio 2, Custom/Sunset Industries 32 in x 24 out; Studio 3, Custom/Sunset Industries 32 in x 24 out
Monitor Amplifiers: H&H, BGW, Crown; Marantz; Yamaha

S. Ca. 24 Track

Monitor Speakers: JBL, custom George Acropoulos design in all control rooms

Echo, Reverb & Delay Systems: (3) Live acoustic chambers: Eventide 1745M DDL, EMT 250, EMT 251, EMT Plates, Echoplex reverb, AKG BX 20, Lexicon Prime Time I & II, Lexicon 1025 DDL

Other Outboard Equipment: Harmonizers, phasers, parametric EQs, Inovoxes 201 limiters, UREI LA2A, UREI LA 3, UREI LA 4 limiters, VSO, ADH Vocal Stessor, Allison Kopyex I & II and Gain Brains, Hoyer Mayer noise gates, B&B Sub Mixer Groupers, 12-channel console, 8 channel console, Clock 210 SMPTE synchronizer, Clock 410 SMITE synchronizer

Microphones: Neumann U64, U47, U87, KM84, U47 FEI, M49, U67, Electro-Voice HE20, 635A, Altec 21D, 633A, BCA 77D, 44RX, Beyers MB301, Sennheiser MKH405, 421, 441, Sony ECM22P, C37, AKG 414, 451, Shure SM60, 1SM54c, SM5c, SM57, SM59, Crown PZM 130, PZM 150, Telefunken 251

Instruments Available: Steinway B concert grand in each studio, upright tack piano, LinnDrum machine

Video Equipment & Services: Sony monitors, 4" Umatics, SMPTE, inter-lock, Audio-for-video post production (for commercials and television audio sweetening)

Rates: Studio 1 \$140/hr, Studio 2 & 3 \$125/hr. Dolby noise reduction and assist-in engineer included in rate. Sunset S and first engineer extra

Extras: Main lobby game room w/snack & coffee bar and lounge, lounges for each studio equipped with refrigerator, Sony TV, and private phone. Ample parking facilities. Basketball court and ping pong. Picnic tables and summer cook-out. Full security services for complete protection

Direction: As one of the oldest and most respected recording studios in Los Angeles, Sunset Sound provides a world-class, high-tech atmosphere for its clientele. Our professional staff and superior quality are unequalled, and we are dedicated to providing the finest in recording services to our customers. We look forward to another 22 years as the leader in our industry.

◆◆◆◆ SUNSET SOUND FACTORY
6357 Selma Ave., Hollywood, CA 90028
(213) 467-2500

Owner: Paul Camarata
Studio Manager: Philip MacDonnell
Engineers: Jeff Minnich, chief engineer, David Leonard, Tedud Blake
Dimensions of Studio(s): A, 26 x 16, isolation room, 20 x 12 1/2, isolation booth, 12 x 7, B, 20 x 22, isolation booth, 9' x 6 1/2
Dimensions of Control Room(s): A, 19 x 13, B, 18 x 16
Tape Recorders: Ampex MM1200 24 track, 3M M79 24 track, Ampex ATH 102 2 track, Ampex ATH 137 2 track, 3M M71 2 track, 3M M64 2 track, Technics 1500 2 track 1/4 track, Ampex ATH 4 track and AIWA cassette machines
Mixing Consoles: A, API, 28 in x 24 out, B, API, 36 in x 32 out
Monitor Amplifiers: Phase Linear, McIntosh Crown
Monitor Speakers: Altec 604k w/Masterson Lab crossovers (both rooms), Yamaha NS10s, JBL 4410s, JBL 119, B9 in 1500s, Auratones, Auratone T-6
Echo, Reverb & Delay Systems: EMI 140 stereo EMT Plates, EMT 251, EMT 970 delay, Cooper Time Culture, Lexicon 224X with LAHC, Lexicon Prime Time, Eventide 1745 delay
Other Outboard Equipment: Dolby, Kopyex 664, Brains 1176s, LA 3As, LA 2A, De Esser, Harmonizers: Harmonizer, Harhold 602, EMT 156, Lana PEQ-2, UREI 550A, Lana EQ 299A, TI MEP 240 PEQ, digital metronome, Kopyex IIs, Orban, V, PEQ API 550A & 560 EQs
Microphones: Neumann U67s, U47s, U47 FEIs, U87s, KM4s, KM86s, KM88s, M49s, Telefunken ELAM 251; BCA 77, 44s, Altec HDC 123, Sony C6S, ECM50, ECM22P, C37As, 201, C500s, AKG C12As, 414EBs, 202s, 224s, 452s, EV HE20s, 666s, 1751s, Shure SM53s, SM56s, SM57s, 585, 544, Sennheiser 421s, 441s, 815s
Instruments Available: Steinway model B grand piano, both rooms), Hammond B3 organ w/Leslie speaker
Rates: Call for rates

◆◆◆◆ SUNSOUND STUDIO
9590 Chesapeake Dr., San Diego, CA 92123
(619) 565-8011

Owner: Peters Productions
Studio Manager: Jim Norr

◆◆◆◆ SUNSWEEP STUDIOS
4181 Sunswep Drive, Studio City, CA 91604
(213) 980-6220

Owner: John Heier
Dimensions of Studio(s): Studio A, 20 x 15, Studio B, 30 x 20
Dimensions of Control Room(s): Studio A, 15 x 15, Studio B, 15 x 30

Tape Recorders: MCI HH 14, 4 track, 30 ips, Otari mix down

Mixing Consoles: Moog/MCI 400 series

Monitor Amplifiers: All in two and three room

Monitor Speakers: UREI Time Aligned monitor

Echo, Reverb, and Delay Systems: FMT, Lexicon, UREI Major MP MIX

Other Outboard Equipment: We have all the usual equipment and we have an extensive in-house library

Microphones: We have a full collection of microphones and we have many tube Neumann

Instruments Available: 3 uprights, two grand pianos, Fender Rhodes, Hammond, other instruments upon request

Video Equipment & Services: Video cassette capabilities

Rates: \$90 an hour

◆◆◆◆ SUNWEST STUDIO
5533 Sunset Blvd., Hollywood, CA 90028
(213) 463-5631

Owner: Herb Williams
Studio Manager: Hema Wurtz

Tape Recorders: Ampex 1200 4 track, Ampex 1100 16 track, Ampex ATR 104 4 track, Ampex ATH 102 2 track, (2) Ampex 4400 2 track, Ampex 4405 2 track, Tomcat cart machine 2 track, UREI and Bopac 4000 cart machines 1 track

Mixing Consoles: Quadrad 6000, 40 in x 24 out, API, 20 in x 24 out, API module 1000 10 in x 4 out

Monitor Amplifiers: B+W Yamaha

Monitor Speakers: UREI 814A, 813, Altec 604 HG, Auratone 5, JBL 4313, 451

Echo, Reverb & Delay Systems: Lexicon 224, EMT 250, 140, 240, Leslie, Harmonizer, Eventide Harmonizer

Other Outboard Equipment: Dolby A, 3, 4, 5, Lexicon 405 and 406, UREI 1100N LA 3, 400, 1065, Korgu, NEA, UREI 814, API, 20, 24, 32, 40, 48, 60, 72, 84, 96, 108, 120, 144, 168, 192, 216, 252, 288, 324, 360, 400, 450, 500, 540, 600, 648, 720, 792, 864, 936, 1008, 1080, 1152, 1224, 1300, 1376, 1452, 1528, 1604, 1680, 1756, 1832, 1908, 1984, 2060, 2136, 2212, 2288, 2364, 2440, 2516, 2592, 2668, 2744, 2820, 2896, 2972, 3048, 3124, 3200, 3276, 3352, 3428, 3504, 3580, 3656, 3732, 3808, 3884, 3960, 4036, 4112, 4188, 4264, 4340, 4416, 4492, 4568, 4644, 4720, 4796, 4872, 4948, 5024, 5100, 5176, 5252, 5328, 5404, 5480, 5556, 5632, 5708, 5784, 5860, 5936, 6012, 6088, 6164, 6240, 6316, 6392, 6468, 6544, 6620, 6696, 6772, 6848, 6924, 7000, 7076, 7152, 7228, 7304, 7380, 7456, 7532, 7608, 7684, 7760, 7836, 7912, 7988, 8064, 8140, 8216, 8292, 8368, 8444, 8520, 8596, 8672, 8748, 8824, 8900, 8976, 9052, 9128, 9204, 9280, 9356, 9432, 9508, 9584, 9660, 9736, 9812, 9888, 9964, 10040, 10116, 10192, 10268, 10344, 10420, 10496, 10572, 10648, 10724, 10800, 10876, 10952, 11028, 11104, 11180, 11256, 11332, 11408, 11484, 11560, 11636, 11712, 11788, 11864, 11940, 12016, 12092, 12168, 12244, 12320, 12396, 12472, 12548, 12624, 12700, 12776, 12852, 12928, 13004, 13080, 13156, 13232, 13308, 13384, 13460, 13536, 13612, 13688, 13764, 13840, 13916, 13992, 14068, 14144, 14220, 14296, 14372, 14448, 14524, 14600, 14676, 14752, 14828, 14904, 14980, 15056, 15132, 15208, 15284, 15360, 15436, 15512, 15588, 15664, 15740, 15816, 15892, 15968, 16044, 16120, 16196, 16272, 16348, 16424, 16500, 16576, 16652, 16728, 16804, 16880, 16956, 17032, 17108, 17184, 17260, 17336, 17412, 17488, 17564, 17640, 17716, 17792, 17868, 17944, 18020, 18096, 18172, 18248, 18324, 18400, 18476, 18552, 18628, 18704, 18780, 18856, 18932, 19008, 19084, 19160, 19236, 19312, 19388, 19464, 19540, 19616, 19692, 19768, 19844, 19920, 19996, 20072, 20148, 20224, 20300, 20376, 20452, 20528, 20604, 20680, 20756, 20832, 20908, 20984, 21060, 21136, 21212, 21288, 21364, 21440, 21516, 21592, 21668, 21744, 21820, 21896, 21972, 22048, 22124, 22200, 22276, 22352, 22428, 22504, 22580, 22656, 22732, 22808, 22884, 22960, 23036, 23112, 23188, 23264, 23340, 23416, 23492, 23568, 23644, 23720, 23796, 23872, 23948, 24024, 24100, 24176, 24252, 24328, 24404, 24480, 24556, 24632, 24708, 24784, 24860, 24936, 25012, 25088, 25164, 25240, 25316, 25392, 25468, 25544, 25620, 25696, 25772, 25848, 25924, 26000, 26076, 26152, 26228, 26304, 26380, 26456, 26532, 26608, 26684, 26760, 26836, 26912, 26988, 27064, 27140, 27216, 27292, 27368, 27444, 27520, 27596, 27672, 27748, 27824, 27900, 27976, 28052, 28128, 28204, 28280, 28356, 28432, 28508, 28584, 28660, 28736, 28812, 28888, 28964, 29040, 29116, 29192, 29268, 29344, 29420, 29496, 29572, 29648, 29724, 29800, 29876, 29952, 30028, 30104, 30180, 30256, 30332, 30408, 30484, 30560, 30636, 30712, 30788, 30864, 30940, 31016, 31092, 31168, 31244, 31320, 31396, 31472, 31548, 31624, 31700, 31776, 31852, 31928, 32004, 32080, 32156, 32232, 32308, 32384, 32460, 32536, 32612, 32688, 32764, 32840, 32916, 32992, 33068, 33144, 33220, 33296, 33372, 33448, 33524, 33600, 33676, 33752, 33828, 33904, 33980, 34056, 34132, 34208, 34284, 34360, 34436, 34512, 34588, 34664, 34740, 34816, 34892, 34968, 35044, 35120, 35196, 35272, 35348, 35424, 35500, 35576, 35652, 35728, 35804, 35880, 35956, 36032, 36108, 36184, 36260, 36336, 36412, 36488, 36564, 36640, 36716, 36792, 36868, 36944, 37020, 37096, 37172, 37248, 37324, 37400, 37476, 37552, 37628, 37704, 37780, 37856, 37932, 38008, 38084, 38160, 38236, 38312, 38388, 38464, 38540, 38616, 38692, 38768, 38844, 38920, 39000, 39076, 39152, 39228, 39304, 39380, 39456, 39532, 39608, 39684, 39760, 39836, 39912, 39988, 40064, 40140, 40216, 40292, 40368, 40444, 40520, 40596, 40672, 40748, 40824, 40900, 40976, 41052, 41128, 41204, 41280, 41356, 41432, 41508, 41584, 41660, 41736, 41812, 41888, 41964, 42040, 42116, 42192, 42268, 42344, 42420, 42496, 42572, 42648, 42724, 42800, 42876, 42952, 43028, 43104, 43180, 43256, 43332, 43408, 43484, 43560, 43636, 43712, 43788, 43864, 43940, 44016, 44092, 44168, 44244, 44320, 44396, 44472, 44548, 44624, 44700, 44776, 44852, 44928, 45004, 45080, 45156, 45232, 45308, 45384, 45460, 45536, 45612, 45688, 45764, 45840, 45916, 45992, 46068, 46144, 46220, 46296, 46372, 46448, 46524, 46600, 46676, 46752, 46828, 46904, 46980, 47056, 47132, 47208, 47284, 47360, 47436, 47512, 47588, 47664, 47740, 47816, 47892, 47968, 48044, 48120, 48196, 48272, 48348, 48424, 48500, 48576, 48652, 48728, 48804, 48880, 48956, 49032, 49108, 49184, 49260, 49336, 49412, 49488, 49564, 49640, 49716, 49792, 49868, 49944, 50020, 50096, 50172, 50248, 50324, 50400, 50476, 50552, 50628, 50704, 50780, 50856, 50932, 51008, 51084, 51160, 51236, 51312, 51388, 51464, 51540, 51616, 51692, 51768, 51844, 51920, 51996, 52072, 52148, 52224, 52300, 52376, 52452, 52528, 52604, 52680, 52756, 52832, 52908, 52984, 53060, 53136, 53212, 53288, 53364, 53440, 53516, 53592, 53668, 53744, 53820, 53896, 53972, 54048, 54124, 54200, 54276, 54352, 54428, 54504, 54580, 54656, 54732, 54808, 54884, 54960, 55036, 55112, 55188, 55264, 55340, 55416, 55492, 55568, 55644, 55720, 55796, 55872, 55948, 56024, 56100, 56176, 56252, 56328, 56404, 56480, 56556, 56632, 56708, 56784, 56860, 56936, 57012, 57088, 57164, 57240, 57316, 57392, 57468, 57544, 57620, 57696, 57772, 57848, 57924, 58000, 58076, 58152, 58228, 58304, 58380, 58456, 58532, 58608, 58684, 58760, 58836, 58912, 58988, 59064, 59140, 59216, 59292, 59368, 59444, 59520, 59596, 59672, 59748, 59824, 59900, 59976, 60052, 60128, 60204, 60280, 60356, 60432, 60508, 60584, 60660, 60736, 60812, 60888, 60964, 61040, 61116, 61192, 61268, 61344, 61420, 61496, 61572, 61648, 61724, 61800, 61876, 61952, 62028, 62104, 62180, 62256, 62332, 62408, 62484, 62560, 62636, 62712, 62788, 62864, 62940, 63016, 63092, 63168, 63244, 63320, 63396, 63472, 63548, 63624, 63700, 63776, 63852, 63928, 64004, 64080, 64156, 64232, 64308, 64384, 64460, 64536, 64612, 64688, 64764, 64840, 64916, 64992, 65068, 65144, 65220, 65296, 65372, 65448, 65524, 65600, 65676, 65752, 65828, 65904, 65980, 66056, 66132, 66208, 66284, 66360, 66436, 66512, 66588, 66664, 66740, 66816, 66892, 66968, 67044, 67120, 67196, 67272, 67348, 67424, 67500, 67576, 67652, 67728, 67804, 67880, 67956, 68032, 68108, 68184, 68260, 68336, 68412, 68488, 68564, 68640, 68716, 68792, 68868, 68944, 69020, 69096, 69172, 69248, 69324, 69400, 69476, 69552, 69628, 69704, 69780, 69856, 69932, 70008, 70084, 70160, 70236, 70312, 70388, 70464, 70540, 70616, 70692, 70768, 70844, 70920, 71000, 71076, 71152, 71228, 71304, 71380, 71456, 71532, 71608, 71684, 71760, 71836, 71912, 71988, 72064, 72140, 72216, 72292, 72368, 72444, 72520, 72596, 72672, 72748, 72824, 72900, 72976, 73052, 73128, 73204, 73280, 73356, 73432, 73508, 73584, 73660, 73736, 73812, 73888, 73964, 74040, 74116, 74192, 74268, 74344, 74420, 74496, 74572, 74648, 74724, 74800, 74876, 74952, 75028, 75104, 75180, 75256, 75332, 75408, 75484, 75560, 75636, 75712, 75788, 75864, 75940, 76016, 76092, 76168, 76244, 76320, 76396, 76472, 76548, 76624, 76700, 76776, 76852, 76928, 77004, 77080, 77156, 77232, 77308, 77384, 77460, 77536, 77612, 77688, 77764, 77840, 77916, 77992, 78068, 78144, 78220, 78296, 78372, 78448, 78524, 78600, 78676, 78752, 78828, 78904, 78980, 79056, 79132, 79208, 79284, 79360, 79436, 79512, 79588, 79664, 79740, 79816, 79892, 79968, 80044, 80120, 80196, 80272, 80348, 80424, 80500, 80576, 80652, 80728, 80804, 80880, 80956, 81032, 81108, 81184, 81260, 81336, 81412, 81488, 81564, 81640, 81716, 81792, 81868, 81944, 82020, 82096, 82172, 82248, 82324, 82400, 82476, 82552, 82628, 82704, 82780, 82856, 82932, 83008, 83084, 83160, 83236, 83312, 83388, 83464, 83540, 83616, 83692, 83768, 83844, 83920, 84000, 84076, 84152, 84228, 84304, 84380, 84456, 84532, 84608, 84684, 8476

Terms of Endearment, "Footloose," "Swing Shift," "Tommy Stinson," "Fire," "The New T. B.," "Success," "The Trading Places," "Jax," "D'Neen," "With the Moon," "The Razor," "No Small Affair," "The Stranger," "Wee Wee," "Don't Answer Others." While our primary focus continues to be top tier post production, we are also available for ADR, Foley work and sound editing, we continue to set the industry standard by offering a wide range of services to meet the highest in performance and value, computer software and advances of best practices and techniques to meet all audio media.

•••• T.A.P.E. RECORDERS, INC
1606 N. Highland Ave., Hollywood, CA 90028
(213) 464 3633
Owner: Joan Baker
Studio Manager: Larry G. Smith



THAT STUDIO RECORDING SERVICES
N. Hollywood, CA

•••• THAT STUDIO RECORDING SERVICES
also REMOTE RECORDING
P.O. Box 958, N. Hollywood, CA 91603
(818) 764 1421
Owner: That Studio, Inc.
Studio Manager: Roger H. Hill
Engineers: Richard Holbrook, Deany M. Lane, Steve Seboldt, independent
Dimensions of Studio(s): 30' x 10' w/extension trap panel live and dead spots
Dimensions of Control Room(s): 4' x 10' (11' x 8' 1/2 track)
Tape Recorders: (1) EMI 1014 4 track, (1) EMI MX5090 8 track, (2) Otari MX5090 4 track, Beyer A77 2 track, TEAC A-640S 4 track, Teac M85 4 track, 4 track
Mixing Consoles: (studio) Harrison MR 4 (4 inputs) 28 in x 24 in, (1) 30 Audio mixer, (1) 19 in x 18 in, 4 x 8 in
Monitor Amplifiers: Crown B-5W, Yamaha (250), Altec
Monitor Speakers: JBL 4415, JBL 4411, Altec 604, Yamaha NS10s, 2-ways
Echo, Reverb & Delay Systems: Lexicon digital reverb 200, Lexicon Time Line DDLs, ML/MR, M, reverb, 11-sec, Scant Workshop
Other Outboard Equipment: Eventide 90 Harmonizer, dbx 160, 161, 162, 1600s, Audio Design and Recor limit comp rack with non-linear A/D, Fender eq, dbx noise reduct, B&Amp EQs, Lexicon PCM 41
Microphones: Neumann, AKG, Crown P2M, Beyer, Sennheiser, PMI, Sony Electro Voice, Shure
Instruments Available: Yamaha C7 grand piano, Hammond B3 w/ Leslie, Sony string kit, Gibson electric, acoustic guitars, Rhodes, assorted acoustic guitars and amps, Fender 6 synth, a wide range of percussion instruments and more, available when reserved in advance.
Video Equipment & Services: Available upon request
Rates: Please call for studio brochure and rate card
Extras: Client lunch, coffee and soft drinks, use of a room in two rooms for TV, that Studio offers a wide range of audio services including: music recording, live music production, sound reinforcement, and consultation, and more, and a demo production assistance. Please call and see how we can fill your needs in person.

•••• JOHN THOMAS STUDIOS
12123 Oxnard St., No Hollywood, CA 91606
(818) 760-4444
Owner: John Thomas

•••• TOTAL ACCESS RECORDING
612 Meyer Lane #18, Redondo Beach, CA 90278
(213) 376 0404
Owner: Allan (Wyn) Davis, Allan H. Jenkins

Studio Manager: Allan Davis, Phyllis Koch, office manager
Engineers: Wyn Davis, chief engineer, David Tarlino, Ron Payne, Mike Landie, Michael Wagner (independent), Peter Butt, chief of maintenance
Dimensions of Studio(s): Main Studio: 25 x 30, Live chamber 40 x 20 x 14, piano in smaller specialty rooms
Dimensions of Control Room(s): 23 x 18
Tape Recorders: Ampex ATH-124 24 track, Ampex ATH 102 12 track, MCI JH 110A 14" 2 track, Nakamichi ZX 7, Akai GF X95 cassette decks
Mixing Consoles: MCI (fully modified) 528H 28x28, Yamaha 1602 Aux mixer 1602 16x4
Monitor Amplifiers: (2) BGW 500 250, 100 Haller 500 Crown Power Line 400 headphone amp
Monitor Speakers: JBL 813, Spendor, Horrotones, Yamaha NS 10, Electro Voice Sentry III, JBL 4415, 4411 Tannoys
Echo, Reverb & Delay Systems: 15,000 cubic ft. live chamber, Lexicon 200, EMI 140G latol, AKG BX 20 (2) Lexicon 95s, Lexicon 95, Roland SF 4000, Eventide 910 Harmonizer, Quantec room simulator, any device you've ever seen or heard of on project
Other Outboard Equipment: (1) UREI 1176s, (2) UREI 11A 3As, (2) dbx 160As, (2) dbx 160s, Eventide Omncompressor, Orban SF 60, 3000 for 4 channels, Philtec tube EQ, Orban stereo

parametric EQ, UREI 10 band graphic EQ, lots more etc
Microphones: Full complement of dynamic mikes AKG, Shure, Electro Voice, Beyer, Sony. Also full complement of high quality condenser Neumann, AKG, Schempp, and more. Also some old tube types
Instruments Available: Steinway 7' grand piano, Roland Juno-60 synth, (3) customized Strats, Gibson Les Paul, Fender Tele. Very large collection of old and rare acoustic guitars
Video Equipment & Services: VHS Beta VCR machines
Rates: Demo rates, project rates, daily rates, please call
Extras: Kitchen micro-wave, refrigerator, video machines (on request) Fully furnished living accommodations located 1.5 mi from the Pacific Ocean stocked with the most beautiful bodies in the world. The most competitive rates on rented instruments, outboard gear etc. full office services, limo service
Direction: We provide one of the most excellent facilities in L.A. We support our clients in every possible way during their association with the studio and continue to support them after their project is finished. We will go out of our way to make recording here the most pleasant experience possible, whether you want to be pampered with extras or simply left alone. Our rates are structured to fit client needs. Satisfied clients include: Producer: Ken Scott, Dokken, Great White "X", White Sister, Producer: Michael Wagner, Joe Pizzulo and more.

"Recording game show theme songs or music for a "Norman Lear" T.V. series demands my very best... and a very good Recording Console."

HAL HIDEY/HAL HIDEY STUDIOS

THE "SPECKMIX Mk II" RECORDING CONSOLE

A complete 16 input-8 output recording console with 16 track monitoring, full function input modules with 3 band parametric EQ, and +4 output levels. Available with "Jensen" mike preamps. Also available, a complete line of "SPECKMIX" expander consoles.

SPECK ELECTRONICS • (818) 897-4188
12455 Branford St., Unit 2, Arleta, Ca. 91331

Circle #079 on Reader Service Card

•••• TRAC RECORD CO.
170 N. Maple, Fresno, CA 93702
(209) 255-1717

Owner: Stan Anderson
Studio Manager: Stan Anderson
Engineers: Stan Anderson
Dimensions of Studio(s): 45 x 20
Dimensions of Control Room(s): 15 x 15
Tape Recorders: MCI JH414 24 track, Ampex 440C 2 track, Ampex PR10 2 track
Mixing Consoles: MCI JH416, 24 in x 24 out
Monitor Amplifiers: Crown & Ampex
Monitor Speakers: Altec A7 and 604
Echo, Reverb & Delay Systems: EMI 140 reverb, DeltaLab delay
Other Outboard Equipment: Altec compressor and dbx compressor
Microphones: AKG, Neumann, RCA, Sennheiser, Electro Voice
Instruments Available: Yamaha grand piano, Elka strings, Fender tube amps
Rates: \$40-\$60 per hour

•••• TRACK RECORD
5249 Melrose Ave., Hollywood, CA 90038
(213) 467-9432

Owner: Thomas M. Murphy
Studio Manager: John Carter
Engineers: Tom Murphy, John Carter, Bill Meloy, Peter Blackman, Dave Jenkins, Hickman
Dimensions of Studio(s): 14 x 15 x 14 and 14 x 18 x 14
Dimensions of Control Room(s): 15 x 20 x 12
Tape Recorders: MCI JH24 24 track, Ampex ATH 100 2 track, Otari MTR 12 2 track
Mixing Consoles: Trident Series 80, 40 in x 24 out
Monitor Amplifiers: H&H, SAE with White 3 octave EQ
Monitor Speakers: UREI 814 Time Alim, JBL 401s, Yamaha NS 10M, Auratones
Echo, Reverb & Delay Systems: EchoPlate I and II live chamber, Harmonizer 910, Lexicon Prime Time, DeltaLab DLI and DLI 2 Acousticcomputer, Cooper Time Cube, MXR digital delay, 224X Lexicon w/ARC
Other Outboard Equipment: (2) UREI 1176LN Teletronix LA2A, (4) Trident limiter compressor, (2) Altec 436C, (2) Pultec EQH2, (2) Trident parametric EQ CB9006, UREI 545 graphic EQ, Cinema End program EQ, Phase Linear Autocorrelator, Walnut Product generator, (4) Kopyex tube direct boxes, and over-



S. Ca.
24 Track

drive units, custom stereo Aural Exciter
Microphones: U47 tube Telefunken, U47 FFT Neumann, (4) U87, (2) KM84, (4) KM64 tube, AKG (2) 452, (3) 451, 414P48, 414EB, RCA 77DX, Sennheiser (4) 441, (2) 421, E.V. (2) RE20, Shure SM7, (6) SM56, PML DC63
Instruments Available: 7 Kawai organs
Video Equipment & Services: 24 track interlock with video
Rates: 24 track \$50/hr, 2 track \$40/hr. Video rates on request

•••• TRIAD RECORDERS
2727 N. Grove Industrial Dr., Fresno, CA 93727
(209) 255-1688

Owner: P.F. Communications, Inc.
Engineers: Eric Seaberg, Jeff Hall, Greg Lankford, various independents
Dimensions of Studio(s): Studio A 28 x 42 x 14, Studio B 20 x 28 x 12, Studio C 12 x 8
Dimensions of Control Room(s): Control Room A 24 x 20 w/ machine room, Control Room B 24 x 20, Control Room C 17 x 11
Tape Recorders: Studer A800 Mk III 24/16 track, Studer A-80 16 track, (2) Studer A 710 cassettes, Studer A80 RC "2" 2 track, (2) Studer A80 RC "4" 2 track, (2) Studer A810 2 track, (2) Shure A710 2 track, (5) Revox PR 99 2/1 track, Nagra IV SL 2 track
Mixing Consoles: Harrison MR 3, 48 in x 24 out, Harrison MR 3, 32 in x 24 out, Sound Workshop Logex 8 12 in x 8 out
Monitor Amplifiers: (12) Crown 300 A II, (9) Crown DS-75, Crown PS 200
Monitor Speakers: Amspencer custom, E.V. Sentry 500, E.V. Sentry 100, Auratone 5C
Echo, Reverb & Delay Systems: Live echo, EchoPlate III (2)

Lexicon 224X, Eventide Time Squeeze Jr., Lexicon Super Prime Time, Lexicon Prime Time II (2)

Other Outboard Equipment: Harrison 864 Auto-set Automation, UREI 1176LN, UREI LA4s, UREI 1178LN, UREI LA 4s, EXR 4 Exciters, UREI 565, Orban parasound stereo synthesizer, Orban parasound sublimance controller, Burwen DNF 1100, UREI 545, SAE 5000, Eventide Omnipressor, Audio Kinetics 310 Q Lock

Microphones: AKG 414s, 460s, C34, E.V. RE20s, Sennheiser 421, 441s, Wahrenbrock PZM 130s, Crown PZMs, Altec 29Hs, Audio Technica ATM31H, plus more

Instruments Available: Yamaha C7B piano (guitar amps, Rhodes Available on request, Sequential Circuit Prophets, Oberheims, Yamaha, Emulator, plus more synthesizers), also Synclavier

Video Equipment & Services: Sync to Sony BVH 1100 2 1/2", Sony 2860/2860A "4", 45 x 50 video studio, Hitachi SK70 SK60 and CEI 410 cameras, Grass Valley 1600 Hi-L switcher, etc.
Rates: A \$90/hr; B \$65/hr; C \$40/hr. Prices include engineer. Block rates available.



TRIAID RECORDERS
Fresno, CA

•••• TRIANON RECORDING
1435 South St., Long Beach, CA 90805
(213) 422-2095

Owner: John Vestman
Engineers: Various independents
Dimensions of Studio(s): 24 x 48 (newly expanded)
Dimensions of Control Room(s): 14 x 15 plus expansion room
Tape Recorders: Modified MCI transformerless JH 24 24 track, Otari 5050 2 track, TEAC 3340 4 track
Mixing Consoles: MCI/DA transformerless custom 48x24
Monitor Amplifiers: Threshold/DA, Quatro, BGW
Monitor Speakers: Custom DSA G Way Bi Amped high definition monitor system, Yamaha, JBL, Auratones, available Turn table system
Echo, Reverb & Delay Systems: Lexicon 224 digital reverb, (2) Eventide 949 Harmonizer, tape delay system
Other Outboard Equipment: Scamp expander/ates, de-essers, (2) dbx 130 limiters, dbx 162 stereo limiter, DSA parametric EQs, Spectrum analyzer, flangers, phasers, etc.
Microphones: Neumann, AKG, Sennheiser, E.V. Shure
Instruments Available: Steinway 7 grand (vinyls 1900), Oberheim 8 Voice, Roland Juno 60, Alpha Syntrian Apple II, Poly synth, Fender Rhodes 88
Video Equipment & Services: 16 track track over-dub capability w/sync to video
Rates: Please call for rates

•••• THE TRUCK
ONLY REMOTE RECORDING
P.O. Box 4573, Glendale, CA 91202
(818) 247-8358
Owner: Rampaging Eighth Note Music
Studio Manager: Bruce Black

•••• UNITED WESTERN STUDIOS
6000 Sunset Blvd., Hollywood, CA 90028
(213) 469-3983

Owner: Harman Int
Studio Manager: Jerry Barnes, traffic mgr. Joan Barnes
Engineers: Cary Fisher, chief engineer
Dimensions of Studios: Studio 1 58 x 42, string room 21 x 21, Studio 2 44 x 24, Balcony 15 x 9, Studio 3 31 x 14, Studio 7 23 x 13
Tape Recorders: Analog Ampex ATH 102 1/2" 2 track, (3) MCI JH 114 24 track, MCI JH 114 16/8 track, (6) Ampex ATH 102 2 track, Digital Mitsubishi X 800 42 track, Mitsubishi X 80 2 track, Sony PCM 10 2 track, Sony F 1 2 track
Mixing Consoles: Neve 8108 56x48, (2) modified Harrisons



Master Control
RECORDING

L.A.'s Newest 24 Track Studio!

Top of the line equipment in a spacious environment — featuring —

TRIDENT console, all STUDER recorders including 1/2" 2 track and LEXICON and AMS reverbs.

A full complement of microphones and outboard gear. 24' x 58' main room.

Call Aseley Otten or Steve Catania at (818) 842-0800 for the most reasonable rates in town.

Circle #080 on Reader Service Card

4 x 4. Neve 880 88x24

Monitor Amplifiers: Mottosh 2x00s, UREI 6500s (modified)
Monitor Speakers: UREI B15, JBL 4411, JBL 4412, JBL 4401, Axiom 5, Versa, Beyer, JBL
Echo, Reverb & Delay Systems: (4) Live chambers, (5) EM1
Other Outboard Equipment: dbx limiters, vocal stressers, UREI
Microphones: UREI, Neumann, AKG, Beyer, Sony
Instruments Available: Fender Rhodes, (4) Steinway B pianos
Video Equipment & Services: Full 1/2 inch projection w/b track

VALENTINE RECORDING STUDIOS
 5330 Laurel Canyon Blvd., No. Hollywood, CA 91607
 (818) 769-1515

the village recorder
 DIGITAL RECORDING & MIXING

THE VILLAGE RECORDER
 W Los Angeles, CA

THE VILLAGE RECORDER
 1616 Butler Ave., W. Los Angeles, CA 90025
 (213) 478-8227
Owner: Glenn Harmon, M. Paul Goller, executive director
Studio Manager: Kerry Knapp
Engineers: Bob Harris, A. Scott, Dave Cramer, Cliff Jones, Tom N. +
Tape Recorders: Ampex, Studer A800 w/Dobey MKIII 24 track,
Mixing Consoles: SSL, A-Neve 605H, 89x24, Studer B
Monitor Amplifiers: B+W, Marantz, Crown
Monitor Speakers: JBL, Ampeg, Axiom, JBL, custom
Echo, Reverb & Delay Systems: Lexicon 224r with 4 (pr)
Other Outboard Equipment: UREI, Eventide, Lexicon, Orson
Microphones: Neumann, AKG, Beyer, Shure, RCA
Instruments Available: Yamaha, Steinway Grand, Fender
Video Equipment & Services: 4 international studio syn
Rates: Up to \$1000
Extras: 1/2 inch digital transfer, optical transfer, Ultra
Direction: Complete studio, video, film post production facility

WEDDINGTON STUDIO
 11128 Weddington St., No. Hollywood, CA 91601
 (818) 508-5660
Owner: Robert Cotton

Studio Manager: Glen Harris
Engineers: Wally Grant, Mike Ross, Tim Robertstad
Dimensions of Studio(s): Approx 1200 sq ft
Dimensions of Control Room(s): Approx 500 sq ft
Tape Recorders: MCI JH24 24 track, (2) Amplex ATR 102 2
Mixing Consoles: MCI 600 (automatic) 36 in x 24 out
Monitor Amplifiers: Haller 220, Haller 500
Monitor Speakers: UREI B15, Tannoy, UREI B13, Tannoy
Echo, Reverb & Delay Systems: Lexicon 224 digital reverb,
Other Outboard Equipment: (2) UREI 1176 compressor lim
 auto-compressors, (2) dbx 904 compulimter, (2) dbx 902 De

essor (2) dbx 904 noise gate, UREI digital metronome
Microphones: Neumann KM84, KM86, KM88, U47, U47 (tube),
 U67 (tube), AKG 414, 451, Shure SM56, SM81, Sennheiser 421,
 441, Crown P2M, Sony C37A (tube), E V RE20
Instruments Available: Yamaha C7 grand piano
Rates: Available on request

WESTERN AUDIO RECORDING STUDIOS
 8050 Ronson Road, San Diego, CA 92111
 (619) 292-9805
Owner: Harlan Lansky, Bob Bishop
Extras: Our 20,000 sq ft audio and video facility includes an
Direction: Western Audio Recording Studios was formed with the
 philosophy of combining 24 tracks and video in one complete
 facility. Using this unique combination, our clients, who have in
 cluded Casablanca, Atlantic, Warner Bros., Alta & MCA Records,
 have the option of performing a live concert with a 24 mix to
 video or bringing pre-recorded tracks and lip-synching

WESTLAKE AUDIO STUDIOS
 8447 Beverly Blvd., Los Angeles, CA 90048
 (213) 654-2155
Owner: Glen Phoenix
Studio Manager: Paula Sauls
Engineers: Matt Forner, Jim Fitzpatrick, Ric Butz, Greg Law-
 ley, Denn King, Gary Starr
Dimensions of Studio(s): A) Approx 1200 sq ft B) Approx
 700 sq ft C) Approx 1200 sq ft
Dimensions of Control Room(s): A) 500 sq ft B) 450 sq ft
 C) 500 sq ft
Tape Recorders: (8) 3M 79 24 track, (6) Ampex ATR-100 2
 track, (2) Studer A-80 2 track, (2) Ampex ATR 100 4 track, (2)
 3M 81 32 track, (2) 3M 81 4 track
Mixing Consoles: (2) Harrison 40/32, API 32/16
Monitor Amplifiers: Crown, AB's, H&H
Monitor Speakers: Westlake HR 1, Yamaha NS 10, Auratone,
 Westlake SM 1, Westlake BBSM-6, JBL 4311, JBL 4312
Echo, Reverb & Delay Systems: Lexicon 224 XL, EMT 250,
 EMT 240, Echo Plate
Other Outboard Equipment: Universal Audio, Eventide, Lex-
 (LISTING CONTINUED ON NEXT PAGE)

Weddington Studio
 -A DIVISION OF PACIFIC ENTERTAINMENT GROUP-
 11128 WEDDINGTON ST., NORTH HOLLYWOOD, CA 91601
 (213) 508-5660

WEDDINGTON STUDIO
 Hollywood, CA

the Sound Solution
 Steve Barncard
 Staff Producer

Steve has an outstanding ability to capture the artist's musical expression into its highest form and capture it on tape quickly and efficiently. "I like to create an environment that allows the technical aspect to be absolutely transparent."

His skill and experience at putting people at ease in the recording environment has resulted in many gold and platinum records. We're honored to have Steve on The Sound Solution team.

1211 Fourth Street
 Santa Monica, CA 90401
 (213) 393-5332

photo by Steve Edwards

Circle #081 on Reader Service Card

(FROM PAGE 137)

ron, Datatronics, GML, Inovonics, Kepex II, Sontec, Grey Laboratories, DeltaLab Marshall, BTX Shadow, 3M Digital Editor
Microphones: Various tube, condenser, dynamic and ribbon mics
Instruments Available: Nine foot Yamaha and seven foot Yamaha Grand, C 5 Yamaha Grand Piano
Video Equipment & Services: (2) 1/4-inch Panasonic NV9600 video disk, (3) Sony 25 inch monitors, projection screen
Rates: Call for rates.



WESTWIND
Westlake Village, CA

**** WESTWIND

41 North Duesenberg Drive, Westlake Village, CA 91362
(805) 497-6911/497-8052
Owner: Larry Muhoberac Billy Walker
Studio Manager: Ron Capone
Engineers: Ron Capone
Dimensions of Studio(s): 40 x 40
Dimensions of Control Room(s): 24 x 20
Tape Recorders: MCI JH 16 w/VSO 2 track, MCI JH 110 w/VSO 2 track, MCI JH 110 w/VSO 2 track
Mixing Consoles: MCI 24/16 24 track
Monitor Amplifiers: (2) BGW 750 C, BGV 250 D, BGV 150
Monitor Speakers: UREI Time Alkon #838
Echo, Reverb, and Delay Systems: EMT, AKG, Eventide, Marshall
Other Outboard Equipment: An array of outboard equipment
Microphones: AKG, Neumann, Shure, Sennheiser, Electro Voice
Instruments Available: Yamaha grand piano, Yamaha CS-80, Fender Rhodes, Mini Moog synthesizer Ludwig drums
Rates: Call for rate quote
Extras: 35 min. from Hollywood, offers a safe and relaxing atmosphere. Offering lounge kitchen, privacy video games and 5000 sq. ft. of the latest in acoustic & interior design. Hotel accommodations nearby
Direction: With the studio we have an in-house production company that writes, performs, records and produces radio and TV commercials. Some of our commercial accounts are 7-11, ABC, CBS, Olympia Beer & Bob's Big Boy



WESTWOOD ONE
Culver City, CA

**** WESTWOOD ONE

9540 Washington Blvd., Culver City, CA 90230
(213) 204-5000
Owner: Brian Hamerl
Studio Manager: Brian Hamerl

S. Ca. 24 Track



WESTWORLD RECORDERS
Van Nuys, CA

**** WESTWORLD RECORDERS

7118 Van Nuys Blvd., Van Nuys, CA 91405
(818) 782-8449
Owner: Robert Schreiner
Studio Manager: Jerry Pearson
Engineers: Robert Schreiner, Roy Braverman, Russ Mitchell
Dimensions of Studio(s): Studio A 13 x 22; Studio B 15 x 45 with separate vocal booth
Dimensions of Control Room(s): 13 x 15
Tape Recorders: MCI JH 100 24 24 track, Custom built Ampex 352 (15-30 ips) 2 track, Custom built Magnacorders 728s (15-30 ips) 2 track, Sony quarter tracks 777 (2 units) 1/4 track, Marantz and Sony cassette recorders
Mixing Consoles: H.S. sound console, 36 in x 36 out 24 track cue & monitor
Monitor Amplifiers: Phase Linear, Marantz, McIntosh
Monitor Speakers: JBL, Altec and Quadrallex
Echo, Reverb, and Delay Systems: EMT 140 tube stereo plate, AKG BX 20 spring system and one custom spring delay
Other Outboard Equipment: Melcor limiters, UREI 1176s, SAE & Alpha graphic EQs, Melcor peak-to-peak and custom parametric EQs, flanger/phasers, Eventide Harmonizer, Lexicon Prime Time 24 channels Westworld Graphic EQs, PCM 41 Lexicon delay, 6 channels Kepex Analogue and digital VSO's for all tape machines
Microphones: Shure SM 57s, AKG 451, C 12, C 28s, C 61, Sony C 47, Neumann M 49, many U 47s, RCA 44s, Telefunken CM 61s, Sennheiser 421s, & misc. Altec, E.V., & others
Instruments Available: Yamaha C 3 grand piano, Fender Rhodes 73 piano, ARP Omni string and horn synthesizer
Rates: Flexable - call for rates
Extras: The studio is conveniently located among three freeways in Van Nuys. We are close to five restaurants. We can assist or contract all phases of musical services. Please call for rates.
Direction: Westworld Recorders is the cost effective answer to the dilemma many producers who must choose between high ticket studios and poorly run garage-type operations. This studio combines the best of vintage tube equipment and some of the latest in computer logic, all meticulously maintained to perform reliably well. We have a growing list of loyal producers and we invite you to become one of them.

**** WHITE FIELD STUDIO

2902 W. Garry, Santa Ana, CA 92704
(714) 546-9210
Owner: White Field Studios, Inc.
Studio Manager: Thom Hoy
Engineers: Chris Taylor, Dan Willard, Derald Daugherty, Thom Hoy
Dimensions of Studio(s): A: 25 x 25, B: 20 x 25 w/2 iso booths Video 40 x 40 (lighting grid at 18')
Dimensions of Control Room(s): 20 x 25
Tape Recorders: Stephens B21 A24 24 track, Ampex ATR 102 1/2" 2 track, Ampex ATR 102 1/4" 2 track, Ampex AG-440 C 2 track
Mixing Consoles: Fort Audio/BA Both custom w/Alcon automation 32 in x 24 out
Monitor Amplifiers: AB Systems, Spectra Sonics, Crown, 400A

Crown D150, Uni-Sync 100

Monitor Speakers: Altec 604E/Utah w/Mastering Lab crossover, JBL, Auratone
Echo, Reverb & Delay Systems: EMT 240 EchoPlate II, Lexicon 224, Prime Time, Lolt 450, Eventide 949 Harmonizer, DL2
Other Outboard Equipment: UREI LA2A, LA3A, Universal 175 1176, Orban De-esser, Stephens De-esser, EXH, Roger Mayer noise gates, Kepex II, Blamp graphics, dbx 902, 903, 907
Microphones: Neumann U47 tube, U67, M49, M269, KM54, KM56, KM84, Sony C37A, C57, C500, Telefunken 250, 251E, AKG C12A, C24, C60, 414, 452, 224, Boyer 160, RCA 77DX, E.V. RE20 Sennheiser 421, 441
Instruments Available: Stenway 9' concert, B3 with 2 Leslies, Rhodes, Wurliizer 140, guitar amps, drums
Video Equipment & Services: Apert Herzog H2, Convergence 203, Sony M-3, 3/4" production and post services, Fortel Y 688 enhanced, A/B roll edit, Crosspoint switchers, 28' track
Rates: Upon request

**** WILDER BROS. RECORDING STUDIO

10327 Santa Monica Blvd., Los Angeles, CA 90025
(213) 557-3452
Owner: George, Warner and Walt Wilder
Studio Manager: George Wilder
Engineers: Walt Wilder (head engineer), Allen Breneman, David Gertz, Ken Suesou, Ray Blair
Dimensions of Studio(s): Studio I 40 x 40, Studio II 20 x 27
Dimensions of Control Room(s): Studio I 20 x 20, Studio II 16 x 20
Tape Recorders: (6) Ampex ATR 100 2 track, MCI 15" 2 track, 24 track MCI w/Autolocator, Ampex MM100 24 track
Mixing Consoles: MCI 600 automatic 36 in x 24 out, Audiohouse Son of 40 Grand 26 in x 16 out
Monitor Amplifiers: Carver, Yamaha, Crown, Phase Linear
Monitor Speakers: UREI Time Alkon, JBL
Echo, Reverb, and Delay Systems: EMT 140, Lexicon 224
Other Outboard Equipment: Eventide Harmonizer, Eventide digital delay, Lexicon Prime Time, Kepex UREI LA3A, EXH Expander
Microphones: Neumann U 47, U 89, U 47, M 49, AKG 414s, 451s, Sennheiser 421s, 421s, Shure KM 80s, etc.
Instruments Available: Fender Rhodes piano, (2) 8' Yamaha grand, Gretsch drums
Video Equipment & Services: Video duplication, film chain, and video tape services
Rates: Studio I 24 track \$125/hr. Studio II 24 track \$85/hr. 16 track \$65/hr.
Extras: Reception area, Wilder Bros. Studio are Kirby Light's hit single "Personally" and her album "Wild Heart of the Young," also, Glen Freys "I Found Somebody" and Glen's album "No Fun Allowed" also Jackson Browne's production of Great Copeland's album



WINETREE RECORDING STUDIO
Claremont, CA

**** WINETREE RECORDING STUDIO

224 N. Indian Hill Blvd., Claremont, CA 91711
(714) 625-3288
Owner: Robert S. Dire
Studio Manager: Robert S. Dire

**** WIZARD MUSIC GROUP

(213) 655-1322
Owner: Hank Donig

**** YAMAHA RECORDING STUDIOS

1019 S. Central, Glendale, CA 91204
(818) 500-0230
Owner: Yamaha International Corporation
Studio Manager: Norm Dinegale
Engineers: Keith Seppanen, Stan Katayama
(LISTING CONTINUED ON PAGE 140)

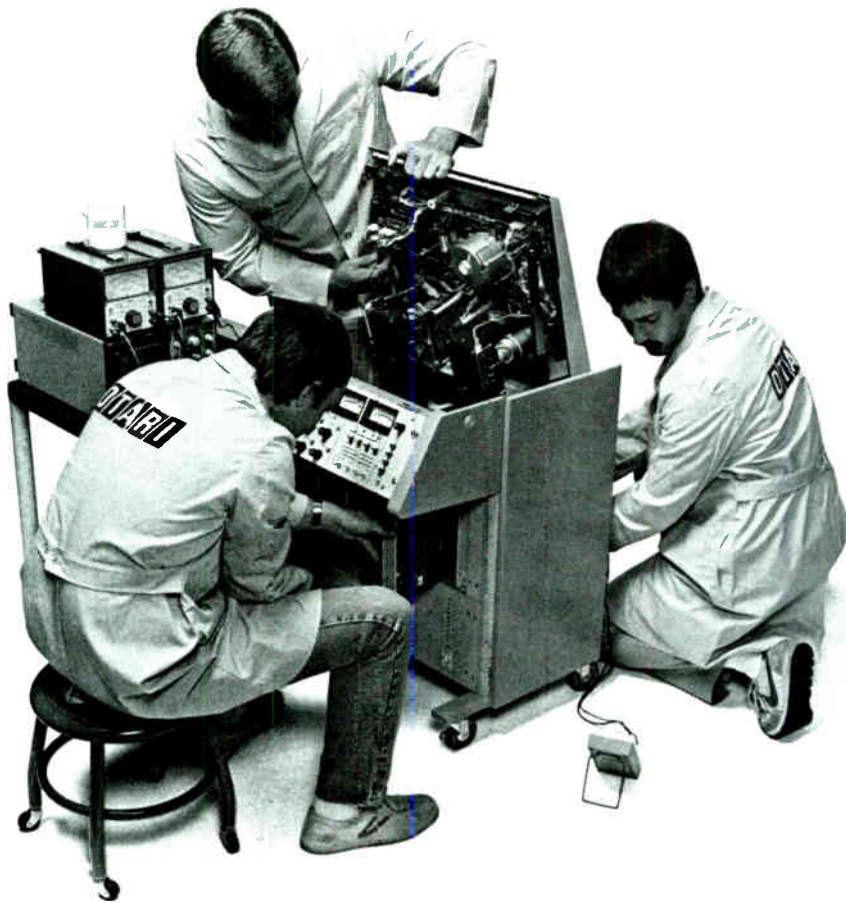

Tuned up for low-speed performance.

Until now, professional tape duplication engineers had to produce their low-speed masters on machines better suited for high-speed record mastering. They've suffered long enough.

Otari introduces the MTR-10-4 LX.

We've taken our popular MTR-10-4 and turned it into a new beast: The LX—a 1/2" four-channel recorder specifically tuned for the requirements of low-speed duplicator mastering.

The LX delivers a frequency response of 20 Hz to 17.5 kHz and signal-to-noise ratio of 64 dB, at 3.75 ips. At 7.5 ips, frequency response is 20 Hz to 20 kHz, with a signal-to-noise ratio of 67 dB. And of course, the LX has all the other professional features of our MTR Series recorders.

The faster master

Once you've recorded a state-of-the-art duplication master on the LX, it would be a shame to reproduce it on anything less than our DP-80 high-speed duplication system.

The DP-80 master runs at an incredible 480 ips—twice as fast as any other duplicator—and fast enough to allow for 7.5 ips masters at a 64:1 duplication ratio. With the LX and the DP-80, duplication engineers now have the tools to take pre-recorded music to new limits. Together, they make great music.

For more information, please call Mike Pappas, Manager, Otari Industrial Products Division, at (415) 592-8311. Otari Corporation, 2 Davis Drive, Belmont, CA 94002. Telex: 910-376-4890.

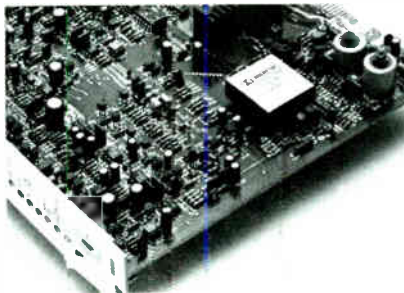

The Dolby® HX pro option is available on both the MTR-10-4 LX low-speed Mastering Recorder and the DP-80 high-speed Duplication System.

The Sound Source

P.O. Box 1495
Hollywood, CA 90028

SYNTHESIZER & AUDIO RENTALS

featuring

YAMAHA DX-1 & DX-7 • AMS • MASSENBURG
E-MU • EVENTIDE • MITSUBISHI X-80
OBERHEIM SYSTEM • SONTEC • PUBLISON
LINN • LEXICON • DOLBY
PPG • DRAWMER • DBX

Call (213) 876-2400 - 24hrs/day
FAST, FRIENDLY, DEPENDABLE
THE BOTTOM LINE: SERVICE

Circle #083 on Reader Service Card

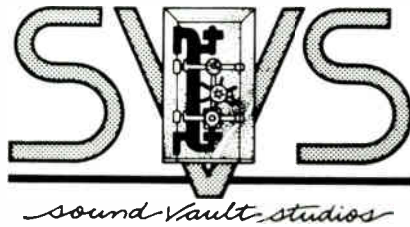

16/24 TRK OTARI (MTR 90)/28x24 AMEK
REHEARSAL AND VIDEO FACILITIES

*Everything to Take Your Music & Video
From Concept to Reality*

818-353-7121 8134 FOOTHILL BLVD. SUNLAND, CA 91040

Circle #084 on Reader Service Card

(FROM PAGE 138)

Dimensions of Studio(s): Studio A main room 14'0" x 26'1" iso booth 8'14" x 15', vocal booth 12' x 10'. Studio B is 26' x 22'

Dimensions of Control Room(s): Studio A 18' x 22' iso Studio B 18' x 22'

Tape Recorders: Ampex ATH 124 24 track Ampex ATH 104 4 track Ampex ATH 102 2 track

Mixing Consoles: Solid State Logic 4000 48 in x 48 in

Monitor Amplifiers: Yamaha L200 Yamaha FC5000 M

Monitor Speakers: Amaprover NS10 4311 NS1000 Amaprover URE1013

Echo, Reverb & Delay Systems: Yamaha REV1 Yamaha YDD 2800 Yamaha H1000 Euphonia FMT 251 AMS 9000 Lexicon 93

Other Outboard Equipment: Korg II Gator II Eventide H949 URE1115 Lexicon 9000 Yamaha F10 AMS DVA 15 80s

Microphones: Neumann U87 U47 U67 KM44 KM88 AKG 452 44 C24 Sennheiser MD 421 Sennheiser MD 421 C24 LYN COA 7, 10, 16 M160 M101

Instruments Available: Yamaha DX7 DX9 DX1 FX20 Yamaha S410 S400S C710 C711 C712 C713 C714 C715 C716 C717 C718 C719 C720 C721 C722 C723 C724 C725 C726 C727 C728 C729 C730 C731 C732 C733 C734 C735 C736 C737 C738 C739 C740 C741 C742 C743 C744 C745 C746 C747 C748 C749 C750 C751 C752 C753 C754 C755 C756 C757 C758 C759 C760 C761 C762 C763 C764 C765 C766 C767 C768 C769 C770 C771 C772 C773 C774 C775 C776 C777 C778 C779 C780 C781 C782 C783 C784 C785 C786 C787 C788 C789 C790 C791 C792 C793 C794 C795 C796 C797 C798 C799 C800 C801 C802 C803 C804 C805 C806 C807 C808 C809 C810 C811 C812 C813 C814 C815 C816 C817 C818 C819 C820 C821 C822 C823 C824 C825 C826 C827 C828 C829 C830 C831 C832 C833 C834 C835 C836 C837 C838 C839 C840 C841 C842 C843 C844 C845 C846 C847 C848 C849 C850 C851 C852 C853 C854 C855 C856 C857 C858 C859 C860 C861 C862 C863 C864 C865 C866 C867 C868 C869 C870 C871 C872 C873 C874 C875 C876 C877 C878 C879 C880 C881 C882 C883 C884 C885 C886 C887 C888 C889 C890 C891 C892 C893 C894 C895 C896 C897 C898 C899 C900 C901 C902 C903 C904 C905 C906 C907 C908 C909 C910 C911 C912 C913 C914 C915 C916 C917 C918 C919 C920 C921 C922 C923 C924 C925 C926 C927 C928 C929 C930 C931 C932 C933 C934 C935 C936 C937 C938 C939 C940 C941 C942 C943 C944 C945 C946 C947 C948 C949 C950 C951 C952 C953 C954 C955 C956 C957 C958 C959 C960 C961 C962 C963 C964 C965 C966 C967 C968 C969 C970 C971 C972 C973 C974 C975 C976 C977 C978 C979 C980 C981 C982 C983 C984 C985 C986 C987 C988 C989 C990 C991 C992 C993 C994 C995 C996 C997 C998 C999 C1000

Video Equipment & Services: Amaprover NS10 4311 NS1000 Amaprover URE1013

Rates: Please call

•••• ZERO STUDIOS

32 W. Anapamu, Santa Barbara, CA 93103
(805) 966-9247

Owner: Zero Studios
Studio Manager: Zero Studios

NORTHWEST STUDIO LISTINGS

coming in January
to MIX

**Questionnaire Deadline
October 1st**

Attention:

Audio/Video/Music Schools

Your students deserve the most up-to-date information in the field of music and recording technology. They can get it each month in MIX Magazine, provided to you on a convenient basis through our special school distribution plan.

For more details on how you can provide MIX to your students, contact Allison Hershey at (415) 843-7901 or write to MIX Magazine, 2608 9th St., Berkeley, CA 94710.



The APRS 17th Exhibition



by Ron Neilson
Marketing Consultant
All photos by Ron Neilson

England's 30 year-old Association of Professional Recording Studios held their largest-ever trade exhibition in London in mid-June. The APRS (founded in 1954) has organized a trade exhibition for its last 17 years. From 1972 to 1981, London's Connaught Hotel was host to the show. In 1981, it moved to its present site, the Kensington Exhibition Centre. In the eight years at the Connaught, the event grew in space demands by more than 250 percent until every available room and half the bars were utilized for exhibitor's stands.

The burgeoning pro-audio event was likened to a walk through the famous Oxford University garden labyrinth (for most of us colonials, that's the eight foot high hedgerow maze we have all seen in a classic Laurel & Hardy film, *Chumps at Oxford*). Until 1982, an APRS attendee had quite a formidable task ahead of him just to locate all the exhibitor's stands tucked into what became known as the "rabbit warrens of the Connaught." That's history, so to speak.

This year's exhibition occupied about 20 percent more floor space than last, and ironically, spread from one to two floors of its new venue to accommodate a total of 118 companies, of which

21 were new. Of note, the APRS have a "ballot" system for allocating space to the exhibitors. Well ahead of the actual show, there's considerable insider's "trading" that leads up to a day of balloting activity resembling the floor action of the London Gold Exchange—occasionally tempered with the good manners and reserve of a Sotheby/Parke auction. Apparently, the system works well for nearly everyone; manufacturers who have tenure and the up-and-coming companies with none.

The total registered attendance for the APRS was posted daily, and the final figure was well-over 4,000. All registration details of attendees were logged

not the manufacturers and marketers will take advantage of this information for the obvious post-show follow-up sales contact.

In marked contrast to other trade events for the pro audio industry, the typical APRS show-goer is a highly qualified, working professional who usually has come prepared to part with at least a portion of their equipment budget. Indeed on the last day of the APRS there were champagne corks popping at the Solid State Logic stand, as twelve consoles were reportedly "sold" during the course of the three day affair. The Otari booth personnel also were pleased with the order level they experienced.



into a computer. This interesting and quite logical establishment of a "database" will be available for all exhibitors. In addition to a straightforward alphabetical listing, exhibitors can obtain a selection according to occupation/interest (complete with computer-prepared address labels), as attendees were required to supply their particular interests when registering. This service is a great idea, however it remains to be seen whether or

This is just one reporter's spot-check on one console maker and one tape machine maker, respectively, but most of the exhibitors noted similar experiences, attesting to the overall success of the event.

There's a keen sense of government politics around British trade events. Understandably, since our cousins practically invented the medium. On-hand for the APRS was John Butcher, Parliamentary Under Secretary of State from

the Department of Industry. He delivered an opening day keynote address for the press and spoke in capitalistic parables about British technology. It's relevant to comment that the British Overseas Trade Board (BOTB) has, for several years, sponsored a large group of U.K. manufacturers on overseas missions like the AES, NAB, etc. Over many years of strong showings at European AES conventions in particular, the U.K. contingent has, (and, in the words of the APRS newsletter): "become the BOTB's big stars." So there. The Queen's Award for Export logo that adorns various U.K. firms' stands and advertising (such as Soundcraft and Audiokinetics) is particular recognition of the fact that the British government does shell-out Sterling to help their lot. I wish as much could be said about our own Department of Commerce, who should offer more assistance by direct sponsorship to the American professional audio manufacturers who, in recent years, have done their best to display their wares abroad.

Before moving on to an overview of the manufacturers and their displayed goodies, two other aspects of the APRS event should be noted. The first is the producer suite which was set aside at

the show to encourage membership of same. Steve Levine, who recently won an accolade for British Producer of the Year for 1983, (Producer for Culture Club-Boy George) put it this way: "It would be a very good thing for producers to join an association...the manufacturers would, I believe, become more aware of producers as a group...this would lead to better communications between the manufacturers and their end users. It would give them the chance to find out what those end users want, and it would let producers have a say in where R&D in pro audio is going."

A second point worth mentioning is an announcement by the APRS of the eleventh studio engineers course which is to be held at the University of Surrey, September 7 to 15. In addition to this well-respected, practical refresher course for working professionals, another APRS sponsored educational program was announced—the first full-time course at Salford College of Technology is biased towards producing maintenance engineers and factory/production/design engineers. After 500 hours of practical work and three years study, an advanced two year course will be offered to successful post-graduate stu-

dents. This is good news for anyone, either side of the puddle, as there's certainly general agreement that increasingly complex technology has resulted in a serious shortage of maintenance engineers everywhere. Bravo to the Earl of Harewood, patron to the APRS, Sir George Solti, president, et al.

Due to space limitations, the following is a quick glance at just a *few* of the many exhibitors present at this year's gathering. In fairness, they are listed alphabetically.

Abbey Road Studios

The hot topic here was the announcement of the world famous studio's availability of direct metal mastering facilities—a U.K. first. In addition to their two studios offering the SSL 48 channel desks (one with total recall automation and computerized mixdown), they claim "...a highly skilled team experienced in the rigorous technical requirements in the preparation of master tapes for compact disc manufacture."

Aces (UK) LTD.

New products included a full function autolocator for their TR24 multitrack and a 10 into 8 in-line multitrack mixer. They also showed their rack gear



WE'RE EXPANDING!

That's right! We're Expanding and Compressing and Limiting and Gating and

Ducking and Reducing Noise. Listen closely and you'll hear that our line of dynamic range processors is the most versatile in the industry. Not only can we boast of unbeatable specs and competitive pricing, but most important, our processors sound great...which means

they make you sound great! If audio is a part of your life, then we can make life easier for you! Call or write for details.

Symetrix

109 Bell Street
Seattle, Washington 98121 USA
Telephone (206) 624 5012
Telex 703282

Circle #085 on Reader Service Card

mounting power amps, graphic equalizers, and spring reverb.

Advanced Music Systems

A complete range of digital audio processing systems were shown. Their DMX 15-80S can now be had with a De-Glitch module and a system for external triggering of data captured by the unit's Loop Editing System (software). New to the RMX Reverb is a memory expansion module with the latest software additions/changes. There was a demonstration of data transfer by light pen and remote terminal for the RMX. Also shown, an A/V sync audio delay compensator for video synchronizers.

Agfa-Gevaert Ltd.

New from Agfa was their PEM 469 reel-to-reel high output studio tape. Also shown was their 3.81 mm duplicat-

with interesting design applied to telephone line balancing.

Allen and Heath Brenell Ltd.

AHB showed their successful System 8 range of mixing desks as well as their Syncon B in-line multitrack console. They had a working demonstration of their *Inpulse One*, an expandable digital drum computer. It's MIDI-equipped, RS232C ported and features an on-board SMPTE generator and reader.

AMEK Systems and Controls Ltd.

AMEK showed their TAC Matchless multi-purpose console. A full 24 buss board with in-line monitoring, it also features 8 aux sends, 2 independent mute groups, the AMEK/TAC equalizer and a dual subgroup module which allows the console to be configured as a "split" board.



ing tape, an alternative to chrome, Magnetite 12. Also displayed were PEV500 video tape and their full line of cassette stocks.

AKG Acoustics Ltd.

New was the C568 shotgun mike, said to be ideal for close, highly directional recording in studios and O/B applications. The C414/P48 condenser was on-hand, and its AKG's "digital era" mike which features extremely low internal noise, SPL of 162 dB and a 4-position selectable polar-pattern switch.

Alice (Stancoil) Ltd.

New developments shown were the 828 series mixer and the new *Probe* unit—a portable reporter's mixer

Ampex Electronics Ltd.

The standard range of mastering tapes were shown (406, 456, 466) along with the U-format 197 series broadcast quality high band video cassettes for digital audio applications (Sony/MCI PCM 1610/DAS 900). On the less technical front, *Ampex* delivered a Golden Reel Award to the group *Shakatak* and their couterie.

Applied Microsystems Ltd.

This firm manufactures a range of add-on digital tape timers for semi-pro machines (A77, Otari MX5050B-II) and also older studio machines with mechanical counters. New items included an autolocator dubbed I-CON 16, primari-

**Worn or
Worn out**

Sprague Magnetics refurbishment facility can take your worn heads with sufficient life and recontour them back to within 10% of new specification. If your heads are not refurbishable, chances are we have replacements on the shelf. We stock Ampex, Otari, Teac and Studer. Our head evaluation is free and our standard turnaround is 24 hours.

**SPRAGUE
MAGNETICS
INC.**

Tel: (213) 994-6602 / Tlx: 66-2922
15759 Strathern St./Van Nuys, CA 91406

Circle #086 on Reader Service Card



Custom Length
BASF
Chrome
Cassettes

AMPEX
Blank Recording Tape



Authorized Distributor

**UNITED TAPE
COMPANY**

10746 Magnolia
N. Hollywood, CA
(818) 980-6700
Ask for Steve

Authorized Reseller
Information Processing Media **BASF**

Circle #087 on Reader Service Card



Microphones, Telcom Noise Reduction Systems, and the Neutrik Audiograph were displayed, which ADR distributes in the US.

Audio Kinetics (UK) Ltd.

In addition to their well-known and regarded Q-lock synchronizer hardware and software systems, AK demonstrated their new *Time-Link*. The unit contains a time code resaper and an electronic "gearbox" for time code standards conversion. The output of the "gearbox" can be used to lock a time code generator to produce one time code standard with reference to another; for example 24 fps to 25 fps out. As in other recent exhibitions, this was a busy, well-attended booth with impressive hands-on demonstrations of their products.

Audio-Music Marketing Ltd.

These were the Yamaha people at APRS showing the new REV-1 digital reverb and the YDD-2600 digital delay, both with remote control facilities. Power amps, mixers, and speakers from Yamaha were also displayed.

Audio Video Marketing Ltd.

Under the name *Ferrograph*, this firm showed the Series 77¼-inch tape recorder, and test equipment and tapes. They also showed the full range of Milab

ly aimed at the Fostex B-16. A synchronizer version (suffix "S") will lock together two B16's.

Atlantex Music Ltd.

This marketing organization showed the following manufacturer's products: Symetrix (audio processors); Aphex controller and Aphex B aural exciter; MXR programmable digital stereo reverberation system and the drum

machine; 360 systems digital sampling keyboard and other products from Ashly Audio, and Whirlwind.

Audio + Design (Recording) Ltd.

New products included the *Ambisonic Mastering System* and the *Complex 2*. The professional format version of the Sony 701E digital processor was shown. In addition, the pro audio lines of EELA *Audio Products, Calrec*

THE POWER of *Zetka*

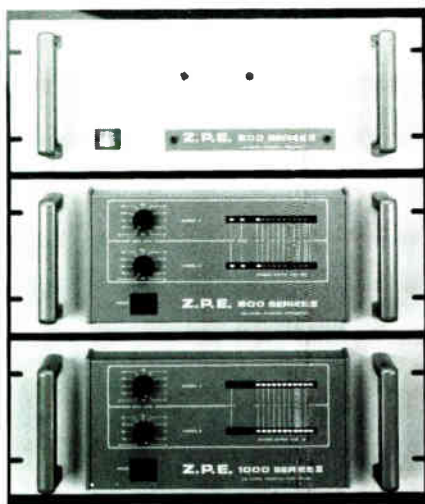

SEE HOW OUR AMPS STACK UP AGAINST THE REST

- FREQUENCY RESPONSE: +0, -0.1db 20HZ TO 20 KHZ
- THD: LESS THAN 0.015% UP TO RATED OUTPUT
- NOISE: BETTER THAN -110db BELOW RATED OUTPUT
- CROSSTALK: 75db @ 1KHZ
- SLEW RATE: 75v PER MICROSECOND
- WARRANTY: 3 YEARS PARTS AND LABOR

POWER OUTPUTS RMS 20HZ -20KHZ	ZPE-1000	ZPE-600	ZPE-500
-BOTH CH. DRIVEN-8 OHMS	500w/CH.	300w/CH.	250w/CH.
-BOTH CH. DRIVEN-4 OHMS	800w/CH.	450w/CH.	350w/CH.
-BOTH CH. DRIVEN-2 OHMS	900w/CH.	700w/CH.	400w/CH.
-BRIDGE MODE INTO 8 OHMS		900w/CH.	
-DAMPING FACTOR @ 50HZ	250	200	200
-INPUT SENSITIVITY FOR RATED OUTPUT 8 OHMS	1v	.8v	.7v
PRICE:	\$1,449	\$1,299	\$879

DEALER INQUIRIES INVITED:

Zetka NORTH AMERICA
P.O. Box 6493
Thousand Oaks, CA 91359

AUTHORIZED DEALER:



4628 West Magnolia Blvd.
Burbank, CA 91505
(818) 843-6320



mikes from the Swedish manufacturer. **Auditronics Inc.**

The US-based manufacturer displayed the new 300 Series audio production console. The board has been developed for use in TV, radio and video post-production and may be configured with up to 32 mono and/or stereo input modules. The board features VCA level control, CMOS switching and "load-lift" bussing for optimizing signal-to-noise performance. The product is available in the U.K. through a new sales office headed by a Mr. Dag Fellner, formerly with MCI U.K.

Audix Ltd.

This firm showed their range of mixing consoles including a "hybrid" design analog/digital board for the first time. They also showed some of the products from US maker, Altec/Lansing (speakers, amplifiers), for which they are the new U.K. agents.

Autograph Sales Ltd.

This distributor displayed the products of: Meyer Sound Laboratories (speakers); Klark-Teknik; Audio Engineering (Micron); Crest Audio (amps); Brooke-Siren and C-Tape developments (a unique, flat tape transducer). The new items were a Klark-Teknik DN780 digital reverb, the Meyer 833 studio reference monitor system and the Brooke-Siren DPR 402 compressor/limiter.

BASF (U.K.) Ltd.

Tapes and floppy disks from the maker who is celebrating its 50th year—the new item being PCM Beta video cassette for digital mastering and the new Master Series of studio tape; 910 is the high output tape for conventional pro audio analog, and 930 is for use on the new digital stationary head recorders (chromium dioxide). Finally, the Loop Master 920 chrome tape for high speed duplicating, and a range of Flexidisk floppies were shown.

F. W. O. Bauch Ltd.

There was quite a line-up from the show's largest distributor: **Studer, Neumann, EMT, Tannoy, Harrison, UREI, Lexicon, Valley People, MRL, Switchcraft, Gotham, IVIE**, etc.—a veritable who's who from the States. New were the **Studer** Series 900 mixing console, and the new **TLS4000** synchronizer. The **Revox** side of things was rep-

resented with a new CD unit. From **Neumann**, the TLM 170 super-mike. **Harrison** showed their new **Raven** console for the first time.

BEL Marketing

Newcomers, they showed their BD60 and BD80 DDL's. In addition, they showed mixers, NR units and signal processing units.

Bestobell Protection

Introduced **Coustone**, an interesting acoustic treatment material which is molded into relatively lightweight squares or building blocks. Made from polyurethane bonded particles of flint, the patent-applied-for process results in a versatile material that could find its way into many applications in studios due to its acoustic absorption and fire-retardant properties.

Beyer Dynamic (GB) Ltd.

The latest product displayed was the MPC acoustical boundary mike. Also shown was the TR 185 UK wireless system with interchangeable heads. Headphones and their standard mike range were additionally on view.

Bruel & Kjaer (UK) Ltd.

The Danish test equipment manufacturer concentrated their exhibit on microphones.

AWARD RECORD MFG., INC.

PREMIUM QUALITY...
MEANS AN

“AWARD RECORD”

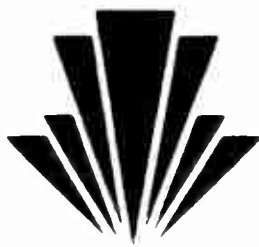

AWARD

- PRESSING
- PRINTING
- PLATING
- MASTERS
- CASSETTES
- PICTURE RECORDS
- GOLD RECORDS

SINGLES • ALBUMS • TAPES

YOUR TAPE TO FINISHED PRODUCT - ANY QUANTITY

AWARD RECORD MFG., INC.

5200 West 83rd Street, Los Angeles, California 90045

(213) 645-2281

Circle #089 on Reader Service Card

Guitar Showcase
**PROFESSIONAL
 SOUND))))))**
 Division

We specialize in the sales and service of Professional Sound and Recording equipment.

We are now the exclusive South Bay Otari dealer.

Servicing Corporations, Churches and Institutional accounts

**Professional
 Recording
 Equipment**

- AKG • Ampex • Audiex
- DBX • JBL • Master Room • Onkyo • Tascam • Teac

**Sound
 Reinforcement**

- | | |
|----------------|----------|
| Atlas | Symetrix |
| Audio Technica | Tapco |
| BiAmp | TOA |
| Bose | Yamaha |
| Delta Lab | Peavey |
| Electro Voice | Fender |
| Goldline | EXR |
| Harbinger | Mike Mix |
| Hill Audio | MXR |
| Ramsa | Furman |
| Sennheiser | New Mark |
| Sescom | Shure |
| Sony | Sundholm |



3090 S. Bascom Ave.
 San Jose, CA
 (408) 377-5864

Open Mon-Thurs 11-9
 Fri 11-8, Sat 10-5
 Closed Sun

Financing Available
 All Major Cards Accepted



Harman U.K.

Brooke Siren Systems Ltd.

This was the first showing for the companies Dynamic Processing range, the DPR 402 Comp/limiter/de-esser. On-hand also were their electronic crossovers and the AR130 Phase checker, the AR116 Direct box and the AR125 Leads/fuse tester.

CBS Fender

This was the first time for CBS/Fender at the APRS. From their Pro Sound Products Division they displayed five powered mixers, three consoles, two power amps, three speakers systems, three series of microphones, and a partridge in a pear tree.

C-Tape Developments

The latest products here were the C-ducer Saxman, their unique mike for the sax and clarinet player. Also, the

new C-Tape Impedance Meter, designed for the measurement of impedance at audio frequencies.

Dolby Laboratories

New were the 326 A-type noise reduction processor and the Model 380. Both are two channel while the former is primarily designed for studios and disk-cutting, the 380 is specifically configured for use with the Ampex VPR3 and VPR80 broadcast video machines.

Elliot Brothers (Audio Systems) Ltd.

The new DDA "D" Series of consoles were unveiled. I noted that these boards had nicely designed facilities, cosmetics and appeared to be built to a very high standard. Interestingly enough, where nearly every stand offered a mixer, these boards stand out. Look for a future for these people, as



Elliot Brothers (Audio Systems) Ltd.

they have landed some very prestigious U.K. business amongst stiff competition. **GTC Ltd.**

On demonstration was a 1/2-inch VHS machine synchronized to a TEAC 1/2-inch eight track. The VHS was a master through the use of the **Editon** synchronizer utilizing longitudinal time code. **Harman UK**

The JBL/Tascam booth had the 40 Series and 50 Series recorders as well as their relatively new professional cassette decks in 3 and 4 channel formats. For JBL, the 4400 Series monitors were displayed, and the new computer system (C.A.D.P.) for cluster/array design.

Hayden Laboratories

Digital here with the Mitsubishi/Telefunken 32 channel machine and editing system. Also, the Denon DN3000F pro CD unit was shown. The long-awaited **Nagra** SMPTE time code recorders were additionally demonstrated.

HHB Hire & Sales

These are the Crown distributors in the U.K., and they appropriately displayed for the first time in the U.K. the TEF 10 computer system, the Delta Omega amp, and the PZM mikes. The Sony PCM-F1 w/Betamax VCR package is the low-budget popular digital package they sell or rent, and on the higher end, they have a combo PCM 1610 with DAE1100 editor and 5850 U-Matic video recorder.

This booth drew very good traffic as they also unveiled a system designed to work with the F1/Betamax, or 701ES—a computer-controlled editor/logger named "CLUE." The machine will enable butt copy-editing in either analog or digital modes to frame accuracy (1/25 sec PAL, or 1/30 sec NTSC). Impressive and easy-to-use facilities for logging, autolocation, and hard copy print-out of recording data are additional features.

HW International

The Shure SM87 hand held condenser, the FP 31 mixer, and the SM83 mini-lavalier were unveiled here.

Neve International Ltd.

Neve launched their **Necam 96** mixdown and post-production automation system. The **Necam 96** features microprocessor technology, a real-time software operating system, and new high-speed "feather-touch" precision motor driven faders. Up to 999 static stores of faders and mutes, auto/manual crossfading and up to 128 separate event switches can be stored. The system was demonstrated in a new 8128 multi-track music/post-production console. Information on the all-digital DSP console was available. The first commercial U.K. client for this advanced system, CTS Studios in London, has taken delivery, but

ONE INCH
AUDIO
POST
PRODUCTION



SUCCESS STORY CONTINUES:

ADVANCED MEDIA SYSTEMS	40x24 S-IIIC
PUGET SOUND AUDIO	36x24 S-IIIC
METRO MOBILE LOCATION RCDG.	32x24 S-II
LOMA RANCH STUDIOS	28x24 S-II
A&R RECORDING SERVICES	28x24 S-II
TRINITY BROADCASTING NETWORK	24x4 S-I PROD.
KCRW-FM	16x8 S-I PROD.
KWGN-TV	24x4 S-I PROD.
KNAC-FM	20x8 S-I PROD.
TOBY ARNOLD & ASSOC.	28x24 S-II

THEIR FUTURE IS CLEAR!

NEOTEK

For over six years, **Neotek West** has been assisting people like these in making NEOTEK audio consoles a part of their success. While other consoles claim superlative audio, NEOTEK consoles have consistently delivered unsurpassed audio quality and flexibility.

If you haven't yet auditioned a NEOTEK, please call us for a demonstration, and start on your own "success story!"

NEOTEK WEST

4007 West 6th Street, Los Angeles, CA 90020 • (213) 387-7999

SALES AND SERVICE OF NEOTEK CONSOLES

Circle #091 on Reader Service Card



Otari Electric (U.K.) Ltd.

reportedly has been experiencing problems related to the complex, proprietary software.

Otari Electric (U.K.) Ltd.

The full MTR Series, 5050 se-

ries, and high-speed duplicating systems consumed most of the Otari's large exhibit space. The new DP80 64:1 high speed duplicator was shuttling tape at 480 ips, and was an impressive show of

precision tape handling technology. New products which were previously "sneak-previewed" at the NAB were absent as the market introduction for the U.K. is scheduled later this year; the EC-101 in-machine synchronizer, the MTR-20 computerized self-aligning mastering 1/4 1/2-inch machine, and the MX-70 1-inch 16/8 multitrack. Reportedly, Otari booked orders for several of their MTR-90 multitracks.

Publison Audio Professional

The **Infernal Machine 90** was demonstrated. This digital processor is a combo reverb/phase shifter/delay, etc. which is capable of handling memorized sounds up to five minutes. There's an RS232C interface, synchronization via SMPTE code, MIDI and hard disk interfaces as options.

Pye Tvt Ltd.

This is Philips Broadcast in the U.K. They demonstrated the CD-Subcode Processor/Editor LHH 0425. Also shown was the new LHH 0502 which is a modular system of CD drives, keyboards and a control unit for fast, random access to disc in broadcast applications. The Adams-Smith 2600 modular tape synchronizing system was additionally demonstrated.

RE Instruments Ltd.

A demo of the RE800 Series 140 megabit video and audio optical PCM transmission system was the highlight at this stand. The RE800 provided the U.K.'s first live stereo outside broadcast (BBC) using a fiber optic PCM transmission path (1983).

Scenic Sounds Equipment Ltd.

Over a dozen US pro audio manufacturers are distributed by this firm. Highlights included a fully operational display of the BTX Softouch/Cypher SMPTE synchronizing system, an active demo of the new dbx 700 digital recording system, and the Lexicon 200 and 224/LARC reverbs.

Solid State Logic

Two large, fully working console systems were shown at this busy booth (SL6000E Stereo Video System and the SL4000E Master Studio System). New products included a synchronizer controller that provides control of an entire machine system via the SSL Primary Studio Computer keyboard, the SL688V Stereo Mix Matrix which is provided in the SL6000E video post-production and broadcast boards, and a new programmable equalizer, which can be retrofitted into existing SSL E Series boards. All control movements are remembered with the automated mixing system.

Sony Broadcast Ltd.

The AVS and AVP500 Series synchronizing system was demonstrat-

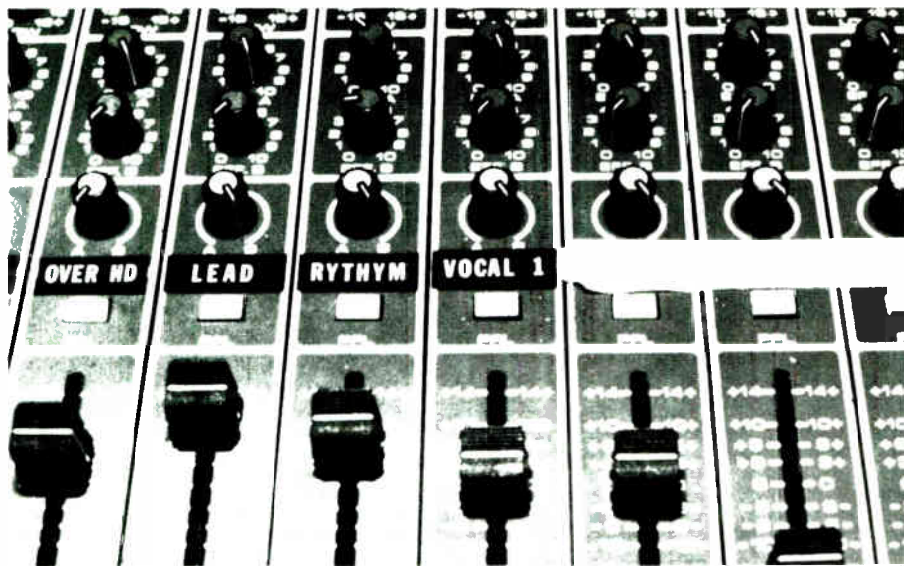

MAGNA-MARKERS™

**over 50 titles
6/\$4.95**

2862 Old North
Farmers Branch, Texas • 75231
(214)484-7385

DEALER INQUIRIES INVITED!

Circle #092 on Reader Service Card

ed. This system will interface with all MCI recorders, Sony BVH video recorders, most ¾-inch U-matic machines and other manufacturer's audio/video gear. The new sync system borrows heavily from techniques and technology in video editing systems, and can provide edit lists with management and can accept lists from CMX compatible video editors.

Two PCM 3324 recorders were synchronized via the newly introduced RM3310 remote control. Without using time code, this set-up provides for true 48 channel operation. CD mastering was featured in a separate area and included the 1610, DAE-1100, DAQ-1000 and two VO5850 digital audio recorders.

An interesting display of two CD players with independent cueing via a separate controller (CDS-3000) was also shown.

Add to all this other Sony professional equipment, and, as usual it was quite an impressive array of technology. **Soundcraft Electronics Ltd.**

The large Soundcraft display featured three new consoles: the TS24 in-line master recording console with optional disk-based automation, the budget Series 600—an 8 buss/16 track monitoring console, and the SAC-2, a stereo on-air broadcast board. In addition to their new consoles, a new range of power amplifiers were shown. The standard range consoles and tape machines filled up the remaining space. Soundcraft planned also to exhibit their new in-cassette duplicating system, but some legal wrinkles denied them an APRS introduction—look for this product, dubbed the CD201 at the AES/New York Convention next month.

Studio Sound

The U.K.'s authoritative magazine for recording professionals had their 25th anniversary party at a nearby hotel bar with mini-disco floor, and it was a packed house. They hosted a literal who's who in the U.K. recording scene (and quite a few Americans and continentals as well) at the evening fete. The evening was capped with a cake-cutting affair and champagne, following a brief and to-the-point speech by Philip Guy, who has recently ascended to group ad manager for several of the Link House magazines. His dedication address will go down as the infamous "Money Speech," backscratching plaudits and all.

Syco Systems Ltd.

This aggressive and very successful distributing firm showed Fairlight Instruments, E-Mu Systems, Linn Electronics, Passport Designs, Simmons, Quantec, Yamaha and AMS musical electronics/cum computing equipment. New software enhancements, and a few

PERFORMANCE GUARANTEE

In the high pressure, fast paced audio industry, survival means maintaining your competitive edge. You demand every ounce of performance from your equipment and its uncompromised operation is vital to your success!

Regular alignment of precision audio equipment is an absolute must. The LofTech TS-1 is a simple to use, inexpensive, quality test instrument which helps you perform important alignment procedures. What you get are accurate results, quickly and easily. The LofTech TS-1 is your performance guarantee.



\$299.00

Suggested Retail

Manufactured in the U.S.A.
by Phoenix Audio Laboratory, Inc.
91 Elm Street, Manchester,
CT 06040
(203) 649-1199

LOFTECH

TS-1 AUDIO TEST SET

Circle #093 on Reader Service Card

RECORD PRESSING & TAPE DUPLICATING

Are you wondering where you can go to get the best possible PRICE, SERVICE and QUALITY for a complete customized package deal for your record pressing and tape cartridge duplication? LOOK NO FURTHER!!

ONE CALL DOES IT ALL

"IT'S A SERVICE YOU'LL APPRECIATE"

JAMES TAKEDA

(213) 760-6644

SERVICES OFFERED:

Disc Mastering, Processing, Labels, Record Pressing, Album Jacket Layout, Designing, Color Separation, Offset Printing, Album Fabricating and Shrink Wrapping, Cassette and 8 Track Duplicating, and more...

SEND FOR YOUR FREE PRICE QUOTATION



Takeda

Record Service

11542 Burbank Blvd. #2, North Hollywood, CA. 91601,

Phone: (818) 760-6644

Circle #094 on Reader Service Card

Coming in December:

SIXTH ANNUAL TAPE-TO-DISK ISSUE

An indepth report on the latest developments in record mastering, pressing and tape duplication.

Special features include:

- Record label forum on release formats: CD, Audiofile, Cassette, Standard
- The latest on the CD situation
- New developments in tape duplication
- Interview: CD Group's Emiel Petrone
- Listings: Mastering, Pressing and Duplication Facilities

Stay current on all aspects of record manufacturing with Mix' once a year Tape-to-Disk issue.

**Advertising Space Closing: October 7th
Materials Due: October 15th**

Call (415) 843-7901 for more information.

new twists for the AMS digital systems were on hand.

Tam/England

These folks now manufacture and service the Danish Ortofon line, which principally has been in the disc-cutting arena. They announced small, hands-on disc-cutting courses for interested professionals.

Tandberg Ltd.

The Norwegian company announced a 1/4-inch pro recorder. Pro cassette decks, and high-quality FM tuners were also displayed. The featured item however was the TES Telephone Enhancement system for broadcast.

Tannoy Products Ltd.

The famous pro loudspeaker maker introduced a new line of dual concentrics, named the Wildcats. They're aimed at PA applications primarily and models feature 12-inch and 15-inch drivers in sturdy, roadworthy enclosures.

S.J. Court & Associates Ltd.

"The Acoustic Chair" (a loudspeaker system) was demonstrated with a CD player and the sound was quite amazing. With only 8 watts input, it's capable of 110 dB SPL! Bear in mind that once you're seated, you're coupled to a professional-level, folded horn, multi-driver designed loudspeaker, that just happens to be upholstered and shaped for your entire body (not just your ears). A bit on the expensive side, 1,200 pounds, the Acoustic Chair should find its way into quite a few studio/producer facilities as well as the well-heeled record company exec offices. Quite an impressive display of speaker engineering, and more than just a curio: the dynamic range and stereo imaging were simply incredible.

Trad Electronics Sales Ltd.

Quite an unusual entry (never to be seen to my recollection at an AES) was a used-equipment booth. Ala' bulletin board, gear which was offered for sale was posted (including some Abbey Road discards). Arranged as a lounge area primarily, this booth was an interesting twist, and a reinforcement to the basic idea that the APRS is an unabashed commercial event.

Trident Audio Developments Ltd.

New for Trident was the t.i.l. Series console. The in-line recording console is available with up to 36 inputs. Also shown were the Series 70, 80 & TSM boards as well as their TSR Multitrack recorder.

Uher Sales & Service Ltd.

Uher announced the CR160, a portable cassette recorder with both Dolby B & C. They also displayed their open reel (ASC) machine, 3000 Series cassette decks and the Visonik David range of studio monitor speakers. ■

Optimize — don't compromise:

If you demand optimum performance from
your tape recording equipment . . .
you need our services!

JRF maintains a complete lab facility insuring precision relapping and optical alignment of all magnetic recording heads and assemblies. Worn unservicable heads can be restored to original performance specifications. 24-hour and special weekend service available.

- Broadcasting
 - Mastering
 - Recording Studios
 - Tape Duplicating

New and reconditioned replacement heads from mono to 24-track . . . Many in stock.

For repair or replacement, we're at your service!

Call or write.

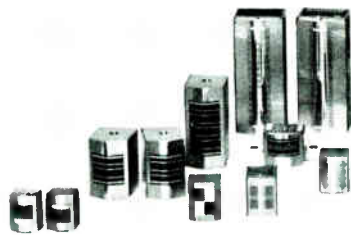

JRF/Magnetic Sciences, Inc.

101 LANDING ROAD, LANDING, NJ 07850 • 201/398-7426

Circle #095 on Reader Service Card

A REPORT FROM

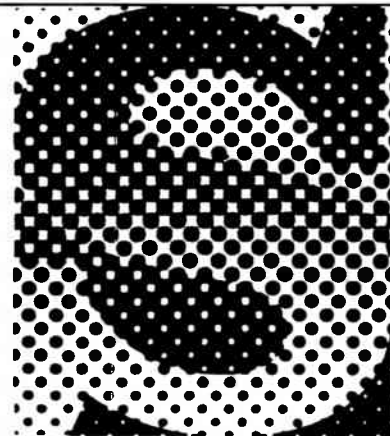
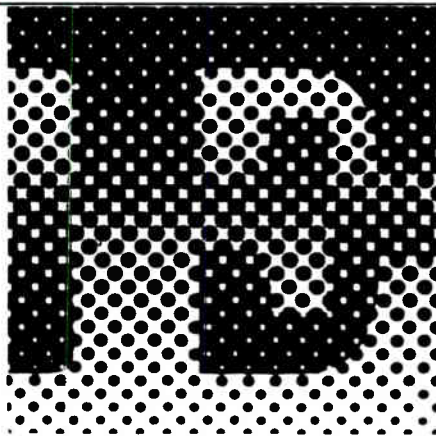
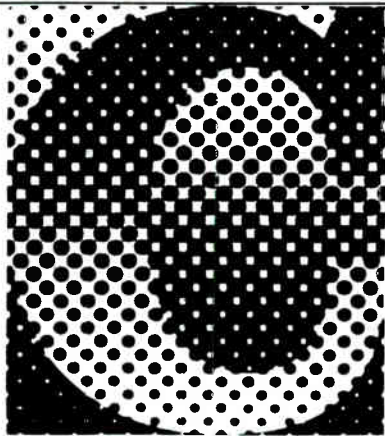

by Neal Weinstock

A twice-yearly carnival called the Consumer Electronics Show just happened in Chicago. Well-known in years past for rides such as the famous videogame roller-coaster, the quadraphonic bungle, the disappearing video-disc and the me-too telephone game, the CES is now by good measure the largest trade show in the world. This June's, largest ever till next time, attracted well over 100,000 sweaty visitors to Chicago's muggy lakefront. The sheer size of this scene, and the importance and interdependence of the consumer electronics market, tend to make each CES a focal point for many professional music industry trends, too.

Trends of the moment: above all, stereo TV. Secondly, AM stereo; a mushrooming video software market; a new high speed video cassette duplicator from Sony that ought to help the mushroom mush even roomier. Thirdly, the compact disc is gaining irrefutably in acceptance, even as it finds more digital music competition. Fourth, some office machinery and recording machinery was introduced that ought to be as helpful to us as anybody—if not much more so. And then, there was the wild rumor that somewhere, at some press party limited to just a select few, the coming out of *The Big Chill* on home video was being celebrated by The Temptations.

We'll run down all these trends, beginning with one unsaid thus far, but implicit in all others: the death of the videogame/computer boom. Let's look at it from a partying point of view: Two years

ago, Activision bursts on the CES scene, rents half of Chicago's Ritz-Carlton Hotel, and throws the biggest party CES had ever seen. It's a jungle motif, everybody's in khakis and pith helmets, boars and buffalo roast on spits, tropical birds fly through the chandeliers, two hot bands help a thousand extramarital affairs begin, and a caged gorilla inhabits each corner of the ballroom. Rumor has it one was the company president in costume. Last year, the action moved from videogames to packaged home computers. Even a press pass and a Playmate of the Month as diversion couldn't push closer than twenty yards to the Coleco booth; but parties were muted, the end was in sight. This year, entrance to the computer hall was dominated by a triple mausoleum complex: the booths of Texas Instruments, Coleco, and Atari. "When are those kids going to stop putting quarters in hand-eye bandits and invest in the eternal wonders of pop music?" we all once asked plaintively. Verily, the time has come.

Record sales are rising—even if you don't count Michael—but the sense of this CES was definitely that home video is the boom of the moment. For instance: to judge by the last few shows, the CES wasn't even supposed to be a home video software show anymore. The Video Software Dealers' Association show in August has gradually taken over CES's primacy in this area. Nevertheless, a slew of last-minute entrants in Chicago made it clear that now is the moment to sell, veritably, *anything* in the way of fodder for VCRs. Independents are springing up out of the woodwork, and are funding their own productions in

some cases. Dealers were there to buy, and buy quite a bit. Certainly the major product is still theatrical movies past prime, but non-theatrical product is slowly growing, and music video is the top non-theatrical product. Home video is finally an extremely viable market for music productions.

Like adding a little kerosene to a fire, Sony's "Sprinter" is a high speed video duplicator that can churn out Beta or dubs 150 times faster than presently possible. Both Sony and Matsushita have talked about developing such duplicators for years; it's finally operational, and high speed video duplication is a reality. Profit margins for distributors and program producers should thus rise, volume should rise as retail prices go down, and the whole market ought to snowball. Nice thought for a 100 degree Chicago evening.

Also in support of this exponential video growth is the trend toward stereo TV. It was to be expected that the major TV makers would each show a stereo model or two. What was not expected before the carnival came to town somehow happened: every TV manufacturer showed stereo sets, and most showed many stereo sets. Retailers bought many stereo sets, and the majors spoke of plans to heavily advertise stereo sets. This is just the push stereo TV can use so well from the hardware side.

(CES also provided a good look at just what stereo TV will do for the recording industry—see this issue's story.)

AM stereo, too, showed good growth, though nothing like the universal acceptance of stereo TV. There were several hi-fi companies that showed pro-

The CES is now by good measure the largest trade show in the world. This June's, largest ever till next time, attracted well over 100,000 sweaty visitors to Chicago's muggy lakefront.

duction models of AM stereo "four-format" receivers, and those numbers ought to grow by next CES in January. The Motorola system seems to get more accepted by broadcasters, slowly, just as these four-format receivers make it unnecessary for broadcasters to make up their minds about mutually exclusive methods. It will be a few years yet till AM stereo is universal, but the change is accelerating. As it does so, radio stations in the AM spectrum should:

1) play more album oriented lists, thus helping record sales of the average musician and the industry as a whole; 2) have less talk, more music, with the same results; 3) do a little more live studio music, thus bringing in a few jobs for engineers.

Doubtless, AM stereo stations will also play their share of compact discs, though the dynamics and frequency response of all AM stereo formats are not even close to what can be achieved with analog records. Neither is FM stereo, for that matter, which hasn't stopped FM stations from playing lots of CDs. Part of the promise of digital audio, for radio stations especially, has been automated play. And the CES offered the first steps down that road, with an industrial multi-play CD player shown by Pana-

sonic. There have been automated radio stations for a long time, so this is not exactly going to revolutionize radio or end gainful employment for any station engineers. For the most part, automated CD players will simply help spread the word on CD.

That is already happening, to the extent that even the audiophile record companies, for whom CES is always a high point, are coming around to accept, and even to emphasize CDs. Now, the audiophile record-makers have the most to lose from the proliferation of CDs, and executives such as Mobile Fidelity's Gary Giorgi have done their share of denigrating the format. Nevertheless, there was Giorgi at CES, selling *only* CDs as new releases. Sink or swim; and it looked like swim.

Bob Carver was at the show with mad scientist's goodies, as usual. His CD equalizer, he assures the world, proves that the CD medium is technologically fine, it's just that recording engineers don't know what they're doing with it yet. This reporter was not inclined to believe him, yet had his mind changed by Carver's demo. Time to go back to school, o ye mixers of bright, cold, harsh CDs. Carver also showed a downsized power amp, 200 watts per channel RMS in a

cube two inches each way. He intends it for licensing.

The CD has never been the only digital audio format, though from birth it has been the one to bet on. VCR-based systems have finally caved in by the way-side, but now a little David of a company called CompuSonics challenged the CD Goliath from a little booth in McCormick Place's basement. Still, CD is going to be difficult to catch; the show made it obvious this disc is picking up momentum.

In other developments, Marantz showed a consumer cassette recorder with dbx, pitch control, good VU gauges, and good location background sound possibilities—it's only a little bigger than a Walkman, and runs \$500. This recorder can think of lots of uses. Ditto for a device not audio at all, but one that ought to come in handy for many a studio: copy machines (for paper, that is) are coming down in price to consumer levels; Canon showed one for \$800, five color, 3.5 cents/copy. In the computer arena, a program called "Songwriter" from Scarborough for Commodore systems looks promising. It teaches kids to read music and compose in three octaves.

And then the air conditioning gave out at McCormick Place On The Lake, and so we left The Humid City. ■

ALPHA STUDIOS NEW FACILITY DO IT, IN OUR WORLD

OUR NEW FACILITY
RECORDING, SWEETENING,
ADR, 1" C-format to 1" C-format
conforming, Dual 24 track lock up
to any combination of video or
audio, sound effects layover. All
audio post for video needs.
STAGE: 48x45x12. 1000 amps grid
production offices.
Lighting & grip equipment provid-
ed by:



World Radio History



4720 W. Magnolia Blvd.
Burbank, CA 91505
(818) 506-7443

Circle #096 on Reader Service Card

Best On Our Bookshelf

AN AUDIO / VIDEO / MUSIC INFORMATION SERVICE

The MIX BOOKSHELF is a catalog of recommended readings available through MIX Magazine by special arrangement with leading industry publishers. MIX has chosen and compiled what we consider to be the best—60 of the most informative audio, video, and music books currently in print. Now, it's easy to order these hard-to-find titles.



1) PRACTICAL TECHNIQUES FOR THE RECORDING ENGINEER, Sherman Keene

A down-to-earth instructional guide for the engineering/producing arts. Divided into 3 categories (basic, intermediate and advanced), the text is accessible and extremely useful to students at different levels of competency. Also available as a correspondence course and for school curriculums with Teacher's Manual, workbooks, and exams. 221 pp. \$29.75

5) PRACTICAL GUIDE FOR CONCERT SOUND, Bob Heil

This brand new 1984 edition covers the fundamentals of professional sound reinforcement, set-up and design, efficient speaker enclosures, mixers and equalizers, digital delays, compressors and limiters, microphones, other outboard gear, hardware and construction tips. \$10.00

6) SOUND SYSTEM ENGINEERING, Don & Carolyn Davis

This excellent volume offers a concise and encyclopedic treatment of the decibel notation system, loudspeaker directivity and coverage, the acoustic environment, acoustic gain, interfacing electrical and acoustical systems, installation, equalization, and instrumentation. Includes sample design applications. 295 pp. \$21.95

9) BUILDING A RECORDING STUDIO, Jeff Cooper, M. Arch., S.M., S.B., B.S.A.D.

A step by step guide to recording studio construction for small or large budgets. Covers principles of acoustics, how acoustics affect recording, soundproofing a room, plus chapters on the studio, the control room, and a glossary of the 100 most misunderstood terms in acoustics. \$30.00

15) DIGITAL AUDIO TECHNOLOGY, H. Nakajima, T. Doi, J. Fukuda, and A. Iga of Sony Corp.

Authoritative handbook covering fundamentals of digital PCM recording, audio and video disk systems. It deals with the nature and causes of code errors, low-pass filters, modulation and demodulation circuits, and analysis of future developments. Hardbound. 304 pp. \$18.95

28) VIDEO PRODUCTION GUIDE, Lon McQuillin

A broad overview placing continual emphasis on the human organizational aspects with lively, comprehensive coverage of both studio and location production from the viewpoint of the producer and director. Divided into four parts: pre-production, production, post-production, and other important topics. 382 pp. \$28.95

42) MUSIC APPLICATIONS OF MICROPROCESSORS, Hal Chamberlain

This superb volume comprehensively covers digital microprocessor sound and music synthesis including standard linear techniques, musical applications for the newer 16 bit micros in non-mathematical language, and all phases of waveform shaping and filtering as applied to electronic music generation. 661 pp. \$21.95

46) HOW TO MAKE AND SELL YOUR OWN RECORD, Diane Sward Rappaport

This thorough book offers technical information, practical tips, and business guidance for self-production. Every aspect of a recording project is covered, from planning and budgeting through sales and promotion. Includes sample forms and worksheets as well as advice on raising money and negotiating contracts. 167 pp. \$11.95

61) HOME RECORDING FOR MUSICIANS, Craig Anderton

Easy to follow and well illustrated, this book is written for musicians without extensive engineering experience. It emphasizes practical knowledge, techniques and tips including information on tape decks, mics, mixing, equipment and acoustics. 182 pp. \$14.95

DEALERS!

RETAILERS,
STUDIOS,
SCHOOLS, etc.

Now, MIX offers you a profitable way to include the BOOKSHELF as one of your customer services. And it costs you nothing!

Send for our dealer information package.

Best On Our Bookshelf

MIX Bookshelf, 2608 Ninth St., Berkeley, CA 94710

PLEASE SEND BOOKS TO:

NAME _____

COMPANY NAME _____

ADDRESS _____

CITY _____ STATE _____ ZIP _____

- Please send complete Bookshelf Catalog (FREE)
- Please send Dealer Information Package (FREE)

Book #	Qty.	Price
--------	------	-------

--	--	--

--	--	--

--	--	--

--	--	--

SUBTOTAL		
-----------------	--	--

\$2.00 postage & handling per book (\$3.00 outside US)		
--	--	--

CA residents add 6.5% tax		
---------------------------	--	--

TOTAL		
--------------	--	--

Check enclosed for total.

Bill to: VISA MC

Credit Card # _____

Exp. Date _____

Signature _____

Notes from Denver...

by Carol Kaye

I've been writing this column for about a year now and, although I've gotten a number of very nice comments from readers, a few have suggested that perhaps I do a little too much name dropping. Well, that's probably true. But let me explain a little about where I'm coming from. You see, when I started playing electric bass in the L.A studios in the early 1960s, there was a very special situation just beginning to happen. It was the beginning of the recording industry as we know it today...the multitrack industry.

The concept was new to everyone and I was fortunate enough to be in the right place at the right time, and to end up doing a lot of session work that contributed to many hit records that we all love. It was a great privilege to do this, and certainly a highlight of my life, and I feel kind of an obligation to let people know a little more about that time and about the origins of multitrack recording, as seen through the eyes of a session player in the early days. I also feel that there are many people who were important to the industry back then who were not fully recognized for their contributions, and if there is anything I can do to spread the word about their good work, then I'm also honored to do that.

But I guess most of all, if I'm trying to find a reason for my name-dropping, it's because those people were much more than business associates to me. Those people were my friends, my family...the people I loved and cared about. Those people meant the world to me and I love to have the chance to talk about them and to share their contributions with the people active in the studios today.

These days I'm living in Colorado, occasionally working with the Denver Symphony. I don't see much of a lot of my old friends anymore, except when I'm on the road or they're passing through Denver on tour. Recently I dropped in at the Turn of the Century club to see my wonderful old friend Lou Rawls. Lou and I met back in 1958 and, coincidentally enough, it was the first recording session for both of us. The date was for Sam Cooke, Jesse Belvin and J.P. Alexander, who had a group called the Pilgrim Trav-

elers. These nice people got me hooked on recording...they made it fun.

Lou pulled out a cassette and played me some of his latest albums, recorded mostly in Philadelphia at the Gamble-Huff studio, with some of the work being done in Memphis. Lou has always been a musician's singer and it was great to hear that his voice was better than ever. The record was beautifully produced, with terrific arrangements and showcasing Lou's belting vocals in a synth-dance groove. I don't know what the album will be called just yet, but I recommend keeping an eye out for it. Also look for Lou to be debuting his acting career in the near future.

Another friend I bumped into recently was Lionel Newman, vice president of the music department at Twentieth Century Fox Studios, in Hollywood. I had worked with him on soundtracks for many TV shows, like M.A.S.H. and Room 222, and this time I had the special treat of working under him as guest conductor for the Denver Symphony. His famous nephew Handy, who

I did some recording with many years ago, played the second half of the show. Randy's zany, high consciousness music must have had an impact on Denver, a very conservative city that deserves to be shaken up every once in a while by people like Randy.

I criticize Denver some, but I am very impressed with the quality of the Denver Symphony and the way that the city supports it. Boettcher Hall is a very artistically designed hall for the orchestra that has a few acoustical problems. Though trying to get a good blend between an electric bass and seven acoustic basses is a bit of a problem on any stage. I get along with the players very well though. The horn players have their typical sense of humor, just like in Hollywood, and the rest of the outfit is composed of fine players who are really nice people.

L.A. will always be my home, though, and I'm looking forward to getting back. In fact, I'll be producing an LP there shortly and I'll let you know how that goes. I can hardly wait. ■



Lou Rawls in Ardent's Studio, at work on "Close Company," a cut for his upcoming album. Seated, left to right: David Porter, writer; Joe Hardy, engineer, Lou Rawls. Standing behind: Donald O'Connor, writer; Henry Bush, assistant engineer.

THE TIME MACHINES

from **Garfield Electronics**

It's time to score. Sequencers, synthesizers and drum machines need to synchronize. Easier done than said when you've got The TIME MACHINES from Garfield Electronics. With The TIME MACHINES monitoring and synchronizing your system to film or video, everything clicks.

SYNC TO THE CLICK.

With DOCTOR FLICK, all makes of sequencers and drum machines simultaneously sync to click tracks thru their clock or sync inputs, including Roland, Oberheim, Sequential Circuits, Linn, Korg, Moog, Fairlight, Synclavier, E-mu, Wave PPG, MXR and even MIDI-ized sequencers and drum machines that sync to tape.

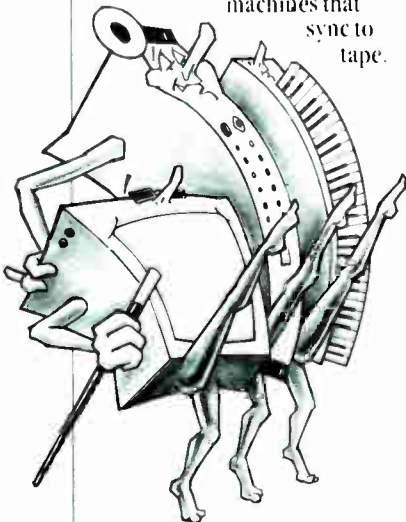

Built into The Good Doctor is the most accurate and versatile metronome in the industry, generating click tracks in 24, 25 and 30 frame per second calibrations with 32nd frame resolution for film and video production.

And from audio sources, DOCTOR FLICK generates individual triggers for arpeggiator, gate and individual drum trigger inputs. \$1195.00

FINE TUNE THE "FEEL".

The difference between a pushed or laid back "feel" can be just a matter of milliseconds when the timing of two drum machines, arpeggiators or

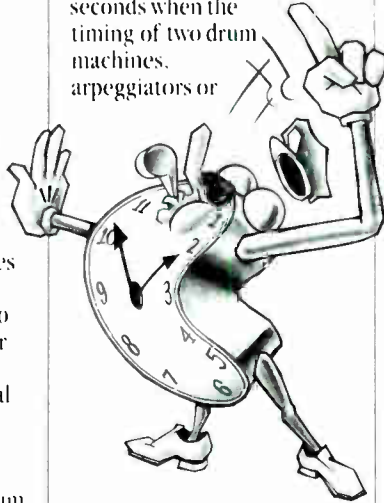

sequencers is even slightly offset.

The high resolution stereo CLOCK DELAY gives you the opportunity to compensate these offsets by fine tuning timing between instruments till you have just the "feel" you're after. \$495.00

CONTROL YOUR SHAKE, RATTLE AND ROLL.

Assume more control over your electronic rhythm section with The MODULATOR original Live Rhythm Sequencer. Programmable Trigger controls arpeggiator, gate and drum machine trigger inputs with auto-corrected rhythm patterns you can create, edit or add to on the fly. And it's Triggered Rhythm Envelope modulates



synthesizer VCA, VCF, VCO, Filter, Amplifier and Vibrato inputs in perfect beat with your system. \$495.00

CHECK YOUR PULSE.

Metering the various clock rates of your instruments is a job for THE TIMEBASE METER. With it, DOCTOR FLICK

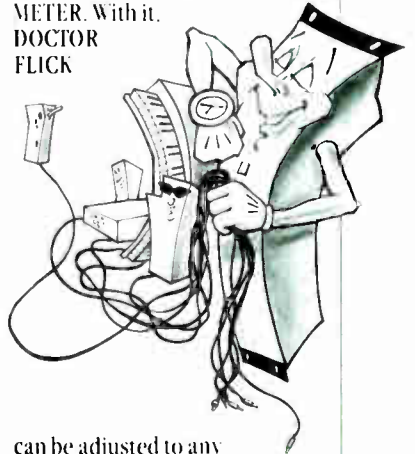

can be adjusted to any timebase, and with a CLOCK DELAY, it shows when the timing of two machines is perfectly aligned. It also serves as a pulse counter and tape sync code adapter, and is ideally suited for studio work. \$395.00

If your music ought to be in pictures you ought to apply the power of The TIME MACHINES.

The CLOCK DELAY, MODULATOR and TIMEBASE METER enhance Doctor Flick, Doctor Click Rhythm Controller or Mini Doc Synchronizer based systems. For more information on the complete line of TIME MACHINES, or the name of your nearest dealer, call or write:

Garfield Electronics

P.O. Box 1941, Burbank, California 91507
(818) 840-8939

© 1984, Garfield Electronics, Inc. TIME MACHINES, DOCTOR CLICK, MINI DOC and DOCTOR FLICK are registered trademarks of Garfield Electronics, Inc.



Our Only Business Is Getting Your Act Together.

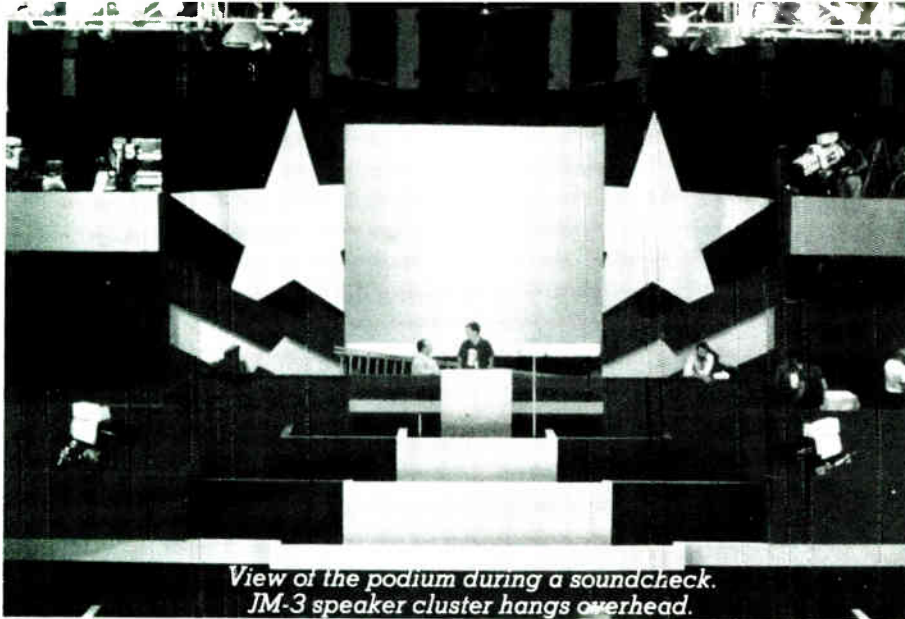

View of the podium during a soundcheck. JM-3 speaker cluster hangs overhead.

SIGHT AND SOUND FOR THE 1984 Democratic Convention

by George Petersen

While the actual measure of the success of this summer's Democratic National Convention will be put to the ultimate test this November, the technical aspects of the event—in the areas of both sight and sound could best be considered as a victory for everyone concerned. Yet throughout the four-day spectacle—with all its hype, hoopla, electronic wizardry, and even an occasional bit of real emotion thrown in—the average home viewer would never realize the months of planning and hard work required to pull off such a polished production. No detail went unnoticed, from the huge Eidophor screens flanking the podium to the extensive fiber optics network which linked the candidates' and delegates' hotels with Moscone ground control central. All in all, the task of transforming the 275,000 square foot exhibition center into the temporary headquarters of the Democratic party proved to be a task of truly gargantuan proportions.

The actual planning began a year earlier, as the San Francisco Convention and Visitors Bureau met with

members of the Democratic Convention Site Selection Committee, who toured the George Moscone Center and were impressed with the facility's unique design which boasts the equivalent of six football fields of column-free floor space. A sound system and temporary stage platforms brought in for the occasion gave committee members a positive feeling that the hall was a good choice.

Eventually, San Francisco was given the nod, and a convoluted set of contracts were drawn up to provide all the required services through a veritable army of subcontractors. A.J. Construction was named as the general contractor, and they subcontracted all the sound, lighting and staging work to rock promoter Bill Graham's former production company, FM Productions (now under the direction of Tommy Mendenhall.) FM provided all the lighting and staging, while Harry McCune Sound Service was selected to take care of sound (both live and media feeds), teleprompting systems, video projection, intercommunications, and hundreds of separate coaxial antenna drops. McCune later subcontracted the teleprompting to Al Eisenberg of Q-TV, and World Stage provided the four Eidophor screens. Pacific Bell (the West Coast telephone company) ran fiber optic cables interconnecting all but one of the city's major hotels with the convention center for the two-way transmission of live video sig-

nals, the in-house convention program, cable services, and both audio and data transmission feeds.

One of the first systems to be installed into the center was the lighting, provided by FM Productions of nearby Brisbane, California. Television broadcast requirements dictated a lighting level of 125 foot-candles on the floor, necessitated the rigging of approximately 600 feet of lighting truss and hundreds of instruments.

The video projection contingent consisted of two Eidophor High Brights (high intensity units placed on either side of the podium) and two Low Brights placed farther back. These units were fed various signals which included a couple of camera feeds, the network video pool (supplied by ABC), a computer displaying the automatic voting results, several VTRs and a graphics generator.

Mort Feld, the general manager of McCune Audio, the San Francisco-based sound contractor which has done numerous shows at the Moscone Center, emphasized that the Democratic Convention was no ordinary event, especially in terms of the unusual microphone requirements. "The 60 delegate microphones were run through a sophisticated priority switch, so only one could be turned on at a time," he explained. "When that mike is on, there were two indicators at the podium that showed which mike had been recognized.

"There were also mikes for the entertainment and orchestra, and all those were transformer split and fed into two mixers which were always on line and kept with the faders in the proper positions at all times, so if something happened, we could instantly switch to the other mixer. We designed complete redundancy into the system: you can't be too careful.

"In addition to that, the console outputs were split in various other ways, such as providing a feed for NBC, who was responsible for the audio pool. NBC, in turn mixed our feed with audience mikes and distributed it to probably hundreds of media people. The responsibility for the audio pool is rotated every year—this year NBC handled the audio and ABC handled the video pool. ABC had the responsibility of providing all the cameras in the major positions, and then each network could switch between the pool and their own cameras."

McCune selected Shure microphones for the convention, using mainly SM-57s and SM-58s on the floor and SM-81s on the podium. "The networks were particularly happy with the sound of the 81s, and the 57s and 58s were perfect for this job—they're rugged, dependable and you know exactly what to expect from them," Feld notes. But one rather unexpected microphone application arose during the convention set-up:

the need for a mike to amplify the sound of the gavel. This was accomplished by attaching a lavalier microphone to the wood block which the gavel strikes.

The main sound system was comprised of two McCune MC-9 boards which were developed by the company, and two 32-input Soundcraft consoles, one of which was loaned to the convention by Soundcraft. Feld commented that the MC-9 mixers had been road-proven after numerous tours all around the world with various artists, but he also felt good about the Soundcraft consoles: "They're hot and we like them—they're quite nice. But most importantly, they're rock steady, and that is one of our key requirements for this show."

A combination of Crown and Hafler amplifiers provided the punch for the thirty John Meyer-designed JM-3 three-way, one box loudspeakers which were set in five clusters around the room. Six were hung in an arc over the podium, two stacks of six were placed at either side of the podium (these were delayed approximately 4 ms) and clusters of six were positioned at the far ends of the hall, delayed between 200 to 250 ms to provide sound for the "end zone" guest seating risers.

However, the sound requirements for the convention did not end with the needs of the people inside the

The fiber optic cable at right has 100 times the carrying capacity of the 3½ inch copper cable shown at left.

center, as McCune was also contracted to provide sound and audio press feeds for the protest stage, located in a large clearing across from the Moscone Center. The stage was made available by the San Francisco Police Department, in anticipation of the numerous protests which were slated to occur during the convention.

Feld feels that despite all the hard work, and months of planning, the convention was well worth it, for everybody concerned. "The hours, weeks and months of meetings got to be a little nerve-racking; and after a while we offered to do the job for free if they would just pay us for the meetings, but we could never swing that deal," he commented wryly. "It was a tremendous chore to complete all the logistics of getting the job, and before the convention there were some doubts as to whether the hall was really a viable site. But the television screens made every seat a good seat, the sound was clean and clear, and we think San Francisco did a good job because we're the city that knows how." ■



FIBER OPTICS SHINE AT THE CONVENTION

An interesting aspect of the media-tication of the Moscone Center into a high-tech communications complex was Pacific Bell's extensive use of fiber optics to handle the flood of television signals into and out of the convention. In comparison to the ten video circuits required to air the latest space shuttle landing at California's Edwards Air Force Base, the convention coverage needed nearly 100 video lines originating from the center.

John G. Harrison, coordinator

AT LAST, within your grasp . . .



700 Watts of Pure MOS-FET Power

Sound Code Systems, P.O. Box 2198, Garden Grove, CA 92640 (714) 554-0903

Circle #098 on Reader Service Card

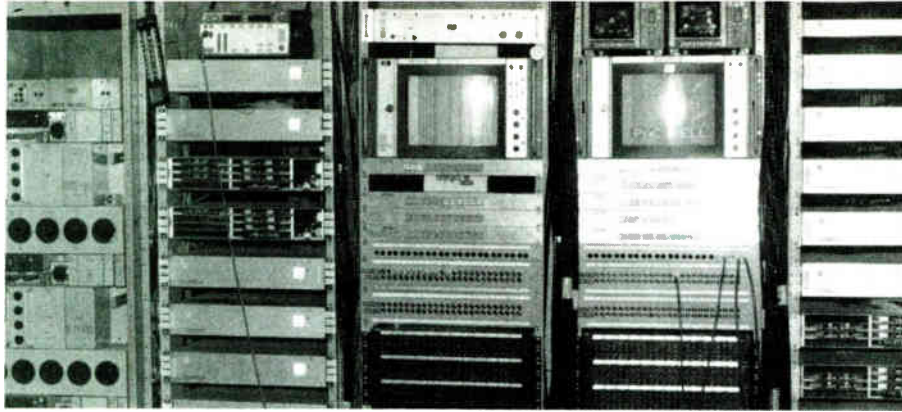

Fiber optics control room at Moscone Center. Two racks of Grass Valley Wavelink units flank the monitoring switching system and normalled patchbay. The rack at far left housed the electronics for the coaxial feeds from the single hotel which refused to allow a fiber optical installation. The Wavelink racks handled over 74 channels of signals.

of Pacific Bell's Democratic Convention Project, felt that fiber optics provided the only viable solution to the unique situation in San Francisco. "The age of the city creates problems," Harrison explains. "The streets are old, so many buildings are old: we're wedging cables and wires into cramped and congested places, already difficult to access. It's not like laying out a system in a new city—instead, we're fitting facilities equivalent to those required for a small city into an older and well-established metropolis."

Using fiber for communications transmission during the convention enabled the system capacity to expand considerably. By transferring signals via glass fiber, the 96,000 bits per second handled by copper can be pushed to 1.5 megabits. An analogy would be that the entire contents of the bible could be sent through fiber optics in less than a second—through copper cable, the same process would take over half an hour.

Pacific Bell ran 600 miles of fiber optic material to augment the exist-

ing fiber optic rings circling the city. The cables carried video, audio, and data feeds between the convention center and almost all of the city's major hotels. The 1.5 million dollar cost of the job was borne by Pacific Bell, who recouped a good portion of their initial investment by selling off some of the equipment after the convention.

Western Electric manufactured the fiber optic lines used in this particular installation, and from all over the city, the cables were snaked through orange fire-/crush-proof corrugated liners to a Fiber Optic Interconnection Terminal located deep within the dark recesses of the convention hall. Here the optical cables, (each having 12 ribbons with 12 fibers per ribbon—each fiber having the capacity of carrying one video signal and two audio lines) were then routed to a main switching/encode-decode/monitoring room. The fibers were then each assigned to two racks containing 74 channels of Grass Valley Wavelink processors which converted the incoming optical signals to electrical form to be routed to the various networks and press feeds. Conversely, outgoing signals were converted to optical via the Wavelinks and were sent out to the hotels (which were equipped with encode-decode units) for remote feeds to and from the center.

—George Petersen

WE DO IT ALL—IN HOUSE

ALSHIRE mastering studio . . .

The Alshire Mastering Studio features the latest state-of-the-art equipment. Neumann VMS-70 lathe with JVC Quartz-lock servo motor—turntable and motor are direct coupled for extremely quiet, rumble free rotation. A Neumann SAL 74-B totally transformerless drive system, with Zuma Disc Mastering computer. A JVC transformerless console led by an MCI tape deck, using matching JVC transformerless electronics. Equipped for DBX and Dolby. Facility for both "real" time and "half speed" mastering. Latest equipment for cassette duplicating running masters.

ALSHIRE cassette tape duplicating . . .

Alshire's Newest Addition! The industry's newest and most refined cassette tape duplicating equipment installed in an air conditioned and humidity controlled laboratory—the Gauss 2400 system—ten slaves and two master loop bins. Constant quality control, we use only top brand quality duplicating tape. All running masters made in our in-house studio using only state-of-the-art equipment and highest quality tape. Alshire uses only the finest quality cassette shells to insure better azimuth control and tracking. We have the best automatic cassette loaders and the latest automatic direct to cassette label printer with automatic film wrapper and shrink wrap. Cassettes packed 30 to the master carton and sealed on pallets to prevent pilferage.

ALSHIRE record pressing plant . . .

Completely automatic twelve inch and seven inch record pressing. We use only 100% pure vinyl compound on all records pressed—thorough and complete quality control and inspection before production leaves the plant. In-house label printing at your service. Albums are shrink wrapped and placed in master cartons—then sealed on pallets to prevent pilferage. Constant monitoring of all exits to insure security.

AND professional assistance in art layout, printing, packaging, and anything you need for quality on time service.

ALSHIRE

Custom Services

Mail or phone for FREE brochure and price list.

ALSHIRE INTERNATIONAL, INC. 1015 ISABEL STREET • P.O. BOX 7107 • BURBANK, CA. 91510
(213) 849-4671 • 1 (800) 423-2936 • TWX: 1-910-498-2759

Circle #099 on Reader Service Card

PREVIEW

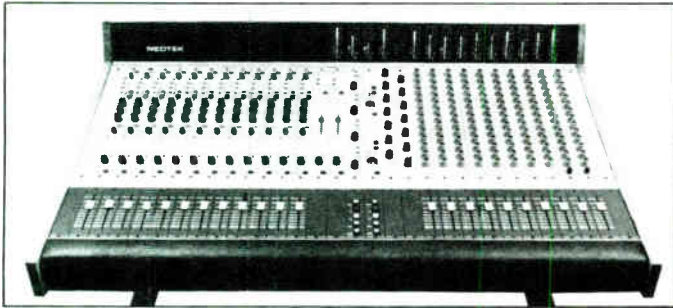

Neotek Theater Consoles

Neotek Corporation has expanded its line of mixers with a Theater Systems Console, designed specifically for theater/auditorium sound reinforcement and recording applications. The new board is available in a large number of input/output configurations. Each input module accommodates two microphones and a balanced line, and the console also provides four equalized auxiliary bus masters; two echo return modules; fourteen preset masters on two modules; two output masters for operator monitoring; and a rack mounted external power supply.

All major inputs and outputs are transformerless balanced with switchable phantom microphone power. Frames can be profiled for either table top or freestanding console installations. A variety of options can be ordered, including: input module insertion patch points and direct outputs; additional metering; integral patchbays; tape machine remote control panels; and VCA grouping.

Circle #156 on Reader Service Card

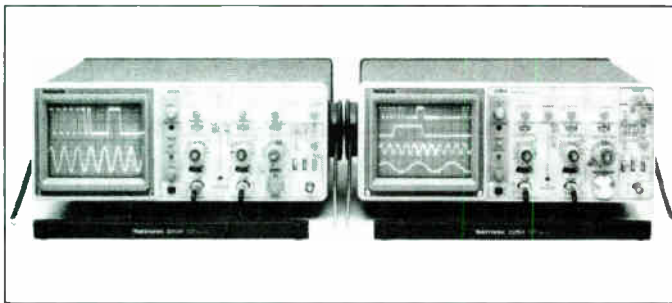

Tektronix 60-MHz Portable Oscilloscopes

The 60-MHz bandwidth 2213 and 2215 portable oscilloscopes by Tektronix, Inc. have been upgraded to incorporate over 25 new feature and specification enhancements, including brighter displays, greater accuracy, and more sensitive triggering. In addition, manufacturing advances make it possible for Tektronix to offer the improved 2213A and 2215A scopes at the same price as the earlier versions—the 2213A will sell for \$1,200; the 2215A is priced at \$1,450 (U.S. base prices).

CRT brightness on the new "A" versions has improved by 40 percent, resulting in sharp, crisp traces at even the

fastest sweep speeds. This makes the new scopes especially useful for testing and video troubleshooting applications. Vertical range, while sweep accuracy (in 10X) has increased from 5 percent to 4 percent, also over a wider temperature range. Trigger sensitivity has increased in both internal and external A trigger and in the B trigger on the 2215A as well.

At 12.8 pounds for the 2213A and 13.5 pounds for the 2215A, these new "A" versions are said to be the lightest 60-MHz scopes on the market. Like all 2000 family oscilloscopes, the 2213A/2215A are covered by Tektronix' three-year warranty on labor and parts, including the CRT. Service plans are available for up to five years in most countries.

Circle #157 on Reader Service Card



Otari EC-101 Synchronizer Module

The EC-101 is a high-performance, in-machine synchronizer module designed for MTR-90 Series transports. When fitted with an EC-101, the transport is capable of maintaining frame lock in both forward and reverse directions from .2 to 2.5 times the play speed and will park within 2 frames (typically within "0" frames) of the master machine.

The EC-101 simply plugs into an open space in the electronics bay of any Series II MTR-90 Master Recorder, and is the first in a series of synchronizers specifically designed to optimize the transport performance of all MTR series recorders. Its preliminary features include a "Digital Widelock" which maintains phase lock of ± 50 percent play speed range; gate array-based longitudinal time code readers operating from $\frac{1}{25}$ to 60 times play speed using time code recorded at 15 ips; selectable external speed reference; offset storage in $\frac{1}{60}$ th frame increments; and an RS-232C interface port.

Otari expects to begin deliveries on the EC-101s in January of next year, and the price is listed at under \$3,500.

Circle #158 on Reader Service Card

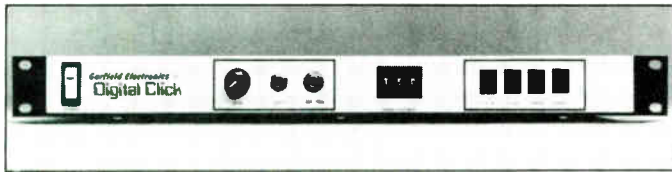

Garfield's Digital Click

Garfield Electronics has introduced the Digital Click, an advanced metronome for film and video production that provides clicks in 24 frame per second calibration for American film rate, in 25 frame per second calibration for European film rate, and in 30 frame per second for video frame rate. Tempos in all three calibrations can be specified with $\frac{1}{2}$ frame resolution. The unit features front and rear mounted jacks for external triggering and click output, and can drive headphones directly. List price is \$595.

Circle #159 on Reader Service Card

Wide Band 35mm Optical System

American Theatre Products, of Hollywood, California, has created the first packaged sound system with a demonstrable improvement in theater sound, designed to optimize the reproduction of monaural optical academy soundtracks. Rather than merely wiring together off-the-shelf audio components, "The System" is a total approach solution to this long-standing problem for the theater owner. The System starts with a voltage regulated exciter lamp power supply and includes a dual constant-current high speed solar cell preampli-

fier with full gain control. This drives the slope equalized bi-amplifier with its own tuned-room equalized, electronic cross-over network, with output to the built-in booth monitor. This preamp/power-amp combination delivers up to 750 watts RMS of power to the matched speaker system.

The System is available in four different basic applications: a small theater/auditorium (up to 100,000 cubic feet); large theater/auditoriums (up to 160,000 cubic feet); auditoriums over 160,000 cubic feet; and screening rooms with optical and magnetic playback. The System VLF (Very Low Frequency) subwoofer system is optionally available.

Circle #160 on Reader Service Card

Conquest Multitrack Wiring Systems

Conquest Sound, of Orland Park, Ill., offer two lines of multitrack interface cables for both professional and semi-pro applications.

Available in four, eight and 16 channel versions, the economical Series II Multi-cables feature individually jacketed color-coded lines that are individually shielded. The fan ends are 1 1/2-feet on the four and eight channel versions and 3-feet on the 16 channel version. Styles include RCA-RCA, RCA-1/4, and XLR-XLR, in five, ten, 15 and 20 foot lengths.

The Pro-MT line features Conqueror multiple pair wires terminated with Switchcraft connectors and number coding. The double fan ends are 2-feet at each end with a 40-inch span. (Longer fans available on request.) Pro-MT multi-cables are available in the following configurations: XLR-XLR, XLR to 1/4-inch, XLR-RCA, 1/4-inch by 1/4-inch, 1/4-inch to

Hear us out.

From full turnkey to budget production studio, we offer an extensive equipment selection equaled only by our technical expertise.

REALLY?

From 24 tracks on down, we specialize in the finest new and used studio equipment -- and we've got more of it than anyone else in the Southwest.

YOU DON'T SAY.

Yes, we do. All you had to do was *listen*.

OTARI SOUNDCRAFT TRIDENT
 LEXICON NEUMANN AMEK 3M
 QUAD EIGHT TASCAM AMPEX DBX

e.a.r.

PROFESSIONAL AUDIO

2641 East McDowell
 Phoenix, Arizona 85008
 (602) 267-0600

Circle #100 on Reader Service Card

RCA, and RCA-RCA. Available lengths are 10-foot, 15-foot, and 25-foot. Custom lengths and configurations available on request.

Circle #161 on Reader Service Card

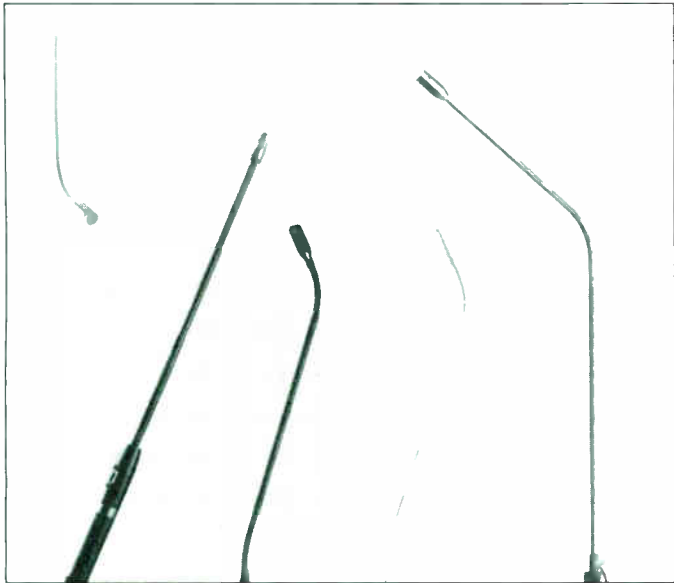

Audio-Technica UniPoint Microphones

Five ultra-low profile back electret condenser microphones—the AT837, AT853, AT855, AT857, and AT859—are the initial members of the Audio-Technica UniPoint series which, according to the manufacturer, are said to reproduce sound with minimal coloration and may be used at considerable working distance from the sound source. This feature, coupled with their slim, unobtrusive outlines, makes them a good choice for miking lecturers or entertainers, as well as choirs and similar sound sources.

The five microphones in the UniPoint series are designed to meet a variety of applications from stand or lectern mounting, a hand held wand mike, or an inconspicuous hanging position. All of the UniPoint microphones feature broad, flat response curves and all are balanced low impedance. Each member of the new series may be used with a 30 VDC source, single-ended with out a power module or with any 9-52 VDC phantom power source. In addition, the hanging and wand models may be used with a self-contained 1.5 volt battery.

Circle #162 on Reader Service Card

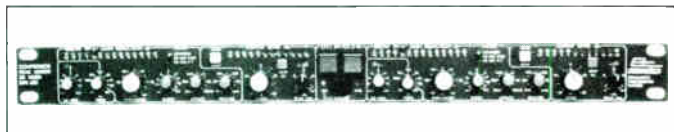

Brooke-Siren DPR 402

Klark-Teknik Electronics Inc., the U.S. importer of Brooke Siren Systems products, have introduced the DPR402 compressor peak limiter/de-esser. The unit combines two channels of compressor/limiter, de-esser, and peak limiter in one standard rack space. The flexibility of the design allows all these units to be used at the same time or separately. A rear barrier strip allows connections for side chain insertion, pre-emphasis strapping, conversion of the compressor to an expander, and other frequency-conscious compression effects.

The compression ratio is adjustable from 1:1 to infinity.

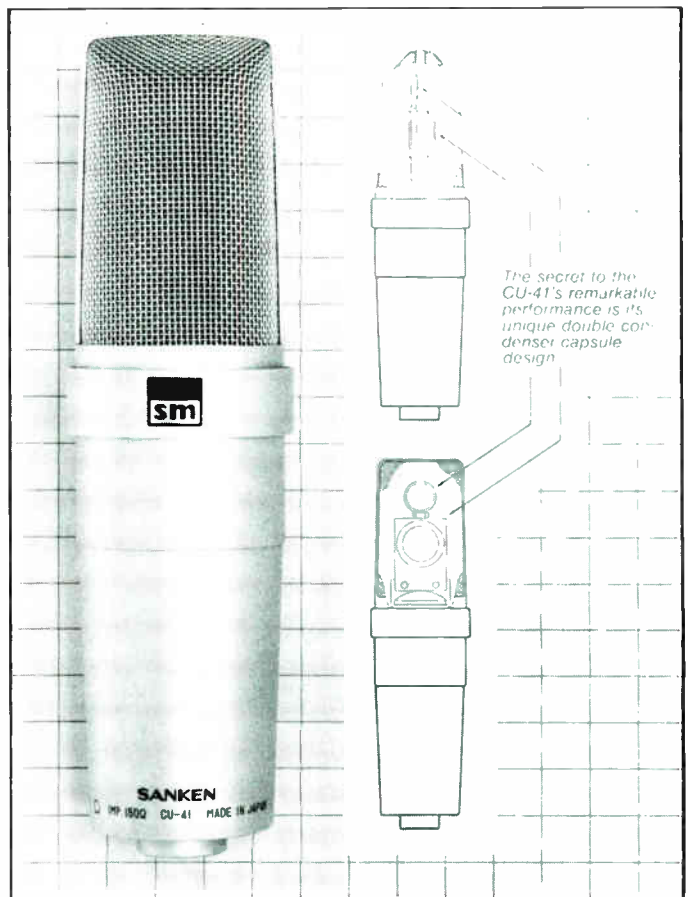

The secret to the CU-41's remarkable performance is its unique double condenser capsule design.

SANKEN PICKS AUTHORIZED DEALERS

New York, Nashville and L.A. companies to market new CU-41 microphone.

Sanken Microphone Co., of Japan, proudly announces that it has selected three authorized dealers to market its CU-41 uni-directional, double condenser microphone and its related accessories in the U.S. The CU-41 is one of the first microphones in the world that can unlock the full potential of digital audio recording. The U.S. dealers for the CU-41 are:

New York: Martin Audio Video Corp.
423 West 55th St., N.Y., N.Y. 10019
TEL (212) 541-5900 TLX 971846

Nashville: Studio Supply Company, Inc.
1717 Elm Hill Pike, Suite B-9, Nashville, Tenn. 37210
TEL (615) 366-1890

Hollywood: Audio Industries Corporation
1419 N. La Brea Ave., Hollywood, Calif. 90028
TEL (213) 851-4111 TLX 677363



Japan's most original microphone maker

Sole export agent Pan Communications, Inc.
5-72-6 Asakusa, Taito-ku, Tokyo 111, Japan

Telex J27803 Hi Tech/Telephone 03-871-1370
Telefax 03-871-0169/Cable Address PANCOMMJPN

Circle #101 on Reader Service Card

ty with variable and auto positions for attack and release control. The de-esser section is frequency selective from 700 to 20k Hz broadband of HF with the additional facility of split-band limiting using the de-ess filters of both channels. The peak limiter has a variable threshold of switchable fast or slow dynamics. The DPR402 can be linked for stereo operation and in addition to the barrier strips on the rear panel, XLR-type input and output connectors are standard.

Circle #163 on Reader Service Card



EDCO Magna Markers

EDCO Magna Markers are flexible magnetic labels for marking instrument and vocal inputs on mixing consoles without resorting to the usual masking tape and marking pens. These highly visible tags, with silk screened lettering come in several color combinations and are available in a wide assortment of instrumental combinations: country, rock, pop, gospel and user-assignable blanks.

The marker sets range in price from \$4.95 to \$5.49, and a three-foot self-adhesive steel strip (retailing at 79 cents) is available for use on consoles with non-steel panels.

Circle #164 on Reader Service Card



Jan-AI Cases

Jan-AI Innerprizes, of Los Angeles, California, is a custom design firm manufacturing a full range of ATA, ultra-light, vulcanized fibre and regular fibre cases. All cases are available in standard configurations or with specialized custom options. Many designs are on file through Jan-AI's relationship with major manufacturers, such as the Fairlight road/performance case set shown above.

Circle #165 on Reader Service Card

Loft Series 600 Crossovers

The Loft Series 600 frequency dividing systems provide for switchable 18 and 24 dB slopes at all crossover points with linear response, low distortion and quiet performance. Other features include electronically balanced inputs/outputs, locking phone connectors and XLR connectors.

Transformers can be field installed or ordered from Loft. Plexiglass security panels with special tamper-proof hardware and drivers are available optionally.

Circle #166 on Reader Service Card

Comprehensive Location Mixer

The MX-1001, a compact, broadcast-quality portable mike mixer introduced by Comprehensive Video Supply Corporation, features three inputs with individual switch controls for line-level, mike-level and phantom power (up to 54 VDC), plus individual gain controls, low-cut filters and -20 dB attenuators. The back panel includes a 1/4-inch headphone output jack, headphone level control, and the XLR-type inputs and outputs.

Other features include a 1 kHz slate tone generator for balancing mike levels, an LED peak indicator and a large VU meter that can be switched to display all input and output channel levels, and a detachable pocket/belt clip. The mixer can be powered externally from a 12 VDC source or from three internal 9-volt batteries, which also provide 18 VDC phantom power for each input. The MX-1001 lists at \$599.95.

Circle #167 on Reader Service Card



Hill Audio Stagemix Console

Stagemix from Hill Audio is a rack mount 12 into 6 monitor console with sound quality usually associated with much larger, more expensive consoles. Utilizing the same circuitry and components as the M Series 3 monitor consoles, the Stagemix features: 12 input channels with transformer isolated parallel input XLR's that can be used as a splitter; 26 dB pad; three band equalization; PFL; mute; peak light and 6 rotary output sends.

The six output channels include transformer balanced outputs; send/return patch points; four band equalization; EQ defeat; PFL; AFL; mute; and smooth action 60mm faders with 12 step LED indicators on each output. The Stagemix uses a steel frame 19 inches wide, 14 inches high and 4 inches deep and has a rack mount, fully regulated remote power supply that is one rack space high. All modules are on ribbon cables and all op-amps are 5532's. Suggested retail is \$1999.

Circle #168 on Reader Service Card

CHECK OUR REFERENCES.

First trust your ears. Then trust the experts. That's a reliable way to judge speaker systems. Especially reference monitors.

We make this point because of the response our studio monitor speakers have received from recording engineers at top studios like A&M, A&R, Hummingbird, Universal and Westlake. As well as Yamaha's own music research and development facility and professional studio in Glendale, California.



Known for its exceptional accuracy and consistent response over a wide range of frequency, beryllium is the material of choice for our NS500M tweeter dome.

And that response has been extraordinary. Here's why: accurate reproduction.

Which brings us to the new NS200M and NS500M.

The NS200M is compact without compromise. It can easily handle the wider dynamic range and frequency response of today's sources. Its 10" pure spruce woofer

cone is made of the same material that goes into the soundboards of our fine pianos. Its titanium carbide dome midrange and tweeter produce crisp, clear highs. And its low-loss crossover makes sure signals get to the drivers unscathed.

The larger NS500M's 12" woofer is made from our exclusive carbon fiber technology. The result is a near-perfect balance between damping, rigidity and strength-to-weight. Which translates to remarkably natural bass response.

Our titanium carbide midrange approaches perfection in transient and frequency response, without break-up. And our beryllium dome tweeter reproduces extremely high frequencies with ease, accuracy and natural realism.

So check our references. Both the speakers and the experts. You'll like what you hear.



Our monitor speakers can give you the level of accuracy and realism pros have come to expect.



Yamaha Electronics Corporation, USA, P.O. Box 6660, Buena Park, CA 90622

Suggested U.S.A. retail prices—NS500M, \$385 each; NS200M, \$285 each



Circle # 102 on Reader Service Card

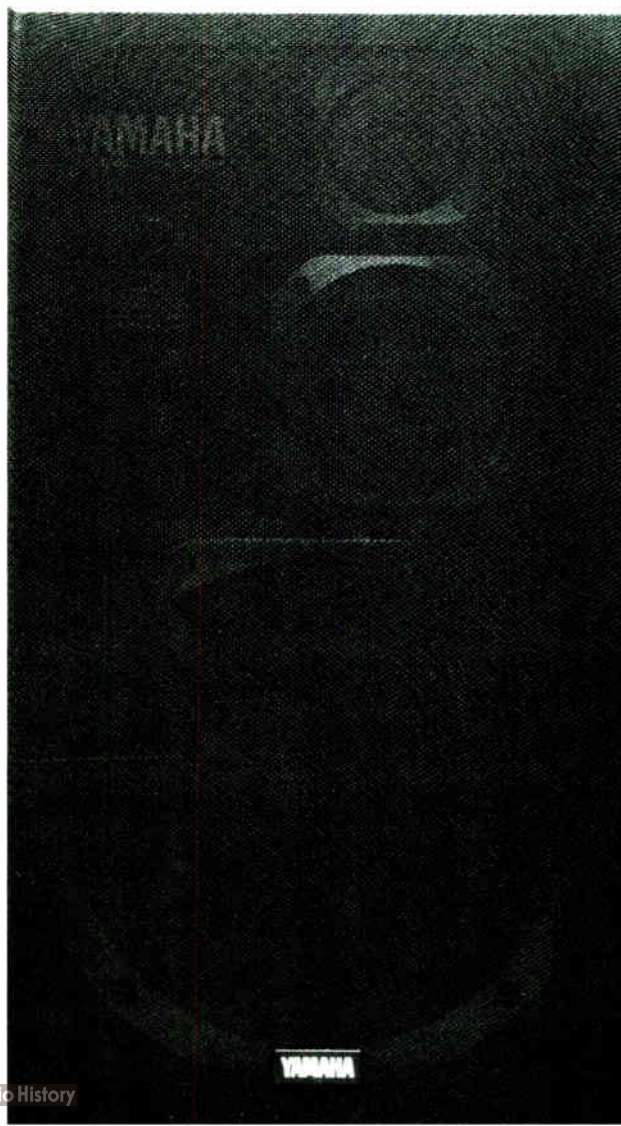

AKG "The Tube" Microphone

by Robert L. Missbach

AKG Acoustics introduced "The Tube" microphone in mid-1983. While tube microphone technology is an old art, this is definitely a new product, incorporating some components from yesterday with today's miniaturization and modern assembly techniques. It's also the only tube-powered microphone currently being produced.

The two primary components borrowed from the 30-year-old AKG C12 are the large double-diaphragm capsule and the preamplifier vacuum tube. The diaphragm is a large diameter affair designed after the CK12 but manufactured with a more space-age approach. It begins with a six micrometer polycarbonate "foil" which then receives a gold-sputter coating via a vacuum deposit process. The result is a capsule of lower cost which proves to be more temperature- and humidity-stable than the gold foil previously used.

The all-important tube used in the preamplifier is the original 6072, also used in the C12. And yes, this vacuum tube is still in production, which is welcome news for any maintenance engineer who has ever tried to find a replacement tube for most old and rare German tube mikes. The 6072 is shock-mounted within the lower portion of the microphone housing and is easily replaced in the field.

The power supply, referred to as the N-Tube, connects to the microphone via a 30 foot cable fitted with 12-pin Tuchel connectors. The N-Tube provides a 3-pin XLR connector for audio output (positive voltage on pin 2!), and two selector switches for remote control of response pattern and bass roll-off. The pattern selector has nine positions: omnidirectional, cardioid, figure-eight, and six intermediate steps, and may be adjusted silently while the microphone is in use. The bass roll-off switch has three positions: off (bypass), and 75 Hz and 150 Hz cut-off points, each having a 12 dB/octave slope. The N-Tube also provides an AC on/off switch and LED indicator. The power supply fuse is located inside on the PC board, and a second fuse may be repositioned to allow cable runs of greater than 60 feet.

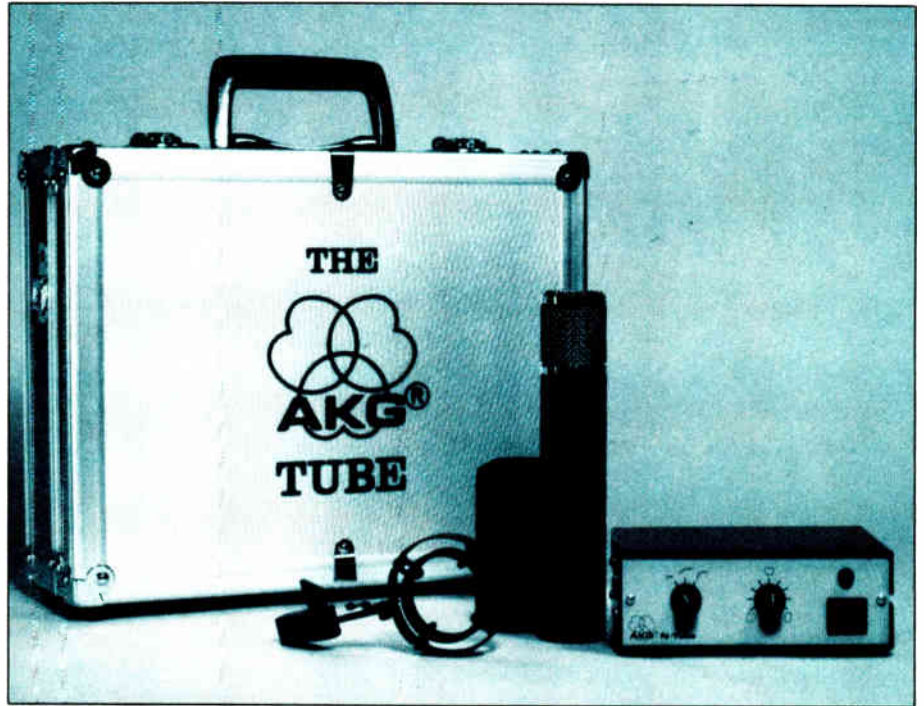

AKG's "The Tube" microphone comes with "N-Tube" electronics package, shock mount, foam windscreen and flight case.

The microphone itself has only two controls. Externally, an attenuator may be switched in for either a 10 dB or 20 dB pad between the capsule and the tube preamp. Internally, three tiny PC board switches will increase the nominal sensitivity by 10 dB. "The Tube" is shipped in a rugged foam-lined flight case with storage space for the N-Tube, cable, and accessories, which include a foam windscreen and an H-15 elastic suspension.

Now that we know *what* it is, how does it sound? Granted, there's nothing more individual than an opinion of a microphone's performance. And I'll admit that I've found AKG's C414EB to be the most versatile condenser I've used: it's frequently the first one I'll try for most vocals. So my first assignment for "The Tube" was a male vocalist. The first thing I noticed was the foam windscreen is practically useless as a pop filter. But the richness of "The Tube's" response was startling. I found that the singer could work a little further back without losing the warmth of proximity. As with most large-diaphragm condensers, breath pops can be a real problem when working close to the mike. The response of "The Tube" requires 3- to 4-inches more to avoid this with most vocalists. On a later session with a different singer, I resorted to the old nylon-stocking-on-the-coat-hanger trick, which proved

successful. But I found in general that the proximity-effect is not as pronounced as with other microphones. The singer usually prefers not to "eat" the mike. Also, he's freer to move around with a little distance. On the occasion when he moves off-axis in his enthusiasm, try opening the polar pattern a bit more from cardioid to omni. No loss of response, but a lot more freedom.

The next thing I noticed was what I perceived as the lack of mid-range "bite" I'd gotten used to with older tube models. Some models are so peaky that they are unusable on many vocalists. But then I realized that "The Tube" wasn't lacking any mid-range—it was picking up all the highs and lows the others were missing. No need to add any highs for that silky breathiness: it's already there. Too much bass? Back off a little. Another thing: the output from the N-Tube is very high—practically line level. With the mike's pad turned off, I had a 20 dB pad in on the console with its mike preamp all the way down, and with the channel fader at unity gain, I still had enough peaks left over to wiggle an LA-2A limiter on the way to the tape machine.

Back-up vocals was the next test. The studio we were in sounded a bit too "roomy" with the polar response in omni, so I picked the figure-eight setting. I got a good mix of four singers farthest

When Choosing Quality The Choice Is LEMO Electronic Connectors



LEMO Audio-Video Connectors

Designed to maximize communication capabilities within a minimum of space. Available in coax, triax, multipin and mixed coax-multipin configurations.

RELIABILITY: Positive locking mechanism and gold plated contacts assure consistent signal transmission to 1.5 GHz.

SPACE SAVINGS: Only finger clearance needed to engage and disengage connectors. No need to twist or turn locking ring.

RUGGEDNESS: Connector components are precision machined. Locking mechanism is totally protected by outer shell, virtually eliminating accidental disconnections and damage to locking mechanism, cables and contacts.

SPEED: Connectors engage and disengage simply and quickly by pushing and pulling axially on the outer shell of the plug.

Over \$1 million inventory stocked in Santa Rosa, California, sold by a network of representatives in North America

For technical data and catalog, as well as the name of your local representative, please call or write LEMO U.S.A., INC. (707) 578-8811, TELEX 340-933, P.O. Box 11006, Santa Rosa, California, 95406.





THINKING ABOUT CASES? CONSIDER THESE:

A.T.A. Airline Approved / Heavy Duty LITE / FLITE For The Around Town User

FIBRE For Your Drum Cases, Etc.
CUSTOM CASES Our Speciality

A TOUGH CASE TO BEAT!

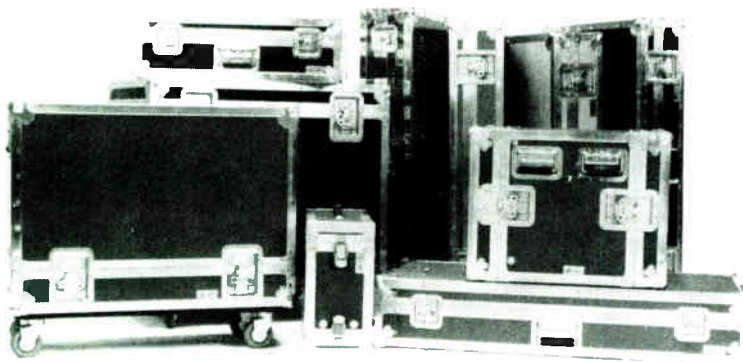

(213) 466-6181
1111 N. Gordon St., Hollywood, CA 90038

Circle #104 on Reader Service Card

990
Discrete
Op-Amp

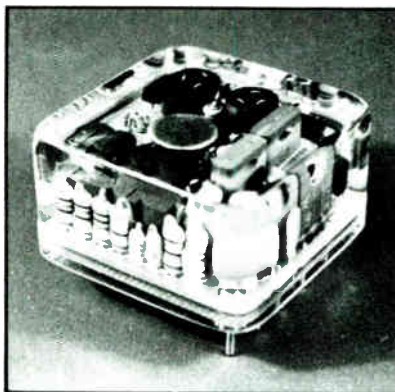

Electrical Design by Deane Jensen
Packaging & Production Design by John Hardy

- **Fast:** 18V/ μ S @ 150 Ohms, 16V/ μ S @ 75 Ohms
- **Quiet:** -133.7 dBv E.I.N. (20—20kHz, shorted input, unweighted)
- **Powerful:** +24 dBv @ 75 Ohms (Ref: 0dBv = .775 V)

AND IT SOUNDS GREAT !

THESE USERS AGREE:

Sunset Sound, JVC Cutting center, Mobile Fidelity, K-Disc Mastering, Sony (Digital Audio Div.), Capitol Records, Inc., WFMT Chicago, Jensen Transformers, Bonneville Productions, DeMedio Engineering, ABC-TV, 20th Century Fox, Armin Steiner, and many more !

THE HARDY CO. Box AA631, Evanston, IL 60204 (312) 864-8060

away (about 8 feet). The high frequencies were still there, which I prefer. For this application, I opened the board's preamp a bit to get enough gain to a compressor. This brought up a slight air conditioner rumble at approximately 60 Hz. The first bass roll-off setting filtered it out successfully.

So much for vocals—what's next? Handclaps. This time it was back to omnidirectional with the bass cut-off position selected. Moving to a more live section of the studio produced a bright, sharp attack while allowing a rounder room ambience. The mike's pad was still switched out and there was no evidence of midrange distortion, even when all five clappers managed to clap at the same instant.

So far, so good. Acoustic guitar was the next audition. There are probably as many ways to mike an acoustic guitar as any other instrument. This was a steel string guitar, fairly bright, and we had a combination of pick and strum to deal with. I've had some success mixing condensers and dynamics for a combination of snappy strings and round strums. This time I found a position slightly up the neck from the sound hole that captured the desired combination. The performer's technique was good in avoiding "string squeak" with the fingering hand, and I got a full bottom end with excellent string definition. However, I had to fight with the elastic suspension to get proper positioning. The H-15 mount is very compliant, which makes for good isolation, but awkward balancing of a fairly large, heavy microphone.

Wind instruments are always a challenge. Herewith, some brief observations. Trumpet: clean and crisp with a little distance (3- to 4-feet), with excellent rear rejection in cardioid for ensemble set-ups. Flugelhorn: clear, a bit breathy, good lower mids. Tenor sax: great range, from sharp middle register to punchy bottom octave. Soprano sax: a tough instrument to capture correctly, sopranos tend to get thin and nasally, and position is *everything*—only fair results on this one. Flute: depending on player's technique and the desired result, "The Tube" hears a lot of breathiness, which is hard to avoid, but still very full and warm.

In sum, AKG has produced an excellent combination of old and new technology. This microphone is wonderfully versatile, and has made many friends. One noted engineer/producer I know received a demo model to check out, and liked it so much he started re-recording all the lead vocals for the album on which he was working. When the salesman called for the return of the unit, it was purchased on the spot. This will certainly be one of the hardest-working, most-requested models in anyone's microphone collection. ■

Ibanez In-service: Jan Hammer's Red Gate Studio

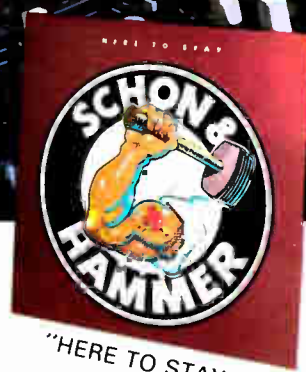

Jan Hammer - long recognized as a pioneer of the electric keyboard - also pioneered the use of advanced signal processing techniques in his medium. Jan learned early on the value of quality signal processing in the creation of his unique musical voicings. In his Red Gate Studio Jan has chosen Ibanez digital processors and graphic equalizers. For Jan has learned what more musicians, producers, engineers and soundmen are learning everyday: Ibanez delivers!

Ibanez

For a full color catalog send \$2.00 to: Ibanez, dept. MX, P.O. Box 886, Bensalem, PA 19020; 17421 "B" East Gale Ave., City of Industry, CA 91748; P.O. Box 2009, Idaho Falls, ID 83403; In Canada: 6969 Trans Canada Highway, Suite 105, St.-Laurent, Quebec, Canada H4T1V8

Look for this banner at your authorized Ibanez dealer.

World Radio History

Circle #106 on Reader Service Card



PHOTO BY HAROLD McCAFFREY

BECK IS BACK

by Iain Blair

Few guitarists have had as intense an impact on their craft as Jeff Beck. One of the holy triumvirate of great British players that includes Eric Clapton and Jimmy Page, Beck emerged from the '60s tradition of blues/rock and, wielding his Strat and Marshall stacks, proceeded to effortlessly define state-of-the-art rock guitar through a stunning series of albums and tours with first, The Yardbirds, and later his own Jeff Beck Group,

fronted by a young singer named Rod Stewart. He delivered virtuoso displays of fretboard pyrotechnics that left most aspiring guitar-slingers gasping for breath, and wrestled with devastating feedback, sustained harmonics and white-hot leads that quickly assured his place in the Guitar Hall of Fame.

Since those early days, Beck has pursued his own vision, alternately joining forces with other musicians in bands such as Beck, Bogart & Appice, and exploring his jazz-fusion interests

with players like Jan Hammer, or keeping busy in the studios on his own projects and as a guitar-for-hire. And now, after a break of some 15 years, he has rejoined Rod Stewart on his current world tour as the featured guitarist. *Mix* caught up with the legendary axeman by the pool of his Hollywood hotel, where he was characteristically relaxing with the latest edition of *Hot Rodder* before taking off for a final rehearsal with "The Tartan Terror."

Editor's Note: Before the Beck-Stewart tour, people said that it was too good to be true and too good to last. They were right. A few dates into the cross-country trek, Beck abruptly quit the tour because of "artistic differences" with Stewart. Perhaps in another 15 years they'll reunite for another three or four shows, but don't hold your breath.

Mix: Is it strange going back on the road with Rod after all these years?

Beck: It is slightly weird, but I'm looking forward to it and I think it's going to be a lot of fun for us both. We've both gone through a lot since the days of The Jeff Beck Group, and hopefully we're a bit wiser now!

Mix: What sort of set-up will you be using?
Beck: Pretty much the same one I always use. For amps I'll use my two 100-watt Marshall stacks—you just can't beat them for the punchy sound and sustain I like. As for guitars, I'll be playing two of my Strats, and the new Grover Jackson model I just got. The Strats are a '54 vintage, which I probably won't play too much as it's so valuable now, and a straight factory '84 "Vintage" series model. Everyone thinks I have tons of special, custom work done to my guitars,

"Everyone thinks I have tons of special, custom work done to my guitars, but I haven't heard a better sound by anyone than the straight factory Strat I use. You might find something with more volume, but not with a better tone."

(Above) Beck during one of last year's ARMS benefit shows. At the lower right is *Rolling Stone* Bill Wyman.

Simply Superior.

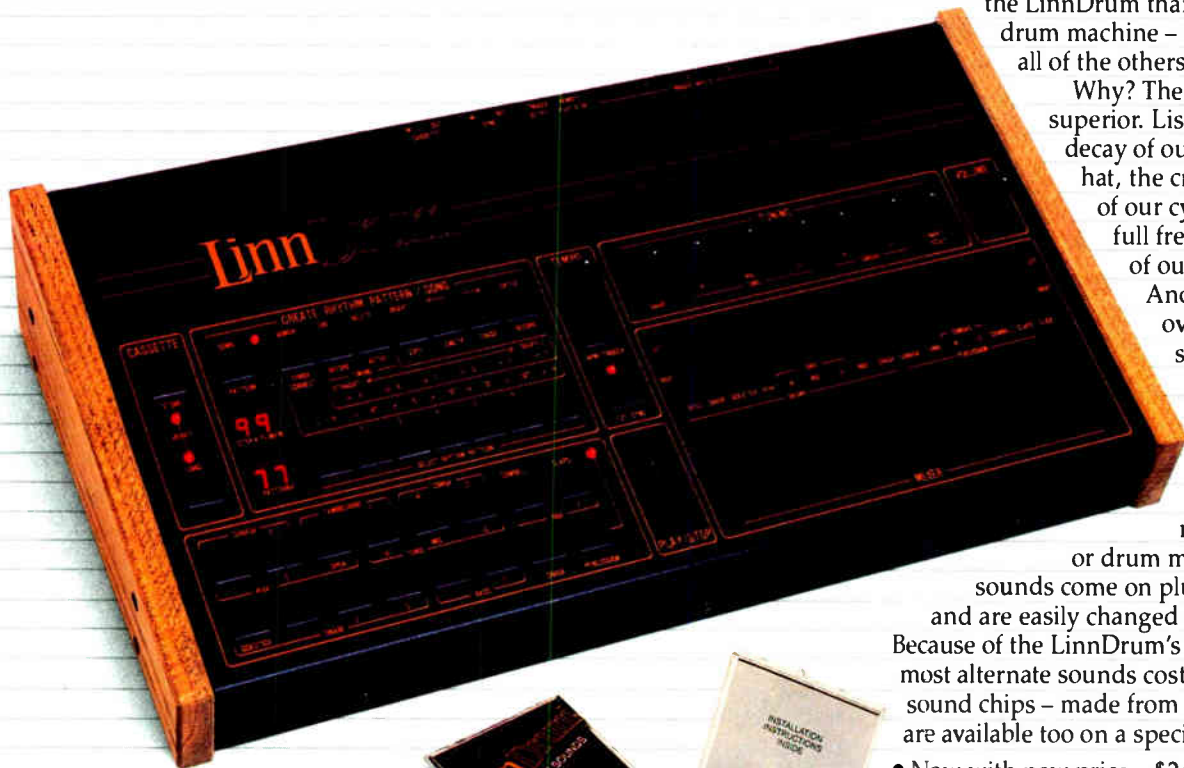

More hit songs are *written* with the LinnDrum, *demoed* with the LinnDrum, *re-recorded* with the LinnDrum, and *performed* with the LinnDrum than any other digital drum machine – maybe more than all of the others combined!

Why? The sounds are simply superior. Listen to the long decay of our adjustable hi-hat, the crystal clear quality of our cymbals, and the full frequency response of our drum sounds.

And we now offer over 100 alternate sounds, including electronic drums and a wide variety of sound effects (so the LinnDrum can sound like most any drummer or drum machine).

These sounds come on plug-in sound chips and are easily changed by the owner. Because of the LinnDrum's advanced design, most alternate sounds cost only \$40. Custom sound chips – made from your own sounds – are available too on a special order basis.

- Now with new price – \$2495 list.
- Now with single step programming.
- Now with an extensive alternate sounds library (over 100 new sounds)
- Now with expanded song capacity (up to 250 steps per song)
- Now with selectable 24, 48 or 96 pulse per 1/4 note clock output (for direct syncing to most popular sequencers)
- Now with optional memory expansion (more than doubles memory capacity)

LINNDRUM OWNERS: New features can be added to your unit for a small charge.

Call or write us for a free demo record, brochure, and the name of your nearest dealer.

From the inventors of the digital drum machine:

Linn LINN ELECTRONICS, INC.

18720 Oxnard Street
Tarzana, California 91356
(818) 708-8131

but I haven't heard a better sound by *anyone* than the straight factory issue Strat I use. You might find something with more volume, but not with a better tone. For instance, the Grover Jackson has a hell of a lot of power, but it also buzzes a lot, so you sacrifice something in clean sound.

how much to use and when, etc.

Mix: What strings do you use?

Beck: Anything I pick up! Seriously, Ernie Ball, Rotosound, I don't really care what. As long as they don't break, and they stay on, too. I hear about some of these guitarists who change their strings

doing some work for Diana Ross at the time, and I don't think she appreciated it so much!

Mix: You've also been working on Mick Jagger's solo album project?

Beck: Yeah, and that was a lot of fun too. Mick and I go back quite a long way, be-

Stars at ARMS shows included Led Zeppelin's Jimmy Page, Beck, singer Joe Cocker and many more.



PHOTO: RICHARD McAFFEY

Mix: What effects are you using now?

Beck: Very few these days. Right now I'm using this new power-boost pedal called a Rat. It's an American pedal, and brand new, but very few places seem to stock them and I was really lucky to even get one. I particularly like it because it gives you a clean, overload sound without sounding like a fuzz-box.

Mix: Do you use any echo effects?

Beck: I actually have a couple of Roland echo boxes that I use in stereo, but basically I prefer to use the soundman to get the effect I want, as acoustics, etc., differ so much from place to place. I think that if you use echo pedals through the PA, it never sounds quite right, so that's a better way of doing it. The trouble is finding a sound guy who knows what he's doing, because echo is a very personal, finely-tuned thing, and it's tough knowing just

every day, but that's ridiculous to me. Let's face it, it takes them about a day just to settle in, so what's *that* all about? In terms of gauges, I'm going for a slightly heavier set-up for live, because you need that bit and punch. But for recording I still use ultra-lights, because you have a lot more control in the studio.

Mix: Rod said you'd been pretty busy working in the studios recently...

Beck: Yeah, I did some work on Tina Turner's new album, *Private Dancer* which was a lot of fun to do. The album's really hot, and Tina's always great to work with, 'cause she's such a character. I asked her to sign my guitar—and I don't ask too many people! Anyhow, the pen wouldn't write properly, and before I realized what she was doing, she pulled out this flick-knife and carved her name all over it. That was fine by me, except I was also

cause The Stones asked me to join back in '74, before they got Ron Wood.

Mix: Why didn't you?

Beck: It just wasn't me, and I still wanted to do my own music. I did fly over to play with them, but in the end I just left without even doing it. Anyhow, Mick called me up to do his album, and I was actually involved in the project from the very start. I went down to Compass Point Studios where they were recording, and played on every track. It was quite hard work, because we'd record for at least ten hours a day, but it was also very enjoyable.

Mix: Who else was playing on the sessions?

Beck: A bunch of different people. There were actually a few problems finding the right players, and occasionally

THE PRICE OF BEING A PERFECTIONIST IS HIGH.

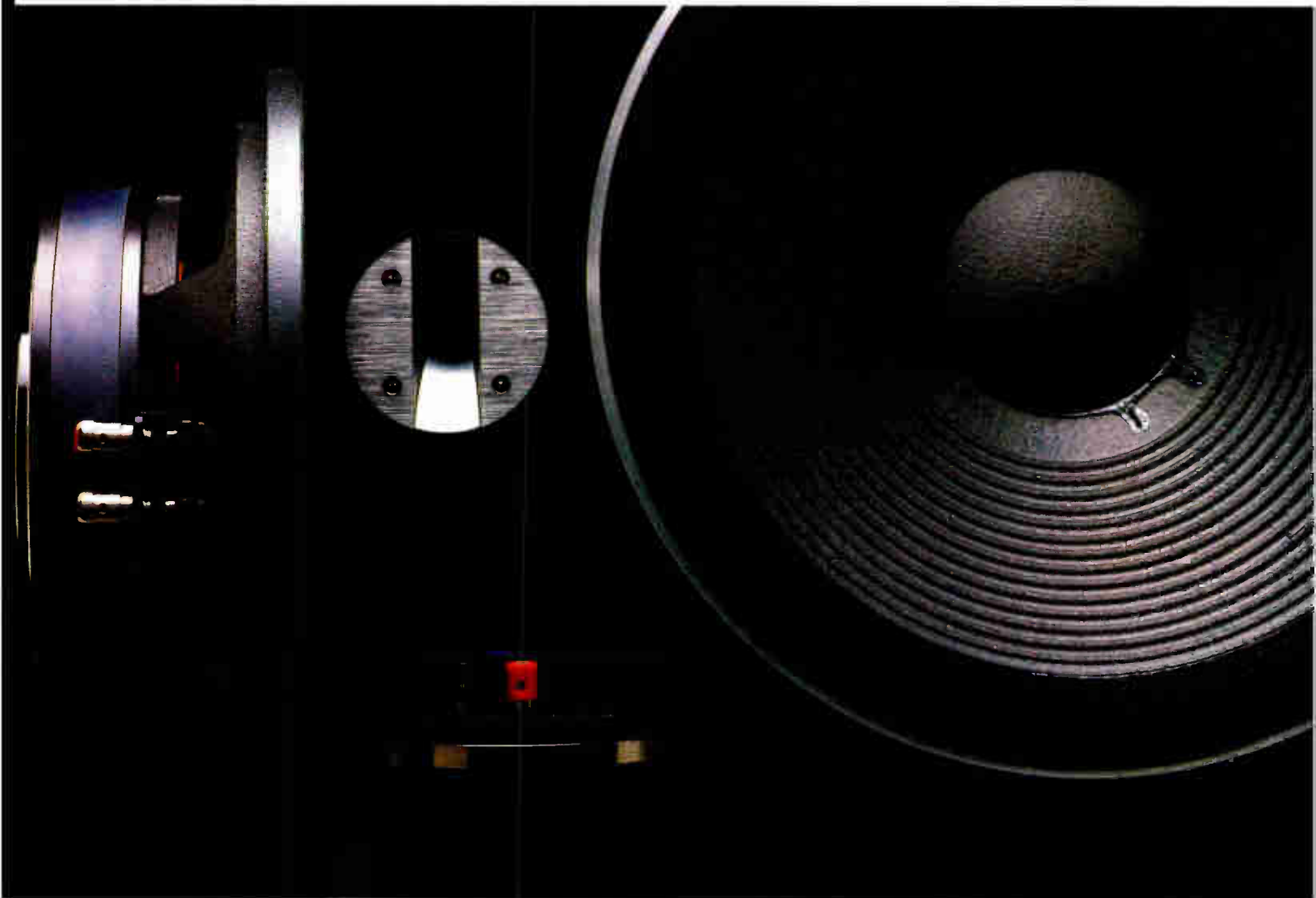

We're not out to sell TAD professional loudspeaker components to everyone.

Only those who can afford to eliminate the word "compromise" from their vocabulary.

Obviously, you won't hear that word bandied about amongst the engineers at TAD.

Because our entire existence is dedicated to the perfection of audio. To accomplish this you can't be willing to skimp, to cut corners, to make sacrifices, to settle for less than the best.

That's why every device we make is assembled entirely by hand. With the precision you'd expect of a watchmaker. Our diaphragm assembly, for instance, is mounted with a gap precision of ± 1 millionth inch to ensure high reliability.

We use tremendously expensive evaluation and testing techniques with the aid of computers and esoteric acoustical equipment like a Doppler Laser, a Laser Holograph, an Impulse Generator, and

an Anechoic Chamber, to mention just a few.

Finally, we feel to make first-rate products you can't settle for second-rate materials. So we use the finest money can buy. Such as Beryllium diaphragms and Alnico magnets.

Consequently, the sound we produce is totally uncolored, uncluttered, and unmatched.

Which is why our professional loudspeaker components are preferred by musicians, audio-system designers and recording engineers who are perfectionists when it comes to sound.

And who feel that the price of *not* being a perfectionist is high.

TAD Technical
Audio Devices

Professional Products Division of Pioneer Electronics (USA) Inc.
5000 Airport Plaza Dr., Long Beach, CA 90815. (213) 420-5700.

Circle # 109 on Reader Service Card

World Radio History

THE MASTER CLICK PROGRAM

For Composers Who Hate Film & Video Math

MASTER CLICK finds the best tempo in Beats-Per-Minute, Frames-Per-Beat or Synclavier Clickperiods for any film or video cue.

MASTER CLICK generates a Beat Location List for any tempo at the touch of a button—No more expensive film books.

MASTER CLICK works in SMPTE time code, EBU time code and 70mm, 35mm, 16mm, 8mm and Super-8 film formats.

MASTER CLICK creates a structured, editable database which includes: Computer Generated Labels, Location, Description, Duration, Beat Number and Measure Location for each hit point you enter.

MASTER CLICK has a super Film and Video Calculator. You can add or subtract SMPTE numbers and film footage entered from the keyboard or from computer memory.

MASTER CLICK generates a list of Note Values in Absolute Time, Video Frames and Film Footage for any tempo so you can program synthesizers and sound effects like never before.

MASTER CLICK lets you select the Frame Accuracy so Master Click's calculations reflect your personal taste.

MASTER CLICK is the best value in click track programs. It's the only *composer friendly* computer program. Composer requests are written into free program updates.

Please send me a copy of The Master Click Program.

- For the Apple II+ and Apple IIe only \$299.95
- For the IBM PC and compatibles only \$399.95
- Owners Manual w/o program disks only \$99.95, refundable with purchase.

Name _____
Address _____
City _____
State _____ Zip _____
Area Code _____ Phone _____

Send Check or Money Order, No C.O.D.'s, to:

SHELTON LEIGH PALMER & CO.
360 East 57th Street
New York, New York 10022
212-980-3445

Order by phone Visa or Mastercard accepted.

Apple II+ and Apple IIe are trademarks of Apple Computer, Inc.

there was a mismatch of styles. Mick asked me to find him a "modern-sounding" keyboard player—I couldn't believe he didn't know anyone! Anyway, I suggested Jan Hammer, and Mick flew him down, but it didn't really work out for a number of reasons. Mick wanted a certain sound, and we had a Fairlight there, but Jan didn't come up with what he was after unfortunately. The same situation happened with Sly Dunbar and Robbie Shakespeare—they're just the best at what they do, but some of the tracks needed a different feel and approach... but the finished tracks sound really great, and I think Mick's really happy now.



PHOTO: RICHARD MCCAFFREY

Beck wails, 1977.

Mix: What sort of music is it?

Beck: It's a great blend of the past, present and future, with all Mick's varied influences and his usual strange lyrics! A lot of the material is blues-based, I guess, but it all sounds very fresh and I think a

the time! I never quite got used to that. I remember one night we were just relaxing and watching TV, and what should come on but The Stones' film, *Let's*

"I think I'm a pretty straightforward player, in that I don't base my style on tons of tricks and gadgets. I just like to plug in and play."

lot of people are going to be surprised by this album.

Mix: What are the studios like to work in?

Beck: Well, it's all very relaxed down here because it's the islands, and they gave me this great little cottage to stay in, right on the beach and covered with hibiscus flowers—quite a change from recording in the center of New York or Hollywood! The studio itself gets a real good sound, and the equipment is all pretty much up to date. The one thing they really need to get a bit more state-of-the-art is the kitchen—it's definitely a bit funky!

Mix: What was Mick like to work with?

Beck: Great. He's a hard worker, and although, like I said, he went through a few times when he wasn't quite sure what he wanted, or perhaps how to get it would be more accurate, he was pretty up and fun to be around. The weirdest thing about working with Mick is just hearing that famous voice around the house all

Spend The Night Together. That was pretty strange, to watch Mick prancing around the stage or the box, and hear him making fun of it all while he watched—he didn't take himself seriously at all, which I guess surprised me.

Mix: It seems that lately, you've been in such demand for studio work and tours with other artists that you've hardly had time to concentrate on your own music.

Beck: [Grins] Funny you should say that, 'cause I'm *still* trying to find the time to finish my new album. But I do seem to get caught up in all these other projects. I've been recording at The Power House in New York, and I'm really pleased with what I've done so far. In fact, I'm kind of disappointed I didn't finish it before I agreed to go out on the road with Rod.

Mix: Rod told me that when he heard some of the tracks, they were so hot that he asked to do some vocals.

Beck: Yeah, I cut "People Get Ready," that great old Curtis Mayfield number, and when Rod heard it, he went crazy! So he sang on it, and it sounds great. In fact, I think it's the best thing he's done in years, and I told him he should have put it out as a single...

Mix: Why didn't he?

Beck: I don't know. There were legal squabbles and hassles. Rod can be really obstinate! [laughs] Anyhow, then he asked me to play on some tracks on *Camouflage*, and I ended up doing the solos for the single, "Infatuation," as well as for "Bad For You" and "Can We Still Be Friends," and then we decided to tour together.

Mix: I think that really surprised a lot of people, that you two would reunite after all these years, and...

Beck: [laughs] ...all the stories? Yeah, I suppose it is a bit unlikely. But a lot of the

stories about us fighting really were greatly exaggerated—we never nit each other, I think!

Mix: The last tour you did was the big benefit for ARMS and Ronnie Lane of The Faces, who's suffering from MS. How did that all come about?

Beck: I just happened to be 'round visiting Eric Clapton when Ronnie called up by chance, and that's the first we all knew of it. He asked Eric if he'd do a benefit—not for himself, but for the organization—and then we all gradually became involved. Eric and Glyn [Johns, ex-Faces producer] put in a lot of effort rounding up all the people, and I think everyone just wanted to help because it was so obviously a worthwhile cause.

Mix: With you, Clapton and Jimmy Page as guitarists, it was almost like a Yardbirds reunion.

Beck: Yeah, and we all had a lot of fun.

It's a pity that sort of thing doesn't happen more often.

Mix: You three guitarists probably sum up the whole rock guitar approach and sound of the last 20 years. How would you define your style today?

Beck: I guess it's still very blues-based, although obviously there's a lot of jazz/fusion type influences there. I think I'm a pretty straightforward player, in that I don't base my style on tons of tricks and gadgets. I just like to plug in and play.

Mix: What young players impress you?

Beck: [Smiles] Eddie Van Halen—he's very slippery, very fast...

Mix: You're almost 40 now. Do you ever see a day when you'll stop touring?

Beck: I don't think so, as long as I keep enjoying it. We'll see how I feel after this one! ■



PHOTO: RICHARD M. CAFFEY

Synclavier's Summertime Seminar

It's not an instrument that everyone can afford, but it's one we are all hearing more and more of every day and which is going to have a profound effect on the sound and methods of music in the future.

It's the Synclavier, a computer that plays music, replicates sound from external sources, prints scores from the notes stored in its memory, and allows a composer, arranger or performer to experiment with orchestrations by instantly reassigning the voices sounding each part. And the sounds the Synclavier makes range from traditional ("natural") to slightly warped to totally fanciful and fantastic instruments.

New England Digital, the maker of the Synclavier, hosted its Third Annual Synclavier II Summertime Seminar, a week of lectures, performances and hands-on practice time. About 50 students, most of them owners or users of the Synclavier, came to Dartmouth College in Hanover, New Hampshire—just a few miles from New England Digital's home in White River Junction, Vermont—to hear presentations by Pat Metheny, Oscar Peterson, Laurie Anderson, producer Martin Rushent, soundtrack composer/synthesist Denny Jaeger, Dartmouth professor and composer/"Synclavierista" John Appleton, N.E.D. president Sydney Alonso, and other members of the N.E.D. staff.

The purpose of the seminar wasn't to sell Synclaviers although a few of the participants were there because they were interested in buying and want-



(Above) Pat Metheny demonstrates the Synclavier's Digital Guitar Option. (Right) New England Digital president Sydney Alonso handles a question during his address to the Synclavieristas on the subject of the "ideal" synthesizer and New England Digital's efforts in the direction of achieving it.

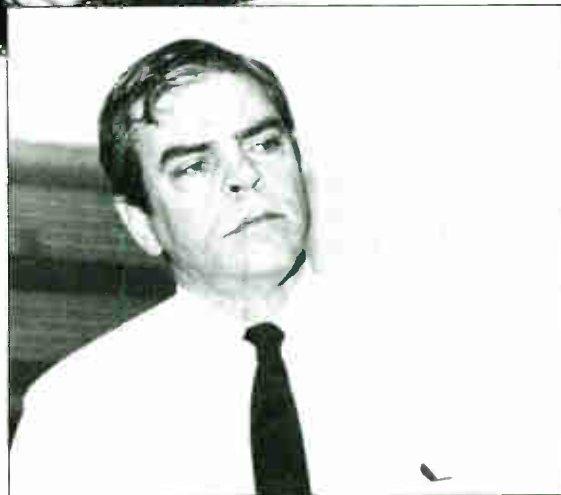

THE FAR SIDE

By GARY LARSON



"Oh, give me a home, where the buffalo roam..."

Professor Appleton's Electro-Acoustic Bestiary

The field of electro-acoustic music, which began taking shape in the late 1940s with tape-manipulation experiments and *musique concrete*, today also encompasses computer music. Throughout its history, this music, so closely tied to technological concerns, has been plagued by the works of practitioners who seem more driven by engineering or analytical concerns than by esthetic impulses. That tendency has at times hindered the progress of the art even as the science of electro-acoustic music has continued to develop.

In his lecture to the Synclavier Seminar, Dartmouth Music Professor Jon Appleton—himself a composer and an electro-acoustic musician since 1963—recalled a paper he wrote with a Swedish colleague, Lars-Gunnar Bodin, and read to a Colloquium of the International Federation of Electro-Acoustic Music a couple of years ago. It was "a bit of a bombshell," Appleton confessed, because in the paper he and Bodin chided their fellows for falling just a bit too easily into intellectual traps. "It is almost as though there is a

—PAGE 181

ed to learn as much as they could about it. It was an opportunity for Synclavier people—the people who build it and the people who use it—to rather formally and informally and exchange views.

Company president Sydney Alonso attended many of the sessions, observing and asking occasional questions, and listening to the questions and comments of the students and speakers. In his own address to the seminar, Alonso spoke of the “ideal” electronic musical instruments and described some of New England Digital’s long-range goals as well as some of the recent developments in the effort to attain the ideal. Currently in the works is resynthesis, a means of mapping sampled sounds into the Synclavier’s parameters so they can be modified just like synthesized sounds. Further downstream is polyphonic sampling, a much-desired feature which will require some technological breakthroughs to implement successfully.

One recent enhancement of the Synclavier system—and one that reaches toward Alonso’s ideal of interfacing with any and all useful transducers—is the Digital Guitar Option. Pat Metheny came to Hanover from a marathon mixing session in New York, picked up the Roland guitar controller and delivered a ten-minute improvisation that demonstrated the extraordinary range of the Synclavier. “Pretty weird, huh?” he said. “This instrument is so hip that you can show the world how sick you can truly be—and isn’t that what music is all about?”

What Metheny likes about the Synclavier is that it “doesn’t change the guitarist’s relationship to the instrument,” most notably as regards dynamics. The guitar features complete polyphony,

**N.E.D. President
Sydney Alonso interview
on page 58.**

and the Synclavier is now capable of stereo output—“but it still won’t correct your mistakes,” Metheny noted with a laugh.

As I found out during my hands-on time with the Synclavier and guitar, playing it requires a very light and clean picking style. Once I got the hang of it, I found the instrument to be quite responsive, and my pleasure in playing the guitar grew along with my facility with the Synclavier’s controls. After loading a diskette full of sounds from the Synclavier library, I began

—PAGE 185



Martin Rushent, known for his production of Human League and Go-Go’s albums, discusses use of the Synclavier in contemporary recording situations.

FIELD TEST

Cruising with Seymour Duncan’s “Convertible” Amp

I heard Seymour Duncan’s new guitar amplifier before I saw it. It was at the NAMM show in Anaheim last January. The clear, tasty picking of James Burton drew me into the Duncan booth, where Seymour himself was explaining the workings of his new product to the smiling guitarist. Burton twanged the strings obligingly and listened to the sounds along with the 25 or so others who’d gathered around.

I asked about the amplifier and was introduced to Bruce Kennedy, a designer from the hi-fi industry (and not a guitar player), who developed the Convertible in Duncan’s Santa Barbara shop over a two-and-a-half year period. Kennedy set me up in front of another Convertible prototype, handed me a guitar and briefly described the amp’s features, then left me alone to explore. With the NAMM Noise Police hovering, it was impossible to put it through all its paces, but I was sufficiently impressed to ask for a chance to try it out at home.

It was a couple of months before a production model was available for evaluation. As soon as I got it I trucked on down to my rehearsal room to check out the sound. I run my system in stereo, with a rack full of signal processors at both guitar and line levels, but before I tackled the task of intertwining the Convertible’s preamp and power amp/speaker stages with my other gear I just plugged

my guitar into it and started playing with the controls.

At \$1260 (plus additional pre-amp modules if desired) it’s a substantial investment, but I’ve never seen an amp capable of delivering so many different sounds. Any musician whose work requires flexibility will find the Convertible well worth the test drive. Seymour Duncan has been studying the relationship between guitars and amplifiers for years in connection with his custom and replacement pickup business. Now he’s



We don't like to drop names but . . .

AKG, AD/A, Ashly, BGW, Biamp, Amek, EV, JBL, EXR, MXR, NEI, RANE, HME, Valley People, Harbinger, Shure, DBX, White, Deltalab, Loft, Audio Technica, Stephens, Fostex, Pulsar, Dynamix, TOA, Clearcom, Sennheiser, Beyer, etc., etc.

Just a few of the almost 200 lines of P.A., Recording & Broadcast equipment we carry. Selection is just part of the story, price & service are the rest. For the rest of the story call:

FILAMENT PRO AUDIO

143 E. Arrow Hwy., San Dimas, CA 91773

818-339-0081

714-592-2848

Circle #110 on Reader Service Card

FEEDBACK PROTECTION. WITHOUT SACRIFICING RESPONSE.



Our remarkable MD 431 lets performers work with amplification as loud as they wish—up to 6 dB over other microphones—without feedback. And without sacrificing the clarity of full, rich response.

SENNHEISER[®]

Sennheiser Electronic Corporation (N.Y.)
48 West 38th Street • New York, NY 10018 • (212) 239-0190
Manufacturing Plant: D-3002 Wedemark, West Germany

© 1980, Sennheiser Electronic Corporation (N.Y.)

Circle #111 on Reader Service Card

turned his company's attention and energy to the amplifier itself, and the result is a device that can be adjusted at several points—from input impedance clear through to damping factor—to suit a variety of instruments and applications.

The Convertible is a 100-watt (RMS) amp with a 12-inch Celestion speaker built in and a host of special features that allow it to be tailored to, among other things, the characteristics of the guitar's pickups. Its sonic flexibility comes from several design features, some of which have never before been available on a guitar amp.

The most notable point of variability is the Convertible's modular pre-amp stage. There are five modules (a common input section and two each for Channels One and Two—following the tone controls, on either side of the Overdrive pot in the circuit), with six styles currently available ("Normal" tube, "Classical" tube 6 dB extra gain, higher distortion), FET, IC, and Hi-Gain Hybrid (a combination of tube and solid state) and more on the way. Any module can be used in any position, so one channel can be configured for screaming tube sounds while the other produces the crisp tones of an FET stage; of course, more subtle combinations can also be created. The modules pop in and out quickly (they reside in an easily-accessed compartment on top of the amp), so if that picky jingle producer wants to try it a dozen different ways, the amp can go from Twin to Marshall to a direct-box sound in a minute (the time it takes for the modules to cool off before they can be changed).

The front panel features two (parallel) input jacks, plus an RCA jack which is used with load resistors to tailor the Convertible's input to the characteristics of the guitar's pickups. Depending on the output of the guitar, plugs of different resistances can be used to flatten, extend or otherwise shape frequency response, optimize signal-to-noise ratio, etc. The input impedance without a load plug is 4.7 megohms.

Each of the two independent preamp channels has the following controls: Overdrive and Master Volume (used together to balance distortion against volume); Treble (passive high-pass filter, 1.8 kHz-20 kHz, 6 dB/octave, maximum 38 dB), Mid (variable notch filter, 12 dB range at 246 Hz) and Bass (passive low-pass filter, 40 Hz, ± 15 dB); and Reverb.

The channel selector can be toggled with a footswitch or with the pushbutton on the front panel. An LED between the Master Volume and Treble knob of each channel glows when that channel is active (Channel One is red, Channel Two green—helpful on dark

—PAGE 179



THIS MONKEY WILL BLOW YOUR DOORS OFF.

In the European tradition of fine craftsmanship, reliability and innovation, PPG introduces the Music Computer System. This component system has more power, more flexibility and more possibilities than you ever dreamed were available in a synthesizer.

The Wave 2.3, PRK, Wave-term and EVU offer Sampled Sounds, Digital sounds and Natural Sounds; Analog Filtering and Envelope Generators; each



voice Individually Programmable; 24-Track Sequencing with Individual Outputs; Weighted Velocity-Sensitive Piano Keyboard; and 12-Bit Audio Output. If you haven't heard a PPG, you don't know what digital sound really is!

For more information on the PPG System, write or call:

Summa
PROPA TECHNOLOGY INC.

1638 W. Washington Blvd.
Venice, California 90291

...IF YOU'RE IN THE STUDIO YOU'RE IN THE MIX

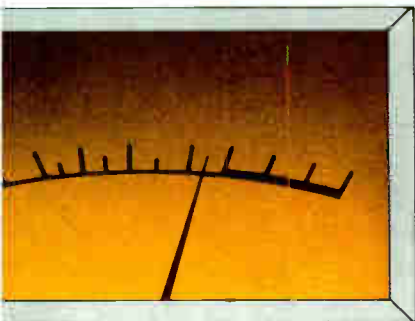

No doubt about it: the recording industry is changing as never before. Digital recording... Video music... declining record sales... computerization in the studio... home taping of records and radio... new markets. As a serious professional, you're probably changing too, and doing your best to keep up with these new developments. That's where **Mix** comes in. ■ No other publication offers such a wide variety of informative columns and feature articles on today's dynamic audio/video scene.

Whether you want to learn about the latest hardware and innovative production techniques... tour the newest, state-of-the-art studio installations... read the views and personal experiences of leading producers, engineers and performers... catch up on recent sessions and other events... or

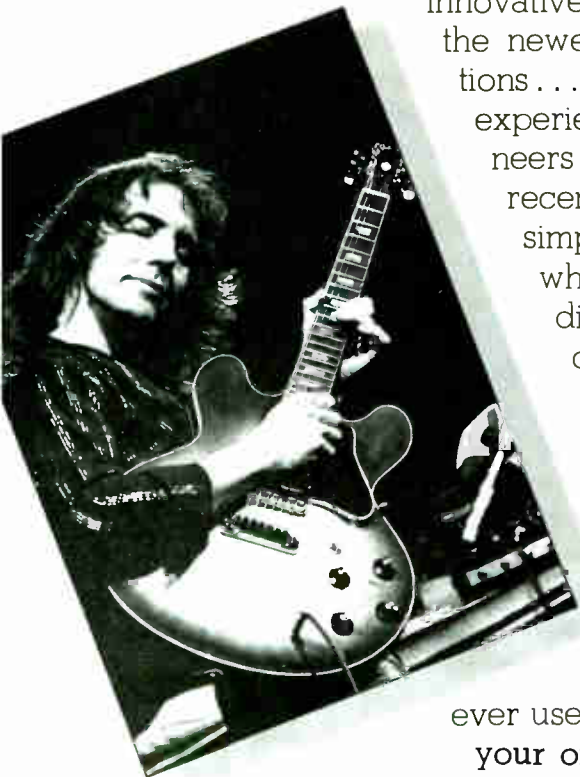
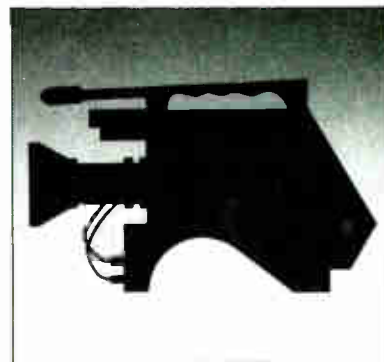

simply be entertained by some of the best writing anywhere—**Mix** has it all! (And only **Mix** publishes detailed directories of studios throughout the U.S., as well as other vital facilities and services.) ■ We want you to find out for yourself how *you* can benefit from reading **Mix** each month, so we're making a special introductory offer: **12 months—one whole year of Mix—for just \$19.95!** That's one-third off our newsstand price. ■ Just return the enclosed card with your check or money order. For only \$1.43 a month, you'll begin receiving one of the most valuable tools of the trade you'll

ever use! (Special bonus: Send payment with your order and receive two extra issues.)

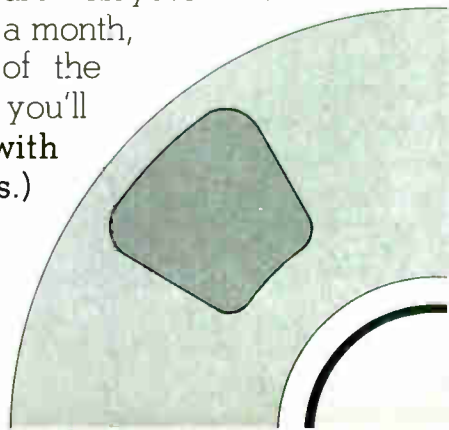

—FROM PAGE 176, DUNCAN

stages). In addition, the remote foot-switch (supplied with the amp) has a red LED which glows when Channel One is selected.

Rounding off the Convertible's front panel is another nice feature: the Variable Power control. Output is continuously variable from 5 watts RMS to over 100 watts RMS. Used in conjunction with the Overdrive/master Volume pair, this knob allows you to adjust the "size" of the amplifier. You can get the full distortion at low SPL of a tiny amp driven flat-out, the clear power of a big amp driven at cruising levels, and so on. There's a jack below the knob so power can be controlled with any passive volume pedal (100-500k ohms).

There are more flexible features on the back panel. The Effects Send has a level control for optimizing the interface with outboard gear; jacks are provided for external Reverb (Send and Receive), 4- and 8-ohm speakers, and Slave (1 volt at full power for mixer, recording console, auxiliary power amp, etc.). A Pentode/Triode switch selects whether three (60 watts) or all five (100 watts) grids of the EL34 output tubes will be used.

Damping Factor is continuously variable from .1 to 4 (a range of 40 to 1). With high damping, the amplifier maintains tighter control over the motion of the speaker cone, resulting in crisper sound and longer sustain. Lower damping gives the speaker a "looser" feel, blurring the sound somewhat and giving it more presence and "speaker coloration."

I received a stock Convertible along with a selection of extra modules. By rearranging them a few different ways I was able to vary the flavor of any given channel from a too-clean, transistorish solid-state sound to unmanageably nasty high-gain tubes. Having explored the extremes, I then sought the happy marriage of tube and FET tones on both channels that would give me a pair of distinctive, but related, sounds. What I couldn't get from an all solid-state system (compactness at the expense of warmth) or the addition of an outboard Super Reverb (great sound, but bulky and with lots of extra wiring if you want channel switching), the Convertible gave me in a compact and sweet-sounding package.

Now came the job of integrating it into my effects rack. The ideal situation would be to have a Power Amp input so I could go from the Convertible's Slave output to my line-level gear (including an ADA STD-1, which is where the signal gets split in two). Absent that feature, I had two choices: use only the preamp end of the Convertible, or go out and back in via its Effects Loop.

Both schemes worked fine. Using the Convertible's power amp gave me access to the subtle but definitely effective Variable Damping feature, which came in particularly handy with solid-state preamp configurations. And with 150 watts of solid-state power driving my "A" speakers (a pair of 12-inch JBLs), it was nice to be able to fatten up the sound of the Convertible's speaker (which carried the delayed signal from the "B" buss of the STD-1)—sort of "dialing in" some extra warmth.

The details aren't as important as the net result: With all its adjustable

features, the Convertible gives the player a high degree of control over both gross and subtle aspects of his sound. Standing alone, it's impressively versatile—you can tweak it into exactly the right tone and adjust its power output to suit the volume requirements of the gig or rehearsal—and it provides plenty of heart and soul when integrated into an amplification/signal processing system. I found my rack's range extended significantly by the Convertible, so much so that I wished I was a working musician again so I'd have an excuse to buy one.

—David Gans

ON STAGE MONITOR



• AHB

Sets the Stage with the New SRM-186 Monitor Mixer. The Monitor System designed to incorporate Communication between Artist & Engineer.

The result . . . Tighter On Stage Mixes Tailored to the Artists needs. The SRM-186, represents the Leading Edge in Detail, Reliable Quality and Affordability.

On Stage and Studio Features: • 18 Microphone/Line Input Channels. • 2 Dedicated Line Input Channels. • All Inputs Fully Matrixed to 6 Separate Outputs. • Full Passive Microphone Splitter System. • Long Throw 100MM Glass Smooth Faders. • Road Tough Flight Case Installation.

For more detailed information on the ALLEN AND HEATH SRM-186 Monitor Call or Write Today. Give yourself "The Edge" with the monitor that achieves its recognition . . . through your results.

imagineering by

mbi / **AHB**

group

Allen & Heath Brenell Ltd.
69 Ship Street, Brighton, BN1 1AE
England

Allen & Heath Brenell (USA) Ltd.
5 Connair Road
Orange, Ct. 06477 / (203) 795-3594

Circle #113 on Reader Service Card



MX

Magnetics

Audio & Video Tape Manufacturers
12 Years of Proven Service
to the Audio Industry

Custom Loaded BASF
"Pure Chrome" Cassettes Any Length.

C-60 as low as \$.69 1M
C-90 as low as \$.95 1M

Custom Cassette Bin Loop
High Speed Duplication

3/4" U-Matic Video Tape
Loading Re-loading

Custom Cassette Label &
Liner Printing

"Reel Cassettes"

3M & AMPEX Reel Tape
Our Low Overhead & High Quality
Workmanship can provide your
Studio with the Highest Quality
for the Lowest prices.

FREE Brochures Available
Upon Request.
Please Write or Call Collect
(817) 756-5303.

Hix Recording Co., Inc.

Name _____
Address _____
City _____ State _____ Zip _____



Circle #114 on Reader Service Card

SOUND SYSTEM

BUZZ

ITS TOO BAD YOU
CANT ALWAYS KEEP IT CLEAN

BUT NOW
ITS ONLY TEMPORARY
INTERFERENCE WITH
A
MODEL PS-1



In addition to reducing RFI the PS-1 can also
protect your sound reinforcement equipment
from:

HIGH VOLTAGE TRANSIENTS
UNEXPECTED POWER UP TRANSIENTS
IMPROPER LINE POLARITY

linear & digital
systems, inc.
46 marco lane
centerville, oh. 45459

Circle #115 on Reader Service Card

Andy Fraser Breaks Free

"We all wanna see the light/Shine through the crack of our window," sings Andy Fraser on his first release in nearly ten years, "But how many miles do we roam/Never coming close to Paradise?/ How many chances come/Only to pass us by?"

Fine Fine Line is Fraser's new chance, one he has waited years for and one he has grabbed with all the zest of a circus daredevil gone berserk. The album has all the right elements: solid and well-crafted pop songs, powerful and innovative production values, and excellent musicianship. From the initial punch of the title track through the final fade of the haunting "Living This Eternal Dream," Fraser never gives an inch of slack.

But the real success of this record is that it was made at all—and on Fraser's terms to boot. Although the actual recording was done over a relatively short period, the album was much longer in the making. *Fine Fine Line* is the story of what it means to maintain friendships in a business that is all too often ruthless—and, even more importantly, it is a story of what it means to hold true to your convictions.

Best known as a member of Free and one of the best bassists to emerge from the late '60s British blues-rock scene (he quit his gig with John Mayall's Bluesbreakers to join Free in 1968), Fraser has been trying for the past ten years to establish himself as a vocalist and songwriter. He has long stood in the shadow of Paul Rodgers, his bandmate and songwriting partner in Free and one of rock's great vocalists. Fraser's desire to sing was one of the main reasons he left Free in 1971, 18 months before the band's demise. "Paul is one of my favorite singers, but singing like he does and being like he is, he didn't want or need another singer anywhere around," Fraser notes. "If I was ever going to develop as an artist, I had to move on."

Fraser next became involved with Sharks, a much-hyped and short-lived band which released one album before dissolving, and then he decided he'd rather concentrate on singing than on bass playing. "I'd always written, and it gets frustrating when you don't get to sing any of your own songs." So Fraser approached Chris Blackwell, Island Records' founder and the man who'd broken Free, and said he wanted to sing. "Chris, along with quite a few others, said, 'You can't sing, you're a bass player!' And that was the end of that." That was in 1972.

Fraser released two solo albums in England in 1975, *Andy Fraser Band*



and ...*In Your Eyes*, but he couldn't interest an American label in picking them up. The reaction in England wasn't earth-shattering, either, and Fraser "didn't do much" until 1978, when he moved to the States and signed with Polydor. Many dollars were spent, but neither artist nor label liked the results and so the record was shelved.

One of the songs on that unreleased album was "Every Kind of People," which Robert Palmer picked up and turned into a hit, thereby helping to earn Fraser some credibility as a songwriter—a step in the right direction. Other tunes were recorded by the likes of Joe Cocker, Chaka Khan, and by 1980 Fraser had enough confidence and clout to take another stab at a solo career.

With the help of his manager, Kim Turner—who'd played drums on *Andy Fraser Band* and later became co-manager (with Miles Copeland) of The Police—Fraser assembled a studio band (which will also back him live) consisting of guitarist Michael Thompson, bassist David Faragher, drummer Tony Braunagel and keyboardist Bob Marlette. Fraser is quick to credit the contributions of Marlette, who co-write, co-produced and played a major role in arranging the album's ten songs. Lyric assistance was provided by Jim Vallance, who is known for his collaborations with Bryan Adams.

John Eden, former producer of British boogie beasts Status Quo and more recently Der Komissar, was the

—PAGE 186

—FROM PAGE 174, APPLETON

virtue attached to the onerous task of programming, even when most of those tasks have little to do with the actual description and composition of the final work," Appleton and Bodin wrote. "An analogy might be to a string quartet that first had to construct their instruments before they could consider a score..."

The paper went on to identify and describe these five electro-acoustic stereotypes and their various ways of putting the cart before the horse:

"Gadgeteers believe that the composition process begins with the actual construction of the electronic device...[which] must in some way be unique, even if the final aural result could be achieved by other means...

"Pseudo-Savants argue that a work must in some degree be experimental to be of value. If a work displays connections to older traditions it is denied approbation, deemed regressive and injurious to the health of electro-acoustic music. Composers such as Boulez, Wiggan and Xenakis have created institutes on the premise that scientific research will definitely lead to a new music...

"We do not mean to denigrate useful and productive experiments in music, but merely those works whose sole justification is their experimental nature and that are then presented as musical compositions.

"Atomistic Morphologists contend that works must be capable of being analyzed in order for them to



PHOTO: DAVID GANS

Professor Jon Appleton, Neo-Beautician

become esthetic objects. The analysis most often consists of a search for the lowest common denominator—the origin of the sonic material (the **object sonor**), or, in the case of instrumental music, the tone row and its permutations.

"In electro-acoustic music, the most obvious example of the Atomistic Morphologist's point of view is seen in the argument between Pierre Schaeffer, the founder of **musique concrete**, and Pierre Boulez: as to the way sound should be categorized... The falling out, if you can believe it, was not over what the music sounded like—it was over how the music should be analyzed.

"Boulez claimed that you should analyze sounds by what produced them...even if you've manipulated it so many times it no longer sounds like that. Schaeffer felt that it didn't matter what the source was;

what is the **quality** of the sound?

"Neo-Beauticians, in response to the general public view that electro-acoustic music is repellent and painful to listen to, search for ways to make their works more superficially attractive. Sometimes this is accomplished by using older tonal procedures and harmonic spectra; in other works it's achieved by reducing the complexity of the musical structure.

"...Computer music seems to attract Neo-Beauticians, perhaps because in many cases this field tends to be populated by the musically naive.

"I [Appleton] am often referred to as a Neo-Beautician. Last summer I wrote an opera with electro-acoustic music in it. A critic in the New York Times said it was a cross between Phillip Glass and Willie Nelson, with a Hawaiian pineapple on top. That, surely, is the **definition** of a Neo-Beautician.

"Uglyists assume an esthetic defined by its opposition to those traits generally regarded as beautiful, lovely or gentle in music. They believe it is somehow more avant-garde to create music which is incomprehensibly dense, extraordinarily long, and excruciatingly loud. Violence, brutality and pain distinguish these works, and the composers think that by being punished the audience will be correspondingly impressed. Uglyists want to shock their audiences, because they equate scandal with greatness..."

—D.G.

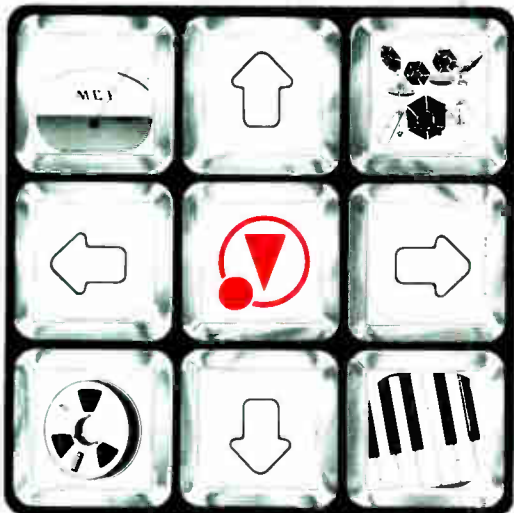

leo's audio and music technologies

Anticipating the needs of musicians and audio professionals since 1956.

5447 TELEGRAPH AVE. • OAKLAND • CA • 94609 (415) 652-1553

Circle #116 on Reader Service Card

They know why...

■ "We can work around lights on the studio floor with far less concern about noise."

W. E. (Bill) Thompson
KPRC TV, Houston, TX

■ "The quietest cable we have ever used."

Jim Bartel, Engineer
Victor Duncan, Inc.
Film & Video
Equip. Dist.

■ "The flexible, smooth surface eliminated our kinking and twisting problems."

Jim Van Waay, Pres.
V. J. Electronics
Sound Contractor

CANARE MICROPHONE CABLES are becoming the professional's first choice.

- Unique "Star-Quad" 4 conductor configuration plus high shield density reduce hum and noise to less than 1/10 that of the leading 2 conductor microphone cable.
- Excellent frequency response preserved due to low capacitance provided by dielectric qualities of Polyethylene insulation.
- Tough, flexible jacket available in 10 colors for easy identification.

L-4E6S cable-sug. ret. 40¢/ft.

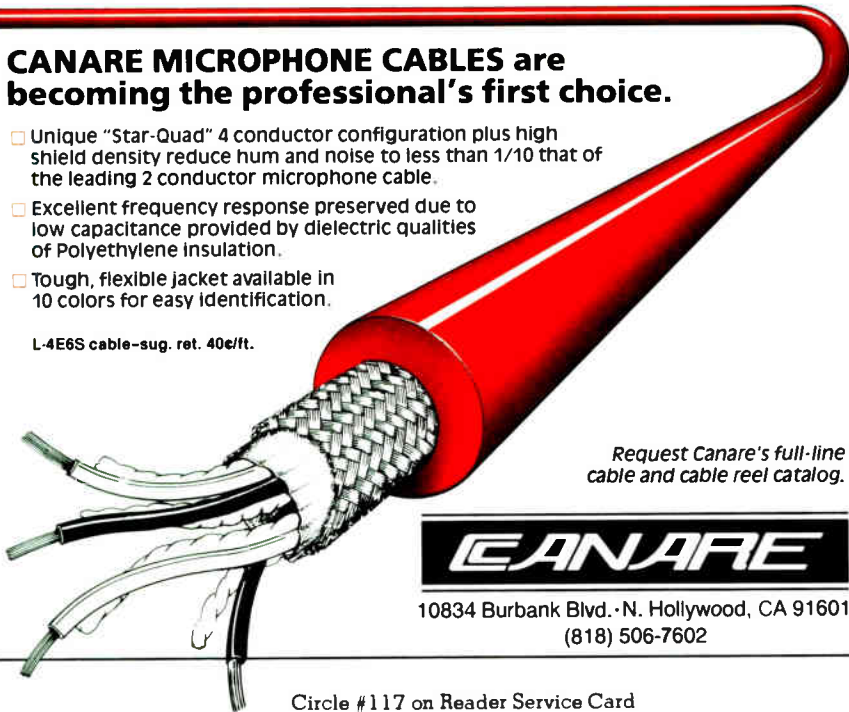

Request Canare's full-line cable and cable reel catalog.



10834 Burbank Blvd. • N. Hollywood, CA 91601
(818) 506-7602

Circle #117 on Reader Service Card

R.M.S.*

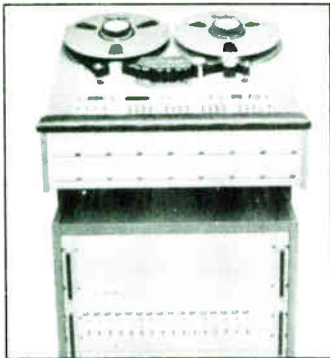

Tascam 85-16B

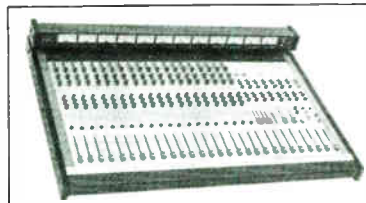

Tascam M520

- *Recording and Musical Systems
- *Recording and Musical Sales
- *Recording and Musical Supplies
- *Recording and Musical Service

The Dream: One store where you can purchase comp/limiters AND guitar strings, keyboards AND tape machines, mixers AND guitars, drums AND splicing tape, studio monitors AND guitar amps, portastudios AND 16 track recorders.

The Reality: Whittier Music Company

*The Recording AND Musical Store
500 Product Lines For Your Recording AND Musical Satisfaction

Whittier
MUSIC COMPANY

(213) 947-4671

Circle #118 on Reader Service Card

SCI's Model 64 Sequencer: Affordable Digital

Some time soon someone is going to market a dedicated MIDI sequencer for live performance use, with enough memory to store an entire set's worth of material. By "dedicated," I mean it'll be a black box with just a few switches: Record, Playback, Start, Stop, and Continue.

The cost of computer memory is still too high to make such a product available at a reasonable price. Sequential Circuits' Model 64 Sequencer is a step in the right direction, although it can't store more than one song at a time.

The Model 64 is a small cartridge that plugs into the back of a Commodore 64 computer. It has MIDI input and output connections, an external click track input and a footswitch jack. The footswitch is not included with the 64, and unfortunately, the system doesn't work very well without it. I guess SCI figures everybody who is going to use this thing already has a footswitch. If you don't have one, you won't get very far.

Another item that is almost essential is a CRT to display the various commands. SCI claims you can use the Model 64 without a screen display; that's true, but you will have to memorize the various command sequences in order to do it. For example, when you power up you will have to remember to type Y or N to the question, "Are you using a drum box?" Then you have to enter the number of clicks per beat that your drum box uses. Then you have to answer Y or N to the question "Do you want to start recording?"

The problem is drastically multiplied when you start getting into the various option screens. After a short period of frustration I gave up altogether trying to make things happen without seeing a display. In my opinion, it's not practical to use the SCI Model 64 without a CRT display.

What the Model 64 does beautifully is sync my Drumulator to my Prophet 600 synthesizer. I can record a drum beat on the Drumulator, play it back while recording a synthesizer part on the Prophet, and then play it all back while I blast away on my guitar. As such, the Model 64 is a great composing tool, making it very easy to do a one-man-band thing with a minimum of effort.

There is also an auto-correct feature that lets me "round off" my synthesizer notes to the nearest even timing. This makes it a snap to do background parts with perfect timing even if you aren't a terribly good keyboard player. It

would be nice if the auto-correct had a "swing" option for jazz or shuffle feels, but I guess you can't have everything.

Once you get a section of music recorded to your satisfaction you can go to work on the next section the same way. Then up to eight of these sections, or sequences, can be linked together to form a complete song. As if that weren't enough, you can then lay down a final "melody" track over the assembled piece. This way, you can concentrate on a smooth-flowing track that is unaffected by the earlier sectioning process. I find this to be a good feature, because although it's easier for the computer to remember music in sections, the brain doesn't work that way. Working on a composition in sections tends to make the final product sound fragmented.

I know that dividing the sequences into sections is the most efficient way to use the computer memories currently available, but I think this kind of approach will disappear as memory prices drop and it becomes feasible to build in enough storage for full-length sequences.

The Model 64 operates exactly like a six-track tape recorder. When you first enter Record mode you are record-

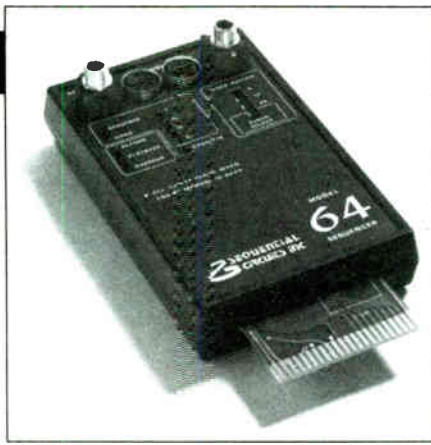

ing on Track 1, and the length of the part you play determines the length of the other five tracks. Each track can be completely polyphonic, so it's possible to stack up enough parts that you run out of voices to play with. This being the case, you are limited by the number of voices your particular synthesizer has. Recording more information than your synth has voices to play will result in some of the notes not sounding the way they should, and some notes possibly not sounding at all.

For live performance situations, however, the Model 64 is not terribly useful, for a couple of reasons. First, you can't stop and restart a sequence without the drum machine and the synthesizer

going out of sync. The Model 64 seems to drop a click or two when you try it. This may be corrected in future versions; it will have to be in order to make the sequencer reliable in live situations.

Another limitation is that the Model 64 can only store one song at a time. With eight different sequences available it's possible to cover more than one actual song, but the capacity of the unit is still too small to be practical.

It also seems impossible to "punch in" to a recorded sequence. I suppose this feature is not considered too valuable, since auto-correct can be used to deal with most timing errors and notes can be recorded at extremely slow speeds, making difficult passages easier to get through.

The Model 64 forces a musician to be a computer operator, and as such it isn't for everyone. I am not particularly fond of the Commodore 64 computer in general, although it offers a good price/performance ratio. If you don't have a computer and aren't interested in learning how to use one, the Model 64 is not for you. But if you have a Commodore 64, Sequential Circuits' Model 64 Sequencer will prove to be a useful tool.

—Kirk Austin

MIDI-MODIFICATION FOR PIANO TRANSFORMS THE RECORDING INDUSTRY! NOW YOU CAN CONNECT YOUR PIANO TO THE WORLD OF SYNTHESIZERS! A MUST FOR RECORDING STUDIOS AND SERIOUS MUSICIANS!

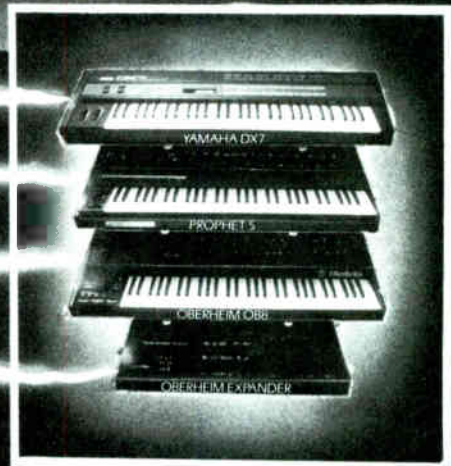

WITH THE REVOLUTIONARY NEW FORTE MUSIC MIDI-ADAPTER YOU HAVE THE POWER TO TRIGGER SEVERAL MIDI-EQUIPPED SYNTHESIZERS DIRECTLY FROM THE KEYBOARD OF YOUR ACOUSTIC OR ELECTRIC PIANO.

- INTERNALLY-INSTALLED MODIFICATION PERFORMED BY EXPERIENCED PIANO TECHNICIANS.
- OPENS YOUR PIANO TO A WORLD OF PHENOMENAL TONAL COMBINATIONS.
- ELIMINATE TEDIOUS AND EXPENSIVE OVERDUBS.

- ALSO AVAILABLE FOR YAMAHA AND KAWAI ELECTRIC GRANDS AND RHODES.
- AVAILABLE WITH OR WITHOUT VELOCITY SENSITIVITY.

FOR SALES OUTSIDE OF SO. CAL. CALL:

FORTE MUSIC™

(408) 262-8865
P.O. BOX 6322
SAN JOSE, CA 95150

FORTE MUSIC MIDI-ADAPTER OFFERED EXCLUSIVELY IN SOUTHERN CALIFORNIA BY:



(818) 789-1212

AGFA **magnetite 12**

**the first cassette
duplicating tape with
cleaner, fuller sound,
more output at
mid-range, super highs
and lows—plus unmatched
versatility and
tremendous enhancement
capabilities.**

For complete information write:

MAGNETITE 12 / MAGNETIC TAPE DIVISION

AGFA-GEVAERT  275 NORTH STREET, TETERBORO, N.J. 07608 (201) 288-4100

AGFA
AUDIO

Circle # 120 on Reader Service Card



PHOTO: DAVID GANS

(Left) Oscar Peterson provides the traditionalist's point of view. (Right) Synclavier virtuoso Denny Jaeger demonstrates soundtrack production techniques.



PHOTO: DAVID GANS

—FROM PAGE 175, *SYNCLAVIER* stepping through them, and when I found a particularly interesting one I'd stay with it a while and try a few variations using the many buttons and the one big knob that comprise the Synclavier's programming panel. I can't describe the thrill I felt when I called the next program and got that exquisite violin sound out of the guitar!

After performing a composition he created on the Synclavier, Dartmouth professor Jon Appleton gave a very entertaining talk on the subject of musicality and musicianship. He doesn't use SCRIPT, the composition language, because "interposing a level of abstraction between inspiration and execution impedes the process." He prefers to make the instruments—create new sounds on the Synclavier—and then write music to play with them.

The essence of Appleton's message was to remind the users that the Synclavier is a musical instrument—albeit a very powerful one. His was a composer's view, and the following day Oscar Peterson made a similar point from the instrumentalist's standpoint. After playing a quick blues passage on the piano, Peterson turned to the Synclavier and pushed a button to start a pattern playing from its digital recorder. It was a string bass, and while it played a blues line Peterson improvised with it. He went on to show how the Synclavier's keyboard can be divided up to play different sounds in different scales—adding up to *enhanced* musicality—and demonstrated how useful it is for rehearsal as well as composition and orchestration.

Denny Jaeger, a West Coast-based film scoring wizard who was an early believer in the Synclavier and has contributed ideas to its development since the introduction of Synclavier I, presented a long and intense session filled with taped examples of his work and live demonstrations. As a practical lesson in Synclavier application, it was unsurpassed.

Martin Rushent, the English record producer who spoke of the Synclavier's usefulness in the studio, will be the subject of a Producer's Desk feature in an upcoming issue of Mix. I'm sorry to report that illness forced me to miss the last day of the seminar, which included Laurie Anderson's presentation on using the Synclavier in live performance.

There were eight complete Synclavier setups available for the participants, and a rotating schedule of 90-minute practice sessions made it possible for each to spend up to six hours alone with

the instrument. N.E.D. staffers and other highly qualified people floated around, helping out with problems and offering suggestions. There was much sharing of ideas among the participants, as discoveries were made and interesting music played all over the place.

As the week progressed and more facets of the instrument and musical technology—not to mention attitudes and personalities—were presented, groups of people would gather after hours and during lunch and dinner

—PAGE 186

THERE IS NO ALTERNATIVE

At US\$ 3'000.— the FM 236 linear-phase electronic crossover has become a rave success.

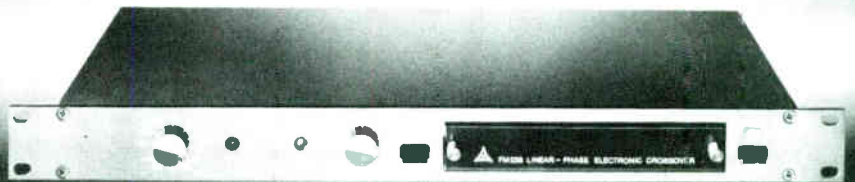

It revolutionises electronic crossover design with features like 36db/Octave attenuation, absolutely perfect step response without any overshoot or ringing, proprietary constant linear-phase filter circuits and more unique features.



Ask for the data-sheet if you are interested in the true State of the Art
 FM ACOUSTICS LTD, Tiefenhofstr. 17, CH-8820 Wädenswil/Switzerland
 Telephone: 01 / 780 64 44, Telex: 875414 FMAC
 US office: FM ACOUSTICS USA, P.O. Box 311, 956170311 Davis CA
 Phone: (916) 7586300
 In Canada: Perspective Audio P.A. Inc., 23 Chatel, Lorraine, P.Q.
 J6Z 3C4 Phone: (514) 621-4087

Circle #121 on Reader Service Card

OX-12



A NEW SLANT IN LIGHTING CONTROL

At Spectrum, we attend to detail. We think its the little things that set our OX-12 apart from the competition. Little things like an adjustable control voltage for inter-system compatibility; externally accessible triacs for in-rock serviceability; or our toroidal filtering. Our modular design and parameters enable the user to "build" the system that most effectively meets his design requirements and many output options. Three power input options, three power models and a flexibility like no other dimmer on the market. Performance, versatility, and economy have always been of paramount consideration in all of Spectrum's designs. We feel you'll find the OX-12 Series Dimmer's designs shining example of our commitment to these ideals. Comparable "Brand Name" dimmers may cost hundreds of dollars more with the OX-12 you don't pay for the name. You pay for performance!

SPECTRUM
DESIGN & DEVELOPMENT, INC.

3420 Walbert Ave., Allentown, PA 18104
(215) 395-6934



PROFESSIONAL PERFORMANCE... BANK ON IT!

Circle #122 on Reader Service Card

It's Just Around the Corner...

1985!

JANUARY: Northwest Studio Listings

Deadline for Questionnaires: October 15th
Display Ad Closing: November 7th

FEBRUARY: NAMM Show Issue/Independent Engineer & Producer Listings

Deadline for Questionnaires: November 15th
Display Ad Closing: December 7th

MARCH: Southeast Studio Listings

Deadline for Questionnaires: December 15th
Display Ad Closing: January 7, 1985

CALL (415) 843-7901 FOR MORE QUESTIONNAIRES AND AD INFORMATION

Listings: Lauri Newman
Display Advertising: Hillel Resner

—FROM PAGE 185, SYNCLAVIER

breaks to talk about what was going on. The "student body" included many working professionals from many disciplines: session players, jingle producers/players, studio owners, composers, etc. Various musical styles and approaches were represented among the students and faculty, from "synthesizer as money-maker" to "Synclavier as compositional utility" (save thousands of dollars in scoring and rehearsal costs by trying out orchestrations on the Synclavier) and "Synclavier as a gateway to new musics." It was a stimulating experience for all concerned, and of course I now want to own a Synclavier.

—David Gans

—FROM PAGE 180, FRASER

record's main overseer, and Hugh (Hall & Oates, Genesis, The Police) Padgham mixed the LP.

Turner took the completed tracks to several labels, only to get thumbs down. "They told him it didn't have a single, it didn't have this and that, da-da-da-da-da," complains Fraser. "It was like dealing with the BBC or the Social Security office." Fraser and his managers considered Copeland's own I.R.S. Records, but they decided that the album and Fraser himself wouldn't fit in with the personality of that new wave-oriented label.

"Then Kim let me call Chris Blackwell. He and I have always respected each other," Fraser asserts. "I feel really close to Island Records, because they really take care of their artists. If Chris hadn't liked the songs he would have said, 'Go make another record.'"

But Blackwell responded positively to *Fine Fine Line*. "I think it took him by surprise," says the singer. "He really, really got into the singing."

Not unlike the more intelligent, driving rock of John Waite, Robert Plant and, of course, Paul Rodgers, *Fine Fine Line* brings back the urgency of Fraser's big Free hit, "All Right Now" (written with Rodgers, and revived this year by Rod Stewart on his new album, *Camouflage*). Fraser can certainly hold his own as a vocalist, adding a soulful edge to the high-energy rock that dominates the record. And on the more introspective songs such as "Branded by the Fire," he never loses the power necessary to convey the emotion behind the lyrics.

Andy Fraser is still serving up the basic rock he pioneered with Free, but this edition is sweetened just enough with tasteful keyboards, alternating rhythms and catchy production to maintain interest throughout. Andy Fraser is free at last.

—Bruce Pilato

How'd They Do It?

Bruce Swedien's Thriller

One of the most incendiary moments in recent pop history is Eddie Van Halen's guitar solo on Michael Jackson's "Beat It." The first time I heard the song, on my weak car radio, I knew it had to be Van Halen playing the solo. I said to myself, "If that's not Eddie, then it's such a good imitation it's embarrassing."

A few of my friends suggested that the knocking during the "pause" just before the solo might be Eddie pounding on his pickups. Although I disagreed, I caught up with Bruce Swedien, engineer of *Thriller*, and asked him about the knocking and other off-the-wall sounds that contributed to the album's production quality.

Contrary to some rumors, the knocking wasn't someone locked in the bathroom, trying to get out during a take. Swedien, at Westlake Audio working on some tracks with Michael for the new Jackson's album said, "Some of the sounds are from my own collection of pre-recorded stuff and others are from a friend's collection."

Sound effects, like the knocking on the door, are used in various spots on the album, though many of them are difficult to single out. "There's one of a loon—the bird—during 'Thriller,' later on in the song," said Swedien. It's part of a collection of recordings he made years ago in Minnesota.

I've tried listening to the song intensively several times through, and still can't figure out where the bird is.

Although the bathroom wasn't the source of the knocking on "Beat It," it was the source of some great rhythms on "Wanna Be Startin' Somethin'." Some of you may have noticed the Bathroom Stomp Board credited on the record sleeve. "That's Michael on a big unfinished piece of plywood in the bathroom here at Westlake," Swedien revealed with a laugh.

"And it's recorded in stereo. This toilet is ceramic tile, and it's got a wonderful sound—we use it all the time." The most obvious stomps in the song are towards the end when the chorus is singing, "Ma ma se, Ma ma sa..." There are also some triplet-type stomps in other parts of the song.

Although Swedien says he couldn't really pick out a single sound that was difficult to record, "Beat It" provided some interesting comments:

Swedien said the ominous-sounding bell noise at the beginning was created using just one sound from a Synclavier. And concerning the less-than-dynamic drums as the song starts, he

Enter A NEW WORLD of Audio Excellence

We specialize in selling quality audio equipment. Equipment you can count on today, tomorrow,... next year. The quality you deserve at a price you can afford.

Discover why so many recording studios, broadcasters, churches, and musicians are ordering from New World.

Shipped from stock: JBL, Otari, Ramsa, HME, Quantum, Fostex, Crown, Lexicon, dbx, AKG, Shure, Sennheiser, QSC, NEI, etc. Over 50 manufacturers to choose from.

If sounding great is important to you,... get to know us! Write today for your FREE audio equipment catalog.

Toll free Order Desk,



NEW WORLD
Professional Audio Equipment
4877 Mercury St.
San Diego, CA 92111

- YES! Please rush me your FREE catalog.
 Please send information on: _____

Print Name _____ PH. _____
Address _____
City _____ ST. _____ ZIP _____

Circle #123 on Reader Service Card

rh "SMART" CROSSOVERS™ and Array Series Enclosures

new *firsts* from RENKUS-HEINZ

now... microprocessor electronics control very compact R-H speaker systems to achieve studio monitor quality sound



SWG SIGNAL PROCESSOR/CROSSOVER



- Incredible 134dB SPL, 40Hz-17KHz
- Fail-Safe System Overload Protection
- Adjustable Intelligibility Enhancement
- Time Coherent System Performance
- Compact Modular Array for Fast Set-up
- Optional Flying Hardware

Designed for:
LIVE MUSIC CLUBS
DISCOS
THEATERS
CONCERT REINFORCEMENT

ASK YOUR DEALER FOR A DEMO OR WRITE US



RENKUS-HEINZ, INC. DRIVERS • HORNS • SPEAKER SYSTEMS
17851AB Sky Park Circle • Irvine CA 92714 • (714) 250-0166

Circle #124 on Reader Service Card

Q: What 3 things are in every top recording studio?



Celebrating our 15th Year

A:

- leading musicians
- state-of-the-art equipment
- staff trained at the **Institute of Audio Research**

Learn Multi-track Recording Technology in our own professional recording studio and fully equipped labs.

Register Now.

Call or write for information.



Institute of Audio Research

64 University Place
Greenwich Village
New York, N.Y. 10003
(212) 677-7580

Established 1969

Licensed by N.Y. State Dept. of Education
Approved for Veterans Training

MIX WORDS

©1984 Armand E. St. Martin

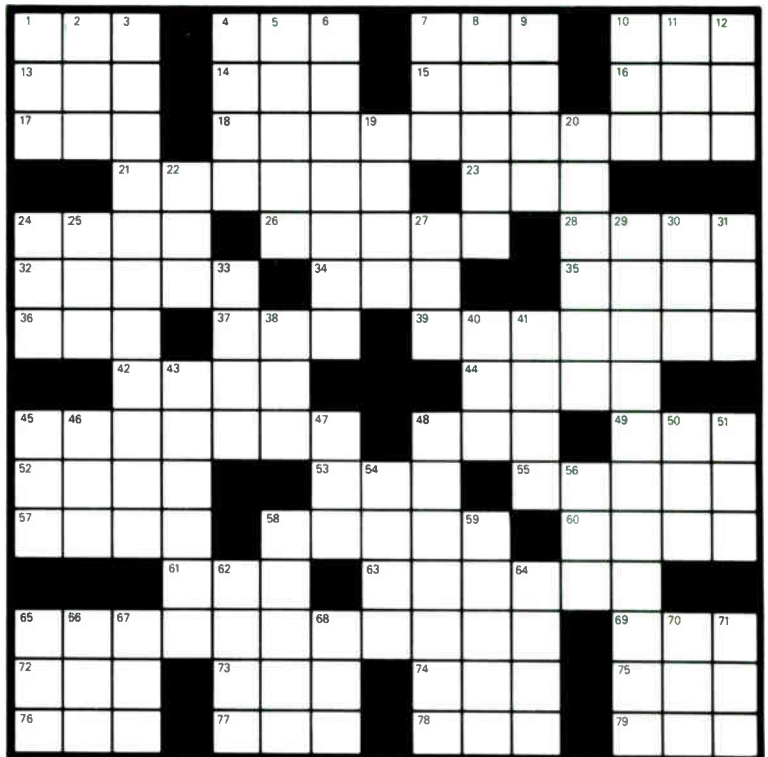

"SUNNY TRACKS"

ACROSS

1. Unusual
4. _____ Rosenkavalier
7. Mao's middle name
10. I was, to Pliny
13. Check out
14. Cockney abode
15. "..... good men to..."
16. _____ o menos
17. Dream state indicator
18. Records you can see
21. Actress Merle
23. Scottish refusal
24. Sun, _____, fui...
26. _____ hash
28. Porno
32. Follower of 24D
34. Old Tokyo (Var.)
35. Sound quality
36. Knobtwister org.
37. Signal peak indicator
39. Aspired
42. WWI aircraft
44. WWI spy
45. Mineral _____
48. Triple _____
49. Old English letter
52. Century plant
53. Child
55. Follow
57. Scams someone
58. Elated
60. Bakery worker
61. _____ the line
63. Gambler's milieu
65. Studio work intended for pressing
69. Grog
72. Rio de _____
73. Imogene's radio pal
74. Israeli mind bender
75. Roof ornament
76. A Cole
77. _____ meal
78. N.Y.C. opera house
79. Deep- _____

3. Not a 65A
4. Not for war (in politics)
5. Arab princes
6. Meted out, again
7. Oriental philosophy
8. Lingo
9. She, to Pedro
10. Flightless bird
11. Aries
12. CIA forerunner
19. Okie town
20. Wake up
22. Wager
24. Greek letter
25. That girl
27. Digits (abbr.)
29. Soundtracks
30. One, to Jacques
31. Sen. Kennedy
33. Asian mountain range
38. Miami time

40. Well-worn article
41. Speed
43. Fast tempo
45. Biol. bag
46. Arafat's grp.
47. Joan of Arc, e.g.
48. Layer
50. Expected
51. "..... name was Magill..."
54. Killer whale
56. Anais
58. Information transmission forms
59. River to the North Sea
62. Approximating phrase
64. "Who _____?"
65. Son of the President
66. Period
67. Bed
68. Pesticide
70. Wire service
71. _____ down

Solution to August Mix Words



DOWN

1. Above, to Burns
2. Rit

©1984 Armand E. St. Martin

MUSIC NOTES

said, "that's a Roland drum machine. What we wanted to do was to set up a real contrast for the ear. It's just to give a contrast when the weight of the real drums come in."

Getting back to Van Halen's solo, Swedien remarked that it was originally in a different part of the song. "Then Quincy and I kind of decided it would fit in another place better, so I moved it." Although Donn Landee did the recording of the solo, Swedien was present. How many takes did Eddie take? Swedien replied with a smile, "Not very many."

—Quint B. Randle

If there's a particular cut off an album, or a sound that leaves you muttering, "How'd They Do It?" let us know about it and we'll do our best to track down and reveal any secrets. Send questions and comments to How'd They Do It?, c/o Quint B. Randle, 255 N. 1600 West #76, Provo, UT 84601.

NAMM on Video

If you were unable to attend the Summer NAMM Expo in Chicago last June, you might be interested in seeing "NAMM-On-Video," a one-hour tape of the highlights of the show. Hosted by author/musician Craig Anderton, the program includes an overview of new products, demonstrations, interviews with industry people, and analyses of current trends. Some of the items featured in this edition are the new guitar synthesizers, Akai's 12-channel mixer/recorder, MIDI and SMPTE synchronization devices, electronic drums, etc. Anderton and director David Karr hope to produce a new edition for each of the two NAMM shows held each year. This one is available in VHS *only* for \$49.95 plus \$2.50 postage and handling from Notch Productions, P.O. Box 580, Langhorne, PA 19047-0580.

MIDI to the Max

Recent months have seen many additions to the hardware and software available for electronic musical instruments using MIDI, the Musical Instrument Digital Interface. In addition to instruments featuring the new communication facility, peripheral devices are being made to enable computer control of performance, editing, recording, and even music instruction. And new entertainment items are emerging, including pop-

SUMMER SALE

ODDS AND END OF

REVOX

Soundcraft







audio-technica®



DISCOUNTS on 140 PRO PRODUCT LINES

TOLL FREE IN ALL 50 STATES
1 (800) 356-5844
 IN WISCONSIN
 1 (800) 362-5445
 LOCAL (608) 271-1100

FULL COMPASS SYSTEMS

6729 SEYBOLD RD., MADISON, WI 53719

Circle #126 on Reader Service Card

Chet McCracken with Joe Walsh says:

"FOR SOUND,
you can compare the Hi-Energy Mics
to any on the market today."
"FOR PRICE,
there IS no comparison."



The Hi-Energy Miking System is unlike any other. Consider these features:

- **New Technology Condenser Microphone**
- **No phasing problems**
- **Handles an Incredible 161 dB SPL**
- **Eliminates boom stands and stage rumble**
- **More volume before feedback**
- **Shock mounted clamps set up fast and easy**
- **Natural, uncolored drum sound**
- **No need to drill holes in the drum shells**
- **Hot, clean signal at the board**

AQUARIAN AQUARIAN ACCESSORIES CORP.
 1140 N. Tustin Ave. • Anaheim, California 92807 • (714) 632-0230

More REAL drum sound at a great price.

Circle #127 on Reader Service Card

THE TIME MACHINES

from **Garfield Electronics**

The DIGITAL CLICK is the most advanced metronome available for film and video production. It not only provides 24 frames per second calibration for American film, but also 25 f.p.s. for European film, and 30 f.p.s. for video and SMPTE.

Tempos in all three calibrations can be specified with 1/2 frame resolution providing more calibrated tempos to choose from than ever before.

The DIGITAL CLICK produces click

tracks of ten times greater precision than previous metronomes with its .001% crystal based accuracy, and the enclosure takes up only one rack space. The unit features front and rear mounted jacks for external triggering and click output, and can drive headphones directly.

These features combine to make the DIGITAL CLICK the most accurate and versatile digital metronome available. List: \$595.00



Garfield Electronics

P.O. Box 1941 • Burbank, CA 91507 • (818) 840-8939

Our Only Business Is Getting Your Act Together

Circle #128 on Reader Service Card

TOTAL CONTROL!



MORE INPUTS. MORE OUTPUTS. MORE SPECIAL EFFECTS. GLI's 5990 does it all!

Our 5990 Creative Controller™ is a complete, flexible system that's ideal for numerous pro and audiophile applications. It puts total sound control at your fingertips with tight-tracking rotary controls and an intelligent layout with instant accessing of all functions. The 5990 offers 3 main channel inputs with switchable line/phono inputs plus 3 band EQ on every input. Plus:

- State of the art. Modular construction. Double sided glass epoxy PC boards.
- 3 phono inputs built-in at factory. • Exclusive LED Beat Match. • Total pre-cue capability. • Toroidal transformer for Hum-free performance. No turn on-off transients.

GLI's 5990 Creative Controller. The finest sound mixer ever designed. And it's yours for only **\$1,195.00.**

GLI * INTEGRATED SOUND SYSTEMS, INC.
 1227 Walt Whitman Rd. Melville, New York 11747 • (516) 351-2100
 In Canada: Jean Hepburn Enterprises 125 West Fifth Ave.
 Vancouver, B.C., Canada V5V1A1 604-879-7761

ular music on diskette for playback on computer music systems.

What follows is a sampling of the new stuff; there's lots more on the way.



MidiMate

Hybrid Arts' *MidiMate* is a software-driven, "slightly intelligent interface," according to Hybrid's Bob Moore. It plugs into the serial port of any Atari computer and communicates with musical instruments and related devices via MIDI In and Out and Sync In and Out jacks. The MidiMate enables synchronization between tape recorders, drum machines, etc. without special sync interfaces. "It accepts any popular sync pulse and voltage," Moore adds, including SMPTE code.

The first product designed to work with the MidiMate hardware is *Miditrack*, a 16 track, 3000-note sequencer. In addition to its versatile recording functions, it can control up to 16 different instruments or groups of instruments, each with its own real-time commands. Features include independent record/playback assign, overdubbing, punch in/out, auto-correct, transpose, track combining, etc.

Moore adds that two more products have just been added to Hybrid's line. The *600 Extender* program and sound editor for the Prophet-600 has a capacity of 2048 patches per disk, visual and alphanumeric display of knobs and switches, and alphanumeric naming of programs; the *DX-7 Extender* stores 320 programs per disk and enables multiple program moves to and from disk, with naming of all programs.

Circle #152 on Reader Service Card

Cherry Lane Technologies and GraceNote Corporation offer *MIDI Connections*, and software and hardware interface that connects one or more MIDI-equipped keyboards with any Apple or Apple-compatible computer and other MIDI-based gear. Depending on available memory, it can store 5,000 to 7,500 notes, with 16 polyphonic MIDI tracks assignable to any of 16 MIDI channels. Features include punch in/out, note correction adjustable from half-note to 32nd-note resolution, autolocate, adjustable tempo change, sync-to-tape, real-time note counter, etc.

Circle #153 on Reader Service Card

Syntauri Corporation recently introduced *Proxima MIDI/16* and *Proxima MIDI/16X* hardware and software, developed by Mimetics. Features include record/playback with 16 track sound-on-sound, pitch bend, touch/aftertouch, modulation amount and velocity. Any MIDI channel can be assigned to any track, with polyphonic punch in/out, and Proxima allows synchronization to drum machines. Files created with Syntauri's Metatrak program are compatible with the Proxima format, so they can be used with the new system. The Proxima MIDI/16 has a 3,000 note capacity; the MIDI/16X expands it to 20,000 notes.

Circle #154 on Reader Service Card

Passport Designs has joined with Hal Leonard Publishing to create *Computer Sheet Music*, a software package which teaches music as well as enabling the playing of popular songs on Passport's computer music systems.

Each package consists of software, recorded music and custom music books. Songs are stored on a diskette and are displayed on the computer's video screen in musical notation and chords. A "bouncing ball cursor" follows the melody so the musician can play along ("learn" mode), or the song can just be played by the computer ("play" mode). Computer Sheet Music works with Apple II and Commodore 64 computers and requires a MIDI interface and a MIDI keyboard. The first release is Michael Jackson's *Thriller*, with all the songs from the album.

Also from Passport is *MIDI/4*, a 4-track digital recording system that allows interfacing of MIDI synthesizers and any drum machine, with real-time editing, unlimited overdubs, transposition, etc. Storage capacity is 5,500 notes, and pitch bend, key velocity, aftertouch, modulation, foot pedals and breath control information is stored as well.

Circle #155 on Reader Service Card

THE CLAW[®] Miking System

THE BEST IS EVEN BETTER!

- Stronger clamping screws.
- Softer, larger rubber insulation greatly improves shock mount.
- Mike holding assembly is now 1/3 the original weight.

Send for FREE fact sheet.

Endorsed by Steve Smith of Journey

DEPT. MX
LATIN PERCUSSION, 160 Belmont Ave., Garfield, NJ 07026 (201) 478-6903

Circle #129 on Reader Service Card

wireworks by design
make your system design a reality:
specify wireworks.

Wireworks shines in the most demanding applications: On Broadway in *42nd Street* and *A Chorus Line*; on the road with ESPN...

And simplifies the most complex installations: Multimillion dollar broadcast systems like the PTL Barn in North Carolina and Radio City Music Hall in New York.

Wireworks' reputation for excellence is based on utilizing only the finest materials and the most technologically advanced production and testing techniques.

In addition, our range of nearly 1,000 *standard* items provides our clients with rapid delivery and an unparalleled selection of audio, video, and audio/video equipment.

Wireworks: The system you never thought could be built might very well be in our inventory — right now — just the way you designed it.

For further information write or call Wireworks Professional Audio Products.

wireworks.

Wireworks Corporation
380 Hillside Avenue
Hillside, NJ 07205
Telephone: (201) 686-7400
Twx: 710-985-4675

Circle #130 on Reader Service Card



REYNOLDS, COOPER

"Recording Miles is very much like doing a remote date in the studio," says engineer Tom Swift of New York's Record Plant, where the legendary trumpeter recorded his latest LP, *Decoy*. "As soon as he walks in the door, he likes to start blowing. He likes to get a lot done real quick. You don't have countoffs and stops and rollbacks of tape and that kind of thing. Things may be sometimes semi-rehearsal, but everything is taped."

Two 24 tracks were rolling constantly, as were a couple of two-tracks and about six cassette players. "That's so they can just walk out of the session and be able to pick through what they did that day and decide what they want to do with it later," *Decoy*, according to Swift, is something of a breakthrough for Miles. "It's the first time he's really gotten into the studio, into the control room, and started using the multitrack, playing with overdubbing and enhancement of the sound. He was learning a lot about the studio, getting into just being able to pick things apart, put a second horn on a thing. In the past he's kind of had everything going live. On *Decoy* there was a lot of taking segments of different performances and putting them together—getting something that was on an entirely different reel, from a different day, and making it sound like one big, flowing performance."

The album's opening track, "Decoy," seems to float a couple of feet above ground, propelled by Mino Cinelu's insistent triangle work and Al Foster's swinging and syncopated hi-hat, and smoothed out by Robert Irving III's synthesizer voices (a blend of metallic shadings and *Get Up With It* Miles organ sounds). Miles doesn't wait long before introducing himself; he proceeds to buzz

Miles Davis discovers the studio

MILES DAVIS
DECOY
Columbia FC38991

Produced in New York by Miles Davis, Robert Irving III and Vince Wilburn, Jr.; executive producer Dr. George Butler; recorded at Record Plant Studios, New York City; engineered and remixed by Ronald F. Lorman; assistant engineering and editing by Tom Swift; live tracks recorded by Le Mobile with Guy Charbonneau; "Freaky Deaky" recorded at A&R Studios, New York; mastered by Bob Ludwig at Masterdisk.

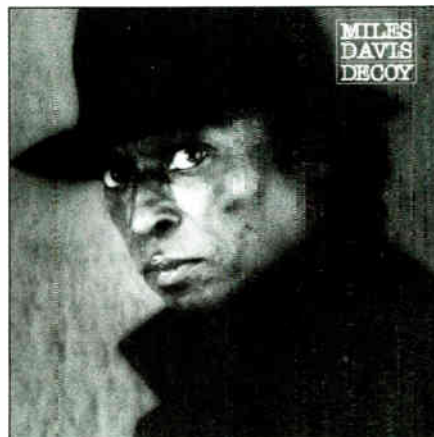

muted all over the place, but he's playing hide and seek, making sure nobody finds him. Branford Marsalis takes an equally fascinating run through the changes.

"Go ahead," Miles growls before launching into "Code M.D.," a Robert Irving tune along the pop-jazz lines of "Shout" (*The Man With The Horn*). John Scofield's bluesed-out funkifications give the song its irreverent twist, and he joins with Marsalis on some strong doubled lines. Scofield even makes clichés sound hip, not that he plays many.

Did you ever think you'd hear Miles tracking with a Linn?" "Code

PLAIN TALK by magnifax

Q: Aren't the Magnefax duplicators obsolete?

A. Magnefax is an "old" company which has been serving the needs of the duplicating community for the past 25 years. The design of the common mandrel capstan has been used since the beginning and still constitutes the backbone of all Magnefax machines. This design has been time-tested and is now proven, this is far to be the definition of obsolescence! Since 1959 the machine has been continuously refined in terms of design and production. Magnefax uses the most recent technology including digital metering, optocoupling and Large Scale Integration circuitry. State of the art equipment is used in all phases of the production and all components used in the machines are of the highest quality available.

Q. How does a Magnefax compare to the competition?

A. Although the duplicating ratio of a Magnefax is only of 16:1, the output in terms of tapes/hour is comparable to machines costing three to four times more. Because our machines come with a seven slaves configuration as standard, in term of cost/output the Magnefax are unbeatable. The main advantages of the "low" 16:1 duplicating ratio of a Magnefax system are found in the quality of the final product: The dynamic range in the high end of a Magnefax is unequaled and would be impossible to achieve at 64:1 or even 32:1, the slower speed resulting of the 16:1 ratio translates into reduced mechanical wear and the lowest maintenance of any machine on the market today.

Comparing a Magnefax duplicator to the competition is being unfair to the competition, a Magnefax duplicator is a standard by itself.

Q. Why does the machine look like that? I mean weird.

A. The common mandrel design dictates the overall look of the system and the advantages of such a design outweigh the machine's unusual appearance. While other manufacturers are using so called sophisticated techniques to achieve constant speed and minimum wow and flutter between master and slaves (PLL, feedback dc motors etc..) Magnefax uses the common mandrel design which solves all of these problems: The common capstan between master and slaves reduces relative speed variations to 0% with only one heavy duty motor driving the capstan thus leading to the lowest possible maintenance. A conventional duplicating machine with seven slaves will use at least eight motors to perform the same job than a Magnefax with its single, reliable motor...In addition, Magnefax has a lower floor space requirement than the conventional duplicating systems: a Magnefax duplicator is at home with only 20 square feet...most brands require this much for the master unit only. As to the vertical handling of the pancakes in the Magnefax vs. the horizontal positioning of the competition's units: we do not say that they are wrong but we do say that we are right to position the tape vertically in the machine when we see the end result: a perfectly packed pancake.

Who said that the machine looked weird anyway?

Q. How expandable is the Magnefax duplicating system?

A. A Magnefax system is not expandable because too many compromises would have to be made in terms of performance and reliability. The fact is that equal or superior output in terms of tapes/hour can be achieved with one Magnefax for up to 75% savings when compared to the competition. If you need more output, buy a second Magnefax machine. By doing so you are still ahead financially, you doubled your output, you can run two different jobs simultaneously and in the very improbable case that something goes wrong with one of your machines your business is not completely dead.

How is that for expandability?

Q. Is the Magnefax system upgradable or am I stuck with what I bought?

A. Good question, here is a good answer: First of all, when you buy a Magnefax duplicator you are not "stuck": you have purchased the best possible machine. Yes the system is upgradable. Although all Magnefax duplicators reflect the best available technology, we are continuously evaluating upgrades to our machines through active research and development. Our modular design for the electronics is a proof of our commitment. Some options will be provided soon for the 7.5 IPS machine but any existing 7.5 IPS Magnefax can be upgraded at any time.

Q. How much maintenance is required on a Magnefax machine?

A. Our favorite question. Near zero is the answer, a drop of oil once in a while for the bearings of the shaft, normal head maintenance (cleaning and lapping) and that is basically it. It is not uncommon to have customers say to us that in years of normal use all that they ever changed were the pinch rollers...Once a customer complained that one of the motor belts broke and he was wondering if it was a sign that things would be starting to go downhill for his machine. After we reassured him we asked how long he had been using the duplicator prior to this unfortunate accident, the answer was 17 years...

Q. Do we need specialized personnel to run a Magnefax duplicator?

A. No. After a normal training phase anyone can load and run the system.

Q. Most Magnefax machines are used for voice duplication and not for music. Why is that?

A. Until now Magnefax provided only a 3.75 IPS stereo machine for cassette tape duplication. This fact seriously limited the market to the voice business although spectacular results are obtained with music recorded at 3.75 IPS. The new machine answers the needs of companies using 7.5 IPS masters and teams unsurpassed quality of music duplication with the legendary Magnefax reliability.

Q. What about field support?

A. As previously mentioned, near zero maintenance is required. Every machine is thoroughly tested prior to shipment but in the unlikely event that something goes wrong we can provide technical support by phone (most of the problems can be field corrected after talking to one of our engineers) or have one of our representatives contact you for further action. In any case the problem will be corrected within a very short period of time.

Q. If the machine is this good how come I don't hear more about it?

A. In order to keep the quality of the production very high we have to work on a small scale. It takes a full two days for a skilled worker to finish by hand the shaft used for the common mandrel to our specifications (and this is the final phase for a piece which first has been hardened and rectified to very close tolerances on the finest machines available. Another fact is that you cannot find too many used Magnefax duplicators on the market since users tend to keep them forever (98% of the Magnefax systems ever built are still in operation). Finally the fact is that since the Magnefax duplicators are a standard by themselves we do not need to advertise the product aggressively. When all things are taken into account we really don't have any competition.

Q. Why should I buy a Magnefax duplicating system?

A. Did you listen to what I said?

magnifax

International, Inc.

Route 1, Rogers, AR 72756

(501) 925-1818 TELEX 53-6433 AIDC LRK

Circle #131 on Reader Service Card

M.D." and a couple other tunes on side one use drum machines along with drummer Foster. "It's like an ambience change that makes it a little different," says Swift. "There are a couple spots where we would pull the drum kit back [in the mix] and leave the electronics up a little more. You ear goes, 'That's not a regular snare drum.' You hear something different." Underneath Miles' in-the-pocket solo, synthesizers whir softly, enclosing another barely-audible Miles solo. Lost, unfortunately, in all the sound of "Code M.D." is Daryl "The Munch"

Jones' bass work. Awesome when up front and munching, it is missed here.

Miles sort of plays Zawinul on "Freaky Deaky," with synthesizers at his command and wide open spaces in which to play. Obviously pleased with the jam, Miles can be heard at the end, "Definitely want to hear that. It's freaky deaky." "They were saying, 'OK mute that,' and I'm going, 'No, leave it in,'" Swift recalls. "When I was going to school with all these jazz musicians they would crank Miles' records up just to hear what he said, talking to Teo

[Macero] and stuff. You could hear him at the end of a fade. It's so unique, and I know so many people do that kind of listening, hoping he'll say something. So we left those things in there."

"What It Is" and "That's What Happened" were originally recorded live at the Festival International De Jazz De Montreal. "You would normally take a live thing and try to make it sound more in-the-house, do the audience thing and all," says Swift. "But actually we tried to make them *not* sound like live cuts. We wanted to match it to the studio sound, but a little more raw." These two Davis-Scotfield collaborations represent some of the best writing on the record, and Miles at his hottest. He blows cool and free, and yes, that is Miles answering Miles during the solo. Miles on top of Miles. He *has* discovered the overdub.

Davis is in classic blues form on "That's Right," keeping it low and smooth, then reaching up to slur a spate of high ones, stopping to get his bearings and check out his cohorts. Scotfield takes Albert King to heart and wrenches it from the gut. Daryl Jones plays incredibly low and supportive pedal tones on his 5-string Steinberger. "The blues on the record is sort of constructed out of a whole lot of ideas," Swift says. "They would play two or three five-minute sections, somebody would blow a great solo, and Miles would say, 'Wow, we've got to get that in there somehow.'" So we'd connive a way to make it happen."

Jones is back to munching on "That's What Happened." He is percussion, melody, rhythm. Scotfield displays his really raunchy side with disarming swoops and bends. "A lot of Scotfield's sound to me has to do with the stereo separation, where he'd use a couple of amps doing different things," Swift recalls. "When I was miking his amps, if I just stood in front of one it didn't really sound like Scotfield's sound that I'm used to. But if I stood about four feet back, right between the amps, it would acoustically mix." Scotfield and saxman Bill Evans pour the inside-out melody loosely, while Miles handles cluster chords on synthesizer, Foster rocks with great finesse, and the versatile Cinelu clammers in hot pursuit.

Davis didn't want much of his horn in the way of special effects on *Decoy*. "The approach was to really try to get the Miles sound," says the engineer, "that really warm thing that makes you melt." *Decoy* may be the most well-rounded record Davis has made since returning to the studio a few years back. It is undoubtedly one of this year's hottest jazz albums. But, says Swift, it wasn't easy capturing Miles. "When we started the record, Miles kind of liked to walk

There are many ways to split a mic, but only one way is best

Jensen MB-series Mic Splitter Transformers

When you need to split a mic, you should use a transformer because it provides a balanced, isolated signal to the input of each mixer; none of the mixers' grounds need be connected to each other (via the mic cable) so ground-loop induced noise is easily avoided. There must be a Faraday shield on each winding so that the transformer will not provide a path for capacitive coupling of common mode noise.

JENSEN TRANSFORMERS are best because, in addition to meeting these requirements, they minimize degradation of the mic signal's frequency response, phase response, and distortion characteristics. To prevent common mode noise from being converted to a differential signal, each end of every winding in a JENSEN TRANSFORMER has its capacitance precision-matched to that winding's Faraday shield. These are just a few of the reasons why most engineers end up using JENSEN splitter transformers.

The JENSEN JE-MB-C, JE-MB-D and JE-MB-E microphone bridging transformers will split a mic signal to 2, 3 or 4 mixers.

**Insist on the best...
insist on a JENSEN.**

jensen transformers
By REICHENBACH ENGINEERING

10735 BURBANK BLVD./N. HOLLYWOOD, CA 91601
(213) 876-0059

Visitors by appointment only.
Closed Fridays.

around the room. He didn't use headphones. He was playing through a wireless, and wasn't on mike very much. And he had to have a set of speakers in the room near him to listen to what was going on. That's not exactly the engineer's dream, you know. But eventually we got him on microphone. And when you've got a good microphone and a guy that plays the horn like that, it's just going to sound wonderful—as opposed to going through a wireless system where it's being compressed and doesn't have the tone. But by the end of the project, on most of the stuff he was working with headphones and cues. It was a little easier to control."

Somebody actually got Miles to stand still?

"Well, don't pass that around, or he'll be moving again."

—Robin Tolleson

Canned Music

Warner Bros. Records has come up with a clever way of marketing its English and Australian rock acts. It's *Survival Sampler*, a cassette-only collection of a dozen tracks packed in a tin can



and placed in counter-top dispensers.

"We had these overseas acts with albums coming out in the next few months, and we wanted to lay some groundwork for them," explains packaging specialist Kevin Laffey. 'Jeff Ayeroff (vice president of creative marketing) came up with the concept of 'What music would you take with you into the fallout shelter,' and that evolved into the *Survival Sampler*.' The idea is "to put it next to the survival food so when people have to go in the bunker

they'll have something to listen to," says Ayeroff with tongue firmly in cheek.

Hale Milgrim, WB's national director of merchandising, took the tin-can idea and ran with it, developing a counter-top dispenser so the package "doesn't get lost on the cassette wall."

Laffey selected and sequenced the tracks, assembling nearly an hour of music from twelve acts including The Smiths, Scritti Politti, King Crimson and Depeche Mode. Many of the cuts are 12-inch versions that would otherwise cost \$4.95 each, and Ayeroff notes that since the acts are all on different labels outside the USA, "this is the only place you'll find them all together." A leaflet titled "Sound Rations" enclosed in the can goes along with the theme, playing off the band names and song titles in humorous ways.

Although it lists for \$8.98, Ayeroff characterizes *Survival Sampler* as a loss leader due to the cost of putting it together. Its novel presentation will attract buyers to *Survival Sampler* at the point of sale, and the music inside will attract the desired attention to the new albums. "Maybe people will buy two," suggests Ayeroff hopefully, "one to open and one to save."

—D.G.

Still the Most Cost-Effective, All Purpose—Reverb

ECOPLATE™ III,

size 56" x 38" x 9", scaled for the Cost-Effective Studio

IF YOU'VE BEEN "GETTING BY" WITH SOMETHING LESS THAN A TRULY PROFESSIONAL REVERB SYSTEM, THEN THE NEW ECOPLATE III IS FOR YOU. PLATE REVERBS ARE THE STANDARD OF THE INDUSTRY WITH THE SMOOTH, BRIGHT SOUND OTHER SYSTEMS TRY TO IMITATE. NOW, FOR ONLY \$1695, YOU CAN STEP UP TO THE BEST. OR, IF YOU ALREADY OWN AN ECOPLATE OR OTHER FINE REVERB, THE III CAN GIVE YOU A SECOND SYSTEM FOR A MODEST PRICE.

Reverb Time: Variable .5 to 5 sec.

Signal to Noise: 65 db

Frequency Response: 80-20 KHz

Input: -10 or +4 dbm 10K ohms. unbalanced, 10K ohms

Stereo Outputs: +4dbm (+24dbm max.) 50 ohm unbalanced

Size & Weight: 56" x 38" x 9", 109 lb.

Equalization: Both Hi and Lo Variable

New Shock-Mounted Plate Tension System is Pre-tuned at the Factory Eliminating Tuning Problems.

STUDIO TECHNOLOGIES, INC.

7250 North Cicero, Lincolnwood, IL 60466 • (312) 676-9177

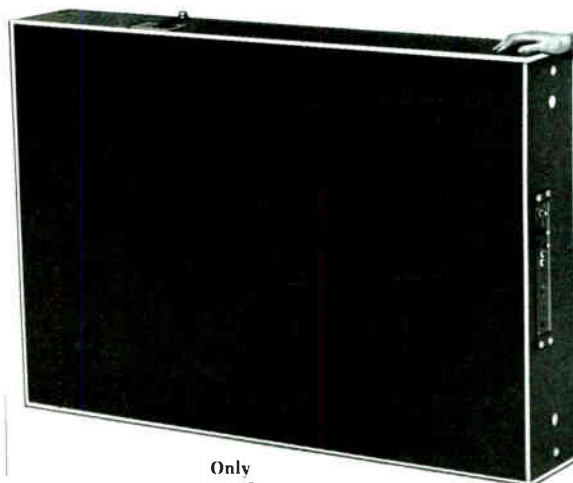

Only \$1695

Circle #133 on Reader Service Card

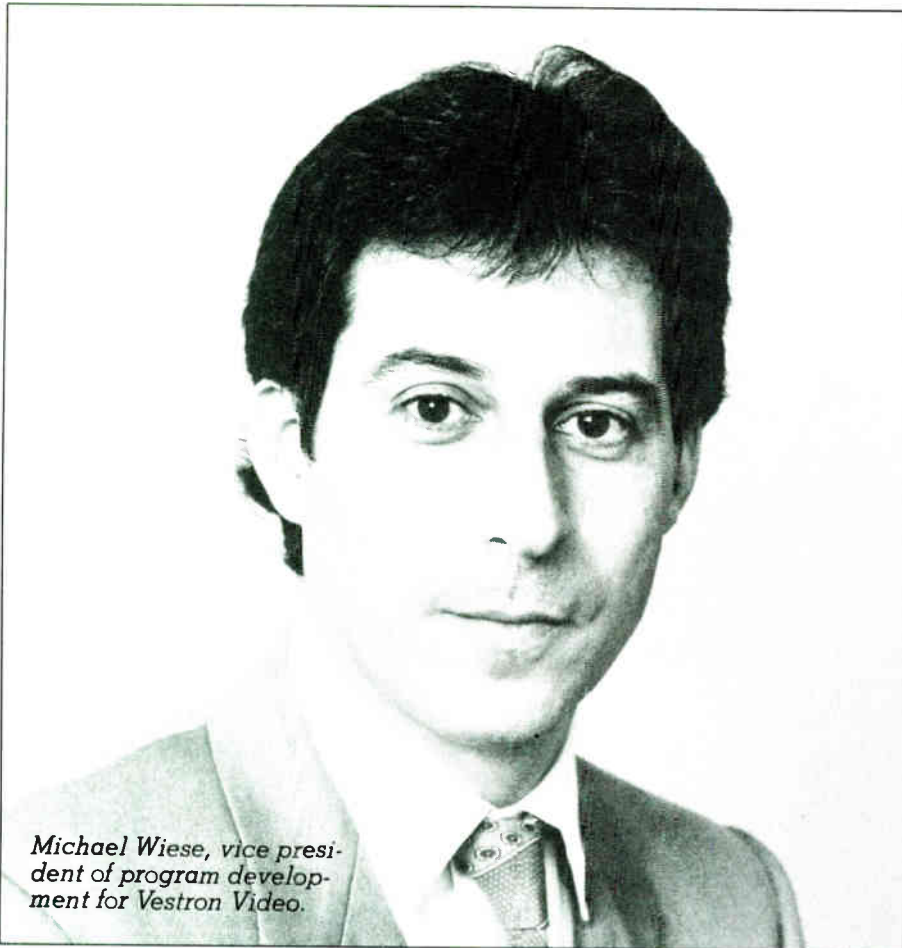

Michael Wiese, vice president of program development for Vestron Video.

MUSIC VIDEO SOFTWARE

by Lou CasaBianca

Music Video is at a very intriguing crossroads, moving out of being a promotional device to push records in stores and on television to becoming a valid programming category. After years of being on the brink of becoming a legitimate business, video music has reached escape velocity as a viable segment of the video marketplace. The question is, in which direction is this young art form/industry headed?

The Way it Was

Control of the music video business is and has been held by a couple of

handfuls of record labels and videomusic producers. As the competition for budgets increases and the demand for higher production values becomes even more critical, it appears that the industry will continue to be dominated by a small group of insiders who have the business wired. Today, however, a new power broker, the independent video distributor is emerging on the scene. Software programming and distribution are perceived as a "glamorous" industry with music video as the most mercurial and potentially one of the most profitable slices of the program pie. In the '70s the Hollywood studios formed their own

home video divisions or licensed their catalogs for sale to the then infant marketplace. For reasons that have as much to do with political and budgetary expediency as they do with a lack of foresight and imagination, the music business has for years treated videomusic as strictly a promotional tool. This is in addition to the fact that in most cases they have contractually tied-up the artists and the music video rights and done nothing or prohibited the artist from doing anything meaningful with the rights to their own music. The phenomenal success of MTV and Michael Jackson's "The Making of Thriller" has forced many of the major record labels to adjust their thinking about their product... "Are we selling records or are we selling music?"

Future — Past

It is clear that if music video is to develop as a business, long form programming (not just three minute clips and concert footage strung together) must become a more important factor. One of the biggest variables in the equation is the question of home video. The explosive sales of 1/2-inch home video videocassette recorders is helping to create an expanding audience for all kinds of programming. Time-shift recording, adult films and blockbuster feature films have dominated home video software from its very inception. As the cost of videocassette recorders drops and the number of machines out there expands, the marketplace itself is beginning to define the kinds of programs that will be successful. It's almost as if we are completing one of those spirals that brings you back to the same place but at another point in time. In the '40s the record business was Columbia, RCA and Decca Records, period. If you couldn't close a deal with one of them, there was no deal. Artists, producers and writers had no option. Out of this frustration and the artificially enforced control of recorded media, the independent label and studio business was born. Atlantic, Motown and A&M Records are some of the more notable examples of independents who helped changed the sound of modern music. Now they have joined the other corporate giants as the establishment and a whole new group of labels like IRS, Tommy Boy and Virgin Records have proven that by knowing where the "beat meets the street," a determined independent can still break through the morass. Independent artists and record companies have forced radio to loosen its stranglehold on the record business by



A few cast members pose in this scene from "Making Michael Jackson's Thriller," Vestron Music Video's best selling program.

going directly to the audience through cable television and the dance clubs. And today the possibility of the independent video producer "breaking" a videotape the way records were once and still are "broken" on radio, looms as a distinct reality.

New Game in Town

Vestron Video in Stamford, Connecticut, is the largest independent videocassette distributor in the US. In 1983 the company reportedly earned

\$5 million on sales of \$50 million. Vestron was formed in July 1981 by Austin O. Furst Jr., who had been president of Time-Life Films and an executive vice president of Home Box Office. When he left Time Inc., Furst took with him a deal for the home video rights to about 200 Time-Life films, which included feature film, concerts and how-to features. Last year Furst heard that the producers of Michael Jackson's "Thriller," were running over budget. "I figured they needed money to finish," he recalls, "so I called Jackson's agent in Hollywood. After a 90-minute talk, we put a deal together to produce "Making Michael Jackson's Thriller." Company president Jon Peisinger, 36, a record business veteran, says, "I have an eight-foot high symphonic gong outside of my office; we ring it to marshal the troops every time there's good news. The loudest gong we ever had was the day Michael Jackson signed with us." The subsequent smash success of "Thriller," about 750,000 units at \$29.95, has helped Vestron to acquire an eight percent share of the market. The company is in part responsible for a major change in the marketing of home video cassettes, by aggressively marketing music video to record stores.

Despite the enormous success Michael Jackson had already achieved



"Linda Ronstadt with Nelson Riddle and his orchestra—What's New" is another of Vestron's recent releases.

as a recording artist, Vestron Video was taking a huge risk when it began shipping the "Making of Michael Jackson's Thriller" at \$29.95 instead of the standard going rate of \$69.95. The price point was to encourage sales rather than rentals. Instead of just selling in video stores, Vestron sold thousands of videocassettes to record stores with a promise they could return any unsold copies. In the past, home video distributors have usually refused to take back more than five percent of unsold product. Over 60

REACHING THE PEAK OF AUDIO PERFECTION



ANNOUNCES ITS OPENING!

Featuring: NEVE with NECAM Automation, STUDER A800 24 track, MITSUBISHI X-80A Digital 2 track, and a COMPLETE Assortment of Outboard Gear.

SOUND SUMMIT is located in scenic Lake Geneva at the exclusive AMERICANA Lake Geneva Resort Complex which provides an atmosphere of relaxation and recreation.

For more information:
SOUND SUMMIT c/o Americana Resort • Highway 50 • Lake Geneva, WI 53147
(414) 248-7666

percent of the sales have come from record stores and mass merchandisers like K Mart and J.C. Penney. If "Thriller" sales had not been huge, Vestron could easily have been driven to the brink of bankruptcy. Instead, "Thriller" has become one of the greatest marketing success stories in the brief history of the home video business.

Vestron president Jon Peisinger says, "We felt it was a prudent risk. Before we made our offer to the record stores we looked at the nature of the product and the Jackson phenomena. Peisinger says that "Thriller" allowed them to open up 2,500 new distribution outlets and make the largest initial shipment of a music video title ever.

In the U.K., the London Sun reported in a front-page headline that over 100,000 were sold in the first three days of release. Similar record-breaking sales for home video were recorded in France, South Africa, Holland and Australia. In Japan, the English-speaking version alone has sold in excess of 30,000 copies. Vestron released a Japanese-subtitled version and will also be releasing the program in Latin America, West Germany, Israel, Greece, Egypt, India, and Spain (a subtitled version) by early summer.

"Making Michael Jackson's Thriller," is the home video program recog-

nized by the industry as the catalyst that brought record retailers and other mass merchandisers into the home video business in US and foreign markets. Retailers have begun to dedicate significant floor space and inventory investments to music video programs as well as other genres.

Directed by Jerry Kramer, and jointly produced by George Jolsey, Jr., John Landis (*Trading Places*, *American Werewolf in London*), Michael Jackson and Optimum Productions, the program includes the 14-minute music movie "Thriller," directed by John Landis, as well as an intimate glimpse of Jackson as both a person and performer, and video clips from the award-winning "Beat It," and the Emmy-nominated performance of "Billie Jean," from the "Mottown 25" television special.

For privately owned Vestron Video, "Thriller" is just another chapter in what is becoming an amazing success story. In its short history Vestron has established itself as the largest, most successful independent (in the industry dominated by divisions of movie studios). Its initial success came primarily from video versions of movies which Time-Life had produced, like *Ft. Apache*, *The Bronx*. Vestron has made other deals—thanks to its ability and willingness to pay top dollar—to insure a steady stream of product, including long

term agreements with Orion Pictures and ABC Motion Pictures.

What Price Music Video

Peisinger sees the home video business splitting in two in coming years. "We're talking about a very different business than the movie rental business. Although the two may overlap in some video stores, the traditional video retail shops will continue to do most of their business in rentals. On the other side you will have record stores and mass merchandisers (department and discount stores) who don't want to be in rentals, but know how to sell." Peisinger cited the case of the giant K-Mart chain of discount stores. They tried selling video cassettes for the first time with "Thriller." As a result they will now sell Vestron's new line of music videos, with a new title each month, in at least 1,000 stores.

Program Development

Michael Wiese, a former San Francisco Bay Area filmmaker, is Vestron's vice president of program development. He comes to Vestron from Showtime/The Movie Channel, where he served as director, on-air promotion and production, for the Movie Channel. Mr. Wiese is a frequent national lecturer on film financing, producing and distribution for the American Film Institute. He

—PAGE 217

AUDIO AFFECTS

— NOW NATIONWIDE —

"DISCOUNTED STATE OF THE ART RENTALS"

(213) 872-3033 (818) 986-9902

YOU NEED IT...WE'VE GOT IT...

- MITSUBISHI DIGITAL 32 & 2 TRACK • OTARI 4 to 24 TRACK
- AMPEX 2 & 4 TRACK • Q LOCK • JVC ¾" VIDEO
- YAMAHA GS1 • DX7 • DX1 • SYNCLAVIER II • 360 SYSTEMS • EMT 252
- AMS EXTENDED LOOPS • LEXICON 224XL • PUBLISON • QUANTEC
- SIMMONS SD7 • DR. CLICK • SRC • MX 1 • LINN • EMULATOR II
- DRAWMER • DBX • DYNAMITE • VINTAGE MICS • KEPEX II • LOTS MORE...

**FOR COMPLETE INVENTORY CATALOG AND PRICES,
GIVE US A CALL.**

Circle #135 on Reader Service Card

Solid Sound For Solid Gold

All Photos
by Tony Thomas

The evolution of high quality audio for television has been a slow one. It seems that, in the not too distant past, nobody really took the aural side of the TV signal seriously. For many years the television industry had viable excuses. The band lines that were once used to bring network programming to the local affiliate had a very narrow bandwidth, ruling out quality reproduction. Then there was the matter of the 3-inch speaker that was to be found in virtually every television, regardless of cost. This, too made quality TV sound virtually unthinkable.

Then, a few years ago, the networks made the switch from cable to satellite and microwave opening up the possibility of improvement in sound. Then, there were the pioneers that experimented with FM stereo simulcasting of televised music programming. And, finally, the advent of the music video which has produced a sight/sound explosion with laser discs, stereo VCRs, integrated TVs with hi-fi capability and large screen TVs as its fallout. The recent FCC decision which now authorizes stereo television broadcasting is the nail in the coffin of lo-fi TV. And with this decision must come a change in the way the television programs are produced from the audio standpoint.

TRENDSETTING

Paramount Pictures Corp., the distributor of such syndication hits as *Solid Gold* and *Entertainment Tonight*

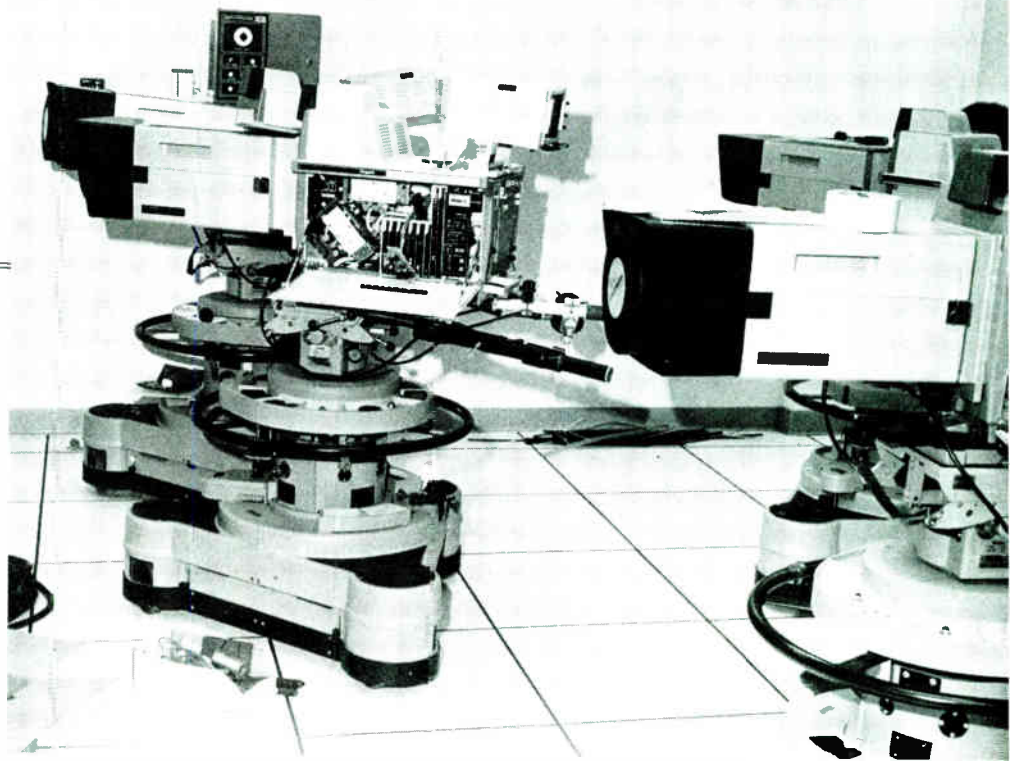

Ikegami television cameras with Fujinon lenses for Solid Gold taping.

has made a bona fide investment in the future of high quality TV audio with the addition of its new \$11 million teleproduction complex which includes the very latest in audio and video technology. Situated in former film stages 28 to 32 on the famous Paramount lot, the new complex has been recently brought up to current seismic standards and rewired for AC (vs. the DC used for filming) operation. Stages 28 and 29 will be used for the production of *Entertainment Tonight* and *Solid Gold*, respectively. Their daily and weekly counterparts, *Entertainment This Week* and *Solid Gold Hits* will also be produced there. Stage 31 will be used for sitcoms, while Stage 32 is an open stage at present.

Stage 30 is the support structure for stages 29 and 31, containing the audio and video control rooms, the dressing rooms, air conditioning and high voltage (1500 KVA) power facilities for lighting. Everything in the facility is state-

of-the-art, from the computerized lighting and rigging systems by Hoffend on the *Solid Gold* stage to the Ikegami cameras, Grass Valley switcher and custom 56 input Amek console. The construction, by Centro Corporation, is superb. Comments Clifford Hay, project manager for Paramount's technology division: "They really did a nice installation, very quick. We found very few problems with the way they put everything in."

DESIGN FOR EYE AND EAR

The rationale clearly evident from the layout of the new facility is the desire for parity between the audio and video elements of the programming, thereby closing a gap that has existed for far too long. In many television studios, the audio console (which was nothing more than a row of black knobs and

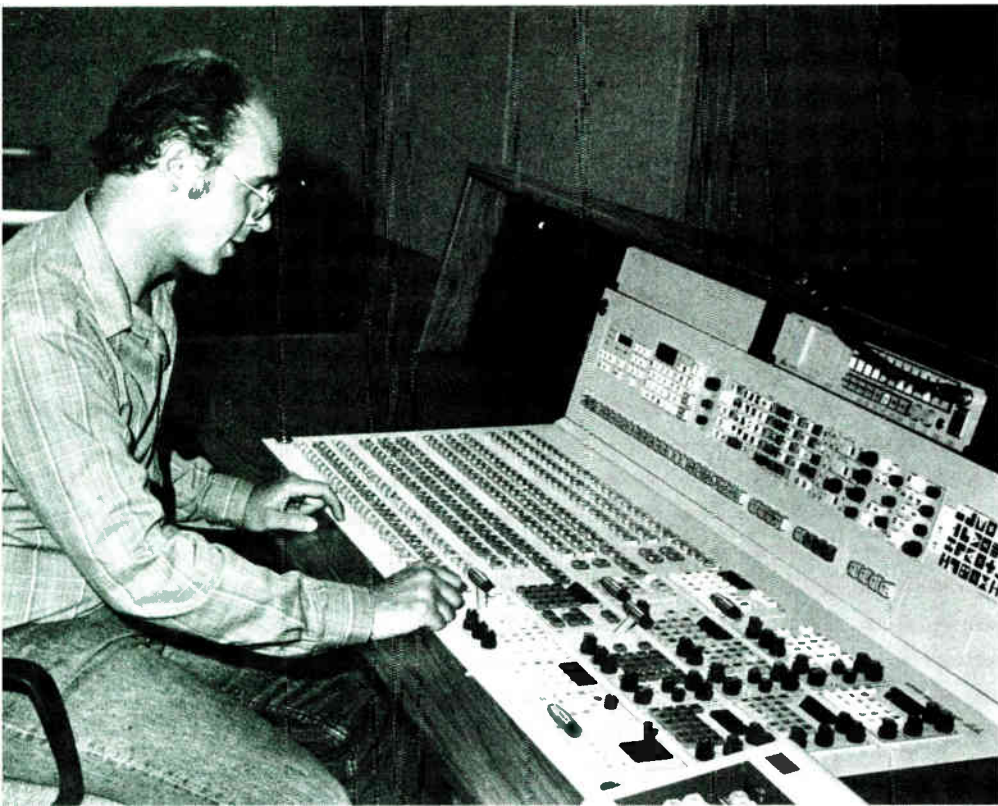

Paramount Pictures' chief audio engineer Bob Lowe at director's position in video master control.

switches in some cases) was relegated to a secondary position in the main video control room, dwarfed by a plethora of sophisticated video equipment. In the new Paramount Stage 30, there are separate control rooms for audio and video, affording maximum control of both signals.

"The overall design was formulated to bring *Solid Gold* onto the lot," says Jerry Barnett, project manager for Paramount Sound. "We wanted to make sure that the *Solid Gold* people got everything that they needed while allowing the possibility of other shows to come in and use the same equipment." Adds Paramount's Hay: "Basically its a musical stage. You could bring in a large musical variety show like the Academy Awards. We designed it so that we can do anything we want in the musical variety format on this stage."

Anything, indeed. Over 100 microphone lines are available to the audio mixer and wiring has been installed for up to twelve camera positions. To facilitate quick communication between the director, sound engineer and crew, an RTS communication system has been installed, permitting dozens of people to be hooked up at any given time. JBL monitors are used in both control rooms, and video monitors abound everywhere, so that both the director and

USED RECORDING EQUIPMENT FOR SALE

MICROPHONES

All AKG and Neumann Tube type Mics are available from us: C24 Stereo; C12A, C28; C61; C12; U67; U47; M269; Sm2 and Sm69 stereo; M50 and M250.

SPECIAL SALE!

Pairs of KM 53 and KM 54 Tube Microphones (take your pick) \$950 • Sony Mics: ECM 377, C500, C22p ECM51 • B and O stereo Ribbon \$200 • AKG Dynamic Mics D19 \$35 • D24 \$40 • D160 \$50 • D30 \$75 • Neumann KM64, KM66, KM56, KM85, U64 • Schoeps tube mics CM51v/M221 \$350 • Schoeps (solid state) CMH 32 \$200 • CMT 36 \$275 • Sennheiser MD 211 \$95 • MD413 \$95 • MKH 405 \$300 • Altec/Shure/ EV Mics of various types • Beyer M500 (as new) \$140 • M101 \$125.

We will go anywhere to demonstrate our tube microphones!! Let us show you why over 500 studios nationwide have obtained their finest microphones from us. You can hear the difference!!

OUTBOARD GEAR

EQUALIZERS

API 550 \$275 • MAP (550 replacement) \$225 • ITI Parametric modules (5) • \$1000 (all) • Melcor EQs (modified) \$80 • Neve EQs inquire • Orange County EQs \$400 • CBS (5 knob) EQs \$100 • Altec/Langevin

console EQs \$125 • UREI Parametric EQs \$325 • Furman Para EQs \$200 • Altec Graphic \$90 • Lang EQs Pultex • Flickinger EQs • UREI Stereo Graphic \$250

LIMITERS

API 525 limiters/de-essers \$250 • Allison Gain Brains \$150 • Electrodyne Limiter • De-Ess UA (UREI) 176 Limiters tube \$325 • UREI 1176 (not LN) \$250 • Orange County Limiters \$400 • dbx 162 Stereo \$500 • dbx 165 \$425.

MISC. GEAR

Dolby A301 stereo noise reduction (A series) \$275 • Dolby CAT 22 Cards \$400 (10) • Dolby CAT 44 Cards \$150 (16) • Dolby Rack M16 \$650 • Dolby CAT 44H (1) \$200 • dbx DX8 (Tascam) \$650 • BGW active Crossover \$450 • Crown VFX Crossover \$450 • API Oscillator \$150 • NPI Phase Scope (console mount) \$250 • Pultex Stereo Panner... Any Offer? • Mastering Lab Crossovers... As Is \$120 each • Quad Eight Noise Gate(1) \$90 • SAE 5000 Impulse Noise Red \$100

EFFECTS

Eventide Phaser \$275 • MicMix Dynaflinger \$300 • DeltaLab DL1 \$300 • Roland Phaser \$300 • Marshall Time Modulator \$900 • Prime Time \$1200 • H910 Harmonizer \$1100 • UREI Cooper Time Cube \$450 • Eventide 1745M... Offers? • MXR Rack With Phasers/Filters \$400 • Eventide Omnipressor \$350

REVERB

MicMix MasterRoom (2) \$550 • Orban 111B \$500

PARTS

Langevin Mic Preamps (8) \$50 • API Faders \$30 • P/G 1820 (20) \$25 • P/G Lnear Taper (new) \$60 • 8 Track (1") Head Assembly Ampex 1100/1200 • MCI 16 track Repro Head \$400 • API Monitor Bucket (24 channel) with 812 modules \$3,000 • 3M Capstan Motor (2 trk) • Large quant. 5/7 pin LEMO connectors \$2 • EMT 140 MONO tube electronics (amp) \$350 • AC701K tubes \$125 • 6072A \$16 • Telefunken UF14 \$65.

*Need Weird Tubes?
Send Us Your Want List!!*

TAPE MACHINES

3M M79-2 \$2,500 • Ampex 351/Haeco Electronics Play Only • 3M M64-2 needs 2 cards \$900 • Otari MTR 90 MK II-24 trk \$29,500 • MCI JH10-16 \$6,500

CONSOLES/MIXERS

Trident B Range 30/16 \$18,000 • MCI 400 series 24/16/24 \$9,500 • Various NEVE and Trident's • TEAC Mod 1 • Pultec Mixer (4x1) \$200 • Cetec-Electrodyne 24/16 \$5,000

MUSICAL INSTRUMENTS

Pre-CBS Fender 6 String Bass \$600 • Gibson Lap Steel \$140 • Epiphone (Gibson) 12 String \$275 • Gibson Les Paul (recent) \$425 • ARP String Ensemble \$400 • Prophet 5 \$1,800 • Crumar DS-2 \$200 • Hammond CV \$400 • Wurlitzer Electric Piano \$300

**We Will Entertain Any Reasonable Offer
On ANYTHING!!**

**Make Me An Offer I Can't
UNDERSTAND....PLEASE!**

WANTED ■ WANTED ■ WANTED
Pultec Equalizers • LA2A Limiters • Fairchild 660, 670, 666 Limiters • API Components of all Types... • ITI and Sontec Equalizers

**Dan Alexander Audio
965 Hilldale
Berkeley, CA 94708**

**415/441-8912
415/527-1411**

the sound mixer can work synergistically to maintain correct spatial balance and sound/image coordination. The acoustic design and treatment, by George Augspurger, assures faithful monitoring.

"We can do anything we want on this stage... Over 100 microphone lines are available, and wiring has been installed for up to 12 camera positions."

A smaller automated ADM audio console has been placed in the video control area and can be controlled by the Grass Valley switcher for post-production purposes.

MUSICAL VIDEO

One significant difference between other teleproduction facilities and Paramount's is the type of audio console used. While many facilities have opted to use large and sophisticated television desks for mixing audio, such boards lack much of the control capability available on recording desks. According to Tim Mungoven of Amek Consoles: "Rather than go with the traditional live-to-tape boards, which are notoriously un-musical, Paramount decided to look at consoles designed specifically to record music."

And look they did. When the round of "musical desks" was completed, the Amek 2500 was the hands-down choice. Paramount Pictures' video operations consulting engineer Bob Lowe, who played a significant role in the studio's design, states the four-band parametric EQ with variable bandwidth

on each channel was the clincher. "It's like having more than an Orban on each channel," Lowe says. The custom Amek board, while stereo-ready, has been modified to include the traditional mono output and has many unique features. The desk, as installed, is wired for 56-in/48-out capability (48 modules are presently installed), which is a full 20 channels larger than the stock 2500.

The criteria for the console included in-place solo, VCA grouping and group-muting, all available without the use of an onboard computer (though one can be added later) and 48 track simultaneous changeover. The latter feature allows two 24 track recorders to be SMPTE-locked to the VTR and the board

can then switch from one recorder to the other, permitting real-time recording without time consuming reel changes. Sixteen and 24 track Studer machines will reside in audio control to allow for stereo mixdown and sweetening after taping has been completed. "The other two automated functions, which I don't believe are available on any other console, are group solo, which is the opposite of group muting, and auto mute which is written as a fader off," Mungoven says.

Other than for decoration, the 1.25 ton Amek board has no wood components. It sports a one-piece, computer-designed welded steel chassis which affords a high degree of RF insulation, one

At Last, a 200 Watt Coax!

Everyone knows the benefit of a well designed coaxial loudspeaker... a single-point sound source. Until now, the most popular coaxials presented severe power limitations... had to have "trick" crossovers... and needed time compensation. Gauss technology has changed all that.

The new Gauss 3588 is the first computer designed coaxial. But, *we know* computers can't hear, so we used a panel of "golden ears" at the fall AES to help determine the final sound of the loudspeaker. This combination of computer design and great ears gives you a coax with the sound *and* the power you want!

With a conservative power rating of 200 watts RMS, this new Gauss coaxial has been tested to 750 watts delivering clean sound... and can "coast" along at control room levels still delivering great sound. Metric sensitivity is 95dB for the low frequency and 109dB HF.

Because of our proprietary design parameters, both drivers are virtually in the same acoustic plane, eliminating the

need for costly time compensation networks. For bi-amp operation, you can use any standard professional quality crossover.

The unique *cosh* horn was designed using Gauss's exclusive Computer Aided Time Spectrometry (CATS™) program. This design provides an extremely stable image... reduced second harmonic distortion... and virtually no midrange shadowing.

For additional information on the new Gauss coaxial loudspeaker, call or write Cetec Gauss, 9130 Glenoaks Blvd., Sun Valley, CA 91352, (818) 875-1900. Or better yet, hear it at a selected sound specialist soon.

Sound Ideas for
Tomorrow... Today!
gauss
by Cetec

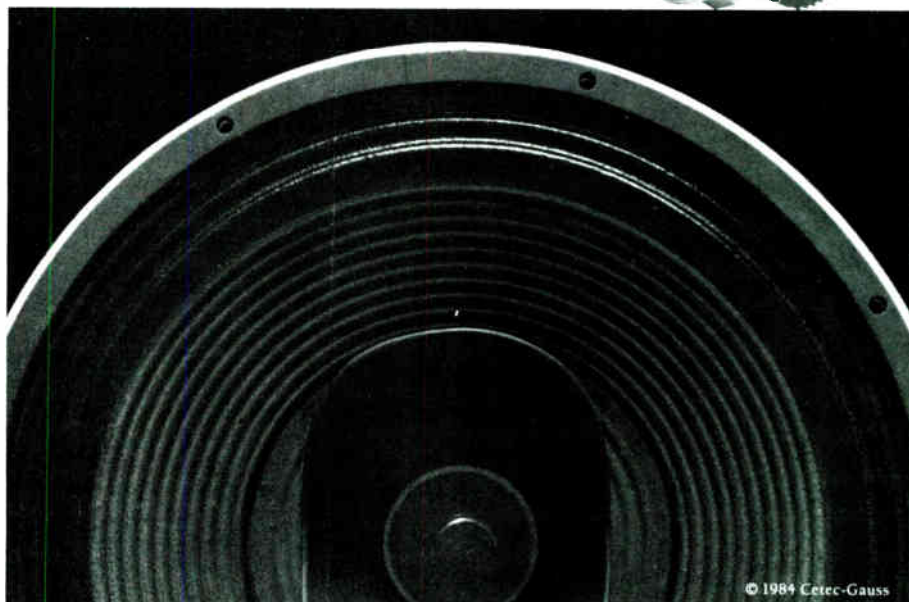

© 1984 Cetec-Gauss

Circle #137 on Reader Service Card

We take the time



because we know the ropes and we know the problems.

Every recording studio is different. They all have their own style and that's what drives the music industry. We at PRS realize this and that's why we take the time to get to know you and your specific needs. We start by providing a wide variety of professional products. We continue with professional studio design consultation and expert service. My name is Luke Furr and I know the ropes and the problems because I've been in the music industry for over 12 years. I've seen it from both sides: from owning a recording studio to playing in a band. I know what it's like to hunt down products and be assured of reliable service. I know what it's like for someone to take the time. And, because of this, we at PRS do just that. I want to be of help so give me a call at (617) 254-2110.

PRS

Professional Recording & Sound
1616 Soldiers Field Road
Boston, MA 02135 (617) 254-2110
Outside Massachusetts (800) 343-3001

The GROUP FOUR COMPANIES
Professional Video Systems
Professional Recording & Sound
Video Technology Resources
The Service Group

Circle #138 on Reader Service Card

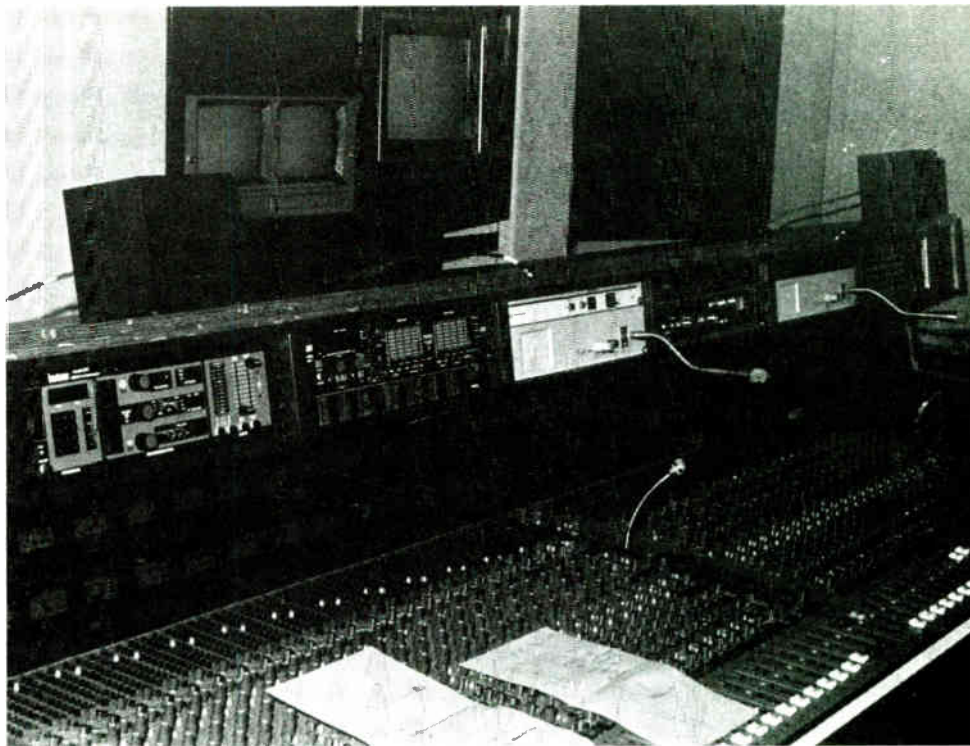

Audio master control with Amek 48 input console with integral patch bay and accessories in overbridge.

of the design criteria since RF is used for communications and spurious RF can be generated by lighting. The console is transformerless and has differentially balanced inputs and single-ended outputs. "We do that to obtain a higher level of signal clarity," says Mungoven. "You want to balance the input, because that's where RF is most likely to occur. There is no reason to balance the outputs unless you're going to drive lines over 100 feet long."

The signal to noise ratio is an impressive 90 dB above 200 Hz, and 72 dB above 20 Hz and the noise floor on the microphone preamps is -129 dB. Besides the four-band parametric EQ, each channel has high-pass, low-pass and band-pass filtering and six sends which can be automated. Accelerated setup is reportedly available through "master status switching" which allows all channels to be set up simultaneously either for recording or for mixdown.

There is also a "Line 2" mode that permits a second set of 56 inputs to be selected instantly. These extra inputs can be used for effects returns. All switching is accomplished without the use of FET's but by gas-filled gold relays with gold contacts for added reliability. There are two power supplies on the Amek console, one for audio and 48 volt phantom operation and the other for lamps and LEDs. The board and its power supplies are designed, according to Mungoven, to operate at room temperature. "We don't need to run the rails

up high to achieve headroom or the low noise spec."

Mungoven warns: "You have to be careful on a live-to-tape console not to put too much on it. Our design may be the absolute maximum that you can have on that type of console and still have it be ergonomic. The convenience aspect of the console would allow the engineer to set up the console, excluding equalization, in the matter of just one minute."

SOUND SUPPORT

In addition to the Amek Console, a 32 input modified Yamaha 1532 console receives split/feeds from each mike and source to drive a Crown amplifier which in turn drives the Shaker wedge monitors used onstage. A full complement of 21 microphones is on hand which include Shure SM-85's and 62's, Sony ECM-50's, a Vega wireless microphone system and Neumann KM-84's. Crown and Yamaha amplifiers drive the JBL 4345's and Auratone 5C's in audio control and JBL 4411's in video control. One 24 track, one 16 track and a pair of stereo Studer machines are used to put the sound down, while a turntable, compact disc and cart machines can provide sound for the small screen.

A broad array of ancillary gear occupies the unique console overbridge including six Amek compressor/limiters, two dbx limiters, an Orban parametric plus a Lexicon digital delay and a Lexicon reverb. An integral 864 (expandable to 1060) point patch bay is housed on

the right side of the console. This equipment complement, coupled with the overall system design, will allow virtually any production to have everything needed on site. Hay comments: "What we tried to do is to anticipate whatever anybody that came in would want to have. While we did change a lot of design to meet Solid Gold's requirements, we didn't design the control room just for Solid Gold. Therefore, if a director would come in and want a certain effect, we could get it through the patch bay without much problem." This is important, since the control room will serve

The ergonomic aspect of the console design allows the engineer to set up the console, excluding equalization in a matter of just one minute.

two stages and there is talk that the new facility may be on-line 24 hours a day, with production taking place during the day and post-production at night.

In the planning stages is wiring that would connect all of the television stages and control rooms, permitting any stage to be used with any control room.

BRIDGING THE GAP

It is clear that the goal of Paramount is to bridge the gap between what you see on the screen and hear with your ears. With their impressive new facility, it is clear that no expense was spared to reach this goal, nor was video quality compromised for the sake of audio quality or vice-versa. Instead, the two will be allowed to work in tandem permitting the viewer/listener to enjoy the programming to the fullest. ■



HARRIS SOUND INC.
IS PROUD TO REPRESENT:



Advanced Music Systems: RMX 16 and DMX-15-80S

NEW! Keyboard Interface for the DMX-15-80S System

NEW! "Timeflex" Stereo Time Compression System

*USA Distributor
Los Angeles Sales/Service Agent*

and

Drawmer Products:

DS 201 Dual Gate System

NEW! Stereo Vacuum Tube Compressor Amplifier 1960

West Coast Sales Agent

For more information contact:

HARRIS SOUND • 6370 Santa Monica Blvd. • Hollywood, CA 90038
(213) 469-3500 • (800) 233-1580 (Outside California)

Circle #139 on Reader Service Card

THE SOUND OF BARGAIN CASSETTE DUPLICATION

SCRATCH AND LISTEN

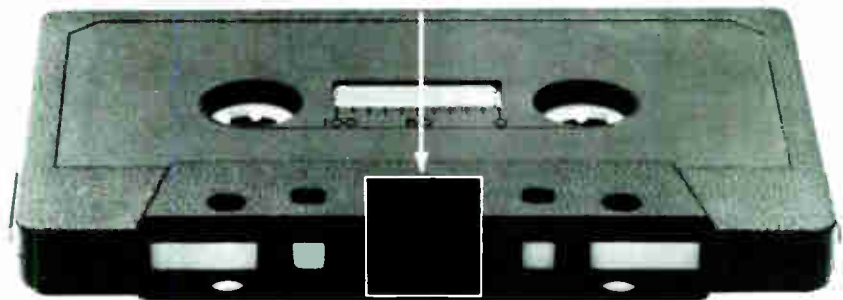

Take the "Scratch" out of Scratch and Listen

Bargain cassette duplication is no bargain. If you've tried it, you know. It's bad enough when cassettes end up sounding terrible, but when the tape jams or breaks, you know you've wasted your money!

At Bonneville Media Communications we make your dubs sound just like your master — that's our specialty. We use tape that sounds good play after play and cassettes designed to last. And we never stop testing our materials and equipment for peak performance.

Bonneville is not "bargain basement." But we're not expensive either. For a very competitive price, you get very high quality cassettes that save in replacement and other hidden costs.

And we've found that's what most people want.

Call us for your next cassette duplication order. Put an end to "Scratch and Listen."

Call 801-237-2677

BONNEVILLE
MEDIA COMMUNICATIONS

A division of Bonneville International Corporation.

Circle #140 on Reader Service Card



BY NEAL WEINSTOCK

Stereo Television Approacheth

RCA THREW A SEDATE LITTLE BASH AT THE RECENT CONSUMER ELECTRONICS SHOW: JUST THE USUAL BEEF WELLINGTON AT THE RITZ WITH A FEW FRIENDS.

Profit center Johnny was on the projection tube, but not quite as usual: this opening monolog was coming out in stereo. One would like to report that the effect on the assembled multitude was akin to that scene in "Singin' In The Rain" where a party screens the first talkie—but, alas, attention was not so rapt. And the only gasps came when Johnny turned to Ed, and the camera turned to Ed, and Ed's voice, which had been far left, suddenly jumped to stereo center, while Johnny's jumped far right.

TV's going multichannel, but the old girl's not going stereo unless she gets a few recording engineers who know what they're doing. The opportunity seems golden. In a way.

The way that it *doesn't* seem golden, first. Let's say you're the guy who's been recording Johnny and Ed in mono all these years. You may admit you don't have a lot of experience working in that dang newfangled stereo, but you're not going to admit it's a problem a couple of hours' practice won't cure.

That out of the way, opportunities exist in quantities and quality that can surely be referred to as galore and deluxe. We'll prove quantity galore first, then move on to wrestle with conceptions of quality.

Back at the CES, stereo TV hardware abounded. A year ago, Bruce Huber, Zenith's director of product planning, told me, "We suspect the driving force will probably be from the networks. Until they see fit to broadcast in stereo, we're going to have a heck of a time convincing customers to buy stereo." Yet things are happening precisely opposite to Huber's expectations. The consumer electronics industry has lately

been such that innovations are quickly mass produced and imitated, due to cut-throat competition for market share. Korean, Taiwanese, and even Japanese manufacturers may be operating at a loss to do it, but they are all offering full lines of stereo TVs. The hardware is going to be commonly available this fall, and the hardware manufacturers are all looking at the major networks, hoping the broadcasters don't let the chance slide.

Producers are aware, too, of a need for multichannel sound on video. If a program doesn't boast two audio tracks, it could be about as valuable in the near future as black-and-white product is now. And the networks are produc-

Producing for Stereo TV

IT'S GOING TO BE INTERESTING. FOR YEARS, THE TELEVISION PRODUCTION INDUSTRY HAS ALL BUT IGNORED THE PRO-

duction industry has all but ignored the audio aspect of television. As long as the levels seemed right and there wasn't too much hiss in the signal, those involved were quite satisfied that they had done the best that was necessary. After all, the sound that people heard in their homes came through a four-inch speaker with all of perhaps 0.2 massive watts driving it.

Meanwhile, back in the recording studios, the music industry remained blissfully immersed in its special area of magic, unencumbered with such technical trivia as SMPTE time code, frame-store video delay, chrominance levels and the like.

Television people concentrated on making pretty pictures, and recording people labored to faithfully capture pretty sounds, and that's the way it was.

And then came MTV. And FM simulcasts. And Beta and VHS HiFi. And all of a sudden we in both fields found ourselves with new partners who practiced arts that were often beyond our ken. We knew that something was in the wind, and by golly, after years of talk and promises, the inevitable has happened: *Television* is going *Stereo*.

—PAGE 208

THE POST PRODUCTION PROFESSIONALS

PROFESSIONALS
PROFESSIONALS
PROFESSIONALS
PROFESSIONALS
PROFESSIONALS
PROFESSIONALS
PROFESSIONALS
PROFESSIONALS
PROFESSIONALS
PROFESSIONALS

PACIFIC VIDEO 

809 NORTH CAHUENGA BOULEVARD, LA, CA 90038 (213) 462-6266

Circle #141 on Reader Service Card

—FROM PAGE 60, ALONSO

but every once in a while a whole passel of notes come in. The idea is that it should fulfill all those demands—find hardware to make those notes with—in zero time.

If you think about a piano action, you find that it takes quite a bit of time for the key to actually go down. Let's say it takes 10 to 20 milliseconds for the key-stroke to happen. If the center of the string is five feet from your ear, it's going to take five more milliseconds for that sound to reach you. So we're up to 15 milliseconds of delay.

Up to this point, our system has sampled external-world controllers at five-millisecond intervals. This is kind of a magic number in some respects, in that if you go much faster—bearing in mind that most of the time nothing is happening, and once in a while there's a lot happening—you're increasing the overhead of the process of sampling these external things.

Albhy Galuten took the [Synclavier] sampling system, got hold of a really good drummer, and sampled the drummer in relation to a click. He said, "I want this kind of feeling," and the drummer drummed very regularly, two milliseconds after the click.

Then Albhy asked for a different feeling, and the drummer reverted to *one* millisecond after the click. The bottom line of the experiment was, good drummers are dealing with time down on the millisecond level. If you sample that good drumming with a five-millisecond level system, you're going to introduce a lot of jitter that is not his fault.

It's the same with a keyboard player. We're going to take a picture of the actual time of day that the demand came in and send it along with the demand, and we're going to swear that 10 to 15 milliseconds from now we'll have fulfilled that demand, come hell or high water.

Instead of hurrying like a bunny to fulfill all the demands in zero time—which we could never do anyway, even with an infinitely fast computer—we know that we have X amount of delay to process that information. The synthesizer will have a little mailbox for "What time shall we start the note?" The computer's through; the synthesizer's counting down, and BOOM—the clock goes off and the note starts precisely N milliseconds after it was played, regardless of when it was played with respect to the sampling rate. So now we have a fixed delay.

The point is, that delay is very well-behaved, and the instrumentalist knows about that. Day One, when he approached the piano, he found out he had to start his body moving before the note came. He's very, very familiar with that

delay, and it's usually compensated for by him, subconsciously.

If we're wrong—if the instrument has too much work—then we're going to miss. But we *consistently* miss now. We'll have to test it out and find out exactly how much we can tolerate. But once we do that, the instrument is going to be rhythmic down to half a millisecond without having to run the computer ten times as fast.

We're not in a position to put that into operation right away, but we're looking toward the future.

We've also streamlined that whole reading process; we've made a tree structure out of it. The computer looks at the top level, and that tells it if there's anything at all to do. It no longer has to go out and ask everybody and that saves the computer time.

We're simultaneously trying to make a faster computer. We have a faster version of this same processor coming on line very soon. It's in the artwork phase right now.

Mix: Is the Synclavier teaching you something about the computer you sell for other applications?

Alonso: Well, it's the driving force. It's forcing us to think about how to make the computer better.

Mix: So the other users get results from your work with the Synclavier.

Alonso: Absolutely. Down on the computer level, there's nothing I could particularly optimize that would make it work better on a music system and not on something else.

We have an "average program" that we use to tune our designs. It happens to be very short, so it's real easy to run. We can either run a new design on paper and calculate how long it will take to do those steps, or we can actually run one and see how it's doing.

I might go to the software department and say, "How often do you interpose vector operations and scalar operations in addressing memory?" or something. They'll say, "Almost never," or "All the time," or whatever. Then I know I have to concentrate on those things.

As far as the architecture of the music system, this thing has implications in the studio for the future. Remember, we want to have the whole process from the loudspeaker back to the mike be all digital—or if you don't like the word "digital" in that sentence, be as good as the medium that we're delivering this stuff on. From this point of view, it looks like it's going to have to be digital. We don't know about the mikes and speakers, but in between it's possible that all the processing of the signal could be done digitally.

Demands on the performer are going to be greater, because of the perfection of the recording required. We've got to do things to help the musician make a better performance under any circumstances.

We also want to use the same type of editing notions that we have in a germinal stage in the Synclavier recorder to operate in the studio. There's no reason we cannot control EQ, faders and what-have-you. We're talking some really wild digital filters that we can control right from the panel, or some nicely human-engineered situation where the whole thing is happening in the same machine.

Studio people are probably not going to embrace this notion right away. But it's clear that the studios—whether they're digital or not—are filling up with digital gear at a rapid rate. Now all this digital gear is off on its own, and we're worried about protocols so this box can talk with that box. Wouldn't it be nice if all that were in one package?

You need tape for certain things, like archiving and field recording, but it seems that some sort of disk technology might be a better way to go in the studio.

One of our customers had a recording where the singer came in late, and sharp as well. He sampled it and put it on the keyboard. Using the knob he corrected the pitch, and by playing the key at the right time he got her on the beat. The whole process took around three minutes, and it sounds fine.

We're talking about the ability to freeze something on a screen and look at it as though you're looking under a microscope. It's very easy to do on a system like this. You can take a sound sample and sort of run the cursor to where you want to look, expand it, zero right in on what you want. Then you can take it out.

If it takes 100 to 1 real time to do these operations—if it takes 500 seconds to fix five seconds of sound—there are not many situations where somebody's going to be real hot to try it. But if the hardware is faster—if the jobs are well-defined, the hardware can be made faster to do that. And software, too, for that matter.

Mix: I guess you could have software that asks you what noise you want to get rid of—"Play me a bit of that air conditioner."

Alonso: I can't sit here and tell you that I know how to do all these things, or how to make them slick or how to make them second nature to people. But I feel pretty confident that it will be necessary to do these things on a routine basis in order to achieve the quality that we have in the media with which music is being described to people. ■

ers, too, let us not forget. Competitive pressure is surely forcing all of the video world into multichannel sound. Says Julius Barnathan, president of ABC broadcast operations, "We are already testing multichannel broadcasts at our own stations, and we'll be testing nationally in the fall. Problems still exist in terms of how you get the multichannel signal to each station—the AT&T lines are not adequate, in many cases, though they can be improved." Most multichannel transmission will rely on satellite delivery, of course, which is becoming ever more universal. Barnathan is careful to refer to this phenomenon as "multi-channel," not "stereo." He says, "This will allow non-English speaking viewers to have a bet-

If a program doesn't boast two audio tracks, it could be about as valuable in the near future as black-and-white product is now.

ter relationship with American TV "

Using the second channel to reach speakers of another language may have an important side effect: it may just greatly damage the health of Spanish language broadcasters. It's hard to see broadcasters in the major markets not using that second audio channel to attract a million extra Spanish speaking viewers. Bilingual TV is likely, though, to be a phenomenon that is limited to news and talk shows.

Will stereo TV increase the amount of music programming on the air? "In the long run, it may not," says producer Alan Wagner. "In the short run, and especially considering the explosion of the music video thing, I think everybody is expecting some growth in music programming."

Long run trends are impossible to predict in TV anyway, allows Wagner. We can't expect an immediate boom in music programs from TV stereo, since the sets have to be bought, the demographics have to be established, and hundreds of pages of Nielsen research have to be written before the really big money jumps in. But the view looks good.

Another good-looking view would take in the fact that 15 minutes out of every TV hour can have a production budget that tops the other 45. Your goal as a music videomaker may be the top of the pops, but an equally lucrative goal

—PAGE 211

Circle #142 on Reader Service Card

INEXPENSIVE SOUND SAMPLING HAS ARRIVED

Now you can digitally record and play back ANY sound with an Apple II. The DX-1 sound sampling system from Decillionix is a versatile hardware/software Apple add-on making sound sampling affordable.

- Plays effectively ANY sound musically over at least five octaves
- Samples sounds from external sources
- Tuning and scale control provided
- Select pre-set sound sequences or program your own sequences
- Play DX-1 "live" in two basic modes
- Select drum rhythms — drum and cymbal sounds included
- On-board high fidelity pre-amp lets you interface to any signal source
- Excellent for musical and sound effects applications
- Includes direct interface to Syntauri and Passport keyboards



DX-1 System Price: \$349.00

Requires a 48K Apple II+, IIe, III, or Franklin, and one drive.

Decillionix

P.O. Box 70985, Sunnyvale, California 94086 (408) 732-7758

Apple is a trademark of Apple Computer Inc.
Syntauri is a trademark of Syntauri Corp.

Passport is a trademark of Passport Designs Inc.

Circle #143 on Reader Service Card

"TREAT YOUR EQUIPMENT"

—FROM PAGE 204

The news we were all awaiting came when the FCC approved the Zenith/dbx system that had been endorsed by the Electronic Industries Association (EIA). The system, in fact, goes beyond stereo, providing a third channel designed to be used for such things as bilingual programming, data transmission, or a number of other features.

The new system has been generally hailed as just what the music video

Within the confines of a television screen—with a nominal maximum diagonal size of 25 inches—it's worthwhile to consider how much sound perspective is appropriate.

business has needed, and the overall level of enthusiasm has been high. It also, however, raises some important questions, and will require us to start thinking about ways to apply stereo to television, both on a creative and on a technical level.

On the aesthetic side, the major question involves the use of stereo imagery and the placement of sound elements. There are some basic factors and limitations of television that make it likely that the mix for a particular music video will be, or should be, different from the mix of the same piece for pure audio release.

Producers and engineers working with mixes for theatrical motion pictures have been able to take advantage of multitrack sound that could be properly placed within the perspective of a relatively large screen. If a performer starts at screen left and moves to screen right, it is at least technically possible to have the location of his or her voice follow in proper perspective.

Within the confines of a television screen—with a nominal maximum diagonal size of 25 inches—it's worthwhile to consider how much sound perspective is appropriate. Considering that many viewers will take advantage of their present stereo systems, hooking them up either to new component video systems, or to adapter boxes that will add stereo to their present TV, the chances are that the speakers will be located to

with CRAMOLIN®
cleans
preserves
lubricates

PLUGS CONNECTORS
 JACKS BATTERIES
 SWITCHES RELAYS
 TERMINAL STRIPS
 SOCKETS FADERS PATCHBAYS
 GOLD POTS



CRAMOLIN®
 SPRAY
R-5
 ANTI-OXIDIZING LUBRICANT FOR ALL MOVING STATIONARY METAL ELECTRIC/ELECTRONIC CONTACTS AND CONNECTIONS

- CLEANS
- PRESERVES
- LUBRICATES

Contains Cramolox® (Red Liquid)
 NON-FLAMMABLE
 CAUTION: CONTAINS UNDER PRESSURE
 READ INSTRUCTIONS ON BACK & PANELS
 The Less You Use The Better It Works
 NET WT. 4 OZ.

CRAMOLIN®
 Cramolin® is a fast-acting anti-oxidizing lubricant that cleans and preserves all metal surfaces, including gold. When applied to metal contacts and connectors, Cramolin® removes resistive oxides as it forms a protective molecular layer that adheres to the metal surfaces and maintains maximum electrical conductivity.
 (ALSO AVAILABLE IN LIQUID AND PASTE)

CRAMOLIN® — USED BY THOSE WHO DEMAND THE BEST:

Ampex	Dolby Lab.	McIntosh Labs	RCA
Bell Labs	General Electric	MCI (Sony)	Studer-Revox
Capitol Records	Hewlett Packard	N.B.C.	Switchcraft

CAIG LABORATORIES INC.
 SINCE 1936
 1175-O Industrial Ave., (P.O. Box J) Escondido, CA 92025 0051 U.S.A. • (619) 743 7143

Circle #144 on Reader Service Card

Synchronize



Tascam Model 58

BTX Shadow Pad

Get Into Audio Sweetening

Pro Audio, Service and Design
(213) 842-9526

Studiobuilders
 919 N. Victory Blvd.
 Burbank, CA 91502

Circle #145 on Reader Service Card

either side of the screen. Full panning in the mix as in the theatrical example cited above would lead to overly exaggerated perspective.

The problem is exacerbated by the variety of configurations that can be expected in the viewer's setups. While some will go for broke, investing in brand-new 50-inch video projectors with built-in sonically-matched stereo speakers, others may end up with their speakers six feet to either side of their present 19-inch set. This guaranteed variety of systems makes it all but impossible to design sound perspective that will fit every situation.

This factor affects virtually all types of television production, not just music videos. The producers of everything from *Dallas* to the evening news are going to have to decide first whether to use, and then how to use stereo for television. (If you've ever done location sound for dramatic television, just imagine recording in stereo—the work doesn't just double; more likely it quadruples, according to Murphy's Law of Logarithmic Complication.)

The producer of a music video must therefore resist the temptation to go overboard with sonic imagery. Thus, with regard to this aspect of the sound, the mix for a music video will not differ too much from the record mix, although

There are also some important technical factors to consider when mixing stereo sound for television. One that cannot be ignored is the "trailing edge" of technology—those people who will continue to be quite content with their 4-inch built-in set speaker.

the opportunity does exist to play around a little bit.

If a performer does indeed move from one extreme side of the screen to the other, it may be appropriate to perform a subtle pan to follow the action without running the risk of causing extreme mental confusion in

those whose speaker placement is wider than ideal. If the next shot places the performer at screen center, though, the pan pot will need to be centered, simultaneously with the cut.

In dramatic production (elements of which, of course, are making their way into music videos, especially in introductory scenes and epilogues), the techniques have yet to evolve, although some initial concepts have started to develop. The opening gambit seems to be to take advantage of the new stereo capability for the music used in productions, while treating dialogue and effects as mono sources.

Unless there is a clear need for it, most characters' dialogue can safely be placed at center, with occasional slight panning to left or right when circumstances suggest it.

Sound effects, on the other hand, are likely to make use of the ability to place sound sources off-screen. For instance, when staging a car crash, it's much cheaper to cut to a closeup of an actor's reaction to the crash, letting the sound effects do the work, than it is to actually stage a crash. The camera can then cut to the accident scene, showing the aftermath, which is much less expensive to rig. Using stereo to place the sound of the crash off-screen in the direction the actor is looking will add tremendously to the believability of the scene.

There are also some important technical factors to consider when mixing stereo sound for television. One that cannot be ignored is the "trailing edge" of technology—those people who will continue to be quite content with their 4-inch built-in set speaker.

It's long been a practice in mixing for television to monitor initially on high-quality studio monitors, and then perform a final check on four-inch speakers. Compromise has been the usual result.

The circumstances that have led to this practice have not undergone an overnight change. We still must be aware of a large market segment that will resist the enticements of high-fidelity sound. At the same time, over the next few years we can gradually "nudge" the quality of the mix closer to the ideal. After all, the viewer shares a certain responsibility for sound quality. If we provide it, and they fail to provide their end of the delivery system, they essentially forfeit their right to complain.

One factor, however, that will continue to require attention, is the matter of phasing when performing a mix. Not only is it necessary to listen to the mix on modest-quality speakers (at least as one consideration); it is also wise to listen to the mix in mono, as many viewers will continue to hear it for years to come.

In a recent incident caused by a mis-wired distribution amp, the author finished a music video done in full stereo.

YOURS FREE!

The essential planning & price guide for all of your custom record and tape needs

*It's quick • convenient
• easy-to-use*



Now available throughout the United States, **WORLD RECORDS** Canada's largest exclusive custom record and tape manufacturer and packager gives you the audiophile pressings, glossy board jackets, chromium cassettes and service you've been searching for.

And we can ship them all to you prepaid, to your door, in as few as 3 weeks! Hassle free!

WORLD RECORDS delivers.. each and everytime, fully guaranteed to your original masters because we know how much you depend on them to promote your image. See what we've got to offer you. Then see just how fast we can deliver it.

STATE of the ART MASTERING
Neumann VMS 80 Lathe/Digital, 1/2" & 1/2 Speed/Full metal protection

ULTRA GLOSS BOARD JACKETS
Quantities as low as 500/
true colour reproduction

CHROMIUM CASSETTES
Full frequency response on CrO₂ tape/
Non-abrasive head cleaning leader

VIRGIN VINYL PRESSING
Audiophile grade/"Assured Excellence
Guaranteed®"

IN-HOUSE CREATIVE SERVICES
Typesetting/Graphic artists/
Colour scanner

AIR DELIVERY
Prepaid air freight delivery to over 200
cities/
No Customs hassles

**call or write for our planning
guide & price lists**



WORLD RECORDS
Baseline Rd. W.
BOWMANVILLE, ONTARIO
L1C 3Z3
416-576-0250

Circle #146 on Reader Service Card

REAL-TIME

CASSETTE DUPLICATION



RESOLUTION DOES IT ALL

- custom length loading
- duplication in any quantity
- magnetite & chrome tape
- label & insert printing
- packaging
- shipping

(802) 862-8881

We put the plus in cassette recording.

RESOLUTION

1 Mill Street—The Chace Mill
Burlington, VT 05401-1514

Circle #147 on Reader Service Card

CONNECTORS AND MICROPHONE CABLES 	
TAPES & CASSETTES from AMPEX MAXELL AGFA TDK BASF 3M	EMPTY REELS AND BOXES
NAB BROADCAST CARTRIDGES 	CASSETTE BOXES, LABELS, ALBUMS
ACCESSORIES 	

Ask for our
44 PAGE CATALOG

of

PROFESSIONAL SOUND RECORDING & DUPLICATING SUPPLIES

Recording Supply Div. of Polyline Corp
1233 Rand Road, Des Plaines IL 60016
(312) 298-5300

35

Circle #148 on Reader Service Card

It sounded just fine in the editing suite. It sounded just fine in the screening room, which was equipped with stereo playback. Only by chance was a 3/4-inch cassette copy played in mono, with the channels mixed together, whereupon it was discovered that the channels were nearly 180 degrees out of phase. The result was that anything that was to be heard in center position all but went away when heard in a mono mix.

The tip-off came when running through the colorbars and tone at the head of the tape. When the audio monitoring switch on the player was switched to send either of the individual channels to the monitor, the tone level was fine. When the switch was set in the mix position, however, the tone level dropped considerably. As mentioned above, the problem was eventually traced to a DA that had been mis-wired at the factory. Fortunately, the problem was caught before the master went out to duplication, and the audio was laid back a second time to correct the problem.

Phase shifts that are used for effect and work well in stereo may also produce odd results when heard in mono, and are worth considering during the mix.

As mentioned earlier, the new system actually provides for a third audio channel, which brings up some interesting questions. The most obvious is the one of how that channel can be used, but equally important is the question of where it will be recorded.

Channel three in the new system is intended primarily for ancillary services, such as bilingual transmission ("Thriller" dubbed in Tagalog?), or for data encoding for videotext/close captioning (music videos for the hearing impaired?). One possible use of the third channel might be for carrying the mono mix, but this is a production matter, rather than one of transmission. Here the situation becomes somewhat sticky.

Few one-inch VTRs offer more than two primary audio channels, which leaves only the address track channel—normally used for SMPTE code—for the third channel, a solution that is problematic at best. The broadcast 3/4-inch and 1/2-inch systems that now offer performance close to one-inch (especially the new 1/2-inch broadcast "cart" machines that are ideal for automated clip playback) make no provision whatsoever for a third audio channel.

Another interesting factor that is not directly related to the advent of stereo, but which was mentioned at the start of this article and must be taken into account, is the problem of maintaining lip sync when using digital effects.

Digital video effects units, by their very nature, delay the video by at least a frame (1/30 second). In some instances, especially when multiple channels

or multiple generations of effects are used, the delay can grow to as many as three, four or even more frames. Most videos are finished by editing the pictures to either a scratch track or the full stereo mix lay-over onto the videotape edited master. SMPTE time code is com-

The new stereo transmission capability of broadcast television will open some opportunities for enhancing the quality and realism of programming, and music videos will be a prime beneficiary of the advance.

monly used to provide a reference both during the shooting, and for post-production synching.

If digital effects are used in the video, however, an exact match of SMPTE numbers is likely to result in a loss of sync during editing, regardless of whether the video is cut to the audio, or the audio laid back after the video has been cut. In the traditional rush of post production, this offset can easily be overlooked. Luckily, such delays are usually constant at any particular facility, and once determined, the delay can be compensated for simply by "slipping" the video against the audio.

In summary, the new stereo transmission capability of broadcast television will open some opportunities for enhancing the quality and realism of programming, and music videos will be a prime beneficiary of the advance. Using the same techniques we have used for the past few years will by no means produce inferior results, but it will be in developing new techniques that we will begin to take advantage of our new capability.

The audience today is becoming ever more technically sophisticated, and will increasingly demand higher audio quality to justify their investments in new equipment and systems. If we don't satisfy their demands, they will vote with the most powerful ballot they have—the channel selector.

—Lon McQuillin

—FROM PAGE 207

can be "top of the spots." According to agency producers, stereo may have its most immediate TV impact on commercials. "There is almost zero commercial product available in stereo," says Robert Hammer, VP, production facilities for CBS TV. But commercials will need to go stereo very shortly after stereo TV is available, he reasons, because ads must be noticed.

Can we look forward to commercials using all those hokey stereo effects like fast phase wah-wah that used to populate effects albums? Undoubtedly. Commercial-makers have, for the most part, never worked with stereo sound. They are typically small, independent production companies that are as open to new ideas and talent as any shops in the movie/TV business. They are, very shortly, going to be a sizeable new market for the talents of those who can handle film-sound and a stereo mix.

Though commercials should be the first segment of the teleproduction industry to feel the effect of stereo, large-scale productions like mini-series and made-for-TV-movies ought not to be too far behind. Alan Wagner specializes in these sorts of productions, and says, "Producers create programming for the widest possible distribution. We often sell

a teleproduction here to the international feature market. Multichannel sound is an element that can help a film's marketability, too."

In fact, some two thirds of Hollywood's feature product is now made with multichannel sound. Filmgoers are getting very used to good audio. Any TV program that purports to be a special event needs this element, too. On the other hand, has multichannel sound changed the movies' subject matter substantially? Well, there certainly are a lot more music-oriented features these days, but these are probably more influenced by the music industry's resurgence than by stereo-physics in theaters. Has Dolby sound in theaters not been an influence on this at all? No, surely—but that influence is certainly hard to quantify.

And what of quality? Will stereo make TV better? Engineers of this writer's acquaintance often argue that stereo, component video, high definition TV—all these technical improvements in television are necessary before programming can really improve. "Who wants to watch the symphony without stereo?" asks famed consulting engineer Joe Roizen. But then, given that PBS has been simulcasting stereo for classical music for years, who wants to watch the

symphony with stereo? Not enough viewers to make it profitable for commercial networks to try it—at least for a long while.

"Narrowcasting" was a buzzword that came in with cable TV. Programmers hoped that technology would allow them to reach just the qualified audience that would pay for—or that advertisers would pay to advertise to while they watch—"culture." CBS VP for technology Joe Flaherty conceives of high definition TV as a technological improvement that could pay for itself in similar manner. "Thus technology could help reach the segment that can afford really high quality programming." In the same way, stereo TV will be bought at first by those who can afford it, and producers can expect stereo programs to reach a highly educated audience. Will they program for that audience? Don't bet on it.

After all the technological improvements mentioned here, this observer does believe the artistic quality of TV will improve—but *not* because of the technology somehow priming audiences for quality. No, this pundit predicts programming will improve only because our population is aging and getting more educated. And age is a technological slide in the wrong direction. ■

- 40'x 60' SOUNDSTAGE W/18' CEILING
- HARD CYCLORAMA
- LIGHTING GRID w/40 CIRCUIT PATCHING
- 600 AMP ELECTRICAL SYSTEM
- 400 WATT SOUND SYSTEM
- FULL ACOUSTIC TREATMENT
- 12x 10' LOADING DOORS
- AIR CONDITIONING
- 2 DRESSING ROOMS
- VIDEO CONTROL ROOM
- COLOR CRITICAL MONITOR

STUDIO D: VIDEO AT THE ANNEX
THE MUSIC ANNEX SOUNDSTAGE IS A QUALITY PRODUCTION ENVIRONMENT FOR MUSIC, COMMERCIALS, AND INDUSTRIAL VIDEOS.

Music Annex Recording Studios 970 O'BRIEN DRIVE, MENLO PARK, CA (415) 328-8338

VIDEO NEWS

by Mia Amato

Fall TV: Cash Commercialism

The most watchable thing this TV season will be how other forms of music television cope with the recently signed exclusivity agreements between *MTV* and several major U.S. record labels.

MTV will be paying each record company between \$2 million and \$8 million over the next few years—in cash and free advertising time. For the labels, the deals struck mean dollars to offset the rising costs of producing music videos. And MTV gets “exclusive” airplay for at least 30 days in most cases to new clips from the signed labels.

Rumblings in the TV biz don't discount rival music video outlets boycotting new releases and promotional material from the record companies involved (who are understandably reluctant to be named, but verified by several sources to be *CBS*, *RCA*, and *MCA*). Broadcast TV shows that feature clips are taking new strategies. Many will be running only Top Ten clips, eliminating the need for brand-new releases and “world premieres.”

And at least one syndicated music video show will air no clips at all. *Puttin' On The Hits*, syndicated by *MCA*'s television arm, will showcase everyday people lip-synching their favorite tunes, often incorporating elaborate costumes and dance routines into their mime acts.

Battle lines are being drawn... *USA Network*, for example, is now running TV commercials for its *Night Flight* music show in the middle of *MTV* programming. It managed this because a certain number of commercial slots each hour is given by *MTV* to cable systems which run the service. The individual systems sell the time locally, typically at very low prices. *USA* simply bypassed *MTV*'s advertising department and bought local spots from cable sys-

tems in 40 cable markets. The TV ads run during the hours *Night Flight* is aired and urge the viewer to switch the channel. For September, *USA* has bought \$100,000 worth of ad time. The strategist behind it all is *Andy Besch*, a *USA Network* marketing VP.

Praxis Makes Perfect: The Palace

In Connecticut, at the turn of the century, the Palace Theatre in South Norwalk played host to the media stars of that period: Houdini, Caruso, Mae West. Today, the vintage theater houses a brand new video postproduction facility christened the *Palace Production Center*: part of *Praxis Media Inc.*

The edit suites are designed around all-Sony equipment. A BVE-5000 editor controls four one-inch Type C BVH-2000 VTRS in the on-line room; off-line uses Sony U-matics. The facility also has the Sony BVH-2500 VTR, which allows single frame recording and editing for video animation and video-disc mastering. The switcher, a Grass Valley 300-B with two-channel DVE is believed to be the largest in the state.

“We're giving producers from New England another good reason to stay in their own backyards,” says marketing director *Wendy Beth Lambert*. “We have all the bells and whistles...yet our prices are substantially lower. The fact that most of our equipment can be updated now with software, rather than hardware, should enable us to stay current without the constantly heavy outlays which would drive our prices beyond acceptable levels.”

For audio, the studio has a 16 channel Neve console, Otari two track and MCI eight track recorders in a no-reverb mixing room. It is outfitted for sweetening as well as mixdown.

In Florida, *CTRON Incorporated* sends news of a digital design network for computer graphics. Users will be able to create 3-D designs by phone,

actually by accessing the companies' mainframe image-processing computer through their own personal computers or graphics terminals. *Peter Archer*, of *Archer Productions*, in Pompano Beach, is putting the project together.

Video People

Arnie Chodorow is the new director of operations for *The Post Group* (LA). *Maury Rosenfield* and *Peter Cohen*, formerly of *Broadway Video*, have also joined the company as staff editor and graphics artist, respectively. NYC mayor *Ed Koch* produced his first music video—a promo for off-track betting parlors which finds him crooning “My Old Kentucky Home.” *Chet Harmon*, who directed the thirty second spot at *Windsor Total Video*, reports the mayor was a pro throughout; with a stand-in for sound and light, the Koch shoot took 15 minutes and the third take was a wrap.

Peter Allen and *Bill Parker* directed the bleakly futuristic “Land of Hunger” for the *Earons*, lensing in a Southern California Bethlehem Steel plant which was being torn down during the week of the shoot. *Michael Feeney* directed “Scene Beyond Dreams” for *The Call*, a clip produced by *Video Caroline's Stephen Rice* for client *Polygram*.

In Texas, two *Stevie Ray Vaughn* clips were shot in 35mm by *Richard Kooris*; “Can't Stand The Weather” makes extensive use of artificial rain, wind, and lightning and the *Ultimate* and was directed by *Charlie Rice* for *Texas Pacific* and client *CBS/Epic*.

Video on the Beach...in France

The first *Festival International Du Video-Clip De Saint Tropez* kicks off October 8 through 11 in the French resort Saint Tropez. Sponsor is *RF Communications*, a publishing company which prints the French equivalent of *Billboard*, *Show Magazine*, as well as the influential homevid publication *Video Club*. The screenings will show both clips and long-form music videos on hundreds of TV monitors to be planted in restaurants, cafes, hotels, shops and beachfront exhibition spaces.

John Nathan, U.S. organizer for the festival, said the festival will represent “a fair amount” of tapes from Belgium, Italy, Scandinavia, Germany, and France, although the largest percentage will be U.S. and British reels. The international jury for artistic and technical awards includes celebs like *Bill Wyman* and *Bob Gheraldi*, as well as internation-

al TV programmers arriving for TV trade shows in London and Cannes. For more information call Nathan at (212) 223-0044.

**Homevid:
Different Drummers**

The drum mastery of *Steve Gadd*, *Lenny White*, and *Yogi Horton* kicks off a series of how-to tapes packaged by *The Drummer's Collective* in New York. Each one-hour color tape is a mini-lesson on musicianship for \$69.95, available through home video stores and by mail order.

Each tape shows one artist explaining and demonstrating technique and personal style, along with philosophy and their insights into the music business. The series, based on master workshops taught at the Drummer's Collective School, also includes cassettes on keyboardist *Richard Tee* and jazz guitarist *John Scofield* of the Miles Davis Band. For more information, contact DCI Music Video Inc., 541 Avenue of the Americas, NY, NY 10011.

"Playboy Jazz Festival Volume One" has been released on tape and disk by Playboy Enterprises, and includes 1982 performances by Lionel Hampton, Grover Washington Jr. and Maynard Ferguson. Programming VP *Chuck*

Mitchell of *RCA Video* says his next major project will be a rock and roll "cliff-hanger" serial in 15 episodes packaged for the home video market. Working title: "The Phantom Empire" is based on a concept by *Michael Uslan*.

**CBS Carries the Torch
for HDTV**

Even though CBS has abandoned its plans for a higher-definition television direct-to-home (DBS) broadcast service, the network's laboratories are still full speed ahead developing a television system which would have twice the resolution and clarity of a present NTSC signal.

Using higher definition cameras and recorders developed by Japanese broadcasters *NHK* and *Sony*, CBS demonstrated a 1,125-line TV system to the world at last year's TV exposition in Montreaux—with the help of demonstration tapes created by European and Soviet producers. European participation is the key, according to CBS engineering VP *Joseph Flaherty*, to standardizing HDTV because any new television system introduced particularly signals which require a larger bandwidth must suit transmission needs of other countries as well as the U.S.

At the CBS Technology Center

in Stamford, engineering pundit *Art Kaiser* suggests that 1,125-line TV is well on its way to becoming a standard because the hardware—Sony's HDC-100 camera, one-inch recorder and HDTV projection screen—already exists. And while it may not be practical now to transmit an HDTV signal, higher-resolution video could be used in production—to provide a better mastering medium for videocassettes based on film, or even to replace film in the creation of action TV series at a substantial savings in cost.

At Stamford, HDTV images demonstrated are clearly crisper—but not yet as sharp as film pictures. Said Kaiser, "To make HDTV attractive and practical for the production of TV programs would require, among other things, different lenses; prime lenses, like those used in 35mm film production, but adapted to the special needs of three-tube color cameras." His team is working now with lens manufacturers: "High definition optics is where the action is going to be."

There are other problems to work out, too. Moving images tend to blur on screen. The present HDTV camera is too large for action shooting, but smaller pickup tubes, which would make the whole camera smaller, would make lens parameters even more critical. They're working on it. HDTV may not be broadcastable now but it may prove useful sooner than you think. ■

EAST COAST SOUND
*is proud to announce its appointment as dealer
for*
HILL AUDIO in the northeast U.S.A.



- | | |
|---------------|---------------|
| RAMSA | KLARK TEKNIK |
| AUDIOARTS | VALLEY PEOPLE |
| LEXICON | TEAC |
| DBX | FOSTEX |
| UREI | MASTER ROOM |
| AKG | DELTALAB |
| CREST | COUNTRY MAN |
| AB | ASHLY |
| CROWN | EXR |
| APHEX | SENNHEISER |
| SOUNDTRACS | OBERHEIM |
| DYNAMIX | ROLAND |
| ALLEN & HEATH | SEQUENT. CIRC |
| ORBAN | |

Complete 8 track systems starting as low as \$2,500.00
Complete 16 track systems from \$10,000.00

eastcoast (203) 748-2799
sound specialties!
40 MAIN STREET • DANBURY, CT 06810

SEND \$3.00 for our 150 pg. catalog, the largest in the industry

Please put me on your mailing list.

Name _____

Address _____

City _____ St _____ Zip _____

Business Opportunities

Seeking investor for partnership purchase of real estate with complete recording studio, two residences, pavilions, and hot tub on a half acre ocean view lot on the west shore of Maui near the beach. Write: "The Studio" at Modelia, 553 Mikioi Place, Wailea, Kihei, Maui, HI 96753, or call 808-879-2485.

Employment Offered

Audio Technician—Subsidiary of major European manufacturer seeks technician for expanding technical department. Position at Nashville headquarters facility requires QC and repair of professional tape recorders, mixing consoles, and associated equipment. Excellent benefits. Salary based on experience. Please send resume to: Studer Technical Dept., Studer Revox America, 1425 Elm Hill Pike, Nashville, TN 37210.

Field Service Technician—Major audio equipment manufacturer seeks experienced service technician for expanding operations at New York City field office. Position involves installation and field servicing of professional audio recorders and associated equipment. Excellent benefits. Salary based on experience. Please send resume to: Studer Technical Dept., Studer Revox America, 1425 Elm Hill Pike, Nashville, TN 37210.

Employment Wanted

Chief Engineer, currently partner in Manhattan studio seeks situation with established or expanding studio. Possible investment, will relocate. (914) 268-9220 or (516) 921-2672.

Equipment For Sale

NEOTEK WEST Sales & Service of New & Used Neotek audio consoles. Call for a quote on any audio or video equipment. Hands-on demonstration available.

Neotek West
4007 W. 6th St.
LA, CA 90020
(213) 387-7999

Your studio budget breathes easier with our Tascam 8-trk pkg. Get (1) Tascam 38 recorder, (1) 42 ½-trk, (1) M50 12x8 console and (2) JBL 4401 monitors for only \$6,195. Full Tascam

sales and service. PI AUDIO, 13329 Pearl Rd., Cleveland, OH 44136, (216) 238-0644.

Infonics 200 "A" cassette and reel to cassette duplication system. Factory reconditioned. Finest quality chrome dups. 3 ¼ to 15 ips. Bargain. Audio Craft Co., 2701 E. Sunrise Blvd., Ft. Lauderdale, FL 33304, (305) 563-0553.

3M M79 24-trk recorder, Saki heads, excellent condition, Audio Kinetics autolocator, transformerless, all updated 3M mods. \$18,000 - Call Jim (818) 761-3882.

8-Track Studio Equipment For Sale Consists of: TEAC 10-24 Track Mixing Console; 8-Track 80-8 Recorder; JVC Power Amp; 2 JVC Speakers; 1 Tapco Reverb Unit. Call (919) 789-9311 and Ask for Mark Hicks.

SOUND WORKSHOP SERIES 30 28 channels, ARMS automation. Custom mainframe w/336 point vertical TT patchbay. 19K. OTARI MTR90 24-trk w/Auto-Locator. Low noise & fast punch mods. Excellent! 24K. Both for 41K. (209) 431-5275.

For Sale: Tangent 3216 \$9K. Otari 5050B 2-trk \$1,800. UREI 811A \$1,500. Power amps and 2 reverbsystems. Would consider trade for 8-trk system. Call Mike at (812) 324-2173.

2 MIDAS Power Supplies (new) \$500 ea; Output Module and P.S. for INTERFACE 104M Monitor Console (new) \$200; 34 CHANNEL SNAKE System 250-foot main, 100-foot monitor; CANNON Gold Multipins, 12 Multipin Subsnakes \$4,500; HUBBELL 2645/2643CY 30 amp 3 pin (new) \$22/set; Racks, Cases, Much More. John (203) 567-0057.

Soundcraft 1600 24x8x24 w/patchbay and stand \$13,900. Baby grand piano, rebuilt \$1,500. Fender Rhodes piano w/satellite amp and speakers \$700. Lexicon PCM-41 \$550. Soundcraftsman 7501 power amp \$550. Soundcraftsman 27 band stereo EQ \$550. Call Tony (312) 356-7069.

MCI JH100 16tr w/locator \$12,500. EMT 140 tube mono \$2,800. EMT 140 tube stereo \$4,800. Ampex AG440 4trk w/2trk heads \$2,400. Ampex AG440 2trk 7 ½ \$950. MXR digital delay \$250. Crown RTA2 real time analyzer \$1,500. dbx 187 \$475. Call (513) 258-2463.

FOR SALE: (2) 813 UREI speakers \$2,500 a pair; (2) UREI 1176 LN limitors \$600 a pair. (816) 931-8735 Grant.

Tangent 3216 console, 24 mainframe with 22 modules \$12,000. Scully 288-16B, 16 track recorder \$8,000 the

work horse of the industry. Gary Scovil (203) 333-3121 or (203) 853-8872.

AMPEX SPECIAL SALE
ATR 800-4 \$4,500 and your Ampex AG 440-B or C in trade. NORTH-WESTERN 1-(800)-547-2252.

EQUIPMENT CLEARANCE
NEW AND USED: Neotek, Soundcraft, Scully, Otari, Lexicon, Neumann, JBL, Klark-Teknik, UREI and much more. All equipment in excellent condition or new in boxes. Call today for pricing. SOUND-SMITH AUDIO (317) 842-4905.

New, Used Demo Equipment
Soundcraft 1600, Lexicon 200, Otari MTR 90 Mark II, Ampex MM-1100 16-trk, ADR Vocal Stressor, BTX 5400 SMPTE gen., many ¼-inch 4-trk machines, E.A.R. buys and sells new and used equipment at competitive prices.

E.A.R. Pro Audio
(602) 267-0600

UNIQUE USED ITEMS AVAILABLE

Harrison MR-2, 48 in, 40 channel with Allison \$75K. MCI 528C with JH, 50 Plasma \$50K. NEVE 8038 36/16/24, 3 band \$75K. NEVE 8048 32/16/24, 4 band \$65K. NEVE 8068 32/16/32, 3 band \$80K. NEVE 8078 40/32/16/32, 4 band \$120K. Neve Custom 36/4 Stereo Buss, 4 Aux Buss, 6 limit \$25K. NEVE 8018 48/36/36 Necam I, \$160K. NEVE film 24/4/4, 3 position, many extras, mint 35K. API 40/28/16/24 automated 45K. Ampex ATR 102, new, full warranty 8.5K. MCI JH100 16-trk, LOC. I 12.5K. Amek 2000, 28/16/28 16K. Ampex 1200, 24-trk. MCI JH 100, 24-trk, 16-trk, LOC II 16.5K. Studer A-80, II, 24-trk, 25K. Soundcraft, series 3B, 18K. EMT 240, 4.5K. EMT 140 (tube) 5.5K. Telefunken M-15 A, 24-trk, 22K. 2 M79, 24-trk, Sel II, 19K. 2 Studer A-80 II, 2-trk, 7.5K. 1 Blustein piano 7-foot-8 black 8.5K. Call us for further information and new listings. OCEAN AUDIO (213) 454-6043.

EMT 140 Tube Stereo \$3,900. API Console 36 inputs, automated w/ grouping. Vintage API console 26 inputs, clean. Auditorics 501 console \$10,000. Call Paul (312) 225-2110 or (312) 241-6885.

Neotek, Soundcraft, ADR, Otari, Clear Com, Eventide, Crest, dbx. Best prices on all the best gear, new, used, and demo. Also, like new, Otari MX-7800 w/remote \$6,500. Soundcraft 800 18x8 \$8,995. Tascam 8516 w/dbx \$7,500. ADR Scamp rack system. Call **Pyramid Audio Inc.** (312) 339-8014. 450 W. Taft Drive, So. Holland, IL 60473. **Call us last!**

Looking for Eventide SP-2016 or H949? Space Station Banner RTA ADR Scanner. Need AKG, BGW, dbx, E/V, Neumann, Orban, Sennheiser, Shure, Technics, UREI or White products? Call UAR for the best quote: (512) 690-8888, 8535 Fairhaven, San Antonio, TX 78229.

Platesound Plate Reverb now available. The finest built units using today's technology. Adjustable decay. ½ second to 6 seconds. Frequency response: 80-20,000. One year full guarantee. \$995. Send or call for brochure and specs. 1-(813) 996-4707. Call collect. **PLATESOUND**, P.O. Box 1500, Land-O-Lakes, Florida 33539.

DANBURY ELECTRONIC MUSIC CENTER, 84 Federal Road, Danbury, CT, 06810, (203) 792-2794. New England's oldest and most experienced Tascam dealer. All professional recording equip. and supplies from stock plus widest selection of electronic keyboards including Yamaha DX-PF.

(2) Studer A80 II 24-trk, 4-trk, 2-trk, (2) B-67, (1) Ampex 1200 24-trk, (1) 440-B 4-trk, (1) 2-trk, (1) Scully 280-B 4-trk, (2) 2-trk, Neve 8068 w/Necam 40/32 API 40-32 (1) Dolby M-24 w/dbx K-9 Cards (4) Dolby 361, (3) EMT 140 ST, Q-LOCK 310. Call or write w/offer to: RCH, Mat Co. 445, W. 45th NY, NY 10036, (212) 408-1630.

TEAC package 40-4 (DX-8) w/dbx (DX-4) 80-8 w/dbx and vari speed. Both mounted in 19" adjustable angle wooden racks on aluminum frames w/ heavy duty casters, professionally wired to Teac MM-20, (2) Ex-20's PE-20, MU-20, 64 point patchbay w/wire harnesses and cables. \$6,000. (212) 242-1996 and leave message.

VINTAGE MIKES

FOR SALE: Tubes mikes of all kinds. I now have power supplies for all tube mikes. Also: Nagra OGB 10" adapter, \$700 firm. Leave message: (312) 751-1216.

Powered monitors. (3) Anchor Systems AN-150, like new in box 35w amp w/line, low Z mic, mag phono inputs; line output; 4 ½" full range driver. Great little monitors for only \$250 ea. or \$700 for 3 (415) 843-7901. Mr. Petersen.

NEUMANN MASTERING SYSTEM Including tape machine, SC68 head, VG66 Amplifiers Rack, level sets, HF limiters, Elliptical Equalizer and variable pitch and depth. Make offer. Dolby. \$8,500. Call Jim at (513) 681-8402.

LOW OVERHEAD MEANS LOWEST PRICES. We carry most major lines of pro audio & recording equipment. **Get your best price, then call me.** 3M Tape and accessories at factory prices.

S.C.M.S.

East U.S. Toll free:
(800) 438-6040

West & N.C.: (704) 889-4509

Sam Ash Music Store Mail Order Service. Deal with the professionals. N.Y.C.'s largest inventory and best prices on musical instruments, sound and recording gear. 1-800-645-3518. N.Y. State 1-800-632-2322.



PLATE REVERBS

Prices start at just \$795.00. For free demo tape and literature contact:

Comerstone Systems
703 So. Second Street
Milwaukee, WI 53204
(414) 643-0879

AVAILABLE IMMEDIATELY: 3-M M79 24-track machine w/Selektake II, ex. cond. \$18,000. Spare parts, reel motor, alignment tapes: \$2,100. Package price: \$19,000. NEW: Capstan motor, take-up reel motor, sync head, pinch rollers, puck and bearings. Call Kurt Shore (215) 649-3277 between 9 and 5 weekdays.

Reliable Music

The Finest In Professional Audio With Service to Back It Up!

Crown, JBL, Tascam/TEAC, Yamaha, Biamp, Technics, Orban, Gauss, Eventide, dbx, UREI, Neumann, AKG, Sennheiser, Beyer, Sony, Shure, Otari, MICMIX, MXR, RTS, Revox, Cetec-Vega, E-V, Omnicraft, Symetrix, Sescam, Ursa Major, Whirlwind, Audio-technica, Ramsa, Lexicon.



(704) 375-8662
1001 S. Independence Blvd.
Charlotte, N.C. 28202

SYNTHESIZER BLOWOUT!

Tired of impersonal service? You think you're getting your best deal? Try Starsound Audio for free! 1-800-354-7252. Fluid synthesis spoken here. Most major lines in stock. Roger, Tom, Scott or Bill.

NEW API PRODUCTS

Modules—Equalizers—Parts
Factory Warranty! Immediate delivery at CLOSEOUT PRICES! For fur-

ther information call: RAATA
AUDIO SYSTEMS, INC.
1446 N. Cherokee Ave.,
Hollywood, California 90028
(213) 469-9593 Telex 910-321-4465

THE NATIONWIDE AUDIO PROFESSIONALS

Shop for Pro Audio and Video from America's oldest, most experienced Professional—no matter where you live. Expert advice, in-depth parts and broadest selection of Otari, Soudcraft, EECO, UREI, Ursa Major, BTX, Fostex, Tascam, Hafler Pro, Sony, JVC and many more for Recording Studios and Audio/Video Post Production facilities.

Harvey Electronics Pro Division
24 West 45 Street
New York, New York 10036
(800) 223-2642
(212) 921-5920

MCI JH114 w/AL II, 24 trk plus 16 trk head stack. All brand new heads. All factory recommended updates \$21,000. MCI 636 Console full MCI automation, 28 inputs w/14 parametric, 5 returns. Excellent condition \$37,000. (415) 332-0983.

NEOTEK 26x24 transformerless console, 4 band parametric eq, light meters, 4 sends-6 returns, excellent condition, 5 yrs old. MCI JH 24-24 w/AL III, like new, under 2 yrs old, light use in home studio. Going automated. Package: \$50,500. BOB (312) 932-1984.

SIGMA SOUND STUDIOS GREAT EQUIPMENT BUYS:

24, 2 tr recorders, console automation, synchronizers, hi speed dupe equip plus lots of audio processing gear.

Call or Write:
212 N. 12th St., Phila., PA 19107
(215) 561-3660

AKG-SPECIAL
IN STOCK-IMMEDIATE SHIPMENT
FACTORY FRESH U.S. WARRANTY
C414EB-P48 \$560
C460B \$245
(Shipping \$3.00-C.O.D. OK)
MICROPHONICS
PO Box 37
BROOKLYN, NY 11204
(800) 431-3232
(212) 438-6400

1 Scully 280B Stereo \$2500, 1 Scully 280 mono tape recorder \$1700, 1 1176 limiter \$350, 2 UREI 527-A graphic equalizers \$400 each, 1 AKG 451 microphone \$200, 2 Sony C-22 \$100 each, 1 3M-M56 16-track recorder remote \$10,000, 1 EITech Board 16x16 \$2,000, 1 Lang PEQ2 Equalizer \$200, 1 2" alignment tape \$200, 1 1" alignment tape \$75, 1 2" splicing block \$50, 1 Delta Lab DL-1 Digital Delay \$400, 1 Synthesizer \$100. All in good condition. Package price \$18,000. Call Dave (419) 241-5961.

NEW AMEK CONSOLES
AMEK ANGELA 28 in, 24 out, 8 sub-groups, 6 sends, solo in place. Less than \$37,000.
AMEK-TAC-MATCHLESS 26 in, 24 out, group muting, 8 sub-groups, 48v Phantom. Less than \$20,000.
AMEK-TAC-SCORPION 16x8x2, 4 band EQ, 4 sends, subgroups less than \$5,500.

NEW & USED

MXR-New 01A digital reverb 7 presets, less than \$1,600.
TASCAM 8-trk studio, packages. Used MCI 428 console, 16 I/O mods, w/producers desk and extras \$12,950.
For all your pro audio needs: CSE Audio, Rochester, NY (716) 227-7763.

BUILD YOUR OWN STEREO PLATE REVERB SYSTEM for less than \$350. No exotic parts, minimum of mech. ability. **COMPLETE DETAILED PLANS...**\$41.00. \$43.46 in TN.
HOW-TO ENTERPRISES
(615) 451-3588
RT. 2, BOX 96
GALLATIN, TN 37066

QUAD-EIGHT 7200 CONSOLE
28x24 I/O w/8 mix busses. Ex. Cond. in sonics & appearance. 6/CL-22 Complimenter/gates & 4/EQ-444 4-band EQ's on-board. Wiring to mikes, mult-trk, 2-trks, & efx \$30K (713) 521-2854.

Equipment Wanted

WANTED: USED MAGNEFAX DUPLICATOR, WOLLENSAK 2772 & 2770 DUPLICATORS. (816) 931-8735 GRANT.

Instruction

WE'LL HELP YOU GET INTO STUDIO MIXING

Job getting secrets revealed. Open doors fast. Guaranteed. New guide tells how. Free details. Write today. Insiders, Unlimited, 14938 1/2 Ventura Blvd., #114, Sherman Oaks, CA 91403.

BE A RECORDING ENGINEER!
New classes quarterly.
INSTITUTE OF AUDIO/VIDEO ENGINEERING
1831 Hyperion, Dept. E
HOLLYWOOD, CA 90027
(213) 666-3003

I.C.A. INSTITUTE OF COMMUNICATION ARTS

Chief Administrator: Niels Hartvig-Nielsen, Shannon Barker. A one year "Communications Media" program and/or part-time courses available. Audio Engineering, Video Production, Entertainment Business, Synthesizers/Modern Electronic Music, Music Theory, Music Arranging, Communications, Record Production, Sound Reinforcement, Systems and Sound. 700 hours of "in-studio." Financing available. For more infor-

mation please call or write: I.C.A. Institute of Communication Arts Assoc., 2nd floor, 1730 Burrard Street, Vancouver, BC, Canada V6J 3G7, (604) 734-5474.

Maintenance Services & Repair

HIGH SPEED TAPE DUPLICATORS

COMMERCIAL AUDIO PRODUCTION'S Technical Service Division provides factory-authorized service and parts for Ampex, Electro-Sound, Gauss, Grandy, Trayco, Otari and other high-volume tape duplicators. We can repair, rebuild, or expand your system in-plant at great savings over purchasing new equipment. Speed and format conversions our specialty. **STUDIOS & PRESSING PLANTS:** Expand into tape duplicating with a rebuilt machine from us. Complete consulting services available. Write or call: C.A.P., Inc., 33B Hillside Terrace, White Plains, N.Y. 10601. (914) 997-8221.

AUTHORIZED DEALER API PRODUCTS

Wolff Associates is now an authorized dealer for all API/Datatronix audio products. Give us a call for new API modules or for factory spare parts. Wolff Associates will repair older modules, etc. We do on location console/studio trouble shooting. Wolff Associates, 1378 Northgate Sq., Reston, VA 22090, (703) 689-0448.

Record & Tape Services & Supplies

AUDIO CRAFT CO.
Audio Cassette Duplication
Quality & Quantity
Demo Cassettes Improved
Old Records 78s, 33s & 45s
Renovated
Service To
Studios & Individuals
Reel or Cassette Masters
3 1/4, 7 1/2 & 15 IPS
1/4 trk or 1/2 trk Stereo/Mono
Fr. Res. 20 Hz to 20 k ± 2
Quality Chrome or Ferric Tape
Our Motto
"Satisfaction Guaranteed"
WHILE-U-WAIT SERVICE AVAILABLE
2701 E. Sunrise Blvd.
Ft. Lauderdale, FL 33304
(305) 563-0553
Toll free: 1-800-432-0405

REAL-TIME

Cassette Duplication C45 as low as 98¢. 4-color printing, foil labels, shrink wrap. Send for complete price list & services inc. bulk price on AGFA & chrome tape. CAT, 3005 W. Glendale Ave., Phx, AZ 85021 (602) 246-4976

EXXEL
PROUDLY PRESENTS
AGFA AND MAGNETIC MEDIA
PREMIUM AUDIO CASSETTES

PRICE EXAMPLE
AGFA 612 **C-60** 74¢

ANY CUSTOM LENGTH
FULLY GUARANTEED
VIDEO CASSETTES, TOO

EXXEL
102 NORTH DITMAR STREET
OCEANSIDE CA 92054
619-722-8284

BLANK AUDIO & VIDEO CASSETTES
20TH ANNIVERSARY
CHEAPEST PRICES IN TOWN

- Audio cassettes • Video cassettes
- Mastering tapes • 8 tracks

Don't delay - call today!!
For more information
Andol Audio Products, Inc.
4212 14th Avenue
Brooklyn, NY 11219
Call Toll Free
(800) 221-6578
N.Y. Res. (212) 435-7322

REAL-TIME CASSETTE DUPLICATION from analog or digital masters, we are the finest, most elaborate facility in the world. Complete packaging, price competitive. Call MIRROR IMAGE (303) 751-2268.

HRC MAGNETICS AUDIO & VIDEO TAPE MANUFACTURERS

12th year servicing the audio/video tape industry. Custom cassette bin loop duplication, 4 color liner printing, custom loaded BASF "Pure" Chrome cassettes: C-60 69¢ C-90 95¢, 3M & Ampex Reel Tape, 1/4"-2". Norelco & Poly Boxes, recording supplies. 3/4" U-matic video loading/reloading. Free complete brochures available upon request. Write or call: HRC Magnetix, 1611 Herring, Waco, TX 76708, (817) 756-5303.

PROFESSIONAL RECORDING SUPPLIES

We are a major distributor of Ampex, Agfa & 3M bulk & reel master tape from 1/4" to 2". We also stock empty reels, boxes, video cassettes, Norelco boxes & other recording supplies. We manufacture custom length bulk cassettes using top quality tapes. Cassette duplication service available. Please call or write for our FREE catalog.

Advance Recording Products
7190 Clairmont Mesa Blvd.,
San Diego, CA 92111
In Calif.: (800) 858-1061
CA Phone No: (619) 277-2540
Outside Calif.: (800) 854-1061

30th ANNIVERSARY RECORDS PRESSED JACKETS PRINTED
Our stock or your custom.
No minimum quantity.
RMR, 8305 Christensen Rd.,
Cheyenne, Wyoming 82001,
(307) 638-8733

BASF & AGFA chrome & normal bias cassettes. Also AGFA master tape in case quantities at dealer cost. Send for wholesale price list.

WORLD CLASS TAPE
Box 7611 Ann Arbor, MI 48107
(313) 662-0669

FACTORY DIRECT PRICES ON 3M TAPE.
We can save you money.
We ship from stock.
Small quantity orders O.K.
STUDIOWORKS
(800) 438-5921

DISC MASTERING - Cut from your tapes at low cost - Plating, Pressing, Labels & Jackets - LPs, EPs & 45s. Write for free information:
THE CUTTING EDGE
Department M
Box 217, Ferndale, NY 12734
(914) 292-5965.

Studios For Sale

FOR SALE: Complete Studio: package price \$100,000. Harrison 24x28 with producer's desk; (2) 3M M79 24 trk machines with SELECTAK 2's; (1) Scully 280 2 trk; (2) UREI Rm EQ's Model 539; Soundcraftsman RP 2201; Eventide DDL 1745A, Harmonizer M910, Omnipressor; (2) Lang PEO; (1) Marshall Time Modulator; Mic Stands, Gobos, Cue Boxes, Large Assortment of Amps Speakers and Cabinets, Spare Parts; Altec

JBL; (1) Steinway B 7 Ft.; (1) Balwin 7 Ft.; B3 Leslie; Standard Tack Piano; Office Furniture and Accessories, Light Fixtures, Equipment Racks; (2) Studer B-672 tracks with Dolby. For a more complete listing and prices please contact Jerry Solomon at Soundworks, 254 W. 54 St., New York, NY 10019, (212) 247-3690.

STUDIO FOR SALE: Sale/Lease of LA Recording Studio, 24-track, 3 rooms plus beautiful 3 bedroom, 2 1/2 ba. home w/pool & spa in WOODLAND HILLS. Info on hr. to monthly rates or sale of: Business, Equip, Real Estate - call ALAN (818) 993-1300.

TOP RECORDING STUDIO FOR SALE OR LEASE. Centrally located in Manhattan. Top equipment and installations, established business. Principals only. Write or call: RCH Management Co., 445 W. 45th St., NY, NY, 10036, (212) 408-1630.

RECORDING STUDIO & BUILDING with 2 bedroom apartment overhead. Brick construction exterior. "Woodland Cedar Theme" inside. MCI 16-trk recorder; MCI & Ampex 1/2-trk recorders; 20 channel custom console with patchbay; Altec monitors; SAE power amp; Rack with dbx limiters, ADC equalizers; MIC-MIX reverb; Shure, Sennheiser, E-V mics with stands & cables; 7 foot Baldwin Grand Piano; Hammond B-3; Rhodes 73 suitcase piano; TAMA Rosewood Drums; Ampeg B-15 bass amp. FULL BASEMENT for storage; parking for 4 cars in rear. 20 minutes west of Chicago's Loop in suburbs near expressway. Still operating after 6 years so do NOT call about any one piece of gear. Owner wishes to relocate to a "Snowless Climate." \$165,000 takes all! \$100,000 less gear and musical equip: Wired. Building dimensions 26 ft by 85 ft - 2 stories. Color photos available for serious inquiries only. Call MR. SMITH (312) 681-2725.

House With Recording Studio for sale West LA Area - Canyon view setting near Malibu beaches. Architect designed redwood with decks, hot tub, tile, 3 bedroom, 220 sq. foot control room, 280 sq. foot studio with air cond. & elec. per Westlake Audio specs. \$279,000. Call Marty (213) 652-4830.

VERY ESTABLISHED 16 & 8 track studio in booming central Florida area. Complete from MCI recorder to phone machine. Well maintained. In business since 1976. Serious inquiries by qualified buyers please. \$75,000. (904) 736-0300.

Remote Recording Truck For Sale

MUST SELL: Criteria-on-Wheels mobile studio GMC 26-foot Transmode Van, MCI JH-648 console JH-24 recorder, plus everything else you need to go on the road now. Call for inventory list, a real bargain at \$115K. Call (305) 947-5611, ask for Mack.

Miscellaneous

Free sample copy . . .
of **GOLDMINE**, the world's largest record collector's publication! Thousands of records for sale in each issue. All types of music, all eras. Plus articles on recording stars past and present, record & music book reviews, discographies. Free sample or send \$22 for 13 issues.
GOLDMINE
Circulation Dept. AGU
700 E. State St., Iola, WI 54990

Need a Hit?

The Song Brokers
3262 Central
Alameda, CA 94501
(415) 523-9876

GET IN ON THE ACTION
How to Place a Mix Classified

Please print or type in CAPITAL LETTERS and lower case. There are 8 lines to the inch and approximately 24 CAPITAL letters per line or 30 lower case letters. \$60 per inch - 1" minimum. Additional lines \$10 per line. **Bold type** \$10 per line. Black border or gray screen \$10 extra. Logos or display advertising up to 4" will be charged at \$75/inch. Multiple insertion rates at 10% discount.

Deadline is 6 weeks preceding issue date. Multiple insertion categories available (check one).

<input type="checkbox"/> Employment Wanted	<input type="checkbox"/> Equipment Rentals	<input type="checkbox"/> Equipment Wanted
<input type="checkbox"/> Instruction	<input type="checkbox"/> Recording Services	<input type="checkbox"/> Rehearsal Space
<input type="checkbox"/> Employment Offered	<input type="checkbox"/> Miscellaneous	<input type="checkbox"/> Equipment for Sale
<input type="checkbox"/> Record & Tape Supplies	<input type="checkbox"/> Maintenance Services	<input type="checkbox"/> Business Opportunities

Name _____
Address _____
Phone _____

If paying by: VISA MASTERCARD
Card #: _____ Expiration Date: _____
Name on card: _____

Payment by check or money order must accompany ad.
Mail to: **Mix Classified, 2608 9th St., Berkeley, CA 94710 (415) 843-7901**

—FROM PAGE 198, MVP SOFTWARE

is the author of *The Independent Film and Videomakers Guide*. He is the independent producer of such films as the popular film parody, "Hardware Wars" and the PBS/BBC underwater special, "Dolphin." As head of program development, Mr. Wiese is the primary liaison between Vestron and the creative community on all original programming. His

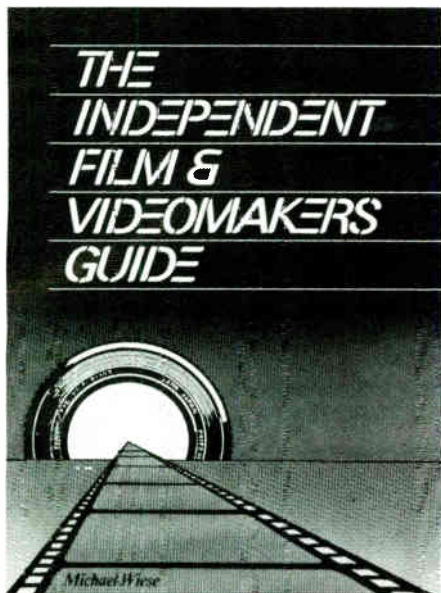

activities will include evaluation of concept submissions and program development, particularly in the area of original comedy programming, as well as serving as Vestron's in-house production executive on all original programming projects. In a meeting with him at Vestron's headquarters in Stamford, Connecticut, he outlined the hardball world numbers for those interested in dealing with the reality of the video software marketplace. "Many people think that because there are 10 or 12 million machines out there that they can safely project sales of a given tape to be some percentage of the machines in use. When in fact the reality is that there are about 3,000 video dealers nationally. Each one is hit with about 300 new titles each month, most of which are feature films and how-to-type productions. The dealer will only buy a small number of titles. So the question is for anyone bringing a title to market is, why should a video dealer buy your title over another? And in fact the dealer may be buying the title for rental purposes only anyway."

Music Video Division

Vestron MusicVideo, is the name of the company's newest distribution line. Aside from "Thriller," few music video cassettes have ever sold more than

about 10,000 units, and most sell under 5,000 copies. To help develop this market, the company recently hired Ian Ralfini as vice president. He comes to Vestron from Alive Video, where he was president, responsible for the creation and development of programming for television and home video. Prior to his affiliation with Alive Video, Ralfini was responsible for starting the European record and music operations for Warner Bros., Elektra, Atlantic, ABC and MGM, working with such artists as the Rolling Stones, Rod Stewart, Fleetwood Mac, America, Yes and Kenny Rogers.

In his newly created position at Vestron MusicVideo, Ralfini will be responsible for creating a full product line video music label. He will serve as the key liaison with the music community, working closely with artists, producers, managers, and record companies in both acquisition and program development. Vestron MusicVideo's catalogue includes such artists as Linda Ronstadt, Asia, Christine McVie, Neil Diamond, Neil Young, Gladys Knight & the Pips, The Kinks and Pink Floyd and has achieved a strong position at the forefront of the music video segment of the home video market. If ever a company was positioned to become a dominant influence in its industry, Vestron is so positioned. ■

In the Yamaha studio in Los Angeles, the isolation booth contains an acoustic prism in the ceiling. Access to the booth is through sliding glass doors which provide isolation while maintaining visual contact.

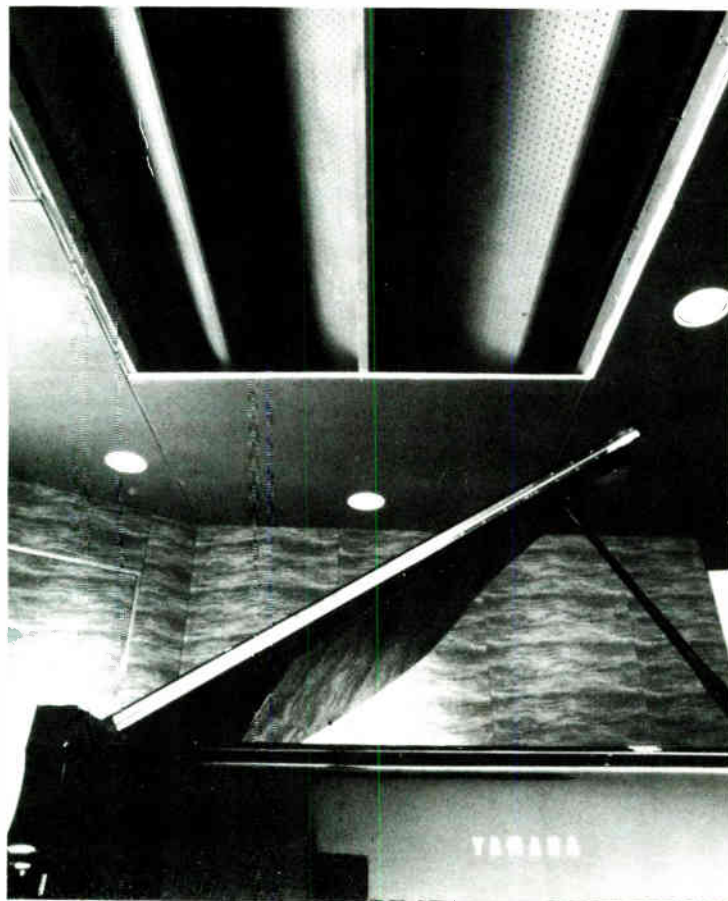

—FROM PAGE 100, SO. CALIFORNIA

ording with Steve Miller; MOR singer Gloria Loring; soul singer Phyllis St. James, working with Ray Burch on a Motown project; the rock band Kiddo (with engineer John Gas); and Teena Marie, in with Bobby Brooks. Moss' point about the studio's diverse client list is well taken, of course, but in fact there have been a number of hot jazz players in recently, too. Jean-Luc Ponty collaborated briefly with Chick Corea for the former's next Atlantic album; the dynamite Toshiko Akiyoshi-Lew Tabackin Big Band did a live 30 ips recording there; Arthur Blythe and James Newton cut LPs at Mad Hatter; and the popular fusion outfit Yellowjackets laid tracks. Two personnel additions that will help the studio: Brent Averill, who built Jeff Porcaro's studio and also has done work for George Duke's home set-up, is now full-time maintenance man for Mad Hatter; and Warren Dewey, the noted engineer who has worked with The Cars and a host of other top groups, has been added to the studio's roster. Recent purchases include an excellent selection of new mikes (Neumann U-67s, AKG C-12As, Electro-Voice RE-20s, six API 550A equalizers, and an overhaul of the John Meyer monitor system. "We're doing great," Moss says, "but we don't want to give the impression that we're going to turn away business. Quite the contrary!" ■

ADVERTISERS INDEX

—FROM PAGE 91

- Bauer Tonstudio GMBH
Markgroening Str. 46
D-7140 Ludwigsburg 10
(07) 141-31097
Rolf Bauer
- Dierks-Studios GMBH
Haupt. Str. 33
D-5024, Pulheim, 3
(02) 238-3333, 30-40
Dieter Dierks
- Farton Studios
Die Sang 7
6365 Rosbach
(06) 003-8081
Frank Farian
- Polygram
Kluesriede 26
3012 Hannover-Langenhagen
(05) 11/7306-236
Mr. Meister
- 3M Germany
Carl-Schurzstr. 1
4040 Neuss 1
(02) 101/142898
H. Viering
- France:**
Societe Translab
12 and 14 Bld Del Hopital
75005 Paris
(01) 707-54-86
Mr. Orsini
- Studio de la Grande Armee
12 Av. de la Grande Armee
75017 Paris
(01) 764-13-47
Mr. J. Dubois
- Studio Guillaume Tell
52 Ave. Du President Wilson
39210 La Plaine-St. Denis
(01) 241-70-70
Mr. Guillotel
- Studio Marcadet
52 Ave. Du President Wilson
93219 La Plaine-St. Denis
(01) 241-88-66
Mr. G. Blumenfeld
- Japan:**
- Alfa Record
3-5-39 Shibaura
Minatoku, Tokyo 108
(03) 455-1791
K. Murai
- Onkyo House
1-23-8 Ginza
Chuoku, Tokyo 104
(03) 654-4181
H. Ryozeji
- Sweden:**
- Polar Music Studios
Polar Music AB, St. Friksgatan
58-60, 511234 Stockholm
(08) 54-06 95
Leif Mases

PAGE ADVERTISER

- 79 Adams • Smith
- 133 Advance Recording
- 184 Agfa Audio
- 12-13 AKAI/IMC
- 200 Dan Alexander Audio
- 179 Allen & Heath Brenell
- 112 Alpha Audio
- 152 Alpha Studios
- 158 Alshire International
- 18 Amek Consoles
- 11 Ampex Corporation
- 189 Aquarian Accessories Corporation
- 166 A & S Flight & Road Case Co.
- 198 Audio Affects
- 74 Audio + Design/Calrec
- 40 Audio Digital
- 98 Audio Engineering Associates
- 60 Audio Intervisual Design
- 219 Audio Kinetics
- 99 Audioarts Engineering
- 77 Audiotechniques
- 145 Award Record Manufacturing
- 129 Kenneth A. Bacon Associates
- 23 Biamp Systems
- 203 Bonneville Media Communications
- 55 Bruel & Kjaer Instruments
- 208 Caig Laboratories
- 182 Canare
- 95 Capitol Studios
- 113 Carver Corporation
- 201 Cetec Gauss
- 70 CMS Digital Rentals
- 30 Crest Audio
- 75 Crown International
- 43 dbx, Inc.
- 207 Decillionix
- 56 Digital Audio Magazine
- 54 Digital by Dickinson
- 36 Digital Entertainment Corporation
- 63 Digital Services
- 82 Digital Sound Recording
- 27 DOD Electronics
- 160 EAR Professional Audio
- 213 Eastcoast Sound Specialties
- 59 Electro-Voice
- 90 Europa Technology/Friend-Chip
- 177 Europa Technology/PPG
- 38 Fantasy Studios/Digital Entertainment Corporation
- 176 Filament Pro Audio
- 73 Flanner's Pro Audio
- 185 FM Acoustics
- 183 Forte Music
- 91 Fostex Corporation
- 189 Full Compass Systems
- 85 Future Disc Systems
- 155, 190 Garfield Electronics
- 190 GLI Integrated Sound Systems
- 98 GRD
- 84, 118 Bernie Grundman Mastering Studio
- 146 Guitar Showcase
- 166 Hardy Company
- 203 Harris Sound
- 2 Harrison Systems
- 26 Hill Audio
- 180 HRC Magnetics/Hix Recording
- 81 Hy James/dbx
- 87 Hy James/Bruel & Kjaer
- 167 Ibanez
- 188 Institute of Audio Research
- 194 Jensen Transformers
- 150 JRF Magnetic Sciences
- 130 K-Disc Mastering
- 29 Klark-Teknik
- 97 Klipsch & Associates
- 111 KM Records
- 20-21 Kurzweil Music Systems
- 191 Latin Percussion
- 165 LEMO USA
- 181 Leo's Professional Audio
- 180 Linear & Digital Systems

PAGE ADVERTISER

- 169 Linn Electronics
- 127 Livingstone Audio
- 105 Mad Hatter Recording Studios
- 148 Magna-Markers/EDCO
- 193 Magnetax International
- 136 Master Control Recording
- 89 Master Digital
- 132 Mastering Lab
- 211 Music Annex Recording Studios
- 53 Neotek Corporation
- 147 Neotek West
- 41 Rupert Neve, Inc.
- 47 New England Digital Corporation
- 187 New World Audio
- 92 Orban Associates
- 139 Otari Corporation
- 205 Pacific Video
- 172 Shelton Leigh Palmer & Company
- 66 Passport Designs
- 61 Peavey Electronics
- 149 Phoenix Audio Laboratory
- 121 Tim Pinch Recording
- 210 Polyline Corporation
- 71 Power USA
- 109 ProAudio Systems
- 103 Professional Audio Services & Supply
- 125 Professional Audio Services & Supply/Audiotek
- 144 Professional Audio Services & Supply/Zetka
- 202 Professional Recording & Sound (PRS)
- 116 Rainbo Records
- 64 Rane Corporation
- 78 RED Acoustics (USA) Ltd.
- 187 Renkus-Heinz
- 210 Resolution
- 51 RolandCorp US
- 85, 111 Saki Magnetics
- 161 Sanken Microphone Company
- 176 Sennheiser Electronics Corporation
- 69 Sierra Audio Acoustics/Hidley Studio Design
- 207 Skyelabs
- 89 Sonic Arts
- 44-45 Sony Corporation of America
- 132 Sound Affair Recording
- 157 Sound Code Systems (SCS)
- 118 Sound Image
- 137 Sound Solution
- 140 Sound Source
- 197 Sound Summit
- 100 Sound Technology
- 140 Sound Vault Studios
- 34, B/C Soundcraft Electronics
- 65 Soundworks Digital Audio/Video Studios Ltd.
- 135 Speck Electronics
- 9 Spectra Sonics
- 186 Spectrum Design & Development
- 143 Sprague Magnetics
- 4 Studer Revox
- 195 Studio Technologies
- 208 Studiobuilders
- 142 Symetrix
- 149 Takeda Record Service
- 16 Tascam
- 171 Technical Audio Devices (TAD)
- 25 TOA Electronics
- 143 United Tape Company
- 88 Universal Recording Corporation
- 127 University of Sound Arts
- 7 Urso Major
- 182 Whittier Music Company
- 133 Steve Williams Keyboard Rentals
- 191 Wireworks Corporation
- 84 Wolff Associates
- 209 World Records
- 163 Yamaha International

MIXING MASTERS?

Console Automation used to be considered a luxury. With the introduction of the MasterMix system, automation becomes not only accessible, it becomes so economical, simple, efficient and accurate as to be essential.

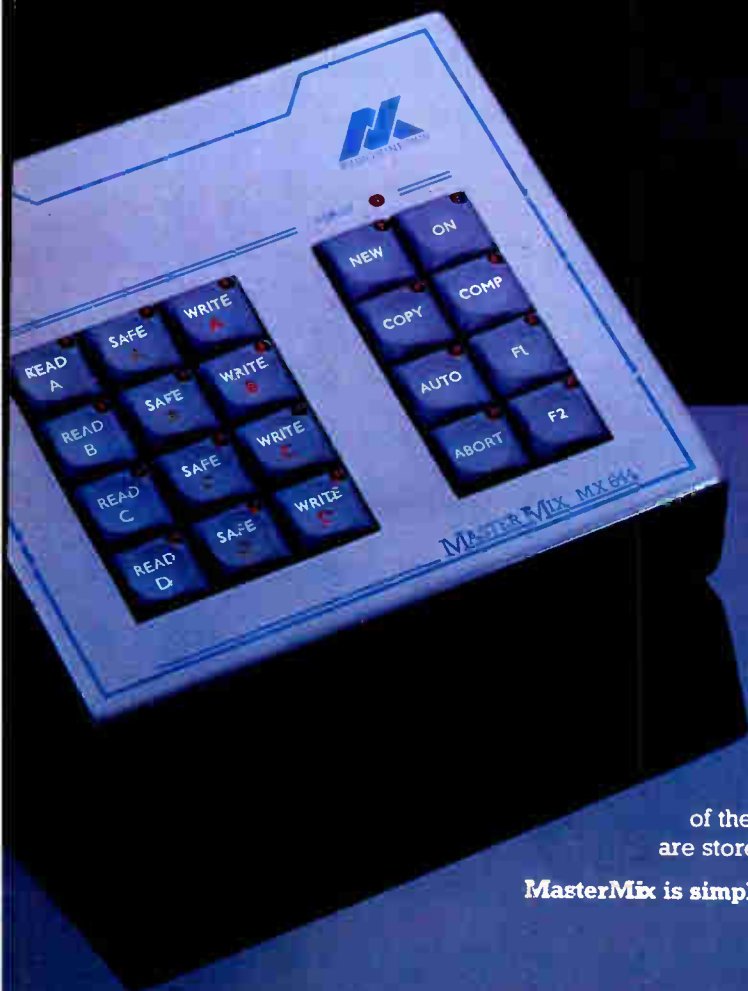
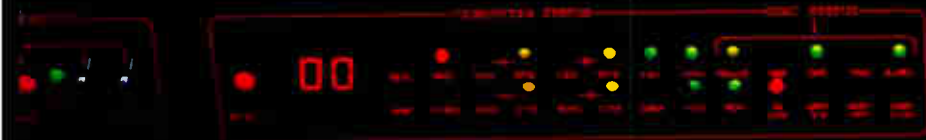

MasterMix can automate your existing console. Interfaces are available for most automation-ready consoles, and the MasterMix VCA fader package permits a complete update of virtually any console.

MasterMix records the Mix data on floppy disc. The traditional disadvantages of contemporary tape based systems, which introduced cumulative errors on repeated passes and were subject to dropouts, noise and distortion interference are eliminated.

Only one track of standard SMPTE/EBU timecode is required for synchronisation and a code generator is included as part of the main computer unit. Automation of level and mute decisions are stored independently and accurately to a single time code frame.

MasterMix is simple to use, and the increase in speed and quality of production will ensure that the system rapidly justifies its installation.

MasterMix is the new standard for automation systems.

MASTER MIX - the obvious choice

AUDIO KINETICS INC., Suite 209, 4721 Laurel Canyon Boulevard, North Hollywood, California 91607, U.S.A. Tel. 818-980 5717 Telex 230 194 781



AUDIO KINETICS

A P P R O P R I A T E

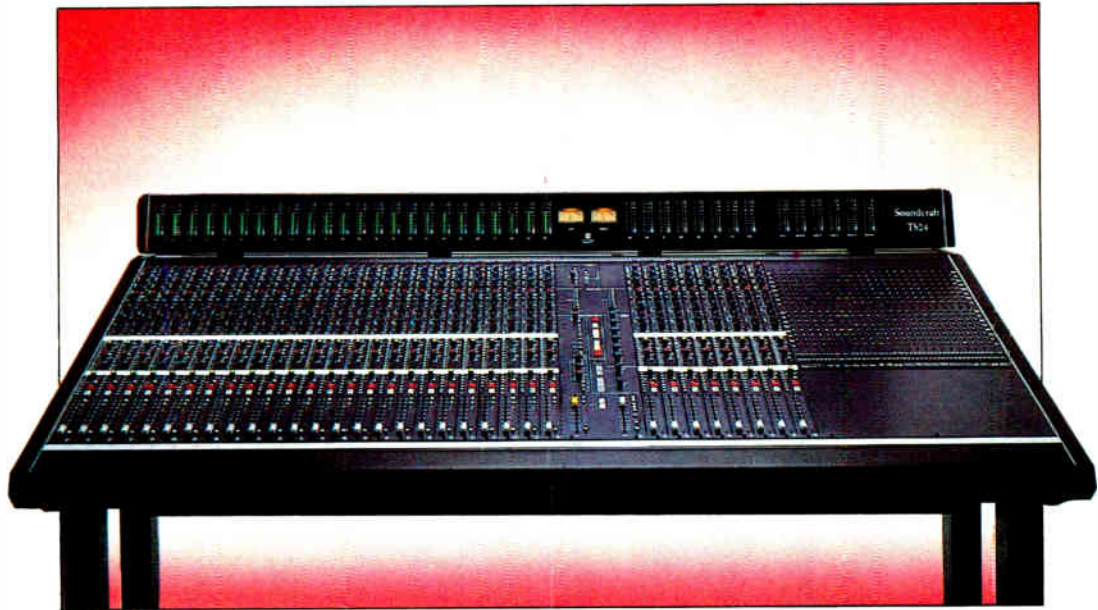

T E C H N O L O G Y

When high technology meets the needs of the user, only then does it become appropriate.

That's the philosophy Soundcraft has applied to their new TS 24 in-line console. A philosophy that has revolutionized in-line console design, producing a meticulously engineered console, with the engineer in mind. Designed for audio purity, not egocentricity.

Master status switching reconfigures the console for each stage of recording and remixing. This allows the engineer to create; not search for a lost signal within the console.

The Soundcraft TS24 is an example of intelligent engineering combined with the common sense necessary for *today's* successes.

When choosing your new console, consider the technology *appropriate* for your requirements. Consider the TS24. And, consider profitability for *yourself*, not just the console manufacturer.

Soundcraft

L O N D O N · L O S A N G E L E S · M O N T R E A L

1517 20th Street, Santa Monica, CA 90404 (213) 453-4591 Telex: 664923