

MIX®

PROFESSIONAL AUDIO AND MUSIC PRODUCTION

HOT SUMMER TOURS

BON JOVI
JUANES
MARY J BLIGE
AND JAY Z
MATCHBOX TWENTY
PARAMORE

Taking Plug-Ins On the Road

Guide to Networked Power Amps

#BXNKXJB *****CAR-RT LOT**R-005
#MX3258212# CONT REG MX01
MARK GANDER 21811
BEAR AUDIO CONTRACTING P087
21000 WINFIELD RD
TOPANGA CA 90290-3636

GET OUT OF THE GARAGE MUSIC CONTEST.

All Icons Begin As Believers.
Enter This Contest, Find Out
If You're The Next One.

The Set Up: Go to Journeys, pick up the official contest envelope, and enter your demo – either in-store or online at www.getoutofthegaragemusiccontest.com – between June 15th and Sept 15th 2008. Ten finalists will be selected, win prizes and be featured on the contest's website. The grand prize winner will receive a trip to NYC for studio time with a record label and produce their single. Now that rocks.



JOURNEYS
JOURNEYS.COM

No purchase necessary. Open to legal U.S. residents, 13 or older. Enter online at www.getoutofthegaragemusiccontest.com <file://www.getoutofthegaragemusiccontest.com>, or enter via mail by picking up official entry kit at participating Journeys retail locations. Contest runs from 6/15/08 to 9/15/08. Mail-in entries must be postmarked by 9/15/08 and received by 10/22/08. Entry must contain 1 original song (accompanied by musical instruments) that is no longer than 4 minutes in duration. Entrant can be individual or band of up to 4 members. Entries will be judged by a panel of judges. One grand prize winner will receive a 4-day trip to NYC, including 16 hours of recording studio time, access to a NYC music producer, airfare, accommodations for 3 nights, and a meal per diem of \$40/day. ARV: \$15,000. Nine first prize winners will each receive 4 CDs, a pair of Converse shoes and music equipment. ARV: \$200 each. Winners will be notified on or about 10/31/08. For complete official rules including judging criteria, visit www.getoutofthegaragemusiccontest.com <[file://www.getoutofthegaragemusiccontest.com](http://www.getoutofthegaragemusiccontest.com)> or participating Journeys retail locations. Void where prohibited.

World Radio History



Save on the Fly.



Capture a Dragonfly and get \$200 cash back.
Purchase a pair and get \$400.

This is one dragon that won't burn a hole in your pocket.

With summer in high gear there's never been a better time to let a Dragonfly loose in your studio. Just purchase a Dragonfly microphone between July 1st and August 31, 2008, from an Authorized Blue Retailer and you'll receive a \$200 rebate. Or become a Frequent DragonFlyer and buy a pair (great for drum overheads) and get \$400 back. The sky's the limit. You'd have to be crazy (or a competitor!) to pass up an offer like this one.

The award-winning, hand-tuned and tested Dragonfly is a unique cardioid condenser mic featuring a rotating spherical capsule head that can be positioned and adjusted in the smallest of spaces. Offering superb detail, the Dragonfly is ideal for recording vocals, drums and percussion, electric guitar, bass and just about any acoustic instrument.

Check in with your local Authorized Blue Retailer for more details or to hear a Dragonfly in action. But hurry! With savings like these, they're likely to zip off the shelves in record time. And that would be a fire-breathin' shame.



Microphones
www.bluemic.com



Blue Microphones Dragonfly Rebate Coupon

Use this Blue Rebate Coupon to save \$200.00 on the purchase of a Blue Dragonfly mic. To be eligible, simply purchase a Dragonfly from a Blue Authorized Dealer between July 1st and August 31st, 2008. Completely fill out, clip and send in this rebate coupon (incomplete coupons will not be accepted), along with a copy of the sales receipt and the original (no copies) UPC code from the bottom of the box to the address at the bottom. Multiple purchases require separate rebate coupons, sales receipts (if applicable) and UPC box codes. Additional rebate coupons are available for download online at www.bluemic.com.

All fields required

Name _____ Address _____ City _____ State/Province _____
ZIP/Postal Code _____ Email _____ Dealer _____ Date of Purchase ____/____/____

Please type or print legibly. One coupon required per product rebate. Confirmation of receipt of your rebate request will be emailed to the email address you provide. Offer good only on purchase(s) from a Blue Authorized Dealer in the U.S. & Canada. All rebate requests must be postmarked no later than September 15th, 2008. Blue Microphones is not responsible for lost, damaged or undelivered mail. Please allow 4-6 weeks for delivery. For a complete list of terms and conditions, please visit us on the web at www.bluemic.com.

Send to: Blue Microphones Dragonfly Rebate • 5706 Corsa Avenue, Suite 102 • Westlake Village, CA 91362-4057 USA

Register to win a TIMEFACTOR
at eventide.com

**EATS COMPLEX ALGORITHMS
FOR BREAKFAST.**



EVENTIDE H8000FW ULTRA-HARMONIZER



Eventide's signature 5.1 reverbs and effects require sheer processing power for dense reverbs and complex algorithms — the kind that can crush mortal effects processors. If you're ready to push the boundaries of creativity, meet the new super-heavyweight champion: the 8-channel, 24-bit/96kHz Eventide H8000FW Ultra-Harmonizer® effects processor.

Built on a foundation of eighteen hundred preset-algorithms that encapsulates Eventide's last 37 years of digital effects processing. And with over eighty 5.1 presets, this baby's ready to take the future head-on with headroom to spare. If, for example, a complex algorithm gets a little too big for its britches, Monolithic Tandem™ runs it on two DSP chips. With that kind of parallel processing power, your creativity is unrestrained.

Despite all that brain and brawn, the H8000FW is remarkably friendly and easy-to-use, optimized for flexibility and control. Virtua racks have been crafted which give you up to five stereo effects processors combined in one preset-algorithm. Search functionality helps you sort presets for easy retrieval.

The H8000FW combines the advantages of the H8000A with the H8000 and adds seamless FireWire connectivity with your computer.

So, crank up an Eventide H8000FW Ultra-Harmonizer and feast your ears on the most amazing effects you've never imagined.

- 8 channels of 24-bit AES/EBU, ADAT and FireWire I/O
- MIDI, BPM and Tap Tempo synchronization
- Up to 96kHz sampling frequency
- PC and OS X graphic editor/development tools included
- 4 channels of pristine analog I/O; s/n > 110dB

For more information visit eventide.com, email audio@eventide.com, or call 201-641-1200

Eventide and Harmonizer are registered trademarks, and Monolithic Tandem is a trademark of Eventide Inc. ©2008 Eventide Inc. All other trademarks are the property of their respective owners.

Eventide®



Not just a great vocal mic...
great on drum overheads!



NT1-A

World's Quietest *and most versatile*
Studio Condenser Microphone

The NT1-A provides the warmth, extended dynamic range, clarity and high SPL capability usually only found with some of the most expensive microphones.

It's also the world's quietest studio condenser mic with only 5dBA of self-noise, and comes with the same industry-leading ten year warranty found on all RØDE mics.

Ask your local RØDE dealer for more information on this award winning microphone or visit www.rodemic.com/nt1a

SM2 shock mount pictured. Mic kit comes complete with SM1 shock mount. Check out www.rodemic.com for more details.

Waves. The Logical Choice.

You've got a powerful host.

Now take your sound to the next level with the world's finest modeled console components, limiters, compressors, equalizers, and reverbs, available only from Waves.

Studio Classic Collection



Waves Gold



L3-16 Multimaximizer

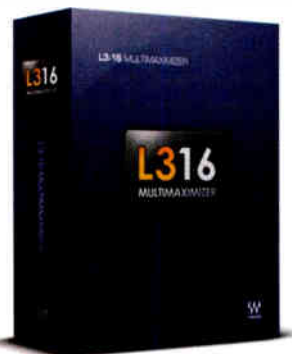

www.waves.com



MIX

PROFESSIONAL AUDIO AND MUSIC PRODUCTION

JULY 2008, VOLUME 32, NUMBER 8



PAGE 24



PAGE 28



PAGE 38



PAGE 56

On the Cover: The Mary J. Blige/Jay-Z double-header tour is being mixed by FOH engineers Kyle Hamilton (Blige) and Bryon Tate (Jay-Z), as well as monitor engineer Brian Evans. The system is provided by Clair Bros./Showco. **Photo:** Steve Jennings



live sound special!

It's July, and once again we're right in the middle of the summer touring and festival season—a busy time of year for sound engineers, SR companies and large venues. In this issue, *Mix* brings you an expanded view of the world of live sound, from profiles of big blockbuster tours and the people who make them happen, to the latest techniques and products.

24 Hip-Hop Tag-Team: Mary J. Blige and Jay-Z Live

Go behind the scenes at one of the biggest, hottest tours of 2008: Heart of the City, a double-bill that pairs the “Queen of Hip-Hop Soul,” Mary J. Blige, with top rapper Jay-Z. Find out how Blige and Jay-Z's top-notch audio crews work together to meet the challenges of presenting each artist's show back-to-back, as well as mixing their bands individually and collectively at stops all across North America.

28 Plug-Ins on Tour

It used to be, “What's in your rack?” Now it's, “What's on your laptop?” FOH outboard racks are slowly shrinking as touring technology embraces digital. Here, top engineers share the pros and cons of using plug-ins on the road.

38 Networked Amplifiers

As with all audio technology, price points of network-cable power amps have dropped and live gear operation is closely tied in with PCs. Even the smallest systems can benefit from a network: Engineers can remotely monitor amp operations without having to stick their heads into dusty rack enclosures.

Plus: More Blockbuster Tours!

54 Matchbox Twenty

56 Juanes

64 Bon Jovi



2008 TEC Awards Nominees, page 36

This year's Technical Excellence & Creativity Awards will be held on Friday, October 3, in San Francisco. Check out this year's crop of nominees in the Technical and Creative Achievement categories. Next month: the voting guide.

Check Out Mix Online! <http://www.mixonline.com>

[Volume 32, Number 8] is ©2008 by Penton Media Inc., 9800 Metcalf Ave., Overland Park, KS 66212. Mix (ISSN 0164-9957) is published monthly with an extra issue in January. One-year (13 issues) subscription is \$35. Canada is \$40. All other international is \$50. POSTMASTER: Send address changes to Mix, PO Box 15605, North Hollywood, CA 91615. Periodicals Postage Paid at Shawnee Mission, KS and at additional mailing offices. This publication may not be reproduced or quoted in whole or in part by printed or electronic means without written permission of the publishers. Printed in the USA. Canadian GST #129597951; Canadian Post Publications Mail agreement No. 40612608. Canada return address: BleuChip International, P.O. Box 25542, London, ON N6C 6B2.

THE NEW STANDARD

A new standard in location recording

A new standard has been added to the 4006 family. The 4006-TL offers extended bass response and higher sensitivity. The precise reproduction, total transparency, high resolution and natural sounding clarity of these microphones continue to make the 4006 family the best microphones in their class.

Upgrade your 4006 to 4006-TL specification

4006 microphones can be upgraded to 4006-TL specification. Undertaken at the DPA factory, the upgrade consists of a new preamplifier, a Close-miking grid, a calibration chart and a new mic case. Visit www.dpamicrophones.com for full details.



DPA 4006-TL

The microphones for sound professionals with uncompromising demands for musical accuracy.

DPA 
MICROPHONES

contents

sections

SOUND FOR PICTURE



PAGE 44

- 44 **Hellboy II** by Blair Jackson
- 45 **The Dark Knight** by Blair Jackson

LIVE MIX

- 50 **Live Mix News**
- 68 **Local Crew: Studio 116**
by Sarah Benzuly
- 70 **New Sound Reinforcement Products**

RECORDING NOTES

- 98 **My Morning Jacket**
by David John Farinella



PAGE 98

- 99 **Cannon Re-Loaded** by Chris Walker
- 100 **Classic Tracks: Steppenwolf's "Born to Be Wild"** by Gary Eskow
- 104 **Cool Spins**

COAST TO COAST

- 106 **L.A. Grapevine** by Bud Scoppa
- 106 **Nashville Skyline** by Peter Cooper
- 107 **N.Y. Metro Report** by David Weiss
- 108 **Sessions & Studio News**
by Barbara Schultz

technology

- 76 **Tools of the Trade**
- 80 **Field Test: Roland Systems Group V-Mixer Live Console**



PAGE 80

- 86 **Field Test: Solid State Logic X-Comp Compressor Plug-In**
- 88 **Field Test: Tube-Tech CL1 B Compressor/Limiter Plug-In**



PAGE 90

- 90 **Field Test: AEA A440 Active Studio Ribbon Microphone**
- 92 **Auditions**
 - Apogee Duet Desktop I/O for Apple Logic
 - Equation Audio DS-V10 Dynamic Vocal Microphone
 - Avantone Insignia Series Active Mix Cubes
 - PFPower M1500 Programmable Uninterruptible Power Supply
- 128 **Power Tools: Muse Research Receptor** by Jamie Muhoberac

columns

- 42 **Project Studio: S.S.R. Recording**
by Matt Gallagher



PAGE 42

- 72 **Tech's Files: Unlocking a Vintage Console's Long-Hidden Secret**
by Eddie Ciletti



PAGE 72

departments

- 10 **From the Editor**
- 14 **Feedback**
- 16 **Current**
- 113 **Mix Marketplace**
- 120 **Classifieds**

Thirsty for Tone?

100% tube, 100% solid-state, and everything in-between



UNIVERSAL AUDIO

The new 710 Twin-Finity Microphone Preamp & Instrument D.I.
Phase-aligned blending of tube and solid state transimpedance circuits.
Satisfy your thirst for tone. www.twin-finity.com



On the Road Again

As I write this, more than 80,000 fans are packed into 700 acres of hot Tennessee farmland to hear Metallica, Pearl Jam, Kanye West and more than 100 other acts at Bonnaroo. Last week, the 2008 CMA Music Festival (also known as Fan Fair) boasted record numbers—180 acts over four days, with 52,000 people a day. On the arena/stadium side of the biz, this summer's Van Halen tour grossed \$93 million by the time it wrapped last month. Last year's The Police shed tour brought in more than \$171 million, according to *Billboard* data. Every industry cycles through highs and lows, but these are good times for concerts, for fans and live sound professionals alike.

We've all heard the bad news about recorded-music sales. Digital-music sales are rising, but in 2007, overall music sales sank by almost 12 percent—more than \$1 billion, according to the latest RIAA figures.

So the music industry shifts and adapts. Some top artists, like Prince and Radiohead, have experimented with giving music away. Others sign all-in-one deals like Madonna's contract with Live Nation, which includes stakes in everything from key chains to albums to film rights. But beyond distribution, the industry is increasingly turning to live performance as a revenue stream. And it's not just about filling arenas and sheds; it's about diversity, from pay-per-view events to corporate gigs to multnight theater stops and a whole new world of casino shows.

Performing artists at every level know they need to up their game, and one way to do that is to take show production to the next level. Rascal Flatts is currently carrying one of the largest systems in the world, with 20 trucks on the road. Package tours allow big-name artists to play even bigger venues: Our cover artists, Mary J. Blige and Jay-Z, joined forces to sell out arenas nationwide with their dazzling show.

The focus on production is good news for audio pros. With the increased acceptance of digital consoles, live sound technology can incorporate more studio technology. Check out George Petersen's inside look at FOH engineers' virtual racks—the ways they're mixing live with plug-ins. This month, we also showcase networked power amps, which offer engineers complete computer control at any system level.

And because summertime means hot tours, this issue brings you expanded concert coverage. In addition to our cover duo, we feature Colombian superstar Juanes, established rockers Matchbox Twenty, new rockers Paramore and arena-rockers Bon Jovi live! Get those lighters (and cell phones!) ready...

Sarah Jones

Editor

MIX[®]

EDITORIAL DIRECTOR Tom Kenny tkenny@mixonline.com
EDITOR Sarah Jones sjones@mixonline.com
EXECUTIVE EDITOR George Petersen gpetersen@mixonline.com
SENIOR EDITOR Blair Jackson blair@blairjackson.com
TECHNICAL EDITOR Kevin Becka kbecka@earthlink.net
GROUP MANAGING EDITOR Sarah Benzuly sbenzuly@mixonline.com
ASSISTANT EDITORS Barbara Schultz bschultz@mixonline.com
 Matt Gallagher m Gallagher@mixonline.com
LOS ANGELES EDITOR Bud Stoppa bs7777@aol.com
NEW YORK EDITOR David Weiss david@dwards.com
NASHVILLE EDITOR Peter Cooper skytinemin@live.com
FILM SOUND EDITOR Larry Blake swellstone@aol.com
SOUND REINFORCEMENT EDITOR Steve La Cera
CONSULTING EDITOR Paul D. Lehman lehman@pan.com
CONTRIBUTING EDITORS Michael Cooper Heather Johnson
 Eddie Ciletti Gary Eskow Barry Rudolph

SENIOR ART DIRECTOR Dmitry Panich dmitry.panich@penton.com
ART DIRECTOR Kay Marshall kay.marshall@penton.com
ASSOCIATE ART DIRECTOR Elizabeth Heaven
PHOTOGRAPHY Steve Jennings
INFORMATIONAL GRAPHICS Chuck Dahmer

SENIOR VICE PRESIDENT Kim Paulsen kim.paulsen@penton.com
VICE PRESIDENT Jonathan Chalon jonathan.chalon@penton.com
GROUP PUBLISHER Joanne Zola joanne.zola@penton.com
ASSOCIATE PUBLISHER Erika Lopez erika.lopez@penton.com

DIRECTOR OF AUDIENCE AND BUSINESS DEVELOPMENT
 Dave Reik dave.reik@penton.com
ONLINE SALES DEVELOPMENT DIRECTOR Angie Gates
angie.gates@penton.com
ONLINE PRODUCT DEVELOPMENT MANAGER Terri Needham
tami.needham@penton.com

WEST/MIDWEST SALES MANAGER Erika Lopez
erika.lopez@penton.com
EAST COAST/EUROPEAN SALES DIRECTOR
 Michèle Kanatous michèle.kanatous@penton.com
SENIOR MANAGER, LIVE & INTERACTIVE MEDIA Erin Hutton
erin.hutton@penton.com

CLASSIFIEDS/SPECIALTY SALES MANAGER
 Kevin Blackford kevin.blackford@penton.com

MARKETING DIRECTOR Kirby Asplund kirby.asplund@penton.com
MARKETING COORDINATOR Tyler Reed tyler.reed@penton.com
SALES & EVENTS COORDINATOR Jennifer Smith
jennifer.smith@penton.com

DIRECTOR, SPECIAL PROJECTS Hilol Resner hilol.resner@penton.com

VICE PRESIDENT, PRODUCTION Lisa Parks lisa.parks@penton.com
DIRECTOR, PRODUCTION OPERATIONS Curt Pordes
curt.pordes@penton.com
PRODUCTION MANAGER Liz Turner liz.turner@penton.com
CLASSIFIED PRODUCTION COORDINATOR Linda Sargent
linda.sargent@penton.com

VICE PRESIDENT, AUDIENCE MARKETING Jerry Okabe jerry.okabe@penton.com

OFFICE MANAGER Lara Duchnick lara.duchnick@penton.com

COPYRIGHT 2008

Penton Media Inc.

ALL RIGHTS RESERVED.

FOUNDED IN 1977 BY DAVID SCHWARTZ AND PENNY RIKER

MIX[®] MAGAZINE IS AFFILIATED WITH



FRANK FILIPETTI

Five-time GRAMMY® Award-winning engineer,
producer whose credits include projects with:

10,000 Maniacs
Barbra Streisand
Billy Joel
Carly Simon
Courtney Love
Elton John
Frank Zappa
James Taylor
John Waite
Kiss
Korn
Luciano Pavarotti
Luther Vandross
Mariah Carey
Ray Charles
Rod Stewart



"When working in a recording environment, I've found it critical to 1. create an atmosphere that people find comfortable and 2. make sure the listening environment, especially your speakers, are as good as you can get - so you don't second-guess what you're hearing. When I first used the LSR6300s, I just loved what I was hearing and I've been using them ever since. They're smooth across the entire spectrum. I don't hear the speaker - just the music. Working in a range of rooms in LA, London, and here in Manhattan, the ability to tune the LSRs to the room is extremely useful. I'm really stoked about the new LSR4300 series especially the 6-inch model. The 4300s, with automated Room Mode Correction, go one step further. I put the supplied calibration mic in the center of the room, push a button and the speaker does all the work. It not only does it, it does it well and it does it right! The technology's amazing - I'm blown away by it. I take my LSRs wherever I go."

Hear why award-winning engineer, producer, Frank Filipetti is blown away by the
LSR series studio monitors. Visit JBLPRO.com/LSR



LSR4300
S E R I E S

JBL
PROFESSIONAL

H A Harman International Company

Seek Out Smart Outputs



OutSmarts® Balanced Line Driver ICs

OutSmarts outputs are quieter, and they're cleaner when clipping into single-ended loads. Insist on products with OutSmarts outputs. Look for our  logo on the smartest audio gear.

THAT Corporation
Analog ICs for Pro Audio®

Tel: +1 508 478 9200
Email: info@thatcorp.com
Web: www.thatcorp.com

UNIVERSAL & CUSTOM FIT IN EAR MUSICIANS' MONITORS

"One Hundred Percent Satisfied"



Michael Prowda, Monitor
Engineer—David Bowie, NIN
Westone ES2 custom fit
in-ear musicians' monitor

Westone
THE IN-EAR EXPERTS

WESTONE.COM/MUSIC

WWW.MIXONLINE.COM

 **Penton Media**

Chief Executive Officer John French john.french@penton.com
Chief Revenue Officer Darrell Denny darrell.denny@penton.com
General Counsel Elise Zealand elise.zealand@penton.com

Sr. Vice President, Administration Eric Jacobson eric.jacobson@penton.com

Vice President, Human Resources Kurt Nelson kurt.nelson@penton.com

Chief Technology Officer Cindi Reding cindi.reding@penton.com

Vice President, New Media Group Prescott Shibles prescott.shibles@penton.com

Vice President, Corporate Controller Steve Martin steve.martin@penton.com

SUBSCRIBER CUSTOMER SERVICE: To subscribe, change your address or check on your current account status, go to www.mixonline.com and click on "Customer Service" for fastest service. Or, e-mail mix@pubservice.com, call toll-free 866/860-7087 or 818/487-2020, or write to P.O. Box 16886, N. Hollywood, CA 91606.

BACK ISSUES: Back issues are available for \$10 each by calling 866/860-7087 or 818/487-2020.

POSTMASTER: Send address changes to *Mix* magazine, P.O. Box 638, Mt. Morris, IL 61054.

PHOTOCOPIES: Authorization to photocopy articles for internal corporate, personal or instructional use may be obtained from the Copyright Clearance Center (CCC) at 978/750-8400. Obtain further information at copyright.com.

REPRINTS: Contact Traci Mueller, traci.mueller@penton.com to purchase quality custom reprints or e-prints of articles appearing in this publication at 888/858-8851 (216/931-9623 outside the U.S. and Canada). Instant reprints and permissions may be purchased directly from our Website; look for the RSCopyright tag appended to the end of each article.

ARCHIVES AND MICROFORM: This magazine is available for research and retrieval of selected archived articles from leading electronic databases and online search services, including Factiva, LexisNexis and ProQuest. For microform availability, contact National Archive Publishing Company at 800/521-0600 or 734/761-4700, or search the Serials in Microform listings at napubca.com.

PRIVACY POLICY: Your privacy is a priority to us. For a detailed policy statement about privacy and information dissemination practices related to Penton Media Inc. products, please visit our Website at www.penton.com.

LIST RENTAL: Marie Brignati marie.brignati@waterford.infousa.com

MAILING LISTS: Penton Media Inc. makes portions of our magazine subscriber lists available to carefully selected companies that offer products and services directly related to the industries we cover. Subscribers who do not wish to receive such mailings should contact the Penton Media Inc. subscriber services at 800/532-8190 or 740/382-3322.

CORPORATE OFFICE: Penton Media Inc., 249 West 17th St., New York, NY, www.penton.com.

NATIONAL EDITORIAL, ADVERTISING AND BUSINESS OFFICES, 6400 Hollis St., Suite 12, Emeryville, CA 94608; 510/653-3307; fax 510/653-5142; Website: www.mixonline.com. **PHOTOCOPY RIGHTS:** Authorization to photocopy items for internal or personal use of specific clients is granted by Penton Media Inc., provided that the base fee of U.S. \$2.25 per copy, plus U.S. \$00.00 per page is paid directly to Copyright Clearance Center, 222 Rosewood Drive, Danvers, MA 01923. The fee code for users of this Transactional Reporting Service is ISSN 0164-9957/2000 \$2.25 + \$00.00. For those organizations that have been granted a photocopying license by CCC, a separate system of payment has been arranged. Before photocopying items for educational classroom use, please contact CCC at 978/750-8400.

**PUT YOURSELF
IN THE MIX**



CONSERVATORY
OF RECORDING ARTS & SCIENCES

**Learn audio
recording at the
Conservatory of
Recording Arts
& Sciences.**

If you're serious about a career in audio recording, you need to attend a recording school that is as committed to your success as you are.

The Conservatory of Recording Arts and Sciences teaches you on state of the art recording equipment in eight world-class studios, six labs, and a 6,000 square foot live sound room. You'll study under seasoned Gold and Platinum award winning instructors who know what it takes to succeed. You'll earn certifications in Pro Tools, Logic Pro, EAW Smaart, Waves, and more. You'll receive a laptop package that helps you follow along in class, access CRAS Connect (our web based curriculum delivery system), and gives you 24 hour educational access even while you're at home. And before you graduate, you'll complete as internship at a location you help choose.

When it comes to audio...

WE ARE THE EXPERTS. LET US HELP YOU GET IN THE MIX.

Call today! 888.273.6412

2300 E Broadway Rd | Tempe, AZ 85282

1205 N Fiesta Blvd | Gilbert, AZ 85233 (satellite facility)

www.audiorecordingschool.com/mix.html



Letters to Mix



TALKBACK: YOUR NASHVILLE STORIES

In recent "Feedback" sections and MixLine newsletters, we asked readers to tell us about their most memorable Nashville sessions and how the scene has changed over the years.

Several years ago, the movie *The Last Castle*, starring Robert Redford, was being filmed at the old prison here in town. A friend of mine, Dean Hall, and I were in the movie. It came to Dean's attention that they were accepting songs for the movie soundtrack. The deadline: the following morning!

Dean had already written a song, "Chiseled In Stone," that would be perfect for the movie, but did not have a version of it recorded. The movie director, Rod Lurie, gave him till around 6 a.m. the next morning to put a version in his hands.

Dean asked me if I felt like doing a little "mercenary recording." At the time, I had a small studio in a building behind my house just outside of downtown Nashville. It was around 10 p.m. before we got into the studio. While we were driving to the room, Dean [was] on the phone calling session players. Only in Nashville could you call so many people this late in the game and have all of them show up! Not just anyone, either—some of this town's most gifted players. The keyboard player was playing a gig at the time and couldn't be there till around 1 a.m. or so. Once he arrived and set up, it was on.

Dean had everything charted out. They went through the song once and then we printed it. We cut Dean's vocals and then did a finished mix. We wrapped things up around 5 a.m. Normally, we would have been bused onto the prison property, but on this day we drove right up to the [prison's] side entrance. Dean rushed in and delivered the song—with minutes to spare.

Our song made it! Not only was it played during the movie, but it was also played during the closing credits. It was a fun job, and definitely what Nashville is all about.

Ronnie Honeycutt
Sound Dragon Studio
Goodlettsville, Tenn.

I was mixing at GroundStar one evening with Ronnie Milsap. He wanted to take the mix over to the Woodland mastering suite to listen to the mix on their monitors. So when we got there, one of Woodland's engineers told us that Conway Twitty was mixing in Woodland's A control room. At the time, Woodland had drapes on the control room windows that they would close off to the studio when a mixing session was going on. I was asked to go in to A and pull the drapes open. And when I did, Ronnie Milsap, his producer, Tom Collins, and a Woodland engineer, Les Ladd, had their "hams" pressed up to the control room glass, mooning Conway.

Conway got on the studio talkback, and asked Ronnie, "Is that some more of that Milsap magic?" (Ronnie's record was titled *Milsap Magic*.) I don't know when I have ever laughed so hard—and so did Conway.

Ben Harris

In 2004, I had the pleasure of arranging and producing 12 songs for a new-age orchestral project by composer Fred Lykes entitled *Journey to the Stars*. Three sessions lasting three hours each, with 32 musicians—strings, woodwinds and French horns—went down to Ocean Way Nashville. A widely spaced stereo pair of Neumann M50s captured the room, with spot mics over each section. The session was engineered by Bob Clark, a veteran orchestral expert. It was recorded to RADAR and then transferred to Pro Tools.

The orchestra players were contracted by Carl Gorodetsky, and the playing was first-class. The room, which has very high ceilings and a springy wood floor, sounds wonderful. The "double Neve" [custom Neve VRP 96-input console] in the control room has excellent preamps.

The total cost for the session (musicians, studio and travel) was about \$30,000—and worth every penny! The composer was very happy with the final product, which we finished at our facility in Orlando, Fla.

It was a thrill to hear it go down and one of the highlight projects of my life!

Michael Hurley
Lone Pine Studios

OF MICS AND TUBES

I recently read [Eddie Ciletti's] *Mix* article online ("Tech's Files: Micro-lution," February 2007) with interest. I would like to respond concerning some of the elements of your article.

In your summary under "New Vistas," you indicate that the 7586 tube has higher gain than the similar 6CW4. This is incorrect. The μ (or gain) of the 7586 (according to the *RCA Radiotron Handbook*) is 35, whereas with the 6CW4 it is 70.

Additionally, your editing of Neumann's published documentation detailing modifications for the U47 and U48 by way of substituting the VF-14 tube with another NuVistor is misleading. Neumann introduced the U47 in 1949. NuVistors were not introduced by RCA until 1959, some 10 years later. The VF-14 is not a NuVistor but an RF/IF-Stage pentode.

Mark Zaluski

Thanks for your input. I apologize for the error; you were the first to catch it. In a future "Tech's Files" column, I plan on including a tube-compatibility table with filament and "mu" specs.

I only recently revisited a few NuVistor data sheets after acquiring a pair of AKG C-61 mics. I was amazed at the NuVistor's low output level. Inside was a 13CW4 (which has a 13-volt filament) where there should have been a 7586 (which has a 6-volt filament)! In that case, no amount of gain can make up for the lack of correct filament voltage.

As for the U47: Many years after it was released, the supply of VF-14s was running low, so Neumann offered an upgrade kit. You are correct—the VF-14 is a pentode, but it is wired as a triode. While the 13CW4 might not have been the best sonic choice, its low-filament current provided an option that required the fewest changes to the mic and the power supply.

—Eddie Ciletti ■



Next month, *Mix* dives into stories about radical mixing—projects that involve some bizarre twists on classic techniques. What was a recent project where you had to fudge the "classic" line to get the best result? E-mail us at mixeditorial@mixonline.com.

SONAR 7

Feature spotlight:

Advanced Mixing

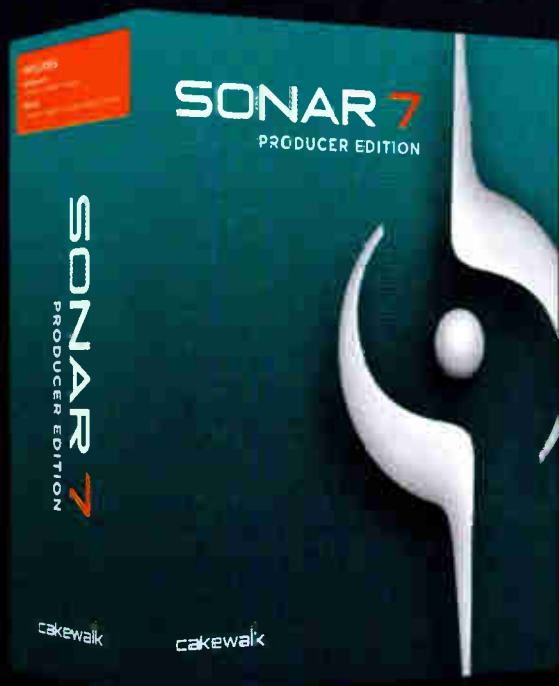

What it is:

Harness all the power and flexibility of a professional hardware mixing console right within your PC. SONAR's advanced mixing environment is powerful, easy-to-use, provides unique features, and offers the best sound in the industry.

Why you'll love it:

- ▶ Superior 64-bit double precision floating point mix engine
- ▶ Over 30 professional effects from Cakewalk
- ▶ Internal sidechaining for sophisticated mixing
- ▶ Surround mixing in over 30 different formats
- ▶ Flexible routing using SONAR's Universal Bus Architecture
- ▶ Insert your favorite hardware FX with delay compensation

This is just one of the thousands of features that makes SONAR 7 Producer Edition the smart choice for professional music production.

For more features and videos visit www.cakewalk.com/SONAR

Available at fine music retailers worldwide including:



Sam Ash

Sweetwater

cakewalk
by Roland

MIX L.A. OPEN STAYS ON PAR

The weather may have been cold, but a sold-out crowd of more than 140 golfers braved the chill at the 13th Annual Mix L.A. Open, sponsored by Guitar Center Professional, in Malibu, May 12. First place went to CCC Information Services (Richard Armijo, Phillip Armijo, Jim Hoover and Bernard Perry), second to Tascam (Tim Crable, Rob Joly, Jerry Klein and John Reda) and third to Sound Design Corporation (Paul Sandweiss, Ken Dahlinger, Cole Pensanti and Scott Spiegel). Tim Hoggart (Warner Bros.) won the Closest to the Pin Award, cruising around in a Porsche for the weekend, provided by The Auto Gallery. Jim Hoover (CCC Information Services) won the Longest Drive Contest, and Richard Armijo (CCC Information Services) took top honors in the Closest to the Pin contest.

Special thanks to Land Rover Jaguar Venture for its Hole-in-One Car, The Auto Gallery for its prize donation for the Closest-to-the-Pin contest, Motley Bird for their energy drink donation and PRP International for their wine-tasting donation. For more photos, go to mixonline.com.

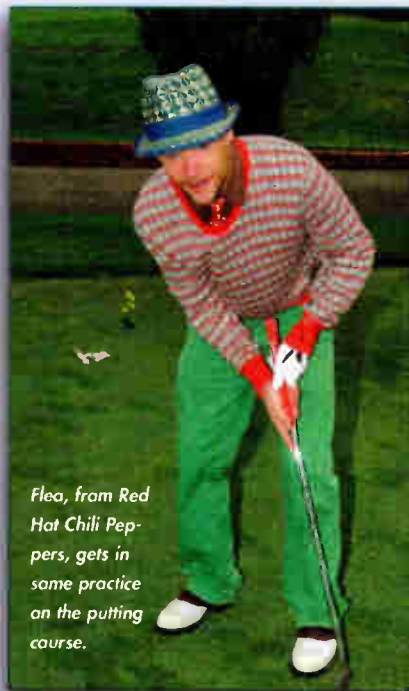

Flea, from Red Hot Chili Peppers, gets in some practice on the putting course.



Record Plant's Rose Mann-Cherney and engineer David Reitzas

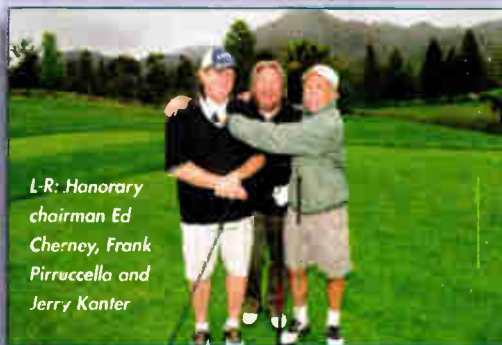

L-R: Honorary chairman Ed Cherney, Frank Pirruccella and Jerry Kanter



L-R: David Marks (Designs By David), Doug Dabransky, Paula Solverson (Capital Studios), Jeff Greenberg (The Village) and Maureen Draney (P&E Wing)

Special Thanks to Our Sponsors

Absolute Music
Acme Audio Labs
C.E. Pickup/IAC
Design FX
Full Sail University

Guitar Center Professional
Harman Pro
KRK
Lurssen Mastering
Maple Jam Music Group

Mix magazine
Producers & Engineers Wing
Record Plant
Sennheiser
Shure Inc.

Sound Design Corporation
Tascam
The Pass Studios
Yamaha Corporation

MIX NASHVILLE DEBUTS!



PHOTO: ANTHONY BOGARD

Mix dropped in on Music City from May 19-21 to host Mix Nashville, the first-of-its-kind, two-day event focusing on studio and live production/distribution. Presented by Apple, Digidesign and Meyer Sound, and held at world-class rehearsal facility Soundcheck Nashville, the event proved a success on every level, from the opening-night welcome at Blackbird Studio to the closing panel with Tony Brown, Chuck Ainlay and LeeAnn Womack (pictured on right, with Ainlay) discussing her yet-to-be released project.

"We've had a lot of success with events here in the Penton Audio Group, especially with our experience producing the Remix Hotels," said *Mix* publisher Joanne Zola. "Still, Mix Nashville surpassed even our best projections, both in terms of the quality of the sponsors and the real professional qualifications of every last attendee. I think this shows that the *Mix* audience is hungry for this type of hands-on, information-packed event."

Besides two full days of industry-related panels on production and distribution, attendees were presented with Master Classes from Apple on the use of Logic in a live recording, featuring the Jimmy Nichols Band; from Digidesign with engineer/producer Steve Marcantonio talking about ICON and Robert Scovill talking about VENUE; and from Meyer Sound, with industry legend Buford Jones performing a live mix through the company's new UPQ-1P loudspeaker.

For complete coverage of Mix Nashville, including downloadable videos of the panels, visit www.mixonline.com/ms/nashville08.



The Yamaha Commercial Audio team—from left: Mike Miereu, John Coward, Val Goray and Raff Sanchez—was the Golf Ball sponsor.

WELCOME HOME



PHOTO: ROBERT WIRSCHT

Troy Germano (left) and mastering engineer Drew Lavayne

The latest entry onto the New York City top-tier studio scene has arrived in the form of Germano Studios (www.germanostudios.com). Located in the downtown environs of Manhattan's NoHo district, the facility takes the expertise of Troy Germano's years of running all of the multi-studio Hit Factories in New York City, Miami and

London, and focuses it onto a much more intimate two-room space.

A visit to the studio revealed a very 2008 approach to the design of a world-class recording and mix facility. Both of the rooms—designed by Germano and David Bell, Studio 1 and Studio 2—are centered around SSL Duality 48-input analog consoles, plus SSL 32-input X-Rack monitor mixers for a total of 80 inputs. A healthy mix of highly varied outboard dynamics processors and plug-in effects combine for a versatile and dependable sound-shaping signal path. The facility represents an intriguing addition to the already competitive high-end New York City studio scene.

—David Weiss

CDS HOLD STRONG

A recent study by the PEW Internet & American Life Project shows that the Internet helps music buyers connect with artists and learn more about music, but it doesn't strongly influence what or how they buy. Interestingly, even with the potential to buy music online via digital downloads, most music lovers are still going the old-fashioned route: CDs.

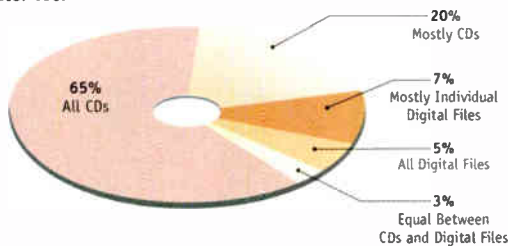

[Note: View report at www.pewinternet.org/PPF/r/248/report_display.asp]

LARRY LEVINE, 1928-2008



Recording engineer Larry Levine passed away May 8, 2008, at his home in Southern California. Levine was a staff engineer at Hollywood's Gold Star Recording Studios in 1962 when he was assigned to work with young producer Phil Spector. The session was girl group The Crystals, who were recording "He's a Rebel." The song went to Number One on the charts and catapulted the band to fame; a year later, with the group's "Da Doo Ron Ron" and "Then He Kissed Me," the Spector/Levine "wall of sound" was established. With Spector at the helm and

Levine at the board, the hits kept coming, including The Ronettes' "Be My Baby," the Righteous Brothers' "You've Lost That Lovin' Feelin'" and dozens more.

Levine also engineered for Eddie Cochran, and Sonny & Cher. He garnered a Best Engineered Recording Grammy in 1966 for Herb Alpert & The Tijuana Brass' "A Taste of Honey," which also won Song of the Year. In addition, Alpert asked Levine to build A&M's first recording studio. Levine worked with Brian Wilson and the Beach Boys on *Pet Sounds*, *Smiley Smile* and *Wild Honey*. In the late '70s, Levine reunited with Spector with projects for Leonard Cohen and The Ramones.

—George Petersen



Levine on the console at Gold Star with producer Phil Spector

BIZ AS USUAL

The headline attached to our June news item about Mastering Lab's Hollywood facility closing was somewhat misleading; the Ojai crew are still as busy as ever, working on mastering projects and perfecting their pool skills. Pictured, from left: Sangwook "Sunny" Nam, Doug Sax, Robert Hadley, Eric Boulanger and Thomas Pessagno.



SEEN AND HEARD

"I'm looking forward to joining forces with Odds On and making the desert bloom with music."

—James "Bonzai" Caruso, Odds on Recording new chief audio engineer/in-house producer



TEACHING THE NEXT-GENERATION PRODUCER/ENGINEER



Students at the Jazz Camp range in age from 13 to adult.

in engineering, teaching setup, miking, recording and editing with Pro Tools, mixing and mastering—all very hands-on,” Bollenback continues. “On the production side, I show them how to choose material to record, rehearse a band, program the material, some specific mix tips and lots of in-studio tricks of the trade, all with an aim to be able to make their own high-level CD. In addition, Shure provides some great mics for our use, and sends a rep to give a lecture/demonstration about mic history, techniques and uses. The students do most of the work, and it’s pretty intensive, but we have a lot of fun, and at the end of the day the kids gain a lot, which is the important thing! When the final mix and master is done at the end of two weeks, I really enjoy the pride they take when the whole camp gets to hear the finished product.”

Young aspiring jazz producers and engineers can take heart: There’s a summer program designed especially for them in Litchfield, Conn. The Litchfield Jazz Camp (www.litchfieldjazzfest.com/jazzcamp_recording.htm) is a two-week course that goes above and beyond for students who are focused on the fine points of jazz production.

“The camp as a whole offers intensive, organized, up-close-and-personal contact with teachers who are primarily high-profile performers,” explains instructor/world-renowned jazz guitarist Paul Bollenback, who leads the camp along with Ed Tetreault, manager of the Peabody Conservatory Recording Arts & Sciences program. “The jazz camp is now in its 12th year in association with the highly successful Litchfield Jazz Festival, but the recording and production course is new as of 2007. We call it the ‘Two-Week Miracle’ because most of the kids are starting from scratch with recording, and when we are done they have produced and recorded a finished CD.

“On the engineering side, Ed works with the kids interested



A student practices his mic technique.

—David Weiss

ON THE MOVE

Who: Chris Foreman,
Community VP/COO

Main Responsibilities: get the job done—plain and simple.

Previous Lives:

- Community
- Electronic Contracting
- JBL
- Panasonic
- Late 1970s, Altec Lansing
- Stanal Sound

The most exciting thing about working in this industry is: the ongoing digital audio revolution. Even loudspeakers are moving into the digital era, which makes this a very exciting time for Community. The most fulfilling part of my career has been all of the truly great people I’ve worked with.

The best concert I’ve ever seen was: in 1997, my band, The Chancellors, played a 30-year reunion concert at the Pla-Mor Ballroom in Lincoln, Neb., where we were inducted into the Nebraska Rock and Roll Hall of Fame. The Chancellors was a nine-piece brass and show band from the late 1960s that did everything from 1960s Motown to Chicago and Blood, Sweat and Tears.

The one thing in my office most like my personality is: my “babes mug”: great photos of my wife and daughter.

Currently in my iPod: “June Bug Rag,” a piano rag I wrote last year.



RAZZLE DAZZLE

Bette Midler’s longtime stint (until the end of this year) in *The Showgirl Must Go On*, at Las Vegas’ The Colosseum at Caesars Palace (previously home to Celine Dion’s *A New Day* five-year run) includes sound reinforcement provided by Montreal-based Solotech, including a Meyer Sound system. Featuring a total of 132 costume changes and framed by curtains created from 75,000 individually painted gold coins, the show features a 13-piece band, 20 backup dances and a backdrop a la Broadway-style theater. The Colosseum’s new system allows for a seamless transition for its three other resident performers (Elton John, Cher and Jerry Seinfeld). Venue personnel involved in the redesign include head of audio Dave Torti and tech director Bob Sandon; Midler is mixed by longtime FOH engineer David Morgan.

PHOTO: ETHAN MILLER/GETTY IMAGES FOR AEG LIVE/CONCERTS WEST



YOU'VE ONLY GOT ONE SHOT...

...to record one of the biggest live performances ever,
and your reputation is riding on it.

The top names in the business rely on the TASCAM X-48 for recordings that work without fail.

With total workstation compatibility, 48-track recording at 96kHz/24bit and legendary TASCAM sound quality, it's no wonder the pros rely on the X-48.



"I use two X-48s as the main 96-track recording system and two more as a backup. I'm very pleased with the sound quality, the support has been great and I'm happy I went with the TASCAMs."

Kooster McAlister

Record Plant Remote (James Blunt, Barry Manilow)

"X-48s are used to record live band rehearsals. We also record all of the live performances on the show for archival purposes using the X-48s, and they have performed perfectly and sound great as well."

Paul Sandweiss

Sound Design

(American Music Awards, Beyonce, Tony Bennett, Will i Am, Usher)

TASCAM 
MAKE IT HAPPEN

© 2008 TASCAM, a division of TEAC America, Inc.
All rights reserved. Features and specifications mentioned are subject to change without notice.

For more information, visit
www.tascam.com

Go beyond the printed page and log on to www.mixonline.com to get extra photos, text and sounds on these select articles—plus much more online:

PLAY: Networked Power Amps

Get your highlighter ready—online you'll find an easily accessible pdf "shopping list" of all the power amps listed in this feature. Now go out and get yourself some new gear—you deserve it.

PLAY: Plug-Ins Go Live

We surveyed a select few front-of-house engineers for our article about using digital technology to its fullest potential out on the road. Tell us how you're using plug-ins on tour and we'll post them online. Let us know at mixeditorial@mixonline.com.

WATCH:

"Tour Profiles" and "All Access"

As always, we've got more photos than we have room to print. Check out these photo galleries for more behind-the-scenes photos.

LISTEN: "Recording Notes"

Check out MP3s for My Morning Jacket's *Evil Urges*; the Cannonball Adderley tribute album *Cannonball Re-Loaded*; and "Born to Be Wild," this month's "Class: Track"—rockin' out is optional.

BLU-RAY FIRST: A DEBATE

Norwegian record label 2L reports it has released the first album (*sans* a video component except for a menu guide) in the Blu-ray format: *Divertimenti* is a collection of "light, uncomplicated and cheerful" classical pieces recorded by Trondheim Soloist (Trondheim Solistene) in a church. The album is available as a 24-bit/96kHz lossless FLAC download or as a two-disc Blu-ray/SuperAudio CD. Some point to Nine Inch Nails' *Ghosts I-IV* as the first available on Blu-ray.



CORRECTIONS

The *Mix* editors wanted to play hide-and-seek with our readers: We inadvertently left off the "Sound for Picture" feature on *Indiana Jones* from the "Table of Contents."

The "State of the City" feature in our May issue spotlighting Nashville omitted the fact that Gary Belz was one of the co-founders of Ocean Way.

In our May article about "Bluegrass Recording," we inadvertently misspelled the name of one of the engineers interviewed. The talented fellow who co-engineered the Grammy-winning Jim Lauderdale album *Bluegrass Diaries* and engineered the new Rhonda Vincent disc, *Good Thing Going*, is named Michael Latterell. He also heads Nashville's Music City Audio Machines.

In last month's "Class of 2008" feature, our cover studio, Inner Machine, has an RCA BA 6A, not a BA 66.

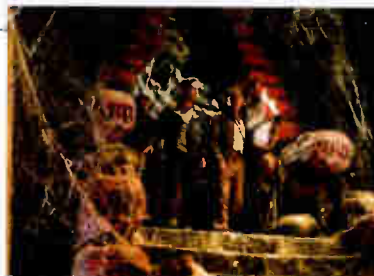

INDUSTRY NEWS



Kevin McLaughlin



Ezra Kelly

Kevin McLaughlin joins **Digidesign** (Daly City, CA) as VP of engineering...**Martin Audio's** (High Wycombe, England) longtime finance director, **Anthony Taylor**, is now the company's joint managing director...**Daniel Nix** takes on the VP of sales, Americas, role for **Bosch Communication Systems** (Burnsville, MN)...New face at **Aviom** (West Chester, PA) is **Shawn Stahmer**, national sales director for U.S. and Canada. The company also promoted **Jeff Lange** to consultant liaison and training manager...Joining **Sennheiser's** (Old Lyme, CN) West Coast sales force is **Aaron Berg**...**Solid State Logic** (Los Angeles) welcomed **Katy Templeman-Holmes** to the fold, acting as broadcast sales manager...**WorxAudio Technologies** (Greensboro, NC) appointed **Ezra Kelly** to inside sales...Germany-based **Ultrasone** has opened up a U.S. subsidiary in Southern California...New distribution deals: **Clear-Com** (Cambridge, UK) selected **Tilts Integration** as its distributor in Latvia; **Microsonic Music** (Ambridge, PA) appointed **Sonic Distribution** (Somerville, MA) for its distributor in North America; and **Midas** and **Klark Teknik** (Burnsville, MN) are rep'd in China by **Rightway Audio** (Guangzhou, China). ■

IN = OUT™

SIGNAL TRANSPARENCY

Now we bring our exclusive In=Out™ pure signal transfer technology to your studio

Let us hook you up

Introducing the  PLANET WAVES™
Modular Snake System

Step 1:

CHOOSE YOUR
Core



- Available Lengths:**
- 5 ft w/ DB25 Connectors
 - 10 ft w/ DB25 Connectors
 - 25 ft w/ DB25 Connectors

Step 2:

CHOOSE YOUR
Breakout



- XLR Male
- XLR Female
- TRS
- AES/EBU

Step 3:

Plug In



Planet Waves cables are the choice of tone masters like Robben Ford, Joe Satriani, Warren Haynes, Peter Frampton and more. Our new Modular Snake System offers the flexibility to mix and match core DB25 cables with TRS, XLR, and AES/EBU breakouts for any situation.

Visit planetwaves.com for a complete demo



Call today and speak to a

Gear Head.



Microphones

We've got an incredible selection of some of the best microphones available for studio and stage alike. You'll find condensers, dynamics, and ribbon models (plus Sweetwater-exclusive mic packages and a wide range of mic accessories) from manufacturers such as Shure, Neumann, Royer, Sennheiser, AKG, and many more!



Toft Audio ATB 32

Mixers

The mixer is the nerve center of your operation, and we know you want the best possible unit for your money. Our knowledgeable Sales Engineers are here to help you find the one that's just right for you. We carry an incredible range of mixers from Allen & Heath, Mackie, Yamaha, and many, many more.



Universal Audio LA-610 Signature Edition

Studio Processors

At Sweetwater, you'll find exactly what you need to create some of that elusive studio "magic," thanks to our incredible selection of processors. Our huge warehouse is stocked with great reverb, delay, and multi-effects units from Eventide, Yamaha, Lexicon, Universal Audio and TC Electronic, plus a host of others.



Focusrite ISA 828

Preamps

There's no more important item in your signal chain than a good preamp — and we have a huge selection of them. Whether you want to add "color" to your sound or seek pristine transparency, Sweetwater has the preamp that's just right for you, from great manufacturers such as Avalon, Focusrite, PreSonus, and Manley, just to name a few.



FREE SHIPPING
NO MINIMUM PURCHASE
*ON MOST ORDERS CONTACT US FOR MORE INFO

Buy Now
Pay Later



NO Payments! NO Interest! For 90 Days!

Service, Selection, and Know-how. It doesn't get any better than that.

▶ THE BEST POSSIBLE PRICES!

Sweetwater's great prices and unparalleled customer service lead the industry.

▶ HUGE SELECTION OF THE LATEST GEAR!

Our massive warehouse is brimming with the latest in pro audio, keyboards, & guitars.

▶ FRIENDLY, KNOWLEDGEABLE SALES!

Our Sales Engineers know the gear inside and out.

▶ FREE 24/7 ONLINE TECH SUPPORT!

At your disposal when you need it.
www.sweetwater.com/sweetcare



Sweetwater
Creation Station

Computers

We offer a stellar selection of both Macintosh and PC computers. When combined with the audio software and hardware of your choice, we can even provide a custom turnkey installation solution for your studio. And did you know we build our own Creation Station PCs? These powerful machines are made to suit your studio needs, with audio-optimized drives, whisper-quiet operation, top-quality components, and rock-solid reliability. Tower, rack, or portable, Sweetwater has the right computer for you!

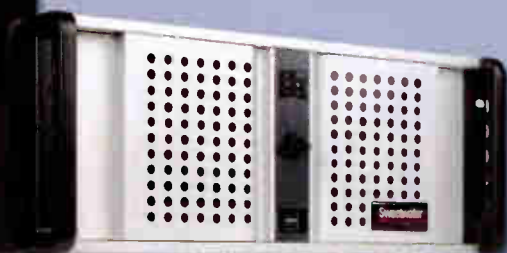

Apple Mac Pro

Studio Monitors

We offer a stellar selection of passive and active studio monitors with a range of wattages and speaker sizes, and we'll help you find the setup that suits your room best at a price that's right for you. With monitors from JBL, Genelec, ADAM, Event, Mackie, and Tannoy (among many others) to choose from, Sweetwater has you covered!



Dynaudio
BM 6A mk II

Computer Audio Production

We know how critical it is to get the best production from your studio. That's why we stock computer audio hardware such as audio interfaces from MOTU, M-Audio, and PreSonus (among many others), to fully featured console-style control surfaces from several manufacturers, including Digidesign, Mackie, and Euphonix. Sweetwater's got the right hardware for your studio.



Digidesign
ICON
D-Control

GENELEC® dynamiaacoustics ADAM
MACKIE. ALESIS TANNOY. EVENT JBL

digidesign MACKIE. Euphonix
M-AUDIO MOTU PreSonus

1-800-222-4700
www.sweetwater.com

Sweetwater®

Music Instruments & Pro Audio

MARY J. BLIGE, JAY-Z



Deemed to be one of the biggest R&B/hip-hop shows on the touring spring lineup (its only true competition in this genre is the Kanye West/Rihanna double-header), the Mary J. Blige/Jay-Z extravaganza has been dazzling fans across the country with its impressive lighting show, which is only surpassed by the tour's commitment to a high-quality audio experience. And this is no easy feat for the audio crew, as Blige (dubbed the "Queen of Hip-Hop Soul") and Jay-Z have racked up a total of 15 Grammys to their names (eight for Blige, seven for Jay-Z), so their fans are

just a bit familiar with their repertoire! Add to that a rather sizeable touring band (each artist has their own backing band), which keeps front-of-house engineers Kyle Hamilton (Blige) and Bryon "Hot Dog" Tate (Jay-Z, also production manager) on their toes.

Both engineers are mixing the two-and-a-half-hour show through twin Digidesign VENUE systems, working side-by-side on identical D-Show mixing boards interfacing with Pro Tools Version 7.3.1 and an additional D-Show as a sidecar. "We wanted a seamless transition without any set-change time," says Tate. "Both consoles are on all the time: mix-out to sub-ins. They're patched the same and we line up channels

the way we want in our consoles, so everything that Kyle sees during Mary's mix, I see in my console, and vice versa. All we do is mute and unmute."

Less than 30 seconds pass between the time that Blige finishes her set and Jay-Z begins his. This is possible thanks to dual digital desks, as well as a shared miking scheme. Blige performs with a 20-piece backing ensemble that includes a drummer, percussionist, keyboard player, guitarist, bassist, an eight-piece string section, a four-piece horn section and three backup singers. As expected, Hamilton has his VENUE maxed out: "We're stretching that console to the fullest!" he enthuses. "I receive about 80

JAY-Z

HIP-HOP'S TAG-TEAM DUO DAZZLE AUDIENCE



PHOTOS: STEVE LENNINGS



Left: At FOH are (L-R) Blige FOH engineer Kyle Hamilton, Jay-Z FOH engineer/production manager Bryon "Hot Dog" Tate and Clair Bros./Showco systems engineer Jim Ragus. **Right:** At monitor land are (L-R) monitor tech Michael Dunwoody, monitor engineer Brian Evans, stage tech Dustin Lewis, P.A. techs Justin Hoffmann and Steven Carter, and Pro Tools engineer Danny Cheung.

hard channels, but we run up to 95 channels with all the ears, so we're pushing it. But it's fun to be able to mix a complete band and mini-orchestra section onstage. That's unusual in the R&B and hip-hop world."

To mix this large band, Hamilton uses minimal signal processing, save for occasional software-based comps and gates. He uses a few samples and loops during Blige's set, but brings them in sparingly. "We run a few channels of Pro Tools, mostly loops, just to make it sound thicker on the percussion side," Hamilton explains. "Almost everything

else is just for color. And if we didn't use them, you wouldn't know it because the band is so incredible."

He applies the same less-is-more philosophy to Blige's vocals. "I use a nice tube compressor plug-in on her voice, but she sings so powerfully I have to find ways to cut gain," he continues. "She's an extremely strong singer. Making her sound good is almost easy because of the mic [handheld Shure KSM9] and what she gives you. She has great mic technique, too: She's dead-center and does not cup the mic at all."

Percussion takes AKG C-414s for overheads and Audio-Technica AE3000s on congas and bongos. DPA pickups are used on the violas, violins and cellos, while an assortment of AKGs mike the horns.

Unlike Blige, who aims for a full, rich sound that's easy on the ears, Jay-Z wants his set to feel like a full-on rock band. "It's hip-hop, but he wants that rock feel in there," says Tate. "He wants it in your face. So I try to create a more powerful mix." Delivering the rapper's horn- and bass-heavy set is a Clair Showco 14 arena P.A.: 12 i4Bs for the

MARY J. BLIGE, JAY-Z

main hang and eight i4s per side with six i4Bs per side used for side-fill, as well as 20 Clair Showco BT218 "Bowtie" subs. QSC amps power the i4 low end, and Crown amps power the mids and highs. Sub power comes from a Powersoft K10. The Bowtie subs are a new addition to this tour, and they've received a positive response so far. "I think a lot of their clients are going to be impressed with them," says Tate. "They're very musical subs," adds Hamilton. "They push a lot of air. It's a nice, tight sound."

THE HEART OF MONITOR WORLD

Monitor engineer Brian Evans has his hands full managing both acts on two Digidesign D-Show Profile mixing consoles, using every output. "Originally, the show was two artists, one band, all ears," he says. "Now, we have two separate bands: one mostly in-ears, another mostly on wedges."

Blige's band relies on Sennheiser G2 wireless systems, Shure PSM 600 hardwired personal monitor systems, and a combination of Ultimate Ears, Sensaphonics and Future Sonics ear molds. When Jay-Z hits the stage, so do the Prism SRM wedges, which are used by everyone except for the background singers, the horn players

and Blige's keyboard player—all of whom remain on ears.

To further complicate matters, the two acts prefer two different volumes, but share musicians and participate in each other's sets. "Mary's show is very quiet and under control onstage," Evans relates. "She's very sensitive about that. So when Jay-Z comes down for her set, I keep the wedges kind of low. But for Jay's set, they're on full-throttle."

There's also a difference in monitor mix. "Mary likes it really bright," Evans continues. "She's more complicated to mix. She's a very dynamic singer—she goes from quiet to very, very, *very* strong, blow-out-the-capsule-of-the-microphone full. And she doesn't like to hear compression, so you can't affect her input at the console. She's very aware of her voice and she can hear when gear interferes with it. You have to be invisible, but not. You can never complain about having enough input! Jay-Z, on the other hand, doesn't ask for much. His monitor mix is just like a big loud rock band—everything up and loud."

To deliver these requests, Evans uses four Prism subs onstage and two Showco L3s per side for sidefill. Three Prism Blue full-range P.A. cabinets per side are flown

for downfill. A total of 24 Showco SRM wedges are scattered around the stage, with 12 downstage for Jay-Z. An additional i4B serves as a drum sub.

With no real intermission between the two acts, Evans faces a long night, every night. "There are a lot of musicians to watch, and from my position I really can't see much," he says. "We have a really good crew. [Monitor systems engineer] Michael Dunwoody is my second set of eyes and ears. It's a long show with a long soundcheck, and it's loud. My ears hurt after every show."

For the benefit of Evans' ears and numerous other factors, Blige and Jay-Z only perform two, sometimes three, nights in a row before taking at least one day off. And for the benefit of everyone, the 150-person crew aims to keep the tour running like clockwork.

"You'd think there would be more clashing of personalities," says Hamilton. "There's three different camps, including opening act Dream, and every one of them is multi-Platinum. But at the end of the day, we come together as a big family. We all stay in our own lane." ■

Heather Johnson is a Mix contributing editor.



Imagine
- then transform

customize YOUR
Matrix
Solid State Logic
SOUND || VISION

The finest facilities in the world rely on Argosy studio furnishings...
so can you.

●●●●● ARGOSY

www.argosyconsole.com 800.315.0878 or 573.348.3333

Mirage console shown with platinum trim package (optional) for Solid State Logic - Matrix

©2008 Argosy Console, Inc.

System. Solution.

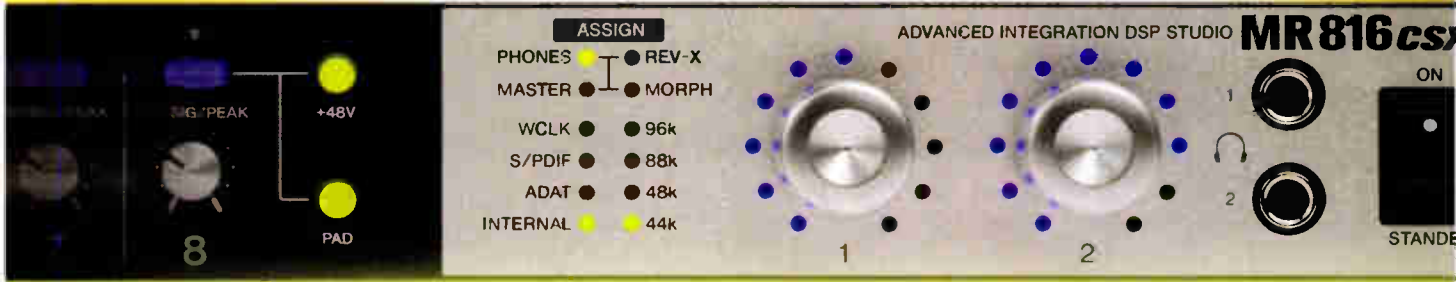

Fall 2008



www.steinberg.net

Steinberg is a registered trademark of Steinberg Media Technologies GmbH. Yamaha Corporation of America is the exclusive distributor for Steinberg in the United States.
©2008 Yamaha Corporation of America. All rights reserved.





PHOTO: JOHN JOHNSTON

PLUG-INS GO LIVE

Making the Transition to the (Virtual) House Rack

BY GEORGE PETERSEN

Once upon a time, live sound technology lagged behind new developments in studio gear. Part of this was simply budget-related. Another factor? Road life is tough on equipment, and with reliability being *everything* in the concert arena, choosing time-tested gear (i.e., Drawmer gates, dbx racks, etc.) typically meant that the show *would* go on. There were always a few exceptions—such as Frank Zappa using Neumann U47s onstage—but typically, studio and live equipment remained two distinct, highly segregated worlds.

But in the late '80s/'90s, as the project studio movement grew, musicians began incorporating "studio" products into their signature sound. When these players went on the road, names such as Summit, Manley and Avalon showed up on riders and front-of-house effects racks. Front-of-

house real estate was freed up somewhat with the arrival of digital consoles from Innovason, Yamaha and DiGiCo, with dynamics on every channel—and in the case of the Yamaha boards, full-on, digital effects/reverbs, as well.

Digidesign's debut of the D-Show VENUE in 2005 brought ease of recording and access to third-party, software-based DSP plug-ins. Yet in this department, Digidesign is hardly the only game in town. Lawo's new Plug-In Server brings plug-in ability to all of its digital consoles, while a just-announced Studer plug-in engine will bring VST effects capability to its flagship Vista 5 SR live board. ADK (Advanced Design of Kentucky) offers packages priced from about \$5,000 to \$10,000 that add plug-ins and simultaneous 56-track recording—typically on the Nuendo, Cubase, Samplitude or Reaper

platforms, with support for outboard DSP plug-in cards such as those from Universal Audio, Waves and TC Electronic PowerCore—with mixers that can be MADI interfaced, such as DiGiCo or Yamaha digital consoles.

A different take on the "traditional" plug-in approach of using DSP programs that work with a variety of manufacturers' gear—such as RTAS or VST—Yamaha offers various proprietary "Add-On" effects for its PM5D. First introduced for its DM2000 and 02R96, these software-based effects packages include channel strips, master strips (both loaded with vintage-style EQs and compressors), reverbs, stomp boxes and even surround 5.1 post effects.

And owners of analog consoles—i.e., Midas XI.4s, Yamaha PM4000s, etc.—need not be left out of the fun. Popular

Bullet Proof Limiting

"All the McDSP stuff is bullet proof, it's a joy to find plug-ins that really do things that are wonderful, useful and great."

Sam Fishkin & Terry Fryer

Third Wave Productions

Bonnaroo Music Festival, Vegoose, Broadcast Post Production



ML4000 HD
Mastering Limiter



INTRODUCING 3 NEW PRODUCTS



FutzBox
Lo-Fi Distortion Effects



DE555
Advanced De-essing



NF575
Flexible Noise Filtering

- PRO TOOLS 7 SOFTWARE
- PRO TOOLS LE 7 SOFTWARE
- PRO TOOLS HDX 7 SOFTWARE



M c D S P P R O F E S S I O N A L A U D I O P L U G - I N S

DYNAMICS • EQUALIZATION • CONVOLUTION REVERB • MASTERING
ANALOG SATURATION MODELING • GUITAR AMP MODELING
MULTI-BAND DYNAMICS • POST PRODUCTION TOOLS • SOUND SYNTHESIS

Download free demos of our entire product line at www.mcdsp.com

in musicians' racks onstage for running virtual instruments, the \$1,999 Receptor from Muse Research also lets users load multiple VST plug-ins (including Antares' Auto-Tune 5) into a two-rackspace host. In addition to low-latency performance from its onboard Linux engine, Receptor features balanced analog I/Os, S/PDIF I/O and ADAT Lightpipe outs, and offers manual or automated control from its front panel, remotely from a desktop/laptop Mac or PC, or via a local mouse/monitor/keyboard.

Today, multiple racks of gear at the house position are fast disappearing. Advantages of this include a smaller FOH footprint (equating to valuable space in shows where a single seat might go for \$200) and reduced costs of cartage/shipping/trucking—a growing concern in the age of \$5-per-gallon diesel.

There's no doubt that plug-ins have brought the "re-create the album live" concept to a new level; for those plug-ins that are available live, parameter settings used in the studio can be stored and imported for the stage show. Another much-appreciated perk of using plug-ins—cited by numerous engineers—is the ease of auditioning a plug-in to see if it "fits" any particular show. This



John Ashton found the switch to digital an easy one as he works in that realm in his project studio.

requires little more than downloading a time-limited demo version that can be purchased later, if need be.

However, the use of plug-ins in live sound does present downsides and occasional pitfalls. To get a real-life assessment of the situation, we talked to some top touring FOH engineers who've made the move to the plug-in world.

DIVE RIGHT IN

The transition to plug-ins can require a "breaking-in" period. Brad Madix, who is currently mixing FOH for Rush, began using Digidesign VENUE on last year's Shakira tour. "I wasn't really a Pro Tools guy back

then, although I knew enough about it to be dangerous," he says. "I've learned quite a bit about it since. Using VENUE took some getting used to, but the platform is intuitive—they've tried to lay it out more like a mixing desk rather than just trying to bus things around on a computer."

John Ashton came off mixing house on the recent Arctic Monkeys tour to focus on his successful career as a solo artist and spend time as keyboardist with the Last Shadow Puppets. "In early 2007, I switched to the D-Show, and the transition period was barely noticeable—probably because I'd been using Pro Tools in my—ahem—'studio' for years," he notes, emphasizing the small "project"

OFTEN COPIED, NEVER EQUALED

In this day of the DAW, your front-end tools have never been more essential. That's why the world's best engineers and studios turn to GT every day!

www.groovetubes.com **Hear the Difference™**

© 2008 Groove Tubes, LLC. All Rights Reserved. 111-0007-001-001

nature of his facility. He was no stranger to digital boards, having previously used InnovaSon and DiGiCo mixers and analog Midas XL4s and 113000s. "But my head was turned with the D-Show's multitrack recording capabilities and simplicity. I tried it. It ticked all the boxes, so I stuck with it for a while."

After two-and-a-half years on the road mixing The Fray, Mark Maher has the summer off—a rare luxury for touring pros—while the band records. But Maher, who previously mixed on PM5D and XL4 consoles, remembers the move to virtual. "I already knew Pro Tools, so using VENUE was just like doing a recording session mix, but live. Before we were in pre-production, the sound company, Eighth Day Sound, sent a system and console to my house so I could set up scenes and get ready for the tour—without the band even being there. And having that time to fine-tune the compression and gates—working from actual performance files—was amazing. This ability is one of the most important things to have happened in live sound in a long time."

Yet he also injects some reality into the equation. "On some fly dates in Europe, we'd show up and I'd plug my card into the VENUE," Maher continues. "Sometimes it would work perfectly; sometimes I'd have to tweak some things, but being able to stick in that card and be ready to go in five minutes was nice. Being so limitless with plug-ins is really mind-blowing, compared to where we were six or seven years ago. And recording every night to Pro Tools was so easy. For soundchecks, I'd play back the multitrack session, and if I wanted to, I could just listen to hi-hat for five minutes."

Keith Urban's FOH mixer, Stephen Law, got into digital consoles by accident. Just before one show, a cameraman moved a tarp, dumping 10 gallons of water into his Midas Heritage 3000, trashing half of its channels and disabling the automation, leaving the board with no fader control. After some clever patching and creative use of the working subgroups, he managed to get through the show.

The next day, the only replacement mixer available was a DiGiCo D5, which he ended up keeping for five years. "It's a great console that never crashed," says Law, who later added an ADK rack with RME MADI cards for recording and plug-in access. "My UAD-1 card has great analog emulations of LA-2As and 1176s, which I like, along with its Pultees and Fairchild's." Recently, Law switched to the new Studer Vista SR, a desk that he says is "sonically amazing, with great analog-sounding preamps." He's now using the Studer with the onboard Classic



Stephen Law's replacement board got him hooked on digital.

PHOTO: PAULE SANTANO

LRX2 audio workstation

location recorder

Record... Where you want, when you want

The SADiE LRX2 is the most flexible location recorder available, meeting the demands of the modern recording environment. This feature-rich, compact unit provides the ultimate solution for increasing the productivity of the time-conscious professional.

- Up to 48 tracks of AES/line/phantom powered mic inputs or 64 channels MADI I/O
- Mirrored recording for secure back up
- User intuitive software for instant multi track recording
- Stereo mix creation during recording
- Redbook CD burning on location
- BWAV recording format for instant transfer into your system
- Waveforms drawn whilst recording and no rendering
- Edit whilst recording to ensure fast turnaround of product

A Prism Sound Company

Contact us now to arrange your demo:
Email: sales@sadie.com
www.sadie.com

+1-973-983-9577
 +44 (0)1223 424988

series

Great Gear. Great Songs. BAD MIX? TUNE YOUR ROOM

If You Think It's The Gear, Think Again. Your Sound
Is Only As Good As The Acoustics In Your Room.



Visit AURALEX.com
or call 800-959-3343
for a FREE Room Analysis.

Auralox
acoustics

Dynamics package but looks forward to checking out the company's new plug-in engine—which will add VST access—when it ships. Meanwhile, he's using a hardware Lexicon 960L (4-in/8-out) for reverb and effects, but adds that the unit's "digital I/O is great, so there are no conversion delays, although latency is much less of a problem when you're dealing with reverbs or ambience effects."

THE VIRTUAL SOUNDCHECK

Recording the show and playing back the previous night's performance as a means of virtual soundchecking is nothing new. In fact, savvy FOH mixers had done this for years, going back to the days of MDMs, hauling a rack of ADATs or DA-88s around to do the deed.

But a DAW at FOH opens new possibilities. On the Shakira tour, Madix recalls that many of the same plug-ins from the album were available for the tour, "so when using Amp Farm to get the bass sound, I loaded in the same preset used on the record, which saved a lot of time. It completely changed the way I worked in rehearsals. I still listened to individual inputs, played with mic placement/selection and tried different DIs, but during rehearsals I was essentially tracking the band, so after they'd gone I could switch to playback and loop certain parts of a song and really home in on something like setting different bass presets from song to song.

"This level of detail would have been almost impossible while the band is going through the material and trying to learn the set," Madix continues. "It also allowed Shakira and her musical director [MD] to be in the room with me afterward, making the mix a more collaborative process. Rather than just handing somebody a CD of a board mix and getting comments later, there's nothing like sitting in a room with the artist and/or MD and being able to go through the live mixes and fix things while you're there. We got mixes that Shakira liked very quickly, including trying out different plug-ins on her voice. For example, she had very specific ideas about spin-off delays—not only with the length, but also the sound of the delays. Also, during rehearsals, playing back actual album sessions [through the console] let me play with the plug-ins in a more realistic situation than simply having the drum tech hit the snare."

That same technique worked on the Rush tour. "Neil Peart hits his drums in a very distinctive way," Madix explains. "I've become a fan of the [Crane Song] Phoenix tape-emulation plug-in, which gives a certain nonlinearity that's like bouncing something

Experience THE WORLD'S LOWEST PRICES! EVERY MAJOR BRAND IN STOCK!

Guitars • Amps • Drums • Keyboards • Sound Systems

Recording Equipment • Software • DJ Gear • Accessories - CALL TODAY!



West L.A. Music staff member with
Bee Gees singer Maurice Gibb

West L.A. Music staff member with
Dokken vocalist Don Dokken

Legendary producer Don Was
with West L.A. Music staff member

Singer/songwriter Tommy Roe
with West L.A. Music's Mark Spiwak

Beck keyboardist Greg Kurstin
with West L.A. Music staff member

Film composer Michael Wandmacher
with West L.A. Music's Rick Waite

Shop Where the Pros Shop • Call Us Today!



West L.A. Music

West Los Angeles (310) 477-1945 • Universal City (323) 845-1145
Fax (310) 477-2476 • sales@westlamic.com

We will beat any price from any authorized stocking dealer anywhere in the United States.



Brad Madix used many plug-ins from Shakira's latest album for her live act.

off tape. I put it across all of Neil's drums and there's no substitute for listening to him play while I'm fiddling all those knobs to get it just right because nobody else can hit those drums in exactly that same way."

ERGONOMICS—GOOD AND BAD

After more than three decades of FOH mixing, David Morgan just can't stop. Currently doing James Taylor's full-band tour, he also mixes for Bette Midler, Paul Simon and other top acts. Formerly an analog console holdout, Morgan migrated to the Digi-ide platform two years ago and likes it.

"People ask me all the time whether I'm bringing along Graces or other high-end preamps, but I'm not. I think the real art of warming up the sound is in the plug-ins," Morgan says. "I have no problem with the Digi preamps and front end. For me, the two main prerequisites were whether the technology sounded good and whether the interface gets in the way of being a member of the band. You've got a large monitor right in front of you, in your view of the stage, and everything is accessible up high—you don't have to look down on the desk to find something. It's easy when you only momen-



Mark Maher's knowledge of Pro Tools helped him make the digital transition.

The Symphony System by Apogee

- X-Series and Rosetta Series converters: Legendary, award winning Apogee sound quality
- Symphony PCI card: Superb stability and latency as low as 1.6 milliseconds at 96k
- Apple's Logic Studio: World class audio production for composers and professional engineers
- Apple's Mac Pro: Ground-breaking processing power and massive storage space
- Incredible performance and expandability with up to 96 channels of input and output

From the Garage, to the Studio... Apogee and Apple offer the most advanced audio solutions available.

Apogee
SOUND AMAZING



TEC Award: "Best Ancillary Equipment"

www.apogeedigital.com/symphony



tarily have to divert your eyes away from the screen to see what's going on onstage. You can't mix a good show without paying attention to what the musicians are doing onstage. You have to be part of the show."

For Maher, the digital console/plugin approach has pluses and minuses. "When you go back to, say, an XL4, it reminds you just how good it can sound, but with digital there's definitely a lot of ease of use," he says. "But mixing on an analog console, when you hear certain things during the show, your hand instinctively goes to that EQ knob to pull down that low-mid that

sounds a little funky. Yet with digital, you might have to press three buttons to get there. It's not that you become lazy, but you might let certain things go by that you would have tweaked in analog."

There are other plug-in complications, as well. "Early in the [Rush] tour, I was using the Waves SSL console bundle, which I loved, yet there were some conflicts with that and VENUE," Madix explains. "Eventually, I'm sure this will be resolved, but it's always been an issue with digital, where hardware and software leapfrog each other or an OS changes. It's part of the game, but

iLoks: The Fine Print



One downside of software plug-ins is copy-protection schemes—typically, the \$50 iLok key that carries user authorizations. On the plus side, engineers can simply show up at a gig, plug the iLok into a USB port and access all their fave plug-ins. Even in the worst possible scenario—disk crash, replacement system with no installs, etc.—copies of the programs can be loaded from CD/DVD-ROMs or downloads in short order, and the show goes on with the authorizations from your iLok.

However, this is not to say everything's always rosy. "Coming back from a European tour, someone in airport security decided to empty my entire computer bag," Morgan recalls. "Then, 15 minutes before I board, I notice my iLoks are gone. There are \$40,000 worth of licenses on that iLok. I panic and sprint back to security where they had the iLok, the backup iLok and two USB drives with all my console settings. I was always told to keep an iLok backup in a separate place, but when you're touring, what can you do? I'm not going to keep my iLok in my suitcase, which could wind up in Istanbul. So now we have something called 'Do I have my iLok?' panic, but, fortunately, the only thing I lost from that was an LED flashlight."

Evidently, the condition is contagious. "I have nightmares about losing the iLok, especially since the tour manager lost his and all his other dongles," Ashton confesses. "We discovered just how useless all these 'protect your licenses/iLok replacement, blah, blah' packages really are!"

Every FOH engineer has experienced that "left my walk-through music CD in the player at the last venue" feeling, but the situation is far more serious with an iLok. "The nice thing about an iLok is that once the desk is turned on, you can pull it out," says Madix, offering his solution. "I have a lanyard on mine and keep it around my neck. I carry four iLoks for different purposes, but I can only imagine what a company like Clair Bros. has to do to keep track of what's installed on what desk or what authorizations go on what tour, moving them back and forth into their account. It's a major juggling act on that scale."

—George Petersen

NEUMANN.BERLIN
 ▶ THE MICROPHONE COMPANY

80 Years ▶

www.neumann.com

Do you know the 70s like nobody else? Check your knowledge in music history!

Win a brand new TLM 67!

Further information at www.80yearsneumann.com

THE 70s

NEUMANN. THE VOICE OF MUSIC HISTORY

keeping track of what works with what can get complicated these days."

THE PLUG-IN ADVANTAGE

"This is the first tour where I'm going all-digital, from the input to the output of the crossovers," Madix says. "Right after the signal's converted at the head amp onstage, it's dig' all the way, including the input of the crossover, which is an AES input. I'm not trying to be a purist about it, because it was a challenge to do and there are certain pieces of gear that I haven't got a plug-in substitute for, but software emulations are getting better all the time."

"Using plug-ins definitely leads to better shows for me; it's an eye-opener," says Morgan. "As someone who was exclusively analog until about two years ago, the change is a refreshing and welcome addition to my life. I *can* produce quality audio on a digital console. I'm really excited about the possibilities and with other breakthroughs—like the Lake Audio stuff and these beautiful line array systems that keep getting smaller and better sounding. As I approach my 60th birthday next year, I'm more enthusiastic about mixing than I've ever been. The whole process is becoming more facile and



David Morgan looks forward to watching the technology advance for front-of-house mixing.

enjoyable."

The use of software plug-ins in live sound is still in its early stages, so the story's far from over. Yamaha is no stranger to the realm of signal processing and its digital consoles are a major force in live sound mixing. The company owns Steinberg, so would a co-venture with these same developers who brought us Cubase, Nuendo and VST really be far-fetched? Meanwhile,

DiGiCo is reportedly negotiating licenses to open the architecture of its consoles. That system is Windows-based, and loading some cool new effects directly into your D5 or SD7 may be a reality in the not-too-distant future. Stay tuned. ■

George Petersen is Mix's executive editor and runs a small record label at www.jenpet.com.

suppress (sə'pres) *vb.* to reduce or eliminate a particular frequency or frequencies in a signal.

SuprEsser (sə'presə) *n.* a new plug-in from Sonnox.

Sonnox

The Oxford SuprEsser plug-in from Sonnox .

A new definition in de-essing.

- Transparently controls aggressive frequencies
- Linear Phase Dynamic EQ
- Automatic Level Tracking
- Graphic Display (FFT) for increased accuracy
- Full spectrum operation
- Easy to use & advanced mode for ultimate control

Time limited introductory price offer.

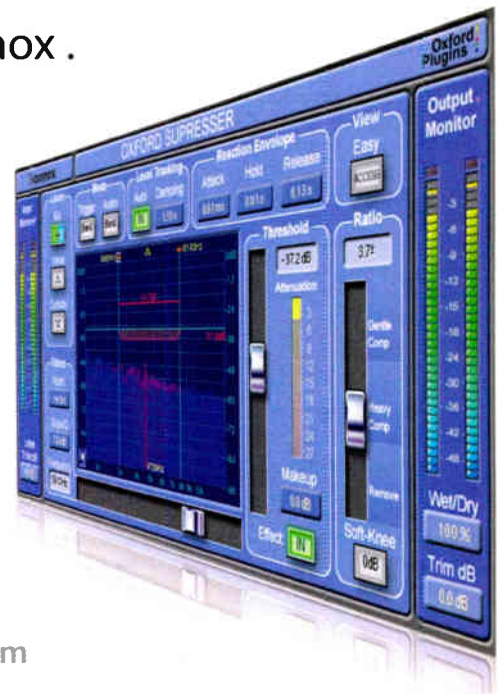

**Oxford
Plugins**

www.sonnoxplugins.com

The 24th Annual Technical Excellence & Creativity Award Nominations

Listed below are the nominees for the 24th Annual TEC Awards—to be held Friday, October 3, in San Francisco—as selected by the members of the 2008 TEC Awards Nominating Panel. A special TEC Awards Voter's Guide will appear in the August issue of *Mix*, and qualified subscribers will also be able to vote online.

OUTSTANDING TECHNICAL ACHIEVEMENT

Ancillary Equipment

Bag End E-Trap
Dangerous Music D-Box
Frontier Design Group AlphaTrack
Primacoustic Recoil Stabilizer
SE Electronics Instrument Reflexion Filter
Sensaphonics 3D Active Ambient IEM System

Amplifier Technology

Aphex HeadPod
Hot House Pro Audio Four Hundred SV
Lab.gruppen PLM 10000Q
PreSonus HP60
QSC PowerLight 3 Series

Digital Converter Technology

Apogee Duet
Digidesign Mbox 2 Micro
MOTU 828mk3
PreSonus FireStudio Project
Prism Sound Orpheus
TC Electronic StudioKonnekt

Recording Devices

ATR Master Analog Tape
Fostex PD606
Korg D888
M-Audio MicroTrack II
Sony PCM-D50
Tascam X-48

Mic Preamplifier Technology

Focusrite Liquid 4PRE
Groove Tubes SuPRE
Millennia Media HV3R Remote Controllable Preamp
Rupert Neve Designs Portico 5015
SSL X-Rack VHD Pre
Universal Audio DCS Remote Preamp

Microphone Technology/ Sound Reinforcement

AKG GN ESP Series
Audio-Technica PRO 92CW
Audix M1250
Beyerdynamic TG-X 930
Heil PR-35
Royer Live Series

Microphone Technology/ Recording

Audio-Technica AT2020 USB
Brauner Panthera
Earthworks PM40 PianoMic
Sennheiser MKH 8000 Series
Soundfield DFS-2
Telefunken|USA Ela M 260

Wireless Technology

AKG IVM 4
Audio-Technica Spectra Pulse Ultra Wideband System
Electro-Voice REV Series
Kaltman Spectran HF4040 RF Analyzer
Mipro ACT-51
X2 XDR955

Sound Reinforcement Loudspeaker Technology

Adamson Matrix
JBL VXR932LAP
Mackie SRM450 v2
Meyer Sound UPJunior
Nexo GEO S12
QSC WideLine-8

Studio Monitor Technology

Blue Sky EXO 2.1
Dynaudio Acoustics BM12A
Genelec SE DSP System
Klein + Hummel O 410
KRK VXT Series
Mackie HRB24 mk2

Musical Instrument Technology

Dave Smith Instruments Prophet 08
Digidesign Structure
Korg M3
Propellerhead Software Reason 4
Waves iGTR
Yamaha Motif XS6

Signal Processing Technology/ Hardware

CEDAR DNS 3000 Dialogue Noise Suppressor
Chandler Germanium Compressor
Elysia Mpressor
Empirical Labs DerrEgger
Solid State Logic Duende Mini
Universal Audio 2-LA-2

Signal Processing Technology/ Software

Antares Harmony Engine
Roger Nichols Digital SPL-izer
Solid State Logic X-Comp Plug-in
Universal Audio SPL Transient Designer
URS Classic Console Strip Pro
Waves The API Collection

Workstation Technology

Ableton Live 7
Apple Logic Studio
Bias Peak Pro 6
Digidesign Pro Tools 7.4
Solid State Logic Pro-Convert
Steinberg Nuendo 4

Sound Reinforcement Console Technology

Allen & Heath iLive-80
DiGiCo SD7
Roland RSS V-Mixing System
Soundcraft FX Series
Studer Vista 5 SR
Yamaha PMSDV2

Small Format Console Technology

Allen & Heath MixWizard³ 12M
Dan Dugan Sound Design Model E-1
Digidesign Control|24
Euphonix MC Mix Controller
Mackie Control Universal Pro Series
Soundcraft GB2R

Large Format Console Technology

Euphonix S5 Fusion
Lawo mc⁹⁰
Rupert Neve Designs 5088
Solid State Logic C300 HD
Stagetec Auratus
Trident 8T-32 RTB

OUTSTANDING CREATIVE ACHIEVEMENT

Record Production/Single or Track

"1234," *The Reminder*, Feist
"Icky Thump," *Icky Thump*, the White Stripes
"No One," *As I Am*, Alicia Keys
"Umbrella," *Good Girl Gone Bad*, Rihanna
featuring Jay-Z
"The Pretender," *Echoes, Silence, Patience & Grace*, the Foo Fighters

Record Production/Album

Icky Thump, the White Stripes
Just a Little Lovin', Shelby Lynne
Long Road Out of Eden, The Eagles
Raising Sand, Robert Plant & Alison Krauss
Revival, John Fogerty

Surround Sound Recording

Fear of a Blank Planet, Porcupine Tree
One Man Band, James Taylor
Oral Fixation Tour, Shakira
The McCartney Years, Paul McCartney
Vaughan Williams: Symphony No. 5; Fantasia on a Theme By Thomas Tallis; Serenade to Music, Robert Spano, Atlanta Symphony Orchestra & Chamber Chorus



Tour Sound Production

Bruce Springsteen, Audio Analysts
The Police, Clair Showco
Justin Timberlake, Clair Showco
Tool, Eighth Day Sound
Roger Waters, Clair Showco

Interactive Entertainment Sound Production

Bioshock, 2K Games
Call of Duty 4: Modern Warfare, Activision
Halo 3, Microsoft Game Studios
The Orange Box, EA Games
Uncharted: Drake's Fortune, SCEA

Remote Production/ Recording or Broadcast

2007 Academy of Country Music Awards, CBS
2007 American Idol Finale, Fox TV
50th Annual Grammy Awards, CBS
Garth Brooks Live in L.A. (live on CBS and benefit for FIRE)
VH1 Rock Honors—Genesis, Heart, ZZ Top, Ozzy Osbourne

Film Sound Production

3:10 to Yuma, Lionsgate
Ratatouille, Buena Vista/Disney Studios
Sweeney Todd: The Demon Barber of Fleet Street, DreamWorks Pictures
The Bourne Ultimatum, Universal Pictures
Transformers, DreamWorks

Television Sound Production

24, Fox
American Idol, Fox
Battlestar Galactica, CW
Lost, ABC
Saturday Night Live, NBC

Studio Design Project

2 Hard Records, Kingston, Jamaica
Cream Recording Studios, London
Inner Machine, Buffalo, NY
Red Bull Studio; Red Bull North America, Santa Monica, CA
Setai Recording Studio, South Beach, FL

creativity meets technology

AUDIO • FILM • PRODUCTION
CERTIFICATE • DIPLOMA • DEGREE*



INSTITUTE

www.sae.edu

*programs differ by location. visit us on the web for more information



New York 212.944.9121 • Atlanta 404.526.9366
Los Angeles 323.466.6323 • Miami 305.944.7494 • Nashville 615.244.5848

Over 50 Institutes in: USA FRANCE GERMANY HOLLAND SWEDEN BELGIUM AUSTRIA SWITZERLAND SPAIN ITALY SLOVENIA
GREECE KUWAIT JORDAN AUSTRALIA NEW ZEALAND UNITED ARAB EMIRATES INDIA MALAYSIA SINGAPORE
Soon in: TURKEY and JAPAN

Networked Amplifiers

Versatility, Flexibility for Tours and Installations

In its most basic form, an amplifier network comprises a power amp with a computer interface, a system controller (generally a PC) and connecting cables. Network-to-amplifier interfaces come in various flavors. Some amps connect directly to a PC via a built-in interface or a network card inserted into a rear panel expansion slot. Other designs employ a "bridge": a device that connects between the amp(s) and PC, and manages communication between the two. Most manufacturers use standard Ethernet hardware (i.e., Cat-5 connectors and cable) for their networks to ensure a familiar, cost-effective, off-the-shelf interface. Often, the network can be



Nexo NXAmp 4x4



Lab.gruppen PLM10000Q

connected to a wireless hub so a physical link to the computer is unnecessary. With your amps and laptop on a wireless network, you can walk the room while listening to the P.A. and tweak output levels or EQ settings.

Amp networking falls into three categories—monitoring, control and audio routing/distribution—so check out what functions an amp is capable of before you buy into a manufacturer's network. *Monitoring* via network allows you to watch what an amp is doing in real time, usually via PC. The amp sends status data to the PC with parameters such as internal temperature, AC mains voltage, input/output levels, clipping, load monitoring, output voltage/current and status of pro-

tection circuitry. (Most manufacturers provide amp-networking software free of charge). Load monitoring is of particular interest as an engineer can spot shorts or open circuits in loudspeakers *before* they become a problem. Some programs store a time-stamped fault log as a text file so failures can be identified even when the engineer is not present.

COMMAND AND CONTROL

Network systems with the ability to *monitor* an amp can also usually remotely *control* the amp. Remotely adjusting the amp gain is a huge convenience, especially in multi-amp systems where you can tweak levels of LF/MF/HF amps without running back and forth to the amp rack. Once limited solely to I/O level changes, modern network control facilitates muting, gain, multiband EQ, channel delay and crossover functions. Another plus is a security lockout feature that prevents unauthorized users from changing DSP parameters.

A recent trend shows DSP (traditionally from an outboard processor) starting to move directly inside the amp. Taking this concept further, Lab.gruppen's PLM10000Q amp merges Dolby Lake processing, Lake Contour and Mesa Parametric EQ with network monitoring, control and audio distribution.

Amplifier networks that support monitoring and control don't necessarily support audio networking, the ability to route and distribute audio over the network. Amps having only traditional analog inputs differ from those that carry the actual audio signal on the network. These amps may accept audio via analog input or AES/EBU digital input, as well as via the network connector. As with control and monitoring networks, most audio networking is accomplished using Cat-5 hardware. Some manufacturers have developed their own proprietary audio network protocol (i.e., Harman's HiQnet), while other networks such as CobraNet or EtherSound are supported



Yamaha TX4n, TX5n and TX6n models

by a number of manufacturers. Some of the amplifiers listed in this roundup are compatible with the latter two protocols, typically with the addition of an expansion card—but be aware that some amps may not be able to play in the CobraNet or EtherSound sandboxes.

Network-able amplifiers have other useful features. In systems without audio networking, an amplifier having audio thru connectors can simplify expanding your system without the need to add audio splitters or distribution devices. When you need to add more amps to the system, simply connect the amps' thru connector(s) to the next power amplifier in the chain. This is great for situations in which you might need to add an amp and a few subwoofers to a mobile P.A. system for a specific venue or performance. On networks that support audio distribution and routing, thru connectors may not be necessary, as audio is carried through the network anyway and the software typically provides a means for splitting an audio signal. Keep in mind that there could be a critical situation in which you may want to input both analog audio and digital audio via a network as a form of redundancy.

Today, networked amplifier control is mostly a necessity in pro touring and fixed installs. Fortunately, there are ample product choices. The chart on the following pages shows a sampling of what's offered. ■

Steve La Cerra is Mix's sound reinforcement editor.

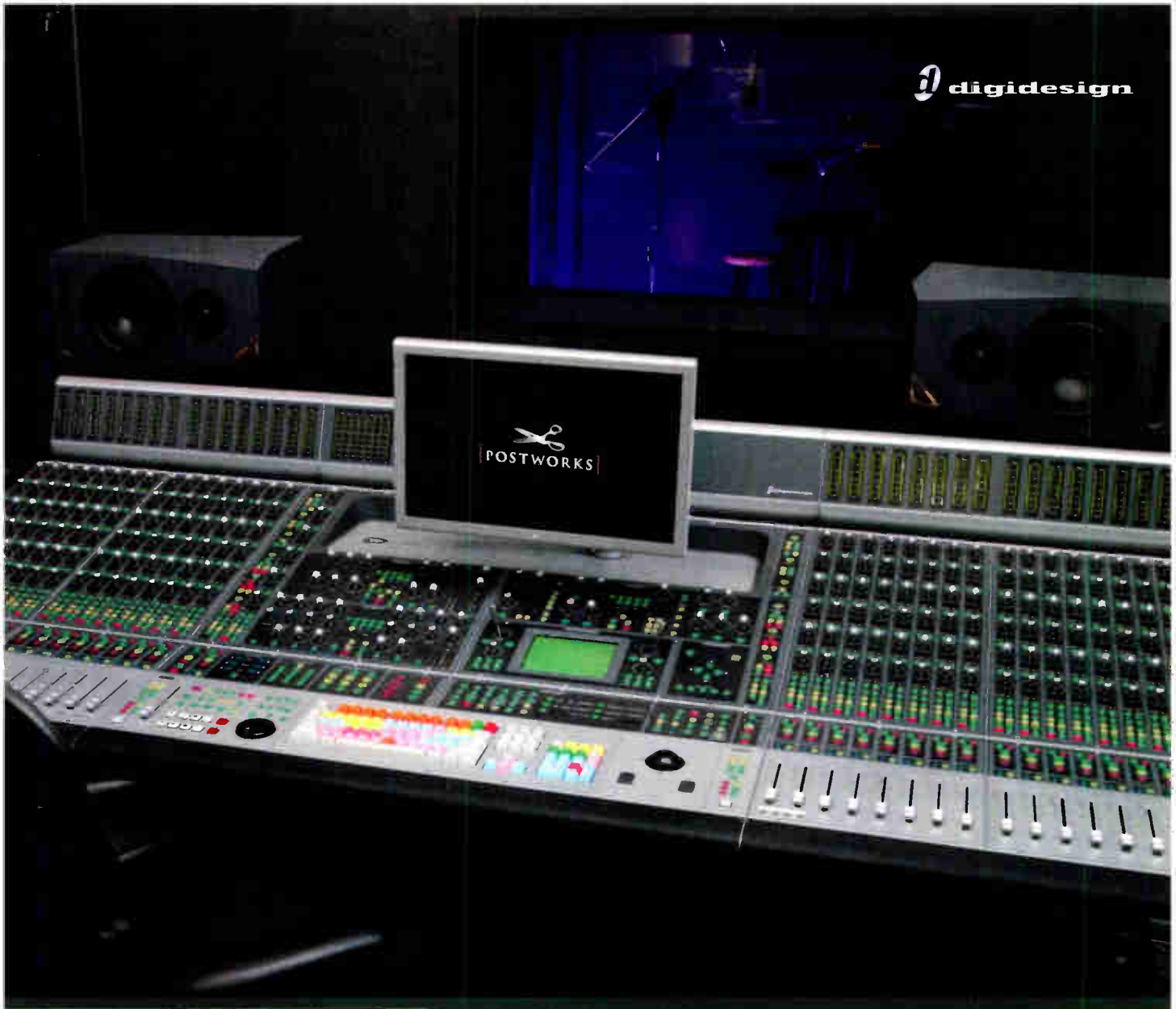

ICON D-CONTROL ES

REDEFINING AN ICON

“The ICON’s tight integration with Pro Tools significantly streamlines our mixing process, and the new design enhancements on the D-Control ES make it even easier to navigate the worksurface. In the world of post production, time is money, and the D-Control ES allows us to deliver completed projects to our clients faster than ever before.”

Bill Ivie

Vice President Sound Group, PostWorks NY

With tighter deadlines, post-production facilities such as PostWorks are in search of better technologies and solutions to meet increasing demands. At Digidesign, we strive to continuously improve our products in order to ensure that customers like PostWorks have what they need to get the job done quickly and easily. For this reason we developed the enhanced ICON D-Control™ ES.

Visit www.digidesign.com/icon_mix or visit your local ICON dealer to learn more about the D-Control ES worksurface, and how ICON is revolutionizing the art of mixing.

Networked Amplifiers, At a Glance

| MANUFACTURER, WEBSITE | MODEL | Channels | WATTS PER CHANNEL | BRIDGED OPERATION? | FREQ. RESP (HZ) |
|---|-------------------|------------|--------------------------------------|--------------------------------|--------------------|
| Ashly Audio, www.ashly.com | ne8250 | 8 | 150 @ 8Ω; 250 @ 4Ω | 500 @ 8Ω | 20-20k, ±1 dB |
| Ashly Audio | ne8250 pe | 8 | 150 @ 8Ω; 250 @ 4Ω | 500 @ 8Ω | 20-20k, ±1 dB |
| CAMCO, www.camcoaudio.com | Vortex 6 | 2 | 2,300 @ 4Ω; 1,350 @ 8Ω | 6,600 @ 4Ω; 4,600 @ 8Ω | 20-20k, ±0.15 dB |
| CAMCO | Vortex 4 | 2 | 1,570 @ 4Ω; 930 @ 8Ω | 4,600 @ 4Ω; 3,140 @ 8Ω | 20-20k, ±0.15 dB |
| CAMCO | Vortex 2.6 | 2 | 860 @ 4Ω; 480 @ 8Ω | 2,800 @ 4Ω; 1,720 @ 8Ω | 20-20k, ±0.15 dB |
| Crest Audio, www.crestaudio.com | Cr™ 30x4 | 4 | 100 @ 4Ω; 300 @ 8Ω; 300 @ 70-volt x4 | 300 @ 8Ω x2, 400 @ 140-volt x2 | 5-20k, ±1 dB |
| Crest Audio | Cr™ 20x8 | 8 | 150 @ 4Ω; 200 @ 8Ω; 200 @ 70-volt | 300 @ 8Ω x4, 400 @ 140-volt x4 | 5-20k, ±1 dB |
| Crest Audio | CKi100s | 2 | 90 @ 4Ω; 60 @ 8Ω | 180 @ 8Ω | 10-20k, +0/-0.2 dB |
| Crest Audio | CKi200s | 2 | 175 @ 4Ω; 120 @ 8Ω | 350 @ 8Ω | 10-20k, +0/-0.2 dB |
| Crest Audio | CKi400s | 2 | 320 @ 4Ω; 255 @ 8Ω | 510 @ 8Ω | 10-20k, +0/-0.2 dB |
| Crest Audio | CKi800s | 2 | 670 @ 4Ω; 440 @ 8Ω | 880 @ 8Ω | 10-20k, +0/-0.2 dB |
| Crown, www.crownaudio.com | I-T4000 | 2 | 2,000 @ 4Ω; 1,250 @ 8Ω | 3,600 @ 4Ω; 4,000 @ 8Ω | 20-20k, ±0.25 dB |
| Crown | I-T6000 | 2 | 3,000 @ 4Ω; 1,500 @ 8Ω | 5,000 @ 4Ω; 6,000 @ 8Ω | 20-20k, ±0.25 dB |
| Crown | I-T8000 | 2 | 4,000 @ 4Ω; 2,100 @ 8Ω | 7,000 @ 4Ω; 8,000 @ 8Ω | 20-20k, ±0.25 dB |
| Crown | Macro-Tech 5000i | 2 | 2,000 @ 4Ω; 1,250 @ 8Ω | 3,600 @ 4Ω; 4,000 @ 8Ω | 20-20k, ±0.25 dB |
| Crown | Macro-Tech 9000i | 2 | 3,000 @ 4Ω; 1,500 @ 8Ω | 5,000 @ 4Ω; 6,000 @ 8Ω | 20-20k, ±0.25 dB |
| Crown | Macro-Tech 12000i | 2 | 4,000 @ 4Ω; 2,100 @ 8Ω | 7,000 @ 4Ω; 8,000 @ 8Ω | 20-20k, ±0.25 dB |
| Crown | XTi 1000 | 2 | 500 @ 4Ω; 275 @ 8Ω | 1,400 @ 4Ω; 1,000 @ 8Ω | 20-20k, +0/-1 dB |
| Crown | XTi 2000 | 2 | 800 @ 4Ω; 475 @ 8Ω | 2,000 @ 4Ω; 1,600 @ 8Ω | 20-20k, +0/-1 dB |
| Crown | XTi 4000 | 2 | 1,200 @ 4Ω; 650 @ 8Ω | 3,200 @ 4Ω; 2,400 @ 8Ω | 20-20k, +0/-1 dB |
| Dynacord, www.dynacord.de | Power H2500 | 2 | 1,200 @ 4Ω; 600 @ 8Ω | 3,800 @ 4Ω; 2,900 @ 8Ω | 10-30k, ±1 dB |
| Dynacord | Power H5000 | 2 | 2,100 @ 4Ω; 1,050 @ 8Ω | 7,000 @ 4Ω; 5,000 @ 8Ω | 10-30k, ±1 dB |
| Electro-Voice, www.electrovoice.com | TG-5 | 2 | 1,200 @ 4Ω; 600 @ 8Ω | No | 10-30k, ±1 dB |
| Electro-Voice | TG-7 | 2 | 2,100 @ 4Ω; 1,050 @ 8Ω | 7,000 @ 4Ω; 5,000 @ 8Ω | 10-30k, ±1 dB |
| Lab Gruppen, www.labgruppen.com | PLM10000Q | 2 in/4 out | 2,300 @ 4Ω; 1,300 @ 8Ω | No | 20-20k, ±0.05 dB |
| Lab Gruppen | FP+10000Q | 4 | 2,100 @ 4Ω; 1,300 @ 8Ω | 5,000 x2 @ 4Ω; 4,200 x2 @ 8Ω | 6.8-34k, +0/-3 dB |
| Lab Gruppen | FP+7000 | 2 | 2,800 @ 4Ω; 1,450 @ 8Ω | 7,000 @ 4Ω; 5,600 @ 8Ω | 6.8-34k, +0/-3 dB |
| MC ² , www.mc2audio.co.uk | T 1000 | 2 | 500 @ 4Ω | 1,380 @ 4Ω; 1,000 @ 8Ω | 20-20k, ±0.5 dB |
| MC ² | T 1500 | 2 | 750 @ 4Ω | 2,250 @ 4Ω; 1,500 @ 8Ω | 20-20k, ±0.5 dB |
| MC ² | T 2000 | 2 | 1,000 @ 4Ω | 3,000 @ 4Ω; 2,000 @ 8Ω | 20-20k, ±0.5 dB |
| MC ² | T 4-250 | 4 | 250 @ 4Ω | 800 @ 4Ω; 500 @ 8Ω | 20-20k, ±0.5 dB |
| Nexo, www.nexo-sa.com | NXAmp4x1 | 4 | 900 @ 4Ω x4; 600 @ 8Ω x4 | Bridgeable 2x2, specs N/A | 10-20k, ±0.5 dB |
| Nexo | NXAmp4x4 | 4 | 3,300 @ 4Ω x4; 1,900 @ 8Ω x4 | Bridgeable 2x2, specs N/A | 10-20k, ±0.5 dB |
| Powersoft, www.powersoft-audio.com | Digam K20 | 2 | 5,200 @ 4Ω; 2,700 @ 8Ω | 18,000 @ 4Ω; 10,400 @ 8Ω | 20-20k, ±0.2 dB |
| Powersoft | Digam K10 | 2 | 4,000 @ 4Ω; 2,000 @ 8Ω | 12,000 @ 4Ω; 8,000 @ 8Ω | 20-20k, ±0.2 dB |
| Powersoft | Digam K8 | 2 | 3,000 @ 4Ω; 1,500 @ 8Ω | 9,600 @ 4Ω; 6,000 @ 8Ω | 20-20k, ±0.2 dB |
| Powersoft | Digam K6 | 2 | 2,500 @ 4Ω; 1,300 @ 8Ω | 7,200 @ 4Ω; 5,000 @ 8Ω | 20-20k, ±0.2 dB |
| Powersoft | Digam K4 | 2 | 1,700 @ 4Ω; 900 @ 8Ω | 5,200 @ 4Ω; 3,400 @ 8Ω | 20-20k, ±0.2 dB |
| Powersoft | Digam K3 | 2 | 2,600 @ 4Ω; 1,400 @ 8Ω | N/A | 5-20k, ±0.2 dB |
| QSC, www.qsc.com | PL325 | 2 | 850 @ 4Ω; 500 @ 8Ω | 2,500 @ 4Ω; 1,700 @ 8Ω | 20-20k, ±0.2 dB |
| QSC | PL340 | 2 | 1,250 @ 4Ω; 800 @ 8Ω | 4,000 @ 4Ω; 2,600 @ 8Ω | 20-20k, ±0.2 dB |
| QSC | PL380 | 2 | 2,500 @ 4Ω; 1,500 @ 8Ω | 8,000 @ 4Ω; 5,000 @ 8Ω | 20-20k, ±0.2 dB |
| Turbosound, www.turbosound.com | RackDP50 | 4 | 1,250 @ 2Ω | Yes, output spec N/A | 5-30k, ±1 dB |
| Yamaha, www.yamahaca.com | TX6n | 2 | 3,000 @ 4Ω; 1,800 @ 8Ω | 6,000 @ 4Ω or 8Ω | 10-20k, ±0.5 dB |
| Yamaha | TX5n | 2 | 2,200 @ 4Ω; 1,300 @ 8Ω | 5,000 @ 4Ω; 4,400 @ 8Ω | 10-20k, ±0.5 dB |
| Yamaha | TX4n | 2 | 1,900 @ 4Ω; 1,100 @ 8Ω | 4,400 @ 4Ω; 3,800 @ 8Ω | 10-20k, ±0.5 dB |
| Yamaha | T5n | 2 | 2,350 @ 4Ω; 1,350 @ 8Ω | 5,000 @ 4Ω; 4,700 @ 8Ω | 20-20k, +0/-0.5 dB |
| Yamaha | T4n | 2 | 2,050 @ 4Ω; 1,150 @ 8Ω | 4,400 @ 4Ω; 4,100 @ 8Ω | 20-20k, +0/-0.5 dB |
| Yamaha | T3n | 2 | 1,400 @ 4Ω; 750 @ 8Ω | 3,800 @ 4Ω; 2,800 @ 8Ω | 20-20k, +0/-0.5 dB |

| | NETWORK FUNCTIONS | MSRP | SNR/THD | INPUT CONNECTORS | OUTPUT CONNECTORS | NETWORKING NOTES |
|--|----------------------------------|---------|--------------|-------------------------------|--------------------------|--|
| | C=Control, M=Monitoring, A=Audio | | | | | |
| | C/M/A | \$1,890 | >98 dB | Euroblock | Euroblock | CobraNet option |
| | C/M/A | \$2,610 | >98 dB | Euroblock | Euroblock | CobraNet option, onboard Protea DSP |
| | C/M/A | \$4,995 | >110 dB (A) | XLR w/thru | Speakon | Options: DSP, CobraNet, EtherSound |
| | C/M/A | \$3,775 | >110 dB (A) | XLR w/thru | Speakon | Options: DSP, CobraNet, EtherSound |
| | C/M/A | \$2,995 | >110 dB (A) | XLR w/thru | Speakon | Options: DSP, CobraNet, EtherSound |
| | C/M/A | \$2,283 | >97 dB (A) | Euroblock | Barrier strip | Options: Crest NexSys, MediaMatrix or CobraNet |
| | C/M/A | \$1,695 | >97 dB (A) | Euroblock | Barrier strip | Options: Crest NexSys, MediaMatrix or CobraNet |
| | C/M/A | \$960 | >105 dB (A) | Euroblock | Barrier strip | Options: Crest NexSys, MediaMatrix or CobraNet |
| | C/M/A | \$1,040 | >105 dB (A) | Euroblock | Barrier strip | Options: Crest NexSys, MediaMatrix or CobraNet |
| | C/M/A | \$1,200 | >105 dB (A) | Euroblock | Barrier strip | Options: Crest NexSys, MediaMatrix or CobraNet |
| | C/M/A | \$1,420 | >105 dB (A) | Euroblock | Barrier strip | Options: Crest NexSys, MediaMatrix or CobraNet |
| | C/M/A | \$5,050 | >105 dB (A) | XLR w/thru, AES/EBU | Binding post, Speakon | Audio via HiQNet |
| | C/M/A | \$6,179 | >105 dB (A) | XLR w/thru, AES/EBU | Binding post, Speakon | Audio via HiQNet |
| | C/M/A | \$7,762 | >105 dB (A) | XLR w/thru, AES/EBU | Binding post, Speakon | Audio via HiQNet |
| | C/M/A | \$4,255 | >110 dB (A) | XLR w/thru | Binding post, Speakon | Audio via HiQNet |
| | C/M/A | \$5,200 | >110 dB (A) | XLR w/thru | Binding post, Speakon | Audio via HiQNet |
| | C/M/A | \$6,855 | >110 dB (A) | XLR w/thru | Binding post, Speakon | Audio via HiQNet |
| | C/M/A | \$827 | 100 dB (A) | XLR w/thru | Binding post, Speakon | All via HiQNet; onboard DSP |
| | C/M/A | \$1,151 | 100 dB (A) | XLR w/thru | Binding post, Speakon | All via HiQNet; onboard DSP |
| | C/M/A | \$1,607 | 100 dB (A) | XLR w/thru | Binding post, Speakon | All via HiQNet; onboard DSP |
| | C/M/A | \$3,840 | 111 dB (A) | XLR w/thru | Binding post, Speakon | Via IRIS-Net option; DSP optional |
| | C/M/A | \$4,590 | 109 dB (A) | XLR w/thru | Binding post, Speakon | Via IRIS-Net option; DSP optional |
| | C/M/A | \$3,840 | 109 dBA | XLR w/thru, Euro, opt AES/EBU | Binding post, Speakon | Via IRIS-Net option; DSP optional |
| | C/M/A | \$4,590 | 111 dBA | XLR w/thru, Euro, opt AES/EBU | Binding post, Speakon | Via IRIS-Net option; DSP optional |
| | C/M/A | N/A | >114 dB | XLR w/thru, AES/EBU | Binding post or Speakon | Onboard Dolby Lake DSP |
| | C/M | \$6,495 | >112 dB (A) | XLR w/thru | Binding post or Speakon | |
| | C/M | \$5,095 | >112 dB (A) | XLR w/thru | Binding post or Speakon | |
| | C/M (audio opt.) | | 105 dB | XLR or Euroblock | Speakon | Ti Bridge adds CobraNet or EtherSound |
| | C/M (audio opt.) | | 105 dB | XLR or Euroblock | Speakon | Ti Bridge adds CobraNet or EtherSound |
| | C/M (audio opt.) | | 105 dB | XLR or Euroblock | Speakon | Ti Bridge adds CobraNet or EtherSound |
| | C/M (audio opt.) | | 105 dB | XLR or Euroblock | Speakon | Ti Bridge adds CobraNet or EtherSound |
| | C/M/A | \$4,600 | 105 dB | XLR w/thru | Speakon | EtherSound module option |
| | C/M/A | \$9,200 | 105 dB | XLR w/thru | Speakon | EtherSound module option |
| | C/M | | >110 dB | Combo XLR/TRS | Speakon | Ethernet control/SmartCard setting storage |
| | C/M | | >110 dB | Combo XLR/TRS | Speakon | Ethernet control/SmartCard setting storage |
| | C/M | | >109 dB | Combo XLR/TRS | Speakon | Ethernet control/SmartCard setting storage |
| | C/M | | >108 dB | Combo XLR/TRS | Speakon | Ethernet control/SmartCard setting storage |
| | C/M | | >108 dB | Combo XLR/TRS | Speakon | Ethernet control/SmartCard setting storage |
| | C/M | | >112 dB | Combo XLR/TRS | Speakon | Ethernet control/SmartCard setting storage |
| | C/M/A | \$1,649 | 106 dB | XLR w/thru | Binding post and Speakon | Using optional RAVE unit; DSP optional |
| | C/M/A | \$2,149 | 105 dB | XLR w/thru | Binding post and Speakon | Using optional RAVE unit; DSP optional |
| | C/M/A | \$3,599 | 104 dB | XLR w/thru | Binding post and Speakon | Using optional RAVE unit; DSP optional |
| | C/M | \$TBA | 110 dB (A) | XLR w/thru | Speakon | Onboard DSP |
| | C/M/A | \$5,699 | 108 dB (DIN) | XLR w/thru, AES/EBU | Binding post and Speakon | CobraSound/EtherSound optional; onboard DSP |
| | C/M/A | \$5,199 | 107 dB (DIN) | XLR w/thru, AES/EBU | Binding post and Speakon | CobraSound/EtherSound optional; onboard DSP |
| | C/M/A | \$4,799 | 106 dB (DIN) | XLR w/thru, AES/EBU | Binding post and Speakon | CobraSound/EtherSound optional; onboard DSP |
| | C/M | \$3,799 | 107 db (DIN) | XLR or Euroblock | Binding post or Speakon | |
| | C/M | \$2,999 | 106 dB (DIN) | XLR or Euroblock | Binding post or Speakon | |
| | C/M | \$2,399 | 105 dB (DIN) | XLR or Euroblock | Binding post or Speakon | |

S.S.R. Recording

Bob Fowler Offers Services From Tracking to Mastering

Bob Fowler has persevered in the music industry for 40 years while wearing a number of hats—as a veteran gigging bassist in the Atlantic City, N.J., area, and a recording artist with the world beat/contemporary jazz duo Fowler & Branca. He currently serves as the musical director for Las Vegas–based entertainer Jimmy Hopper and is employed by the Atlantic City Hilton as a front-of-house engineer, where he operates a Yamaha PM5D console. “It’s a fun gig, but I consider myself more of a studio rat than a live engineer,” Fowler says.

For the past 35 years, this self-taught recording engineer/producer has worked in project studios that he himself designed. “When I was young, I realized I loved writing, but I had this need to record at the same time,” Fowler recalls. “Home studios [were] extremely rare in this tri-state area, so I would hang out with people that were doing what I wanted to do eventually. Since I was 15, I’ve never lived in a home or been anywhere that didn’t have a studio.”

In the 1990s, Silver Wave Records released four Fowler & Branca CDs. The proceeds helped Fowler and Stephen Branca to build and open S.S.R. Recording in Galloway, N.J. “I had the home built with the studio in mind,” Fowler says. “I worked with a guy named Mike Kehr, who had his own studio. We did blueprints and wiring schematics. At the time, [Fowler & Branca] were doing quite well on the radio. We built the entire room on royalty checks.”

Today, S.S.R. Recording offers tracking, editing, mixing and mastering services. “I don’t advertise too much,” Fowler says. “I mostly do word-of-mouth, and since I’ve been here for such a long time I have a decent client list in this area.” Fowler also composes for music production library companies such as FirstCom, Sound Ideas’ BMG FX and Music One, and often works with UK-based entertainment company Spirit Productions as an editor and remixer.

He notes that the rise of personal studios allowed him to cultivate a newly specialized niche. “Ten years ago, I was doing a lot of live tracking, but now I’m doing more sweetening and EQ’ing. I get a lot of people who are looking to better their projects. People are finding that they can get what they want in their house, until they can’t. [Laughs] And then they’ll call me, and say, ‘It’s just not happening.’”

Fowler describes his studio space as a “half-basement” that’s submerged about five feet into the ground. “The windows are actually at ground level,” he describes. S.S.R. Recording comprises a 15x14-foot control room, a 15x14-foot tracking room and a 12x12-foot drum room. He was meticulous in planning acoustic treatment and soundproofing. “We did isolated walls and floating floors, and all the wiring is under the floor. Ceilings are floating on a resilient [sound-isolation] clip. And I had



Bob Fowler in the control room of S.S.R. Recording, which includes a balanced complement of analog and digital gear

the home designed with silent floor joists; I still haven’t heard footsteps [from above].”

Fowler’s DAW of choice is Apple Logic Pro 8, which runs on a dual-processor, 1.8GHz Power Mac G5 with two Universal Audio PCI expansion cards. He uses plugins from Waves, Universal Audio and Metric Halo, and soft synths/samplers from Spectrasonics, Native Instruments and IK Multimedia. Digital hardware includes a 16-channel Lynx Aurora 16 AD/DA converter, Apogee Big Ben master clock, TC Electronic M3000 reverb and an Ensoniq DP4 effects processor.

Analog outboard gear includes an SPL Transient Designer, Jensen Twin Servo 990 mic preamps, six channels of FMR RNP8380 mic preamps, and two Avalon U5 DI/preamps and an VT-747SP compressor. S.S.R.’s analog centerpiece is a 24-channel Toft ATB24 console. “The sound of the [console’s] EQ is something that I’m not able to get in the DAW system,” Fowler says. “During [a project’s] sweetening phase, I’ll stay within the box and try to get a good, solid sound. Once I feel like we’re happy, I’ll usually output the majority of tracks through the Aurora and bring them into the console. From there, I use primarily outboard gear. Going analog has been making such a difference. People are really noticing that.”

S.S.R.’s mic closet includes Neumann U87s, AKG C 535 EBs, an Electro-Voice RE20, and Apex 460 and 210 models. Fowler uses seven sets of monitors: ADAM Audio S3As, Genelec 2029s, Yamaha NS-10s, Alesis Monitor Ones, JBL 4312s, Auratones and the (consumer) Mirage M-490s. “I have a mix position in front of the DAW and a mix position in front of the console,” Fowler says.

In operating S.S.R. over the past 12 years, Fowler has responded to his clients’ needs with care. “To me, it’s all about building a reputation on what walks out of the room. I’ve listened to and played enough music my whole life to know what a good track sounds like.” ■

Matt Gallagher is an assistant editor at Mix.

EXPERIENCE MORE .: VERSATILITY .:



This groundbreaking side-address stick condenser does more than get in & out of impossibly tight spots in your drum kit. The ATM450 effortlessly handles high SPLs & offers crystal-clear reproduction of live & amplified acoustic instruments. Whatever your music demands, experience more. audio-technica.com

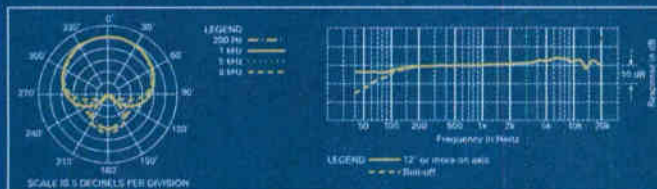

ATM450 SPECIFICATIONS

| | |
|---------------------------|-------------------------------|
| Element | Condenser |
| Polar Pattern | Cardioid |
| Frequency Response | 40-20,000 Hz |
| Open Circuit Sensitivity | -41 dB (8.9 mV) re 1V at 1 Pa |
| Impedance | 200 ohms |
| Maximum Input Sound Level | 152 dB SPL |
| Switches | Flat, roll-off; 10 dB pad |

See our web site for complete specifications.
 Specifications are subject to change without notice.



Budapest Calling

Capturing Production Sound for *Hellboy II*

By Blair Jackson

With such striking and imaginative films as the Oscar-winning *Pan's Labyrinth*, *Hellboy* and *Blade II* under his belt, Mexican director Guillermo Del Toro has established himself as a master storyteller and a visual poet. And though we may think of those films as effects extravaganzas to a degree, they are all rooted in strong conventional filmmaking techniques. Del Toro's latest is a fantastical sequel to *Hellboy*—*Hellboy II: The Golden Army*—and it required an army of top film craftspeople to realize his vision of a battle royale between the mythical world and the human world.

"Despite the superhero, superblockbuster exterior, *Hellboy II*'s challenges for the sound department were fairly traditional," comments the film's production sound mixer, Mac Ruth. "In fact, the stakes were pretty high to capture the actors' performances faithfully, adding credibility to the 'character beneath the costume,' so to speak."

For Mac (as *everyone* calls him)—who got his start in the film business in the mid-'90s as a boom operator, and has worked on numerous features (*Underworld*, *Eragon*, *The Cave*, etc.) and film-style TV productions (BBC's *Robin Hood*, Showtime's *The Lion in Winter*, et al)—working on *Hellboy II* meant spending six solid months at the brand-new Korda Studios complex outside Budapest, Hungary, beginning in June 2007. This wasn't the hardship it might have been for some—though American, he's lived in Eastern Europe for a number of years, so it was essentially a local job.

"I was working on another show until six hours before call time on the first day



PHOTO: EGON ENDREWY/COPYRIGHT © 2007 UNIVERSAL STUDIOS. ALL RIGHTS RESERVED.

of *Hellboy II*," Mac recalls during a break from shooting *Bunraku* in Romania, "and although I had tried repeatedly to meet Guillermo for a prep discussion, we never managed to be free at the same time. This is, of course, very unusual, but as it turned out, the way he works is very conducive to the work of the sound department, and the work was fairly traditional, so it went smoothly.

"Compared to more and more shows that rely on a completely computer-generated environment," he continues, "*Hellboy II* was created on very detailed and elaborate sets for the most part." In addition to using four giant soundstages and various back-lot locales at Korda, which opened just two months before the *Hellboy II* shoot, the film required Mac to bring his production sound rig to a few unusual spots. "One significant interior location was shot entirely on an elaborate set built in what used to be a working mine," he recalls. "Obviously, the walls were not 'flyaway,' so we were forced to work within the space provided. The air was a little funky, as well, but the set was amazing!"

Wherever possible, Mac likes to capture production sound with one, or preferably two, boom mics (typically Schoeps CMC 641), operated by his longtime associates Paul Szuros and George Mihalyi. "I rely

on them entirely," he says. "I couldn't do without them.

"In most cases, the use of two booms and hard-wired plants—as opposed to the indiscriminate use of one boom and wireless body mics on all characters—creates a more faithful reproduction of a given space, maintaining camera perspective in the production sound. Frankly, I'm inclined to use wireless equipment as little as possible."

As for his recording rig, Mac says, "I've made a recent major shift in recorder manufacture to Sound Devices' 7 Series recorders. They have a very clever, 'scalable' system, which I use to add tracks or use fewer tracks—for greater portability—as needed. A multiple-recorder system allows the flexibility of recording in discrete locations simultaneously without being tethered to just one cart. A multiple-recorder system also allows for material with differing delivery specs to be handed off to their separate destinations without the burden of receiving unnecessary data—for example, picture editorial via telecine needing two 'mix-down-only' files that can be pulled down to match image converted to video—with sound editorial receiving iso tracks and safety tracks recorded with a sample rate not modified for pull-down. A very robust file-naming convention identifies sound roll,

—CONTINUED ON PAGE 48



Production sound mixer Mac Ruth

Batman Rides Again

In Search of Cool Sounds for *The Dark Knight*

By Blair Jackson

This may be the Summer of the Hero, from *Iron Man* to *Indy* to *The Incredible Hulk*, yet it's hard to shake the impression that something very strange is going on in Christopher Nolan's *The Dark Knight*, the follow-up to *Batman Begins*.

"Chris has continued the development of the characters from *Batman Begins*, and introduced a maniacal force of nature—The Joker—who's like a hurricane that blows through the whole movie and seems basically unstoppable," says sound designer and supervising sound editor Richard King during a break from working on the final with re-recording mixers Lora Hirschberg and Gary Rizzo at Warner Bros.' Neve DFC-equipped Stage 9.

King is a veteran sound supervisor who won an Oscar for the 2003 *Master and Commander*; was nominated for *War of the Worlds* in 2005, and has worked on such diverse recent films as *Lemony Snicket's A Series of Unfortunate Events*,

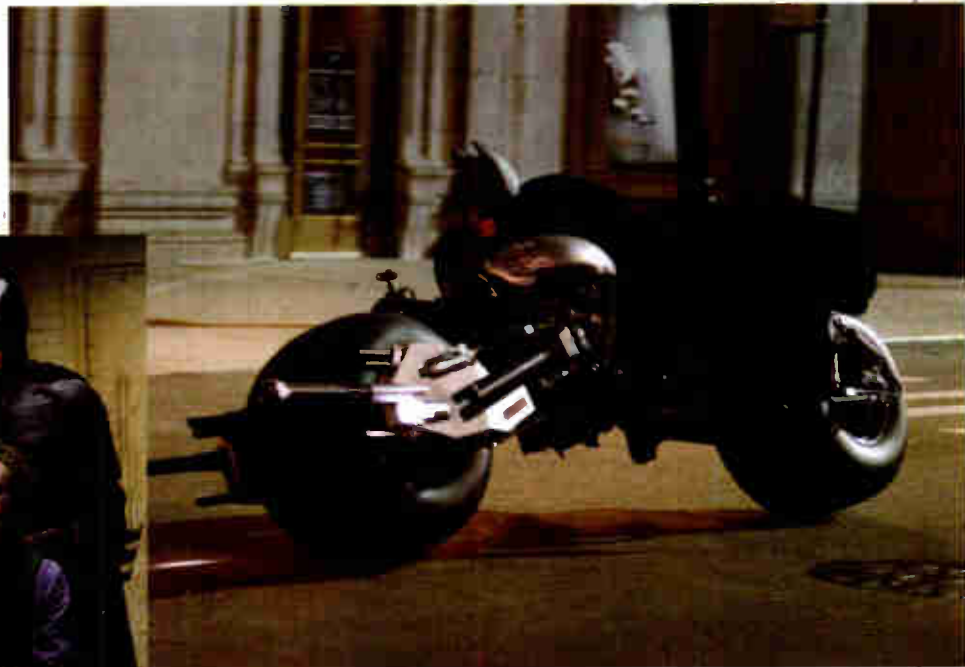

The Prestige and *The Assassination of Jesse James by the Coward Robert Ford*.

"Every film presents unique challenges," he comments, "and every filmmaker's vision is different, so I can't say there's anything I've done before that really prepared me for *The Dark Knight*. It's been a long process. I came on about a year ago and did a month of sound design work without seeing any picture, just based on the script and what I imagined things would look like. This was as they were beginning the shoot in England and the picture editor, Lee Smith, asked me for a library of sounds to cut with. Then in October, November, we prepared and mixed the IMAX trailer, or prologue, which was released in December. Several scenes in the film were shot with IMAX cameras, and there will be a simultaneous IMAX release for which we'll do a special mix."

King says there's little in the way of sonic continuity

between this film and the 2005 *Batman Begins* (which he did not work on) other than the sound of Batman's voice, "which mostly differs from Bruce Wayne's voice in [Batman actor] Christian Bale's performance, plus a little console EQ. Chris also wanted some similarity in the sound of the Batmobile, although we weren't required to slavishly replicate it. For this we used huge gas engines from both high-speed race boats and cars, big electric turbines, and the occasional processed animal roar or scream for emphasis.

"Batman's other ride is the Batpod—a large, very impressive-looking motorcycle," King continues enthusiastically. What was the approach? "Chris liked the concept of the Shepard Tone, which, simply put, is a continually ascending tone: If you imagine a musical scale and you overlap it with the same material pitched to a different octave, you can crossfade from one to the other, creating the illusion of continually ascending (or descending) pitch. We used this concept with the Batpod, so it sounds like it's always accelerating. The Shepard Tone works best with fairly pure sounds, so



Sound designer/supervising sound editor Richard King

FILM PHOTOS: STEPHEN VAUGHAN; WARNER BROS. PICTURES; TM AND © DC COMICS

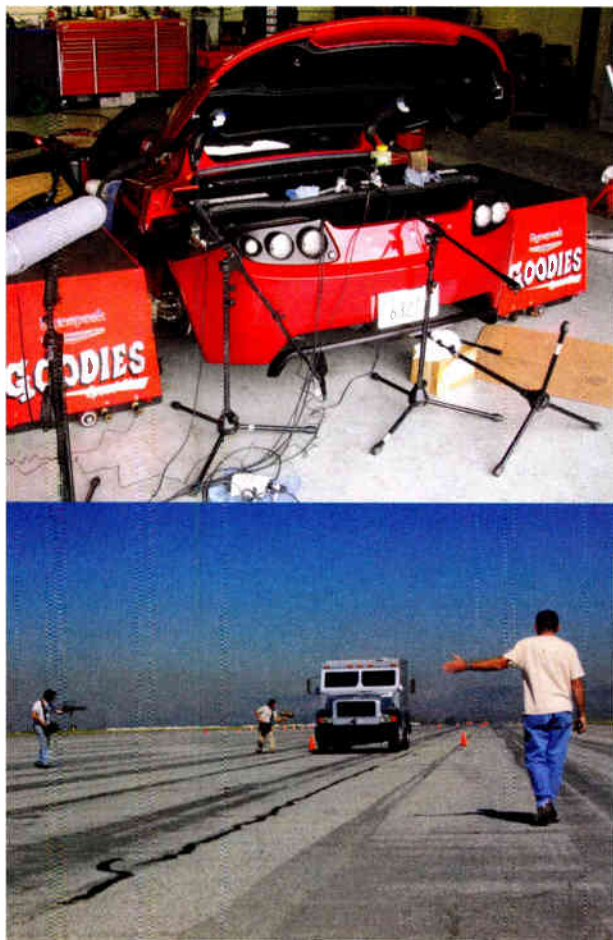

Top: A Tesla sports car being recorded on a dynamometer at a hot-rod shop in San Jose, Calif., to gather sounds for the Batpod.

Bottom: At the decommissioned El Toro Marine Air Station south of Los Angeles, Eric Potter, John Fasal and Richard King record the sounds of a diesel armored car.

PHOTOS: ANDREW BLOCK

of time recording different kinds of tires, like off-road tires on trucks, knobby tires on all-terrain vehicles—just experimenting, trying to find a good tire sound. One day, I was running on my treadmill and I dragged my running shoe over the back of the tread as it was moving, and thought, ‘That’s a cool sound!’ So I recorded it on my little Sony PCM D-1 and that’s been integrated with the other tires into the Batpod tire sound. It’s been an evolution, which still continues!”

Though obviously there are a number of fantasy elements like that in the film, King says that Nolan’s overall approach is “to go for a very gritty, real-world feeling. There are some truly spectacular action scenes. But these big set pieces don’t rely solely upon visual effects; they’re mostly composed of practical shots. And that helps establish the reality of what you’re seeing, and in a sense grounds the movie. People are so accustomed to seeing fantastic CGI images that when they see a fantastic image that they can tell was actually shot with a camera, I think it makes even more of an impression. We’ve tried

that led us to electric motors, which also matched the sleek look of the Batpod. We recorded a lot of big electric motors and a couple of electric race cars—like the Tesla and a Wrightspeed X1 prototype,” even putting them on a dynamometer, which allowed King to record extreme acceleration and engine torque in a very controlled fashion without the car actually moving.

As has been the case on many films King has worked on, he was aided and abetted by top Hollywood sound recordists John Fasal and Eric Potter (profiled in the July 2005 issue of *Mix*), who brought their arsenal of Sound Devices 744 recorders to that and other tasks, such as recording a variety of weapons and various vehicles for the film.

“Then we experimented with tires,” King continues. “The Batpod has huge, wide tires, and we knew that would be an important component, so we spent a lot

to keep the track gritty and real, and then when Batman appears on the scene and does his thing, we ratchet up the coolness factor and make everything sound bigger and more awesome. The contrast between gritty and naturalistic and epic and hyper-real makes for an interesting track.” This same philosophy extends to the production sound, recorded by Ed Novick. “There are very few ADR lines in the film,” King says. “Chris loves the sound of the production, and Gary Rizzo did a wonderful job of weaving it together.”

When King and I spoke in mid-May, he and the mixers were working on a climactic chase scene involving the Batmobile and several other vehicles, and he seemed particularly excited, because, “Chris decided to play the scene with sound effects and no music for the most part, which is rare for a scene like this, so it’s been a great opportunity for Lora, Gary and me to look at

the sequence, and say, ‘What tonalities and textures will do some of the work music would normally do? There’s a lot of gunfire, so what kind of frequencies, pitches and sounds can we highlight in the gunfire? What kind of odd sounds can we throw in?’ It’s been a really fun scene to work on. A huge amount of recording was done for this sequence, from diesel trucks to a wide variety of weapons.” Still, King notes that he and co-composers Hans Zimmer and James Newton-Howard collaborated closely throughout the posting of the film.

“I always try to hear early versions of the music, and conversely if I have an idea of how something is going to sound, I’ll make it available to the composers. Chris wanted the temp mix to be a very close template of what the final mix would sound like. We worked very hard on the temp, for which we had sampled versions of the final score assembled by the music editor, Alex Gibson, which would eventually be recorded with an orchestra. Once I heard the music mock-ups that Hans and James had composed, I was able to then go back and make sure the frequencies and textures we were using didn’t clash with the music. But that barely happened at all. I think they got a sense from the temp dub and early sound demos what we were up to, and we got an idea what the music would be doing, and both the music and sound effects evolved from there.” Beyond that, “It was worked out early on in Chris’ head where sound effects were going to rule, where music was going to rule and where they would work together.”

There are lots of high-tech gadgets in the film, from components of the Batsuit, to various weapons. One of King’s favorites is “a superpowerful hydraulic device that fits inside [Batman’s] hand, so powerful that he can, say, bend the barrel of a gun. We don’t need to understand how it works, but we have to make it sound cool and also believable. Remember, Batman’s no superman; he’s a very clever guy whose arsenal of devices allows him to do superhuman things.”

King says Nolan gave him and his sound crew plenty of latitude in developing sounds, but, “He’s a director who knows what he wants. He knows what sound can bring to the table, and he wants to exploit it fully. He’s a very active participant in the creation of the track. He doesn’t necessarily tell you what to do—in fact, we never had a spotting session for the show. We just showed up at the first temp mix and learned through that experience what worked and what didn’t.” ■

hear **your** vision



UNIVERSAL STUDIOS SOUND

- Mixing Stages _ Sound Design _ Digital Sound Editing Services
- Digital Mastering _ Restoration _ Trailers & Commercials
- ADR _ ISDN _ Foley _ Projection _ QC _ Telecine Services
- Audio / Video Transfer _ Gigabit Ethernet Network
- Engineering / Technical Support
- Wireless Internet Access
- Business To Business
- Website



UNIVERSAL
OPERATIONS GROUP

818.777.0169 800.892.1979

WWW.FILMMAKERSDESTINATION.COM

Final PlayBAEC
Program - ~~Master~~ ~~Speech~~
P ~~will~~ ~~to~~ ~~sub~~ ~~to~~ ~~high~~
low ~~by~~ ~~see~~ ~~the~~ ~~for~~
Also on ~~man~~ ~~ditto~~ ~~ma~~

Need
what
to set up



Hellboy II

—FROM PAGE 44

discrete recorder and recording number sequentially throughout the sound roll, and slate metadata is identified by cross-referencing a written *and* computer-generated

over the windy weather condition they're caught in! Even then, a lot of time what you're getting will only be a good guide track [replaced later in ADRL]."

Typically, Mac delivers "mixed tracks to picture editorial via telecine, and ev-

PHOTO: UNIVERSAL STUDIOS COPYRIGHT © 2007 UNIVERSAL STUDIOS. ALL RIGHTS RESERVED



sound report, thus eliminating any errors in metadata entry that can cause more harm than good when scene and take information change very rapidly on set, often *after* the take itself.

"One always pays attention to what's going on in terms of technical advancements in the field, and attempts to implement them when they improve things," he continues. "But, basically, I'm a traditionalist, and the most accurate, transparent sound reproductions are created by recording a clean signal chain in a clean acoustic environment paying close attention to the perspective that the visual image calls for."

Asked if miking a scene that is going to be dominated by blue- or green-screen action changes his approach at all, Mac replies, "On a green-screen set, the mics can be well within the frame of the camera, as they'll be 'drawn' over later. This allows for recordings [that have] lots of presence, but often don't take into careful account an attention to camera perspective sound, which is an important part of the aesthetic we're trying to create."

And what about the presence on set of noisy wind machines or hydraulics? "If the visual image calls for the use of wind machines or water pumps or hydraulics," Mac says, "then everyone knows that those are required for the shot. It's pretty simple acoustic physics: If the sound source is there, it's there; all one can do is hope that the visual effect that requires such a device also calls for the character to yell like hell

everything including mixes, iso and safety tracks to sound editorial. Ambiances and specific effects are nice to get, but dialog is always the priority. Generally, the production schedule dictates what we have access to record, and a 600-person crew is not going to stand still for a stereo ambience recording on the studio back lot—maybe on a student film, but this was a summer blockbuster studio picture."

That said, Mac notes that "*Hellboy II* supervising sound editor and sound designer Martin Hernandez and I did go on a field trip on an off-day to a zoo in the quiet early morning off-hours, and gathered natural organic animal sound elements to aid in the sound design of various creatures in the world of Hellboy. I was on the edge of the zoo's staff-only lion-feeding cage, recording several females hissing and growling at our furry-animal-like [mic] windscreens when the male lion freaked and charged the fence, jumping up on hind legs *way* taller than me and less than a foot from my head! Let's just say I wasn't thinking about signal-to-noise ratio at that moment! The limiters in the mixer held, but the limiters in my human survival instinct almost didn't!"

In director Del Toro, Mac found an ally who was both sympathetic to his requirements on set and someone who is interested in sound in general. "Undeniably, Guillermo's attention to the artistic aesthetic includes an attention to sound, as well as image, to further the narrative." ■

RME International Distributors

North America

USA, CANADA: Synthax Inc. . www.synthax.com

South America

CHILE: Videomedia LTDA. . www.mediamy.com.cl

Europe

BULGARIA: Almar Co. Ltd. . www.almar.bg

CROATIA: Neuron . www.neuron-d.com

CZECH REPUBLIC: Disk Multimedia s.r.o. . www.disk.cz

DENMARK: Soundworks . www.soundworks.dk

ESTONIA: IS Music Trading Ltd. . music@online.ee

FINLAND: Carbo'n Music Oy (Ltd) . www.carbonmusic.fi

FRANCE: SCV Audio . www.scv.fr

GERMANY, AUSTRIA: Synthax GmbH . www.synthax.de

GREECE: Logothetis Music . www.logothetismusic.gr

HUNGARY: Midisoft Studio Kft. . www.midisoft.hu

ICELAND: Tonabudin Ltd. . www.tonabudin.is

IRELAND: Future Sounds . www.futureounds.ie

ITALY: MidiWare Srl . www.midiware.com

LITHUANIA: Midiaudio Ltd. . www.midiaudio.com

NETHERLANDS, BENELUX: AudioAG . www.synthax.nl

NORWAY: ProLyd . www.prolyd.no

POLAND: Audiostacja s.c. . www.audiostacja.pl

PORTUGAL: Audiolog, Lda . www.audiolog-lda.com

ROMANIA: A.V. Audio Sys s.r.l. . www.avaudiosys.ro

RUSSIA: 4Sonic . www.4sonic.ru

SERBIA, MONTENEGRO: Artist d.o.o. . www.artistsystems.co.yu

SLOVAK REPUBLIC: Sound Service . www.soundservice.sk

SLOVENIA: MTD . www.mtd-el.si

SPAIN: Microfusa . www.microfusa.com

SWEDEN: Fitzpatrick Import Group S.A. . www.fitzpatrick.se

SWITZERLAND: Music Network GmbH . www.musicnetwork.ch

TURKEY: BL Muzik Co. Ltd. . www.blmuzik.com

UKRAINE: Real Music Ltd. . www.realmusic.ua

UNITED KINGDOM: Synthax Audio UK Ltd. . www.synthax.co.uk

Asia and Pacific Rim

AZERBAIJAN: Promix . www.promix.az

AUSTRALIA, NEW ZEALAND: Innovative Music Australia Pty Ltd.

www.innovativemusic.com.au

CHINA: Central Music Co. . www.centrmus.com

HONG KONG: Central Music (HK) Ltd. . www.centrmus.com.hk

INDIA: Modi Digital Audio Pvt Ltd. . www.modidigital.com

JAPAN: Synthax Japan . www.synthax.jp

KOREA: Soundcat . www.soundcat.com

INDONESIA: M-Station . www.m-station.biz

THAILAND, KAMBODIA, MALAYSIA:

KDM Trading Co Ltd . www.kdm.co.th

TAIWAN: MidiMall Inc. . www.midimall.com.tw

Middle East

ISRAEL: Music-Shop LTD . www.music-shop.co.il

UAE, EMIRATES: Thomsun Trading Est . www.thomsun.ae

IRAN: Raajmaan System Ltd. . www.raajmaan.com

Africa

SOUTH AFRICA: Tuerk Music Technology . www.tuerkmusic.co.za

All other countries: Please check www.rme-audio.com

Worldwide distribution

audio ag

FireWire Audio MADE by RME

Mobile . Functional . Reliable

"The superb sound of these pieces and the most comprehensive feature set out there, combined with unparalleled support, makes them the only choice for anyone serious about their work."
Husky Hoskulds, Producer & Engineer



FIREFACE 800

56-Channel, 24 Bit/192 kHz FireWire Audio Interface

10 x Analog I/O . 4 x Mic/Line Inputs with Preamps . 2 x ADAT I/O or 1 x ADAT I/O plus 1 x SPDIF I/O optical
1 x SPDIF I/O coaxial . 1 x MIDI I/O . 1 x Stereo Headphone Out . 1 x Instrument input adjustable
2 x FireWire 800 . 1 x Firewire 400 . optional: Time Code Module



FIREFACE 400

36-Channel, 24 Bit/192 kHz Bus-powered FireWire Audio Interface

8 x Analog I/O . 2 x Mic/Line Inputs with Preamps . 1 x ADAT I/O or 1 x SPDIF I/O optical
1 x SPDIF I/O coaxial . 2 x MIDI I/O . 1 x Stereo Headphone Out
2 x Firewire 400 . FireWire-Bus-powered Operation

RME FireWire Technology . Optimized for audio applications

RME Low Latency . Absolutely live! – Playing, feeling – and recording

RME Cross-Platform Drivers . Best performance – State of the Art – Anytime!

RME Sound & Vision . No compromise high-end components. Audibly better!

RME TotalMix . Total Mixing – Total Routing – Total Recall

RME ZLM . Zero Latency Monitoring – Direct control

RME SteadyClock . Perfect Jitter Reduction – Improved sonic quality

RME DSP Technology . Lowest CPU-load – Headroom for all applications

www.rme-audio.com

Engineered and Made in Germany

RME

World Radio History

North America Distribution

SYNTHAX USA

www.synthax.com

Paramore



Photos & Text by Steve Jennings

Four-piece rock outfit Paramore (the Farro brothers—Jeremy, bass; Joshua, guitar; and Zachary, drums—and lead vocalist Hayley Williams) are out in support of their second release, *Riot!* *Mix* chatted with front-of-house engineer Ronnie Gardner and monitor engineer Carrol Miller.

Gardner is manning a Digidesign D-Show Profile. "I still love my big old Midas consoles, but this has the convenience of being small and digital, as well as [providing] a warm sound. I'm using the Impact compressor plug for my group compression and running outboard Avalon 737s on vocals. For effects, I use the Line 6 Echo Farm plug-in for delay and Revibe 'verb plugs for various 'verbs.'" Miller is also on a Digidesign board—a VENUE—and is recording each show in Pro Tools. "For plug-ins, I'm using the 2.0

package. We're all on stereo in-ears and everyone has the Joemeek Compressor and Focusrite Red EQ plug-ins on all stereo buses. I use the Impact plugs for Zac's drums with a 4:1 ratio and 1 to 2 dB of gain reduction, medium attack and fast release. For the bass direct and mic, I use a Purple Audio MC77 comp. It is very smooth and helps Jeremy's bass sit tight in the ear mixes. The sound of the Fairchild 660 on Hayley and Josh's vocals really help keep them above the mix."

Rat Sound is providing a rig that comprises 12 L-Acoustics V-DOSC with three dV-DOSCs down, six box ARC side hangs, dV-DOSC front-fills and 10 Rat subs per side; on hand for tuning is FOH system tech Greg Mahler, who uses SIA Smart. Sennheiser units are used throughout, including 935 mics for vocals, and IM-300 transmitter and G2 receivers for in-ears.

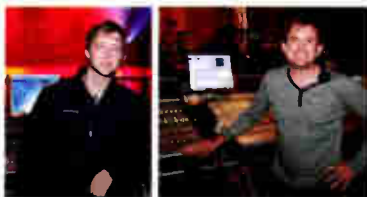

FOH engineer (left) Ronnie Gardner and monitor engineer Carrol Miller

inside

- 50 **Live Mix News:**
Tours, Events, Installations
- 54 **All Access: Matchbox Twenty**
- 56 **Tour Profile: Juanes**
- 64 **Tour Profile: Bon Jovi**
- 68 **Local Crew: Studio 116**
- 70 **New Sound Reinforcement Products**

News



Japanese rockers MUCC relied on Shure guitar systems, in-ear monitoring and mics on the recent Rockstar Taste of Chooz tour.

FixIt

Raymond Gubbay's production of Tosca features a sound design by Bobby Aitken. Tosca is one of the recent operas performed in the round at London's Royal Albert Hall.

Working on *Tosca*, or any opera, always brings the same challenge. An in-the-round production means a singer will be performing straight to some of the audience while their back is to another section, so the challenge is to make where the sound is coming from believable. An additional challenge is that the operas at the RAH are all sung in English, which means you have to be able to hear all the words, yet we still need to make it sound unamplified. We bring radio mics [for vocals] into the DiGiCo D5T and then straight out on direct outputs. We don't mix any radios on the DiGiCo. We simply use the faders and then we're straight into the TiMax Talent Tracker, with all the individual vocals and mixing done on the TiMax matrix. We do mix the orchestra on D5T and we also have a complete backup on it, so should the TiMax system fail, we can instantly switch back to the console.



Stevie Wonder returned to the New Orleans Jazz and Heritage Festival as a headliner this year. William Barnett and Dwayne Jones mixed on dual DiGiCo D5 monitor boards...Legacy Sound Productions (Castle Rock, CO) brought in a D.A.S. Audio system for Dare 2 Share's Survive tour...The Paradiso (Rimini, Italy) club has been restored, with a new sound system by Titansound & Light, which chose a Martin Audio array...Sound Image (Escondido, Calif.) passed the 5-million-watt mark in its Crown Audio i-Tech inventory and the SR company's president, Dave Shadoan, will be presented with a special plaque on the opening day of InfoComm 2008...Clair Bros. (Lititz, PA) invested in 300 Lab.gruppen PLM 10000Q loudspeaker-management systems, which are being deployed on both the main full-range system and subwoofers, along with monitors and side-fills, for upcoming Alicia Keys and Dream Theater tours.



Nuendo 4 features a world-class automation system, 38 all-new VST3 audio effects plug-ins, advanced post-pro editing features and more.

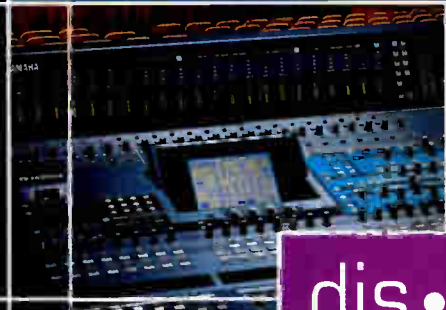

dis•tinct

(di-stingkt') -adj.
1. Readily distinguishable from all others.

Some things just have a way of standing out. A prime example — Yamaha's DM2000VCM. 96 inputs at 96 KHz, on-board mix automation, 6.1 surround, a series of add-on effects, EQ's and dynamic processors are just a few of its notable qualities. With the capability to control the new Nuendo 4, along with various other DAW's, the DM2000VCM is an industry favorite for reasons beyond compare.



When you need help, time zones shouldn't matter. Yamaha provides coast to coast 24/7 technical support. With dedicated staff and regional service centers, assistance is around the corner. If we can't fix it over the phone, we'll put a part or a person on the next plane out. It's that simple.



Now Playing

R.E.M.

Sound Company: Rat Sound (Oxnard, Calif.)
FOH Engineer/Board: Brett Eliason/Midas XL8
Monitor Engineer/Board: George Squiers/Midas XL8
P.A./Amps: L-Acoustic V-DOSC, dV-DOSC, ARC/Rat Sound dual 18-inch subs, EAW MicroWedge MW12, Chevin Q6, Crest Audio 7001, L-Acoustic LA48a
Monitors: EAW MicroWedge MW12
Outboard Gear: XTA DP-428, TC Electronic TC6000, Klark-Teknik DM9696
Microphones: Audix DM7, D6, I5; Sennheiser e908d, e609; AKG C 414, C 480; Shure SM57, Beta 91, Beta 57, VP88; Audio-Technica AT4050; beyerdynamic M 88
Additional Crew: Lee Vaught, crew chief/system tech; Peter Baigent, stage tech; Greg Mayler, sound tech; Matt Fox, V-DOSC tech

Rihanna European tour

Sound Company: Britannia Row Productions
FOH Engineer/Board: Davy Kirkwood/Midas XL8
Monitor Engineer/Board: Richard Galecki/Yamaha PM5D
P.A./Amps: L-Acoustics V-DOSC, dV-DOSC, ARCs, SB219, 108s/Lab.Gruppen
Monitors: Sennheiser G2 in-ears, L-Acoustics ARCs/SB218 sidefills
Outboard Gear: Dolby Lake, Avalon 737
Microphones: Sennheiser
Additional Crew: crew chief Josh Lloyd, system engineer Chris Morrison, systems tech Jono Dunlop

Concert Turns It Down

More than 250 concertgoers attended the Evergreen Speech & Hearing Clinic's third annual EAR-responsibility concert in Kirkland, Wash. at the Kirkland Teen Union Building in mid-May. Patrons heard (under 100dB) performances by musicians from the Seattle music scene (including Portugal the Man, pictured, and Man Down Medic) while increasing



PHOTO: BRENNON GÖMM

their awareness of hearing protection—free earplugs were given out at the door and raffles were held throughout the show for in-ear monitors and custom-molded ear plugs (which were also available for purchase at cost). A total of 17 impressions were made for custom-fit earplugs and \$1,614 was raised through admission and raffles; all proceeds went to the venue to obtain new sound equipment and a limiter to ensure that it is a safer listening space. Sponsors from the pro audio sector included Grammy U, Westone and Oticon.

Opening Its Doors

New company Rational Acoustics LLC (Putnam, Conn.; www.rationalacoustics.com)—founded by industry veterans (pictured above, from left) Karen Anderson, Jamie Anderson, Adam Black and Calvert Dayton—offers a range of training classes and product sales for users in the field of acoustic text and measurement, and system alignment. The company also plans to develop new system-alignment software and hardware gear.

Classes (seen above, right) will focus on general system-alignment theory and practice, and specific product training. "Right now, our product-focused training is specific to [SIA] Smaart because that is where the majority of us have recently come from," says Jamie Anderson, company CEO/resident "Educator Guy." "But as we continue to grow, we'll include other measurement platforms. We're not promoting a single product or solution; rather, we're here to provide the best range of technologies, techniques, tools and practices to help people get their jobs done."

Products offered for sale by Rational Acoustics through its Website store include a selection of microphones, pre-amps, cables and other measurement peripherals.

Notes company COO/"Den Mother" Karen Anderson, "System-alignment professionals have traditionally been one of the smallest niche markets within the professional audio industry. But in recent years, the field of system alignment has grown substantially, going from 'nice-to-have' to 'must-have' for any serious audio application. As a group, system-alignment pros are very passionate and highly technical, and Rational Acoustics is here to provide them with the community support, education and tools they deserve."



ROYER

Jim Ebdon
FOH Engineer

Kyle Cook
Guitars

Paul Doucette
Guitar/Keyboard

Royers On The Road With **MATCHBOX TWENTY**

"Live guitars sound amazing with R-121 Live mics on the cabinets, and they stand out well in the mix. Royers are warm, natural, present and uncolored - not at all harsh like several of the other mics we auditioned, and the band loves the natural sound they get in their in-ear monitors.

"I've used Royers on Aerosmith for a few years and currently on Matchbox Twenty and they've been among my most reliable microphones. These are amazing ribbons."

Jim Ebdon

FOH Engineer - Matchbox Twenty, Aerosmith, Annie Lennox



R-121

Royer Ribbons - Hears Like Your Ears

Handcrafted in Burbank, CA • www.royerlabs.com • 818.847.0121

Copyright Royer Labs 2008. Photo Ana Gibert

MATCHBOX TWENTY

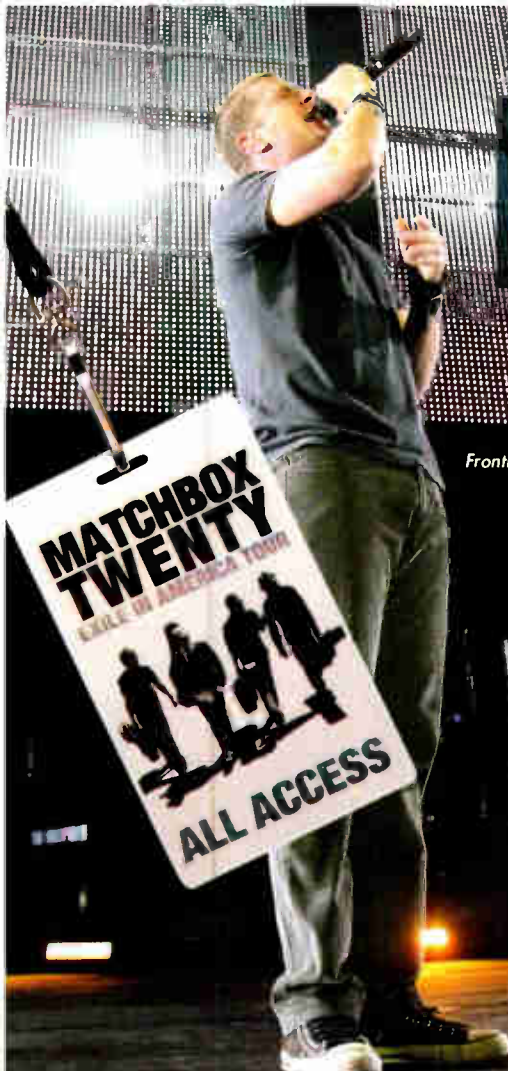

Frontman Rob Thomas

Photos and text by Steve Jennings



Lead guitarist
Kyle Cook

It's been almost five years since Matchbox Twenty released a studio album of new material, and in the interim, frontman Rob Thomas has built a successful solo career and duetted with Carlos Santana. But the bandmembers are now reunited, touring behind a greatest-hits collection produced by Steve Lillywhite: *Exile on Mainstream*. *Mix* caught up with the Exile in America tour at the HP Pavilion in San Jose, Calif.

As with previous Matchbox Twenty outings, PRG is supplying the P.A. According to front-of-house engineer Jim Ebdon (right, with crew chief/system tech Chuck Wells), they are hanging 15 L-Acoustics V-DOSC and three dV-DOSC per side for the main hang, as well as six dV-Subs. Eight SB 2x18 subs are on the ground, set up for omni bass. The side hang comprises eight KUDOS per side, and four dV-DOSCs are situated along the front edge of the stage for in-fill.

"I'm using the DiGiCo D5 Live EX 56 [inputs] for the tour," Ebdon adds. "I'm mainly using the onboard gates and comps, but have a [Drawmer] MX50 de-esser and a Focusrite ISA 430 for Rob [Thomas'] vocal, and an SSL comp for the drum mix."

Chuck Wells relies on SIA Smaart for room tuning: "The only way I have found to tune is my voice through an [Shure] SM58," Wells says.

"This band has some great guitar tones and I have found the mic choice is very important and can take the mix to a new level," Ebdon says. "I experimented in rehearsals and found the Royer 121s the best guitar mics for this tour."



Monitor engineer Chris "Sharpie" Sharp (left, with secondary monitor engineer Wayne "Chan" Teaster) is mixing on a DigiDesign D-Show board, using the onboard Focusrite comp limiters, Smack! and Crane Song plug-ins, as well as D-Show.

Thomas sings through a Shure UHF8R with a KSM9 capsule. "I loved it the first time I heard it," Sharp enthuses. "The rest of the guys are using SM58s. We have Sennheiser E300 G2 Series packs with transmitters for in-ear monitors. The band and I are all on Ultimate Ears UE7c ear molds. I am using the Professional Wireless Systems' GSX-8 antennae combiner; they have provided a stable RF platform that is unrivaled."





Drummer Ryan MacMillon

Tom Wilhelm, drum tech, describes his miking setup: "[Shure] SM 91 and Beta 52 in the kick; SM57 and AKG 414 for snare; [Beyerdynamic] Opus 88 on toms; Neumann 185 for hat and ride; and AKG 414 XLS for overheads."



Bassist Brian Yale

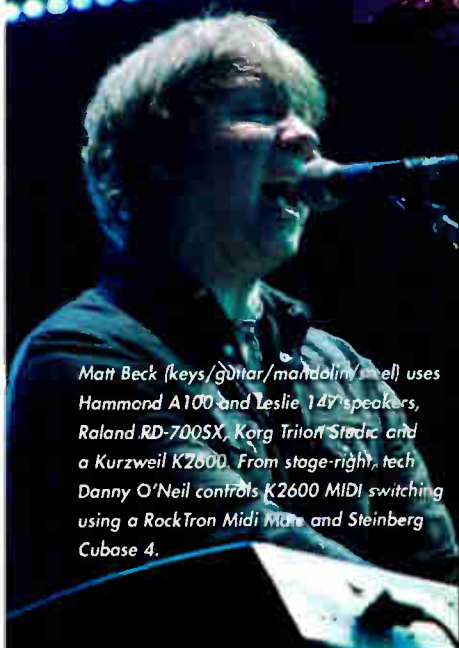

Matt Beck (keys/guitar/mandolin/viol) uses Hammond A100 and Leslie 147 speakers, Roland RD-700SX, Korg Triton Studio and a Kurzweil K2600. From stage-right, tech Danny O'Neil controls K2600 MIDI switching using a RockTron Midi Mate and Steinberg Cubase 4.

Brian Yale's bass tech, Lonnie Totman (at right, to the left of Valjean Leiker, guitar tech for Paul Doucette and Rob Thomas), explains that Yale's rig was built by himself and Rack Systems' Dave Friedman. "It comprises two Somson UR6DC dual-wireless units and a DA-5 distribution amp," Totman says. "From there, the signal goes to a Whirlwind Selector to choose wireless outputs. Next, it heads to a custom-made rock switcher. The rig is non-MIDI."

In the rack sits a Tech21 SansAmp, an Ibanez TS-9 and an Expandora distortion pedal. The other key unit, according to Totman, is a Sadowsky preamp box used for level matching. "The interesting part of Brian's rig is we don't use an amp and mics," he adds. "We have a couple Ashdown Engineering EVO 500 heads and one of their 4x10 cabs, but it's there in case of a special circumstance. It's a great-sounding amp and cab, but by eliminating the live bass amp onstage, we are able to keep the overall mix less washy."

According to Leiker, Doucette plays through a Vox AC30 (miked with a Royer model), Bad Cat 2-Channel (Audio-Technica AT4050) and a Fender 3-Channel Super Sonic Head (Shure SM57). Doucette rocks out on a number of guitars, including Gibson 335s, Epiphone Sheratons, and Fender Jaguar and Mustang, etc.; Thomas relies on a Gibson J200.



According to guitar and keyboard tech Danny "Borga" O'Neil, both guitarist/keyboardist Paul Doucette and Thomas use a Baldwin Piano Shell with a Roland RD-700SX. Beck plays with numerous guitars, including models from Gibson, Rickenbacker, Fender and Gretsch. Guitar amps include a Vox AC30 with a Royer R-122 mic and a Fender Twin Reverb Deluxe (lap steel) with a Shure SM57.



Multi-instrumentalist Paul Doucette

Juanes

LATÍN MUSIC
HEATS UP
THE STAGE



PHOTO: JOHN JOHNSTON

By Candace Horgan

Mixing elements of rock, soul, funk, blues and Latin music, Columbian musician Juanes has risen to the top of the Latin music scene. His electrifying live shows attract sold-out audiences around the world, and his passionate support of political causes has earned him comparisons to Bono. He has also received critical acclaim, winning a total of 12 Latin Grammys and counting so far. Touring with his six-piece band (for a complete list, see the sidebar “Miking the Backing Band” on page 60) in support of his 2007 album, *La Vida...Es Un Ratico*, Juanes delivered a stellar performance at Denver’s Magness Arena, where *Mix* caught up with the tour midway through its trek across the country. Production is in the capable hands

of front-of-house engineer Rob “Cubby” Colby, monitor engineer Anselmo Rota (who speaks very little English), monitor assistant Jordan Kolenc, system engineer Edgardo Vertanessian (of Eighth Day Sound) and system tech Craig Laskowski.

SOUND TRANSLATION

Colby got his introduction to Juanes at the 2000 Latin Grammy Awards. “I was doing other Latin artists and this drummer that’s with him now, Waldo Madera, came

by this tour that we had done, the Living La Vida Loca tour with Ricky Martin, which was a really nice production,” Colby recalls. “Their front-of-house engineer had gone to be the monitor engineer, and I got the phone call. They had me come out to do a couple of shows, one in L.A. and one in Las Vegas, and everything went very well, and I really enjoyed mixing the music. I really enjoyed the artist, too.

“Even though he is singing in Spanish, you can still hear the emotion in what he is singing,” Colby continues. “I’ve never had a problem mixing an artist singing in Spanish. It’s more a feel than what the artist is singing about. I ask a lot of questions in rehearsals so I have some idea of what the song is about!”

Situated at FOH is a DiGiCo D5 board, which Colby says he’s been using for the past seven or eight years. “This type of footprint and its layout, for me, it’s all right there in front of me. Of course, the sound is great. It serves my purposes; I don’t need a lot of different things. I’m pretty consistent with the type of outboard gear I use, which is really a very minor amount. I mostly use what’s on the console. I have two external dynamics—two Distressors for the two different bass channels—and I have a couple Lexicon PCM units for reverbs. Otherwise, I use what’s on the console.”

Juanes likes to mimic the sound of his albums as closely as possible, so Colby puts minimal effects on the instruments. “I’ve just



PHOTO: JOHN JOHNSTON



FOH engineer Rob Colby (l) and system engineer Edgardo Vertanessian



PS Series — Ability to field any position with: dedicated rotatable asymmetrical horns, handling anything from touring to installed sound.

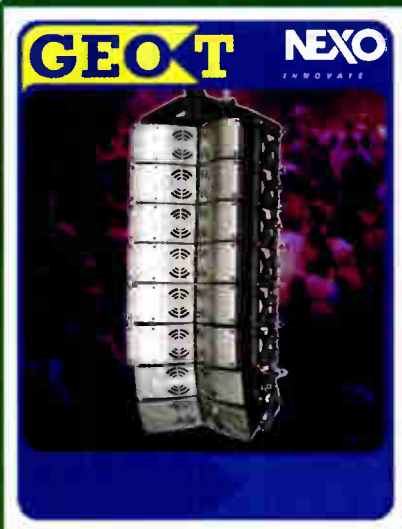

GEO T Series — The big slugger with quad 8's and a 3" HF device. Newly outfitted with NXtension settings for improved clarity and control.



GEO D Series — Pitching too good to be true. 12" fastball with dual firing side arm 8's, finishing with a 3" HF device.

COLLECT THEM ALL

Buy them, rent them, trade them with your friends. The lineup is large and the products diverse. Whether looking to complete a small PA in a house of worship or choosing a rig for the next big tour, NEXO's family of speakers have got you covered. From the transparent sound of the ALPHA Series to the gripping power behind the GEO T, each speaker in the NEXO group is sure to become a collector's item.



GEO S12 Series — Future star grand slam hitter featuring a rock solid 12" LF and a 3" HF driver.

For more information or to request a speaker demo, email nexodemo@yamaha.com.



GEO S8 Series — 8" 2-way hitter with a stunning 1" HF device. When size matters, nothing out slugs this all-star.



Alpha/Alpha E Series — MVP compact high power hitter with modules and subs for touring and installed sound.



Yamaha Commercial Audio Systems, Inc.
P. O. Box 6600, Buena Park, CA 90620-6600
©2008 Yamaha Commercial Audio Systems, Inc.

introduced a few little echo trails on some of the re-arrangements of the songs, which he likes a lot," Colby explains. "I'm using some longer reverbs, and that's really about it. There's a slight 12-string guitar doubler that I use a little, just to give it some more warmth because it sounds so thick sometimes in the way that it's played for this type of music; it's really not strummed a lot. It's an impact-type mix: Guitars out front and a real punchy drum sound."

Colby has been recording all the shows with the goal of making a live record at some point next year. "I'm multitracking to Pro Tools," he says. "We've got six 500-gig drives that we are filling up with all of the North American concert dates. We're doing four out in L.A., and I think those are the ones he's hoping to capture. I'm running 52 lines in, plus four audience microphones, two Neumann KM 184s at the stage and two Audio-Technica shotgun mics at FOH."

Eighth Day Sound is providing a d&b audiotechnik line array system. According to the production company's Vertanessian, "In this room, I'm flying 14 on the mains—12 J8s and two J12s per side—and I'm flying eight Q1s for the side hangs per side. Then we have six J-SUBs flown and six B2-SUBs on

the ground per side, as well as with six Q7 front-fills. It's quite a significant P.A." Vertanessian tunes the room using a combination of SIA Smaart, a d&b Ethernet system and a wireless Lake Controller tablet. Vertanessian works hard to compensate for the unusual geometry of Magness, the home arena for the Denver Pioneers hockey team. One side of the mostly concrete venue is significantly higher than the other: "The reflections are kind of annoying me," Vertanessian says. "One side is way up with lots of seats and the other side is very low, so having the side hangs set up the same and sounding the same as the P.A. becomes very challenging."

Colby, for one, appreciates the nuances of the d&b system. "I find that all of the line arrays nowadays, they only make the bad-sounding rooms sound much better because of the technology and the aiming programs. All the rooms are challenging, but I don't think there's such a thing as a bad-sounding room anymore. This is a rock show, so it's a punchy, impact mix. It's going to be loud,



Monitor engineer Anselmo Roto (l), monitor assistant Jordan Kolenc

so by introducing that volume into the room and taking out all the excitable frequencies, these rooms can sound very good, but it's very in-your-face, and that's what these line arrays do for you. The d&b system, it's very compact, very consistent, lightweight and extremely powerful. We're covering 220 degrees with the full system."

CROSS-CULTURAL PERSONNEL

In talking with Rota, who hails from Argentina, Vertanessian served as our translator. Rota started out as a DJ, and has worked for most of the major Latin tours during the

GTR3

Professional Guitar Sound

19 Guitar Amps • 7 Bass Amps • 22 Cabs
26 Stomps • Custom Interface • Multiple Mics
Realistic Dynamic Response • Standalone or DAW-Ready

GTR SOLO

Studio Guitar Sound For Everyone

10 Amps • 10 Cabinets • 13 Stomps
Easy to Install, Easy to Use
Standalone or DAW-Ready, No iLok Needed
Now only \$140 MSRP

**WAVES
GUITAR
SOUND**

Pick the GTR package that's right for you.



www.waves.com



WHAT ARE YOUR DREAMS MADE OF?

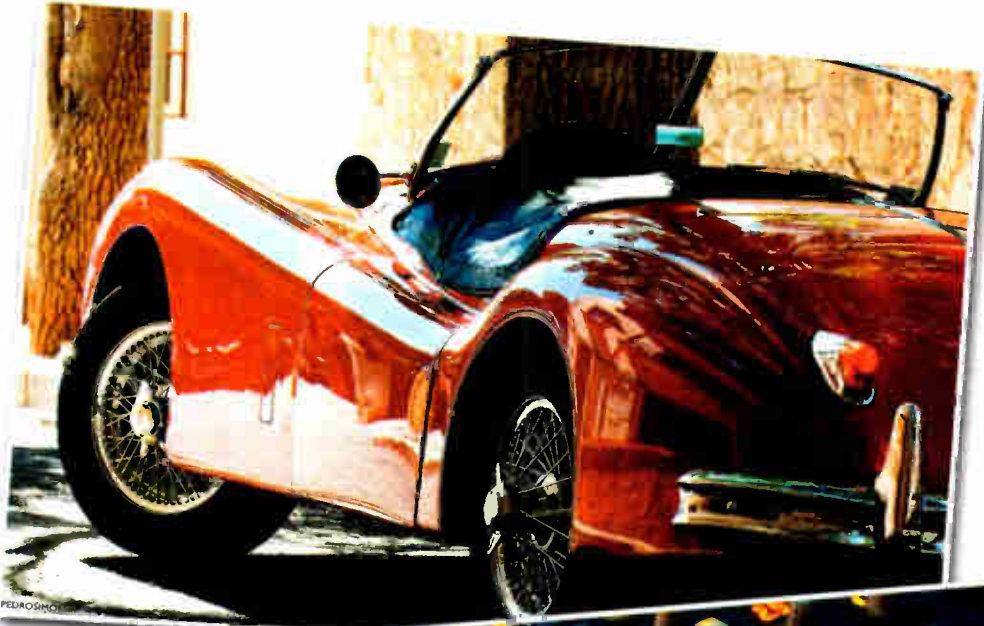

a.



b.

EVERYONE WHO CHECKED "B" IS ON
WWW.AUDIOFANZINE.COM
JOIN US !



www.audiofanzine.com
The Audio Community

past two decades; this is his first time working with Juanes. As the artist sings all of his songs in Spanish, it was important to him to have a Spanish-speaking monitor engineer.

"On the last tour, Juanes and his production were looking for a monitor engineer replacement because there were a couple of dates that the former monitor engineer couldn't cover," Rota says via Vertanessian. "They called me and I couldn't make it because I had other shows to do. Finally, that monitor engineer left the production and they called me as the replacement. Juanes wanted a Latin mixer so he could talk to me in Spanish during the show to understand signs and words."

Like Colby, Rota is mixing on a DiGiCo D5 console: "I'm very comfortable with it and think it's the easiest to use as a monitor mixer," he says. "I like the way it sounds and think it's the best monitor desk available today. I use the onboard effects, as well. I have two reverbs—one for the acoustic guitars and one for the vocals—and use a compressor on the vocal and on the acoustic and the percussion and the conga."

Rota is sending several different mixes out to the stage, some of which are then remixed by the musicians. "I run a stereo mix

for the drummer—one with the band only and one with the drums only—and send him the click and Juanes' vocal, and the drummer has a little console and he mixes the six feeds in his in-ears.

"The percussionist has a console, too. I mix a left/right for him and send him the click, and he has a lavalier microphone that gets all the toys that he plays on the percussion. He has a little desk and mixes the left/right, the click and the lavalier.

"The keyboard player has another console, and I mix left and right for the keyboard, plus I send him the click, the vocal and the keyboard player's headset vocal." The bass player and two guitar players use in-ear monitors, and Rota sends them a standard L/R mix.

As Juanes sings from both the stage and the end of a thrust (he sings through two Shure KSM9s—one onstage and one at the end of a thrust), he has two separate d&b M2 wedges onstage and two separate d&b

Miking the Backing Band

Drummer Waldo Madera's kit: Sennheiser e901 and e905 (snare), e904 (toms); Neumann KM 184 (overheads, hi-hats); Audio-Technica 2500 (kick).

Felipe Alzate's percussion: Shure Beta 98s, Beta 52 (tambora) Beta 57s (djembe, top and bottom) and Neumann KM 184s.

Felipe Navia's bass: Two Radial DIs.

Emmanuel Briceño's keyboards: Eight Radial DIs panel, Moog, Motif, Rhodes, Wurlitzer

Juan Pablo Villamizar and Fernando Tobon's guitars: Shure KSM 32s and an L/R on Juanes' guitars (acoustic: Shure wireless system with Avalon DIs).

M2 wedges at the end of the thrust. "Juanes wants to listen to everything, but his own voice and guitar are a little louder than the rest," says Rota. "Juanes wants to keep the stereo image as he is playing, so the stage-right guitar and the keyboards are on his right, and the stage-left guitar player is on his left. What Juanes told me from the very beginning is he wants to listen [to the mix] as if he is listening to the record." ■

Candace Horgan is a Denver-based writer.

Waves Live Bundle

27 plug-ins custom-engineered and optimized for Digidesign Venue Series D-Show Consoles.

L1 Ultramaximizer™ | L2 Ultramaximizer™ | C4 MultiBand
C1 Parametric Compressor | Q10 Paragrophic Equalizer
S1 Stereo Imager | MaxxBass® | Renaissance Compressor
Renaissance Reverb | Renaissance Vox | Renaissance EQ
Renaissance Bass | Renaissance Channel | Renaissance Axx
Renaissance DeEsser | SuperTap | TrueVerb | TransX
Doppler | Doubler | Enigma | MetaFlanger | MondoMod
PAZ Analyzer | PS22 Stereo Maker | DeEsser | AudioTrack

Plus Waves complete Platinum TDM Bundle

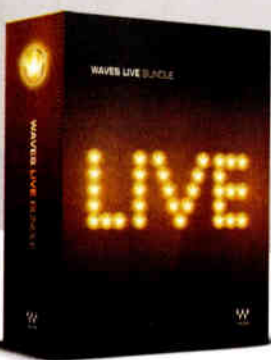

WAVES LIVE SOUND

Bring your studio sound to the stage.

www.waves.com



LET'S BE CLEAR Q8



equator

per
prof
com
volume
limiter
display

Are your mixes not what you expected? Numerous obstacles exist in even the best designed studios that prevent you from achieving that perfect mix. Our solution: The Q8 - the latest in the acclaimed Equator Q Series monitor line.

By incorporating time and phase-accurate Zero-Point Reference™ Co-Axial transducers with cutting edge DSP, the Q Series deliver a level of performance that until now was unimaginable.

Each Q8 monitor includes a dedicated internal CPU which executes a series of complex tasks designed to eliminate sonic obstacles. All Q8 Digitally-Controlled Transducers™ are internally matched every time to ensure perfect imaging. A slope-less crossover approach eliminates mid-range distortion associated with traditional crossovers. Complete analysis and compensation of environmental acoustic anomalies including Secondary Reflection Correction™ automatically take the room issues out of the equation*.

The accuracy and control are astounding but the results are even more delicious. Hi-powered, real compression driver horn, incredible software control, unparalleled translation, 13-ply Baltic Birch cabinet ... a small 13" cubed 8" 2-way monitor with no compromises. The Q8s - they just may be the last set of monitors you ever need.

Zero-Point Reference, Digitally-Controlled Transducers and Secondary-Reflection Correction are Trademarks of Equator Audio Research

*Automated SRC Software & Mic optional - Manual Control Software Included

www.equatoraudio.com



equator
audio research



vintageking.com

new | used | vintage

FROM THE BASEMENT TO THE BIG LEAGUES

Shopping for studio equipment can be overwhelming. Don't know where to start? Call us today for friendly, expert advice. We offer the widest array of pro audio recording equipment in the world and our customer service is second to none.

So whether you own a small project studio or a world renowned mastering house, let Vintage King Audio be your creative partner!

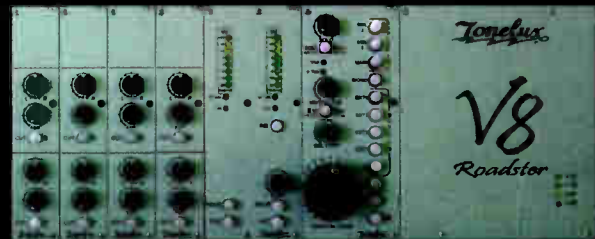

Tonelux Mixers

Mixers with real tone - from 8 slot with a handle to 96 input desks. Mic pres, EQ's, Compression, Fader Automation. From legendary mixer designer Paul Wolff.
(8x2 mixer with control room pictured)



Solid State Logic Matrix

Matrix is a SuperAnalogue™ 16 channel, 40 input mixing console with inbuilt signal router and multi-layer digital workstation control. In use it's simply the most elegant way to be creative with your entire arsenal of analogue outboard and cutting-edge digital equipment. Let us quote you on a complete turnkey system bundle with patch bay/cabling, DAW, outboard mic pre's and eq's, monitors and headphone system. We can arrange complete system install and configuration on site. Give us a call today to discuss your specific needs.

Solid State Logic
SOUND | VISION



A Designs Pacifica Solid State Stereo Mic Pre

"The Pacifica has the depth of the Neve, the top end of a GML and the punch of the API - all rolled into one great mic pre."

- Tony Shepperd



Weiss ADC2 A/D Converter w/Firewire Option

The Weiss ADC2 has the ability to capture the highest level of detail while keeping the tonal integrity of any instrument the best that I have heard. The ADC2 is my favorite converter."

- Helik Hadar



"Bill Me Later" is subject to credit approval as determined by the lender. CIT Bank, Salt Lake City, Utah, is governed by Utah and Federal Law, and is available to US customers who are of legal age in their state of residence. See website for important disclosures about payment amounts and terms.

STUDIO STANDARDS
 VINTAGE CLASSICS
 CUTTING EDGE DIGITAL
 RECORDING CONSOLES
 DIGITAL CONTROL SURFACES
 PATCHBAYS AND CABLING
 TURNKEY PACKAGES
 STUDIO INSTALLATIONS
 MASTERING
 LEASING



Shadow Hills Mono GAMA 500 Series Mic Pre

Centered around Shadow Hill's custom discrete op-amp, the Mono GAMA's no-compromise design exudes hugeness, fidelity, punchiness and depth, across the full frequency range, without becoming veiled or choked, the way non-discrete varieties can.

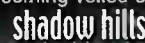

Pay Later! Bill Later
 Subject to credit approval

FREE SHIPPING!
 When you order online



Telefunken | USA Ela M 251E System

Already acknowledged as identical to the original by leading recording engineers, Telefunken | USA has spared no expense in meticulously reproducing, to original historical specifications, the legendary Telefunken Ela M 251.



Prism Sound Orpheus Firewire Interface

All-in-one firewire interface solution for your DAW. Includes 8 channel AD/DA, 4 mic preamps, and "Over-killer" limiters on every channel, along with a host of other cutting edge features.



Audio Accessories Shorti Patchbay

Professional quality 2x48 audio patchbay terminated to DB25's. Pinned out to allow direct connection to ProTools and other popular pro audio gear. Quick-Switches on rear of unit to allow reconfigurable normals and grounds.



Bricasti Design Model 7 Stereo Reverb

With a deep appreciation of the best designs which precede it, and a passion for moving the science of reverberation forward, the Model 7 provides a palette of sounds that encompass the familiar as well as new expressions in the art.



D.W. Fearn VT-15 Vacuum Tube Amplifier

The VT-15 Vacuum Tube Recording Channel combines the mic pre from the D.W. Fearn VT-2, and the DI input functionality of the new VT-3, plus the acclaimed dynamics control of the VT-7 Compressor, and the most-often used features of the VT-4 Equalizer.



Barefoot Sound MicroMain27

Nearfield. Main. Mastering. In one. The Barefoot MicroMain27 is a ground-breaking active monitor that lets you hear what's really happening in your mixes from top to bottom.



877.841.7779 | info@vintageking.com

vintageking.com

Bon Jovi

TRIED-AND-TRUE MIX TECHNIQUES
FOR ARENA ROCK LEGENDS



PHOTOS: STEVE JENNINGS



At FOH, from left: Chris Daughtry FOH engineer Mo Russell, Bon Jovi FOH engineer David Eisenhauer and crew chief/systems engineer Mike Allison

By David John Farinella

When David Eisenhauer got the call in October of 2007 to mix 10 Bon Jovi shows at the new Prudential Center in New Jersey, he thought it would be a short, fun reunion with old friends; he has worked with this band on and off for the past nine years. Six months later, Eisenhauer and the rest of the production crew are still at it; they have spun through the States, into Canada, over to Japan and across Europe, and they are readying for a final run through venues in the States this month. The shows continually sell out, too; fans are still clamoring for the the rock intensity of vocalist Jon Bon Jovi, guitarist Richie Sambora, drummer Tico Torres, keyboardist David Bryan, bassist Hugh McDonald, guitarist Bobby Bandiera and violinist Lorenza Ponce; added to that excitement is opening act Daughtry.

"It was just going to be 10 shows, but everyone, Jon [Bon Jovi] especially, was having so much fun with the new record

[*Lost Highway*] that it blossomed into a tour," Eisenhauer says. "It's been arenas in the States, enormo-domes in Japan and outdoor stadiums in Europe."

Given the inherent strains of a spontaneous global tour, Eisenhauer is glad to have benefited from a consistent front-of-house and P.A. package. The supply of Clair Bros. boxes has expanded and contracted to suit the different-sized venues in which the band performs. When the tour pulled into the HP Pavilion in San Jose, Calif., where *Mix* caught up with the crew, the main front hang included 28 Clair Bros. i4s with i4Bs, 16 i4s per side hang and an additional 24 i3s for a rear hang because the show was being sold 360 degrees; there are eight i4s as an additional side hang to cover the rear corners.

One might assume that the tour has stocked that many boxes to push the dBs to mammoth rock 'n' roll levels. However, Eisenhauer points out, "The show isn't that loud. [We brought in the boxes] to get proper coverage to

Ten Good Reasons Why Lynx Aurora Converters are the Tools to add to your Pro Recording System.

LYNX: THE ART OF AUDIO INNOVATION
*Lynx*TEN
1996 2008

Well, maybe 11.

As an owner of a professional recording system, you have made a significant investment to provide world-class audio production for you and your clients. The single most crucial factor is the quality of the converters you choose. In developing the Aurora 8 and Aurora 16 converters, we had your needs in mind. We would like to point out 10, 11, maybe more reasons why Lynx is a great choice for you.

Of course we can't give you all of these reasons in this ad. But, here is just one...

Reason #1 Aurora 16 offers 32 simultaneous channels - sixteen channels of analog I/O and sixteen channels of digital I/O at sample rates up to 192 kHz.

Okay, maybe one more...

Reason #6 The sound / audio quality - Rich, open, transparent. Let your ears give it a try.

So whether you are just starting out, adding channels or upgrading the system, you'll have good reason to try out Lynx Aurora converters.

Lynx
**STUDIO
TECHNOLOGY**

To see the entire list, please go to <http://www.lynxstudio.com/10reasons>.

get high fidelity throughout the arena. We are typically at about 102[dB] A-weighted throughout the show."

The first 10 rows are covered by the front hang of i4s, and four S4s and eight FF2s that are tucked under the stage. "We spent a lot of time making sure that it sounds nice there and hi-fi everywhere," Eisenhauer says. In fact, he takes great care to set up zones at each venue so that fans get a left/right stereo separation no matter where they sit.

ROAD-TESTED FOH

Eisenhauer is using a Midas XL4 console. He says that the band's tones and the nature of the music "screamed out for analog gear. I know a lot of people are jumping on the digital bandwagon, but I love the way the console sounds and I get out of it exactly what I need." Also sitting at FOH is a rack of outboard, complete with a couple TC Electronic M5000 reverbs, Summit Audio and Tube-Tech compressors and a few Empirical Labs Distressors—Eisenhauer's tried-and-true gear. "I know what it sounds like, and most of it I can dial up before I even turn it on and be in the ballpark when I first start seeing inputs on the stage," he says

Bon Jovi's vocal chain runs from a Shure Beta 58A through an Amek Neve 9098 EQ into a Summit TLA-100. Eisenhauer came up with this chain before his first tour and is quick to admit it was influenced by his days in the studio. "When I am tuning the sound system, I try to do the same things that I would do if I were sitting in the studio in front of a pair of Genelecs," he explains. "We spend a lot of time in the afternoon getting the sound system balanced properly, and then I do things across the board that you would do, like in a studio, which is more about sweetening things as opposed to fixing problems."

That said, while the band and crew strive to re-create the subtle touches heard on the band's recordings, all realize there are limitations. "Jon is realistic," Eisenhauer states. "He knows that when you are in an arena with 22,000 people, you are mixing in a hostile environment. At the same time, a lot of these new arenas have acoustical treatments in them and you actually do have a fighting chance to bring out some of the [material's] nuances."

Of course, part of that success requires proper miking, which Eisenhauer believes can be achieved with "non-Gucci-type microphones. For example, Richie [Sambora's guitar rig] has a head that controls what he hears onstage and I have my own Marshall head that I can EQ any way that I want. That head goes into an iso box and I have

MEDIA SERVICES

GO GREEN SAVE GREEN

\$1180.00

4 PANEL CD WALLET

SUMMER SPECIAL

Summer is almost here and with the cost of gas soaring, thinking green isn't a fad anymore... it's a necessity. That is why for our summer special, Media Services is featuring a 4 panel CD wallet on recycled board, printed with 100% vegetable based ink, and a water soluble finish. This package is neatly and carefully stuffed with your CD in any 3 colors of your choosing, and we will actually poly wrap your discs for No Added Cost! Crazy, but we know that you don't like last minute surprises on your bill. Top the whole thing off with a Free Barcode, and you have yourself a green, retail ready package that stands on its own!

*all materials are FSC certified green with at least 30% post consumer waste. Price does not include shipping and is subject to a 5% VAT rate.

CALL TODAY 888.891.9091
VISIT WWW.MEDIAOMAHA.COM

the leaders in cd & dvd manufacturing



I am incredibly impressed by the seemingly contradictory combination of warmth, crispness and definition that was captured by the sE Gemini. It was a beautiful, natural sound - we didn't even use any eq.

Don Was
Rolling Stones, Bob Dylan, Elton John

www.sonicus.net

Emerging producers and studio legends alike are setting aside their classic tools for sE's award-winning product line. Whether it be the dual-tube Gemini or the innovative Reflexion Filter, sE delivers the results that discerning ears demand.





Down in monitor land: tech David Ferretti flanked by monitor engineers Glen Collett (left) and Mike Adams

a [Shure] 57 and a [Sennheiser] 421 in the iso box that is basically my head. Richie's tech will EQ Richie's rig to get it to where it sounds really good to him onstage, and then I can go back and adjust my head, if you will, to whatever I want to make it sound as big in the P.A. as possible."

"INVISIBLE" MONITOR ENGINEERS

If you look under a canvas tent below a video deck under the stage, you will find monitor mixers Glen Collett and Mike Adams. The duo stand back-to-back, with Adams handling all of Sambora's monitors and Collett tackling the rest of the band. Because there isn't a direct sightline to the stage, the two watch the show on monitors.

Adams, who is touring with Bon Jovi for the first time, is using a Midas Heritage 3000 console to mix Sambora's personal ear monitors (Sennheiser EK8-300), wedges (Clair 2X12s for guitar solos and a Clair 12 for vocals) and a rear-fill system (Clair Bros./Showco L3). Outboard gear used at Adams' position includes CBA antenna combiners and a TC Electronic 1128 EQ.

The wedges carry the bulk of the monitor responsibilities, Adams explains, while the personal monitors are there for vocals and cues. "Honestly, [Sambora] is not atypical of any heavy guitar player," Adams says. "I haven't worked with very many guitar players who can really say, 'God, I love wearing ear monitors.' They will do it, and they might even say, 'Yeah, that sounds really good,' but I have never worked with anyone with a guitar in his hand who didn't prefer to have the sound pressure as opposed to it injected into their ear directly."

The rear-fills boast a big, full-band mix with Sambora's guitars on top. That same mix is provided in the down-stage fills, which are only turned up when the guitarist heads to the front of the stage for a solo. "We try to keep the stage as quiet as possible so that I don't get in Glen's way," Adams

reports. "We try to direct everything into an area and keep it that way."

Collett is also working on a Heritage 3000, but he's stocked his outboard racks with Summit tube compressors for the vocals and the violin, and a TC Electronic M5000 for a vocal reverb and an M2000 on snare drum and piano.

All of the mixes he provides (the band except for Sambora) are heard via personal monitors. As far as specific requests, Bon Jovi wants to hear a bit of everything, with an emphasis on pitch and time. "There are not a whole lot of guitars in there, except for his own," Collett describes. "The guitars are there, usually just for the intros and solos, but down quite low. It's mostly piano and drums, and any of the big synth parts. The background vocals are a nice blend of everybody, but down quite low so they don't get in his way."

The rhythm section of Torres and McDonald get what you'd expect: bass and drums with a bit of vocals. Torres has a pair of 18-inch subs tucked behind him and a Thumper under his stool. Bryan, Ponce and Bandiera get their own tracks with vocals.

Personal monitor hardware varies by player, with Bon Jovi, Bryan and Bandiera using Sensaphonics; Torres, McDonald and Ponce on Future Sonics; and Sambora relying on Ultimate Ears. Collett uses Shure PSM 600s for Bon Jovi, Shure PSM 700s for McDonald and Bandiera, and Sennheiser G2s for everyone else.

The goal of the crew, from FOH to monitors, is to stick with what works. "You plug it in and you know what it's going to sound like," Eisenhauer says. "The last thing we want to do, with ticket prices the way they are and with today's audiences being as intelligent as they are, is experiment in front of 20,000 people." ■

David John Farinella is a San Francisco-based writer.

"I've always liked
a beauty with brains."

Josh Homme, Artist/Producer,
Queens of the Stone Age

SIGMA

Active ribbon microphone



 **SONTRONICS**
INSPIRED BY SOUND

for a retailer near you, visit
sontronicsusa.com

Studio 116

If You Have Good Sound, Then the Rest Falls Into Place

The owner and engineers at Studio 116 (Hollywood, www.studio116.net) are, first and foremost, audio aficionados. Rather than jumping to bring in the latest digital console, line array or outboard goodie, owner Philippe Carillo and his team (engineer Tyler Davis, Jon Coyne and a slew of on-hand engineers) focus on what matters most during a gig: the sound. "If you have good sound, you help the artist communicate to the audience," Carillo explains. "The main goal is for the sound engineer to be pretty much 'invisible' to achieve this. If the audience sees that there is a problem, they're going to turn back, and ask, 'Where is the sound engineer?' So if there is no problem and the band arrives onstage and everything is going right, it's an ideal situation."

This ties in nicely to Carillo's adherence to the importance of sound, which he believes is the last thing most customers think about as you can't really see a sound wave. So the folks at Studio 116 maintain a strict adherence to employing top engineers and gear to get the job done right. "You have to be prepared to have the right equipment, have the right people; you have to keep in mind that even if it's done right, problems can happen," Carillo explains. "So with the experience you have, you can figure out what can [go wrong at an event] even if you think everything is good. And when you know that, you can avoid the problem by checking everything."

But that's happening behind the scenes. For the company's more lower-end customers, such as weddings, red-carpet events and the like—and even with some of the more complex gigs—a duty to work side-by-side with the client still reigns as Number One on their to-do list. According to Coyne, "We work for the client: We put a lot of time into planning the event ahead of time. We come to an agreement with the client and then we make their event right no matter what it takes."

"When I'm sound-engineering on a job, it's a selfless position," Coyne continues. "My Number One is the event and the event is my life at that point. Anything it takes to make the event go correctly is my goal. When you're on a crew, it's really selfless in that you're working as one entity to make the event go correctly."

It's this attention to quality sound and detail that has kept the company in high demand in the Hollywood area, but it's interesting to note that Studio 116 hasn't upped the ante with their equipment offerings—yet. While the company keeps a stock supply of Allen & Heath, Yamaha and Soundcraft boards, as well as a full EAW system and Crown amps, the move to digital hasn't really happened. "Digital boards are more suitable for tours and such where you're actually going to go out and do rehearsals," Coyne



Some of the Studio 116 crew (L-R): Tyler Davis, Philippe Carillo, Jon Coyne

explains. "A lot of the stuff we do is really same-day: We go to the site, set up and we may only have that day to operate the event. When we get into more extended periods of time where we're going to be working with clients such as a tour or an installation, we may go digital."

"It's not that we can't handle a digital necessity if that's required," Coyne is quick to point out. "For instance, I just put in a bid for University of Southern California where they require digital boards and I'm going to bid that in because what it comes down to is if that's what's needed for the job, we'll provide that and we'll find a way to make that work. It's not something we use all the time because right now it's not necessary, but we are getting to that level where it will be."

Always looking toward expanding the business, Studio 116 recently opened a recording studio in the same facility. Carillo, who has experience as a studio engineer, designed the room, which has hosted dates with big-name gospel/R&B artists, including Angie Stone, Warren Campbell and PK Carter.

"We're family," Davis adds. "We communicate and have everything flow in one space. We run one of our Soundcraft boards using the pre's from that and using that to monitor with Delta SR Series. We also use a variety of rackmount preamps: PreSonus, Alesis FireWire A/D, which goes into either Logic or Pro Tools. We're fully digital, although we do have a 2-track mastering deck." Monitoring is via Event 20/20s, Blue Skys, Tannoys and ADAM mains.

"What [artists] love about the studio is it's very different from 'Hollywood' studios; it's in the foothills of L.A. and we have windows in the studio where you can see the sunset," Davis continues. "We designed it with sound in mind." ■

Sarah Benzuly is the group managing editor at Mix, EM and Remix magazines.

Lexicon Reinvents Reverb



Now Shipping!

PCM96 Stereo Reverb/Effects Processor

28 New and legendary Lexicon reverbs and effects delivered by powerful hardware processors, controlled and automated by your DAW.

Get the full story at www.lexiconpro.com

Lexicon[®]

Harman International Company

©2008 Harman International Industries Incorporated. All Rights Reserved.

World Radio History

New Sound Reinforcement Products

POWERSOFT K3 DIGITAL POWER AMP

Powersoft (www.powersoft-audio.com) expands its flagship Digam K Series with the ultracompact, single-rackspace K3 power amp, measuring 14 inches deep and weighing only 17.6 pounds—yet delivering 800 watts/channel @ 2 ohms. The K3 also features a digital gain-attenuator control, user-selectable maximum output power for each channel, and Power Factor Correction (PFC) for low power consumption and wide mains operating range. An interactive, front panel LCD matrix shows load impedance, output power and mains voltage measurements for each channel, while a variable-speed fan reduces noise. The K3's built-in remote control (RS-485 interface) offers full diagnostic, operational setting and system monitoring with Smart Card parameter storage. Options include built-in DSP and Ethernet control via Powersoft's KAESOP protocol, and proprietary Audio Suite software.



KLEIN + HUMMEL INSTALL LOUDSPEAKERS

Intended for mid- to large-sized music venues, new install speakers from Klein + Hummel (www.klein-hummel.com) feature precise pattern control and wide frequency response. The IS-122 is a 12-inch/two-way design; the 12-inch IS-123 and 15-inch IS-153 are three-way systems. Each was designed with Mathematically Modeled Dispersion™ technology for optimum coverage control and smooth arrayability with rotatable horn patterns in 80x50 and 50x40 formats. A modular, removable back-plate system can be factory-ordered or field-swapped with a passive crossover, wired for external bi-amping or in a self-powered version with DSP tunings optimized by Klein + Hummel. A single Cat-5 cable distributes digital audio to powered speakers while providing integrated remote control and monitoring when used with the company's K8 system.



AVLEX SUPERLUX D108A VOCAL MIC

The Superlux D108A (S64) from Avlex (www.avlex.com) is a handheld vocal mic with a dynamic capsule in an all-metal, shock-resistant housing with a foam-mesh grille. The mic's supercardioid element is designed to provide off-axis rejection and high gain-before-feedback. Offering a flat (50-16k Hz) frequency response and a proximity effect optimized for the performing vocalist, the D108A also has a built-in locking plate to ensure the switch remains in the on position.

CREST X SERIES MIXERS

The successor to the X-Rack Series, the X Series rackmount mixers from Crest (www.crestaudio.com) offer the same features as their predecessors and are available in four new models

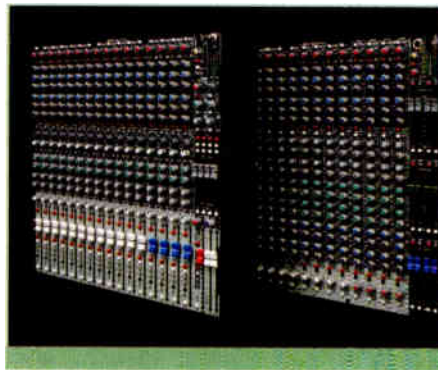

with improved performance. Units are available with up to 14 mono and up to four stereo inputs, long-throw faders, 4-band semi-parametric EQ, channel inserts and low-noise mic preamps. The X18R and X20R have six configurable aux buses and three main buses for front-of-house mixing, while the X18RM and X20RM have up to 12 mono or six stereo mix buses for floor or in-ear monitoring. Integral monitor and tape-level outputs provide additional flexibility.

MARTIN AUDIO W8VDQ

The W8VDQ compact, three-way system from Martin Audio (www.martin-audio.com) combines line array and differential-dispersion technologies to provide even coverage over wide angles and throw distances, with a short-throw horizontal dispersion of 120° narrowing to 100° as the throw increases. The vertical differential directivity (VDQ) creates progressively more HF output as throw distance increases. The resulting dispersion pattern is suited to covering audiences located on flat or gradually sloping surfaces. Designed for passive or bi-amp operation—combining a Hybrid™ quad 8-inch LF and MF configuration with quad 1-inch HF—the all-horn-loaded system achieves 131dB/continuous SPLs or 137dB/peak. Options include the WMX, WS18X and WS218X subwoofers.



WHARFEDALE PRO S SERIES AMPS

Now available in the U.S. through American Music & Sound (www.americanmusicandsound.com) is the entire Wharfedale Pro (www.wharfedalepro.com) line, including the new S-Series dual-channel amps. The S Series comprises three models—S-1000, S-1500 and S-2500. All are two-rackspace designs with identical layouts, differing only in output power. The front panel has LED indicators for power, protect, bridge, peak and signal presence, along with a power switch and volume pots for the input channels. Rear panel mode switches offer selection of signal limiting, low-cut filter set/frequency selection, stereo and mono input modes, and output bridging. Inputs are XLR and ¼-inch TRS, along with 4-pin, NL-4-style Speakon and binding post outputs.

The Breakthrough Live Mixing and Recording Solution

Digital Snake
S-1608 Digital Audio Transfer System

V-Mixer
M-400 Live Mixing Console

V-Mixing System



Mix Magazine
Certified Hit: S-4000



Radio World
Cool Stuff Award: S-1608



ProAudio Review
PAR Excellence: V-Mixing System

REAC
Roland Ethernet
Audio Communication

More than a digital console... it's a system.

System Solution

- Configurable Digital Snakes
- 48-Channel Digital Mixing Console
- 40-Channel Multi-track Recording
- Cat5e or Fiber Audio Distribution

Easy To Learn, Easy to Use

- Dedicated Knobs
- Intuitive Graphical User Interface
- Easy Transition from Analog Consoles
- Onboard Help
- Bright TFT LCD Display

Outstanding Sound Quality

- 24-Bit Digital Audio
- Remote Controllable Pristine Preamps
- Roland's Best Digital Effects

Powerful Digital Benefits

- Built-in Effects
- Record to USB Flash Memory
- Stored Scenes With Instant Recall
- User Accounts with Password Level Protection

SONAR
REAC RECORDING SYSTEM

Live Multi-Track Recording

- Record Up to 40 Channels of Audio Using Cat5e
- Connect to Computer Gigabit Network Port
- Capture, Mix Down, Master, Deliver

REAC Fiber Option for Long Distance Audio Distribution



Extend audio distribution up to 2 km (1.2 miles) over fiber optic cable with the RSS S-OPT REAC Optical Converter.

Roland
System Group

Get More information Online
www.V-MixingSystem.com
800.380.2580

REAC
by Roland

Eureka Moments

Unlocking a Vintage Console's Long-Hidden Secret

In geekville, there are those pesky pieces of gear that don't want to be fixed, and then, "Eureka!"—the mystery is solved. A year ago, a 12-input, 1970s-era Raindirk portable recording desk (pictured at right) arrived from an owner willing to invest in both the shipping and repair charges. I usually discourage such things, but some combination of temporary insanity and a piqued curiosity made me say, "Yes." I never envisioned it would take a whole year, but hopefully, desk and owner will be happily reunited by the time you read this.

This particular Raindirk is a rare and curious beastie, a hybrid of discrete and op amp circuitry designed into a location mixer capable of both AC and battery operation.

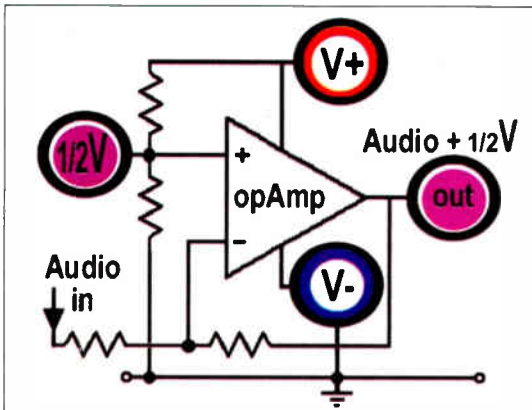

Figure 1: Running an op amp on a single-ended power supply requires a voltage divider to "tell" (bias) the op amp to live in the middle—where "ground" (common) is in a bipolar environment.

The owner had upgraded the op amps and meticulously replaced all of the electrolytic caps with Nichicon's Muse Series. Then I came in to tame the quirks. The initial job was as simple as fixing dead channels—the few broken wires on each channel strip were easier to find than the funky pins on the Penny & Giles faders.

MYSTERY ONE: TRANSMITTER OR AUDIO DEVICE?

One obstacle to upgrading op amps is that their extended high-frequency response at high gain settings can emphasize other shortcomings in the design, like the circuit board



layout or power distribution. Troubleshooting Mystery One's asymmetrical headroom issues revealed oscillation when cranking the gain and/or boosting the HF EQ. The typical approach to solving oscillation is adding power supply bypass capacitors (0.1 μF to 10 μF , and sometimes both) at the IC sockets, which reduced the problem but didn't eliminate it.

As the console was designed for battery operation, the power supply is single-ended—just \pm (ground) rails—which is typical in Class-A circuitry like the Neve 1073 and 1272 modules. To work in this environment, op amps must be biased halfway between the supply rails with a matched pair of resistors (Fig. 1) configured to make a voltage divider. Checking each channel's behavior at clipping revealed an inclination to oscillate that wasn't due to resistor tolerance. In fact, the console has a mix of 2- and 5-percent resistors, and—judging by the range of values found—some were hand-selected.

The two op amps in each channel strip were responsible for the mic line gain trim and the EQ network. As such, they were designed to drive a 600-ohm load at the insert point, which was still very common at that time. The original dual op amp, a 14-pin TBA231 (UA739), was not really capable of driving a 600-ohm load, so it was buffered by a transistor configured as an emitter follower for current gain (power) rather than for voltage gain.

The transistor was now unnecessary—and part of the

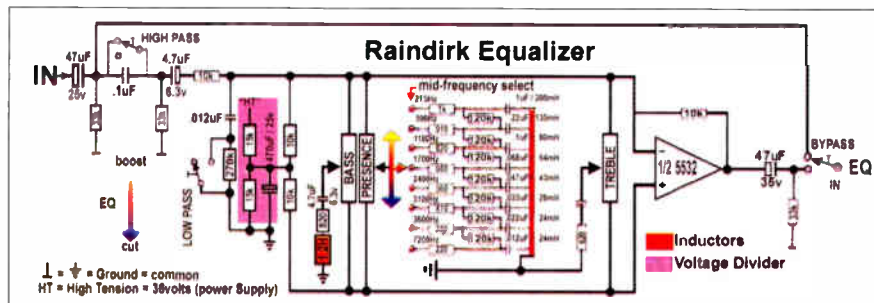
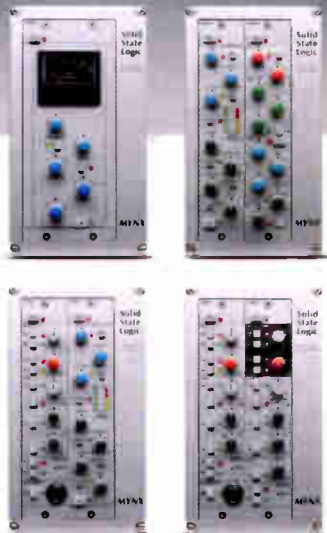

Figure 2: The Raindirk EQ has fixed low/high bands, a stepped midrange, and simple low- and highpass filters.

Mynx

It's part of something bigger...



Mynx has a two X-Rack module capacity. Modules are sold separately.

Based on our award-winning X-Rack system and using identical circuitry to our acclaimed Duality and AWS 900+ consoles, Mynx makes the hit-making SSL SuperAnalogue™ sound more accessible than ever.

Capable of housing two X-Rack modules, Mynx can be used to create a range of recording and mixing tools designed to dramatically enhance your DAW recordings. Combine the 'SuperAnalogue Mic Pre' and 'Dynamics' modules for a pristine front-end recording system for vocals. Slot in the 'EQ' and 'Dynamics' modules for classic SSL channel strip processing. Fit the Stereo Bus Compressor module for our legendary full mix compression. Or load the 'Master Bus' and 'Line Input' modules to create an analogue monitor & foldback system for your studio.

Discover Mynx and the full range of modules at www.solid-state-logic.com

Mynx. This is SSL.

Solid State Logic
S O U N D | | V I S I O N

headroom/oscillation problem—so it was removed and replaced with a piece of copper that became a convenient place to hook an oscilloscope probe. I also chose to reduce the op amp's gain by just enough to ensure stability, even with "wild" EQ settings.

MYSTERY TWO: THE LOW CEILING

Under real-world conditions, the console still seemed to be plagued by what turned out to be two additional and completely separate headroom issues. For this reason, I'd been running the console's gain structure to favor

headroom over noise, making up gain with a compressor/limiter after the main stereo outputs. The first problem was "simply" an intermittent section in the power supply.

The console runs on 36 volts—or three 12V car batteries in series—which, when divided in half (for the op amps), simulates the more typical bipolar configuration of $\pm 18V$. Inside the power supply chassis were three supplies, two of which were wired in series to make the 36 volts, the other unused. Somewhere in transit, a wire had been weakened and eventually broke loose, reducing the 36V

supply to 24V and resulting in a 3.5dB headroom loss.

MYSTERY THREE: SLOW ON THE FAST CURVES

Used in session, the Raindirk behaved relatively well, the talkback being more useful than the EQ. (The midrange EQ bandwidth was far too narrow, and the starting point of the HF shelf seemed too low.) Again, there seemed to be a headroom issue at high frequencies, which was most noticeable on sibilance when trying to add a little "air." Again, I solved this problem using external EQ on the mix bus.

THE EQ DETOUR

While modifying the EQ wasn't part of the original assignment, it *is* one of the key reasons for choosing a console and one reason I investigated the possibility of tweaking. As the console's peak program meters (PPM) were a bit flakey, I initially chose to monitor the console's output using the VU meters on an Otari MTR-10 2-track.

Boosting the treble pot all the way and sweeping a sine wave oscillator yielded a "bump" around 7 kHz, a clue that confirmed what I had heard in-session. This seemed odd because there were no "bandwidth-related" components in the treble-EQ circuit—at least I didn't see any on the various schematics, all of which were similar to the actual circuit but never completely accurate.

Switching to a square wave oscillator and monitoring the channel strip and the mix bus via 'scope revealed another clue: much better square waves on the former compared to the latter. Boosting the treble exacerbated the problem to the point where pursuit of any HF EQ mods was temporarily abandoned. I could at least explore the mid-band EQ.

Note: A perfect square wave is so "vertically fast" (the rise time) as to be nearly invisible, leaving only the top and bottom "horizontal lines" representing the fundamental. As the rise time is at least 10x the fundamental, it's possible to "see" EQ and even more subtle anomalies, like the effect of cable capacitance on a high-impedance circuit or amplifier slew-limiting at high-level swings. A 1kHz square wave is a useful test signal, albeit hardly one that you'd want to listen to.

CALL IN THE PARAMETRICS

Thanks to George Massenburg and Burgess MacNeil, we now take for granted equalizers that have the ability to continuously sweep frequencies. Previously, multifrequency EQs like Pultec and Neve required switches and inductors (resonant coils of

SENNHEISER

Musical Match
MKH 8000 Series Modular Microphones

Lou Mannarino of L&M Sound Design knows it takes a master microphone to faithfully reproduce a musical masterpiece. Lou relies on our MKH 8000 series to accentuate the already spectacular sounds of the New York Philharmonic. Our compact, modular mics are discreetly placed on-stage, lending subtle personality and warmth to the live mix. The MKH 8000 series mics feature special symmetrical capsules that eliminate transducer non-linearity while providing exceptionally low self-noise, accurate directional patterns, extended high frequency response, and much more.

www.sennheiserusa.com

Sennheiser Electronic Corp. • Tel 860-434-9190 • Latin America: Tel 52-55-5638-1020 • Canada: Tel 514-426-3013 • www.sennheiser.ca

MKH 8020 Omnidirectional MKH 8040 Cardioid MKH 8050 SuperCardioid

wire) in addition to resistor-capacitor (RC) networks. Many op amps are required to achieve Massenburg and MacNeil's parametric EQ magic. By contrast, the Raindirk has only one op amp available, so its designers chose to use inductors for the low- and mid frequency EQ. The mid inductor was particularly elaborate in that it had "taps" for each frequency. Similar inductors are available from Sowter (www.sowter.co.uk) for about \$80 each.

I knew that the solution to the Raindirk's narrow mid Q had to be simple or it wasn't going to happen. If easy, then it might be possible to modify the front panel with a pot and/or switch. As all of the taps on the inductor were in series, my instinct was to put a resistor across the whole thing, which worked out nicely. (See Fig. 2.)

MYSTERY REDUX: A-HAI

Back to the HF equalizer and the treble-related headroom issue. I was simultaneously monitoring the channel strip module and the mix-bus signals. The square wave revealed a severe "speed" limitation that turned into slew-limiting as the signal approached its maximum peak-to-peak level. With little accurate documentation avail-

able, it was necessary to open a cable harness to trace the signal flow.

The Raindirk's two aux-return modules contain mono versions of the ADR model 760R, a FET-based signal processor known as the Compex limiter (because the rack version includes an expander). On each module, a switch routes the Compex to either the stereo bus or to a patch point on the console's rear panel. Choosing the latter solved the "speed" issue, indicating that the problem was in the 760R's circuitry—specifically, its output amplifier, which is used even when the processing is bypassed.

MISCHIEF MANAGED

Once the problem was localized, I blew up that portion of the schematic, surveying all of the possible causes. I lifted one cap sitting on the output (used to keep RF from entering the feedback loop). When it did nothing, I had my assistant try the 3.3 picofarad (pF) cap (see Fig. 3); it's between the base and the collector of that transistor and guess what? The "Eureka" moment! Two caps in that application are not likely to fail. Looking closely at the pulled cap, it was labeled 332, which is 33 plus two zeros, or 3,300 pF! To be off by a factor of 1,000, obviously a mistake was

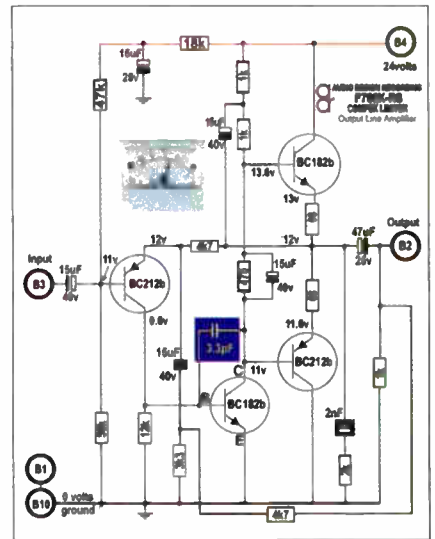



Figure 3: One tiny portion of the Compex limiter's circuitry—the output amp—with a highlighted capacitor that was off by a factor of 1,000 (on both channels).

made during the assembly process that only took some 30-plus years to troubleshoot. ■

For more geek fun, visit Eddie online at www.tangible-technology.com.

NO COMPROMISES

PRE420
4 Channel Mic-Pre/Mixer



ADC1 USB
2-Channel 24-bit 192kHz A/D Converter



NEW DAC1 PRE
Stereo Pre-Amplifier / DAC / Headphone Amp



ADC1 USB and DAC1 USB
2007 ProAudio Review
PAA Excellence Award

PRE420
2007 ProAudio Review
Reviewer's Pick



Benchmark

...the measure of excellence!

www.BenchmarkMedia.com/mix
800-BNCHMRK (262-4675)

Benchmark has developed a family of audio tools that never compromise: the **PRE420** microphone preamplifier; the **ADC1 USB** A-to-D converter; and the **DAC1 PRE** D-to-A converter.

Benchmark products set the standard for performance and reliability. Engineers have praised our mic-preamps for their breath-taking realism, true-to-life detail, and consistent performance - even in harsh RF environments. Our digital converter technology has become the benchmark of absolute accuracy due to the jitter-immune UltraLock™ clocking system, intelligent circuit layout, and pristine analog sections.

All **Benchmark** products are designed, assembled, and tested in Syracuse, New York, USA, by a team that is committed to quality craftsmanship and tireless customer support.

The **PRE420** is a 4-channel mic-preamp with a plethora of features, including built-in, independent stereo mix and solo busses.

The **ADC1 USB** is a reference-quality, 2-channel, 24-bit, 192-kHz A-to-D converter. The UltraLock™ clocking system delivers unvarying mastering-quality performance - regardless of clock source.

The **DAC1 PRE** is a reference-quality, 2-channel, 24-bit, 192-kHz D-to-A converter. The **DAC1 PRE** continues the legacy of the **DAC1**, which has become a staple of control rooms around the world. The AdvancedUSB™ input supports native 96 kHz, 24-bit operation without cumbersome or invasive driver software.

Superior performance, reliability, and indispensable features have made **Benchmark** products absolute studio essentials.

Tools of the Trade



UNIVERSAL AUDIO 710 TWIN-FINITY

Dual-path, single-channel, tube/solid-state preamps are nothing new, but the ability to continuously vary the amount of either path in your "mix" is a handy new innovation. Universal Audio's (www.uaudio.com) 710 Twin-Finity (\$999) tone-blending preamp features a knob that's continuously variable from 100 percent tube to 100 percent solid-state, offering myriad tonal options. The unit offers Class-A design, boasting high headroom, more than 70 dB of gain, a phantom-powered mic preamp and a DI input. It comes in a single-rackspace metal chassis and includes a rack kit.

SPL PHONITOR MONITORING AMP

Wanting to be your monitoring "everything," SPL's (www.spl-usa.com) Phonitor (\$2,149) is a high-end headphone-monitoring amplifier based on the 120-volt rail technology initially developed for SPL's Mastering Series. The Phonitor offers new parameters such as crossfeed, speaker angle and center level to control sound impressions in a way that compares to using speakers in a room.



GENELEC 6010A/5040A

Genelec (www.genelec.com) has announced its smallest speaker system to date (prices TBA): The 6010A is just 7x4.75x4.5 inches and is designed for computer sound systems, workstations and other close-proximity listening applications requiring a low-profile monitoring solution. The two-way active monitors resemble the cabinet



geometry of the company's other recent builds, using a die-cast, all-aluminum Minimum Diffraction Enclosure™ (MDE). Each monitor features a 3-inch bass driver and a 3/4-inch tweeter, and boasts a frequency response of 74 to 18k Hz (± 2.5 dB). The

companion 5040A active subwoofer (pictured) extends the LF response to 35 Hz, and offers volume control of five main input/output channels and a dedicated LFE channel with reproduction bandwidth that's selectable at 35/120 Hz, making it an all-in 5.1 solution with a small footprint.



HOLOPHONE N-CODE, D-CODE

Holophone (www.holophone.com) has brought Dolby Pro Logic II encoding technology to its larger mic models with the release of the N-CODE (\$1,499) portable multichannel companion encoder. The low-profile box takes six channels of audio from the Holophone H2-PRO or H3-D mics and, using Dolby Pro Logic II technology, converts them to two channels. This allows the user to capture or transmit full 5.1-channel surround sound audio to be captured or transmitted to virtually any stereo recording device or broadcast over an existing stereo infrastructure. The N-CODE provides 48V phantom power through six mic preamps and is battery-powered. The Holophone D-CODE multichannel decoder (\$599) converts the two channels encoded by the N-CODE into six discrete channels of decoded audio, which are then delivered via six RCA outputs or multichannel USB directly to a computer.

SENNHEISER MKH 800 TWIN

The MKH 800 Twin (\$3,356) microphone from Sennheiser (www.sennheiserusa.com) lives up to its name by offering a dual capsule comprising two symmetrical push-pull transducers. The signals of both transducers are





available separately as two channels at the microphone output, which allows remote adjustment of the mic's pickup pattern. The signals can be combined in any desired way in the mixing console to create polar patterns ranging from omnidirectional to figure-8, with an infinite number of intermediate stages—even after recording. The mic ships with a stand clamp, shock-mount, breakout adapter cable and aluminum transport case.

umes can also be used for recording and playback, with all three storage media selectable for simultaneous, redundant recording. Other features include a time-code generator, selectable word clock sync source and more. The unit's LCD is viewable in all lighting conditions, including direct sunlight. Additionally, the LEDs are dimmer-adjustable for any lighting condition, including a lights-out setting for blacked-out sets.

IZOTOPE ANR-B

The 2-channel ANR-B (\$4,995) real-time noise-reduction box from iZotope (www.izotope.com) intelligently identifies and then suppresses environmental broadband noise, hum, phone line artifacts and more. The ANR-B features analog and digital I/O, LAN for advanced parameter control (using a Windows/Mac host) and remote automation capability. Presets are available for common applications, while dedicated controls and meters allow the user to customize settings quickly for unique situations. ANR-B is designed to determine a noise print automatically, and its manual-learn function enables the unit to reduce noise of a specific trained profile.



SOUND DEVICES 788T RECORDER

The 788T (\$5,995) is the latest portable multitrack location production recorder from Sound Devices (www.sounddevices.com), offering eight mic inputs that record to a 160GB internal SATA hard disk providing up to 30 hours of uncompressed 24-bit, 8-track recording. CompactFlash cards with UDMA support and external FireWire mass-storage vol-

KRK SYSTEMS ROKIT G2 SPEAKERS

KRK's (www.krksys.com) Rokit G2 speakers are the second generation of the company's Rokit speakers, and replace the current 5, 6 and 8-inch Rokit models. The Rokit G2 speaker incorporates several technologies from the company's flagship VXT and E8B lines, including radically radiused edges along the front of the cabinet. The Rokit G2's curved front baffle was engineered to minimize diffraction of high frequencies for a larger sweet spot. The baffle also houses a molded front-facing bass port that minimizes low-frequency phase distortion



FOCAL CMS ACTIVE NEAR-FIELD MONITORS

Focal Professional's (www.focalprofessional.com) new CMS 65 (\$995) and CMS 50 (\$695) monitors feature die-cast aluminum cabinets housing inverted-dome aluminium/magnesium tweeters boasting lightweight mass and superb damping. The Polyglass bass driver combines hollow microscopic



and the unwanted frequency emphasis that is common in rear-ported designs. Rokit G2 models have MAP prices of \$149, \$199 and \$249 for the 5, 6 and 8-inch versions, respectively.

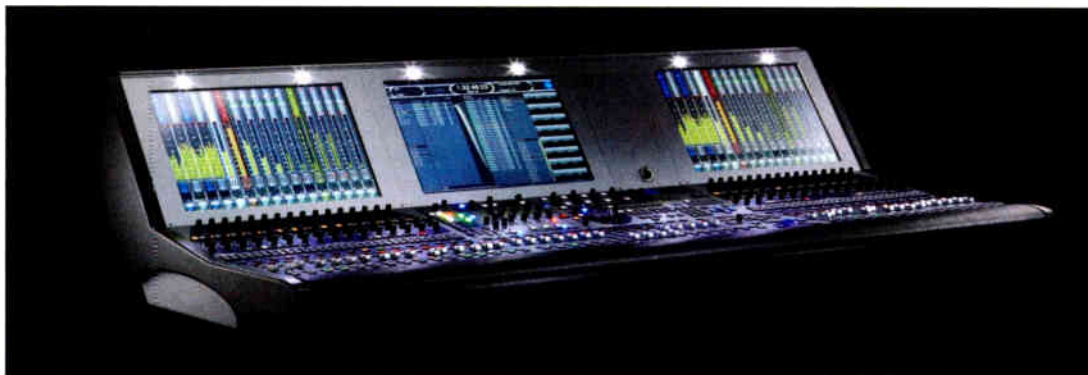

company's original FruityLoops. The latest version has an improved interface and sound engine, and a revised mixer. It adds pattern clips to the playlist, and includes a suite of new plug-ins and updates to many others. Plug-ins include SynthMaker, which lets users

balls of glass to a pulp cellulose cone with an impressive rigidity vs. mass ratio. The CMS 65 is powered by 165 watts while the CMS 50 is powered by 130W, and each model benefits from the smoother sound of two high-end, Class-A/B amps. Other features include separate HF and LF shelving adjustments, a Desktop Notch correction filter for controlling first reflections in applications where the speakers are located over the mixing board, a rubber decoupling stand, and spikes for tilting the speakers and adjusting soundstage height.

return (for recording, playback and effects on a PC or Mac), dual-stereo input capability and advanced monitoring facilities. The 16 mono channel strips on the Zed-24 (\$799) are complemented by four stereo channels, each with a main stereo input on jack sockets, and with the ability to take additional stereo inputs from phono sockets or from the USB audio input, enabling the engineer to control and route any source. Other features include a 3-band swept-mid EQ, DuoPre™ preamps and Cakewalk's SONAR LE music production software.

create their own virtual instruments: Slicex, a drum-loop slicer/re-arranging tool; Fruity Limiter; Maximus maximizer; Wave Candy audio analyzer; and the Poizone 2 subtractive performance synth. FL Studio 8 supports VST/VSTi/VST2, DXi, DXi2, MP3, WAV, OGG, MIDI, ASIO and ASIO 2 formats, and is additionally supported through DirectWave Editor. It's available in four editions: Express (\$49, download only), FruityLoops (\$99 download, \$139 boxed), Producer (\$199 download, \$269 boxed) and XXL (\$299 download, \$399 boxed).

LAWO MC²56 CONSOLE

Lawo (www.lawo.de) has released a new addition to its mc² Series consoles. The mc²56 (price depends on size configuration) features the Lawo HD core with up to 512 DSP channels, 144 summing buses and a routing capacity of up to 8,192 cross-points. The mc²56 supports complete cross-compatibility with the mc² Series, including the transfer of snapshots, as well as dynamic automation and network-

ing with other Lawo products. The redesigned control surface relegates rarely used functions to the touch-screen graphical user interface. Every 16-fader bay offers fully featured metering on a high-resolution TFT display. It comes in frame sizes from 32 to 80 faders and special flight-case versions, making the console's small footprint suitable for remote applications where space is tight.

IMAGE LINE SOFTWARE FL STUDIO 8

FL Studio 8 from Image Line Software (www.flstudio.com) offers a pedigree stretching back to the

STERLING MODULAR SYSTEMS GEAR POD STUDIO RACK

Looking like R2D2's square cousin, the 12-rackspace Gear Pod (\$399) from Sterling (www.sterlingmodular.com) is set on heavy-duty, powder-coated steel legs that support a Thermofoil-treated cabinet that's vented for ample air flow and slotted for cable management, and can be set at angles of 0 to 20 degrees. Casters are optional. ■



BLUE CAT AUDIO TRIPLE EQ SERIES

Blue Cat's (www.bluecataudio.com) Triple EQ Series is a set of three hybrid parametric EQ/filter plug-ins that feature a streamlined user interface, zooming, frequency response measurement, window-opacity management, noiseless bypass and undo/redo. Blue Cat's Triple EQ is free; the EQ Pack is \$55.66, the Stereo Triple EQ is \$35 and the Widening Triple EQ is \$47.07.

ALLEN & HEATH'S ZED-24 MIXER

This small-format, USB-equipped mixer from Allen & Heath (www.allen-heath.com) offers 23 independent sources to the mix, 10 independent outputs, four aux sends (two pre/two post-fader), a USB send and

Give your studio a new heart



Solid State Logic
SOUND | VISION



Control your DAW

- 16 +1 Fader Controller
- Plug-in control
- Ethernet DAW connection
- Control up to 4 DAWs simultaneously
- Programmable Soft-Keys
- DAW automation control of Matrix

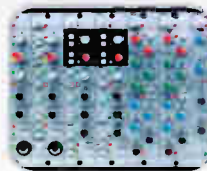

Integrate your outboard

- Advanced 32 x 16 x 16 routing matrix
- SuperAnalogue™ router to manage the sends and returns of sixteen outboard processor units
- Save FX chains and set-ups
- Full control via PC application

An SSL console at the heart of your studio. Focusing your creativity and streamlining workflow. Seamlessly integrating your outboard analogue equipment within a powerful routing matrix. Elegant control of up to four DAWs simultaneously. And a first-class SSL mix surface.

Matrix. This is SSL.

The future of the project studio is Matrix. Call a Sweetwater Sales Engineer and see the future today.

1-800-222-4700

Sweetwater
Music Instruments & Pro Audio

Roland Systems Group V-Mixer Live Console

24-Fader/48-Input Desk With DSP and Digital Snake

Two years ago, Roland first entered into the live sound market with the RSS Digital Snake. Since then, the company has been quietly developing a small-format digital console using some of the RSS' technology. The Roland V-Mixer includes the M-400 desk, whose simple looks and small footprint belie the fact that much lies beneath the surface. The mixer communicates audio control via two Cat-5e cables to the remote S-1608 or S-3208 stage boxes, which comprise 16 or 32 phantom-powered mic or line inputs and eight outputs. The scalable and affordable system offers all the bells and whistles you'd expect from a digital board.

FROM THE TOP

The M-400 features 25 motorized, 100mm touch-sensitive faders and a large 800x480 TFT color screen with eight corresponding soft keys underneath for choosing various screen-driven options. I was impressed by the screen's readability—even off-axis or in bright light. At 29x24x9 inches (WxDxH) and weighing 29 pounds, this is not a large console and is perfect for applications where space is a factor. The 24 faders are bankable in four layers: channels 1 to 24, channels 25 to 48, 16 auxes/eight DCAs and a user-definable layer. The desk's fader module section offers what you'd expect: Apart from the fader, there's mute and solo buttons, 7-position LED meter and a channel-select button that directs the channel's settings to the screen. I liked the Touch-Select option, which sends the channel automatically to the screen simply by touching the fader. You can also set the fader's sensitivity to adjust the amount of "touch" it takes to make the system jump to the selected channel.

The left side of the desk offers hardware control of the software processors and other channel strip functions. If you want to adjust the EQ, simply select a channel,

hit the On button in the equalizer section and start tweaking. There are dedicated gain and frequency controls for the low and high bands, plus Q control for the two mid-bands. This type of master channel setup lets you control the software processors using one knob per function, plus you get a nice, bright readout of the parameters represented on the screen. You can zoom in on various sections by pushing the DISP button, which brings up a detailed pop-up of the that section.

To the right of the screen are various functions that you'd want at your fingertips, such as cursor navigation, talkback control, mute group recalls, scene memory record/recall and controls for the USB playback/recorder. Speaking of which, the recorder's inputs can be assigned from the aux outs or main outs, with playback coming directly to two channels on the console. The recorder's display gives you source control L and R, record level, two meters, time remaining and destination (your return channels). I found this function especially useful and the output sounded great. You can use it to record the show or playback tracks between acts—all on a simple USB stick.

Although the system maxes out at 48

inputs, it can be purchased in three ways. The Basic (\$10,450) configuration comes with a single S-1608 stage box with 16 inputs and eight outputs; Standard (\$11,995) comprises two S-1608s for 32-channel operation with 16 outs; and Expanded (\$15,495) offers an S-1608 and an S-3208 for 48 total channels of remote input and 16 outs. These inputs can be split off as many times as you'd like (to monitorland, for instance) using a Gigabit router. Keep in mind that there are only 40 channels available digitally; if you want to bring a full 48 inputs back to front of house, you have to use the console's analog inputs.

The V-Mixer's software (PC only) allows you to configure the console offline or run it from a laptop via USB 2, even while someone else is using the console's surface. You can record up to 40 tracks of audio using a Gigabit Ethernet port via Cat-5 to a computer directly into Cakewalk's SONAR REAC software, which carries 40 channels of 96k/24-bit audio, plus MIDI and remote-control data. Remember that the V-Mixer maxes out at 48k/24-bit, but who knows what this portends for the future?



DREAMERS WANTED.



SCHOOL OF RECORDING ARTS

800.226.7625

3300 University Boulevard • Winter Park, FL 32792



Financial aid available to those who qualify • Career development assistance • Accredited School, ACC&CT

DEGREES IN: COMPUTER ANIMATION > DIGITAL ARTS & DESIGN > ENTERTAINMENT BUSINESS > FILM > GAME DEVELOPMENT > RECORDING ARTS > SHOW PRODUCTION & TOURING

ONE OF THE FIVE BEST
MUSIC PROGRAMS
IN THE COUNTRY

- Rolling Stone Magazine

fullsail.com

© 2006 Full Sail Inc. All rights reserved.

World Radio History



The rear of the M-400 looks deceptively simple despite the fact that the V-Mixer can mix and process up to 48 channels of audio.

ABLE-BODIED PROCESSING

The system gives you four stereo effects engines (FX 1 to 4) that can be used as inserts on a channel or in the traditional sense, where you'd send signals from several channels to the effect via an aux send. There are 48 effects presets spanning 11 different effects types and 199 user-definable presets. The four effects can be linked as one stereo effect or split as two mono engines, giving you eight effects total. Within the engine is an inline channel strip effect that gives you an expander/gate/ducker, compressor, de-esser, enhancer, EQ A, EQ B (both are 4-band parametric EQs) and a delay. This can

be inserted across the stereo bus and as a channel. In addition, there are four 31-band graphic EQs available (GEQ 1 to 4).

The reverbs, effects and delays sound great and are very musical. You can see where Roland's years of experience in the desktop recording market has paid off. What surprised me most was how usable the EQ, gates and compressors were. Not that I'm jaded, but at this price range—in addition to my experience with the stock software processors in Roland's VS Series recorders—I wasn't expecting much. However, they sounded great. The compressor has nine different knee settings with adjustable ratio from 1:1 to

infinite and auto-makeup gain. Although I liked the compressor's responsiveness and sound, the auto-gain seemed to be counterintuitive in that the gain shot up sharply with auto-gain on, way above the level when the compressor was off. For the beginner, there are presets for the gates, EQ and compressors for various instruments, some of which made sense. You could use these presets as a start, but I wouldn't rely on a preset by its name alone—your ear should be the ultimate arbiter of what works.

I tested the EQ on a kick drum with great results. I was lucky enough to hear the V-Mixer through an L-Acoustics KUDO line array system with four subs through Lab. Gruppen amps, so playback was impressive. I quickly turned on the EQ, grabbed 50 Hz and boosted the fundamental frequency, bringing out the kick drum's thump. I could also eliminate some of the drum's boxiness by ducking 400 Hz on the lo-mid band. Here, the Q control came in handy as I was able to keep adjacent info untouched while zeroing-in on just the frequencies that were keeping the drum from sounding great.

The gates worked very well with one small exception. I quickly set up the gate

UNDISPUTED HEAVYWEIGHT KINGS OF MICROPHONES

A HUGE VARIETY OF MICS FOR ANY APPLICATION

Choose from 76 separate brands:



FULL COMPASS
 PRO AUDIO | VIDEO | AV | LIGHTING
 FULLCOMPASS.COM | 800.356.5844

CALL 800.356.5844 TODAY
 SHOP ONLINE AT FULLCOMPASS.COM
 REQUEST YOUR FREE 400-PAGE CATALOG

on a snare, adjusted the threshold and saw it all reacting on the screen. However, when I went to filter the hi-hat out of the feed to the gate by assigning the filter to the sidechain and rolling off the top end, I quickly realized that not only does the filter go to the sidechain, but so does the whole EQ, which renders the snare channel's EQ useless. While you can use an unused EQ from another channel, I'd like to see the ability to split off the filter separately from each channel to its own gate while leaving the EQ independent and on the channel.

EASY TO GET AROUND

The M-400 is all about workflow, with some great options that make it easy to get things done quickly. I especially liked how easy it was to copy a channel's settings to a single or a range of channels. By choosing Copy from the main channel display, I could choose which part of a channel's settings to copy. Most settings can be copied, excluding the pad—another option I'd like to have.

The Sends-On Fader button flips the aux levels to the fader, making it easy to jump through 16 mixes quickly when you're using the M-400 for monitor applications. There are also eight dedicated hardware buttons that can be set to almost anything you'd like. You can assign the button to snap to a scene, mute group, oscillator screen, effect bypass or graphic EQ, meter-peak clear, change meter point, or channel-select Prev or Next. This feature makes it easy to get to those buried functions quickly with a dedicated button.

The Group button makes multichannel control a breeze by bringing up eight DCAs and letting you easily assign a channel or aux send to that fader. You can also name and color the DCAs so that they'll show up on-screen with an instrument name and color.

However, there's some room for improvement. For instance, Scene recall takes about two seconds, and while it doesn't mute the audio, it isn't as nimble as it needs to be. Creating a mute scene would be a workaround but wouldn't involve anything but mutes.

STADIUM-READY

I tested the V-Mixer at the cavernous 63,400-seat University of Phoenix stadium in Glendale, Ariz., home of the NFL's Arizona Cardinals. On Easter Sunday, Glendale's Radiant Church rented the venue for its services, and the V-Mixer captained by engineer Keith Morris was at FOH. The input list was formidable and every possible input on the console was used, but the V-Mixer stood up to the task. There were 25 channels for the band and eight for the featured singers and choir. In addition, two opening acts were al-

lotted a total of seven channels, and there was a mic for the pastor on one channel, another channel for video playback, two channels for walk-on music and two stereo effects inputs—a total of 48 inputs. All of these were routed to the appropriate channels via the V-Mixer's digital patchbay, which allows you to set up, save and recall various console configurations. All digital and analog inputs were used. However, if your setup is larger, it's possible to gang two units together, effectively doubling your I/O capacity.

The output setup in the venue was just as extensive as the input setup. There was a

stereo digital out sent to a 2-channel recorder, one channel back to video and 40 channels were recorded to a PC using Cakewalk's REAC recording software via Cat-5. The board's stereo out was sent to six L-Acoustics V-DOSC loudspeakers facing front (left and right)—two auxes were linked, making a matrix that was sent to six V-DOSC arrays for left and L/L, and two more linked auxes created a matrix sending six outs to JBL VerTec 4088s L/L/L. The same setup was used for the right side, where six subs were used. The entire show went off without a hitch, and the V-Mixer easily jumped between setups.

RECORDING. STUDIO. CAREER. PICK ANY THREE.

Experience matters - learn from the pros how to be a pro. Musicians Institute, the world's most innovative school of contemporary music and recording.

MUSICIANS INSTITUTE

FOR MORE INFORMATION

1.800. ALL PLAY (US and Canada)

1.323.462.1384 (International inquiries)

visit us online: www.mi.edu

OPEN HOUSE
AUGUST 23RD
2008
11AM

A V-ANTASTIC SYSTEM

The V-Mixer had me doing a "reality check" over and over as I reviewed the product. This much *usable* functionality at this price is nothing short of astounding. I say "usable" because there is no fluff in the V-Mixer; the software gates, effects, compressors and EQs are musical and easy to use. In addition, the GUI is friendly, intuitive and gives you a lot of useful feedback as to what's going on inside the box. The educational factor is important because this system is perfect for house of worship and A/V situations where users aren't often audio pros and you have to get up-close and personal with the gear in a short amount of time. If you get stuck, the Help screen contains the entire manual, making it easy to query the "oracle" if you have a question. The manual is well written and takes nothing for granted. All of this is written in basic terms that any user could understand.

V-Mixer also provides a user-definable system lock for keeping some or all console settings out of the reach of unauthorized users. The system also carries some nice unexpected extras. The REAC multichannel recording and USB recorder/playback features add value, as does V-Link, which



The M-400's Channel Editing display offers an analog-style layout of channel parameters. You can change values using the M-400's dedicated knobs and buttons.

integrates the system with other Roland and Edirol gear. I saw V-Link in action at NAB 2008, where an Edirol video mixer controlled the V-Mixer's audio. As you cross-faded from one video feed to another on the Edirol, the audio faders on the V-Mixer that carried the corresponding audio would fade up or down—simple but slick.

All this for just around \$10k is quite something and well worth a look if you're on a budget yet thinking of stepping up to a pro-quality digital live system.

Roland Systems Group, 800/380-2580, www.rolandsystemsgroup.com.

Kevin Becka is Mix's technical editor.

PEAK PRO 6

RECORD, EDIT, MASTER, DELIVER

THE EVOLUTION OF AN AWARD-WINNING STANDARD.



Whether you're a musician, composer, audio editor, podcast/multimedia producer, or mastering engineer, Peak Pro offers more creative potential than ever before. Reliably mature, yet always inspired. Feature rich, yet flexible and friendly. By itself, or with your favorite DAW, Peak Pro streamlines your workflow — with industry renowned sonic quality and precision.



BIAS, Inc. 140 Keller St., Petaluma, CA 94952, USA • [800] 775-BIAS • www.bias-inc.com

Apogee, Apple, and Sweetwater... the Sweetest Sounding Symphony



The Symphony System
Up to 96 channels of I/O



Ensemble
Multi channel FireWire audio interface

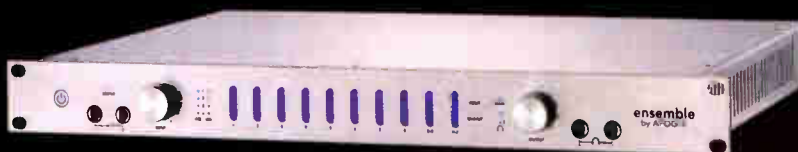

Duet
Portable, Two channel
FireWire audio interface

From the Garage to the Studio, advanced audio for any application

Whether you're recording a simple guitar part or an entire orchestra, capture it all with the legendary sound quality of Apogee and with the power and ease of Apple. The combination of Apogee interfaces, Mac computers and Apple audio creation software offers unsurpassed professional recording solutions for any application.



Let the pros at Sweetwater configure your custom Apogee/Apple System.

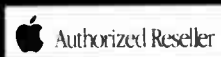

Sweetwater
Music Instruments & Pro Audio



(800) 222-4700
www.sweetwater.com/apogee

Solid State Logic X-Comp Compressor Plug-In

Multiband Dynamics for the Duende Platform

Solid State Logic's X-Comp is the latest plug-in for Duende, the company's external DSP unit. Duende comes in three models: the original single-rackspace unit, Duende PCIe and Duende Mini, the new 1/3-rackspace unit. All three models connect to the host computer's FireWire 400 bus. Duende plug-ins run on internal DSP chips that are based on SSL's C Series digital consoles. Each chip is divided into eight "slots," with X-Comp requiring one slot at 44.1/48 kHz in mono or two slots for stereo. Mini ships with 16 active slots and can be upgraded to 32 slots. Duende plugs are available in VST, Audio Units and RTAS (with wrapper) formats on PCs and Macs, and operate at 44.1/48/88.2/96kHz rates.

X-Comp is capable of many compressor modes and styles—from gentle and unobtrusive control to stricter, more confined dynamics and up to special effects that radically change tonality. This is accomplished with precision and resolution using two methods: dual-symmetrical compressor knees and frequency-dependent parallel compression.

PARALLEL PATH

X-Comp can pass input audio around the compressor through a frequency-dependent sidechain that uses first-order highpass/low-pass filters. You can stress certain frequencies with further compression while allowing other bands to pass through unaffected. With frequency controls at 30 to 300 Hz and 2 to 12k Hz, the filter will operate in high-pass, lowpass or bandpass modes. The LF Bleed and HF Bleed blend controls mix any amount of the sidechain signal with the compressed signal to the final output. There is no filter-bypass button or Listen mode for hearing and tweaking this action in solo.

X-Comp has all the usual compressor suspects: threshold (-48 to +12 dB), ratio (1:1 to 50:1), attack (0.5 to 100 ms), release (1 ms to 2 seconds) and makeup gain (-6 to +36 dB). Most impressive on the GUI is the Compression Law display, an I/O transfer-function graph that changes shape with parameter changes.

A GR History shows gain reduction and recent gain-reduction values. Another amplitude histogram, I/O Difference, displays



The X-Comp's dual-symmetrical knee design allows detailed shaping of the compression characteristic.

a brief history of input peaks vs. post-compression output peaks. I like this display, but I wish it was wider with greater resolution. Input and output level meters include peak-overload indicators and a moving pair of white brackets showing the upper and lower values (in dB) of the dynamic ranges of input and output levels.

UP AND RUNNING

A few caveats for Duende users: Do not run other FireWire devices or drives along with Duende. Pro Tools users will have to lengthen the H/W buffer size depending on the number of running RTAS plug-ins. Install only the RTAS installer; if you run a VST-RTAS wrapper for other plugs, verify that the wrapper has not surreptitiously wrapped the SSL VST plug-in versions.

I ran X-Comp on a quad-core Mac G5 running OS 10.4.11 and Pro Tools Version 7.4cs2. Duende launches from the plug-in list like any other plug. X-Comp has the standard plug-in GUI with a full complement of parameter automation choices. Loading and saving presets happens within the plug-in's GUI, and X-Comp operation was identical at 44.1 and 96 kHz.

I particularly liked using X-Comp for extreme, wild compression effects. Unlike most compressors (including hardware units), X-Comp lets you apply vast amounts of gain reduction and high ratios without experiencing unwanted artifacts and distortion. X-Comp's preset collection favors special effects and offers plenty of starting points for

experimentation. I also liked using the A/B feature to quickly compare two different setups: toggling between them worked seamlessly, although I wish this process could be automated.

As a simplified multiband compressor, X-Comp is hard to beat. I liked it as a stereo bus compressor, letting the high frequencies pass without compression for a more open sound. If your mix is intentionally bass-heavy, you can keep the bottom from modulating gain reduction by using the LF Bleed feature. I could squash vocals to better effect by closing down the pass band so that compression only occurred on important midrange frequencies. This resulted in a warmer vocal sound but with good control, open highs and less of a dulling effect.

Loop processing is endless fun: You can nearly "remix" the loop with presets called Crisp Snare or Punchy BD. You can use superhigh ratios to get outrageous rhythmic pumping effects.

IN RESERVE

X-Comp is sold exclusively through SSL's Website for \$499. It is an excellent tool and a worthwhile addition to your Duende processor. Reserve it for extremely tough dynamics problems or for creating a special, one-of-a-kind effect.

Solid State Logic, www.solid-state-logic.com.

Barry Rudolph is an L.A.-based recording engineer/mixer. Visit www.barryrudolph.com.

Great Audio begins with Audix.

Ask anyone who owns one.



The Audix M1250
Nominated for the 2008 TEC Award in the category of
MIC TECHNOLOGY/SOUND REINFORCEMENT

AUDIX
MICROPHONES

For a dealer near you call Toll Free 800-966-8261
Ph 503-682-6933 Fax 503-682-7114 www.audixusa.com
Also check out www.MySpace.com/AudixMicrophones

Tube-Tech CL1 B Compressor/Limiter Plug-In

TDM Version of Original Dynamics Processor

Introduced in the mid-'80s, the three-rackspace, single-channel Tube-Tech CL1 B compressor/limiter became a coveted and trusted dynamics processor noted for its great sound in a wide range of applications. The CL1 B has its optical gain-changing element (LED- and light-dependent resistor) placed directly after the input transformer, so there's no added coloration or distortion from an audio input amplifier. Two solid-state, time-constant circuits (one fixed, the other for variable or manual) control the opto element's attack and release characteristics, followed by an all-tube signal path with up to 30 dBU of makeup gain. For external sidechain interconnection, the CL1 B uses two buses. Up to 10 units can be slaved for processing multitrack stems or surround material.

ENTER THE VIRTUAL CL1 B

Previously offered only for TC Electronic PowerCore users, the Tube-Tech CL1 B virtual compressor/limiter plug-in is now available for Digidesign Pro Tools HD, HD Accel and VENUE systems. It's for TDM systems only (Mac or PC) and works at sample rates up to 96 kHz, precisely emulating the hardware unit in all ways—including its Fixed, Manual and Fix/Man modes.

Fixed mode has 1ms attack and 50ms release times. Manual mode has controls for continuously varying attack from 0.5 to 300 ms and release times from 50 ms to 10 seconds. The plug-in retains the hardware CL1 B's unique Fix/Man mode, which combines the attack/release times of Fixed and Manual modes. Designed for program compression, Fix/Man's attack time is the same as Fixed as long as program peaks are longer than or equal to the attack time setting. For program peaks that are shorter than the attack time setting, the attack time can control or delay the onset of the release timing.

The Fix/Man mode results in a variable release with a constant fast attack (when fully counterclockwise). You'll have faster release times for short-duration peaks and longer release times for program peaks with longer expiries.

You can vary the compression ratio from 1:1 to 10:1, and a large VU displays input,



The TDM-only CL1 B emulates the hardware version with its Fixed, Manual and Fix/Man modes.

output and gain-reduction levels. The stereo plug-in version allows you to select the channel—left, right or a combination—that drives gain reduction.

TAKING IT FOR A DRIVE

After installing CL1 B into my Pro Tools HD3 Accel rig and authorizing via iLok, I replaced my usual compressor choices for vocals, bass, drums and backing vocal stems. At 48kHz sample rates, one mono or stereo instance uses 50 percent of a chip while 96kHz sessions use an entire chip per instance. Its 28 presets offer many good starting points. You can toggle between A/B compressor settings. "A" lights up as soon as you tweak any preset. Click "B" to create another setting, and clicking on "A" returns to the first setup.

My first session had a difficult male vocal track that eluded previous processing, with no middle ground between oversquashed and loose control. The CL1 B's Male Vocal preset came ready to work with fixed attack and release times (those knobs were grayed out), so I changed to Manual mode and lengthened the attack time to regain some lost brilliance and experiment with different ratio settings. In Manual, I had to reset the threshold, which was too bad because I liked the preset value. I wish that the current values of attack, release, threshold, ratio and makeup gain were indicated in boxes in which you could type values.

As with the hardware unit, the singer sounded full and had a very high fidelity—when peaks resulted in 10 dB or more of gain reduction, the vocal didn't sound distorted or extremely dulled out.

The next track was a Fender bass. Like its hardware cousin, the CL1 B plug-in may be the best compressor for bass guitar be-

cause it's clean, yet offers a tube warmth that imparts harmonic richness. I used Fix/Man mode so that the attack time turned into a kind of hold function. This gave me the best of both worlds: a long release time for the legato bits—whole notes in the verses—and then faster release times for the straight eighth notes in the choruses. I set the attack control to the full-clockwise position and release to about 2 o'clock. The verse "foothalls" were held to a constant level while the eighth notes in the chorus chugged along evenly.

On kick drums, the CL1 B tightened the low frequencies considerably. I started with the Kick Drum preset and got more punch and aggressive attack with little sacrifice of the drum's acoustical size. The CL1 B will do its own unique version of "crazy drum limiter" that's cleaner (with fewer distortion artifacts) than other plugs. Set the ratio to 10:1, turn the threshold down to about -40 dB and set a fast attack time, but play around with the attack time and the release time depending on a song's tempo and the drummer's style.

I used my ears more than the CL1 B's metering—what looks like a lot of gain reduction on the meter doesn't necessarily sound like it. It's easy to overload the plug-in, with red LEDs lighting up long before the GUI's output meter reaches mid-scale.

But my ears kept confirming that the CL1 B sounds great—it was excellent on every source I tried. And like the hardware unit, its smooth operation and fat sound never disappoint. The CL1 B is first-call and first-class for vocals, bass and guitars—but use it on any source. At \$995, it's a winner.

Tube-Tech, dist. by TC Electronic, 818/665-4900, www.tcelectronic.com, www.tube-tech.com. ■

"When I got my Radial DI, it gave me a special sound that was natural, with a fine presence... and the engineer said 'What is that? I've got to get one!'"

~ Will Lee

(George Benson, Dave Matthews, Bob James, Billy Joel, Spyro Gyra)

"With the Radial JDI, my bass comes through extremely clean, very quiet and with a smooth transparent low end. I use my Radial DI for everything."

~ Tony Levin

(Peter Gabriel, King Crimson, Mark Knopfler, John Lennon)

"Radial builds DI's exactly how I would do it. Real quality and they sound great. I love them. They are not going back!"

~ Bruce Swedien

(Quincy Jones, Michael Jackson, Jennifer Lopez, Paul McCartney)

"Radial direct boxes make everything I put through them warm, punchy and clear. They are great DI's!"

~ Chick Corea

(Electric Blue Band, Miles Davis, Return to Forever)

"I love my J48 DI's! They produce a big, fat, clean signal that is so good, I use them for my live recording. Thank you Radial!"

~ Tommy Emmanuel

(Certified Guitar Player, Two time Grammy nominee)

"Radial DI's provide the flexibility I need to perfectly match any situation. I specify Radial exclusively for every tour I mix."

~ Dave Natale

(The Rolling Stones, Fleetwood Mac, John Mellencamp, Jimi Turner)

"My JDV DI is crystal clear and easily configures to the most elaborate set ups. I love it and use it every day!"

~ Billy Sheehan

(Shenon Vai, Mr. Big, David Lee Roth, Greg Howe, Paul Gilbert)

"You need to carry direct boxes that are reliable and the perfect match for your direct input devices. That's why I choose Radial DI's."

~ Rob 'Cubby' Colby

(Phil Collins, Prince, Paula Abdul, Janet Jackson, Cindy Lauper)

"Radial makes a DI box that does exactly what it is supposed to do. No compromise."

~ Paul Boothroyd

(Paul Simon, Paul McCartney, AC/DC)

"Live or studio, Radial DI's are the only ones we use. They're built like tanks and eliminate noise without killing tone. I love them."

~ John Rzeznik

(Goo Goo Dolls)

STUNNING!



From a place far far away... come the Radial Phazer™ and JDX Reactor™, two out-of-this-world 'Power Tools' made to seek out rich tones... to boldly go where no sound engineer has gone before!

The Phazer™ is a 100% discreet analogue phase alignment tool that lets you combine any two sound sources and bring them together in phase. Combine top and bottom mics on a snare, inside and out on a kick, two mics on an acoustic guitar and finally... an affordable way to phase align that bass! The Phazer makes it easy with a single-dial phase control and a filter that focuses the effect like a tractor beam!

The JDX Reactor™ may be the best sounding guitar amplifier direct box in the cosmos! A reactive load combines the direct feed from the amp head with the return electromagnetic impulse from the loudspeaker to create guitar tones so thick it'll make a Vulcan cry! Combine a mic'd signal with the direct feed from a JDX through the Phazer to create fat new sounds that are nothing short of ... well... stunning!

Radial - Power Tools for Power Players



Radial
engineering
...true to the music™

www.radialeng.com

1638 Keblet Way, Port Coquitlam, BC V3C 5W9 tel: 604-942-1001 email: info@radialeng.com

World Radio History

AEA A440 Active Studio Ribbon Mic

High-Output, Retro-Styled Transducer Delivers Big Tone

Audio Engineering Associates' Wes Dooley has released another remarkable ribbon transducer in the A440 (\$5,800). This "long ribbon" figure-8-patterned mic is based on the RCA 44, which was discontinued in 1955 after 23 years of production.

The A440 comes in a foam-lined soft case with a sturdy handle that keeps the mic in the preferred upright position for storage. This mic is no lightweight in any sense of the word: It weighs in at seven pounds and is more than one foot tall, 4.6 inches wide and 3.3 inches deep. The 2.35-inch, pure-aluminum ribbon is 0.185 inches wide and 1.8 μ m thick. The A440 comes with a sturdy, attached 9-foot cable that terminates in a standard XLR. You can even take advantage of custom color, mic flag and tuning options.

Taking the A440 more than one step beyond the original, this new model is an extremely quiet, high-output, phantom-powered transducer. With a noise floor of only 6 dB(A), the signal-to-noise is an impressive 88 dB (94dB SPL minus equivalent noise), and its dynamic range is better than 127 dB. Frequency response is the classic 44 curve with solid bass down to 20 Hz and useful treble out beyond 20 kHz.

FIRST IMPRESSIONS

Can I say "love at first sight" in a product review? Sure, why not, because that was literally the impression of everyone who saw the A440 up close. It is hefty, well crafted and impressive. This is a mic you can't wait to put up on anything that makes sound: It brings out the fun factor, big-time. Not only does it look good, but it also performs quite ably in the sonic department.

The first test was on a male vocal, an especially strident vocalist whose pipes crave the tonal taming of a dynamic mic. A condenser is just too revealing for this singer. (For examples, listen to the Online Extra sound clips at mixonline.com.) I placed the singer in front of the mic and quickly realized that the proximity effect is greatly magnified with the A440—the closer you get, the more the bottom end blooms. So I employed a pop filter to stop

the plosives and established a proximity standard. The optimal distance seemed to be three inches, which provided plenty of bottom end, and smooth mid-frequencies and top end. Overall, the balance in the track was perfect and I could play with the bottom end even more by compressing the vocal using the SSL 4000's channel compressor set to slow attack and a 3:1 ratio, compressing about 8 to 10 dB at the peaks. This tamed the voice's edge, and a beautiful, warm low-end presence came through. I should mention that as I expected, little gain was needed to get the mic's perfect level to Pro Tools, and it was whisper-quiet.

When placed about a foot in front of the f-hole on an upright bass, the AEA proved to be one of the best mics I've ever heard in this application. I generally place the mic lower on the instrument, pointing up to where the player is plucking the strings to capture the lower frequencies, but that wasn't necessary in this application. The balance was perfect between the sound of the fingers on the strings, and the full and round bottom end of the instrument. The part called for pizzicato and bowed parts, and the A440 captured both quite well.

When used 12 inches *outside* of a kick drum with a pop filter in front to protect the engine, the A440 sounded great paired with a Beyerdynamic M88 on the inside of the drum. It had the effect of a sledgehammer to the chest that would please any engineer. However, later in the day on the same kit, it didn't fare as well when paired with a Sennheiser e604.

Using the A440 on acoustic guitar proved a most revealing test. With cues from the control room, I moved the mic around to find its sweet spot. The null point at the side of the mic is so strong that I could use it to "tune out" the guitar's big bottom end by pointing the mic's off-axis point toward the low end of the instrument and capture the pick on the strings perfectly on-axis. While the A440 wouldn't be my first choice for this particular acoustic-guitar model, I wouldn't hesitate to use it on an instrument that was sounding a bit thin.



FINDING BOTTOM

It didn't take much effort to fall in love with the AEA A440, but like all good relationships, you've got to work at it. Placement is more critical with this mic than any other ribbon I've used. The A440 is a low-frequency magnet: It's *the* mic of choice for upright bass, hands-down. On kick drum, it rocked as long as it was partnered with another mic to bring out the attack of the beater. It was great on trombone and tuba, and even sounded good on acoustic guitar.

The A440 is pricey, but well worth it if you're looking for a unique-sounding niche microphone that can reliably take on more than 130 dB of SPL and deliver plenty of bottom end.

AEA Microphones, 626/798-9128, www.ribbonmics.com. ■

The Million \$ Pre



The Focusrite Studio Series console
BOP Studios, South Africa

ISA One

Classic Microphone Pre-amplifier with Independent D.I.

With an installed studio cost of over \$1,000,000, the Focusrite Studio console (72+ channels) was probably the most expensive, and sonically impressive console ever built. Its unique sound has contributed to countless gold and platinum recordings over the last two decades.

The Focusrite consoles were based around the ISA110 Microphone Pre-amplifier and EQ module, originally commissioned in 1987 for AIR studios, London, to extend the custom Neve console in Studio One. Sir George Martin, the AIR Studios team and Focusrite tuned the microphone pre-amplifier by ear. It went on to form the cornerstone of all ISA products. The topology has never changed, except for the addition of a variable impedance circuit, providing ISA users with increased control and a broader variety of sounds.

The new Focusrite ISA One shares the same pre-amplifier topology, featuring the original Lundahl LL1538 transformer and bespoke Zobel network. A host of other features, including an independent D.I. and an optional class-leading 192kHz A-D converter, ensure this classic design fits seamlessly into your modern studio environment.

Now you too can own the million \$ pre. Only one thing has changed. The price - \$799.99*

[www.focusrite.com/million\\$pre](http://www.focusrite.com/million$pre)



- The flexible and independent D.I., allows engineers to blend a mic'd cabinet and D.I'd Instrument, or track a vocal and guitar simultaneously.
- ISA One's optional Stereo 192kHz A-D card embodies cutting-edge conversion technology within Focusrite analogue circuitry to deliver the best performance in its class.
- ISA One comes in its own flight case, built to protect your ISA One from the rigors of the road.

* US MAP Price \$799.99

audio heritage | sonic integrity | professional solutions

Sweetwater
Music Instruments & Pro Audio

For more information: 800-222-4700 or www.sweetwater.com

World Radio History

ff
Focusrite
www.focusrite.com

Snapshot Product Reviews



APOGEE DUET Desktop I/O for Apple Logic

The Apogee Duet is a \$495 FireWire bus-powered, stereo I/O audio interface with dual mic preamps. Capable of sample rates up to 96 kHz, and exclusively designed to work with Apple's OS 10.4.10 or 10.5.x, Duet takes its sound and styling cues from Apogee's rackmountable Ensemble interface, but shrinks it into a sleek aluminum package a bit smaller than a VHS videotape. With one large endless encoder knob, you can control the preamps' input gain or output volume, or even generate MIDI continuous controller commands. Pressing the encoder switches between the settings, and LEDs indicate Duet's current functionality. Dedicated seven-segment stereo meters above the control knob show input or output levels.

After installing the drivers and restarting my MacBook, getting started required little more than plugging the included FireWire cable between my computer and Duet. I confirmed a message asking if I wanted Duet as my main system audio output. Connecting my beyerdynamic DT-770 headphones into the unit's integrated 1/4-inch headphone jack, I fired up iTunes and was impressed with what I heard. While listening to my usual reference mixes, it was immediately apparent that high-frequency detail, transient articulation, low-frequency definition and positional imaging were greatly improved in comparison to the MacBook's direct headphone out.

Unfortunately, to gain access to I/O beyond the headphones, you must dangle a 20-inch breakout cable with plastic-molded cables and wiring that reminded me of something made by Radio Shack. A 15-pin, VGA-style connector connects to Duet; the other end sports four 1/4-inch (two inputs/two outputs) and two XLR input connectors. The 1/4-inch, unbalanced -10dBV line outs can also be configured for instrument level output. I really wanted to see balanced +4dBu outputs for driving long lines in live situations.

Making settings such as choosing the balanced/unbalanced inputs, applying phantom power and inverting input polarity is handled using the included Maestro software. Maestro launches when Duet is plugged in, but Logic users will appreciate that they can directly access most of the same features within Logic.

As Duet fits so nicely into my laptop bag, I always had it with me and ended up using it in more applications than I expected to. I tracked percussion overdubs, recorded voice-overs and played soft synths through it, and it always sounded great. I did however, have one problem: On unplugging the FireWire cable, my computer locked up. Apogee tech support was quick in responding and said that they were aware of an issue with FireWire interfaces causing problems in computers with more than 2 GB of RAM. I hope this gets resolved because other than this issue, I loved Duet. (At press time, Apple released a software update and Apple FireWire audio driver, Version 242, which fixed the problem.)

The bottom line? Duet truly delivers great sound in a portable package. Certainly, Mac laptop owners will love Duet, but even desktop users who just want great stereo sound produced through two

exceptional mic pre's and converters should take a listen to this little powerhouse.

Apogee Electronics, 310/584-9394, www.apogeedigital.com. —Robert Brock

EQUATION AUDIO DS-V10 Dynamic Vocal Microphone

Equation Audio is a relative newcomer to the microphone market, having been established approximately five years ago. The company offers a complete line of dynamic and condenser mics, including its popular handheld, the Dominion Series DS-V10 (\$179 list). This dynamic, supercardioid vocal model employs Neodymium magnetic materials and has a 40 to 17k Hz response. Its zinc body is coated with a rubberized, matte-black finish intended to reduce handling noise. A steel-mesh grille protects the capsule from harm while reducing plosives. Maximum SPL is rated at 140 dB.

I used the DS-V10 on vocals in a number of live sound situations, and took it for a quick spin in the studio. Without saying anything, I put DS-V10s onstage for Richie Castellano (keyboard and guitar player for Blue Öyster Cult) in his two mic positions. It was comical to watch him sing into the mic while trying to read the brand and model of the mic. Castellano fell in love with the sound of his voice on the DS-V10, and so did I. It's clear that someone on Equation Audio's engineering team did their homework. The mic is voiced such that it requires little (if any) EQ to get presence in the mix without harshness. The DS-V10 produced a smooth response yet maintained clear articulation across the frequency range.

The DS-V10's off-axis rejection was outstanding and I noticed a significant drop in leakage of keyboard and guitar amps into his vocal mic. In fact, the pattern of the DS-V10 is so tight that if you're speaking into



TOOLS FOR CREATION

MICROPHONES

INTERFACES

MIXERS

RECORDERS

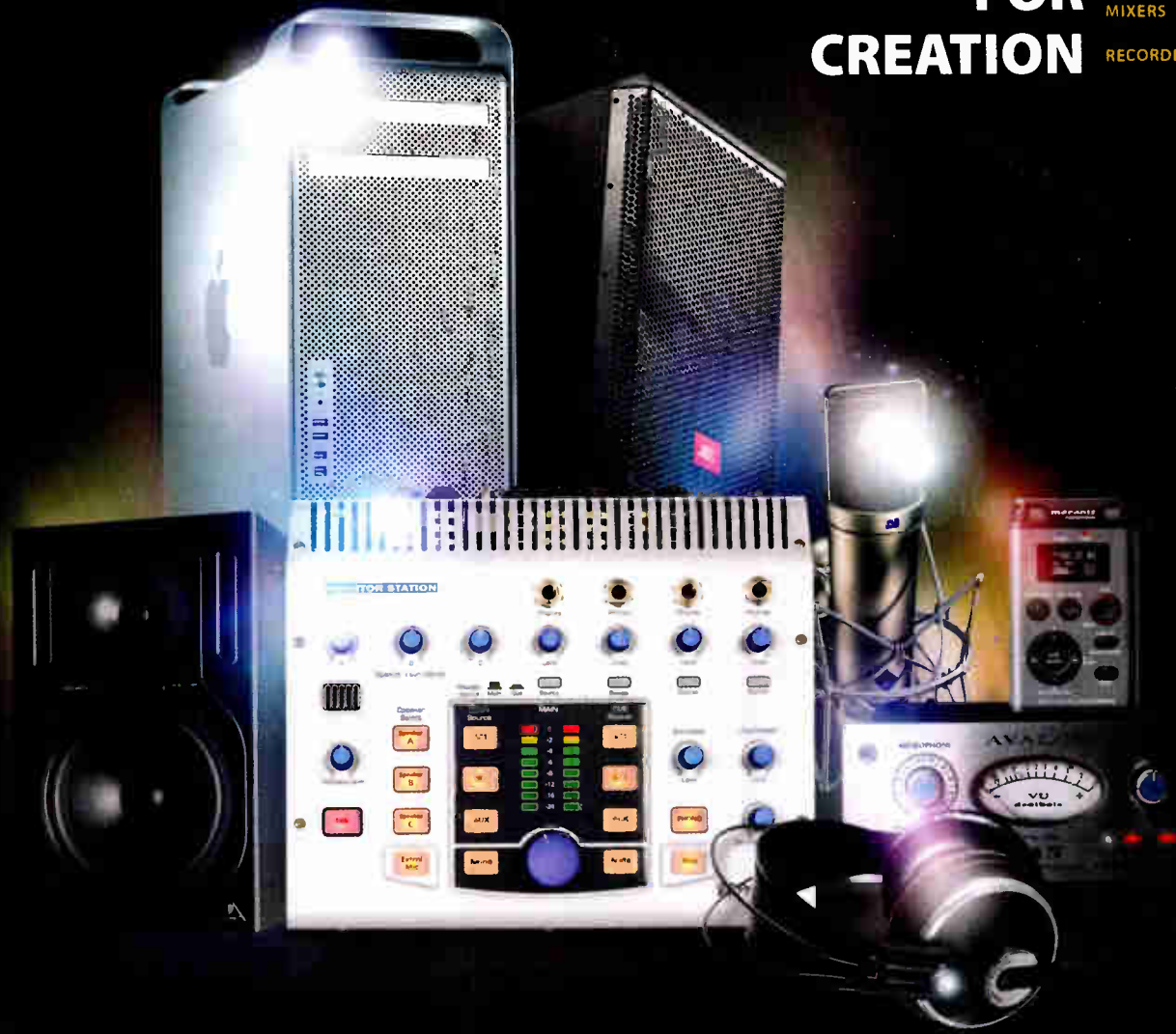

Visit Our SuperStore

420 Ninth Ave, New York, NY 10001

Drop by our SuperStore where you can handle the gear of your dreams. You'll find an oasis of competitively-priced stock, and unrivaled customer service with the most knowledgeable sales staff anywhere.

800-947-5508

Speak to a Sales Associate

With more than 30 years of renowned service, we continue to be your "ProSource." Our sales staff is made up of industry professionals with years of experience. Simply call, and a sales associate will assist you with all your individual needs.

bhproaudio.com

Shop conveniently online

180,000 products at the tip of your fingers. Quick searches and live support help you get everything you want and exactly what you need. Create an account, make a wish list, and sign up for our newsletter, all in our secure environment.



Deep, Dimensional Sound

Introducing...

The Wedge



Large-diaphragm studio
condenser microphone

Class-A fully discrete
transformerless circuit

Handles SPL up to 134dB

Handmade using carefully
selected components



violetusa.com

the mic on-axis and turn your head, your voice all but disappears. This could be a double-edged sword: The mic rejects stage spill very effectively, but a singer who doesn't stay on-mic will experience drastic dropouts when he/she moves off-axis.

Proximity effect on the DS-V10 is gentle. When Castellano sings a falsetto part, he gets right up on the mic, and if there's too much proximity effect, his voice can become muddy. Not so with the DS-V10, which maintained clarity under these circumstances. The DS-V10's pop filter works extremely well when a singer's mouth is right on the grille, but (surprisingly) less so when the mic is pulled back around six or eight inches, where plosives are still audible.

When you add solid construction and a

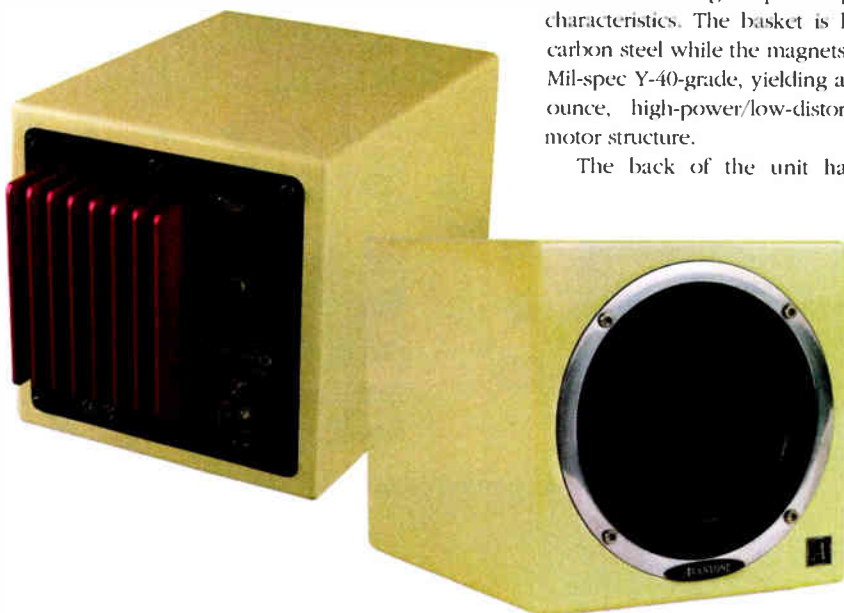

finish that helps minimize handling noise to the DS-V10's sonic attributes, you come up with a vocal mic that's a clear winner.

Equation Audio, 800/575-4607, www.equationaudio.com. —Steve La Cerra

AVANTONE INSIGNIA SERIES ACTIVE MIX CUBES

Compact, Powered Reference Monitors

In 2006, Avantone released the passive Mix Cubes, paying homage to the Auratone 5c monitors—studio stalwarts offering engineers the ability to listen to what their mixes might sound like on a far-from-audiophile, but close-to-consumer playback system. Avantone's latest incarnation of the Cube is an active model, a Limited Insignia Edition that offers the same output driver, this time powered by a 35-watt Class-A/B amp.

The cabinet is constructed of a nonlayered, high-rigidity MDF board featuring low-resonance characteristics and radiused edges. These little guys deliver as promised: they are solid as a rock and offer no resonance when you subject them to a considerable rap of the knuckles. Unfortunately, they are only available in a buttercream finish. It was the one thing that seemed to bug everyone I showed them to, and perhaps the second version could offer these in basic studio black. However, the cabinet shows attention to detail and design: There's a non-skid, 7mm-thick neoprene pad on the bottom, and a standard mic stand socket ($\frac{3}{8}$ -inch/27-thread) in the base. The single driver has a custom-designed, 5.25-inch paper cone blended with mica fibers for rigidity and longevity, and a cloth-surround material boasting unique damping characteristics. The basket is low-carbon steel while the magnets are Mil-spec Y-40-grade, yielding a 43-ounce, high-power/low-distortion motor structure.

The back of the unit has a

large, red aluminum heat sink, an XLR/TRS balanced input, RCA unbalanced input, adjustable (+6 to -30dB) output gain trim, power supply input and on/off switch. The cable that attaches the power supply to the speaker is beefy and woven with a 3-pin screw-on adapter. Each cabinet weighs 8.8 pounds and is 6.5x6.5x8.125 inches. They can be purchased as a pair or as mono units.

When I first plugged them in, I mounted them on the console top and borrowed the XLR line outputs from another pair of powered speakers for this test. On first listen, the 60-cycle hum was substantial. I looked on the power supply and the back of the speaker to verify that there was no ground lift and then called the manufacturer. I was

told they had encountered this before and to simply use a ground lift. Not my usual MO, but it worked and I was ready to listen. (Avantone later hinted that a future model would fix this with a ground lift and/or an amp upgrade.) Familiar with Auratones, I didn't expect much of a frequency bonanza from the Mix Cubes and I was not disappointed. These sounded lean on the bottom and top, and consistently flat in the midrange—the same characteristics that made the Auratone a valued listening reference. They got plenty loud without distortion and showed off the vocal, snare, toms, upper range of the kick and solo instruments in a number of mixes, just as I expected.

I'm a big believer in listening to tracks across a wide range of speakers. The Avantone Active Mix Cubes offer another chance to evaluate creative studio output and make judgements regarding how my work would translate across a wide range of systems. At \$359 list, these are a no-brainer for those wanting another quick-and-dirty reference to help in the quest for tracks that translate.

Avantone Electronics, 909/931-9061, www.avantonelectronics.com.

—Kevin Becka

PFPOWER M1500 Programmable UPS

The M1500 (\$999) is the first product under the new PFPower brand from Panamax and Furman. Specifically designed for studios and home theaters, the M1500 is a programmable, uninterruptible power supply with voltage regulation, power line conditioning and integrated power-down sequencing.

Guaranteed for three years, the two-rackspace M1500 weighs 59 pounds, complete with a sealed lead-acid battery. Under normal operation, the 1500 is a voltage regulator that outputs a constant 120 VAC and only switches to battery operation when the input line voltage falls below 88 volts or exceeds 147 volts.

Most UPS units are DC-to-AC inverters running on batteries kept charged by the AC line. They're okay for keeping a PC powered during a power failure, but worthless for powering audio and video equipment. Besides providing non-sinusoidal AC voltage that decreases the efficiency of power transformers and causes electrical noise and interference, battery-only UPS units do not have the current "headroom" required for the huge, instantaneous current demands made by audio power amps, powered speakers or

Bad Drum Sound? Replace It.



Is your drum sound driving you nuts? Relax - Drumagog will make those old, stale drums sound like a million bucks! It works by automatically replacing what's on your audio drum tracks with samples of new drums. The industry choice for over 5 years, Drumagog is available for both PC and Mac, in VST, RTAS, and Audio Units plug-in formats. See why producers Chuck Ainlay, Brian Tankersley, and Greg Ladanyi use Drumagog in their projects every day.

877-318-WAVE
www.drumagog.com

WAVEMACHINE LABS

MIXBooks

Required Reading For Everyone

Mixbooks has hundreds of books and DVDs to choose from to help you be successful. Choose from studio production to learning to play guitar — we have it all.

Check out our musicware too — Mix t-shirts, hats, sweatshirts, studio organizers and more...

Click to learn
www.mixbooks.com

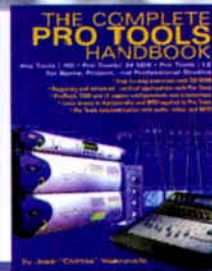
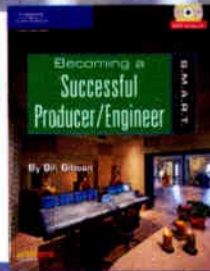
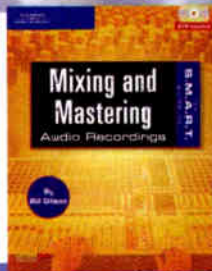

a DLP projector lamp.

The M1500 produces 1,000W (1,500VA) of pure, 60Hz (± 1 -percent) sine wave 120VAC (± 5 -percent) output with 50 dB of noise and RF suppression from 100 kHz to

RS-232 port and the included software, the UPS can be programmed using a PC for use with home theater gear and/or home automation. The IR ports use the "learn" feature in your remote control to configure

With 1,000W available, I used only about 50 percent of the unit's load capacity to power my entire Pro Tools studio. The M1500 has six sets of circuit breaker-protected AC sockets: four for noncritical loads and two for critical loads. You can program the unit so that critical loads (DAW, computer, interfaces, monitor, drives and recording chain) have more minutes of run time beyond the moment when noncritical loads (CD player, video monitor, lava lamps, etc.) shut down.

After a series of momentary outages in my neighborhood during a crucial recording project, I kept working, oblivious to the outside world. The M1500 paid for itself that day in work/time otherwise lost. If you're serious about protecting your DAW and—more importantly, the artistic audio assets you're entrusted with—don't fly without a PFPower M1500.

PFPower, 707/763-1010, www.furmansound.com.

—Barry Rudolph ■

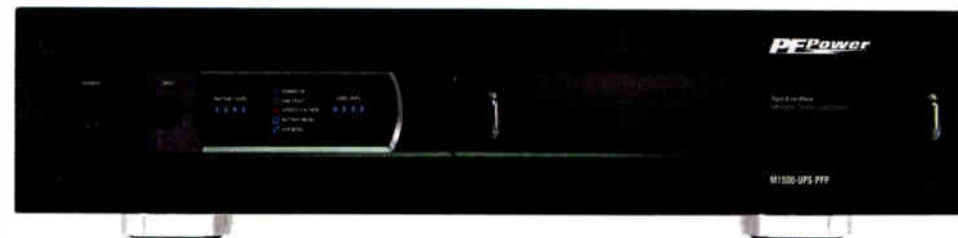

1 MHz. When the AC line fails, it will supply full power for eight minutes—much longer if the load is lighter. It can transfer to battery operation in 4 ms. This is an important feature for DAWs, as many computers' power supplies will not tolerate line voltage outages any longer than 6 to 10 ms before they will restart.

The M1500 extends its utility by providing programmability through a rear panel RS-232 port and IR (infrared) ports. Via the

sequential power-down commands in two steps to your A/V gear. Sent over IR flashers (not included), amps and powered monitors could be powered-down first, followed by all other gear.

A simple front panel display shows power-on/off, load level, battery condition, unsafe line voltage and any line faults such as broken grounds. Another great feature is that the onboard battery is replaceable while the unit is turned on and regulating.

THE MICROPHONE THAT EVERYONE IS TALKING ABOUT.
THE NEW HEIL PR 35.

HEIL SOUND www.heilsound.com TEC 2008 NOMINEE

ONE FOR THE ROAD REBATE

BUY ANY FIRESTUDIO RECORDING SYSTEM GET A
FREE INSPIRE 1394 MOBILE RECORDING SYSTEM



FIRESTUDIO

24x24 FireWire Recording System



"The FireStudio took my studio up a huge notch! I can now record an entire band while sending each musician their own headphone mix"

Sam Daniel, Engineer, Producer and Musician

The award-winning FireStudio is PreSonus' flagship and highest channel count professional recording system with 26 simultaneous inputs and outputs including eight XMAX preamplifiers, 16 channels of optical ADAT, MIDI and SPDIF I/O, zero latency DSP mixer/router with up to 9 individual stereo mixes, optional MSR remote controller and more, perfect for recording bands and general music production.

FEATURES

- 24-bit/96K FireWire (IEEE 1394) interface
- 26x26 simultaneous record/playback channels
- 8 XMAX microphone preamplifiers
- 8 analog line Inputs, 2 Instrument Inputs
- 16 channels of optical ADAT I/O
- SPDIF I/O, MIDI I/O
- Control console - zero latency DSP mixer/router
- ProPak Software Suite with Cubase LE 4, plug-ins, virtual instruments, loops and samples
- Windows and Macintosh compatible
- Works with Cubase, Nuendo, Sonar, Logic, Digital Performer and more





expand.

One of the most unique features of the FireStudio is its expandability. PreSonus has created a number of products that integrate flawlessly with the FireStudio to enhance your music creation process. Adding microphone preamplifiers, talkback, speaker switching, transport control and fader automation is easy. A complete FireStudio System with MSR remote, FaderPort and two DigiMax FS' delivers the power and flexibility you need to effortlessly create your music.



MSR Optional Remote for FireStudio

Communicate from your control room with built-in talkback, control your mixes with 3 mix modes: Track (9 stereo mixes), Mix (allows switching between 3 sets of stereo monitors), Surround (5.1 speaker switching) and more.



FaderPort USB Automation Controller

Write single channel or group channel automation, pan and mute automation, complete transport control, quickly select windows in your DAW, and enhance your music recording and production.



DigiMax FS 8 ch. mic preamplifier with lightpipe I/O

Easily add eight channels of XMAX preamplifiers to your FireStudio with the DigiMax FS. The DigiMax FS features the same high-quality, 24-bit 96K word clock from the FireStudio, along with JetPLL jitter reduction technology. Take advantage of direct outputs and inserts on every channel for ultimate flexibility. Add up to 2 DigiMax FS for 16 additional microphone preamplifiers to your FireStudio.

FIRESTUDIO TUBE

16x6 FireWire Recording System with 2 SuperChannels



"...the tube preamps with limiters sound huge on vocals and electric guitar!"

BB Peters, producer and musician

The FireStudio Tube is loaded with the perfect combination of inputs and outputs for bands, producers, musicians and engineers to produce commercial-quality recordings: SIXTEEN analog inputs with TEN microphone preamps (two vacuum-tube preamps with analog limiter), input and gain reduction metering, MIDI I/O, zero-latency monitor mixer with up to 5 individual stereo mixes, and more!

FEATURES

- 24-bit/96K FireWire (IEEE 1394) interface
- 16x6 simultaneous record/playback channels
- 2 SuperChannels (tube mic/instrument preamplifier with analog limiter)
- 8 XMAX microphone preamplifiers
- 6 balanced TRS line inputs/outputs
- MIDI I/O
- FireControl - zero latency DSP monitor mixer
- ProPak Software Suite with Cubase LE 4, plug-ins, virtual instruments, loops and samples
- Windows and Macintosh compatible
- Works with Cubase, Nuendo, Sonar, Logic, Digital Performer and more



FIRESTUDIO PROJECT

10x10 FireWire Recording System



"I recorded my last record with the FireStudio Project. It's rock-solid and sounds amazing!"

Roland Guerin - Producer, Composer, Bassist

Great for project studio recording, live sound recording, podcasting and more, the FireStudio Project is designed for flexibility and ultra-high sonic performance. Whether you need to record a live drum set, mic a guitar amp, or a complete band, the FireStudio Project is ready and more than able. With the FireControl Mixer/Router you can send up to five individual mixes to different musicians during recording so that every band member can have a custom headphone mix.

FEATURES

- 24-bit/96K FireWire (IEEE 1394) interface
- 10x10 simultaneous record/playback channels
- 8 XMAX microphone preamplifiers
- 8 Analog Mic/Line Inputs, 2 Instrument Inputs
- 8 Analog Line Outputs
- S/PDIF Digital Input and Output, MIDI Input and Output
- FireControl - zero latency DSP monitor mixer
- ProPak Software Suite with Cubase LE 4, plug-ins, virtual instruments, loops and samples
- Windows and Macintosh compatible
- Works with Cubase, Nuendo, Sonar, Logic, Digital Performer and more



FIRESTUDIO LIGHTPIPE

32x32 ADAT to FireWire Recording System

"I can now offer 32-channels of recording on every live event I mix!"

Ryan Miller - FOH and Recording Engineer, Premier Sound Services

Great for recording live performances and house of worship. Connect a FireStudio Lightpipe directly to a digital mixer or add up to four DigiMax's and record up to 32-channels simultaneously via FireWire. Compact, portable, professional, powerful, the FireStudio Lightpipe makes live recording effortless.

FEATURES

- 24-bit/96K FireWire (IEEE 1394) interface
- 32x32 simultaneous record/playback channels
- Word Clock I/O
- MIDI I/O
- Balanced TRS stereo main outputs with volume control
- Headphone output
- Fast-acting LED input metering
- FireControl - zero latency DSP monitor mixer
- Windows and Macintosh compatible
- Works with Logic, Cubase, Nuendo, Sonar, Digital Performer and many others



ONE FOR THE ROAD REBATE LIMITED TIME OFFER!

Buy any FireStudio Recording System get a
FREE Inspire 1394 Mobile Recording System

Rebate valid on FireStudio, FireStudio Tube, FireStudio Project and FireStudio Lightpipe sales from June 1 to August 31, 2008.



Take your music recording and production anywhere with the **Inspire 1394**. Loaded with professional quality microphone and instrument inputs, software controlled for recallability, portability and toughness and bus-powered the Inspire 1394 is ready for the road. Buy a FireStudio today and get a FREE Inspire 1394!

FEATURES

- 24-bit/96K FireWire (IEEE 1394) interface
- Four simultaneous input channels
- Two microphone/instrument preamplifiers

- Switchable line input or phono input (with RIAA filter)
- Software control panel and zero-latency mixer
- Daisy-chain up to four Inspire 1394's for 16 channels of I/O
- FireWire bus-powered or powered externally
- ProPak Software Suite with Cubase LE 4, plug-ins, V1's, loops and samples
- Windows and Macintosh compatible



www.presonus.com

Master Classes
Training Sessions
Tutorials
Live Sound Seminars
Broadcast Events

- Exhibits
- Platinum Panels
- Special Events
- Historical Events
- Tours

- Exhibitor Seminars
- Technical Papers
- Educational Events
- Workshops

www.AESshow.com

125th AES CONVENTION

MAKE THE RIGHT CONNECTIONS

Conference: October 2-5, 2008
Exhibits: October 3-5, 2008

Moscone Center
San Francisco, CA



PHOTO PHILLIP ANGERT



PHOTO: AUTUMN DEWLEDE

My Morning Jacket are (L-R) Carl Broemel, Two Tone Tommy, Jim James, Bo Koster and Patrick Hallahan.

MY MORNING JACKET

GIVING IN TO EVIL URGES

By David John Farinella

Producer Joe Chiccarelli knew all about My Morning Jacket when the band walked into Avatar Studios in New York City this past November. He'd listened carefully to the band's previous releases, absorbed their compelling blend of rock/country indie tendencies and seen them live a handful of times. It would be fair to say that he was a fan of the Louisville, Ky., quintet.

"I was very, very excited about working with them," Chiccarelli says a couple of months after the final tracking dates wrapped. "It is really fortunate when you get called to work on projects where you are a

genuine fan of the band. *Z* [the band's 2005 breakout release] is definitely one of my favorite albums, and, quite honestly, I was like, 'How am I going to top that?'"

Jim James, My Morning Jacket's frontman and main songwriter, made sure that the producer didn't have to worry about topping anything—he showed up in New York City with 18 songs were ready to go. Yet the move to New York City was a new experience for

My Morning Jacket because they had recorded their early releases in a home studio in Louisville and *Z* at Allaire Studios in upstate New York.

Chiccarelli suggested New York City after hearing the *Evil Urges* demos. "I felt like the songs were much more accessible and melodic and had stronger grooves," the producer reports. "I felt that they need-

ed to be recorded in a more live environment. The idea of going off to a mountain and being isolated didn't make sense to me for this music—it felt like this needed some inspiration and invigoration, and needed to be done in a city."

According to James, the move to an urban studio did influence the sessions. "We had already had our remote fantasy land experience out in Colorado [where they wood-shedded the new material] so we wanted the actual recording to feel different, tighter and more focused, as they say," he explains. "We looked at it almost as if we were a construction crew working on a house, coming into work and leaving at the same time every day. So there wasn't really a lot of time lying around and dilly-dallying."

Chiccarelli and the band—guitarist and singer James, Two Tone Tommy on bass, drummer Patrick Hallahan, guitarist Carl Broemel and Bo Koster on keys—set up shop in Avatar starting the first of November 2007 and worked straight until December 10, with three weeks of that dedicated to live tracking. Songs were recorded live to 24 tracks of analog tape until they needed extra space for background vocals or guitar overdubs, and then they went into Pro Tools.

Working on the tracks for *Evil Urges* was the first time My Morning Jacket had gone in the box at all, and James was leery of the experiment. "The great thing about tape is that you cannot screw with it infinitely like you can in the digital TV-screen world," the singer explains. "Once you record to tape, there are only so many things you can do to it. I like that you cannot look at it; you can only hear it. I think there's something to be said for that."

"This record was cool because I felt like we had one foot in the past and one in the present," he continues. "I enjoyed this process, as it was the first My

—CONTINUED ON PAGE 101





The people behind Re-Loaded (L-R): John Levy (Nancy Wilson's manager), Marcus Miller, Steve Gadd, Terence Blanchard, Nancy Wilson, Tom Scott, George Duke and Gregg Field.

CANNON RE-LOADED

JAZZ GREATS PAY TRIBUTE TO CANNONBALL ADDERLEY

By Chris J. Walker

As a trumpeter and bandleader, Miles Davis was highly regarded for being incredibly innovative and creative. Yet he was equally extraordinary as a talent scout. Other jazz leaders in the modern era—such as drummer Art Blakey and pianist Horace Silver, who co-led the Jazz Messengers before splitting—were skillful recruiters, too. But Davis was particularly consistent in hiring players who, after departing his groups, made nearly as much of an impact on jazz as he did. One of them was alto-saxophonist Julian “Cannonball” Adderley, whose style and personality were nearly opposite to Davis’ cool, detached and sometimes arrogant persona.

Adderley played with Davis in the late '50s, contributing to such landmark recordings as *Milestones* and *Kind of Blue*, but soon found his footing leading his own stellar bands, which featured such notables as keyboardists Bobby Timmons, Joe Zawinul (who wrote “Mercy, Mercy, Mercy,” the Adderley group’s biggest hit), George Duke and Michael Wolff; saxophonists Yusef Lateef and Charles Lloyd; and Adderley’s prodigiously talented brother, Nat, on cornet. Unlike Davis, Adderley always set out to be an *entertainer*,

as well as a great musician and bandleader, so he became one of jazz’s most popular live attractions for a number of years. Like Davis, however, he also embraced funk and electronics later in his career. He died of a stroke in 1975 at just 46.

Drummer and Concord Records co-owner Gregg Field and saxophonist Tom Scott are among succeeding generations of musicians influenced by Adderley’s musicianship and earthy attitude. They both met Adderley at different times and places. For Scott it was as a member of Don Ellis’ Big Band at the Monterey Jazz Festival in 1966. Not knowing what to say, he nervously asked Adderley if he gave lessons—he politely declined. Field met him in 1974 at the San Francisco club Keystone Korner while a teenager. The legendary saxophonist recognized the kid’s interest in jazz and invited him to a session at Fantasy Records in Berkeley, Calif., the next day for *Love, Sex and the Zodiac*, one of Adderley’s last.

Field and Scott crossed paths many times afterward during assorted sessions and performances, and as they got to know each other they discovered their mutual affinity for Adderley, even making it into a friendly competition to see who knew more obscure facts about him. But it was when Field attended a 2005 gig by Scott and pianist Roger Kellaway at a Santa Monica, Calif., jazz spot called The Vic that the wheels started turning

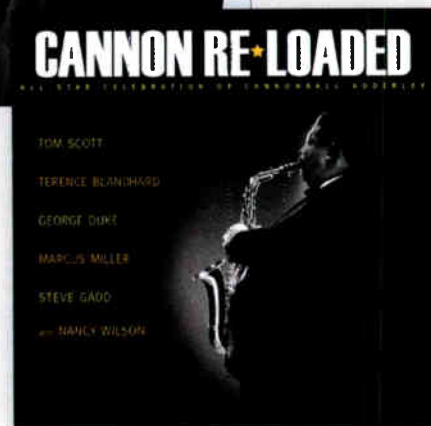

in his mind about putting together an Adderley tribute album—specifically after hearing Scott and Kellaway’s rendition of Adderley’s “Sack o’ Woe” and noticing how much it excited the audience.

From his home studio in Tehachapi, about 120 miles northeast of Los Angeles, Scott recalls Field’s reaction after the show: “Gregg said, ‘Wouldn’t it be fun to do an entire record of Cannonball stuff?’ So we planned it and then it languished for a long, long time. We had a deal on one label lined up that ultimately fell through. Then Greg and I got pretty busy for a while. Finally, we went to Concord, Gregg’s label, and they said, ‘Let’s do it!’ After that things came together quite quickly.”

The co-producers agreed on the concept, selections and type of musicians they wanted on the CD. Field—whose label has recently enjoyed success partnering with Starbucks for Ray Charles’ Grammy-winning *Genius Loves Company*, Paul McCartney’s *Memory Almost Full* and the *Love Letters to Ella* (Fitzgerald) tribute—slanted the record

—CONTINUED ON PAGE 102

STEPPENWOLF'S "BORN TO BE WILD"

By Gary Eskow

The road to becoming a rock 'n' roll icon is stranger for some than others. Take John Kay—the voice and face of the L.A. band Steppenwolf—for example. He was born Joachim Fritz Krauledat during World War II in what would later become East Germany. His father was a German soldier killed on the Russian front a month before his birth in 1944. He grew up listening to American rock 'n' roll on Armed Forces radio but didn't start playing music and writing songs until after his family emigrated to Canada in 1958; in fact, Kay says he learned English partly from listening to records. He was steeped in rock and blues by the time he joined his first major band, The Sparrow, in Toronto in the mid-'60s. They played in a few key U.S. cities, signed a deal with Columbia and cut an album's worth of sessions, but nothing much came of it. Along with Sparrow organist Goldy McJohn and drummer Jerry Edmonton, Kay relocated to L.A., changed the name of the band to Steppenwolf (after a Hermann Hesse novel in vogue with college students) and signed with Dunhill Records, home of The Mamas & The Papas and others.

With an album's worth of tunes, including a few originals—Don Covay and Steve Cropper's "Sookie Sookie," Hoyt Axton's "The Pusher" and a song by former Sparrow guitarist Dennis Edmonton, then going as "Mars Bonfire," called "Born to Be Wild"—Steppenwolf marched into United Western Studios one day in early 1968 with producer Gabriel Mekler to record their first album. They were, however, not pleased with the results, says Kay. "The engineers kept telling us to turn it down, but we wanted to play loud! The recorded sound was too tame. We had heard good things about American Recording Company, a studio on Sunset Boulevard, so we went over there and re-tracked everything with Richard Podolor, who owned the studio, and Bill Cooper. We immediately fell in love with the sound they captured."

By the time Steppenwolf walked into his studio, Podolor had already achieved a real measure of success in the music business. A session guitarist—both he and Cooper played guitars on "Go Little Honda," a hit for The Hondells—Podolor was also a successful songwriter. As players themselves, Podolor and Cooper understood that rock musicians needed to interact at a high sound pressure level for them to be comfortable while tracking.

"American Recording was the first independent studio in L.A.," says Podolor. "My father and I built a console back in 1959, and it was the first solid-state console in the business. We initially ran it on car batteries! We purchased a pair of LA-2As directly from Bill Putnam, who was the head of UREI at the time. We used them on John's vocals.

"We had a Scully 8-track tape recorder," Podolor continues. "We'd roll off some of the high end wherever we could because the Scully had an oscillation that could be disturbing. With Steppenwolf, we were dealing mostly with



the fundamental frequencies so we weren't looking for the upper harmonics! When we got a bass drum sound or even a piano in some cases, we'd filter out some of the lows and the highs and pinpoint the frequency that we wanted.

"Our policy was that we wanted a band to sound as big on playback as they would onstage. Steppenwolf had Fender Dual Showman amps that they turned up to 10. That was fine with us! We were the first guys to throw a mic on the bass drum to isolate it," Podolor claims. "Back then, we'd use a Shure 556 on the kick and a Synchron ST—the first solid-state cardioid mic—on the rest of kit. The Synchron ST had a tremendous amount of rejection on the back side so it let us get a great amount of separation when we were recording a band like Steppenwolf live. We'd put somebody else behind the drums. A total of four or five STs were used on the Steppenwolf sessions—drums, guitars, even vocals.

"We liked the Sony C37 tube mics and tracked John's vocals with them. Later on, when I produced Three Dog Night, we'd pull out a C37 all the time. That was a warm mic, quite forgiving, with more presence than a U47 and less sibilance. We had a trick we used all the time with singers, where we'd have them sing into a mic that wasn't turned on! We'd set up a C37 about two inches off to the right and track it without the singer knowing it was being used. John had no trouble getting his sound, though, and so we didn't have to use that ruse.

"John had so much style. He actually could produce a very beautiful tone, and if he had had a good night's sleep, he could sing a ballad with the best of them. But during those early sessions [the group tracked 11 songs in two days], we encouraged John to go for the gravel. His voice actually had a sound that had a bit of a fuzz tone effect to it, and that blended perfectly with the instruments—particularly the Lowry organ the group used, which had a cracked speaker! People think we used a Hammond B3 with the Leslie cranked up, and in fact the studio did have a B3, but the sound of that Lowry was perfect for the group."

Bill Cooper remembers being immediately impressed

with Steppenwolf. "It's rare when all of a group's members contribute something unique to create an identifiable sound, and Steppenwolf had that. It wasn't about virtuosity. There was a collective sense of what their sound should be, and all of the players helped define it. Richie and I then added a little bit."

Podolor says that he and Cooper used the tools that were available to help the sound congeal. "For example, I mentioned that John's vocals had a gravelly sound that seemed to have a touch of fuzz tone to them. Rushton Moreve played the bass quite loudly, and the guitarists, particularly Mike Monarch [then a 17-year-old who'd been playing for about two years], also played loudly. To make sure that the bass didn't get muddy and drowned out, and to

Back then, it was routine
to have the bass, drums
and organ on the left,
guitars on the right
and John's vocal in the
middle so that
nothing was competing
with his voice for space.

—Richie Podolor

create a blend in the sound, we sneaked a bit of fuzz tone onto it. We'd back the fuzz knob down—going through the device was itself the effect we were going after, not actually using much of the fuzz sound. It was a trick that helped create a space for the bass that kept it from being eaten up by the guitars. We also Y'd out the bass and recorded both its direct and amped sound using a UTC A11 transformer. The idea was to pick up the fundamentals from the A11 and the grunge from the amp."

After two days of tracking, the group sat down to mix with Podolor and Cooper. "We used Ampex 350s as mixdown decks," says Podolor. "These were ¼-inch machines running at 15 ips. Ampex also had the 351 out at that time, but the 350 was fatter. When we mixed down, we always A/B'd the console and the tape and we wouldn't stop until you couldn't hear the difference between the two.

"We never mixed in a single pass, and Bill was a wizard at cutting tape. We'd mix a bar at a time if we needed to, and generally made two mixes with different panning. Today, the bass and drums are normally sent up the middle, but back then it was routine to have the bass, drums and organ on the left, guitars on the right and John's vocal in the middle so that nothing was competing with his voice for space. I was in a supermarket once and heard 'Born to Be Wild.' Half our side was in aisle 20 and the other was about 10 aisles away! Still, that's the way we worked back then, and the goal was that even if one side goes out, you'd have a good record. Ultimately, we provided the label with a mono version, as well."

After touring with Steppenwolf in a variety of incarnations, Kay recently hung up his traveling shoes to concentrate on writing and the work of his foundation (www.mauckay.org). His memories of Steppenwolf's first recording sessions, however, remain vivid. "No one had a clue that 'Born to Be Wild' was going to be a hit," Kay recalls. "During the sessions, it got no more or less of a response than anything else we were working on. 'Sookie, Sookie' came out earlier and did fine, but it got no airplay in the South. It was vaguely suggestive, and our sound didn't make it clear whether we were a black or white band. A song called 'A Girl I Knew' was actually the first single off the album, but it got very little airplay.

"We knew we'd only have the opportunity to release one more single off the album before it got buried," Kay continues. "The label was leaning toward 'Everybody's Next One,' a song that I'd co-written with our producer, Gabriel Meckler, but our manager, Red Foster, was also a disk jockey at KRLA in L.A., and he put feelers out to friends of his who were also jocks, and the consensus opinion was that 'Born to Be Wild' was the strongest contender."

"Born to Be Wild" made a rapid rise to Number 2 on the pop charts ("Magic Carpet Ride," from their sophomore album, called *The Second*, rereleased at the end of 1968, would also crest at that chart spot) and launched Steppenwolf into the pop stratosphere. The street cred of both the song and group received a boost when "Born to Be Wild" was incorporated into the sound track of *Fatsy Rider* a year after its release. It's been covered often since, appeared in many films and commercials, and countless musicians continue to be influenced by the rifle shots of "heavy-metal thunder" (as the second verse says) that Steppenwolf set into motion. ■

MY MORNING JACKET

FROM PAGE 98

Morning Jacket record where we had tried using a computer. In hindsight, working with the computer frustrates me more than I feel it helps because people want to look at that screen and analyze it to death."

Chiccarelli certainly kept that in mind,



Jim James in the studio

tracking the band playing live and always keeping his ears tuned to the overall sound. "Having seen the band live and knowing what they're capable of doing, it was definitely important to have that energy, but still have the production value that Z had," Chiccarelli says. "There is so much texture in the record that I wanted to make sure we were able to meld both worlds."

To accomplish that, the producer kept the sessions moving, choosing songs to record each day based on a combination of band vibe and logistics. For example, Chiccarelli says that they tackled all of the R&B-flavored songs in a row because of where they had to set up Hallahan's drum kit. "We did them in the vocal booth," Chiccarelli says, "which was a closet, basically. We crammed the drums in there with very few mics. Most of the time it was an [Electro-Voice] RE20 on the bass drum, a [Shure] 57 on the snare and a tube [Neumann] 47 overhead."

The disc's more rocking songs were tracked in the main room with multiple mics and very little baffling, while for the mid-tempo numbers Chiccarelli sound-proofed the room differently with baffles and cut the number of microphones by half.

Tommy's bass tracks varied from song to song, depending on the song's vibe. To that end, he bounced from bass to bass, and his rig varied from an Ampeg B-15 to a big 8x10 cabinet. Guitarist Broemel pushed his tracks through two or three different amplifiers, and his rig was recorded in stereo. What made Broemel's sound interesting, Chiccarelli says, was his use of pedals like Durham Electronics' Sex Drive and an



Joe Chiccarelli (right) confers with the members of My Morning Jacket in the studio.

Eventide Time Factor. In fact, those two pedals show up all over the record: “The Sex Drive pedal was also used on a lot of keyboard and vocals,” Chiccarelli says, “and the Time Factor pedal also showed up on vocals. We did experiment a lot.”

My Morning Jacket fans know that James has a penchant for reverb-drenched vocals, and while the performances on *Evil Urges* are a bit more up-front and clean, there are moments where reverb carries his track. “Jim uses reverb just like a painter uses light,” Chiccarelli says. “In fact, it’s a color to him, a texture, and it’s one that he really likes. I will say, though, that these songs are a little bit more immediate and perhaps not so surreal, so it called for less of that.”

James also views his vocals as another instrument in the band, so just as they would swap out guitars and amps for different feels, the team changed mics and reverbs for each song. Some of the vocal microphones included a Neumann 47 tube, an Altec 639 ribbon, an RCA 77DX ribbon, and Shure SM58s and SM7s.

There was also some experimentation on Koster’s keyboards. “We used the new Leslie that has a tube overdrive in it and a preamp,” Chiccarelli says. “Most of the keyboards were amped—anything from Fender to Matchless, depending on the song and the sound. Bo likes the three-dimensionality of putting it through an amplifier and being able to use the reverb or the tremolo on the amp.”

During the six weeks at Avatar, the band recorded about a song a day, but that’s not to say that they only worked on one song each day. Chiccarelli says that after they got a track down, rather than calling it quits

they would start to work on the next song to sow the seeds for the next day. “Very often, most of the takes that we kept came in the first or second take the next morning,” the producer says. “It’s sort of like everyone had to be rehearsed and get their parts clear, and then come in and hit it fresh.”

During those late-night spins through the songs, Chiccarelli says the band was always open to suggestions. “A lot of the foundations they got out of the way in Colorado, but when you get in the studio and listen to things, all of a sudden bass parts seem a little busier than they need to be and drum grooves aren’t as solid as you thought, so a lot of that stuff got worked on,” he explains. “Most of Jim’s vocals were done very casually in not many takes. Sometimes there would be songs that he would sing once and we would get a vocal, and a few days later, he would say, ‘I wonder if I can beat that? You think I can beat that? Let me try it again.’ He was very open to going back to things that I felt weren’t really killing vocally.”

Some of those vocals were cut at Avatar, but most were done at Blackbird Studio in Nashville, where band and crew reconvened after a three-week break. In addition to James’ vocals, the Blackbird dates were taken up with tracking guitar overdubs and background vocals. Once those dates were completed, the tracks were handed over to Michael Brauer, who had previously worked with My Morning Jacket on the 2006 *Okonokos* live release.

Fans and critics alike have heralded *Evil Urges* for its diverse soundscape, with songs bouncing between dance influenced-R&B numbers and more traditional Americana

rock ‘n’ roll. From James’ seat, he’s looking forward to taking this experience into the next album. “I’m very happy with and proud of this record, but I’m never really 100-percent happy with anything I do,” he says. “So I am always looking forward to making the next record and to see how we can do it different and better and be excited time and time again.” ■

CANNON RE-LOADED

FROM PAGE 99

for a general or possibly contemporary jazz audience. “I wanted the groove-oriented, straight-eighth-note repertoire of Cannonball’s, not the bebop,” Field says. “We cast the rhythm section with Steve Gadd [drums], Marcus Miller [bass] and George Duke with that specifically in mind. Those guys have serious jazz credentials, but at the same time can lay down a groove pocket for this kind of music.”

Trumpeter Terence Blanchard, Scott on saxophone and vocalist Nancy Wilson rounded out the project, along with bassist Dave Carpenter and organist Larry Goldings. Naturally, getting Duke, who played with Adderley in the later stages of his career, was a major coup. Field adds that landing Miller was also a great bonus: “You’ve got guys who are both record producers, and from my standpoint as the producer, when you get other guys who are also producers, they understand what the challenges are and that really helped me get everything I needed.”

But landing Wilson, who collaborated with Adderley on their groundbreaking *Nancy Wilson/Cannonball Adderley* album in 1961, was perhaps the most important catch of all from both a fan and marketing perspective. Field has known Wilson for many years and produced several of her CDs, along with a PBS television program. “It was simply a matter of calling and telling her what we were thinking about doing,” he states. “She said, ‘Absolutely,’ and didn’t even think twice about it.”

However, getting this dream band together in the same place at the same time turned out to be one of the more challenging aspects of *Cannon Re-Loaded*. Gadd is constantly touring and recording with the likes of Eric Clapton, Paul Simon, James Taylor and other high-profile performers, so “ultimately, we had to build the recording around his schedule,” Scott notes. “The other people fell in line, but Marcus Miller barely made it at all and was told by his management he



PHOTO: TONY LANE

George Duke lent his talent on Re-Loaded.

couldn't do it because he was finishing up a record project. He did it basically as a favor to me, and I really appreciated that. Of course, I'm sure he didn't mind playing with those guys." [Laughs]

Considering the wealth of material Adderley recorded between 1956 to 1975, choosing selections for the tribute was definitely daunting. Initially, Scott compiled a three-CD set of the tunes he thought had the best potential. Then he and Field narrowed them down to about a dozen. Wilson selected "Save Your Love for Me" and "The Masquerade Is Over," also two of Field's favorites from her work with Adderley. Basically, it became Adderley's "greatest hits," with a possibility of additional volumes later to get deeper into the catalog.

On November 27 and 28, 2006, at NRG Studios in North Hollywood (where Field often works), the project finally became a reality. Field comments, "I wanted this record to have a sound that was very much 21st-century state-of-the-art sonically, but I also realized that the musicians needed to play *together*. So they're on every track as a group, there aren't any overdubs and no edits between songs." Scott eagerly agreed to that approach, and espouses what he says is Quincy Jones' method of producing: "Get the very best people you can get in every field and encourage them to do the best work they can possibly do. If everything goes well, you'll be a hero."

Engineering the sessions was Don Murray, who had previously worked with Field, other Concord Records producers and many of the musicians on *Cannon Re-Loaded*. (Murray got his start at Sigma Sound in Philadelphia working with R&B hit-making producer Tom Bell in the '70s.) The room at NRG where the album was cut is equipped

with a modified Neve board that includes 24 channels of 1073 preamps and another 24 1081s, along with Flying Faders automation—no wonder it's one of the most popular boards in town. Murray says he exclusively used the 1073s here, recording to Pro Tools and using only minimal outboard processing (rather than plug-ins).

Gadd and Wilson were in iso booths with clear lines of sight to all of the musicians in the tracking area. The singer used a Neumann M49, and the drummer was set up with a Sennheiser 421 on the kick, a Shure SM57 on the snare and AKG 451s on the hi-hat and toms. Miller was taken direct, as was Duke when he played Wurlitzer organ and Fender Rhodes; his acoustic piano was recorded using two AKG C-12s. A Telefunken 251 captured Scott's sax and a Coles 4038 for Blanchard's trumpet.

Murray, who won a Grammy this year for singer Patti Austin's *Avant Garde* CD, notes of the sessions, "I've worked with a lot of them and know their sound, and what appropriate mic configurations would capture it best. It all fell together very well, and right from the beginning they all sounded great—within the first half-hour we were tracking. It actually was a pretty easy session to do. The tracks with Nancy really stand out and she sounds so great with everybody else. The musicians were incredible to work with. I rank it as one my most memorable sessions."

The album was mixed during a week in March 2007 at Fields' G Studio Digital in nearby Studio City by Josiah Gluck—who had a long association with the now-defunct GRP Records and is currently associate music engineer for *Saturday Night Live*—along with Field and Seth Present. In keeping with the straightforward approach to recording the album, relatively little was added at the mix stage. "I think we might have used the TC Electronic 6000," Gluck says, "but the thing is, Don's tracks are terrific and don't need a tremendous amount. Greg was there to give me direction where he felt it was needed. Otherwise, it was just pretty much get a good balance and try to create a nice space around things. The challenge was knowing when *not* to do anything, then finding all the little gems and making sure everything was polished. To me, the great thing was getting paid to sit and listen to these guys. I would have loved to have been at the tracking sessions."

Field concludes, "If Cannon heard this record, I know he would love it, and if he were making records now, they would hopefully sound something like this. That was one of the primary goals, and I think we achieved it." ■

332 STUDIO
Stereo / 5.1 Mixing & Mastering

T.C Electronic System 6000, Lipinski, Dangerous Music, Cranesong, Manley, Avalon, SSL, Digital Domain DD-2, Weiss, DCS, Z-Systems.

Architects: Walters-Storyk Design Group.
Acousticians: John Storyk, Renato Cipriano, Dirk Noy, Sergio Molho

info@332studio.com // www.332studio.com

NEED MORE MIX

News | Online Events | Blogs, Vlogs + Podcasts | MixLine | *Pro* Gear

GET YOUR MIX FIX AT MIXONLINE.COM

Mix

Various Artists

Get the Led Out! Led Zeppelin Salute
(BHP Music)

Since I'd never heard of any of the artists on this disc of instrumental covers of Led Zeppelin tunes (except for guitarist Leslie West on a track credited to bassist Randy Coven), this doesn't quite qualify as an "all-star" tribute. But it really is the best kind of tribute because it takes the source material and does something interesting and creative with it. The brainchild of New York producer/guitarist Brian Tarquin, it features a broad range of intriguing Zep interpretations—part of what makes it so cool is that on most tracks, both the Jimmy Page and Robert Plant parts are covered by guitars. And without exception, the guitarists acquit themselves very well. No one is directly copying Page's style (even as they borrow iconic licks and lines); rather, there is a variety of different guitarists' voices, several in the speedy, modern Van Halen/Yngwie/Vai mode. A lot of the key touchstones of the LZ catalog are here, from Chris Mahoney's exciting re-working of "Whole Lotta Love," to Martin Winch's appropriately hypnotic acoustic "Kashmir" (which has a dobro playing Plant's part and a Spanish guitar break), to Greg Rapaport's sleek and glistening "Immigrant Song" and James Ryan's ultracrunchy "Black Dog." Two of the most creative are acoustic: Steve Booke's "Friends" sounds like a jam from a Marrakesh market, and Steve Bingham's "The Battle of Evermore" is centered around a lovely violin arrangement. The weakest part of the album will probably be its biggest selling point for some—four previously unreleased "Bonus Tracks" from 1970 featuring Page and the awful singer David "Lord" Such (and John Bonham on three).

Overall producer: Brian Tarquin; however, many different producers and engineers were involved. Mastering: Chris Landen/Pacific Mastering (North Hollywood). More credits at mixonline.com.

—Blair Jackson

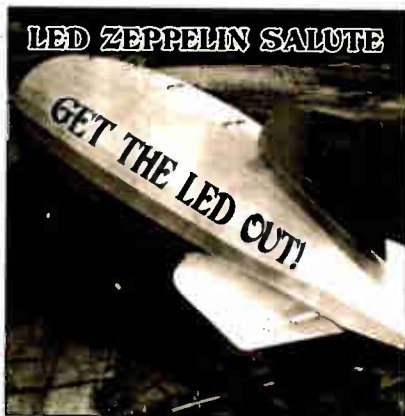

The Proclaimers

Life With You
(W14 Music)

Scottish twins Craig and Charlie Reid, also known as The Proclaimers, have recorded some of the most joyful, soulful, delightful pop music of the past two decades. Their vocal harmonies have a magical synergy reminiscent of the Everly Brothers; live, their voices sound so big and full together you'd think there were several more spectacled Scotsmen onstage. On *Life With You*, the Reid brothers hold nothing back; the first track on this album, the title track, is an infectious folk/pop powerhouse, fully embellished with piano and horns on top of the brothers' trademark guitar strumming. Other highlights include a cover of Wreckless Eric's "Whole Wide World" and the passionate original "Blood Lying on Snow." A wonderful bonus live recording is included for good measure.

Producer/mixer: Steve Evans. Recording engineer: Tom Dalgety. Studios: Rockfield Studios (Monmouth, UK), The Stone Room (London), Riverside Studios (London). Mastering: Kevin Metcalfe/Soundmasters (London). —Barbara Schultz

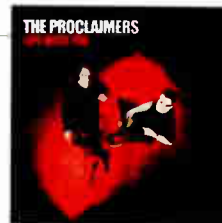

Amos Garrett

Get Way Back: A Tribute to Percy Mayfield
(Stony Plain)

PercyMayfieldwrote

a string of amazing blues and R&B hits (mostly for others) from the late '40s through the '70s, so it's great to hear Amos Garrett, with his deep baritone voice and his exquisite sense of phrasing—as both a vocalist and guitarist—tackle an album's worth of Mayfield treasures (well-known and not). It's like we've been dropped into a smoky club after hours and Garrett is leading a small band through its paces: Everything sounds very relaxed and casual, yet there is unmistakable darkness and even urgency in so many of the lyrics. The arrangements—featuring keys, sax, trumpet, bass, drums and guitar—are classy, not flashy, and *juuust* right. Garrett doesn't imitate Mayfield; rather, he imbues his songs with an appropriately world-weary wisdom and gravitas, which suits the material perfectly.

Producers: Garrett and Dave Allcock. Engineers: Allcock and Nick Tjelios. Studios: Casa Roxton (Toronto), Sundae Sound (Calgary). Mastering: Dave Horrock/Infinite Wave (Calgary). —Blair Jackson

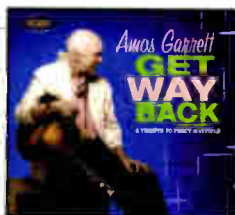

Old 97's

Blame It on Gravity
(New West)

If I ran the zoo, a couple of the songs on Old 97's

just-released *Blame It on Gravity* would be big hits. The first song on the album, "The Fool," effectively combines jangling guitars borrowed from "P.nball Wizard" with a country bounce and clever lyrics. And then there's "Dance With Me"—who doesn't love a rock 'n' roll tango? The band waited four years to make another album of new material (they released a "best-of" collection in '06), and it seems their sound and gang songwriting have matured quite a bit during the interval. I used to be somewhat confused about this band: Were they Americana? Indie rock? Now, though they still wear all of their influences on their sleeves, they have a well-formed sound all their own.

Producer: Nouralish. Engineers: Rip Rowan and Salim Nouralish. Studio: Pleasantry Lane (Dallas). Mastering: Gavin Lurssen/Lurssen Mastering (Hollywood).

—Barbara Schultz



Missy Higgins

On a Clear Night
(Reprise Records)

Singer/songwriter Missy Higgins hits her stride with this latest offering, where she combines some of the melodic sensibility of Sarah McLachlan with the more uptempo drive of Alanis Morissette to create a sound that is both stirring and lyrically rich. Most of the tracks reflect her life as a young woman hitting the big city to find herself, getting trampled by new experiences, but dusting herself off and moving on. Producer Mitchell Froom showcases Higgins' assertiveness as a vocalist, and it's easy to imagine the stellar cast of A-list musicians—drummer Matt Chamberlain, guitarist/backing vocalist Neil Finn, guitarist Val McCullum, bassists Davey Faragher and Ian Walker, horn player Cathy LaMothe and mandolinist Greg Leisz—encircling Higgins (who also provided some instrumentals) in Froom's home studio and providing a smooth and comfortable backdrop for her musings.

Producer: Froom. Mixer: David Boucher. Studio: Therabeta Studio (Santa Monica, Calif.). Mastering: Bob Ludwig/Gateway Mastering (Portland, Maine). —Sarah Benzuly ■



YOUR LOCATION FOR CREATION

65,000 square feet of gear



Subscribe to the
B&H Pro Audio Catalog
www.bhphotovideo.com/catalog

Visit Our SuperStore
420 Ninth Ave, New York, NY 10001

bhproaudio.com
Shop conveniently online

800-947-5508
Speak to a Sales Associate



L.A. GRAPEVINE

by Bud Scoppa

During the 1970s and '80s, I made frequent visits to the Sunset Marquis, a high-end but unpretentious hotel tucked away on Alta Loma, a side street a block west of La Cienega just below the Sunset Strip. The Tubes stayed there during one of their recording projects during their years at A&M, and as their product manager I had an excuse to

placed by a quietude approaching serenity. It's hardly surprising that the hotel is favored by showbiz people who prefer to keep a discreetly low profile, in marked contrast to the nearby Chateau Marmont, with its see-and-be-seen vibe. But there have been some changes to the Sunset Marquis—changes in some ways indicative of the particular needs of the clientele. The recently expanded villas boast underground parking big enough for tour buses. And if an artist needs to do some overdubs or mixes in a top-of-the-line recording facility, there's just that—a floor below the lobby area on the parking level, though you'd never know it was there. I certainly didn't until a few months ago.

The idea for NightBird Studios—renamed on its 15th anniversary from its unwieldy original moniker, the Studio at Sunset Marquis Hotel & Villas—was hatched by keyboardist/producer/songwriter Jed Leiber as a joint venture with the hotel's owners. The

event that led to its genesis falls into the grand tradition of L.A. rock 'n' roll hotel stories, as close to Led Zeppelin's TV-off-the-balcony episode at the old Continental Hyatt House on Sunset as this laid-back hotel is likely to get.

It went down in the wee hours of the morning in 1993, when New Yorker Leiber and his pal Jeff Beck were jamming in the guitarist's Sunset Marquis suite, only to be interrupted by a knock on the door. It was Sunset Marquis general manager Rod Gruendyke, who expressed concern about nearby hotel guests who were trying to sleep. "Sleep?" Leiber said incredulously. "They should be slipping *money* under the door." Gruendyke suggested that they take their axes down to the underground garage, which they did. They wound up at the

—CONTINUED ON PAGE 110

NASHVILLE SKYLINE

by Peter Cooper

Charged with producing vocals on the King of Broken Hearts himself, Buddy Cannon figured it was best to be smiling and positive. After all, George Jones knows how to sing a country song and doesn't need a lot of help in the matter.

"Man, George was on his 'A' game, and we were recording an album on him," says Cannon, who back then—in 1993—was a young buck producer with a couple of country hits under his belt. "And he made me feel intimidated as hell. I don't think he tried to, but just his presence was intimidating. One time, he got finished with a vocal, and I said, 'That was pretty good.' He said, 'Pretty good—hell! Let's do it again, then.'"

Cannon—who has gone on to produce smash country hits for Kenny Chesney, Reba McEntire, Chely Wright and Sara Evans—smiles when he recounts the story of Jones' profane perfectionism. He smiles at lots of other things, too. Knowing he's being interviewed for an audio magazine, Cannon is well-pleased to announce his love of digital reverb, his lack of technical prowess and his insistence that it's more important to have a room that's comfortable than it is to have a room that's sonically superior.

"I don't know nothing about this stuff," he says, gesturing to a digital board at Blackbird Studios. "I'm a technical dummy. I guess I wish I knew, but I don't want to make the time to learn. I figure, 'Why should I do that when I have an engineer who already knows how?' So I choose rooms by comfort level. I like a room that's big enough for the whole band to come back in and hear the playback."

So when Cannon and Chesney set about producing a Willie Nelson album last year, it was Cannon's choice to use Sound Kitchen, one of the Southeast's largest recording studios. Sound Kitchen has a studio called the Big Boy room, with a custom API Legacy board, 3,000 square feet of tracking space and an ample control room. That's where Cannon was recording Nelson.



From left: Jason Fleming, Dom Trenier, Teddy Riley, John Oates and Jed Leiber at NightBird Studio, situated in the Sunset Marquis Hotel

hang out with the band in and around the courtyard pool. (What transpired in the rooms is none of your business.) My wife (who also worked at A&M) and I got our first taste of The Police's second album, *Regatta de Blanc*, in Ian Copeland's suite, and during the '80s I interviewed hotel guests like Michael Hutchence of INXS and Robert Palmer, who autographed the albums I'd remembered to bring with me. A few years later, I got my first glimpse of the Sunset Marquis villas while interviewing Grace Slick on a grassy hillside. Early on, I decided that if I were a visitor to L.A., this was where I'd choose to stay.

Now, as in the old days, when you walk through the lobby and into the courtyard, with diners at its patio restaurant noshing and conversing in civilized murmurs under umbrellas, the bustle of L.A. is instantly re-

NEW YORK METRO

by David Weiss

"Yeah, but it wasn't big enough," Cannon says, smiling again. "You ever seen all the people that Willie attracts? Plus, song-writing buddies of Willie's kept dropping by, and at one point there were so many people in the control room that the band couldn't get in there."

The Nelson album, called *Moment of Forever*, came out this past July. It finds Nelson singing songs from sources as disparate as Kris Kristofferson, Dave Matthews, Big Kenny (from Big & Rich) and a bluegrass-leaning Shakespeare-type named Paul Craft. Because of Chesney's relative youth, many listeners and reviewers assumed that the country superstar brought Matthews' "Gravedigger" to Nelson. In fact, it was Cannon, who heard Matthews sing the song at an Emmylou Harris tribute concert one evening.

"I'd heard of Dave Matthews, but I'd never seen him or heard a song of his," Cannon says. "When he sang it, I was frozen. I thought, 'That could be cut in our format.' That was three months before we started the Willie record, and when I showed it to Willie he jumped all over it."

That's another thing about Cannon: He believes song-finding is more important than microphones or preamps in the grand scheme of things. He began working in

—CONTINUED ON PAGE 110



Joan La Barbara and Mort Subotnick in their His & Hers home studios

His and hers studios? We've heard of such a distinction for bathrobes, luggage and even Corvettes, but not audio facilities—not until we met experimental vocalist/chanteuse Joan La Barbara at a swank New York City party, that is.

It turns out that a His & Hers music production combo is exactly what La Barbara (www.joanlabarbara.com) and her husband, electronic music founding father Morton Subotnick (www.mortonsubotnick.com) are running in their digs. Set in the heart of Greenwich Village, their roomy apartment is home to a friendly old dog, an occasionally talkative parrot and separate-but-equal studios that allow these two musical pioneers to get wired, inspired and collaborate as needed.

"His" studio is an unassumingly compact surround-sound setup that at first glance gives zero indication of being operated by the man who many credit as being the co-inventor of the modern synthesizer. Subotnick's work in the early 1960s to bring the Buchla 100 Series modular synth into existence is the stuff of legend (learn

more from *Remix* writer Bill Murphy's article at remixmag.com/artists/electronic/remix_morton_subotnick/), and subsequent works such as *Silver Apples of the Moon*, *Touch* and *Sidewinder* are considered classic/electronic classics.

Today, instead of a wall-to-wall-to-wall behemoth of a Buchla, Subotnick, at an extremely youthful 75, is perfectly content to be based on a G5 and surrounded by quadraphonic Mackie FR monitors with a Samson sub. "Originally, I was going to be in the big room," says Subotnick, gesturing over to the larger part of the space, "but I have two or three assistants, so they have the big room and I have my little sanctuary here. For basic monitoring, I don't have to blast it and the subwoofer works quite well. It's really just a small space—but it's just me."

No DAW out there has truly satisfied the pioneering Subotnick. Instead, his studio center of choice is the PreSonus FireStudio. "I must have five different FireWire devices—this one I like the best because it has the best software mixer in it," he explains. "It's quite well-designed. What I don't like about the others is that they assume that you want to do x, y or z, and I never do what is assumed. This is a matrix, so I can do anything I want with it."

Right now, the projects his studio is supporting include an updating of his 1975 work *Until Spring* called *Until Spring Re-*

—CONTINUED ON PAGE 111



Willie Nelson with Buddy Cannon and Kenny Chesney (in baseball cap) during work on Nelson's album *Moment of Forever*

NOT JUST A FANTASY LEGENDARY STUDIO IS BACK FROM THE BRINK

By Barbara Schultz

In the San Francisco Bay Area studio scene and beyond, Fantasy Studios (www.fantasystudios.com) and the Fantasy Records label are the stuff of legend. The facility has been situated in West Berkeley for more than three decades—part of an indie media mini-empire once owned by filmmaker Saul Zaentz. The studio most famously hosted recordings by the Fantasy label's biggest act, Creedence Clearwater Revival, as well as other national acts, including Santana and Green Day. Because the facility changed hands a couple of times in recent years, you may have heard through the grapevine that Fantasy Studios was going to close last year, or this year...

There was more than a grain of truth to those rumors. The studios, label and back catalog were taken over by Concord Records a few years ago, with Concord renting space in the building Zaentz still owned, but then Zaentz sold the building itself to a real estate developer, Wareham Development. When Concord's long-term lease on the building expired at the end of 2007, the label's management decided to move the label and catalog south to Concord's Beverly Hills headquarters and dismissed all of the Fantasy Studios staff. Longtime studio manager Nina Bombardier began making plans for a new life outside the music business, and all of her employees assumed the studios would close.

"But the Wareham principals were huge fans and wanted to keep the studios open," explains new studio manager Jeffrey Wood. "They stepped up to the plate in a big way. We talked with them about the importance of the studios to the Bay Area, not just historically but in terms of keeping these



PHOTOS: STEVE MARUTA

Fantasy Studios' grand Studio A is equipped with an SSL 8056 G+ console, Pro Tools HD3 and Augspurger custom mains.

the C room to a private client. They also replaced some decades-old wiring, finished upgrading their Pro Tools rigs to HD (two of three systems were done a couple of years ago), and added a Digidesign Control24 board and Neve 8816 summing mixer in Studio B.

"Now we have two consoles in there," says Willetts, who joined Fantasy as a second engineer eight years ago. "We added the Digidesign console, but we still have the Trident [80B]. I've never seen this before!"

"Studio B will become a mix room, as well as a lower-cost independent band room," explains Wood. "We have a lot of clients who love the Trident and still want to work in analog, but we also have engineers who come in and want to mix inside the box. Now we can accommodate all of these projects.

"We've also made some cosmetic changes. But it's been important to respect the history of it as we continue to move the studio into the future. We also have people come in to Studio D, for example, which looks very '1980,' but when I talk to new clients or prospective clients about changing the appearance of it, they say, 'No, don't change a thing! It looks very modern!' It seems the aesthetic has ridden the wave back around!"

Wood worked with Bombardier to make the transition smooth for clients and staff. And since the changeover, he and his staff have been pushing hard to complete all of the renovations and book the rooms. Since December, the studio has hosted sessions with Counting Crows, Dolphin City, Peppermint James and local favorites Camper Van Beethoven. The facility, which retains all of its analog Studer machines, also continues to do frequent A/D transfer work for Concord Records and others.

"When I found out the studios might close, I booked a ticket to New York for the [October 2007] AES show," Willetts recalls. "But then Wareham stepped in and I ended up only taking a couple of weeks off. I think Jesse only took three days, and James Gangwer just plowed right through! We're all very excited to be here and have the opportunity to work with the mix of incredible talent who use Fantasy Studios." ■



Engineer James Willetts in Studio D

large rooms available."

In addition to hiring Wood, a producer with decades of experience in the control room and in artist management, and assistant manager Amanda Howell, Wareham re-hired engineers James Willetts and Jesse Nichols and chief technician James Gangwer. The developers and the streamlined staff decided to scale down from four studios to three; they plan to rent out

HIT FACTORY CRITERIA AT 50

STUDIO MARKS GOLDEN ANNIVERSARY WITH UPGRADES

Hit Factory Criteria Studios (Miami) is celebrating its 50th anniversary this year, and recent upgrades show how the studio continues to thrive in this tricky business. With help from SSL, the studio's older Sony Oxford console has been replaced with an SSL Duality. In addition, with assistance from Guitar Center Pro, five Pro Tools systems were upgraded to HD5s with Apple 30-inch Cinema displays.

Bob Lanier, general manager of Hit Factory Criteria Entertainment says that the new console, with its flexible control surface, allows the studio to accommodate diverse projects. "One thing about this studio and where [late owner] Eddie Germano and Janice Germano, owner/CEO, always wanted it to be was to be on target as far as the versatility of the rooms," says Lanier. "With the variety of clientele we have, we've got to have that versatility."

"A lot of our clients have established a comfort level with SSL products," says studio manager Trevor Fletcher. "We've bought our share of them over the years, and this is the next cutting edge.

It's got the analog control surface and the integration of DAW control. While we've got lots of established, large-format consoles here, we keep an eye to the future."

During his 25-plus years with the studio—dating to long before Hit Factory acquired the facility in 1999—Fletcher has seen the clientele change, from primarily soul and R&B to rock to disco to today's mix of urban, Latin, rock 'n' roll, pop and more.

"Just in the past couple of months," Lanier says, "we've had the Australian group Jet with Iggy Pop, Chris Cornell with Timbaland, Madonna mixes, Mariah Carey mixes."

Fletcher and Lanier acknowledge that the proliferation of project rooms, low-budget gear and lower label budgets have changed the way they work over the years, but Fletcher says the studio will simply "grow with it. It's just another day and another way you have to be creative to give your clients the best service for the money."

"Would I prefer it was 1977?" Lanier asks with a laugh. "Yeah. That would be great. The business



At Hit Factory Criteria's new SSL Duality console are (from left) studio manager Trevor Fletcher, general manager Bob Lanier and chief technician Simon Soang

model for record companies then was essentially, 'Here's a starting budget. Let us know when you need more.' Now it's oriented to the business side and costs and control. But people recognize what we provide here—the service and acoustic spaces—and people are willing to pay for that when the best matters."

—Barbara Schultz

TRACK SHEET

SOUTHEAST

Jeff Powell mixed a new release for Susan Marshall and Paul Mark in Studio A at Ardent Studios (Memphis)...At Catalyst Recording (Charlotte, NC), Jeff Hahne, music editor of *Creative Loafing* magazine, is producing a series of CDs featuring local music that's thematically connected to the four seasons. Artists on the first CD include Erika Blatnik, Holster, Blue Static and Gigi Dover. The collection is being mastered by studio owner Rob Tavaglione.

NORTHEAST

Former Sony Music mastering engineer Dave Kutch has opened his own New York City mastering studio, The Mastering Palace. The new facility is equipped with Pro Tools, TC Electronic System 6000 digital processing, Magix Sequoia DAW, Prism Sound AD-2 and DA-2 stereo converters, and more...Joe Sample and Randy Crawford tracked in Avatar (NYC) Studio A with producer Tommy LiPuma, engineer Elliot Scheiner and assistant Rick Kwan...Rob Harari recorded a new album for Mark Barkan at Harariville Studio (Weehawken, NJ). Also at Harariville, Spyro Gyra recorded a Christmas song with Broadway singer/actress Christina Ebersole...At Range Recording Studios (NYC), the band Refurb recorded with engineers/co-pro-

ducers Michael McCarthy and Brian Ritrovato; the band also co-produced.

NORTHWEST

Bruce Brown mastered an EP for Miles From Home at Puget Sound Studios (Seattle)...Kevin Nettleingham recorded a gospel CD featuring Carl Wirkkala and Lucas Holmgren at Nettleingham Audio (Vancouver, WA).

WEST

Epitaph artists Escape the Fate recorded an album with producer/songwriter John Feldman at Feldman's Foxy Studios (Las Vegas). The engineers are Matt Appleton and Kyle Moorman...Rick Montoya mastered a live CD by the Williams Brothers Band at SoundandEntertainment (Grand Junction, CO).

SOUTHERN CALIFORNIA

Indie singer Angela Luna recorded some of the basic tracks for her CD *Hope Nation* at Mad Dog Studio (Burbank) with producer Derek Nakamoto and engineer Eric Corne. The release was mixed by Ryan Freeland at Origin Stampede (Venice)...Producer/songwriter Kenny Nolan has set up shop in the former Westworld Studios (L.A.). The studio, renamed SoundQuest Recording, is equipped with a Neve



L-R: Burt Bacharach enjoys a little refreshment with keyboardist/arranger Rob Shrock and Ocean Way owner/engineer Allen Sides.

BACHARACH VISITS OCEAN WAY

Burt Bacharach and longtime keyboardist/arranger Rob Shrock visited Ocean Way (Hollywood) to mix live recordings that were made at the Sydney Opera House in Australia this past February. Shrock did a Logic/Pro Tools edit and pre-mix, and studio owner/engineer Allen Sides did the final mix.

8248 console and UREI Time-Align monitors. Ocean Way Recording's Allen Sides assisted with the gear and studio acquisition/returbishment...Rob Chiarelli remixed tracks by Mary Mary for a "best-of" album in Final Mix Studios (L.A.).

Send Track Sheet news to bschultz@mixonline.com.

present location of Studio A, which George Augspurger had built for New England Digital as a projected sales room for Synclaviers. Leiber jokes that he's been down there ever since. He carted all his gear out from New York and gradually expanded the studio from its humble beginnings next to the laundry room to its present snazzy state. It's now snazzy enough for Madonna, who very quietly spent three months here working on *Hard Candy*.

I take the elevator down from the lobby, step out into the parking garage and notice a row of heavy doors across the front wall. Out of the one on the far-right pops studio manager Lisa Yastic, who shows me around the compound. To the far-left is Studio B, which is currently being occupied by New Jack Swing pioneer Teddy Riley, who brought John Legend down two days earlier. Next door is a smaller workstation where staff engineer Steve Sundholm (son of the creator of Sunn Amps) spends a lot of his time. The adjacent A room, which is primarily used for recording, is dominated by a recently-arrived Yamaha 9-foot Concert Grand Pro/Mark IV Disklavier. All three spaces are dark and cocoon-like, thanks to muted lighting and mahogany wall coverings.

Yastic leads me into the main control room, where Leiber is huddled with John Oates, and staff engineers Sundholm and Jason Fleming. They're just days away from completing the mix of Oates' rootsy, all-star-laden solo project, *1,000 Miles of Life*, which Leiber co-produced in Nashville's Ronnie's Place with the artist; he also played keys on eight of the 10 tracks. The room, its walls finished in mahogany, boasts a Digidesign ICON HD running Pro Tools HD6, with racks of vintage outboard gear to its right. Covering the front wall is a 120-inch projection screen, winged by Tannoy monitors. A half-dozen HD LCDs measuring up to 65 inches line the side walls. The dark-leather sofa on which Oates is seated stretches across the back of the room.

"John brings his Philly soul roots to the table; there's the pop sensibility he's known for, but there's also all of these wonderful new elements," Leiber says of the project. "The combination creates something I really haven't heard before. From the beginning, John said, 'I trust you, but please, I want this to be warm and natural.' We accomplished that in tracking—it was recorded by the amazing Nashville engineer Bil VornDick—and we took that concept into the mix,

running the tracks through analog gear to warm them up."

Sundholm picks up the thread. "The basic signal chain," he explains, "was the 1081, which is on everything, 1176, LA-2A, Vari-Mu, GML EQ. It's classic music, and it called for classic vintage gear."

The album was largely recorded live off the floor, and Oates was intent on retaining the sense of musicians interlocking in the moment. "I had this brand-new, \$200,000 9-foot grand that I couldn't wait to play and replace all my parts," says Leiber. "And behind my back, John has my guys put a sign on the piano that says, 'Jed is not allowed to play this piano until the mix is completed.'"

Oates is in the midst of a busy week, which started two days earlier when he and Daryl Hall received the BMI Icon Award and culminates with the duo's two-night stand at the Troubadour. He's staying at the hotel, of course.

The first stage of a major remodel visualized by Leiber was completed in January. "We had a very high-tech room," says Leiber of the studio's previous décor, "and having spent a fair amount of time in John's studio in Aspen, I wanted something cozier. Plans are being drawn up for further expansion, including an enclosed lobby area. On order is a 72-channel SSL Duality to go in the main room because a number of producers who use the facility have expressed the desire to work on a traditional console. When the SSL arrives, the ICON will be moved to Studio B.

After touring the studio, I head up to the patio dining area with Yastic and Fleming. Sitting at the next table is David Cook, who had won *American Idol* the night before, enjoying a quiet moment during the busiest day of his life. Lisa, Jason and I all opt for the steak sandwich, which Sundholm had assured us was one of the five best he'd ever eaten. I hereby second that emotion. ■

Send L.A. news to Bud Scoppa: bs7777@aol.com.

Nashville as a bass player in the 1970s, and Mel Tillis saw fit to hire him in his band and employ him at Tillis' publishing company. After shifting to an A&R position at Mercury Records, Cannon became interested in producing.

"What drove me to producing was the creative side," he says. "I hated picking up records and looking at the liner notes and seeing 10 songs from one publishing company, when I knew there were better songs



Producer Buddy Cannon at Nashville's Blackbird Studio

available. I always wanted to make a better record by doing better songs. I have never been any better at the skill of producing than anybody else, but I thought my song sense was better. It's like a challenge: 'I can beat that.'"

Cannon's first major shot at producing came on an artist named Sammy Kershaw, who initially detested a song that Cannon liked called "Cadillac Style."

"All we had was a work tape, done on a jam box, as a guitar vocal," Cannon says. "It was really rough, but it sounded like an obvious hit to me. Kershaw said, 'You're crazy, I ain't cutting that. That's terrible.'"

But at session's end, there were about 15 minutes left in the musicians' contracted schedule. "Cadillac Style" was a simply structured song, and Cannon asked the band to give it a try. "As soon as we cut it, Sammy fell in love with it. And that became his, and my, first Number One hit."

Cannon's old-school country pedigree did not hinder him from accepting and embracing Nashville's move away from analog tape. "Man, I thought the best thing I ever heard was that crisp, digital reverb; that little Lexicon box," he says. "I loved it. And I was one of the first guys to get on those 32-track

digital Mitsubishi machines. I guess most people don't like to change, but there's no sense in letting any of that bother you."

Cannon's most successful regular client is Chesney, who has become the top touring act in contemporary country music and a regular pick for Entertainer of the Year at country awards shows. Cannon co-produces Chesney's albums with the artist, and the two men are currently working on a new album at the Sound Emporium's Studio A, with engineer Tony Castle manning the Neve VRP console. The project, which has been going on in fits and starts (when stadium shows collide with available studio time, the stadium shows tend to win) for two years, was begun at the now-shuttered Emerald Sound Studios.

"You couldn't ask for a better-hearted guy to work with than Kenny," Cannon says. "And he's talented, man. In the studio when we're making a record, he is the creative force. The musicians have absolute respect for him, and he drives it when we're recording. My job is to let Kenny be Kenny. If I thought he was going wrong somewhere, I would speak up. But he doesn't do that."

While plenty of folks on Music Row beaman MP3s and ear buds and all of that, Cannon keeps thinking it might be best to just go ahead and start monitoring in MP3 and listening through the ear buds.

"We spend thousands of dollars mixing records, but we don't even know what it sounds like to 90 percent of the people listening," he says. "Go with the state of the listener."

And though he's fussier about microphones than about most other gear, Cannon doesn't care to be on a first-name basis with those mics. He sets one up in front of the singer, listens for awhile and then makes adjustments based on what sounds good.

"I will make the decision on what mic we use, but I don't have any idea what they are," he says. "Someone asked me about what mic we were using on Kenny, and I said, 'It was either that round one or that square one. Call Tony Castle and ask him if you want to know for sure.'" ■

Send Nashville news to Peter Cooper: skyline mix@live.com.

NEW YORK METRO FROM PAGE 107

visited, ongoing development of his music learning curriculum "Creating Music" (www.creatingmusic.com) and the creation of a collection of Soundfonts ("more than a full-time job"). Also on the docket is an

extension of his famous "ghost pieces" for live performance, as well as myriad other musical adventures.

Decades after his own tireless efforts led to the vast array of soft synthesis options available to bedroom producers today, Subotnick seems pleased with how his innovations have played out in modern music production. "I sort of did have a vision of where we'd be," he says. "I didn't know I'd be seeing it in 2008—I didn't know if I'd make it to the 21st century! I was playing on my clarinet, for example, and I couldn't see why I would spend my life using electronics to design what I could already play; I thought people would want to be creative and express what they couldn't play [with existing traditional instruments]."

"But now with the computer, people are creating what they couldn't play by making laptop orchestras. In the last 10 years, computers have gotten smaller, quicker and cheaper, and a lot of people's home studios look like mine now. This looks almost like a prototype of a lot of home studios, and that's what I imagined in 1960."

Go back into the living room, walk past the muttering parrot, hang a left and you're into the "Hers" section of the pad. This is sonic HQ for La Barbara, as much of a pioneer with the human voice as Subotnick has been with synthesis. La Barbara first started making waves in the mid-'70s with the Philip Glass Ensemble, and went on to collaborate with the likes of John Cage, Robert Ashley and, of course, Subotnick, her spouse since 1979. Along the way, her development of advanced vocal techniques has gone way beyond singing, making her mark with glottal sounds, grunts, clicks, multiphonic voicings, falsettos and circular singing in celebrated works such as *Sound Paintings* and *Shamansong*.

Like Subotnick, La Barbara continues her trailblazing work with a relatively streamlined setup. Next to the west-facing window of the sun-drenched room resides an Apple G5 connected to a Digidesign Mbox, a pair of M-Audio Project Studio 5 monitors and a Yamaha Clavinova digital piano.

Aside from this recording setup and an unlimited imagination, a Beyerdynamic M88NC microphone is all the vocal adventurer really needs, wrapping the mic up after she's in the studio and promptly taking it out for live use. "I recently did a piece called 'Shimmer,' which is a recording of an opera in progress," she explains. "When I did the playback and sang over that, it was so transparent you couldn't tell if what you were hearing was live or the recorded

material. What I really like to do with live and recorded sound is mix my voice so it can be immersed into the live texture. Using the same mic for everything helps contribute to that sense of mystery."

Looking out on the Avenue of the Americas, La Barbara remarks that her current vocal projects are focusing inward. "I'm working on what I think of as interior sounds—sounds inside one's head," says La Barbara. "The challenge to me is to record these sounds that are not huge, not projected. They're more intimate and personal kinds of sounds. I'm able to work on these very quiet sounds because of the nature of the technology and how it's advanced at this point: You can get sonic blackness, which is something you could never get with analog. The idea that you can get this with voice the same way that painters talk about negative space is something I'm finding a real challenge to incorporate into the sound."

Even though La Barbara and Subotnick's studios are interconnected via Ethernet, there are still important boundaries that separate the His & Hers studios of Greenwich Village. "If one of us sees the need, we'll come in and comment [on what the other is working on], but we don't comment unless asked—I think that's a good rule of thumb," she says. "That's because composers have their own individual ideas. But if I'm stuck on something and I want an opinion on how a certain sound mixes with another sound, I'll ask him to come in. I think having that kind of availability of another composer to bounce things off of is really marvelous. He's certainly more adept at electronic modification of sounds, and I've done a whole lot with the voice and the layering of materials."

Even as an electronics adventurer nearly 50 years ago, one of Subotnick's primary goals was not just to elevate experimental musical possibilities, but also make the process of its creation available in every home. Looking at Subotnick and La Barbara's everyday His & Hers studios tucked neatly into their New York City apartment, there's no question he's succeeded very nicely on that count. "A lot of what I was doing in those days has become a feasible reality," he says. "I was thinking of a sound easel in your living room, a cheap little thing you could create with. Now it seems to be there, and I'm thrilled that I'm not only seeing it, but in perfect health and living it." ■

Send New York news to David Weiss: david@dwords.com.



a wave of change is breaking

Millennia partners with

Music & Media artists moved to action

ARTIST: Grammy nominated **switchfoot**
Latest release: Oh! Gravity - peaked at #1 on iTunes top albums chart

ACTION:
Launch of 07 & 08 "Music Builds" tours in support of Habitat for Humanity.
Host **The Annual Switchfoot Bro-Am Surf Contest** which raises funds for organizations serving homeless children in San Diego.

Founders of **lowercasepeople.com** 
online magazine which focuses on the appreciation of noteworthy artists, art and social justice issues.
With the help of Geneva global, LCP Justice Fund helps fund specific projects to select communities around the world...

Musical contributors to the rockumentary film "Call and Response: Concert To End Slavery"
08 Tour benefitting "To Write Love on Her Arms"

WANT TO GET PLUGGED IN?

VISIT

www.mil-media.com/pdf/wavechange.pdf



Corporation
Setting the new corporate standard for 100% profit and maximum performance
bcorporation.net

Millennia
Music & Media Systems
www.mil-media.com

MARKETPLACE

JOSEPHSON ENGINEERING C700A

"... clear, realistic, noise-free and quite neutral without a hyped high end or midrange.

... allows you to explore and experiment with mic patterns and the subsequent shift in tune, after the recording, during the mix."

- Barry Rudolph, *Mix* magazine



Josephson.com

The Horizon Tube Microphone

"Like all great mics, the Horizon's got a SOUND... Built like a tank, this mic can handle anything."

Nick Raskulnec - Multi-Grammy® winning Producer/Engineer (credits include Rush, Foo Fighters, Velvet Revolver)

"The Horizon is a Go-To microphone on all of my sessions"

White Terry - 2-time Grammy® nominated Producer/Engineer (credits include Eagles, Jessica Simpson, Foo Fighters)

Our users say this is their best mic for Acoustic Guitar, Guitar Amps, Drums, Piano, Strings and Voice-overs.



LAUTEN AUDIO 1-877-721-7018 LautenAudio.com \$799.99

Studio Suite 8

STUDIO MANAGEMENT SOFTWARE



Simplify your Office Manage your Studio Organize your Tech with **ONE** Product!

1.800.450.5740

International: 1.818.752.3900

www.studiosuite.com altermedia

IN-HOUSE CD • DVD • VINYL MANUFACTURING

300 CD Package: \$775.00

Includes: 1-color booklet & 1-color CD label from print-ready film, jewelbox, shrinkwrap

1000 CD Package: \$1199.00

Includes: 4-color booklet & 2-color CD label from supplied artwork, jewelbox, shrinkwrap

D.J. 12" VINYL PROMO

100 12" VINYL \$799.00 Additional LP's: \$1.30 each

500 12" VINYL \$1,279.00 REORDER \$710.00

1000 12" VINYL \$1,889.00 REORDER - \$1319.00

PACKAGES INCLUDE: WHITE JACKET w/ HOLE • MASTERING • FULL PROCESSING • TEST PRESSINGS • 2-COLOR LABELS (stock background) • SHRINKWRAP • QUICK TURN AROUND



RAINBO RECORDS MANUFACTURING CORPORATION

8960 Fion Ave., Canoga Park, CA 91304 • (818) 280-1100

Fax: (818) 280-1101 • www.rainborecords.com • info@rainborecords.com



CDs • DVDs • SHAPED DISCS • SPECIALTY PACKAGING • CASSETTES

NEED CDs? THE CHOICE IS

CRYSTALCLEAR
DISC AND TAPE

CHECK OUT OUR CURRENT SPECIALS!

1000 CDs • \$999 (COMPLETE RETAIL READY)

1000 PROMO CD PACK • \$599

1000 DVDs • \$1499 (COMPLETE RETAIL READY)

TRUSTED EXPERIENCE FOR OVER 35 YEARS!

WWW.CRYSTALCLEARCD.COM • 1-800-880-0073

Discount Pro Audio
1-877-258-0563
www.sweetwaveaudio.com

SWEETWAVEAUDIO

Sonic Studio GENELEC BLUETOOTH AVALON DESIGN DRAWMER
BSS AUDIO lexicon DPA MOPS

AKG, Audix, Auralex, Avalon, Crown, DBX, EV, Focusrite, Furman, Ghost, Grace, Heil, JBL, K&M, Lab.gruppen, M-Audio, Mackie, Presonus, Primacoustic, Radial Engineering, Tascam, Ultimate, and much more!

COMPUTER MUSIC PRODUCT GUIDE
THE ESSENTIAL GUIDE FOR DESKTOP MUSIC PRODUCTION

MIX BOOKS

To order *Computer Music Product Guide*, or any of our other publications, please visit www.mixbooks.com, or find it on newsstands wherever *Electronic Musician* is sold.

Small Footprint. Big Sound.

KLEIN + HUMMEL
PAS100
INDOOR/OUTDOOR
PORTABLE POWERED SPEAKER

Featuring a built-in rechargeable battery and two rear slots for Sennheiser evolution series wireless mic receivers or an optional CD player, the PAS100 delivers 118 dB of clear, natural sound in a sleek and compact design.

PROAUDIO.com
www.proaudio.com
1-800-433-2105

[Industry Best]
Pricing | Turn Times | Quality

NationWide Disc specializes in the manufacturing of **digipaks, jewel cases, sleeves & wallets.**

Free Posters | A \$279 VALUE
300 11"x17" full color posters **FREE** with complete package order of 1,000+ discs.*

*Some conditions apply. For more information, call toll free 1-866-704-3579.

NationWideDisc
www.NationWideDisc.com
866-704-3579 Toll Free

Surround. Simple.

Good Things Come in Threes.

H2-PRO
H3-D
H4 SuperMINI

AWARD WINNING PRODUCTS

HOLOPHONE[®]
Surround Sound Microphone Systems
www.holophone.com 01.416.362.7790



ADL 600
2-ch high voltage tube preamplifier

Like a hug from your grandma...
Warm and loving.

www.presonus.com

PreSonus

**ALTERNATE SPEAKER SWITCHING WITH THE SUB
SPK5+1**



Coleman Audio
(516) 334-7109
www.colemanaudio.com
coley@colemanaudio.com

Features:
Passive switching
Sub mute switch
All connections are XLR's

One stereo input
Five alternate speakers
Plus a stereo sub output
Balanced input and outputs

Northern Sound & Light
Pro Audio, Stage Lighting, Theatrical Supplies

**EFFORTLESS
SEAMLESS
LIMITLESS
WIRELESS**



SHURE

A lecture hall or a conference room. A church or a theatre. Whatever the venue, Shure has the wireless system to deliver the quality and consistency you need. The SLX and UFX series draw on over 80 years of Shure technology, including Shure's patented Audio Reference Companding for crystal-clear sound beyond the limits of conventional wireless. For more information, call or visit our website.

**CALL TOLL FREE
1-866-796-6232
MON-FRI: 9-6 EST
www.northernsound.net**

**Top Name Brands
Award Winning Service
Maximum Discount Prices**

CASCADE FAT HEAD

AES Winner PAR Excellence 2007



A microphone doesn't have to cost one-thousand dollars to win an award - It just has to sound good!

\$159.00

Lundahl Available

360.867.1799

cascademicrophones.com

Mercury

'Plug Into Reality'

"The M76m is the Real Deal. Full of Das Funken tone"



Mercury Recording Equipment Co. - (510) 581-3817 - MercuryRecordingEquipment.com

GATOR
CASES

For All Your Case Needs

Over 50 Mixer Cases To Choose From



Find Your Case

www.gatorcases.com

explore our cross reference chart under the support tab



CDs/DVDs MASTERING/EDITING GRAPHIC DESIGN MULTIMEDIA

WHERE SIGHT AND SOUND MERGE

PLAY-IT
PRODUCTIONS

259 W. 30th Street, NY, NY 10001 TOLL FREE: 1-800-815-3444 or 212-695-6530 WWW.PLAY-ITPRODUCTIONS.NET

SUCCEED IN MUSIC WITH
THIS **FREE** SEMINAR DVD.



Contact us today and we'll send you our **FREE** Seminar DVD *Achieving Success With Your Music*. It's full of hard-hitting tips on marketing, A&R, and more – only from Disc Makers.

Call us at (866) 677-7912 or visit www.discmakers.com/mix to get yours today.

DISC MAKERS®

fast - real fast



The MA-2.2 True Class A Microphone Amplifier sports a lightning fast slew rate so you can capture every last transient in flawless detail. But it does not end there, the firm bass response and juicy midrange ensure your recordings retain their natural character and never sound harsh or sterile.

buzzaudio

UK Call 207-231 9661
USA Call 866-235-0953
Canada Call 450-227-3818

visit www.buzzaudio.com and read what our users say



www.AtlasProAudio.com
 US Toll Free 1.866.235.0953
 Open 'til Midnight EST - 7 days

THE NOW SHIPPING!!
JUGGERNAUT

The NEW all Discrete Class A switchable input transformer microphone preamp for the modular 500 series format

FEATURES INCLUDE:

- Fully Class A & Discrete Design
- Switchable custom input transformer - Iron or Nickel
- Custom Iron core output transformer (optional nickel output available)
- Variable mic input impedance ranging from 300 ohms to 10k (works like a tone knob!)
- All Potentiometers on high quality detented Alps brand (approx 1db steps on gain)
- Gain range from 6db to 70db - perfect for ribbons
- +THD is 10db pad on OUTPUT
- Boost/Low input gain function to allow for modern hot output mics on high SPL sources (without the tonal degradation of an input pad)
- Mute button (Auto mute when switching input transformer)
- Heavy duty fluted metal knobs
- Multicolor LED's on buttons for on off functions



Over 80 brands of NEW gear!

Mics - Preamps - EQs - Compressors
 A/D Converters - PlugIns - Speakers

Also from Atlas Pro Audio

The Revolver Rack
 2 Slot 500 series rack
 400 mA internal supply

See our website for details and special bundle pricing

(shown left with double width Buzz Audio Essence)

The Ultimate Portable Rack



Think Outside The IsoBox

You know us for our critically-acclaimed IsoBox, now check out our desks and racks. Our products feature superior design, construction, materials and a variety of available options.

CUSTOM CONSOLES

- API
- Yamaha
- DigiDesign
- Toft
- Solid State Logic
- Tascam



"Sound Construction designs and builds the best studio furniture available, period."
 – Brian Tankersley

ISOBOX

- Studio, Flight and Post

RACKS

- Slant Racks
- Lowboys
- **NEW** Craftsman Series Racks

www.custom-consoles.com

Above: Custom Console for DigiDesign D Control

 Sound Construction & Supply, Inc.

Brent Averill ENTERPRISES

BAE 1272 repro

Single w/ps: \$1139 | Two-Channel w/ps: \$1859

BAE 1073 repro

Single w/ps: \$2550 | Two-Channel w/ps: \$4900

14300 Hortense Street • Sherman Oaks, CA 91423
 (tel) 818-784-2046 • 818-784-0750 (fax)
www.BrentAverill.com

MixBooks

The one-stop online shop featuring the latest books, directories, and cool stuff. Instant access to top titles in the biz such as *MIM Pro*, *Mix's Master Directory*, EM's *Personal Studio Buyer's Guide*, back issues, Thomson Guide publications and much more



Online at mixbooks.com

Coleman Audio

(516) 334-7109
www.colemanaudio.com
coley@colemanaudio.com

Digital meters measure a number, peak meters a transient. A VU meter is like seeing what you are hearing. After chasing all those digits around, can you relate to the real world?

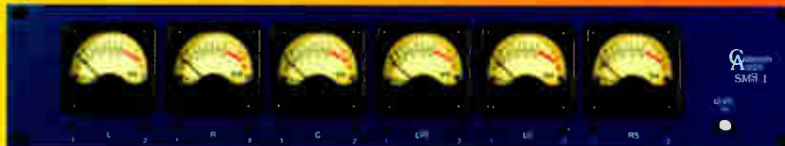
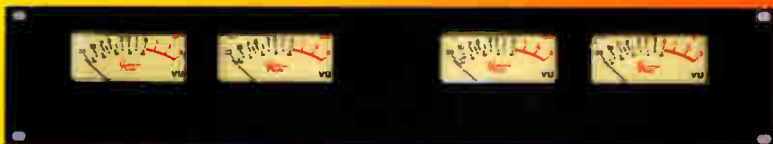

CLASSIFIED ADVERTISING:

Get your company's name into the minds of thousands of customers!



emclass@PENTON.COM
www.emusician.com



mixclass@PENTON.COM
www.mixonline.com



www.livedesignonline.com

For classified advertising rates and deadlines call:

(510) 985-3259

ANTHONY DEMARIA LABS



ADL 660 MONO TUBE LIMITER



"FINALLY, TRUE FAIRCHILD COMPRESSION IS AVAILABLE IN THE NEW, SERVICEABLE UNIT. I WON'T DO A SESSION, WHETHER CUTTING OR MIXING, WITHOUT MY ADL 660."

PETE MATHEWS

845-255-4695

WWW.ANTHONYDEMARIALABS



THE NEW PELUSO VT8
VACUUM TUBE BOTTLE
MODERN SOUND, CLASSIC LOOK
HAND BUILT IN VIRGINIA

DEMO BOTH
TODAY!

this and much more available
from your pro audio experts:

sound pure

BEST GEAR BEST PRICES BEST ADVICE

www.soundpure.com / sales@soundpure.com
call toll free 888.528.9703



NEW PRODUCTS
IN STOCK NOW!

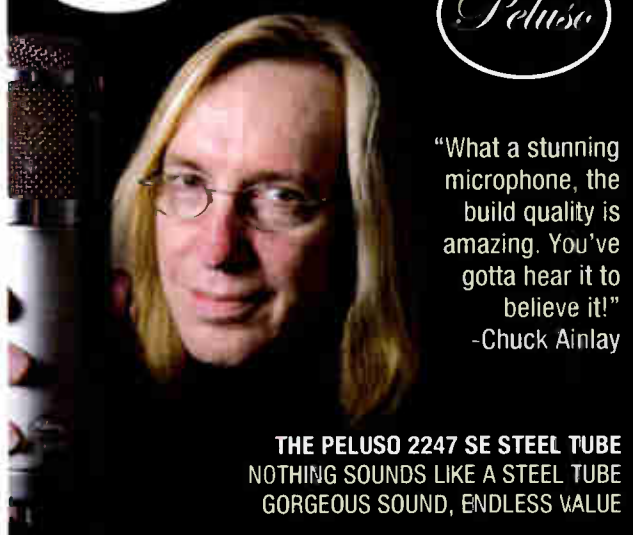

"What a stunning microphone, the build quality is amazing. You've gotta hear it to believe it!"
-Chuck Ainlay

THE PELUSO 2247 SE STEEL TUBE
NOTHING SOUNDS LIKE A STEEL TUBE
GORGEOUS SOUND, ENDLESS VALUE

em AND THOMSON COURSE TECHNOLOGY PRESENT

PERSONAL STUDIO SERIES

Featuring Steinberg Cubase™

Electronic Musician magazine and Thomson Course Technology PTR have joined forces again to create the second volume in their Personal Studio Series, Mastering Steinberg's Cubase™.

Edited and produced by the staff of Electronic Musician, this special issue is not only a must-read for users of Cubase™ software, but it also delivers essential information for anyone recording/producing music in a personal-studio.

Order your copy today!



MIX Books

To order the Personal Studio Series, Mastering Cubase™, or any of our other publications, please visit www.mixbooks.com, or find it on newsstands wherever EM is sold.

CLASSIFIEDS

MIX Classified Ads are the easiest and most economical means to reach a buyer for your product or service. The classified pages of Mix supply our readers with a valuable shopping marketplace. We suggest you buy wisely; mail-order consumers have rights, and sellers must comply with the Federal Trade Commission, as well as various state laws. Mix shall not be liable for the contents of advertisements. For complete information on prices and deadlines, call (510) 985-3259.

Acoustic Products



GK Acoustics
Quality Treatments
at Affordable Prices

"The GK Monster was the perfect trap to reduce a resonance that I detected in Studio B."
Bob Katz Mastering Engineer

1.888.986.2789 • www.gkacoustics.com
"Bringing your sound to life!"

REALTRAPS®
High-Performance Acoustic Treatment
Rave Reviews From Top Pros



The room is so much flatter and true, the peaks and nulls remarkably smoothed out, mixing there is now sonically accurate and a real pleasure. REALTRAPS eliminated the guess work in getting my mix room acoustically correct. We are really happy about how well the room is now translating both to other top mix rooms in NYC and also mastering. —Tony Maserati, mixer for Black Eyed Peas, John Legend, Mariah Carey, Destiny's Child, R. Kelly, Jennifer Lopez, Jessica Simpson, Tupac.

Please visit our web site for a wealth of product information, demo videos, and some of the clearest explanations of room acoustics you'll find anywhere.

Toll-Free: 866-732-5872 www.REALTRAPS.com

BLACK BOX
VOCAL BOOTH
 CALL 647.723.2858



Vocal, Practice and Broadcast Booths

Seulx Acoustics
www.seulxacoustics.com

RPG AcousticTools
 PROVEN, AFFORDABLE ROOM SOLUTIONS
 FROM THE MUSIC INDUSTRY'S LEADING
 ACOUSTICAL INNOVATOR.



RPG DIFFUSOR SYSTEMS, INC.
www.rpginc.com/proaudio

GK Acoustics
 ORDER: 800-833-1554 (or) 541-947-2602

We Custom Manufacture and Ship Worldwide

Sound Isolation Booths
 And
Sound Control Products

Be Professional. Buy the Best!

www.gkacoustics.com

ACOUSTIC
 Design
 Consulting
 Products

www.soundcontrolroom.com
 toll free 866-788-1238

Silence Cases
 practical solutions for
 recording studios



Record, Mix, Master
 Think...In Peace

www.silencecases.com
 510-282-7867

WhisperRoom INC
 SOUND ISOLATION ENCLOSURES

*Celebrating over 17 years of
 reducing sound to a Whisper!*

Recording, Broadcasting, Practicing



MDL 102126S
 (8.5X10.5)

19 Sizes and 2 Levels of Isolation Available

New! SoundWave Deflection System
 (Change parallel walls to non-parallel)
 Immediate Shipping!

www.whisperroom.com
 PH: 423-585-5827 FX: 423-585-5831

VOCALBOOTH.COM, INC
 Professional Sound Isolation
 & Pro Audio Solutions

Custom Gold Series 4' x 6'



**Standard & Custom Size
 Rooms Up To 16' x 16'**

www.vocalbooth.com
 Toll Free 866-330-6045
information@vocalbooth.com

SILENT
 Source

58 Nantucket St., Northampton, MA 01062
 Info: 413-584-7944 Fax: 413-584-2377
ORDER: 800-583-7174

Acoustical Fabric Panels •
 Sound Barrier • Isolation Hangers
 Tube Traps • Silence Wallcovering •
 WhisperWedge • ProFoam • ClearAcoustic
 • Hushfoam • R.P.G. Diffusers •
 Sonex • Sound Quilt • More

www.silentsource.com
info@silentsource.com

QUALITY • PRICED RIGHT • INTEGRITY

AcousticsFirst
 Toll Free 888-765-2900

Full product line for sound control and noise elimination.
 Web: <http://www.acousticsfirst.com>

ACOUSTICAL SOLUTIONS INC
 Sound Control &
 Noise Reduction
 Products

Call
(888) 529-9220 Free Catalog
www.AcousticalSolutions.net

Subscribe to
Electronic Musician
www.emusician.com

Acoustic Products

ACOUSTONE

Use *Acoustone Fabrics* to conceal the source of sound without interference. Or, to cover unsightly sound-absorbent materials. Flame retardant. **Call today!** Sample card now available.
tel. 718-782-5560 • fax 718-782-7367



acoustone@newcastlefabrics.com
acoustonegrillecloth.com

PERDUE ACOUSTICS

Bring Drum Roar to a Whisper!



Isolating Drum Booth
LSS-DBK

- Fully Functional Back Door
- Enhances Drum Kit Clarity for Recording or Performance
- Reduces Stage Volume

800.729.9402
www.perdueacoustics.com

Equipment For Sale



NEW & VINTAGE MICS FROM RUSSIA

TEL/FAX: 007-495-9115565
E-mail: aeg210268@mtu-net.ru
www.valvemics.webzone.ru/

Business Opportunities



FDW-Worldwide, the exclusive distributor of Violet Design and Neaton microphones in the Americas and the exclusive international distributor of Cable Up pro-line cables and accessories is seeking to establish new strategic partnerships with manufacturers exploring the outsourcing of their sales and marketing operations. We operate out of a 75,000 square foot facility in Wisconsin and provide a wide range of services including sales, marketing, customer service, credit, service, warehousing, and shipping. We have sales representatives positioned throughout the USA and Canada and can react immediately to expand your current distribution.

Contact Garry Tompkins, Brand Manager, at 615-308-7808 or visit www.fdw-w.com for more information.



Electronic Musician's

weekly e-newsletter delivers the latest news direct to your inbox!

Subscribe today at

www.emusician.com

buzzaudio
the future of great recordings
visit www.buzzaudio.com to begin...

MARQUETTE AUDIO LABS
com

Cables

Upscale Music
Custom Cables Made to Order
Canare® Neutrik® Mogami Instrument / Microphone Neumann Tube Mic Cables M47 M50 M49
860-667-7747
www.upscalemusic.com
Complete Satisfaction

Cases/Covers

UNDER COVER
Custom Covers and Bags
Speaker Cabinets / Consoles Anything!
www.undercovernyc.com
917 237 1535
Get your gear Under Cover!

Sound Good? Absolutely not, Sound Real? **ABSOLUTELY**
HEAR THE SOUND OF TV & RADIO
PYRAMID SPEAKERS
www.triplepdesigns.com

JOSEPHSON ENGINEERING C700A
Two-capsule condenser microphone
Variable pattern
For vocals, spot and far-field pickup.
josephson.com

ADL 600
2-ch high voltage tube preamplifier
 PreSonus
www.presonus.com

Introducing **JOBzone**
RECRUIT > RETAIN > EXPLORE
It's so much more than a job bank.
Entertainment Technology's JOBzone brings you the most user-friendly, network-wide online job bank that is exclusively dedicated to serving professionals in the Audio, Video, Broadcast, System Integration, Lighting, and Performance industries. With job recruitment as the next biggest growing area online, JOBzone ensures your company is part of this momentum!
Start your search today. Hit the JOBzone link at any of our magazine websites:
emusician.com | remixmag.com | mixonline.com | svconline.com | livedesign.com | digitalcontentproducer.com

Equipment For Sale

Vintech



The Vintech X73i!

"I used five X73i's and one X81 to record all of Carlos Santana's guitar tracks for both the 'Shaman' and 'All that I am' albums." **Jim Gaines**
Engineer for Carlos Santana, Stevie Ray Vaughn



The Vintech X73

"I use the X73 for recording Patti Scialfa and Bruce Springsteen in their home studio." **Toby Scott**, Engineer for Bruce Springsteen



THE "X81 CLASS A"

1-877-4-MIC-PRE



The Model 473

www.vintech-audio.com

Odyssey

PRO SOUND

Your Source for the Finest New & Pre-Owned Recording Equipment Anywhere

API | AEA | CHANDLER | MANLEY | DPA & MUCH, MUCH MORE!

VISIT OUR NEW WEBSITE AT **WWW.ODYSSEYPROSOUND.COM**

TOLL FREE: 1 800 249 1821
tel: +1 (978) 744-2001 fax: +1 (978) 744-7224

Instruction

BE A RECORDING ENGINEER

★ TRAIN AT Easy Home-Study practical training in Multi-track Recording. Join our successful working graduates or build your own studio. Career guidance. Diploma. Registered School. **FREE INFO!** Audio Institute of America
www.audioinstitute.com 914 460 Ave, San Francisco, CA 94121

Subscribe to **REMIX**
www.remixmag.com

NEED CDs? THE CHOICE IS CRYSTALCLEAR DISC AND TAPE
CHECK OUT OUR CURRENT SPECIALS!
1000 CDs • \$999 (COMPLETE RETAIL READY) 1000 DVDs • \$1499 (COMPLETE RETAIL READY)
1DDD PROMO CD PACK • \$599 500 DVDs • \$999 (COMPLETE RETAIL READY)
WWW.CRYSTALCLEARCD.COM • 1-800-880-0073

STEDMAN
Keep your headphones convenient and safe. Clamps to music stand or mic stand. **NEW!**
888-629-5960
www.stedmancorp.com
Lifetime Warranty
Made in USA

Mastering

MASTERING
Guaranteed to give you that "Big Label" sound.
Complete Album Deal!
\$475.
1-800-692-1210
www.musichousemastering.com

KICKASS MASTERING
BIG! FAT! LOUD!
Tube Analog Compression
\$350.00 Album Deal
559-251-1516
prs@pyramidrecording.net
FREE TEST MASTER!

Furniture

Studio Transformation
800.313.0673
furniture
ARGOSY
www.argosyconsole.com

OMNIRAX Studio Furniture
Force Series
Force 24 MF
pictured in audiogony
high pressure laminat
800.332.3393 415.332.3392
www.omnirax.com

HIGH FIDELITY
HIMFI
MASTERING
Offering the finest facilities for all your audio needs, restoration, 5.1 conversion, film
www.highfidelitymastering.com

DRT Mastering
the Analog specialist
You will have the fat, slammir major-label sound that sells discs. Or the work is free...
Custom gear. 1st-class results. Free broch
800-884-2576 www.drtmastering.com

Professional Mixing and Mastering Services
Nathan Eldred
www.AtlasRecording.com
US Toll Free 1.866.235.0953

Subscribe to **MIX**
www.mixonline.com

Music Production

Elie Maman Productions

Your 1 stop shop for quality music production

Recent Projects Include:

Arty Skye (Madonna, Will Smith, Macy Elliot)
Steven Kubie (MTV's Making the Band, Danity Kane, Donnie Klang)

www.ElieMaman.com
Info@ElieMaman.com
(718)408-0793

Music Sales

SEND US YOUR MUSIC!

We'll set up your dedicated artist/band page, help you promote it, and pay you for every download! We'll even convert your songs to MP3 for you!

Call for your free starter kit:

775-825-3886

Records Tapes CD Sevicees

www.yourmusiconcd.com

100 BULK CDRS \$59 includes cd, ink and duplication

100 BASIC CDRS \$89 includes cd, ink and duplication

100 FULL COLOR CDR PACKAGE \$169

1000 FULL COLOR PACKAGE \$899

100 BULK DVDRS - \$99
100 BASIC DVDRS - \$110
1000 FULL PACKAGE DVDRS - \$1199

SNS ATLANTA 678-442-0933
INC TOLL FREE 1-877-442-0933

Software

Subscribe to
Sound&Video
contractor
www.svconline.com

sweet studio?
get
Studio Suite 8
Studio Management Software
www.studiosuite.com
See our ad in MarketPlace

eDeals

Bi-weekly Newsletter Delivers

Hot deals, discounted gear, B-stock, real estate, jobs and more to 85,000 music & audio pros.

Call (800) 544-5530 to find out more

BROUGHT TO YOU BY MIX, ELECTRONIC MUSICIAN, AND REMIX

Don't miss out on eDeals!

Shop Now and Buy Anytime.

eDeals sends the best buys to your inbox so they're only a click away! This bi-weekly e-newsletter brings you product updates and blowout deals on manufacturer overstock equipment, demo gear, discontinued products and more.

In addition, **eDeals** includes a services and employment section of interest to musicians and audio pros everywhere.

Subscribe today at: <http://www.mixonline.com/edeals>

For details on how to place your ad in the classified section, contact the Mix Classified Department at (510) 985-3259

The MOTU studio — compact and powerful

Run DP6 and all your virtual instruments and plug-ins on the latest MacBook Pro for unprecedented compact processing power, then customize your desktop studio with all the latest gear.



Apple MacBook Pro

The mobile creative powerhouse

Powered by the most advanced mobile processors from Intel, the Core 2 Duo-based MacBook Pro is up to 74% faster than the original Core Duo-based MacBook Pro — perfect for DP.

MOTU Digital Performer 6

Award-winning audio workstation software

An inspiring new interface, track comping, XML file interchange with Apple Final Cut Pro, MasterWorks Leveler™, ProVerb™ Convolution reverb, plus many more advanced new features.

Euphonix Artist Series

High-end console for your MOTU studio

Euphonix brings high-end console technology to your MOTU personal studio in a revolutionary ergonomic, slim-line design that fits perfectly in front of your Mac. Use MC Control and MC Mix independently or together as the ultimate unified desktop console with up to 36 faders.

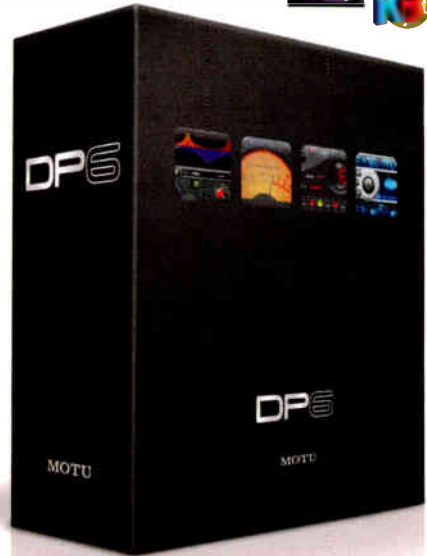

MC Mix

MC Control



www.sweetwater.com

MOTU

World Radio History

©2008 Sweetwater, Inc.



NI KOMPLETE 5 and KORE 2 Legendary virtual instruments with hands-on control

For Digital Performer users who want it all: 11 legendary instruments including KONTAKT 3 and the award-winning MASSIVE, combined with instant hands-on control. Choose from 7,500 presets in seconds and instantly tweak with real knobs.

NI Guitar Rig 3 Kontrol Edition Guitar Effects & Amp Models

The ultimate all-in-one guitar and bass solution for your MOTU studio. Simply connect your guitar to the enhanced RIG KONTROL foot pedal and you are ready to go. Includes an incredible array of expertly modeled classic amps, cabinets, mics and effects.

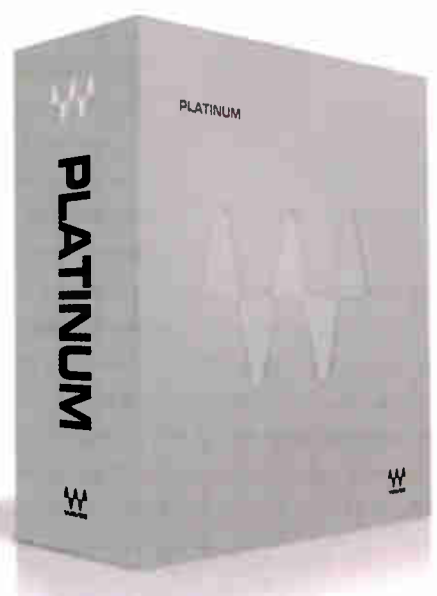

Waves Platinum Bundle Waves and DP together on Intel

The Waves Platinum Bundle delivers across-the-board Waves processing to Digital Performer on the MacBook Pro, Mac Pro tower and today's other latest Intel Macs. Waves processing is absolutely essential for any DP-based MOTU studio.

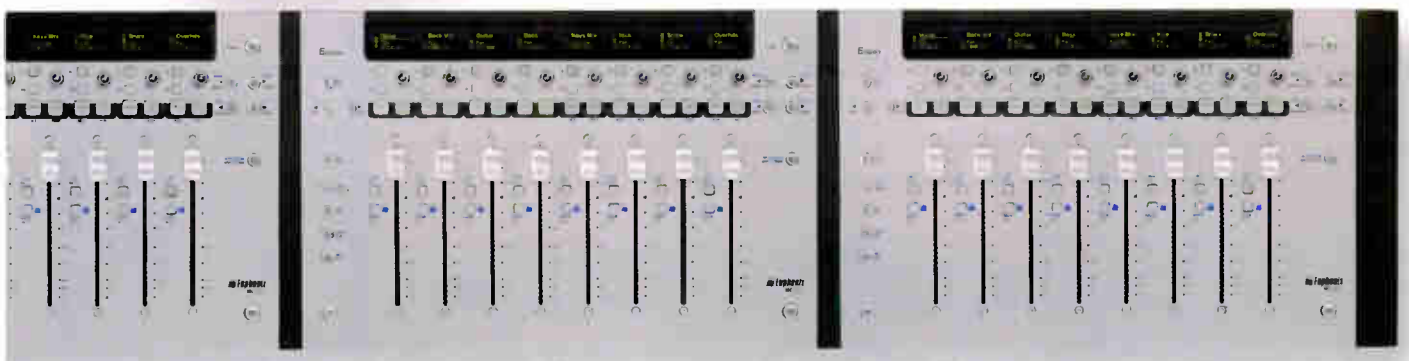

Sweetwater
Music Instruments & Pro Audio

(800) 222-4700

World Radio History

The MOTU studio — compact and powerful



Novation Nocturn

Dedicated intelligent plug-in controller

Featuring touch-sensitive rotaries and Novation's exclusive Automap Universal 2.0 software, the Nocturn provides instant, intelligent, bi-directional control of plug-ins within DP. Easy to use "learn" feature makes customizing any of the Nocturn's controls a breeze. Unique "Speed Dial" controls anything directly beneath your mouse.

Shure KSM 44

Multi-pattern condenser mic

The flagship of the KSM line — and the new must-have mic for any MOTU studio. The KSM 44 has extended frequency response specially tailored for critical studio vocal tracking. Includes flexible polar patterns: cardioid, omni & bidirectional.



BIAS Peak Pro 6

Evolution of an award-winning standard

Whether you're a musician, composer, sound designer, audio editor, podcast/multimedia producer, or mastering engineer, Peak Pro offers more creative potential than ever before. Reliably mature, yet always inspired. Feature rich, yet flexible and friendly. Used side by side with DP6, Peak Pro streamlines your workflow with industry-renowned sonic quality and precision.

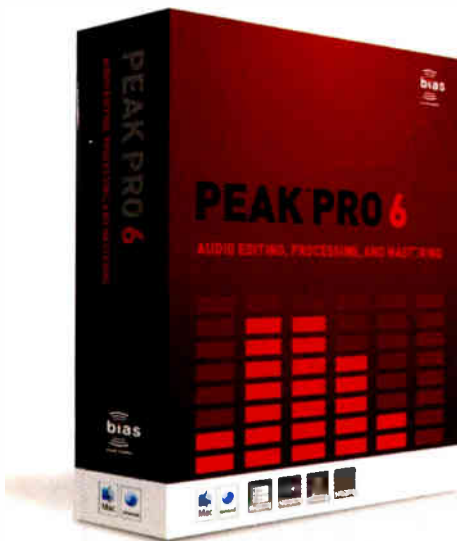

PreSonus Central Station

Control room monitoring with remote

The missing link between your MOTU recording interface, studio monitors, input sources and the artist. Monitor from among 5 sets of stereo inputs (3 analog and 2 digital) and manage your sessions with hands-on control room features like talkback and listenback.

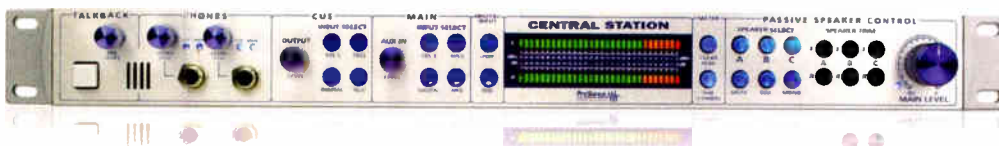



Mackie Control Universal Pro

Automated control surface for Digital Performer

The ultimate hands-on control for Digital Performer. Nine motorized, touch-sensitive Penny + Giles faders, eight V-Pots and more than 50 master buttons let you tweak to your heart's content. Apply the included custom overlay for Digital Performer for dedicated labeling of DP-specific functions.

Mackie HR824mk2

Active studio reference monitors

These high-resolution monitors sound as smooth as they look. The new Zero Edge Baffle™ minimizes diffraction for a crystal-clear image and controls sound waves for wide, even dispersion. Acoustic Space, LF roll-off and HF controls let you tailor the sound to suit your MOTU studio space — and your taste.



Monster Power Pro 900 / 5100

Conditioning and surge protection

The Monster Power Pro 900 provides high-performance, optimized Monster Clean Power and surge protection for AC power lines. For even more complete protection, the Power Pro 5100 features Monster's Clean Power filtering, color-coded outlets, and audible and visual indicators for ground and protection status monitoring.

Sweetwater
Music Instruments & Pro Audio

(800) 222-4700

World Radio History

Muse Research Receptor

Taking Your Virtual Gear on the Road—The Easy Way

Because I'm primarily a session musician, I hadn't done much live playing in years. So when a few interesting touring opportunities came up, I was happy to discover the Muse Receptor, a hardware plug-in player that lets you run soft synths and plug-in effects without latency issues or the need to use a computer onstage.

USE SNAPSHOTS

Snapshots let you have many plug-ins sitting on deck, waiting to be used. With snapshots, you can switch between songs immediately, just as you would in Performance mode on any hardware synth. A snapshot contains synths and samples that are loaded into RAM, and they'll cover as many songs as you can fit into the snapshot. With 16 slots available within each snapshot for loading synths, I usually need only two snapshots for a whole set. And if possible, leave a blank space or two in a snapshot: Last-minute changes in the set you're playing may require that extra space.

ZLOAD, ZLOAD!

If you switch between snapshots without first enabling Receptor's Zload feature, Receptor will need to clear its RAM and then load the contents of the new snapshot. This process can take between 20 and 30 seconds. I recommend enabling Zload before the show, which will cut the load time between snapshots down to about five or six seconds. Zload keeps your snapshots pre-loaded in RAM and ready to call up quickly. However, first make sure to check RAM in the SystemMenu to ensure you have at least 25 percent of your RAM available because overtaxing the RAM cuts down on the Receptor's performance efficiency.

SLOT IN THOSE EFFECTS

Rather than using a few effects slots to add individual FX to a sound, I often use the multi-effects patches found in Native Instruments' Guitar Rig or FM8. These are



great-sounding effects for live use. They're easy to tweak and control, and they let you stack a greater number of effects on the sound. Some of my patches have distortion, delay, phasing, chorusing, EQ and more using just Guitar Rig and a single FX slot. However, there are a few issues to address. Reverbs can consume a lot of CPU, so unless you absolutely require the reverb, take it off the patch. (And many venues are naturally reverberant anyway.) Also, when used with certain high-powered soft synths, Guitar Rig and FM8 can heavily tax a CPU, which leads to the next point.

THE EYE ON THE METER

If Receptor's CPU meter is jumping far to the right, it means that Receptor is being overworked, which can lead to freeze-ups. In this case, try something less CPU-intensive for that pad or effects. Sometimes I've found that a small sound used in only one part of a song isn't worth the processing power it requires. When programming, it's easy to forget the importance of bypassing, leaving multiple excess plug-ins running, so make sure that you bypass anything you're not using in a snapshot.

NOT ENOUGH KEYS?

One of my controllers is an M-Audio Axiom 61 semi-weighted USB MIDI controller. I like the feel of it, and for certain parts I don't like to use weighted controllers, which usually have 88 keys. However, having only 61 keys can create problems. With two or three different synths and one-shot samples spread across the keyboard, I need more than 61 keys for a few songs. I put one-shot samples on the keyboard's extreme left or right, leaving everything in the middle for the sounds I need to play traditionally. The tonality of a sample may not match the note

you're hitting on the keyboard, but you get used to that after playing it for a while.

In a situation where you need extra octaves, the Octave button may get you out of a jam. For instance, on the Axiom or a Yamaha Motif keyboard, the Octave button is right there on the front panel. It jets you right to the outer regions of the keys and can zap you right back immediately. If you can get away with using it while playing, you gain a lot of real estate by jumping octaves on the fly, making it unnecessary to reach for another keyboard. This has saved me in numerous programming situations.

TAKE THE TIME

If possible, use Receptor for a while before you apply it in a working situation. It takes a little time to get used to the rhythm of programming the unit. It's also a good idea to play through a set on your own numerous times to make sure the combinations of instruments, effects and plug-ins you've chosen are stable. This means playing through the *entire* set note-for-note, and not merely switching patches and hitting the keys.

HELP ME, TECH SUPPORT

As Receptor is a relatively new concept, it's inevitable you'll have at least a few important questions. My apologies to the people at Muse Research for perhaps increasing their call traffic, but every call to tech support helped me immensely in getting to know Receptor. When I called to ask a few things, I learned a few major facts in two or three minutes. So call—it will save you time and give you peace of mind. ■

Jamie Muboberac is an L.A.-based session musician whose credits include Seal, John Mayer, the Rolling Stones, My Chemical Romance and many others.

GRACE DESIGN



With vast headroom and ultra-wide bandwidth, the m801 is musical, detailed, open and pure. It can effortlessly resolve even the lowest level ambient information, resulting in recordings of astonishing clarity and realism which reveal the essence of the source being recorded. Regardless of your application, the m801 faithfully captures what your microphones hear, allowing you to focus on the music, not the gear.

m801 8 channel microphone preamplifier



fully balanced, transformerless design • fast, musical transimpedance amplifier architecture • ribbon mic mode • precision gold contact rotary gain controls • no electrolytic capacitors in the signal path • sealed gold contact relays for all signal switching • regulated linear power supply with custom wound toroidal transformer • highest quality components used throughout • five year warranty

Power • Detail • Grace

info@gracedesign.com • www.gracedesign.com • 1.303.443.7454

Introducing the

896mk3

FireWire audio interface with eight preamp-equipped mic/guitar inputs, plus on-board effects and mixing

- **Comprehensive audio I/O** — 8 "combo" mic/guitar inputs with preamps, 10 XLR analog outs, AES/EBU, optical (ADAT and TosLink) and S/PDIF — a total of 28 inputs and 32 outputs.
- **Individual front panel input controls** — 48V phantom power, -20dB pad and +60dB boost for each analog input.
- **192 kHz recording** — Supports 44.1, 48, 88.2, 96, 176.4 and 192kHz sample rates.
- **Clip protection** — Hardware limiter for mic/guitar inputs prevents digital clipping on signals up to +12dB over zero.
- **Digital mixer with effects** — 28 input by 16 bus mixer with on-board DSP effects, including reverb with sands, plus EQ and compression on every input and output.
- **CueMix FX software** — Advanced graphic control for on-board mixing and effects with tabbed design, graphic EQ and precision peak/RMS metering.
- **Vintage compression** — Automatic Gain Control that faithfully models the legendary Teletronix® LA-2A® leveling amplifier.
- **British console EQ** — 7-band parametric EQ available on every input and output modeled after British analog consoles.
- **Classic Reverb** — five room types and length up to 60 seconds.
- **Two banks of optical digital I/O** — 16 channels of ADAT lightpipe, 8 channels of SMUX (96 kHz) lightpipe or stereo TosLink. Mix and match optical formats on both input & output.
- **Luxurious metering** — Dedicated 10-segment ladder LEDs for all eight analog inputs, plus programmable meters for all other I/O banks with convenient front-panel bank selection.
- **Stand-alone operation** — Adjust mixing and effects with intuitive LCD menus.
- **Drivers for Mac and Windows** — Works with all of your favorite software.



MOTU
motu.com

