





## Dolby TrueHD Lossless Audio

**Not a single splat, crunch, whoosh, ping, or ka-thunk will be lost on your home audience.**

From mastering to playback, truly lossless high-definition sound quality is here. In fact, only Dolby® TrueHD guarantees lossless HD audio playback from every HD DVD player and supporting Blu-ray Disc player. And with up to eight audio channels and bit-for-bit accuracy, every nuance of your original soundtrack will make it from the mastering room to the living room.

*dolby.com*



Dolby and the double-D symbol are registered trademarks of Dolby Laboratories. © 2006 Dolby Laboratories, Inc. All rights reserved. 506/17349





"I'm proud to share my secret  
presets with SSL 4000 users.  
Waves SSL models are the best  
I've ever heard."

**Chris Lord-Alge**

Mixing Engineer  
*Green Day, Sheryl Crow, All American Rejects*

# SSL 4000 Collection

Now Featuring the Chris Lord-Alge Presets

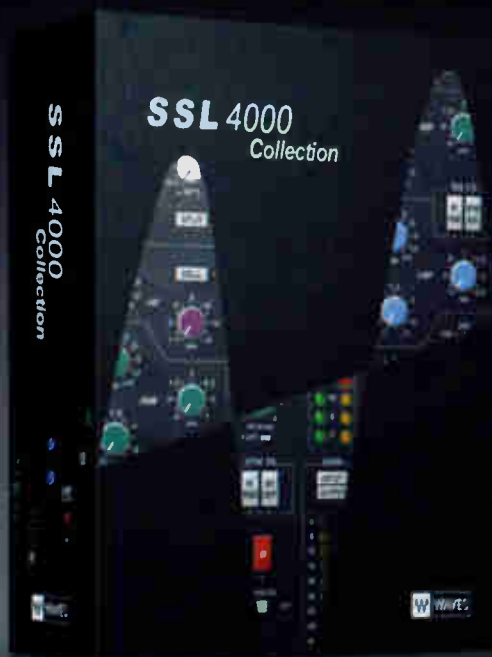

**The SSL Sound. In the box.**

Developed under license from Solid State Logic, three meticulously modeled plug-ins:

- E-Channel
- G-Master Buss Compressor
- G-Equalizer

SSL 4000 Collection is Native and TDSP and requires SSL authorization. [www.waves.com](http://www.waves.com)



**WAVES**  
Superior Sound Tools

# think inside the box



From the maker of the world's first digital audio product, and whose legendary reverbs are found in the world's best studios, comes the world's first stand-alone reverb that's also a hardware plug-in: **the MX200 Dual Reverb/Effects Processor.**

All the control and automation you want from a software plug-in, with the uncompromising quality you expect in a dedicated hardware box from Lexicon®.

**Make the connection, and start thinking inside the box.**



[lexiconpro.com](http://lexiconpro.com)

**MX200** | Dual Reverb  
Effects Processor

**Lexicon**

 A Harman International Company

World Radio History



Grooves. Solos.

Sometimes the music  
goes to magical places.

When that happens, make  
sure the fans feel it.

**AKG WMS 4000** Galactic is known for being musically adventurous with its funk/fusion style. That's why AKG offers products like the WMS 4000. A wireless mic system for vocals or instruments that's simply unrivaled for audio quality and reliability. It captures those unexpected moments with very expected clarity. When the music is going places, make sure your equipment is worthy of the journey.

Visit [www.akg.com/us](http://www.akg.com/us) to find your nearest AKG distributor or dealer.  
Catch the band on tour: [www.galacticfunk.com](http://www.galacticfunk.com)



Believe In Your Passion™



studio network solutions  
HIGH PERFORMANCE STORAGE NETWORKING

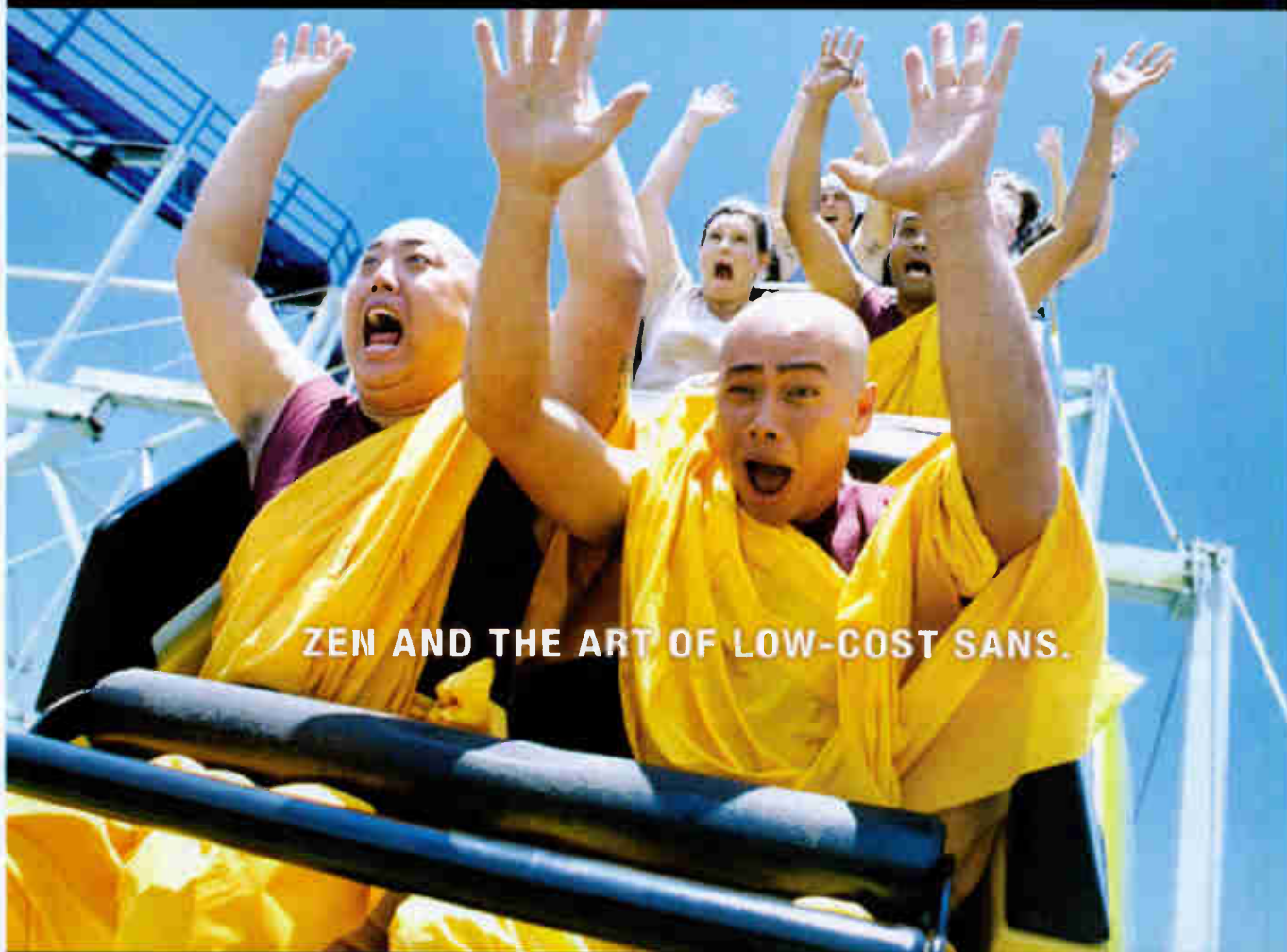

ZEN AND THE ART OF LOW-COST SANS.

## THE HEART-POUNDING X-4™, THE SAN FOR PRO TOOLS®

What do you do to enhance the performance of Pro Tools - the most powerful audio editor on the market? You engineer a low-cost SAN for it, one "seat" at a time.

globalSAN™ X-4 for Pro Tools. Start small. Share. Stack to expand. At a price so low, it will make your heart pound.

Toll-free 1.877.537.2094

[www.studionetworksolutions.com](http://www.studionetworksolutions.com)

©2005 Studio Network Solutions. globalSAN X-4™ is a trademark of Studio Network Solutions. Other brands and product names are trademarks or registered trademarks of their respective holders. Pro Tools® is a registered trademark of Avid Technology, Inc. Avid Technology, Inc. does not necessarily endorse this product.

World Radio History



# Revolutionary

Introducing the LSR4300 Series Studio Monitors, revolutionary technology designed for your workspace with computer recording in mind. The next-generation automated version of JBL's RMC Room Mode Correction technology and built-in analyzer, automatically calibrate each speaker to ensure accurate response at the mix position, in any work environment. The 4300 series is the first studio monitor that incorporates the Harman HiQnet™ network protocol, enabling system-wide intelligence and synchronized control of all speakers in the system from the mix position. Control system level, individual speaker solo, input source selection, high and low frequency EQ settings, and adjustment of all parameters from the speaker's front panel, infrared remote control or your desktop with the 4300 Control Center Software. With automatic room compensation, centralized system control, and high-resolution digital inputs, the LSR4300 Series is the most elegant advancement of technology on behalf of better mixes ever offered in a studio monitor.

**LSR4300**

[www.jblpro.com](http://www.jblpro.com)

Stunning sound and revolutionary intelligence to analyze and correct the problems in any room.



A Harman International Company

© 2008 JBL, www.jblpro.com



# MIX

PROFESSIONAL AUDIO AND MUSIC PRODUCTION

August 2006, VOLUME 30, NUMBER 8

## features

### 26 The Pre-Production Payoff

In any industry, the "bottom line" is always lurking; for music recording projects, keeping an eye toward cost-cutting efficiency has become the name of the game. Top engineers and producers tell us how they deal with pre-production issues—whether it is songwriting, rehearsing or coming up with backbeats before entering the studio.

### 32 Hard Disk Drives—Issues and Answers for Recording's New Media

When most people think of hard disk drives, disk space and cost rank high on their "must-have" list. However, there are other specifications and issues to think about before purchasing the medium on which your tracks will live.

### 46 Sylvia Massy Shivy's RadioStar Studios

Producer/engineer Sylvia Massy Shivy has uprooted her studio business—and entire life—from the hustle and bustle of Los Angeles to the quaint, small Northern California town of Weed, where her RadioStar Studios is attracting top artists to travel up the mountain to record.

### 54 TEC Awards Voter's Guide

This year's ceremony, to be held October 7 in San Francisco, will see singer/songwriter/guitarist Steve Miller take home the Les Paul Award and remote recording engineer David Hewitt inducted into the TEC Hall of Fame. Check out the guide to this year's nominated people and products—and then fill out your ballot!



PAGE 26



PAGE 32



PAGE 46



PAGE 54

**On the Cover:** RIOT Atlanta, designed by Brett Thoeny of BOTO Design and Marshall Long of Marshall Long Acoustics, features a Fairlight Dream Constellation console and ADAM 5.1 monitoring. **Photo:** Pete Winkel. **Inset:** Steve Jennings.



Check Out Mix Online! <http://www.mixonline.com>

(Volume 30, Number 8) is ©2006 by PRISM Business Media, 9800 Metcalf Ave., Overland Park, KS 66212. Mix (ISSN 0164-9957) is published monthly. One-year (12 issues) subscription is \$35. Canada is \$40. All other international is \$50. POSTMASTER: Send address changes to Mix, P.O. Box 638, Mt. Morris, IL 61054. Periodicals Postage Paid at Shawnee Mission, KS and at additional mailing offices. This publication may not be reproduced or quoted in whole or in part by printed or electronic means without written permission of the publishers. Printed in the USA. Canadian GST #129597951; Canada Post Publications Mail Agreement #40597023. Canada return address: DP Global Mail, 4960-2 Walker Rd., Windsor, ON N9A 6J5.

# EXTRAORDINARY MICROPHONE UNPRECEDENTED PRICE

While many microphones add a 'certain something' to the sound, DPA microphones are world renowned for capturing the performance - and the performance only - with breathtaking sonic accuracy.

The new 4090 exhibits an open natural sound, with an imperceptible noise floor and an impressive 134 dB of SPL handling capability, making it a perfect choice for a wide variety of both live and recording applications. From acoustic guitar to drum overheads, acoustic piano to full symphony, this mic excels.

Find out more about the 4090 at [www.dpamicrophones.com](http://www.dpamicrophones.com).

Also available: the acoustically identical 4091 with an additional 10 dB of SPL handling.



## DPA 4090

The microphones for sound engineers with uncompromising demands for musical accuracy.

**DPA**   
MICROPHONES

DPA Microphones, Inc. 2432 North Main Street,  
Suite 200, Longmont, CO 80501  
Ph: 303 485 1025, Email: [info-usa@dpamicrophones.com](mailto:info-usa@dpamicrophones.com)

[www.dpamicrophones.com](http://www.dpamicrophones.com)

# contents

## sections

### SOUND FOR PICTURE

58 **Trailer Mixing** by *Blair Jackson*

### LIVE MIX

64 **Live Mix News**

68 **All Access: Pink** by *Steve Jennings*

70 **Tour Profile: Melissa Etheridge**  
by *David John Farinella*



PAGE 70

74 **Local Crew: Bayou City Sound,**  
Tomball, Texas by *Sarah Benzuly*

76 **New Sound Reinforcement**  
Products

### RECORDING NOTES

116 **Cassandra Wilson** by *Chris J. Walker*

117 **Jessi Colter** by *David John Farinella*

118 **Classic Tracks: The Cyrkle's**  
"Red Rubber Ball" by *Gary Eskow*

126 **Cool Spins**



PAGE 117

### COAST TO COAST

128 **L.A. Grapevine** by *Bud Scoppa*

128 **Nashville Skyline** by *Rick Clark*

129 **N.Y. Metro Report** by *David Weiss*

130 **Sessions & Studio News**  
by *Barbara Schultz*

## technology

82 **Tools of the Trade**

86 **Field Test: Sony Media Software**  
ACID PRO Pro 6



PAGE 86

90 **Field Test: Yamaha AW2400 24-Track**  
Hard Disk Recorder/Mixer

96 **Field Test: Steinberg WaveLab 6**  
Audio Editing Suite

100 **Field Test: Rimage 2000i Duplicator/**  
Printer

104 **Field Test: Anthony Gallo A'Diva Ti**  
Speakers, TR-2 Subwoofer

106 **Field Test: Universal Audio Solo**  
610/110 Mic Preamp/DI



PAGE 110

110 **Auditions**

- Abbey Road/Chandler Limited TG12413 Limiter Plug-Ins
- Arturia ARP2600 V Synth Software Clone
- Glyph GT050Q Hard Drive
- M-Audio Foley CDs
- SE Electronics Reflexion Filter

160 **Power Tools: SPL Transient Designer**  
by *Michael Cooper*

## columns

24 **Insider Audio: And the SCAB**  
Goes To... by *Paul D. Lehrman*



PAGE 24

38 **Mix Interview: Geoff Emerick**  
by *Matt Hurwitz*



PAGE 52

52 **The Dave Smith Mix Room at Sony**  
Music Studios by *Gary Eskow*

78 **Tech's Files: Guerrilla Remote**  
by *Eddie Ciletti*

## departments

10 **From the Editor**

14 **Feedback**

16 **Current**

22 **On the Cover: RIOT Atlanta**  
by *Barbara Schultz*

141 **Ad Index**

142 **Mix Marketplace**

150 **Classifieds**





# UHF-R. DO MORE.

**More Productivity. More Reliability. More Control.**

## UHF-R™. Premier Wireless Technology.

Redefining wireless for the largest, most demanding applications. UHF-R helps you master the complexities of large-scale wireless installations with greater efficiency, enhanced flexibility and complete control. With fast setup, robust wideband performance, full PC system monitoring via Wireless Workbench Software and Shure audio quality, UHF-R frees you to do even more in less time.

### UHF-R ADVANCES

**Advanced control** | Shure's Wireless Workbench Software, Ethernet and USB compatibility give you comprehensive PC control and monitoring of large systems.

**Unparalleled RF performance** | Advanced Track Tuning shifts the RF filter along with the selected frequency – maximizing isolation from interference and preserving signal integrity with UHF-R's extended bandwidth. 2400 selectable frequencies across a 60MHz band, up to 40 compatible systems per band.

**Superior sound quality** | Shure's patented Audio Reference Companding delivers crystal-clear audio, far superior to conventional wireless.

**Intuitive usability** | Fast automated setup saves you time and effort. UHF-R usability innovations include networked automatic frequency selection, infrared transmitter sync and smart, menu-driven system operation.

**Road-tested durability** | Rugged components – including a compact, lightweight bodypack – withstand the abuses of the road and deliver consistently reliable performance.



Wireless Workbench® Software is included. Experience it firsthand at [www.shure.com/software](http://www.shure.com/software).

Audio Reference Companding



**SHURE**  
It's Your Sound™



## It's Your Vote—Use It!

**A** long time ago—a very long time ago—I was a poor college student. I scraped by doing technical jobs, like repairing electronics, running films (my low-union-seniority specialty was working Hindi- and Spanish-language theaters) and running P.A. systems. This was in Oakland, Calif., during the early '70s, and one of my regular customers was the Black Panthers.

It must have been odd to see this blond, Scandinavian guy at the edge of the stage during Black Power rallies, but the Panthers treated me well, always referring to me as "cousin" rather than "brother." A side benefit was witnessing history being made in the speeches by founders Bobby Seale and Huey Newton (and others), often quoting exiled member Eldridge Cleaver (*Soul on Ice*), who said, "You're either part of the solution or you're part of the problem." Those simple words made a strong impression on me.

Flash-forward to about 10 years ago, when a colleague asked me about joining The Recording Academy (NARAS). I was working at *Mix* and operating a studio and small record label, but even as involved as I was in the industry, NARAS seemed elitist—fine for big-label folk, but not my scene. Besides, after the Jethro Tull heavy-metal Grammy fiasco of '89, did I really want to be one of *them*? But thinking back to the words of my Panther cousins, I thought perhaps I was part of the NARAS problem: Change comes easier from within. I joined NARAS, and at the local chapter found an amazing community with common goals, interests and needs. I became involved with seminars and engineer panels, networked with peers and added my vote to the Grammy-selection process.

During that past decade, the music biz model has changed and NARAS has adapted. Previously, becoming a NARAS voting member required working on at least six tracks on commercial releases distributed through record stores. A recent Digital Qualification Initiative recognizes the impact of digital downloads and Internet music sales, offering a new means by which artists and recording pros can become voting members. Requirements include having credits on at least 12 tracks, with product available on an established online site, such as Amazon.com, CD Baby, iTunes, Rhapsody, Yahoo, eMusic, Musicmatch, CD Universe, etc. As an alternative, an applicant could be endorsed for membership by two Academy voting members. Full details are available at [www.grammy.com](http://www.grammy.com).

This development is good news, not only for NARAS, but for the entire music community. (And speaking of community, read Rick Clark's "Nashville Skyline," page 128, to find out how NARAS' MusiCares organization is helping musicians affected by hurricane Katrina.) New members and new ideas help The Academy break out of its "old-school" image, while strengthening its ability to promote the industry, fight piracy and illegal music distribution, and bring more diversity to NARAS programs and the Grammy Award selection process. It's a good thing for all concerned.

And speaking of voting, in this *Mix*, subscribers will find a postage-paid ballot for the TEC Awards. It's your industry, so be part of the solution: Take a few minutes and help select pro audio's best. Every vote counts!

George Petersen  
Editorial Director

# MIX<sup>®</sup>

**EDITORIAL DIRECTOR** George Petersen [gpetersen@mixonline.com](mailto:gpetersen@mixonline.com)

**EDITOR** Tom Kenny [tkenny@mixonline.com](mailto:tkenny@mixonline.com)

**SENIOR EDITOR** Blair Jackson [blair@blairjackson.com](mailto:blair@blairjackson.com)

**SENIOR EDITOR/FEATURES** Sarah Jones [sjones@mixonline.com](mailto:sjones@mixonline.com)

**TECHNICAL EDITOR** Kevin Becka [kbecka@earthlink.net](mailto:kbecka@earthlink.net)

**MANAGING EDITOR** Sarah Benzuly [sbenzuly@mixonline.com](mailto:sbenzuly@mixonline.com)

**ASSISTANT EDITORS** Barbara Schultz [bschultz@mixonline.com](mailto:bschultz@mixonline.com)

Matt Gallagher [mgallagher@mixonline.com](mailto:mgallagher@mixonline.com)

**LOS ANGELES EDITOR** Bud Scoppa [bs7777@aol.com](mailto:bs7777@aol.com)

**NEW YORK EDITOR** David Weiss [david@dwards.com](mailto:david@dwards.com)

**NASHVILLE EDITOR** Rick Clark [mrlburge@mac.com](mailto:mrlburge@mac.com)

**FILM SOUND EDITOR** Larry Blake [swellstone@aol.com](mailto:swellstone@aol.com)

**SOUND REINFORCEMENT EDITOR** Steve La Cera

**CONSULTING EDITOR** Paul D. Lehman [lehman@pan.com](mailto:lehman@pan.com)

**ONLINE AUDIENCE DEVELOPMENT MANAGER** Tami Needham

[tneedham@prism2b.com](mailto:tneedham@prism2b.com)

**CONTRIBUTING EDITORS** Michael Cooper Heather Johnson

Eddie Ciletti Gary Eskow Barry Rudolph

**SENIOR ART DIRECTOR** Dmitry Panich [dpanich@prism2b.com](mailto:dpanich@prism2b.com)

**ART DIRECTOR** Kay Marshall [kmarshall@prism2b.com](mailto:kmarshall@prism2b.com)

**ASSOCIATE ART DIRECTOR** Elizabeth Heavern

**PHOTOGRAPHY** Steve Jennings

**INFORMATIONAL GRAPHICS** Chuck Dahmer

**SENIOR VICE PRESIDENT** Pete May [pmay@prism2b.com](mailto:pmay@prism2b.com)

**PUBLISHER** Dave Reik [dreik@prism2b.com](mailto:dreik@prism2b.com)

**ASSOCIATE PUBLISHER** Erika Lopez [elopez@prism2b.com](mailto:elopez@prism2b.com)

**EASTERN ADVERTISING DIRECTOR** Michele Kanatous [mkanatous@prism2b.com](mailto:mkanatous@prism2b.com)

**NORTHWEST/MIDWEST ADVERTISING MANAGER** Greg Sutton

[gsutton@prism2b.com](mailto:gsutton@prism2b.com)

**SOUTHWEST ADVERTISING MANAGER** Albert Margolis [amargolis@prism2b.com](mailto:amargolis@prism2b.com)

[prism2b.com](mailto:prism2b.com)

**CLASSIFIEDS/MARKETPLACE ADVERTISING DIRECTOR**

Robin Boyce-Trubitt [rboyce@prism2b.com](mailto:rboyce@prism2b.com)

**CLASSIFIEDS/SPECIALTY SALES MANAGER**

Kevin Blackford [kblackford@prism2b.com](mailto:kblackford@prism2b.com)

**MARKETING DIRECTOR** Christen Pocock [cpocock@prism2b.com](mailto:cpocock@prism2b.com)

**SALES & MARKETING COORDINATOR** Clarina Raydmanov

[craydmanov@prism2b.com](mailto:craydmanov@prism2b.com)

**MARKETING & EVENTS COORDINATOR** Jennifer Smith

[jsmith@prism2b.com](mailto:jsmith@prism2b.com)

**ONLINE SALES AND MARKETING DIRECTOR** Samantha Kalin [skalin@prism2b.com](mailto:skalin@prism2b.com)

[prism2b.com](mailto:prism2b.com)

**DIRECTOR, SPECIAL PROJECTS** Hillel Resner [hresner@prism2b.com](mailto:hresner@prism2b.com)

**VICE PRESIDENT, PRODUCTION** Lisa Parks [lparks@prism2b.com](mailto:lparks@prism2b.com)

**GROUP PRODUCTION MANAGER** Melissa Langstaff [mlangstaff@prism2b.com](mailto:mlangstaff@prism2b.com)

[prism2b.com](mailto:prism2b.com)

**PRODUCTION MANAGER** Liz Turner [lturner@prism2b.com](mailto:lturner@prism2b.com)

**CLASSIFIED PRODUCTION COORDINATOR** Jennifer Kneebone-Laurie

[jknbone@prism2b.com](mailto:jknbone@prism2b.com)

**VICE PRESIDENT, AUDIENCE MARKETING** Jerry Okabe [jokabe@prism2b.com](mailto:jokabe@prism2b.com)

[prism2b.com](mailto:prism2b.com)

**DIRECTOR, AUDIENCE MARKETING** John Rockwell [jrockwell@prism2b.com](mailto:jrockwell@prism2b.com)

[prism2b.com](mailto:prism2b.com)

**OFFICE MANAGER** Lara Duchnick [lduchnick@prism2b.com](mailto:lduchnick@prism2b.com)

**ADMINISTRATIVE ASSISTANT** Karen Carter [kcarter@prism2b.com](mailto:kcarter@prism2b.com)

COPYRIGHT 2006

Prism Business Media

ALL RIGHTS RESERVED.

FOUNDED IN 1977 BY DAVID SCHWARTZ AND PENNY RIFER

MIX<sup>®</sup> MAGAZINE IS AFFILIATED WITH







# The Best...

*Why do more musicians, engineers, and producers make Sweetwater their source for music technology?*

## SELECTION

Our huge, intelligently stocked inventory provides numerous options for every step of the signal chain.

## PRICE

Broaden your choices with our great, budget-stretching prices, exclusive package deals, and money-saving offers in Sweetwater's DealZone!

## SALES

The audio world's most knowledgeable sales staff will help you make the right choice every time.

## TECH SUPPORT

Free, unlimited tech support via phone or Internet, plus a factory-trained, world-class service department.

## FREE SHIPPING

With the absolute best FREE shipping deal in the industry, there's really only one choice — Sweetwater!



TO FIND OUT MORE, CALL SWEETWATER TODAY

**1-800-222-4700**

[www.sweetwater.com](http://www.sweetwater.com)





**SCHOEPS**  
Mikrofone



Finally... Your **shotgun** will sound like a Schoeps

Schoeps **CMIT 5U** — Bringing the shotgun microphone to the next level



Innovation  
Redefined

REDDING AUDIO, Inc. 97 S. Main St. #10  
Newtown CT 06470 phone: 203.270.1808  
www.reddingaudio.com www.schoeps.de



[www.griffinaudiousa.com](http://www.griffinaudiousa.com)

914.248.7680

[sales@griffinaudiousa.com](mailto:sales@griffinaudiousa.com)

[WWW.MIXONLINE.COM](http://WWW.MIXONLINE.COM)

**PRISM**  
BUSINESS MEDIA™

**President/Chief Executive Officer** John French [jfrench@prism2b.com](mailto:jfrench@prism2b.com)  
**Chief Operating Officer/Chief Financial Officer** Andrea Parsly [aparsly@prism2b.com](mailto:aparsly@prism2b.com)

**Sr. Vice President, Business Development** Eric Jacobson [ejacobson@prism2b.com](mailto:ejacobson@prism2b.com)

**Vice President, Human Resources** Kurt Nelson [knelson@prism2b.com](mailto:knelson@prism2b.com)

**Chief Information Officer** Kris Paper [kpaper@prism2b.com](mailto:kpaper@prism2b.com)

**Vice President, General Counsel** Bob Feinberg [bfeinberg@prism2b.com](mailto:bfeinberg@prism2b.com)

**SUBSCRIBER CUSTOMER SERVICE:** To subscribe, change your address or check on your current account status, go to [www.mixonline.com](http://www.mixonline.com) and click on "Customer Service" for fastest service. Or, e-mail [mixam@xable.com](mailto:mixam@xable.com), call toll-free 800/532-8190 or 815/734-1216, or write to P.O. Box 638, Mt. Morris, IL 61054.

**BACK ISSUES:** Back issues are available for \$10 each by calling 800/532-8190 or 815/734-1216.

**POSTMASTER:** Send address changes to *Mix* magazine, P.O. Box 638, Mt. Morris, IL 61054.

**PHOTOCOPIES:** Authorization to photocopy articles for internal corporate, personal or instructional use may be obtained from the Copyright Clearance Center (CCC) at 978/750-8400. Obtain further information at [copyright.com](http://copyright.com).

**REPRINTS:** Contact *FasteReprints* to purchase quality custom reprints or e-prints of articles appearing in this publication at 866/436-8366 (219/879-8366 outside the U.S. and Canada). Instant reprints and permissions may be purchased directly from our Website; look for the RSCopyright tag appended to the end of each article.

**ARCHIVES AND MICROFORM:** This magazine is available for research and retrieval of selected archived articles from leading electronic databases and online search services, including *Factiva*, *LexisNexis* and *ProQuest*. For microform availability, contact National Archive Publishing Company at 800/521-0600 or 734/761-4700, or search the *Serials in Microform* listings at [nopubca.com](http://nopubca.com).

**PRIVACY POLICY:** Your privacy is a priority to us. For a detailed policy statement about privacy and information dissemination practices related to Prism Business Media products, please visit our Website at [www.prism2b.com](http://www.prism2b.com).

**LIST RENTAL:** Marie Briganti [marie.briganti@walterart.infousa.com](mailto:marie.briganti@walterart.infousa.com)

**MAILING LISTS:** Prism Business Media makes portions of our magazine subscriber lists available to carefully selected companies that offer products and services directly related to the industries we cover. Subscribers who do not wish to receive such mailings should contact the Prism Business Media subscriber services at 800/532-8190 or 740/382-3322.

**CORPORATE OFFICE:** Prism Business Media, 9800 Metcalf, Overland Park, KS 66212, 913/341-1300, [www.prism2b.com](http://www.prism2b.com).

**NATIONAL EDITORIAL, ADVERTISING AND BUSINESS OFFICES,** 6400 Hollis St., Suite 12, Emeryville, CA 94608; 510/653-3307; fax 510/653-5142; Website: [www.mixonline.com](http://www.mixonline.com). **PHOTOCOPY RIGHTS:** Authorization to photocopy items for internal or personal use of specific clients is granted by Prism Business Media, provided that the base fee of U.S. \$2.25 per copy, plus U.S. \$00.00 per page is paid directly to Copyright Clearance Center, 222 Rosewood Drive, Danvers, MA 01923. The fee code for users of this Transactional Reporting Service is ISSN 0164-9957/2000 \$2.25 + \$00.00. For those organizations that have been granted a photocopying license by CCC, a separate system of payment has been arranged. Before photocopying items for educational classroom use, please contact CCC at 978/750-8400.

Now with  
VST 2.4  
Support\*

# Production getting tools rusty?



## SONAR 5



Music production doesn't have to be a series of compromises. Technology has advanced the art of recording significantly, but some production tools still limit you with outdated audio quality and non-intuitive workflow. Sure, you can get the job done, but is it fast, is it enjoyable, and what's the quality of your finished product?

SONAR 5 presents an inspiring creative environment without sacrificing editing precision or audio mix fidelity. In fact SONAR 5's 64-bit double precision engine offers unmatched headroom without the summing bus limitations found in 32-bit or 48-bit DAWs.

Bring your studio tools into the 21st century with SONAR 5, available at fine music retailers worldwide. For more information visit [www.cakewalk.com/SONAR](http://www.cakewalk.com/SONAR).

\*VST 2.4 support included in 5.2 update for registered SONAR 5 customers. Free download available at [www.cakewalk.com](http://www.cakewalk.com).

**cakewalk**

## Letters to Mix

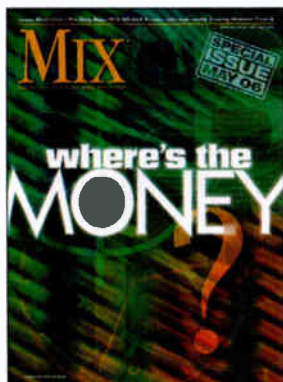

### RING, RING—MONEY'S CALLING

The money is out there, and as always, it gravitates to skill and assets. If you want to succeed, then think of yourself as a survivor and arm yourself with both [skill and assets]. If you are a musician, then develop engineering skills, and if you want to fill a need here in L.A., study electronics and become a skilled tech. Learn to fix a Pultec and a Neve, and you will never go hungry in this town.

I have been collecting mics for the scoring stage and may soon offer a service assisting with Neumann M50s, spot mics, KM54s, M49s and ribbons and such. I am also putting together a package of vintage Universal Audio, Helios and Neumann consoles and EMI and Decca gear to hopefully find its way into a well-funded room. I work one night a week as a house engineer in West L.A. and two nights a week as a musician in a cover band—anything to stay active, meet folks and learn something new.

I know of a seasoned engineer/mixer, "David," who is getting a steady stream of work from a parent company in the "download to cell phone" field. I currently assist him with my mics, outboard gear and such; as a musician, I help him with tracks for bass, guitar, cello, glockenspiel.

The content-to-cell phone market will soon explode, and the need for content and qualified mixers is there. David told me that I am one of the few people he trusts to mix for him, so I told him that if the big budgets continue and he gets backed up, get me a Pro Tools HD rig. I will learn what I can and I will mix stuff he gets backed up on. I will help him make his deadline. I am not a young pup, but new opportunities still excite me, and I still love to hang with smart and creative people—I still love music.

Jeff Sherman

### WE'LL GIVE YOU CREDIT, RALPH

Thanks so much for Maureen Drone's "Credit Where Credit's Due" (May 2006). Among other audio engineering duties, I'm also a freelance

recording engineer. About 10 years ago, I was the recording engineer for an on-location project involving a full symphony orchestra and large choir, and had what I consider to be a unique experience precisely on the issue of proper crediting.

When the project was complete, I promptly received a contract stating that I agreed to never claim ownership of the recording project—all or in part, etc. Even though I had never seen that wording before, I concluded that it made sense and there were no stipulations regarding not getting credit for my work. When the first run of CDs was released, there were no audio engineering credits listed. This had me completely confused, as with the previous 10 CD projects I had completed by that time (for other individuals and companies), this was not an issue. As it turns out, that CD project became the most requested disc of all the recordings released by that recording company at that time. With this information, I wrote a letter to the record company asking why the first release of the CD did not include engineering credits. They replied that it was not their custom, and included a separate letter of thanks for my engineering services—on company letterhead.

About three years after the first release of the CD project, a second release was made and, again, no engineering credits. That entire situation continues to bother me. Back then, I did not want to make waves because I only had 10 CD projects under my belt that had been distributed on a national scale. However, in light of the fact that the CD in question was the most successful for that company up to that point, it really has become a slap in the face that they never included engineering credits. All other individuals involved in that recording were credited, including every member of the choir and orchestra. As a then-struggling audio engineer, having my engineering credits included would have really helped my up-and-coming career, not to mention being a morale booster for me.

Thankfully, this had never happened before and has not happened since.

Ralph Sanchez

### LAVALIER INTRIGUES

I just read "Tech's Files: Are Commercials Really Too Loud?" in the April 2006 *Mix*, which I found interesting, but one thing was in error. [Eddie Ciletti] says, "Local TV affiliates face a particularly muddy, uphill battle considering the number of lapel mics that they use. Nearly all are cardioid for minimizing phase issues with other mics, as well as studio noise."

Most lapel (lavalier) mics are omnidirectional. I've been doing TV audio since 1976 and have found that there are many reasons to use omnis. For example, if the presenter/host/on-air talent turns his or her head to the left or right, you can have a significant drop in level and a definite change of tonality with a cardioid—worse with a hypercardioid. This often happens with weatherpersons, who usually stand in profile to the camera, as well as during their presentation when they look at the "map" beside them on one side, the TV monitor showing the off-camera map graphics in front of them and the "audience" (the camera) to the other side.

Many shows have a panel of presenter/host/on-air talents who banter to one another throughout the broadcast. This could be a disaster if you aren't using omnis. The best way to combat studio noise is to have a mixing engineer who can ride levels, fade out unused mics and anticipate the flow of the conversation. Phase is a problem, but adhering (when you can) to the "three feet apart" rule helps eliminate the comb filtering that occurs; otherwise, you had better be quick with your fader moves.

Also, lavalier microphones used to be huge and were just "regular" small mics hung by a cord around the neck of the speaker. They got their name from a piece of jewelry—a pendant with a dangling stone that hangs from a necklace worn by the infamous Duchess Louise de La Valliere (1644-1710), a French woman who was a mistress of French King Louis XIV and was involved in many intrigues at court.

Douglas Kaye

Douglas,

*Thanks for writing. I apologize for the lack of clarity regarding cardioid mics. My statement should have read, "Based on what I'm hearing—too much mud—it would seem that nearly all lapel mics being used are cardioid, which I would not recommend." I, too, prefer omnis. You, at least, seem to care more about the audio part of the program; here in the Twin Cities, I am frustrated by what seems to be the complete lack of regard or care for what goes on the air. No one seems to be listening, or if they were, they'd attempt to reconcile the disparities. And thanks for the history lesson!*

—Eddie Ciletti

Send Feedback to *Mix*  
mixeditorial@mixonline.com



# GENELEC®

## Measured Success

Built on the solid foundation of the 8000 MDE™ and 7000 LSE™ series products, Genelec introduces the new 8200 and 7200 DSP series monitors. They are a measure of our continued commitment to customers who rely on the purity of sound reproduction.

With new technologies of DSP, GLM™ and AutoCal™ we have made our new DSP products powerful and easy to use, with the innate ability to adapt to your environment. And they do it uncompromisingly, accurately and quickly.



Genelec has utilized sophisticated digital signal processing in the new 8200 bi-amp monitors and 7200 subwoofers to achieve the next level of resolution in accurate reference monitoring.

### GLM

The Genelec Loudspeaker Manager software package provides all necessary connectivity for a comprehensive computer-to-8200/7200 series DSP monitor interface.

GLM™ includes:

- Control of 30 loudspeakers on standard CAT5 cabling
- Eight section EQ
- Level, D stance and Vertical Axis settings
- Compensation audio delay for digital video
- Custom User Setups
- Solos and Mutes

### AutoCal™

Genelec's automated calibration software, AutoCal™, combines decades of acoustic research along with our proprietary DSP and GLM™ network control. AutoCal will properly align and integrate each and every 8200 and 7200 speaker into any acoustic environment with exceptional precision. It's like having a Genelec acoustic product specialist on hand any time you wish – and more.

Digital monitoring systems are not new, yet none have realized the real potential, until now. For more information please visit our website.

[www.genelecusa.com](http://www.genelecusa.com)

## IN LOVING MEMORY

### ARIF MARDIN, 1932-2006

Arif Mardin, the legendary producer/arranger whose career spanned landmark recordings from Aretha Franklin to the Bee Gees to Norah Jones, died on June 25 in New York. Mardin had been suffering from pancreatic cancer for about a year.

PHOTO: COURTESY ARIF MARDIN



From left: Aretha Franklin, Donny Hathaway and Mardin in session

Born in Istanbul, Turkey, Mardin graduated from Istanbul University in economics and studied at the London School of Economics. Although he was a self-professed jazz fanatic and an accomplished orchestrator/arranger, Mardin never intended to pursue a career in music. However, in 1956, meeting Dizzy Gillespie and young arranger Quincy Jones changed the course of his life. Soon after, he was the first recipient of the Quincy Jones Scholarship at the Berklee College of Music in Boston.

In 1958, Mardin and his wife, Latife, left Istanbul for Boston. After graduating in 1961, he taught at Berklee for a year and then moved to New York City. Mardin began his career at Atlantic Records in 1963 as an assistant to the legendary jazz enthusiast and founder, Nesuhi Ertegun. He rose through the ranks quickly, becoming studio manager, label house producer and arranger. In 1969, he became a VP and subsequently served as senior VP until May 2001. Mardin worked closely on many projects with founder Ahmet Ertegun and Jerry Wexler. He ranks among the 20th-century's most important record producers, with more than 40 Gold and Platinum discs to his credit. From the Young Rascals' 1964 Number One hit, "Good Lovin'" and Bette Midler's 1989 Number One and Record of the Year "Wind Beneath My Wings," to his recent work with Norah Jones (which resulted in Grammys for Record of the Year and Album of the Year in 2002), Mardin has transcended genres and contributed to many of contemporary music's most brilliant works. He was inducted into the TEC Hall of Fame in 2005.

According to the BBC, he will be buried in his native Istanbul.

PHOTO: JULIE MARDIN



### DAVE SMITH, 1950-2006

David Smith, head of engineering at Sony Music Studios in New York City, passed away at the age of 56 on June 17, 2006. Widely regarded as a top-tier technical engineer, Smith was responsible for the integration of digital and analog equipment throughout Sony's West 54th Street complex.

"David Smith was a bridge to a time when vacuum tubes, analog tape machines and large-diaphragm condenser microphones were state of the art, yet he was more familiar with the digital realm than anyone else on the globe," said SMS executive VP and general manager Andy Kadison. "His ability to span generations of audio technology was unsurpassed and will never be seen again. He was an invaluable asset, and Sony Studios is devastated by his passing.

Brian McKenna, SMS VP, audio operations and marketing, commented, "David had a unique ability of relating to everyone, from an entry-level engineer to a CEO. He respected and understood that each integral part of a music studio and label was similar to a piece of a microphone. He not only helped build the technical infrastructure of Sony Studios, but also was largely responsible for the type of people who worked this technology. He was a dear friend and mentor who will be missed, but never forgotten."

Grammy Award-winning producer Bob Power, who had a room at SMS



for several years, also remembered Smith as a superior engineer who treated everyone with respect. "David was hands-down the most technically competent person I've ever known," Powers said. "He had a measured and even approach to people, and he listened to everyone's opinions and ideas. David's passing has left a monumental gaping hole, both in the mental libraries of how things really work, and more importantly, how to be a magnanimous and kind human being. Fortunately, he has left a little of that in all of us."

Smith's brother, Tony, told *Mix* that the family is in the process of setting up a scholarship in Smith's name for young people pursuing careers in audio engineering. *Mix* will release details as they become available.

Check out a profile on a one-of-a-kind studio Smith helped build on page 52.

—Gary Eskow

## COMPANY WATCH

### SSL PURCHASES SYDEC

Advancing its commitment to its workstation users, Solid State Logic purchased Sydec Audio Engineering, developers of the Soundscape range of workstation partner products, bringing significant PC platform development to SSL. According to Sydec's general manager, Erik Wijnen, "This will allow us to work with the SSL team to focus on new ideas for products and expand the team here at Sint-Niklaas in Belgium."

SSL's managing director, Antony David, said, "We're committed to working with a range of companies to improve and democratize the creative process, and this gives us a great opportunity to accelerate our involvement."

### BOSCH BUYS TELEX GROUP

Telex Communications (Electro-Voice, Dynacord, Midas, Klark Teknik, Telex, RTS) has signed a definitive merger agreement with a wholly owned subsidiary of Robert Bosch GmbH, whereby Bosch will acquire Telex for \$420 million. Upon closing of the merger, the surviving company's name will be Telex Communications Holdings Inc., with headquarters remaining in Minneapolis.

"With the acquisition of Telex, Bosch Security Systems can significantly expand its communications systems product offerings and penetrate the professional audio equipment market," said Bosch Board of Management member Peter J. Marks. "The strength of the Telex distribution network will enhance our worldwide market position as a provider of comprehensive security and communications systems."

## STEVE MILLER TO RECEIVE LES PAUL AWARD



Singer/songwriter/guitarist Steve Miller will be honored with the prestigious Les Paul Award at the 22nd annual Technical Excellence & Creativity Awards, Saturday, October 7, 2006, at the Hilton San Francisco. For a list of this year's TEC nominees, go to page 53.

Initially a fixture in San Francisco's "Summer of Love" scene as leader of the Steve Miller Band, the Texas-bred Miller used his blues/rock roots to transcend psychedelia and develop his own enduring sound. In the ensuing decades, Miller has consistently toured and seen his songs covered by artists as diverse as Smashing Pumpkins, The Deftones, Seal, Run-D.M.C. and k.d. lang. The band's *Greatest Hits 1974-1978* has been certified Platinum 13 times. Cumulatively, the Steve Miller Band has sold 23.5 million records since its 1968 Capitol debut, *Children of the Future*. *Fly Like an Eagle* proved to be a career-defining album for the Steve Miller Band. With more than 4 million albums sold to date, *Fly Like an Eagle* is the band's biggest-selling studio album. It spent nearly two years on the *Billboard* 200,

peaking at Number 3 and yielding the Top 40 singles "Rock'n Me," which was the band's second Number One single (following the 1973 "The Joker"), the title track, which reached Number 2 on the pop charts and Number 20 on the R&B charts, and "Take the Money and Run," which peaked at Number 11.

In other TEC news, as of July 1, 2006, more than 20 pro audio and technology industry leading companies have signed on to sponsor the 22nd Annual Technical Excellence & Creativity Awards, Saturday, October 7, at the Hilton San Francisco. Intel Corporation has come onboard as the official sponsor of the Technical Awards, and Gibson Guitar Corp. will once again sponsor the Les Paul Award, which will be presented to guitarist Steve Miller.

These companies are joined by Platinum sponsors Harman Pro Group, Digidesign, *Mix* magazine, Sennheiser and Shure. Numerous companies are also supporting the event as Gold, Silver and Bronze sponsors. A complete list of sponsors, as well as nominee profiles, appears on page 54. For sponsorship information, contact Eric Geer at 925/287-1657 or [eric@mixfoundation.org](mailto:eric@mixfoundation.org), or go online to [www.mixfoundation.org](http://www.mixfoundation.org).

## AWARDS FOR HARTT STUDENTS

Two students from The Hartt School's Music Production and Technology (MPT) program at the University of Hartford have been named winners of a prestigious *Down Beat* magazine Student Music Award.

Junior Shane McMahon and senior Robert Murray are the winners in the Best Engineered Studio Recording category, for their recording of a studio performance by assistant professor Steve Davis' Advanced Ensemble from Hartt's Jackie McLean Institute of Jazz.

Murray will receive his Bachelor of Music degree from the MPT program this month. He plans to continue his education in the Master of Music program at McGill University in Montreal. McMahon will be interning this summer at Allaire Studios in upstate New York.

PHOTO: SCOTT METCALFE



Up-and-comers Shane McMahon (left) and Rob Murray

## SOUNDS GOOD WHEN I GO VROOM



More than 10 years ago, Acura teamed up with Grammy Award-winning engineer Elliot Scheiner and Panasonic to create the first ELS DVD-A surround sound system for the Acura TL luxury sedan. Today, the group launched the RDX SUV, which sports the next generation of the ELS sound system. The Acura/ELS Premium Sound System uses a 25-bit D/A converter and is the first production sound system to use a digital 96kHz sample rate for smoother sound. Advanced electronics allowed Scheiner to precisely tune the acoustics of each speaker and the timing of each of six audio channels.

Nine of the 10 speakers use a high-energy Neodymium magnet (subwoofer uses a Ferrite magnet) for high-quality sound and drastically reduced weight. A 6.7-inch mid/low-range dual-thickness polypropylene cone speaker is in each door and a 1-inch soft-dome tweeter near each A-pillar. A center-channel 2.75-inch midrange polypropylene cone speaker is centered on top of the instrument panel, and the left and right two satellite channel speakers are positioned just behind the second-row seats, positioned high and angled into the interior. A special superlow-distortion 8-inch subwoofer powered by a separate 100W amp is positioned in a tuned enclosure on the right sidewall of the cargo area to provide rich, deep bass, without intruding on passenger room or useful storage space.

For more information, check out [www.panasonic.com/els\\_surround](http://www.panasonic.com/els_surround).



## SOUND LOUNGE GROWS NEW SITE IN SOHO



Sound Lounge's second location, Sound Lounge Hudson (SoHo, [www.soundlounge.com](http://www.soundlounge.com)), features two 5.1 mixing suites and will serve as home base for the New York City's company new music and sound-design division, featuring a full complement of mixing for television (SD and HD), radio production and voice casting, as well as original music production. Physically, the addition boasts a music recording studio, a live room, a writer's studio, a casting room and a client lounge.

The SoHo studio's mixing staff includes Scott Persson, who joins Sound Lounge from McHale Barone, and Peter Buccellato, who has more than 20 years of experience as a mixer. Brad Stratton as executive producer will head the new division. Stratton previously served as a music producer at the New York post house Fluid. The creative staff of music and sound design division includes Marshall Grupp, a co-founder of Sound Lounge, and composer Kevin Ferguson, co-founder of London's Boiler Room; composer Harry Frost has also joined Sound Lounge. Heading a new sales effort to support the expansion is Jack Fahey.

## BOOKSHELF

Jeff Touzeau's *Making Tracks: Unique Recording Studio Environments* includes hundreds of photos and interviews from a wide range of international recording studios and the personalities behind them. The book, available at [www.studioenvironments.com](http://www.studioenvironments.com), highlights 18 recording studios in places as diverse as France, The Bahamas and Big Sur, Calif. According to Touzeau, "My objective was to discover what made each recording environment special in its own right. I tried to cover the gamut in terms of location, music genre and personality. What quickly became apparent was that the studios often mirrored the personalities of the individuals behind them. There is an indelible and unmistakable personal signature apparent on each studio." Schiffer Books, [www.schifferbooks.com](http://www.schifferbooks.com).

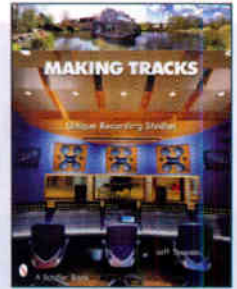

## PEACOCK FINDS SELF AT CAPITOL



*Alice Peacock, singer/songwriter and recently named president of NARAS' Midwest chapter, completed her latest release, Who I Am, at Capitol Studios in L.A. From left: engineer Curt Schneider, producer Andrew Williams and Peacock.*

## INDUSTRY NEWS



Dusty Wakeman

Mojave Audio (Burbank, CA) promoted **Dusty Wakeman** to president; Wakeman recently spent his pro audio days with Mad Dog Studios...Filling the newly created post of music director, Los Angeles, is **Shauna Krikorian** at 615 Music...Previously employed as mixer at AudioBanks, **Dona Richardson** joins **UNION Editorial** (Santa Monica, CA) as in-house mixer...**Digidesign** (Daly City, CA) appointed **Kent Margraves** as house of worship and installation specialist...Stockholm,

Sweden-based **Propellerhead Software** named **Robert Pointer** to director of U.S. markets...Joining **LOUD Technologies** (Woodinville, WA) as interim senior VP of domestic sales is **Michael MacDonald**; Frank Loyko continues on as senior VP of international sales...Three years after joining **Auralex**

(Indianapolis), **Tracy Chandler** has been promoted to the newly created position of director of worldwide sales...New sales director at music/sound design company **RIDE** (NYC) is **Tiffany McCannon**...**Sennheiser** (Old Lyme, CN) new appointments: **Eric Mayer**, Eastern regional sales manager/professional products; and **Chris Spahr**, Northeast market development manager/installed sound...**Michael Trimble** joins **JBL** (Northridge, CA) as market development engineer, Asia/Africa/Middle East...**The Stanton Group**, **Cerwin-Vega**, **KRK** and **Stanton Magnetics** (Chatsworth, CA) appointed **Enio Martinez** director of customer service...New distribution deals: **SurgeX** (Pipersville, PA) is represented in northern Illinois, Wisconsin, Minnesota and North and South Dakotas by **LoFT AV** (Chicago); **Aviom** (West Chester, PA) appointed **Halwani Audio Visual** (Saudi Arabia), **Yedakol** (Israel) and **POL Teknik** (Sweden).



LOPE FILTER.  
PAN SYNTH LEAD.  
INCREASE DE-  
CAY ON BASS  
LINE. HIT STOP.  
REWIND. DROP  
SNARE ONE  
OCTAVE. BRING  
UP REVERB ON  
VOCAL SAMPLE.  
ADD CHORUS  
TO GUITAR LINE.  
EQ STRINGS.  
ADJUST VELOC-  
ITY SENSITIVITY.  
RETWEAK FILTER.  
SELECT NEW  
LEAD PATCH.  
FINE TUNE BASS  
LINE LFO. DROP  
SNARE ONE MORE  
OCTAVE. CHANGE  
OSCILLATOR  
WAVEFORMS.  
MAKE REASON  
YOUR B\*TCH.

**MACKIE CONTROL C4: 32 V-POT CONTROLLERS,  
4 SCRIBBLE STRIPS, FULL REASON 3 INTEGRATION.**



[www.mackie.com](http://www.mackie.com) ☎ 425 487 4333 (Outside U.S.) ☎ 800 898 3211 (Toll free within U.S.)

**MACKIE®**

© 2006 LOUD TECHNOLOGIES INC. ALL RIGHTS RESERVED. "MACKIE" AND THE "RUNNING MAN" ARE REGISTERED TRADEMARKS OF LOUD TECHNOLOGIES INC. ALL OTHER TRADEMARKS ARE PROPERTY OF THEIR RESPECTIVE OWNERS. SVENSK PROGRAMVARA ROCKAR FETT.

World Radio History



Go beyond the printed page and log on to [www.mixonline.com](http://www.mixonline.com) to get extra photos, text and sounds on these select articles:



### Sylvia Massy Snivy's RadioStar Studios

Take your own virtual tour of this producer's new Weed, Calif., RadioStar Studios, as well as take a look at the studio's vintage gear, with quotes from Snivy on why each piece holds a place in her heart.

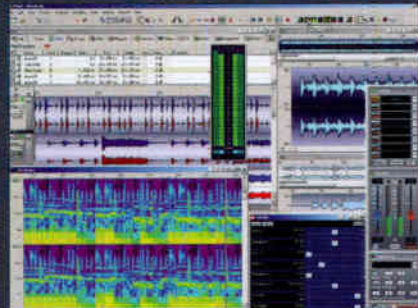

### Field Test: Steinberg WaveLab 6

Dig deeper into this audio editing software with additional screen shots.

### Mix Interview: Geoff Emerick

There are more words of wisdom from The Beatles' recording engineer than we could fit in print. Check out what Emerick also had to say, as well as what he's told *Mix* in past articles.



### The Pre-Production Payoff

Get more tips from these engineer/producers on getting the right sounds down. Also, check out a full discography from these pre-production masters.



## NOTES FROM THE PRODUCERS & ENGINEERS WING OF THE RECORDING ACADEMY

### EXAMINING EXCELLENCE—SOMETIMES IT'S THE LITTLE THINGS

BY MAUREEN DRONEY

This month, *Mix* subscribers vote for the 2006 recipients of the Technical Excellence & Creativity Awards—no easy task. But one great thing about the audio industry is that there's no lack of people who naturally strive for excellence. Although a few score big in the audio world, no one actually goes into this business for the money. Most have ended up here because they just can't help themselves. Think Rupert Neve, Joe Meek, Greg Mackie, Bob Clearmountain, Tom Dowd, Geoff Emerick—people who make audio gear and the people who use it are compelled to create greatness. As engineer/producer Robert Margouleff commented recently, "The desire for excellence is the overriding obsession of a music producer; if it's not, they don't belong in the business." Margouleff, whose credits range from Devo to Stevie Wonder, is a prime example of his own maxim. It was his frustration with the sound of DVD movie releases that prompted him to start Mi Casa Multimedia, the successful company he originally founded (with Brant Biles) to remix theatrical releases to sound correct in home listening environments.

The obsession for excellence manifests itself in hundreds of ways in the daily routine of those who make great records. No matter what format their work will end up being heard in, they're always reaching for that extra ounce of quality. Sometimes, it's a battle.

"Lately, I find myself having to convince clients to spend the time to get things right," notes engineer Ralph Sutton, who has worked with such artists as Mary J. Blige, Elton John and Stevie Wonder. "There are things that you do in your work that seem small, but ultimately add up to making a big difference, like getting rid of noise at the front and back of takes. Sometimes clients think I'm wasting time; I have to show them it's cumulative."

To address this increasingly common lack of procedural knowledge, Sutton has started classes at his Memphis studio for up-and-comers who, thanks to the home studio revolution, rarely get the benefit of formal training at a commercial studio. Dubbed "Young Producers Boot Camp," the series provides the basics of engineering, production and songwriting craftsmanship.

Engineer/producer Dave Schiffman (System of a Down, Anti-Flag, Stellastarr) also offers insight into the quality battle. "You notice that people who work a lot have consistent habits," he points out. "They know how to take the extra time to make sure everything is right. Something I'm compulsive about, for example, is that when I'm tracking, I come in every morning and shake down all the mics. Gear, especially tube mics, can change from one day to the next, so I make sure everything is still working as it was the day before. Fifteen extra minutes in the morning, and you've avoided a potentially ruined take, where a mic is distorting—or dead. I'm also careful with alignment. If I'm mixing someone else's recording, I often don't know what their Pro Tools reference level is. People frequently record as loud as possible into Pro Tools, and when you bring those tracks out into the console, you destroy the gain structure. You flatten out all the headroom and lose the benefits of using the console. So I'll sit there and, using my ears and the VU meters, spend the time to get the console and the Pro Tools in harmony."

Schiffman's words reminded me of watching Ron Nevison—famed producer of Heart, Ozzy Osbourne and The Who, among countless others—setting up for vocal sessions. "Nevo" has sold millions of records and recorded hundreds of artists, yet every morning, he arrived as early as the assistant engineer and personally checked that every detail was perfect, from turning on the mic to warming it up to reviewing the lyric sheets for spelling accuracy. Obsessive? Well, yeah, and excellent. ■

*Maureen Droney is the executive director of The Producers & Engineers Wing of The Recording Academy. Her 20-plus years in the recording industry have led to an obsessive interest in excellent drummer jokes.*

## CORRECTION

In the June 2006 issue, the photographer for the cover shot is Peter Figen, not Amanda Strong.

Mix regrets the error.







**M7CL**  
DIGITAL MIXING CONSOLE

Thank you to the readers of MIX for nominating the Yamaha M7CL digital console for the 2006 Technical Excellence and Creativity Award in the category of:

**Outstanding Technical Achievement**  
*Sound Reinforcement Console Technology*

We look forward to continued success with the wide-spread acceptance and appreciation of the latest in the line of Yamaha digital consoles.



## R!OT Atlanta

By Barbara Schultz

In June, *Mix's* "Class of 2006" design feature announced the expansion of this month's cover studio, R!OT Atlanta. Serving the booming Atlanta TV advertising and broadcast community since 1988, the studio has grown and evolved along with that market.

A little history: Formerly known as Editworks, R!OT was an independent studio that was acquired by venerable post company Todd-AO in '96. Much of the Editworks staff stayed, but when a faction moved on, managing director Buddy Hall and senior mixer/composer Chris Basta were hired to create the audio department. In '96, the studio had one audio room, but within the year added another room and another engineer, Matt Melberg. In 2000, Liberty Livewire (now Ascent Media) purchased Todd-AO, and in 2002, Editworks was renamed R!OT Atlanta.

With ad clients such as J. Walter Thompson and the Turner and Discovery networks, and backing from its corporate parent, business grew beyond the facility's physical capabilities. "We had cannibalized every square inch of space that we had," Hall recalls. "We built additional Avid suites and [Discrete Logic] Smoke suites and reached our limit."

R!OT's parent company first considered moving the facility from its home on the second floor of a Buckhead office complex to a dedicated building in Midtown. Bret Thoeny's L.A.-based BOTO Design was hired to create a new, expanded space for R!OT. "Ascent wanted to do some upgrading and remodeling," Thoeny says. "We designed from California and hired a local architect, Kennedy & Associates, and then at the eleventh hour, the decision was made to take over the floor above where they were."

Thoeny and his team came up with an elegant design that places all of R!OT's visual effects design, animation and communal spaces on the second floor of the building, and three enlarged audio suites, editorial/finishing bays, administrative offices and machine room on the third floor.

Melberg says that one of the main improvements the R!OT staff sought from the remodel was "true isolation," which proved challenging for the designers. "We're in a traditional office space, and if something really

loud happens on the seventh floor, you'll hear it on the second or third floor," Melberg says. "If you're situated on the ground floor when you build a studio, it's easier to get great isolation because you can just use mass. We couldn't do that in this building because the load would have been too great."

"Marshall Long [of Marshall Long Acoustics, Los Angeles] did the calculations on the floor system so we could balance the weight and the acoustical requirements with the structural engineer in Atlanta," Thoeny adds. "The rooms are floated and all the air conditioning is separate-zoned with sound dampers to kill the sound coming down the ductwork."

Construction had to be timed to allow the busy facility to keep operating—a nearly impossible feat that was accomplished through careful planning and the staff's dedication.

"We started demolition in January of '05 on the floor above us," Hall explains. "Naturally, the crews had to work odd hours. Then we built it out, got everything to a finished state and had an integration company come in—part of the Ascent group—that pre-wired everything, pre-qualified everything, and over Memorial Day weekend of '05, we moved upstairs six Avid bays, two Smoke bays and a Flame bay, had them up and working on the following Tuesday. The next Friday night, we commissioned our new Fairlight Constellation consoles, and over the weekend moved all the outboard gear, all the monitors, had everything hooked up over that weekend, and Monday morning, we were rolling with all three audio suites hot.

"We never missed a beat, and I think our clients were very patient throughout the process. The staff really hung in, too. We had 18 guys here over Memorial Day



In R!OT Atlanta's Sound 2 (L-R): audio production manager Brian Anderson, managing director Buddy Hall, senior mixer/composer Chris Basta (seated), senior mixer Matt Melberg and mixer Erich Netherton

weekend to help with that move—that's 18 people out of 37 in the entire shop on a holiday weekend!"

Simultaneous with the construction of the new rooms, Fairlight's local rep, Media Gear, sent trainer Michael Haprov to help engineers get up to speed on the new Constellations. "He lived with us for a week, got the consoles assembled and commissioned, and got us up and running," Melberg says. "The thing I love about the Constellations is everything is in one spot. You never have to leave the sweet spot to edit, to mix—to do anything. And for the most part, it's one button per function. The way the Fairlight edits audio is truly amazing. The automation runs really well. It's very intuitive. The machine control is superb." In addition to the new consoles, R!OT installed new ADAM Audio 5.1 speaker systems in each suite, the winner of an elaborate shootout that started months before the rooms were built.

Thoeny feels that at the end of the day, the studio ended up better situated without a new building. "They have a better location," he says. "They're in the heart of the Buckhead financial district, and there are hotels right there. It works well for their clients, especially those coming from New York, where they can basically walk across a lobby and walk into the facility." ■

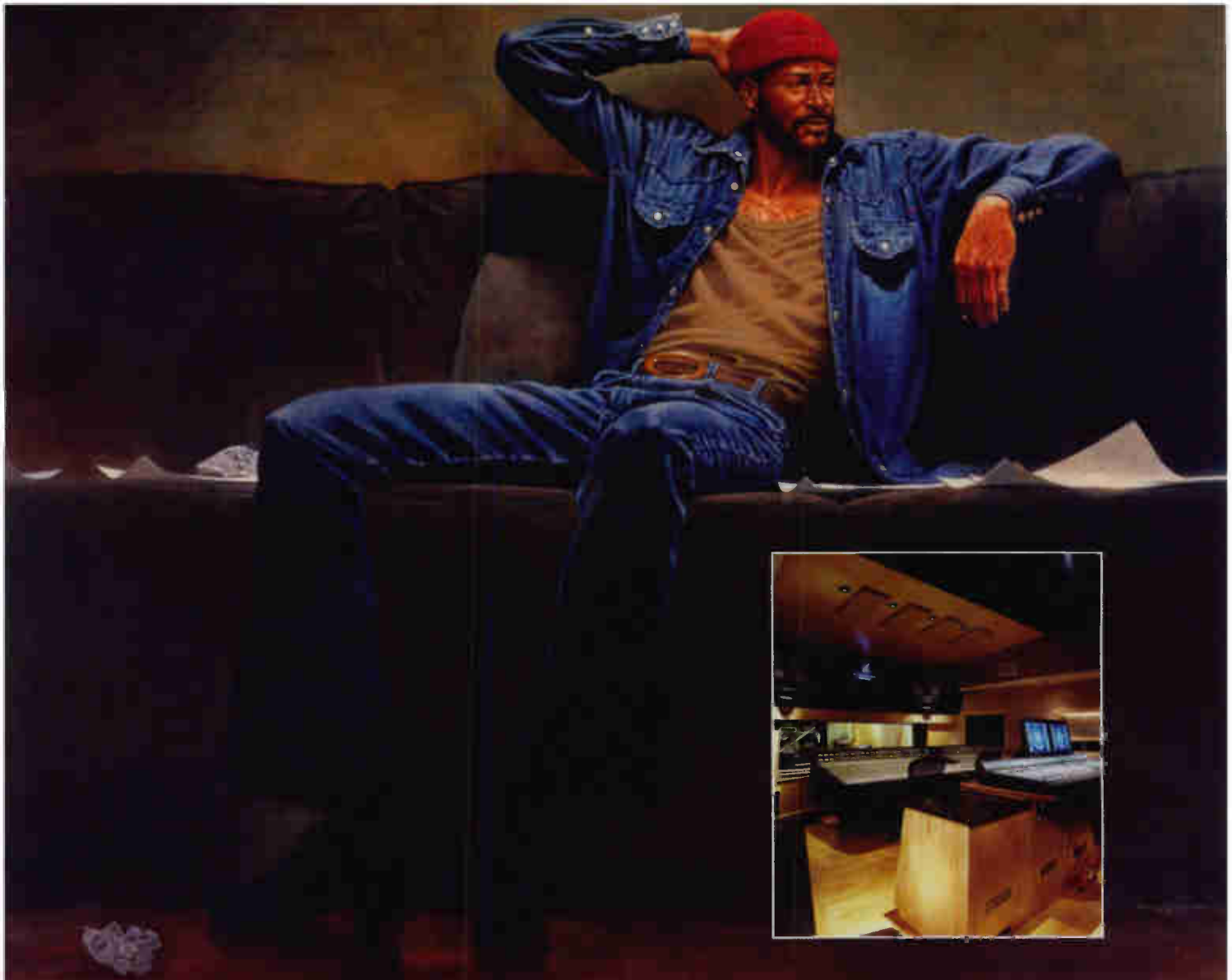

# MARVIN'S ROOM

THE PLACE WHERE MARVIN MADE SOME OF THE GREATEST MUSIC AND WHERE HIS SOUL AND SPIRIT STILL DWELL.

## MARVIN'S ROOM STATE-OF-THE-ART STUDIO

is now open for private, professional recording sessions.

Featuring the most gear-intensive collection of classic analog and current digital equipment available anywhere. This historic studio was built by Marvin Gaye over 30 years ago and has been lovingly restored by John McClain and has hosted sessions by some of the industry's top platinum recording artists.

## MARVIN'S ROOM RECORDING STUDIO

H O L L Y W O O D , C A L I F O R N I A | 3 2 3 . 8 6 0 . 0 9 9 2

Artwork of Marvin Gaye by Kadir Nelson | [www.kadirnelson.com](http://www.kadirnelson.com)

World Radio History



# And the SCAB Goes To...

## Award Winners From the Dawn of Modern Audio



ILLUSTRATION: JACK DESROCHER

This is the month when *Mix* readers get the chance to vote for their favorite candidates for the venerable TEC Awards, a tradition that has been going on for so long it can now drink legally in all 50 states. But did you know that the first awards in pro audio were given out 60 years ago? Back in 1946—the year the UN, the CIA and the NBA were established; Tokyo Telecommunications Engineering was founded (later to be known as Sony); Jackie Robinson started playing professional baseball; the bikini showed up in Paris store windows; and John Paul Jones (the bass player, not the Navy guy), Keith Moon, Suzanne Somers, Oliver Stone and the Texan in the White House all were born—the still wet-behind-the-ears pro audio industry thought it was time to honor their own.

The world was recovering from a long and nasty war, and millions of people no longer worried about life, death and where to buy gasoline suddenly had time—and money—on their hands. Entertainment, which meant radio, movies, television and records, was booming. Technologies that had been developed during the war, such as radar (by the British good guys) and tape recording (by

the German bad guys), could now be adapted to peaceful uses, and prominent among those uses were tools for audio production and distribution. With everyone (at least on the winning side) in such a celebratory mood, members of that fledgling industry couldn't wait to give themselves a collective pat on the back and put on an awards show.

That first awards party was a small affair, taking place during the semi-annual conference in New York of The Vinyl, Cardboard and Stylus Manufacturers Association, one of the precursors of today's AES. There was a festive brunch of war-surplus C-rations (including large quantities of Spam®) in the cafeteria of the YMCA near Penn Station, followed by a brief ceremony, during which the Sound, Communications and Broadcasting Awards, fondly known as The SCABbies, were given out.

Thanks to the historians behind the Website scabbies.org, I've uncovered a list of the awards given out and texts of the acceptance speeches and even some notes about the audience. As we look back over our industry's achievements during the past year, I invite you to travel with me back in time to glimpse what was going on at the dawn of

—CONTINUED ON PAGE 136

Shine Brighter

# Gold Platinum Diamond

Now More Plug-ins Than Ever

## Gold Bundle

**24**  
Plug-ins

Now including:

- Tune LT
- IR-L Convolution Reverb
- Doubler
- RenAxx

## Platinum Bundle

**32**  
Plug-ins

Now including:

- Tune LT
- IR-L Convolution Reverb
- Doubler
- L3 Ultramaximizer
- RenAxx

## Diamond Bundle

**41**  
Plug-ins

Now including:

- Tune LT
- IR-L Convolution Reverb
- Q-Clone
- L3 Multimaximizer
- RenAxx

Make the world's finest audio processors part of your sound.



[www.waves.com](http://www.waves.com)

# The

# Pre-Production

# Payoff

## Making the Most of Studio Time—In Advance

BY BLAIR JACKSON

In the way olden days—pre-*Pet Sounds* and *Revolver*—pre-production was a fairly well-defined process. It involved choosing material for a group or artist, hiring musicians to play (if there wasn't a band) and then rehearsing the tunes until they could be cut live in a studio. And then, my, how things changed. When recording budgets seemed unlimited and the proliferation of studios meant there was always a room that could be locked out for months at a time, many artists started writing their songs in the studio and building tracks from the rhythm section up and working out their ideas through endless experimentation. And there are still artists who work that way—the rise of the sophisticated home studio has allowed that slow evolution of material to continue. But today, the industry is leaner and meaner: Record labels don't like paying for major studio lockouts, and cost-cutting and efficiency are the name of the game. Now, more than ever before, it's essential that artists—and the producers who work with them—keep an eye on the bottom line when they're recording, and that often means devoting more time and energy to pre-production.

Every project is different, of course, and the nature of the music and the agreed-upon production style will dictate what and how much needs to be done in advance. Obviously, musicians who want to cut mostly live in the studio need to have their act together before the red light goes on. In genres that use pre-programmed beats and other computer-generated elements, the pre-production process might involve just a single engineer or producer or songwriter working in isolation and all but completing the track before a singer or rapper comes in. There's no right or wrong way to do it, and the line between pre-production and actual tracking is blurring more each day.

Recently, we spoke with four producers working in different styles of music to find out about how they deal with pre-production issues.

### GEORGE DUKE

With a career spanning four decades, keyboardist George Duke has appeared on literally hundreds of albums and produced dozens for a wide variety of R&B and jazz artists, including Marilyn Scott, Billy Cobham, Dianne Reeves, Dexter Gordon, Jeffrey Osborne and Dee Dee Bridgewater, to name just a few. His latest self-produced solo effort, *In a Mellow Tone*, finds him tackling a pleasing selection of original tunes, as well as classic and obscure standards.

"For my new album," he says, "the first part of pre-production was finding musicians who understood the concept of what it was supposed to be. I chose a couple of musicians who had never worked together, but I'd worked with



George Duke: "The producer's job in the pre-production stage is to marry a song with the artist."



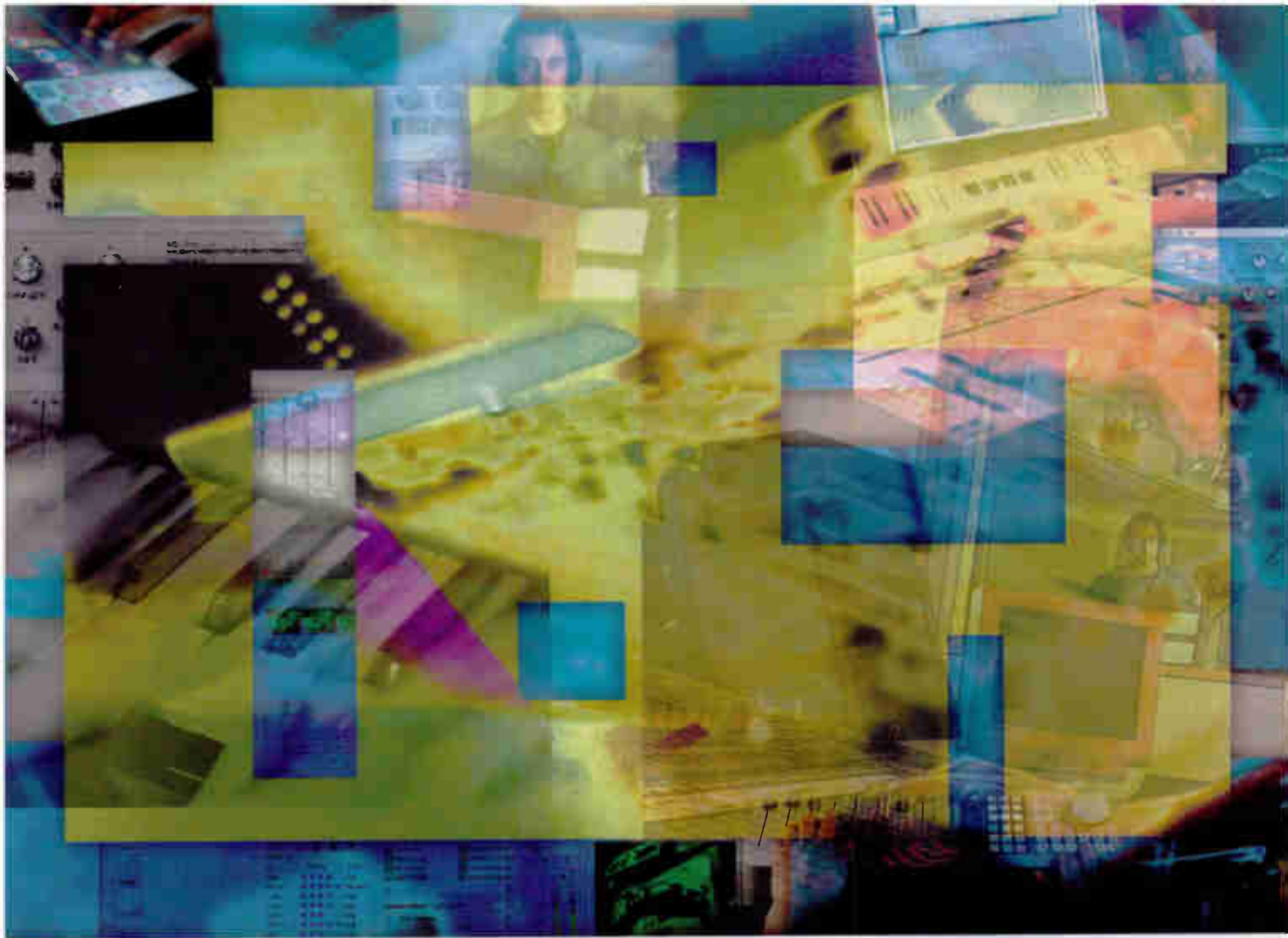

them separately—Terri Lyne Carrington on drums, Brian Bromberg on bass—both tremendous players. That was the nucleus of the record, along with Airtio [Moreira] and Munyungo [Jackson] playing some percussion. The other thing was to find the songs. The producer's job in the pre-production stage, whether it's me or another artist, is to try to marry a song with the artist. There's usually some give and take there about song choice and the way it could be arranged and how to approach it—simple or some orchestration, real instruments, electronic instruments.

"When I'm producing a singer, I might make synthesizer mock-ups to get the feel of it. I don't get it sounding too involved because I don't want the musicians when they hear it to feel like they're obligated to play what I did on the synthesizer. But it gives a general direction and it allows the singer to actually rehearse with it ahead of time so they get a feel of what it might be. I didn't do that on this album because I didn't feel I needed to. But on the previous one, *Duke*, I did mock-ups of every song and they were pretty doggone detailed. In

that case, I really did want the other musicians to get an idea of what I was looking for, so I sent it to them on an MP3 file and I also sent a chart, so by the time they arrived at the studio, they really knew the song." In his studio, Duke has Pro Tools HD and a Euphonix console, "but I'm a Logic guy and I use GigaStudio, as well, so between those and my analog gear and [the] virtual instruments I have in my Mac, I'm pretty well pimped out here," he says with a laugh.

"The other factor involved in pre-production I can't ignore as a producer is budget, and that part is a drag for me," Duke continues. "These days, with budgets being cut, I have to really keep an eye on costs. People say, 'But you have your own studio.' Well, that's true, but this equipment costs money. I have a first engineer [Erik Zabler] and a second engineer to pay. I have a staff that works in the office that makes calls to musicians, keeps the contracts and does the bookkeeping. If I need to rent some outboard gear, if we're recording it or mixing it somewhere else...meals, hotels if people are coming

from out of town—all that goes into the fee and all that has to be down in writing for the record company before they agree to let you produce a record."

#### KEITH CLARK

Keith Clark (aka Keith Clizark) came to production from a considerably different route. Born in Mississippi and raised in Long Beach, Calif. "I started out DJ'ing in high school for a hip hop radio station," he says. "Later, I went to Long Beach City College, which has a top-rated music school, and I learned some theory there and I learned some technical things just from being around equipment and messing with it. I made my first record at the age of 17."

Clark's big break came when he hooked up with fellow Long Beach native Snoop Dogg. He's done production for tracks on a few of Snoop's albums, as well as discs by Tha Eastsidaz, Master P. and others. Like many rap producers, Clark takes the reins early in a production and devotes much time and energy to building tracks layer by layer.

"For me, pre-production starts with the

## The Pre-Production Payoff

concept of the song and it doesn't really stop until I get to the last element that is to be applied, which is usually the vocals," he offers. "For pre-production with a rapper, or any style that's using a drum machine-based composition, the sound of the kick and snare is the foundation—that's *everything*. If it doesn't sound right, it's not going to work. With rap in particular, the better your foundation is, the fewer elements you have to add to your composition. I have a studio at home and I'm using Pro Tools, and I have an [Akai] MPC 4000 [24-bit/96kHz sampler and sequencer] that I swear by. I'm also using GigaStudio with the live orchestra strings—that's a really beautiful thing. And I'm using the [Yamaha] Motif ES [synth] and the Phantom, which is a brand-new module from Roland. It's almost like the JV-2080s and 3080s, but it's the next level. I primarily use that for acoustic sounds and string sounds.

"So I'm working with all of that and I'll build the sounds of the beat, and then add as much ear candy as I need; I might have more than 40 tracks goin' down," he continues. "One thing I do that not many producers do anymore is put the kick and



**Keith Clark:** "So, really, 'pre-production' doesn't stop until it's time to mix."

snare in stereo—it fattens up the sound a lot. Once I've got the track pretty much where I want it, I can take it to a bigger studio—like Larrabee [Los Angeles]—and prepare for vocals. I'll also record live strings occasionally; I have a violin and cello player I work with. But even after the vocals get on it, you might hear something musically that will tie a vocal in better, and I'll sometimes do that back in my studio. So, really, 'pre-production' doesn't stop until it's time to mix."

Clark prides himself on coming up with original beats in pre-production and

indeed he's been so successful in that area that his work is represented on a pair of top-selling beat sample libraries from Big Fish Audio called Platinum Essentials. "I've owned every drum machine there is and I've kept those sounds," he says. "But a lot of my signature beats have started with a live drummer. He'll come in with a drum pad, and I'll sample it and tweak it and layer it. I get a kick out of it when I hear one of my beats on another producer's record," he says with a chuckle.

Clark says that pre-production can take anywhere from a couple of days to a week or more, depending on the track. "So far, I've been fortunate in that most of the tracks I've done don't get changed much later on," he says. "I just try to think it all the way through and put on whatever needs to be there; if anything, they might want to take a sound *out*. That's fine. [Laughs] "I'm cool with that. Just use the song!"

### JIM JONSIN

Miami-based producer and mixer Jim Jonsin also started as a DJ, then got into production, "But I couldn't really pay my bills early on, so I started engineering and



www.mackie.com ☎ 425 487 4333 (Outside U.S.) ☎ 800 898 3211 (Toll free within U.S.)

© 2006 LOUD TECHNOLOGIES INC. ALL RIGHTS RESERVED. "MACKIE" AND THE "RUNNING MAN" ARE REGISTERED TRADEMARKS OF LOUD TECHNOLOGIES INC. ALL OTHER TRADEMARKS ARE PROPERTY OF THEIR RESPECTIVE OWNERS.

World Radio History



did that for a number of years and learned everything about how to make my sound right—from the console to Pro Tools to outboard gear to MIDI,” Jonsin says. “I can do it all and that’s been important because if I’m trying to get a song onto an album, I want it to sound as good as I can make it. When you find producers who don’t understand [gear and technical things], they might have great ideas, but sometimes their sound isn’t really *there* and their demos are pretty rough. Those people don’t have a chance in hell with their demo. When they play his track against my track, it’s like a Casio to a Motif.”

Jonsin’s managed to get in a lot of doors since he broke into the biz in the late ’80s. He’s produced tracks for Trick Daddy, Twista, Pretty Ricky, Diddy, Ruben Studdard and Jamie Foxx, and mixed for many other artists. On the afternoon we spoke, he was mixing a track for Buckcherry and finishing a track for Trick Daddy.

“I don’t have any rules about what I’ll do in pre-production,” Jonsin says. “I’ll do everything from taking drum sounds and EQ’ing them—changing them—to laying keyboards in to get a base. Or maybe it’s



*Jim Jonsin: “I treat the pre-production mix seriously because sometimes we’re trying to get in the door.”*

a record that needs guitar, so we’ll do guitars from the keyboards until we can get a guitar player in; or a string section—I’ll put the strings down from the keyboard. For example, I did a Trick Daddy record with strings from the keyboard, but tomorrow night in Miami, I have these guys coming in—the Black Violins—to replay that part.

I love the feel of live instruments.

“In general, the pre-production would be me programming from say, a Yamaha Motif or an MPC 2500, but then bringing it into the studio when the record is pretty much there and adding the live elements to it. During pre-production, we’ll also do a full mix. That doesn’t mean you won’t do a bigger mix later when you have everything, but I treat the pre-production mix seriously, too, because sometimes we’re trying to get in the door—you’re trying to [sell] the track and you want the person hearing it to understand what it can really be.

“These demos we do—you could really release a lot of them as records. And some people *do* pretty much release their demos.” Does Jonsin become so attached to a sound in the demo process that he chooses not to replace it later as intended? “Once in a while,” he replies. “Sometimes, the string sound on the keyboard is better than what you’d get out of just a couple of players because you can make it so lush that you’d need a large section to reproduce it and you might not have the time or the budget to get that. The Yamaha Motif has a real lush string section that sounds great. But guitars,

Portable recording devices have always seemed like a good idea... Until the seventeenth time you had to disconnect all your studio cables. No more. Introducing Onyx Satellite: the world’s first two-piece FireWire recording system. The portable Satellite pod offers acclaimed Onyx preamps, superior A/D converters, and simple FireWire connectivity; while the Satellite Base Station gives you monitor control, routing and additional I/O that stays on your desktop. It’s portable recording, without the cabling calisthenics.

## Onyx Satellite. Giving desktop musicians the power to go.



**MACKIE**



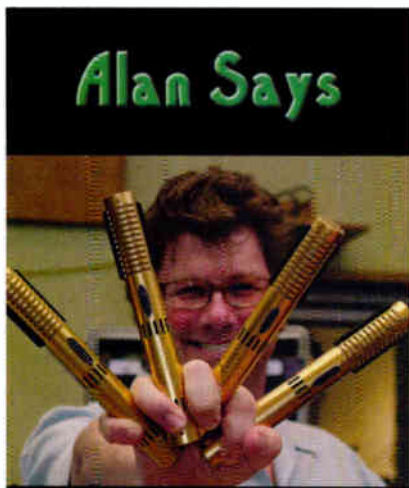

## Alan Says

We just wrapped up *Pirates of the Caribbean: Dead Man's Chest*, and there are Royer R-122V tube ribbons all over the score. I used three R-122Vs on the decca tree, and also extensively on the woodwinds.

There's something going on in the mids with Royer's tube ribbon mics that's hard to explain; there's a reach and depth and lushness that sounds magical to me.

For some remote island cues that needed a cannibal vibe, Vinnie Colaiuta, Abe Laboriel Jr., and JR Robinson played drum kits simultaneously on the Sony scoring stage. I captured each kit as a mono setup - panned left-center-right - using a single R-122V over each kit. It sounded amazing.

### Alan Meyerson

(Scoring Engineer & Mixer - Hans Zimmer, James Newton Howard)

See photographs  
of Alan's 'Pirates'  
sessions at  
[royerlabs.com](http://royerlabs.com) -  
Session Photos

ROYER

Royer Ribbons

818.847.0121 • Burbank, CA  
[www.royerlabs.com](http://www.royerlabs.com)

never; bass, never; horns, sometimes I keep those [electronic versions]. Still, I always try to stay open."

### TIM PALMER

We close out our informal survey with a rocker: Working both in his native England and in the U.S., Tim Palmer has produced scads of great rock bands in a wide variety of styles, including Tears for Fears, Robert Plant, Gene Loves Jezebel, the Mission UK, Tin Machine, the Mighty Lemon Drops, H.I.M., Switchfoot and Ozzy Osbourne. He's also done top-drawer mix work for the likes of U2, Faith Hill, Psychedelic Furs, The Cure and many others.

"What you need to achieve in pre-production is unique to every project," he says



Tim Palmer: "[Pre-production] is a great time to get to know the band."

from his home in L.A. "A rock band may wish to capture a live, organic feel, in which case, you need to perfect the arrangements and make sure everyone knows their parts. An electronic band may need to sort out any loops or keyboard sounds before entering the studio to save valuable dollars. When a musician is desperately trying to remember an arrangement, he is not likely to play to his best ability. If pre-production goes well and you get a good performance, then you are less likely to have to use any technology to fix it later.

"One thing that stands true for any pre-production is that it is a great time to get to know the band," he continues. "It's a great opportunity to make them feel relaxed and find out some information on what methods have worked, or not worked, for them before. It's also the perfect time to figure out how they think and what they are looking for. Pre-production and the arrangement of a song are such an important

part of the bigger picture. It's better to get the song to feel right and be in the correct order than to spend too much time on mic choices for a hi-hat."

However, Palmer also notes that "the line between pre-production and regular production has become increasingly blurred because of technology," he says. "It's true that sometimes band demos contain great sounds and performances, and when I hear something that is good I am happy because I will use it on the final master. The word 'demo' should be struck out of our vocabulary. The demo is dead. The reason for this is simple: The quality that can be achieved on a laptop or home studio is often better now than the best we could do in a major studio in years gone by. So, if something has that magic spark, then we can keep it and use it. I always say to bands, 'Take the extra 15 minutes and make sure what you are recording is decent, as we may eventually use it.' Always record everything and keep it."

Palmer says that the high quality of Pro Tools and other hard disk recording systems has also changed the playing field. Now, pre-production rehearsals and writing sessions can be recorded and potentially used later as parts of a master take. "It's obviously not essential, but it's fair to say that today's producer does need a good knowledge of Pro Tools and plug-ins," he says. "It's good to keep up if you can, because if you don't, the bands can be faster than you are, as I've found on this recent Switchfoot album. Bands that have grown up with Pro Tools are so fast. It's a weird feeling to have a band breathing down your neck and to know that they could do what you're doing faster! Switchfoot has taught me a lot, and in return, I've tried to encourage them not to rely *as much* on the technology. I think this new album sounds better for being a little more human and quirky.

"Then, on [Osbourne's] *Down to Earth* album, Ozzy was not too keen on hanging around a rehearsal room for hours on end, so I rehearsed with the band and recorded it all in my Pro Tools rig that I set up in the rehearsal room. This was very useful, as we could listen back and try simple overdub ideas before reaching the studio. When Ozzy would come in, I could play back the arrangements to him and he could try vocal ideas without having to deal with the huge volume, and at the same time, we could be fast, too." ■

Blair Jackson is the senior editor of Mix.

# Still trying to picture yourself owning an SSL console?



Sonawriter/Producer Vincenzo LaRusso

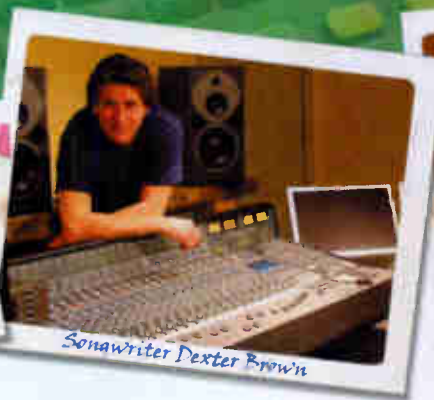

Sonawriter Dexter Brown

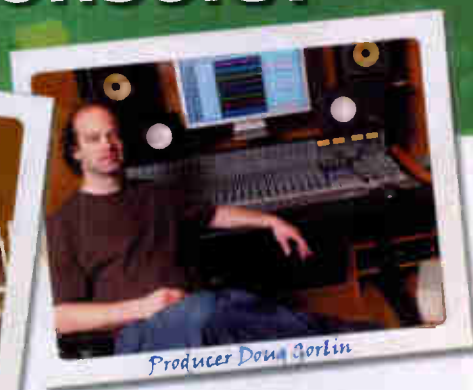

Producer Don Gorlin

## These guys did. How about you?

An SSL console in a home studio? Out of reach for most people... until now. With the **AWS 900 Analogue Workstation System**, anyone can take advantage of the outstanding sound quality and feature set of a real Solid State Logic console. Combining a world-class mixing console with a powerful integrated DAW controller, the AWS 900 delivers legendary SSL quality for every environment from the biggest commercial facility to the smallest personal studio.

## Solid State Logic **AWS900** Analogue Workstation System



## Make It Happen With GC Pro!

When it's time to add some new gear to your studio or live sound system, GC Pro is dedicated to earning your business. Along with the excellent pricing you'd expect from the world's largest pro audio dealer, you receive the expertise and extraordinary service you deserve.

From the most coveted microphones and the finest outboard gear to vintage instruments and sophisticated DAW systems, we are your one-stop solution. Contact your local GC Pro Account Manager for a personalized consultation.

GC Pro has expert Account Managers in nearly every territory of the USA... contact us today!

☎ 800-935-MYGC  
💻 [www.gcpro.com](http://www.gcpro.com)

Music • Post • Live Sound • Lighting



© 2006 Guitar Center, Inc. All rights reserved.  
All images and trademarks are property of their respective holders.

**GC PRO**  
[www.gcpro.com](http://www.gcpro.com)



# Hard Disk Drives



## Issues and Answers For Recording's New Media

BY GEORGE PETERSEN

When media theorist Marshall McLuhan published his landmark *The Medium is the Message* in 1967, he wasn't talking about recording media, but perhaps he could have been. At the time, multitrack recording was exploding on the scene and this newfound technology brought with it an examination and debate about tape types that continued for decades. In the U.S., devotees fell mainly into two camps led by American tape manufacturers 3M and Ampex, and over the years, recording engineers have held heated talks over which formulation had the superior sound. Opinions abounded, but there was no clear answer.

With the arrival of high-output formulations in the early '90s, such as 3M's 996 and Ampex's 499 (later from Quantegy), the discussions showed no signs of slowing down. In fact, with more choices available to the pro user, the issue became more complicated. Add in individual engineer's preferences for bias current settings and maximum operating levels (MOLs), along with the variations in the heads and record electronics of different models of multitrack and 2-track decks, and the

result was the ability to access an incredibly wide tonal palette. The irony here? There was no wonder plug-in or gimmick device—these results were achieved simply through the right combination of media choice, machine setup tweaks and user techniques, such as knowing how hard to "hit" the tape for tape saturation, riding that fine line between rich analog fatness and undesirable overload distortion.

Flash-forward some four decades since the publication of McLuhan's book, and the recording media of choice for most engineers is digital, where the storage media itself has virtually no impact on sound. In past years, shoot-outs where engineers made blind A/B listening comparisons between competing tape types were common. Today, it's unlikely that even the golden-est of golden ears in our industry could really discern the difference between a track recorded on a Seagate or a Hitachi drive. This is not to imply that all hard disks are the same—they're not. However, though all drives may sound the same, there are numerous differences between products that recordists should be aware of.



# Rack 'Em or Stack 'Em



**New!** Primera's Bravo II Disc Publisher is now available in a tough rack-mountable package.

Primera's newest member of the Bravo-series of disc publishers is the Bravo XR. Bravo XR is packaged in an extra-rugged case that's designed specifically for the needs of audio and music professionals, whether in the studio or on the road.



Up to 50 CDs or DVDs are automatically burned and printed at a time. For maximum convenience, everything is accessible from the locking front panel.

Rack-mount your Bravo XR or even stack two or more on top of each other for increased production.

Call **1-800-797-2772** (USA and Canada) or +1-763-475-6676 for a FREE sample disc. Visit us on the Internet at [www.primera14.com](http://www.primera14.com) or email to [sales@primera.com](mailto:sales@primera.com)



**PRIMERA**  
TECHNOLOGY, INC.

Interestingly, when recording pros talk about drives, the subject usually turns to pricing rather than performance. These days, we're well under the dollar-per-Giga-byte mark for internal 500GB drives, and terabyte units are just starting to appear. As a rough guide of drive capacity-to-recording time, figure 1 GB per minute of recording time of 48 tracks at 96kHz/24-bit. So an album project with 10 five-minute songs would require some 50 GB of drive space—just in tracking space alone. Of course, this figure goes up quickly when you start saving alternate takes and all your edits were non-destructive (with lots of “undos”) rather than destructive. Bump that rate up with more tracks, or to 192 kHz, and storage requirements increase exponentially. The bottom line is that you need plenty of drive space.

## COUNTING TRACKS

Among audio users, the main concern regarding drives is track count. In terms of DAW performance, the two most important drive specifications are seek time and spindle rotational speed. Digidesign's drive performance requirements for Pro Tools HD (Mac) states a minimum drive speed of 7,200 rpm and an average seek time that's less than 10 milliseconds. Most new drives on the market easily meet this spec, with the majority of IDE/ATA and SATA (Serial ATA) disks offering 7,200 rpm and access times in the 8ms range. According to Digidesign requirements, such drives should handle 24 to 32 tracks (44.1/48 kHz), but in my experience, these are very conservative figures, and 40-plus from a single drive is common. This assumes that you aren't recording to the boot drive (a bad practice on any DAW) and the target drive is dedicated to audio storage—a good idea, given the value of your creations and the low price of hard disks.

Another caveat? Avoid spreading audio files from one session across drives of differing types. When working on a session on an IDE/ATA drive, you can't record or play Pro Tools files to/from a SCSI disk. In such situations, it's simple enough to copy the session from one drive type to another and continue working. And performance is also improved when large video files are streamed from a disk that does not contain audio data.

As with other disk parameters, rotation speed is on the rise. Today's higher-end SCSI drives typically operate at 10,000 rpm, and 15,000 rpm drives are becoming more common. Such drives can handle 32 tracks with ease, and users frequently report sessions in the 48-track (and higher) range.

All of these figures are bound by the

axiom of “your mileage will vary.” A major factor in determining track count stems from your session's edit density. Here, a project with multiple crossfades and intensive, closely spaced edits can significantly reduce track count, particularly at higher sampling rates, making the need for a high-performance drive even more critical. In such cases, writing to a drive with an ultra-fast seek time (some are in the 4ms range) really pays off. In complex (higher track count) sessions at 96 or 192 kHz, writing to/from multiple drives is a must.

One parameter that isn't critical to DAW operations is the disk's buffer (cache) size. Most modern drives have at minimum 8MB onboard RAM, which seems more than adequate for any audio work. Interestingly, a drive's throughput isn't a major concern, either, because DAW data flow tends not to be that large (typically as lots of little packets) rather than huge streams like high-definition video.

Fortunately, today's hard disks are not only more affordable than their cousins of just five years ago, but reliability is also on the upswing. The good news is that modern drives offer greater dependability with higher capacity at a lower cost, but even here, there are a few trade-offs. That honkin' 250- or 500-gigger produces far more noise and heat than earlier smaller-capacity models, which should be no surprise considering they're typically packed into that same 3.5-inch form factor that once housed the 250MB drive from a decade ago.

## ENVIRONMENTAL RISKS

Environmentally, heat is the Number One enemy of any hard disk, and overheating can and will lead to catastrophic failures unless kept under control. Part of the problem comes back to the form factor itself. With consumer demands of smaller, lighter, more powerful devices, heat will continue to be a major issue, and it's not simply limited to drives: I find it strangely ironic that Apple's powerful new MacBook Pro line of laptops warns that allowing the bottom of the computer to contact the user's lap could “cause discomfort or potentially a burn.”

Compared to a graphics application such as Adobe Photoshop (a frequent yardstick used to compare CPU tasking speed), running a DAW program with lots of edits really puts a drive's actuating heads to the test, creating a lot of heat in the process. As hard drive mechanisms operate within self-sealed housings, heat can build up fast, and the only way to dissipate this excess

## Unraveling the Acronyms

**ATA:** Advanced Technology Attachment; same as IDE or Parallel ATA

**ATA-2:** Fast ADA; same as EIDE

**ATAPI:** AT Attachment Packet Interface

**EIDE:** Enhanced IDE; same as ATA-2 or Fast ADA

**IDE:** Intelligent Drive Electronics; same as ATA

**IEEE 1394a:** FireWire 400 (400 Mbit/sec max)

**IEEE 1394b:** FireWire 800 (800 Mbit/sec max)

**iSCSI:** Internet SCSI

**SAN:** Storage Area Network

**SAS:** Serial-Attached SCSI

**SATA:** Serial ATA (150 Mbytes/sec)

**SCSI:** Small Computer Systems Interface

**Ultra-ATA 100:** Same as ATA-6 (100 Mbytes/sec max)

**USB:** Universal Serial Bus; also called Original USB, USB 1.1 or full-speed USB (12 Mbits/sec max)

**USB 2:** high-speed USB (480 Mbits/sec max)

thermal energy is to wick it off the drive body, either through forced air or convection cooling (or both). Here, there are several differing schools of thought.

Obviously, in a studio, a fanless enclosure seems like the best choice, and companies such as Quantegy and WiebeTech offer products using passive cooling, incorporating aluminum-slab cases designed to act as heat sinks for the drives within their external enclosures. Avastor uses a low-noise fan to move air across the drive—a more traditional approach, but in audio recording applications where the drive is within the confines of the control room, a (quiet) fan and/or passive cooling system is essential. Of course, all bets are off if a loud CPU (many today have several fans) shares the listening space.

The best solution is placing the CPU and external disks in a machine room, closet or sound-isolating cabinet. Once out of the control room, CPU/drive noise is no longer an issue, and products for putting some distance between the keyboard/mouse/monitor and noise/heat-generating computer/drive(s) from suppliers such as Gefen provide easy-to-implement, practical solutions for this purpose.

## AURORA INTERFACE OPTIONS

### AES16

Expansion card offers direct connectivity to PC or Mac to all 16 digital I/O channels with remote control. Includes Aurora software mixer, added routing and 64 channels of metering.

### ADAT

Expansion card provides up to 16 channels of ADAT Lightpipe I/O at 48 kHz. Higher sample rates supported using S/MUX. Permits format conversion between ADAT, S/EBU and analog I/O.

### HD

Expansion card provides digital input and output in a format that is recognizable by Digidesign® ProTools | HD®. Operates with all ProTools-compatible ProTools. Supports up to 32 I/O channels at sample rates to 192kHz.

### FW

Expansion card available Fall 2006. FW provides a 16 channel cross platform FireWire® interface.

### LYNX TWO AURORA INTERFACE

Enabling kit gives LynxTWO and Lynx 2 owners direct connectivity for up to 16 channels of Aurora I/O.

### 1824 AURORA TRIM OPTION

Aurora 16/1824 and Aurora 8/1824 models feature +18 dBu and +24 dBu full scale trim settings, which replace the +6 dBV and +20 dBu full scale trim settings of standard models.

# Aurora Converters from Lynx. Okay, let's review...

"Aurora offers superb converter quality and small footprint for such a powerful piece of gear. Imaging was so pin-point sharp that I could almost reach out and touch each instrument, and I have never been able to listen so far into reverb tails before. To my ears, Aurora offers something special, and can compete on audio quality with converters from other companies, but often at a significantly lower price per channel."

**Sound on Sound, June 2006**

"Aurora has amazing high and low frequency definition and a notable sonic depth. After using the Lynx Aurora for several weeks, I can say that it is one of the finest sounding A/D and D/A boxes in existence today. It is the perfect solution for stereo or multichannel music production or mastering or simply as the front end for digital audio work stations, digital mixers, or modular recording devices."

**Pro Audio Review, March, 2006**

"Lynx Studio Technology scores another hit with Aurora. Aurora has the necessities for audio acquisition / playback without some of the pricey extras that mastering facilities and careful audio engineers tend not to use, such as soft distortion or soft clipping limiters. It's no surprise that the Aurora provides superior sound for less than other converters with similar features."

**Mix, June 2006**

"Lynx offers a new standard in high end AD/DA conversion. The sound is very impressive. Aurora delivers a clear, transparent sound that is completely free of digital 'roughness'. Its stereo image is stable, with remarkable width and realistic depth. The highs are brilliant and shiny, the bass is punchy and solid."

**Beat, Germany,  
November 2005**

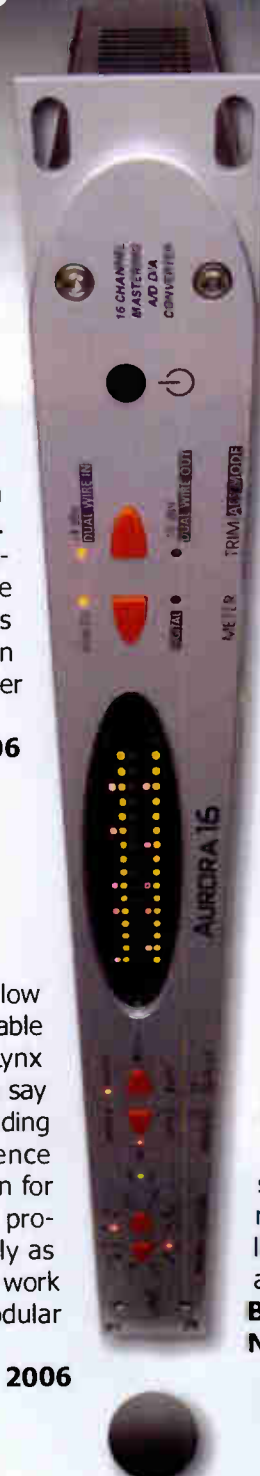

## Any questions?

For more information, go to:  
[www.lynxstudio.com/aurora1](http://www.lynxstudio.com/aurora1)

Digidesign, ProTools, ProTools|HD, and DigLink are trademarks of Digidesign, a division of Avid Technology, Inc. FireWire is a trademark of Apple Computer, Inc.

*Lynx*  
STUDIO  
TECHNOLOGY



## THE INTERNAL DRIVE

If you plan to add an internal drive into a computer residing in your control room, the issue becomes more complex. One problem arises from the drive manufacturers themselves, who often provide noise specs (sometimes at idle and/or various operating modes) but fail to indicate how such measurements were taken. Here are some manufacturer-provided noise specs on several current 500GB 7,200 rpm models: Western Digital Caviar SE 16: idle, 28 dBA; Seek Mode 0, 33 dBA; Seek Mode 3, 29 dBA

(all stated as "average"); Hitachi Deskstar TK500: 31 dB; and Maxtor Diamond Max II: 31 dB average. Seagate's promo material stated its 7,200 rpm drives were the "world's quietest," but I couldn't find any specs or measurement details to substantiate this.

Unfortunately, whether stated in dB or A-weighted, a noise measurement of a drive (or any device, for that matter) is essentially meaningless unless some measurement standard exists. Were these taken in a typical office space or in an anechoic environment? And at what distance? Taken from a half-mile

away, a 441cc BSA Victor motorcycle with a hole in its muffler could present quieter specs than any of the drives mentioned here.

More important is the effect that the enclosure (external housing or within your computer) has on drive noise. Assuming the case doesn't resonate with the drive or have a noisy fan (thus exacerbating the situation), any case should reduce the drive noise to some degree. And if your Mac or PC's case provides several drive bay locations, examine them in terms of noise and airflow and try to select the spot that offers maximum cooling and minimal noise transmission.

Speaking of enclosures, alternatives abound, ranging from bus-powered pocket drives to desktop and rackmount chassis, large arrays and huge RAID systems. A USB or FireWire bus has ample current to power the 2.5-inch pocket drives—hardly enough for comprehensive storage needs, but certainly adequate to move a single or two from studio to studio. The issue involving housings with larger drives is whether the power supply is onboard or external. The internal solution adds to the enclosure's size and heat, but sidesteps the chance of misplacing a wall wart-style supply, which can be tough to replace when you arrive at an all-night session. The external route keeps the heat-producing power supply away from the heat-producing drive, but adds another component to the chain.

Another essential link is the interface itself. An increasing number of companies are offering external drives with multiple interfaces—for example, USB and FireWire 400/800—offering additional flexibility, especially when projects are moved from one facility to another. Speaking of same, several businesses, such as Quantegy and Avastor, offer portable drives in shippable outer cases that are ideal for the traveling engineer/producer.

## GOOD, BETTER, BEST!

The best part about the drive situation is that today's drives are actually better and more reliable than ever. There are many points in the signal chain where saving a couple bucks with an inexpensive product can make sense. However, hard drives and storage systems are not one of them. And with drive costs at rock-bottom levels buying some quality storage devices not only represents a smart investment in your current and future projects, but should also buy you some peace of mind. And that is priceless.

*George Petersen is Mix's editorial director.*

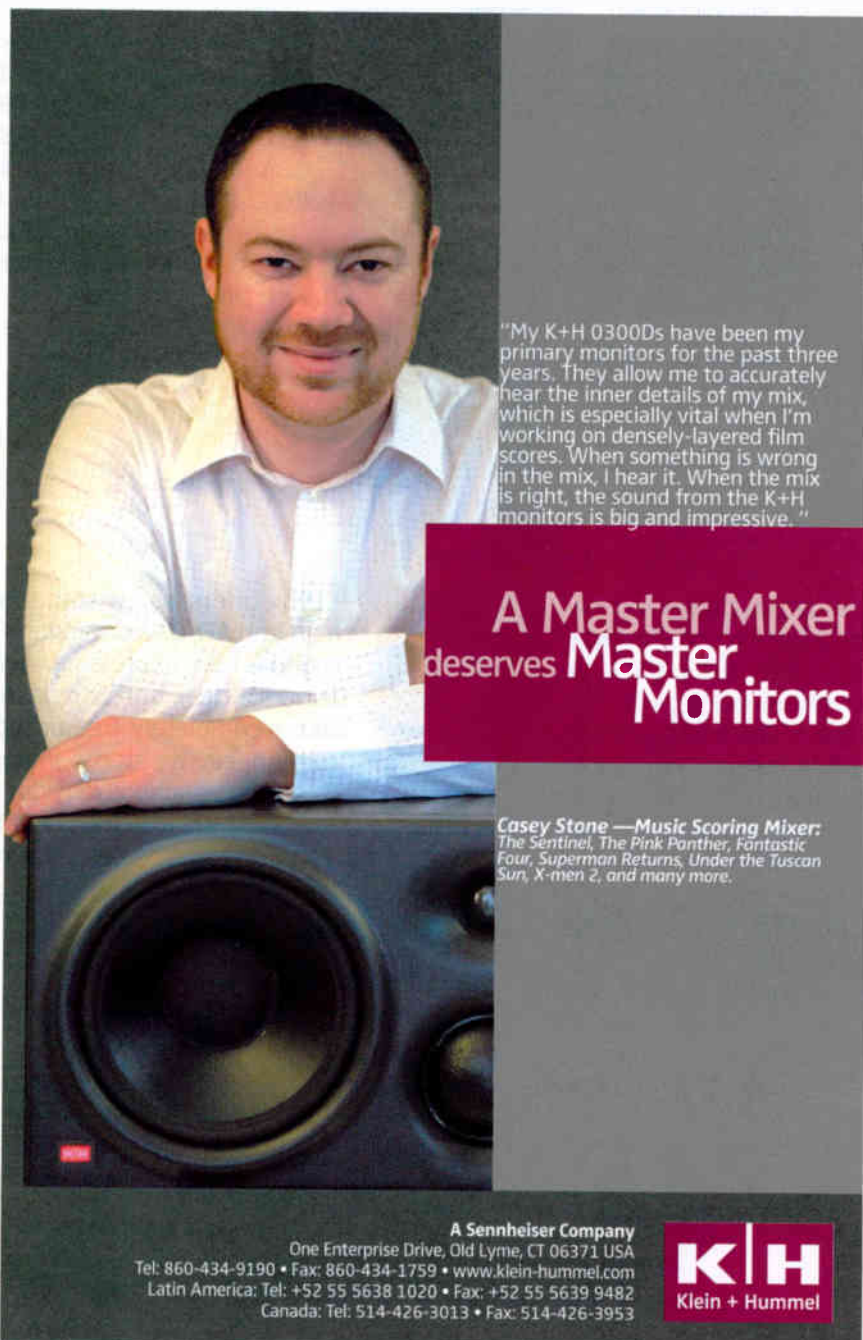

"My K+H 0300Ds have been my primary monitors for the past three years. They allow me to accurately hear the inner details of my mix, which is especially vital when I'm working on densely-layered film scores. When something is wrong in the mix, I hear it. When the mix is right, the sound from the K+H monitors is big and impressive."

**A Master Mixer  
deserves Master  
Monitors**

**Casey Stone — Music Scoring Mixer:**  
*The Sentinel, The Pink Panther, Fantastic Four, Superman Returns, Under the Tuscan Sun, X-men 2, and many more.*

**A Sennheiser Company**  
One Enterprise Drive, Old Lyme, CT 06371 USA  
Tel: 860-434-9190 • Fax: 860-434-1759 • [www.klein-hummel.com](http://www.klein-hummel.com)  
Latin America: Tel: +52 55 5638 1020 • Fax: +52 55 5639 9482  
Canada: Tel: 514-426-3013 • Fax: 514-426-3953

**K+H**  
Klein + Hummel

## DIGIDESIGN ICON INTEGRATED CONSOLE

Over 1,000 systems installed worldwide . Fully modular, state-of-the-art console control . Seamless Avid interoperability . 192 kHz sample-rate support . Industry's finest plug-in options . Automatic Delay Compensation . Integrated video and delivery . Total session recall



"In my wild world of R&B and hip-hop, the **ICON** is a perfect match. My ICON sounds great, and the automation and recall features make it easy to take what I've learned about an artist's music over the course of a project, and go back and tweak the earlier songs. The result is a consistent sound throughout an album. I love the way it works and the way it's completely integrated into Pro Tools."

Ken "DURO" Ifill  
Mix Engineer

*Mariah Carey, Mary J Blige, The Neptunes, T.I., Beastie Boys, Jay-Z, R. Kelly, Usher*

For more information on Digidesign™ ICON, please visit [digidesign.com](http://digidesign.com).

©2006 Avid Technology, Inc. All rights reserved. Avid and Digidesign are either trademarks or registered trademarks of Avid Technology, Inc. in the United States and/or other countries. All other trademarks are the property of their respective holders.

# Geoff Emerick

## Beatle Memories, From the Inside

A lot of us can relate to Geoff Emerick: a young teenager who used his tape recorder to capture everything he could and wondered how one of those things made phonograph records. That, unfortunately for most of us, is where the similarity stops. We didn't record The Beatles.

In his recent memoir, *Here, There and Everywhere: My Life Recording the Music of The Beatles* (Gotham Books, co-written by Howard Massey), the Grammy-winning engineer walks readers through a career that began with listening to classical records in his grandmother's basement and led to recording such masterworks as *Revolver*, *Sgt. Pepper's Lonely Hearts Club Band* and the *White Album*. Although The Beatles' recordings have been well-chronicled—most notably in Mark Lewisohn's remarkable *The Beatles Recording Sessions*—Emerick's book is the first to place the reader inside Abbey Road Studio 2.

Emerick began working at the studio at the age of 15 in September 1962, when The Beatles recorded "Love Me Do." While climbing the Abbey Road ladder, he had only occasional sessions working under the group's original engineer, Norman Smith. But at the age of 20, he was asked to become their engineer when Smith moved on to become a producer. The rest is history.

I spoke with Emerick at his home in the Hollywood Hills about some of his Beatles memories.

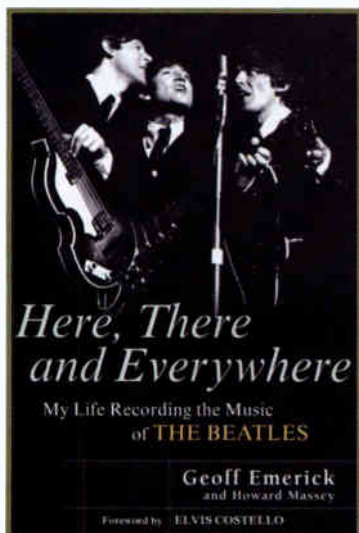

the Life" to the rest of them, just saying, "This is how it goes." And you'd be down in the studio, and you'd think, "My God, that's unbelievable!" I always remember when we went for the real vocal on that song—shivers



PHOTO: MATT HURWITZ

**What was it like to hear a Beatles song for the first time—to have one of them walk in and start playing a new song? How would they introduce a song to the others?**

Oh, it was magic. It was all done in the studio. They may have rehearsed it sometimes, perhaps at Paul [McCartney's] house nearby in St. John's Wood [London]. But normally, they'd come in with the lyric: "I've got this idea for the song, and it goes a bit like this."

I remember John [Lennon] picking up his acoustic and playing "A Day in

ran down our backs as soon as he started singing.

**What were The Beatles' reactions to your taking Norman Smith's place?**

Well, the first session, I was obviously very nervous. I hadn't slept all night because of nerves. I thought [producer Sir] George Martin would have informed them that Norman wasn't going to do it anymore. I've got a recollection of George Harrison asking George Martin, "Well, where's Norman?" And then George Martin saying, "Well, Norman's not doing it anymore." I was thinking, "Oh, my God, George hasn't told them."

I really genuinely felt dreadful. We started doing "Tomorrow Never Knows," and then we got the vocal sound that John wanted through the Leslie speaker. And he fell in love with that, so I sort of passed the first test, I guess.

**Things had always been done pretty much by the book during Norman's time. What changes did you make?**

In Studio 2, the normal arrangement was to have the rhythm section on the carpeted end of the room and the strings and orchestra on the hard floor. I changed it all around and put the rhythm on the hard floor and the orchestra on the dead floor. Now I had a live rhythm section and a dead orchestra sound, and I put on a bit of echo. It all started from there. Looking back on it, it seems so trivial, but, of course, it did change things.

**What else did you begin doing differently from Norman's method, with respect to The Beatles?**

Well, one of the first things I did differently—and this





# ( 40 SERIES: UNMASKED )

From the outside, the side-address condensers in Audio-Technica's acclaimed 40 Series look pretty much identical: One elegant, acoustically ideal case design. That's the way our engineers wanted it—so they could concentrate all resources under the hood, where the distinct character of each microphone is born. This left us with the challenge of differentiating near look-alikes in our ads. Solution: We've opened up the hoods to give you a tour through five unique interior landscapes. Check our web site for a closer look.

## LISTEN AND COMPARE ONLINE

But there's an even better way to appreciate the warmth, power, clarity and sensitivity that make each 40 Series model so individual: Listen for yourself. We've posted audio samples on our web site so you can experience the distinctive sound of each microphone.

Inspired sound. It's what the 40 Series is all about.  
Listen in at [www.audio-technica.com](http://www.audio-technica.com).



### AT4033/CL A Studio Classic

*Back in 1992 when Audio-Technica introduced the AT4033, it was the microphone that began the revolution in price/performance standards for professional side-address condensers.*

### AT4050 Multi-pattern Condenser

*With three switchable polar patterns, the AT4050 exhibits a remarkable combination of qualities: high-SPL capability with transparent and airy uppers/mids complemented by rich low-end qualities.*

### AT4047/SV Vintage F.E.T. Sound

*The rich, warm sound takes you back to the classic F.E.T. studio microphones. But there's nothing remotely old-fashioned about the technology behind that vintage sound.*

### AT4060 Modern Tube Technology

*Audio-Technica's AT4060 cardioid vacuum tube condenser offers exacting detail, superb clarity and superior dynamic range in a classic tube design.*

### AT4040 Technically Advanced Large Diaphragm

*A blend of technical precision and artistic inspiration, the AT4040 offers exceptionally low noise, wide dynamic range and high-SPL capability for greatest versatility.*

(40) SERIES

[www.audio-technica.com](http://www.audio-technica.com)

 **audio-technica**  
always listening™

was on "Tomorrow Never Knows"—was change the way Ringo [Starr's] bass drum was recorded because I always used to feel the bass drum sounded weak. And I'd heard other records where the bass drum really thumps out.

*How did Norman used to mike it?*

Well, the usual fashion for recording drums was you had a stand mic and a hi-hat mic, which were AKG D19s. And I think he used a 4038, which was made by Standard Telephones and Cables [now Coles], for the overhead. Now, there was an AKG D20 on the bass drum. So off came the front skin and I placed it inside, right up close to the other skin—and got into trouble for it because the powers that be said, "The air pressure's going to damage the capsule," which is a fair enough statement. Whether it did or not, I don't know. But I did it, and that day got a special letter from the management saying that on Beatles sessions *only*, I could move the bass drum mic closer than 18 inches.

*How did The Beatles respond to that?*

They liked it because we were starting to get into more tracks where the bass drum's really in your face, and the snare's a lot more focused. And then Paul began to hear better

bass sounds, especially on "Paperback Writer" and "Rain," which we recorded next.

*You did something kind of unusual on "Paperback Writer."*

I was grasping at straws. The theory was to get the power of the bass out; if a loudspeaker could push it out, a loudspeaker could take it in. If you reversed it and placed another bass cabinet speaker face-to-face against the bass speaker, you could use it as a mic. It was as simple as that. I then compressed it, and then compressed it again, EQ'd it and squashed it off, basically.

Of course, the only real way to experience the sound of "Paperback Writer" or "Rain"



PHOTO: GEORGE PETERSEN

A 15 ips, 1-inch, 4-track master tape from The Beatles' Sgt. Pepper's Lonely Hearts Club Band sessions. Recorded at Abbey Road Studios on January 20, 1967, this tape has tracks from "A Day in the Life," with rhythm on track one, vocals on two, bass/drums on track three and orchestra on track four. Recorded on February 2, 1967, the other 4-track tune on this tape is the title track, with rhythm, effects, horns and vocals (with printed echo). The "GE" initials on the box indicate the engineer was Geoff Emerick, with PMc (Phil McDonald) assisting on the first session and "RL" (Richard Lush) on the second date. The tape itself was EMI's house brand.

**PUT YOURSELF IN THE MIX**

Would you like to mix concert sound like Conservatory graduate Eddie Mapp for Evanescence, Staind, POD and Zakk Wylde? What about winning a Grammy for Radiohead's 'Hail to the Thief' like Darrell Thorpe? Thousands of audio recording professionals have graduated from the Conservatory to work in a career that they had only once dreamed about. With your passion and our training you too could be working as a recording engineer, mixing sound for motion pictures and even touring with bands as their Front of House engineer. When it comes to audio... WE ARE THE EXPERTS. LET US HELP YOU GET IN THE MIX.

**CONSERVATORY OF RECORDING ARTS & SCIENCES**  
 2300 E. Broadway Rd. | Tempe, AZ 85282  
 1205 N. Fiesta Blvd. | Gilbert, AZ 85233  
**1-800-562-6383**  
[www.audiorecordingschool.com/mix.html](http://www.audiorecordingschool.com/mix.html)



is to play the 7-inch mono vinyl single. That's how it's supposed to sound, with the bass punching out—it really shoots out the speaker unlike the stereo, which doesn't have that kind of impact.

*What kind of gear was there at Abbey Road at that time?*

We had a desk with eight mic inputs, with very limited equalization, which was treble and bass—no selective frequencies—an echo chamber and a tape machine. That's all we had. And then the Fairchild limiters came in, I think, around the time of *Revolver*.

*So there wasn't a whole lot to work with, other than ingenuity, to come up with new sounds.*

No, and they became more demanding, sonically. They'd be saying, "Well, we don't want that sound. We want this, we want that." And I had *nothing*—what could I do? I just had to conjure up these things in my head and try to experiment.

They'd say, "Geoff, we're gonna do a guitar, we're gonna do a piano. But we don't want it to sound like a piano, we don't want it to sound like a guitar. Can't we make it sound different?" Remember, when I was working with them, we didn't have any great boxes to put on the guitars. So we tried to not use the same techniques from song to song so they all sounded totally different, particularly on *Pepper*.

*Things got pretty complicated starting with Revolver and Sgt. Pepper, particularly with regard to working in 4-track. Could you talk about how you would plan your recording—what you would have to bounce down from four tracks to one?*

Well, we could only plan to a certain extent, because we didn't know what overdubs were yet to come. Most of those tracks were constructed in the studio. At the very least, we got the basic rhythm track down on one track. So drums would have been mono. Then it could be keyboards and a couple of guitars on the next track.

*Did you think in terms of placing different instruments on different tracks, in terms of, "What is it I'm going to want in stereo later when I'm mixing?"*

No, we didn't think in stereo. We were still monitoring mono—just one loudspeaker. It wasn't until *Abbey Road* that we actually decided to listen in stereo.

*What was your relationship with The Beatles like? Were you friends?*

You could never get that close to them. They were a little on the defensive, especially George [Harrison]. You couldn't overstep the line, which is the protocol of working in the studio. You just didn't get too close with the artist. Except for a few oc-

# Don't just hum along! Eliminate hum in the real world



Insist on products with InGenius balanced inputs  
Look for the  logo

# InGenius<sup>®</sup>

## Balanced Line Receiver ICs

THAT Corporation

Analog ICs for Pro Audio™

[www.thatcorp.com/mix2.html](http://www.thatcorp.com/mix2.html) e-mail: [mix2@thatcorp.com](mailto:mix2@thatcorp.com)



## KILL WALL-WARTS!



SMARTRACK™



**PATHX™**  
WE CONNECT

(316) 262-8788

MPATHX.COM



# Everything. Under control.

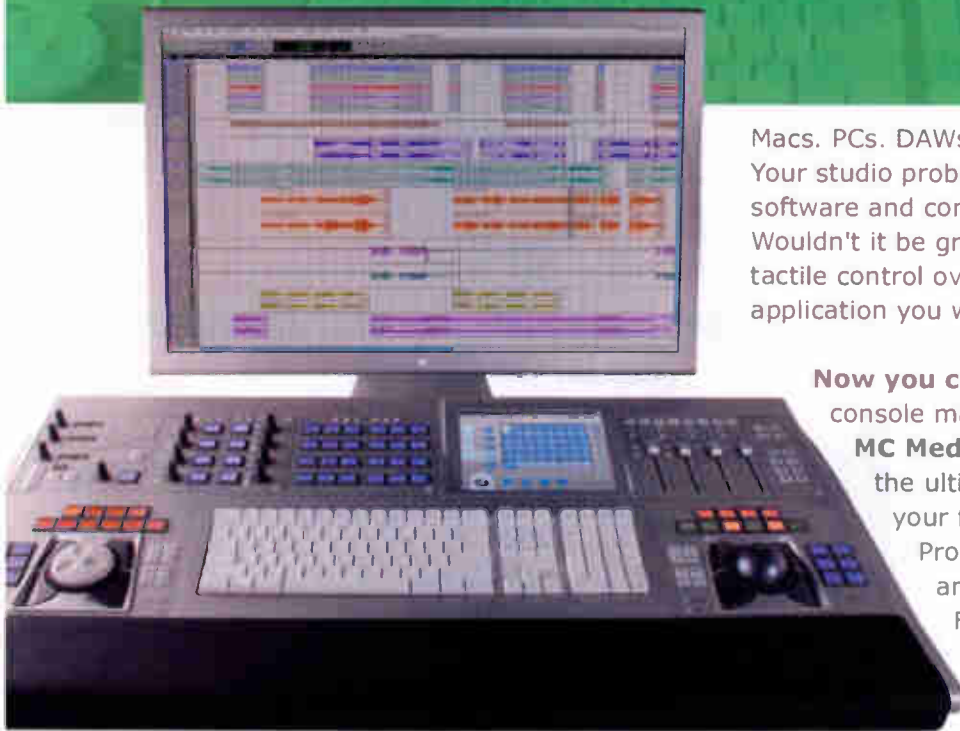

Macs. PCs. DAWs. Soft synths. Samplers. And more. Your studio probably contains a wider variety of software and computer platforms than ever before. Wouldn't it be great to have perfectly integrated tactile control over every computer and software application you work with?

**Now you can.** Euphonix, the world-renowned console manufacturer, has delivered the **MC Media Application Controller**. It's the ultimate worksurface for controlling your favorite software apps, from Pro Tools<sup>®</sup> and Logic<sup>®</sup> to Nuendo<sup>®</sup> and more. Hell, use it with Final Cut Pro<sup>®</sup> or Photoshop<sup>®</sup>, or your web browser if you want. Because if there's one thing we all need, it's a little more control.

*The Euphonix MC includes a full sized keyboard with trackball and jog wheel, plus 56 LCD SmartSwitches, 4 faders, 9 rotary controls, and a monitoring section. Works with ANY software application on Mac or PC.*

 **Euphonix** **MC**

## Get In Control With GC Pro!

In a world where music and audio gear is more and more sophisticated, GC Pro is here to offer personalized expert consulting on putting together the best combination of equipment for your specific requirements. You also take advantage of the excellent pricing you'd expect from the world's largest pro audio dealer.

From mics to monitors... front end processors to dedicated audio computers... vintage instruments to the most cutting-edge software tools... we are your one-stop solution. Contact your local GC Pro Account Manager today!

**Music • Post • Live Sound • Lighting**



**GC Pro has expert Account Managers in nearly every territory of the USA... contact us today!**

 **800-935-MYGC**  
 **www.gcpro.com**

© 2006 Guitar Center, Inc. All rights reserved.  
All images and trademarks are property of their respective holders.

World Radio History

**GC PRO**  
**www.gcpro.com**

casions, they never asked us to have a meal with them on a Saturday or Friday night. They used to have meals sent in. And very rarely would they even ask George Martin to come down and join them. It was like a "them" and "us" sort of situation. But it was something we respected. They were stuck in that studio for such a long time, and they had to have their space.

*In the book, you describe how things began to change during the making of the White Album and how they began to break up.*

It was building up and building up. I don't know whether they were in competition with each other or what it was. It was just bickering and annoying each other and second-guessing everything. It was as though they were trying to outdo each other and fight each other at the same time.

*What were some of the things that led to your quitting working with them?*

A week or so before I left, John said something to me that really infuriated me. I was trying to get a distorted guitar sound on "Revolution," and I was down on the side of the mixing console, trying to overload those mic amps—which we certainly weren't supposed to do—to get that distorted guitar sound. And he looked down at me and said, "Three months in the Army would have done you good." I don't know why he said it, but it made me angry.

Not long after that, we were really working a lot on "Ob-La-Di, Ob-La-Da." Paul was doing another attempt at his vocal. George Martin made some remark to Paul about the vocal, and Paul said, "Well, why don't you come and f\*\*\*ing sing it?" It was horrible.

So I sort of toyed with the idea [of leaving]. I think it was on a Monday. On the Tuesday, I slept on it, and decided to say to George Martin when he came in, "George, I'm leaving." He said, "Can you stay till Friday?" And I said, "No," 'cause I knew I was on the verge of a nervous breakdown. So George and I went to see the manager, Allan Stagg, to tell him the situation, and Stagg said, "Well, can you stay till Friday?" And I said, "No, I'm going to leave now." So we went back to the control room, and I went down the stairs and just said, "I can't take this anymore. I'm leaving." And it was John that actually said, "It's not you, it's *this*—being in the studio." I mean, brick walls and those enameled industrial lights in the ceiling, and all that seaweedy stuff hanging on the walls. They were stuck in there for week after week. And I left.

*You finally left EMI for good in March of 1969. Why was that?*

I couldn't progress any further at Abbey Road.



2006 NOMINEE



**ARCHITECTURAL DESIGN AND ACOUSTIC CONSULTING**

JSA • EUROPE • LATIN • BRAZIL

WWW.WSDG.COM



**KILL NOISE & HEAT!**



SMARTRACK™



**PATHX™**  
WE CONNECT

(316)262-8788

MPATHX.COM





I was so young, and what could I do for the next 40 years except be a recording engineer at Abbey Road? Paul had asked me to manage the construction of their new studio at their offices at Apple on Savile Row. George Martin came to me and said, "We're having trouble getting the studio completed at AIR, and it's going to be awhile before we're finished." And he knew that Paul had asked me about Apple. Paul had said to George, "Well, I want Geoff." And I was desperate to leave Abbey Road; I'd made up my mind. And I just said, "Okay, I'll go with Apple."

*You describe in the book about John Lennon's strong belief in his friend, "Magic Alex" Mardis, who built an entirely unworkable studio for them in the Apple basement, which they realized when they tried to use it to record Let It Be. What did you find when you arrived there?*

The desk [console] was made of particle board. It had eight or 16 faders on it, and eight speakers on the wall, little Telefunken speakers, and an oscilloscope in the middle. They found out before doing *Let It Be* that there was no hole in the wall to pass the cables through from the studio to the control room. They had to run them down the corridor.

Having come from Abbey Road, my stan-

Well, the usual fashion for recording drums was you had a stand mic and a hi-hat mic, which were AKG D19s. There was an AKG D20 on the bass drum. So off came the front skin and I placed it inside, right up close to the other skin—and got into trouble for it because the powers that be said, "The air pressure's going to damage the capsule," which is a fair enough statement.

dards were pretty high. It was simply going to be the best studio in the world, and that's how we went in and built it. There was nothing there to start with that would function to my standards, so they eventually pulled it all out and started from scratch and rebuilt the studio, which took about two years.

*The studio eventually opened in September 1971. What kind of gear did you have in there?*

I had wanted a Neumann mixing console, which Neumann was actually designing. But with Apple's financial situation at the

time, we never ended up with it. We ended up with a 16-track Helios, which became available—a very clean mixing console.

*In the middle of '69, you were asked by Paul to come back and work with them again on Abbey Road, which you then did at the same time as you were building the new studio. What was that like?*

Well, I'd worked there for eight or nine years—and then I was an outside engineer and they treated me like one. [But] I basically just did what we'd always done. And they had Phil McDonald work on it, as well,

## GT PROFILE

### Greg Ladanyi and his GT microphones, ViPRE and Glory Comp

**WHAT HE'S DONE:** Produced and/or engineered some of the biggest records in rock and pop history, by artists including Toto, Jackson Browne, Fleetwood Mac, Don Henley, Jeff Healey and many more.

**WHAT HE'S DOING:** Working with a great band out of Baton Rouge called The Terms.

**WHAT HE USES:** Groove Tubes' ViPRE™ tube mic preamp, Glory Comp™ tube compressor, and all of GT's studio mics.

**WHAT HE SAYS:** "Nothing comes close to capturing my passion for sound than all the GT tools I use. For all the most important vocal and instrument sources, my GT mics, ViPRE mic pre, and Glory Comp tube compressor are what I turn to every day in the studio."

*Greg*



More info on Greg Ladanyi and GT's other Friends & Relations at [www.groovetubes.com](http://www.groovetubes.com)

© 2006 Groove Tubes LLC. All Rights Reserved. GT 1510 / 1115 v1.0



because I couldn't be there to work with them all of the time because of meetings, et cetera, for the studio, and also because I would otherwise be keeping one of their staff from doing their job.

*Was the atmosphere any different at Abbey Road from what you had left six months before?*

To a certain extent, it was better, but it wasn't like before the *White Album*, where if people were doing their overdubs, they'd all hang around. On *Abbey Road*, if one of them was going to do an overdub, the others would leave. There wasn't the camaraderie there was before.

*You mention that by the time of Abbey Road, George Harrison had become quite skilled in the studio and sure of what he wanted on his songs.*

He was more secure. When Paul was overdubbing a bass on "Something," he would say, "That's too busy; I just want it more straightforward." He wouldn't have dared say that on one of the earlier albums. You don't dare tell Paul how to play bass. And "Something" is brilliant.

*Ringo received his first drum recordings in stereo on Abbey Road, as well as his first solo. We always think of a bazillion microphones these days for drum kits. How did you record Ringo's for that album?*

That was one of the luxuries of having the new mixing console we had at that time. I think it was on *Abbey Road* that I started close-miking the toms, top and bottom. Prior to that, I used to have a little mixer that went on top of the mixing console. It had eight inputs and four faders on it, with one output. So for this, I put the tom-toms on there and the hi-hat—four inputs and one output, which came down one other fader, with treble and bass on it. So that was my little premix. I had the bass drum on its own fader, and the snare. So I had three faders for the drums out of my eight.

*Did you have a sense, at the time, that this would be their last album?*

I didn't. Remember, I was building the studio during *Abbey Road*. Up until that time, they kept asking, "When's the studio going to be finished?" Remember, it was going to be their studio, whether they were going to work as individuals or not. That's why, in my mind, I didn't think that would be the last Beatles album. Because if the studio had been finished by the end of the *Abbey Road* album, I'm quite sure plans would have been made to have gone into the new studio to do another album. ■

*Matt Hurwitz is an L.A.-based freelance writer.*



available now



16 channels, 4 band Series 80 EQ \$3500  
meterbridge \$1100 extra (other frame sizes 24 & 32 NOW available)

**SPECIAL DISCOUNTS NOW AVAILABLE !!**

incredible legendary Trident sonics

made in england

by the original Trident designer

**TRIDENT® SERIES 8T**  
CONSOLES

details from: [mix8T@tridentaudio.co.uk](mailto:mix8T@tridentaudio.co.uk)

011 44 147 481 5300

[www.tridentaudio.co.uk](http://www.tridentaudio.co.uk)

**KILLER RACK!**

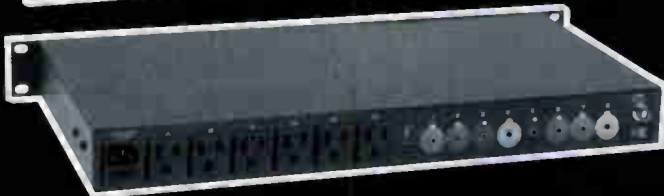

SmartRACK™



**PATHX™**  
WE CONNECT

MPATHX.COM

(316)262-8788



SYLVIA MASSY SHIVY'S

# RadioStar Studios

BY JEFF FORLENZA

Snow is falling on Weed, the tiny logging town at the foot of Mount Shasta in Northern California. Inside a 90-year-old structure formerly known as the Weed Palace Theater, Sylvia Massy Shivy is proudly showing off her rare, vintage and downright weird gear.

Massy Shivy has a long résumé; she has produced, mixed and tracked the likes of Tool, System of a Down, the Red Hot Chili Peppers and Johnny Cash. Today, she is the owner and chief staff producer of RadioStar Studios, located in the Weed Palace on Main Street, in a town with no stoplights. Seven years ago, she was the hot hand on the faders around Southern California studios. After several albums she produced went Platinum, she was in demand by bands wanting that big sound and labels seeking that big paycheck. So why did she decide to leave the bright lights and head north to a quiet mountain town that sounds more like something you smoke than an actual city?

PHOTO: GREG SHIVY



## Hard Rock Renaissance At the Foot of Mount Shasta

"When I left L.A., I had a little house with half a yard in West Hollywood," Massy Shivy explains. "I would sit in traffic all day. I would drive a long way to work in a studio that I was never really happy with. I wound up dragging racks and racks of gear into studios just so I'd have what I needed, because no studio was set up the way I liked it. I was ready to leave."

She bought a four-wheel-drive Jeep in anticipation of a move to the mountains near Lake Tahoe, an area very much like the place where she grew up in Colorado. But fate intervened and she met Greg Shivy on a family outing to Mount Shasta in 1999. The couple married in 2000, and a year after moving to the mountains, they discovered and bought the vacant Weed Palace Theater for a fraction of what a similar property would have cost in L.A. "In fact, my car cost more than this building," she says. So she loaded up her gear and moved up to Weed.

Nearly five years later, RadioStar is a full-fledged hard-rock Mecca, where the perks are clean air, abundant spring water, wide-open spaces and a 14,000-foot snowcapped giant right outside the front door. It's a studio, a record label, a video production company, a merchandising outfit and an equipment manufacturer. It's the successful fruition of Massy Shivy's vision of getting musicians, artists and engineers to leave behind the urban sprawl

to live, play and record together without a lot of distractions in a beautiful, inspiring location.

On a February visit to RadioStar Studios, people are busy moving lighting gear, draping the stage with a white backdrop and preparing for a video shoot. A 20-foot-high sculpture by artist Finley Friar dominates much of the room. It's a manlike figure named "Stan" made from vinyl records and colored vinyl that is lit up from inside. The room has theater seating for 600, Egyptian art deco styling on the walls and ghosts from another era.

"There's fantastic natural acoustics in here," Massy Shivy says of the spacious theater, which is now RadioStar's Studio A. "It has 30-foot ceilings, and the floors are local-milled hardwood. What makes it special is that it was originally designed for vaudeville and there was no amplification then. They designed it so you could whisper onstage and the people in the back of the room could hear it. So you can't talk shit about bands when you're working in here. We removed the back row of seats and put in the Neve. The console is completely open. When we track drums, we wear headphones. We left most of the seats and are retaining the theater because we want to reopen as a live venue."

The console is a classic 8038 Neve featuring Neve 1073 EQ modules. It was





**At the console in RadioStar's Studio A, from left: co-owner Greg Shivy, engineer Kale Holmes, co-owner Sylvia Massy Shivy and engineer Rich Veltrop**

**The outside of RadioStar Studios, as seen from Main Street, Weed, Calif. Once past the front door, visitors will find a studio, record label, video production company, merchandising outfit and an equipment manufacturer.**

built in 1972 specifically for CTS Studios in London, where it lived until Massy Shivy bought it and moved it to L.A.'s Sound City in the mid-'90s. There's a subfloor beneath the theater seating, and tielines run under the floor from the stage to the back of the room where the console resides. Bands set up onstage and play with headphones and individual Furman headphone mix boxes. Engineers back at the console also wear headphones when tracking the performers onstage. Everyone removes headphones when they're doing overdubs and mixing.

"It's really like playing in a live venue, a really good live venue," Massy Shivy says. "There are catacombs under the stage that we have set up as iso rooms for speaker cabinets. We have speaker tielines that go under the floor back into the catacombs where the cabinets are. We just have the amp heads up here near the console. If we want to use combination amp/speaker units, we can put the combos in various places for isolation. We can use the projection booth or the lobby. Actually, we use every inch of this place. We set up drums in the kitchen last week. We did vocals in the bathroom."

RadioStar is an analog/digital hybrid when it comes to tracking. There's a combination of Pro Tools systems and good ol' analog tape recorders: a Studer A820 in Studio A and a Sony JH-24 in Studio B. (More on the B room below.) There are three sets of monitors in Studio A: big Genelec 1038s, custom-made NHTs and the standard Yamaha NS-10s. Studio B has Genelec 1031A and Yamaha NS-10 speakers. In her 20 years of recording, Massy Shivy has acquired hundreds of pieces of outboard gear, ranging from the unusual to the sublime. (Visit [www.mixonline.com](http://www.mixonline.com) to learn about her rare and unique toys.)

### ROOM FOR EVERYONE

Due to overwhelming demand, the Shivys built a second room a couple doors down from the Weed Palace/Studio A in 2003. Studio B is also loaded with vintage recording gear. It features an Amek/TAC Matchless console and a Neve BCM-10 sidecar, which also has the classic 1073 EQs and 1272 amps. The Amek/TAC console is mainly used for monitoring, and the Neve BCM sidecar is used for tracking and mixing. Because so many bands had to be turned away in 2005, there are plans to build an SSL-equipped Studio C in a dancehall farther down Main Street.

Bands travel from all over the globe to work at RadioStar, often booking a studio for two months at a time to work on an album project. Australian band Spiderbait came to RadioStar in 2003 and recorded their *Tonight Alright* album for Interscope Records. That album included their remake of the Leadbelly song "Black Betty," which became a huge hit and climbed to Number One on the Australian charts. While we were visiting, an all-woman band from Norway called Furia were busy working in Studio B. Other acts that have traveled up the mountain to work at RadioStar include Dishwalla and Seven Mary Three, and renowned rock producer Ross Robinson recently brought in hard rockers From First to Last to record their latest for Epitaph Records.

### FROM COLLEGE RADIO TO PLATINUM ALBUMS

Massy Shivy got her start in audio production at a college radio station in Chico, Calif. She then moved to San Francisco where she honed her craft as an assistant engineer at Starlight Studios and various studios around the Bay Area. She credits Matt Wallace as an early mentor in the art of tape alignment, mi-

crophone placement and mixing. When she first moved to L.A., she worked at Tower Records on Sunset Boulevard. That's where she first made connections with bands Green Jelly and Tool. She considers Rick Rubin to be the most influential person in her career as a record producer, even though many of her greatest commercial successes as a producer (like the Platinum-selling albums by Tool) came before her work with Rubin.

These days, Massy Shivy keeps her ears fresh and mainly produces acts. "I used to do everything—produce, track and mix," she explains. "But it's much better to just be the producer and to have someone else set up the sounds. The guys I work with—Rich Veltrop and Kale Holmes—we've worked together for several years now. So they know exactly what I want. So they'll dial it up. I still do a lot of engineering on vocals because I can get really intimate with the singer to get the right performance that I want."

Not only does she have extensive microphones and outboard gear, Massy Shivy often uses "psychological processing" on the artist to elicit the appropriate vocal performance for each song. "Making them comfortable gets one result," she explains. "Making them uncomfortable gets another result. Sometimes being uncomfortable is good to get an edgy performance. Also, the strange thing about being here in Weed is it's isolated. There are only 3,000 people in this town. There's no distractions here. Issues come up in people's lives and they have to deal with it. There's emotion that comes out of that. There's nothing to cover up any raw nerves. So it can be very, very good."

Massy Shivy has a knack for working with unknown bands and then watching those bands blow up to major-label stardom. "I'm looking for originality of sound and style," she says of her criteria for choosing

which acts to produce, "something that gives them a really distinct identity. I prefer to work with those people instead of working with the latest, greatest sound.

"It's funny being a producer because the record companies come to me because they want something that they can market commercially," she continues, "but in reality, my biggest commercial successes have been with artists that don't fit that mold. Like Tool—there's not much commercial about them with their 10-minute songs. System of a Down—there's nothing commercial about them, though they are more commercial now than when I worked with them. It was very surprising for either Tool or System of a Down to get on the radio at all. Because I seek out bands with originality, that's where as a producer I have to decide if I want to mess with a band's sound. I don't



Inside the spacious RadioStar Studio A, formerly the Weed Palace Theater. At right is "Stan," lit up.

want to make them into something they're not. So I think I'm really good at knowing

when to say, "Leave it. Don't touch it." Massy Shivy wants to help bands get to a

PHOTO: GREG SHIVY

## Rare, Vintage and Weird

*We asked Sylvia Massy Shivy to describe some of her most unusual pieces of outboard gear. We only have room here for a select few items; there's much more to check out at [www.mixonline.com](http://www.mixonline.com).*

This is the collection of gear that I've acquired from 20 years of digging around boxes in basements and stuff. I have hundreds of nice pieces of rack gear: compressors, limiters, effects, EQs—really unusual things—that I've used in recording music.

### RCA BA-6A Compressor

During the early '90s, I was determined to find a Fairchild 670 compressor stashed in the basement of some obscure radio station somewhere—that elusive golden discovery we all dream about. I got the *Broadcast Yearbook* and began calling every radio station in the country, asking if they had any "old worn-out analog equipment gathering dust." Unfortunately, I never did find a \$300 doorstep Fairchild. (I wound up paying a pretty penny for my 670 several years later.) But I did find the most incredible load of \$100 compressors, including Gates, UAs, Collins, Altecs, CBS' and RCAs. This RCA BA-6A was the cream of the crop. An excellent choice for vocals and acoustic guitar.

### Pultec EQP-1a EQ

The most-copied EQ design around. Big, simple and right to the point. Excellent on kick drum and bass guitar, and surprising on vocals.

### American DR332 Ribbon Mic

Makes everything sound deep and old. Excellent for effect vocals.

### Acoustic Tuned Tube Guitar Amplifier

The weirdest guitar amp I've ever seen. It uses adjustable wooden panels to deflect the sound. Called the "Tuned Tube" not because it is full of tubes—in fact, it is a solid-state amp—but because it is built around a tubular structure with a speaker on each end pointing outward. The amp does sound unique, and has an excellent deep tremolo and spring reverb. I pulled this down out of the attic at the legendary

Chicago Store in Tucson, Arizona, in 1994. I think it is an early design by the Acoustic company that went on to make those great bass amps in the '70s.

### Roland Vocoder

Originally designed to combine vocals with keyboards for a robotic sound. We like to combine vocals with guitar for an entirely different effect, or drums and guitars, or combine whatever with whatever!

### Hammond C-3 Organ

I can't believe this beautiful, pristine Hammond was sitting in a thrift store in Yreka, California. In absolute perfect condition, it had been pulled out of the local church and put in storage for nine years before the church finally donated it to the thrift store. With its original stool and complete service record starting in 1961, we could not have asked for a finer instrument.

### 1920s National Triolian Steel Resonator Guitar

This thing is so old, and is so wise. It starts talking to you the minute you pick it up. It tells tobacco-filled stories of hot sticky summer evenings on the front porch. Crickets chirping—hell, there's probably crickets living in this thing! The main character instrument from Spiderbait's hit song "Black Betty."

### Trixon "Speedfire" Drum Kit

Made in Germany in the '50s, this drum kit has an array of five bongo-sized toms mounted backward to most traditional kits. And the "melted" kick drum is that way for a reason. The bass drum is actually divided into two acoustically tuned chambers and is played with a double-kick pedal. The world's first double-kick drum! The Trixon company later became today's Sonor drums. It took several years of searching, assembling and restoration for me to come up with these drums. Jim Keltner gushed over this kit after playing it at the Village Recorder on a session, making it worth all the effort.

—Sylvia Massy Shivy

**SURROUNDED!**



H O L O P H O N E ®

2006 TEC AWARD NOMINEE  
FOR OUTSTANDING  
TECHNICAL ACHIEVEMENT

**Grab A Pair.**

*(You'll be glad you did.)*



Holophone Products Make Surround Sound Simple.

**Holophone congratulates all 2006 TEC Awards Nominees.**

Award Winning Products



**H O L O P H O N E ®**

Surround Sound Microphone Systems

[www.holophone.com](http://www.holophone.com) 01.416.362.7790

World Radio History



# Bad Drum Sound? Replace It.



Is your drum sound driving you nuts? Relax - Drumagog will make those old, stale drums sound like a million bucks! It works by automatically replacing what's on your audio drum tracks with samples of new drums. The industry choice for over 5 years, Drumagog is available for both PC and Mac, in VST, RTAS, and Audio Units plug-in formats. See why producers Chuck Ainlay, Brian Tankersley, and Greg Ladanyi use Drumagog in their projects every day.

877-318-WAVE  
www.drumagog.com

WAVEMACHINE LABS

## RadioStar Studios

major label. When hands record at RadioStar, they not only get excellent recordings, but also electronic press kits and merchandising, and they may even be on RadioStar's label, National Recorder, which is distributed nationally by Universal through Fontana. "I recognized the need for a label like this," she explains, "because the majors aren't doing artist development anymore. We're here just to help the band move to a bigger market with a major label. I just saw that not happening for some of these great records that were recorded here at RadioStar. So we're trying to help with basic artist development."

RadioStar also gives opportunities to local kids to get them interested in music and recording, and to get them away from methamphetamine, which is a big problem in the area. "Any kid who wants to come here and sit in on sessions, we'll make an arrangement for them," she explains. "In fact, one kid, his name's Cecil Gregory, is on staff now. He's not even finished with high school yet, and he's the fastest editor [on Pro Tools] out of everybody. He's crazy good. We have another five kids who come here. They have their own day, and they have their duties list. So we give them something to do, and we give them the opportunity to see what's going on."

This fall, Massy Shivy will expand RadioStar's commitment to next-generation engineers by opening the National Academy of Entertainment Technology (NAE-Tech), a trade school offering courses in audio recording, music business, live sound reinforcement and video production. Specialized instruction in rock music production, running an independent label and high-tech music marketing are planned. She's also helping young hands with the development of National Roadshow, a touring company designed to provide custom-designed touring rigs for artists on tight budgets.

With so much talent, enthusiasm and energy, Massy Shivy is much more than a producer who owns a recording studio, and she has big plans for the little town of Weed. "You only live once," she says. "I've been doing a lot of producing, and I'll continue to do music producing. But there are a lot of other things I want to do, as well. Like my record label. Doing video. Merchandising. Then there's the whole line of guitar pedals and rack gear. We have plans for a recording school and the live venue after we renovate the theater. And what else—I'd like to make root beer!"

*Jeff Forlenza is a freelance writer in Oakland, Calif.*

Circle R Media, RadioShack campus  
48,000 s.f. LEED Silver certified production facility

**R  
U  
S  
S  
B  
E  
R  
G  
E  
R  
D  
E  
S  
I  
G  
N  
G  
R  
O  
U  
P**

4006 BELT LINE RD. SUITE 160  
ADDISON, TX 75001  
972.661.5222  
www.rbdg.com

**EATS COMPLEX ALGORITHMS  
FOR BREAKFAST.**



## H8000FW ULTRA-HARMONIZER



**FIREWIRE UPGRADE  
AVAILABLE**

Eventide's signature 5.1 reverbs and effects require sheer processing power for dense reverbs and complex algorithms — the kind that can crush mortal effects processors. If you're ready to push the boundaries of creativity, meet the new super-heavyweight champion: the 8-channel, 24-bit/96kHz Eventide H8000FW Ultra-Harmonizer® effects processor.

Built on a foundation of nearly sixteen hundred preset-algorithms, it encapsulates the last 30 years of digital effects processing. And with over eighty 5.1 presets, this baby's ready to take the future head-on with headroom to spare. If, for example, a complex algorithm gets a little too big for its britches, Monolithic Tandem™ runs it on two DSP chips. With that kind of parallel processing power, your creativity is unrestrained.

Despite all that brain and brawn, the H8000FW is remarkably friendly and easy-to-use, optimized for flexibility and control. Virtual racks have been crafted which give you up to five stereo effects processors combined in one preset-algorithm. Search functionality helps you sort presets for easy retrieval.

The H8000FW combines the advantages of the H8000A with the H8000 and adds seamless FireWire connectivity with your computer.

So, crank up an Eventide H8000FW Ultra-Harmonizer™ and feast your ears on the most amazing effects you've never imagined.

- 8 channels of 24-bit AES/EBU, ADAT and FireWire I/O
- MIDI, BPM and Tap Tempo synchronization
- Up to 96kHz sampling frequency
- PC and OS X graphic editor/development tools included
- 4 channels of pristine analog I/O; s/n > 110dB

**For more information call (201) 641-1200, email [audio@eventide.com](mailto:audio@eventide.com) or visit [www.eventide.com](http://www.eventide.com)**

Eventide and Harmonizer are registered trademarks; Monolithic Tandem, and VISIG are trademarks of Eventide Inc. ©2006 Eventide Inc. All other trademarks are the property of their respective owners.

# Eventide®

World Radio History



# The Dave Smith Room at Sony Music

## Hidden Gem Inside Top New York Facility

[Room 309 at Sony Music Studios, one of the best-kept secrets in Manhattan, will soon be renamed to honor Dave Smith, the man who was instrumental in its design. This article was written before Smith passed away last month. Read more about Smith in "Current," page 16.—Eds.]

It's not easy running a major recording facility these days, even when the rooms are mostly full. The rate pressures brought on by decreased budgets and increased competition from the personal studio market have forced many of the majors to rethink their operations. Like other major recording, mixing and mastering facilities in the country, Sony Music Studios is developing strategies to bring back some of the business that has been lost to smaller, less-expensive studios. "We are now offering clients the opportunity to mix in Room 309—a relatively small room that features a custom console and a pristine signal path—at reduced rates," states Brian McKenna, VP, audio operations and marketing. "We must be creative in offering quality solutions given the state of the industry."

A 36-input, 12-bus Massenburg GML console, with Flying Faders that run on Neve Encore Automation, is the room's centerpiece. Digital tracks can be loaded into a Pro Tools HD or Pyramix workstation. Avoiding gain changes inside Pro Tools is still considered imperative by many engineers, and 36 faders can't accommodate the number of tracks that routinely are brought into a mixing session. The Sony solution? "We have three types of sidecars, which allows us to handle sessions that exceed 36 inputs," says engineering consultant Dave Smith. "One of these matches the electronics in the main desk, minus the automation."

Gear generally found in mastering suites, including Lavry 4496/dB Technologies, Meitner and DCS converters, can be wheeled into 309 at any time. According to mixer Todd Whitelock, "We also have a Sonoma/DSD system. This combined package lets us cover every sampling rate and format currently in use."

"DSD is the most satisfying, to my ear," Whitelock continues. "After a mix has kissed DSD, I can generally find more separation in it. On the other hand, DSD can sound a bit glassy on rock material; it gets a little hard-sounding the harder you hit it. Pumping heavily compressed drums and bass into DSD takes away its depth of imagery. You have to have the greatest tools possible at your disposal and understand the recorded material you're working on."

In the 1980s, B&W monitors became standard issue for classical sessions. Room 309, which is set up for surround mixing, features B&W Nautilus 802 loudspeakers powered by Chord Electronics amplifiers. "We 'imported' the B&W/Chord



Dave Smith (inset) and Sony Music Studios Room 309.

combination from Abbey Road Studios," says Smith. "The speakers accurately reflect the timbre of the electronics

driving them. The Chord has a smooth top and excellent control of low-frequency transients. This combination is particularly well-suited to jazz and classical material, and it works extremely well in a smaller room like 309."

Yeah, but there's barely room for the engineer and a single client to sit in the sweet spot to check a mix, right? "One of the advantages of the B&W Nautilus lies in the fact that these monitors can be tailored to control the size and position of the sweet spot—so much so that they are used successfully both in large spaces and small ones, including little remote recording rooms in live venues. They can literally be tuned into an image that needs to sit like a knife on the tip of your nose or one more like a large cloud that easily covers the width of two people. This year, four major motion pictures [*Star Wars*, *Memoirs of a Geisha*, *War of the Worlds* and *Munich*] used this type of loudspeaker. In all cases, the engineer, composer and director sat inside the sweet spot."

Often overlooked, cabling is an important part of a room's sound. "Cabling choices will certainly affect the sonic characteristics of any critical listening environment," says Smith. "The bulk of the cabling in 309 is Mogami, which we chose because of its excellent performance in the high-frequency area."

There is certainly space in the industry for affordable, high-quality mixing environments such as 309. It's debatable whether the sonic quality offered by rooms like this eliminates the mastering stage or simply reduces the amount of time spent in this part of the process. But pick up a copy of *The Light in the Piazza* or the new Sonny Rollins DVD, and check out the sheer beauty of the sound and the depth of the stereo image Whitelock achieved in Room 309. Very impressive, and Room 309 may possibly become a model that other studios will emulate. ■

Gary Eskow is a Mix contributing editor.



The Mix Foundation for Excellence in Audio presents the

22ND ANNUAL

# Technical Excellence & Creativity Awards

**Saturday, October 7  
Hilton San Francisco**

Sponsored by **Mix Magazine**

Technical Achievement Awards  
Sponsored by



**Ticket Information**

Karen Dunn (925) 939-6149  
Karen@tecawards.org

**Sponsorship Information**

Eric Geer (925) 287-1657  
Eric@mixfoundation.org

This is your chance to vote for the best professional audio products and projects of the past year. Beginning on page 56 are two pages of nominee descriptions. More detailed descriptions can be found at [www.mixfoundation.org](http://www.mixfoundation.org). Please take the time to read this information before voting, and then vote in the categories in which you are most knowledgeable.

**Your ballot must be returned no later than August 31, 2006**

A Benefit for  
Hearing Health and  
Audio Education

STEVE  
MILLER



Les Paul Award

Sponsored by



DAVID  
HEWITT



TEC Hall of Fame

2006

SAN FRANCISCO





**Intel | Official Sponsor Technical Awards |** For over 35 years, Intel Corporation has developed technologies that change the world. Intel supplies the chips, boards, systems and software building blocks for computer and networking solutions worldwide. From 64-bit to multi-core processors, Intel leads the industry in delivering the server and workstation technologies that meet the high-performance demands of the entertainment industry.



**Gibson Guitar Corporation | Official Sponsor Les Paul Award |** Gibson is known worldwide for producing classic models in every major style of fretted instrument, including acoustic and electric guitars, mandolins and banjos. Gibson's digital guitar represents the biggest advance in electric guitar design in over 70 years. Founded in 1894 in Kalamazoo, Mich., and headquartered in Nashville since 1984, Gibson Guitar Corp.'s family of brands now includes Epiphone, Dobro, Kramer, Tobias, Slingerland, Valley Arts, Maestro, Baldwin, Chickering, Hamilton and Wurlitzer. Visit Gibson's Website at [www.gibson.com](http://www.gibson.com).

## Platinum Sponsors

**ALLEN&HEATH**



**American Music & Sound |** Allen & Heath manufactures professional audio mixing consoles for the live sound, installed systems, nightclub and professional DJ markets. Focusrite manufactures professional mic preamplifiers, EQs, compressors and digital audio interfaces for the recording, broadcast, post and live sound markets. Both brands are distributed in the U.S. by American Music & Sound.



**Digidesign |** Digidesign, a division of Avid Technology, Inc., is the world's leading manufacturer of digital audio production systems and the winner of the 2001 Technical Grammy Award® and 2003 Academy Award® of Merit (Oscar statuette) for the design, development and implementation of the Pro Tools digital audio workstation. Digidesign provides the professional music, film, video, multimedia, live sound and radio broadcast industries with tools for digital recording, MIDI sequencing, editing, signal processing, and live and surround mixing. For more information, visit [www.digidesign.com](http://www.digidesign.com).



**Harman Pro Group |** The Harman Pro Group, headquartered in Northridge, Calif., includes AKG, BSS, Crown International, dbx, Digitech, JBL Professional, Lexicon Professional, Soundcraft and Studer, which design, manufacture and market the world's leading professional audio products for recording and broadcast, musicians, cinema, touring sound, commercial sound and contracting applications. The Harman Pro Group is a division of Harman International Industries, a leading manufacturer of high-quality, high-fidelity audio products and electronic systems for consumer, professional and OEM automotive markets.

**MIX**

**Mix Magazine |** As the leading magazine for the professional recording and sound production industry, *Mix* covers the entire spectrum of professional audio and music: studio recording, live sound production, sound for picture and multimedia, digital audio technology, facility design and construction, broadcast production, education and more. Founded in 1977, *Mix* reaches more than 48,000 professionals worldwide. *Mix* also publishes the annual *AES New Products Guide*, the *Mix Master Directory*, the *MixLine* series of e-newsletters and [mixonline.com](http://mixonline.com). *Mix* is the founding sponsor of the TEC Awards.



**Sennheiser |** Established in 1945 in Wedemark, Germany, Sennheiser is the acknowledged world leader in microphone technology, RF wireless and infrared sound transmission, headphone transducer technology and, most recently, in the development of active noise-cancellation. Sennheiser Electronic Corporation is the U.S. wholly-owned subsidiary, with headquarters in Old Lyme, Conn. SEC represents all Sennheiser products in the United States. It distributes a variety of other pro audio lines, including Neumann, Turbosound, HHB, K+H, Rosendahl and Australian Monitor.



**Shure, Inc. |** Founded in 1925, Shure Incorporated is one of the world's leading manufacturers of microphones and audio electronics. Over the years, the company has designed and produced a wide variety of high-quality professional and consumer audio products, providing a vehicle for an individual's personal sound. Shure's diverse product line includes world-class microphones, premier wireless audio systems, consumer earphones and mobile phone headsets, problem-solving mixers, digital signal processors, personal monitor systems, and top-rated phonograph cartridges.



## Gold Sponsors



audio-technica.

**Audio-Technica** | Established in 1962, Audio-Technica is a leading innovator in electroacoustic design, recognized for high-performance microphones, wireless systems, headphones and other audio equipment. A-T products set quality/durability and price/performance standards for live sound tours, broadcast and recording studios, and more. Product lines include the critically acclaimed 40 Series studio microphones and Artist Elite microphones and wireless systems. A global leader in its field, Audio-Technica is committed to providing superior performance and exceptional value for audio professionals worldwide.

broadjam

**Broadjam, Inc.** | Broadjam, Inc. provides Web-based technology, software and services for the music industry and independent musicians around the world. The company operates one of the world's largest Web communities for musicians and hosts a massive online database of searchable independent music. Broadjam.com also offers artist services such as turnkey Website hosting, download sales and desktop promotional tools. The Broadjam Pro Services group designs and builds custom technology for music industry clients such as Warner/Chappell, Academy of Country Music, Peavey, Yamaha and others.



**Dolby** | Dolby Laboratories, known for its more than 40 years of innovation and leadership, continues to lead with the latest solutions for the high definition era. With its newest technologies, Dolby Digital Plus and Dolby TrueHD, Dolby is extending beyond the industry acclaimed Dolby Digital to provide the high quality audio Dolby is known for in today's and tomorrow's high definition world.



**GC Pro** | GC Pro is Guitar Center's outside sales division focusing on the needs of professional users. GC Pro gives you access to expert personal consultation and extraordinary service from account managers in your area, as well as the benefit of pricing from the world's largest dealer of musical instrument and pro audio equipment!



**Meyer Sound Labs** | Meyer Sound Laboratories manufactures premium professional loudspeakers for sound reinforcement and fixed installation; digital audio systems for live sound, theatrical and other entertainment applications; acoustic enhancement and electroacoustic measurement systems; and acoustical prediction software. An innovator for over 27 years, Meyer Sound creates wholly integrated systems designed for optimal performance and ease of use.



**The Producers & Engineers Wing** | Comprising almost 6,000 professionals, the Producers & Engineers Wing of The Recording Academy is an organized voice for the creative and technical recording community. The Wing addresses issues affecting the craft of recorded music, including new technologies, music education, and archiving and preservation, and it presents professional development events around the country throughout the year. [www.producersandengineers.com](http://www.producersandengineers.com).



**RØDE Microphones** | RØDE has built an enviable reputation as a pioneer in the development of the microphone for the modern era. RØDE set out to deliver professional studio quality microphones that were more accessible to the recording communities. Today they are acknowledged for their engineered performance, versatility and superior design. From its \$10 million, state-of-the-art facility in Sydney, RØDE continues to design and manufacture an ever-expanding range of precision microphones, changing the way musicians and engineers record their art.

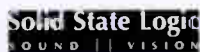

**Solid State Logic** | Solid State Logic has grown over 30 years to become one of professional audio's most successful high-technology enterprises. A constant innovator, the company is building on its solid mixing console foundations with new technology to improve DAW audio quality and workflow, while new digital media server technology provides broadcast video production workflow from capture to transmission. SSL supports its leading-edge technology with an international network of offices, establishing an industry benchmark for customer service.



**TASCAM** | TASCAM is the professional audio division of TEAC Corporation and produces the most comprehensive line of audio recorders, mixers and related equipment in the pro audio industry. TASCAM is a pioneer in home recording and post-production, and is relied on by customers around the world.



**TC Group** | TC Group consists of Tannoy, Lab.gruppen, TC Electronic, TC-Helicon and TC Applied Technologies. The Group formed in 2002 to design, produce and distribute the best engineered and most recognized and respected brands of high-performance audio products in the world. Differentiated from the competition by strong brands and a high-end profile, TC Group combines expertise with market access to capitalize on the convergence of digital and acoustic technologies in the audio industry.



UNIVERSAL AUDIO

**Universal Audio** | Founded in 1999 and based in Santa Cruz, Calif., Universal Audio ([www.uaudio.com](http://www.uaudio.com)) is best known for its vintage analog reproductions and advanced Digital Signal Processing technology. The company is devoted to merging the best of analog and digital technology, embodying its motto, Analog Ears, Digital Minds.

## Silver Sponsors

Adamson Systems  
Engineering

Cakewalk

Clair Brothers/  
Showco

Fairlight

Holophone

Loud Technologies

Oram-Trident

Sony

Yamaha

## Bronze Sponsors

Conservatory of  
Recording Arts &  
Sciences

DPA Microphones

Eventide

Skywalker Sound

Telefunken USA



## 2006 TEC NOMINEES | go to [www.mixfoundation.org](http://www.mixfoundation.org) for product descriptions

The official eligibility year is April 1, 2005-March 31, 2006. Extended descriptions of each product can be found at [www.mixfoundation.org](http://www.mixfoundation.org). Please note that the Creative Awards are nominated by project. In each category, the engineers, mixers, producers and production facilities will receive TEC Awards recognition. For the Studio Design Project category, please check our Web page at [www.mixfoundation.org](http://www.mixfoundation.org) for project photos and descriptions. Take time to read through each category before voting. Please cast only one vote in each category.

### OUTSTANDING CREATIVE ACHIEVEMENT

#### A. Studio Design Project

**Firehouse 12 Recording Studio**  
New Haven, CT

**Remote Recording Digital Studio**  
The White Truck, NYC

**Right Track/Sound on Sound Studio D1**  
NYC

**Studio at the Palms** Las Vegas, NV

**Timbaland Studios** Virginia Beach, VA

#### B. Television Sound Production

**American Idol** Fox

**Deadwood** HBO

**Lost** ABC

**The West Wing** NBC

**24** Fox

#### C. Film Sound Production

**King Kong**

**Star Wars: Episode III - Revenge of the Sith**

**The Chronicles of Narnia: The Lion, the Witch and the Wardrobe**

**Walk the Line**

**War of the Worlds**

#### D. Remote Production/Recording or Broadcast

**Cream, Royal Albert Hall**

**Eagles Farewell Tour—Live From Melbourne**

**48th Annual Grammy Awards**

**Ozomatli Live at The Fillmore**

**Neil Young: Heart of Gold**

#### E. Tour Sound Production

**Alison Krauss + Union Station, featuring Jerry Douglas, SE Systems**

**Dave Matthews Band, Ultra Sound/Pro Media**

**Rolling Stones Band, Clair Brothers/Showco**

**James Taylor, Clair Brothers/Showco**

**White Stripes, Thunder Audio**

#### F. Surround Sound Production

**Brothers in Arms—20th Anniversary Edition**, Dire Straits, Warner Bros. Records, Inc., Warner Music Group

**In Your Honor**, Foo Fighters, Sony BMG Music Entertainment

**Brick**, Talking Heads, Rhino/WEA

**Mussorgsky/Stokowski: Pictures at an Exhibition—Boris Godunov—Night On Bare Mountain**, José Serebrier & Bournemouth Symphony Orchestra, Naxos Music

**With Teeth**, Nine Inch Nails, i nothing, Interscope Records

#### G. Record Production/Single or Track

**"Feel Good, Inc.," Demon Days**, Gorillaz w/ De La Soul, Virgin Records

**"Gold Digger," Late Registration**, Kanye West, Reprise Records

**"La Tortura," Fijacion Oral, Vol. 1**, Shakira, Epic Records

**"Mas Que Nada," Timeless**, Sergio Mendes, Concord Music Group

**"We Belong Together," The Emancipation of Mimi**, Mariah Carey, Island Records

#### H. Record Production/Album

**Morph The Cat**, Donald Fagen, Reprise Records

**Late Registration**, Kanye West, Roc-A-Fella

**Back Home**, Eric Clapton, Reprise Records

**Good Night and Good Luck soundtrack**, Dianne Reeves, Concord Records

**Timeless**, Sergio Mendes, Concord Music Group

### OUTSTANDING TECHNICAL ACHIEVEMENT

#### A. Ancillary Equipment

**Ampeg SVT-DI**: Tube direct box for studio or stage

**Crown Xti Amplifier**: Live sound amp with onboard DSP

**Dangerous Music ST/SR**: Studio controller for stereo and surround

**Frontier Design Group Tranzport**: Wireless DAW controller

**Shure E4 Earphones**: Sound-isolating, full range earphones

**Whirlwind E-Snake 2 (ES2)**: Next generation E-Snake digital snake

#### B. Digital Converter Technology

**Benchmark Media ADC1**: Two-channel 24-bit/192kHz A/D converter

**Digidesign Mbox2**: USB audio/MIDI production system

**Focusrite Saffire**: FireWire 24-bit/192kHz interface with DSP

**Lavry DA-10**: Stereo digital-to-analog converter

**MOTU UltraLite**: Portable 10-in/14-out FireWire interface

**RME AES-32**: PCI card with 16 24-bit/192kHz AES I/Os

#### C. Mic Preamplifier Technology

**A-Designs Audio Pacifica**: Preamp based on classic Quad-8 designs

**Grace m802**: Remote-controlled 8-channel preamp

**Mackie Onyx 400F**: 10-channel FireWire recording preamp

**Neve 1073 DPD**: Classic 1073 preamp with onboard ADCs

**PreSonus ADL 600**: Tube preamp designed by Anthony DeMaria

**SSL XLogic E Signature**: E-Series console preamps in a rack chassis

#### D. Microphone Technology/Sound Reinforcement

**AKG HSD Series Headset**: Studio-quality headphones/dynamic mic

**Audio-Technica Unipoint Series**: High-performance miniature condensers

**Beyerdynamic Opus 89**: Handheld neodymium dynamic vocal mic

**Groove Tubes GT Convertible**: Converts from handheld to probe-style

**Heil Sound PR20**: Handheld neodymium dynamic mic

**Sennheiser HSP Headworn Mic**: Cardioid/omni headset condenser vocal mic



## E. Microphone Technology/Studio

**AEA R92:** Large Ribbon Geometry design mic  
**DPA 4090/4091:** Small-diaphragm omni condensers

**Holophone H2-PRO:** Eight-capsule surround microphone

**Neumann TLM 49:** Large-diaphragm cardioid mic

**Schoeps CMT 5U:** Lightweight, compact shotgun mic

**Soundelux E251C:** ELUX 251 in cardioid-only version

## F. Wireless Technology

**AKG WMS40 Pro Flexx:** Wide response (35-20k Hz) UHF systems

**Audio-Technica 3000 Series w/Scanning:** UHF system with auto frequency scanning

**Lectrosonics UCR401:** Compact UHF receiver for film/ENG/video

**Sennheiser SKM5200:** Interchangeable capsule handheld wireless

**Shure UHF-R:** UHF system with Track Tuning technology

**Zaxcom TRX900:** Compact digital wireless transceiver

## G. Sound Reinforcement Loudspeaker Technology

**Adamson T-21 Subwoofer:** Sub with dual 3,000-watt drivers

**EAW NT Series Powered:** Systems with Gunness Focusing DSP

**JBL Professional VRX932LA:** Compact 12-inch, two-way line array

**Meyer Sound MICA:** Compact high-power curvilinear array

**Renkus-Heinz ICONYX:** Digitally steerable system

**Turbosound Aspect:** Scalable two-box/four-way system

## H. Studio Monitor Technology

**ADAM Audio Artist:** Compact two-way folded ribbon monitor

**ATC SCM 110ASL Pro:** Triamped "Compact Far Field" monitors

**JBL LSR4300 Series:** RMC Room Mode Correction monitors

**Miller & Kreisel Professional MPS-1611P:** Bi-amped, two-way monitors

**Tannoy Precision D Series:** Dual Concentric monitors with active DSP

**Yamaha HS Series:** Reference monitors in the NS-10 tradition

## I. Musical Instrument Technology

**Cakewalk Dimension Pro:** Cross-platform (Mac/PC) software synth

**Dave Smith Instruments Poly Evolver Keyboard:** Analog/digital hybrid polyphonic synth

**Korg OASYS:** Synth workstation, DSP and 16-track recording

**MOTU Symphonic Instrument:** Universal orchestra instrument for Mac and PC

**TC Electronic G-System:** TC's flagship guitar processor

**Vienna Symphonic Library Symphonic Cube:** Virtual instrument with 800,000+ samples

## J. Signal Processing Technology/Hardware

**dbx DriveRack 4800:** Full 96kHz processing for live sound systems

**DW Fearn VT-7:** Stereo all-vacuum tube compressor

**Eventide H8000FW Multi-Channel Effects System:** Stereo/5.1 effects with analog/digital/FireWire I/O

**Rupert Neve Portico 5042 Tape Emulator:** Tape-emulation for nostalgic rounding/compression

**SSL XLogic X-Rack:** Up to eight XL 9000 dynamics with memory stores

**TC-Helicon Voicepro:** Vocal pitch, time and character manipulation

## K. Signal Processing Technology/Software

**Antares AVOX Vocal Toolkit:** Suite of five vocal processing modules

**Digidesign Dynamics III:** Compressor/limiter/expander/gate/de-esser suite

**Eventide Anthology II:** EQs, filters, dynamics, pitch shift and more

**SSL LMC-1 Listen Mic Compressor Plug-in:** The classic E Series console compressor

**Universal Audio Precision Multiband for UAD-1:** Five bands of spectral dynamic range control

**Waves SSL 4000 Collection:** Re-creations of classic SSL console EQs

## L. Workstation Technology

**Ableton Live 5.2:** Complete music solution for Mac and Windows

**Apple Logic Pro 7.2:** Music creation/audio production application for Mac

**Cakewalk SONAR 5 Producer Edition:** Record/editing with 64-bit floating-point mix engine

**Digidesign Pro Tools 7:** DAW software with enhanced feature set

**Steinberg Nuendo 3.2:** Pro recording/editing/automated mixing tool

**TC Electronic PowerCore PCI mkII:** Four 150MHz DSPs with 14 plug-ins

## M. Sound Reinforcement Console Technology

**Allen & Heath GL2800:** Dual-function 8-bus/10 aux/12x4 matrix/4-mute groups

**APB-Dynasonics Spectra Series:** VCA-based consoles in 24 to 56 mono frames

**DiGiCo Mini DiGiRack:** Expands the functionality of DiGiCo's D1 and D5 consoles

**Mackie Onyx 80 Series:** 24- to 48-input consoles with Onyx preamps and 4-band EQ

**Soundcraft MH2:** Dual-mode 8-group/10-aux/8-VCA/6-mute groups

**Yamaha M7CL:** 32/48-channel digital mixer with touch-panel control

## N. Small Format Console Technology

**Allen & Heath Xone 3D:** DJ controller with analog mixer/MIDI control/USB

**API DSM Series:** Create your custom compact API console

**Digidesign D-Command:** ICON Pro Tools functionality in a compact package

**Neve 8816 Summing Mixer:** Analog summing with optional 192kHz/DSD ADC

**SPL DMC:** Stereo analog mastering control with 150dB dynamic range

**Trident Series 8T:** Analog 16- to 32-channel board with clone of 80B EQs

## O. Large Format Console Technology

**Euphonix System 5-MC:** High-speed editorial controller/mixer

**Fairlight Anthem:** 192 channels/72 buses with full processing

**Harrison Trion:** Digital console with analog-style control surface

**Neve 88D:** Digital console with DAW control

**SSL C300:** Digital console with DAW control for post

**Trident Dream 32:** Analog Trident sound for mixing digital

Find product descriptions  
and project credits at  
[www.mixfoundation.org](http://www.mixfoundation.org)



# Trailer Mixing and Music

## Selling the Film Through Commerce and Art

By Blair Jackson

At its best, a movie trailer gets the heart racing, the mind reeling and prompts a little voice in your head that says, "I've gotta see this film!" Creating a trailer is an art form in itself, but it also has critical fiscal implications: After all, trailers are basically commercials for films, designed to create a buzz and put fannies in the seats, as they say—especially on that critical first weekend of a film's release, which can make or break a feature. Is it any wonder, then, that making a



Trailer mixer David Brolin, at left, works out of Universal Studios Sound Theater 1, the "trailer" stage, on a Digidesign ICON.

Universal Studios Sound. Brolin estimates he probably mixes 40 to 50 trailers a year, but then there are also "consumer trailers," which are tacked

### BRINGING IN DIALOG, FX

Digital technology has had an enormous impact on the world of trailers, and at this point, Pro Tools has become ubiquitous throughout the creative chain. In his studio at Universal, Brolin mixes on a Digidesign Icon D-Control (after several years of working on a ProControl), handling dialog, music and effects tracks delivered to him as Pro Tools sessions. The number of tracks varies from trailer to trailer, he says. "With music, the most simple would be two tracks, but in trailers, everything is layered so you might have a stereo music track, and you might have a drone underneath that, and you might have a cymbal roll or whatever. It could go out to be five or six tracks wide, which doesn't seem huge in the music world, I suppose. Typically, we have one to two narration tracks, dialog would range to about five, and then effects tracks depend—it can be very simple or it can be something that's 20 or 30 tracks wide.

"Working on the ProControl and the Icon has been perfect for our needs," he continues. "Everything is internal and almost everybody cuts on Pro Tools, so it comes in that way and then making changes to the mix is easy. We'll mix a

trailer involves a delicate dance between creative craftspeople and the forces of business/marketing?

There are a number of different categories of trailers, from "teasers" that might come out a year or more in advance of the film and contain little or no footage from the actual film (but get you salivating for that new Pixar flick or that action sequel you've been anticipating); to "product reels" designed to excite exhibitors; conventional three- to four-minute trailers, each one perhaps highlighting different aspects of a film—It's an action film! A buddy picture! A romance!; and 30- and 60-second commercials for different TV market/audiences.

"Basically, I'm mixing all day, every day," says David Brolin, who has made a career of mixing trailers, first for trailer houses or "boutiques"—businesses that specialize in making film trailers from top to bottom—and for the past six years, for

onto the front of DVDs, TV spots, foreign-language trailers and more. He's a busy guy.

Because trailers are almost always created long before films have finished post-production (and in some cases, before shooting is even completed), the teams that put them together rarely have sound or music elements from the film to work from, save for some temp dialog tracks (and, if they're lucky and the film is a sequel, some recognizable bit of score to use). But usually it's almost a blank slate, so that means that sound editors are raiding commercial effects libraries (such as Universal's own extensive library) to find the requisite explosions and squealing tires and all manner of whooshes and crashes, and the music supervisor is either licensing existing songs, commissioning original music or using library music of some sort to flesh out the trailer soundtrack.

HEAR YOUR VISION.



UNIVERSAL  
OPERATIONS GROUP

DEDICATED TRAILER & COMMERCIAL MIXING STUDIOS

**UNIVERSAL SOUND**

818.777.0169 • 800.892.1979 **THE FILMMAKERS DESTINATION** [WWW.UNIVERSALSTUDIOS.COM/STUDIO](http://WWW.UNIVERSALSTUDIOS.COM/STUDIO)



# THINK WITH YOUR EARS!



**ADK MODEL TL**  
X-FO-LESS 4-POLAR / 3-MICRON

*"TL is beautiful on Nylon String Guitars!"*

Ted Periman - Grammy® Winner / ADK Fan  
Beach Boys, Dylan, Burt Bacharach, Peggy Blu

*"TL Decca-Tree & Ray Charles Steinway!!"*

Terry Howard - Multi-Grammy® Winner - "Genius"

*"Spyro Gyra Toured for years with TL and SL's."*

Joel Rosenblatt - World-Class Drummer / ADK Beta

Grammy is the registered trade-mark of the Grammy Foundation

# ADK

"THINK WITH YOUR EARS!" SM

1-503-296-9400 • www.ADKMIC.com

sound for picture



Music supervisor/producer Nathan Duvall and composer Daniel Nielsen, right, the duo behind the trailer library music *Siren Cues*.

trailer and that will be 'trailer 1.' I'll give 'trailer 1' to my editor, Brendan Cravitz, and he'll cut and conform to the next trailer, add the differences and come back to me, and it retains its mix without ever having to deal with stems."

Unlike a feature film, where the director is making ultimate decisions about the final mix, here there might be the trailer producer and a top honcho in marketing calling the shots and asking for changes.

Brolin says a typical trailer mix is about two days. "We'll get the elements first thing in the morning, do a mix, get the first round of approvals and then we'll shoot tracks that night. The second day we'll listen to the DTS tracks along with the film print and we'll make final changes. It's so easy to make the changes right there now; it's made everything much faster."

Mixing spots for TV has its own requirements, he says, "because there's so little dynamic range. You mix your narration as loud as you mix your dialog and as loud as your music. Everything is just in your face. If you try to mix something dynamically, unfortunately the dialog is going to sound too low. At least with trailers, it's dynamic and you have more time to work with."

Busy as he is today, Brolin thinks there will actually be *more* trailer work in the future, as marketing becomes ever more sophisticated and niche-conscious, "and when digital cinema really arrives. Then they won't have to make all these film prints and send them out to theaters. They'll just send out a digital file, so I think you'll see trailers mixed in more versions."

## MUSIC CREATIVITY

"A trailer score will in some ways mimic the score of a film," says Daniel Nielsen, who has written music for many a trailer

and TV promo. "There's a beginning, a middle and an end. Trailers are created visually and musically the same way as features, although we might have only three minutes to tell the story rather than two hours. Obviously, we have to get to the selling point of the trailer more quickly—we don't have as much time to build the intensity. But it can still be a complicated process. A trailer score can be quite intricate and there might be five, six, seven cues trying to get you from the beginning to the end."

Music for trailers takes many forms, from a licensed pop song that may or may not be part of the soundtrack for the eventual film (remember when it seemed like "Who Let the Dogs Out?" was part of every comedy trailer for a while?), to dramatic original cues created by composers like Nielsen and others, to library music. Indeed, there are now music libraries devoted to trailer music: Nielsen and trailer music supervisor/producer Nathan Duvall joined forces with library giant Associated Production Music (APM) to put out *Siren Cues*, and last March, APM released what has proven to be a hugely popular entry in the genre—*Epic Score*, by L.A.-based composer/mixer Gabriel Shadid and Swedish promo music composer Tobias Marberger. Already, some of their *Epic Score* tracks have found their way into trailers for *Pirates of the Caribbean 2*, *X-Men 3*, *Lady in the Water*; promos for a wide range of CBS shows, including *CSI: Miami*, *The Unit* and *Without a Trace*; and several videogames.

Though trailer music composers will occasionally be asked to imitate the music of established film composers, they also get the opportunity to stretch themselves creatively, packing a big wallop in a short amount of time. Shadid and Marberger pride themselves on creating highly original dramatic music; for *Epic Score*, Shadid sampled a choir in L.A., "and most of my orchestras are from custom sampling sessions I did in Prague," he says. "I've also recorded percussionists in L.A., and Tobias is great at both percussion and percussion programming. We combined a lot of these custom elements for our first release." Not surprisingly, they're already working on a follow-up to their successful library, and

# Post pro's, no cons.

Part One – John Ross

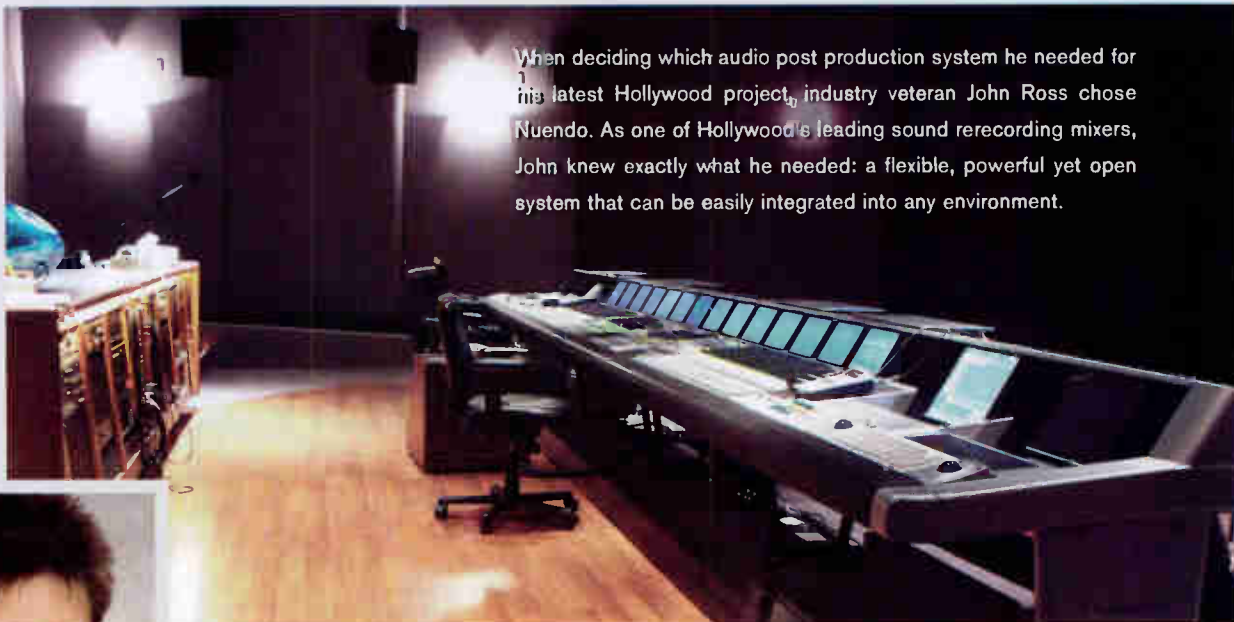

When deciding which audio post production system he needed for his latest Hollywood project, industry veteran John Ross chose Nuendo. As one of Hollywood's leading sound rerecording mixers, John knew exactly what he needed: a flexible, powerful yet open system that can be easily integrated into any environment.



“What excites me about this product is you've now come out of that little world of DSP cards that were setting the pace of development. This system is both powerful and flexible enough to accommodate anything that would come our way.”

Not only did editing with Nuendo turn out to be a joy, John was also impressed by the next-generation Nuendo networking features.

“The editing in general is far superior in Nuendo. And the networking for editing is another layer that hasn't been achieved by any other system I've seen.” John also treasured his Nuendo system's ability to blend in to almost any existing post facility with its huge range of supported interchange formats.

With major Hollywood movie credits under his belt such as *Austin Powers: The Spy Who Shagged Me*, *Blade II*, *American History X* and *Lost Highway*, John was wrapped with his system's performance throughout his work on *De-Lovely: The Life Of Cole Porter*. So much so that he used Nuendo as the sole DAW on this major motion picture, which he mixed at leading post facility Todd AO West, California. In fact, John has adopted Nuendo as his number one preferred system for all his future post projects.

Post pro solutions for post pro people.

And that's no con...



**NUENDO 3**  
THE FUTURE OF AUDIO POST

[www.steinberg.net](http://www.steinberg.net)

 **steinberg**  
Creativity First



You asked for an  
**AFFORDABLE  
 HD SOLUTION**  
 We delivered  
**HD DREAM  
 FACTORY**



**A COMPLETE HD  
 STUDIO PACKAGE\***

- 2 Bay Constellation-XT Console
- Fully Configured Pyxis HD
- 2 Hours HD Video Storage
- 80 Third Party Plug-Ins Library
- Comprehensive Monitoring
- Unique Bus Reduction System
- Tri-Level Sync
- Bus to Bus Mixing

\*OPERATOR NOT INCLUDED

**DELIVERING TRUE HD  
 CAPABILITIES  
 NO COMPROMISE**



**POWERING  
 YOUR CREATIVITY  
 IN THE HD WORLD**

**FAIRLIGHT**  
[www.fairlightau.com](http://www.fairlightau.com)  
 Email: [sales@fairlightau.com](mailto:sales@fairlightau.com)

sound for picture



Gabriel Shadid, half of the team (with Tobias Marberger) behind Epic Score, a library of original material for promos and trailers.

they have also enlisted other composers in the field to widen their palette. "We both love trailer music," Shadid says. "It's the height of drama, the height of tension, the height of conflict. It's promo to the max. I like that there's a lot on the line, so [studios] are willing to put a lot into the trailers and go to the ends of the Earth to promote their films."

According to *Siren Cues'* Nathan Duvall, film directors rarely have input into the music that is used in a trailer, "so generally speaking, it's the trailer houses and the [studio] marketing department who set the tone and the pace with the music and the images. Occasionally, you have a seriously powerful director who either has a franchise, like *The Lord of the Rings* or *Spy Kids*, and he has an idea of what the themes should be, and then possibly you have some kind of collaboration or you just re-introduce the themes from an earlier installment." Although in the case of the second *The Lord of the Rings* campaign, Nielsen actually borrowed the string quartet theme from another film—the indie *Requiem for a Dream*—and had it re-orchestrated to sound much bigger.

"Our production level for a trailer has to visually match the impact of the film,"

Nielsen notes. "The music has to be consistent with what you're looking at."

"But I can't tell you the number of times we've heard, 'Can it be bigger?'" Duvall adds with a laugh.

Nielsen and Duvall have no illusions about the function of their work. This is, after all, still advertising, "and there are many levels of approval in trailer music," Duvall says. "Generally, Dan, the composer, is answering to the music department, editor, and producers and partners of the trailer house. Then it is approved by the VP of marketing and then they test the trailer, and if it doesn't test well, you might be back to the beginning or maybe you just make a few adjustments."

But the actual work has an infinite amount of variety, which is what keeps it interesting.

"You might have five genres of music in one trailer," Nielsen says. "One day I might be working on a full-on techno cue, like Crystal Method or Massive Attack, and the next it might be working with a giant orchestra. It's been an interesting education trying to get a handle on all the different styles. To me, it doesn't matter: I'm still creating music, which is what I

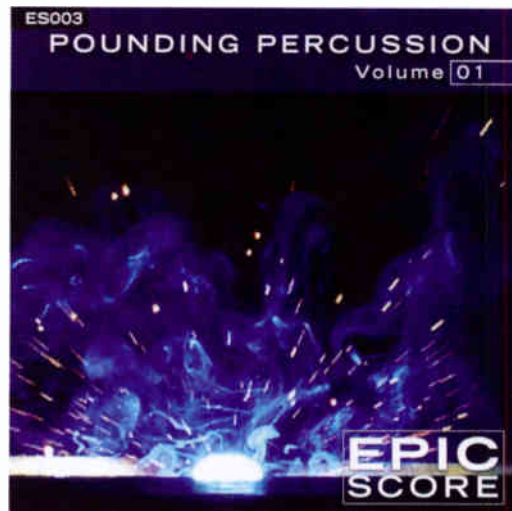

love to do. And it's music that's servicing an industry.

"This is always a team effort. As a composer, the way I would define my success is to deliver what everybody wants. I'm the happiest when I see it working in everybody's vision." ■

# Stellar Sound · Boutique Build · Project Price

◀ Classic Putnam 610 & flagship Precision 110 Mic Pre & DI    ▶ Gain, Level & Impedance selection for maximum tonal variety    ▶ Portable, "Go-Anywhere" design. Hand-built in the USA.

Expires August 31st  
For each  
SOLO/110 or SOLO/610  
registered, get a  
**\$100 UA voucher**  
for any UAD plug-ins at  
[my.uaudio.com](http://my.uaudio.com)  
Automatically retro-active to all existing registered SOLO customers.



**Introducing the brand new SOLO/610™ and SOLO/110™ mic-pre & DI boxes from Universal Audio.** All the UA heritage, tone and hand-built US-made quality you ever dreamed of in a single-channel format, at a price every Project Studio can afford. Now its no longer a choice between the sound you covet and the gear you can realistically afford. UA designed the SOLO series to be portable, functionally lean yet sonically mean, with the familiar solid build and audiophile components that define UA quality.

From desktop studio to stage, the SOLO/610 and SOLO/110 are the go-anywhere essential preamp & instrument DI. Choose either the all-tube SOLO/610 for that silky vintage warmth or the SOLO/110 (from the mighty 8110) for lightning-fast transients, and sheer tonal versatility—ultra-clean to crunchy Class A. The SOLO series preamps will flatter the humblest to the most esoteric microphones with their own signature sound. The best news of all is that UA's innovative engineering and meticulous manufacturing mean you don't have to make a choice: you can afford both!



UNIVERSAL AUDIO

analog ears | digital minds

[www.uaudio.com](http://www.uaudio.com)

toll-free: 1-866-UAD-1176

330 Encinal St. • Santa Cruz, CA • 95060-2101 • USA voice: 831-466-3737 • fax: 831-466-3775 • ©2006 Universal Audio, Inc. All rights reserved. Universal Audio, the Universal Audio logo, SOLO/610, SOLO/110 and "Analog Ears Digital Minds" are trademarks or registered trademarks of Universal Audio, Inc. All features and specifications subject to change without notice.

World Radio History



## Martina McBride



### Photos and Text by Steve Jennings

*Mix* caught up with Martina McBride when she passed through the Oakland Arena (Oakland, Calif.), in late June. Mixing Martina at front of house is her husband and longtime engineer John McBride. Clair Bros. is supplying an i4 P.A., which the engineer describes as "the finest line array system available anywhere. I use no subs whatsoever. We hang 14 deep i4s left and right and Clair T2s for side coverage in the arenas."

McBride is mixing on an ATI Paragon board, using all four stereo outputs (left/right front, left/right sides, recording, video feed). According to the engineer, "The mono outputs are used for front-fills, press feeds if necessary and sub outputs if we are on a festival and need a separate sub output, and one for CD playback to stage for an intro CD we use. We have loaded the mainframe with 40 mono modules and eight stereo modules, giving us 56 inputs from stage. Since we don't use

a bunch of pre-recorded music in our show, the 56 inputs work well. There are also eight stereo returns for CD players, 'verbs, et cetera. I have to have an SPL Transient Designer, and the EMI EQs are the greatest. They are almost impossible to find, unfortunately. I couldn't get by without a Lexicon 200; I need the noise and that sound.

"Martina's vocal mic is the latest Shure UHF-R with a regular 58 capsule," McBride says. "We have been very happy with this system. Martina's crew is one of the best anywhere. We come in, do what we do, pack it up and go again the next day. The bar is set high by Martina, who delivers night after night, so we better do the same."



Front-of-house engineer John McBride

## FixIt

*A veteran of many Paul Simon tours, David Morgan (Steely Dan, James Taylor, Bette Midler and countless others) is currently mixing FOH for Simon's new Surprise tour.*



PHOTO: STEVE JENNINGS

Learning to mix from a bad mix location, such as way off-center or under a balcony, is difficult. Here, you need strong faith in your decisions. Hopefully, you had time to listen to the P.A. from a good spot before the show. After adjusting the P.A. to your taste, trust your previous decisions while listening to less-than-perfect audio. This is a good case for carrying SIA Smaart or some other system that will verify the correlation between your mix out of the desk and a test mic placed in a "good" listening position. I also carry a pair of trusted near-field monitors (Tannoys). After delaying them to the P.A., I use them at the least-perceptible volume to fill in what I can't hear from the main system. This is a luxury solution, but I can depend on them in problem venues. And remember, the house sound person is your friend. Accept constructive help if you can't hear the P.A.

## inside

- 64 **Live Mix News:**  
Tours, Events, Installations
- 68 **All Access: Pink**
- 70 **Tour Profile: Melissa Etheridge**
- 74 **Local Crew: Bayou City Sound**
- 76 **New Sound Reinforcement Products**

## News



PHOTO: JERRY RICHARDSON

At this year's MerleFest (Wilkesboro, N.C.), SE Systems president Cliff Miller (left, with one of 20 FOH engineers for the event) relied on dbx DriveRack 4800 system processors.

NSCA's ([www.nsc.org](http://www.nsc.org)) proprietary insurance program provides its member companies with customized solutions, including the new NSCA SystemsPlus that launches with SystemsPlus P&C (Property and Casualty) and SystemsPlus Surety components; a SystemsPlus Health offering is also slated for release in the coming months...For the current *Take That* tour, Capital Sound Hire (London) is providing XTA DP224/226/428 processors with the latest AudioCore Version 8.11 software. System techs Al Woods and Sam Kruger are supporting the XTA gear, which works with the Martin Audio line array...In the South Bank of London, the National Theatre has upgraded its Sennheiser wireless mic system to 40 channels (24 channels of EM1046 receivers across the three theaters and 16 wherever required)...UK sound rental company SSE Audio Group purchased six Dolby Live Sound Lake Contour Pro26D units, four of which are being used on the current Deep Purple tour, providing management and system control of L-Acoustics and Nexo speaker elements; systems engineer Gert Sanner is supervising the control and is supporting FOH engineer Doug Hall...Now boasting an Adamson SpekTrix rig is Quebec City's Club Animation; the gear was purchased by club owner/head of technical department Jean Doyon.

*dream of*

# Everything you ~~need~~ between the mixer and the amplifiers.



## DriveRack® 4800/4820



**DriveRack® 4800 and 4820.** The new flagships of the hugely successful DriveRack family provide incredible versatility, sonic excellence and intuitive control for performance applications. With 4 inputs and 8 outputs, both analog and AES/EBU connectivity as well as an optional CobraNet™ card, the DriveRack 4800 and 4820 offer amazing flexibility. The Ethernet - HiQnet™



control backbone along with HiQnet System Architect™ control software take the DriveRack to the next level of integration capability. Digital I/O and 96 kHz operation provides extended frequency response and ultra low-latency. Processing includes a large roster of selectable DSP inserts and a wealth of EQ, Delay, Bandpass and Crossover Filters, all designed to maximize

system performance. A built-in ¼ VGA color screen, ultra-fast 2-button navigation and seamless tablet integration make the 4800 incredibly quick and easy to use. For fixed installation the 4820 provides all the same processing features with a tamper-proof front panel.

From control to flexibility to processing capability, the new DriveRack 4800 and 4820 are everything you want in a system processor. For more information, contact your dbx representative or visit us at [www.dbxpro.com](http://www.dbxpro.com); to download System Architect please visit [www.harmanpro.com](http://www.harmanpro.com).

### Features

- 48 and 96 kHz operation
- Color ¼ VGA Display (4800)
- 4 analog and AES/EBU inputs
- 8 analog and AES/EBU outputs
- Full Bandpass Filter, Crossover and Routing Configurations with Bessel, Butterworth and Linkwitz-Riley filters
- 31-Band Graphic and 9-band Parametric EQ on every input
- 6-band Parametric EQ on every output.
- Loudspeaker Cluster and Driver Alignment Delays
- Selectable DSP inserts on all input and outputs including Classic dbx® Compression, Limiting and Advanced Feedback Suppression
- Ethernet HiQnet™ networking and control
- Optional dbx ZC wall panel control
- Optional CobraNet® I/O
- Optional Jensen I/O Transformers

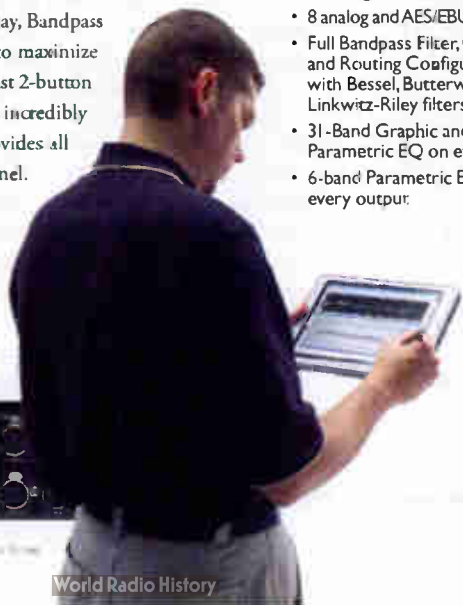

[www.dbxpro.com](http://www.dbxpro.com)

**dbx®**  
PROFESSIONAL PRODUCTS





## On the Road

### John Ward

One of the year's most successful tours, country superstar couple Faith Hill and Tim McGraw have wowed audiences with Soul 2 Soul II 2006, which reprises their acclaimed 2000 tour. Handling FOH for this all-Clair Bros. show is Dave Kob mixing Hill and John Ward, who's worked with McGraw for the past 12 years. It's a long tour that kicked off in April and ends next month in Las Vegas. We caught up with Ward during load-in at the Verizon Center in Washington, D.C.

#### *What's different about this tour?*

Dave [Kob] is mixing Faith on a Yamaha PM5000. I was an analog AT1 Paragon guy for a long time, but I'm using two DiGiCo D5s, which are stacked and set up in a hallway. That way, I can mix using a tablet from anywhere in the venue. I can walk the room and check the sound from the cheap seats and don't have to rely on anyone else's opinion about the sound during the show. All the outboard is MIDI'd and I have full control right there. The only downside is that sometimes people see me in the house with the tablet and think I'm taking drink orders.

#### *What's in your FOH rack?*

The D5s have a lot of onboard stuff, so I don't need so much outboard. I do have have a TC [Electronic] M5000 that connects to the D5 via AES/EBU and a dbx 120XP for sub bass. Tim's vocals go into an Avalon VT-737 vocal channel. This is fed from a Sennheiser SKM565 wireless—the one with the e865 capsule.

#### *What are some of your favorite venues?*

Lately, I'm mostly doing large venues, but I like the new Charlotte [N.C.] Arena, The Palace of Auburn Hills [Detroit] and the Philips Arena in Atlanta.

#### *What do you like doing when you're off the road?*

I'm usually out riding dirt and street cycles with my son.

## Now Playing

### AFI

Sound Company: Rat Sound (Oxnard, Calif.)  
 FOH Engineer/Console: Ron "Ronnie Rat" Kimball (also system engineer) and Mikey "Rhino" Bakowski/Yamaha PM5D  
 Monitor Engineer/Console: Mike "Pork Chop" Souder/DiGiCo D1  
 P.A./Amps: house-provided  
 Monitors: Sennheiser G2, Micro Wedges  
 Outboard Gear: TC Electronic D2, Eventide H3000  
 Microphones: Audix OM-7, Shure SM58  
 Additional Crew: Tyler "Youngster" Arnold, assistant engineer



### KC & The Sunshine Band

Sound Company: Concert Systems USA  
 FOH Engineer/Console: George Stakis/Digidesign VENUE  
 Monitor Engineer/Console: Chad Griswolf/Yamaha PM5DRH  
 P.A./Amps: Meyer Sound MICA, M'elodie, 600-HP, UPJ-1P  
 Outboard Gear: Digidesign VENUE onboard  
 Monitors: Electro-Voice XW12A with Nexo Alpha E  
 Microphones: Shure  
 Additional Crew: audio system engineer/SIA Smaart tech James Bergoyne, lighting systems engineer Christopher Grosek



### The Futureheads

FOH Engineer/Console: Andrew Thornton/spec Yamaha PM5D/1D or Midas Heritage/XL4  
 Monitor Engineer/Console: Andy Williamson/spec Yamaha PM5D/1D or Midas Heritage/XL4  
 P.A./Amps: spec Meyer Sound MICA/MILO; EAW 760; JBL; V-DOSC/dV-DOSC; EAW SM15, SB412; MSL4s; ARCs  
 Outboard Gear: spec Summit Audio TLA100, TL Audio C1, Drawmer gates, dbx compressors, TC Electronic D2, Roland SDE-3000, Yamaha/Lexicon reverbs



Microphones: Shure Beta 52, SM57; Sennheiser e 902, e 904, e 906, e 935; Neumann TLM 103, MKH50

## Nady Systems Celebrates 30 Years

It's been 30 years since Nady Systems' ([www.nadywireless.com](http://www.nadywireless.com)) CEO/founder John Nady put the music industry on its "cordless" ear. Nady introduced the wireless concept to many top touring acts, including the Rolling Stones, Jefferson Starship, Aerosmith, Neil Young, Stevie Wonder, Bruce Springsteen, Toto, Heart, Styx and many others. The company kicks off its 30th-anniversary celebration with a host of events and special sales.

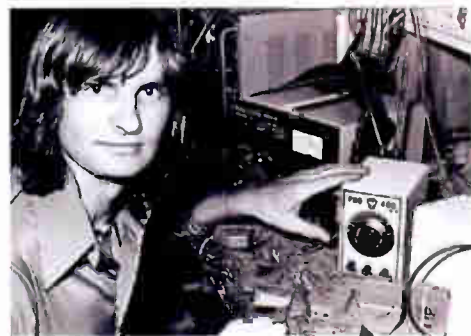

Nady Systems' CEO/founder John Nady hunkered down in the lab from the early days of his wireless development.

Officially incorporated in July 1976, Nady pioneered a revolutionary new technology—wireless microphones. In recent years, Nady has expanded its line to include a broad spectrum of professional audio gear (speakers, mixers, amps, studio mics, effects pedals, etc.) in addition to its expanding wireless line.

thinking sound



Meyer Sound builds products to meet the real needs of you, the user. Judging by our five TEC Awards and 24 TEC nominations, you seem to feel we're pretty good at it. This year's nomination for MICA is the third for the MILO family of loudspeakers in the last three years, and we would like to extend our thanks to TEC voters and the Mix Foundation for your support.



Just a few of the people and places that have already realized MICA is a winner

British Virgin Islands Music Festival  
 Tracy Chapman  
 Schlossgrabenfest  
 Bloc Party  
*League of Gentlemen*  
 Celine Dion  
 Discovery Channel's Upfront Tour, New York  
 Rod Stewart  
 Olympic Opening Ceremonies, Turin  
 Udo Juergens

KC & the Sunshine Band  
 Montreux Jazz Festival  
 Finn Brothers  
 Elton John  
 Partylite National Sales Meeting, Washington DC  
 Sydney Convention and Exhibition Centre  
 Kanye West  
*Tonight's the Night*  
 Katie Melua  
 Kasabian  
*Little Britain*  
 Nigerian National Sports Festival

Zazie  
 Gotthard  
 Il Divo  
 The New York Philharmonic  
 San Francisco Hilton  
 Orchestra and the Metropolitan Opera  
 Colosseum at Caesar's Palace

Carnaval  
 Victoria's Secret Brand Conference, Orlando, Florida  
 Autodesk University, Orlando, Florida  
 Proms in the Park

The MICA Compact High-Power Curvilinear Array Loudspeaker is a 2006 TEC Nominee



[www.meyersound.com/mica](http://www.meyersound.com/mica)

TEC Award nominations have become a family affair | **MICA**



# P I N K



Hot off a stellar new album, *I'm Not Dead*, and a new marriage, Pink is currently taking her punk rock-tinged styling out to clubs across the U.S., with a world tour beginning next month.

Accompanying Pink onstage is a full band comprising (below, clockwise from top-left) Mylious Johnson (drums), Janis Tanaka (bass), Suzie McNeil (backup vocals), Justin Derrico (guitar), Adriana Balic (keyboards/vocals) and Jason Chapman (keyboards/musical director). *Mix* caught up with the Showco (monitor/front-of-house package; local racks and stacks) tour in late June at San Francisco's Fillmore; for the arena dates, the tour will pick up a Showco Prism rig.



Photos and text by Steve Jennings

FOH engineer Bruce Jones at the Midas Heritage H3000

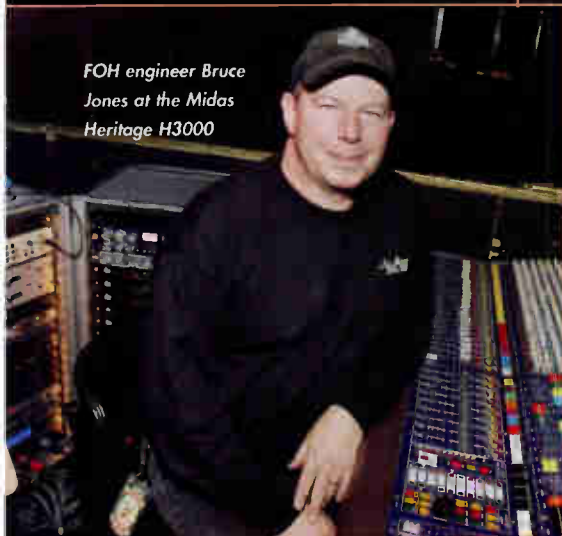

Front-of-house engineer Bruce Jones is using a Midas Heritage H3000, which he says is his favorite board to mix on. "It sounds great and is completely user-friendly," Jones says. "You can also set up a drum mix on groups right above your VCAs and do most of your mixing at the center of the desk. I do a lot of fine drum mixing from song to song. I also like to break my vocals up into background groups on the VCAs."

For the next leg of the tour, Jones plans to switch to a DiGiCo D5 for the added channels. "I've used the DiGiCo on a couple one-offs with Joe Cocker," Jones says, "and some Pink radio shows. The DiGiCo sounds great, but if you don't have your show on a memory stick, it takes a while to label and assign."

Jones' outboard rack is chock-full of choice pieces, including a dbx 160SL daisy-chained with a Brooke Siren DPR-901, Sony MUR-201 (reverb), Roland SDE 3000 and Aphex Aural Exciter for Pink's vocal. For background vocals, Jones employs a dbx 160XL, Lexicon PCM 300 and Eventide Eclipse; acoustic guitars take Yamaha SPX-990s; drums are on Yamaha REV 5 and Drawmer 210 gates; keys take BSS DPR 4021s; and Vactronics tube comp, Klark Teknik stereo EQ and DN-60 RTA for main L/R inserts.

"This is my first tour with Pink," Jones says. "Pink has awesome vocals and the band is great. There are a lot of cues and you stay very busy throughout the show. The tour manager, Nick Cua, is the best, and the crew is strong across the board."

Drum tech Mark Bennett (left) with drummer Mylious Johnson



Drum tech Mark Bennett mikes the kit with SM91 and Audix D6 (kick), Shure Beta 86 (snare top), Beta 87 (snare bottom), Audio-Technica AT3000s (toms), AT3031s (hat/ride) and Shure KSM32s (overheads).

Jason Chapman (left) and keyboard tech David Rapp



Musical director Jason Chapman is using a Roland XV5080 module. "We have just started using a Muse Research Receptor," says keyboard tech David Rapp, "along with a Roland XV5080 module. We use a Roland VK-8 as a controller for the Receptor. All run through a Mackie 1604-VLZ, with a main left and right send and a sub-group L/R send to control his own mix levels. Adriana [Balic, keyboards] is using a Roland [Fantom] X8 and a Roland [Fantom] X7 run through a Mackie 1402-VLZ mixer."

"Justin Derrico is working Gibson Les Paul and Explorer guitars," says guitar tech Tony Hanuman. "Both are equipped with Fishman acoustic pickups in the bridge so each guitar can double as an acoustic with the aid of a Bradshaw switching box in the pedal board. We are also using Yamaha acoustics and a Fender Stratocaster for one song. His amp is a Bogner Shiva head with two Bogner 2x12 close-back cabinets."

Guitar tech Tony Hanuman

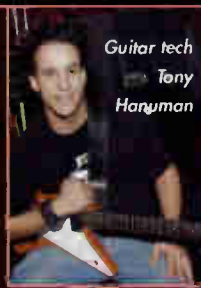

Justin Derrico



Monitor engineer Doug Deems works on a Yamaha PM5DRG console.

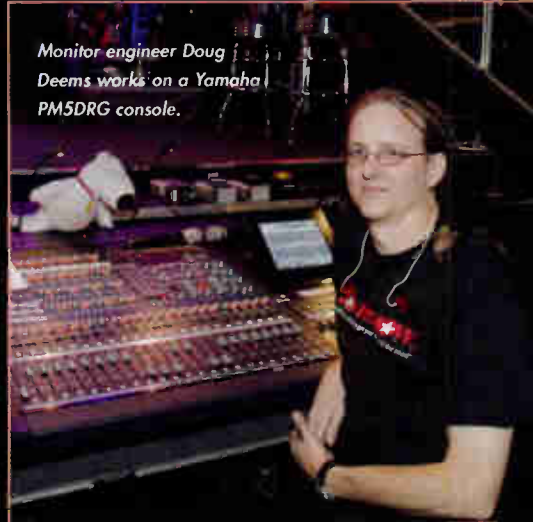

As this is a small tour, monitor engineer Doug Deems is using a Yamaha PM5DRG for its compact size; he will also be picking up a DiGiCo D5 for the arena dates. "It's nice with a digital desk to have access to comps/gates/delay on all ins and outs," Deems says of the DiGiCo board. "When they're available, one comes up with some creative uses for them." The Yamaha board is taking 44 inputs from the stage—about 58 channels—and all 24 aux outs, plus a few matrices. Interestingly, he is also using five effects without using up aux sends by using the stereo buses, direct outs and other "tricks."

A look inside Deems' rack shows two Distressors, two dbx 160s, an Aphex Exciter

and Lexicon PCM81; everything else comes from the board.

"All the bandmembers are using ears," Deems says. "Brand-new Ultimate Ears UE-7s all around and Sennheiser G2 IEMs—by far my favorite. We've got Shure Beta 86s on U4D wireless for Pink and regular 58s on everyone else—old-school rules."

"Pink is a great vocalist, great band, really fun people to work with. After doing pop/R&B acts with huge bands and tons of outputs for the last few years, it's nice to have a small number of really talented people onstage and time to dig deep and polish the details. It is a pleasure to mix this band."





# Melissa Etheridge

## Triumphant Return for Summer Tour 2006

**M**elissa Etheridge is standing center stage at the Paramount Theater in Oakland, Calif., in late June (the third show of her 20-plus-date tour), belting out a series of favorites that fans have been waiting to hear since she stopped touring in 2004 after being diagnosed with breast cancer. Given her zip and the audience's fervent response, it's clear that the evening was a marked success for both.

Etheridge's tour kicked off in the middle of June and will run through the summer, including dates in New York, Montreal and Chicago. The Oakland show came just four days into the tour and front-of-house engineer Dan Wise (who has mixed for Jason Mraz for the past three or so years) and production manager/monitor engineer Jon Schimke have already hit a pace where Etheridge and her band—bassist Mark Browne, drummer Fritz Lewak and guitarist Philip Sayce—cut through the audience's ardor. Schimke has been with Etheridge since 1994, and this is



No, that's not his real hair—  
front-of-house engineer Dan Wise

Wise's first long run with her.

Sound Image (Escondido, Calif.) supplied the crew with a JBL VerTec VT 4889 rig with VT 4880 subs, which cover the main hall. While the line array covers the orchestra and balcony seating, the crew brought in a pair

of Sound Image 1160s and a pair of Sound Image CF boxes to cover the premium seats upfront. "I use those down front on every tour that I do," Schimke says. "The 1160s have a 160-degree horn and an 8-inch speaker. The CF boxes are single 12s with



# Line Array For the Rooms You Play

Perfect for concert sound, JBL's industry leading VerTec line arrays can be a bit impractical for smaller rooms. Meeting the need for VerTec quality in a smaller, more portable format, JBL designed the VRX932LA Constant Curvature Line Array for sound rental companies, installers and discerning musicians looking for the ultimate, flexible, no-compromise sound system. Using VerTec's lightweight drivers mounted along JBL's unique Constant Curvature waveguide, the VRX delivers extraordinary power and flexibility, making it the perfect line array for the rooms you actually play. For a small club, simply mount a single cabinet on a tripod, or pair it with the VRX918S subwoofer cabinet, for wider coverage and bandwidth. For a ballroom or small hall, fly up to six cabinets with JBL's patent pending suspension system. Regardless of the configuration, the VRX delivers cohesive, articulate, stunningly clear JBL sound. Hear the VRX at your Authorized JBL Professional Dealer or learn more at [jblpro.com](http://jblpro.com).

## VRX900

VRX932LA

VRX918S





two inches. I also have sidefills onstage, which helps fill out the stage and gives it more beef." The sidefills came in handy, as the entire band is on personal monitors and there are only two speakers onstage: a double 12-inch sub behind Browne and an 18-inch sub and a Thumper behind Lewak.

For the most part, the crew places four subs per side, although there is the possibility of using five. "We use four because of the sight lines," Schimke explains. "Being the production manager, I lean into Dan for that reason. I know what [the subs] can do and I won't put [Dan] in a bad spot, but you gotta look at the whole picture." Wise answers that he isn't missing the extra sub. Crown I-Tech 8000 amplifiers power the P.A.

For checking system performance during the show, Wise uses Metric Halo's SpectraFoo for reference. "I don't rely on it too much when I'm tuning the P.A., but I do have it sitting there in case anything pops out during the show," he explains.

#### STRAIGHT-AHEAD MIXING

At FOH, Wise is using a Midas Heritage 2000. "When this tour came around, I was looking for small, easy and simple," he explains. "I'm happy with it." In terms of outboard gear, Wise carries an ADL 1500 tube compressor on Etheridge's vocals and dbx 160A compressor/limiters on the guitars and bass to keep things even. The goal, he says, is to keep Etheridge's vocal on top. "That's pretty much the whole thing," Wise says with a smile. "Her band is really good, so it's pretty easy to mix. They mix themselves for the most part. As

long as her vocal is on top, I'm happy."

Miking the band is straightforward, although Lewak's drum kit came in bigger than they anticipated. "We were expecting three toms, but he came in with four and he added a bunch of overhead stuff," Schimke says. "I laughed at some of that stuff when I saw it, but it sounds good, so I can't complain." The kick drum is miked with a Beyer M88 and a Shure Beta 91, the snare gets a Shure 57, Sennheiser 421s are

used on the toms and hi-hat, and Shure KSM 32s mike the overheads.

"We went with the 421s because they sounded good," Schimke reports. "I had been working with Dennis DeYoung and getting [Shure] 98s every day. One day, they didn't have enough of them, so I asked if they had anything else. They had [421s] and I thought, 'This is what drums sound like.' So I called [Dan] up and asked if he had a problem if we tried 421s, and he didn't. Then I called up the drummer to check with him, but he could care less. It just sounds good."

Browne's bass rig is taken DI with a 160A on top with slight compression. Sayce's 4x12 guitar cabinet and Etheridge's Bad Cat 2x12 amplifier are miked with Sennheiser 409s.

In terms of vocals, the band sings through Shure 58s and Etheridge uses a Crown CM-311 headset mic run through a Shure wireless. "We went to it four or five years ago because she runs around [onstage] so much," Schimke says. "She liked it, so it stuck."

Lewak and his drum tech trigger a handful of drum loops from Ableton Live running on an Apple PowerBook G4.

#### RECLUSIVE MONITORS

As for monitors, Schimke mixes through a Ramsa SX-1 console. "It's been my favorite console the last 10 years. It sounds as good as the Midas stuff and it works better," he says. "I use all the outputs—the bottom four are set up in stereo, which is perfect be-

cause I have four stereo in-ear mixes. The rest are sidefill sends, the wedge send and four reverb sends, so it adds up pretty fast. It's got 22 outputs and I use 19 of them."

The band went to personal monitors about 10 years ago, although Sayce pulls the right ear out to listen to the sidefills. Schimke upgraded to Shure PSM 700s for this tour. "So far, so good," he says of the new additions. "I kept the 600s in the rack just in case [the PSM 700s] sounded dif-

Her band is really good, so it's pretty easy to mix.

As long as her vocal is on top, I'm happy.

—FOH engineer Dan Wise

ferent, but they sound exactly the same. There are just more frequency choices. We started having trouble on the last tour with just two frequency choices—sometimes it would be a little dirty, so we have the option of more and it's nice."

Schimke gives Etheridge a full mix, while Browne receives a lot of overheads and the drummer gets most of the rest of the band. "The guitar player is mostly guitar," Schimke says with a laugh. "Imagine that."

At monitor central, Schimke has an AMS Neve RMX 16 reverb for drums, a pair of Yamaha SPX-990s for vocals and acoustic guitar, 10 channels of Amek CL01 compressor/limiters and a Yamaha PRO R3 reverb on Etheridge's voice. "It fattens up her voice," Schimke says. "As soon as I turn it off, it distracts her, so I leave all the effects on all the time."

"I won the Ameks in a coin flip against Gary Hartung, who was mixing Pat Benatar," Schimke continues with a laugh. "I was doing a Los Lonely Boys show and the owner of the company [Sound Image's Dave Shadoan] called me up and asked if I really needed 'em. I said I'd like to have them; it was on my list. He said, 'Gary wants 'em, too.' I said, 'Well, let's flip for 'em.' They went outside, and I won two out of three."

Schimke says the job is pretty straightforward. "She comes out and plays, and that's really the extent of it. She's as easy as it gets as far as mixing monitors. She doesn't even look at me. Her wife sits behind me sometimes and she looks at her, so I try to get in between 'em. It's become the running gag on our side of the stage." ■

*David John Farinella is a San Francisco-based writer.*

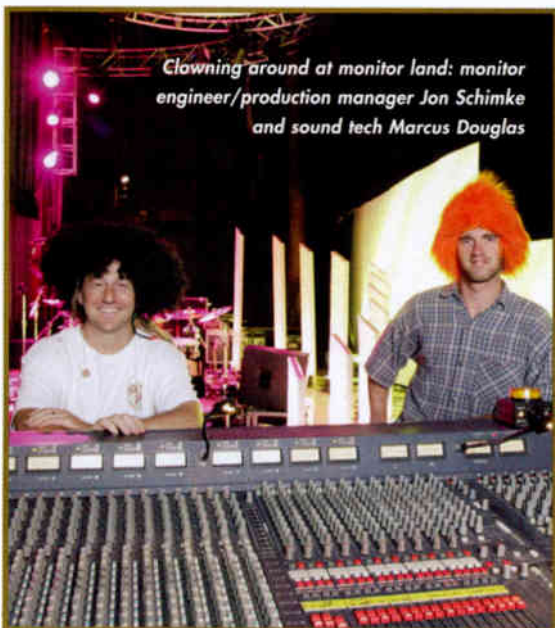

Clowning around at monitor land: monitor engineer/production manager Jon Schimke and sound tech Marcus Douglas



# feel the sound.

From acquisition to playback, SRS Labs delivers the ultimate audio experience. SRS Circle Surround® makes it easy to record and transmit surround sound for live events. Capturing up to 6.1 channels on a two-channel carrier, now your surround sound is free to travel anywhere your audience takes it. **Capture the Personal HD Experience with SRS Labs.**

For information on SRS Circle Surround production tools, visit [www.srslabs.com](http://www.srslabs.com) or call 1-800-243-2733.

**CAPTURE** → **CREATE** → **CONVERGE** →

**SRS** (●)



# Bayou City Sound

## Owners' Different Backgrounds Fuel Same Passions

Our industry is chock-full of professionals who stumbled into the sound reinforcement business from a pure love of music and took that interest and molded it into a successful endeavor. This career path holds true for the co-owners of one of the busiest local sound providers in the Houston area, Bayou City Sound (Tomball, Texas; [www.bayoucitysound.com](http://www.bayoucitysound.com)). Tom Bohacek and Scott Powers first crossed paths 15 years ago while working freelance production for a local radio station, but their journeys to that moment couldn't be more different.

At an early age, Bohacek studied in a vocational electronics training course, finding a love for all things electronic and audio design. From there, he worked in the technical department for Maxim Sound and later started his first company, North Start Productions, where his duties included designing, servicing and installing sound and lighting systems. While there, he signed on with major Houston radio station KILT-FM, providing live sound and production services for county fairs, rodeos, amphitheaters, cruise lines and the 1992 Super Bowl after-party, as well as providing engineering and production services for Vince Gill, Diamond Rio, Willie Nelson and the Houston Pops Orchestra. With these credentials under his belt, Bohacek began collecting and maintaining equipment to produce his own shows.

Powers joined the music world at the age of three, when he was singing in the children's—and later adult—choir. However, his vocal stylings were more of an enjoyment, so after high school, Powers began working for an insurance company, adjusting claims and cases, followed by marriage and family life—and a move to Houston in 1979—all the while maintaining a love for music. Years later, a friend of Powers suggested that he help with their live show production, hiring him on as stage manager and monitor engineer. Powers also created a side gig with KILT-FM, performing many of the same duties as Bohacek.

Today, Bayou City Sound handles a broad range of events and services. "Outside of the corporate market, which is growing rapidly for us," Bohacek says, "a good portion of our business is with various ethnic groups. We stay active in houses of worship, fairs, festivals and benefits. Houston's music [scene] has become much more diverse and has lost a number of small and mid-sized venues we were working with. To grow as a company, we had to become diversified." BCS is contracted for local and national touring acts, and can be found providing SR expertise in churches, conventions, golf tournaments and



Bayou City Sound's co-owners, Scott Powers (left) and Tom Bohacek, at recent SR gigs

whatever else comes through the Houston scene.

Supporting these events is an extensive equipment inventory, including a recently purchased Turbosound Aspect loudspeaker system, and 56- and 48-input Midas Verona boards. In mid-June, the company also purchased an arsenal of JBL 712M stage monitors to outfit a new monitor system and has its eye set on the Dolby Lake Processor. BCS' racks are full of gear from the likes of Crown Audio, Yamaha, Lexicon, dbx and Klark Teknik, while clients can request AKG, Sennheiser, Shure, Electro-Voice and Beyerdynamic mics. Wrangling all this gear is done by six employees and "an unlimited labor pool of individuals that share a similar passion for the industry," Bohacek enthuses. "Two of our main guys are Robert Bronner and Jade Fontenot. Robert is on every show—great tech and extremely devoted to us. He approached us five years ago to learn more about sound to support his video passion. Jade is a fantastic FOH and monitor engineer and always gives 110 percent toward excellence.

"BCS has always concentrated on customer service and what we offer on a personal level," Bohacek continues. "We have taken time with musicians and clients to gain a better understanding of what they wanted for their performance or event, which is where we feel we have excelled in the local market. It has helped us grow when our equipment was not as 'rider-friendly' as it is now." And BCS will now have one more perk to offer its customers: Bayou City Video ([www.bayoucityvideo.com](http://www.bayoucityvideo.com)), a full video production division offering projection systems, camera operation, editing and A/D transfer of media. In addition, Bohacek reveals that they have something on the drawing board that is "exciting and unique to our industry," but cannot comment further until plans are set for a hopeful 2007 launch. ■

Sarah Benzuly is Mix's managing editor.

ADD AMBIENT SOUND,  
MONITOR FEED,  
COMPRESSION,  
EQ AND LIMITING.  
MIX TO TASTE.

IMAGINE THE PERFECT IN-EAR SOUND.  
THEN BUILD IT WITH SD1.

OPTIMIZE MONITOR  
SOUND IN ANY  
ACOUSTIC SETTING  
WITH SD1, THE  
BREAKTHROUGH  
SIGNAL PROCESSING  
TOOLKIT

**Ambient ear-level mics** let you reconnect with your environment, audience, and band.

**SD1 Bodypack** with four selectable memory locations gives you dynamic, real-time control over your ambient and monitor mix.

**Sound Design Audio Manager software** lets you create personalized "sound environments" that you can save, edit, and use again and again. Compress and equalize both monitor and ambient signals using 20-bit DSP on your PC or Mac. Download up to four selectable memories to the SD1 Bodypack.



For the whole SD1 story, and a free copy of SDAM software, visit:

**INEARSOUNDDESIGN.COM**

World Radio History

**Westone**  
**GENNUM DSP**



# New Sound Reinforcement Products

## AUDIO-TECHNICA HYBRID EARPHONES

Now available in the U.S., the ATH-EC7 GM ear bud/clip-on hybrid headphones from Audio-Technica's ([www.audio-technica.com](http://www.audio-technica.com)) Import Series blend the comfort of an ear bud with the secure, adjustable fit of a clip-on. These lightweight phones have 15.5mm drivers with neodymium magnets for deep bass with extended treble response. (Total response is 10 to 24k Hz.) The unit's asymmetrical cord wraps around the back of the user's neck, draping over one shoulder, minimizing cable interference. Termination is a gold-plated stereo mini-plug. Retail is \$249.95, including carry pouch and a 1-meter cable extension.



## QSC POWERED MD SERIES

QSC ([www.qscaudio.com](http://www.qscaudio.com)) is now shipping powered versions of its modular, arrayable MD enclosures, including full-range models MD-FP122/64r, MD-FP122/94r, MD-FP152/64r and MD-FP152/94r. All powered MD models feature lightweight 1,000 and 1,400-watt Class-D amp modules, and are offered in various coverage patterns with 12- or 15-inch woofers—all sharing the same 35-inch-tall, 30-degree trapezoidal enclosures as the passive range for easy creation of full-range or combined full-range/LF clusters. Cabinets

can be tightly packed, splaying their 60x40-degree horns for uniform coverage in any multiple from 60 degrees to 360 degrees, with the radial front grilles forming a contiguous cylindrical surface. Other features include black or white finish, 15 attachment points, and rotatable HF horns (in full-range models) for horizontal or vertical use.

## LECTROSONICS DM84 DIGITAL AUDIO PROCESSOR

The latest product in Lectrosonics' ([www.lectrosonics.com](http://www.lectrosonics.com)) DM Series of digital audio processors with LecNet2™ control software is the DM84. The unit can route any combination of inputs to any combo of outputs, and offers auto-mixing via a proportional gain algorithm, sophisticated filtering on each input and output, built-in delay on each input and output, and low throughput latency. Other features include eight mic/line inputs with four outputs, switchable phantom power, programmable front panel control knobs, and AMX and Crestron compatibility with USB and RS-232 interfaces for setup, control and daisy-chaining to additional LecNet2 devices.



## CELESTION EXPANDS CDX SERIES

Celestion ([www.celestion.com](http://www.celestion.com)) augments its CDX range with two new compact, lightweight, neodymium compression drivers: the CDX1-1730 and CDX1-1731. The CDX1-1730 is a standard bolt-on, flange-mount design; the CDX1-1731 is intended for screw-mount applications. Both share the same specs: Power handling is 75 watts; impedance is 8 ohms; sensitivity is 110 dB (1W/1 m); frequency response is 1.2k to 20k Hz; and a 1.75-inch voice coil with 1-inch throat exit is offered. The new drivers use Celestion's Sound Castle™ system to ensure even clamping pressure on the diaphragm surround, reducing distortion while allowing the full internal volume of the rear cover to act as a loading chamber for the diaphragm. In related news, Celestion also launched the CDX-1746 (a screw-mount version of the ceramic-magnet CDX1-1745 driver) and an adaptor for screw mounting its CDX1-14 Series drivers.



## RENKUS-HEINZ CF/CFX SERIES

Offered in powered (CF) or passive (CFX) versions, the new CF/CFX Series from Renkus-Heinz ([www.renkus-heinz.com](http://www.renkus-heinz.com)) brings R-H performance to a lower price point. Powered models use the company's PF-1 Intelligent Digital Amplifier. Using simpler cabinet designs and offering fewer options to achieve cost efficiency, the series has four trapezoidal, two-way full-range cabinets with HF compression drivers on rotatable Complex Conic horns: the CF/CFX61 (6-inch LF and 150x60-degree horn), CF/CFX81 (8-inch LF with 150x60-degree

horn), CF/CFX121 (12-inch LF and 90x60-degree horn) and CF/CFX151 (15-inch woofer and 90x40-degree horn). A two-way CF/CFX121M 12-inch woofer slant monitor is available, as is the CF/CFX18S single-18 direct-radiating subwoofer. Multipurpose hardware (such as handles, pole sockets and six-point universal mounts) makes the line adaptable for portable or fixed installs.



## SYMETRIX SYMNET DESIGNER 7

The latest update to Symetrix' SymNet Network Audio DSP platform, the SymNet Designer application Version 7 for Windows is available for download at [www.symnetaudio.com](http://www.symnetaudio.com). Among its new loudspeaker-management and room-optimization modules are parametric EQ, high/lowpass filtering, delay, gain, invert and mute functions. The modules are offered in standard and Smaart™-compatible versions, the latter directly controlled from SIA Software's SmaartLive RTA software. Other enhancements include DTMF generator/auto-dialer modules for teleconferencing, third-party Ethernet Control of all SymNet functions, simplified workflows and more. ■

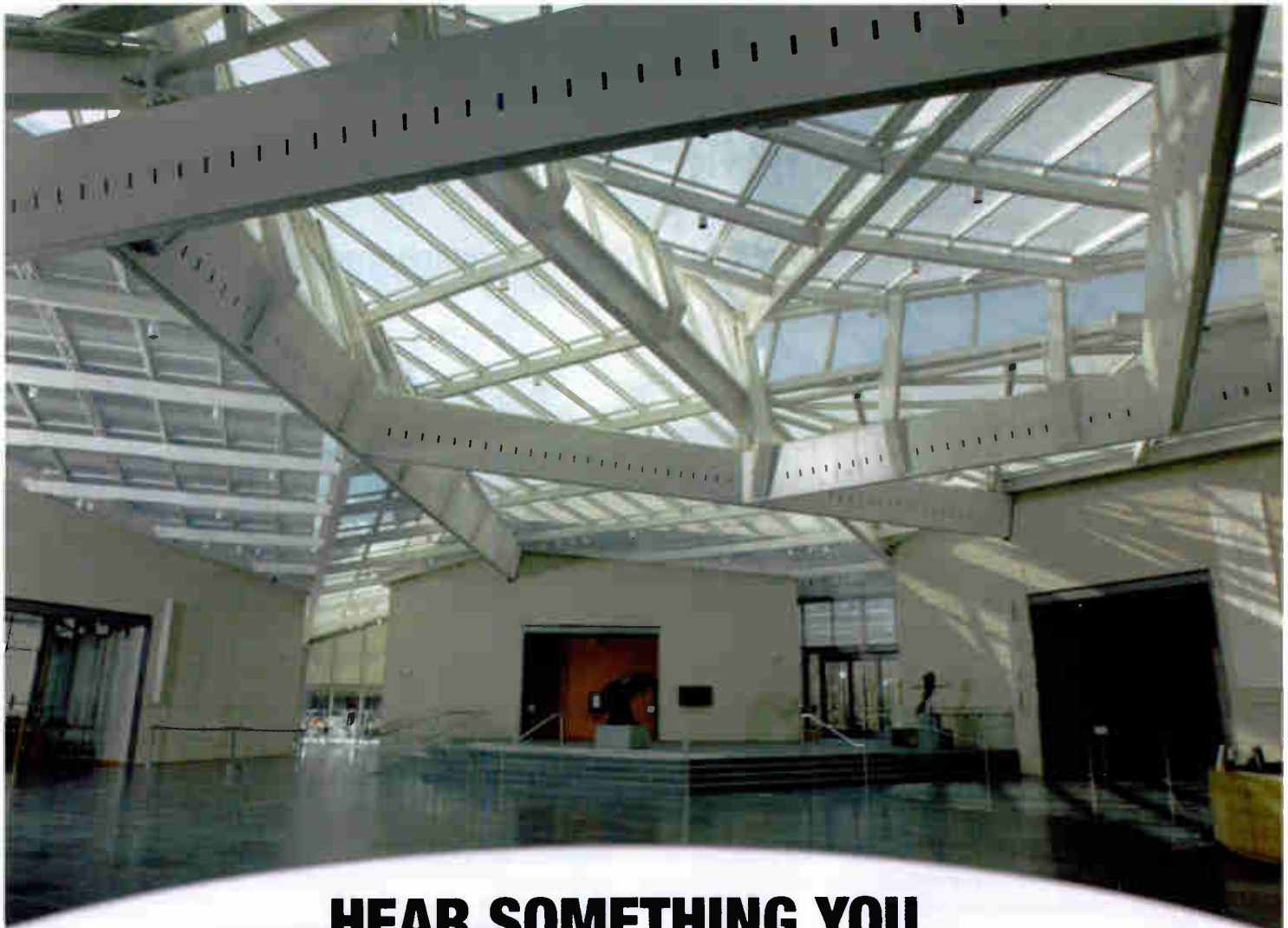

# HEAR SOMETHING YOU DON'T SEE EVERY DAY



**2006 TEC Award Nominee**  
Sound Reinforcement Technology Loudspeaker

Intelligibility **ICONYX** Musicality

## Steerable Array Systems



Give Iconyx six inches of wall space,  
and it will give everyone within  
300 feet over 99 dB of articulate,  
detailed, naturally balanced  
full range sound.



Hard to believe? It's easy to prove -  
just contact us for a demonstration  
of Iconyx: a system that offers unique  
solutions to architectural and  
acoustical challenges.



**RENKUS-HEINZ**  
FOR A BETTER SOUNDING WORLD

Renkus-Heinz, Inc. 19201 Cook Street, Foothill Ranch, CA 92610-3501, USA • Phone: 949 588 9997 • Fax: 949 588 9514 • [www.renkus-heinz.com](http://www.renkus-heinz.com)



# Guerrilla Remote

## Creating the Personalized Recording Environment

Remote audio comes in many flavors, and “guerrilla” aptly describes this sonic challenge. Getting to the next level is like playing a videogame where experience counts: You learn to recognize and collect both useful and odd adapters along the way. Of course, a cool demeanor and good troubleshooting skills are also keys to success in this genre. This month, I’m spotlighting three recording pros who are comfortable outside the conventional control room/studio environment and have taken a different path in their approach to the craft.

### FEED THE GUERRILLAS!

A live performance that requires P.A. support generally implies that the mic signal must be split between that and the recording preamps. This can be accomplished in many ways—put up extra mics or take a feed from a mic preamp via the insert send, or even use fiber optic or Cat-5 digital snake/breakouts—but let’s focus on the traditional.

Transformers are very good at rejecting induced common-mode noise. Two pieces of gear can have their chassis grounds at different potentials. If this causes power-related hum and buzz, then a mic-level isolation transformer can be inserted between them. And thanks to the isolation between primary and secondary windings, it’s possible to break the ground connection and stop the current flow (and the accompanying noise).

The figures show two flavors of transformers designed to isolate and split a mic signal. Isolation transformers, for audio and power, can solve common audio problems. The 1:1 ratio transformer in Fig. 1 allows a mic signal to drive two preamps—live and recording mixers, for example. Switch S1 breaks the connection between the two system grounds, eliminating noise current—if it exists and causes problems. Multiple winding versions of such transformers are also available. The transformer in Fig. 2 has four identical windings, so one mic signal can be routed to three preamps (plus direct/mult). Switches SW1, SW2 and SW3 break the ground connection when necessary.

Digital audio has changed two primary aspects of

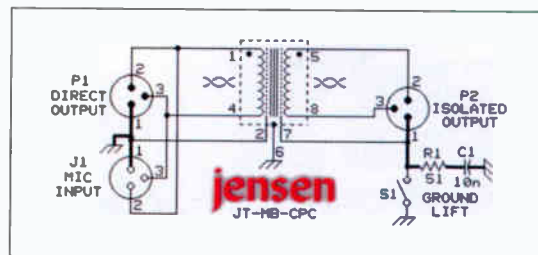

Figure 1: This 1:1 ratio transformer lets a mic signal drive two pre’s.

location recording. Laptops have made workstations portable, and digital consoles have allowed most of the signal wiring and electronics to remain onstage, while only the control surface and its cabling go out into the house. Harboring a desire to capture that ever-elusive live performance are a number of road warriors who have combined new and old technologies to create their own personal recording systems. Each has their application-specific rig, and laptops play a key role in two of the three applications.

### STAY IN THE ROOM WITH THE MUSICIANS

After more than a decade of working within the confines of traditional major recording studios, Bryce Goggin took a different approach to the recording environment in his Trout Recording ([www.troutrecording.com](http://www.troutrecording.com)) in Brooklyn, N.Y. The room has no defined control room; Goggin shares the studio space with the band.

“It took nearly 10 years before I finally managed the discipline to not tweak signals on their way to the multitrack,” says Goggin. “Recording in the same room with the band forces me to rely more on mic placement and selection rather than get distracted by whatever gear is around. Though I haven’t eliminated the need for processing—an occasional highpass filter or a gentle limiter during the tracking phase of a production—bare-bones tracking yields a result much closer to what I perceive is occurring while the musicians are playing.”

But Goggin takes his pursuit of the live performance an extra step further. “I keep the tape machines rolling all the time and may even walk around the room, adjusting mics or repositioning amps. This approach seems to counteract the instinct to tense up because there is no official transition from rehearsing a song to shooting for an actual take.”

### KEEPING IT SIMPLE

Joe Hannigan’s Weston Sound ([www.westonsound.com](http://www.westonsound.com)) has become one of Philadelphia’s leading sources for classical, jazz and choral location

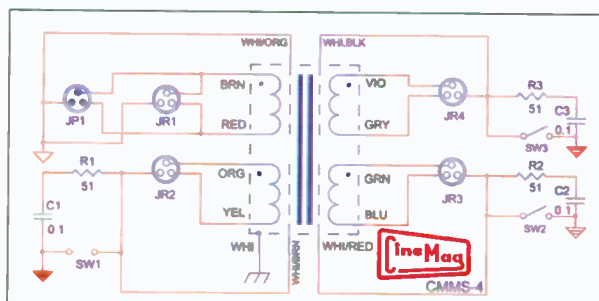

Figure 2: Four identical windings can route one mic signal to four sources.

 **SENNHEISER**

Reality TV

Broadcast

West End, London

**Broadway, NY**

Live Concerts

Shows & Theaters

Sports Events

Reliably covered by  
**Sennheiser RF wireless**



You can always rely on Sennheiser RF wireless systems, wherever you are in the world, whatever the task you face. As one of our customers puts it, "Sennheiser RF works where others fail". Try the surprisingly small and rugged new SK 5212 bodypack and the awarded microphone SKM 5200 on any stage or broadcast situation. Choose from the world's most comprehensive RF wireless portfolio for proven quality and innovative products – with microphone and accessories of every sort of custom-made specials and global support service. Sennheiser equipment is upwards and downwards compatible so it always remains a reliable investment  
[www.sennheiser.com](http://www.sennheiser.com)



recording.

Hannigan keeps his rig simple, running Magix Sequoia V8 on a Sony VAIO laptop. The front and back end is a Mackie Onyx 1640 with FireWire option. In an SKB road case is an HHB Burn-It CD recorder, power supplies and cables, and for safety—always important during live recordings—a Tascam DA-38 digital 8-track deck connects to the Onyx via balanced D-25 connectors.

"As many as 16 tracks can be recorded this way," says Hannigan. "Our 16-channel snake has four returns back to the stage for talkback and headphone feeds, which is

perfect for classical, jazz or pop sessions, and concerts. It all goes in and out of the van to the venue quickly on a hand truck."

It's surprising how many recording essentials can be found at your local mall. Hannigan's hand truck was a \$50 Office Depot purchase, as was a Rack-n-Roll plastic carry case for cables and paraphernalia with collapsible handle and tilt-back wheels—a steal at \$19. "However, custom reinforcement of the bottom tray is strongly suggested," Hannigan warns. One more mall treasure? Quick-fold aluminum tables that come in easy-to-carry black canvas travel bags—

another \$19 bargain at Bed, Bath and Beyond. "Our clients walk away with a temp CD copy (made from the console's various stereo outputs) and we take home a pristine multitrack recording," Hannigan says.

#### LIVE FOR LIVE

"A laptop is a very useful live television tool," says Fritz Lang, who makes sound cues happen on time for live programming. "For award and other entertainment shows, I use two Apple PowerBooks: a 15-inch as a virtual card machine and a 17-inch for my DAW." Although Ableton Live is geared toward the gigging musician and DJ, "It does an excellent job of replacing four cart machines," Lang adds.

"For the front end, I use the MOTU Traveler FireWire hardware that provides four analog stereo outputs. The first channel pair is for voice-overs—presenter intros or bumper teasers—in or out of a segment. Bumper music and play-ons are on the next pair. I'll use two 'tracks,' as Live calls them, when crossfading between cuts, but they output to the same analog outs. The third pair of outs are used when an artist sings to a backing track. Sometimes I'll add audience sweetening to the mix on the fourth pair so that a segue out of a live performance to the next element isn't littered with room mics."

Lang has discovered other useful features in Live. "You can set a loop in music and turn it on and off at will while playing," he says. "This comes in handy when someone takes a bit longer to get to the podium or to thank everyone involved."

On the recording side, "The Traveler has four good mic preamps and Live lets you record even while simultaneously playing back other cuts, which is very handy," Lang continues. "I also take advantage of the Traveler's MIDI capabilities by using a MIDI fader console to control the fades and crossfades ahead of the production mixer. This helps reduce the number of extra hands required to get through the 96-plus inputs that are so typical on shows of this type."

Lang's system—the 15-inch PowerBook, MOTU Traveler, a FireWire drive and a trackball—fits in a small backpack. The 17-inch PowerBook is the control side of a very portable DAW package, with a Magma external CardBus chassis plugged into the PowerBook's PCM-CIA slot. "This combo gives me enough firepower to easily record 48 tracks at 48kHz/24-bit." The entire rig fits into a small Pelican case. ■

Visit Eddie online at [www.tangible-technology.com](http://www.tangible-technology.com).

# Legend Redefined!

## Toft Audio Series ATB Consoles

From world renowned designer Malcolm Toft, come the first consoles to bear his name. Crafted using today's technology on a foundation of classic analogue design, Toft Series ATB Consoles are destined to become the cornerstones of project and professional studios alike.



Available in 16, 24, & 32 Channel configurations offering up to 88 channels on mixdown!



**Toft Audio Designs**

[www.toftaudio.com](http://www.toftaudio.com)

Prototype Shown. Features, specifications and appearance subject to change without notice.  
Toft Audio Designs® is a registered trademark of PMI Audio Group ©2006. All Rights Reserved.  
PMI Audio Group 1845 W 169th ST Gardena, CA 90247 V 877.563.6335 F 310.323.9051 E [info@toftaudio.com](mailto:info@toftaudio.com)



Find the right music content every time.  
Fast, easy, and 100% royalty-free.

When you need music and audio content, you want to cut through the clutter and locate unique materials that won't blow your budget. The Sony® Sound Series™ catalog contains over 125 royalty-free content libraries—from single instrument files and song construction kits to exclusive sound effects and our groundbreaking Artist Integrated™ series of fully synchronized libraries. Our sounds are expertly organized so you can find what you need—fast. Our legendary pitch-shifting and time-stretching materials has made ADGeeq® loops an industry standard that is supported by most music creation applications. Sony Sound Series loops can be imported into any program that supports the .wav file format.

To audition and purchase Sony Sound Series loops or locate a dealer near you, go to [www.sony.com/loops](http://www.sony.com/loops).





# Tools of the Trade



## EDIROL R-4 PRO RECORDER

The highly skilled big brother to the portable R-4 handheld recorder, Edirol's R-4 Pro ([www.edirol.com](http://www.edirol.com), \$1,595) provides the ability to slave to or act as a master to any device via SMPTE timecode. The 4-channel recorder also features AES/EBU I/O (XLR), 4-channel analog I/O (XLR combo), DC input for an external battery, USB 2 backup, individual monitoring of its four channels and uncompressed recording up to 96kHz/24-bit. The internal 80GB hard drive can record approximately 116 hours at 16-bit/44.1kHz, 106 hours at 16-bit/48kHz, 70 hours at 24-bit/48kHz, 34 hours at 16-bit/96kHz and 30 hours at 24-bit/96kHz. The four inputs include phantom-powered mic preamps with individual gain control and an onboard limiter as a safety net against sudden transient peaks. The R-4 Pro includes built-in omni mics and a pre-record function that captures audio before the Record button is pushed.

## BUZZ AUDIO ELIXIR PRE

The latest preamp from Buzz Audio ([www.buzzaudio.com](http://www.buzzaudio.com)) is Elixir (\$895), a Class-A unit



with a transformerless input coupled with a Lundahl transformer on the output. Designed to fit into the API 500 Series rack format, Elixir offers up to 70 dB of gain, +34 dBu of output level before clipping, low noise level (-132.5dB EIN) and an upper frequency response out to 300k. Controls include an output mute switch, high- and low-input impedance selection, polarity flip, input pad and phantom power on/off. A front panel 1/4-inch jack

accepts instrument level input.

## NADY TRM-6 TUBE/RIBBON MIC

Said to inarry the richness of a tube output with the unique transient and frequency characteristics of a ribbon mic, the TRM-6 (\$499.99) tube/ribbon transducer from Nady ([www.nady.com](http://www.nady.com)) features a low-tension, 45mm-long, 2-micron-thick aluminum ribbon and a 12AX7A preamp tube. The mic boasts an ultrahigh dynamic range and >135dB SPL capability. It includes a spider shock-mount, foam windscreens power supply, 33-foot XLR cable and lockable aluminum flight case.

## DK-TECHNOLOGIES DK-MATRIX SOFTWARE

DK-Technologies ([www.dk-technologies.com](http://www.dk-technologies.com)) has released DK-Matrix for its line of high-end meters. Although DK's MSD600M and PT0660M meters are front panel-configurable, this new PC software option lets users tweak aspects of the meters to suit their needs, as well as add new features. The software allows crosspoints within the internal matrix to be set to

connect the audio inputs to the outputs and to a variety of displays, such as PPM bars, the JellyFish surround sound display, phase meter and spectrum analyzer. DK-Matrix also allows input/output labeling and assigning different color/widths to the PPM bars. DK-Matrix is available to all new audio meter customers, and is included with updates to DK's new Version 5 instrument software as part of the company's SoftWare Assurance (SWA) package.



## TROODON TECHNOLOGIES TROOTRACE ANALYSIS PLUG-IN

Studio and live sound engineers will be able to take the guesswork out of room setup, tuning, equalization and time-alignment problems by using the TDM TrooTrace (\$495) plug-in from Troodon Technologies ([www.troodontechologies.com](http://www.troodontechologies.com)). The plug features 10 audio analysis and system-alignment tools, including single- and dual-channel FFT analysis functions such as input spectrum (RTA) and spectrograph; system frequency, time and phase response; auto-delay; coherence; SnapDiff Live; and peak/RMS level meters. The interface allows the user to store and recall custom layouts, view multiple functions simultaneously and quickly zoom in on areas of interest. New signal routing features in Digidesign's VENUE D-Show 2 software allow any solo'ed instrument or mix to be sent to TrooTrace for immediate analysis.

**DISC MAKERS  
REFLEXAUTO3/REFLEXAUTO8**

Duping CDs and DVDs is easier than ever with Disc Makers' ([www.discmakers.com](http://www.discmakers.com)) first automated tower duplicators: the ReflexAuto3 and the ReflexAuto8. Promising high-volume output with minimal interaction, the ReflexAuto8 (\$4,790) lets users burn 32 DVDs or 48 CDs per hour with a 1,000-disc capacity. The ReflexAuto8 carries eight Plextor 16x DVD±R/48x CD-R drives and includes a 160GB internal hard drive. The ReflexAuto3 (\$1,890) duplicates 18 DVDs or 26 CDs per hour, uses three Plextor 16x DVD±R/48x CD-R drives and includes a 160GB internal hard drive.

**LINEAR ACOUSTIC  
AEROMAX AACPLUS**

The AEROMAX aacPlus from Linear Acoustic ([www.linearacoustic.com](http://www.linearacoustic.com), \$10,000 base price) is the first surround sound encoder and decoder to accommodate Dolby-E Metadata format directly throughout the broadcasting transmission chain. The unit is the chosen audio codec for XM Satellite Radio and is standardized across a variety of platforms as a compression format for digital audio, including DVB, MPEG, 3GPP and other international standards.

**IK MULTIMEDIA AMPEG SVX**

IK Multimedia's Ampeg SVX plug-in ([www.ikmultimedia.com](http://www.ikmultimedia.com), \$399) features more than 20 bass gear emulations—including classic Ampeg bass amp models and stomp boxes—powered by AmpliTube's unique DSM (Dynamic Saturation Modeling) technology. The emulations include



Ampeg amp models of the BA-500, B-15R "Portaflex," SVT-CL and SVT-4PRO, along with six Ampeg cabinet models and six microphone simulations in four positions each. Also included are eight modeled stomp boxes, a precision tuner and support for all major plug-in platforms on Mac/PC.

**AUDIOBASE TECHNO BASE 1**

"Try before you buy" can be music to your ears if you're looking for samples. AudioBase.com has released Techno Base 1 (\$99.90), a collection of 2,000 loops by seven of AudioBase.com's top techno producers. Both Apple Loops and WAV versions (16-bit/44.1kHz) of the collection are available. By visiting the Website, users can download 80 full-quality files from the collection for free.

**NEUMANN KM SERIES DIGITAL MICS**

Taking the legacy KM line of mics into the future, Neumann ([www.neumann.com](http://www.neumann.com)) has introduced three new digital models: the KM 183 D, KM 184 D and KM 185 D. The mics' modular construction permits the passive omnidirectional, cardioid and supercardioid capsules to be combined with the KM

D output stage, with more directional options promised soon. The Neumann A/D converter from the Solution-D D-01 is located immediately next to the capsule. Integrated DSP functions—including gain, compressor/limiter and de-esser and a peak



limiter—can be configured and controlled remotely via the DMI-2 digital microphone interface and the RCS remote-control software. The mics come in nickel and black Nextel finishes, and support all sampling frequencies from 44.1 to 192 kHz.

**SFX MACHINE PRO 1**

This versatile and affordable multi-effects plug-in for Mac and PC from SFX Machine ([www.sfxmachine.com](http://www.sfxmachine.com)) features more than 300 presets and a preset editor, which allows users to create their own effects. Other features include host tempo sync, which facilitates locking LFO frequencies and delay line lengths to a sequencer's





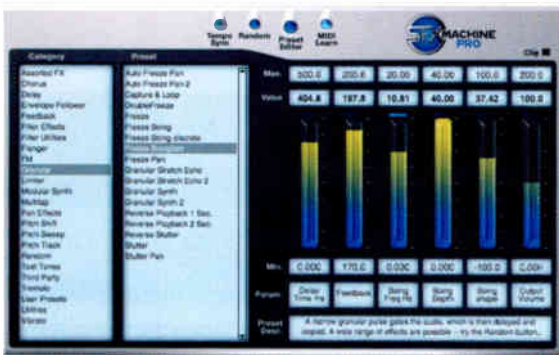

tempo, an output limiter, automated parameter control via a MIDI Learn interface and a Randomize button for quick effect paradigm shifts. The plug is available in VST and Audio Units formats for Mac OS X, and in VST format for Windows. Price: \$199.

**URS CLASSIC CONSOLE STRIP**

This new DSP-sipping plug-in from URS ([www.ursplugins.com](http://www.ursplugins.com)) features separate compressor and EQ sections, each with separate in/out switching. The Classic

Console Strip allows 12 instances per HD Accel chip, five instances per HD chip (TDM) and 48 instances at 30% CPU usage on a 2GHz Mac G5 Quad. The URS Strip Compressor digitally re-creates characteristics of a transformer input and a specially

designed 1975 VCA gain-reduction amplifier. It features fully adjustable threshold, ratio and gain makeup, and has three preset attack and release settings. The EQ section offers LF and HF bands with three different frequencies, while the midrange band is fully sweepable with a selection of wide or sharp

“Q” bandwidth. Prices: \$499.99 (TDM, RTAS, Audio Units, VST); native, \$249.99 (RTAS, Audio Units, VST).

**SENNHEISER E 602 II**

The e 602 II (\$289) cardioid dynamic mic from Sennheiser ([www.sennheiserusa.com](http://www.sennheiserusa.com)) is designed to work with kick drums, bass guitar cabs, tubas and other low-frequency instruments. The mic is 40% lighter than its predecessor, the e 602, making it easier than ever to tuck into tight spots at the end of a boom arm. The mic also offers high-performance voice coil construction, a shock-mounted capsule, fast transient response and extended LF response, and is housed in a rugged aluminum body. The e 602 II also features a hum-compensating coil to help eliminate electrical interference, and it comes with an integrated stand-mount and protective pouch.



# Upgrades and Updates

Muse Research ([www.museresearch.com](http://www.museresearch.com)) has released new UniWire audio and MIDI networking technology in the V. 1.5 system software update for its Receptor hardware plug-in player. UniWire allows customers to offload processor-intensive tasks to Receptor while retaining complete control and integration with their computer DAW program. This way, Receptor can serve as an external, modular DSP processor that can be used as an accelerator for any desktop or laptop PC or Mac...**TL Audio** (dist. in the U.S. by Independent Audio, [www.independentaudio.com](http://www.independentaudio.com)) has launched the **TL Audio M4/40-channel and M4/48-channel tube mixers**. The new desks carry additional channels and still feature four valve stages from input to output, 4-band swept EQ, four aux sends, separate track level output, an optional ADAT interface and 24-bit/96kHz output...**Sony Media Software's** ([www.sonymediasoftware.com](http://www.sonymediasoftware.com)) **Cinescore**, its new software-based soundtrack creation platform, is now shipping. The software gives videographers, photographers and broadcasters the ability to select a basic theme and then sit back while Cinescore's music-generation engine creates custom music that can be shaped to fit any

project...**Audio Ease** ([www.audioease.com](http://www.audioease.com)) has released a **Windows RTAS and VST version of Altiverb**, the convolution reverb originally released only on the Mac. The new version is available as a free download for all Altiverb 5 owners. Also on the horizon for Altiverb is a version that runs on Digidesign TDM chips, RTAS versions optimized for Pro Tools 7 and an Intel Mac-compatible version...Speaking of which, **MOTU's** ([www.motu.com](http://www.motu.com)) **Ethno Instrument V. 1 is now shipping as a Universal Binary** for Intel Mac, PowerPC Mac and Windows. In a simultaneous release, **V. 1.1.2 of the MOTU Symphonic Instrument is also now shipping as a Universal Binary update** that includes numerous enhancements and optimizations...**Steinberg Media Technologies** ([www.steinberg.net/hso](http://www.steinberg.net/hso)) is now shipping the **HALion Symphonic Orchestra (HSO)**, a new 27GB orchestral library offering more than 1,250 orchestral string, woodwind, brass and percussion instrument patches, including a vast array of articulations and playing styles. HSO also offers state-of-the-art sampling technologies such as RealAmbience, RAMSave,



Crescendo Control and more...All PreSonus ([www.presonus.com](http://www.presonus.com)) recording systems, including Firepod, Firebox and Inspire 1394, are fully compatible with all Apple computers loaded with Intel processors. As all PreSonus recording systems are class-compliant and built into the OS X operating system, there was no need for a driver update. However, software control panels need to be updated and are now available for download...It's always nice to end this section with something free, so here goes! **Ableton** ([www.ableton.com](http://www.ableton.com)) announces a free upgrade to **Live Lite 5 Enhanced Edition** for current Live Lite Digidesign Edition and all Ableton Live Lite M-Audio versions. Live Lite 5 Enhanced Edition offers many features found in Live 5, including plug-in delay compensation, MIDI remote control, full ReWire support, high-definition recording and rendering (up to 32-bit), Mackie Control support, track freeze and the Complex Warp mode for high-fidelity, on-the-fly time stretching. ■



# Xrange

high quality 64-bits

tools

monitoring

hundreds of full-featured channels

native engine

low latency

scalability

affordable solution



*Harrison has Something **NEW**  
Under the Hood!*

## THE SCALABLE AND AFFORDABLE NATIVE ENGINE

X-Range™ is Harrison's new Ethernet-based audio solution. The X-Range product line includes native processing PCs and a proprietary Ethernet-based audio router. All solutions are made with Harrison's attention to scalability and audio quality. Each of the X-Range components can be fitted together to make an entire low-latency audio system. Combine with Harrison's new Trion™ surface to obtain a high quality Harrison console for an amazing price.

X-Range is synonymous with Ethernet audio. Harrison's Gigabit Ethernet connection (X-Link™) is able to

deliver a *whopping* 256 channels of 64-bit floating point audio. X-Link enables the components in the X-Range system to never experience ANY audio degradation due to truncation on the transmission medium. If you are interested in the X-Range Processing Solution, call Harrison at (615) 641-7200, visit our website at [www.harrisonconsoles.com](http://www.harrisonconsoles.com), or email Harrison at [info@harrisonconsoles](mailto:info@harrisonconsoles) for more information.

*Twenty-eight years of producing the  
BEST audio solutions for film and post!*



# Sony Media Software ACID Pro 6

## Multitrack Recording, MIDI Editing and Loop Playback for PC

Sony has never been shy about updating ACID, the company's workhorse program for PC. The recent release of ACID 6—hot on the heels of last year's 5 update—satisfies the wishlists of its dedicated user base. With V. 6, Sony has added a number of important new tools and performance upgrades that, for many media producers, may make it the place where they can spend the vast majority of their musical lives.

### WHAT'S NEW WITH YOU?

New features in V. 6 include multitrack audio and MIDI recording; multiple media files per track; inline MIDI editing, with filtering and processing; VSTi parameter automation; drum map editing; project sections for increased arranging efficiency; support for hardware control surfaces, including native support for Mackie Control Universal; record input monitoring; a high-performance audio engine with 24-bit/192k support; and an included Native Instruments Kompakt sample playback interface with a custom sound library. Advanced features such as 5.1 and full video support carry over from V. 5.

These features look very compelling on paper, so how does the program work in practice? Installation on my machine, a Windows XP PC with a 2.26GHz processor and 1 GB of RAM, went relatively smoothly, although there were a couple of bothersome quirks.

ACID 6 also hung up when I set up my VSTi synths folder due to an incompatibility with one of the soft synths that had worked fine in 5. Rooting out the offending .dll file took a lot of time and should not have been necessary. Lastly, registration of the Kompakt player was very poorly managed on NI's end, with a frustrating labyrinth of online steps that made completing the full install of ACID 6 needlessly painful.

### LET'S GET ORGANIZED

The heart of ACID's appeal is its ability to provide flexible audio control within the firm logic of its grid. With this upgrade, several simple new features give you expanded control over project management. ACID now offers a friendly environment to audition different arrangements.

The Paint Clip Selector button introduces more versatility. Essentially a "box" within the track, you can now make each track home to multiple clips—loops or other audio events—by dragging them from the Explorer window or from other existing tracks to the destination track's box. Using a variety of methods, you can instantly switch between the available clips. (I prefer right-clicking on the drawn-in audio on the timeline.) This allows for quick comparisons between two different drum loops or bass lines, for example, without having to create another track and then draw or paint in the audio.

Another key development is the ability to quickly create and move sections of a project. To create a region, highlight it with the Time Selection tool and click Section from Insert. Give the section a name, and if you want to move that section, just click it and drag it on the timeline. A red symbol appears, showing where the clip will land. Simply release the mouse button and there you are.

### ACID TEST

A surface examination of ACID 6 reveals only the subtlest of differences between it and its predecessors, and for good reason: Its all-business, grid-oriented user interface is what makes it uniquely efficient to work with. Beyond the tiniest of cosmetic changes, however, a deeper look begins to show what makes this update so significant.

Create an audio track, and the expanded control group in its header reveals deeper functionality with greater control. Volume and pan sliders now coexist simultaneously alongside a very DAW-like Automation Settings button that allows you to turn automation on and off, and select between two different write modes.

Most significant is the red-colored Arm for Record button to the left of the long-standing Track FX button. Clicking on Arm for Record causes the selected track to



ACID Pro 6 main screen shows metering, inline MIDI editing, regions and more.

display the number of the audio input to which it's routed. Users can click on that number to dial up a range of options for changing the audio input—depending on how many inputs your soundcard has—as well as changing input monitoring modes in the event that you want to apply effects and monitor in real time as you record. In addition, an attractive, highly legible and accurate horizontal meter joins the party to show your signal's strength.

### RECORDING ON EASY STREET

In the past, recording audio into ACID was an activity purely for the masochist. It required using a large, screen-blocking window that worked primitively and only allowed recording one track at a time. Now, you can record multiple audio or MIDI tracks quickly and intuitively.

In one project, I plugged a microphone into input 1 of my soundcard and the stereo outputs of a drum machine into inputs 3 and 4. Once I had set up three audio tracks in ACID, routing each input to an independent track was a snap, as was setting the appropriate levels. With each track armed, the last step was to press the red Record button on the Transport and go. The audio was recorded cleanly at 24 bits, and I was able to watch the waveform's progress as I went—something that wasn't possible in previous versions. As a result, ACID is now a very fast, efficient multitrack recorder, and just as easy to use, if not easier, than my chosen DAW platform,

# They're not for everyone!

Some people want their studio monitors to sound good. Others want them to look good.  
The ASP8's promise one thing and one thing only... **Accurate monitoring!**

*The first time you listen to a pair of Studio Precision™ monitors, you'll almost surely shake your head in disbelief - then break out in a smile. We've seen it happen time and time again: People just can't believe that they're hearing a sound so big and so alive coming from direct field monitors. But your ears aren't deceiving you.*

*Studio Precision monitors deliver a sound that's much wider, much deeper, much more defined, and packed with much more low-end punch than mere mortal direct field monitors.*

*Simply put, they far exceed people's sonic expectations—and by a huge margin.*



EVENT  
ASP8

Electronic Musician

2005  
EDITORS  
CHOICE



## STUDIO PRECISION

Direct Field Monitor System



Made in the USA

- **Tight, Punchy, In-Your-Chest Low End**
- **Soaring Highs, Expansive Soundscape**
- **High-Powered Performance**
- **No More Guesswork**

[www.eventelectronics.com](http://www.eventelectronics.com)

Event Electronics

Phone: 805 566 7777

P.O. Box 4189

Santa Barbara,

California, 93140 US



Steinberg Cubase SX3.

With previous versions of ACID, as the number of audio tracks grew, I found that the program had a much lower tolerance for effects than Cubase, with the CPU choking much more quickly than my DAW when a fairly standard number of reverbs, choruses, compressors, delays, etc., were inserted. Unfortunately, this is still the case with 6—for large projects requiring higher amounts of DSP power, you may need to finish your tracks elsewhere.

Experienced ACID users may be shocked to think that their beloved "Use Original Tempo" option on the Track Properties has been eliminated, but, fortunately, it has simply been moved. That control is now on the Event Context menus as tracks can have multiple media clips.

### MIDI POWERHOUSE

The enhancements to ACID's audio capabilities are perhaps even more exciting than its improved audio recording functionality, especially because soft synths form the core of so many artists' and producers' workflow.

Just like audio, MIDI recording is now much easier, more intuitive and more musical than it was in previous versions. Playing in real time is again simply a matter of inserting a soft synth into the track, pressing Record and proceeding. To record multiple passes, activate loop playback on the Transport and ACID will save each take and number them, leaving the most recent as the active clip when recording is completed.

It's easy to switch between the different

passes you've just laid down and choose the best: Right-click on the track's new MIDI event and then select the top option, Event Clip, which then leads you to a numbered list of "MIDI Recording-1", "MIDI Recording-2" and so on, which you can then choose to drop into the track. This process, which works the same for ACID audio recordings, makes it extremely easy to locate and use the best take for your project.

Astute ACID users will notice two new buttons on the right side of the Transport, Step Record and Merge Record, both of which also affect MIDI recording. Step recording involves using a convenient and intuitive dialog box, which, when enabled, allows you to move note by note through the timeline, changing the values of step size, duration and velocity. For the first time, I felt like I had complete step sequencer-style control of the synth parts I recorded into ACID as I constructed a lead on my VoltKitchen Minimogue VA software synth (a virtual Minimogue synth).

Also, putting MIDI control data on a prerecorded MIDI track is now easier. Press the MIDI Merge Record button, go wild with your pitch bend or other hardware MIDI control, and the automated changes appear on the track over your MIDI note information. Once recording is complete, you can manipulate the MIDI data—note position, velocity, pitch bend, controller info—directly on the ACID timeline without leaving the main interface, another time-saver that will make a big difference to MIDI-heads.

A MIDI Input button on the track now allows for a much higher level of control for

soft synth users. Clicking there gives users quick access to output settings, input filters and the Clip Pool. Combined with multiple input MIDI recording, this makes it easy to split a keyboard, for example. I was able to quickly assign an organ patch to A1-B4 and a Clav to C5-C9 with the Filters Note message and send each instrument to a separate track while recording in real time—very handy. Everything is intuitive, but a quick visit to ACID's Online Help section for many of these features will probably be time well spent.

### A SIGNIFICANT UPDATE

From its inception, ACID has been useful to producers, artists, composers and arrangers who appreciated how its businesslike interface could be a place for meticulously building songs, especially when working with loop-based music. With the V. 6 update, however, ACID has officially become an inspiring tool for PC users. (I hope there will be a Mac version someday.) Audio recording is now fast, efficient and—yes—fun. MIDI capabilities, meanwhile, have become extremely useful and deep, making ACID a creative playground for the fast-growing legions of people who use soft synths almost exclusively. You might realize this with just a glance, but after some serious use, it becomes obvious that ACID 6 is a big step forward.

Prices: ACID Pro 6, \$399.96 (box); \$374.96 (download); \$199.95 (upgrade); \$299.95 (upgrade to ACID Music Studio)

Sony Media Software, 608/204-7680, [www.sonymediasoftware.com](http://www.sonymediasoftware.com). ■

David Weiss is Mix's New York editor.



**E-Signature Series**

**19" of Pure Wickedness.**  
The classic console sound in a rack.

 [www.solid-state-logic.com/esig](http://www.solid-state-logic.com/esig)

**Solid State Logic**  
SOUND | VISION

# Session-proven plug-ins that matter.

Powerful tools from the expertise of Roger Nichols.

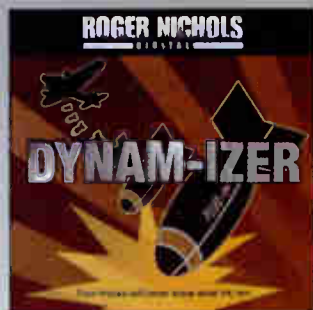

### Dynam-Izer™

Get Those Levels Under Control

Includes RTAS, VST, AU for Mac OS X & RTAS, VST for Windows®  
Why always apply the same compression to all audio levels? This plug-in lets you break your audio levels up into zones so you can control them exactly how you want. **\$249.00**



### Finis™

Peak Limiter That Controls Dynamics

Includes RTAS, VST, AU for Mac OS X & RTAS, VST for Windows®  
This plug-in employs the most advanced limiting algorithms we know of. Great Tools don't need to have complicated user interfaces. There's nothing else to do after Finis. **\$249.00**

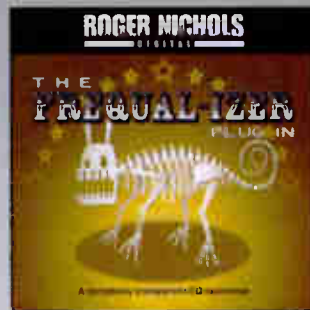

### Frequal-Izer™

Surgically-Accurate Mastering EQ

Includes RTAS, VST, AU for Mac OS X & RTAS, VST for Windows®  
This plug-in builds a complex FIR (Finite Impulse Response) filter to your specifications. Draw and edit your own EQ curve. **\$249.00**



### Uniquel-Izer™

The Swiss Army Knife of Equalizers

Includes RTAS, VST, AU for Mac OS X & RTAS, VST for Windows®  
Why work within the confines of an EQ configuration? This plug-in lets you determine your ideal EQ. And if you ever need more bands or filters, they're just a click away..... **\$249.00**

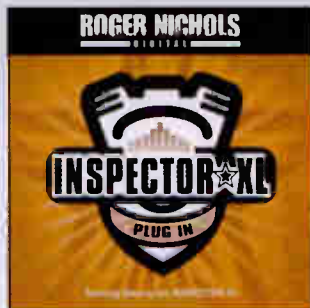

### Inspector XL™

Collection of Powerful Analysis Tools

Includes RTAS, VST, AU for Mac OS X & RTAS, VST for Windows®  
A collection of six individual, powerful audio analysis tools designed to fulfill a number of familiar analysis tasks with professionalism, style and finesse..... **\$299.00**



### Inspector

It's Free - Compact but Powerful Analysis

Includes RTAS, VST, AU for Mac OS X & RTAS, VST for Windows®  
Get a full picture of your audio. Inspector is a compact yet powerful tool that offers everything from spectral analysis to extensive peak/RMS metering and a balance meter..... **\$FREE**

You need these plug-ins. Let nearly four decades of production success work for you – Roger Nichol's name is on the box so you know they work in your workstation to produce scintillating results. We have five hot new plug-ins and a freebie available now, with more to come by the AES Convention in San Francisco.

Roger Nichols has worked with the *crème de la crème* of the world's most successful artists – and picked up seven Grammy® Awards in the process – he definitely knows of what he speaks. Now that hands-on experience can be owned by digital audio workstation users in the form of a quintet of truly powerful plug-ins. Plus a freebie!



www.RogerNicholsDigital.com | 727.230-1603 | Also available thru Sweetwater and other dealers.



# Yamaha AW2400 24-Track Hard Disc Recorder

## New Addition to AW Series Brings More Effects, Tracks and I/O

Yamaha knows a thing or two about building personal digital audio workstations. In 2001, the company launched its AW Series, which was largely based on the prowess of its 02R digital console, 24-bit recorders, performance samplers, multi-effects DSPs and CD-R burners. Yamaha crammed all this technology into a gig- and travel-friendly package.

The AW2400 updates and improves on many of the AW product line's features. Backward-compatible with previous models, the new flagship boasts a series-largest 24-track 40GB HD recorder with superior-sounding mixing and flexible signal routing capabilities borrowed from the company's 01V96 V2 console. Other features include moving fader automation, four independent stereo multi-effects processors, eight microphone preamps, I/O expansion, an internal CD-RW drive, and data transfer and controller between computers and external equipment.

### IMPRESSIVE WORKSURFACE

The 25-pound AW2400 has a 21x20-inch (WxD) footprint and measures six inches to the top of its highest knobs toward the rear. This space allows for plenty of front panel control without feeling crowded. Layout is logical with the all-important Work Navigate section directly to the left of an 02R-sized 320x240 backlit display for easy page navigation. Grouped functions such as mixer, transport/locate and data entry/control fill the bottom half of the panel. Selected Channel is a 4x4 matrix of parameters located to the right of the display for adjusting dynamics, aux sends, effects and pan/EQ settings for each channel.

By default, four soft knobs across the bottom of the matrix are assigned to pan, equalizer Q, frequency and gain duties, but take on respective parameters for the other three groups. Pushing these buttons toggles deeper pages to edit and assign effects for each of the four DSPs. Spanning the top-left of the panel are input gain control knobs with peak indicators and input-select keys; to the right are studio monitor and headphone gain knobs.



The AW2400 is the series' first unit to feature 100mm motorized faders, though they're still not touch-sensitive. In addition to a single stereo master fader, 12 channel faders are provided in five selectable layers: tracks 1 through 12; tracks 13 through 24; inputs 1 through 8/return 1 through 4; inputs 9 through 16/return 1 through 4; and master bus 1 through 2/aux send 1 through 4/effect send 1 through 4. A sixth layer is used to assign the faders to remote-control mode. The data-entry section features a 40mm non-spring-loaded jog nudge wheel with an adjacent cluster of nine user-locate keys that can be number-locked, doubling as a keypad for entering specific locate points in measure/beats. Track or song navigation is certainly one area in which the AW2400 excels, with a bounty of features including jump-to A/B, section loop/repeat, auto-punch in/out with jump-to in/out locate functionality and up to 99 markers per song with mark search. Tucked under the armrest on the right-hand side is the CD-RW drive.

The back panel sports balanced 1/4-inch

TRS and XLR mic/line sockets for each of inputs 1 through 8, with phantom power switchable on/off in groups of four; channel inputs 1 and 2 also feature TRS insert jacks. Stereo main out and monitor out are balanced TRS, while four unbalanced 1/4-inch omni outputs are for auxiliary sends to outboard effects or performer mixes to recording room monitors, headphone stations, etc. Only a single headphone jack is provided, but I'm happy to report it has one hell of a hot output for a change! Coaxial S/PDIF I/O, MIDI In/Out/Thru, a footswitch and a USB 2 port round out the unit's built-in connectivity.

You can install one of Yamaha's optional mini-YGDAI cards in the expansion slot for additional I/O or functionality, including the MY16 mLAN or Waves Y96K DSP card. Older Waves and Apogee cards are no longer listed in the manual as being compatible.

An included CD-ROM has a backup for restoring the demo song that ships on the AW2400's internal hard drive; control surface profiles for Cubase/Nuendo (Cubase LE now

# vienna instruments

VIENNA SYMPHONIC LIBRARY

## The Power of 10.

- 10 Vienna Instruments, now shipping!
- 10 of the most powerful sample-based Virtual Instruments on the planet.
- 10 times faster than creating music with conventional samplers.
- 10 easy-to-use and intuitive software instruments with literally zero learning curve.
- 10 user-configurable Interfaces for drag-and-drop Orchestra Creation.
- 10 real-time controls to trigger hundreds of articulations on a single MIDI channel.
- 10 "mind-reading" Performance Detection algorithms that switch automatically between articulations.
- 10 online Video Tutorials that show you how easy it is to achieve the dream.
- 10 Collections that make your computer the ultimate Orchestral Workstation.
- 10 years in the making.



10 reasons to get all 10 Vienna Instruments now, available separately or together in the Symphonic Cube.

### SYMPHONIC CUBE



TEC Award  
Nominee 2006

Watch the Videos at  
[vsl.co.at/vi/](http://vsl.co.at/vi/)

All 10 NOW SHIPPING!

AU (OS X and Mac Intel)  
VST (OS X and Win XP)

VIENNA SYMPHONIC LIBRARY  
[www.vsl.co.at](http://www.vsl.co.at)

**ILIO**  
ilio.com



included), Logic and SONAR; and a Yamaha USB MIDI driver. System requirements to use the driver are Windows XP and Mac OS 10.3. Once I got the USB driver running, I used it to update the AW2400 with the latest Version 1.13 firmware/OS from Yamaha's Website.

### STUDIO TOUR

Up to 16 inputs (with expansion card installed) can simultaneously feed the 24-track recorder uncompressed 16- or 24-bit audio at 44.1 or 48 kHz, with one nasty caveat: In 24-bit mode, the total available tracks halve to just 12 and a maximum of eight tracks may be recorded at once. An independent stereo track exists per song, used mainly as a dedicated mixdown track. Eight virtual tracks are provided per physical track, including the stereo track (meaning, 26x8 in 16-bit mode), providing plenty of room for alternate takes and mixdowns. Independent of the main recorder and therefore not influencing its track count is a handy Sound Clip feature (with metronome) that's quickly accessible from the front panel, allowing you to capture up to three minutes of inspired moments per song.

All 24 tracks and up to 16 live inputs can

be mixed for a total of 40 possible sources, internally processed at 32-bit. Routing is the most flexible it has ever been in this series. Effects can be inserted on inputs, tracks, stereo output, bus master and aux send channels in one of three positions: pre-channel EQ, pre-fader or post-fader. Dedicated compressor/expander blocks on each channel are always present and can be likewise inserted. Input channels also feature a gate. Channel EQ is 4-band parametric on all inputs, tracks, sends, returns and buses, with lo-mid and hi-mid bands providing peaking EQ, while the low and high bands can be shelving, peaking or HP/LP. In addition to the original AW Series EQ, a new Type-II EQ promises to more closely represent analog response. Also new is a dedicated PitchFix tool with formant correction.

The USB port is only for data transfer and cannot be used for audio streaming. By default, it handles MIDI messages, but can also transfer WAV files to and from a PC or Mac for storage or further manipulation. For example, you might transfer a recording made on the AW2400 to your computer and use software for advanced waveform editing as the AW2400 sorely lacks this

crucial utility. It is also possible to directly access data on the AW2400's internal hard disk from the computer and edit the data in place.

The MIDI functions are pretty straightforward: You can synchronize operation with an external device; remotely control the AW2400's transport and automate scene changes and mix parameters; or launch MIDI Remote mode, turning the AW2400 into a physical controller for an external device, such as your favorite DAW application or MIDI sound module (using the MIDI Learn feature).

### RECORD, MIX, BURN!

Cherished condenser mics in hand, I set out to record a highly dynamic session of hand drums, tambourine, acoustic guitar and female vocals "en ensemble" to test the chops of the AW2400's preamps. I can't say these blew me away, as they didn't seem to capture the warm, woody tones in the drums or Taylor guitar in the way I'd demand from a dedicated outboard. It is true, of course, that you cannot expect eight channels of \$1,300 tube pre performance from a \$2,600 solid-state DAW, either. But they did do justice to the vocals, which sounded sweet,

## Raise Your Wireless Standards



Venue Modular Receiver  
shown with UT-300, UM400, LM, MM400B, and SM transmitters

Today's PA system requirements demand superior sound to accompany advanced lighting and staging techniques. Trust Lectrosonics to deliver the sound, with rock solid RF performance.

Lectrosonics' wireless systems are designed to meet only the highest quality standards. They are rugged, reliable, flexible, and sound as good as the best hard-wired system without the hassle of cables.

Lectrosonics' latest UHF system, the **Venue Modular Receiver**, operates with Digital Hybrid Wireless™ transmitters, and a variety of analog transmitters. The receiver uses a host assembly that includes:

- Six channels in a single rack space
- Built-in antenna multicoupler
- Computer interface included with USB and RS-232 ports
- Compressorless Digital Hybrid Wireless™ technology

For more information, call **Location Sound Corp.**, an authorized Lectrosonics dealer at (818) 980-9891 or outside CA at (800) 228-4429.

A complete line of Lectrosonics products are available at



**LOCATION**®  
**SOUND CORP**

SERVING THE PROFESSIONAL AUDIO INDUSTRY FOR OVER 25 YEARS.

**Employee  
Owned & Operated**

**www.locationsound.com**  
**SALES • RENTAL • SERVICE**



PRODUCTION

# THE PROFESSIONAL'S SOURCE



real world solutions from industry professionals!

[www.bhphotovideo.com](http://www.bhphotovideo.com)



800-947-5508 | 420 Ninth Ave, New York 10001 | We Ship Worldwide





natural and quite present. Thankfully, these pre's were much quieter than previous units I had experienced in the AW Series.

I then tried to compensate for some of the lost warm tones using EQ. I've found Yamaha digital EQ to be pretty sterile in the past, so I was excited to find that the Type-II EQ does have a deeper, more natural analog color that won me over. Once I moved on to record more tracks, though, I soon discovered the Type-IIs aren't available on input channels—for processor preservation, I assume. If you prefer or need a more transparent EQ, then revert

to the original, but I still found transient smearing to be a problem with both types, particularly when I mixed a harmonically rich 24-track orchestral piece. I'm also dismayed as to why Yamaha still hasn't implemented simple gates on monitor channels as part of the inline dynamics section. Gates are available as an effect insert, but this seems like an unnecessary step given that they're available at input just the same.

Upon critical listening, you'll hear the hard drive ticking away under the hood more than you will the ultraquiet cooling

fan on the back panel, but neither snuck their way into the recordings, even at 6-foot proximity. Mixing this and larger projects, the AW2400's transport, automation and scene recall system were straightforward and far more responsive-feeling than my experiences on earlier models, handling quick locate and demanding punch-in/out without even a hint of lingering.

To my ears, the effects sound about the same as they always have in the AW Series: somewhat middling and benefiting from a dedicated outboard reverb or chorus on crucial tracks such as lead vocals. I did put the PitchFix tool to work with success and appreciated it being accessible without having to dig through effects menus. However, I do wish for a full-blown waveform editor and a MIDI sequencer onboard. And for the last gripe, why are we still living in an age of being limited to eight virtual tracks? There's got to be a way to implement dynamic track allocation from unlimited files on disk that is intuitive and practical to operate on a 5-inch LCD.

Mixdown involves selecting the channels you want to record to the stereo track (from track, input and effect return channels) with the Mastering Library as an option, where you can recall EQ and dynamics settings specifically for the stereo output channel. Finalized levels can be checked onscreen before you hit Mixdown Record, a real-time process. Burning audio CDs and backing up song files to CD-R was smooth-sailing and can be performed track-at-once or disc-at-once up to a maximum write speed of 8x.

#### AS GOOD AS IT GETS?

Minus my hankering to sequence MIDI and perform advanced waveform editing onboard, you can't fault the AW2400 for not delivering on its promises. Operation is fast, smooth and intuitive, with solid recording and mixing clout, more effects provided than previously in the series and a 24-track count that should satisfy most everyone's needs.

Add to this the far improved channel routing and insertion flexibility, more robust tone of Type-II EQ, onboard mastering and the ability to burn demo CDs, and you have the most significant personal audio workstation at a relatively blockbuster price (\$2,699).

Yamaha, 714/522-9011, [www.yamahaproaudio.com](http://www.yamahaproaudio.com). ■

*Jason Scott Alexander is a producer/mixer/remixer in Ottawa, Ontario.*

**TANNOY**

**ACCURACY THROUGH PRECISION**

- Tannoy Dual Concentric™ point source drive unit
- WideBand™ SuperTweeter™ extends frequency response to over 50kHz
- Digital amplification with analogue and digital inputs
- Automated Activ-Assist™ software driven digital calibration

**ACTIV-ASSIST™**  
acoustic measurement software

**PRECISION**  
ACTIVE STUDIO MONITORS

Tannoy United Kingdom	T: +44 (0) 1236 420199	F: +44 (0) 1236 428230	E: <a href="mailto:enquiries@tannoy.com">enquiries@tannoy.com</a>
Tannoy North America	T: (519) 745 1158	F: (519) 745 2364	E: <a href="mailto:inquiries@tannoy.com">inquiries@tannoy.com</a>
Tannoy Deutschland	T: 0180 1111 88 1	F: 0180 1111 88 2	E: <a href="mailto:info@tannoy.com">info@tannoy.com</a>

# Soundcheck doesn't have to be so painful.



*The great thing about the Aviom system is that it puts control in the musicians' hands. The units are easy to set up and troubleshoot, and they function great in day-to-day use. As a musician and engineer myself, I couldn't ask for more.*

**Matthew Peskie, Jars of Clay**  
Production Manager

Musicians and engineers alike know that, even under the best of circumstances, soundchecks can be tedious and frustrating. By giving performers the ability to adjust their own monitor mixes, Aviom's Pro16™ Monitor Mixing System guarantees a smoother, faster soundcheck – with better results in less time.

Live performance is always unpredictable. No matter what combination of wedges, headphones, and in-ears you're working with, Aviom's Pro16 Monitor Mixing System makes soundcheck – and the gig itself – a better experience for all.

To learn more about Aviom's solutions for Live Sound, visit [www.Aviom.com](http://www.Aviom.com)



**AVIOM**



# Steinberg WaveLab 6 Audio Editing Suite

## Upgrade to DVD Authoring, Tone Shaping, Sample Rate Conversion

Calling Steinberg's WaveLab an audio editor would be an oversimplification because it's a high-end suite of tools for massaging, compositing and archiving almost any type of audio production. WaveLab only runs on Windows 2000/XP machines and requires a free USB port for the Syncrosoft dongle.

At \$699.99 list, WaveLab is more than twice as expensive as its most significant competition, Sony Sound Forge. A point-by-point comparison would take pages. Briefly, Sound Forge has no equivalent of WaveLab's Montage multitrack setup, Sound Forge doesn't author DVDs, it won't load AES-31 sessions and it doesn't do surround. Conversely, WaveLab won't author Acidized WAV files, which are used by Sony's Acid Pro DAW.

### PITCH CORRECTION, TONE SHAPING

WaveLab's new Spectrum edit mode allows you to pinpoint and notch out offending frequencies by drawing Photoshop-style rectangles with the mouse. I used this mode to get rid of a snare's ringing tone in a drum loop. Selected time/frequency ranges can also be copied and pasted, even to higher or lower ranges. The Spectrum display shows the frequency content of a file with adjustable time vs. frequency resolution (from 3 ms/344 Hz to 372 ms/2 Hz). I found spectrum editing surprisingly useful for adding shimmering metallic overtones to a cello track I had recorded, but the process is fiddly because a maximum of 10 seconds of audio can be edited at a time.

Before I acquired Celemony Melodyne, I had tried to use WaveLab 4 to correct the pitch of a few out-of-tune notes in a cello solo. This proved impractical, because in V. 4, the file's overall length was changed by pitch-correcting a region, even when I set the length compensation to 100 percent. In WaveLab 6, this problem has been fixed: Making pitch adjustments has no effect on file length, probably due to the use of the new high-quality DIRAC pitch-change algorithm. I'd still prefer to find the out-of-tune notes by hand rather than use WaveLab's Pitch Quantization algorithm, though, because it introduces

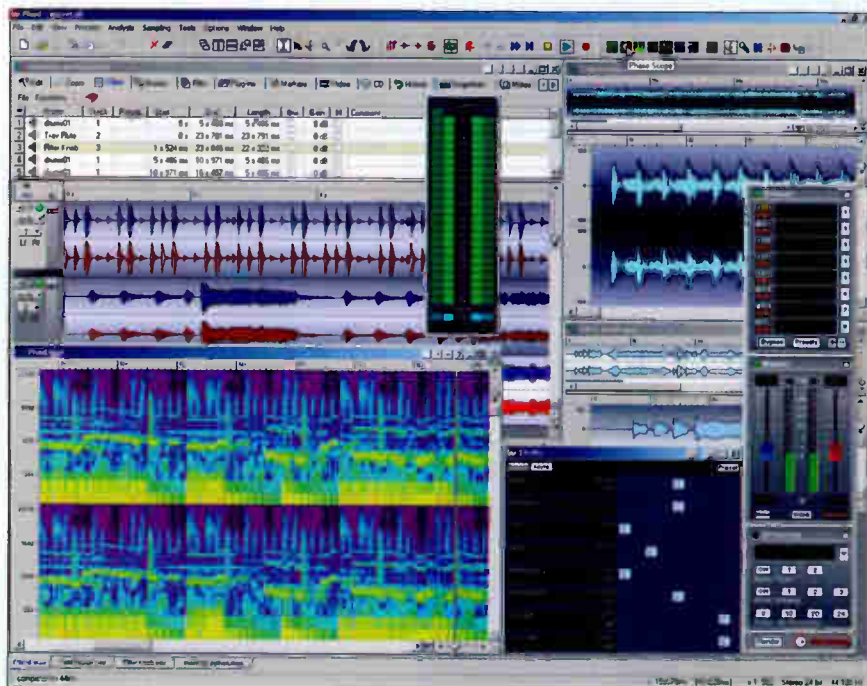

WaveLab's multitrack Montage window (upper-left), two waveform displays (right), a spectrum display (lower-left), output controls (lower-right), a bundled echo effect (lower-center) and the bit meter (center).

audible artifacts.

Plug-in effects can be applied to a section of a file with before/after morphing, which is basically a programmable crossfade between the processed and unprocessed audio. File size is now essentially unlimited, which will be appreciated by producers working on film soundtracks and other data-intensive projects. Steinberg has also added a new sample rate converter.

### MONTAGE PYTHON

Steinberg's literature carefully refers to the Montage window as primarily being a place to assemble audio files for CD and DVD creation, but in some respects, this window is as functional as a multitrack recorder. Many tracks can play back at once (you're not limited to two stereo clips with crossfading), insert VST effects can be applied to any track or individual clip and envelope-based automation is provided. There's no support for real-time automation recording or control surfaces, however. Even more problematic, there's no way to bypass an inserted effect.

The user can either monitor existing

tracks while recording a new one into the Montage or monitor the audio input through the computer, but monitoring both the input and the existing tracks while recording requires an external mixer. Global effects can be used, but the tracks have no aux sends or EQ. Video playback is supported, along with markers, snapshots and a notepad. In sum, the Montage window has plenty of tools for tasks such as assembling soundtracks from multiple stems, but it's not a full-fledged music recorder.

### BIG AUDIO FUN

Cut/copy/paste and the proverbial pencil tool are only the tip of WaveLab's iceberg. Its Process menu offers standard normalization, RMS loudness normalization and pan normalization. An offline (rendering) compressor/limiter/expander is included, along with a multi-voice harmonizer, time and pitch-change algorithms, and more standard options such as DC offset removal and phase (polarity) inversion. Tools in the Analysis menu include FFT analysis, a bit-usage meter and an analyzer that looks for



**ADAM**  
PROFESSIONAL AUDIO

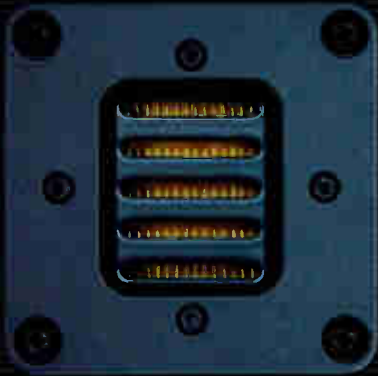

## The ADAM A.R.T. Tweeter Accelerated Ribbon Technology

ADAM's unique folded ribbon diaphragm moves air four times faster than any driver in any other professional monitor, resulting in incredible clarity, breathtaking detail and imaging like you've never heard before. You'll work faster, better, and more confidently than ever.

S6A MK2



THRILLING EARS AROUND THE WORLD

(805) 413-1133 | [usa@adam-audio.com](mailto:usa@adam-audio.com) | [www.adam-audio.com](http://www.adam-audio.com)



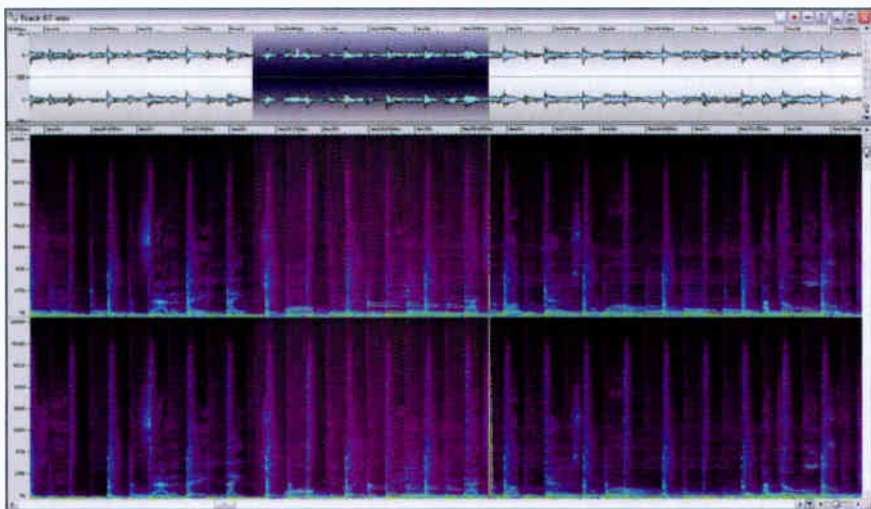

Spectrum edit mode lets you notch out selected frequencies with your mouse.

peaks, pitch and errors.

MIDI keys can duplicate the user-configurable key commands. The time ruler in the audio edit window displays time, timecode, samples, file size or bar/beat location. The latter mode has a bug, however, that causes the ruler to be blank or unreadable at certain zoom magnifications.

The Waveform Restorer is supposed to be able to remove intermittent clicks and pops, but when I drew a few obvious clicks into a file, the Waveform Restorer couldn't find them. A more complex utility, the Audio Error Detection and Correction box, also failed, no matter what settings I tried for the parameters.

A new plug-in called External Gear can

route a file through ASIO I/O hardware to an outboard effect. This plug-in can be inserted anywhere in WaveLab's master effects chain. Some online retailers report that WaveLab 6 includes a set of 8-channel surround plug-ins, but these weren't in the version I received, and they were not mentioned in the manual.

**READY TO UPGRADE?**

I've used WaveLab 4 since its release, so one of the things I noticed first and like best about WaveLab 6 is that the look and feel haven't changed. There are a lot of new features, but for current WaveLab users, the learning curve is close to nonexistent.

Many of the basic features of WaveLab 6 are included in most DAWs. The reasons to buy such an expensive program are for professional tools such as 384kHz support, 32-bit batch processing and the audio file database. If you need it, go for it—you won't regret it.

Steinberg, dist. by Yamaha, 714-522-9011, www.yamahaproaudio.com. ■

*Jim Aikin is the author of Power Tools for Synthesizer Programming (Backbeat Books).*

# TRANSPORT™

## Wireless DAW Controller

"You are now free to move about the studio."

- ⌘ 2-way RF for wireless, through-the-wall communication with your DAW
- ⌘ Presets for Pro Tools®, Digital Performer®, Sonar®, Cubase® and other DAW apps
- ⌘ Easy setup, fast access to your most often-used functions
- ⌘ Remote control of transport, mutes, solos, punches, markers, loops and more
- ⌘ Onboard metering, time display, track info, footswitch jack
- ⌘ Compatible with Mac® OS X and Windows® 2000/XP

FRONTIER  
DESIGN GROUP

www.frontierdesign.com

SCHOOL OF: COMPUTER ANIMATION > DIGITAL ARTS & DESIGN > ENTERTAINMENT BUSINESS > FILM > GAME DEVELOPMENT > RECORDING ARTS > SHOW PRODUCTION & TOURING



School of  
**Recording Arts**

**ONE OF THE  
FIVE BEST  
MUSIC  
PROGRAMS  
IN THE COUNTRY**



800.226.7625  
fullsail.com

**GET STARTED**

— *Rolling Stone Magazine*  
August 11, 2005

*If you're serious about your dream,  
we'll take your dream seriously.*

3300 University Boulevard • Winter Park, FL 32792  
Financial aid available to those who qualify • Career development assistance • Accredited College, ACCSCT

World Radio History



# Rimage 2000i Duplicator/Printer

## CD or DVD Operation With Twin Drives

This review actually began late last year, when *Mix* evaluated the Rimage 360i DVD/CD duplicator, which yielded inconsistent performance. (See sidebar.) We talked to developers at Rimage, and they felt this particular unit was not suited to the rigors of heavy professional use; they asked us to check out the midline (\$3,995) DVD CD 2000i system.

Housed in a 16x21x20-inch, 58-pound metal enclosure, the 2000i is built like a tank. The design has a 100-disc capacity and incorporates pro features such as a metal worm drive that moves the robotic arm along a linear axis rather than the semi-circular motion employed in many other duplicators, Communication to your host PC (software is provided) is via FireWire and USB, and a PCI FireWire card is included to ease the simple install process.

The DVD version pairs twin Plextor PX-716A DVD drives and a proprietary HP-designed inkjet printer for print-to-disc

functions. The printer (also offered stand-alone as the Rimage 480i) is capable of photo-quality resolution up to 4,800 dpi, thanks to its 3-picoliter micro-droplet ink jets. The system has no stand-alone capabilities and must be used with a host PC.

The unit ships with a comprehensive suite of tools for disc content mastering/duplication (QuickDisk), label creation (CD Designer), global system management control (System Manager) and system control/monitoring/logging (Production Server). The latter also has a job streaming feature, where masters can be interspersed into the blank media stack for automatic job changeovers. Some slick tricks in QuickDisk include bar code support and a mail merge-style function that can individualize each disc by inserting text from a list. Optional Office Net software (installed on a host PC) lets you send jobs over a network.

QuickDisk and CD Designer's production capabilities are serviceable, but won't replace



more intensive apps such as Adobe Photoshop and higher-end authoring tools. However, the disc master can exist as a physical CD or DVD that's cached before duplication starts or can be read from a standard disc image file, and complex graphics designs can easily

## Rimage 360i Desktop Duplicator

The 360i desktop duplicator can burn/print 25 CDs or DVDs per batch. Priced at \$1,703, it ships with an integrated software package for labeling and managing production runs and uses a Plextor 716A burner and HP print technology. Minimum PC requirements are a 800MHz Pentium III with 256MB RAM. My test system was a 4.2GHz Pentium with 1 GB of RAM.

With its white, molded plastic case and purple disc-loading access door, the 360i resembles a small 19x20x15-inch (HxWxD) robot. Setup is as simple as loading the software, unwrapping the print cartridges and plugging in a USB 2 cable. Rimage's full-featured software is easy to use and has clever features, such as the ability to customize a single label with different fields of text, which can be database-driven.

However, the unit's good first impression faded as I tested the unit. Just loading 25 CDs is cumbersome. The CDs sit on an angle, requiring some fiddling to correctly load the discs. The large, plastic main access door feels flimsy and does not open/shut smoothly.

My first 360i batch were DVDs, which seemed to burn/print just fine. However, further inspection revealed that all the discs showed two parallel scratches on the data side. Rimage acknowledged this and assured me the problem had been corrected.

While doing multiple batches of CDs and DVDs, the machine required constant attention. For example, during a CD job, the 360i would sometimes place two discs instead of one into the burner tray and jam. Several times, the robotic arm picked the disc from the burner but failed to place it in the printer tray. Once, a disc fell behind the printer and I had to dig it out.

DVDs burned fine at the maximum speed of 16x, yet CD burning speeds were an issue. One job resulted in five rejects out of 25. I could eliminate the rejects by slowing the burning speed from the promised 48x to 24x. My PC far exceeded the 360i's system requirements, but the disc image was streamed from an Ultra 320 SCSI drive with no other programs running in the background. Still, the only way to eliminate the "streaming error" message was to slow the burning speed down to 24x.

The 360i was replete with problems, so I asked for a replacement unit, which did not scratch discs and performed some duplication and print jobs without any errors. However, errors were still encountered during subsequent jobs. This 360i was more reliable than the first, but it exhibited random errors, such as when the software would not recognize the machine or the machine failed to create a CD image file and locked up.

When the 360i worked, the quality of the burned discs was outstanding and the HP print technology looked superb, especially on silver-coated media. The first 360i required so much attention that the excellent quality was overshadowed by its inability to run on its own. The second unit performed much better, requiring less babysitting, performing some (but not all) multiple jobs without errors. After my Jekyll and Hyde experience with the 360i, it's hard to recommend this duplicator.

—Rick Spence



DM1000



DM2000



## Control Freaks.

Feel like you're losing control? Put the power back in your hands with the DM Series of digital mixers from Yamaha. With the freedom to push buttons and slide faders, you can intuitively operate DAW's such as Nuendo, ProTools and Logic, while boosting your DSP with extra effects, EQ's and dynamic processors. Whether working in stereo or surround, everything you need from monitoring to panning is literally at your fingertips.

**Drop the mouse, and take control of your mixes.**



When you need help, time zones shouldn't matter. Yamaha provides coast to coast 24/7 technical support. With dedicated staff and regional service centers, assistance is around the corner. If we can't fix it over the phone, we'll put a part or a person on the next plane out. It's that simple.





be imported for printing. Originally, the 2000i also shipped with Mac OS X software, but this has been discontinued. Third-party Mac Discrite software for the 2000i is still offered through [www.charismac.com](http://www.charismac.com).

#### IN THE TRENCHES

Setup was straightforward and easy: Install the software, insert the print cartridges, connect the FireWire and USB cables and/or card, drop the disc bin into place and select the 480i as your printer. The proprietary Rimage inkjet carts are available separately or in Media Kits bundled with 600 Rimage-branded (Taiyo Yuden) CDs or DVDs.

Starting with a PC (AMD Athlon 2.2GHz with 1GB RAM and Windows 2000), I loaded a DVD for a 100-disc run. Two of the discs were bad—even the best media yields a few coasters—but I liked the fact that the 2000i recognized these as such and printed “reject” across them so they wouldn’t be confused with the good DVDs. And the inkjet print quality was excellent.

The Rimage DVD media was 8x speed—okay, but not blazing. A second DVD job was equally smooth, as were a couple of CD jobs. The latter ran at 48x on Imation and TDK media. A later DVD run resulted in about 20-

percent coasters. Rimage’s tech support told me one of their batches of DVD media was defective and sent me replacement DVDs. Repeating the run with new media, the failure rate went down to between 10 and 15 percent—better, but not pretty. Another call to tech support suggested lowering the duplication speed and/or selecting verification on each disc—both significantly slowed down the duplication time. This didn’t change the failure rate, which was still about 10 to 12 percent. Also, the robotics occasionally failed to grab a feed disc, which would pause the duplication—no disaster, but if this occurred during an overnight run, your discs wouldn’t be ready by morning.

The issues with the robotic arm gripping the feed discs continued to the point where every job had to be monitored. Occasionally, the arm gripped two discs, causing a jam. Tech support suggested reinstalling the firmware, but problems continued. Another quirk? The printer door would sometimes fail to close, causing the robotic arm to jam. Besides aborting the job, the only remedy was to reboot the entire system. If I owned a 2000i, I’d remove this (mostly unnecessary) door.

I also tried variations, including a print-

only run, followed by duplication, but problems with disc failures and the robotics continued. Eventually, one drive robotics became completely unreliable, producing 60 to 80-percent write failures or not responding.

#### THE BOTTOM LINE

Wondering if my results were typical, I talked to other 2000i users. The majority were quite positive, offering comments such as “real workhorse” and, “We love it.” However, one production company I spoke to had “nothing but problems” and sent the unit back.

To be fair, the 2000i we tested failed during the warranty period. The 2000i includes a one-year parts/labor agreement, where you pay shipping back to Rimage in Minneapolis, with a typical 15-day response. Several optional extended warranties are offered, including overnight shipping of loaner units during repairs; a “Depot Repair” plan, where your unit is expedited through service and returned within five days; and extended second-year coverage. Based on our experiences with the 2000i and 360i, we’d say one of these plans is recommended.

Rimage, 952/944-8144, [www.rimage.com](http://www.rimage.com).

## MAKES YOU WANNA SING

Innovative, High-quality Microphones with Vintage Style



With names derived from Greek mythology, audio clarity that rivals the most prestigious European microphones, a build quality backed by a 3-year

warranty and a price point that you will absolutely love, our British-designed Sontronics microphones will be heading to a mic stand near you.

available at

**samash.com**  
1-800-4-SAMASH

- ◆ Free shipping on thousands of items
- ◆ Extended Financing available
- ◆ The guaranteed lowest prices

DISTRIBUTED BY  
**mm**  
music marketing

For more info visit [www.musicmarketing.ca](http://www.musicmarketing.ca)

World Radio History

# TASCAM's DM-3200. The 32-channel digital center of your universe.



- 32 channels and 16 aux returns for 48 total inputs @96k/24-bit
- 16 busses or two 6.1 surround busses
- 8 aux sends
- 16 analog mic/line inputs with inserts
- Powerful automation with 100 mm touch-sensitive motorized faders
- Dedicated DAW control surface layer for Pro Tools®, SONAR®, DP™, Logic, Cubase® and Nuendo®
- EQ and dynamics on each channel
- 2 built-in effects engines with TC® reverb
- Per-channel LED ring encoders for pan, aux sends, EQ and more
- 24 channels of TDIF and 8 channels of ADAT™ built in
- 2 expansion slots for FireWire®, Surround Monitoring, ADAT™, AES/EBU, TDIF and analog cards
- TASCAM Mixer Companion software (Win®XP/OSX) with driverless USB connection to computer for back-up/restore of mixer data
- Get the whole DM-3200 story on-line @[www.tascam.com](http://www.tascam.com) or visit your TASCAM dealer today.

©2005 TASCAM, a division of TEAC America, Inc. All Rights Reserved.  
All trademarks are the property of their respective holders.. And so forth. And so on.

World Radio History

# TASCAM®

[www.tascam.com](http://www.tascam.com)



# Anthony Gallo A'Diva Ti Speakers, TR-2 Sub

## Active Reference System for Mixing and Mastering

New from Anthony Gallo Acoustics, the A'Diva Ti loudspeaker (with companion TR-2 subwoofer) is the newest product in an acclaimed line of audiophile speakers. Unlike other Gallo efforts, the speakers and sub are not in any kind of fixed array; rather, they are broken up into two 1.9-pound "orbs" using a supplied rubber O-ring support and a separate sub, allowing you to angle/tilt the satellite speakers to fit your room or listening area. Gallo recommends a 50-hour break-in period for the rig. My demo system seemed to require less time than that to sound its best; your mileage may vary.

### UPSTAIRS, DOWNSTAIRS

Nominal impedance for the speaker is 8 ohms, and it can handle up to 120 watts of power when the sub is being used as the source, or 50W if you choose to use your own amplification. Gallo cautions against sending the satellites a lot of bass directly from a power amp's unfiltered output. The five-way (high-power) banana output jacks on the sub roll off some of the low end, letting the satellites have a little more power without damaging them with too much low-frequency info. (More on connections



later.) There is no crossover inside the 5-inch sphere, only one 3-inch driver (made of paper-damped titanium) rated at 90 to 22k Hz bandwidth measured on stands, with a slightly better response down to 76 Hz when wall-mounted.

The TR-2 offers a 250W high-current Class-A/B amplifier with increased bass EQ. The 10-inch long-throw speaker is housed in a heavy (36 pounds!) enclosure that

measures 12x10.75x13.5 inches (HxWxD) and sits on four sturdy support legs. A variety of controls are available on the back panel. Three trim pots provide crossover point (50 to 180 Hz), phase and level. One three-way toggle switch selects EQ boost (0/+3/+6) and the other selects always on vs. auto-on. Internal thermal protection against heat buildup and overload is also provided. A handy red/green power-status LED rounds out the rear.

There are two ways to connect the TR-2 sub: as a separate, stand-alone unit via stereo RCA input jacks (with bass management from a receiver or multichannel delivery system) or as the lower end of a composite system, running full amplifier power into the stereo five-way binding posts (with additional stereo speaker outs for the satellites). Note: If you're running the speakers alone from a powered source, then select "small" for your speaker settings. If you're running them after the TR-2's crossover, then use "normal" settings for the satellites and let the TR-2 handle things to avoid redundant crossover errors.

### ROUND SPHERES OF SOUND

Once they were out of the box, I simply followed the quick-start guide and set up the speakers for some initial background listening while I worked on other pressing issues, not expecting much. Boy, was I pleasantly surprised!

The heart of the system is, of course, the sub, which never seemed to lag or sound overtaxed. Organ recital recordings with plenty of low bass and tracks with huge sonic blasts all sounded great—at times, almost scary. I never felt like I needed more from the sub. The system also sounded great with a variety of material; it responds well to being pushed hard. I tend to listen at comfortable levels, but I admit there were times when I was cranking these things and enjoying the never-harsh results, wondering what the neighbors were going to say.

In a case of form following function, there is essentially no crossover for most of the system's bandwidth (aside from the subwoofer's lowpass filter, of course) and this is always a good thing for phase coherency. When one is aware of what



crossovers can do to any (upper or) midrange image, there's always a sense of relief and less restriction when listening to speakers without crossovers. The 3-inch driver in the A'Diva Ti's spheres takes full advantage of this phenomenon, and the result is an open, effortless upper midrange that's pleasant and direct. Listener fatigue is minimal.

### THE A, B OR Cs OF REFERENCE AUDIO

Specs and techs aside, I found this system to be a respectable and sonically comfortable "bridge" between my professional system and home theater setup. The A'Diva Ti speakers offer all the strengths and features of pro gear while looking and sounding great in any modern home environment. Because many of us are constantly testing mixes (in stereo and surround) on systems other than our studios for reality checks, this is another great option to have. Even when used in a small mixing suite, this system is a great A, B or C option to have when checking mixes. When properly set up, the sub-to-satellite integration was smooth and seamless, with little or no loss or phase problems at the 120Hz crossover point that I selected for my demo space.

This is a smart, clever, all-in-one system that sounds great (way better than it should, especially for its size) and will let you enjoy your mixes on a console top or anywhere you prefer.

Prices: A'Diva Ti, \$275 each or \$300 each for stainless; TR-2, \$700.

Anthony Gallo Acoustics, 800/459-4183, [www.roundsound.com](http://www.roundsound.com). ■

*Joe Hannigan runs Weston Sound & Video in Philadelphia.*

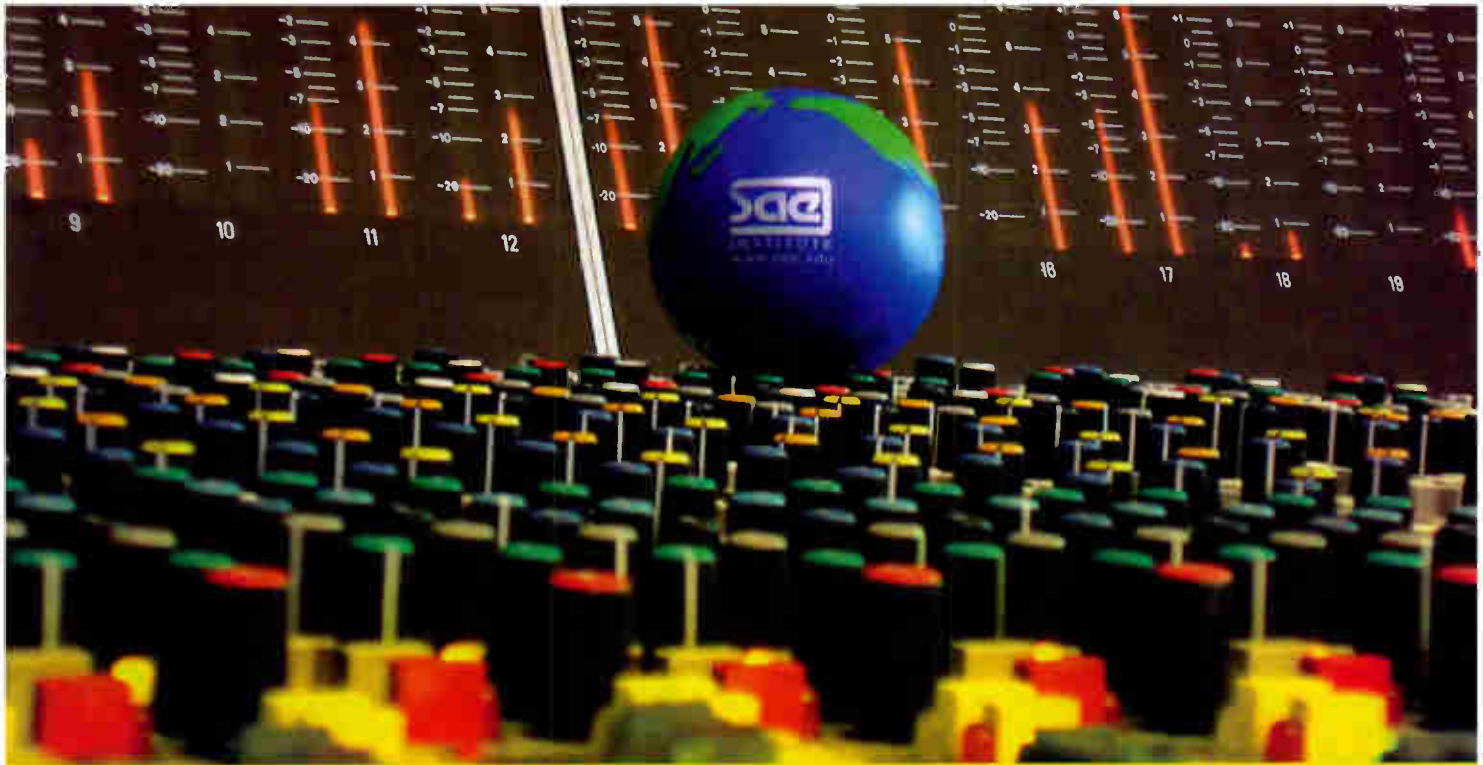

# SEE IT FROM THE OTHER SIDE

training for a career in the audio industry

Over 45 Campuses Worldwide

Official Neve Training

SSL Approved Training

Individual Studio Time

Full and Part Time Classes

## OPEN HOUSE:

LA, Miami, Nashville: August 5th

New York City: August 6th

New York City • 212-944-9121

1293 Broadway, 9th Floor, New York, NY 10001

Los Angeles • 323-466-6323

6565 Sunset Blvd., Suite 100, Los Angeles, CA 90028

Miami • 305-944-7494

16051 W. Dixie Hwy, Suite 200, North Miami Beach, FL 33160

Nashville • 615-244-5848

7 Music Circle North, Nashville, TN 37203

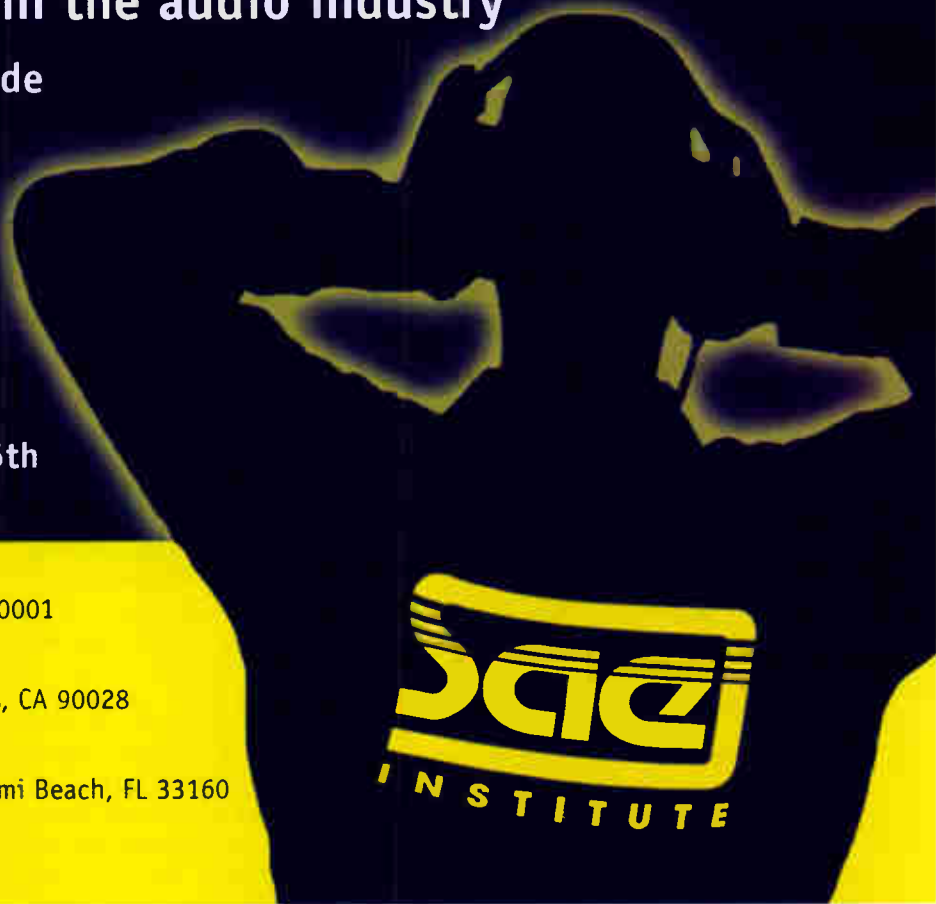

**877-27-AUDIO • WWW.SAE.EDU**

Nashville offers federal financial aid for those who qualify

New York City and Nashville Accredited by The Accrediting Commission of Career Schools and Colleges of Technology

World Radio History



# Universal Audio Solo 610/110 Mic Pre/DI

## Class-A Lunchbox Design With Impedance Switching

Since 1999, Universal Audio has been steadily building up a stable of quality hardware products, first starting with the LA-2A and 1176 legacy compressors and, more recently, units such as the 8110 and 4110 mic preamps released last year. The latest additions to the company's profile are the slick and portable Solo 610 (tube) and Solo 110 (solid-state FET) mic pre/DI boxes.

The lunchbox design is nothing new: Martech used it with great success on its MSS 10 preamp. What's nice about this design idea is that it makes it easy to put the preamp out with the player/singer, making for cleaner cable runs at line-level. What's new is this kind of performance and feature set at such an affordable price.

to provide a bit of crunch if desired by overdriving the input stage. Both units feature a tri-color LED for input gain and a blue power-on LED.

Where the units differ most is in output gain: The 110 provides a clean 77 dB of gain through the 600-ohm input and 75 dB through the 2k in, while the 610 offers 60 dB through the 500-ohm input and 55 dB through the 2k in. As stated, the 610 is a tube unit, using a single 12AX7 and 6072 for the tube complement.



input to optimal. This configuration turned out to be perfect for this situation. The sound was full, rich and warm with plenty of low end, just what I expected from a tube unit of this price and quality.

Setting up the gain worked in the completely opposite manner on another date with another bass player using a passive bass. The input was set optimally and the output used as a master volume control as you would expect. The nice thing about this unit is that it can adapt to just about any situation. In both cases,

### AN ACE ON BASS

The first outing for the 610 was as a DI on an Elrick Gold Series 5-string active bass. The unit was in the room with the player and the feed was then run at line-level into the studio. The rugged and portable 610/110 design gives you no qualms about setting it on the floor, table or windowsill in the studio and having either the talent or an assistant tweak the levels to perfection. The unit was set to DI with the impedance switch set to high and the output switch on the back set to line out. I experimented with the impedance switch set at both low and high, but it oddly made no audible difference in level or tone.

For this active bass, it was tricky at first to get the gain structure figured out. I adjusted the gain knob until it lit up the input LED to what I thought was optimal and then ran the output as a master volume to tape, but the bass was breaking up when the player hit it hard, even though I was in the "legal" zone according to the LED. Then I tried the counter-intuitive approach and set the output level control to maximum and adjusted the

### SOLID DESIGN

Both units are housed in rugged black steel boxes with rubber handles on the top (more on that later), XLR I/Os on the back and 1/4-inch input and thru plugs on the front, making them user-friendly in the control room, stage or studio. All buttons, pots and toggles are top-notch. Both units carry all the same functions, but are differentiated at first by looks and then by sound. The Solo 610 (9 pounds) has a retro look with old-school aircraft-style knobs with toggles for all major functions: mic/DI, high/low impedance, phantom power, low-cut filter, polarity on the front panel, and mic/line and ground lift on the back. The Solo 110's (5.4 pounds) knobs look more modern, and the unit uses blue LED buttons for all major functions. Gain and level knobs are the main volume controls on each unit, allowing you



## SPECS AT A GLANCE

### SOLO/110

**Circuit Topology:** Discrete Class-A FET  
**Mic Input Impedance:** 500/2k ohms, switchable  
**DI Input Impedance:** 2.2k/47k ohms, switchable  
**Max Gain, DI Input:** 57 dB  
**Max Gain, Mic Input:** 77 dB (600-ohm input)  
**Frequency Response:** 10 to 60k Hz, ±0.2 dB  
**Power Requirement:** 90 to 250 VAC  
**Dimensions:** 5x5.75x14 inches (HxWxL)  
**Weight:** 5.4 pounds

### SOLO/610

**Circuit Topology:** One 12AX7, one 6072 tube  
**Mic Input Impedance:** 500/2k ohms, switchable  
**DI Input Impedance:** 2.2k/47k ohms, switchable  
**Max Gain, DI Input:** 37 dB  
**Max Gain, Mic Input:** 60 dB (500-ohm input)  
**Frequency Response:** 20 to 20k Hz, ±1 dB  
**Power Requirement:** 100 to 130 or 200 to 240 VAC  
**Dimensions:** 5x5.75x14 inches (HxWxL)  
**Weight:** 9 pounds

# NOW YOU CAN.



 **KORE**

THE UNIVERSAL SOUND PLATFORM

[www.native-instruments.com](http://www.native-instruments.com)

 **NATIVE INSTRUMENTS**  
SOFTWARE SYNTHESIS

GENERATE THE FUTURE OF SOUND

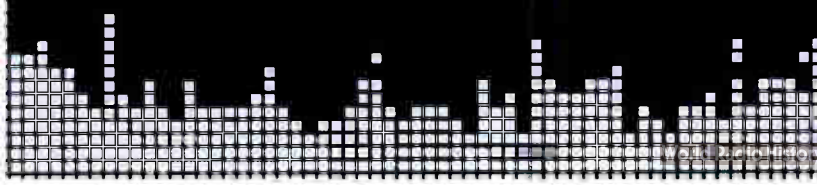



it sounded big and round, with plenty of bottom and nicely rounded transients, giving it a mildly compressed sound. The bass sat right down in the track and felt great with the kick drum.

Later that day, I ran the bass into the 610 and then through to the 110 for a side-by-side comparison. After levels were matched, the 610 exhibited more of a pronounced low end, while the 110 was more clinical, with more precise transients and less color and personality. Although both sounded very good, in this application, the 610 was the clear winner.

#### DRUMS AND VOCALS

The next test for the 610 was as a kick drum mic preamp. A Sennheiser e 602 was plugged directly into the box in the studio. The kick drum sounded full and clean with a nice low-end component, perfect for this application. Later, I heard the 610 used as a preamp with a newly refurbished AKG 414 B-ULS used as a mono overhead. The top end was clear, with snappy transients and a nice, even low end. The nice thing about the tube and transformers is that you get that nice crunch when you hit it hard. This was completely variable based on how you

set the input in relation to the output and was easy on the ears.

Next, the 110 was put to use on a male vocal. The factory-refurbished AKG 414 B-ULS was run into the box, which was put on the floor in the vocal booth. Going with what I learned on the bass recording, I ran the output level full on and set the input level after that, but that setup proved too hot. For this application, the input level ended up being set about 10 o'clock, while the output was set at 3 o'clock. This unit has plenty of headroom and, sonically, the mic and preamp married perfectly. The 110 was transparent and crystal-clear, and made it sound like the singer was in the control room. The combination sold many in the room on this combination for vocals.

#### SHOULD YOU GO SOLO?

Just a few minor gripes marred my experience with the 610/110. The lighted switches on the 110 are slick, but there was no documentation as to which position referred to which label. This is not a big deal unless you're a first-time user and you're using a ribbon mic where phantom power would be critical or the line/mic button on the back when it would result in a blast of volume in the control room, which unfortunately happened. Another oddity is the In vs. Out label attached to the polarity switch. Does that mean the signal is absolutely in or out of polarity, or does it mean the out of polarity switch is "in" or "out"? C'mon, guys!

Also, the handle seems a bit flimsy. It is made of a very pliable rubber and although it's impossible to see, it doesn't seem that there's any reinforcement at the end where it's fastened to the box.

Other than these small issues, the Solo 610 and 110 shined in every application. What's really exciting is this kind of quality and sound at this price. At \$799, these babies are not only affordable for the studio engineer looking for both another preamp flavor and something that can cleanly drive a ribbon mic, but also for the bass player looking for a great-sounding, solid DI that can handle input from the hottest bass down to the good old passive model, and do it with style.

The Solos get the highest marks in the three "p"s: performance, price and portability—it doesn't get much better than this.

Universal Audio, 866/UAD-1176, [www.uaudio.com](http://www.uaudio.com).

*Kevin Becka is Mix's technical editor.*

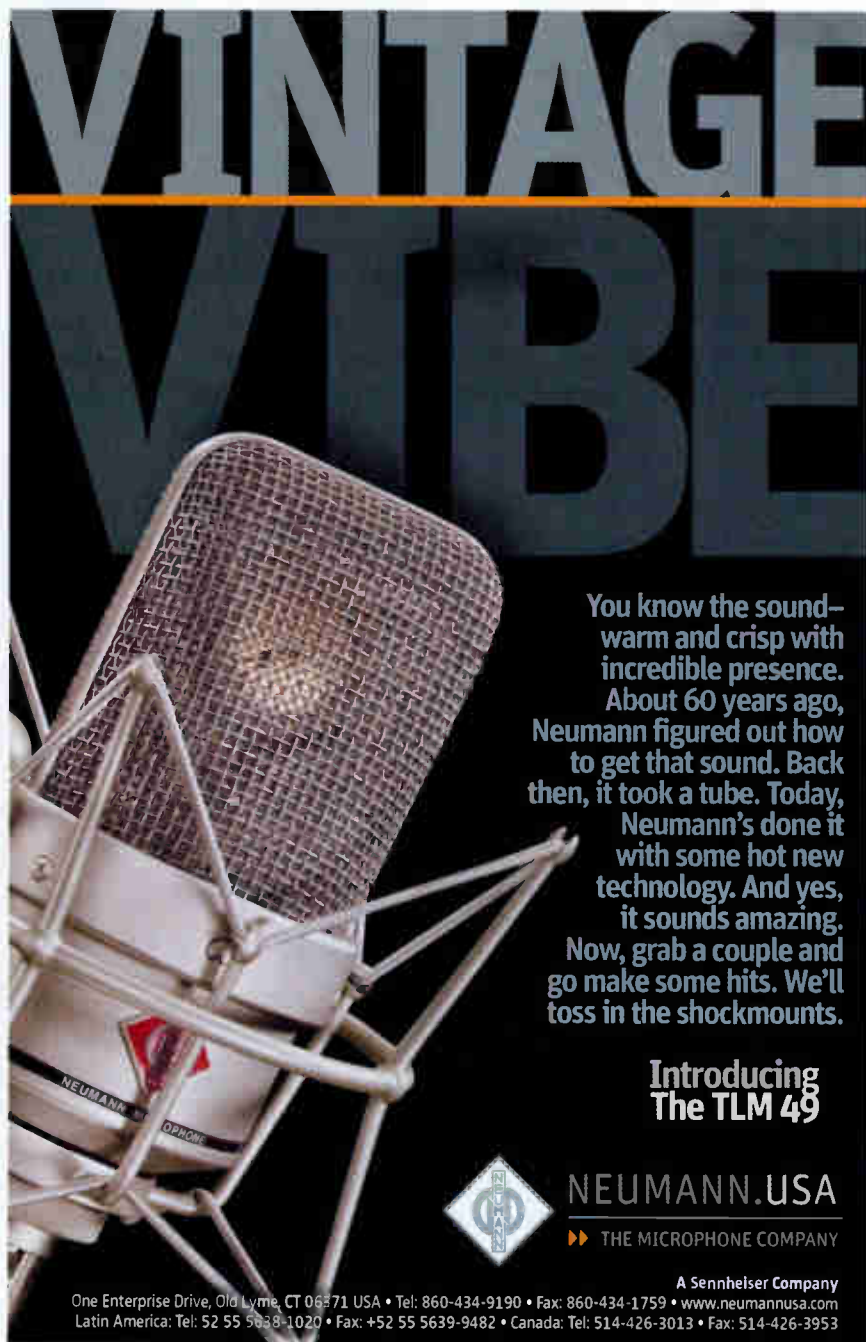

**You know the sound—warm and crisp with incredible presence. About 60 years ago, Neumann figured out how to get that sound. Back then, it took a tube. Today, Neumann's done it with some hot new technology. And yes, it sounds amazing. Now, grab a couple and go make some hits. We'll toss in the shockmounts.**

**Introducing The TLM 49**

**NEUMANN.USA**  
▶ THE MICROPHONE COMPANY

A Sennheiser Company  
One Enterprise Drive, Old Lyme, CT 06371 USA • Tel: 860-434-9190 • Fax: 860-434-1759 • [www.neumannusa.com](http://www.neumannusa.com)  
Latin America: Tel: 52 55 5638-1020 • Fax: +52 55 5639-9482 • Canada: Tel: 514-426-3013 • Fax: 514-426-3953

For 25 years, we've led the industry by introducing newer, better, faster ways to express yourself and your art. Today, we offer the highest quality, most mixable, most usable and easiest to use music available, whether you're looking to build a custom library or you simply need a hard-drive full of options right now. If you're a visionary who can close their eyes and see beyond the horizon – look to FirstCom Music for what's next.

*Visit [firstcom.com](http://firstcom.com) today and find your voice.*



firstcom  
MUSIC

# music for the auditory visionary

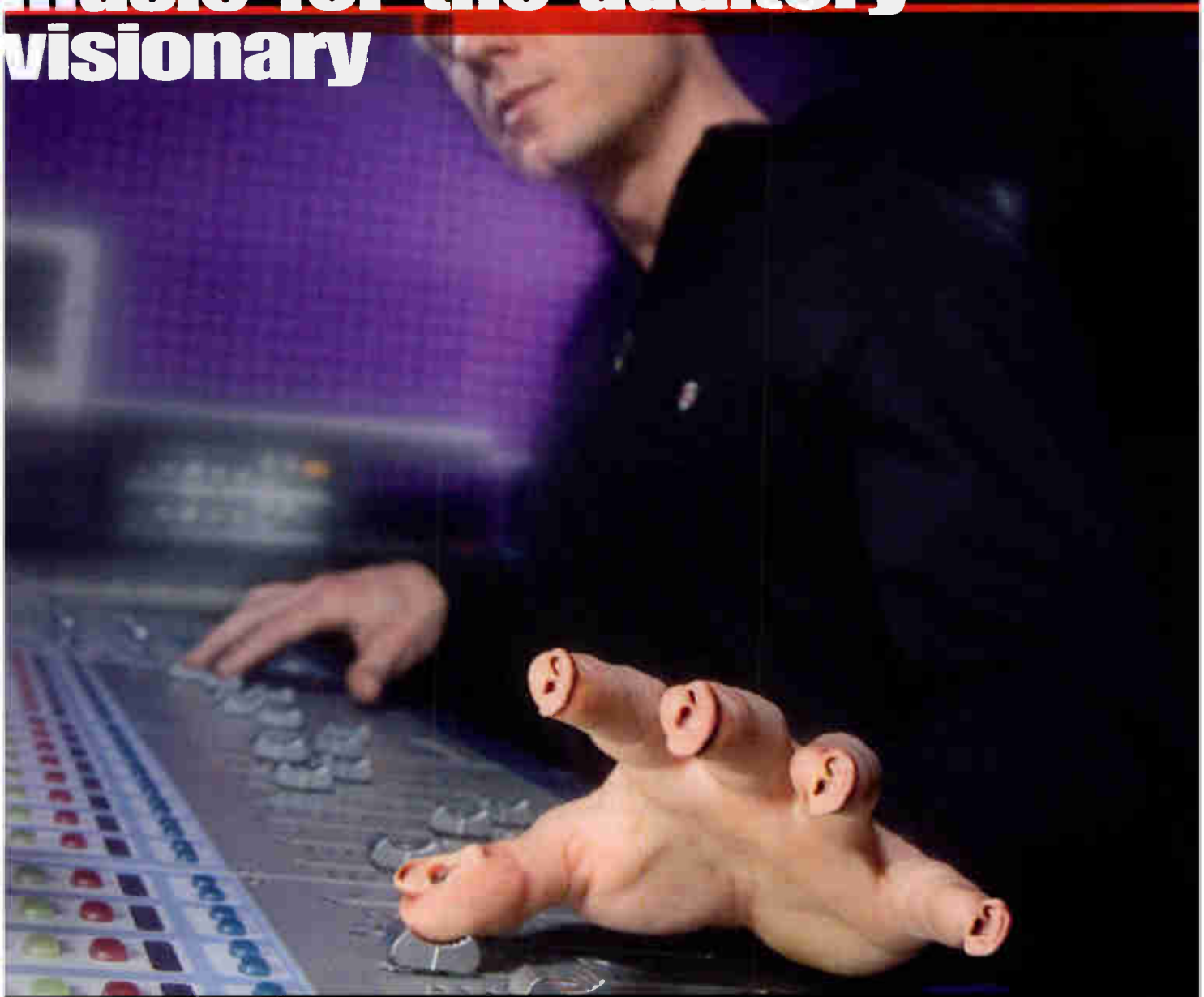

25 Years and  
Just Getting Started

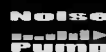
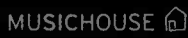
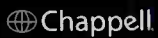

DALLAS • 800.858.8880 • LOS ANGELES

World Radio History



# Snapshot Product Reviews



## ABBEY ROAD/CHANDLER LIMITED TG12413 Limiter Plug-In

The TG12413 Limiter plug-in is based on the '60s transistorized EMI Abbey Road TG12413 Limiter module from its vintage 24-input, 8-track mixing console. The plug-in is available in RTAS, TDM and Audio Suite versions for Pro Tools HD, LE and M-Powered systems on both PCs and Macs; VST and Audio Units versions are planned. It supports up to 192kHz sample rates and mono, stereo and multichannel tracks up to 7.1. Standard Pro Tools plug-in setting file format, multichannel linking and automation are also supported. The TG package includes two plug-in versions: the TG12413 1969, a re-creation of the classic module, and the TG 12413 2005, which emulates the Chandler Limited TG1 hardware unit.

The 1969 version has a Hold control that sets the threshold for either compression or limiting. Without signal, the VU meter tracks the Hold control's setting. Start at the 0dB center position and as you turn clockwise, more gain reduction occurs and the level increases.

The 2005 version uses an input control that pushes more and more level into the gain reduction section for more squash—working just like an 1176LN. The 1969 version is for more subtle compression and limiting chores, while the 2005 version can be set to pump madly to fantastically affect drum tracks or any dynamically chaotic recording.

The TG Limiter is iLok-authorized with a license card provided with the installer CD-ROM. After a quick install into a Mac G5 Quadcore, both plug-ins came up normally.

Bass guitar tracks can be made to "freeze"

in level change. This super-compressed sound is clean and solid with no objectionable artifacts—pumping and breathing were evident, but it sounded great on this particular bass part with its many octave jumps and soloistic fills. I set the TG 2005 version to comp (compression), the slowest recovery (6) and the input to 6.5. The meter hovered around -5 dB, meaning about 15 dB of reduction!

Using both plug-ins in series on a female vocal track imparted a thick sound quality and constant level. For this "double spank," I set the TG 1969 version on compression with the Hold control set about midway and selected the fastest recovery setting (1). I set the TG 2005 version on limit (limiting) with the input set to 6, and also selected the fastest recovery (1).

Electric guitars sounded great through the EMI TG. Bright guitar tracks become thicker, with a little more sustain while retaining brightness and size.

At \$675 for the TDM version and \$450 for the LE version, the Abbey Road/Chandler Limited TG12413 Limiter plug-in is a useful tool that's full of personality, as opposed to being clear, neutral and transparent-sounding. I use them any time I want a track to take on a unique and colorful quality.

Chandler Limited, 319/885-4200, [www.chandlerlimited.com](http://www.chandlerlimited.com).

—Barry Rudolph

## ARTURIA ARP2600 V Vintage Synth Software Clone

In the mid-1970s, the ARP 2600 was a serious rival to the Minimoog. I learned synthesis on a 2600, so the panel of Arturia's ARP2600 V brought back fond memories—as did its rich, organic sound.

The 2600 had numerous normaled audio and modulation routings, which could all be overridden by inserting patch cords. It had three oscillators, a 12dB-per-octave resonant lowpass filter, two envelope generators (ADSR and AR) and extras such as sample and hold, a lag processor, a ring modulator and a spring reverb.

Priced at \$249, the 2600 V looks and operates very much like a hardware 2600, but offers numerous enhancements, starting with polyphony (up to 32 voices),

patch memory and MIDI Learn for controlling any slider from a MIDI Control Change message. MIDI velocity, mod wheel and after-touch are available via "jacks" on the keyboard module. The 2600 V also includes a re-creation of ARP's 1601 step sequencer, which sports a couple of useful voltage-level quantizer modules.

New synth features not found on the original 2600 include a chorus and stereo delay, oscillator octave switching and semitone tuning, a synchable oscillator, a multi-mode filter, four dual-input "voltage" processors and four unique (and extraordinary) tracking generator/LFOs.

The voltage processors each have two inputs, with a crossfade slider that can be modulated from a third input. By using these patch points, you can mix two signals and send them to a single input elsewhere, set up LFO-based panning or add LFO vibrato under mod wheel control. I did spot an obscure bug: When the voltage processor module is used polyphonically, the output is lower for one of the voices.



I love the hundreds of factory presets, which show off the 2600 V's versatility and expressive power. I had fun patching up some buzzy drones using audio rate modulation of the filter, and quickly found a sound that inspired a new tune. Using the 2600 V as a VST effect, its audio input and envelope follower worked more or less as expected, allowing me to filter and ring-modulate a sampled beat.

I regularly use a couple of software-



## 50 YEARS OF INNOVATION. REMIXED.

Introducing the new XTi Series amplifier from the experts at Crown. With integrated processing and three models from 500 to 1200 watts, we've just reinvented history.



**CROWN**

[www.crownaudio.com](http://www.crownaudio.com)

 A Harman International Company

World Radio History





based modular synths that go much further than the 2600 in terms of flexible signal routing and sound design. Even so, I love the 2600 V, not only for its vintage appeal and authentic analog sounds, but because the whole patch is right there on the screen, with no hidden functions.

Arturia, dist. by Yamaha, 714/522-9011, [www.yamahaproaudio.com](http://www.yamahaproaudio.com).

—Jim Aikin

**GLYPH GT050Q  
FireWire Hard Drive**

DAW users often think of a hard drive as the “bank” where precious work and irreplaceable assets are stored and organized. With that in mind, why trust a brand “x” FireWire drive that was on sale at the local discount electronics store? Pros understand that a drive failure during a session is disastrous. Designed for serious use, Glyph offers tested and verified drives with a three-year warranty and overnight replacement during the first year.

The latest drive system in Glyph’s GT Series, the GT050Q features Seagate Technology’s new SATA drive technology. GT050Q drives come in many sizes—from 80 GB to 750 GB—all with Seagate 7,200 rpm drives, an Oxford 924 bridge chip, 8MB buffer cache and an average seek time of 8 ms. This stand-

alone desktop drive weighs a little more than four pounds and is housed in a stainless-steel case with optional 19-inch rackmount hardware. To absorb the transmission of the

drive’s acoustic noise to the outside, three-layer laminated metal sound-damping brackets attach the drive to the internal chassis. The GT has a built-in power supply (no wall wart to chase down!) and a quiet cooling fan. But the big surprise is on the back panel.

The rear panel has five interface port connectors. Known as a “quad” interface, it offers a single FireWire 400 port, two FireWire 800 ports, a USB connector and one eSATA port. eSATA provides for even faster transfer data rates than FireWire 800—up to 1.5 gigabits per second. eSATA is an offshoot of internal SATA 1, and eSATA ports are being added to the newest PC motherboards. You can also add a separate PCI card to your computer, one card per port per eSATA drive—these can’t be chained together like FireWire drives. Using the eSATA port, the GT050Q can provide transfer rates of up to 109 MB per second, making the drive ideal for video editing and/or huge audio track counts.

Connected by a single FireWire 800 cable (both an 800 and 400 cable are supplied), the drive never worked hard to play and record 96 tracks at once. Furthermore, there is no noise; it is quieter than the internal hard drive in my Mac G5 Quadcore computer.

With four different connectivity options, the proper port ought to be available to

a studio’s computer. The Glyph GT050Q drive is a remarkable and worthwhile studio workhorse that will instill a quiet confidence and peace of mind within your daily session routine, and I highly recommend it for audio and video professionals.

Prices: \$699, 500GB model; \$299, 250GB model.

Glyph Technologies, 800/335-0345, [www.glyphtech.com](http://www.glyphtech.com).

—Barry Rudolph

**SE ELECTRONICS REFLEXION FILTER  
Portable Vocal Booth**

New from SE Electronics, Reflexion Filter is a \$399 portable vocal booth that sits behind a mic, providing isolation from problem reflections and room ambience.

This sturdy metal unit is approximately



**FREE SSL For Every Reader.**

Compress yourself. Download LMC-1 now.



[www.solid-state-logic.com/lmc](http://www.solid-state-logic.com/lmc)

**Solid State Logic**  
SOUND | | VISION



Music is your life. Make it a career.

THE  
**LOS ANGELES**<sup>SM</sup>  
RECORDING SCHOOL

888 688 LARS 6690 Sunset Blvd. Hollywood CA 90028 [larecordingschool.com](http://larecordingschool.com)

© 2005 The Los Angeles Recording School. All Rights reserved. The term "The Los Angeles Recording School" and The Los Angeles Recording School logo are service marks of The Los Angeles Recording School.

World Radio History



# Mojave Audio

A New Pro Audio Company  
by David Royer



Tube Condenser

3-Micron Capsule

Jensen Transformer

Performance you've  
come to expect from  
David Royer.

Welcome to the  
Great Wide Open

www.mojaveaudio.com  
818.847.0222  
Burbank, CA.

a foot tall and two feet across and is composed of multiple layers. The outer layer is an aluminum skin with holes punched at regular intervals. Below that is a layer of absorptive wool, then a layer of aluminum foil. The next acoustic barrier is a small air space followed by a series of suspended and angled aluminum, wool-covered baffles. These absorptive barriers prevent room energy from entering the back of the mic, while keeping the voice from leaving the area of the mic and reflecting back.

The Reflexion Filter can be set up on the same stand as your mic, but don't try to do this without instruction. Somewhat Rube Goldberg-ian in design, it can't be figured out by mere mortals. Unfortunately, the diagram that came with the package I received was imprecise and incomplete. I printed a picture of the mounted unit from the SE Website, which made setup easy. [Eds. note: This review unit was an early release. Since then, the company has written a comprehensive manual detailing the setup of the filter.] In any event, use a sturdy mic stand because the Reflexion Filter and mic together carry a lot of weight.

Dubbed the Robo-Gobo by one of my session players, the unit was set up in a medium-sized vocal booth. The first track was done without the filter, and then a second ad-lib track was recorded so I could compare the two. The recording done with the filter was decidedly warmer. The engineer commented that she usually has to notch out 1k when recording voice in this particular room. Here, the filter naturally reduced this problem peak without EQ.

Next, I cut a vocal in the control room with the singer set up in the back of the room, off to the side and facing the console. Even with the speakers in the control room turned up considerably, the vocal tone was solid. I was able to cut a good-sounding, usable vocal track live in the room with minimal leakage.

I was skeptical of the Reflexion Filter at first, but after some experimentation and comparing tracks, it made a believer out of me. Be aware that it's impossible to read a lyric sheet or see visual cues during use. But if that doesn't bother you and you're having problems recording vocals in less-than-perfect environments, then the Reflexion Filter is worth a look.

SE Electronics, dist. by Sonic Distribution, 617/623-5581, www.sonic-distribution.com.

—Kevin Becka

## M-AUDIO BUNKER 8 BEYOND FOLEY Foley Effects DVDs

M-Audio's ProSessions 24 line of sample/loop collections is known for its cool drums, instruments and electronica sounds. Now, the line expands with *Bunker 8 Beyond Foley* in two single-DVD volumes, each priced at \$49.95. Recorded by Toronto's Bunker 8 Digital Labs, these 24-bit WAV files are sampled at both 44.1 kHz and 48 kHz, and easily load into just about any DAW.

Each disc is packed with about 3 GB of sounds. *Volume 1: Inorganic* has man-made sounds: taps, hits, smacks and crashes; clothing, fabrics and materials; kitchen and bathroom; home sounds; office, tools, gadgets and equipment; stereo ambiences and atmospheres; and transportation. It's not all Foley—there are also long stereo ambiences (restaurants, streets, car interiors) and sound effects (car starts, computer sounds, toilet flushes and bathroom/kitchen water). All are cleanly recorded and most are quite useful—the pots and pans, car starts, door slams and clothing sounds are particularly good.



Some sounds are odd—almost otherworldly (“walking on plastic muffin container”)—while others seem esoteric, such as “scraping CD through radiator in washroom,” which could easily pass for applying concrete or mortar with a trowel.

*Volume 2: Organic* follows the same routine, with a mix of Foley, sound effects and ambiences. Categories include animal kingdom; outdoor environments; stones, ceramics and glass; streams, falls, beaches and lakes; underfoot and water zone; and wood vibes. There are lots of effects: animal sounds, glass breaking, etc., and long ambiences. But here, again, the best part is the Foley stuff, such as footsteps on various (mostly outdoor) materials and water splashes/items dropped into water.

A simple HTML file arranges each disc's sounds into logical categories and subcategories, and a Click to Listen feature makes auditioning sounds a breeze on Mac or PC. There are lots of sound effects sources, and true Foley is hard to come by. The main downside is that these leave you wanting more, especially Foley—no footsteps on wood, concrete or marble? No body thuds, breathing, grunts, punches and carcass drags? Maybe that's what future volumes hold, but at \$100 per set, this one's off to a good start.

M-Audio, 866/657-6434, www.m-audio.com.

—George Petersen ■

# Freedom of Choice

Have questions about AES/EBU? We have solutions...

## PREMIUM LINE



▶ BOB-32



▶ ADI-642



▶ ADI-6432

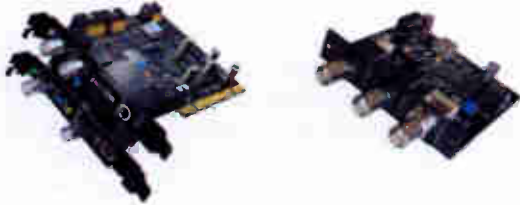

▶ MADI Card

▶ Time Code Option

## PRO LINE



▶ ADI-4DD



▶ HDSP 9632



▶ OctaMic-D



▶ ADI-192 DD

For more details, contact



info@synthax.com  
V: 330.259.0308



www.rme-audio.com

Outstanding Technical Achievement  
Digital Converter



▶ HDSP AES-32

No matter what your AES/EBU needs; RME has the solution.

Whether it be MADI to AES conversion or a Single Stereo Balanced application, RME delivers the Professionals Interface of Choice!

### Introducing the all new AES-32!

- ▶ With individual sample rate connectivity per port
- ▶ 32 Channels of MIDI
- ▶ Support up to 192kHz at full channel count
- ▶ DigiCheck Analysis/Recording Software (PC only)
- ▶ Native support for Double and Quad Wire transfer
- ▶ Direct conversion between these formats
- ▶ SteadyClock for highest jitter suppression and clock regeneration
- ▶ TotalMix: 512 channel mixer with 42 bit internal resolution with MIDI Remote Control
- ▶ 48 Channel Meter Bridge Peak/RMS in-hardware
- ▶ Windows 2000/XP (MME, GSIF 2.0 and ASIO 2.0)  
Mac OS X (Core Audio and Core MIDI)





## CASSANDRA WILSON

### TAKING A TURN WITH T BONE

By Chris J. Walker

Three years ago, the paths of jazz/blues vocalist Cassandra Wilson and producer/musician/soundtrack composer T Bone Burnett intersected for a single song for the soundtrack of the NBC television drama *Crossing Jordan*—a haunting version of the Jimi Hendrix ballad “Wind Cries Mary.” They were, not surprisingly, already aware of each other’s work: Burnett had been deeply affected by Wilson’s version of Billie Holiday’s classic “Strange Fruit,” and the singer knew that Burnett had an encyclopedic knowledge of blues and American popular music. The two hit it off, and yet it would be another two years before they would collaborate on Wilson’s latest album, *Thunderbird*.

Wilson’s singing career has been both varied and provocative. She’s noted for her nuanced vocal style, her understated power and her always interesting choice of material, which has spanned many genres during the course of several albums. In the early 1980s, upon moving to New York from Mississippi, she was a member of saxophonist Steve Coleman’s M-Base Collective and fought for breathing space in that dense, jazz/funk/avant garde consortium. Her first solo recording came out in 1985 and carried on some of M-Base’s most adventurous traits. Yet she also paid dues going the traditional route of most jazz singers—interpreting standards. She didn’t really come into her

own musical identity until she signed on with the Blue Note label and recorded the highly successful *Blue Light Til Dawn* in 1993 with producer Craig Street. It featured Wilson in a pre-Norah Jones-style, acoustic-driven setting, converting songs by Joni Mitchell, Van Morrison, Ann Peebles, blues icon Robert Johnson and others into her own swampy and sensual creations. *New Moon Daughter*, her next CD, was also done with Street and followed a similar formula, but with even more pop diversity; it, too, was a success with the public and critics. More recently, Wilson’s albums have been slightly less accessible: *Traveling Miles* was a tribute (in part) to the legendary Miles Davis (and very popular internationally); *Belly of the Sun* offered an organic mixture of blues classics and pop hits; and then there was *Glamouré*, the first project to truly highlight Wilson’s originals (about half), recorded in Mississippi and co-produced with guitarist Fabrizio Sotti.

For the new *Thunderbird* album, the soft-spoken singer had Burnett at the top of her wish list for producers and used their collaboration as an excuse to move in yet another direction. For one thing, Wilson decided not to use her regular band, except for the phenomenal bassist Reginald Veal and the equally astounding harmonica player Gregoire Maret. Otherwise, she gave herself over to Burnett’s team of musicians and engineers and decided to record in the L.A. area for the most part. Principal musicians included drummers Jim Keltner, Bill Maxwell and Jay Bellerose; guitarists Colin Linden and Marc Ribot; and bassist/programmers

—CONTINUED ON PAGE 122

# JESSI COLTER

HONORING WAYLON,  
BUT TRUE TO HERSELF

By David John Farinella

It's one thing to follow in the footsteps of a loved one, but it's quite another when that loved one is Waylon Jennings, a legend who has passed on after a genre-defining career that has touched millions of fans around the globe. Yet Jessi Colter opted to walk down that path 20-plus years after releasing her previous solo album when she sat across the table from producer Don Was and asked, "Are you interested in hearing what I've been working on?"

"I said, 'Yeah, let's put that on,'" Was recalls of the songs he heard after a lunch that took place on the one-year anniversary of Jennings' death. "The first thing she played was 'You Took Me By Surprise,' and it was staggering. She totally took me by surprise, and she kept playing me new songs. I'm hard-pressed to find a precedent for someone at that point in their lives coming out of left field with material of that caliber. I can't think of anybody."

Not that Colter was a novice—she has had a long career of her own, though mostly in the shadow of her famous husband, with whom she performed for many years. Still, this creative burst was unexpected. While there were dozens of songs written, Colter and Was winnowed the material down to include such knockout tracks as the haunting "Starman," "The Canyon" and a cover of Bob Dylan's "Rainy Day Women #12 & 35" for the 12-track album *Out of the Ashes*, which came out on the Shout Factory label



in late spring to considerable acclaim. The key to picking songs for this collection, Was explains, was making sure that they were true to a theme. "The songs were written over a period of time, and I saw this person emerging from not just a tragic situation of loss, but also a person finding her own legs again after being in a partnership for a long time. Each time we'd get together to listen to songs, she was farther along the path and therefore writing about it.

"I thought that you could actually sequence the thing in order. That doesn't necessarily work," he continues with a laugh, "but it was a nice way to build a temporary spine for the album."

He was also careful that subjects didn't get repetitive: "If there were two songs that dealt with a certain emotion or a certain situation, then we only used one. I think there were a couple of songs about being somewhat tentative about jumping into a new relationship and we chose one."

The original songs that Was heard on that first day in Los Angeles were recorded at Colter's house by Mike Breen, who works in Phoenix, where she is currently living. "I started going to her house on and off for about two years," Breen says. "I would just mike up her piano and her. I think at the first session, [cellist] Jenny Lynn Young was there and a couple of times Ray Herndon was there playing guitar and singing. I was really there trying to capture these brand-new songs as she would sit at the piano and start playing them."

Breen used a Roland VS-1680 to record

the tracks. He put a couple of Shure KSM 32s on the piano and a Marshall MXL tube condenser microphone on her vocals. After each day, he would dump the tracks from the VS-1680 into Pro Tools, set up a rough mix and then send it back to her. Colter played a restored 1910 Chickering & Sons grand piano.

During those early dates, Breen recalls, the sessions were very relaxed. "After lunch, we'd go in and she would sit down at the piano," he says. "A lot of times, I wouldn't even know she was going to start a song, so I would try to have the machine running right as she sat down because she would just kind of start playing and this beautiful song would come out. A lot of the stuff that we did was first or second takes, rarely more than three. My main thing was being ready for her to do her thing."

The tracks that Breen and Colter worked on at her home formed the backbone for what *Out of the Ashes* would become. Once Was got involved on a full-time basis, the project was tracked mostly at Cartee Day Studios in Nashville—where Jennings had done the bulk of his recording over the years. In addition to Cartee, sessions took place at CarBarn in nearby Franklin and Starstruck in Nashville, with engineers Al Cartee, Steve Crowder, J.R. Rodriguez and Barney Robertson.

In the studio, Colter and Was were joined by a cast of local all-star musicians that included guitarist Tony Joe White, who wrote "Out of the Rain," guitarist Reggie Young, drummer Ritchie Albright, steel and Dobro

—CONTINUED ON PAGE 124



# THE CYRKLE'S "RED RUBBER BALL"

By Gary Eskow

Folk singers wouldn't throw in the towel. The Brits were here. Blues masters tossed jagged contrapuntal lines into a densely textured pop symphony. Back in 1966, young musicians like Tom Dawes and Don Dannemann had a lot of influences from which to draw. Along with drummer Marty Fried and keyboardist Earl Pickens, they were The Cyrkle, a group that recorded a pair of hits in 1966—"Red Rubber Ball" and "Turn-Down Day"—and spent a season in the sun with The Beatles.

While students at Lafayette College in Easton, Pa., Dawes, who sang the upper part on "Red Rubber Ball," and Dannemann, who handled the equally weighted lower part, formed a band called The Rhondells with Fried and Pickens. The group quickly moved from being the most in-demand party band on campus to playing clubs along the East Coast. Eventually spotted by Nat Weiss, a New York attorney who had a partnership with Beatles manager Brian Epstein, the group was rechristened The Cyrkle by either Epstein or, as legend has it, John Lennon.

The Vietnam War was raging, and Dannemann decided to spend six months in the Coast Guard Reserves rather than risk getting drafted. Dawes, meanwhile, had been spotted playing bass in a New York club by Barry Kornfeld, who was putting together a touring band to support Simon & Garfunkel, whose *Sounds of Silence* was at the top of the charts. At some point during the tour, Paul Simon played Dawes a demo he'd made of "Red Rubber Ball," a song he'd written with Bruce Woodley of The Seekers.

Meanwhile, John Simon (no relation) was making his way up the ladder at Columbia Records. "I had been a 'trainee' at Columbia," says John Simon, "and had just been moved to the pop department as an associate producer and assigned a few acts that the experienced producers didn't see as profitable when Nat Weiss walked into my 10-by-10 windowless cubicle. He said he was 'an associate of Brian Epstein' and that every other producer in the place had turned him down. He played a demo of 'Red Rubber Ball,' which I thought was okay. I screwed up my courage and went to ask my scary, imposing boss—gruff Bill Gallagher—if I could have \$5,000 to cut it. He said sure, as if it were pocket change!"

John Simon and The Cyrkle headed into Studio B at Columbia to work with Roy Halee. "Roy was the real deal," says Dawes. "He had that flowing combination of 'big ears' and technology savvy that's hard to find. You know how, given the same ingredients, one person will cook a mediocre meal and the other will get the balance just right and it will be twice as good? That's what Roy did, and he made it look easy. I remember [engineer] Freddie Catero was around, but Roy Halee did everything on 'Red Rubber Ball' and 'Turn-Down Day.'



"We sat down in the session and headed out the arrangement, building on the demo," Dawes continues. "John Simon thought it should have a Hammond organ calliope-stop lick, and that little 'so-mi-fa-mi-re-do' lick popped into my head. I hummed it to him, we adopted it and the first pass was Dannemann on electric guitar, me on acoustic, Marty Fried on drums and Simon on Hammond. Then I overdubbed bass. John and I overdubbed tambourines for the "think...it's gonna be all right" parts, then Don and I sang and doubled the parts. I'm not sure where all this went on the 4-track, but I don't think we had to bounce down to another machine. John Simon was the catalyst: He had interesting musical ideas, played keyboard really well and he drove the boat. He was the real deal, like Halee. It took me a few years to realize that The Cyrkle had started with the best. I was so young I thought *all* engineers and producers in New York were great like these guys. Er, *not!* [Laughs]"

"Roy was the engineering king at the time. A lot of the equipment was primitive, but he could make anything sound good—he'd make those limiters sing. I have a tech-y bent and love to know how equipment works, and I remember asking Roy and others a lot of questions. At first, people were reluctant to waste time explaining things to me, but that changed. I studied the way Roy premixed a track and still was able to end up with just the right amount of bass." At the time, Columbia Studios was equipped with its own custom-built consoles, and the outboard gear of the time comprised mostly simple analog boxes that are cherished today—from Pultecs to 1176s and EMT reverbs.

Dannemann recalls playing his Fender Strat through the Fender Bandmaster amplifier that currently occupies a corner of his Pennsylvania studio. "It took awhile to get the basic track down. Finally, we're coming to the end of the take that we all know is going to be the keeper and I missed a note.



**DESKTOP  
AUDIO**

**THE PROFESSIONAL'S SOURCE**



real world solutions from industry professionals!

**www.bhphotovideo.com**



800-947-5508 | 420 Ninth Ave, New York 10001 | We Ship Worldwide





We talked about it afterward and decided to leave it in."

"Red Rubber Ball" traveled up the charts in a hurry during the spring of '66 but stalled at Number Two, outflanked by the Tommy James & The Shondells' song "Hanky Panky." Buoyed by the success of their debut album, which also included the breezy but melancholic "Turn-Down Day" (featuring a prominent electric sitar line played by Dawes), The Cyrkle was given a golden opportunity: the chance to join The Beatles on their farewell tour in 1966.

"That tour was totally awesome," Dannemann recalls. "I'll never forget that first concert. We hadn't met The Beatles and we were in awe of them. The first night we wondered if the crowd would boo us off the stage and demand The Beatles, but they whooped and hollered, and we did well. That was a relief.

"We were playing an indoor arena that first night in Chicago, or maybe it was Detroit. After we played, I stood behind the stage waiting for The Beatles to come on. They looked really good in their dark-green velvety jackets. I was watching all these young girls sitting in the front rows, and it seemed like they were sitting on electric chargers. Every once in a while, one girl would fly out of her seat, almost higher than you'd think was possible. Then another one—there was this out-of-control popping of girls! I looked around and there was a grown woman, possibly a reporter, standing next to me, sobbing uncontrollably. You couldn't hear enough to know if The Beatles were performing their stuff well, though—you just couldn't tell!

"The first meeting we had with any of

them was in the chartered airliner after that show. The Beatles had a walled-off area at the back of the plane. Tommy, Nat Weiss and I were sitting three-across near the front of the plane, waiting to see them. Finally, oh my God, there's Paul [McCartney]! He seemed like a normal, good guy as he worked his way up the aisle shaking hands and saying hello to people. Finally, he reached us. Nat knew Paul through Brian, and so he introduced us to him and we had a brief,

[Roy Halee] had that flowing combination of "big ears" and technology savvy that's hard to find.

—Tom Dawes

mundane exchange. Tom and I spent the rest of the trip analyzing every word that was said, pondering what we could have done to engage and keep him around longer!"

But as the song says, the roller coaster ride they took was nearly at an end. One minute you're playing Candlestick Park in San Francisco, waiting for The Beatles to take the stage and give their last live concert performance. And the next? "I remember most vividly the contrast between Candlestick Park [now Monster Park] with, what—50,000 people cheering and screaming," says Dawes, "and The Cyrkle's next gig two nights later is at some low-life dive in the Catskills [N.Y.],

where there were 14 people in the audience, including one guy who's tapping on his water glass and yelling, 'Hey, keep it down, keep it down, I'm tryin' to eat here!'"

"Coming off the mountain was very difficult," Dannemann confides. "The last job we played was in the beginning of 1968, at a teenage nightclub somewhere in Pennsylvania. We actually had broken up, but the gig had been booked way in advance. We drove two rented station wagons ourselves and dragged in the equipment.

"Once out of that 15-minute bubble, nothing went right. We were heading into the studio one day to work on our second [and last] album when we ran into Paul Simon. He and Art [Garfunkel] were working in the same studio. Paul told us they'd just finished a song he thought would be perfect for us, and said that since they wouldn't be releasing their version of it for months, we could put it out first. But we passed on '59th Street Bridge Song (Feeling Groovy).'"

Pickens left the group to pursue a career in medicine, and Fried became a lawyer. Like Dawes, Dannemann built a successful jingle house in New York. By and by, though, The Cyrkle remained unbroken. "A few months ago, Tommy called me and said that Earl, who's living in Gainesville, Florida, and Marty, who lives in Michigan, were both going to be in the city," says Dannemann. "Tom and Ginny have an apartment in Manhattan, and they hang out at the Café Des Artistes all the time, so they were able to book a dining room for us with a private bar and bathroom. It was great. My wife and I drove in from Pennsylvania, and we spent the whole evening reminiscing." ■



**X-Rack**

**SSL STUDIO WITHIN**

**Box Clever.**  
Scalable SSL processing for your studio.

[www.solid-state-logic.com/xrack](http://www.solid-state-logic.com/xrack)

**Solid State Logic**  
SOUND | VISION

# Instant Pro Studio

Just add creativity.

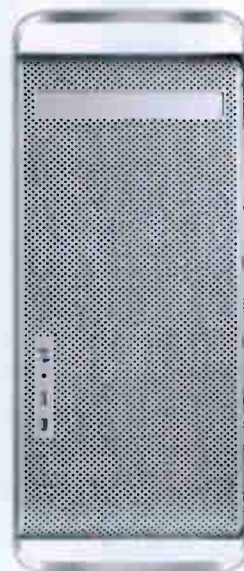

## LOGIC PRO® — THE PROFESSIONAL'S CHOICE FOR CREATIVE AUDIO PRODUCTION

 Logic Pro has long been the professional's choice for creative audio production. Pair it with a **dual processor Power Mac® G5**, and you've got an unbeatable combination of power, flexibility and expandability. With 34 software instruments, 70 effects and distributed audio processing, all that's missing is a way to get high-quality audio into and out of the Mac...

## ROSETTA 800 — THE PROFESSIONAL'S CHOICE FOR AUDIO I/O.



...which is where the **Apogee Rosetta800** comes in. A name synonymous with top-notch digital I/O for two decades, more professionals get audio in and out of their DAWs through Apogee converters than any other standalone pro A/D/A converter.

- 8 channels of balanced analog I/O
- 8-channel digital I/O via AES/EBU & ADAT/SMUX
- Up to 24-bit/192kHz resolution
- Ultralow-jitter Intelliclock
- SoftLimit clip protection
- Plug-in play FireWire connectivity\*



Sweetwater puts it all together for you. Our Apple® Certified sales engineers can answer any and all questions you may have about building the perfect Apple audio system, and our computer audio install techs have built more systems than any other retailer on the planet. Let us help you design the perfect system for the way you like to work. We'll build it, configure it, test it, and ship it straight to you. All you've got to do is unpack it, plug it in, and start making music.

\*Optional XFireWire card required.

**CALL SWEETWATER TODAY!**

**(800) 222-4700**

**www.sweetwater.com**

**Sweetwater**®  
music technology direct™



World Radio History



## CASSANDRA WILSON

FROM PAGE 116

Mike Elizondo and Keith Ciancia, who additionally acted as keyboardist and co-producer. (Not coincidentally, this is the principal cast of characters on Burnett's latest solo album, *The True False Identity*. See last month's issue for an in-depth interview with Burnett.) Singer/guitarist Keb' Mo', an old friend of Wilson's, was also featured on a track.

Wilson only had one song, "Poet," fully composed when she began working with Burnett and company at the Village Recorder in West L.A. during November 2004. Some other songs were still in the conceptual and fragmentary stage—Wilson, Burnett and the band worked on developing them together, sometimes through extensive jamming on different motifs and ideas—at the Village and Capitol Studios during early to mid-2005.

Wilson was highly receptive to most of Burnett's production notions, including using three drummers (also featured on Burnett's disc). "While we were in the studio, we all worked on the lyrics, including the engineer, Mike Piersante, who's also one of the writers," Wilson says. "They were all feeding me ideas, and I think this was the first time I had such a collaborative situation. This took place over a period of a year, going back and forth, exchanging files, living with the music and communicating ideas, especially with Keith. He was a master, and I can't say enough about him. I call him the 'texturizer.' I've never seen anyone do such intensive work on a sound, an idea, a thought, an impression or a feeling. We had a really wonderful rapport—so much so that I felt like I was leaving family when [the record was completed]."

Because the music was so well-thought-out and the players so strong, Burnett decided to try a gutsy approach to the recording: going live to 2-inch tape. "That's the most fun," Burnett comments. "It's the ultimate when the musicians are playing and the singers are singing. When they're finished, they can listen to the piece and say, 'That's great,' or, 'Let's do it again.' When you get one of those [takes], it's an incredible feeling of accomplishment. What can take months in the studio often happens in three minutes.

"With Cassandra, we used a combination of [live to tape] with some digital editing, and we also grabbed samples of things we recorded—and a few things from other sources—and moved them around and 'composed' with things we did live. Then, 10- or 15-minute pieces were cut down to five minutes."

Ciancia gave a couple of examples of the sort of track modifications that were made along the way: "It Would Be So Easy" was

done during the first week and was about 20 to 30 minutes long," he says. "I chopped it and made an arrangement, and then using an [Akai] MPC drum machine with that frame, rewrote it. 'Go to Mexico' is also backbeat-heavy and stems from a sample, too. That comes from my background in hip hop, and T Bone is a big fan of it, too. Mike Piersante's recordings were a blessing—dealing with several drum sets, guitars, basses and keyboards. The bleeds were minimal, so I could mute things out and rewrite on top of a drum track, vocal or something. That's something T Bone taught me; he just mutes everything down to a vocal and then maybe brings one element in. 'See, that sounds great just like *this*,'" he says, mimicking his mentor.

Ciancia has worked often with Burnett during the past four years, and his responsibilities have varied greatly. "Each project is so different," Ciancia explains from his L.A. home studio. "T Bone is obviously all over the place with different stuff. If it's going to be a live record, I'm usually hired on as a keyboard player. For this record, he wanted me to co-produce so I could spend some time working on it in my own studio and at his, directly with Cassandra. I've been learning from him as I go, and he's been generous to teach me a lot." Ciancia, who also records and produces his own projects, only partially in jest calls Burnett's knowledge "Jedi Power." He defined it as trusting people around him to do the right thing at critical points.

Piersante has been with the producer for about a decade now and has been behind the board for most of his albums during that time. Like Burnett, he's one of those guys who just *loves* music and the thrill of recording, and he's very enthusiastic about Wilson. "Even when she walked through the control room going 'la-la-la,'" Piersante says, "you would stop what you were doing and just think, 'Oh, what an amazing-sounding instrument!' I was really focused on trying to make her comfortable and capturing all the glory she has to offer."

To capture Wilson's vocals, Piersante used an AKG C 12 through a Neve preamp direct to the 2-inch recording deck. Many of the instruments were also cut through 1073 and 1081 modules. The consoles at the Village Recorder and Capitol Studios were used just for playback. A drummer himself, Piersante enjoyed the challenge of capturing three kits simultaneously. "I usually set up an overhead, and that will pretty much pick up the whole drum kit and cymbals," he offers. "You get a nice envelope because you're miking from a couple of feet away and things tend to sound more natural that way. Often, I use some kind of dynamic [mic] for kick drum and snare. And



Included:  
Mic Clip, Windscreen,  
Omnidirectional Capsule

## Instrument Miking taken to the Next Level

Introducing the new MXL 604 dual capsule Instrument Miking System. Based upon the highly accepted MXL 603 microphone, The MXL 604 is the latest in quality instrument microphones. The 604 delivers the dynamic range required in the most demanding instrument miking applications. It features; -10dB switchable attenuation; selectable low-frequency roll-off; and an interchangeable omni-directional capsule making the the 604 perfect for acoustic guitar, ambient and overhead drum miking. Audition a new MXL 604 today and see how MXL has again moved the bar in affordable microphone technology.



(800) 800-6608  
[www.MXLMics.com](http://www.MXLMics.com)



**NEW**

**POWERCORE PCI MKII /  
POWERCORE UNPLUGGED**

**POWERCORE EXPRESS**

## Who says all PCI cards are the same?

PowerCore Express is the latest member of the PowerCore family, a superior range of high-end plug-ins that run on tailor-made hardware. This new PowerCore PCI card supports PCI Express slots, and includes the same 14 high quality plug-ins as PowerCore PCI mkII. You can also create a custom PowerCore package by adding optional plug-ins to PowerCore Unplugged, the PCI card without bundled plug-ins. All 3 "PCI flavors" give you access to all optional TC processing tools like the VSS3 Stereo Source Reverb and MD3 Stereo Mastering known from TC's flagship System 6000, as well as a wide range of plug-ins from 3rd party developers like Sony Oxford, Access and TC-Helicon. PowerCore integrates with virtually any VST, AU and RTAS\* based digital audio workstation for Mac and PC.

\* Via the VST to RTAS adapter from FXpansion (optional)



 **POWERCORE**

Superior plug-ins, tailor-made hardware

**t.c. electronic**  
ULTIMATE SOUND MACHINES

TC ELECTRONIC A/S DENMARK ▶ ☎ +45 8742 7000  
TC ELECTRONIC INC USA ▶ ☎ (818) 665 4900 ▶ MAIL: INFO@TCELECTRONIC.COM

[WWW.TCELECTRONIC.COM](http://WWW.TCELECTRONIC.COM)

World Radio History



there are always a few ribbons involved with whatever we do. I used a Coles mic over the back of Jim Keltner's shoulder and, of course, put old RCA [77] mics out in front of the drum kit. It makes a nice sound in the right room. Typically, T Bone will have the drummers playing very softly, and what we do is crank that up with the preamps and limit it pretty well. It gives you a nice, full sound because the drums are ringing and not choking off from being hit hard. I also used low baffling between the kits—which were three to five feet from each other—in a semicircle. So I try to minimize the bleed, but not get rid of it entirely since it's a beautiful thing for us."

Mixing for Wilson's CD was left up to Piersante and Ciancia at Burnett's Electro Magnetic Studio in Brentwood, Calif., using the producer's vintage API board. Wilson and Burnett were often touring or involved with other things during that period, but they had imparted their own instructions in advance and checked mixes via the Internet.

"The hardest thing about mixing this whole record was keeping all the drum kits in phase," Piersante notes. "Being that they were stretched across the whole panorama of things, that was something I tried to pay particular attention to. But you put Cassandra over the top of just about anything, it's going to sound good, and with a great music bed, it's not that hard to do."

"A studio is not just a studio—it's the people who run it and who you are working with," Wilson adds. "They're all very important, and it's a form of alchemy that you're able to put everything together. T Bone cracks the whip in a very quiet manner and that's what I love about him. When he wants

you to do something, you do it without feeling as if you've been handled. There are very few producers who can do that well." ■

## JESSI COLTER

FROM PAGE 117

player Robby Turner and saxophonist Jim Horn. Colter calls them her "musical family." Her son, Shooter Jennings, also worked on the collection, playing and singing on the track "Please Carry Me Home."

"It was fairly obvious who to choose," Was reports. "Everyone on the session pretty much had a lot of history with her. There was a lot of love in the room, and it was a labor of love for everybody."

Was includes himself in that list; he played stand-up bass while producing, a task that turned out to be a bit of a challenge: "There were times in choosing the initial takes where I had to turn the bass off. The tendency is to listen to yourself. Even if you were being objective, you would overstate the importance of the bass part in choosing the take. So I would turn the bass off and listen to everything else, particularly the vocals. Then, if it was great, I would turn the bass up and listen to it. If I had to fix something, I would fix it, but if the vocal is great, then you choose the take for that reason."

That was especially true, Was says, working on sessions with a singer like Colter, where emotion trumped perfection every time. "Part of the deal when you're producing a Jessi Colter record is knowing when not to get too slick," Was notes. "Like 'His

Eye Is on the Sparrow' wasn't even intended to be recorded. She was just warming up and, fortunately, the engineer kicked it into Record. That's a really stirring performance. Now there's stuff all over the place—fingernails and stuff being moved and people noodling—but that spontaneous moment is what makes it effective."

In fact, there were a handful of songs, Was reports, that didn't need much work. "I had no idea what to add to 'You Took Me By Surprise,'" he admits. "We did a little bit of work to it, but as she played it to me that day, I thought it was perfect." On the song "Never Got Over You," Was says, "We added some things to it and remixed it, but it was of the moment. Not only that, but you couldn't take the vocals out of the mics. There's a tambourine that comes in really loud at the end and that's just what happened in the room. I think it was pretty much a live take that was augmented with a few things. That happens a lot on that record."

And, according to Colter, that was the design all along. "I'm messy and I love some of the great records that were done messy," she says with a laugh. "I think *Exile on Main Street* [by the Rolling Stones, 1972] is awesome. It was a mess. And some of Bob Dylan's early stuff was a mess. It was true to the moment, mistakes and all. Now, with digital, everything can be so perfect, but that's pretty boring. You know—try to be good, but you don't have to be *too* good."

With *Out of the Ashes*, Colter returns to the music business and plans on sticking around: "I've got two albums in my library," she says, "and I've continued to write, sing and cut." ■

**Dream Machine.**  
The sound of a successful production.

[www.solid-state-logic.com/c300](http://www.solid-state-logic.com/c300)

**Solid State Logic**  
SOUND | VISION

# RETURN OF THE FADER.

{music production USB Automation/Transport controller | mouse-free music production}



## FADERPORT

{music production USB Automation/Transport controller }

The FaderPort puts the fun, vibe, and efficiency back into music recording and production. No more clicking through menus and drawing automation editors with a mouse. The easy-to-use FaderPort delivers complete transport control for fast and efficient recording along with its ultra-sensitive motorized fader for writing perfect fades and automation. Pan, mute, solo, and record enable can also be easily controlled with the FaderPort along with window selection, play, stop, record, and marking markers (locate points) for fast and easy recording. The FaderPort works with all Mac or Windows-based recording software including Pro Tools, Cubase, Nuendo, Sonar and more. Over the past 25 years, Sweetwater have become experts at getting the best music production tools in your studio, and the FaderPort is another essential. Call Sweetwater today and experience the return of the fader.

### FEATURES:

- complete recording transport control
- touch sensitive, step-down motorized fader
- write single channel or group channel automation
- pan control, mute, solo, record enable
- quick window selection (solo, mix, transport)
- sustain lock for easy free-punch (solo)
- compatible with all major recording software including Pro Tools, Cubase, Nuendo, Sonar, Digital Performer and more!
- Mac and Windows compatible

[www.presonus.com](http://www.presonus.com)

**Sweetwater**

800-222-4700  
[www.sweetwater.com](http://www.sweetwater.com)

World Radio History

**PreSonus**



## Solas

*Reunion: A Decade of Solas*  
(Compass)

The name sounds vaguely Hispanic, but folks in the know will tell you that Solas is among the most original and creative purveyors of traditional Irish music of any U.S.-based group. (Indeed, their self-titled Shanachie debut from a decade ago is among my favorite discs in the genre.) The key to their success is they work from such a broad palette, mixing elements (and instruments) from other folk traditions—from American old-time to central European styles—yet they never seem

to be too far from a spry reel or jig or a heartbreaking ballad that *drips* Ireland green. *Reunion* is a wonderful, spirited live album, recorded in their home city of Philadelphia, that brings together players from various incarnations of the band, all anchored by leader Seamus Egan. The CD features 17 selections that range from traditional instrumental and vocal pieces to group originals by Egan and Antje Duvekot, and even Woody Guthrie's lovely "Pastures of Plenty." The presence of piano, drums, electric and acoustic guitars, and bouzouki are indications that, Toto, you're not in Dublin anymore, but it all still feels somehow like it's rooted in Irish soil. But wait—there's more: Also included is a DVD with an expanded, nearly two-hour version of the concert, plus interview footage, 5.1 surround mixes and a photo gallery. It's a great way to get to know what has always been a very special group.

Producers: Egan and John Anthony. Recorded at Indre Studios (Philadelphia) by Ivan O'Shea, Mike Comstock and Pete Girenti. Mixed and Mastered by John Anthony/Maja Audio Group.

—Blair Jackson



## Elvis Costello & Allen Toussaint

*The River in Reverse*  
(Verve Forecast)

June's "Cool Spins" included Elvis Costello's classical-jazz *My Flame Is Blue*. This month, he reappears in another of his musical multiple personalities: New Orleans soul singer. Costello collaborated with artist/composer/producer Toussaint and producer Joe Henry on an emotional tribute to Toussaint and his hometown. New Costello/Toussaint songs, Toussaint classics and one by Costello were recorded in the wake of Hurricane Katrina, giving new meaning to Toussaint's themes of personal loss and human-rights struggle. Henry also has a talent for showcasing singers. Layers of arrangements enlivened by Toussaint's piano and Steve Nieve's B3 draw back like theater curtains to reveal Costello's passionate voice. Am I the first reviewer to think of Joe Henry as the T Bone Burnett of soul?

Producer: Joe Henry. Engineer: Husky Hoskuld. Studios: Sunset Sound (L.A.), Piety Street Recorders (New Orleans). Mastering: Gavin Lurssen/The Mastering Lab (L.A.).

—Barbara Schultz



## Neil Young

*Living With War*  
(Reprise)

Neil Young's much publicized anti-war polemic is worth

some ink not because it was made in less than a week from start to finish (that used to be typical), but because it's one of his better albums of recent years. Young is in gritty, heavy-guitar mode for most of it, but it's *not* a Crazy Horse record (Chad Cromwell plays the elemental drums and Rick Rosas the bass) and there's important augmentation from outside his droning rock formula: Trumpeter Tommy Bray adds some spice to several songs, and there's also a full choir on every track—sounds like a bad idea, but it works! One or two songs sound slightly recycled, but the overall effect of the album is quite powerful, and the best songs—"Families" and "Flags of Freedom"—are deeply moving.

Producers: Young and Niko Bolas. Engineered by Bolas, with John Hausmann, John Nowland and Steve Genewick. Recorded at Redwood Digital and Capitol Studios. Mastering: Tim Mulligan.

—Blair Jackson

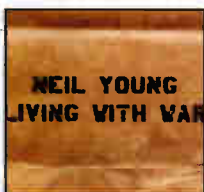

## Wolfmother

*Wolfmother*  
(Modular/Interscope)

Sherman, set the Way-back Machine to some high school stoner kid's bedroom, circa 1971. Close your eyes and prepare to use your air-guitar and head-banging skills as Wolfmother expertly revives late-'60s, early '70s hard rock a la Black Sabbath and Led Zeppelin. The Australian trio's debut album has monster power chords, fuzzed-out guitar riffs and heavy psychedelic keyboards. The album's opener, "Dimension," begins with a crazed scream and launches into a dark guitar rhythm that will send chills down your spine. "Apple Tree," the album's only modern-sounding track, delivers a White Stripes-esque punk vibe. "Witchcraft" has a Jethro Tull-style flute solo that's not at all out of place with the feel of this album. So kick back with your vice of choice and bask in this retro delight.

Produced and mixed by D. Sardy. Engineer: Ryan Castle. Studios: Sound City, Sunset Sound, The Pass and Village Recorder. Mastering: Stephen Marcussen/Marcussen Mastering.

—Lori J. Kennedy



## Dave Alvin

*West of the West*  
(Yepco)

Dave Alvin has been a champion of American roots music since his early days writing and playing rockabilly songs with his brother, Phil, in The Blasters. On *West of the West*, he narrows his focus, covering a stellar selection of songs written by other native Californians, including Merle Haggard ("Kern River"), Tom Waits ("Blind Love") and Brian Wilson ("Surfer Girl"). These unexpectedly sultry versions compose an homage to Alvin's home state, and with his cigarette-fueled baritone and tuneful guitar work, he artfully transports the listener to a smoky club, a lonely highway, a beach at twilight. Alvin's strength as a performer is so impressive; not many singer/songwriters could own these songs and fit them together so beautifully.

Producer: Greg Leisz. Recording engineers: Greg Parker Adams, Bill Dashiell. Mixing: Jim Scott. Studios: Winslow Court (Hollywood), Plyr Studio (Santa Clarita, Calif.), Leon Haywood's Eye-Jim (L.A.). Mastering: Joe Gastwirt/Joe Gastwirt Mastering (Oak Park).

—Barbara Schultz



**What the pros are saying about Gefell:**

**Bill VornDick** - Engineered 42 Grammy-nominated recordings and 8 Grammy winners. Artists include Alison Krauss, Bob Dylan, Chet Atkins, Bela Fleck, James Taylor, T-Bone Burnett, Mark O'Connor, Ralph Stanley and Dolly Parton.

It's like having a secret weapon... My Gefell mics are extremely clear and transparent. They give me the definition that many other mics do not capture."



**Alan Silverman** - Engineered 21 Grammy-nominated recordings. Credits include Chaka Khan, Norah Jones, Cheap Trick, The Kinks, Bebo Valdés, Ricky Skaggs, Bill Monroe, Art Garfunkel, Meatloaf, Keith Richards and The Producers.

It's the ultimate compliment when a singer or musician says they've never sounded better. In particular, the sound of the UM900 is sparkling, enormous and exciting. My Gefell microphones have earned this praise time and again."



**David Rideau** - Multi-platinum engineer/producer and three-time Grammy nominee. Clients include Sting, Jimmy Jam & Terry Lewis, TLC, Janet Jackson, Earth Wind and Fire, George Benson, Tom Scott, Al Jarreau and Kirk Franklin.

The Gefell M930 is a wonderful sounding mic that has given me great results on acoustic piano, acoustic guitars, percussion and drum overheads. The low self noise also makes it a perfect choice in situations where wide dynamic range is an issue. I call it my elegant workhorse!"



**Dave Bottrill** - Peter Gabriel, Deep Forest, King Crimson, Robbie Robertson, Tool, Silverchair, Tony Childs, Joai Mitchel, Trey Gunn, Youssou N'Dour, Kid Rock, Roger Eno and the "Philadelphia" soundtrack.

For vocals, the Gefell UM900 is warm, open and very robust. The control also makes it flexible. It works well on percussion and acoustic instruments, all the while retaining the air and presence that one expects from a large diaphragm microphone."



# Get Real

## Real History

Since 1928, Gefell has led the world in microphone technology, starting with the world's first condenser. In 1935, the remarkable M7 capsule was introduced. That led to the legendary sound of the U47, the U49 and in 1957, the UM57 – the first ever multi-pattern microphone. Today, Gefell continues the tradition under the direction of Mr. Kühnast Jr. with the original M7 capsule featured in the UM75 and UM92.15 tube microphones.



Georg Neumann with Chief Engineer Mr. Kühnast Sr. – circa 1933

## Real Quality

Quality comes with the desire to do it right. For over 75 years, Gefell has built microphones by hand in order to achieve the highest standards possible. From the precision machining of raw metal stock to the hand-stretching of each diaphragm and individual testing of each microphone in an anechoic chamber, Gefell sets a standard that is simply higher than any other.



2004 – Hand-drilling an M930 back plate

## Real Innovation

Introducing the M930 – the most advanced condenser microphone made today. Compact for easy placement, the M930 features a full-size 1" diaphragm mounted on a triangulated pedestal to diffract body reflections away from the capsule and minimize acoustic field disturbance. Inside, the M930's optical power isolation lowers self-noise to a mere 7dB while providing 80 Volts to the capsule for an unprecedented 142dB signal handling. The results are stunning: that 'big bold German sound' without compromising sensitivity, articulation or tonal structure. No other microphone comes close.



M930 matched stereo pair with SH93 X/Y bracket

## Gefell is the Real Thing

# Gefell™

the original hand-made German microphone

[www.gefell-mics.com](http://www.gefell-mics.com)



## L.A. GRAPEVINE

by Bud Scoppa

Welcome to L.A.: This month's column features two out-of-towners—visitors from Boulder, Colo., who began their project in their home state and then brought their tracks here to Hollywood. Veteran producer Dik Darnell and technologist/engineer Gus Skinas head up Boulder's Super Audio Center. I caught up with them in Ocean Way's Studio D as they neared completion of an album project that had started with tracking at Immersive Studios in Boulder and continued with orchestral overdubs



In Ocean Way Studio D, Lindsey Brier (left) and producer Dik Darnell work on Brier's album on the Neve 88R analog console.

at George Lucas' Skywalker Sound complex in Northern California. The artist is contemporary jazz writer/singer/pianist Lindsey Brier, and the label is Darnell's Ethereal Records. At press time, the producer was lining up meetings with major labels about licensing the album.

"It's nice when I come to L.A. because I get the best of the city," says Darnell, who lived here in the late '70s while working for Casablanca Records, but now resides on a spread midway between Aspen and Telluride. "I'm here just long enough not to get burned out by it. Then I head back to paradise."

What's most interesting about this project is that it was made entirely on the Sonoma multitrack workstation, which has all the editing and mixing capabilities of a normal digital workstation, but its recording technology is far beyond the 24-bit/192kHz

standard, resulting in what Skinas describes as "a completely different character. It's a 1-bit sigma delta system running at 2.8 million bits a second and focusing on the accuracy of sonic information in the time domain rather than the dynamic aspect of multi-disc PCM systems. I think that's much more true to the way we hear as humans."

The Sonoma is derived from the Super Audio recorders developed by Skinas and his team for Sony; the first-generation rigs were used primarily for surround sound and high-end, live-to-2-track recording projects. Sony ended the relationship early in 2005, allowing Skinas' company to retain the Sonoma technology. "We then did what I'd always wanted to do and turned it into a multitrack," Skinas explains. "Sony paid for all the hard work, and we did a little finish-up work."

The first project to employ Skinas' new Sonoma 24 was John Hiatt's *Master of Disaster* (profiled by Rick Clark in September 2005), but Darnell's undertaking is the first 64-channel session for the ever-expanding Sonoma. "This is a big project for us," Skinas confirms.

"Gus built the first 32-track Sonoma recently," Darnell explains, "and he knew I was getting ready to do this project, so he said, 'Why don't you do it on the Sonoma?' I told him I loved the idea but that I'd need more than 32 tracks because I was going to record a full orchestra, so he put two of them together. I simultaneously cut the basic tracks to Sonoma and to 2-inch tape on a Studer 24-track A827. Then we A/B'd the two of them, several engineers and myself, and they both sounded wonderful so we decided to do the whole album on Sonoma. It's so nice to have a digital system that has the sonic quality of analog, and you could hear the difference."

Darnell chose Ocean Way D for the

—CONTINUED ON PAGE 132

## NASHVILLE SKYLINE

by Rick Clark

My neighborhood was nearly destroyed by a major tornado eight years ago, but it's hard for me to imagine the unfathomable devastation—the equivalent of many thousands of my neighborhoods—that hit New Orleans and the Delta South. It has now been a year since Katrina roared onshore and, having heard the stories of many of those who are now engaged in the rebuilding and healing, I can't say enough about what the gestures of assistance from organizations and individuals have meant.

The National Association of Recording Arts & Sciences might be best known for the Grammy Awards, but this organization has done so much to educate and assist people in the industry. I've been a proud member of the Memphis chapter of The Recording Academy since the mid-'80s, and I can't tell you how many times I've had to re-educate musicians who have told me they didn't see any reason to pay dues to be part of an organization that seemed primarily about an awards show. I feel it is time to shine a light on a very important wing of the organization, MusiCares ([www.grammy.com/musicares](http://www.grammy.com/musicares)).

Established in 1989, MusiCares is a safety net of critical assistance for music people in times of need, and its services and resources cover a wide range of financial, medical and personal emergencies. In the wake of hurricanes Katrina and Rita, the Recording Academy and MusiCares sought a way to help those directly affected by the disasters and created the MusiCares Hurricane Relief Fund, with an initial contribution of \$1 million. This fund was established within three days after Katrina.

Reid Wick, one of many in the local New Orleans music community whose property was wiped out by the storm, relocated to Memphis to help coordinate the Hurricane Relief Fund with Debbie Carroll, who runs MusiCares out of its Nashville-based headquarters. Before Katrina, Wick was co-owner of indie label STR Digital Records and worked at Loyola University's College of Music as the marketing and PR manager, concert

## NEW YORK METRO

by David Weiss

series and special events producer, and instructor in the Music Industry Studies program.

"The first few weeks after the storm were like a blur," Wick remembers. "The phone rang off the hook both in Nashville [where the MusiCares 800 number rings], as well as in Memphis, the chapter office of all Recording Academy members in the affected areas. The online assistance forms were quickly created, and they really opened the floodgates of clients coming to us for aid. Working in this capacity quickly gave me a sense of what this assistance meant to all these people who didn't know what their futures were going to be like. It also amazed all of us that we were helping so many people so fast. We were getting thank-you calls and notes, saying that they got help from MusiCares way before FEMA [Federal Emergency Management Agency] or the insurance companies helped."

Recording artists Russ Broussard and his wife, Susan Cowsill, who lost two family members in the storm, as well as most of what they owned, are quick to agree about how MusiCares helped. "While you had to stand in lots of lines to find out the help

—CONTINUED ON PAGE 132

Thrillseekers craving adventure in professional audio can find everything they're looking for in the mobile devices department. As PDAs, pocket PC phones and good old cell phones get smaller, faster and more powerful, and users can gain access to higher-bandwidth wireless connectivity via WiFi, there's more room for quality audio in the games, advertising and other applications that are being produced for them.

The good news is there's plenty of room for adept audio developers who want to get involved. The bad news is that rules, standards and guidelines are few and far between. "Mobile audio is the Wild West—anything goes," says Steve Horowitz, founder and creative director of New York City-based Mobile Audio 2 Go ([www.ma2g.com](http://www.ma2g.com)). "By nature, this is an audiocentric medium. Everyone is claiming that they have the secret formula, but in fact, there's a tremendous amount of opportunity and risk."

Horowitz is betting that mobile audio will take off. A successful indie film composer (*Super Size Me*), experienced Internet music developer for Nickelodeon Online and a member of the Manhattan Producers Alliance, Horowitz has plugged into New York City's thriving, media-rich content scene to found ma2g, which he describes as the world's first mobile music and sound effects library. By offering multiple libraries created for mobile games—in a single package that can satisfy the hundreds of formats and data size limitations that mobile developers contend with—Horowitz and his collaborators believe they

can ensure better-quality audio for all users of the coming generation of games and applications.

"ma2g is a custom depository that developers can go to where they know there's music that's been pretested on the phones by people who understand how these systems operate," says Horowitz. "When they're assembling their games, if they purchase an ma2g library, they don't have to worry about multiformat compatibility."

Horowitz compares the evolution of mobile audio to that of music and sound effects for Web applications during the past few years. "When you originally started with games on the Web, they couldn't be more than 150 kilobytes [of memory]," he notes. "Now, they can be as large as 20 megs, and you can get a lot of rich content—music, sound effects and voice-over—into a 20-meg Flash game. The same will happen with mobile games.

"Meanwhile, the Interactive Audio Special Interest Group [[www.iasig.org](http://www.iasig.org)] is getting ready to issue a white paper with recommendations for a baseline standard for mobile handsets," he continues. "Currently, everyone is trying to support different

—CONTINUED ON PAGE 134

PHOTO: DAVID WEISS



Attached to their phones: Mobile Audio 2 Go's Steve Horowitz (left) and Devin Maxwell, making the most of mobile audio.

PHOTO: RICK DIAMOND/WIREIMAGE.COM, COURTESY OF THE RECORDING ACADEMY



President of The Recording Academy and MusiCares Neil Portnow (foreground), Kristen Madsen (senior VP of MusiCares) and staff view a mud-encrusted grand piano that was ruined by floodwaters from the 17th Street Canal levee break.



## COUNTRY MEETS SOUL BUDDY MILLER PRODUCES SOLOMON BURKE

Soul legend Solomon Burke recorded his first country album with artist/songwriter/producer Buddy Miller in Miller's home studio. Burke met Miller when they both performed at the Americana Awards at the Ryman Auditorium in Nashville last September. Miller was guitarist and bandleader for the event, and Burke performed the Hank Williams classic "Wealth Won't Save Your Soul." "It was off his last record," Miller observes. "It meant a lot to him to be singing a Hank Williams song at the Ryman—on the same stage where Hank Williams performed.

"He hadn't done a real country record, but a lot of his records were country songs interpreted for the R&B market," Miller continues. "Even his early Atlantic Records, like the song 'Just out of Reach,' was a country hit, too. He did 'Four Walls'; he did 'He'll Have to Go.' Being a huge Solomon Burke fan, I wanted to make it a special time for him to come and do a record here in Nashville."

Miller's studio occupies the entire ground floor of the home he shares with his wife, singer/songwriter Julie Miller, with large glass doors separating the rooms and providing sight lines between the players. Engineer Jake Burns recorded the tracks live to Pro Tools HD3, with Burke's astounding vocal going from a Neumann U47 through a Telefunken B76, a UREI 1176 and a Manley Massive Passive EQ.

"We'd go from a full band tracking in the house to situations like the night-after session when Gillian [Welch] and David [Rawlings] came over and we sat around the living room and just played. It was just them and a bass player and Solomon, recording live, sitting around in a circle."



*It's all American music: Solomon Burke (with guitar) and Buddy Miller.*

Miller says that whenever possible, he made sure the songwriters whose work appears on the album (Welch, Miller, Jim Lauderdale, Dolly Parton, Paul Kennerley, Emmylou Harris, Patty Griffin and others) played on their own tracks. "I had them come because they're great players and singers, but also so I could turn around when he sings the first line of their song and see the look on their face. It's such an incredible thing to hear that voice singing your song!"

—Barbara Schütz

### BEHIND THE GLASS

## CARRYING THE "TORCH" ALLMAN DEBUT AT ARDENT



*Engineer/co-producer Pete Matthews (left) with artist/co-producer Devon Allman of Honeytribe at Ardent Studios (Memphis).*

Devon Allman (son of Allman Brother Gregg Allman) recorded and mixed his band Honeytribe's first album at Ardent Studios (Memphis). The debut was engineered by Pete Matthews, who also co-produced the album with Allman, on Ardent's 64-input API 8200 series mixing surface with Pro Tools HD3 Accel. While in Memphis, Honeytribe took time to perform at the Beale Street Music Festival.

## ALL ABOUT ADAM NUMEROUS GIGS AT GATEWAY



*As Fast As at Gateway: Adam Ayan (center) with bandmembers (from left) Andrew Hodgkins, Pat "Hache" Hodgkins, Zach Jones and Spencer Albee.*

At Gateway Mastering (Portland, Maine), busy engineer Adam Ayan has mastered releases in a variety of genres in his Pro Tools HD/Sonoma-equipped Studio B over the past few months, including country stars Rascal Flatts and Tim McGraw, soul legend Irma Thomas and alt-pop/rockers As Fast As, who recently signed with Octone Records.

## NEW CLASSICS

### RETRO UPGRADE CLASSIC NEVE AT ANNEX

PHOTO: DAVE BOND



Seated, from left: engineer Chris Wolfe, producer/engineer Forrest Lawrence, engineer/sound designer Jeremy Park. Standing, L-R: engineer Andy Heller, studio manager Tony Wentzel and owner/producer/engineer Russell Bond.

The venerable Annex (Menlo Park, Calif.) is celebrating 30 years of music recording with the installation of a Neve VIII/60 Series console in its Studio A. The "new" board features 56 channels of Flying Faders and integration of a 48-track Pro Tools HD system.

### METHENY GUEST STARS A SIDEMAN AT EASTSIDE



From left: engineer Thom Berkley, engineer Stephen Joseph, guitarist Pat Metheny, chief engineer Fran Cathcart and engineer Marc Urselli.

The virtuosic Pat Metheny added his talents to bassist/composer Me'shell NdegéOcello's new album, which is being recorded at Eastside Sound in New York City. The whole staff jumped at the chance to appear with the guitar hero.

#### SOUTHEAST

Donna the Buffalo laid down tracks at Blackbird Studios (Nashville) and Echo Mountain (Asheville, NC) with producer/engineer Joe Blaney...Producer/engineer Khalifani and drum tech Tony Adams were in Tree Sound Studios (Norcross, GA) with alt-rock band Fervor working on the band's debut album for Khalifani's Kraftwerk Music label.

#### MIDWEST

Former Buddy Holly guitarist Tommy Allsup was in Studio VMR (Brookfield, IL) producing tracks for singer/guitarist Johnny Rogers with Don Griffin engineering...At Up on the Roof Recording (Lombard, IL), owner/engineer Mark Blas recorded the latest release by local band Mitch & The Polecats.

#### NORTHEAST

Grammy winner Mick Guzauski mixed Mig in his own Barking Doctor Studios (Mt. Kisco, NY) with producers Matthew Wilder and Rob Mathes...At Avatar (NYC), Counting Crows were in recording with producer Gil Norton, engineer Steve Mazur and assistant Peter Doris, and Joshua Redman tracked with engineer James Farber and assistant Brian Montgomery...Nolan Neal's latest Virgin Records release was mixed by Mario McNulty at Allaire Studios (NYC)...Singer/songwriter Linda Thompson was in Dubway Studio's (NYC) Yellow Room cutting a track written for her by Rufus Wainright. Dubway chief engineer Jason Marcucci recorded, and Ed Haber produced...Pilot Recording (NYC) hosted singer/songwriter Shawn Colvin, recording overdubs and mixing her latest Nonesuch Records release with producer/mixer John Leventhal and assistant Matt Shane...At Loho Studios (NYC), Nicole Atkins recorded Columbia Records debut with producer (and multitalented punk pioneer) Lenny Kaye. Emory Dobyns engineered...Mountain recorded and mixed a new album at Showplace Studios (Dover, NJ) with engineer/producer Ben Elliott...Al DiMeola is tracking for an upcoming Telarc release in his home studio with engineer Lester Lovell. John Patitucci, Chick Corea, Barry Miles and Steve Gadd also contributed to the album...Lawrence Manchester recorded Elvis Costello, Odetta, New Birth Brass Band, Bill Cosby, Will Calhoun and Ron Carter and Friends live at the Apollo Theater (NYC) for the Concord Records album *A Great Night in Harlem* using the Remote Recording Services (NYC) truck...At Threshold Music (NYC), Kids in the Way tracked with engineer/producer Kato Khandwala...Bridges in a Bottle recorded and mixed *Trojan Horse* at StarCity Recording (Bethlehem, PA) with producers Jeff Glixman and Zack Rizvi, and engineer Carl Cadden-James.

#### NORTHWEST

At Rudy's Lair (Bothell, WA), engineer Ivan Schwartz



Singer/songwriters Shelby Lynne (left) and Willie Nelson recorded a track for an upcoming Barbara Mondrell tribute at The Village (L.A.). Brian Harrison engineered, but Village staffer Jason Wormer filled in at the board when Harrison joined the performers to play some bass. Jim Monti assisted.

mastered a new album for Seattle-area artists Zero Tapestry...In his Nettleingham Audio facility (Vancouver, WA), Kevin Nettleingham mastered releases for Portland artists Fatecage, Tony Green Orchestra, Headless Human Clones, Stan Lessard, Silentist and Ray Ottoboni.

#### SOUTHWEST

San Antonio, Texas, rockers Rose of Jericho were in Razor's Edge Sound (Austin) tracking and mixing an upcoming album with producer Kevin Hamilton...Fried Ice Cream were in Tierra Studios (Houston) recording the song "Peace in the Valley," and rapper Da Menace mixed and mastered his new song "H-Town Chick"; both acts were engineered by Aaron Morris.

#### SOUTHERN CALIFORNIA

The Heavens' debut on Epitaph was mixed at Paramount Studios (Hollywood) by engineer Ryan Hewitt and producer Ben Lovett...Hewitt also worked at The Pass, mixing a Pepper album produced by Tony Kanal, Paul Leary and Nick Hexum...Ziggy Marley was in Boogie Motel (Woodland Hills) with engineer/mixer/co-producer Ross Hogarth...At indie mastering studio Sound Bites Dog (L.A.), engineer Hans DeKline mastered releases from Mondo Generator and Minor Canon...POP Sound (Santa Monica) prepared Dolby Digital surround mixes for two cinema spots promoting Microsoft's new game platform, Xbox 360. Peter Rincon helmed the recording and mix sessions...Ocean Way's (Hollywood) Studio D hosted award-winning mixer Steve Kempster, who was in mixing the score for *PU-239* (HBO); the music was composed by Abel Korzeniowski...Lyle Lovett's double-bassist for the past dozen years, Viktor Krauss stepped into Studio A at Sound Factory (L.A.) to work on his second solo record; Jason Lehning handled engineering and mixing duties, while Lee Townsend produced. Session musicians Dean Parks (guitar) and Matt Chamberlain (drums) were on hand. ■

Send news for "Track Sheet" to [bschultz@mixonline.com](mailto:bschultz@mixonline.com).



mixdown partly because he has fond memories of working at United Western (as it was then known) back in the '60s and because the room is equipped with a Neve 88R console; Sonoma requires an analog board. "If we went through a digital console," Damell explains, "we'd have to convert it back to that stream and we would immediately lose the quality we'd captured. We're mixing to Sonoma itself for the surround sound and stereo mixes, and we're also mixing to half-inch tape for the stereo mix because a lot of mastering engineers are used to dealing with a half-inch master as their source. But again, the difference is so minute that you can't tell. And the music works perfectly with the system; we need that clarity and warmth."

Damell shelled out a pretty penny on the project, violating the age-old music biz rule: Never spend your own money. But he says, "When you hear it, you know it's worth it."

"If this technology takes off, this will be seen as a very historic recording," Skinas theorizes. "I worked with Sony back in the days when they launched the multitrack and this could be just as big a breakthrough." ■

Send L.A. news to Bud Scoppa at bs7777@aol.com.

had stopped for the day or until the Red Cross and FEMA figured out how they could help, MusiCares was the first to step in," states Broussard. "Debbie Carroll in the Nashville office embraced us with such warmth, compassion and strength, we felt that things would turn out okay in a time when we couldn't make simple decisions or hard ones like where do our kids go before we leave on our scheduled tour around the album release."

So far, the Relief Fund has provided more than \$3.2 million in financial assistance for basic needs such as food, clothing, gasoline, transportation and medications, as well as instruments and other supplies to more than 3,000 individuals directly affected by the disasters. As the months have progressed, music people's needs have shifted from immediate and basic to longer-term, deeper ones, including rent deposits, relocation costs and funds for medical care that has been postponed.

As part of its overall relief efforts, MusiCares is also a lead partner of Music Rising, an initiative to raise funds to replace instruments lost by the musicians located in the Gulf Coast. The number of musicians affected by the hurricanes

is estimated to be as high as 7,000. MusiCares was joined by Gibson Guitar, the Guitar Center Music Foundation, U2's The Edge and Bob Ezrin in committing to an initial goal of \$1 million. Gibson Guitar and Guitar Center collaborated on the design, manufacture and sale of an exclusive Gibson guitar, with all proceeds going directly to the Music Rising program.

Since its launch in November 2005, Music Rising has replaced the instruments of more than 1,700 musicians located in 34 states from California to New York. The pool of applicants has remained steady, and each week new clients emerge who need assistance.

Music people who are still struggling can contact MusiCares' South Region office at 877/626-2748 and request an application. All approved grants are issued directly to a third party. To qualify for assistance, an applicant must be able to document five years of employment in the music industry and/or credited contribution to six commercially released recordings or videos. ■

Send Nashville news to Rick Clark at mrblurge@aol.com.

### Why pay for all of these?

Sound Level Meter	\$ 350
Leq Meter	\$ 300
Dosimeter	\$ 300
Sound Study Graph	\$ 300
Real-Time Analyzer	\$ 400
FFT Analyzer	\$ 600
Energy-Time Graph	\$ 400
Reverb Decay Time	\$ 400
Multi-Band Decay	\$ 200
Time-Delay Analysis	\$1000
RaSTI	\$ 400
STI-PA	\$ 500
Noise Criteria	\$ 400
Transmission Loss	\$ 200
Audio Stethoscope	\$ 150
Level/Freq Meter	\$ 200
Signal Generator	\$ 400
Amplitude Sweep	\$ 200
THD+N Distortion Meter	\$ 150
IMD Distortion Meter	\$ 150
Phase Meter	\$ 150
Crosstalk Meter	\$ 150
Speaker Polarity	\$ 100
Speaker Distortion	\$ 150
Impedance Meter	\$ 200
Impedance Sweep	\$ 300
Cable Tester	\$ 100
Audio Scope	\$ 200
USB Audio Preamp	\$ 800
<b>\$ 9,150</b>	

### The SoundPro Audio Integrator

- totally analyzes sound systems and room acoustics - on the spot
- tunes audio systems and documents system performance
- relieves stress at showtime by providing quick cures for show stoppers
- gives you all the audio tools you need, in one unit, for maximum effectiveness and convenience



**Audio Integrator Less than \$3,000**

**Integrate it ALL for less.**

**The Audio Integrator!**

**SENCORE**

3200 Sencore Drive Sioux Falls, SD 57107

sales@sencore.com

www.sencore.com

1-800-736-2673 or 1.605.339.0100

# HUGE SOUND.

TOTALLY VERSATILE :: TOTALLY PRO

INTRODUCING THE ULTRA-COMPATIBLE DIGIMAX FS DIGITAL PREAMP AND I/O.

**8 HUGE-SOUNDING**, High headroom, Class A Microphone Preamps / Line Inputs / Instrument Inputs.

96k Sampling Clock With **JETPLL™** Low Jitter Technology.



**::ADAT SMUX::**  
8 Channels of  
Digital I/O at 96k.

**::DAC OUTPUTS::**  
Add 8 Output Channels  
to your DAW or  
Digital Mixer.

**::DIRECT OUTPUTS::**  
Analog Preamp Outputs  
for Digital/Analog Splits.

**::INSERT POINTS::**  
Insert Compressors, Limiters,  
Gates, and Effects.



CONNECT DIGIMAX FS TO ADAT INPUT/OUTPUT ON DAW OR DIGITAL MIXER.



## DIGIMAX | FS

(8-Channel Preamplifier with 24-bit/96k ADAT I/O (dual SMUX))

The DIGIMAX FS is an eight-channel microphone preamplifier with 24-bit/96k ADAT (dual SMUX) I/O and word clock I/O. Loaded with direct outputs and inserts on every channel, the DIGIMAX FS is the perfect hardware expansion for your PRESONUS, FIRESTUDIO or any digital recording system with native (high) processing capability including DigiDesign's HD and 002 system, RME, YAMAHA, Alesis, Mackie and many others.

The DIGIMAX FS is loaded with new patented JetPLL™ jitter reduction technology from TC Applied Technologies, ensuring ultra-high converter performance, fast and robust locking through a wide range and variation of frequencies and noise shaping to remove nearly all audio band jitter.

Sweetwater has been selling digital recording systems for over 25 years and knows the ins and outs of every type of system on the planet. Call Sweetwater today to find out how your system can take advantage of the huge sound and versatility of the DigiMax FS!

WWW.PRESONUS.COM

### FEATURES:

- 8 Class A microphone preamps
- 24-bit resolution, 44.1k, 48k, 88.2k and 96k sampling rate
- 96k ADAT input and output (dual SMUX)
- JetPLL jitter reduction technology for ultra-high converter performance
- Direct outputs and inserts on every channel
- Word clock input and output
- Works with DigiDesign's HD and 002, RME, YAMAHA, Alesis, Mackie and many others.
- \$599

© 2006 PreSonus Audio Electronics, Inc. All rights reserved. DigiDesign's HD and 002, RME, YAMAHA, Alesis, Mackie are property of their respective owners.

**Sweetwater**

800-222-4700  
www.sweetwater.com  
World Radio History

**PreSonus**



formats because each company has its own proprietary formats, and a lot of those are low-level compression schemes that are just horrible. The way it is right now, certain handsets and game development platforms support a certain set of codes and others support others, so to make it simple for producers, we founded ma2g on the principle of delivering for all possible North American handset formats."

Horowitz collaborates closely with Devin Maxwell, president of Brooklyn, N.Y.-based mobile media specialists Loud Louder Loudest (LLL, [www.loudlouderloudest.com](http://www.loudlouderloudest.com)). Maxwell has deep experience developing mobile and audio/visual content for record companies. Horowitz points to the creation of a stirring package called Cinematic Suspense, with six audio music loops, a MIDI arrangement and 10 sound effects as a good example of the ma2g development workflow and subsequent user interface.

"In deciding the length and number of cues, think of it just like a radio or TV library where everything is cut to fit the format," he continues. "ma2g conforms to, at the moment, the way mobile games are built, so there's an intro for the loader splash screen that plays when the title screen first appears. Then we

created small loops, broken out into four-bar patterns that increase in intensity, so as you're progressing up to further levels of the game, you get a somewhat adaptive, interactive soundtrack. Then we cap it off with an outro flourish for game's end. We also provide an extended MIDI arrangement."

After an audio package has been composed and recorded, ma2g posts its availability on the Website. Developers can preview the sound of the files and can find out what size file will be in any of a laundry list of formats, including AAC & AAC+, MP3 and QCP.

Once an order is placed, ma2g sends the raw package to LLL in the form of WAV and General MIDI files. Then, Maxwell's team oversees a painstaking but speedy process wherein each file will be reformatted 450 times in as little as two days, depending on the client's deadlines.

Next, LLL becomes a highly prolific mastering house, albeit one where critical listening happens in the worst possible environment—a plastic cup with a small speaker inside to simulate the ultralow-level speaker quality of many handsets. "We master them in [Sony] Sound Forge using a lot of the Waves plug-ins, like the L3 multiband limiter," says Maxwell.

"On handsets, dynamic range is generally a bad thing, so we'll cut out everything the phone can't play, which is generally above 8 kHz or below 125 Hz, depending on the format. However, my goal is to not really impose a lot of restrictions on Steve's team; I want them to think about music with a little bit of mobile, while I think of mobile with a little bit of music."

Following the mastering process, LLL does the file encoding, followed by a meticulous quality assurance process, wherein a digital procedure of verification is followed by a manual QA that places many, but not all, of the files on LLL's sizable phone collection for hands-on testing. Once QA is complete, the files are zipped up and sent back to ma2g, which expedites their delivery to the client.

"You've got to be able to get your hands dirty," Horowitz adds. "If people say, 'I'm composing music for films and TV, and I heard you can make money doing game music so now I'm going to try that,' that's the wrong approach. If you want to write music for mobile games, you should really want to do it, be interested and be willing to learn everything about it." ■

Send your New York City news to [david@dwords.com](mailto:david@dwords.com).

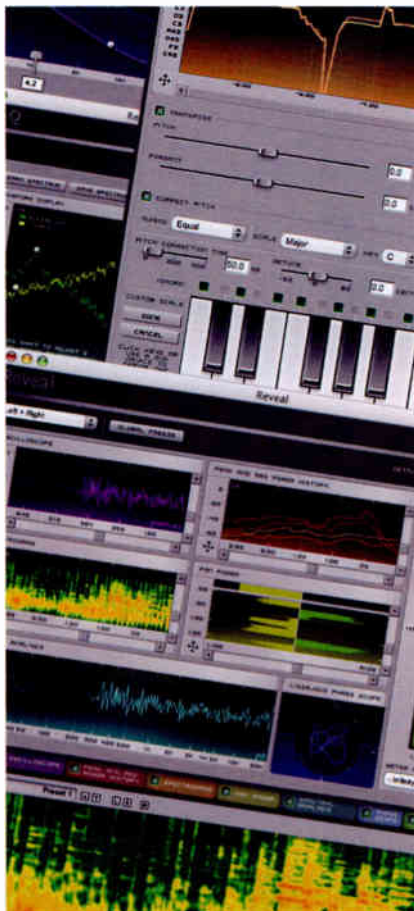

## Master the universe.

Designed from the ground up for mastering and sound design professionals, these state-of-the-art plug-ins were originally available as part of Peak Pro XT™. Now the Master Perfection Suite™ is available for virtually every host application on Mac and Windows, offering more features and many interface improvements over other plug-ins in their class.

- PitchCraft™** — Real-time pitch correction/transposition
- Reveal™** — Seven-tool analysis suite
- SuperFreq™** — 4-, 6-, 8-, and 10-band parametric EQ
- Repli-Q™** — Spectral matching with linear phase EQ
- Sqweez™-3 & -5** — Linear phase multiband dynamics
- GateEx™** — Professional Gate/Expander

Find out more at [www.bias-inc.com](http://www.bias-inc.com)



Master Perfection Suite

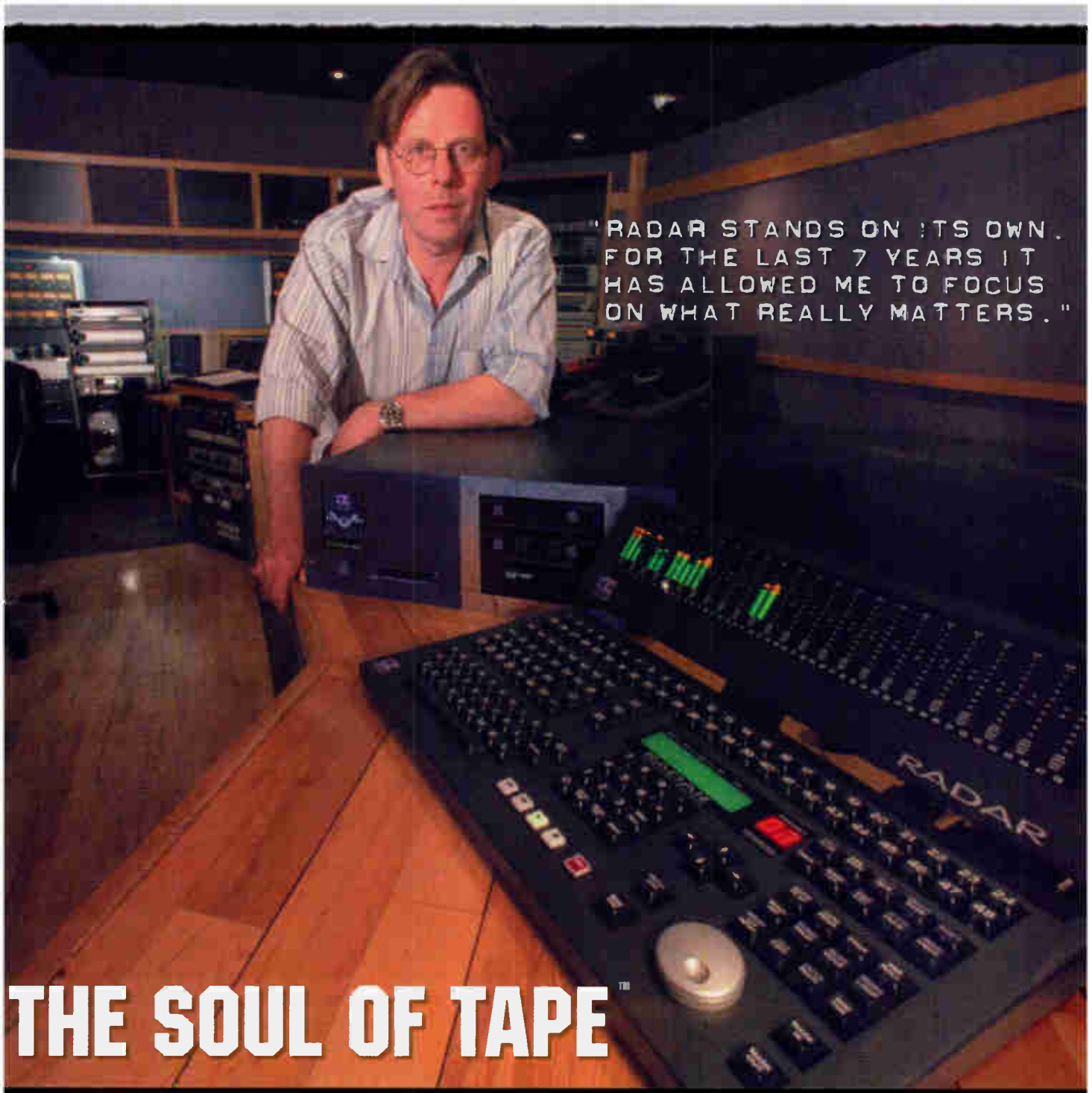

A photograph of Hugh Padgham, a man with glasses and a light-colored shirt, leaning over a wooden desk in a recording studio. On the desk is a large, black, multi-track recording console with a keyboard and a mouse. The console has 'RADAR' written on it. In the background, there are shelves with various pieces of audio equipment.

"RADAR STANDS ON ITS OWN.  
FOR THE LAST 7 YEARS IT  
HAS ALLOWED ME TO FOCUS  
ON WHAT REALLY MATTERS."

**THE SOUL OF TAPE™**

**HUGH PADGHAM**

**PRODUCER/ ENGINEER**

**DAVID BOWIE, PHIL COLLINS, PETER GABRIEL, STING**

Get the rest of the story at [www.izcorp.com/radarview](http://www.izcorp.com/radarview)

**The world's best multitrack recorders™**

RADAR® & RADAR 24 are registered trademarks of iZ Technology Corporation





# GET YOUR COPY OF THE ULTIMATE GUIDE TO HOME STUDIO GEAR



The equipment resource  
for musicians building  
and supplying their  
personal studios.

## ON SALE NOW!

Order PSBG online at  
[www.emusician.com/  
embookshelf](http://www.emusician.com/embookshelf), or find it  
on newsstands wherever  
*Electronic Musician* is sold.

800-245-2737

—FROM PAGE 24, AND THE SCAB GOES TO...

the modern age of audio, six decades ago.

The award for Best Technology That Will Either Save Us or Put Us All Out of Business went to John Mauchly and J. Presper Eckert for ENIAC, the first electronic analog computer. One of two award-winning products that could not be shown at the conference, it had a footprint the size of a large house, weighed 60,000 pounds and its 17,468 tubes, 70,000 resistors, 10,000 capacitors, 1,500 relays, 6,000 manual switches and 5 million solder joints sucked up 160 kilowatts of power. In his acceptance speech, Professor Mauchly said, "Someday, we'll be able to use machines like this to automatically determine the maximum number of grooves you can cut onto a 78 rpm record, and perhaps you won't have to get up and change the disc every three minutes any more!" After the cheers died down, he added, "Either that, or our children will use them to make weird noises."

In Loudspeaker Technology, the award went to Dr. Siegfried Klein for his work on the ion tweeter, which produces sound by modulating a high-energy plasma stream with an electrical signal. Klein's work was based on a late-19th-century discovery that current going through an arc lamp would cause it to literally sing, and by changing the current, you could control its pitch. Klein put the element of an arc lamp inside a small quartz tube and coupled it with a horn, and thus produced rather remarkable non-directional high-frequency reproduction. He was, unfortunately, unable to attend the ceremony as he was recovering from third-degree burns to his left earlobe.

The Microphone Technology award was given to the RCA 77D, the first single-element, multi-pattern ribbon mic. Dr. Harry Olson, the product's chief designer, accepted the award, and opined, "This mic does it all. I think this is the last mic anyone's ever going to have to make. I'll bet that 60 years from now, the most popular broadcaster in America will still have one of these sitting in front of him!"

The award for Musical Instrument Technology ended in a tie. One winner was Canadian composer Hugh LeCaine for his Electronic Sackbut, a keyboard instrument with a self-contained waveform generator that could be controlled in real time three ways: vertical pressure corresponded to volume, lateral pressure changed the pitch and moving a key forward and backward controlled the timbre. He regaled the crowd with a stunning rendition of a Bach partita for solo violin. "I know some musicians are worried that it's going to replace them," he said, "but there's no need to be. There isn't a

lot of classical or jazz that can be played with electronic instruments like this. I mean, how are we going to handle all of that harmony and counterpoint, eh?"

The second winner was more—as we would call it today—polyphonic, and thus a bit more controversial. Harry Chamberlin came up with the idea of building several dozen loops of tape with instrument sounds recorded on them into a keyboard and then attaching tape heads to the keys, so that pressing down each key played a particular loop. As he began his speech, someone in the audience yelled out, "That thing is stupid! Why would anyone want to play back a recording on a session when they can just hire a saxophone player?" Chamberlin replied with a well-recorded Bronx cheer.

The award in Record-Making Technology went to an engineer who had found a way to make records—obsolete: John T. Mullin, the U.S. Army Signal Corps captain, who, when the Allies walked into Radio Frankfurt as the war was ending, discovered two "magnetophones" and several dozen reels of tape made by the BASF division of IG Farben (who otherwise were engaged in the manufacture of various types of poison gas) and shipped them home in pieces in mail sacks. "You can slice it, you can dice it, you can play it backward, and you can use it over and over again!" he said. He then announced, "I'm going to start a company with that crazy Russian Alexander M. Poniatoff and maybe Bing Crosby, and we're going to make these things. We're going to call it JMAMPBCEX, with the last two letters standing for 'Excellence!'"

The competition for Best Improvement to Productivity in the Audio Industry ended in a three-way tie. One award went to Achilles Gaggia, the Italian inventor of the espresso machine. "Achilles thinks that someday there will be three of these on every block and four on every street corner in America," joked the inventor's American patent lawyer, Henry Starbuck, who accepted for Gaggia, "and people will ask for the beans to be burned before they're ground." That got a big laugh, but several could be seen rolling on the floor in hysterics after he said, "And Achilles is absolutely certain that they will pay more for one tiny cup of this stuff than it takes to feed an Italian war orphan for a month."

The second Productivity award went to Percy Spenser of the Raytheon Corporation, who, one day while fooling around with a magnetron tube in a radar lab, noticed that a candy bar in his pocket had melted. Rather than immediately run to the dry cleaners, he experimented with some popcorn and an egg, and before long, he had the first



# LIQUID MIX

32 channels of classic EQ and Compression simultaneously...  
on-board DSP means you get it all!



Only Focusrite's Dynamic Convolution gives you genuine emulations of the most revered signal processors used on every hit throughout recording history.

40 Compressors and 20 EQ's at your fingertips.

32 channels running within your recording application,\* powered by Liquid Mix's on-board DSP, means your DAW becomes a powerhouse at mixdown.



The extensive Liquid Assets library means virtually any classic processor you've ever dreamed of is yours to use. You can even build your own hybrid EQ band by band!

Want to learn more? Call the computer audio experts at Sweetwater today, and check out the liquid mix video at [www.sweetwater.com/liquidmix](http://www.sweetwater.com/liquidmix)

You'll wonder how you ever lived without it.

\*VST/AU/RTAS compliant.  
(RTAS via included FXpansion wrapper.)

IMPORTANT INFORMATION. FOCUSRITE, the FF logo, LIQUID TECHNOLOGY, LIQUID MIX and the LIQUID MIX logo are trademarks of Focusrite Audio Engineering Ltd. The Liquid technology utilises the patented process of Dynamic Convolution to actually measure examples of the sonic impact of original analogue products upon an audio stream, so as to electronically emulate the performance of the original products studied. The result of this process is subjective and may not be perceived by a user as producing exactly the same effect as the original products studied.



audio heritage | sonic integrity | professional solutions

(800) 222-4700 • [www.sweetwater.com/liquidmix](http://www.sweetwater.com/liquidmix)

World Radio History





# ARGOSY.

studio furniture



Go to Workstations: AURA.260



seating now available at Argosy

**ArgosyConsole.com**

573.348.3333 or 1.800.315.0878



## WHAT DOES YOUR FUTURE SOUND LIKE?

THE CENTER FOR DIGITAL IMAGING ARTS  
AT BOSTON UNIVERSITY  
RECORDING ARTS PROGRAM

Using the latest technology and working with other CDIA students, you'll gain real-life experience in audio for new media, film, television and games. **APPLY NOW.**



CALL 306.866.CDIA (2342)

VISIT [WWW.CDIABU.COM](http://WWW.CDIABU.COM)

## INSIDER AUDIO

microwave oven. "You don't have to run out for lunch and interrupt that important session," Spenser enthused, "when you can get last night's Chinese leftovers hot in just three minutes!" He asked for a moment of silence to be observed in memory of his friend Felix Schmidlap, a New Jersey studio engineer who was one of the first customers for Raytheon's "compact" model. Schmidlap, Spenser said, didn't read the directions before he tried to heat up some tomato soup—without taking it out of the can.

And the third award in this category went to Bell Labs for introducing the first commercial mobile-telephone service. "Singers can now phone in their parts from their cars," explained Bell engineer D. Ed Ringer, "and record-label executives can tell the engineers what they're doing wrong no matter how far away from the studio they are, whether they're in a restaurant or by the pool at their hotel in Maui. Soon, everything will be wireless and you can make recordings anywhere!" Just then, his mobile phone (which he had carried onto the podium with him in its steamer trunk-sized case) rang. It was a wrong number.

Bell Labs won another award—Best Signal Processing Technology—for its SIGSALY system. This cunning little device, which took up 40 equipment racks, weighed 55 tons and was designed with the help of legendary British mathematician Alan Turing, was used to encrypt communications between Churchill and Roosevelt during the war. Random noise emanating from a mercury-vapor lamp was sampled 50 times a second with 4-bit resolution. The sampling data shifted the frequency of an audio oscillator, whose output was recorded on a phonograph record. Copies of the disc went to London and Washington, D.C. There they were placed on precision turntables whose motors were synchronized to WWV, the National Bureau of Standards' short-wave radio time signals, and whose startup time was locked to the BBC's broadcast of Big Ben striking the hour (with a 16ms delay on the English side to compensate for the trans-Atlantic transmission latency). When one leader spoke into his telephone, his voice was processed with a vocoder (an earlier Bell Labs invention) whose frequency was controlled by the shifting audio. On the other end of the conversation, the transmission, which was sent by FM radio and therefore was completely undistinguishable from pure noise by someone without the proper equipment, was decoded by another vocoder using the same data. It made Churchill sound like Alvin the Chipmunk with a sinus infection, but he could be understood.

Of course, even though the system was taken out of service in 1946, the attendees at the ceremony didn't know any of the details, but instead had to rely on their trust in the judging panel—as the information was to remain classified until 1976. In his acceptance speech, delivered over a coded phone line, former Bell Labs engineer and now National Security Agency R&D director, A.B. Clark, said, "Phrt fdygui jfsowria meeqm wuiosn jxolwps fuekswusjnvkci! Thank you!"

A special Lifetime Achievement award went to Scotsman John Logie Baird, who had died earlier in the year, for his many pioneering efforts in the development of television, and especially for engineering the first TV broadcast with sound. The BBC's Lord Crumbeigh Tyme-Coade, who accepted the award on the inventor's behalf (even though they rejected his system), was greeted with hearty applause when he said, "Among the many advantages of television with sound is the opportunity for us to develop a whole new market in complex and expensive synchronization equipment." But his next remark nearly brought the house down on his well-coiffed head: "And although we would never do such a thing, perhaps you Yankees could give that market a little extra boost by doing something really idiotic, like changing your frame rate by 0.1 percent or so."

The award in the newly created Surround Technology category was given to Los Alamos National Laboratory for its development of the atomic bomb. "This brilliant invention not only creates a completely enveloping audio experience," said guest presenter General Jack B. Nimble, "but it also makes us so much more secure and safe. I'm sure that, especially because we are the only country that could ever possibly develop this technology, it will make it unnecessary for us to send Americans off to war ever again." Accepting the award was physicist J. Robert Oppenheimer, whose speech was unfortunately unintelligible due to the three layers of duct tape over his mouth.

And finally, the most coveted industry award of 1946, for the individual who did the most to advance the art of recording, was given to a man who invented the project studio and the concept of multitracking, pioneered close-miking and tape echo, invented flanging and had a major guitar manufacturer produce custom instruments just for him. (Although for years they wouldn't put their name on them.) Yes, the Les Paul Award went to... Les Paul. ■

*Paul D. Lehrman—composer, producer, engineer, author, educator and filmmaker—wasn't invented until a few years later.*

# Didn't make it to **Remix Hotel NYC?**

Don't worry, *Remix* has your back. You can pretend you were there by checking out [remixhotel.com](http://remixhotel.com), where you can read the RHNyc blog, listen to podcasts from the event and watch panels—featuring artists, producers, DJs, music executives and industry experts—on Remix TV.

## Featured NYC guests

included:

Sleepy Brown

DJ Spooky

Easy Mo Bee

Jean Grae

J-Boogie

Talib Kweli

Lord Finesse

Marley Marl

Mocean Worker

Ali Shaheed Muhammad

Rockwilder

Roc Raida

Hank Shocklee



**Be there for the action next time:**

**Remix Hotel Atlanta**

**September 6-8, 2006**

**[remixhotel.com](http://remixhotel.com)**





# CALIFORNIA



Audio  
Engineering  
Society

dreamin'

where audio  
comes alive!

## 121ST **AES** CONVENTION

exhibits: Oct. 6-8, 2006 conference: Oct. 5-8, 2006

MOSCONE CONVENTION CENTER  
SAN FRANCISCO, CA, USA

# ADVERTISER INDEX

ADVERTISER	WEBSITE	PAGE
Adam Audio USA	www.adam-audio.com	97
ADK	www.adkmic.com	60
AES Convention	www.aes.org	140
AKG Acoustics	www.akgusa.com	3
Argosy Console	www.argosyconsole.com	138
Audio Technica	www.audio-technica.com	39
Aviom	www.aviom.com	95
B&H Pro Audio	www.bhphotovideo.com	93
B&H Pro Audio	www.bhphotovideo.com	119
BIAS	www.bias-inc.com	134
Cakewalk	www.cakewalk.com	13
Center for Digital Imaging Arts Conservatory of Recording Arts & Sciences	www.cras.org	40
Crown	www.crownaudio.com	111
dbx Professional Products	www.dbxpro.com	65
Digidesign	www.digidesign.com	37
Dolby Labs Inc.	www.dolby.com	IFC
DPA Microphones	www.dpamicrophones.com	7
Event Electronics	www.eventelectronics.com	87
Eventide	www.eventide.com	51
Fairlight	www.fairlightau.com	62
Firstcom Music	www.firstcom.com	109
Fostex Corporation	www.fostex.com	IBC
Frontier Design	www.frontierdesign.com	98
Full Sail	www.fullsail.com	99
Genelec	www.genelec.com	15
Griffin Audio USA	www.griffinaudiousa.com	12
Groove Tubes	www.groovetubes.com	44
Guitar Center	www.gcpro.com	31
Guitar Center	www.gcpro.com	42
Harrison	www.harrisonconsoles.com	85
Holophone	www.holophone.com	49
Ilio	www.ilio.com	91
iZ Technology	www.izcorp.com	135
JBL Professional	www.jblpro.com	5
JBL Professional	www.jblpro.com	71
Klein+Hummel	www.klein-hummel.com	36
Lexicon	www.lexicon.com	2
Location Sound Corp	www.locationsound.com	92
Los Angeles Recording School	www.larecordingschool.com	113
Lynx Studio Technology	www.lynxstudio.com	35
Mackie (Mackie Control)	www.mackie.com	19
Mackie (Onyx Satellite)	www.mackie.com	28-29
Marvin's Room Recording Studio		23
Meyer Sound	www.meyersound.com	67
Mojave Audio	www.mojaveaudio.com	114
MDTU	www.motu.com	8C
MPathX	www.mpathx.com	41
MPathX	www.mpathx.com	43
MPathX	www.mpathx.com	45
MXL Professional Microphones	www.mxlincs.com	122
Native Instruments	www.native-instruments.com	107
Neumann/USA	www.neumannusa.com	108
Primera Technology	www.primera.com	33
Radial	www.radialeng.com	127
Redding Audio/Schoeps	www.schoeps.de	12
Remix Hotel Atlanta	www.remixhotel.com	139
Renkus-Heinz Inc.	www.renkus-heinz.com	77
RME	www.synthax.com	115
Roger Nichols Digital	www.rogernicholsdigital.com	89
Royer Labs	www.royerlabs.com	30
Russ Berger Design Group	www.rbdg.com	50
SAE Institute of Technology	www.sae.edu	105
Sencore	www.sencore.com	132

ADVERTISER	WEBSITE	PAGE
Sennheiser Electronic GmbH	www.sennheiser.com	79
Shure	www.shure.com	9
Solid State Logic	www.solid-state-logic.com	88
Solid State Logic	www.solid-state-logic.com	112
Solid State Logic	www.solid-state-logic.com	120
Solid State Logic	www.solid-state-logic.com	124
Sontronics/Music Marketing	www.musicmarketing.ca	102
Sony	www.sony.com/acidpro6	71
SRS Labs	www.srslabs.com	83
Studio Network Solutions	www.studionetworksolutions.com	4
Sweetwater Sound	www.sweetwater.com	11
Sweetwater Sound/Apple/Apogee	www.sweetwater.com	121
Sweetwater Sound/Faderport	www.sweetwater.com	125
Sweetwater Sound/Digimax FS	www.sweetwater.com	133
Sweetwater Sound/Focusrite	www.sweetwater.com	137
Sweetwater Sound/MOTU	www.sweetwater.com	156-157
Sweetwater Sound/MDTU	www.sweetwater.com	158-159
Tannoy North America Inc.	www.tannoy.com	94
Tascam	www.tascam.com	103
TC Electronic	www.tcelectronic.com	123
TEC Foundation	www.tecawards.org	53
That Corporation	www.thatcorp.com	41
Toft Audio Designs	www.toftaudiodesigns.com	80
Trident Audio	www.tridentaudio.co.uk	45
Universal Audio	www.uaudio.com	63
Universal Studios	www.universalstudios.com	59
Walters-Storyk Design Group	www.wsdg.com	43
Wave Machine Labs	www.drumagog.com	50
Waves Ltd.	www.waves.com	1
Waves Ltd.	www.waves.com	25
Westone	www.westone.com	75
Yamaha	www.yamahaca.com	21
Yamaha	www.yamahaca.com	101
Yamaha/Steinberg	www.steinberg.com	61

## MARKETPLACE

Atlas Pro Audio	www.atlasproaudio.com	146
Audio Engineering Associates	www.ribbonmics.com	147
Audio Accessories, Inc.	www.patchbays.com	144
Bayview Pro Audio	www.bayviewproaudio.com	148
Buzz Audio	www.buzzaudio.com	142
Chameleon Labs	www.chameleonlabs.com	146
CharterOak Acoustic Devices	www.charteroakacoustics.com	144
Clearsonic	www.clearsonic.com	146
Coleman Audio	www.colemanaudio.com	147
Crystal Clear Sound	www.crystalclearsds.com	149
Cypress Media, Inc.	www.cypressmediainc.com	145
Discmakers	www.discmakers.com/mix	147
D.W. Fearn	www.dwfearn.com	145
Firehouse 12 Recording	www.firehouse12.com	145
Gator Cases	www.gatorcases.com	144
Healey Music	www.healeymusic.com	145
Josephson Engineering	www.josephson.com	142
Lonely Records	www.lonelyrecords.com	147
MegaTrax	www.megasonicfx.com	142
Progressive Media & Music	www.progressivecds.com	146
Pump Audio	www.pumpaudio.com	143
Ddds Dn	www.oddsonecording.com	149
Omnirax	www.omnirax.com	148
Play-It Productions	www.play-itproductions.net	149
Rainbo Records	www.rainborecords.com	142
Sonic Circus	www.sonicircus.com	148
Ultra Disc	www.cdsfast.com	144
Vancouver Film School	www.vfs.com	144

## MIX ADVERTISER SALES REGIONS AND REPRESENTATIVES



### Northwest/North Central

**Greg Sutton**

847/968-2390

gsutton@prismb2b.com

### Southwest

**Albert Margolis**

949/582-2753

amargolis@prismb2b.com

### East Coast/Europe

**Michele Kanatous**

732/851-5937

mkanatous@prismb2b.com

### Classifieds

**Kevin Blackford** (West Coast)

800/544-5530 or 510/653-3307

mixclass@prismb2b.com



# MARKETPLACE

**IN-HOUSE CD • DVD • VINYL • CASSETTE**

**300 CD Package: \$775.00** Includes: 1-color booklet & 1-color CD label from print-ready film, jewelbox, shrinkwrap

**1000 CD Package: \$1099.00** Includes: 4-color booklet & 2-color CD label from print-ready film, jewelbox, shrinkwrap

**D.J. VINYL PROMO**

**100 12" VINYL \$799.00** Additional LP's: \$1.30 each

**500 12" VINYL \$1,279.00** REORDER \$710.00

**1000 12" VINYL \$1,889.00** REORDER \$1319.00

PACKAGES INCLUDE: WHITE JACKET w/ HOLE • MASTERING • FULL PROCESSING • TEST PRESSINGS • 2-COLOR LABELS (stock background) • SHRINKWRAP • QUICK TURN AROUND ASK FOR OUR FREE BROCHURE!

**WE'VE MOVED!**  
to larger facilities in Canoga Park

**RAINBO RECORDS MANUFACTURING CORPORATION**  
8960 Eton Ave., Canoga Park, CA 91304 • (818) 280-1100  
Fax: (818) 280-1101 • www.rainborrecords.com • info@rainborrecords.com

VISA MASTERCARD

**JOSEPHSON ENGINEERING**

side-address cardioid **e22S** transformer output condenser

Overall, the e22S is a winner!  
-George Petersen  
(Editorial Director, Mix Magazine)

"Literally the only microphone used on every session."  
-Steve Albini

Josephson.com

JOSEPHSON

"The only preamp I'll use to record guitar, voice and percussion."

Ney Mello  
www.neymello.com

the MA2.2 True Class A Microphone Amplifier

**buzzaudio**  
the future of great recordings  
visit [www.buzzaudio.com](http://www.buzzaudio.com) to learn more

Distributed in the USA by  
Atlas Pro Audio  
Toll free 866-235-0953  
[www.atlasproaudio.com](http://www.atlasproaudio.com)

Photo by Jer Olsen, KulturShok.com

**MEGASONICS™**

SOUND DESIGN  
PRODUCTION ELEMENTS

**THE ULTIMATE  
Sound Design Toolkit**  
for post production,  
video games & websites

Over 1200 Production Elements and  
FX on 4 Audio CDs + Data Disc

[www.megasonicsfx.com](http://www.megasonicsfx.com)  
**888-MEGA-555**



**PUMPAUDIO**  
Independent Music

**Stop using stock music.**



Channel

Playgyrl Slim

Matt A. Thorne

Dhebel

The New Dealers



Deathray Davles

Izm & Skyler Mic

Bitstream Dream

Lassic

Hillbilly Hellcats



Gary Robinson

Five O'Clock Heroes

Zllo Groove

Edward Raffliff

Ivan Rosenberg

K.P. Devlin

**Music licensing made easy—and better.**

Over 65,000 of the world's best independent tracks:  
pre-cleared, production-ready, competitively priced.

[www.pumpaudio.com](http://www.pumpaudio.com)

New York London Los Angeles Amsterdam Toronto Melbourne Tivoli





**When Buying a Microphone  
Ask Yourself Two Things**  
How Does the Mic SOUND? and  
How Does the Sound Make You FEEL?

Clean and Simple Electronic Design.  
Gorgeous Sounding, Dependable and Consistent  
Vacuum Tube Condenser Microphones.

*we're not recreating the old classics,  
we're creating the classics of tomorrow.*

CALL, DISTRIBUTOR & DEMO INFORMATION LOG ONTO:  
[WWW.CHARTEROAKACOUSTICS.COM](http://WWW.CHARTEROAKACOUSTICS.COM)

# CDs FAST!

Complete CD packages in just 7-10 days! Ultradisc is committed to giving you a product that'll blow you away — and you'll get it in record time at a great price.



ultradisc

Give us a call at  
**(866) 2 CDSFAST**  
or visit us at  
[www.cdsfast.com](http://www.cdsfast.com)



**GATOR CASES** [www.gatorcases.com](http://www.gatorcases.com)

**Rolling Laptop  
Rack Case  
GSRW-2U**

*The Next  
Generation*

Tel: 813.221.4191 Email: [sales@gatorcases.com](mailto:sales@gatorcases.com) Fax: 813.221.4181

## Got ProTools? Need a Patchbay?

- Mini/TT Patchbay to DB25
- All Normals & Grounds are Reconfigurable



**audio accessories**  
**audio-line**

Audio Accessories, Inc. • 603/446-3335 • [www.patchbays.com](http://www.patchbays.com)

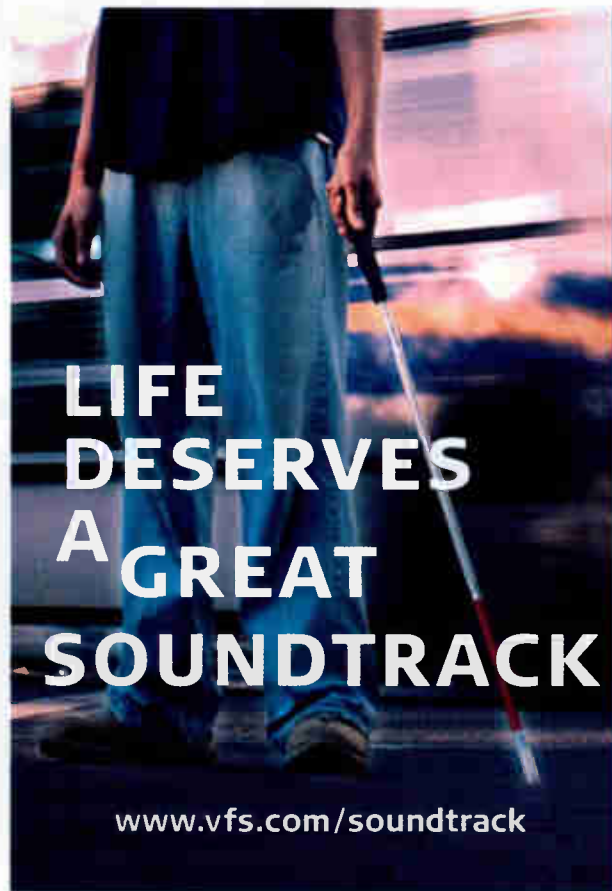

**LIFE  
DESERVES  
A  
GREAT  
SOUNDTRACK**

[www.vfs.com/soundtrack](http://www.vfs.com/soundtrack)

## Sound Design for Visual Media at VFS

ONE YEAR, ONE LIFE-CHANGING EXPERIENCE  
At VFS, we have one year production programs covering Film, Animation, Design, Video Games, Entertainment Business Management, and more. Igniting your creative side, building your portfolio, and launching you into the entertainment industry — this is how VFS delivers the results that can truly change your life.

# VFS™

Vancouver Film School  
Where Results Matter

# The Retail Ready Big Break Special is Back!!!

1000 **CDs for ONLY** \$1099 **USD**

Package includes:

- 1000 Replicated CDs
- 3 color silk-screen CD Label
- Jewel Box w/Clear or black tray
- 2 panel/4 page Insert and Traycard printed 4/1
- All film/Pre-Press
- File check for supplied artwork
- Assembly, Overwrap & Barcode

**CALL NOW!**  
1.800.835.1362

Servicing the Independent  
Music Scene for over 12 years!

Add Full Graphic  
Design & Layout  
for ONLY \$249

Visit us online at:  
[www.healeymusic.com](http://www.healeymusic.com)

 **healeymusic.com**

**CD/DVD Replication  
Duplication**

**1,000 Retail Ready CDs  
for only \$930**

**1,000 Bulk CDs \$450**

[www.cypressmediainc.com](http://www.cypressmediainc.com)  
CYPRESSMEDIA 1-888-333-0343

Anyone who has heard it knows . . .

**NEW VT-7 Vacuum Tube  
Compression Amplifier**



**D.W. FEARN**  610-793-2526  
[www.dwfearn.com](http://www.dwfearn.com)



Recording Studio

Music Venue

No-compromise  
multi-tracking

48-input API Legacy  
PrismSound Conversion  
Studer 24/16 track 2"

**FIREHOUSE  
12  
RECORDING**



FIREHOUSE 12

TEC Nominee  
Studio Design Project

Architects:  
Gray Organschi Architecture  
Walters-Storyk Design Group

Acoustician:  
John Storyk, WSDG

Studio Owner:  
Nick Lloyd

45 CROWN ST NEW HAVEN, CT 06510  
[www.firehouse12.com](http://www.firehouse12.com) • [studio@firehouse12.com](mailto:studio@firehouse12.com) • (203) 785-0468





**GET CONTROL!**

**NEW MegaPac Isolation Package**

7-feet of Headroom and Even More Isolation!

**CLEARSONIC PANEL**  
Drum Shields

**SORBER**  
Absorption Baffles

Portable and Free-Standing

1.800.888.6360  
clearsonic.com

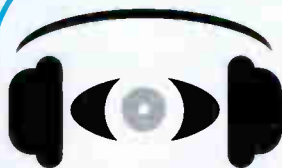

**Progressive**  
Media & Music

**CD & DVD Replication**

Full Retail Ready Packages  
State of the Art A/V Facilities  
Mastering • Editing • Authoring  
Award-winning Art Department  
The Best Customer Service

www.progressivecds.com

Toll Free: (800)421-8273

**THERE'S A REASON WE'VE BEEN HERE 28 YEARS!**

**Model 7602**

Discrete - Class A  
Mic Preamp - Equalizer

**You've already heard it.**

**Chameleon Labs**

**\$799.00**  
MSRP

www.chameleonlabs.com 206-264-7602

**Over 70 brands of NEW gear!!!!**

Microphones - Preamps - A/D/A converters  
Mic Preamps - Compressors - EQs

**Featured Brands:**

**Mytek Digital**

**Peluso Mics**

**Vintech Audio**

**Mercury Recording Equipment**

**Millennia Media**

500 series API™ compatible preamps from Buzz Audio, Purple Audio, & OSA

Coming Sept '06  
The new Buzz Audio ESSENCE Class A transformer coupled Opto Compressor for API™ 500 series racks

**www.AtlasProAudio.com**  
**US Toll Free 1.866.235.0953**  
**Open until Midnight - 7 days EST**

DO IT AGAIN WITH FEELING !  
If you want them to hear you.....you need what's here.



TB4 MKII Talkback Monitor

Four stereo inputs  
Selectable balanced stereo cue  
Selectable engineer headphone  
Balanced inputs and outputs  
Passive stepped attenuator  
Tracks to .05db

**Coleman Audio**

(516) 334-7109  
www.colemanaudio.com  
coley@colemanaudio.com

Two alternate speaker outputs  
Remote talkback microphone  
Remote talkback switching  
Talkback level control  
Handcrafted in the USA  
Built to last a lifetime

**millimeter**

For the latest news  
and technology,  
check out Millimeter at

[www.millimeter.com](http://www.millimeter.com)

*The Professional Resource for  
Production and Post.*

**Lonely RECORDS**

Get a FREE Catalog  
1.800.409.8513  
www.lonelyrecords.com

National Price Guarantee

GRAPHIC DESIGN, MASTERING, POSTERS,  
DVD, CARDBOARD, BARCODES AND MORE.

500 PRESSED  
Retail Ready CDs

**\$799**



Hear Now



New!



*The Ribbon Pre*

**AEA** Audio Engineering Associates  
www.ribbonmics.com • 626-798-9128

Your band.  
On a giant poster.  
Just \$199

Come on, you know  
you want them.  
Now Disc Makers  
makes it affordable.

Get 300 huge,  
18" x 24" full-color  
posters for just  
\$199 when you  
place a new  
CD replication  
order. Plus,  
if you order in  
2006, you get  
60 extra CDs, free.



Call 1-866-677-7912 or  
visit [www.discmakers.com/mix](http://www.discmakers.com/mix)

**DISC MAKERS™**



# OMNIRAX

SUPPORTING CREATIVITY WITH  
INNOVATION AND STYLE

## Aria SC

The mini workstation  
for your living room

www.omnirax.com  
info@omnirax.com



### The Aria SC

gives you a beautiful home for your keyboard  
and mini computer studio

- Room under the riser for 19" rack mount gear
- Cable grommets galore for neat wire runs
- Cable trough under desk surface which can hold power bars, surge protectors and all the cables from the riser and desk areas
- Optional KMS4 adjustable keyboard mouse shelf mounts under the desktop

P.O. Box 1792 Sausalito, CA 94966  
800.332.3393 415.332.3392  
FAX 415.332.2607

# SONIC CIRCUS

Serious Studio Infrastructure



The most comprehensive selection of recording  
equipment in the world

Shop online and take  
advantage of frequent  
buyer benefits.



617.696.9360  
www.soniccircus.com



### CASCADE FAT HEAD Ribbon



### CASCADE MICROPHONES

Setting a new standard for Professional Studio Microphones  
without the additional manufacturer's mark-up.

[cascademicrophones.com](http://cascademicrophones.com)

**CHECK OUT BAYVIEW PRO AUDIO FOR NEW FREE GEAR PACKAGES**

You will be amazed by the deals we are offering!



It's time for a change

888.718.0300

[bayviewproaudio.com](http://bayviewproaudio.com)

CASCADE MICROPHONES a division of BAYVIEW PRO AUDIO



OUR PRICES NUKE THE COMPETITION

# BARE BONES PRICES!



**Odds On**  
cd & dvd manufacturing

14 Sunset Way, Benderson, NY 89014  
Call Odds On Customer Service Direct  
at (702) 318-6001

[www.OddsOnRecording.com](http://www.OddsOnRecording.com)

**ORDER TODAY**



**Odds On Blow-Out Discounts!**  
Includes on-disc printing, full-color printed booklet, barcode and cello wrapping.

100 CDs	250 CDs	500 CDs	1,000 CDs	2,500 CDs
\$299	\$499	\$699	\$1,099	\$1,999

**Toll-Free 877-ODDS ON 1**  
6 3 3 7 6 6 1



CDs/DVDs    MASTERING/EDITING    GRAPHIC DESIGN    MULTIMEDIA

## WHERE SIGHT AND SOUND MERGE

# PLAY-IT PRODUCTIONS

259 W. 30th Street, NY, NY 10001 TOLL FREE: 1-800-815-3444 or 212-695-6530 [WWW.PLAY-ITPRODUCTIONS.NET](http://WWW.PLAY-ITPRODUCTIONS.NET)

CDs • DVDS • SHAPED DISCS • SPECIALTY PACKAGING • CASSETTES

## NEED CDs? THE CHOICE IS

# CRYSTALCLEAR

DISC AND TAPE

**CHECK OUT OUR CURRENT SPECIALS!**

1000 CDs • \$999 (COMPLETE RETAIL READY)  
1000 PROMO CD PACK • \$599  
1000 DVDS • \$1499 (COMPLETE RETAIL READY)

**TRUSTED EXPERIENCE FOR OVER 35 YEARS!**

[WWW.CRYSTALCLEARCD.COM](http://WWW.CRYSTALCLEARCD.COM) • 1-800-880-0073



# Don't miss out on eDeals!

## Shop Now and Buy Anytime.

**eDeals** sends the best buys to your inbox so they're only a click away! This bi-weekly e-newsletter brings you product updates and blowout deals on manufacturer overstock equipment, demo gear, discontinued products and more.

In addition, **eDeals** includes a services and employment section of interest to musicians and audio pros everywhere.

Subscribe today at: <http://www.mixonline.com/deals>



# CLASSIFIEDS

MIX Classified Ads are the easiest and most economical means to reach a buyer for your product or service. The classified pages of Mix supply our readers with a valuable shopping marketplace. We suggest you buy wisely; mail-order consumers have rights, and sellers must comply with the Federal Trade Commission, as well as various state laws. Mix shall not be liable for the contents of advertisements. For complete information on prices and deadlines, call (800) 544-5530.

## Acoustic Products

**AcousticsFirst**  
Toll Free 888-765-2900

Full product line for sound control and noise elimination.  
Web: <http://www.acousticsfirst.com>

**ACOUSTICAL SOLUTIONS INC.** Sound Control & Noise Reduction Products

Call (888) 529-9220 Free Catalog  
[www.acousticalsolutions.com](http://www.acousticalsolutions.com)

**ACOUSTIC**  
Design Consulting Products

[www.soundcontrolroom.com](http://www.soundcontrolroom.com)  
toll free 866-788-1238

Subscribe to **Electronic Musician**  
[www.emusician.com](http://www.emusician.com)

**SILENT Source**  
58 Nonotuck St., Northampton, MA 01062  
Info: (413) 584-7944 Fax: (413) 584-2377  
**ORDER: 800-583-7174**

Acoustical Fabric Panels • Sound Barrier • Isolation Hangers • Tube Traps • Silence Wallcovering • WhisperWedge • ProFoam • Ceramic • Hushfoam • R.P.G. Diffusers • Sonex • Sound Quilt • More

[www.silentsource.com](http://www.silentsource.com)  
[info@silentsource.com](mailto:info@silentsource.com)

QUALITY • PRICED RIGHT • INTEGRITY

**RPG ACOUSTIC TOOLS**  
PROVEN, AFFORDABLE ROOM SOLUTIONS FROM THE MUSIC INDUSTRY'S LEADING ACOUSTICAL INNOVATOR.

**RPG DIFFUSOR SYSTEMS, INC.**

BASE TRAPS • DIFFUSORS • FOAM KITS

[www.rpginc.com/proaudio](http://www.rpginc.com/proaudio)

**VOCAL BOOTH**  
Vocal, Practice and Broadcast Booths  
4 1 6 - 8 8 5 - 4 3 1 8

Simple Assembly (Steel Framing)  
Various colors available  
Cost Effective

Vocal, Practice & Broadcast Booths

[www.seulxacoustics.com](http://www.seulxacoustics.com)  
**Seulx Acoustics**

**SILENCE CASES**  
Record Edit Mix Master...

THINK in PEACE.  
Attenuation cases keep your PC gear QUIET and COOL  
Multiple designs available starting at \$429  
510-655-3440  
[www.silencecases.com](http://www.silencecases.com)

## Acoustic Products

**VocalBooth.com**  
MODULAR SOUND REDUCTION SYSTEMS



Listen to your dreams. Follow your heart. Don't ever stop.

- Calvin Mann

541-330-6045  
[www.vocalbooth.com](http://www.vocalbooth.com)

**WhisperRoom** INC.  
SOUND ISOLATION ENCLOSURES

Celebrating over 15 years of reducing sound to a Whisper!

Recording, Broadcasting, Practicing



MDL 1021265 (8.5 X10 5')

19 Sizes and 2 Levels of Isolation Available

New! SoundWave Deflection System (Change parallel walls to non-parallel) Immediate Shipping!

[www.whisperroom.com](http://www.whisperroom.com)  
PH: 423-585-5827 FX: 423-585-5831

**www.SoundSuckers.com**  
Be Professional, Buy the Best!  
**Sound Isolation Booths Soundproofing Products**

Custom Projects & Free Advice Toll Free 1-888-833-1554 (or) 541-947-2602

**REALTRAPS**<sup>®</sup>  
High-Performance Acoustic Treatment  
*Rave Reviews From Top Pros*



"After adding seven Mondo Traps the bass response in my mastering room smoothed out measurably and audibly and not a bass note is out of place. Plus the sweet spot has grown!"  
- Bob Katz, *Official Domain*

Grammy Award-winning mastering engineer, and author of *Mastering Audio - the art and the science*



Learn why REALTRAPS has fast become the most sought-after brand in treating pro recording studios and listening rooms. Please visit our website for a wealth of product information, demo videos, and some of the clear explanations of room acoustics you'll find anywhere.

Toll-Free: 866-732-5872 [www.REALTRAPS.com](http://www.REALTRAPS.com)

## THE BOOKSHELF IS BACK!

Shopping access to our top titles like *MIM Pro*, *Mix's Master Directory*, *EM's Personal Studio Buyer's Guide*, coveted Remix Hotel t-shirts and *Remix* CDROMs, Thomson Guide publications and more.

REMIX

[remixmag.com/remixbookshelf](http://remixmag.com/remixbookshelf)

Electronic Musician

[emusician.com/embokshelf](http://emusician.com/embokshelf)

Mix

[mixonline.com/mixbookshelf](http://mixonline.com/mixbookshelf)

## Business Opportunities

ENTERTAINMENT TECHNOLOGY LIST BUY-SELL

Reach more than 1.1 million web visitors! The Entertainment eClassifieds are the user friendly, affordable way to connect buyers, sellers, job seeker and employers. [www.mixonline.com/eMarketplace](http://www.mixonline.com/eMarketplace) Buy/Sell Gear • Find/Post Jobs

Macintosh and ProTools Consulting

**Oakbog**  
IT for Media Production

286 Washington St. #2 Malden MA 02148  
info@oakbog.com 617-480-6436  
[www.oakbog.com](http://www.oakbog.com)



Sign up for the  
REMIX HOTEL Newsletter  
[www.remixhotel.com](http://www.remixhotel.com)

## Cases/Covers

**UNDER COVER**  
Custom Covers and Bags  
Speaker Cabinets / Consoles  
Anything!  
[www.undercovernyc.com](http://www.undercovernyc.com)  
917 237 1535  
Get your gear Under Cover!

## Design & Installation

**AUDIO DESIGN SOLUTIONS** 301-607-6607  
Specializing in audio/video/acoustic design & installation for studios and sound systems.  
[www.audiodesignsolutions.com](http://www.audiodesignsolutions.com)

## Computer Systems

*If you built it...  
Let the world  
know it!*

Mix Studio Showcase found  
monthly in Coast-To-Coast

**800-544-5530**

# The Ultimate Music Production PCs!

- Single/Dual Core Racks
- Towers
- Mid-towers

starting under **\$1000**

- Super Reliable
- Whisper Quiet — Certified by Auralex
- Maximum Audio Horsepower!

Optimized for:

Pro Tools	Acid Pro
SONAR	Live
GigaStudio	Reason
Nuendo	...and more!
Cubase	

**Sweetwater**  
music technology direct

Visit [sweetwater.com/PC](http://sweetwater.com/PC) or call today!  
**1-800-222-4700**



**Employment**

**SERVICE TECH / CUSTOMER SUPPORT**

Event and Rode are looking for a **Customer Support Technician**.

This is a full-time position with training available. Phone/e-mail support, troubleshooting, basic electronics repair work. Knowledge of speaker and microphone terminology as well as modern digital recording techniques a must. Great salary and conditions. Come join the best company in the industry!

SEND YOUR RESUME TO:  
**peter@rodemic.com**

We are located in Carpinteria, CA.



Subscribe to

**MUSIC EDUCATION TECHNOLOGY**

[www.metmagazine.com](http://www.metmagazine.com)



**"As a customer, Sweetwater's service blew me away. Now I'm on the team!"**

— Brandon McSwain, Sweetwater Sales Engineer

**Ever wonder what it would be like to work here?**

**Learn more at Sweetwater's Online Career Center.**

- The Company
- The Culture
- The Community
- The Perks
- Current Openings

Visit: [www.sweetwater.com/careers](http://www.sweetwater.com/careers)

Call: **1-800-222-4700** Jeff McDonald x-1052



**Exclusive Web Video:**

Step Inside the doors and get an in-depth look at Sweetwater

**Equipment Financing**

**A/V EQUIPMENT FINANCING**

**\$100,000 Tax Write-Off in 2006**

**\* \$99 Payments For The First 6 Months**

Specializing in **Audio-Video** Visit Our **Web Site**

**No Financials Required**

**New & Used Equipment**

**New Businesses**

*(With Clean Personal Credit)*

For Application & Qualifications

**LFCI** [www.lfci.net](http://www.lfci.net)

**Call: 800 626 LFCI**

**Equipment For Sale**

**THE MIC SHOP**

TUBE MICROPHONES

BOUGHT/SOLD/SERVICED

Mic Power Supplies & Cables

Bill Bradley: (615) 595-1717

Fax: (615) 595-1718

[www.micshop.com](http://www.micshop.com)

**Equipment For Sale**

Portable Iso-Booths

**(CLEARSONIC)**  
manufacturing Inc

800.888.6360

[clearsonic.com](http://clearsonic.com)

**buzzaudio**  
the future of great recordings  
visit [www.buzzaudio.com](http://www.buzzaudio.com) to begin...

**BAE REPRO 1272 PREAMPS with D.I.**



**\$1089 Single w/ps \$1759 Two channel w/ps**

**BAE REPRO 1073 \$2550 Single w/ps**



**\$4900 for 2 channel 1073 w/ps**

**Brent Averill**  
ENTERPRISES

14300 Hortense Street • Sherman Oaks, CA 91423  
818 784•2046 FAX 818 784•0750  
[www.brentaverill.com](http://www.brentaverill.com)

**Equipment For Sale**

**o d y s s e y**  
p r o s o u n d

The outlet for the finest new & pre-owned recording equipment anywhere.

[www.odysseyprosound.com](http://www.odysseyprosound.com)  
**1-800-249-1821**  
Phone: (978) 744-2001 Fax: (978) 744-7224

JOSEPHSON ENGINEERING  
**C700A**  
Two-capsule condenser microphone  
Variable pattern  
For vocals, spot and far-field pickup.



[josephson.com](http://josephson.com)

VT-2 Vacuum Tube Mic Preamp  
[www.dwfearn.com](http://www.dwfearn.com)



**D.W. FEARN**

**VINTECH AUDIO**  
CLASS A MIC PREAMPS MADE WITH



NEVE™ 1272 COMPONENTS  
[www.vintech-audio.com](http://www.vintech-audio.com)  
call toll free: 1-877-4-mic-pre

**FURMAN AC LINE VOLTAGE REGULATOR**  
Almost new, hardly used, in box.  
Unit is in England currently;  
Seller will pay for shipping.  
\$1495

**EMU E6400 ULTRA SAMPLER W/128MG RAM**  
Pristine condition, used once;  
\$399. Shipped from England.

[simon.roskoff@virgin.net](mailto:simon.roskoff@virgin.net)

Subscribe to  
Digital Content Producer online!  
[www.digitalcontentproducer.com](http://www.digitalcontentproducer.com)

**NEW!**



**STEDMAN**  
888-629-5960  
Our new PC1 ProClip holds sheet music in place where it's needed!  
[www.stedmancorp.com](http://www.stedmancorp.com)

Made in USA

[DIGITALPROAUDIO.COM](http://DIGITALPROAUDIO.COM)  
**DIGITALPROAUDIO**  
1-800-240-4079



**vintageking audio**

Our product lines range from vintage classics and esoteric rarities to exciting new boutique gear, many of which are exclusively available from Vintage King. We offer a full warranty and a staff of experienced engineers and technicians, bringing you friendly and unparalleled service.



More high end, boutique audio manufacturers have given their exclusive trust to Vintage King than any other dealer.  
...Shouldn't you?  
[vintageking.com](http://vintageking.com) | 248.541.3275 | [info@vintageking.com](mailto:info@vintageking.com)

**digimusician.com**  
...the ultimate Music & Audio technology store  
...with maximum EURO service at minimum EURO's!



For All Your Pro Audio Needs  
**Nashville Audio Connection**  
Professional Audio Broker  
**SSL • Neve • Trident**  
[www.nashvilleaudio.com](http://www.nashvilleaudio.com) **615.847.3798**

SEE OUR NEW WEBSITE

**Vintech**

**Introducing the Vintech X73i!**  
We put this piece head to head with vintage Neve 1073's at this year's AES show. It is 100% guaranteed to meet your expectations and is an incredible value. List price \$1595 **Special \$1375**

**The Vintech X73**  
Custom hand wired concentric style switches with gold plated pins. Swiss made military grade attenuator switch. List price \$1995 **Special \$1795**

**THE "X81 CLASS A"**  
**1-877-4-MIC-PRE**

**The Model 473**  
[www.vintech-audio.com](http://www.vintech-audio.com)







**Equipment For Sale**



**SONIC CIRCUS**  
A SOUND ALTERNATIVE  
617.696.9360  
soniccircus.com



Sound Good?  
Absolutely not,  
Sound Real?  
**ABSOLUTELY**  
HEAR THE SOUND  
OF TV & RADIO  
**PYRAMID  
SPEAKERS**  
www.triplepdesigns.com

**Furniture**



gear racks and more  
Modular, stackable  
oak furniture  
Factory direct since 1984  
Per Madsen Design  
Free brochure (mention Mix)  
800-821-4883 www.rackittm.com

**CLASSIC MICS  
FROM RUSSIA**

VINTAGE TUBE & FET  
Telefunken, NEUMANN  
AKG, LOMO, OKTAVA, etc.  
TEL/FAX: 011-7-095-250-4200  
E-mail: aeg210268@mtu-net.ru  
www.valvemics.webzone.ru/



**KK AUDIO.com**  
Studio Furniture  
30th Anniversary



Control | 24  
console desk  
888-765-4499

**Studio Furniture**  
800.315.0878 **FREE CATALOG**



**ARGOSY®**  
argosyconsole.com

**Equipment Rental**

**"RENTALS AND SERVICE"**

Providing The Pro Audio Industry with:

**DESIGN FFX AUDIO**

- \* **Rentals** - Pro Audio Rentals
- \* **Systems** - Pro-Tools Rentals
- \* **Remote Recording** Services
- \* **Service Center** - Pro Audio Repairs
- \* **Transfer House** - Multi-Format Transfers

800.441.4415  
818.843.6555 www.dfxaudio.com

**Instruction**

**Learn the Art of Recording**



**mediatech institute**  
www.mEDIATECHINSTITUTE.COM 1.866.498.1122

**Furniture**

**THE ORIGINAL**  
RACKMOUNT YOUR GS • WWW.ISO-BOX.COM



ORDER TOLL-FREE: 888.580.9188  
Sound Construction & Supply Inc.

**OMNIRAX**  
STUDIO FURNITURE



CODA D8  
with Sidecars

OMNIRAX 800.332.3388 415.332.3382  
FAX 415.332.2807  
www.omnirax.com

**BE A RECORDING ENGINEER**

**TRAIN AT HOME**  
Easy Home-Study practical training in  
Multi-track Recording. Join our successful  
working graduates or build your own studio.  
Career guidance / Diploma / Registered School.  
**FREE INFORMATION:**  
Audio Institute of America  
614 46th Ave, Suite A1, San Francisco, CA 94121  
Or visit us at www.audioinstitute.com

**ARTI** Audio Recording  
Technology Institute  
ORLANDO, FLORIDA

- Extensive Hands-On Training
- Music, SFX Design, Audio Post
- Low Student/Teacher Ratio
- Placement Assistance
- Financing to Qualified Applicants
- Accredited by ACCSCT

FEATURING **THX pm3** MIX THEATER  
888-543-ARTI • audiocareer.com

Subscribe to  
**millimeter**  
digitalcontentproducer.com

**SUBSCRIPTION QUESTIONS?  
Call 866-860-7087**

**Studios**

**FOR SALE**

2,120 sq. ft. home with a  
**Professionally Designed  
Recording Studio**  
West of Fort Worth, TX on 1 acre

CONTACT:  
Jason (817) 929-3235  
JasonT@  
HeritageRealtors.net

**Mastering**

**THRESHOLD MASTERING**  
Las Vegas • Milwaukee • Houston  
**STEPHEN MARSH**  
Chief Mastering Engineer  
**310.571.0500**  
www.thresholdmastering.com

**Analog/Digital MASTERING**  
by world class engineers  
\$495 for complete album up to 12 songs  
1-866-414-5266 www.2020music.com  
Located in NY, mastering hundreds of major releases since 1995

**Records Tapes CD Services**

**NEED CDs? THE CHOICE IS CRYSTAL CLEAR**  
DISC AND TAPE  
CHECK OUT OUR CURRENT SPECIALS!  
1000 CDs • \$999 (COMPLETE RETAIL READY) 1000 DVDs • \$1499 (COMPLETE RETAIL READY)  
1000 PROMO CD PACK • \$599 500 DVDs • \$999 (COMPLETE RETAIL READY)  
WWW.CRYSTALCLEARCD.COM • 1-800-880-0073

**MASTERING**  
Guaranteed to give you that "Big Label" sound.  
\$475 Complete Album Deal!  
1-800-692-1210  
www.musichousemastering.com

**DRT Mastering**  
the Analog & Specialist  
You will have the fat, slamm'n major-label sound that sells discs.  
Or the work is free...  
Custom gear. 1st-class results. Free broch  
800-884-2576 www.drtmastering.com

Subscribe to  
**REMIX**  
www.remixmag.com

**Lonely RECORDS**  
Get a FREE Catalog  
1.800.409.8513  
www.lonelyrecords.com  
Retail Ready CD Packages **99¢**

**MIRROR SOUND**  
Affordable Mastering  
For the ultimate final touch to your CD.  
Any Format-Quick Turnaround!  
"Reflecting Your Ideas Since 1985!"  
Hearing IS Believing!.....click on  
mirrorsound.com/mastering.htm  
206.440.5889

**NATHAN ELDRED**  
Professional MIXING & MASTERING Services  
Phone 813.662.5028  
AtlasRecording.com/Mastering

**Lowest Price Period!**  
CD Audio / CD Rom / DVD Replication  
Video Duplication / Graphic Design  
Printing / Packaging / Pre-Press  
BALL MEDIA  
888.256.3472  
www.ballmedia.com

**DIGITAL DOMAIN™** Mastering  
CD Manufacturing  
Booklet Printing  
Graphic Design  
Unsurpassed mastering quality by **Bob Katz**  
CD Mastering is an art  
The Definitive, Award-Winning CD Mastering Website  
http://www.digido.com  
(800) 344-4361 in Orlando

**Records Tapes CD Services**

**You should care who makes your CD.  
Your career is worth it.**

**MUSIC MANUFACTURING SERVICES**

Fast, quality, affordable CD, DVD and vinyl manufacturing for independent labels and musicians since 1988.

**NEW YORK**  
1-800-293-2075  
**NASHVILLE**  
1-800-909-7568  
**TORONTO**  
1-800-667-4237

musicmanufacturing.com

**1000 Store Ready CDs \$899**  
**INCLUDES 100 FULL COLOR POSTERS**  
1000 Bulk CDs \$490  
www.TrackmasterAV.com  
Toll Free: 888-374-8877  
Your 1-stop shop for CD, AUDIO & VIDEO cassette projects!

**www.yourmusiconcd.com**

100 BULK CDRS \$59  
100 BASIC CDRS \$99  
100 FULL COLOR CDR PACKAGE \$199  
1000 FULL COLOR PACKAGE \$999

300 FULL COLOR PACKAGE \$549

100 BULK DVDRS - \$110  
100 BASIC DVDRS - \$149  
1000 FULL PACKAGE DVDRS - \$1199

SNS DIGITAL ATLANTA 678-442-0933  
INC TOLL FREE 1-877-442-0933



# The Powerful and Portable MOTU Studio

Run Digital Performer 5, the new UltraLite FireWire I/O, MOTU instruments and a wide range of third-party products on Apple's fastest laptop lineup ever



What is an Intel chip doing inside a Mac? A whole lot more than it ever did in a PC. Apple's new Intel MacBooks deliver unprecedented laptop performance. Take the power of the Intel Core Duo processor to go. Choose **MacBook** in black or white,

both with a brilliant, 15.3-inch glossy widescreen display. Nearly one inch thin, 5.2 pounds, 100% perfect for anyone who wants power in an affordable package. Push the envelope of pro performance with the 15- & 17-inch **MacBook Pro**.

Featuring an Intel Core Duo processor, ultimate expansion via FireWire, and the

power to stream through **MOTU DP5** and your entire suite of **MOTU Instruments** on the go, MacBook Pro is one inch thin and miles deep. Connect the ultra compact **MOTU UltraLite**

fire-powered 10/14 FireWire audio interface for 8 high-quality analog inputs — including two mic inputs with preamps, 16 analog outputs and a host of advanced features like SMPTE sync and front-panel programming.



## Universal plug-in control



As a Universal Sound Platform, **Native Instruments KORE** operates not only as a plug-in within Digital Performer but also as an instrument host application. It allows you to integrate all your VST- and Audio Units-based software instruments and effects into a single, unified interface. KORE provides greatly increased control, overview and ease of use in all creative situations. Both Native Instrument's own range of instruments and effects as well as third-party products are supported. The seamless integration with KORE's advanced hardware controller gives hands-on control with unprecedented analog feel, finally turning today's software synthesizers and samplers from applications into true instruments.

The MOTU experts at Sweetwater can put together the perfect DP5 rig for you. We'll help you select the right components to build a system that seamlessly integrates into your workflow, and we can even install, configure and test the entire system for you. Why shop anywhere else?

## Synthesis ignited

Combining power, elegance, control, and unbeatable sounds, **Dimension Rapture** is one of the most exciting synthesizers to hit the market in years. Capable of producing rich, hypnotic, and rhythmic basses, leads, and pads, Rapture is perfect for performing and designing the modern synthesized sounds igniting today's pop, dance, and electronic music. What better way to expand the sound possibilities of your Digital Performer studio?

Rapture complements Digital Performer with pristine wavetable synthesis and a sophisticated palette of hundreds of patches. Its staggering array of modulation features includes brilliant multi-point envelopes, a powerful MIDI control matrix, and 40 step generators to add rhythmic complexity to patches. Discover timbres you've never imagined with this truly unique instrument. Ask Sweetwater today about using Rapture with DP5.



## Amazing sounds

**Dimension Pro** is the critically-acclaimed synthesizer that combines real instruments with advanced synthesis, giving you endless sound possibilities. The immense two DVD sound library that ships with Dimension Pro makes it the ideal go-to instrument for musicians, while its deep editing and sound generation capabilities have a natural appeal to sound designers.

Digital Performer users looking to create rich, ambient film-score beds will love the "Dimensions" bank, which features complex, evolving atmospheres. Dimension Pro also offers an abundance of vital, playable sounds that range from pristine realistic acoustic instruments to thumping basses and cutting leads. This wide tonal range can be attributed to both advanced sample mapping and a powerful sound-sculpting engine with analog sound generation that lets you mutate and recombine any sound you might imagine.



## Waves native processing

Waves delivers the classic sound of the SSL 4000 Series to your Digital Performer mixes. Developed under license from **Bob Katz Labs**, The **SSL 4000 Collection** includes three meticulously modeled plug-ins based on the legendary SSL 4000 Series: the SSL E-Channel, the SSL G-Master Buss Compressor, and the SSL G-Equalizer. Now featuring **SSL Gold Native** — personal presets from the legendary Grammy® Award-winning, multi-platinum mixer. Now add the **Waves Gold Native** bundle, packed with all the first rate plug-ins that put Waves at the top of computer-based professional audio processing. If you want a complete, world-class processing and mastering package for DP5, the Gold Native Bundle is it. You get total control of the highest-resolution tools for a broad range of applications.



## The ultimate groove

**Reference Series RMX v1.5**, the award-winning "groove standard", gets better and better with new features like "Chaos Designer™ Buzz" for stuttering edits, 500 incredible new categorized Multi grooves and 250 slamming new Kits. It's even easier to learn RMX now with the new Reference Guide/Help System and hours of brand new tutorial videos — including one specifically for Digital Performer users! Ask Sweetwater about "Xpanding" RMX with all nine SAGE Xpanders, now shipping!



[www.sweetwater.com](http://www.sweetwater.com) (800) 222-4700



World Radio History



# The Powerful and Portable MOTU Studio



## Advanced waveform editing

The ultimate in audio processing awaits you: BIAS **Peak Pro 5** delivers award-winning editing and sound design tools, plus the world's very best waveform editing solution for Mac OS X. With advanced playlisting, superb final-stage processing, disc burning, plus PQ subcodes, ODP export (optional add-on), and other 100% Redbook-compliant features. Need even more power? Check out our **Peak Pro XT 5** bundle (with over 7,000 worth of additional tools, including our acclaimed **SoundSoap Pro**, **SoundSoap 2** (noise reduction and restoration), **Squeeze-3 & 5** (linear phase multiband compression/limiter/upward expander), **Reveal** (precision analysis suite), **Pitch-bend** (pitch neural pitch correction/transformation), **AutoEQ** (linear phase EQ matching), **CoverPeg** 4, 6, 8 & 10 band parametric EQ, and **Gate-Match** (a noise gate with downward expander) — all at an amazing price. So, when you're ready to master, **Peak Pro 5** has everything you need. It's the perfect complement — and finishing touch — to **Digital Performer 5**.



## Headphone amplifier

The **Grave Design m902 Reference Headphone Amplifier** is the final word in high fidelity headphone amplification and the must-have tool for audio playback in your MOTU power-on-demand studio. Combining a full complement of analog and 24-bit/192kHz digital inputs with dual headphone and unbalanced line outputs, the m902 is an ideal solution for critical editing, mastering and monitor control for a MOTU studio of any scope.



## Control room monitoring

The **PreSonus Central Station™** is the mixing hub between your MOTU recording interface, studio monitors, input sources and the artist. Featuring 5 sets of stereo inputs (3 analog and 2 digital with 192kHz D/A conversion), the Central Station allows you to switch between 3 different sets of studio monitor outputs while maintaining a purely passive signal path. The main audio path uses no amplifier stages including no amps, active IC's or tubes. This eliminates coloration, noise and distortion, enabling you to hear your mixes more clearly and minimize ear fatigue.

In a MOTU, the **Central Station** features a complete studio communication solution with built-in condenser talkback microphone, MUTE, DIM, two separate headphone outputs plus a cue output to enhance the creative process. A fast-acting 30-segment LED is also supplied for flawless visual metering of levels both in dBu and dBfs mode. Communicate with the artist via talkback. Send a headphone mix to the artist while listening to the main mix in the control room and more. The **Central Station** brings all of your inputs and outputs together.



## 16-pad drum controller

**Trigger Finger** puts the power to record your own expressive percussion and drum parts into **Digital Performer 5**. Its 16 velocity-sensitive pads are perfect for playing DP5's included Model 12 drum models, branching loops and samples via DP5's Non-sampled, or even controlling video projections — and applying pressure to the pads can generate any MIDI controller you wish. **Trigger Finger** also gives you 8 Knobs and 4 faders that are freely assignable to MIDI parameters such as volume, pan, pitch, and effects. Full programmability lets you customize the unit to fit your needs. Settings are easy to store via 16 presets and M-Audio's free **Enigma** librarian software. A simple USB cable is all it takes to connect and power **Trigger Finger** with your computer.

The MOTU experts at Sweetwater can put together the perfect DP5 rig for you. We'll help you select the right components to build a system that seamlessly integrates into your workflow, and we can even install, configure and test the entire system for you. Why shop anywhere else?



## Automated mixing & control

Imagine the feeling of touch-sensitive, automated Penny & Giles faders under your hands, and the fine-tuned twist of a V-Pot™ between your fingers. You adjust plug-in settings, automate filter sweeps in real-time, and trim individual track levels. Your hands fly over responsive controls, perfecting your mix — free from the solitary confinement of your mouse. **Mackie Control** delivers all this in an expandable, compact, desktop-style design forged by the combined talents of Mackie manufacturing and the MOTU Digital Performer engineering team. Mackie Control Universal brings large-console, Studio A prowess to your Digital Performer desktop studio, with a wide range of customized control features that go well beyond mixing. It's like putting your hands on DP itself.

## Purified power

To get the most out of your MOTU studio gear, you need the cleanest power possible. The negative effects of poorly supplied wall outlet AC power on your gear can be dramatic, without your ever knowing how good your gear can really sound with properly supplied power. **Furman Sound** introduces the all-new **Power Factor Pro** with its ground-breaking **Clear Tone Technology™**, which actually lowers the AC line impedance supplied by your wall outlet while storing energy for peak current demands — over 45 amps of instantaneous current reserve. Additionally, **Linear Filtering Technology™ (LIFT)** dramatically lowers AC line noise to unprecedented levels in the critical audio frequency band. Also included are Furman's unique **Series Multi-Stage Protection Plus (SMP+)** surge protection and automatic **Extreme Voltage**

## Accurate monitoring

The **Mackie HR-Series Active Studio Monitors** are considered some of the most loved and trusted nearfield studio monitors of all time, and with good reason. These award-winning bi-amplified monitors offer a performance that rivals monitors costing two or three times their price. Namely, a stereo field that's wide, deep and incredibly detailed. Low frequencies that are no more or less than what you've recorded. High and mid-range frequencies that are clean and articulated. Plus the sweetest of sweet spots. Whether it's the 6-inch HR-624, 8-inch HR-824 or dual 6-inch 626, there's an HR Series monitor that will tell you the truth, the whole truth, and nothing but the truth.

**Shutdown (EVS)**, which protect you from damaging voltage spikes or sustained voltage overload. Equipped with the same **LIFT** and **SMP+** features, plus **EVS Extreme**, the **Reagan Sound IT-20 II** ultra-low noise balanced isolation power conditioner is designed for the most critical, ultra-low noise installations. Delivering an astonishing 80dB of common noise reduction from 20Hz-20kHz, you're assured the lowest possible noise floor for all the gear in your MOTU studio. The IT-20 II's toroid transformer design assures a contained magnetic field for complete isolation from sensitive studio components nearby. The ultimate in purified power.

©2006 Sweetwater, Inc.



www.sweetwater.com (800) 222-4700



Authorized Reseller

World Radio History



# SPL Transient Designer

## Pushing the Envelope for Room Mics, Reverbs and More

I wouldn't dream of recording drums in my studio without my SPL Transient Designer 4 (TD4). Boosting its attack controls on drum tracks can give kick, snare and toms the extra punch often needed to make them come alive. When you're processing tom tracks, lowering the TD4's sustain controls is a much more transparent (and speedier) remedy for reining in timpani-like sustain than smothering batter heads with duct tape. And for reducing excessive cymbal bleed into tom mics, just turn the TD4's sustain controls counterclockwise for inputted toms and you're done.

However, Transient Designer sounds great on more than just drums. Crank that sustain knob on soaring guitar solos to make David Gilmour blush. Or boost the attack on dampened ostinato parts played low on a six-stringer to make that rock 'n' roll vamp jump. These are just a few of the well-known—but powerful—applications that the TD4 and its 2-channel sibling, Transient Designer 2, excel at. But there are more tricks up these designer sleeves than what the casual engineer might at first think to fashion.

### TALKIN' TRASH

Tight, discrete-sounding drum tracks are cool, but trash is a bash. When your drums' room mics sound like they were placed in a shoe closet and you'd prefer the sound of an empty warehouse, Transient Designer can provide instantaneous moving services. Route the stereo room mics through two of the TD4's linked channels (channels 1 and 2, or 3 and 4) and crank the unit's attack controls to put a point on the traps. Then, slowly raise the sustain controls on both channels to bring up the room tone for an "all-buttons-in," 1176-type sound—without pumping cymbals. Fine-tune the sustain control settings so that the room mics' envelope more or less ends on the desired upbeat or downbeat for a driving rhythmic effect.

Did your bass player drink one too many beers before your recording session and play a bit too legato on that samba

tune? Even so, you may not need to re-cut the track to make it swing. Here, Transient Designer works better than coffee. Route the bass track through one of TD4's channels and lower the sustain control until the player sounds like he or she is leaving clear breaks on the downbeats. Legato becomes staccato, propelling the rhythm section forward.

### AND NOW, FOR NEW REVERB

Are you bored with using the same tired reverb patches on your productions? Patch your reverb's left- and right-channel outputs through linked Transient Designer channels to add a little pizzazz. (For all of the applications in this article that involve processing reverb, return the Transient Designer's two outputs to your DAW or mixer and pan their signals left and right, respectively, to match the pan settings you originally used for the reverb's outputs.) Boost both attack controls on TD4 to the max and lower the sustain controls to their minimum settings. You'll notice that the reverb's intensity at its onset will subtly increase while the apparent decay time decreases.

Take the exact opposite approach to process a reverb patch so that it exhibits a pyramidal slope. Turn Transient Designer's attack controls on two linked channels fully counterclockwise and crank the sustain controls to the max. With these settings, the onset of the reverb patched through Transient Designer will be de-emphasized, but the effect will bloom and then tail off over time (as long as the reverb program's decay time is set to a sufficient length so that it continues evolving during the unit's sustain phase).

Transient Designer can also create reverb effects that "move" from one channel to another. For this application, the best reverbs have a long decay and long pre-delay or prominent reflections programmed to occur *after* the onset of

the diffuse reverb tail. Once again, patch the left- and right-channel outputs of your reverb processor through two channels of Transient Designer, respectively—only this time, leave the Link button switched out for the channel pair. On Transient Designer's "left" channel (e.g., channel 1), set the attack control fully clockwise and back off the sustain control slightly (to roughly -1.5 dB). On TD4's "right" channel (channel 2), set the attack control fully counterclockwise and the sustain control to roughly the three o'clock position (or +12 dB). With these settings, the reverb will retain the original complexity of its reflections, but the effect's maximum intensity will move from your mix's left channel to the right channel (while the overall reverb effect still persists in both channels).

You can make the movement more dramatic by setting Transient Designer's channel 1 attack and channel 2 sustain to their maximum settings and channel 1 sustain and channel 2 attack to their minimum settings, but the resulting stereo image of the effect may sound too lopsided.

### ONE LAST DRUM TRICK UP MY SLEEVE

TD4 can also be used to superimpose the dynamics of one track onto those of unrelated tracks. For example, patch two mults of a kick drum track into channels 1 and 3 of TD4 and send the outputs of those two channels "out to get pizza" (i.e., somewhere they won't be heard). Patch a stereo keyboard track into TD4's channels 2 and 4 and activate both of the unit's Link switches. Next, boost channels 1 and 3 attack controls to emphasize the kick drum's slammin' nature. TD4 will dynamically adjust the attack of its processed keyboard tracks to track the dynamics of the kick drum. Try it—you'll get the point! ■

Mix contributing editor Michael Cooper is the owner of Michael Cooper Recording, located in beautiful Sisters, Ore.



# The heartbeat of your studio.

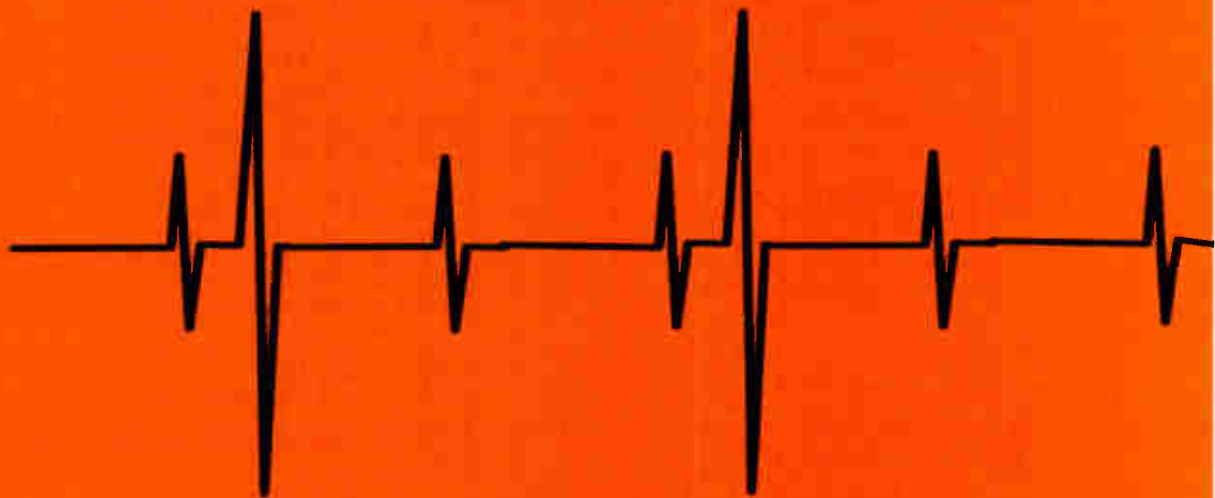

6.5" High Resolution Nearfield Studio Monitor

Dedicated 60W ILLFI + 40W IHF bi-amplifier

6.5" (160mm) HR (Hyper Radial) diaphragm LF unit

20mm magnesium diaphragm dome tweeter

Extended 55Hz - 38kHz frequency response

Magnetically shielded drivers

Time-aligned front baffle design and internal HF sound reflectors

Comprehensive level, tweeter and LO EQ controls

## NX-6A

### Powered Near Field Studio Monitor

Studio reference monitors are the life blood of any studio. If they're not not up to par or tarnish the sound in any way, it puts the whole audio recording process in jeopardy.

Listen to a pair of powered Fostex NX-6A monitors, and you'll discover a sound free of the 'enhancements' often found in other speakers.

A natural sound, transparent and precisely defined even at high sound pressure levels - including all those elusive low frequencies.

The heartbeat of your studio.

# Fostex



Fostex Company, 3-2-35 Musashino, Akishima, Tokyo Japan 196-0021 Tel: +81 (0)42-546-4974 Fax: +81(0)42-546-4272 [www.fostex.co.jp](http://www.fostex.co.jp)  
Fostex America, 13701 Cimarron Ave., Gardena, CA 90247, USA Tel: +1 310-329-2963 Fax: +1 310-329-1230 [www.fostex.com](http://www.fostex.com)

World Radio History



# Solid feel.



## Remarkable performance.

Solid feel. It's the first thing you notice when you hold the UltraLite 10 x 14 FireWire audio interface in your hands. Plug in the FireWire cable to your PC or Mac, and the next thing you notice is the depth of the features in the programmable LCD display. Connect your mic, guitar and instruments via the UltraLite's plentiful analog inputs, and watch the 7-segment input meters dance. Crank the phones and hear the ultra-clean sound. The UltraLite is the only compact audio interface that offers these advanced features, and much more, at a price that will surprise you.

- Compact size — powered by FireWire and housed in sturdy 8.5 x 7-inch aluminum alloy, the UltraLite provides rugged portability.
- Digital Precision Trim™ — use digital encoders to boost mic/instrument input gain in precise 1 dB steps with numeric feedback in the LCD.
- Three-way pad switch — apply zero, -18 or -36 dB pad to any XLR input signal, from a dynamic mic to a +4 dB line level input.
- Stand-alone mixing — connect the included DC power supply and mix your band live, without a computer. Save up to 16 mix setups and then recall them on the spot with the front-panel LCD.
- "Mix1" return bus — record the UltraLite's live mixdown back into your audio software for archiving or further workstation editing.
- Mac OS Universal Binary and Windows XP x64 drivers — use the UltraLite with today's latest Intel-based Macs or with a super-fast high-performance 64-bit Windows XP Pro audio workstation.
- Cross-the-board compatibility — works with all major audio software for Mac OS X and Windows XP. Includes AudioDesk for Mac OS X.



The CueMix Console software gives you direct access to the UltraLite's 10-input, 8-bus digital mixer. Route any combination of inputs to four separate output pairs. Create and save up to 16 mix setups. You can even set up talk-back and listen-back for studio recording sessions.

## UltraLite

Compact bus-powered 10 x 14 FireWire audio I/O



**MOTU**  
motu.com