

# HI-FI Music

AT HOME



ILLUSTRATED RECORD & TAPE REVIEWS

WorldRadioHistory

WITH RATINGS FOR COMPOSITION,  
PERFORMANCE, AND AUDIO QUALITY

# SMART SANTAS



GIVE



No gift gives more than music — to receiver  
and giver, alike. No record gives more music than  
**WESTMINSTER** — the only records with "Natural Balance".

## Gift Albums

### BACH

Mass in B Minor. Loose, Ceska, Burgthaler-Schuster, Dermota, Poell, Heiller (organ), Vienna Symph. Orch. and Akademie Kammerchor; Hermann Scherchen cond. (3 records) XWN 3305

St. Matthew Passion. Laszlo, Roessel-Majdan, Munteanu, Standen, Cuenod, Rehfuß, Symph. Orch. and Chorus; Hermann Scherchen cond. (4 records) XWN 4402

Well-tempered Clavier (Books I and II). Demus, piano. (5 records) WN 5501

### BEETHOVEN

Symphonies (Nos. 1 through 9). Vienna State Opera Orch. and Philharmonic Symphony Orch. of London; Hermann Scherchen cond. (7 records) WN 7701

String Quartets Op. 18 (Nos. 1-6). Barylli Quartet (3 records) WN 3302

### BRAHMS

Symphonies (1-4), Alto Rhapsody, Haydn Variations, Academic Festival and Tragic Overtures. Philharmonic Promenade Orch.; Sir Adrian Boult cond. (4 records) WN 4401

### CORELLI

12 Concerti Grossi (Op. 6 complete). English Baroque Orch.; Argeo Quadri cond. (3 records) WN 3301

Concerti Grossi — Op. 6, No. 8, G min. ("Christmas"); Op. 6, No. 11, B flat maj. English Baroque Orch.; Argeo Quadri cond. (1 record) W-LAB 7015

### HANDEL

The Messiah. Ritchie, Shacklock, Herbert, Standen, London Symph. Orch. and London Philh. Choir; Hermann Scherchen cond. (3 records) XWN 3306

Beloved Choruses from "Messiah". London Symph. Orch., London Philh. Choir; Hermann Scherchen cond. (1 record) WN 18099

Concerti Grossi for String Orch., Op. 6. English Baroque Orch.; Hermann Scherchen cond. (4 records) XWN 4403

### HAYDN

The London Symphonies (Nos. 93 through 104). Vienna State Opera Orch. and Vienna Symph. Orch.; Hermann Scherchen cond. (6 records) WN 6601

### RAMEAU

Complete Harpsichord Works. Veyron-Lacroix. (3 records) WN 3303

## Christmas Records

Adventure in Carols. Ferrante & Teicher, duo-pianos. WP 6021

A Festival of Lessons and Carols. Choir of King's College Chapel, Cambridge, McLean (organ); Boris Ord directing. WP 6036

American Children Sing Christmas Carols. WP 6025

Carillon for Christmas. Robert Locksmith, Robert Owen, organs. WP 6020

Choral Evensong at King's College Chapel. Choir of King's College Chapel, Cambridge; Boris Ord cond. WP 6026

Christmas at Home (Let's All Sing Carols). Westminster Choraleers. WP 6027

Christmas at Radio City. Dick Leibert, organ. WP 6035

Christmas Carols. Deutschmeister Band; Julius Hermann cond. WP 6024

Christmas Carols. Conducted by Frederick Jackson. WP 6033

Christmas Carols. The Randolph Singers; David Randolph cond. Vol. I WP 6022

Vol. II WP 6023

Christmas Carols from Austria. Vienna Akademie Kammerchor; Günther Theuring cond. WP 6019

The Christmas Story in Carols. Scriptures read by Basil Rathbone, music by Randolph Singers, Choir of King's College Chapel, Vienna Akademie Kammerchor, others. WP 6034

## For the Collector with "Everything"

TRC: Check and Double Check. "It's a tool, not a record!" Test and demonstration material with lucid commentary by John Conly, Editor, High Fidelity. The finest available check-up of an audio system!

**YOUR DEALER, or write WESTMINSTER RECORDS, 275 Seventh Ave., New York City 1, N.Y., for information.**

# BUILD YOUR OWN FINE Jensen HI-FI SPEAKER SYSTEM

COMPLETE KITS NOW AVAILABLE—EVERYTHING YOU NEED  
NO SAWING . . . NO DRILLING . . . NO WOOD FINISHING . . . NO SOLDERING

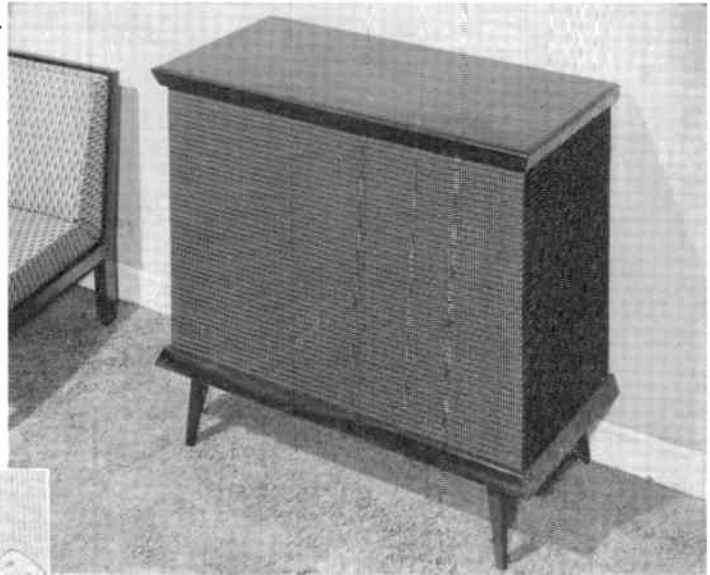
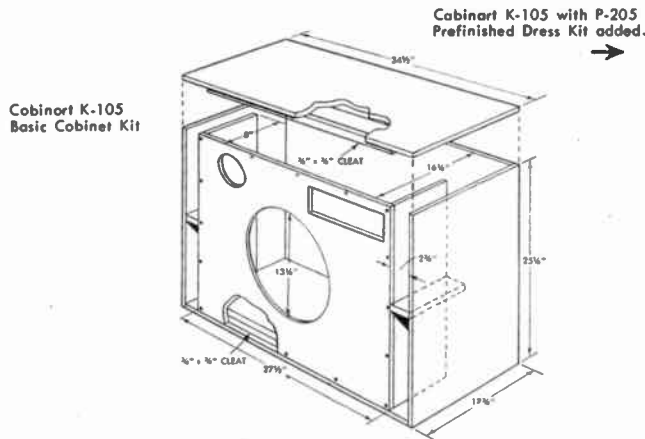

- YOU SAVE UP TO \$252.50\*
- YOU DON'T HAVE TO BE A TECHNICIAN
- YOU DON'T NEED A WORKSHOP
- YOU DON'T HAVE TO BE A FURNITURE FINISHER

\*Compared with factory-built Jensen Imperial reproducer

The proud owner of the Jensen 3-way hi-fi speaker system illustrated assembled the handsome low boy cabinet in a few hours *in his living room* with no tools except a screwdriver, pliers and a stapler. No cutting, sawing, or soldering. And the wood finishing? He just wiped off the finger prints, for the beautiful genuine selected hardwood was factory pre-finished and rubbed by professional finishers. Best of all, *he saved nearly \$100* compared with cost of the equivalent factory-built speaker system.

You can have the fun and satisfaction of building your own Jensen speaker system with size and performance ranging all the way from the diminutive, economical Duette up to the big incomparable Imperial at savings which will stretch your hi-fi equipment budget. Jensen and Cabinart with their specialized skills have collaborated to make this easy and trouble-free. Everything you need is furnished.

Jensen Speaker units are matched components, carefully pretested, with the smooth, balanced, wide-range performance for which Jensen factory-made reproducers are famous. Cabinart Cabinet Kits were designed by Jensen to give the best possible acoustic performance with Jensen Loudspeaker Kits; each is carefully coordinated with the recommended Jensen Loudspeaker Kit for correct loading of the low frequency channel ("woofer"). Wood pieces are accurately cut and drilled, with all cut-outs provided. Hardware, cleats and glue are included with complete instructions for easy assembly. If you like, you can start with the Basic Cabinet Kit of your choice, add the Prefinished Dress Kit later.

Here's your way to finest hi-fi speaker performance at least cost! Ask your dealer, or write now.

System Type	"Woofer" Size	Equivalent Jensen Reproducer	Jensen Speaker Kit		Type	Cabinart Cabinet Kits			
			Model	Price		Basic Cabinet Kit	Price	Dress Kit†	Price
3-Way	15"	Imperial	KT-31	\$184.50	Corner* Horn	K-101	\$89.00	P-201	\$54.00
3-Way	15"	Triplex	KT-32	169.50	Corner* Bass-Ultraflex	K-103	48.00	P-203	39.00
3-Way	15"	Triplex	KT-32	169.50	Low Boy Bass-Ultraflex	K-105	48.00	P-205	39.00
2-Way†	15"	—	KT-21	99.50	Corner* Bass-Ultraflex	K-103	48.00	P-203	39.00
2-Way†	15"	—	KT-21	99.50	Low Boy Bass-Ultraflex	K-105	48.00	P-205	39.00
2-Way†	12"	Concerto	KT-22	73.00	Corner* Bass-Ultraflex	K-107	39.00	P-207	36.00
2-Way†	12"	Concerto	KT-22	73.00	Low Boy Bass-Ultraflex	K-109	39.00	P-209	36.00
2-Way†	8"	Contemporary	KDU-10	24.75	Corner* Bass-Ultraflex	K-111	23.00	P-211	25.00
2-Way	8"	Duette Treasure Chest	KDU-10	24.75	Duette	K-113	18.00	P-213	21.00

\* Gives excellent results against sidewall. Bass-Ultraflex is a Jensen trademark.  
† Cabinet provides for expansion to 3-way system at any time with Jensen KTX-1 Range Extender Supertweeter Kit, price \$43.75.  
‡ Available in Mahogany or Korina Blonde.

For information about Jensen Speaker Kits write:

**Jensen**  
MANUFACTURING COMPANY  
Division of The Muter Company  
6601 SOUTH LARAMIE, CHICAGO 38, ILLINOIS  
In Canada: Copper Wire Products Co., Ltd.

For information about Cabinart Cabinet Kits write:

**CABINART**

The Pioneers in High Fidelity Radio Furniture

A Division of G & H Wood Products Co., Inc.  
99 North 11th Street, Brooklyn 11, N. Y.

November-December 1956

Why are Wharfedale Loudspeakers so hard to get?

*Because they are made by people, not machines.*

*Because they are designed by G. A. Briggs, whose unique personality and undeviating principles guide every step of their manufacture.*

*Because their exclusive "surround" construction requires painstaking accuracy and unfaltering craftsmanship.*

*Because every one is carefully tested before it leaves the factory. Each carries its own certified report.*

*That, in essence, is why Wharfedale speakers are hard to get.*

Are they worth ordering and even waiting for?

*We know of no single product in the entire catalog of high fidelity components which so richly deserves a little patience.*

*Place an order with your dealer and exercise only a moderate degree of patience. You will be rewarded by the cleanest, least distorted, least colored and most natural sound source now available.*

*Despite their clear-cut superiority, Wharfedale speakers are very moderately priced.*

*Three-Way System—W/15/CS (\$76.15) Super 8 (\$21.50) Super 3 (\$21.50)*

*Two-Way System—W/12/CS (\$42.75) Super 3 (\$21.50)*

*Single, Full Range Speakers—Super 12/CS/AL (\$76.15) W/10/CSB (\$40.00)  
Super 8/CS/AL (\$21.50)*

*In Enclosure—R-J Wharfedale combination 8" speaker in patented R-J enclosure (\$57.50)*

*You may start with a single speaker and add as you go along, if you care to. Suitable crossover networks are available. Free construction sheets recommending cabinets for all speakers or combinations of speakers are available on request.*



British Industries Corporation Dept. WS-36  
Port Washington, New York  
Please send Whorfedale construction sheets,  
and B. I. C. High Fidelity Plan Book.

Name.....

Street.....

City..... Zone..... State.....

A Quality Endorsed Product of the B.I.C. Group

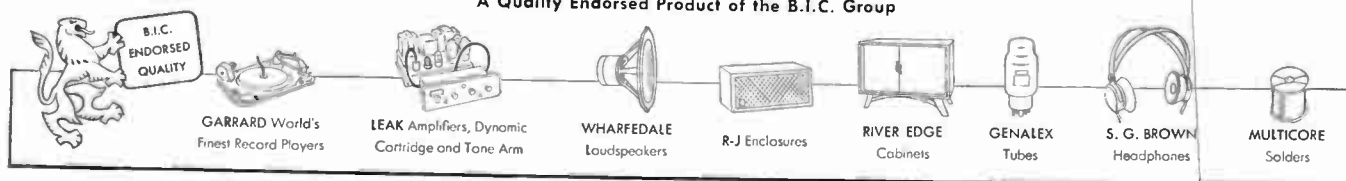

BRITISH INDUSTRIES CORPORATION PORT WASHINGTON, NEW YORK

# HI-FI Music

## AT HOME



THE COMPLETE GUIDE TO HI-FI REPRODUCTION FROM RECORDS, TAPE AND FM RADIO

**Publisher:**

**Milton B. Sleeper**

**Music Editor**

**James Lyons**

**Editorial Assistant**

**Shirley Fleming**

**Art Director**

**Ray Robertson**

**Photography**

**William Leftwich**

**Cover Design**

**Melhado**

**Production Manager**

**Mary Yiotis**

**Circulation**

**Myrna Sossner**

**Contributors to this issue**

<b>Ward Botsford</b>	<b>James Lyons</b>
<b>Jean Bowen</b>	<b>George L. Mayer</b>
<b>Oliver Daniel</b>	<b>David H. Miller</b>
<b>Warren De Motte</b>	<b>David Randolph</b>
<b>Leonard Feather</b>	<b>Richard DePass</b>
<b>Arthur Ferrante</b>	<b>Fred Reynolds</b>
<b>Shirley Fleming</b>	<b>Robert Sobin</b>
<b>P. Glanville Hicks</b>	<b>Abraham Skulsky</b>
<b>Donald Hoefler</b>	<b>Milton Sleeper</b>
<b>Edward Joblonski</b>	<b>Walter Stegman</b>
<b>Alfred Kaine</b>	<b>Saul Taishoff</b>
<b>Ezra Laderman</b>	<b>Harold Taplin</b>
<b>Nelson Lansdale</b>	<b>Louis Teicher</b>
<b>C. J. Luten</b>	

HI-FI MUSIC AT HOME \* is published bimonthly by Sleeper Publications, Inc., HI-FI House, 207 East 37th Street, New York 16, N. Y. Telephone: Oxford 7-0542. THIS OFFICE IS CLOSED FROM THURSDAY NIGHT TO MONDAY MORNING. Editorial, advertising, and circulation departments are located at the address above. HI-FI MUSIC AT HOME is not connected or associated with any other magazine.

Subscription rates are \$5.00 per year (7 issues including the HI-FI Yearbook issue) or \$10.00 for 3 years (21 issues including 3 HI-FI Yearbook issues). Single copies 50¢ except for the HI-FI Yearbook issue which is \$2.00. Outside the USA, Canada, and the Pan American Postal Union, rates are \$6.00 per year, or \$13.00 for 3 years. Copies are mailed on the 10th of January, March, May, July, September, October, and November. Allow time for delivery by second class mail.

Editorial contributions and interesting photographs are welcome, and will be paid for upon publication. No responsibility can be accepted for unsolicited manuscripts, and they will not be returned unless they are accompanied by return postage.

Entered as second class matter at New York City, and additional entry at Concord, N. H., under the Act of March 3, 1879. Printed in the U. S. A. by Rumford Press, Concord, N. H.

The cover design and contents of HI-FI MUSIC AT HOME \* are fully protected by copyrights, and must not be reproduced in any manner or form. Quotations are not permitted without specific authorization in writing from the Publisher.

\*Registered U. S. Patent Office

Copyright 1956 by Sleeper Publications, Inc.

**Sleeper Publications, Inc.**

207 East 37 Street, New York 16, N. Y.

**Milton B. Sleeper, President and Treasurer**

**Ethel V. Sleeper, Secretary**

# C O N T E N T S

VOLUME 3 ••• NUMBER 5 ••• NOVEMBER-DECEMBER, 1956

## SPECIAL FEATURES

Editorial: Six Years of Progress.....	31
The Hi and the Fi.....	33

## MUSIC

Rival Visitors—Nelson Lansdale.....	34
Schumann: Respected, Neglected—Robert Sabin.....	36
Guide to Record Collecting—James Lyons.....	37
Those Strange Sounds—Arthur Ferrante and Louis Teicher.....	38
Vaughan Williams—Edward Jablonski.....	39
Hi-Fi Records—Reviews and Ratings.....	41
Orchestral Music.....	41
Concertos.....	44
Chamber Music.....	45
Opera.....	46
Vocal.....	47
Keyboard Music.....	48
Mozart.....	49
Miscellany.....	49
Jazz.....	50
Popular Albums.....	51

Do You Remember—Shirley Fleming.....	52
Hi-Fi Tapes—Reviews and Ratings.....	54

## EQUIPMENT

Recording at the M.I.T. Auditorium and Chapel.....	56
Workshop Project No. 10: the Dynakit—Harold Taplin.....	58
We Re-Discovered Caruso's Voice—Donald Carl Hoefler.....	60
Readers' Round Table.....	63
"Inside Information".....	64

## INSTALLATIONS

Planning a Stereo Installation, Part 2—Milton B. Sleeper.....	62
---	----

## DEPARTMENTS

Records, Tape, and FM Radio.....	4
Books You Ought to Own.....	24
Advertisers Index.....	85
Buy Hi-Fi Here.....	85
Buy, Sell, and Swap Department.....	86

**COVER** There's no particular season for enjoying music, but without music we would lose much of the joy of Christmas holidays! So artist Melhado identified the Magazine with the holiday season by giving us a picture of Santa Claus in his special record shop, instead of the usual toy factory manned by gnomes. Yes, we too discovered, after the printing plates were made, that a word was not spelled correctly, but Melhado passed it off as artistic license, and said no one would notice if we didn't mention it. Besides, the purpose of the cover is to say Merry Christmas to the nicest people we know: Our Readers!

# MERCURY



**RECORDS  
TAPE  
AND  
FM  
RADIO**

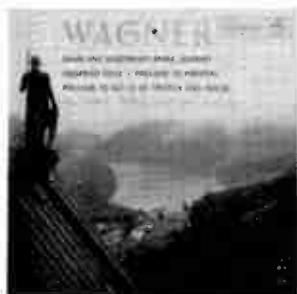

**WAGNER** Dawn and Siegfried's Rhine Journey; Siegfried Idyll; Prelude to Parsifal; Prelude to Act III of Tristan and Isolde. Detroit Symphony, Paray conducting. MG50107

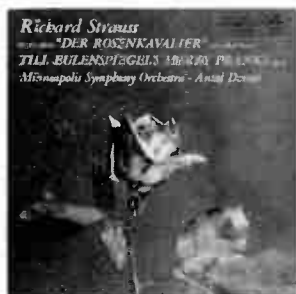

**STRAUSS** Till Eulenspiegel's Merry Pranks; Suite from "Der Rosenkavalier." Minneapolis Orchestra, Dorati conducting. MG50099



**PINOCCHIO** HANSGERS FANTASY VARIATIONS HANSGERS THE BRIGHT LAND HANSGERS EASTMAN ROCHESTER SYMPHONY ORCHESTRA HANSGERS HANSGERS

**HANSGERS** Fantasy Variations; **ROGERS** Leaves from "The Tale of Pinocchio"; **TRIGGS** The Bright Land. Eastman-Rochester Orchestra, Hanson conducting. MG50114



Eight ENIGMA VARIATIONS PURCELL SUITE for STRINGS

**ELGAR** Enigma Variations; **PURCELL-BARBIROLLI** Suite for Strings. Halle Orchestra, Sir John Barbirolli conducting. MG50125



**CHRISTMAS CAROLS** in Hi-Fi. Carlos Salzedo, harp. MG50116



POLOVETSIAN DANCES LE COQ D'OR ANTAL DORATI

**BORODIN** Polovetsian Dances (with Chorus); **RINSKY-KORSAKOV** Le Coq d'Or Suite. London Symphony Orchestra. Dorati conducting. MG50122



**MOZART** Eine Kleine Nachtmusik, K. 525 SYMPHONY IN C MAJOR (Linz'), K. 541 LONDON SYMPHONY ORCHESTRA ANSAL DORATI



CHAUSSON SYMPHONY IN B-FLAT ANSAL DORATI

**CHAUSSON** Symphony in B-flat. Detroit Symphony, Paray conducting. MG50108



**TCHAIKOVSKY** 1812 Overture (original scoring with cannon and bells); Capriccio Italien. Minneapolis Symphony, Dorati conducting. MG50054

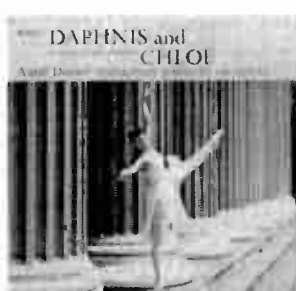

DAPHNIS and CHLOE

**RAVEL** Daphnis and Chloe (complete recording). Minneapolis Symphony, Dorati conducting. MG50C40

**L  
I  
V  
I  
N  
G  
P  
R  
E  
S  
E  
N  
C  
E**

### Hi-Fi Shows

Dates are now being set for fall and winter shows. The list below will be supplemented in future issues as fast as information is received.

- DALLAS, Hotel Adolphus, Nov. 16 to 18
- ST. LOUIS, Hotel Statler, Nov. 23 to 25
- MILWAUKEE, location to be announced, Jan. 4 to 6
- MINNEAPOLIS, location to be announced, Jan. 18 to 20
- SEATTLE, location to be announced, Feb. 1 to 3
- LOS ANGELES, location to be announced, Feb. 6 to 9
- SAN FRANCISCO, Roger Whitcomb Hotel, Feb. 15 and 18
- PORTLAND, ORE., location to be announced, Feb. 15 to 17
- KANSAS CITY, location to be announced, Mar. 1 to 3
- OMAHA, location to be announced, Mar. 15 to 17
- DENVER, location to be announced, Mar. 29 to 31
- SALT LAKE CITY, location to be announced, Apr. 5 to 7
- LONDON, ENGLAND, Waldorf Hotel, Aldwych, April 12 to 15
- PITTSBURGH, location to be announced, Apr. 19 to 21
- CLEVELAND, location to be announced, Apr. 26 to 28
- DETROIT, location to be announced, May 3 to 5

### Music in the Air

In equipping its DC7's for music aloft, United Airlines acted with more enthusiasm than practical knowledge. On the ground, before the engines are started, the audio quality is good, for the Company spared no expense on the equipment and its installation. In the air, however, with the volume turned up to compete with the roar of the engines, only the treble comes through, for the bass is drowned out by the ambient noise. The net result is shrill and so disturbing that, if one

*Continued on page 10*

*Hi-Fi Music at Home*



**THE FIRST CHARLES EAMES DESIGNS FOR STEPHENS**

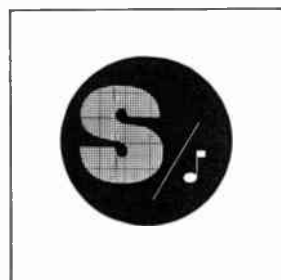

Shown here, the first of the Charles Eames designs for Stephens Tru-Sonic speaker enclosures. Essentially, they are a combination of Eames' design talent and Stephens' pioneer audio engineering. Mr. Eames has already designed the most important group of furniture ever developed in this country. His achievements in this and other fields indicate both technical inventiveness and aesthetic brilliance. There are more Eames designed enclosures to come... fresh, exciting concepts in form and audio structure.

**STEPHENS TRU-SONIC INC.**  
8538 Warner Drive, Culver City, California

AMPEX Approves



# FERRO-SHEEN TAPE

## for Revolutionary VIDEOTAPE\* Recorder

A full hour's TV program—picture and sound—on a single 12½-inch reel of magnetic tape, ready for instantaneous playback . . . that's the electronic miracle made possible by the epoch-making Ampex Videotape Recorder unveiled last spring. The television industry immediately bought up the available prototype models of the amazing new machine, and one of the first questions to come up was, of course, "Which tape?" The Ampex Videotape Recorder records on a special 2-inch wide tape, which must be made to the most rigid specifications to capture fre-

quencies as high as 4,000,000 cycles per second. All along, Orradio Industries, manufacturers of the famous **irish FERRO-SHEEN** process tapes, had been working with Ampex, so they were ready for the question. Now **irish FERRO-SHEEN** Videotape is available in production quantities, and delivery has just been completed on the television industry's first full-scale commercial order.

The successful adaptation of the exclusive **irish FERRO-SHEEN** process to the extraordinarily exacting requirements of commercial Videotape production is the culmination of a long-term research and development program—implemented by the same staff and facilities responsible for the development and current production of the five famous **irish FERRO-SHEEN** tapes for audio tape recorders: Shamrock, Green Band, Long Play, Double Play and Sound Plate.



\*Reg. T.M. Ampex Corp.

### ORRADIO INDUSTRIES, INC. OPELIKA, ALABAMA

World's Largest Exclusive Magnetic Tape Manufacturer  
Export: Morhan Exporting Corp., 458 B'way, New York 13, N.Y., U.S.A.  
Canada: Atlas Radio Corp., Ltd., Toronto, Ontario



"MUSIC'S MOST ARTICULATE SPOKESMAN" IS HEARD AS COMPOSER, CONDUCTOR, PIANIST AND MUSIC ANALYST IN A REMARKABLE SERIES OF FIVE NEW RECORDINGS, ISSUED FOR THE FIRST TIME...PERFORMED BY

# LEONARD BERNSTEIN

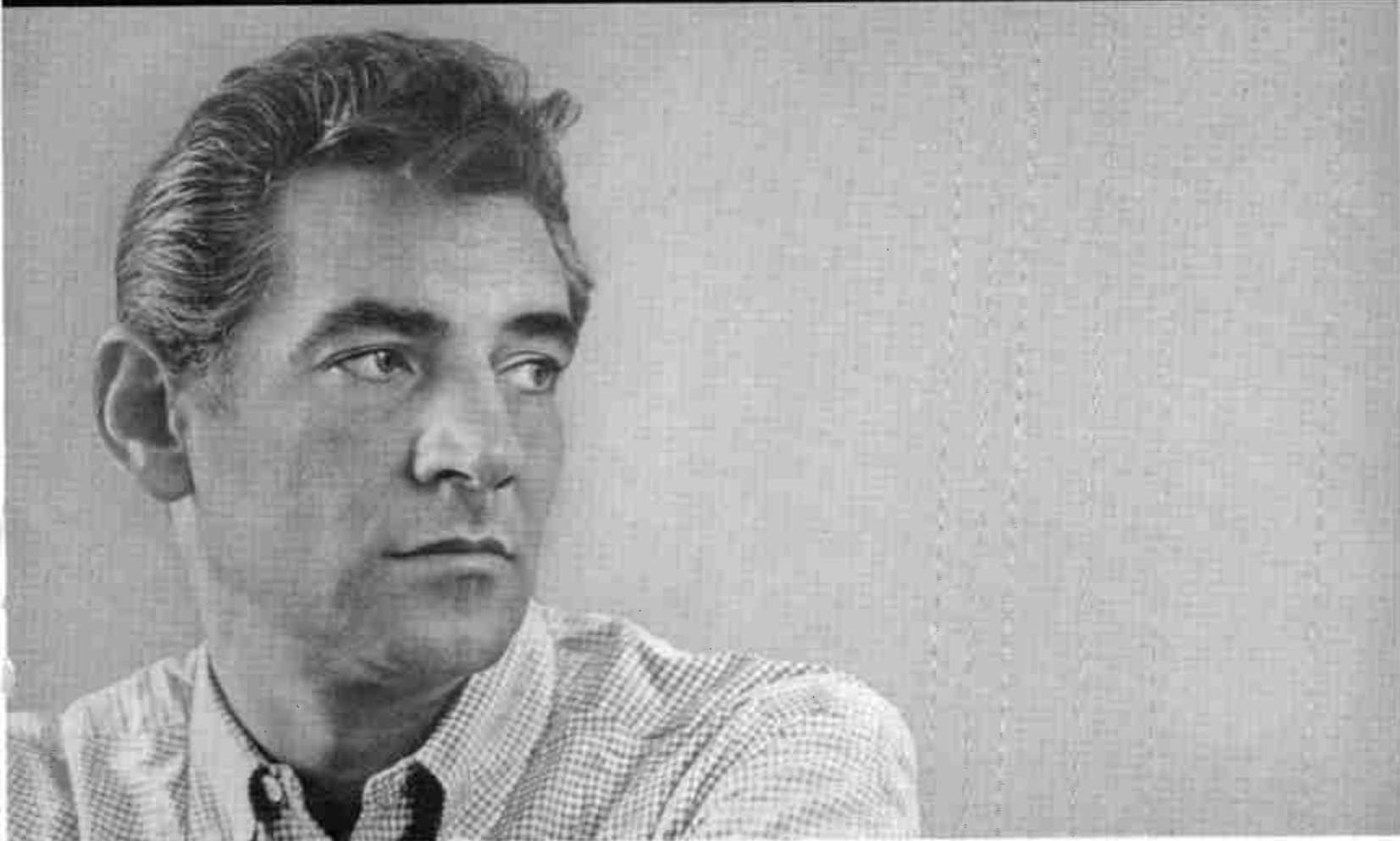

**As Composer-Conductor—**

**BERNSTEIN:** *Serenade for Violin Solo, Strings and Percussion*—Isaac Stern, violin, with Leonard Bernstein conducting the Symphony of the Air. ML 5144 \$3.98

**BERNSTEIN:** *Fancy Free*; **COPLAND:** *El Salon Mexico*; **MILHAUD:** *La Creation du Monde*—Leonard Bernstein conducting the Columbia Symphony Orchestra. CL 920 \$3.98

**As Conductor-Pianist—**

**MOZART:** *Piano Concerti No. 17 in G Major, K. 453 and No. 15 in B-Flat Major, K. 450*—Leonard Bernstein, piano, and conducting the Columbia Symphony Orchestra. ML 5145 \$3.98

**As Music Analyst—**

**BEETHOVEN:** *Symphony No. 5 in C Minor*—Leonard Bernstein looks at Beethoven's original sketches for the first movement. The entire work is on [World Radio History](#)

performed by Bruno Walter and the Philharmonic-Symphony Orchestra of New York. ("Omnibus" series) CL 918 \$3.98

**WHAT IS JAZZ?**—Leonard Bernstein looks at Jazz assisted by Buck Clayton's Jazz Band and illustrations from Columbia's Jazz Catalog. ("Omnibus" series) CL 919 \$3.98

® "Columbia" ℗ All prices are suggested list

THE SOUND OF GENIUS  
COLUMBIA  RECORDS



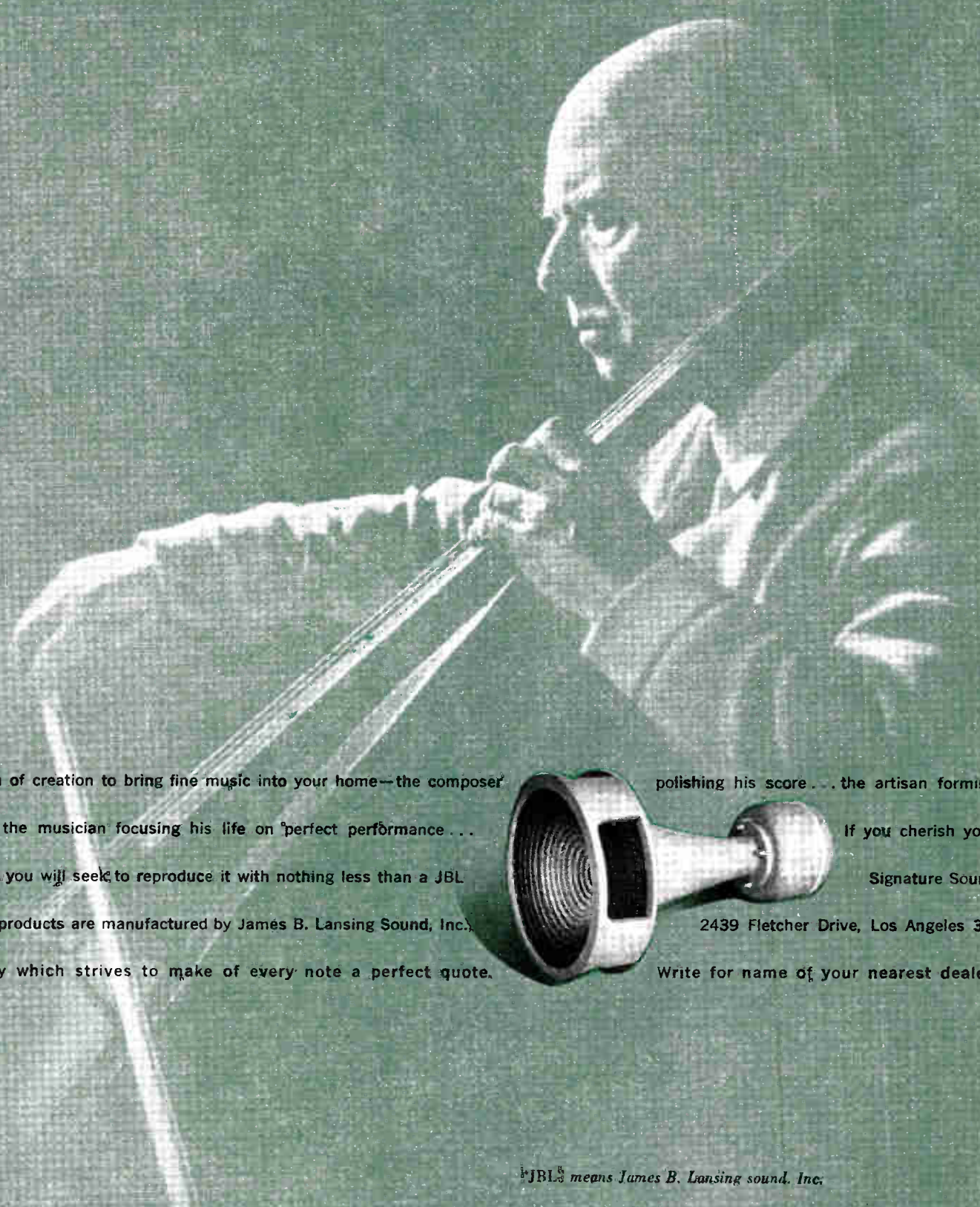
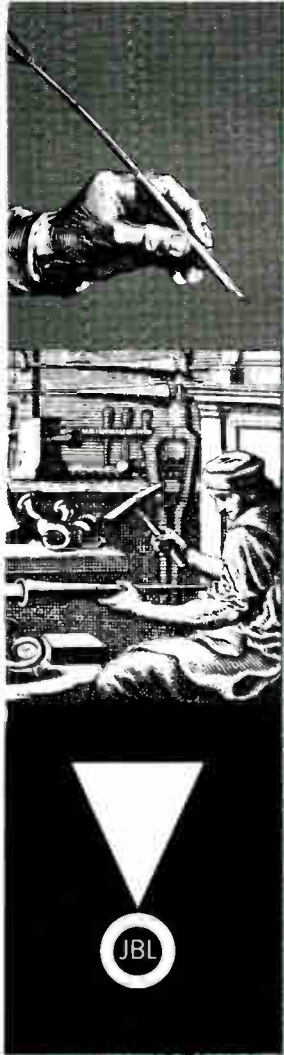

It has taken a whole train of creation to bring fine music into your home—the composer  
a flawless instrument . . . the musician focusing his life on perfect performance . . .  
heritage of exalted music, you will seek to reproduce it with nothing less than a JBL  
System. "JBL Signature" products are manufactured by James B. Lansing Sound, Inc.,  
California; the company which strives to make of every note a perfect quote.



polishing his score . . . the artisan forming  
If you cherish your  
Signature Sound  
2439 Fletcher Drive, Los Angeles 39,  
Write for name of your nearest dealer.

*JBL means James B. Lansing sound, Inc.*



## Mr. Slatkin's cup of tea

Conducting is an art requiring a combination of talents seldom found in the same human being. Toscanini maintained conductors were "born," not made. Rodzinski called conducting "unteachable" by formal means.

Result: only 21 first-rank conductors in the world.

For a conductor needs the sensitivity of a poet and the iron discipline of a top sergeant. Above all, he should be able to "hear" an entire work *in his mind*, and then communicate it to a hundred different musicians.

Obviously, this isn't every man's cup of tea. It is Mr. Felix Slatkin's, though.

A superb violinist, Slatkin has performed under the baton of a dozen of the greatest maestros, including

Toscanini, Stokowski and Reimer. But he indicated a greater talent when he created the famed Hollywood String Quartet and molded it into the world's foremost string ensemble. Now, conducting a 100-piece symphony orchestra, his genius is most clearly heard.

Enjoy the thrill of discovery inside the jacket of any of Mr. Slatkin's wide-ranging Capitol albums. Recorded in "Full Dimensional Sound," they represent the highest fidelity known to the recorder's art.

They also introduce a major American conductor.

**Recorded by Mr. Slatkin:** With the Hollywood Bowl Symphony Orch.: Gershwin's *Rhapsody in Blue*, Grieg's *Peer Gynt*, Grofé's *Grand Canyon Suite*. With the Concert Arts Orch.: St.-Saëns' *Carnival of the Animals*, Hindemith's *Four Temperaments*, Debussy's *Children's Corner*.

*FREE!* "From Bach to Gershwin"—a handsomely illustrated musical calendar depicting all major composers, their works, dates, and other data. Suitable for framing. Write: Capitol Records, 1758 No. Vine Street, Hollywood 28, Calif. (Offer expires Jan. 1, 1957.)



# YOUR INVITATION TO JOIN THE STEREOPHONIC MUSIC SOCIETY

## HERE ARE A FEW MEMBERSHIP BENEFITS

### 20% SAVINGS ON STEREOPHONIC TAPE

RCA, HMV, Omega, Hi-Fidelity, Livingston, AV, Concert Hall.

### 20% SAVINGS ON MONAURAL TAPE

(Complete listings in "Harrison Catalogue of Recorded Tapes" or "Tape Reel." You receive a copy of one upon receipt of membership application.)

### UP TO 50% SAVINGS ON RECORDING TAPE

All first grade, professional quality, recording tape!

### FREE HI-FI MUSIC MAGAZINE SUBSCRIPTION

You get 1 year subscription (regular value \$3.00) contains complete coverage of tape, records and FM, reviews, articles, etc.

### FREE CATALOGUE OF RECORDED TAPES

Complete-up-to-date tally distributed quarterly.

### NO MINIMUM PURCHASE REQUIREMENT

Order as few or as many tapes you wish.



**H**ere's the most exciting news since you first discovered the listening pleasures of recorded tape!

AT LAST . . . you can stop wearisome shopping tours hunting for the recorded tapes you want. The Stereophonic Music Society has been created to serve the needs of every music lover who appreciates the true fidelity and convenience of this ultimate music medium. This unique plan offers you *one central source* for every fine recorded tape on the market, and—through its large volume purchases—passes on tremendous savings to you!

### MEMBERSHIP RATES

Your entire cost for participation in the Society Purchase Plan and all the privileges described for a period of  
**6 Months . . . . . \$6.00 1 Full Year . . . . . \$9.00**

*The Stereophonic Music Society opens the door to you to the finest recorded tapes in the world—offered to you as soon as it is made available by all labels—at prices you can't beat anywhere. Send in this application blank today, and enjoy the benefits of membership immediately!*

### MEMBERSHIP APPLICATION FORM

TO: STEREOPHONIC MUSIC SOCIETY, Inc.  
303 Grand Avenue, Palisades Park, N. J.

GENTLEMEN: Please enroll me for a  6 month period as a member in the Stereophonic Music Society. I understand that I am under no obligation to purchase any specified minimum of stereophonic, monaural or recording tapes under the Society's discount purchase plan. As part of my membership I am entitled to a free one-year subscription to Hi-Fi Music Magazine, as well as the quarterly listings of all recorded stereophonic and monaural tapes available.

My  Check for  \$6.00 is enclosed herewith (payable to Stereophonic Music Society, Inc.).  
My  Money Order for  \$9.00

NAME \_\_\_\_\_

ADDRESS \_\_\_\_\_ ZONE \_\_\_\_\_ CITY \_\_\_\_\_ STATE \_\_\_\_\_

MAKE OF TAPE RECORDER \_\_\_\_\_

Stereophonic  Stacked  Staggered  Monaural

## RECORDS, TAPE, AND FM

*Continued from page 4*

of the stewardesses does not remember to turn off the system, the passengers request it.

### Radio up, TV down

According to RETMA, the radio-TV trade association, sale of TV sets during the first seven months of '56 amounted to 3,273,500, down 311,000 from the same period a year ago. Home radio sets sales were 3,967,555, up 1,234,572. The figures do not include the thousands of FM and AM-FM tuners sold for use with separate hi-fi audio systems.

### Soldering Made Easier

The Anaconda Wire & Cable Company has

developed a new kind of magnet wire insulation, similar to enamel, which does not have to be scraped off before the wire is soldered. You just put the insulated wires together, apply the solder, and the joint is made.

### Hi-Fi Coming up

It's the Electro-Voice hi-fi road show, with a huge cargo-carrier and two smaller trucks, loaded with equipment, kits, and complete music systems. Traveling from Portland, Ore., to New York and down to Miami, it is expected that hi-fi demonstrations will be given to more than 1,000 people each day.

### Speakers and Green Peas

It's a long way from speakers to truck farming, but L.E.E., Inc. makes a ma-

chine by which such things as string beans and asparagus are tested to determine when they have reached their prime state for picking. If your frozen vegetables taste better this year than previously, it's probably thanks to one of those L.E.E. machines!

### TV Crash Time Table

It's not surprising to note that the engineering survey planned to investigate VHF television and produce information on the possible shift of all TV to the 70 idle UHF channels is having slow-down trouble. Dr. W. R. G. Baker of GE heads the group advocating fast action. Harold E. Fellows, president of NARTB, the broadcasters trade association, feels that two to five years will be required for the study. Principal supporters of NARTB are the TV broadcasters now on VHF channels.

### Those Strange Machines

Most striking exhibit at the New York Hi-Fi Show was Oliver Read's collection of old phonographs. It was fascinating. And it made us think: each one of those machines, crude as we consider them now, was looked upon in its day by the public as a modern marvel, to be bought and prized for home entertainment. What, then, will we have for audio equipment 50 years from now, when our present-day marvels will be exhibited as antiques?

### Audio Contest

A contest in which 33 awards will be made to winners in each of two classes has been announced by Audio Devices, Inc., 444 Madison Avenue, New York. Contestants in high school and college groups will answer a 3-part question. First prize is \$2,000's worth of tape or disc equipment, and \$500's worth of tapes or discs. If you'd like to enter on behalf of your school, write Audio Devices for an entry blank. Contest closes February 1, 1957.

### Program Guide for WCRB, Boston

The special program edition of Hi-Fi Music for the Boston area will carry the schedule of station WCRB-AM-FM, and not WXHR, as announced in our last issue. WCRB is now serving a much larger area since their recent increase in FM power, and further changes are in the planning stage at this very progressive station. We are delighted that we shall have this opportunity of working with Theodore Jones, president of WCRB, and Richard Kaye, program director. The WCRB program will be contained in our January-February issue. Starting at that time, present subscribers to the WCRB guide will receive Hi-Fi Music Magazine instead. The address of the station is Boston 54.

### New FM Stations

Every once in a while, comments appear in the public press concerning the sad

*Continued on page 13*

*Hi-Fi Music at Home*

**at last!**

**Engineering  
Artistry  
Craftsmanship  
Systems Concept**

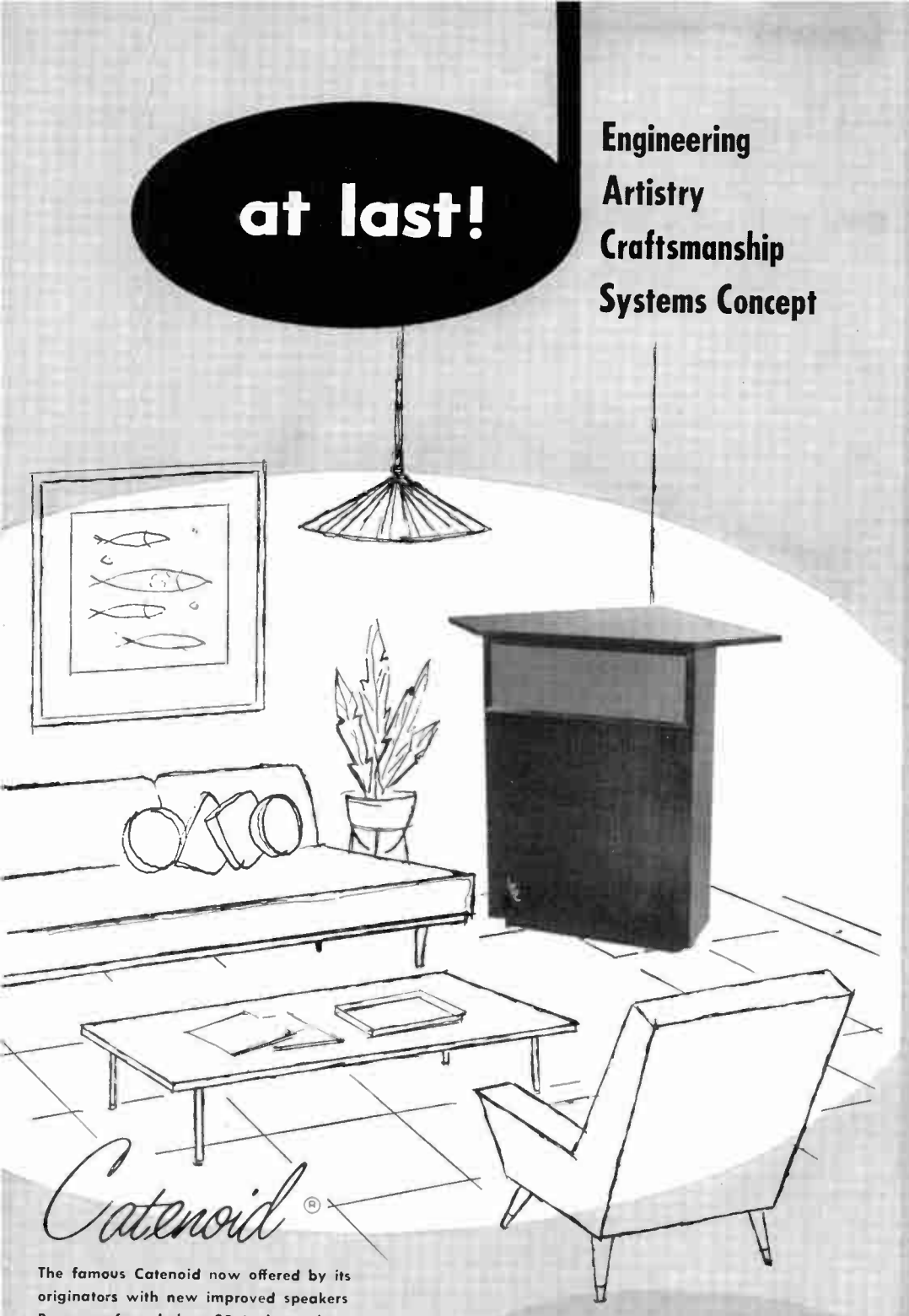

*Catenoid*®

The famous Catenoid now offered by its originators with new improved speakers  
Response from below 30 to beyond 18,000 cps

Three-way system with full bass horn and electrical crossovers of 300 and 5,000 cps  
Power 30 watts, dimensions 37½" H x 29" along wall from corner  
Net Price \$395.00

FROM THE AUDIO LEAGUE—"We have never heard a smoother overall sound. The balance of lows, middles, and highs, was well-nigh perfect."

All LEE speakers available in mahogany, blonde and walnut pressure laminate finishes



*Chorale*

New three-way speaker system with 15 inch resistance damped enclosure  
Response from 40 to 18,000 cps  
Electrical crossovers of 300 and 5,000 cps, Power 30 watts  
Net Price \$249.00

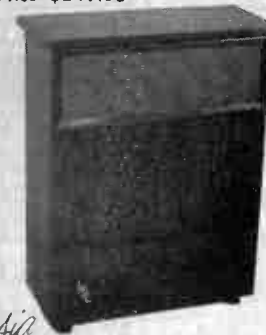

*Fantasia*

New three speaker system incorporating a resistance controlled enclosure  
Response from 50 to 15,000 cps,  
Power 20 watts  
Net Price \$129.50



*Trio*

New corner system utilizing three speakers and a resistance controlled enclosure  
Response 50 to 15,000 cps,  
Power 20 watts  
Net Price \$119.95



*Musette*

Two-way bookshelf speaker utilizing an isothermal backvolume  
Response from 70 to 15,000 cps,  
Power 15 watts  
Net Price \$69.95



**L. E. E. INCORPORATED**

*The laboratory of electronic engineering*

625 NEW YORK AVENUE, N.W., WASHINGTON 1, D. C. • NA. 8-3225

# Special Gift Albums for Special People

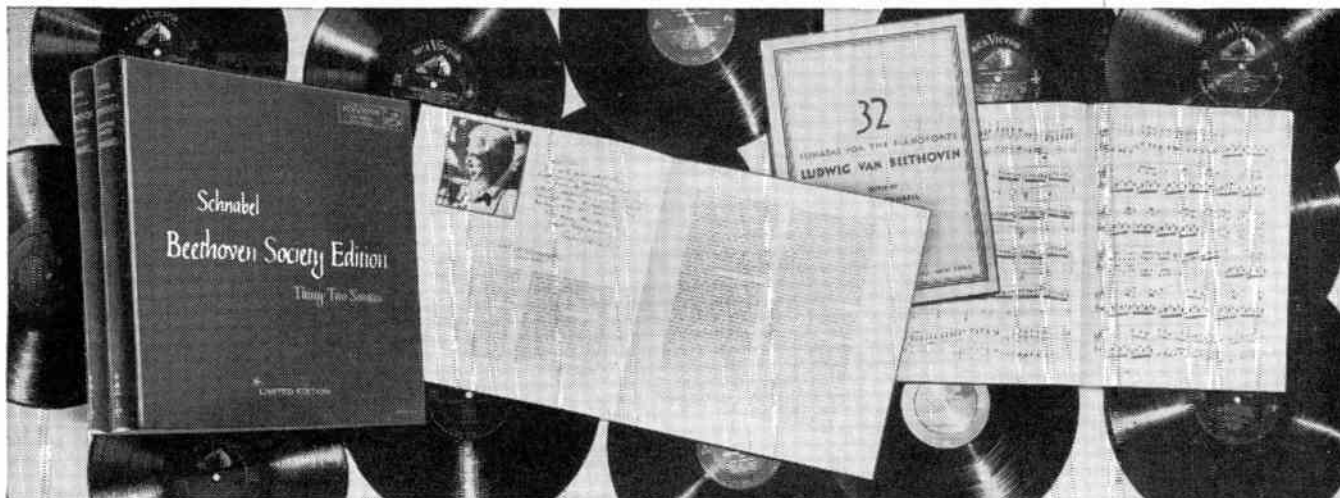

A historic collection of all the Beethoven Piano Sonatas, superbly interpreted and performed by Artur Schnabel. It has been acclaimed nationally as "the most notable contribution ever made to recorded music." Handsomely

packaged in a leather bound album, it contains a biography of Schnabel, analysis of the sonatas, and a 2-volume edition of the piano music edited by Mr. Schnabel. Thirteen Long Play records, \$80.



This limited edition is a tribute to Mozart, commemorating the 200th anniversary of his birth. It represents a magnificent cross-section of his genius and features some of the greatest singers, instrumentalists and orchestral

conductors of our time. In an exquisite, leather bound album, it contains rare photographs and portraits of places associated with Mozart and his works. Three Long Play records, \$50.

and other great performances by some of the world's greatest artists



\*Long Play \$3.98

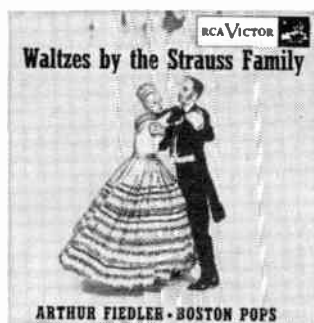

\*Long Play \$3.98



Three Long Play records \$14.98

**Gershwin: Rhapsody In Blue: Concerto in F.** Morton Gould and his Orch. Long Play \$3.98\*; 45 EP (Rhapsody In Blue, only) \$1.49

**Schumann: Symphony No. 3.** Arturo Toscanini, NBC Symphony Orch. Long Play \$3.98  
**Delibes: Sylvia.** Robert Irving, Philharmonia Orch. Long Play \$3.98

**Love In A Home:** The incomparable Mario Lanza sings four exciting songs. 45 EP \$1.49\*



Nationally Advertised Prices—Optional

\*Hear these New Orthophonic High Fidelity recordings best on an RCA Victor New Orthophonic High Fidelity "Victrola."

## RECORDS, TAPE, AND FM

*Continued from page 10*

state of FM broadcasting, and the deplorable dropping out of FM stations. Where such information comes from we do not know, but it is certainly not from any authoritative source. One of Major Armstrong's pet expressions was: "Let's keep the record straight." So, to keep the record straight, we shall publish in each issue hereafter a record of FM stations as reported by the Federal Communications Commission. Here is the record for September:

### NEW FM STATIONS

Wilmington, Del. — 99.5 mc., 20 kw.  
John B. Reynolds, 902 Marsh Rd., Wilmington 3

Chicago, Ill. — 101.9 mc., 17 kw. Carol Music, Inc., 333 N. Michigan Ave., Chicago 1

Lubbock, Tex. — 93.7 mc., 9.6 kw. Southwestern Broadcasting Co., 1916 Avenue "Q", Lubbock

Los Angeles, Calif. — 93.9 mc., 16.7 kw. Coast Radio Broadcasting Corp., 4628 Wilshire Blvd., Los Angeles 5

Jonesboro, Ark., 91.9 mc., .76 kw., John E. Cramer, Arkansas State College, Box 176, State College, Ark.

Santa Barbara, Calif., 97.5 mc., 17.5 kw., C. A. Warren, 2919 De La Vina St., Santa Barbara

Greenville, N. C., 91.3 mc., 4.5 kw., J. D. Messick, Pres., East Carolina College, Greenville

### INCREASED POWER

WKBR-FM, Manchester, N. H., 95.7 mc., 3.6 kw.

### STATIONS DELETED

WCAR-FM Pontiac, Mich.

WEMP-FM Milwaukee, Wisc.

In the month of September, therefore, the record shows a gain of five FM stations, and one power increase.

### Price and Quality

From Robert Newcomb, president of Newcomb Audio Products Company, Los Angeles, this comment: The editorial in your September-October issue says exactly what the public should know. In these days of intense competition, no manufacturer charges more for his products than they are worth, nor can he charge less than it costs him to maintain the particular quality standards he has set for his products.

It's time someone, like yourself, helped the public to understand that "hidden costs" greatly influence quality, and to realize that the more expensive product is very likely worth every bit asked for it, while cheaper products, requiring "hidden sacrifices", are not likely worth one dime more than the prices asked for them.

Congratulations on your bravery. It's not easy to go against the general trend. We know the constant "discovery" of new lower-priced merchandise is the accepted

*Continued on page 14*



## CHAMPION CARTRIDGE

*There is only one champion in the fine phono cartridge field: the ESL. After impartial testing of nineteen leading pickups, the authoritative Audio League continues to report:*

"By a practically unanimous decision, our listening panel considers the ESL Professional and Concert Series cartridges to be by far the finest phonograph reproducing instruments we have heard.

"In A-B comparisons with its closest competitors, even persons who had never previously been exposed to high fidelity reproduction were struck by the superior definition of the ESL."

"The smoothness and clarity of these cartridges are unique. ... For sheer naturalness and undistorted ease, ESL has no peer."\*

*Is your pickup obsolete? No matter how respected nor how recent it may be, you're missing plenty if you don't have the world's most advanced cartridge: the ESL. Write today for free information.*

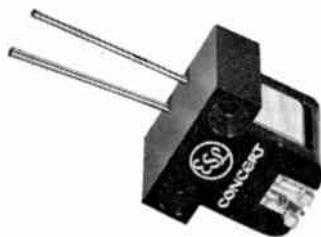

FOR LISTENING AT ITS BEST

**Electro-Sonic Laboratories, Inc.**

Dept. M, 35-54 Thirty-sixth St. • Long Island City 6, N. Y.

Soloist Series from \$14.95 • Concert Series \$35.95 • Professional Series arm and cartridge \$106.50

\*Authorized quotation No. 51. Please consult The Audio League Report, Vol. 1, No. 6-7 (March-April 1955) for the complete technical and subjective report. Additional information in Vol. 1, Nos. 10 & 12. Subscription: 12 issues \$4, from P. O. Box 262, Mt. Vernon, N. Y.

## NEW! STEEL! COOK!

Brand-new steel-band and Caribbean releases from Cook Laboratories—be the first on your block to own them!

### MUSIC TO AWAKEN THE BALLROOM BEAST

(Brute Force Steel Band of Antigua, B.W.I.)  
(12" LP—\$4.98—#1048)

A new record by the hypermelodic gentlemen of the Leeward Islands—an an-the-scene recording that proves they're greater than ever.

### PRIZE-WINNING KATZENJAMMERS

("Steel Band With Velvet Gloves")  
(12" LP—\$4.98—#1047)

Dazzling orchestral arrangements, featuring the amazing "humming-bird" style of Percy Thamas, tenor pan, by the winners of the major steelband festival competition.

### CASTILIANNE

(Maracas Waltz)  
(12" LP—\$4.98—#10890)

A sultry jazz waltz version of the Venezuelan jarapas and manzanas—a panorama of equatorial jazz and dance forms from Belem to Caracas (including the Girl Pat All-Girl Oil Drum Orchestra).

### LE JAZZ TRINIDAD

(12" LP—\$4.98—#10850)

Insidious new sounds from Trinidad, featuring Rupert Clemendare and Camba in sophisticated jazz with a pixie beat; vibes, 4 drummers, sax, piano. Recorded stealthily at Part of Spain.

### THE CHAMPION STEEL BANDS OF TRINIDAD

(12" LP—\$4.98—#1046)

Six sassa bands from "the birthplace of steel"—a glorious kaleidoscope of steel styles and prize-winning performances on a single disc.

### DANSE CALYPSO

(12" LP—\$4.98—#1180)

Jahnnny Gamez and his Orchestra far calypsa dancing; four great Calypsonians (The Dictator, Lord Crista, Herbert Howard and Small Island Pride) sing their greatest numbers. An an-the-scene recording.

at your Dealer NOW!

**COOK** Laboratories, Inc.

101 2nd St., Stamford, Conn.

### Get the Complete Catalog

Cook Laboratories, Inc.  
101 Second Street, Stamford, Conn.

Dear COOK:  
Please send the latest COOK Catalog and also put my name on the list to receive the COOK publication "Audio Bucket".

Name \_\_\_\_\_

Address \_\_\_\_\_

City \_\_\_\_\_

State \_\_\_\_\_

## RECORDS, TAPE, AND FM

Continued from page 13

route to greater leadership. For this reason, your attitude is all the more heroic, and should cause your readers to consider seriously what you say. Your readers and the industry should derive genuine benefits from such frankness and truth.

### Armstrong Foundation

Friends of the late Major Armstrong, leaders in the radio industry, and hi-fi enthusiasts from all over the United States are taking part in the establishment of the Armstrong Memorial Research Foundation. This non-profit corporation, of which George E. Burghard is president, was formed for the express purpose of aiding in the continuation of basic research that was being carried on by Major Armstrong at the time of his death.

Information on applying for membership can be obtained from Thomas J. Styles, secretary, Philosophy Hall, Columbia University, New York 27, N. Y. We urge our readers to join in the activities of the Foundation, and to take part in furthering its aims and purposes.

### Subscribers' Names

If your daily mail is augmented by catalogs you didn't send for, and requests for contributions to charities you never knew existed, the chances are that some magazine to which you subscribe has been selling its list. At Hi-Fi Music, we feel that this is an invasion of privacy. Because our readers comprise an upper-bracket group, we are solicited frequently to sell the names and addresses of our subscribers. But our answer is just plain "No." And we are glad to assure you that there will be no change in this established policy.

### Hi-Fi at Carnegie Hall

On October 3, G. A. Briggs gave a full house an opportunity to compare live and recorded music. It was his second demonstration here, and again it was carried out with seemingly effortless precision. Only those privileged to know about the months of preparation preceding this event realize the complexity of planning such an event, the preparations involved, the rehearsals necessary, and the time spent on innumerable details by Mr. Briggs, H. J. Leak, Leonard Carduner, and Arthur Gasman.

Add to their efforts the talents of E. Power Biggs, Morton Gould, and the Teicher and Ferrante team, and the skill of the Columbia engineers who made the tapes. Then consider that the acoustics of Carnegie Hall at the time of the performance were entirely different from those which prevailed during rehearsals, when the seats were empty, and you'll wind up in sheer amazement at the preparation, skill, and teamwork that made such a flawless performance possible.

Continued on page 16

The  
Microphone  
makes the  
difference...

between an ordinary  
performance and a  
truly fine distortion-  
free recording.

Your tape recording or PA  
equipment can reproduce a  
much wider range of voice  
or music—if you use these

**SHURE** microphones!



"SONODYNE" Model 51

A dynamic semi-directional microphone with excellent response to 10,000 cps. Widely used by performers, bands and recording artists. Ideal as a moderate-cost replacement for conventional tape recorder and PA microphones. Multi-impedance switch gives you the versatility of three microphones in one. Supplied with 15' microphone cable. Rich satin chrome finish. List price \$49.50.



"MONOPLEX" Model 737A

The only uni-directional crystal microphone made! Super-cardioid polar pattern reduces pickup of background noises and reverberation by 73% to provide clear noise-free recordings. Frequency response to 10,000 cps. Has moisture-proofed "Metal Seal" crystal and internal sponge-rubber floating mount for long operating life. 15' cable, satin chrome finish. List price \$46.00.

**SHURE**

The Mark of Quality

**SHURE BROTHERS, INC.**

218 Hartrey Avenue, Evanston, Ill.

Hi-Fi Music at Home



SAVE UP TO 50%

**ASSEMBLE YOUR OWN**  
*Electro-Voice*  
**HIGH-FIDELITY**  
**SPEAKER ENCLOSURE**

It's Easy and Economical

**Electro-Voice KD Kit speaker cabinets** are partially-assembled, pre-cut counterparts of famous Electro-Voice speaker enclosures. You get everything you need—parts, glue, and screws. Build any of seven carefully-engineered speaker cabinets by following simple, step-by-step illustrated instructions. Kits from \$26 (KD-7, The Baronet) to \$118 (KD-1, The Patrician).

If you prefer, buy only the Electro-Voice instruction book (75c to \$1.50) and secure materials from local suppliers.

**Give your completed cabinet a fine furniture finish.** Electro-Voice finishing kits—cherry, cordovan mahogany, walnut, golden oak, fruitwood or ebony—\$5. Decorative Metal Trim kits from \$4.80.

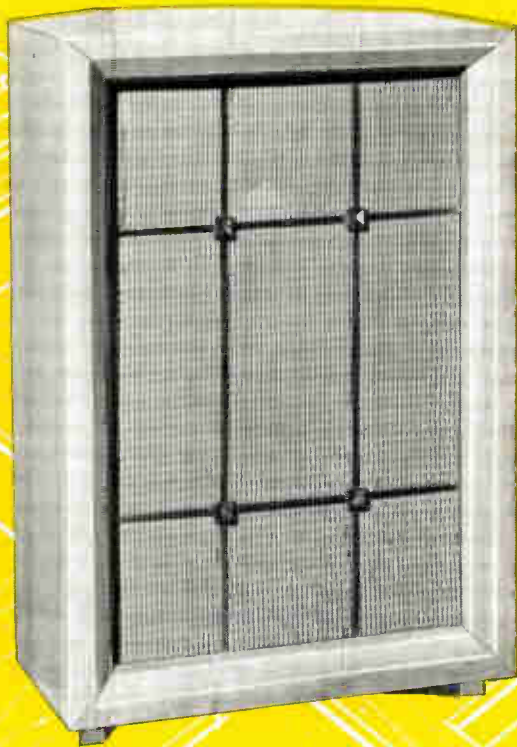

**THE ARISTOCRAT KIT**  
 KD-6,

Start With an E-V Coaxial Speaker and Improve Your System One Step at a Time

**Electro-Voice Building Block plan** lets you step up the quality of your high-fidelity speaker system as your budget permits. You start out with an E-V coaxial speaker, add very high frequency driver and crossover, then mid-range driver, horn and crossover until you have a complete, multi-speaker system. You can do it with confidence because Electro-Voice components are completely compatible—designed to work together for the finest reproduction.

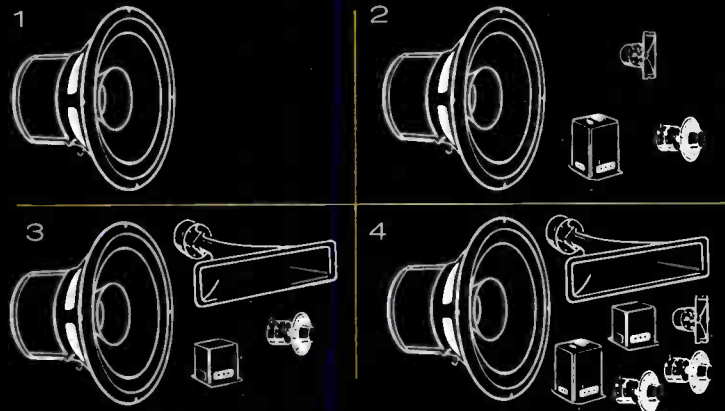

KD-1, The Patrician      KD-3, The Centurion      KD-2, The Georgian

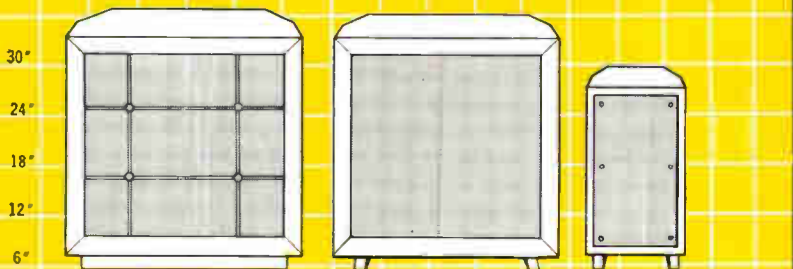

KD-4, The Regency      KD-5, The Empire      KD-7, The Baronet

**HEAR THE DIFFERENCE**

There is a difference in high-fidelity equipment—and you can hear it. Dial the unique E-V SYSTEMS SELECTOR at your dealers. Hear the improvement as you add components to the basic system. Let your own ears tell you the story of Electro-Voice superiority. See your dealer right away.



WRITE FOR BULLETIN 211 H611

*Electro-Voice*

ELECTRO-VOICE, INC. BUCHANAN, MICHIGAN

Export: 13 East 40th Street, New York 16, U. S. A. Cables: ARLAB



# LISTEN...

There's a  
New World of Sound on  
**DECCA RECORDS!**

What does Decca's New World of Sound mean to you? High Fidelity? Of course. Rich tone quality? Naturally. But, more basic, the music of internationally-famous orchestras and artists is literally *re-created* on your own home sound system by a blending of unique musical skills and advanced sound engineering techniques . . . as you listen, the walls move out and a New World of Sound pours in!

Hear these two superb examples of Decca's New World of Sound!

**POPULAR**  
**BING CROSBY:** 'Songs I Wish I Had Sung The First Time Around'; Vocal tribute to America's great singers from 'the Greatest'. DL 8352

**CLASSICAL**  
**HAYDN:** The Creation; Soloists—Seefried, Holm, Borg, Choir of St. Hedwig's Cathedral, Berlin Philharmonic, Igor Markevitch. DX-138\*

\*Recorded in Europe by Deutsche Grammophon.

## DECCA® RECORDS

*a New World of Sound®*

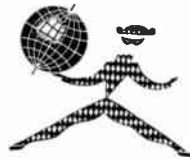

Largest  
Tape  
Treasury  
in

# STEREOPHONIC

First in monaural . . . first in stereophonic . . . always the quality leader in recorded tape for home music performance. **LIVINGSTON** is rapidly adding to its library of new stereophonic releases.

The LIVINGSTON catalogue contains the greatest diversity of recorded works ranging from the monumental classics to Jazz and Dixieland, from Bach's works for the Organ to the Rampart Street Ramblers. Included in the LIVINGSTON listings is the finest material from such famous independent labels as:

**AUDIOSPHERE • BOSTON • ATLANTIC  
EMPIRICAL • ESOTERIC • LIVINGSTON**

ALL LIVINGSTON tapes are 1200', splice-free, on 7" reels, fully guaranteed. All tapes come in attractive individual boxes, immediately identifiable and with complete program annotation.

List Price \$11.95

*ivingston*

LIVINGSTON ELECTRONIC CORP., Livingston, N. J.

## RECORDS, TAPE, AND FM

*Continued from page 14*

It appeared so deceptively easy, but any one of a hundred things might have slipped and upset the whole show. As, for example, the unfortunate error made at a recent demonstration at Hartford by another group. During one part of the program it was planned to tape the 75-piece Hartford Symphony Orchestra, and play it back to the audience by FM radio. But somehow the radio playback heard by the audience carried not one composition but two, superimposed. Presumably, a two-track tape was played back on a one-track machine at the station.

### A Bad Situation

Some dealers handling Columbia phonographs in New York are telling people that Columbia does not recommend diamond styli. In one case it was reported to us that a dealer said Columbia advised against diamonds because they "play too deep in the grooves and ruin the records." We don't believe, of course, that any such pronouncement was ever issued from Columbia. Rather, we think that some of the less reputable dealers are trying to grab off a piece of the "high-fidelity" business — those fast-talking operators who are smart enough to always have answers, but not smart enough to have the right answers.

### Orchids by Hi-Fi

Dr. Everett V. Dulin, a subscriber to the WASH program edition of Hi-Fi Music at Silver Spring, Md., raises orchids as a hobby. He told us: "Most of my hi-fi equipment is in humidity-protected cabinets in my greenhouse. I'll bet I'm the only one of your subscribers to raise orchids by hi-fi!" We wonder if he brings them up on romantic music, such as *Love in Bloom* or *Dancing with the Stars*.

### Society of Music Enthusiasts

Hi-fi enthusiasts in the Toronto area are invited to attend the very interesting lectures and demonstrations staged by the Society at its regular meetings. Complete information can be obtained from the secretary at 141 Dundas Street West, Toronto 2.

### Les Paul and Mary Ford

New tape recorder built for them has 8 channels for 1-in. tape. Purpose is to improve the quality of their recordings over the sound-on-sound method they used in the past. With the new machine they will record on channel 1, then listen to it while they record on channel 2. This will be repeated until they have up to 8 channels on the tape. Finally, those channels will be mixed to produce a single-channel master tape. Purpose is to eliminate the degrading of audio quality experienced with the sound-on-sound method. Also, any track can be redone, if necessary, without affecting the others.

Here are a few of the outstanding additions to our Stereophonic Catalogue in various categories:

#### CLASSICAL

**MOZART:** Concerto No. 2, 3 for French Horn and Orch. (K.447,417), James Stagliano and Zimble Sinfonietta Boston 7-4 BN

#### CHORAL

**STRAUSS, JOHANN:** Voices from Vienna, Vol. 1, Incl. Blue Danube, Sweets from Vienna, Thunder and Lightning, featuring the 106 voice Vienna Choir with Orchestral Accompaniment. Audiosphere 705 BN

#### ORGAN

**BACH, J. S.:** Toccata and Fugue in d minor, Kurt Rapf playing Piaristenkirche Organ; also contains Mendelssohn's Sonata #2, Franck's Chorale in E major Audiosphere 705 BN

#### POP

**LENNY HERMAN:** Music in Motion, Vol. 1 — Standard dance favorites with striking stereo effects. Livingston T-1088 BN

#### JAZZ

**RAMPART STREET RAMBLERS** with Wilbur de Paris, a Sensational Hi Fi recording of Dixieland tunes. Atlantic 7-5 BN

*LIVINGSTON tapes can be auditioned at your High Fidelity—Audio Dealer or Record Shop. Send for our complete catalogue and the name of your nearest dealer.*

When only the best is  
good enough...

# Soundcraft

magnetic recording tapes on

magic "Mylar" \* base



Model's outfit by Mme. E. Grangé  
Car by Jaguar  
PLUS 50 by Soundcraft



For true high fidelity now — and from now on — choose from these Soundcraft tapes. All are made with Oscar-winning Soundcraft oxide on extra-strong "Mylar" base.

PLUS 50 — get 50% longer play

PLUS 100 — twice as much on a reel

"LIFETIME" — guaranteed for life

FOR EVERY SOUND REASON

REEVES **SOUNDCRAFT** CORP.

10 East 52nd Street, New York 22, N. Y.

\*DuPont trademark

November-December 1956

17



# THERE IS A DIFFERENCE IN HIGH-FIDELITY EQUIPMENT!

HEAR IT! SEE IT! IT'S

*Electro-Voice®*

Hear whole octaves others miss! Look at the clean, functional lines which are the outward indication of inner quality. That's the result of "Listening" engineering by Electro-Voice.

All authentic high-fidelity equipment reproduces sound pleasantly. But to recreate living "presence," choose Electro-Voice as experts do. In the Aristocrat folded-horn corner enclosure and related equipment shown, you have an *integrated* three-way system which gives you amazingly wide tonal range without distortion. The enclosure with 12TRXB triaxial speaker, the Circlotron amplifier with controls and the 80 Series Ultra-Linear Ceramic cartridge in the record player of your choice combine to thrill you with concert hall realism in your home.

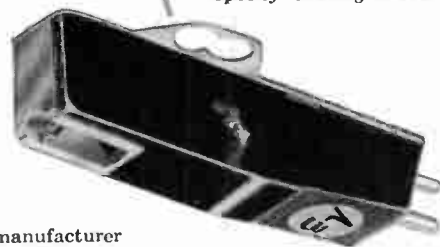
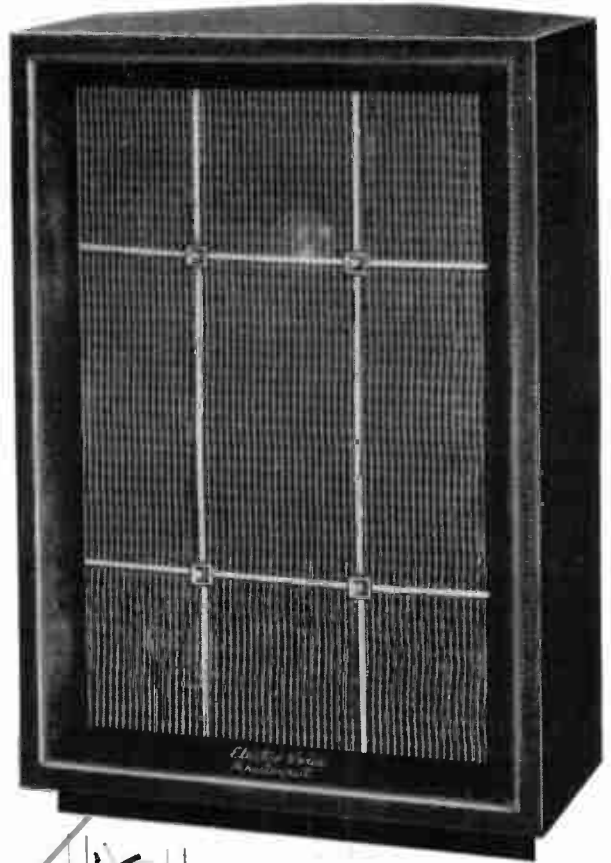

Twenty-six years of single-minded devotion to making only the finest is built into all Electro-Voice products . . . units designed to perform together as complete systems . . . units which, when added individually to *any* high fidelity system, make it sound better.

New Catalog-Guide gives quick facts on Speaker Systems for true high-fidelity music reproduction. Send 25c to cover postage and handling. Specify Catalog No. 117-II611.

*Electro-Voice®*

ELECTRO-VOICE, INC. • BUCHANAN MICHIGAN  
Export: 13 East 40th Street, New York 16, U. S. A.  
Cables: ARLAB

Electro-Voice, world's largest manufacturer of high-fidelity products, offers you the world's most complete line—speakers, speaker enclosures, systems, amplifiers, pre-amps, tuners, phono cartridges, Power-Point cartridges, Do-It-Yourself enclosure kits and microphones. Available everywhere.

\*Slightly higher in the West.



THE ARISTOCRAT Folded Horn Corner Enclosure augments bass reproduction without "boom" or distortion, provides balanced bass and treble, adds to speaker power-handling capacity. You enjoy purity of extended tone never before achieved in a cabinet of this size, 29 $\frac{3}{8}$ " x 19" x 16 $\frac{1}{8}$ ". Mahogany, Net \$69. Korina Blonde, Net \$76.



LOW-BOY CIRCLOTRON AMPLIFIER WITH CONTROLS, easy to operate, designed for music lovers who want a compact, moderately-priced high quality amplifier. Five position playing selector for radio tuner, tape recorder, TV and 2 position phono. Model A15CL, \$99.50\*



12-INCH TRIAXIAL REPRODUCER gives you phenomenal bass response, full-bodied mid range and silky-smooth upper octaves without distortion. Used in the Aristocrat enclosure, this integrated three-way system has a response of 35-15,000 cps. Model 12TRXB, Net \$64.00.



ULTRA-LINEAR CERAMIC PHONO CARTRIDGE, for finest reproduction of 45, 33 $\frac{1}{2}$  and 16 $\frac{1}{2}$  rpm records with true high fidelity. 1-mil sapphire tip. Model 84S, Net \$9.60.



## Chopin played for Liszt

... and spoke of fidelity

Liszt had embellished Chopin's nocturnes as he played one night in a Paris *salon* for the composer . . .

Chopin said: "I beg you my dear friend, when you do me the honour of playing my compositions, to play them as they are written, or else not at all."

Then *Chopin* played Chopin . . .

Why not give yourself the pleasure of hearing *your* musical recordings as they *should* be heard?

**EXCLUSIVE THREE-CHANNEL FRONT-LOADED EXPONENTIAL HORN SYSTEM:** Below 45 cps to 16,000 cps flat with usable response in excess of those frequencies. Exceptional transient response. Three-way frequency dividing network with cross-over at 550 cps and 4,000 cps. High output 22 watt amplifier with preamp. 20 to 20,000  $\pm$  1.5 db. Less than 2% IM distortion (60 cps and 7,000 cps; 4:1 ratio signal). Precision calibrated bass and treble tone controls for definite steps in cut and boost; separate continuously variable volume control; professional three-step loudness control; 12 db/octave high frequency roll-off control (scratch filter) with 3-6-10 "KC" and "Flat" positions. Other input selector positions: "Mic," "Tuner," "Tape," and "TV." AM-FM tuner with AFC; 4-speed precision intermix changer of advanced design; G-E variable reluctance cartridge with 1 mil diamond and 3 mil sapphire styli.



### AMI CHOPIN ENSEMBLE

Control unit, corner horn enclosure, and record storage console. Corner horn enclosure couples acoustically with floor and walls of your listening room to extend the bass horn within the enclosure. One of six fully integrated sound systems as well as remote control console models and wall and corner horn enclosures for a variety of combinations. Light or dark Honduras mahogany, satin finish hand rubbed by Grand Rapids fine furniture craftsmen.

...the Precision Instruments of High Fidelity



1500 Union Avenue, S. E.  
Grand Rapids 2, Michigan

Engineers, Designers and Manufacturers of  
Professional and Commercial Sound Systems Since 1909



a **Pilot** first

# BEACON TUNING

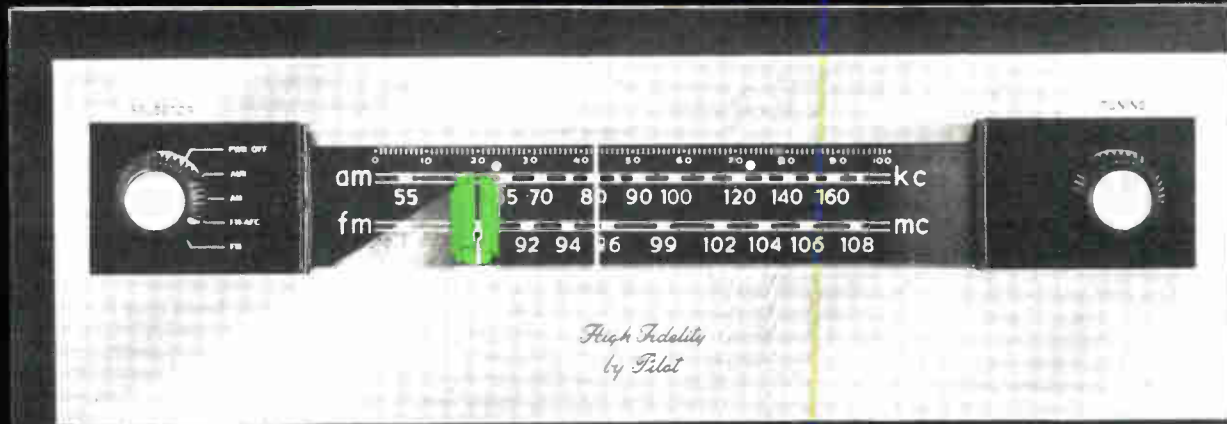

now featured in all  
new Pilot Tuners

for easy, accurate station selection

*Tuning Ease  
and  
Modern Styling  
have been added  
to  
Quality Engineering*

BEACON TUNING is an exclusive Pilot feature found only in the new Pilot Tuners. It is a simple, yet infallible visual indicator that assures the absolute tuning accuracy required for distortion-free FM and AM reception.

But Beacon Tuning is only one of the new Pilot features. Appearance, too, has been refined. Styled along simple lines — color-contrasted in deep burgandy and burnished brass — the new Pilot tuners reflect the discriminating modern taste.

And beneath the handsome exteriors of these tuners is a quality that speaks of more than 35 years of Pilot experience in electronics expressed in the most advanced design features known today. Automatic Frequency Control, Cathode Followers and Beacon Tuning are but a few. The preamp-equalizers built into the new Pilot Tuners and Amplifiers are designed for use with tape heads as well as tape amplifiers and records. And these preamp circuits are designed to operate with dc on tube heaters for hum-free performance.

The demand for Pilot tuners to match the performance of the modern Pilot amplifiers has been most compelling. Today, there is a Pilot tuner for every Pilot amplifier — handsomely styled for appearance and electronically matched for performance.

ILLUSTRATED  
FA-540 TUNER  
AA-920 AMPLIFIER

the **Pilot**

...in the New **Pilot** TUNERS

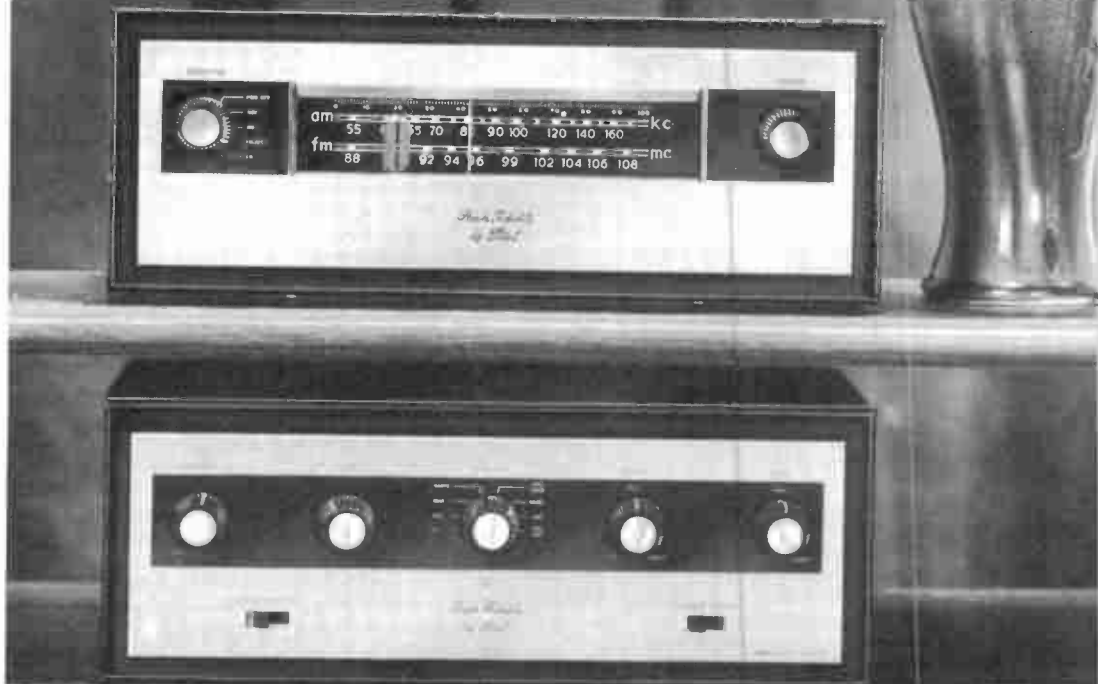

PILOT Tuners			Suggested PILOT Amplifiers			
FM-530	FM Only	\$ 79.50	}	AA-903	10 watts	\$ 69.50*
FA-540	FM-AM	109.50		AA-920	20 watts	99.50*
FA-550	FM-AM	159.50*	}	AA-410A	20 watts	54.50
				AA-904	30 watts	99.50
AF-850	FM-AM	154.50	}	AA-903	10 watts	69.50*
				AA-920	20 watts	99.50*
AF-860	FM-AM	189.50*	}	AA-410A	20 watts	54.50
				AA-904	30 watts	99.50

\*with built-in preamp-equalizer

slightly higher  
West of Rockies.

NOTE: The AF-850 FM-AM Tuner may be used with the Pilot PA-913 Preamp-Audio Control in conjunction with either the AA-410A or AA-904.

Hear these Pilot combinations at your hi-fi dealer — or write for complete details to:

**RADIO CORPORATION** 37-06 36th STREET, LONG ISLAND CITY 1, N. Y.



Litho U.S.A.



Make this a Christmas long remembered—  
with full fidelity listening pleasure  
for the entire family



*Norelco F.R.S.*

speakers are available  
5", 8" or 12" sizes in standard impedances.  
Priced from \$6.75 to \$59.98  
Blue prints are available for the  
do-it-yourself enclosure builder.

You will hear a remarkable difference in the clarity of Norelco \*Full Resonance Speakers. In a single speaker, twin-cones reproduce low frequencies, middle range, as well as the higher frequencies extending beyond the audible range—without distortion.

**WHY ARE NORELCO FRS SPEAKERS SO EXCEPTIONAL?**

They have incorporated a number of technical refinements which are evident the moment you listen. The air gap has been made long so that the coil is completely enclosed in an even magnetic field at all times. A copper ring has been fitted into the deep air gap to keep the

voice coil impedance constant over the whole frequency range: this avoids incorrect matching. High flux densities are obtained through the use of "Ticonal" magnet steel.

Norelco speaker-matched enclosures are scientifically designed acoustical boxes which enhance the exceptional tone qualities of FRS speakers; bringing out their true performance values.

Norelco FRS Speaker Enclosures are available in three sizes to match the characteristics of the speaker in use. Supplied in either mahogany or blond, these enclosures incorporate a removable base permitting the enclosures to be placed horizontally or vertically to suit any room arrangement or decor.



ADD TO...and improve any sound system with *Norelco* \*FULL RESONANCE SPEAKERS

Write today to Dept. 112 for brochures and prices of these unique speakers.

**NORTH AMERICAN PHILIPS CO., INC., 100 E. 42nd Street, New York 17, N. Y.**

## YOU ARE INVITED . . .

The following Berlant-Concertone distributors invite you to visit their store to see the new TRIPLE PLAY RECORDERS and to get your free \$50.00 tape library or Concertone Custom Microphone for \$20.00 with purchase of any Berlant-Concertone recorder.

**AKRON**  
Audio Hall  
326 W. Bowery St.  
Olson Radio Warehouse Inc.  
73 E. Mill Street

**ALBUQUERQUE**  
Hi Fi Equipment Inc.  
816 San Mateo S. E.  
Sound Eng. & Equipment Co.  
3011 Monte Visto, N. E.

**BALTIMORE**  
American Distributing Co.  
2 North Howard St.  
Wholesale Radio Parts Co.,  
Inc.  
311 W. Baltimore St.

**BEVERLY HILLS**  
Crowfords of Beverly Hills  
465 N. Rodeo Drive

**BROADVIEW, ILL.**  
Hi-Fi Unlimited  
1305 Roosevelt Road

**BUFFALO**  
Buffalo Audio Center.  
Arrowlite Co. Inc.  
153 Genesee Street

**CENTRAL CITY, NEB.**  
Simpson Electronics  
102 G. Street

**CHICAGO**  
Allied Radio Corporation  
111 N. Campbell  
Continental Corporation  
3239 W. North  
Newark Electric Company  
223 West Madison Ave.  
Voice & Vision  
53 E. Walton Place

**CINCINNATI**  
Customcrafters Audio Inc.  
2259 Gilbert Avenue  
Steinberg's Inc.  
633 Walnut Street

**CLEVELAND**  
Audio Craft Co.  
2915 Prospect Ave.  
National Manufacturing Co.  
1000 Hamilton Ave.

**COLUMBUS**  
Shoffer Music Company  
849 North High Street

**DAYTON**  
Custom Electronics Inc.  
1000 South Main St.

**DENVER**  
Electric Accessories  
Stout at 20th Street

**DETROIT**  
Haco Distributing Co.  
9730 Burnette  
K. L. A. Laboratories, Inc.  
7375 Woodward Ave.  
Lobby-Hobby Inc.  
17300 Woodward Ave.

**EAST CHICAGO, IND.**  
J. N. E. Television  
2013 Broadway

**HEMPSTEAD, L. I.**  
Island Audio & Hi Fi Center  
441 Fulton Avenue  
Newmark & Lewis  
43 Main Street

**HOLLYWOOD, CALIF.**  
Hollywood Electronics  
7460 Melrose Ave.  
Magnetic Recorders  
7115 Melrose Ave.

**HOUSTON**  
Busocker Elec. Equip. Co.  
1216 West Cloy

**LAFAYETTE, IND.**  
Lafayette Radio  
408 North Street

**LAKESWOOD, OHIO**  
Music Unlimited  
13410 Detroit Ave.

**LAS VEGAS**  
Nevodo Book & Sound  
306 E. Charleston  
Radio and Sound Supply Co.  
25 E. Colifornio St.

**LONG BEACH, CALIF.**  
Dockney Electronics  
343 East Market Street  
Scott Radio Supply Inc.  
266 Alamitos Avenue

**LOS ANGELES**  
Beverly Hi-Fi  
468 So. Robertson Blvd.  
Bushnell Electronics  
12026 Wilshire  
Gateway to Music  
3089 Wilshire Blvd.  
Midway Electronics  
2817 Crenshaw Blvd.  
L. A. Portable Recorders  
521 No. Lo Cienega Blvd.  
Sound Unlimited  
6320 Commodore Sloat Dr.

**MIAMI**  
Hi-Fi Associates  
3888 Biscayne Blvd.

**MILWAUKEE**  
Hi Fi House, Inc.  
2630 N. Downer Street  
Photoart Visual Service  
840 No. Plankinton Ave.  
Wock Soles  
3131 W. North Avenue

**MINNEAPOLIS**  
Electronic Industries, Inc.  
2451 Hennepin Avenue  
Paul Schmitt Music Company  
68 South Tenth Street

**NEWARK**  
Hudson Radio & Tele. Corp.  
35 Williom Street

**NEW YORK CITY**  
Airex Radio Corporation  
64 Cortlandt St.  
Audio Unlimited, Inc.  
119 East 59th Street  
Shoffer Music Company  
Goody Audio Center, Inc.  
235 W. 49th St.  
250 W. 49th St.

Grand Central Radio  
124 East 44th Street  
Heins & Bolet  
65 Cortlandt Street  
Hudson Radio & Tele. Corp.  
48 W. 48th Street  
212 Fulton Street  
Liberty Music Shops  
450 Madison Ave.

Pearless Camera Stores  
138 East 44th Street  
Radio Wire Television Inc.  
100 Sixth Avenue  
Recording Wire & Tape Co.  
163 East 87 Street

Sonocraft Corporation  
115 West 45th Street  
Sun Radio & Elec. Co.  
50 W. 20th Street  
Terminal Radio Corp.  
85 Cortlandt Street

**ONTARIO, CALIF.**  
Rudi Pock Hi-Fi Shop  
604 N. Euclid

**PASADENA**  
Audio Associates  
689 So. Fair Oaks  
Daw Radio  
1759 E. Colorado  
High-Fidelity House  
536 So. Fair Oaks

**PHILADELPHIA**  
Almo Radio  
913 Arch St.

**PHOENIX**  
Audio Specialists  
333 E. Camelback Road

**PITTSBURGH**  
Concerto Room, Inc  
642 Grant St.  
M. N. Mansfield Co.  
937 Liberty Ave.  
Radio Parts, Inc.  
6339 Penn Ave.

**PORTLAND, ORE.**  
Meier and Frank Co.  
Sandy's Camera Stores  
714 S. W. Washington St.

**RED HOOK, N. Y.**  
Harter, Inc.  
10 South Broadway

**RIVERSIDE, CALIF.**  
Custom Music  
3980 Main Street

**SACRAMENTO**  
Hi-Fi Sound Supply  
1910-16th St.

**SALT LAKE CITY**  
Sound by Craftsmen  
358 South 3rd East

**SAN DIEGO**  
Breier Sound  
3781 Fifth Street  
Recording Center  
1342-5th Avenue  
Wright's House of Hi-Fi  
5140 El Cajon Blvd.

**SAN FRANCISCO**  
Son Fran. Radio & Supply  
1280-84 Market Street

**SAN MARINO**  
E. O. Bulkley Co.  
2533 Mission St.

**SAN PEDRO**  
Bower's Music  
810 So. Goffey

**SANTA BARBARA**  
Pacific Audio Supply  
2919 De La Vino Street

**SCHENECTADY, N. Y.**  
House of Harmony  
1034 Eastern Ave.

**SEATTLE**  
Toll's  
1415 Third Ave.  
Seattle Radio Supply Inc.  
2117-2nd Avenue

**STOCKTON, CALIF.**  
Quality Sound Service  
1217 North Wilson Way

**TOLEDO**  
Jamiesons High Fidelity  
840 W. Central Ave.  
Torrence Radio, Inc.  
1314 Madison Avenue

**TOPEKA, KAN.**  
Plozo Television  
140 S. Huntoon

**TROY**  
Trojan Radio Co.  
15 Middleburg St.  
Troy, N. Y.

**TUCSON**  
Art Electronic Supply Co., Inc.  
145 South Park Ave.

**VAN NUYS**  
Volley Elec. Supply Co.  
17647 Sherman Way

**WASHINGTON, D. C.**  
Lab. of Electronic Eng.  
625 New York Ave., N. W.

**YONKERS**  
Westlab  
2475 Central Park Ave.

## Books you ought to own

**HIGH FIDELITY, THE WHY AND HOW FOR AMATEURS**, By G. A. Briggs. 192 pages, 8¾ by 5½ ins. 65 illustrations. Published by Wharfdale Wireless Works Ltd., Idle, Bradford, England. Board covers. \$2.95.

Mr. Briggs needs no introduction to hi-fi music enthusiasts anywhere, and particularly to readers of this Magazine, since his latest article appeared in our May-June issue.

As for his new contribution to hi-fi literature, there is enough significant information to warrant its being read by engineers, yet Mr. Briggs has such a wonderful capacity for clarity and brevity, sparked by the Yorkshireman's refusal to take himself seriously, that the complete neophyte can gain useful information from every page.

One gains the impression that the author wrote this book around questions asked him, in person and by mail, about the performance and use of individual items of equipment, from pickups to speakers, and about various subjects from listening tests to room acoustics — all of which are covered in 14 chapters. Indeed, the concluding section is devoted to 15 pages of typical questions and most helpful answers.

This book is principally concerned with record reproduction, although there is one chapter on tape recorders and another on stereophonics. Strangely, FM is merely mentioned, although the BBC, after the most exhaustive VHF tests, decided that FM offered the most advantageous means of overcoming the AM inter-station interference that is even more of a night time plague in the British Isles than in the U. S. and, in consequence, is building an elaborate system of FM stations there, some of which are already on the air.

**INTRODUCTION TO OPERA**, edited by Mary Ellis Peltz, with "A Guide to 40 Operas on Long-playing Records", by C. J. Luten. 332 pages, 8⅞ by 5½ ins. Paper bound. Published by Barnes and Noble, 105 Fifth Ave., New York 3. \$1.65.

Carol Ann and C. J. Luten adapted this "guidebook" to the standard repertory from the earlier "Opera Lover's Companion" and the continuing *Opera News* (from which journal the "Companion" itself had been assembled). These publications are sponsored by the Metropolitan Opera Guild.

Mr. Luten, a member of Hi-Fi Music's Board of Reviewers, is responsible for the 52-page critical collation of recorded opera that forms a supplementary section. It is at once the most succinct and the most sensible coverage of the field to be had — with the usual qualification that certain of the recommended performances have been supplanted since the book went to press.

Now! **ONE** *Berlant-Concertone Recorder*  
 does the work of **THREE**

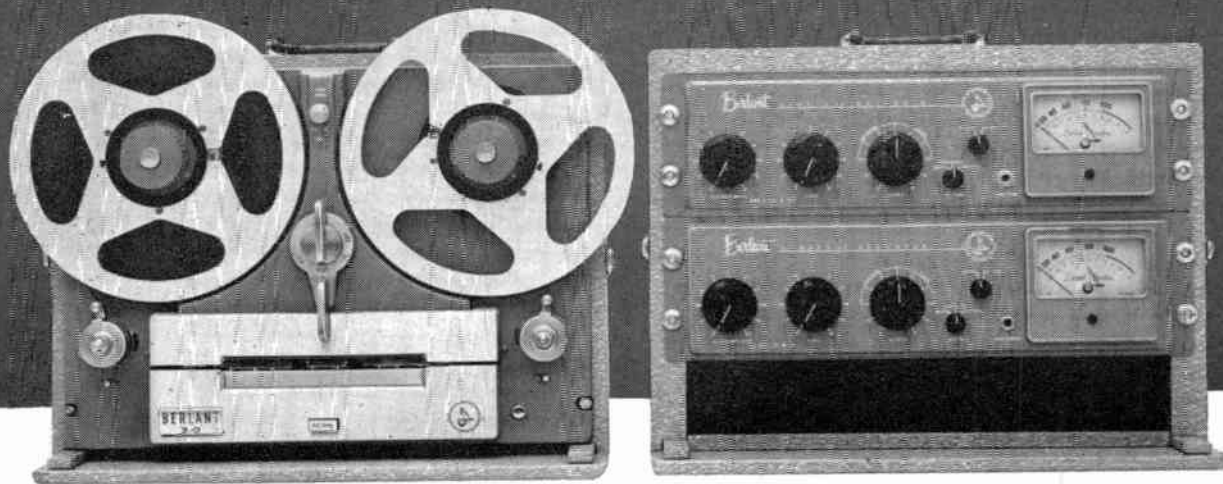

The 36ST Berlant Deluxe Recorder is ideal for radio station use. Delivers performance characteristics for the most exacting quality use. Hysteresis synchronous drive model - (99.8% timing accuracy). Frequency response 40 to 15,000 cps at 15 ips  $\pm$  2db. Save the cost of a second recorder plus savings in space, operator time and tape. Perfect for the station planning stereo tape broadcasts on AM and FM simultaneously.

**For the Advanced Audiophile**

the Concertone Custom Recorders answer recording and playing needs for years to come. Full professional features include use of 10 1/2 reels, editing and cueing, 4 1/2 signal level meter, 3 motors, monitoring from tape while recording, 2 channel input mixer.

**Take Time to Pay...**

Terms to meet your budget on all models. (Model 22) As low as \$49.50 down, \$7.50 per week, 24 months to pay.

**THIS NEW STEREO TRIPLE PLAY HEAD DOES IT—**  
*Plays Full Track, Half Track, Stereo*

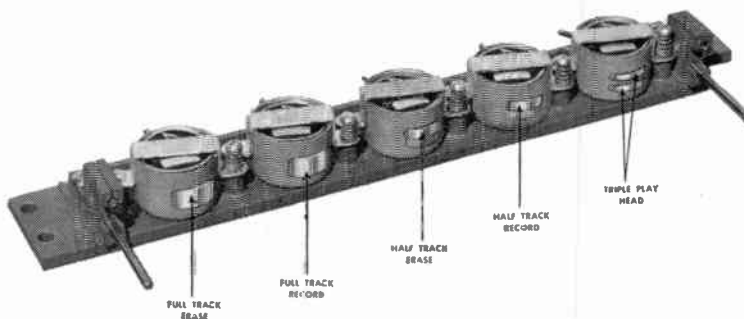

Head Compliment Model 26ST and Model 36ST. Another exclusive development of the superb engineering laboratories of American Electronics - America's foremost manufacturer of electronics for military, home and industrial use.

**TWO SPECIAL OFFERS  
 FEATURED NOW  
 BY YOUR  
 BERLANT-CONCERTONE  
 DISTRIBUTOR**

1. **FREE**—\$50.00 worth of recorded tape with the purchase of any B-C recorder.
2. **SAVE**—\$73.50 on a new \$93.50 Concertone Custom Microphone.

Offers limited and may be withdrawn without notice. See your Berlant-Concertone distributor today for your FREE tape library or for the microphone savings... featured at the dealer stores listed on opposite page. Write for new 6-page brochure No. 21-N.

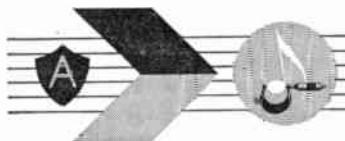

Audio Division,  
**AMERICAN ELECTRONICS, INC.**  
 655 West Washington Blvd.  
 Los Angeles 15, California

# Bogen

## BOGEN DB130 35 WATT AMPLIFIER

Glance down at the "specifications and controls" or at the control panel in the photo. It's obvious that our engineering department (largest in the high-fidelity industry) hasn't spared itself on the DB130. Many experts consider this the finest "full-control" amplifier ever built. Spin those knobs and flick those switches at your nearest Bogen Sound Salon. You'll get the hi-fi thrill of your life.

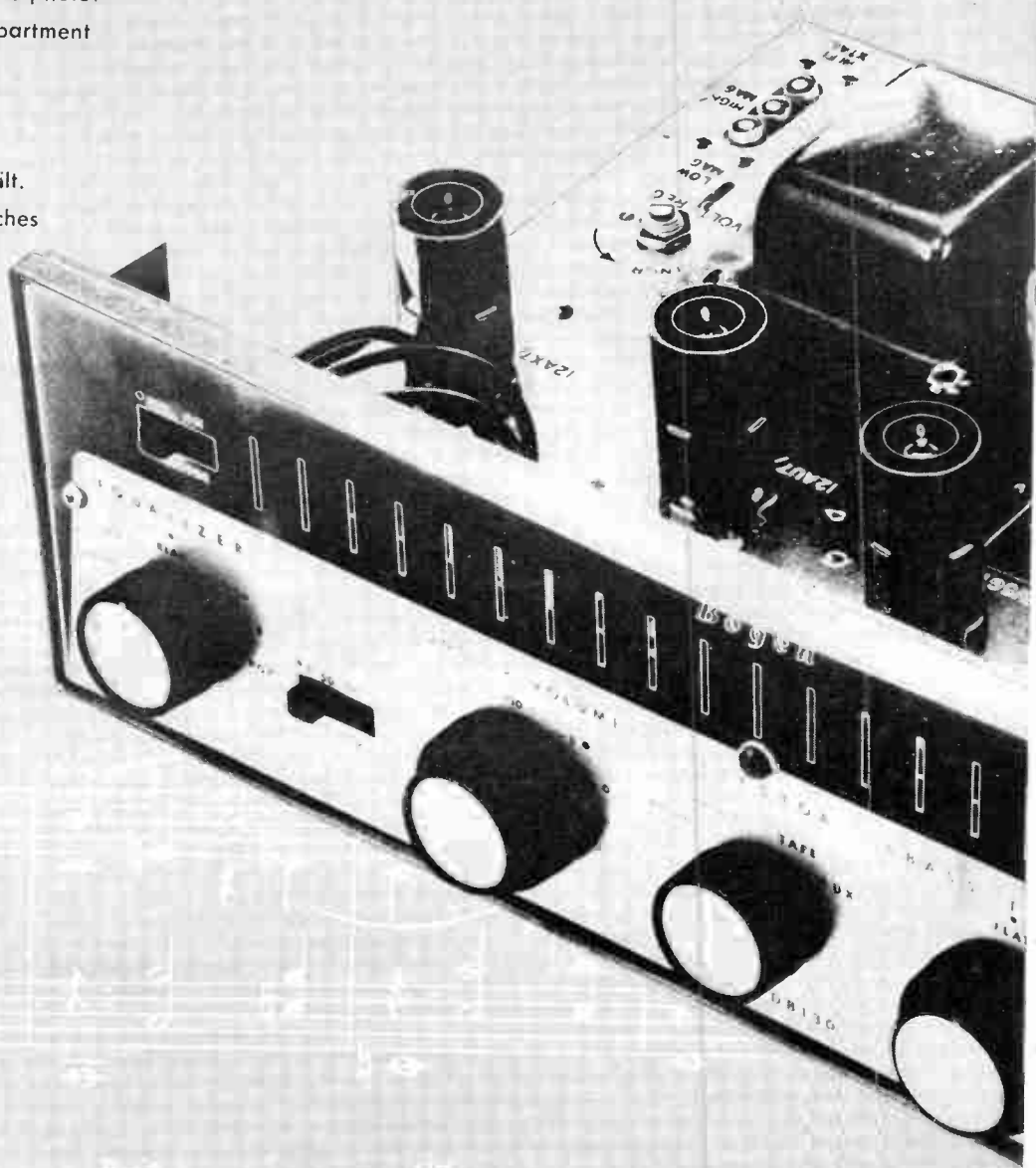

POWER: 35 WATTS, PEAK: 100 WATTS • FREQUENCY RESPONSE: 15-30000 CPS WITHIN 0.5DB • DISTORTION: 0.3% AT 35 WATTS • INPUTS: LOW MAGNETIC, HIGH MAGNETIC, HI-FI CRYSTAL, TUNER, TAPE, AUXILIARY (2) • OUTPUTS: SPEAKER(S), TAPE • CONTROLS: POWER (ON-OFF) • CONTINUOUSLY VARIABLE BASS AND TREBLE • SEPARATE CONTINUOUSLY VARIABLE LOUDNESS CON-

TROL SELECTOR • INPUT SELECTOR: PHONO, RADIO, TAPE, AUX, 7-POSITION RECORD EQUALIZER • INFINITE DAMPING CONTROL • LO FILTER (FLAT, 50C, 100C) • HI FILTER (FLAT, 8KC, 4KC) • SPEAKER SELECTOR SWITCH: A, AB, B • TAPE MONITOR (ON-OFF) • AUX ADJUSTER • HUM ADJUSTER CHASSIS: \$115.00 • BLONDE OR MAHOGANY-FINISHED ENCLOSURE: \$7.50

# e n

*because it sounds better . . .*



**Bogen**  
HIGH FIDELITY

A UNITRONICS CORPORATION AFFILIATE

## what the 'sound men' say...



*Anton Schmitt, Harvey Radio, known to thousands of New York audiophiles as one of the most knowledgeable hi-fi consultants in our industry.*

**"....I get lots of calls for Bogen** from the high-fidelity fans who really know what they're doing. This is especially true of Bogen's premium amplifiers and tuners. And as far as the budget-conscious beginners go, I've started a lot of them out on Bogen's DB110 12 watter . . . and most of them wind up as confirmed Bogen enthusiasts.

"I handle many fine brands of equipment here at Harvey. I'm sure that none of these manufacturers would object to my saying that Bogen's complete line of tuners, amplifiers, receivers and record players is a marvelous hi-fi value throughout."

*Anton Schmitt*

HARVEY RADIO COMPANY  
NEW YORK CITY

*Have you read our new 56-page edition of "Understanding High Fidelity"? Send 25¢ to Dept. 7Y, David Bogen Co., Inc., P.O. Box 500, Paramus, New Jersey.*

faithful reproduction \*

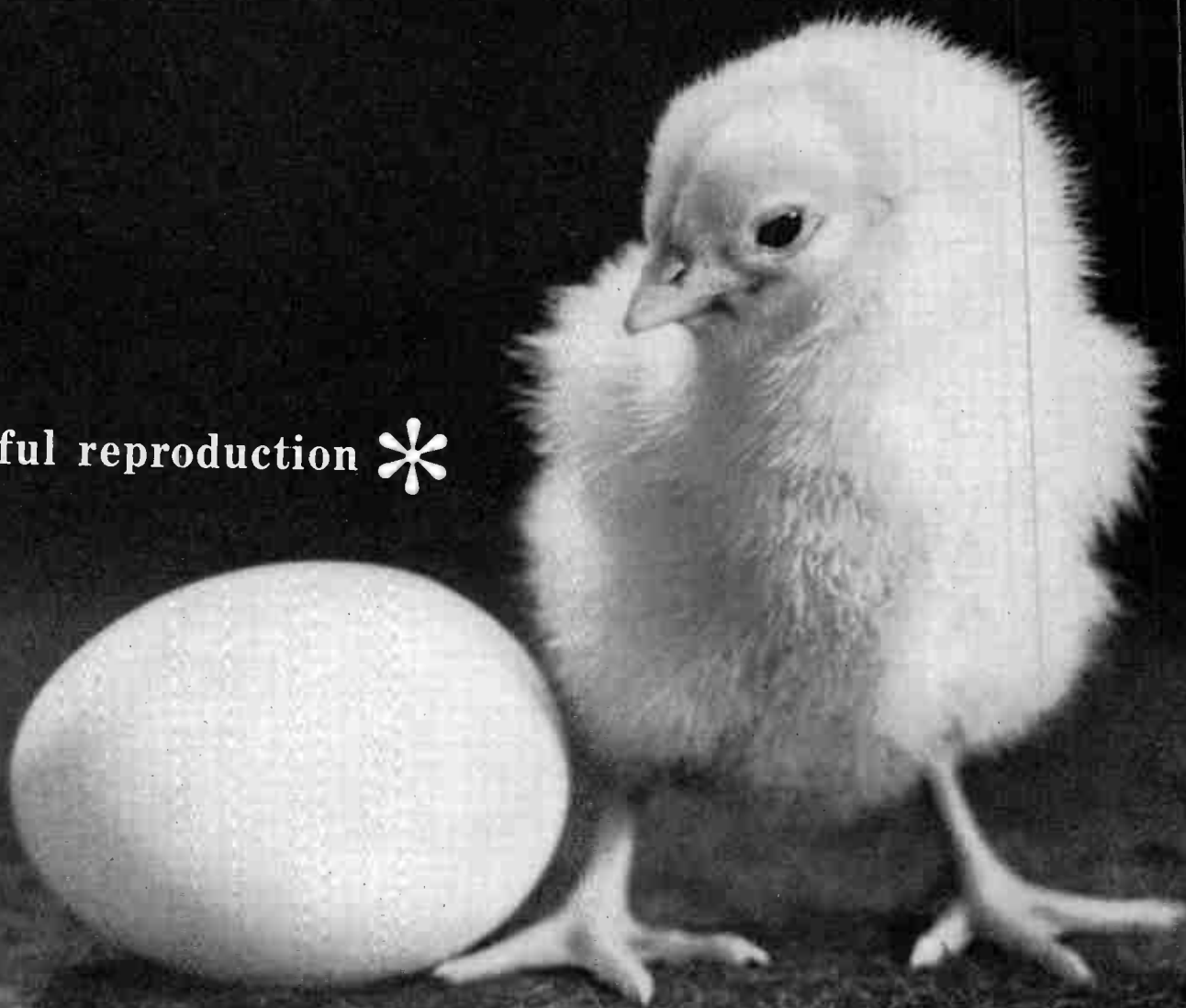

*Another reason why today's fastest  
selling high fidelity record changer is*

**Collaro**

\* Faithful Reproduction —

distortion-free performance —  
balanced motor, pulleys and couplers reduce  
rumble to an inaudible  
minimum. Automatic muting switch  
eliminates 'clicks'.



For other features and new popular price, see your hi-fi dealer or write Dept. SL-5

**ROCKBAR CORPORATION** 650 Halstead Avenue, Mamaroneck, N. Y.

# New Styling . . . New Features . . .

## A New Line from H. H. Scott

Easy to operate . . . easy to install . . . easy to look at! That's H. H. Scott for '57. Behind each component is an outstanding record of engineering leadership and uncompromising standards . . . factors that make H. H. Scott components outstanding values whatever their price. H. H. Scott engineering innovations include: FM tuners with wide-band design • Best sounding AM ever developed • Patented Dynamic Noise Suppressor • Add-A-Unit styling so H. H. Scott components go together in any combination.

*Sculpture courtesy Museum of Fine Arts, Boston. Accessories courtesy Talisman Shop, Boston.*

**H. H. Scott**  
introduces  
a new  
**EASIER**  
way to  
operate  
your  
hi fi  
system

**GREEN  
DOT  
CONTROLS**

**NOW** everyone in your family can operate your high fidelity system! All they do is set controls on the Green Dots . . . adjust volume . . . and play.

All important operating features are retained . . . no controls have been eliminated. But Scott designers have labeled all controls so they can be operated as easily as a TV set.

In fact you'll find components from the H. H. Scott Laboratories offer you versatility, exclusive features, new engineering innovations found nowhere else. If you want to hear truly professional equipment, designed for you and your family, ask your H. H. Scott dealer for a demonstration.



(above)  
FM Tuner (Model 311B). One of 1 new H. H. Scott tuners. Rated tops by leading high fidelity publications. Features include • Wide-band circuit design for highly selective drift-free performance • Sensitivity 3 microvolts for 20 db of quieting • Signal strength and tuning meter for precision tuning on weak stations • Separate tape and multiplex outputs • Automatic gain control makes manual adjustment of sensitivity unnecessary • Dimensions in wood cabinet: 13½ x 5 x 9½. \$119.95

(below)  
"THE 99" (Model 99C complete amplifier) 22 WATT CONTROL & POWER CENTER One of 5 new Scott amplifiers. • Green Dot controls • 2 magnetic inputs • 5 position record compensator that includes special NARTB tape curve • Separate in-out switches for scratch and rumble so even old 78 records sound good • Loudness control for perfect sound at any volume setting • 2 tape outputs, one for recording, one for monitoring • Separate bass and treble tone controls • Output connections for any speaker impedance • Frequency Response: flat 20 cps - 30 kc • Harmonic distortion less than 0.8% • First-order difference-tone intermodulation distortion less than 0.3% • Hum Level: 80 db below full output • Dimensions in wood cabinet 15½ x 5 x 12½. \$99.95

**ACCESSORY CABINET PRICES:**

Traditional or blond mahogany (all models) . . . \$19.95  
Leather finished plastic covered metal (all models) . . . \$9.95

ALL PRICES SLIGHTLY HIGHER WEST OF ROCKIES  
ALL TUNERS MEET FCC RADIATION SPECIFICATIONS



**FREE!** Send for brand new H.H. Scott catalog M-11 • just off the press!

H. H. SCOTT, INC., 385 Putnam Ave., Cambridge, Mass., Export Dept: Telesco International Corp., 270 Park Ave., N. Y. 17

# Buy Top Quality **KNIGHT** Hi-Fi Components



**CUSTOM DESIGNED FOR THE EXPERTS—THE VERY FINEST FOR LESS**

KNIGHT Custom Hi-Fi components are built to ALLIED's own special high standards. They incorporate the most advanced circuit designs and the very best of materials and craftsmanship to deliver outstanding performance plus

distinguished styling at very moderate cost. All KNIGHT Hi-Fi components are *unconditionally guaranteed for one full year*. Here is the best in musical quality at money-saving minimum cost.

**ALLIED**



**EXCLUSIVES**



### **Knight Deluxe 24-Watt High Fidelity Amplifier**

- Response,  $\pm 0.75$  db, 20-40,000 cps
- 12 Positions of Compensation
- Variable Damping Control
- Loudness Control
- Rumble Filter
- Separate Tone Controls
- Equalized Tape Head Input
- Hum Balance Adjustments
- U.L. Approved

This superb new amplifier is housed in a beautiful space-saver metal case finished in attractive cork-grain with gold-tone control panel. Only 4 x 15 1/2 x 11". Shpg. wt., 30 lbs.

94 SZ 709. NET only **\$94<sup>50</sup>**



### **Knight Deluxe Basic FM-AM Tuner**

- "Lock-in" FM Tuning (AFC)
- Tuning Meter for FM & AM
- Sensitivity: 5 Mv for 30 db quieting on FM; 5 Mv for 1.5 volts output on AM
- Tuned RF Stages on FM & AM
- FM Discriminator
- 2 Cathode Follower Outputs
- FCC Approved Radiation
- U.L. Approved

Circuit includes 11 tubes plus rectifier. Matches Deluxe Amplifier; in attractive cork-grain finished metal case with gold-tone control panel. Size: 4 x 13 1/2 x 10". Shpg. wt., 17 lbs.

94 SX 711. NET only **\$99<sup>50</sup>**

**ALL PRICES NET F.O.B. CHICAGO**

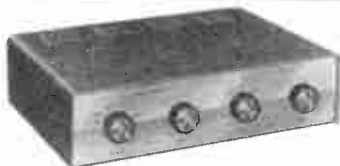

### **Knight "Bantam" 12-Watt Hi-Fi Amplifier**

only **\$64<sup>50</sup>**

U. L. Approved

- 3-Position Record Compensator
- Variable Damping Control
- Loudness Control
- Built-in Preamp
- $\pm 0.5$  db, 20-20,000 cps
- 7 Inputs
- Equalized Tape Input

In handsome case, with smart cork-grained finish. "Space-Saver" design, only 3 1/2 x 13 x 10 1/2". Shpg. wt., 14 lbs.

94 SX 708. NET only **\$64.50**



### **Knight "Bantam" Basic FM-AM Tuner**

only **\$74<sup>50</sup>**

U. L. Approved

FCC Radiation Approved

- "Lock-in" FM Tuning
- Latest 8-Tube Circuit
- Improved AFC
- Output Level Control
- Wide Frequency Response
- High Sensitivity • RF Stage

A perfect match for the "Bantam" amplifier, in beautiful cork-grain finish metal case, only 3 1/2 x 11 1/2 x 9 1/4". 10 lbs.

94 SX 710. NET only **\$74.50**

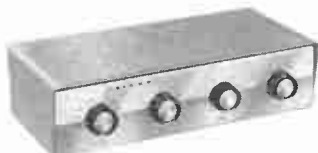

### **Knight Preamp-Equalizer**

- U.L. Approved
- $\pm 1$  db, 30-30,000 cps
- 3-Position Compensation
- Rumble Switch
- Loudness Switch
- Equalized Tape Input

For use with any basic amplifier. Matches KNIGHT units; 13 x 3 1/2 x 5 1/2".

94 SX 712. NET only **\$44<sup>50</sup>**



### **Knight "Uni-Fi" Tuner-Amplifier Combination**

only **\$104<sup>95</sup>**

- Single Chassis Construction—Simple To Install
- Complete FM-AM Tuner—Preamplifier-Amplifier
- Compact Styling—4 1/4 x 15 1/4 x 11 1/4"—Fits Anywhere
- FCC Radiation Approved
- 10-Watt High Fidelity Amplifier With Every Advanced Feature

The logical high quality complete ensemble for limited-space applications; an ideal replacement for obsolete equipment in existing cabinets. Available in cabinet illustrated or in chassis form (4 1/4 x 15 x 10 1/2").

94 SX 730. Chassis only. Shpg. wt., 17 lbs. NET only **\$104.95**

94 SZ 731. As above, in cork-grain finish metal cabinet. Shpg. wt., 19 lbs. NET only **\$109.95**



### **ALLIED'S 356-PAGE 1957 CATALOG**

Send for this value-packed catalog featuring the world's largest selection of Hi-Fi components and complete music systems. Includes recorders, famous KNIGHT-KITS, everything in Electronics—P.A. systems, Amateur gear, test instruments, electron tubes, parts, tools and books. Send for your FREE copy today.

## **ORDER TODAY FROM ALLIED RADIO**

**ALLIED RADIO CORP., Dept. 76-L-6**  
100 N. Western Ave., Chicago 80, Ill.

Our 36th Year

Ship me the following KNIGHT Hi-Fi components: \_\_\_\_\_

\_\_\_\_\_ \$ \_\_\_\_\_ enclosed

Send FREE 356-Page ALLIED 1957 Catalog

Name \_\_\_\_\_

Address \_\_\_\_\_

City \_\_\_\_\_ Zone \_\_\_\_\_ State \_\_\_\_\_

## **ALLIED RADIO**

America's Hi-Fi Center

100 N. WESTERN AVENUE, CHICAGO 80, ILLINOIS

*Hi-Fi Music at Home*





*Milton Sleeper discusses*

## MUSIC IN YOUR HOME

HERE could be no more definitive evidence of progress in the development and design of audio components than the remarkable demonstration staged by G. A. Briggs at Carnegie Hall, directly after the recent New York Hi-Fi Show.

Imagine, if you can, asking audio equipment such as we had in 1950 to reproduce E. Power Biggs' organ music so perfectly that listeners had to watch Mr. Biggs in order to make sure whether they were hearing his playing or its reproduction via audio components! Or Morton Gould with his musicians and tap dancer Danny Daniels, as H. J. Leak switched back and forth from the microphone on stage to a tape made weeks earlier. Even more impressive was the comparison between the playing of Ferrante and Teicher in person, and a tape of a selection included in their Westminster recording, for it was necessary to listen and look to tell the difference!

Such improvement in audio reproduction is not a phenomenon of nature, like the inevitable unfolding of a flower, or the growth of a tree. It is the product of imagination, patience, experience, and competition. There is another essential factor in the achievements of the hi-fi equipment manufacturers. It is increased capital, either in the form of profits ploughed back, or additional investment used for continued research and for new facilities by which standards of quality and performance are being raised to still higher levels.

For the truth is that in this business there is a pride of achievement and craftsmanship that is found in few other fields today.

I KNOW how much the manufacturers have accomplished in the last six years, because I had many discussions with them when I was preparing to bring out the first hi-fi magazine. At that time, the men who now head the leading companies in the industry were operating shops with perhaps three or four employees. They were bending chassis by hand and drilling the holes one at a time instead of stamping them out in presses; assembling parts they picked up from jobbers because their orders were so small they couldn't buy direct; and they were checking performance by ear, for they had no adequate laboratory measuring equipment.

How different it is today! Those little shops have grown up to become factories where mounting costs of material

and labor are offset by the use of modern tools and methods. Increased sales now justify the employment of skilled workers and capable supervisors. Parts and materials are purchased in quantities that qualify for the lowest prices. Without this progress, 1956 hi-fi components would cost more than twice what we are now paying.

This increased efficiency, however, does not mean a shift to mass production methods employed in plants which grind out radios, phonographs, and TV sets by the hundreds of thousands. On the contrary, the engineering, production, and sales philosophies of these very separate activities are still distinguished by the differences resulting from primary emphasis put on quality, and concern with cutting costs to the point of marginal performance.

What about equipment for the people who want the musical quality made available by hi-fi components, but who are reluctant to undertake the work of installing their own systems? This demand is now being met in two ways: with cabinets designed to house standard components, and with standard components factory-built into cabinets, ready to operate when the antenna is connected and the line cord plugged into a socket.

HERE is still one problem, not concerned with apparatus design or production, however. It is the matter of educating people in the correct use of hi-fi equipment. Some simply will not read instructions, no matter how clear and explicit they are. Others, like accident-prone drivers, have a faculty for doing things the wrong way, sometimes with unfortunate results. Also, of course, we have those who take short cuts to save time or expense, and then complain because they do not realize the full capabilities of their equipment.

Yet manufacturers are meeting even this situation. They are establishing such confidence in the quality of their products that, if something seems wrong, people are beginning to ask themselves: "Did I do this the right way?" Thus, more and more, they are learning by finding and correcting their own mistakes.

Yes, when you dare ask a Carnegie Hall audience to compare live and recorded music, hi-fi equipment has come a long way in six years. How interesting it will be, six years from now, to look back on the further progress that will surely have been made in the reproduction of music from records, tape, and FM radio!

you'll  
want  
to  
look  
for  
the



When your authorized Pickering Dealer is demonstrating the revolutionary new ISOPHASE SPEAKER, please, don't look behind it for the orchestra. Take our word for it—these magnificently realistic sounds are coming from the curved diaphragm itself. "Unbelievable," "extraordinary," "breathtaking," and "window-on-the-studio quality" are some of the comments we've heard from dealers and customers alike. But don't be persuaded by mere words alone. *Hear it for yourself.*

The Pickering ISOPHASE SPEAKER uses the electrostatic principle to recreate musical sounds with a degree of realism unattainable in conventional speakers.

The ISOPHASE reintroduces the original sound

into the air *at a low velocity*—instead of at a high velocity as in ordinary speakers. In addition, the ISOPHASE generates sound in phase *from the entire surface* of its large curved diaphragm—instead of from a point source as in conventional cone speakers. Thus the sound reproduced by the ISOPHASE *closely approximates the unit-area energy of the original sound* entering the microphone in the studio or concert hall.

Unlike ordinary speakers, the ISOPHASE does not "break up" at high frequencies. And because of the inherent linearity of the push-pull electrostatic design, harmonic and intermodulation distortion are virtually nonexistent—a tremendous advantage over conventional speakers. For further details, please write Department X-13.



**PICKERING & CO., INC.** OCEANSIDE, N. Y.

Professional Audio Components

*"For those who can hear the difference"*

Demonstrated and sold by Leading Radio Parts Distributors everywhere. For the one nearest you and for detailed literature: write Dept. X-13.

EXPORT: AD. AURIEMA, INC., 89 BROAD ST., NEW YORK / CANADA: CHARLES W. POINTON LTD., 6 ALCINA AVE., TORONTO

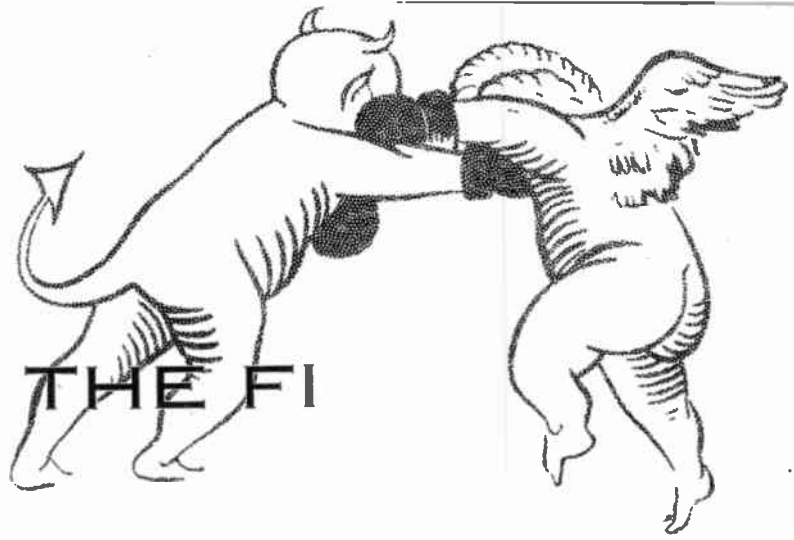

## THE HI AND THE FI

AT LONG LAST the easily accessible Caribbean will have a music festival. Snob appeal has led peripatetic Americans to Europe for so long that a bit of Europe will have to be transplanted to the subtropics for the occasion, but whose presence would be more welcome anywhere than that of Pablo Casals?

It was Casals — unquestionably the greatest cellist of our age — who brought the world of music to Prades and to Perpignan, and it is Casals who will bring it again to San Juan, Puerto Rico, this April.

Already scheduled are the Budapest Quartet, pianists Rudolf Serkin, Jesús María Sanromá, Eugene Istomin, and Mieczyslaw Horszowski, violinists Joseph Szigeti and Isaac Stern, soprano Maria Stader, baritone Gérard Souzay, conductor Milton Katims (in his erstwhile role as violinist), flutist Julius Baker, and clarinetist David Oppenheim.

A battery of soloists like these would bring the tourist-listeners to darkest Africa, but certainly the name of Casals is itself a guarantee of success. To have him within our borders is an honor indeed; he has not performed outside the secluded Pyrenees for decades. (A little bird tells us that Columbia will be taping many of the performances. Let us pray.)

The interested should contact Miss Dinorah Press, Casals Festival, 14 West 44th Street, New York 36, N. Y.

SPECIALIZATION may be the curse of modern society, but it is handy to have around a magazine that prides itself on authoritative opinion. Hence the latest additions to our Board of Reviewers.

Ward Botsford is a member of the American Rocket Society, American Astronautical Society, American Society of Mechanical Engineers, and the British Interplanetary Society, all of which is irrelevant but impressive. More pertinently for our purposes, he is a clarinetist *par excellence* and a recording executive, having made more than his share of outstanding LP's. Good ears, and he can write, too.

George Louis Mayer comes to us through the express recommendation of Philip L. Miller, who is an astute talent scout as well as a pre-eminent vocal critic. George is on the music staff of the New

York Public Library. His credentials include degrees from New York University and Columbia. His specialties are vocal and dance music. The latter being a preoccupation of your Music Editor, some problems may arise over division of assignments. Oh, well.

GUEST REVIEWER this month is Edward Jablonski, whose article on Gershwin appeared in the July-August issue and whose study of Vaughan Williams appears in this one. His interest in these composers amounting to a passion, it seemed reasonable to assign him the latest batch of their music on records. Not that his passions are so limited, as you will see in due course.

CONGRATULATIONS to Robert C. Bagar and to The New York *Journal-American*, the former having joined the latter as record reviewer — not only because Bob is a chronicler of discernment but also because his appointment marks the first recognition on the part of any newspaper that recordings, like concerts and plays and books and movies, are *news*.

Instead of the usual Sunday article collating months-old releases, the new *Journal-American* column will cover the scene every day of the week. From a strictly journalistic point of view, that is the only way to do it. It is a pleasure to remark on the enterprise, however belated, of the *J-A* editorial brass. When will other newspapers start covering records as they do other news — daily?

THE ENGLISH critic Peter Heyworth, writing in *The New Statesman and Nation*, had it that the "Anglophile music lover in foreign parts . . . is, after all," the listener "whom the British Council have in mind".

Now, the British Council have underwritten (we preserve the English plural form out of deference) numerous recordings of contemporary music as yet unknown to us. Some of its earlier projects reached fruition here via RCA Victor in the more roseate phase of the latter's alliance with HMV, but most of them did not.

So we dropped a note to E. M. I. in England, suggesting that the American public would like to hear this music and request-

ing review copies of whatever was deemed fitting for export consumption.

From deep in the labyrinth at Hayes, Middlesex, an A. M. Smith, Esq., replied cryptically that "due to certain difficulties" the *status* of listeners in foreign parts would have to remain *quo*; no review copies were available. End of report. Mr. Heyworth, please note.

WHILE WE are speaking of United Kingdom matters, this department would like to add its voice to those who have been asking for an American release of the Australian composer John Antill's score for the ballet, *Corroboree*. It seems to be in the catalogue of Australian H. M. V., but unlike that label's issues in England proper, its "down under" stuff, we are told, cannot even be imported.

Antill's music is for the most part *terra incognita* to us, but the work in question we know on the best information to be a "natural" for hi-fi, quite aside from its apparently substantial musical merit. And how could it be otherwise, being a stylization of the centuries-old rites of the aboriginal race? A twenty-minute suite from the complete score of *Corroboree* may be perused through the good offices of Messrs. Boosey & Hawkes. Won't some enterprising A & R man take a look?

ELECTION NOTE: An eleventh-hour release from RCA Victor, "The President's Favorite Music", includes the Bach-Stokowski *Sheep May Safely Graze* and *We All Believe in One God*, Beethoven's *Coriolan*, *Di provenza il mar* from "La Traviata", the overture to "Die Fledermaus", a symphonic synthesis of "Porgy and Bess", the spiritual, *He's Got the Whole World in His Hands*, *Do Not Forsake Me* from the film "High Noon", and the *Fingal's Cave* overture of Mendelssohn.

We are apprised that Mr. Eisenhower personally selected this program. Considering the season, it is regrettable that RCA Victor did not feel constrained to ascertain the musical tastes of Adlai Stevenson. A year or so ago this point would not have been raised, but in the time of our quadrennial rites is it fair to enlist Euterpe's charms for one ticket and not for the other?

— J. L.



*A roster of distinguished conductors and composers-turned-conductors has been shared by the Berlin and Vienna Philharmonic Orchestras. These men held the baton before both. Left to right, in chronological order: Johannes Brahms (who led the Vienna in the 1873 premiere of his Variations on a Theme by Haydn), Artur Niksch, Richard Strauss, Felix Weingartner, Wilhelm Furtwängler, and Bruno Walter*

# Rival Visitors

*The Berlin and Vienna Philharmonic Orchestras Arrive for U. S. Tours*

By NELSON LANSDALE



*Above: Composer Theodor Berger discusses his Rondo Ostinato with André Cluytens at a Vienna rehearsal*



*Left: Hans von Bülow was engaged in 1882 by the Berlin Philharmonic as its first conductor*

*Right: Herbert von Karajan, shown walking down the Ku'damm, is the Berlin's fourth permanent conductor*



Two of Europe's great orchestras, rivals for more than half a century, carry their rivalry across the Atlantic this fall — the Berlin Philharmonic Orchestra conducted by Herbert von Karajan and the Vienna Philharmonic, co-conducted by André Cluytens and Carl Schuricht.

Both orchestras have been long familiar to record collectors. The Berlin Philharmonic, under Arthur Nikisch, was the first big-name orchestra to face the recording horns — in 1914, with a Beethoven *Fifth* for the Gramophone Company. It is currently under contract to Decca. The Vienna Philharmonic and conductor Carl Schuricht are heard on London discs. Herbert von Karajan records for Angel, which will shortly release his first performances with the Berlin Philharmonic. André Cluytens also records for Angel, variously with the Paris Opéra-Comique, the Paris Conservatory Orchestra, and the Orchestre National de la Radiodiffusion Française. In addition, the Vienna Philharmonic is heavily represented in the catalogues of RCA Victor and Columbia under such conductors as Wilhelm Furtwängler and Bruno Walter.

The Berlin Philharmonic has arrived already, opening its itinerary in Washington's Constitution Hall on October 7th. Although six major European orchestras<sup>1</sup> have toured the U. S. since the end of World War 2, only the Berlin Philharmonic has returned for a second tour, now taking the orchestra for the first time from coast to coast and back home again across the top of the world. For the second time, also, the City and Senate of Berlin have underwritten the air transportation for the more than 100 players to the U. S. and back at a cost of something more than \$40,000.

On November 4th, again in stately, flag-draped Constitution Hall, the 114-year-old Vienna Philharmonic will make its first appearance in America under the baton of André Cluytens, who simultaneously makes his American debut. On the five-week tour of the east and middle west he will share the podium with veteran Carl Schuricht.

Both orchestras are concentrating on staples of the 19th Century repertory on which their reputations chiefly depend; both will play Haydn's *London Symphony* No. 104, Mozart's *Haffner* No. 35, Beethoven's *Seventh* and "Egmont" overture, and the Richard Strauss *Don Juan*. The Concertgebouw shrewdly included a work by a contemporary Dutch composer on every program, but only the Vienna Philharmonic is playing the work of a living composer — the *Rondo Ostinato* of Theodor Berger — and this is optional with local sponsors of the concert. Nobody expects or wants a great German orchestra to turn its back on Bach, Beethoven and Brahms, but it does seem fair to point out that if any music is being written in Berlin or Vienna worth listening to, this is the ideal time for it to be heard. There may be a last minute change of plans.

#### The Vienna Philharmonic Orchestra

The Vienna Philharmonic is just eight months older than New York's Philharmonic-Symphony. Organized in 1841

<sup>1</sup> The Royal Philharmonic with Sir Thomas Beecham; the Israel Philharmonic with Serge Koussevitzky and Leonard Bernstein; the Danish State Symphony with Erik Tuxen and Thomas Jensen; the Concertgebouw of Amsterdam with Eduard van Beinum and Rafael Kubelik; the Berlin Philharmonic and the Philharmonia Orchestra of London with Karajan.

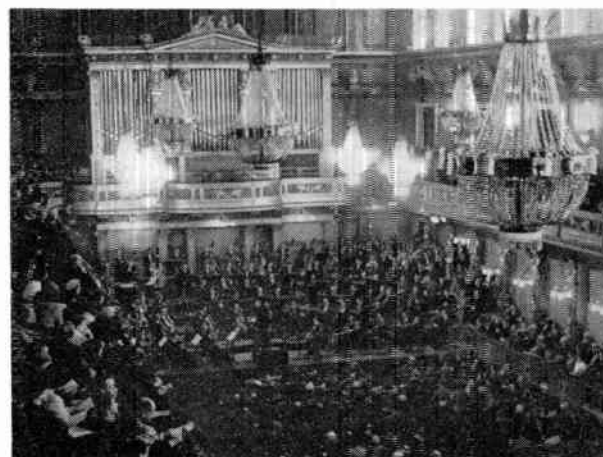
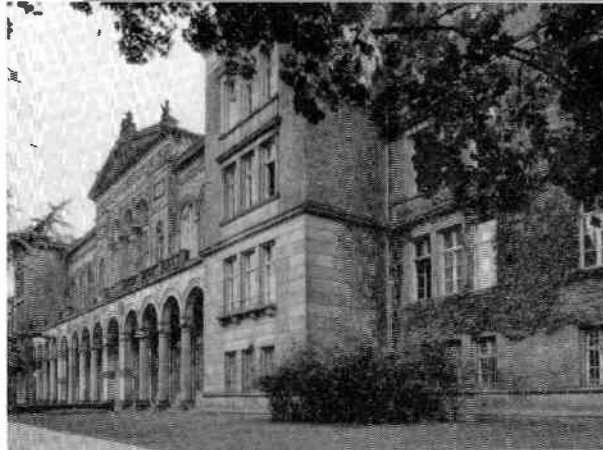

Top: Joachimsthal High School, site of Berlin Philharmonic's new home. Center: Vienna Philharmonic in permanent residence in the Musikvereinsaal. Bottom: von Karajan before his Berliners

by Otto Nicolai of "The Merry Wives of Windsor" fame, the musicians were mostly professionals from the Court Opera Theatre, as indeed they are today, since the Vienna Philharmonic is the orchestra of the Vienna State Opera, of which Karajan has recently been appointed artistic director. The orchestra gave its first concerts in the Redoutensaal of the Imperial Palace; by 1860, when Clara Schumann appeared as soloist in her husband's *Piano Concerto*, they had moved to the Karntnertochtheatre, home of the opera.

In 1870 the wave of prosperity which gave Vienna a new opera house also produced the classic music-palace of the Gesellschaft der Musikfreunde, where the Grosse Musikvereinsaal (only slightly damaged by a grenade during World War II) remains its perma- Continued on page 70

# SCHUMANN: *Respected, Neglected*

Out of Fashion in a Neo-Classic Era, the Supreme Romanticist Is Closer to Our Time Than We May Think. Through Records, a Revival of His Music May Get Its Start — *By Robert Sabin*

Just a hundred years ago, on July 29, 1856, Robert Schumann died in the asylum at Eendenich where he had been taken after his attempted suicide on February 27, 1854. His forty-six years had been crowded with feverish activity of the mind and spirit. Not only had he produced incredible amounts of music in short periods of time (almost half of his more than 250 songs were composed in 1840, the year he married Clara Wieck). But over the years his output of music was matched by a formidable literary activity. No one ever wrote more wisely and penetratingly about his art than this dreamer and poet who could analyze shrewdly when he wanted to do so.

How much of his music is really known today? How many people have actually read his musical criticism and other writings? Shockingly few have read much, if any, I fear. For Schumann is out of fashion — a respected but neglected Romantic who is definitely not *comme il faut* in a neo-classic era which has made a fetish out of Mozart and is busily engaged in unearthing the pre-Mozart Baroque and even remoter epochs of music. If you disclose a passion for Vivaldi, a rage for Rameau, you are smiled upon, but if you confess a deep and quiet love for Schumann, people are apt to shrug their shoulders and mutter something about old-fashioned sentimentality.

Granted that our age finds the solidity and the clear design of classic and pre-classic music reassuring. Granted that our times are so tortured and so confused that we thirst for positive, precise, objective art. Is the current neglect of Schumann historically and esthetically just? Is it right that Mozart should have fanfares, revivals, publications, and endless festivals, while Schumann, by comparison, is barely mentioned? I think not, and I shall attempt to show why Schumann is closer to us than we may think, and why his music may well come into its own again within our lifetime. I shall confine myself largely to works which have been recorded, for it is through recordings that a Schumann revival may well get its start.

What are the qualities that made Schumann the supreme Romanticist, that made his music so important to such utterly different temperaments as Brahms, Tchaikovsky, and Fauré? How can we explain the peculiar freshness and visionary power that remind us ever and again in his music of Schubert? (By comparison, Brahms, even in his most ardent and inspired moments, is apt to seem heavy and self-conscious.)

One of his most significant qualities is his faith in the powers of inspiration. In 1839, when he was writing some of his greatest piano music, Schumann wrote to Clara: "I have found that imagination is released when I am full of expectation and longing." In a period of creativity at full-tide, he wrote exultantly: "I used to rack my brains for an idea, but now, everything comes from within and I often feel that I could go on playing forever. It is rare for me to erase a single note . . . Music comes to me in such wonderfully interwoven shapes in spite of its simplicity; it is the eloquence of the heart itself and moves all those who hear it."

Such a miracle of expression is the first of the five *Albumblätter* included in the *Bunte Blätter*, Op. 99, which Brahms used as a theme for his *Variations*, Op. 9. As Kathleen Dale points out in her study of the piano music in "*Schumann; A Symposium*", edited by Gerald Abraham, the "artless exterior" of this "wistful miniature . . . conceals a particularly subtle arch-wise construction."

No. 4 of this same set of *Albumblätter* is Schumann at his greatest. In one brief page he compresses a tragedy so poignant that it is impossible to play the piece or listen to it without a flash of pain and understanding. And yet we find the marvelously buoyant *Novellette in B minor* following upon the heels of these *Albumblätter*. Winged, impulsive as a swallow's flight in its symmetry and faultless organization, this *Novellette* reminds us of another of Schumann's qualities — his epigrammatic power of organization.

The late Sir Donald Francis Tovey, *Continued on page 77*

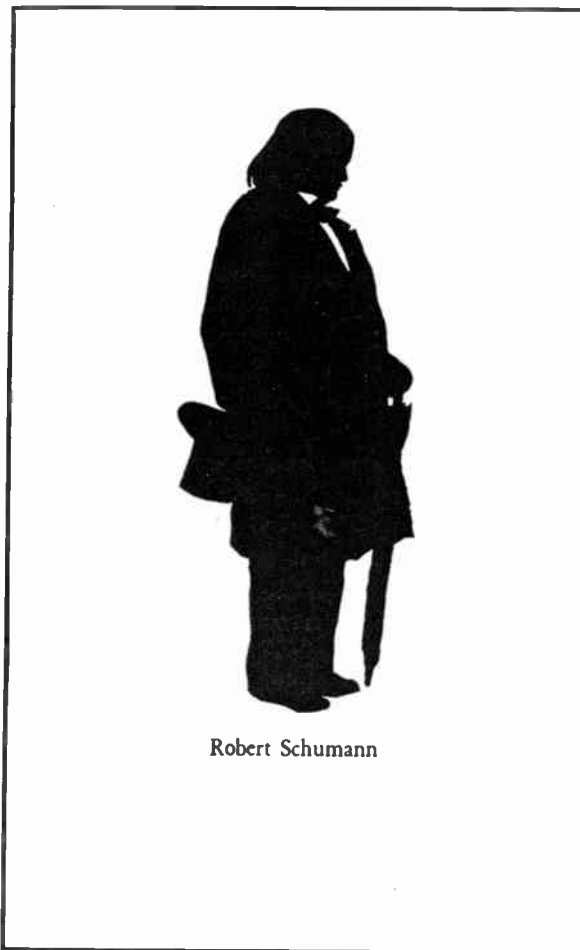

Robert Schumann

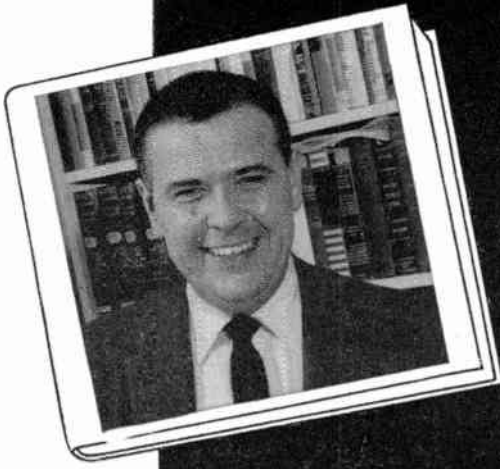

A basic guide for the planned selection of records, enabling each collector to build a library of related compositions which best represent the most significant periods, composers, and types of music

An Introduction by James Lyons

## Guide to Record Collecting

IT IS PERHAPS the highest office of a critic to communicate enthusiasm. As an esthetic policeman, he has certain duties to perform, but these do not include bringing offenders to justice. That is for the public to do; the critic can offer but one man's opinion. With that same limited power, however, the critic can be a catalyst of remarkable effectiveness — provided always that he does not promise to disclose music's arcane secrets, because nobody knows them and the man who says he does is a liar.

The road to music is no hidden path, but it does not go in a straight line, either. The interested traveler can go it alone — many have, and without mishap. As in all explorations it is well, just the same, to have a guide along. He should be an expert on the terrain, able and willing not only to show you the best path to take, but to tell you why he recommends it.

Hence the Hi-Fi Music "Guide to Record Collecting", a regular department which this comment introduces.

Someone once said that architecture is frozen music. The metaphor is not altogether acceptable, but it helps to establish the premise from which we will proceed. To wit, that music is like a building or a book or any other product of human expression insofar as it is of a fixed time and place — and has a significance in its time and place quite apart from those imperishable attributes that make it a work of art.

Consider. Real estate does not build itself. Only the architect acts in a solo capacity. His plans for any edifice, however noble, are as nothing until the contractors come along. So with the composer, who rolls his own until his score goes to the printer. But the music must be performed before anything, esthetically, can happen. Nor does a book take on its meanings before it is read.

Now, let us use the book to prove the principal point because it lends itself most easily: Does not any volume, on any subject, reflect its contemporaneous political, social, and economic background?

Books, like buildings and symphonies, are brought into being for good reason. The reason is not the same from one case to the next, but it tends to include the author's unconscious motivations and the prospect of profit. These are the *why* of any art. Too often the music appreciation fellows bedevil themselves and their audiences by pursuing this *why* all over the place.

Our "Guide to Record Collecting" will take a new tack altogether. It will pursue the *what*, which seems to us a much more sensible goal because it is achieved with less difficulty and it is bound to be, in sum, more rewarding.

It has been remarked previously in this space that music history does not follow the hit parade. It only seems that way, especially in retrospect. It is surely true that in any of the arts there are big names that never would have been big without the prior contributions of others who are now forgotten.

The basic texts, quite understandably, credit the man who did a thing *best* and *most* rather than the one who did it *first*. On the whole, this makes for an imbalance that amounts to misinformation, and it is apt to keep the unwary or gullible traveler away from some mighty interesting side roads.

We propose to take you down those side roads, and to go behind the billboards. Everyone wants to know *what* it is about a composer that makes him a name to conjure with. That is what we will tell. And in the composer's music we will isolate *what* is important for what reason — admitting that this amounts to a *why*, but of the most informative variety.

And then we will talk about his time and place, and how he and his music were a logical outgrowth of them, or a logical reaction against them.

Lastly, we will ask an authority to select the outstanding works by the composer under discussion, and we will ask another authority to make specific recommendations as to the available recordings. *Continued on page 80*



# Those Strange Sounds

By Arthur Ferrante and Louis Teicher



PEOPLE who own *Soundproof*, which we recorded for Westminster recently, seem to be divided into two groups: those who enjoy it, and those who are amazed by it. Both, it appears, have a common curiosity about us and the manner in which the music was played and recorded, and they seem to share a lurking suspicion that the selections cannot be played in a live performance.

We are glad, therefore, to have this opportunity to answer, for the benefit of all, the questions that we haven't been able to answer individually!

The Ferrante half of our team was born in New York City; the Teicher half is a native of Wilkes Barre, Pa. We must have had a musical affinity when we met at the Preparatory Division of the Juilliard School of Music, because even at that tender age we found ourselves teamed together whenever an opportunity for piano ensemble presented itself. We progressed to the Regular School and ultimately to the Graduate School. We both studied piano with Carl Friedberg and shared the same teachers in all the allied subjects such as composition, orchestration, and conducting. We even taught the same subjects when we were appointed to the faculty at Juilliard following our graduation there.

Coming from families of modest financial means, we were pleased to discover that playing for dances and parties on weekends was a good way to earn pocket money. After practising Bach, Brahms, and Beethoven all week, we would demonstrate musical schizophrenia by playing with jazz bands on Friday and Saturday *Continued on page 68*

*Ferrante and Teicher at work. They explain their purpose: "to exploit to the fullest an instrument which for two centuries has been recognized by its distinctive sound, and to create completely different sounds".*



# Vaughan Williams

At 80, He Is Still Busy Living His Life and Composing His Music — *By Edward Jablonski*

RALPH VAUGHAN WILLIAMS must be bored with being classified "the doyen of English music", or "British music's grand old man", and all the other deferential if affectionate clichés the British are fond of bestowing upon their contemporary great. He may even be bored with having heard all this for so long, because his immortality has begun during his lifetime. But then Vaughan Williams is too active, inquisitive, and prickly a personality to give much heed to labels and other ephemeral impedimenta. (The only official decoration he has accepted is the coveted Order of Merit.) Vaughan Williams is much too occupied attending to the business at hand — living his private life, and composing his music.

Directness in both his music and conversation is a Vaughan Williams trait. During a rehearsal he was conducting of the *F Minor Symphony* (the contentious fourth in an impressive and important series that has now reached number eight) a member of the orchestra pointed out a certain passage that "did not look right" in his score. The composer studied the offending passage for a moment then said, "It looks wrong, it sounds wrong, but it's right." He is still, after 22 years, undecided whether or not he likes the *F Minor Symphony*, of which he once said after conducting a performance, "If that is modern music — I don't like it!"

Having his music praised and sometimes damned for its "Englishness" must be tiresome also. As if Vaughan Williams could be other than completely English! His roots are deep in the traditions of English folk song and the almost equally ancient church music. The subject of nationalism in music is a favorite one with him. Not nationalism in its narrow political sense, but in the sense that Bach is German and Bartók Hungarian. Their art is based on native traditions that are as much a part of their natural equipment as their native speech. This quality endows their work with universality and timelessness. Historically, Vaughan Williams enters the mainstream of English music where the Tudor composers left off. The contribution of the latter was all but lost in post-Elizabethan times, when an effete court life encouraged the importing of foreign musicians whose understanding of British music was nil.

A profound knowledge of English history and literature (and other histories and literatures) contributes further to the integrity, power, and authority of Vaughan Williams' utterance. His songs and choral works are eminently singable because the musical setting is never at odds with the words. His melodic invention (and what melodies!) is as inexhaustible as his un-

*Vaughan Williams today, and when he conducted the London Symphony Orchestra in his London Symphony on July 31, 1946, in a performance at the Royal Albert Hall*





# COLLECTORS' CORNER

**S**PECIAL ATTENTION: Gary Graffman, outstanding among the new generation of pianists, has made a stunning disc debut on RCA Victor LM-2012 with a pair of early Prokofiev sonatas and the Schubert *Wanderer*. Isaac Stern, ever a dependable artist, reaches new heights altogether with a Bruch *G minor* and a *Symphonie espagnole* on Columbia ML-5097.

Honorable mention on various counts: Furtwängler's *Ninsh*, the all-Gottschalk recital by Eugene List, and Orff's "Die Kluge" with the composer himself participating.

**F**OR THIS ISSUE, the "Collectors' Corner" is devoted to a communiqué from Dennis Andrews, London critic for *The Liverpool Daily Post*.

LONDON, ENGLAND

**T**OWERING over recent releases like skyscrapers in Holland come Decca's issues (the first) of Wagner's "Die Götterdämmerung" (12 sides) and Strauss's "Die Frau ohne Schatten". To issue the last quarter of the Ring Cycle alone, and in a Norwegian performance, might seem a lunatic decision — solely on those counts. But given the sudden emergence from retirement of the greatest Brünnhilde of our time, in a broadcast that sent amazed whispers rolling round the world, who would blame any record company, knowing that they could hope for no repeat, from filling in, making improvements and releasing? The engineers have done a remarkable job here and the balance is well-regulated throughout.

Mme. Flagstad as Brünnhilde projects as magnificently as ever. Her voice, at its most alert in the scene with Waltraute, appears elsewhere somewhat cautious, and in the closing scene, clearly tired; but excuses are rarely needed. Both conductor (Fieldstad) and orchestra (Norwegian

Radio) sound "off their home ground". The former, though more than adequate, remains obstinately earthbound; and the latter is not always note-perfect. None of Furtwängler's intense and compelling magic over his vast forces here, but rather a serviceable accompaniment.

Svanholm's Siegfried, always intelligent and musical, suffers from his customary dryness of tone: for the rest, no individual mention seems called for. A valuable record of a great artist, then, (just past her prime) in one of her greatest roles, but leaving the field still clear for a truly memorable whole. The next version must be the culmination of the complete Ring though, such as we might already have possessed but for inter-company red tape. For Flagstad fans, a still more recent complete "Alceste" (Gluck) is on the way, in the Italian version, newly-edited.

The Strauss-Hofmannstahl "Die Frau ohne Schatten" is a high Freudian peak among the mountain ranges of Allegory, which also include Mozart's "The Magic Flute", and Tippett's "The Midsummer Marriage". An Empress from the spirit world is given three days in which to acquire a shadow (symbol of humanity and fertility). Failure will result in her return to the barren spirit world, and her husband's ossification. With success within her grasp, she refuses to benefit from the unhappiness of others and so loses the shadow. Her self-sacrifice, however, wins her the reward that she thought only the shadow could bring — and her husband is saved.

Visual transformations play an important part here, and despite the atmospheric appeal of music and performance, much is lost on disc. (The libretto's elaborate stage directions provide a helpful guide to the imagination, however.) Four and a half hours of mellifluous mid-period Strauss, of honeyed anguish and richly nostalgic

lushness, is not to my personal taste. But this is not a work likely to be much performed; its availability on disc is therefore to be welcomed wholeheartedly. Karl Böhm is the efficient and loving conductor of the Vienna Philharmonic Orchestra; Leonie Rysanek's effortlessly soaring lyricism as the Empress immediately places her in the front rank of Strauss singers; Christel Goltz's human portrayal of the dyer's wife is one of her finest characterisations yet, and Paul Schoeffler as Barak, her husband, could not be bettered in the warm sincerity and passion of his performance. Try the love duet at the beginning of the third act, "Mir anvertraut. . . ." — unbeatable for ravishing sugared decadence — if you are unsure of how you will stand up to all 10 sides of this extraordinary work!

Another make of honey (French as opposed to German) is offered by Decca again with Gounod's pleasurable *Little Symphony in B flat for Winds*, delightfully scored and enchantingly played by L'Ensemble d'Instruments à Vent Pierre Poulteau. A more substantial symphony — English this time — is the octogenarian Vaughan Williams *Eighth*. Personally I find a descent to near-bathos in the final Toccata (featuring percussion and electronic instruments) after three movements which compare very favourably with anything he has written. A remarkably likeable work, it is here recorded by the Hallé Orchestra under Sir John Barbirolli, to whom the work is dedicated, and issued by Pye-Nixa, a company of which Barbirolli has recently become a director. In due course no doubt Decca will also add this work to their series of this composer's symphonies by Boult. Boult's conducting of Brahms' *Fourth* for Nixa places on record a performance that has long been familiar to concertgoers here, for this work is one of Sir Adrian's favorites. His reading is strong and sober, remarkable in its feeling for the symphony's architecture and its sinews, but sometimes strangely lacking in drama. The orchestra is the Philharmonic Promenade, a little rough sounding, but well enough recorded.

A really satisfactory *Francesca da Rimini* has still to be made. The fourth to be issued — Decca's Anthony Collins and the London Symphony Orchestra — provides a most insensitive, bombastic reading which cannot but support the all-too-frequent accusation aimed at this fine piece — tawdry! It is anything but this, although it is perhaps a mistake to play it uncut as here. Three rarely-heard works by Prokofiev are grouped together on a Ducretet-Thomson disc by the L'Orchestre du Théâtre des Champs-Élysées conducted by Jouve — "The Ugly Duckling", a Hans Andersen tale most capably sung by Françoise Ogéas; the *Summer Day Suite*, deriving from a 1935 collection of children's piano pieces; and the *Overture on Hebrew Themes*, played in full orchestral instead of its more usual chamber-scale dress. None

*Continued on page 79*

# Record Reviews and Ratings

**BOARD OF REVIEWERS:** Ward Botsford • Jean Bowen • Oliver Daniel • Warren DeMotte • Leonard Feather • Shirley Fleming • David Hall • Peggy Glanville-Hicks • Allen Hughes • Alfred Kaine • Ezra Laderman • C. J. Luten • James Lyons • George Louis Mayer • David H. Miller • Robert Prestegard • David Randolph • Richard RePass • Fred Reynolds • Abraham Skulsky • Walter Stegman • Saul Taishoff

**BEETHOVEN: Overtures — Leonore, Nos. 1, 2, 3; Fidelio; Coriolan** **A C**  
 Boston Symphony under Charles Munch **B**  
 Victor LM-2015 12"

Munch runs into formidable competition here, principally from Krauss' smooth romanticism, Toscanini's electric excitement, and Van Beinum's enthusiastic vigor. Indeed, almost any of the performances listed in the catalog is more suited to Beethoven's music. The Bostonians punch, drive, and slash; Munch chooses tempi as the mood strikes him. The recording is good although not Victor's best. **DHM**

**BEETHOVEN: Symphony No. 6 in F, Op. 68 (Pastoral)** **A B-B**  
 Berlin Philharmonic Orchestra under **A-A**  
 André Cluytens  
 Angel 35350 12"  
 Boston Symphony Orchestra under  
 Charles Munch  
 RCA Victor LM-1997 12" Cluytens



To me the most notable aspect of Munch's performance is the vitality and incisiveness of approach that he brings to the score. Perhaps there is too much vitality, for there is a suggestion of a breathlessness about it. On the other hand, Cluytens' way with the work is expansive as to tempi, particularly in the first and second movements, during which I experienced a bit of restlessness. Both have rousing storm scenes (Munch's is cyclonic) and both do an expressive job in the finale. My affection, however, remains with the Szell-New York Philharmonic reading on Columbia. The reproduction on both of these albums is excellent. **AK**

**BEETHOVEN: Symphony No. 9 in D minor, Op. 125 (Choral)** **A A C**  
 Elisabeth Schwarzkopf, Elisabeth Höngen,  
 Hans Hopf, Otto Edelmann, Bayreuth  
 Festival Orchestra, Chorus under Wil-  
 helm Furtwängler  
 RCA Victor set LM-6043 2-12"

In an admirable program note Irving Kolodin tactfully enjoins the listener from regarding any revelation as the ultimate. The uniquely resilient Ninth nevertheless is the ultimate measure of a conducting art. Furtwängler's conception needs four LP sides despite an omitted repeat in the Scherzo, which may disenchant the penny-wise. Otherwise picayune parties could remark on rhythmically lethargic string playing in the same movement. And hi-fi extremists will deplore the chorus miking. But the quartet is grand and over-all this unretouched souvenir of the 1951 Bayreuth reinauguration is a success as "actual performance" recordings go. As history, a document beyond price. Wagner had opened the *Festspielhaus* with the Ninth, remember. His pre-eminent disciple affirms that faith in great, great music-making. **JL**

**BLISS: A Colour Symphony; Introduction and Allegro** **B-A A-A**  
 London Symphony Orchestra under **A-A**  
 Sir Arthur Bliss  
 London LL-1402 12"

Conveniently, if hardly coincidentally, Boosey & Hawkes has just brought out a miniature score of the Symphony. The work dates from 1922, though much revised a decade later. Its programmatic implications are clarified somewhat by the subtitles of the four movements: "Purple" (amethysts, pageantry, royalty, death); "Red" (rubies, wine, revelry, furnaces, courage, magic); "Blue" (sapphires, deep water, skies, loyalty, melancholy); and "Green" (emeralds, hope, youth, joy, spring, vitality). Befitting such a profusion of heraldic significances, this is a big, many-textured piece, ingeniously orchestrated. But its unpretentious disc-mate is better music. **JL**



**BRUCKNER: Symphony No. 9** **A-B**  
**BEETHOVEN: Choral Fantasy, Op. 80** **C-B**  
 Symphony Orchestra of the Bavarian  
 Radio under Eugen Jochum; Andor  
 Foldes, pianist, with RIAS and Berlin  
 Motet Choirs, Berlin Philharmonic Or-  
 chestra under Fritz Lehmann  
 Decca set DX-139 2-12" Jochum



With Furtwängler gone, Jochum is probably Germany's foremost exponent of the lethargy school of conducting. But whereas Furtwängler's exhaustive deliberateness often had estimable results, Jochum frequently provides evidence to be used against Bruckner by his detractors. The Horenstein performance must remain the preferred version. Beethoven's Choral Fantasy is a curiosity but a more than interesting one, since it is in effect a study for the finale of the Ninth Symphony (the great theme of which keeps popping up, albeit in rough form). Foldes might have applied a little more muscle to the proceedings, but otherwise the performance is fine. **ST**

**COPLAND: 3 orchestral works** **B-B-A**  
 House Orchestras under Arthur Wino-  
 grad, Izler Solomon **B-B-A C-C-R**  
 M-G-M E-3367 12"

A partially new coupling finds Solomon's effective, chamber-scale performance of Copland's inventive *Music for the Theatre* (previously with a suite from "The Threepenny Opera") with the pretentious *Music for Radio and Music for Movies*, the latter being a potpourri from such scores as "The City", "Of Mice and Men", and "Our Town". The later recordings are clear but dry of sound, the playing insensitive. **CJL**

**COWELL: Symphony No. 7** **A**  
**WARD: Jubilation, An Overture; Adagio and Allegro** **A A**  
 Vienna Symphony Orchestra under William  
 Strickland  
 M-G-M E-3084 12" Cowell

The American Composers Alliance has sponsored several worth-while recordings of music by contemporary American composers. This record is among the most successful. Henry Cowell's Seventh Symphony, written in 1947, is a work of impressive power and moving lyricism. It has real symphonic breadth and substance. Strickland's conducting is forthright and the orchestral response is commendable. The sound of the recording is clear and surrounded by air. Ward's two pieces have the ring of sincerity and the virtues of tunefulness and direction. Strickland makes out a good case for them and it is engineered skillfully. **WD**



## RATINGS OF CLASSICAL MUSIC

The following explanation of the Record Ratings which accompany the Record Reviews is given so that you will understand exactly the significance of the three letters which appear at the left of each review.

### COMPOSITION (Top Letter)

- A: Outstanding**  
 Indicates that the composition is one of the composer's best works, or that it is outstanding in a particular class of music. Assignment of this rating is an unqualified recommendation.
- B: Important**  
 This rating is but slightly below the A rank.
- C: Worthy**

A composition which may merit representation in a library of the composer's works, or in a collection of that particular music.

### PERFORMANCE (Middle Letter)

- A: Outstanding**  
 Indicates a superb performance. Assignment of this rating is an unqualified recommendation.
- B: Excellent**  
 A noteworthy performance, subject only to minor criticism.
- C: Satisfactory**  
 A performance not without flaws, yet deserving public notice.

### RECORDING QUALITY (Bottom Letter)

- A: Outstanding Realism**

Representing the highest present attainments in acoustic and recording techniques.

### B: Excellent Quality

Slightly below A rating because of minor faults in the acoustics or recording, or because the noise is considered somewhat above the minimum currently attainable.

### C: Acceptable Quality

Representing the current average of the better LP records.

### R: Indicates a re-issue.

**Important Note:** Records which are rated below C as to the composition, artist or orchestra, or recording quality are not ordinarily reviewed here. However, the omission of a record does not mean that it was rejected, as it may not have been submitted to HI-FI MUSIC AT HOME for review.

DEBUSSY: *Iberia*; *La Mer*; *Prelude to The Afternoon of a Faun* A-A-A  
 Detroit Symphony Orchestra under A-A-A  
 Paul Paray  
 Mercury MG-50101 12"

None of Paray's other records so far, excellent as they all are, has given me quite so much pleasure. In *Iberia* his only real competition, I would say, comes from Ansermet. This is tough competition indeed, but I feel that Paray has won hands down. More than any of his confreres he really distills that aromatic Hispanic elixir which Debussy crammed into the score. The results are almost literally tangible. *The Afternoon of a Faun* and *La Mer* are scarcely less well done, but it is *Iberia* that is the big news in this release. The orchestra plays with astonishing virtuosity, and the recorded sound is magnificent, even for Mercury.



Paray

DUKAS: *La Péri*; *The Sorcerer's Apprentice* A-A-C  
 SAINT-SAËNS: *Omphale's Spinning Wheel* B-B-B  
 Orchestra of the Paris Opéra under  
 Robert Benedetti  
 Capitol P-18008 12"

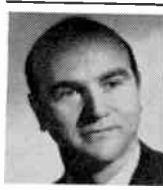

Benedetti

Pavlova, Chauviré, and Fonteyn among ballerinas have been identified with *La Péri*. This is magnificent choreographic music. Indeed, Benedetti's reading seems to have been geared to the ballet stage rather than to the concert hall. It is never overplayed. Actually, a more decisive thrust would have added to the excitement of the more brilliant sections. The result here, in any event, is a spacious, clean, and well-controlled performance. But *The Sorcerer's Apprentice* lacks much of the magic and mischief that it needs. Slow tempi are prolonged and the scherzo feeling is never fully captured. Uneven rhythmic precision weakens the *Saint-Saëns*.

GLM

DVORÁK: *New World Symphony* A  
 RIAS Symphony Orchestra under Ferenc B  
 Fricsay; Decca DL-9845 12"  
 Philadelphia Orchestra under Eugene Or- A  
 mandy; Columbia ML-5115 12"  
 Symphony of the Air (conductorless); "Pre- B  
 sentation Album 2" 12"

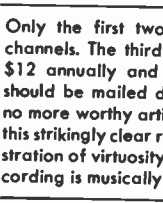

Fricsay

Only the first two of these simultaneous issues may be had through commercial channels. The third goes to all "Friends of the Symphony of the Air"; membership is \$12 annually and checks payable to The Symphony Foundation of America, Inc., should be mailed directly to Room 1101, Carnegie Hall, New York 19, N. Y. There is no more worthy artistic philanthropy, though a certain stridency of string tone afflicts this strikingly clear reproduction (by SOA violinist David Sorser) of a phenomenal demonstration of virtuosity. The Ormandy disappoints; it lacks drive. Fricsay's bass-heavy recording is musically the best of all; what an irrepressible surge and sweep it has!



FALLA: "El Amor Brujo"; *Danza española from "La Vida Breve"* etc. A-C  
 Marian de Gabarain, mezzo; L'Or- A  
 chestre de la Suisse Romande under  
 Ernest Ansermet  
 London LL-1404 12"



Ansermet

This is probably the best all-around version of "El Amor Brujo". Gabarain, whoever she is, is an artist with one of those low, powerful Spanish voices which suits this music to a "T". Ansermet is an exciting technician at all times, even though he may not give the ultimate in home-cooked flavor as only a Spaniard could. Notably it is the *Pantomime* rather than the *Ritual Fire Dance* which emerges as the *pièce de résistance*. The complete Spanish-English text is enclosed. Appended are four short works — Chabrier's *Habanera*, Mussorgsky's *Gopak*, and Debussy's *Clair de lune* and *Marche ecossaise*. Of these the Chabrier is especially gorgeous. A-1 sound.

WB

HAYDN: *Symphony No. 100 in G (Military)* A  
 Philharmonic Symphony Orchestra of Lon- A  
 don under Hermann Scherchen  
 Westminster W-LAB 7024 12"

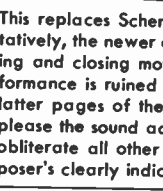

Scherchen

This replaces Scherchen's first *Military*, which made phonographic history. Interpretatively, the newer one is much the same, except for slightly faster tempi in the opening and closing movements. What would be otherwise a completely satisfying performance is ruined by the all too clear blasts of the cymbals and bass drum in the latter pages of the second and fourth movements. These exaggerations surely will please the sound addicts, and as effects they are impressive. The trouble is that they obliterate all other instruments. The volume of the percussion far exceeds the composer's clearly indicated intentions. But I must admit that the fi is very hi.



d'INDY: *Jour d'été à la montagne*; *Symphony on a French Mountain Air* A  
 Orchestras under Ernest Bour A  
 London/Ducretet-Thomson DTL-93029 12"



An extremely welcome issue that couples a long overdue première recording of the enchanting *Summer Day on the Mountain* with as good a performance as any of the more familiar piece. Pianist Daniel Wayenberg excels in the latter with an excellent pickup group. The Champs-Élysées pit is far from the composer's beloved Cervennes but its ensemble evokes the grandeur of those heights with marvelous verisimilitude.

JL

MENDELSSOHN: *Symphony No. 3 in A minor, Op. 56 (Scottish)*; *Symphony No. 4 in A, Op. 90 (Italian)* A-A  
 Philharmonic Promenade Orchestra under A-A  
 Sir Adrian Boult  
 Westminster XWN-18239 12"



Boult

The *Scottish Symphony* comes off the better in these performances. Boult was ever a fine hand at detail work and some of the wind passages, especially in the final movement, are exquisitely turned by his players. The *Italian Symphony* suffers by close comparison with the less well recorded version of Boult's compatriot, Sir Thomas Beecham. Here there is a notable lack of verve. Some of the string playing is not too good, either; it lacks pull and unison. As to quality of sound, both sides of the present release are excellent in every way. It might be noted that this is the only coupling of these works currently available.

WB

OFFENBACH-ROSENTHAL: *Gaité Parisienne (Complete)* A  
 Philadelphia Orchestra under Eugene A  
 Ormandy  
 Columbia KL-5069 12"

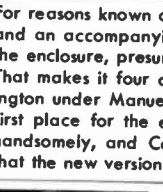

Ormandy

For reasons known only at its source this album is entitled "The Pleasures of Paris", and an accompanying brochure details same with photos and text. On account of the enclosure, presumably, you are asked to pay an extra two dollars for the disc. That makes it four dollars more expensive than the excellent performance on Remington under Manuel Rosenthal, who had fashioned the famous hybrid score in the first place for the ever popular ballet. Ormandy's nonpareil virtuosi play it more handsomely, and Columbia's engineering certainly is superior. But I could not say that the new version is worth three times what the competition is asking.

JL

PUGNANI: *Symphony No. 5* B-B-B  
 SARTI: *Concertone per piu strumenti obbligati* B-B-B  
 SAMMARTINI: *Oboe Concerto in F* B-B-B  
 Italian Chamber Orchestra under  
 Newell Jenkins  
 Haydn Society HSL-136 12"



Jenkins

Italy never produced a great symphonist, and these three were no exceptions. The Pugnani is a warm, sunny work which lacks, for all its optimism, one decent theme, and evolves in a pedantic manner. Sarti, contemporaneous to Mozart, has built, above an insistent Alberti base, Corelli-like figurations which have much sophistication and little bite. Sammartini's *Oboe Concerto* is really a *sonata del chiesa* with an oboe obbligato and in truth it barely scratches the surface of the future solo concerto. Sidney Gallesi, the soloist, plays a heavy instrument with command and excellent intonation, but his tone is rather pallid and unyielding.

EL

RAVEL: *Ma Mère l'Oye*; *Rapsodie espagnole*; *Une Barque sur l'Océan* A-A-A  
 L'Orchestre du Théâtre des Champs- B-A-A  
 Élysées under Desiré Inghelbrecht B-A-A  
 London/Ducretet-Thomson DTL-  
 93087 12"

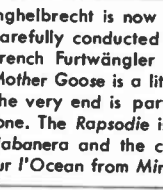

Inghelbrecht

Inghelbrecht is now approaching eighty but you would hardly guess it from these carefully conducted performances. He has a habit of lingering over details like a French Furtwängler but, as with the great German, this is often rewarding. The *Mother Goose* is a little dull. Even so, the details which emerge are quite fascinating. The very end is partially ruined because an engineer suddenly cut off the room tone. The *Rapsodie* is better in sound and performance. Extraordinary detail in the *Habanera* and the closing *Feria*, especially of sarrusophone and harp. The *Barque sur l'Océan* from *Miroirs* is very effective in Ravel's orchestration.

WB

REGER: *Variations and Fugue on a Merry Theme by Hiller* A  
 Hamburg Philharmonic State Orchestra A  
 Telefunken LGX-66049 12"

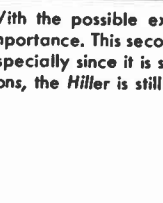

With the possible exception of Busoni, Max Reger remains the least familiar of this century's figures of importance. This second recording of one of his major pieces (under Joseph Keilberth) is therefore welcome, especially since it is superior to the Spa version in almost every way. If not so glowing as the Mozart *Variations*, the *Hiller* is still a marvelous work, culminating in a gorgeous triple fugue.

ST

**RIMSKY-KORSAKOV: Fantasy on Russian Themes; See Episode BALAKIREV: Russia** A-A-B B-B-B B-B-B  
State Orchestra of the U. S. S. R. under Konstantine Ivanov and State Radio Orchestra of the U. S. S. R. under Nikolai Anosov Westminster XWN-18120 12"



The Fantasy is a find. It is a lucid, beautifully scored work, and its virtual extinction from the musical scene is really a sin. It is actually a one-movement violin concerto. (Marina Kozolupova is the soloist here.) The two main themes, both folk melodies, are lovely, and Rimsky's handling of the violin has the dash and drama of the romantic virtuoso. The performance is excellent, and if plugged by our classical disc jockeys it would be a hit in no time. The "Sadko" excerpt is ballet music, melodious and grand; for all its familiarity the idiom is timeless. By comparison, Russia is a rather tame and uninspired tone poem. EL

**ROSSINI: Semiramide Overture** A to C  
Philharmonic-Symphony Orchestra of New York under Arturo Toscanini RCA Victor/Camden CAL-309 12"

Praise be, it looks as if we are going to get to replace those treasured but tattered shellacs of The Maestro's pre-NBC period. This Semiramide is far more electrifying than its recent sequel; listen and be convinced. Also hereon coupled: *The Sarcerer's Apprentice*, the "La Traviata" Preludes, the *Siegfried Idyll*. The sound is best described as primitive, but the early thirties shine right through the fog. JL

**SCHUBERT: Overtures** A to C  
Philharmonia Orchestra of Hamburg under Arthur Winograd M-G-M E-3362 12"

Surely among the happiest ideas of the season. Schubert never realized his aspirations to the lyric theater, but many of his operatic failures are prefaced by orchestral delights. Herewith the Overtures to "Alfonso und Estrella", "Die Zauberkraft" (later affixed to "Rosamunde"; this band might better have been given to something less familiar), and the Italian (concert) Overtures in C and D. Slightly opaque playing. JL

**SCHUBERT: Symphony No. 5 in B flat (Military)** A-A B-B B-B  
Concertgebouw Orchestra of Amsterdam and the Vienna Symphony Orchestra under Carlo Zecchi Epic LC-3258 12"

The use of cymbals, bass drum or triangle in symphonies was rare during Haydn's time. His employing all three in the *Military* was considered downright temerity. This work, which was written three years before Schubert's birth and pre-dated the latter's Fifth by twenty-two years, actually sounds the more modern of the two. Zecchi's readings, although tasteful, are painted in lighter and paler hues than either composer intended. Quickened tempi would have helped to add some of the needed color. Less timidity with the "bold" percussion instruments also would have helped to season the otherwise pleasing performance. Reproduction is good. AK



**SCHUMANN: Symphony No. 1 (Spring); Symphony No. 4 in D minor** A-A A-A A-A  
Israel Philharmonic Orchestra under Paul Kletzki Angel 35372 12"

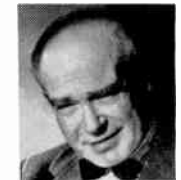

The youthful Israel Philharmonic has established a reputation as an excellent symphonic ensemble, thanks largely to its series of recordings for Angel. The two symphonies on this disc find the members of the orchestra in a most responsive mood. Kletzki's interpretations are spirited and propulsive, but the lyrical portions of the music sing appealingly without lapsing into languor. The First Symphony goes right to the head of the class for performance and recording. The D minor also is handsomely done, although it faces more substantial competition. However, it nudges the elsewhere unsurpassed Paray and Furtwängler versions in all respects. WD

**J. STRAUSS: 6 Waltzes** A A  
Columbia Symphony Orchestra under Bruno Walter Columbia ML-5113 12"

Nobody, but nobody, knows better than this octogenerian master how a Strauss waltz should go. On the present evidence, moreover, he is quite able to impart the secrets involved to a pickup orchestra in a Manhattan recording studio. This particular program assembles the *Emperer*, the Overture to "Die Fledermaus", *The Blue Danube*, *Tales from the Vienna Woods*, *Vienna Life*, and the Overture to "The Gypsy Baron". Everything has just the right insinuating lilt, and the warm-toned ensemble has been quite well, if not shimmeringly, recorded. Unshamed clichés and all, the engaging notes by Joseph Wechsberg lend a further echt aspect. JL



**R. STRAUSS: Don Quixote, Op. 35** A B  
Frank Miller, cellist; Carlton Cooley, violist; Daniel Guilet, violinist; NBC Symphony Orchestra under Arturo Toscanini Victor LM-2026 12"

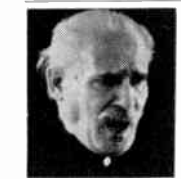

The annotator of the Eulenberg miniature score remarked in his 1904 foreword that "a finished performance of Don Quixote is extremely difficult to accomplish". This is still true. The NBC Symphony handles Strauss' captivating complexities with a fairly sure hand, but this record does not match Victor's earlier Boston Symphony release (Munch). The NBC soloists are a bit less vivid, the overall performance less incisive. Part of the trouble no doubt stems from recording under actual broadcast conditions (Nov. 1953), which may account for the somewhat cloudy sound and the frequent failure of important single instruments to project over the orchestra. SF

**VAUGHAN WILLIAMS: 3 Works** A-B-B A-A-A A-A-A  
Philharmonic Promenade Orchestra under Sir Adrian Boult Westminster W-LAB 7048 12"

The Greensleeves rarely has been dressed in such luxurious sound. Neither has the Prelude to "The Wasps" buzzed to such sonic effect. The main offering on this record is the moving *Fantasia* woven about the churchly melody of VW's Elizabethan forebear, Thomas Tallis. Boult's interpretation was admired in Westminster's regular issue; in this Laboratory Series release, the strings glow hypnotically. WD

**VAUGHAN WILLIAMS: Symphony 8 in D minor** B-B-A A-A-A A-A-A  
**BUTTERWORTH: A Shropshire Lad** A-A-A  
**BAX: The Garden of Fand**  
Hallé Orchestra under Sir John Barbirolli Mercury MG-50115 12"

The new Eighth may not be in the class with the Fourth or Sixth, but it is nevertheless a pure delight. Our British cousins greeted the work with mixed joy and dismay; the finale, especially, presented problems to them with its non-symphonic gongs and other exotic percussion (see Collectors' Corner in this issue). To these ears it is a beautifully crafted work of directness and simplicity, masterfully and characteristically orchestrated. The first movement alone is worth the price of admission. Of the bonuses the Bax (known to balletomanes as the score of "Picnic at Tintagel") is an LP première. In every way, this disc is well worth having. EJ



**Nights at the Ballet (Volume I)** A to C  
Concerts Colonne Orchestra under Daniel Stirn London/Ducretet-Thomson DTL-93019 12"

Contents: the Minkus score for *Dan Quichotte* and three Tchaikovsky truncations — the Suite from "The Nutcracker", *The Blue Bird* from "Sleeping Beauty", and *The Black Swan* from "Swan Lake". Atmospheric performances, well recorded. One hopes that there will be, as implied, additional volumes. Ballet has not been slighted on LP, but also it has not been surveyed systematically, and that is what it needs. JL

**The Tone Poem** A to C  
(Works by Liszt, Tchaikovsky, R. Strauss, Ravel, Casella, Copland, Debussy, and Ibert) A to C A to R  
Various orchestras under Fritz Reiner, Charles Munch, Pierre Monteux, Leopold Stokowski, and Arthur Fiedler RCA Victor set LM-6129 3-12"



Anyone who wants the surpassingly Tchaikovskyan performances of *Francesca da Rimini* and *Rameau and Juliet* under Munch will be obliged to buy this omnibus package, the only other newness in its contents being a marvelously melodramatic *Mephisto Waltz* under Reiner and Fiedler's rather coarsely vivacious espousal of the rarely heard *Italia* (which really deserved better). Also included, but previously released in other couplings, are Reiner's *Dan Juan*, Monteux's *Les Préludes*, Munch's *La Valse*, Fiedler's *El Salón México*, and Stokowski's *Nuages and Escapes*. One supposes that the Tchaikovsky, Liszt, and Casella sides will be made available separately. JL

**Virtuosi di Philadelphia** B  
Philadelphia Orchestra under Eugene Ormandy A  
Columbia ML-5129 12"

Someone had a bright idea. Since it involves the Philadelphia Orchestra, it probably will pay off handsomely. As to virtuosity there is no gainsaying the collective mastery of that organization; but neither is Ormandy's own brand of virtuosity hidden under a bushel. Actually, this record is a recognition of the technical and musical proficiency of the various choirs as units. Hence a Paganini *Mata Perpetua* for the strings, a *Gabrieli Pian e Forte* for the brass, a *Milhaud Concerta for Percussion and Small Orchestra* for the battery. Richard Strauss, Brahms, Elgar, and the engineers also contribute to this delightful miscellany. WD



**CONCERTOS**  
**The Concerto**  
 (the Grieg, Liszt's *E flat*, Rachmaninov's  
*C minor and Rhapsody*)  
 Artur Rubinstein, pianist; Chicago and RCA  
 Victor Symphony Orchestras under Fritz  
 Reiner and Alfred Wallenstein  
 RCA Victor set LM-6039 2-12"



Last season Rubinstein gave a series of concerto cycles "to see if I have learned anything in these fifty years". I do not know what Rubinstein's playing of fifty years ago was like, but I do know that finer performances of these thrice-heard works would be difficult to imagine. The drama, tenderness, and fire of the Liszt have seldom been so fully realized, and only the imperishable performances by Rachmaninov himself surpass these for sheer poetry. Indeed, I am bound to confess that the masterful Pole even made me fall in love anew with the hackneyed Grieg. The collaboration of both Reiner and Wallenstein is first rate, as is the reproduction.

A  
A  
A

Rubinstein

AK

**BLISS: Violin Concerto; Theme and Cadenzo for violin and orchestra**  
 Campoli, violinist, with London Philharmonic under Sir Arthur Bliss  
 London LI-1398 12"

In the light of this Concerto's grandness of intent — it is a 40-minute essay in the great romantic tradition and offers a rigorous part to the soloist — it is disappointing to report that as music it has little to say. It is a monument to one of art's curious truths: that you can follow all the rules (in this case, set up a sonata form well stocked with contrasting themes and violin gymnastics, and seal it with the proper amount of orchestral glue) and in the end produce a work which seems merely windy. When the project has been carried on with obvious sincerity, as here, more is the pity. The performance is very good.



Campoli

SF

**BRAHMS: Violin Concerto in D, Op. 77**  
 Zino Francescatti, violinist; Philadelphia Orchestra under Eugene Ormandy  
 Columbia ML-5114 12"



An awesome performance. Though the difficulty of comparing it with the seventeen other versions currently on the market is obvious, it is a safe assumption that none of them could surpass this one very far. Francescatti's tone is beautiful, and his great musicianship is displayed in the perfect sense of rhythmic flexibility with which he shapes a phrase. The pace is less deliberate than Stern's (with Beecham and the Royal Philharmonic), and the work thereby gains in vitality what it may lose in grandeur. Ormandy is sensitive to dynamic levels, and his woodwind players in particular deserve a bow for the second movement opening. Fine sound.

Francescatti

SF

**GERSHWIN: Rhapsody in Blue; Concerto in F**  
 Jesús María Sanromá, pianist; Boston Pops Orchestra under Arthur Fiedler  
 RCA Victor/Camden CAL-304 12"

No offense intended towards those who think of Gershwin and Levant like ham in eggs, but for me Sanroma's *Rhapsody* remains the all-time best, and it is ideally coupled in this welcome, economy-priced release. Unfortunately, the dubbing is not all that it might have been, but Sanromá's incandescent pianism quite dispels the sonic fog and the disc is easily worth a buck ninety-eight of anyone's money. Now, then, when will we be vouchsafed those Hindemith Sonatas that this artist once did with Primrose and the composer, respectively? Better yet, perhaps one or another of the major labels will have the sense to get him into a recording studio once again. JL



Sanromá

**GLANVILLE-HICKS: Etruscan Concerto**

**HOLMBOE: Concerto No. 11 for trumpet, two horns, and strings**

Carlo Bussotti, pianist; Robert Nagel, trumpeter; M-G-M Chamber Orchestra under Carlos Surinach  
 M-G-M E-3357 12" Glanville-Hicks



The *Etruscan Concerto* is an agreeable work which, though built of rather slender stuff, draws the breath of life from vigorous and compelling rhythms and some catchy scoring that enlists a variety of percussion instruments. The center of gravity lies in the middle movement, which achieves a composure well suited to the quotation from D. H. Lawrence's "Etruscan Places" to which it refers. Throughout, the piano is first among equals rather than soloistic, and it adapts happily to this role. Holmboe's Concerto seems to me to lack, in each movement, the element of tension-and-release. He does some pleasing things, however, with melody and a relaxed polyphony. SF

The heroes are the architects of M.I.T.'s chapel. They dispel the canard that good halls are accidental and bad ones planned. Soundwise this disc is magnificent. I can imagine that a dozen other companies will be after the Cambridge auditorium. Moe is a fine organist with an unquestionable sense of style, but Liepmann conducts rather pedantically. The program: Op. 4, Nos. 2, 5; Op. 7, Nos. 1, 5. OD

**HANDEL: 4 Organ Concerti**  
 Lawrence Moe, organist; Unicorn Concert Orchestra under Klaus Liepmann  
 Unicorn UNLP-1032 12"

**LALO: Symphonie espagnole**

**BRUCH: Concerto in G minor, Op. 26**

Isaac Stern, violinist; Philadelphia Orchestra under Eugene Ormandy  
 Columbia ML-5097 12"

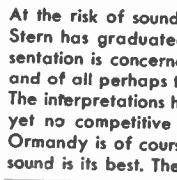

At the risk of sounding extravagant, not to say fatuous, I am bound to report that Stern has graduated to greatness with these performances insofar as his LP representation is concerned. For years he has been one of our most dependable virtuosos, and of all perhaps the most steadily growing in stature. Today his art is fully mature. The interpretations herewith are manifestly unique in their eschewal of *Schmaltz*, and yet no competitive versions are more effective. Truly, this is triumphant violinism. Ormandy is of course the soloist's dream-accompanist, and Columbia's Philadelphia sound is its best. The disc is recommended unreservedly. JL

Stern



**LISZT: Wanderer Fantasy, etc.**  
 Edith Farnadi, pianist; House Orchestra under Sir Adrian Boult  
 Westminster XWN-18242 12"



Westminster has intelligently and liberally re-coupled its previously released *Totentanz* and *Hungarian Fantasy* with a brand new recording of the wonderful Schubert-derived *Wanderer*. The latter work, especially, is an excellent weapon to be hurled at those who claim that Liszt vulgarized everything he touched. Farnadi continues to impress as an interpreter of this composer in particular. Superb sound. ST

**PAISIELLO: Piano Concerto in C**

**BRUNETTI: Symphony No. 31 in D**

Carlo Bussotti, pianist; Piccola Accademia Musicale under Newell Jenkins  
 Haydn Society HSL-135 12"

Bussotti

We are still largely oblivious to the musical treasures that have gathered the dust of centuries in Italian libraries. The whooping banalities of nineteenth-century opera effectively slopped over anything earlier like a smothering of spaghetti sauce. We are therefore indebted to Jenkins, who discovered many fine scores and organized his own group to perform them. Paisiello's Concerto is a delight; Bussotti plays it with a kind of Florentine elegance. And the Brunetti is another find, what a relief to find such pleasant music! Jenkins conducts his virtuosic ensemble with an almost Latin warmth, tempered with fine restraint. OD

**PINKHAM: Concertante for violin, harpsichord, strings, and celesta**

**BERGER: Serenade Concertante**

**BLOCH: Chamber Episodes**

**BRITTEN: Sinfonietta, Op. 1**

Soloists; Brandeis Festival Orchestra, Knickerbocker Chamber Players  
 M-G-M E-3245 12" Solomon

Here are two new additions to M-G-M's splendid and growing collection of contemporary music. The older works of Bloch and Britten, previously released on a ten-inch disc, are recorded with a tubby sound that rather detracts from the value of the pieces (and that of the Britten is slender to start with). The sonic treat here comes principally from the least known of the four composers, Daniel Pinkham, whose *Concertante* is a joy for its delicious combination of celesta, harpsichord, and strings. Arthur Berger's *Serenade Concertante* is a fine and typical example of his current style: secco, cerebral, and effective. Izler Solomon conducts very well indeed. OD



**PROKOFIEV: Piano Concerto No. 3 in C, Op. 26; Violin Concerto No. 1 in D, Op. 19**

Emil Gilels, pianist; David Oistrakh, violinist; State Radio Orchestra of the U.S.S.R. under Kiril Kondrashin  
 Westminster XWN-18178 12"

Gilels



This is Gilels' first recording of the Piano Concerto and, as might have been expected, he simply sweeps all before him. There is *Borscht* and good brown bread as well as electricity in his fingers. It is just about the most exciting twenty-five minutes of piano playing that this listener ever has heard. The recording is fairly good, but not very well balanced. It is unfortunate that the orchestral accompaniment is inadequate. This seems to be King David's third espousal of the Violin Concerto. Although not so well recorded as his recent Angel performance of the same work, it is not too bad a recording. And the fiddling is terrific. WB

**ROZSA: Violin Concerto** A-B-B  
**SPOHR: Violin Concerto No. 8** A  
**TCHAIKOVSKY: Sérénade mélan-** A  
**collique**  
 Jascha Heifetz, violinist; Dallas Sym-  
 phony under Walter Hendl, and  
 others, respectively  
 Victor LM-2027 12'' Heifetz



Rózsa's Concerto, première this year, should interest violinists and listeners alike. It has individuality and the capacity to absorb, although it grows, for the most part, out of fairly undistinguished thematic material. A slightly rakish finale complements the serious first movement, and the woodwind opening of the second recalls Brahms' precedent (in this respect only). Heifetz was the composer's guiding spirit during the work's creation, and he gives a most sympathetic performance. The Spohr is a display piece to end them all. Heifetz takes the hurdles head on and runs a little out of breath, but it's a good race even so. Excellent sound. SF

**TAKTAKISHVILI: Piano Concerto** C-C  
**GORDELLI: Piano Concerto** A-A  
 Alexander Iokheles, pianist; State Or-  
 chestra of the U.S.S.R. under Abram  
 Stassevich; State Radio Orchestra  
 of the U.S.S.R. under Alexander  
 Gauk  
 Westminster XWN-18171 12''

The names of both composers are quite unknown in this country, but they have very much in common. They are both named Otar, they both wrote in C minor (a well chosen tonality) in the manner of Tchaikovsky and Rachmaninov, and they both completely ignore the last fifty years of musical development. They could quite easily be fictional composers in some Hollywood film in which, while they are achieving their first triumph by playing their Concerti in C minor, we would witness during the sad second movements their girl friends' betraying them by running off with bourgeois twelve-tone deviationists. Both performances are excellent. AS



**TCHAIKOVSKY: Concerto No. 1** A  
 Paul Badura-Skoda; Philharmonic Prom-  
 enade Orchestra under Sir Adrian Boult  
 Westminster XWN-18162 12'' A

Having demonstrated his prowess in Classical repertory, Badura-Skoda turns to the massively virtuosic Tchaikovsky Concerto. If this be a fair sample of his way with the late Romantics, he should hasten back to the school in which he excels. His rendition of the venerable warhorse is disconsolate, timid, and unconvincing. One waits in vain for the inherent drama of the score to come through. AK

**Italian Music for Strings of the Baroque** A  
 Period A  
 Richard Burgin and Ruth Posselt, violinists; A  
 Cambridge Society for Early Music un-  
 der Erwin Bodky  
 Unicorn UNLP-1030 12''



There is a refreshing masculinity in these performances, maintained by Posselt (Mrs. Burgin) in a degree to match her husband. They are well supported by the players and by Bodky, who practices the almost lost art of improvising the harpsichord continuo. Good rhythm, good intonation, good tempi, and the results are handsome. Five works make up the whole: Concertos by Torelli and Vivaldi (Op. 8, No. 7 and the "Pisendel Concerto", respectively); a Veracini Sonata for violin and continuo (Op. 1, No. 3); dall'Abaco's Sonata for two violins and continuo (Op. 3, No. 1); an Albinoni Trio Sonata (Op. 1, No. 3). The sound is close-up and true. SF

**BRAHMS: Horn Trio, Op. 40** A-A  
**HAYDN: Trio No. 30 in D** B-B  
 Emil Gilels, pianist; Leonid Kogan, B-B  
 violinist; Mstislav Rostropovich, cel-  
 list; Jacob Shapiro, horn  
 Westminster XWN-18181 12''

Kogan



Four of the Soviet Union's best musicians are heard in this recording. Kogan, although unknown in the United States, is a delightful fiddler, and Shapiro's horn playing evokes constant pleasure. However, Gilels dominates both of these performances with his electrifying precision. Of the two trios the Brahms comes off better. The Haydn is just a shade on the heavy side. Westminster solves the delicate problem of balance by having the piano played with all stops open, but back, and having the violin played up close. The result is that the instrumental weights are equal, and the overall sound is glorious, relatively. EL



**JANÁČEK: String Quartet No. 2** A-A  
**MOZART: Quartet in G, K. 387** A-A  
 Janáček Quartet A-A  
 Decca DL-9851 12''



Meat and potato playing. What is lacking in subtlety is countered quite interestingly in a directness that stamps the group with a personality wholesome and genuine. Janáček's last work, which is also one of his most complex, deals less with nationalism than with self-searching. It is in a sense a musical conversation among four participants. The patchwork dialogue becomes a fascinating quilt of narrative and in its unfolding Janáček reveals much about the characters of his tale. It is a loving, tender, happy tale. And there is just enough ruggedness in the Mozart performance to bring this unearthly beautiful music to earth. EL

**MARCELLO: 6 Sonatas for viola da** A  
**gamba and harpsichord, Op. 1** A  
 Janos Scholz, viola da gamba; Egida Gior- B  
 dani Sartori, harpsichord  
 Epic LC-3260 12''



One can but marvel at the natural gift for string writing of the Italian Baroque composers. Marcello's sonatas of Op. 1, while stylistically in keeping with his time, seem to me to offer something special in the slow movements. They are broad, gracious, and wonderfully expressive; they epitomize the viola da gamba or the cello. Janos Scholz (who, like harpsichordist Sartori, is a member of I Music!) gives a performance that is the last word in skill and sympathy. Only one complaint about the engineering: an overly prominent harpsichord gets in the way of the gamba's dynamic shading. After all, there can be too much of a good thing. SF



**SCHUBERT: Octet in F** A  
 David Oistrakh, violinist; Mikhail Terian, C  
 violist; Sviatoslav Knushevitzy, cellist; C  
 Vladimir Sorokin, clarinetist; Joseph  
 Gertovich, double bass; Joseph Stidel,  
 bassoonist; Jacob Shapiro, horn  
 Angel 35362 12''

D. Oistrakh



This is first of several recordings which Angel will make in the Soviet Union. Although we have heard the elder Oistrakh in chamber music on several LPs, he has not been called upon to submerge himself quite so completely heretofore. It must be said that he makes a sincere attempt; the trouble is that the other instrumentalists here are not on the same plane. Also, the collective approach is so un-Viennese that one wonders at times if this is indeed Schubert. The album has no notes at all on the performers, but a whole paragraph is devoted to a biography of the annotator! Curious. Either the London or the Westminster would be preferable. WB

**R. STRAUSS: Sonata for Violin and** A-A  
**Piano** A-A  
**DEBUSSY: Sonata for Violin and** A-A  
**Piano**  
 Joseph Fuchs, violinist, and Artur Bal-  
 sam, pianist  
 Decca DL-9836 12''

Fuchs



The early Strauss is ultra-romantic and here it is played to the hilt by two of our best musicians. Fuchs is powerful and pliable, works at the piece from every angle. Balsam dovetails perfectly, with bravura and with sensitivity. A hint of "Der Rosenkavalier" in the muted second movement throws off the heavy Teutonic mantle for a short while and replaces it with a delicate lace shawl. Debussy's last work is formally conceived, with a strong tonal pull that leans back to the Classic era. In the opening phrase this team tells us there will be no ethereal pussyfooting; the performance is so effective that I am inclined to list it as my favorite. EL



**VAUGHAN WILLIAMS: Violin Sonata** A-B  
**BENJAMIN: Sonatina** A-A  
 Frederick Grinke, violinist B-B  
 London LL-1382 12''

The first Vaughan Williams chamber work on records is this terse, powerful Sonata (1954) introduced to the United States last season by Szigeti. Its complexities are not evident in the smooth collaboration of Grinke (for whom it was written) and pianist Michael Mulliner. The lighter Sonatina of Arthur Benjamin is lyrically charming; the composer's presence as accompanist is an enhancement. EJ

**WEBER: Grand Duo Concertante** C-C-C  
**SCHUMANN: Phantasiesstücke, Op.** B-C-C  
**73** B-B-B  
 Reginald Kell, clarinetist, and Joel  
 Rosen, pianist  
 Decca DL-9744 12''

Kell



The engineers rather muffed this one. The clarinet is super-focused while the piano for the most part is a blur in the background. And for all his flawlessness and artistic impeccability, Kell somehow makes his instrument sound vulgar. His phrasing is emphatically obvious, as if he were showing a high school student how the music should go. Of the three pieces the Debussy, it seems to me, comes off best. The relationship between the two artists is good here, and the Impressionist esthetic is suited well to the combination. On the review copy there are no program notes for the Rapsodie, but Decca will rectify this in the next printing. EL

**OPERA** ANTHEIL: "The Wish" C  
 Members of the Kentucky Opera Association and The Louisville Orchestra under Moritz Bomhard B  
 Louisville LOU-56-4 12" A

Antheil



The libretto is presumably by Antheil himself; it consists of harsh realism, fantasy, and a tragic ending. I doubt that he can be called the composer in the usual sense. This is a mere sampling from the works of others, whose ideas, moreover, are used in their original texture; these recur throughout as *Leitmotive* and they are most admirably put together. One encounters an idea from "Wozzeck", two or three "Rosenkavalier" waltzes, an excerpt from Milhaud's "Le Pauvre Matelot", a figure from Honegger's *Pacific 231*, and a little Stravinsky and Shostakovich seasoning. Dramatically very effective. The performance is up to Louisville standards. AS

BERGSMAS: "The Wife of Martin Guerre" B  
 Mary Judd, Regina Sarfaty, Stephen Harbachick, Chamber Orchestra under Frederic Waldman A  
 Composers Recordings CRI-105X 12" B

Bergsma

The Juilliard School can be very proud of this distinguished production. All of the participants are students or alumni. The opera (abridged for the recording) is Bergsma's first. From a fine libretto by Janet Lewis he has created what I would describe as a lyric poem with dramatic overtones. It demonstrates, in my judgment, a tremendous potential for the stage. The style is derivative, to be sure, but at the same time it is sane, and the composer handles the vocal line, the orchestral background, and the mass movements with commendable skill. That he reaches for no new dimension is not necessarily grounds for censure. E.L.



BIZET: "Carmen" A  
 Opéra-Comique production under Piero Coppola B  
 RCA Victor/Camden set CCL-100 3-12" R

Collectors will remember the early orthophonic shellac original as VM-61. This ancient production still has strong merits, among them the imperious gypsy of Lucy Perelli, the fragile Micaela of Yvonne Brothier, and the stylish Toreador of Louis Musy. Yet the performance as a whole doesn't quite equal Columbia's vintage album with Budeas, Pertile, and Franci. Sound throughout is just bearable. RR

BRITTEN: "The Little Sweep" C  
 David Hemmings, Jennifer Vyvyan, Trevor Anthony, Peter Pears, others; English Opera Group Orchestra; Choir of St. Allyn's School under Benjamin Britten A  
 London XLL-1439 12" B

Britten



This is an LP première of the musical portions of "Let's Make an Opera". Having been supervised by the composer, the performance has all the virtues of authenticity. Also, this is a clear, if slightly noisy, recording. American listeners may eschew the treacly sentiments and the English-nursery playfulness of this little opera, but the music, let it be admitted, is properly inventive and dramatic. Indeed, there are times when it rises well above the text. The work has been carefully edited for the phonograph (although it includes rather "professional" versions of the audience-participation songs), and the cast as a whole is excellent. RR

CIMAROSA: "Il Matrimonio Segreto" A  
 La Piccola Scala production A  
 Angel set 3549 C/L 3-12" B

Milan's Little Scala was christened a year ago with this hilarious "melodramma giocoso". Angel reassembles most of the original cast: Graziella Sciutti is a predictably charming Carolina; the Peruvian tenor Luigi Alva, making his LP début as Paolino, discloses a lovely lyric voice that will be better known; others include Ebe Stignani and Franco Calabrese. Nino Sanzogno conducts with knowing aplomb. Altogether a treat. JL

GERSHWIN: "Porgy and Bess" A  
 Mel Tormé, Frances Faye, Betty Roché, George Kirby, Sallie Blair, Duke Ellington's orchestra (one number), Australian Jazz Quintet, others, Bethlehem Orchestra under Russ Garcia B  
 Bethlehem set EXLP-13-12" C

Gershwin



To some this may be a revelation, to others a desecration. This is not Gershwin's opera, but a giant mélange in modern jazz styling, neither well nor idiomatically performed (Faye sings as if everything were *I Got Rhythm* and Tormé as if it were not). The original orchestrations (nine months of hard work) were discarded for Garcia's. Also, an obtrusive, fatuous narration is exuded by "Jazzbo" Collins. The score is cut, moreover, and incredibly there are even changes in the lyrics. All in all, this is decidedly not an issue for the delectation of Gershwinites — who will be more grateful than ever to Columbia for its earlier complete recording. E.J.



MASSENET: "Manon" A  
 Victoria de los Angeles, Henri Legay, Michel Dens, Chorus and Orchestra of the Théâtre National de l'Opéra-Comique under Pierre Monteux A  
 RCA Victor set LM-6402 4-12" A

De los Angeles



Phonographic justice finally has overtaken "Manon". Heretofore, admirers of this exquisite opera have had to endure an abridged version — the vocal excellences of which are minimized by the recurrence of a French-speaking counterpart of Milton Cross. Now we have a complete performance that is, in addition, a better performance. De los Angeles is perhaps too ladylike a Manon, but her mid-range opulence would still the most carping critic. Legay (Des Grieux) and Dens (Lescaut) make the most of their less velvety voices — and it suffices, for the entire cast was born to the style. Monteux unfolds every last sentimental page with loving scrupulousity. JL

MUSSORGSKY: "Boris Godunov" A  
 Belgrade National Opera production under Kreshimir Baranovich C  
 London set XLLA-31 3-12" B



The H. M. V. version is more expensive but it remains the exemplar. For one thing, it is complete, while this one cuts out Act III, Scene I and many shorter passages. For another, Christoff is every moment commanding in the all-important title role (if also obtrusive elsewhere), while Miro Changolovich is not. For another, the late Dobrowen conducted magnificently, while Baranovich just beats time. In sum, second best. JL

ORFF: "Die Kluge" A  
 ("The Wise Woman") A  
 Elisabeth Schwarzkopf, Marcel Cordes, Carl Orff, others, Philharmonia Orchestra under Wolfgang Sawallisch A  
 Angel set 3551 B/L 2-12" A

Sawallisch



The continuing Orff vogue augurs well for the musical theater generally, although he has insisted that none of his stage works are opera *per se* (not even "Der Mond", which is being done this season at New York City Center). Call "Die Kluge" what you will, but it has been recurrent in European opera houses since its 1943 première, and deservedly so. All about a peasant girl who wins a king, the work is in every way characteristic of the Orff we have come to know — a vivid vision of the past, evoked in terms of the present. The cast is supplemented by a speaker; that the composer himself narrates this recorded performance is enough to certify it as definitive. JL



PROKOFIEV: "The Love For Three Oranges" A  
 Soloists, Choir, and Orchestra of the Slovenian National Opera, Ljubljana, under Bogo Leskovich A  
 Epic set SC-6013 2-12" A



Prokofiev's engrossing early opera is recorded here (in Russian) for the first time in its entirety, and welcome it is, for this score contains some of the composer's best and most inventive music, mostly to be found in the orchestra and in the choruses. There is incisiveness, vigor, and rhythmic drive in the present performance. It is difficult to single out any one soloist as outstanding. There is much very good singing, especially among the men, and excellent teamwork throughout. Instead of the text, Epic provides a detailed account of the continuous nonsense onstage. This should suffice for anybody's full enjoyment of the work. AS

PUCCINI: "La Bohème" A  
 Jussi Bjoerling, Victoria de los Angeles, others under Sir Thomas Beecham A  
 RCA Victor set LM-6042 2-12" A

A rather suburban lot of Bohemians, these. Most of the principals cannot bring themselves to emote, let alone act. Voices are held down to a proprietous level. Unavoidably, in consequence, the proceedings are alien to Puccini. A pity, for the Mimi is seraphically done, and the orchestral aspects of the whole are no end impressive. Terrible Tommy seems to have become tolerant with singers all of a sudden. Unlike him. JL

R. STRAUSS: "Salome" Finale; "Elektra" Excerpts; Le Bourgeois Gentilhomme (Suite) A-A-B  
 Inge Borkh and Frances Yeend, sopranos, Paul Schoeffler, baritone; Lyric Theatre Chorus; Chicago Symphony under Fritz Reiner A-A-B  
 RCA Victor LM-6047 2-12" A-A-A

Reiner

This rather odd but nevertheless welcome release enlists the talents of three first-rate instruments in the pursuit of questionable ends: The remarkably powerful voice of Borkh, the high virtuosity of Reiner's orchestra, and the redoubtable resources of RCA's engineers are employed to present chunks of Straussian apotheosis out of context. The "bonus" is a performance lacking in wit of the most witty Suite. Even the order of the *Elektra* excerpts has been re-arranged. The only complete recording of this opera is six years old and it had glaring weaknesses in the first place. It is a pity that these forces failed to fill the obvious need. ST





**Operatic Choruses** A  
 Chorus of the Accademia di Santa Cecilia, Rome A to R  
 London LL-1346 12"

Would that one could infer that London plans to do "Nabucco" and "I Lombardi". But why not? The six other operas sampled here — "Aida", "Madama Butterfly", "Pagliacci", "Otello", "La Traviata", and "Rigoletto" — already repose in the *ffrr* catalogue, and surely these rousing choruses were snipped from tapes of those fine performances under Erede and Molinari-Pradelli. We shall see. **WS**

**CHERUBINI: Requiem Mass in C minor** A  
 NBC Symphony Orchestra and Robert Shaw Choral under Arturo Toscanini B  
 RCA Victor LM-2000 12"

Cherubini has been a victim of the academicians for a great many years. This is an irony, because Cherubini was an outstanding academician himself. But we have been taught without surcease that his music is dry, cold, and lacking in humanity. This verdict stood up better before it was challenged by recent performances of his Requiem and the opera "Medée", which have made a re-evaluation necessary. Certainly, Toscanini's searing performance of the great C minor Mass proves that Cherubini could write with warmth and much humanity, as well as with power and brilliance. Fortunately, this recording is satisfactorily enough engineered. **WD**



VOCAL MUSIC

**COUPERIN: Trois Leçons de Ténèbres; Motet de Sainte Suzanne** A-A  
 C-B  
 B-B  
 Pierrette Alarie, Basia Retchitzka, Leopold Simoneau, George Abdoun; L'Orchestre de Chambre Gerard Cartigny under Ernest Bour  
 London/Ducrètel-Thomson DTL-93077 12"



This performance of Couperin's magnificent *Leçons de Ténèbres* is not very inspired. There seem to be two major faults. One is the too-fast tempi, in which the embellishments become mere virtuosic effects. The other is the subdued playing of the organ, because of which we lose most of Couperin's harmonic subtleties. Alarie does some fine vocalizing, but it is sometimes tonally insecure. A previous recording of the work on the Westminster label did it much more justice. The performance of the deeply felt Motet fares better on the whole. Here too, however, one would have preferred more differentiation in the shadings. **AS**

**DEBUSSY: The Martyrdom of Saint Sebastian** A  
 B  
 Florence Kopleff, Catherine Akos, contraltos; Phyllis Curtin, soprano; New England Conservatory Chorus; Boston Symphony Orchestra under Charles Munch  
 RCA Victor LM-2030 12" Curtin

Debussy's music for D'Annunzio's mystery play comes off well as a concert piece. The preludes and choral scenes are complete musical entities. Munch, making his disc début as an actor, supplies the text accompanying the music. Hardly an ardent young athlete, he nevertheless does deliver with warmth and feeling. Musically he is in fine form and gives a clean, energetic reading. His framework is more expansive than Ansermet's but a shade less expressive in the most moving passages. Curtin's bright soprano is lovely, but nowhere does it enhance the meaning of the words as does Danco's on the competitive recording. Spacious sound. **GLM**



**FAURÉ: The Complete Songs** A to C  
 Renée Doria, Berthe Monmart, sopranos; Jacques Dutey, Pierre Mollet, baritones; Paul Derenne, tenor; Simone Gouat, Tasso Janopoulo, Harry Cox, pianists  
 Westminster set XWN-5502 5-12"



It is hardly news that LP brought with it an endemic compulsion for "completeness". Hence the staggering collection herewith — something over a hundred varied manifestations of a singular lyric genius. And I mean varied, for there was nothing static about his music for all the illusory sameness of its expression. The interpretative artistry invested in this marathon recital does not bulk large; of the participants only Mollet impresses. But the evolving Fauré esthetic is a fascination, and the qualities of mind and heart in any one of these subtle masterworks are magnified to unsuspected proportions by repeated exposure to the corpus. That is the news. **JL**

**GESUALDO: Madrigals** A  
 The Singers of Ferrara under Robert Craft A  
 Sunset LP-600 12" Craft

This reviewer is in the odd position of having himself produced the only other LP containing any sizable representation of the madrigals of Gesualdo. Moreover, some of the works on this disc duplicate those which were included on my own previous release. If, on occasion, I am more dramatic where Craft is more lyric — or vice versa — that makes his interpretations not one whit less valid than mine. Aside from an occasional momentary inconsistency in the high soprano tone, the performances are completely idiomatic, and show a fine insight into the emotional and stylistic demands of this difficult music. It is a pleasure to recommend the disc. **DR**



**HANDEL-BEECHAM: "Solomon"** A  
 John Cameron, Alexander Young, Lois Marshall, Elsie Morison, Beecham Choral Society, Royal Philharmonic Orchestra under Sir Thomas Beecham  
 Angel set 3546 B 2-12" Marshall



I have longed for a worthy recording of "Solomon" since the far away days of the Columbia History of Music, one of the real joys of which was a perfect performance of the *Nightingale Chorus*. That enchanting section is not perfectly done here; these birds have the daintiness of condors. It is a scandal that Beecham has so heavily edited the original score to start with, however honorable his intentions. But it is worse that he has paced his forces with a drearily square tread — the kind that is so typical of amateur oratorio societies and so atypical of the Handelian spirit. The whole is somewhat redeemed by the soloists. Imperfect or not, however, a must. **JL**

**POULENC: Fiançailles pour rire; Chansons de Gorgio Lorco** A  
 B  
 B  
 Geneviève Touraine, soprano; Francis Poulenc, piano  
 Haydn Society HSL-154 12" Poulenc

The cycle *Fiançailles pour rire* once more demonstrates Poulenc's ability to write for the voice in a supremely convincing manner. Possessed of extreme sensitivity to poetic diction, he combines flowing line with piquant harmonic invention in a personal idiom that conveys intense and often bitter irony. The performance in this recording reveals much rapport between pianist Poulenc and singer Touraine, who is a good musician if not a fine technician. Her vocal limitations are rather more distracting in the three Debussy *Ariettes oubliées*, which demand greater security than she is able to bring to them. The sound is good throughout. **JB**



**STRAVINSKY: "Oedipus Rex"** A  
 Paul Pasquier (Speaker); Ernst Häfliger A  
 (Oedipus) A  
 Helene Bouvier (Jocasta); Société Chorale du Brassus and L'Orchestre de la Suisse Romande under Ernest Ansermet  
 London XLL-1273 12" Stravinsky



This is an eloquent and splendidly recorded version of Stravinsky's monumental opera-oratorio. Ansermet conducts it with drive and precision, and his ensemble responds with first-rate singing and playing. On the whole, it seems to me, this is a better-rounded performance than the Stravinsky-Cocteau version on Columbia, but the most dedicated collectors no doubt will want to keep that one, too, both for Cocteau's contribution and for the presence of the composer. Ansermet's cast is generally excellent; of the principals only Häfliger in the title role falls below par in a few difficult passages. Highly recommended. **RR**

**Canzoni Napoletane** B  
 Tito Schipa, tenor B  
 Durium DLU-96020 10" B

Eight popular Neapolitan songs sung with ravishing style by the sexagenarian tenor. The old beauty of voice peeps through, but ends of phrases suffer from the type of breath control you would expect in a man of Schipa's years. The arrangements, the playing, and the conducting by Mino Campanino are acceptable in this type of material. The recording, however, is apt to break up in loud passages. **CJL**

**Grailville Sings** A  
 (Music of Advent and Christmas) A  
 Audio-Fidelity AFLP-1820 12" A

The loving care which has gone into the selection and performance of this music does much to make it a welcome prelude to the Christmas season. Heard in an unusual program of Gregorian chant, folksong, and polyphonic music of various periods, the unaccompanied voices of the young women of Grailville Community College in Loveland, Ohio, possess a freshness and artlessness that more than compensate for their lack of solid tone or extensive expressive range. Of special interest to those who wish to proceed from listening to singing is the partial list of musical sources printed on the record jacket. Excellent sound. **JB**



KEYBOARD MUSIC

**BACH: The Clavier Partitas** A  
Agi Jambor, pianist A  
Capitol set PBR-8344 2-12'' A

Jambor



Jambor makes an auspicious and belated recording debut with performances which maintain the clarity of Bach's contrapuntal lines, yet never descend to mere rhetoric. Her feel for phrasing, her fluid legato, and her somewhat small, though expressive dynamic range, in all reveals a lifetime of dedicated study which, to my ears, is lacking in the more personalized, deliberated, and slightly over-dramatic playing of Badura-Skoda. Purists may prefer the fine harpsichord version by Kirkpatrick, but if a piano must be used, it should be used with Jambor's excellent taste. Capitol has done its part with beautifully natural keyboard sound. **DHM**

**BACH: Passacaglia and Fugue in C minor; Toccata, Adagio and Fugue** A  
Carl Weinrich, organist A  
Westminster W-LAB 7047 12'' A

Weinrich

This disc is a sonic wonder, but also much more. Weinrich's rhythmic vitality, his formidable technique, and his brilliant choices of registration are all in evidence, as on previous occasions. The Swedish organ, a Baroque-type masterpiece, leaves nothing to be desired in variety of tone color — mellow, yet clear. One may feel a bit uneasy, as I do, at the rather swift tempi, especially in the C major Toccata. But thanks to Weinrich's mastery, as well as the superb job done by Westminster's engineers, there is not the slightest hint of muddiness. The only real competition is Walcha's somewhat slower, more introspective approach. **DHM**



**BEETHOVEN: Sonatas No. 4 in E flat, Op. 7, and No. 5 in C minor, Op. 10, No. 1; No. 6 in F, Op. 10, No. 2, and No. 7 in D, Op. 10, No. 3** A  
Friedrich Gulda, pianist A  
London LL-1372; 1374 each 12'' A

Gulda



These gems of Beethoven's youth appear all too rarely on recital programs. Managers, I am told, do not look upon them as "good box office". Rarer still does this music engage the attentions of such a poet as Gulda. There is no trace here of his avocational "hep-cat" propensities; these performances are the work of a devoted classical artist who has molded each phrase and nuance with loving care. At times there are strange overtones to be heard as well, particularly in the slow movement of the Seventh Sonata. Otherwise the reproduction is quite good. Collectors will be grateful for the consecutive sequence of the couplings. **AK**

**BEETHOVEN: Sonatas, Opp. 109, 110** A-A  
Ernst Levy, pianist B-B  
Unicorn UNLP-1033 12'' A-A

Levy

Levy is a formidable technician and a supposed scholar, but his re-creations here are at times in terrible taste. Thunderous, explosive pianism, almost always coupling a crescendo with an accelerando, a diminuendo with a ritard. Levy rephrases, adds accents, chooses unique tempi. Unorthodox and unpretty. Still, there is the image of Beethoven at the piano, doing just these things to his own music. **EL**

**BEETHOVEN: Sonatas — Op. 109, Op. 110, and Op. 111** A  
Glenn Gould, pianist A  
Columbia ML-5130 12'' A

Gould

I can think of no other new pianist who is endowed with such a fortunate combination of musicality and sensitivity. Such unflagging absorption, such compelling identification; it is rare indeed. Gould's Beethoven is for the most part both poetic and convincing; it is always devoid of the "tyranny of the printed page" that has troubled more eminent interpreters. True, his performance of the first movement of the Op. 111 is too fast and too glib. But in the second movement the calm and serene theme and variations unfold quite classically. In sum, the good so outweighs the bad that we have cause to rejoice. Columbia's stock should rise a point. **OD**



**GOTTSCHALK: 12 Piano Works** A  
Eugene List, pianist A  
Vanguard VRS-485 12'' A

List



A *cordon bleu* to List and to the brothers Solomon of Vanguard for following through with an inspired A & R idea. Programmatically, this must be the most original debut recital in phonographic history, and I do not remember any so engaging, either. A really important contribution to recorded Americana, for New Orleans-born Louis Moreau Gottschalk (1829-1869) was our first real piano virtuoso and, with all due respect to Billings et al., our first celebrated composer. Today, ironically, his pianistic music is known mostly in orchestral guise; balletomanes will note the various sources of "Cakewalk" herewith. For them and others, history at its most palatable. **JL**

**LISZT: Soirées de Vienne** B  
Edith Farnadi, pianist A  
Westminster XWN-18218 A

Liszt sincerely loved the music of Schubert. Dozens of the little Austrian's compositions found their way thus into the repertory of the virtuoso pianist. The nine dance tunes collectively titled *Soirées de Vienne* are among the most successful of these transcriptions. Farnadi unquestionably has a flair for this kind of thing; she plays with real charm and vivacity. Westminster's recording is superior. **WD**

**PROKOFIEV: Sonata No. 2, Op. 14; Sonata No. 3, Op. 28** A-A-A  
**SCHUBERT: Fantasy in C, Op. 15 (Wanderer)** A-A-A  
Gary Graffman, pianist  
RCA Victor LM-2012 12''

Graffman

This debut recording is worth its weight in gold. That anyone could be endowed with such maturity so young is difficult to credit, but the evidence is irrefutable. I anticipate with great impatience the Graffman of ten and twenty years hence. The electrically charged, immensely difficult Prokofiev sonatas date back to student days. This is the young, unpredictable, and sometimes quixotic Prokofiev who was soon to write the *Scythian Suite* and *Classical Symphony* in consecutive opuses. Graffman's command of the scores is complete. The same may be said for his Schubert. Victor has favored its new favorite son with excellent engineering. **AK**



**SCRIABIN: Sonata No. 3 in F sharp minor, Op. 23; 16 Preludes** A to C  
Vladimir Horowitz, pianist A  
RCA Victor LM-2005 12'' A

Absolutely monumental pianism, albeit a little stop-and-go in its flow. On the other hand, who is to adjudicate the interpretation of a Sonata subtitled "State of Soul"? The Preludes are Nos. 1, 3, 9, 10, 13, 14, and 16 from Op. 11, Nos. 1 and 4 from Op. 16, and one each from Opp. 13, 15, 27, 48, 51, 59, and 67. Score-stickers are apprised that Horowitz knew Scriabin and heard him play, which they did not. **JL**

**D. SCARLATTI: 16 Sonatas** A  
Kathleen Long, pianist B  
London LL-1130 12'' R

The harpsichord has come into its own again and it is properly entitled to the music of this great Italian composer. However, pianists do enjoy sharing it and why deny them the pleasure? Long plays with style and grace. Her tone is pleasing and it is captured realistically. The bargain program lists Longo Nos. 129, 256, 14, 119, 45, 46, 265, 209, 10, 223, 142, 315, 292, 382, 325 and 294. **WD**

**SCHUBERT: Fantasy in C, Op. 15 (Wanderer); Moments musicaux, Op. 94** A-B  
Walter Hautzig, pianist B-B  
Haydn Society HS-9000 12'' A-A

Hautzig



This handsomely packaged album signals the return to our midst of the newly-organized and ever welcome Haydn Society. It also represents the phonographic debut of Walter Hautzig. His exposition of the great and lesser Schubert works is essentially lyric, his approach technically assured and musically probing. If we are accustomed to a bit less *rubati*, he more than makes up for it in the grasp and vitality of his playing. I am not familiar with the edition of the *Wanderer* used here; in the restatement of the opening theme the chords falling on the second beat of bars 20, 23, 25, and 27 are consistently omitted. Excellent sound throughout. **AK**

**The Art of Paderewski** B  
14 Piano Works A  
Ignace Jan Paderewski, pianist R  
RCA Victor/Camden CAL-310 12''

Paderewski

This is a bargain and a welcome recognition by Victor that dubbings of many 78s belong in the current catalogue. Today there are few who would be foolhardy enough to challenge the great Paderewski's interpretations of these recital standards by Chopin, Schubert, Schumann, and Liszt. (Of course, certain critics will.) His individualism was entirely valid for the period in which he lived, and all of the music herewith possesses conviction under his fingers. What a gorgeous tone he could produce! If only high fidelity had existed then to capture its full beauty! Do not let the outmoded sound deter you; this is magnificent playing. **WD**

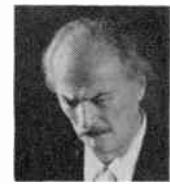

**La Femme** B  
 Franck Pourcel and his French Strings A  
 Capitol T-10015 12" B

To coin a phrase, it is not nice to judge a recording by its cover. But that is just how many a new disc invites or discourages the customer's initial interest, and I am here to tell you that the, er, art adorning the front of this album will bring more attention to it than might otherwise be the case. If I be not mistaken, this is the very first nude to reach LP. Oh, yes, the contents. Well, Pourcel used to be heard on Westminster and his work is more or less predictable. It's all lushness à la Mantovani and easy to take if you happen to be in the mood. Les Baxter's "La Femme" is a twelve-movement sequence of mood studies that need not detain us. JL



MISCELLANY

**Jungle Drums** A to C  
 Morton Gould and his Orchestra A  
 RCA Victor LM-1994 12" A

An exciting hi-fi travelogue of primitive cultures, simulated in sveltly sophisticated treatment but never mind. The disc is especially notable for its restoration to currency of the Fernandez Batuque and the Villa-Lobos *Little Train of the Caipira*. Also included: Ellington's *Caravan*, Falla's *Ritual Fire Dance*, Mooney's *Swamp Fire*, the Hawaiian *War Chant*, Gould's own *Tropical*, and lots of more indigenous exotica. JL

**Ceremonial Music of the Synagogue** A  
 Emil Kaçmann, bass, with chorus and organ A  
 Angel 35295 12" A



One side is devoted to music of the Day of Atonement; the other to prayers sung on the Sabbath and Festivals, along with a section of the Marriage Ceremony. The singing is not in the tradition of Central European orthodoxy; there are no elaborate embellishments. The cantor does not make his effects with trills, cadenzas, or falsetto. Kaçmann's synagogue is the Union Libérale Israélite of Paris. Judging from its name and his singing, the service is modern, with traditional roots. Kaçmann has a rich, appealing voice, somewhat lacking in intensity. The simple arrangements range in time from the sixteenth century to the present. WD

Kaçmann

**The Song of Spain**, Consuelo Rubio, Soprano A  
 Unidentified ensemble under F. M. Torrôba A  
 Decca DL-9817 12" A

Consuelo Rubio's voice is one of the most ecstatically beautiful around for those who like the free, rapturous line of the peasant singer combined with the precise artistry of the trained *Lieder* artist. For those who approve a voice innocent of vibrato, and always on the dead center of the tone, here's another Madeleine Grey. Torrôba's orchestrations, in both idiom and orchestral color, recall those of Canteloube in his *Songs of the Auvergne*; and indeed, these lovely folk pieces from Spain are somewhat similar as material. Torrôba's settings deftly underline, without obscuring, their character. PG-H



**Man's Early Musical Instruments** A  
 Folkways set P-525 2-12" .R

For those whose interest in musical anthropology has not impelled them to follow the releases of this invaluable ethnic label, here is an omnibus of sixty-eight snippets from nearly as many previous Folkways recordings. Accompanying is a splendidly succinct brochure by musicologist Curt Sachs, the acknowledged authority on instruments, who edited the collection. All of the principal cultures are represented. Fascinating. JL

**Spanish Guitar Music** A to C  
 (Works by Sor, Turina, and Falla) A  
**Guitar Music of Villa-Lobos** A  
 and  
 Torrôba  
 Julian Bream, guitarist  
 Westminster XWN-18135, '37 Each  
 12" Bream



The catalogues are full of guitarists, but this English youngster has got something very special. He sounds like — and he is — a former student of Segovia. "Former", I take it, because there is nothing more the master can teach him. Such purity of style and technique is uncommon to say the very least. The first of these discs is given over to seven works by Fernando Sor, five by Turina, and the touching *Tombeau de Claude Debussy* of Falla. The Villa-Lobos sequence comprise the *Five Preludes* of 1940. Properly, the Torrôba grouping belongs with that of Sor; of the composers represented they are the only authentic Spanish Classicists. Ravishing sound. JL

**The Modern Age of Brass** A to C  
 (Dahl: *Music for Brass Instruments*; A  
 Hindemith: *Morgenmusik*; Berezowsky: *Brass Suite*; Sanders: *Quintet in B flat* A  
 Roger Voisin and his Brass Ensemble  
 Unicorn UNLP-1031 12" Hindemith

Writing for brass instruments imposes certain firm limitations upon the composer, and upon the listener, too, after a while. Dahl's piece stands out as the best in this sampling. Although written in the pure Stravinsky idiom, it has strength, rhythmic vitality, and an abundance of original ideas. Hindemith's *Morgenmusik* is an unimportant work. Berezowsky's *Suite* is witty "à la manière des Six"; undoubtedly he was a most gifted composer. The conservative Sanders Quintet does not sustain interest on the whole. Voisin and his ensemble, all of them members of the Boston Symphony, blast away with the utmost precision. Sound is superb. AS



**MOZART: Requiem, K. 626** A  
 Soloists, Chorus, N. Y. Philharmonic under A  
 Bruno Walter C  
 Columbia ML-5012 12"  
 Soloists, Chorus, Vienna Pro Musica under A  
 Jascha Horenstein B  
 Vox DL-270 12" A  
 Horenstein



As it comes to all years, winter has come to the Mozart bicentennial. Henceforth, consideration of new Mozart recordings will be deployed throughout the review section as before. And so, as the editorial writers say, *ave atque vale*. Of this lot of late arrivals a number are welcome indeed. As to certain of the duplications it is difficult to indicate a clear-cut preference. A special vote of thanks should go to Vox, in any case, for devoting an entire month's release to Mozartiana. In addition to the discs listed in the adjoining space, this label has just given us a *Divertimento, K. 563*, coupled with the *Adagio and Fugue, K. 404a*, by the Kehr Trio (PL-9560); the *Quartets, K. 464-5*, by the Barchets (PL-9820); and a program of overtures by

MOZART

**15 Church Sonatas** A to C  
 Eva Holderlin, organist; S. W. German Chamber Orchestra under Rolf Reinhardt A  
 Vox PL-9980 12"

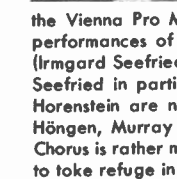

the Vienna Pro Musica under Perlea (PL-8720). All can be recommended. The two performances of the Requiem present a dilemma. Certainly the one under Walter (Irmgard Seefried, Jennie Tourel, William Warfield, Leopold Simoneau) is a joy, and Seefried in particular sings with haunting loveliness. But the Viennese forces under Horenstein are not easily put in second place; the soloists (Wilma Lipp, Elisabeth Höngen, Murray Dickie, and Ludwig Weber) are excellent and the Musikfreunde Chorus is rather more satisfactory than the Westminster Choir. Perhaps it is defensible to take refuge in the price differential, the Columbia version being fully three dollars less expensive if not as vibrantly recorded. The one-disc sampling of organ sonatas is a tremendous buy, brilliantly performed and very well engineered. The contents: K. 67-9, 144-5, 212, 225, 244-5, 274, 278, 328-9, and 336. That comprises all but two of the total sequence. The remaining K. 241 and 263 are included in the Biggs omnibus, in addition to the *Fantasias, K. 594* and 608; *Adagios, K. 356* and 580a; *Fugue, K. 375*; *Andante with Variations, K. 616*; and *Prelude and Fugue, K. 546*. The dry style of this artist is more or less suited to these variously worthy masterpieces; the sound is stunning except in the K. 546; and the accompanying brochure in itself is virtually worth the outlay. Also, the use of several instruments once played by the composer lends an authenticity to the whole. Gulda's way with Mozart is musical,

**A Mozart Organ Tour** A to C  
 E. Power Biggs; Camerata Academica under Bernhard Paumgartner B  
 Columbia set K3L-231 3-12" A  
 Biggs

**Piano Concerti, K. 503, K. 537** A-A  
 Friedrich Gulda, pianist; New Symphony under Anthony Collins C  
 London LL-1370 12" A



and contrariwise, plays as if she loves the composer, and there is a jeunesse in her approach that does not seem to me inappropriate. Late Mozart, after all, is not late Beethoven. Barchet's tone is not pretty but his intonation is impeccable, his overall conceptions eminently Mozartean. Much the same might be said for Schneiderhan. He has the smaller technique to be sure, also the less endearing tone. This notwithstanding Europe values him highly as a Mozart interpreter. And while it is true that we are accustomed to a higher order of virtuosity, our scale of values does not preclude the singleness of expressive purpose evinced by these music-makers of another, older tradition. JL

**Piano Concerti, K. 467, K. 503** A-A  
 Maria Tipo, pianist; Vienna Pro Musica under Jonel Perlea A  
 Vox PL-10060 12" B  
 Tipo

**Violin Concerti, K. 218, K. 219** A-A  
 Wolfgang Schneiderhan, violinist; Berlin Philharmonic, Vienna Symphony Orchestras under Hans Rosbaud, Ferdinand Leitner B-B  
 Decca DL-9857 12" A-A



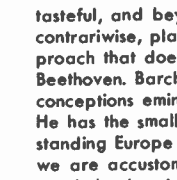



**Violin Concerti, K. 216, K. 219** A-A  
 Reinhold Barchet, violinist; Pro Musica of Stuttgart under Rolf Reinhardt B-B  
 Vox PL-10050 12" A-A  
 Schneiderhan



and contrariwise, plays as if she loves the composer, and there is a jeunesse in her approach that does not seem to me inappropriate. Late Mozart, after all, is not late Beethoven. Barchet's tone is not pretty but his intonation is impeccable, his overall conceptions eminently Mozartean. Much the same might be said for Schneiderhan. He has the smaller technique to be sure, also the less endearing tone. This notwithstanding Europe values him highly as a Mozart interpreter. And while it is true that we are accustomed to a higher order of virtuosity, our scale of values does not preclude the singleness of expressive purpose evinced by these music-makers of another, older tradition. JL



## JAZZ, THEATRE MUSIC, AND POPULAR ALBUMS

<p><b>JAZZ</b> The Magic Horn George Wein's Dixie-Victors RCA Victor LPM-1332 12"</p>	<p>B A B</p>	<p>Pianist George Wein, who triples as Boston night club owner and Newport Jazz Festival producer, pulled a rabbit out of his hat last June when, by assembling a first-class bunch of Dixieland musicians for playing and acting roles, he made a Sunday evening NBC-TV "Alcoa Hour" drama enjoyable despite a ludicrous script. Ruby Bruff's trumpet is heavily featured in this LP of music from the telecast; other joyful solos are by Jimmy McPartland (whose acting was the hit of the show), Vic Dickenson, Peanuts Hucko and Ernie Caceres, seasoned Dixielanders all. Except for the attractive title tune, material comprises serviceable two-beat standards. LF</p>	
<p>Patti Page In The Land of Hi-Fi EmArcy MG-36074</p>	<p>A B A</p>	<p>As the notes point out, "the thin, almost non-existent line between popular singing and jazz singing disappears entirely" as Miss Page is immersed in the bracing waters of Pete Rugolo arrangements. She may have felt like Cinderella at the palace, but the gown and slippers fit well enough to preclude any embarrassment; indeed, she has never been more attractive. Rugolo's big, brassy band includes such men as J. J. Johnson (solo in <i>Taking a Chance on Love</i>), Pete Candoli (<i>Lady Is A Tramp</i>) and Bud Shank (<i>I've Got My Eyes On You</i>). A few more sessions like this and Patti might relax enough to become a really warm, uninhibited jazz singer. LF</p>	
<p>The Glory of Love Jackie and Roy ABC-Paramount 120 12"</p>	<p>A A B</p>	<p>Mr. &amp; Mrs. Roy Kral (Jackie Cain is the pianist's wife and vocal partner) remain unmatched as a jazz-influenced team of musical sophisticates. Their choice of material ranges from no words at all (on Kral's own <i>Miz Margret</i> and Al Cohn's <i>Tain't No Use</i>) to the most complex lyrics around, as in the rapid-fire substitution of adjectives for adverbs on <i>I Love You Real</i>, and the smart East Side balladry of Miss Cain on Alec Wilder's <i>The Winter Of My Discontent</i>. Also heard: Gershwin's <i>Could You Use Me?</i> and <i>Love Is Sweeping The Country</i>, Berlin's <i>The Best Thing For You</i>. Simple, effective rhythm accompaniments have Barry Galbraith on guitar. LF</p>	
<p>Piano Interpretations By Bud Powell Norgran MGN 1077 12"</p>	<p>B A C</p>	<p>With Fats Navarro, Charlie Parker and Clifford Brown gone, one must be thankful that pianist Bud Powell, one of the few geniuses of modern jazz, still is alive and creating. Here he produces nine items, accompanied by the superb bassist George Duvivier and an over-loud, over-recorded drummer, Art Taylor. Powell's style, despite its surgingly intense beat, always sounds completely effortless, as though each phrase represented a flow of thought direct from mind to keyboard with no time out for passage through the fingers. He is at his best on George Shearing's <i>Conception</i>. Despite imperfect balance, this is highly recommended. LF</p>	
<p>Gene Ammons All Star Sessions Prestige LP-7050 12"</p>	<p>B B B</p>	<p>On one side of this heat-radiating couplet is a fairly recent date led by tenor sax man Gene Ammons, son of the late boogie-woogie pioneer Albert Ammons. <i>Woofin' and Tweelin'</i>, a lengthy blues, turns the spotlight on Art and Addison Farmer, trumpet and bass; Lou Donaldson, one of the most Bird-like of the Charlie Parker school, on alto, and Freddy Redd, a talented modern pianist. <i>Juggernaut</i>, a basic riff tune, discloses the same men at a brighter pace. Overleaf are some reissues of 1950 and '51 dates when Ammons was battling Sonny Stitt in two-tenor forays. These efforts have a Norman Granz type of excitement, full-blooded and competitively spirited. LF</p>	
<p>The Cool Sounds of Stan Getz American Recording Society G-407 12"</p>	<p>A A B</p>	<p>Superior samplings of the tenor sax Pied Piper in various small-group sessions over the past couple of years. The titles are mostly standard tunes such as <i>Handful of Stars</i>, <i>Down By The Sycamore Tree</i>, <i>Of Thee I Sing</i>, <i>Flamingo</i>, <i>Serenade In Blue</i>. Getz's work is air-conditioned, room-temperature jazz, cool but never frigid. His sidemen at one time or another include Tony Fruscella, trumpet; Bob Brookmeyer, valve trombone; Jimmy Rowles, Lou Levy, Johnny Williams, pianos; Max Roach, Shelly Manne, drums; Bill Crow, Leroy Vinnegar, basses. The accompanying leaflet by Bill Simon is alone worth a substantial part of the price. LF</p>	
<p>Corky Hale Gene Norman LP-17 12"</p>	<p>B A B</p>	<p>Merrilyn (Corky) Hale is a comely blonde with so much talent that at 25 she hasn't decided what to do with it. She's tried singing with name bands, touring with Liberace as harpist, accompanying Mel Tormé as pianist. In her own LP début she shows that gentle jazz and the harp are compatible, and takes a flute or piano solo now and then. Material: 12 Gershwin and Duke standards. Personnel: West Coasters Howard Roberts, guitar; Larry Bunker, vibes; Red Mitchell, bass; Chico Hamilton, drums. Inadequate liner notes fail to state which flute parts are by Corky and which by Buddy Collette; and the cover shot fails to do justice to Corky's visual charms. LF</p>	
<p>Introducing Milli Vernon Storyville STLP-910 12"</p>	<p>B C B</p>	<p>The singing of popular songs is usually a miniaturist art at best. The practice of placing an inexperienced vocalist in a jazz setting and immediately announcing the discovery of a "great new jazz singer" has gained alarming currency lately. For all the presence of Ruby Bruff's trumpet and Dave McKenna's piano, Miss Vernon is by all odds no jazz singer, as is clearly shown when she goes out of her depth tackling such items as <i>St. James' Infirmary</i>. A strictly pop performance like <i>Every Time</i> is more her speed. Though there are moments of dubious intonation, in general she shows promise as a potential night club or dance band singer — but not as a jazz singer. LF</p>	

### RATINGS OF JAZZ AND POPULAR RECORDS AND TAPE

It must be obvious to everyone that popular music, jazz, and music of the theatre and motion picture, cannot be rated in the same manner as classical music, save for the audio quality of the records. Therefore, the following explanation is given so that you will fully understand the significance of the three letters which appear at the left of reviews of popular, jazz, theatre and motion picture albums:

#### COMPOSITION (Top Letter)

##### A: Extraordinary

Indicates that the collection is of superior character, both from a standpoint of material and programming. Assignment of this rating means an unqualified recommendation.

##### B: Good

In general, the collection is excellent, but additions or substitutions might have made the work more attractive and more lastingly enjoyable.

##### C: Satisfactory

A collection that is highlighted by only a few numbers, yet the over-all is quite acceptable. This might often apply to collections that have a limited appeal, yet are important to those who specialize in specific types of music. It might often apply to collections of historic importance where the artistic performance is the primary factor.

Indicates a superior performance throughout the collection. Assignment of this rating means an unqualified recommendation.

##### B: Good

In general the performance is excellent, save that there are minor imperfections or breaches of artistry.

##### C: Satisfactory

To all intents and purposes an enjoyable recording, yet one that does not qualify for B rating.

#### RECORDING QUALITY

##### (Bottom Letter)

A, B, C: The same as for classical recordings.

R: Indicates a re-issue.

#### PERFORMANCE (Middle Letter)

##### A: Extraordinary

Clifford Brown & Max Roach At Basin Street  
EmArcy MG-36070 12"

B  
A  
B  
  
Brown



This is a final testament to the dynamic quintet that was tragically dismembered last June when trumpeter Clifford Brown and his pianist-arranger Richie Powell were killed in an auto accident. It is also the only LP by the group to feature Sonny Rollins, a tenor sax man held in high esteem by his contemporaries. Powell fashioned ingenious arrangements of such popular songs as *What Is This Thing Called Love?* and *Love Is A Many Splendored Thing*, and of his own composition *Powell's Prances*. Brown, though only 25, was a mature and amazingly skilled musician, his style a logical extension of Dizzy Gillespie's. Bassist George Morrow completes the group. LF

The Drum Suite  
Manny Albam-Ernie Wilkins  
Victor LPM-1279 12"

C  
A  
A

Described as "a musical portrait of eight arms from six angles", this unique set unchains four drummers — Osie Johnson, Gus Johnson, Teddy Sommer, Don Lamond — flashing their virtuosity in a variety of frameworks written and conducted by Albam and Wilkins. Other soloists: Joe Newman, Conte Candoli, Al Cohn, Hal McKusick, and trombonist Jimmy Cleveland masquerading as "Jimmy O'Heigho". The technical assurance of the drummers is never in doubt, but the premise for the whole affair is. Musically, it lacks continuity. Commercially, though, it could hardly help becoming a best seller, for all the world loves a drum roll except jaded critics. LF



Swedish Jazz  
Goesta Theselius  
Bally BAL-12002 12"

B  
B  
B



First among Continentals to dig the new jazz, the Swedes now are represented by many LPs on the U. S. market. Though late, this is one of the best, for Theselius, the pianist-conductor, is the country's most resourceful jazz arranger and he is abetted here by the cream of Stockholm swinging society, including Lars Gullin on baritone, first foreign jazzman ever to win a U. S. critics' poll; Arne Dommerue on alto sax and clarinet, and the brilliant young Bengt Hallberg alternating with Theselius at the keyboard. New to our ears: the first flutist-Swede, Rolf Blomkvist. Material: 12 originals, including a long and comfortable blues. Unsensational but enjoyable. LF

History of Classic Jazz  
Numerous artists  
Riverside set SDP-11 5-12"

A  
A  
A to R

Twenty thousand words of annotation by Charles Edward Smith embellish this handsomely got up outline of "the parent style, root and branch"—by which is meant blues-oriented jazz out of Africa. That it remains "the tree of hope" for "every jazzman", as Smith insists, is perhaps debatable. But there can be no gainsaying the value of Riverside's exhaustive documentary. The ten sides assemble some five dozen examples of the genre, beginning with a sizable band of African and proceeding thence to the domestic transplantations out of which grew (to retain the order of their efflorescence here) the ragtime, blues, New Orleans, boogie woogie, South Side Chicago, Chicago, Harlem, New York, and eclectic revival (or so-called Dixieland) styles. The cast of characters is overwhelming—none of the greats is left out. A superb set. JL

That Towering Feeling  
Vic Damone  
Columbia CL-900 12"

A  
B  
C

Vic sings *You Stepped Out of a Dream*, *Wait Till You See Her*, *Out of Nowhere*, *The Song Is You*, *Spring is Here*, *Let's Fall in Love*, *Smoke Gets in Your Eyes*, *Time on My Hands*, *I'm Glad There is You*, *The Touch of Your Lips*, *All the Things You Are*, and *Cheek to Cheek*. The redoubtable Camarata directs three different accompanying orchestras. On one, trumpeter Buck Clayton is heard against strings. On another, that superb trombonist, Urbie Green, does it with rhythm. Vic, through it all, sings warmly and well. Unfortunately, too much echo was used by the recording engineers. The disc is otherwise highly enjoyable, however. FR



POPULAR

Solitude  
Billie Holiday  
Clef MG C-690 12"

A  
B  
C

For those who care, here are *East of the Sun*, *Blue Moon*, *You Go To My Head*, *You Turned the Tables on Me*, *Easy to Love*, *These Foolish Things Remind Me of You*, *I Only Have Eyes for You*, *Solitude*, *Everything I Have Is Yours*, *Love for Sale*, *Moonglow*, and *Tenderly*. I am not one who is still enthralled by Billie Holiday's singing. The voice is little more than a memory of the great artistry that used to be. FR

Frances Bergen  
Columbia CL-873 12"

A  
C  
A

Bergen offers such as *I Was Doing All Right* and *Let's Begin* with Johnny Eaton's collegiate group; *This is New* and *Better Luck Next Time* with Matty Matlock's swinging Dixieland outfit; and *All I Need Is You* and *Soft Lights and Sweet Music* with Art Van Damme's fine quintet. The latter go it alone on *Shivers*. This lady is an actress rather than a singer (she's Mrs. Edgar B.) but my, what a pretty cover she makes! FR

Sweet — the Trumpet of Ernie Englund  
Cadence CLP-1014 12"

B  
C  
B



Englund is a Swedish-American trumpeter from Urbana, Ill., who since 1953 has been living in the home of his ancestors. Recorded in Stockholm, these sides show him in melodic treatments of a dozen standard tunes — *Stardust*, *Margie*, *Sposin'*, *Blue Room*, *Love For Sale*, *Maria Elena* etc. — backed by Hammond organ, tenor sax, bass and drums. The mood is reposeful throughout, almost somnolent at times. Mr. Englund is a skilled musician but his tendency to resemble Harry James, particularly in excessive vibrato, tends to remove his work from the realm of jazz, or even popular music, bringing him closer to the spirit of the Salvation Army. LF

Johnny Mathis  
Columbia CL-887 12"

B  
C  
C

This thoroughly athletic young man sings *Autumn in Rome*, *Easy to Love*, *Street of Dreams*, *Love*, *Your Magic Spell is Everywhere*, *Prelude to a Kiss*, *Babalu*, *Caravan*, *In Other Words*, *Star Eyes*, *It Might as Well Be Spring*, *Cabin in the Sky*, and *Angel Eyes*. I say "athletic" because the Mathis style is rather like, if you can imagine it, a combination of the voices of Nat "King" Cole, Bill Daniels, and Eartha Kitt. I found it all quite nerve-racking, hardly anything that is going to make a deep impression on the public. The vocalizing is absolutely unique, but the end result is rather akin to participating in a track meet. I'm out of condition. FR



Smart Songs for the Smart Set  
Chris Dane  
Cadence CLP-1010 12"

B  
B  
C

Included are *There'll Never Be Another You*, *My Ideal*, *Stella By Starlight*, *I Had a Love Who Loved Me*, *April in Paris*, *Love You Didn't Do Right By Me*, *I'm Through with Love*, *Paradise*, *Cynthia's in Love*, *In the Wee Small Hours*, *I Understand*, and *A Love Like Ours*. Dane, who is Danish, has a full, pleasant voice, and all of these tunes he handles gracefully. His backing is excellent. Over-all pleasing. FR

Swingin' for Two  
Don Cherry  
Columbia CL-893 12"

A  
B  
C



Songs: *When the Sun Comes Out*, *For You*, *Love Is Just Around the Corner*, *I'll String Along with You*, *I Didn't Know About You*, *So Rare*, *I'm Yours*, *I'm Gonna Sit Right Down and Write Myself a Letter*, *Please Be Kind*, *My Future Just Passed*, *I Don't Care if the Sun Don't Shine*, *Sleepy Time Gal*. Crooner-golfer Don Cherry, now married to Miss America of 1955, is a warm, winning singer — excellent backswing, splendid follow-through, good style. A quarter-finalist rather than a champion, but he always gives a smooth performance. His vocalizing is enjoyable, never tiring. Ray Conniff's orchestra assists in caddy style. Nice album. FR

Ethel Merman  
(A Musical Autobiography)  
Decca set DX-153 2-12"

A to C  
A  
R

Gershwin once warned La Merman against vocal instruction: "It'll ruin you". Sound advice, demonstrable with any of the thirty-four examples of Mermania herewith. She is an irreplaceable artist, and one of the few clearly entitled to this kind of discographic collation. The contents range over her Broadway career from "Girl Crazy" to "Call Me Madam", not forgetting her extraordinary TV marathon of a twelve-month ago. JL



*Above left: Richard Bartelmeess and Lillian Gish appeared in an early radio production of D. W. Griffith's "Way Down East". Above right: Singer Helen Graves during the first full evening broadcast over station WEAJ, on August 3, 1922*



# Do You Remember . . .

There's a Wonderful Thrill to Hearing the Sounds and Voices of Long Ago on NBC's "Recollections at Thirty" — By Shirley Fleming

*Left: Rudy Vallee, first of the famous crooners, presented his "Variety Hour" from 1929 to 1939. Below left: Walter Damrosch conducted NBC's "Music Appreciation Hour". Below right: Bud Abbott and Lou Costello appear with Bobby Clark*





*Above left: Ed Wynn scored success as "The Fire Chief" in 1930's. Above right: Alice Brady during 1926 performance. Mike is concealed in lampshade; she had broadcast jitters. Below right: The late Major Bowes, who originated the "Amateur Hour"*

IF YOU have turned on the radio of a recent Wednesday evening and found yourself startled by the voice of King Edward VIII delivering his speech of abdication, Gertrude Lawrence singing a famous song or two, or W. C. Fields entangled in the meshes of an argument with Charlie McCarthy, you are not "hearing things" — at least, the things you hear have a comfortingly solid explanation of audio techniques behind them. But there is more than mere equipment involved in this remarkable instance of radio's turning back the clock. It started as a bright idea hatched by Bob Wogan, eastern radio program and production manager at NBC, executed by virtue of the immense and priceless collection of master *Continued on page 80*









*Below left: The sound effects crew goes to it in a 1926 production of "Rip van Winkle" which took place in the studio of WGY, Schenectady. Below right: Jim and Marion Jordan, known to millions as Fibber McGee and Molly, as they appeared in 1932*



# Tape Reviews and Ratings

For Names of Reviewers and Explanation of Ratings, See the Record Review Section

- BACH: Cantata No. 140, "Wachet auf, ruft uns die Stimme"** **A**  
**A**  
**A**  
 Soloists, Chorus, Vienna State Opera Orchestra under Hermann Scherchen  
 7½ ips. Double Track  
 Sonotape (Westminster) SW-1037
- Laszlo
- 
- This is one of the finest accomplishments of Scherchen's recording career, and an issue that reflects nothing but credit on Westminster. Scherchen has a capacity for submerging himself in the music he conducts, and when it is as profoundly moving as this cantata is, his performance becomes an emotional experience for his hearers as well. The soloists are Magda Laszlo, Waldemar Kmentt and Alfred Poell, and they sing with understanding and sensitivity on the whole. The chorus and orchestra heed the injunctions of the conductor faithfully and the recording is exemplary in detail, balance and power. Altogether a triumphant exposition of a triumphant work. **WD**
- BEETHOVEN: Sonata in E Flat, Op. 81a; Sonata in C Sharp minor, Op. 27, No. 2; Sonata in D minor, Op. 31, No. 2** **A**  
**A**  
**A**  
 Guiomar Novaes, pianist  
 7½ ips. Double Track  
 Phonotapes-Sonore (Vox) PM-117
- Novaes
- 
- To get the *Les Adieux*, the *Moonlight* and the *Tempest* Sonatas on one tape is a real surprise. For a change, a tape offers more music than the disc it parallels. The *E Flat Sonata* on the record has the *D minor* as its mate, while the *Moonlight* is the filler on a later recording of the *Beethoven Fourth Concerto*. The first two sonatas were issued about five years ago, but the original tapes had better sound on them than the technicians of that day could transfer to discs, as this current "de-transference" to Phonotapes proves. These *Les Adieux* and *Tempest* are about the best performances available and the *Moonlight* is near the head of the list. **WD**
- BEETHOVEN: Sonata, Op. 27, No. 2 (Moonlight); Sonata, Op. 13 (Pathétique)** **B-B**  
**A-A**  
**A-A**  
 Paul Badura-Skoda, pianist  
 7½ ips. Double Track  
 Sonotape (Westminster) SW-1009
- Badura-Skoda
- 
- These are perhaps Badura-Skoda's most successful essays in the realm of the Beethoven piano sonata. The reason, probably, is that he has lived with the *Moonlight* and the *Pathétique* since his student days and they have had time to take shape interpretatively. Given the benefit of music that has become a part of him, Badura-Skoda fulfills his potential as an artist. He has no technical handicaps. He plays as fast as the next fellow and he can color his tone more subtly than most of his contemporaries. This beautifully clear recording presents his fine performances most attractively. My only reservation is that the parallel disc has the *Appassionato* as an added inducement. **WD**
- BEETHOVEN: Symphony No. 5 Philharmonic Symphony of London** **A**  
**B**  
**A**  
 7½ ips. Double Track  
 Sonotape (Westminster) SW-1001
- Scherchen
- Hermann Scherchen allows himself so many uncalled for, albeit carefully thought out, eccentricities (or departures from the traditional interpretation, if one must be euphemistic) as to make this performance almost a lesson in what not to do when doing Beethoven's *Fifth*. The tape is exceedingly brilliant, and the (Royal Philharmonic) orchestra once again responds virtuosically to the conductor's every wish. **EL**
- DVORÁK: Scherzo Capriccioso** **B**  
**B**  
**B**  
**ENESCO: Rumanian Rhapsody No. 1** **B**  
**KODÁLY: Dances of Galanta** **B**  
 Bamberg Symphony under Jonel Perlea  
 7½ ips. Double Track  
 Phonotapes-Sonore (Vox) PM-127
- Perlea
- 
- Jonel Perlea is a good man to have around. Put a stick in his hand and a competent orchestra before him and he'll always deliver a performance of which no one need be ashamed. He has a good ear for balance, ample vitality and respectable musicianship. The music he makes is healthy and not tortured by conductorial idiosyncrasies, yet it does not lack personality. All of these compositions are melodious and lively and tinged with the flavor of eastern Europe. Himself a Rumanian, Perlea has a natural feeling for this music. He leads it with conviction and the orchestra lays to with a will. There is a lot of music on this tape and it is all very well engineered. **WD**
- DVORÁK: 6 Slavonic Dances Philharmonic Symphony of London** **B**  
**A**  
**A**  
 7½ ips. Double Track  
 Sonotape (Westminster) SW-1036
- Rodzinski
- The sixteen Slavonic Dances comprise some of the most attractive examples of nationalism in the musical literature. The six on this tape (Nos. 1, 2, 3, and 5 from Op. 46 and Nos. 2 and 7 from Op. 72) are characteristically varied in style and character from gay to sad, abandoned to refined. These performances (under Artur Rodzinski) preserve the special flavor of each. The recorded sound is handsome. **WD**
- FRANCK: Chorale in E** **A-A-A**  
**BACH: Toccata and Fugue in D minor** **A-B-B**  
**A-A-A**  
 Kurt Rapf, organist  
 7½ ips. Stereo  
 Audiosphere 711-ST
- Audiosphere
- 
- The organ of Vienna's *Piaristenkirche* is quite an instrument to bring into the living room of a New York apartment. With stereo, that is where it actually seems to be. The Aviantic playback machine on which I heard this tape peeled forth as if it had hundreds of pipes, all going simultaneously at times. Rapf plays with plenty of energy and there are exciting moments in his performances. The Bach made a bit of a hit at the New York High Fidelity Show; it must have been played hundreds of times. It is under such conditions that the durability of tape recording really is proved; the last playing sounded as fresh as the first. **WD**
- GLIÈRE: "The Red Poppy" Suite** **B**  
 Vienna State Opera Orchestra  
 7½ ips. Double Track  
 Sonotape (Westminster) SW-1026
- Scherchen
- The propagandistic import of the ballet need not affect our reaction to the music. I find that the latter (under Hermann Scherchen) is part tall corn, part potted palm. Why pay a high price here? For the sound. Also for the *Sailors' Dance*. The score is otherwise inferior to those of countless contemporary Americans. But taste is a curious matter and many a number like this has sold in the millions. **OD**
- GRIEG: Peer Gynt Suites** **B**  
 Philharmonic Symphony of London  
 7½ ips. Double Track  
 Sonotape (Westminster) SW-1025
- Rodzinski
- The eight movements comprising the two orchestral suites that Grieg drew from his complete score jump back and forth in the chronology of the play. They make pleasant, light listening; however, they lack the power that is in the music as it originally was written. Be that as it may, Artur Rodzinski leads finally balanced performance of these popular works and both are taped with brightness and balance. **WD**
- GROFÉ: Grand Canyon Suite** **A**  
 Boston Pops Orchestra under Arthur Fiedler  
 7½ ips. Stereo  
 RCA Victor ECS-17; ECS-D-17
- Fiedler
- A year ago, more or less, this performance was issued on a disc in tandem with Copland's *El Salón México*. In clarity of detail it is no match for Toscanini's, but a case could be made for the proposition that The Maestro gave the music more than it is worth. Be that as it may, Fiedler's conception is the more idiomatic, and it is superior in this respect to the Kostelanetz and Winterhalter versions as well. The composer's own realization, on the Capitol label, has the maximal interest as to authenticity, but he did not have the shimmering virtuosity of the Bostonians at his disposal. In sum, a wonderfully clangorous and Kodachromic evocation. **JL**
- 



**HAYDN: Toy Symphony** B  
**MOZART: Eine Kleine Nachtmusik; A** A  
**Musical Joke** A  
 Pro Music Chamber Orchestra of Stuttgart under Rolf Reinhardt  
 7½ ips. Double Track  
 Phonotapes-Sonore (Vox) PM-148  
 Reinhardt

**KODÁLY: Háry János; Golonta A-A**  
**Donces** A-A  
 7½ ips. Double Track A-A  
 Sonotape (Westminster) SW-3303

**LISZT: 4 Hungarian Rhapsodies** B  
 Edith Farnadi, pianist B  
 7½ ips. Double Track A  
 Sonotape (Westminster) SW-1030

**MOZART: Horn Concertos, No. 1 in D, A**  
**K. 412; No. 4 in E flat, K. 495** A  
 James Stagliano with the Zimblet Sin-fonietta A  
 7½ ips. Stereo  
 Livingston BO 7-5 BN  
 Stagliano

**PROKOFIEV: Suite from "The Love A-A**  
**For Three Oranges"; Classical A-A**  
**Symphony** A-A  
 Philharmonic Symphony Orchestra of London under Artur Rodzinski  
 7½ ips. Double Track  
 Sonotape (Westminster) SW-1038  
 Rodzinski

**PROKOFIEV: Excerpts from "Romeo A**  
**and Juliet"** A  
 NBC Symphony Orchestra under A  
 Leopold Stokowski A  
 7½ ips. Stereo  
 RCA Victor DCS-18; DCS-18  
 Stokowski

**PROKOFIEV: Scythian, Lt. Kijé Suites A-A**  
 Vienna State Opera Orchestra B-B  
 7½ ips. Double Track B-B  
 Sonotape (Westminster) SW-3005

**RACHMANINOV: Piano Concerto No. A**  
**2 in C minor, Op. 18** B  
 Edith Farnadi, pianist; Vienna State Opera A  
 Orchestra under Hermann Scherchen  
 7½ ips. Double Track  
 Sonotape (Westminster) SW-1003  
 Farnadi

**D. SCARLATTI: 6 Sonatas** A  
 Fernando Valenti, harpsichordist A  
 7½ ips. Double Track B  
 Sonotape (Westminster) SW-1031  
 Valenti

**SCHUBERT: Trio No. 1, Op. 99** A  
 Jean Fournier, violinist; Antonio Janigro, B  
 cellist; Paul Badura-Skoda, pianist A  
 7½ ips. Double Track  
 Sonotape (Westminster) SW-1028  
 Janigro

**Music for Sleepwalkers Only** A to C  
 Murray McEachern's Orchestra A  
 7½ ips. Double Track A  
 Bel Canto 104

**New Orleans Jazz** A  
 Paul Barbarin's Orchestra A  
 7½ ips. Stereo A  
 Livingston (Atlantic) AT-7-8-BN

**Music in Motion (Volume 2)** B  
 Lenny Herman Ensemble B  
 7½ ips. Stereo A  
 Livingston T-1089-BN

Despite their gaiety, these compositions are subject to constant scholarly scrutiny. The Geiger counters of musicological prospectors tick madly over the *Toy Symphony*. Michael Haydn, no, Leopold Mozart is the rightful composer, they aver. But we blithely credit it to Joseph Haydn and enjoy it. The *Musical Joke* can be side-splitting if one knows all of the clichés Mozart parodied in it. Most can chuckle at the obvious moments, anyhow, and take the rest of it much as we do other Mozart. His *Eine Kleine Nachtmusik* poses no such problems, and everyone loves it. All three works are done deftly and the recording is bright. WD



Both of these modern works are full to overflowing with engaging folkloric elements that make them immediately acceptable to the widest musical audience. This tape rates lavish praise in almost every division. Artur Rodzinski does a superb job, the "Philharmonic Symphony of London" likewise, and the recording from start to finish is fine, without any of the brashness that is so often mistaken for hi-fi. Recommended. OD

In the heyday of the virtuosi these pieces provided for the requisite mane-tossing. Recordings have a strange way of distilling musical qualities; without the visual aspect that old-fashioned virtuosity loses much of its appeal. So far out of fashion have these works become of late, however, that they now seem almost fresh once more. Farnadi plays them (Nos. 2, 6, 9, 15) very well and her tone is beautifully reproduced. OD



The charm of Mozart's Concertos for French horn and orchestra has never entered the home with such naturalness as it does in this tape. Of course it requires excellent equipment to glean all of the beauty that the recording engineers have captured here. However, the important thing is that this beauty has been captured in its entirety. Stagliano is a master of his difficult instrument and the conductorless (Boston Symphony) ensemble follows his lead with unerring musicianship. This tape is labeled "Volume 2", so I assume that Livingston soon will release the two other horn concertos of Mozart on a companion stereo tape. WD

Rodzinski, who left the American scene after kicking up a mighty storm or two, has come back on tapes and discs to tweak the noses of his detractors in triumph. These are very good performances. I found the suite particularly rewarding; it is conducted and played with high virtuoso skill. The *Classical Symphony* is fine too, but having been introduced to this work by the late Serge Koussevitzky I find that I am conditioned to the latter's manner. Those not so indoctrinated will like this recording. The sound is most satisfactory; in fact there are some moments that are spectacular. OD Highly recommended.



Today, as ever, the beloved "Stoky" is unique for the beauty of sound he can elicit from orchestras not noted for their tonal sheen. Prokofiev's now pathetic, now plangent ballet score is the perfect foil for this particular aspect of the many-faceted Stokowski art. He brings it to life with a lambent glow that evokes the Shakespearean context to perfection. From the three standard concert suites he offers a sequence comprising "Romeo at the Fountain", "Juliet", "Romeo and Juliet", "Romeo at the Tomb of Juliet", and "Death of Juliet". The same performance is available on LP, but only in an omnibus (LM-6028) inspired by the play. JL

Hermann Scherchen's conducting skill is of no mean order, although the Viennese do not exhibit the utmost lustre. What a pity that the American movie industry has not helped to bring such film scores as "Lieutenant Kijé" into being! Prokofiev's essay on the rites of the ancient Scythians is dated 1914 but it sounds less modern today than works by Ives and Stravinsky written earlier than that. OD

The *Grand Style* is a terrific asset in performing this warhorse. The composer was one of the grandest stylists of them all and he set a standard that is still very well remembered and fondly so. Edith Farnadi's performance is aided by excellent recording, but the most magnificent sound cannot compensate for stylistic and interpretative shortcomings, especially as there are a couple of other recordings of this work that exhibit more rapport between performers and composition. Scherchen's interpretation goes along well with his soloists', but it is no closer to the heart of the music. The triumphs garnered by this tape belong to the engineers rather than the performers. WD



Magnified miniatures. The sound is so large that it can actually be mistaken for organ with the harpsichord stop open. Aside from this, and also a hammering left hand which necessitates a treble adjustment, this is a superior recording throughout. Valenti is always an exciting artist and the room vibrates with all sorts of tensions when he plays. The six sonatas that comprise this recital are characteristically adventuresome *morceaux*, each one of which is full of delightful surprises. Included are the infrequently heard Longo Nos. 86, 129, 155, 375, 376, and 407. All have the stamp of greatness and a bit of the mad genius in them. EL

Beautiful music, stunningly captured. The quality of sound is really remarkable considering the vintage of this performance, which was issued on LP as far back as 1951. Unfortunately this group does not generate the excitement that the work deserves, but they play well, particularly Badura-Skoda. One never fails to marvel at Schubert's creation. The proportions of movement to movement, of section to section, of the most serene lyricism to surcharged dynamism, are perfect. The opening of the *Andante* has one of the composer's longest lines; the present threesome does its best playing here, holding the line taut but flexing its tensions. EL



This tape is guaranteed to let sleepwalkers go in peace. The arrangements are smooth as silk and plushy as velvet: *Laura*, *That Old Black Magic*, *My Funny Valentine*, and five other numbers are insinuating and seductive. Besides the trombone, McEachern tackles the bass guitar, clarinet, and saxophone. He also offers some electronic goings-on that the program notes do not explain; nor can I. WD

That grand old-fashioned stuff (*Bourbon Street Parade*, *Bugle Boy*, *Sister Kate*, *Someday Sweetheart*, and *Eh là là*) somewhat newly-fashioned by a combo enlisting drummer Barbarin, trumpeter John Brunious, clarinetist Willie Humphreys, tram Bob Thomas, pianist Lester Santiago, Milton Hinton (!) on bass, and Danny Barker doubling as banjoist and, in the last-listed, as vocalist. Ringing, atmospheric sound all the way. JL

This group is billed modestly as "The Mightiest Little Band in the Land". It plays a familiar program in a nice, easy, relaxed manner: *Say It With Music*, *Sylvia*, *Linger Awhile*, and *Pagan Love Song* are typical of the ten more or less popular pieces listed. The sound is impressive; stereo does all but place a drink in your hand to complete the illusion of being right in your own cocktail lounge. WD

# M.I.T. Auditorium and Chapel

Acoustics of These Buildings Create  
Unusual and Interesting Sound Effects

MASSACHUSETTS Institute of Technology has one of the finest acoustic engineering laboratories in this Country. Particular interest attaches, therefore, to the new Kresge Auditorium and the Chapel at M.I.T. as examples of modern structures representing advanced thought in acoustics and architecture. The successful marriage of engineering and art has always been difficult to consummate, however, to the complete satisfaction of the audience, performers of music or the spoken word and, as of today, the recording engineers who inevitably make their appearance in such places.

Just recently, Peter Bartók made the tape recordings for six Unicorn records of organ and brass ensemble music, the former in the Chapel, and the latter in the Auditorium. We called on him at his office in Steinway Hall, New York City, to get his impressions of the acoustics in these buildings.

Fig. 1 is a cross-section of the Auditorium, designed by Eero Saarinen. The triangular concrete roof, Fig. 3, is supported only at the three corners; *Continued on page 69*

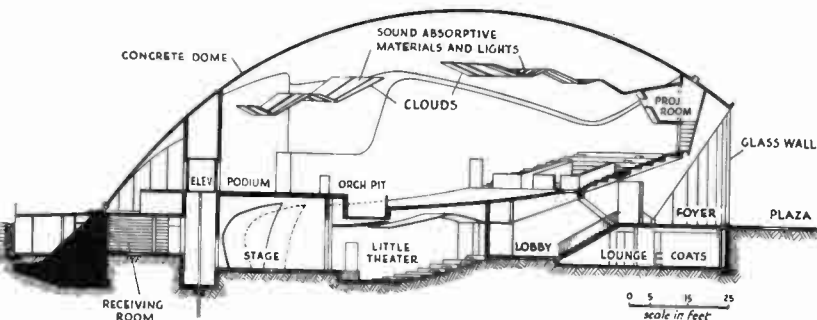

Fig. 1. Cross-section of the Kresge Auditorium designed by Eero Saarinen

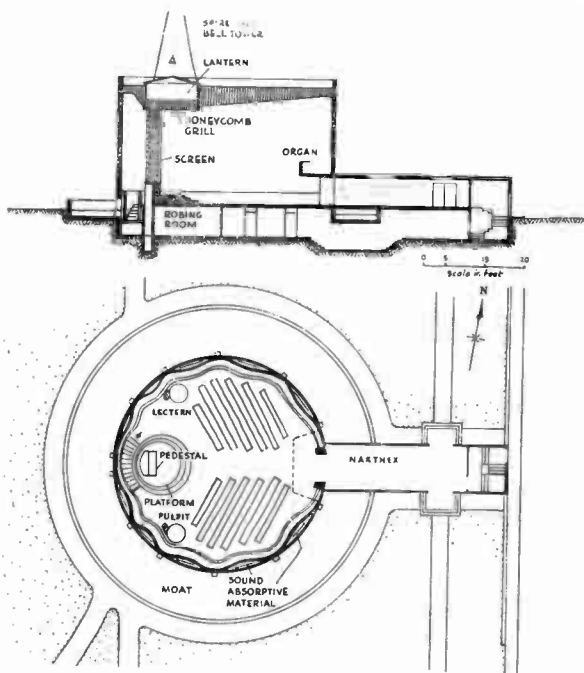
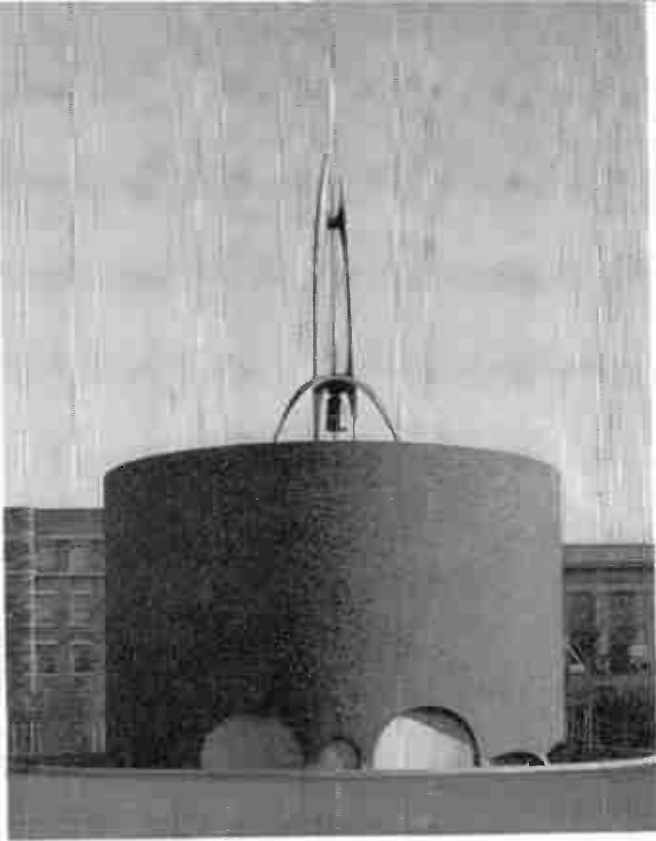

Fig. 2. Construction of the Chapel, featuring unusual acoustic treatment

Fig. 3. The roof of the Auditorium is supported only at the three corners. Dome shape causes an echo effect, making it necessary to use "clouds" of sound-absorbing materials as the drawing shows. This treatment, plus the use of wood walls, makes the auditorium quite dead, except in small areas





*Fig. 4. Quite different from conventional designs is the new Chapel, adjacent to the main buildings in the background*



*Fig. 5. Prof. Klaus Liepmann conducting the Unicorn Concert Orchestra. Lawrence Moe is at the organ*



*Fig. 7. Detail of the Chapel wall. No two curves are of the same radius, a design employed to avoid standing waves. Openings in the brickwork are a part of the acoustic treatment. They are used also for ventilation*

*Fig. 6, left: Prof. Ernst Levy played the Beethoven sonatas recorded for Unicorn at the Auditorium. Fig. 8, left below: Rosario Mazzeo conducted the Roger Voisin brass ensemble for the Unicorn Series. Fig. 9, below: Interior of the Auditorium*





*Notes on Assembling and  
Wiring a Fifty-Watt  
Dyna Power Amplifier*  
— By Harold Taplin

## HI-FI WORKSHOP PROJECT NO. 10

**A**S THE next undertaking in this series of hi-fi workshop projects, the 50-watt Dynakit amplifier was a logical choice, both because it has attracted a great deal of interest, and because of the increasing use of low-efficiency speakers which require a substantial amount of driving power.

The Dyna amplifier can be used with any preamp. For a preamp that does not have its own power supply, a socket is furnished on the amplifier chassis to take off 200 to 400 volts DC at 20 milliamperes, and 6.3 volts AC at 1 ampere. Standard output impedances are 8 and 16 ohms. An additional 4-ohm connection can be ordered at an extra cost of \$5.25.

Fig. 1 shows the complete kit, which includes one 6AN8 tube, two 6AC7/EL-34's, and a 5U4GB or GZ-34 rectifier. All the parts are of excellent quality, and the chassis and cover are of rugged construction, attractively finished.

There are top and bottom views of the printed-circuit panel in Figs. 2 and 3. It comes assembled, with all the connections soldered. This not only reduces the amount of work to be done, but eliminates that part of the assembly where mistakes are most likely to occur.

### First Assembly Stage

The step-by-step instructions are clear and easy to follow. Provision is made for checking off each step — a practice

which is recommended as insurance against skipping a single step. The only tools used to assemble the kit were a screwdriver, side-cutting pliers, and a soldering iron. A pair of long-nose pliers and a pair of diagonal cutters would have made the work a little easier since it was necessary to snip off some of the leads close to the terminals. Rosin-core solder *must* be used, of course. Any flux other than rosin, even though it is described as non-corrosive, is ruled out for this kind of equipment.

Diagram No. 1 illustrates the assembly and wiring steps to be carried out in the first stage. They include mounting of the sockets, the transformers, most of the small parts, and much of the wiring. The photograph in Fig. 4 was taken when the first stage was completed. No problems were encountered. The parts and the chassis fitted together perfectly, and the assembly and wiring were done without a hitch. *Time required: 1 hour, 45 minutes*

### Second Assembly Stage

Work to be done in the second assembly stage is shown in diagram No. 2 of the instructions. In this stage, the printed-circuit panel is mounted, and the assembly and wiring completed. Fig. 5 shows the under side of the chassis with the job finished.

When connections are made to the printed circuit, it is important to transfer as little heat as possible to the solder-filled eyelets. Therefore, the iron should be applied

*Fig. 1, below: The set of parts supplied for assembling the 50-watt Dyna amplifier. Figs. 2 and 3, left: Top and bottom views of the printed-circuit panel as it is furnished in the kit, with parts mounted and leads soldered*

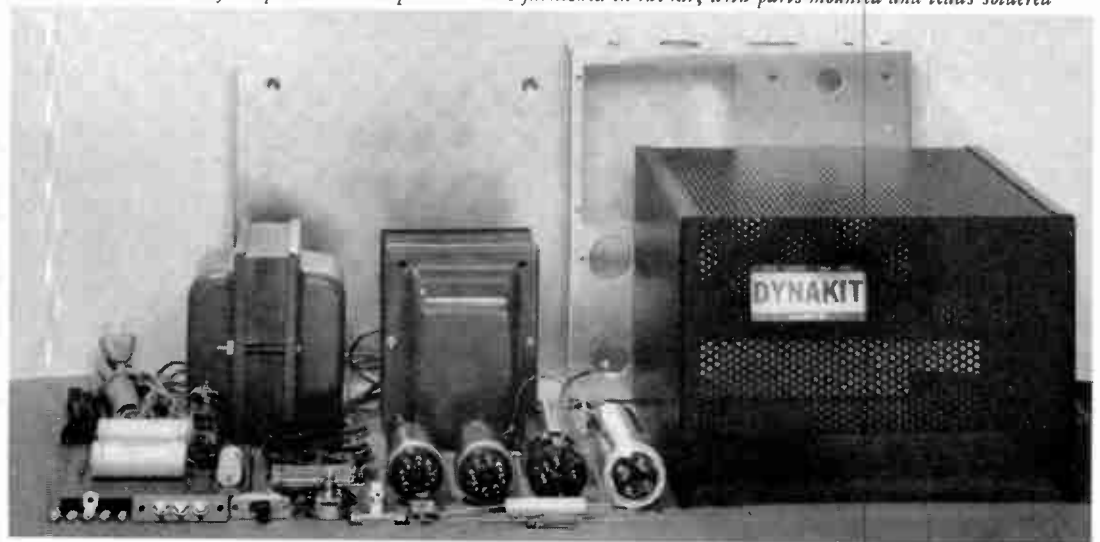
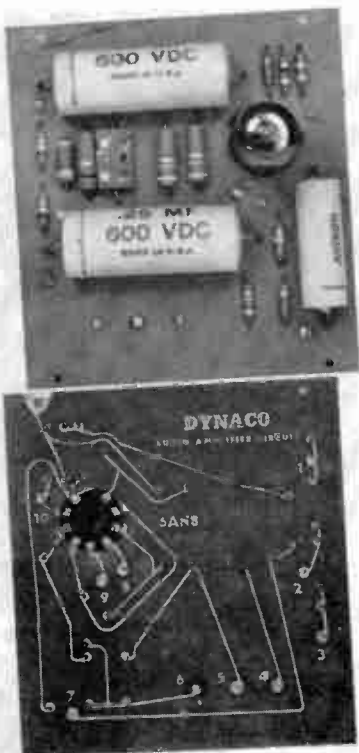

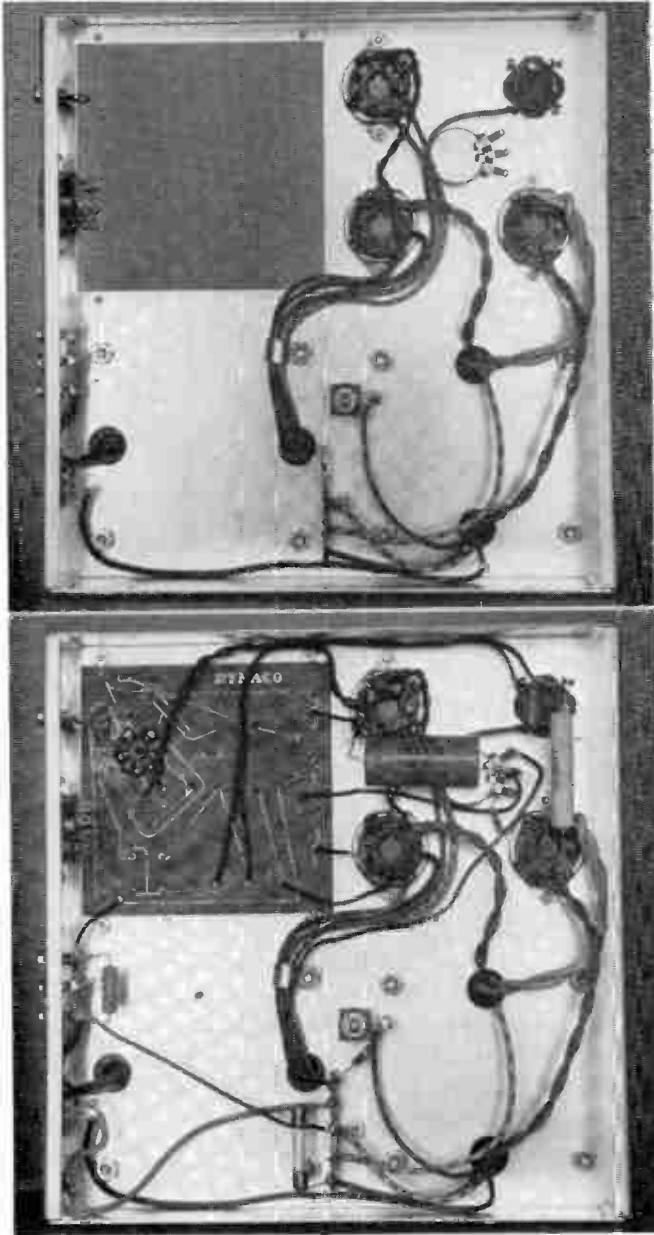

Fig. 4, top: The chassis as it looks with the first assembly stage completed. Fig. 5. All the parts mounted and wired at end of second stage

to the wire until it sinks into the solder, rather than heating the eyelet until the solder melts. This procedure is suggested as a means of avoiding the possibility of melting the printed lead away from the eyelet.

You will notice that the leads to the printed circuit from the sockets, Fig. 5, are dressed exactly the way the instructions specify. Presumably, there was some good reason for this particular detail, perhaps to avoid the possibility of a harmful coupling effect. In any case, when special instructions of this sort are given, it is always advisable to follow them exactly even though, in this instance, the leads could be shortened by running them more directly.

The instructions call for making the leads from the  $\frac{1}{2}$ -watt resistors as short as possible. At the same time, the resistors must not be damaged by over-heating. One way to reduce the amount of heat conducted to a resistor is to hold the lead during the soldering operation with a pair of pliers on the resistor side of the terminal. Thus, the pliers absorb a part of the heat.

The only mistake made by the writer in the course of this stage was a very silly one: Instead of tying a knot in

the line cord *after* the cord was put through the grommet. The knot was tied first! But that error was corrected readily. *Time required: 1 hour, 45 minutes*

#### Notes on the Dyna Amplifier

The instructions explain that the rectifier tube should not be put into the socket at first. Instead, the other tubes should be inserted and the power switched on for a few minutes so that the electrolytic condenser can form at its normal working voltage. Only then should the rectifier be plugged in. This is standard practice with any amplifier. Note also the instructions for checking the resistance from lug 1 of the electrolytic condenser to ground, and for setting the potentiometer. The Handitester (Project No. 9, July-August 1956) is just the instrument for this purpose. It can be used also for making the voltage checks listed in the instruction book.

The performance check made on this amplifier was made with a preamp that had its own power supply. Hence, the power socket was not wired into the amplifier. The instructions, however, explain the connections to be made if operating voltages are required for the preamp. The same socket and cable can be used for switching the amplifier on and off from the preamp, if it is desired to do so.

Altogether, the writer's experience with this kit indicates that its assembly can be undertaken safely by a complete novice, with reasonable certainty of success, and that the performance of the amplifier is such that it will satisfy even the most critical of the hi-fi music enthusiasts.

Fig. 6. Dynakit completed except for cover and bottom plate. Fig. 7. Only the terminals and the power switch are exposed when the cover is in place



# WE RE-DISCOVERED CARUSO'S VOICE

Despite Recording-Speed Variations and Confusion over Musical Pitch, We Discovered How the Real Caruso Voice Sounded, although We Had Never Heard Him — By Donald Karl Hoefler



Fig. 2. The author, right, and music editor Dan Slick

IT SURE sounds better that way, I admit. But it just doesn't sound like Caruso." I was speaking to my music editor, Dan Slick.

Danny was handling musical production and I the recording for "Caruso", the RCA Victor album LM-6127, which presents nearly fifty performances spanning the fabulous Caruso career. Our job was to make new tape recordings of each selection, and to edit them into the correct program sequence for the three LP's.

Each recording had to be as free of noise and distortion as possible, and faithful to the true sound of that renowned tenor voice. But just what was the true Caruso voice? Hardly had I finished uttering my remark about the Caruso record which sounded better than his voice, when Slick and I realized what a fatuous comment it was.

## What Was the Caruso Voice?

I had never heard Caruso in live performance. Neither had Slick. In fact, not many people now living have had that memorable experience. Our best clues, then, to the sound of the Caruso voice were the recordings made during his lifetime and the writings of his contemporaries. The writings, of course, gave us only vague hints.

And what, then, about the many recordings that Caruso made? Are they truly representative of the voice of this great artist? Obviously many people think so. It has been said, in fact, that a sizable number of tenors of this generation, from Rome to New York to Hollywood, have grown up trying to sing as Caruso sounds on the old 78's.

But we know that recording at the turn of the century was, by modern standards, exceedingly crude. So let us suppose — just suppose — that Caruso recordings were in fact *quite* different from the master's voice. Then perhaps with today's equipment and techniques we could correct the faults of the old recordings, and make the real Caruso voice live again. With the enthusiastic blessing of RCA vice-president George R. Marek, this is exactly what Danny Slick and I set out to do.

## Recording Was All Different Then

Our first step was to obtain a good 78 record of each selection scheduled for the new Caruso album. Since our own predecessor company made the records, this would seem

to be a relatively simple problem. In actual fact, it was one of our toughest. This may be understood when we consider the methods of mass duplication of records thirty to fifty years ago.

In those days electrical recording was unknown, the method employed being what we now call *acoustical*. There was a direct mechanical linkage between a horn which collected the sound waves and the cutter which engraved the record grooves. The varying air pressure provided all the power for driving the cutter. The recording material was a very soft wax. Still, there was barely enough force available to engrave it suitably. Thus the recording of more than one record simultaneously was out of the question.

Today we always make two or more original tapes, the spares being known as *safety* or *protection* tapes. But in Caruso's time there simply was no protection at all. There was one original recording and that was the sum of it. And to make matters worse, the single original wax could neither be played nor duplicated without being destroyed in the process!

When used for duplication, the wax surface was first carefully electroplated. A heavy backing was applied to this metal plating. Then the metal was stripped away from the wax. The result was a negative impression of the original. The grooves were represented by ridges, as shown in the cross-section of the metal master in Fig. 1, where the old and new processing methods are shown diagrammatically. This master could have been used to stamp out records in some soft plastic material, but it would have become worn and useless very soon.

To forestall this self-annihilation of precious masters, a three-step method of processing was developed. While a few test pressings may have been struck off from the master, it was used primarily to produce other metal discs known as *mothers*. These were exact positive reproductions of the original recording and, when suitably trimmed to size, could be played like any ordinary record. Their main function, however, was to act as the source of *stampers*, which were once again negative representations of the original. And it was these which were placed in the presses and used in the manufacture of the records sold to the public.

Now why such a roundabout approach to the making

of a record? The answer lies in the multiple reproductions required. While only one metal master could be made from the wax, many mothers could be made from the master, a number of stampers could be made from each mother, and many hundreds of records could be made from each stamper.

But there is a saturation point where no more pressings can be made from the stampers, no more stampers can be made from the mothers, and no more mothers from the master. Since the popularity of Caruso records often pushed production to this saturation point, nearly a half-century later Dan Slick and I were hard put to acquire all the material we needed.

Our best source was a test pressing made from the master at the original time of plating. Lacking this, we often used metal mothers. If neither of those sources was available, we tried to get a new pressing from the master or best stamper. But in some cases we simply had to go out and get commercial pressings from dealers or collectors.

### Problems of Noise and Distortion

Our re-recording equipment, designed by William Miltenberg, manager of recording, is shown in Fig. 2. The rack at the right carries the limiter amplifiers, filters, equalizers, and switching equipment. The small cabinet in the foreground is our variable-frequency power supply, for adjusting the turntable speed and musical pitch.

In re-recording the discs to tape we minimized noise as much as possible. Both high-pass and low-pass filters were used whenever it could be done without harming the music. Often a modified version of the Scott dynamic noise suppressor was used. As for the reproducer, the basic consideration at all times was the best possible contact between groove and stylus. This often meant that the usual rules about stylus angle and force were completely disregarded. Particularly on the metal mothers a very heavy stylus force was used. Since our objective was to get the ultimate in a tape copy, we were not so greatly concerned about the wear and tear on the stylus and record. Instead of the usual vertical stylus, we often used a needle which was tipped forward or raked back. Sometimes the pickup was even rotated slightly, so that the stylus rode higher on one groove wall than the other. The remaining noises, in the form of very brief ticks, were simply snipped out of the tape wherever they occurred.

Stylus angle and force were also paramount factors in minimizing distortion. In a few cases we perceived that

one wall of the groove was in much better condition than its opposite. Then we simply tipped the turntable 10° or so away from horizontal, so that most of the stylus contact was with the good wall of the groove, and tracking was almost hill-and-dale.

Another frequent cause of distortion was now due to an off-center spindle hole. The remedy was to enlarge the hole to about twice normal size, and then orient the record by eye and ear until there was no eccentricity. An unusual gimmick for reducing distortion was the re-recording of a second copy tape from the first, while running the first backwards, and sending the signal through a carefully-adjusted volume-limiting amplifier. Listening to a half hour of this backwards cacophony was more than Slick could endure, but he had to agree that the end result was amazing. For when the second copy tape was reversed end for end and played back correctly, it exhibited far less harmonic distortion! There are a number of theories why this limiter trick works, and why it only works backwards, but they are beyond the scope of this article. At any rate it does help in alleviating distortion to a remarkable degree.

The overall quality was further improved by the judicious use of equalizers and tone controls. We were able thereby to hold down resonant peaks in the original system, and to correct for deficiencies in acoustic balance. The "dead" studios of the time and the necessary bunching together of the artists usually resulted in a very

"dry-sounding" record. We felt that a sound simulating a concert hall would be more appropriate, and so artificial reverboration was often added by means of an echo chamber.

### The Problem of Musical Pitch

Finally, we were faced with the question of correct musical pitch. The records were seldom if ever on pitch when played at the usual speed. There were several reasons for this. The records were made in a number of different places over a period of more than two decades, and standards were simply not tight enough then to assure that every wax master was rotating at exactly 78.26 rpm. And even when standards existed, precise controls did not. The methods of measuring and adjusting speed were necessarily crude.

Pitch corrections can be made very easily by adjusting the speed of the playback turntable by varying the frequency of the current supply to the motor. The problem was to find out what that original speed *Continued on page 83*

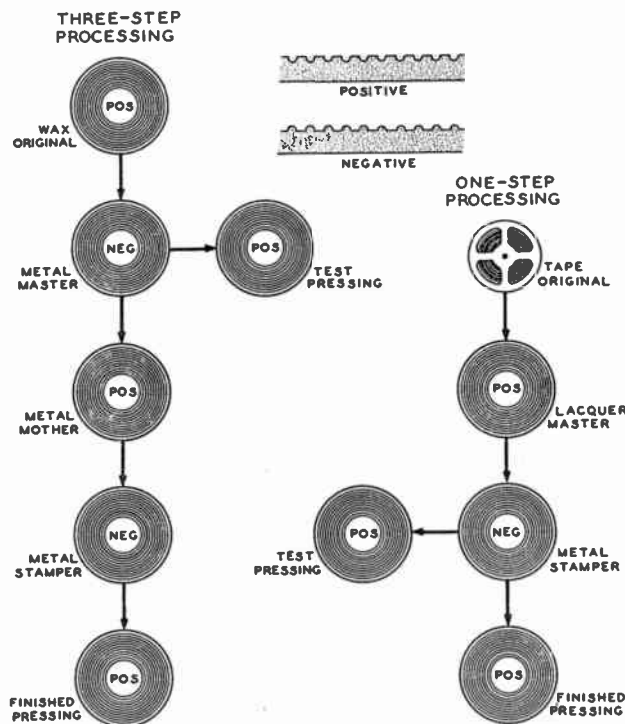

Fig. 1. Processing of records has been vastly simplified and perfected since Caruso's time, as you can see from the diagrams above. And now the original is a rugged tape, instead of an expendable disc of wax

# PLANNING A STEREO SYSTEM

Part 2: A Stereo System is Simpler Than You May Think — By Milton B. Sleeper

**M**ANY PEOPLE have the idea that there is something very technical and complicated about a stereo tape system. Actually, it is very simple indeed, differing from the conventional (monaural) tape equipment only in that an extra amplifier and speaker are required.

The second amplifier and speaker are used because two tracks are recorded simultaneously on the tape, as explained in Part I. The upper track is recorded from a microphone at the left of the singers or musicians, and the lower track from a mike at the right. To reproduce those conditions for playback, the upper head of the machine must be connected through an amplifier to a speaker at the left of your listening position, while the lower head must be connected through another amplifier to a speaker at your right. That's the whole story!

The separate amplifiers and speakers are necessary because the two microphones do not pick up exactly the same sounds, just as you hear different sounds with your right and left ears. That difference enables you to tell what sounds come from the left, and which from the right. A single-channel system, such as a phonograph record or a monaural tape, cannot provide that dimensional effect, even though several speakers are used.

Unfortunately, some of the less ethical manufacturers of small phonographs have equipped their instruments with two or three speakers, and advertised them as giving a "stereo effect". That is not merely confusing. It is downright misleading, because ordinary records provide only one channel. "Stereo" reproduction, in the true meaning of the term, identifies the provision of separate right and left channels.

Some two-channel disc records have been made, requiring the use of two pickups on a single arm. However, stereo phonograph records did not prove practical, and now tape is used exclusively for stereo recording and reproduction.

## Stereo Tape Recorders and Playback Machines

The first stereo tape machines were built for both recording and playback. That was before recorded stereo tapes were available commercially. Thus, to have stereo

music at that time, people had to make their own recordings. Machines that record and play back are relatively expensive, and few can afford them. Moreover, at the beginning, their use was limited to playing back such music as the owners had the opportunity to record.

Meanwhile, although the record companies had all kinds of master stereo tapes, they were not interested in producing copies because so few people had stereo equipment. This impasse was ended with the introduction of less expensive playback-only machines, also called tape phonographs, designed to take stereo tapes and single-track and double-track monaural tapes as well.

Then the record companies were encouraged to make

and sell copies of the stereo tapes made originally during their recording sessions. From that point on, the sale of stereo tapes and playback machines has increased rapidly. The reason is that the musical quality from a stereo tape of a given musical selection is definitely superior to monaural reproduction from a record of the same selection for which the same stereo tape was made.

## The First Stereo Tapes

Master stereo tapes were not made in the beginning with the idea that tape copies would be made for playing on stereo tape systems. The original purpose was to enable the recording engineers to control the mixing of the two channels, so as to produce the most effective balance when they were mixed to make a monaural tape from which master records could be cut.

Consequently, they did not take full advantage of the dimension in sound added by stereo reproduction. More recently, although not invariably, the musicians, or the musicians and singers, are arranged specifically for stereo playback, and the microphones are placed accordingly. Then, to make a master monaural tape to cut records, the two channels are mixed, as before.

Already, stereo tapes of important compositions are available in considerable variety, and the list will be augmented greatly as time goes on.

## Types of Stereo Playback Machines

There are two basic types of stereo playback machines. One is a simple tape deck, carrying the

*Continued on page 69*

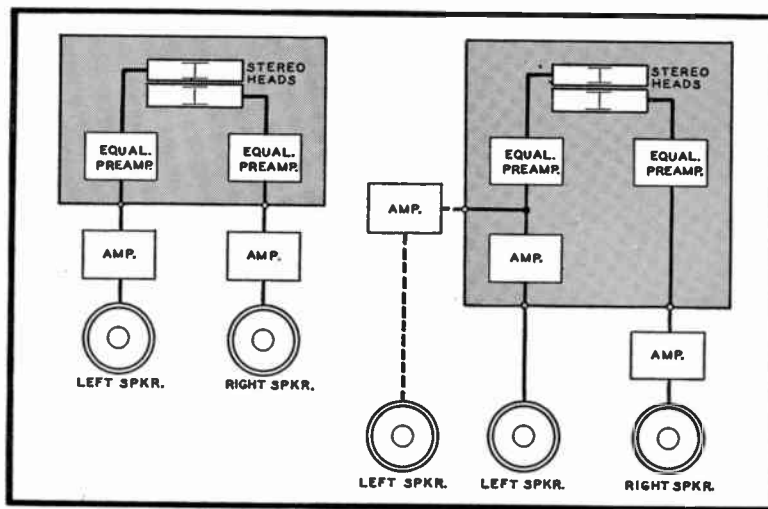

Fig. 2. Left, a tape deck with built-in equalizers and preamps, used with external amplifiers and speakers. Right, a tape deck with equalizers, preamps, and one amplifier, used with one or two external amplifiers. Latter should have tone controls





# READERS' ROUNDTABLE

*The New Topic for Discussion Is the Audio Quality of FM Broadcasting — Are the Stations in Your Area Making the Most of FM's Capabilities?*

**FM** broadcasting *can* provide audio quality superior to the best obtainable from records or tape. This capability was recognized by the Federal Communications Commission when engineering standards were set up for the proof-of-performance tests under which a station must qualify before its license is issued by the FCC.

There is a definite implication in the engineering standards, therefore, that the Commission intended to require FM stations to make available to their listeners the full audio capabilities of FM transmission. But are they doing it? A few years ago, the typical audio quality of broadcasting was accepted without complaint, just as we accept the normal (however limited) quality of the telephone. People complained about radio reception only when static was heavy, just as they complain about a telephone connection only when speech from the other end becomes unintelligible.

Since the advent of hi-fi reproduction, however, listeners in increasing numbers have become more and more critical of broadcast quality. Just as they now object to needle scratch from records, so they have turned to FM to get away from AM background noise and interference. But they expect the same improvement in audio quality on FM radio that has been made in records and tape.

What are the FM broadcasters doing about this? We know that demands of the musicians' union have increased the cost of live music to the point of virtually eliminating it from radio programs. Nor do we expect much by way of audio quality on network operation because the connecting telephone lines are only equalized to handle a part of the audio spectrum.

Nevertheless, taped programs originating at an FM station's own studio should be virtually equivalent to live music, and records should sound as good or somewhat better than when they are played at home. Even speech should be so crisp and clean on FM as to make you feel that the announcer is standing right behind your loudspeaker.

**It Should Be That Way**

That's the way your FM reception should

be. But is it? Can you switch from AM to FM with the same program and hear a decided lift in the audio quality? Are the stations in your area making the most of FM's capabilities?

If so, they are performing an important service to listeners who want, appreciate, and enjoy hi-fi radio programs, and their efforts deserve public recognition. If not, the fact should be brought publicly to their attention. This is a matter of interest to the FCC, too.

Accordingly, we shall make this the subject of our forthcoming Readers' Roundtable discussions. Whether you want to praise or criticize the programming of your local FM stations, we would like to have your comments and opinions.

## **Awards for Your Letters**

We shall publish as many of the letters as possible in the January-February issue, and checks of \$25.00 will be sent to the writers of the two most interesting letters postmarked before December 1st. The next three best letters will win lifetime subscriptions to Hi-Fi Music Magazine.

To start the discussion, we asked James Lyons, our Music Editor, to do some critical listening to New York City FM stations and to report on what he heard. Just at this time we received an open letter addressed to the Federal Communications Commission by H. Peter Meisinger, director of engineering at L. E. E., Inc., Washington, D. C. He is an audio engineer of long experience in broadcasting. Here is what they had to say:

**James Lyons, New York City** — I live and listen in mid-Manhattan, so that even the weakest of New York City's FM stations enjoy a theoretical equality of opportunity to stay my itchy right thumb and index finger.

Perforce, I suppose, the quality of sound emanating from any one source is variable to say the least. That is the only generalization I will permit myself — that, and the parallel conviction that *all* stations need to tighten up on their sonic standards.

From my own broadcasting experience I know that records are subject to the whimsy of the control booth. This fact alone tends to invalidate any remarks as to

audio capabilities of the receiving equipment on the living room end, not to mention the variable sonic attributes of the records themselves.

Listen to "While the City Sleeps" over WNYC, as I have done from midnight to one ayem or so since I can remember, and you will hear a dramatic demonstration of mostly unretouched variety of recorded sound. This program is devoted to new discs largely, and the engineers on the late staff happily do not worry their dials. What happens is that the listener finds himself constantly raising or lowering the volume level to compensate for the range involved. But there is no monkey business about the sound *quality*; what you hear is what is on the disc.

All said and done, it seems to me that the imponderables of broadcasting recorded music are such that these remarks might be centered more profitably on the quality of the human voice (*i.e.*, not recorded) and that of live music over FM.

Needless to say, there are numerous militating factors in this matter, also. Too often an announcer or a newscaster is careless in his mike technique, or uses an approach that is as incorrect for one mike as it might be correct for another (meaning distance from lips, angle, and so forth). Two or more people of different voice levels on one mike can frustrate the most conscientious engineer. Then there is the problem of acoustics, especially when a busy schedule takes the listener from studio to studio.

I am trying to be the devil's disciple just a little bit, out of compassion. It is not easy to be tolerant, however. In the middle morning there is an unsettling and violent change of quality over WRCA that I do not understand. Through 10:00 A.M. all is as usual, which means average quality. But the moment "Bandstand" comes on, things start happening. At first one is horrified; the emcee's voice might be coming out of an old Atwater Kent receiver, and the expensive musical talent suggests the effect of a juke box as heard from the opposite end of a restaurant.

Shortly, however, the sun breaks through the clouds. Mere seconds later,

*Continued on page 74*



*You Can't Judge a Book By Its Cover,  
nor Hi-Fi Equipment By Its  
Outward Appearance. Here Are  
Photographs Showing the Actual  
Inside Construction of New Components*

## "INSIDE INFORMATION"

**Bogen model ST-10 stereo amplifier.** This unit is designed for use with stereo tape decks of various types. Basically, the instrument contains two preamps with NARTB equalizing characteristics, and one 10-watt amplifier. Circuits and connections are provided to meet different requirements, according to the particular type of tape deck employed.

Channel 1 circuit starts with a preamplifier, followed by a treble cut control and volume control, feeding a 10-watt amplifier. The amplifier output goes to a terminal strip for speaker connections of 4, 8, and 16 ohms.

Channel 2 circuit starts with a preamplifier, followed by a volume control ganged with the Channel 1 volume control, and terminating in a cathode follower. Output jack for this channel, at the left of the group of three, is marked CH2. The output is about 1/2 volt, so that connection can be made directly to a power amplifier or to the high-level tape input of a separate preamplifier.

If there are no preamps on the tape deck, connections should be made to the TAPE INPUT jacks 1 and 2, and jumpers must be run from PA OUTPUT jacks 1 and 2 to corresponding AUX INPUT jacks 1 and 2. The system is then completed by connecting one speaker to this unit, and a separate amplifier and second speaker.

If the tape deck is equipped with preamps, connections should be made

directly to AUX INPUT jacks 1 and 2.

In either case, the volume control regulates both channels, but the treble control is in Channel 1 only.

Tubes are two 12AD7's for the preamps, 6C4 cathode follower, 6U8 phase inverter, two 6AQ5 output tubes, 6BQ4 rectifier. Price is \$52.50, or \$59.50 with cover and legs as illustrated. *David Bogen Co., Inc., Paramus, N. J.*

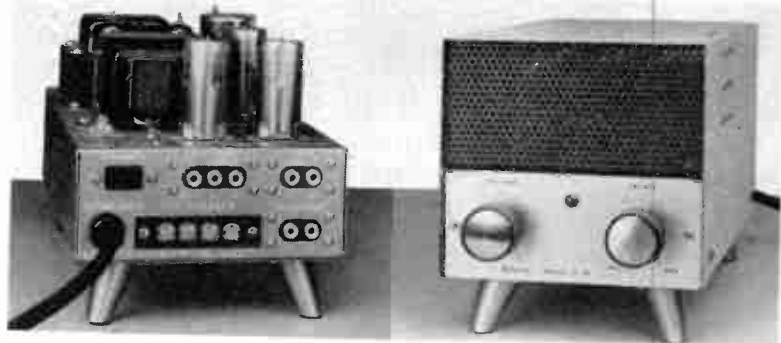

*Bogen unit for stereo tape systems contains two preamps and one 10-watt amplifier*



**Rek-O-Kut professional B16H three-speed turntable and C7B cabinet.** For many home installations this combination offers the advantage of housing a preamp and an amplifier, making a complete unit except for the speaker. If desired, one or both doors can be replaced by instrument panels,

making the controls available at the front.

The cabinet is 22 ins. wide, 33 high, and 20 1/2 deep. Price of the metal cabinet only is \$115, plus \$240 for the professional 16-in. turntable, and \$29.95 for the long tone arm. *Rek-O-Kut Co., 38-01 Queens Blvd., Long Island City, N. Y.*

**Stephens model E1S enclosure and speaker system.** This high-styled enclosure, designed by Charles Eames, is mounted on a stand, so that it can be swung around to face any direction, as desired, a feature that makes this model particularly suited for use in stereo systems.

Speakers provided are the Stephens 120LX woofer and wide-range 214 super-tweeter, with 16 ohms impedance. The enclosure is 21 5/8 ins. high, 29 3/4 wide, and 13 1/8 deep. The stand adds 7 ins., making the overall height from the floor 28 5/8 ins. Price is \$258. *Stephens Tru-Sonic Inc., 8538 Warner Dr., Culver City, Calif.*

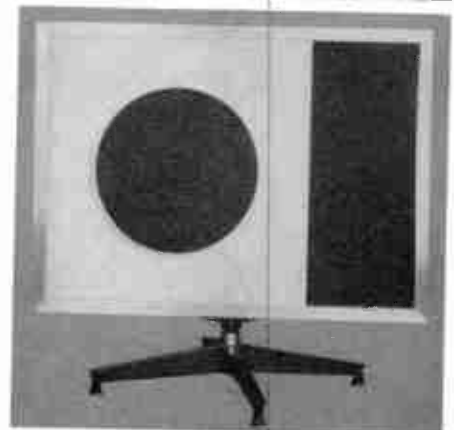

*Left, Rek-O-Kut turntable and cabinet. Right, new Stephens speaker system*

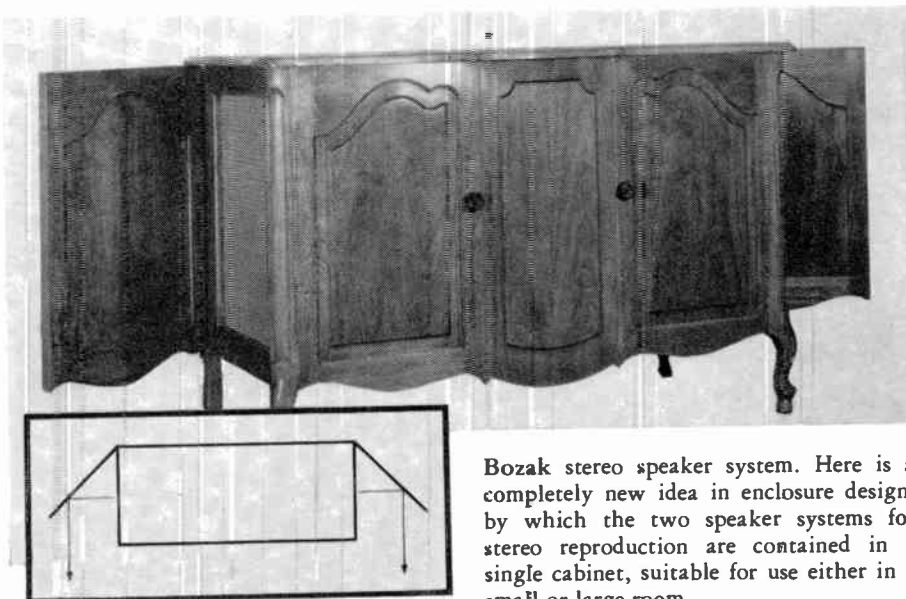

**Bozak stereo speaker system.** Here is a completely new idea in enclosure design, by which the two speaker systems for stereo reproduction are contained in a single cabinet, suitable for use either in a small or large room.

In this model, a 302 speaker system comprised of a woofer, midrange speaker, and dual tweeters, is mounted at each end of the cabinet, facing left and right. There are no doors at the front. The doors are at the ends, as the photograph and insert sketch show. With the cabinet backed up against a wall, and the doors open at 45°, the sound is reflected forward. This arrangement has the advantage of locating both speakers in a single and very handsome enclosure. At the same time, it provides adequate separation of the two sound channels — much greater separation than if the speakers were at each end facing forward.

If you should have this system without knowing that it was being used for stereo reproduction, you would immediately recognize the stereo effect. Dimensions of the walnut cabinet are 48 ins. long, 20 deep and 32 high. Price \$820. R. T. Bozak Sales Co., Darien, Conn.

**Janszen electrostatic speaker** with rated response to 70 cycles is intended for use alone or with a woofer if reproduction of low organ notes is required. There are 5 tiers of 5 elements. Controls at the rear adjust rolloff of two bottom tiers, and next two tiers, and the overall rolloff. There is an overload indicator at the front, with an adjustment for setting it at the desired level at the rear. Impedance is 16 ohms. The outside dimensions of the frame are 36 ins. wide by 39 high. This model has been demonstrated at the audio shows, but deliveries are not expected to start until next summer. Price will be about \$500. Nesbamy Electronic Corp., Easton Rd., Nesbamy, Pa.

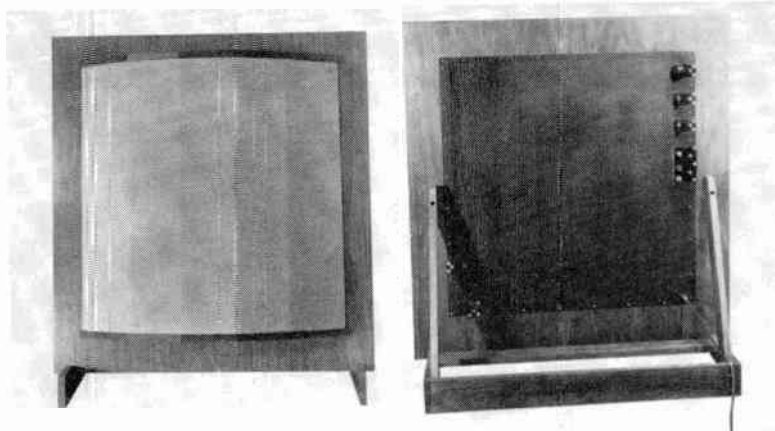

**Gray Research model AM-50 power amplifier.** Latest addition to their line of hi-fi components is this 50-watt amplifier using the Dyna circuit, intended to give high stability at the extremes of the audio range. At this time of writing, samples had been in continuous operation for two weeks, indicating that, provided there is

ample ventilation, this model need not be switched on and off, but can be allowed to run continuously with the power on, in accordance with the usual broadcast station practice. A take-off socket is provided for supplying voltages to a preamp if it does not have its own power supply.

Tubes employed are one 6AN8 and two

EL34 or 6AC7 output tubes, with a 5U4GB or G234 rectifier. Output impedances are 8 and 16 ohms. The chassis measures 12 ins. wide, 8 deep, and 10½ high overall. Weight is 35 lbs., price \$134.50. Gray Research & Development Company, Manchester, Conn.

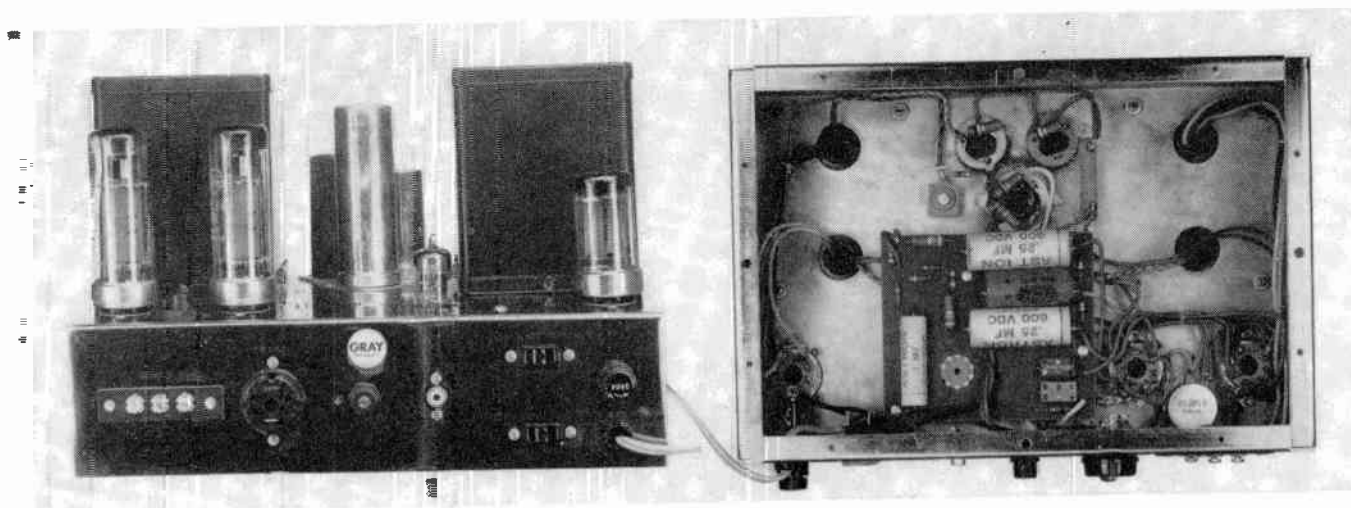

Illustrated on this page: The Bozak stereophonic speaker system, Janszen wide-range electrostatic speaker, and the Gray 50-watt power amplifier

# Fine High-Fidelity is for you too . . .



You can enjoy savings without sacrificing quality—if you “build-it-yourself” and eliminate labor charges; and if you buy direct from the manufacturer and eliminate extra profit.

## Here's what you get:

High-fidelity amplifiers, tuners, and speakers that you *assemble yourself*, from the step-by-step instructions furnished. You get, top-quality parts at lower cost through Heath mass purchasing power. You get the equivalent of systems costing approximately twice the Heathkit price.



MODEL BC-1

### MATCHING CABINETS

The Heathkit AM tuner, FM tuner, and preamplifier kits may be stacked one on the other to form a compact “master control” for your hi-fi system.



BC-1

FM-3A

WA-P2



MODEL WA-P2



MODEL W-3M

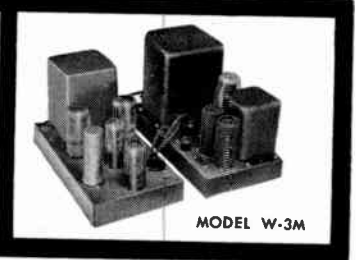

MODEL W-3M



MODEL FM-3A

## HERE'S WHY A **Heathkit**<sup>®</sup> IS FUN TO BUILD:

Instructions are *complete*, and our amazing step-by-step method, tied-in with large pictorial illustrations, guide the beginner through each stage of assembly. If you can follow directions you can succeed, and can build high-fidelity equipment you will be proud to show off to your family and friends.



## Here's the proof:

Thousands of Heathkits have been built at home by people just like yourself, and you should treat yourself to this same experience by dealing with the world's largest manufacturer of top-quality electronic kits for home and industry.

**Heathkit Model FM-3A High Fidelity FM Tuner Kit**

Features A.G.C., and stabilized, temperature-compensated oscillator. Ten uv sensitivity for 20 DB of quieting. Covers standard FM band from 88 to 108 mc. Ratio detector for efficient hi-fi performance. Power supply built in. Illuminated slide rule dial. Pre-aligned coils and front end tuning unit.

**\$269.5\***  
(With Cabinet)  
Shpg. Wt. 7 Lbs.

**Heathkit Model BC-1 Broadband AM Tuner Kit**

Special AM tuner circuit features broad band width, high sensitivity and good selectivity. Employs special detector for minimum signal distortion. Covers 550 to 1600 kc. RF and IF coils pre-aligned. Power supply is built in.

**\$269.5\***  
(With Cabinet)  
Shpg. Wt. 8 Lbs.

**Heathkit Model WA-P2 High Fidelity Preamplifier Kit**

Provides 5 inputs, each with individual level controls. Tone controls provide 18 DB boost and 12 DB cut at 50 CPS and 15 DB boost and 20 DB cut at 15,000 CPS. Features four-position turnover and roll-off controls. Derives operating power from the main amplifier, requiring only 6.3 VAC at 1 a. and 300 VDC at 10 ma.

**\$217.5\***  
(With Cabinet)  
Shpg. Wt. 7 Lbs.

**Heathkit Model W-5M Advanced-Design High Fidelity Amplifier Kit**

This 25-watt unit is our finest high-fidelity amplifier. Employs KT-66 output tubes and a Peerless output transformer. Frequency response  $\pm 1$  DB from 5 to 160,000 CPS at one watt. Harmonic distortion less than 1% at 25 watts, and 1M distortion less than 1% at 20 watts. Hum and noise are 99 DB below 25 watts. Output impedance is 4, 8 or 16 ohms. Must be heard to be fully appreciated.

**\$597.5**  
Shpg. Wt. 31 Lbs.  
Express Only

**MODEL W-5:** Consists of Model W-5M above plus Model WA-P2 preamplifier. Shpg. Wt. 38 Lbs. Express only **\$81.50\***

**Heathkit Model W-3M Dual-Chassis High Fidelity Amplifier Kit**

This 20-watt Williamson Type amplifier employs the famous Acrosound Model TO-300 "ultra linear" output transformer and uses 5881 output tubes. Two-chassis construction provides additional flexibility in mounting. Frequency response is  $\pm 1$  DB from 6 CPS to 150 kc at 1 watt. Harmonic distortion only 1% at 21 watts, and 1M distortion only 1.3% at 20 watts. Output impedance is 4, 8 or 16 ohms. Hum and noise are 88 DB below 20 watts.

**\$497.5**  
Shpg. Wt. 29 Lbs.  
Express only

**MODEL W-3:** Consists of Model W-3M above plus Model WA-P2 preamplifier. Shpg. Wt. 37 Lbs. Express only **\$71.50\***

**HEATHKIT SPEAKER SYSTEM KITS**

These speaker systems are a very vocal demonstration of what can be done with high-quality speakers in enclosures that are designed especially to receive them. Notice, too, that these two enclosures are designed to work together, as your high-fidelity system expands.

**Heathkit Model SS-1 High Fidelity Speaker System Kit**

Employing two Jensen speakers, the Model SS-1 covers 50 to 12,000 CPS within  $\pm 5$  DB. It can fulfill your present needs, and still provide for future expansion through use of the SS-1B. Cross-over frequency is 1600 CPS and the system is rated at 25 watts. Impedance is 16 ohms. Cabinet is a ducted-port bass-reflex type, and is most attractively styled. Kit includes all components, pre-cut and pre-drilled, for assembly.



**\$399.5**  
Shpg. Wt. 30 Lbs.

**Heathkit Model SS-1B Range Extending Speaker System Kit**

This range extending unit uses a 15" woofer and a super-tweeter to cover 35 to 600 CPS and 4000 to 16,000 CPS. Used with the Model SS-1, it completes the audio spectrum for combined coverage of 35 to 16,000 CPS within  $\pm 5$  DB. Made of top-quality furniture-grade plywood. All parts are pre-cut and pre-drilled, ready for assembly and the finish of your choice. Components for cross-over circuit included with kit. Power rating is 35 watts, impedance is 16 ohms.



**\$999.5**  
Shpg. Wt. 80 Lbs.

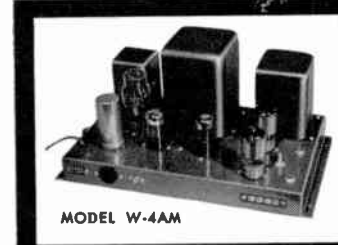

MODEL W-4AM

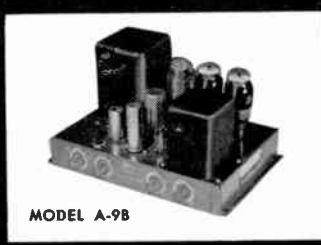

MODEL A-9B



MODEL A-7D



MODEL XO-1

**Heathkit Model W-4AM Single-Chassis High Fidelity Amplifier Kit**

The 20-watt Model W-4AM Williamson type amplifier combines high performance with economy. Employs special-design output transformer by Chicago Standard, and 5881 output tubes. Frequency response is  $\pm 1$  DB from 10 CPS to 100 kc at 1 watt. Harmonic distortion only 1.5%, and 1M distortion only 2.7% at this same level. Output impedance 4, 8 or 16 ohms. Hum and noise 95 DB below 20 watts.

**\$397.5**  
Shpg. Wt. 28 Lbs.

**MODEL W-4A:** Consists of Model W-4AM above plus Model WA-P2 preamplifier. Shpg. Wt. 35 Lbs. Express only **\$61.50\***

**Heathkit Model A-9B 20-Watt High Fidelity Amplifier Kit**

Features full 20 watt output using push-pull 6L6 tubes. Built-in pre-amplifier provides four separate inputs. Separate bass and treble tone controls provided, and output transformer is tapped at 4, 8, 16 and 500 ohms. Designed for home use, but also fine for public address work. Response is  $\pm 1$  DB from 20 to 20,000 CPS. Harmonic distortion less than 1% at 3 DB below rated output.

**\$355.0**  
Shpg. Wt. 23 Lbs.

**Heathkit Model A-7D 7-Watt High Fidelity Amplifier Kit**

Qualifies for high-fidelity even though more limited in power than other Heathkit models. Frequency response is  $\pm 1\frac{1}{2}$  DB from 20 to 20,000 CPS. Push-pull output, and separate bass and treble tone controls.

**\$186.5\***  
Shpg. Wt. 10 Lbs.

**MODEL A-7E:** Same, except that a 12SL7 permits preamplification, two inputs, RIAA compensation, and extra gain. **\$20.35\*** Shpg. Wt. 10 Lbs.

**Heathkit Model XO-1 Electronic Cross-Over Kit**

Separates high and low frequencies electronically, so they may be fed to separate amplifiers and separate speakers. Selectable cross-over frequencies are 100, 200, 400, 700, 1200, 2000, and 35,000 CPS. Separate level control for high and low frequency channels. Minimizes inter-modulation distortion. Attenuation is 12 DB per octave. Handles unlimited power.

**\$189.5**  
Shpg. Wt. 6 Lbs.

\*Price includes 10% Fed. Excise tax where applicable.

**HOW TO ORDER:**

It's simple—just identify the kit you desire by its model number and send your order to the address listed below. Or, if you would rather budget your purchase, send for details of the HEATH TIME-PAYMENT PLAN!



**HEATH COMPANY**

A Subsidiary of Daystrom, Inc.

BENTON HARBOR 5, MICHIGAN



**HEATH COMPANY** A Subsidiary of Daystrom, Inc.  
BENTON HARBOR 5, MICHIGAN  
Please send Free HEATHKIT catalog.

Name \_\_\_\_\_  
Address \_\_\_\_\_  
City & Zone \_\_\_\_\_ State \_\_\_\_\_

## THOSE STRANGE SOUNDS

*Continued from page 38*

nights. Our understanding and appreciation of this kind of music, which we feel is a distinct part of the American way of life, grew constantly. We feel most fortunate for that experience because it added a dimension to our studies of the classical repertoire at Juilliard. We found that there is an untold wealth of good music to be found in the works of such composers as Gershwin, Kern, Rodgers, Porter, Duke, and many others.

While teaching at Juilliard we were building a large two-piano repertoire. Besides studying nearly every existing work originally written for two pianos, we also did, and still do, a great deal of arranging. At that time, we came up with our first new sound. It was in Ravel's *Bolero*. Not satisfied with the repeated *G* on the piano, we spent a great deal of time and effort searching for a sound which would closely resemble the unsnared drum sound of the orchestral version. By using a rubber wedge which we have since come to call a *mute*, because of its resemblance to the violin mute, we found a sound was very close to what we wanted. We were so well pleased with the results that we decided to continue with our experiments. By holding the keys down and strumming the strings, we were able to simulate the harp. And so it went from one new sound to another. With each discovery we became more and more fascinated with what we now realize are the unlimited possibilities of the piano.

Although our early experiments were expressly designed to closely match the sounds of other instruments, our work in the past four years has been aimed at finding as many new sounds as possible from only our two pianos. If any of these sounds resemble other instruments it is purely incidental, for we are no longer interested in imitation. Our purpose is to exploit to the fullest an instrument which for two centuries has been recognized by its distinctive sound, and to create completely different sounds.

As to our method of arranging tunes to utilize these new sounds: Most of the time we choose a composition first, and then try to fit the mood of the piece with certain sounds. At other times, we find the sounds first, and then seek out the tune

which these sounds fit best. Either way, we are confronted with the double problem of making a two-piano arrangement, and at the same time incorporating sounds to further enhance that arrangement.

Throughout *Soundproof*, you will hear many different sounds, some closely related, others very far afield from one another. We have a name for every sound, including the term *straight piano* which means just that. There are mutes, bones, bleeps, strums, plucks, sticks, zips, buzzes, pows, bangs, and dozens of others. These titles are not designed to shroud things in mystery, but are used merely for the purpose of cataloging them. We do not limit ourselves to the keyboard; we use just about each and every part of the piano, plus many devices made of rubber, paper, cardboard, wood, metal and combinations of those materials. One device can produce as many as a dozen different sounds, depending on where and how it is placed on the strings or other parts of the piano. Also by striking different areas of the instrument, either with the hand or one of our devices, and depending on whether or not we use the pedal, dozens of sounds are created. The only prerequisite is that the pianos be grands, not uprights or spinets. We use Concert D Steinways.

You may find it interesting to compare our recording methods with what you hear on *Soundproof*. We have two 2-track stereo machines, running at 30 ips. They are arranged in a standard over-dubbing setup, which allows for multiple recording.<sup>1</sup> Two other machines are used, though not for actual recording, in a tape-loop echo setup. So as a total there are four machines running at each session. This installation of recording machines, equalizers, mixers, and filters takes three Westminster engineers two days of preparation, setup, and checkout.

The microphones are Telefunken and Altec calibrated 21-D's. Special effects are accomplished by adding tape-loop echos, room echo, or reverberation, equalization, and filtering. Usually eight or nine microphones are in use at the average session to produce a stereo tape. For monaural records, the two stereo channels are mixed and transferred to a full-track monaural master. The stereo tape is released on the Sonotape label.

Kurt List and Chuck Gerhardt are the musical and recording directors at these sessions. All our arrangements are done beforehand. Therefore, the first order of business in the recording studio is for us to prepare our pianos. Then List and Gerhardt go over our arrangement. They memorize the arrangement very quickly before the actual recording starts. More than 90% of the sounds heard on the finished record come from the pianos exactly as they are heard on the LP. The other 10% is done in the control room, where they may make a roar out of a whisper or vice-versa. The echoes, tape-loops, and other electronic sound effects are done there, too. But the fact remains that the bulk of new sounds emanate from the pianos themselves.

Surrounding us and the two pianos is a veritable jungle of microphones and cables. These "mikes" are so sensitive that they pick up the slightest movement in the studio. Therefore, when either or both of us have to move from one part of the piano to another, we merely omit that bit of the arrangement for the time being and go back to it later, rather than risk having our movements picked up by one of the mikes. When we are happy with what we have recorded we each put on a set of earphones through which we hear what we have on the tape. While we listen, we add whatever was not recorded the first time by super-imposing what is to be added. Some of the arrangements in *Soundproof* have a very full and complete rhythm section. This was accomplished by first recording only the rhythms. All the melody and contrapuntal lines were superimposed later. On rare occasions we add a third recording, but in most instances we limit ourselves to two.

Many people are under the impression that the twelve tunes in *Soundproof* cannot be reproduced in live performance. This is not true. With the exception of the effects which were done in the control room we can and do play these arrangements on the recital stage without benefit of electronic equipment. In fact, for some of our concerts during the current season, we intend to use arrangements from *Soundproof* as encores to prove to any skeptics around that these can be performed live.

<sup>1</sup> The method of adding a second "layer" of sound to a tape recording was explained in "Now You Can Record Sound-on-Sound", by Harlan Thompson, HI-FI MUSIC Magazine, July-August, 1954.

## RALPH VAUGHAN WILLIAMS

*Continued from page 39*

erring good taste in choice of texts, some of which are written by the poet Ursula Wood, in private life Mrs. Vaughan Williams.

Another Vaughan Williams classification is that of "mystic", connoting otherworldliness or detachment, which are completely out of keeping with the man.

His music can be thoughtful, contemplative (as in the *Pastoral Symphony*, and the lovely *Fifth Symphony*), but the thinking and contemplation are of this world and this time. "The composer should not shut himself up and think about art", he has said. "He must live with his fellows and make his art an expression of the whole life of the community." Vaughan Williams molds

the stuff of life into music: man thinking, at worship, or singing in his fields, roistering in a tavern, or grappling with the eternal problem of good and evil, dancing, or contemplating the vast mysteries of the sea or the countryside and the cities that border upon it.

These are all big and timely themes that Vaughan Williams has taken for his subject matter. Some of his interpreters have gone him one better and assigned extra-musical meanings to his music, especially

to the symphonies, for which the composer himself has not supplied any programmatic clue, preferring a simple key designation that is severely, but often amusingly, technical. For example he describes the first movement, the "Fantasia", of the new *Eighth Symphony* as *variazioni senza tema* — variations without a theme. It has been nicknamed "seven variations in search of a theme". And he observes that "I understand that some hearers may have their withers wrung by a work being called a symphony when its first movement does not correspond to the usual symphonic form. It may perhaps be suggested that, by a little verbal jugglery, this movement may be referred to the conventional scheme." After two paragraphs of "verbal jugglery" he concludes: "Thus all wounds will be healed and honour satisfied." To the practice of making tone poems of his symphonies, Vaughan Williams has raised vigorous objections. "Music means itself!"

Vaughan Williams fortunately has not suffered neglect on LP's, though the bulk of recordings emphasize the orchestral compositions. London deserves only commendation for the splendid, magnificently recorded series of the first seven symphonies, plus the masque *Job*. The symphonies constitute a towering edifice that belongs among the masterworks of symphonic form.

Unfortunately, there still remains a vacuum as far as recordings of the choral works and operas are concerned. Important are *Flos Campi*, the *Five Tudor Portraits*, and the *Mass in G Minor*, but new recordings are needed also of *Sancta Civitas* and the *Five Mystical Songs*. (Both have appeared on LP but not in authentic settings.) Although slighter compositions, *A Serenade to Music* and *Folk Songs of the Four Seasons* should be recorded. There are also many choral compositions for the church that are truly beautiful: *The Magnificat*, the *Fantasia on Christmas Carols*, *Benedicite*, the anthem "Let Us Praise Famous Men". And there is the masterful Christmas oratorio *This Day*, finished just prior to the composer's visit to the United States in 1954. Composed in his 82nd year, *This Day* utilizes a narrator, soloists, chorus, and a large orchestra; it is a full expression of Vaughan Williams' mature, rich imagination. The opening prologue is unforgettable, but so is the oriental, percussive, "March of the Three Kings," with an evocative text by Mrs. Vaughan Williams. There are beautiful melodies, a typical one being the "Pastoral" to a poem by George Herbert. The choral writing is fresh and vigorous, sensitive, yet endowed with grandeur. Of the operas, possibly the least known of Vaughan Williams' works in the United States, some attention might be given at least to "Riders to the Sea" (1931) and "The Pilgrim's Progress" (1936). We already know "Sir John in Love" (1929) a little, from its *Greensleeves* pages.

There is not a great deal of chamber music. Of the *G Minor* and *A Minor String Quartets*, *Household Music* (for any convenient group of four instruments), and the recent (1954) *Sonata for Violin and Piano*, only the last has been recorded. [See review pages.] Works for solo instrument and orchestra seem to attract Vaughan Williams rarely, and then with a specific soloist in mind. The concerto is of the Romantic Age and for the virtuoso. Vaughan Williams has little affinity for either. Most of his concertos are conceived on a small scale, the violin *Concerto Accademico*, the *Oboe Concerto*, and the two delights, the *Romance for Harmonica* and the *Tuba Concerto*. The *Piano Concerto* is a grander work, a relative of the *Fourth Symphony*.

#### SELECTED VAUGHAN WILLIAMS DISCOGRAPHY

**Symphony No. 1** "Sea"—Boult—London LL-9723  
**Symphony No. 2** "London"—Boult—London LL-569  
**Symphony No. 3** "Pastoral"—Boult—London LL-721  
**Symphony in F Minor**—Boult—London LL-974  
**Symphony in D**—Boult—London LL-975  
**Symphony in E Minor**—Boult—London LL-976  
**Symphony No. 7** "Antartico"—Boult—London LL-977  
**Symphony in D Minor**—Boribrali—Mercury MG-50115  
**Job**, Mosque for Dancing—Boult—London LL-1003  
**Fantasia on a Theme of Tallis; Greensleeves; English Folk Songs; Norfolk Rhapsody**—Boult—Westminster WL-5270  
**Flos Campi**, for viola and chorus—Hull—Concert Hall CHS-1151  
**Five Tudor Portraits**—Steinberg—Capitol P-8218  
**Mass in G Minor**—Lawrence—London LL-805  
**Songs of Travel**: "Silent Noon", "The Water Wheel", etc. Stonden—Westminster WLE-103  
**On Wenlock Edge**: 7 Songs from Pilgrim's Progress Westminster XWN-18097  
**Sancta Civitas**—Jacobsen—Music Library 7049  
**Concerto in D Minor for Violin**—Fuchs—Decca DL-9625  
**Concerto for Oboe**—Miller—Mercury MG-10003

Vaughan Williams' song output is too vast to go into in detail, but several songs have been recorded such as *On Wenlock Edge* (which may be considered a chamber work also, being scored for string quartet and piano), *Songs of Travel*, *Silent Noon*, *Linden Lea*, and *The Water Mill*. There are also captivating songs for children's voices or non-professional choral groups — for Vaughan Williams believes that music is "first and foremost, self-expression" and not merely a passive experience; therefore the composer should not neglect those who are not virtuosos. He agrees with his late friend Gustav Holst that "if a thing is worth doing at all, it is worth doing badly," provided the doing is a sincere attempt at self-expression. "All art is the imperfect human half-realization of that which is spiritually perfect. . . . Superficiality, half-heartedness, sham, and swagger must have no part in the scheme," he states, unconsciously describing his own music.

Vaughan Williams wears his greatness with diffident unconcern and gruff charm, ruffled and heedless of show. He looks ill at ease in evening clothes (which he dons with obvious disdain) and looks comfortable in shaggy tweeds, topped by an object that once may have been a hat. He is an imposing figure, bardic — his

fine white hair wild in the wind, his collar awry — as if the fussier, petty details deserve but perfunctory notice. Vaughan Williams' vision encompasses only the higher attributes of man; his philosophy pierces those realms beyond conscious thought that defy verbalization. Still his mode of life and work, his role as a participant in the life of his time, mark him as at once Biblical, Elizabethan, and contemporary: a twentieth-century humanist.

## STEREO SYSTEM

*Continued from page 62*

tape transport mechanism, the heads, and the equalizer-preamp circuits. The deck, or panel, can be mounted vertically or horizontally. This is the simplest and least expensive design, adapted particularly to permanent installation as part of a home music system. A variation of this type has the tape deck and electrical circuits contained in a wood case, usually with a hinged cover.

If you have a monaural system already installed, one output channel from the tape deck can be plugged into the TAPE INPUT jack of your preamp. Then you will need another amplifier — but not another preamp — and a loudspeaker similar in design to the other to handle the second output channel from the tape deck.

The second type of stereo playback machine is intended for portable use. It has equalizer-preamp circuits for both channels, and a small amplifier and built-in speaker for one channel. Thus it is a complete monaural playback machine, although the audio quality is limited by the low power of the amplifier and the small size and mounting of the speaker.

Machines of this sort have an output jack for the second channel, to be connected to an external amplifier and speaker. Also, there is usually another jack, wired directly to the preamp of the first channel, so that both channels can be played over external amplifiers and loudspeakers.

Unless there is some special reason for wanting to play monaural tapes on a portable machine, the first type is preferable for a permanent home installation, because of the limited audio capabilities of the built-in amplifier and speaker. It is hardly worth while to buy a unit so equipped if those components will not be used.

*Part 3 of this series will show specific circuits and other details of home stereo tape installations.*

## RECORDING AT M.I.T.

*Continued from page 57*

the vertical framework at the sides is only to carry the windows. This design, as you might suspect, was chosen by the architects, over the objections of the acoustical engineers. The "clouds", Figs. 1 and 9, were added to eliminate a t-t-t-t that is a repeated echo, rather than a "live" effect. Still, footsteps echo sharply under the space between the clouds at the front and those at the rear. However, the

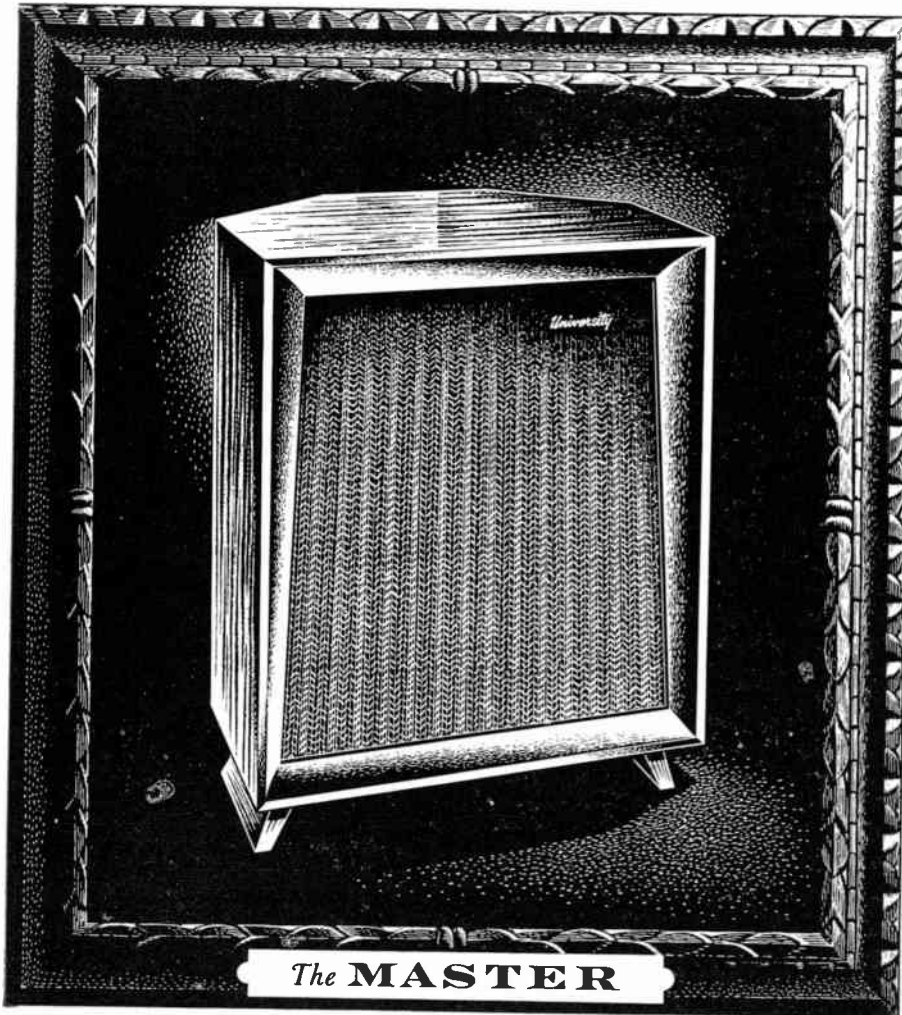

## Truly a Masterpiece among systems!

What's in a name? Though most products have little relation to their names, the only name we could possibly have given this system is the MASTER. It is truly a masterpiece . . . a Work of Art that can be *seen* and should be *heard!*

The finest principles of acoustic engineering and the most tasteful elements of styling have been lavished on the MASTER speaker system.

Each component of the MASTER is a gem which contributes to its overall magnificence. Just listen to the sonorous "big theatre" 15" woofer, the rich full-bodied middles produced by the exclusive "reciprocating flare" horn with heavy duty compression driver and the crystal clear, natural highs emanating from the super-tweeter—all kept in perfect balance by the N-3 ACOUSTIC BATON 3-way crossover network.

The MASTER employs the best features of rear-horn loading, phase inversion and direct radiation, integrated to achieve a highly efficient extended range enclosure. This results in unusual power handling capacity and transient response. This versatile enclosure can be used in a corner or flat against a wall, since it is a *true* cornerless-corner enclosure.

For an exciting thrill in high-fidelity, listen to the MASTER at your favorite Hi-Fi center . . . soon.

UNIVERSITY LOUDSPEAKERS, Inc., 80 So. Kensico Ave., White Plains, N. Y.

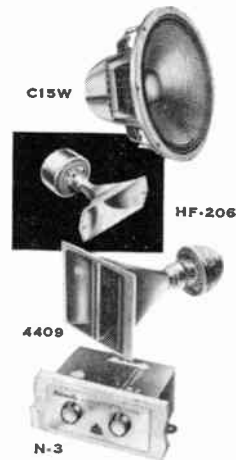

Power Capacity: 50 Watts  
Integrated Program

Dimensions:  
37"Hx28"Wx19 1/4"D

Shipping Weight: 120 lbs.

Price: Mahogany \$285.00  
Blond ..... 290.50

LISTEN

*University sounds better*



## RECORDING AT M.I.T.

*Continued from page 69*

wooden walls, Fig. 9, improve the acoustics, and the damping effect of the clouds is heightened by lining them with glass wool, with result that most parts of the Auditorium are quite dead. In fact, Ernst Levy, playing Beethoven sonatas, complained that the sound of the piano went out, but did not come back to him.

The net result was to produce some very interesting effects which can be heard in the Unicorn records. Extreme care was required in placing the microphones. In fact, trouble with a microphone suspended overhead was corrected only when it was found that the clothes line had sagged 2 ins. overnight.

Fig. 2 shows the plan and elevation of the Chapel. The organ, Fig. 5, was designed and built by Walter Holtkamp. Peter Bartók described the tone quality as "really wonderful". The Chapel, about 50 ft. in diameter, has walls of brick in undulating curves, no two of which have the same radius. Sections of the wall are laid as if the courses were alternately headers and stretchers, with the headers omitted. You can see this in Fig. 7. The open effect provides sound absorption and ventilation. The Chapel is extremely live, yet there are no standing waves because of the undulations except, possibly, at the very low frequencies. The unusual acoustics of the Chapel, for which Messrs. Bolt, Beranek, and Newman were responsible, are evident in the Unicorn recordings made there. Also, if you listen very closely, you may be able to hear the mechanical hum of the power transformer transmitted from the basement.

Because of their unique design, these buildings will undoubtedly be the subject of much discussion and further investigation by architects and acoustic engineers, and it is expected that further experiments will be made in recording music there.

## RIVAL VISITORS

*Continued from page 35*

ment home. The long gold and crimson parallelogram is not unlike Boston's Symphony Hall in shape, but is rather grander, with ten great crystal chandeliers and gilded half-nude caryatids supporting a narrow row of boxes which bespeak an audience of real music-lovers rather than show-offs. Here in 1873 Johannes Brahms conducted the first performance anywhere of his *Variations on a Theme by Haydn*; here later were heard the world premières of his *Second* and *Third Symphonies* and his *Tragic Overture*. Wagner appeared at the Musikverein for the first time in 1872 when he was trying to raise funds for Bayreuth, and enjoyed huge success with what he described as "the greatest orchestra in the world" in three 1875 concerts at which he conducted excerpts from "Götterdämmerung". Hard on Wagner's heels

*Continued on page 71*



## RIVAL VISITORS

*Continued from page 70*

came Verdi to conduct his *Requiem*.

Even after Hans Richter, who had been Wagner's assistant and who had copied pages of "Die Meistersinger" while it was still wet from Wagner's pen, took over the orchestra, it took no sides in the battle between the Wagnerians and the Brahmsians — the Romantic versus the Classic, the progressive versus the conservative. Anton Bruckner also was living in Vienna during this period, and one of the treasures of the orchestra's library is an 1885 letter asking "the respected committee" not to play his *Seventh Symphony* because he was afraid the Viennese critics would destroy the good reputation he had made in Germany.

There are other treasures in the library which suggest the orchestra's glamorous past. In addition to Beethoven's diamond ring and elegant cane, they include the hat that Gustav Mahler (conductor 1898-1901) wore back from America, the unfinished manuscript of a symphony called *The Danube* (and dedicated to the orchestra) by Richard Strauss, who conducted its second South American tour in 1923, and an affectionately autographed picture from Arturo Toscanini, who appeared as guest conductor in Vienna, Budapest, and Salzburg on more than fifty occasions.

Furtwängler, for whom (like founder Otto Nicolai) a special annual concert is named, was permanent conductor for only three years (1927-30), but he continued his interest in the orchestra even after Hitler marched up the Ringstrasse in 1938 to demonstrate that Austria had become a German province in which Aryan supremacy was the law of the land. Thanks to Furtwängler, musicians with non-Aryan wives were able to hold their positions, their homes, and their families, but they "were forced to play at every official function" and they were still playing — their war service — when the Russians were fighting in the suburbs during the Siege of Vienna. In April of 1945 the Vienna Philharmonic gave its first postwar concert by agreement with Russian headquarters.

The orchestra re-entered the international scene with an appearance at the 1947 Edinburgh Festival under Bruno Walter, toured England the following year with Furtwängler, and the next year visited London, Paris, Geneva, and Zurich, again with Furtwängler. They have subsequently toured Egypt, Scandinavia, Finland, and most recently (spring, 1956) Japan.

### The Berlin Philharmonic Orchestra

The Berlin Philharmonic owes its inspiration to a joint appearance by Johannes Brahms and Hans von Bülow in 1882 at Berlin, when the city had been Germany's capital for only eleven years. The local musical life was then confined to symphonic soirées of the Royal Court orches-

*Continued on page 72*

**...OR**  
**Have fun-**  
**save**  
**money!**



## BUILD THIS MAGNIFICENT SPEAKER SYSTEM *It's so simple!*

**"DO-IT-YOURSELF" KWIKITS** — You can build your own version of the fabulous MASTER with a KwiKit, University's "do-it-yourself" enclosure kit. With this truly amazing kit, you don't end up with a "cheesebox"! You do end up with an enclosure as good as the finest factory-assembled enclosure, in construction and design.

The KEN-15 KwiKit is similar in every respect to the MASTER, except that the KwiKit employs a simplified front frame design. It's so easy to assemble . . . almost all you need is a screwdriver. ¾" cabinet plywood used throughout. Finest ¾" Birch hardwood used for all finishing surfaces. Kit contains: all pre-machined and pre-shaped wood sections; glue; hardware; plastic wood; sandpaper; easy-to-follow instructions. *If you like to build your own and save money then the KwiKit is made to order for you.*

KEN-15 KwiKit \$49.75 net.

**THE EN-15 ENCLOSURE** is the exact enclosure used in the MASTER system; minus the speaker components. University makes this enclosure available for those who either have speakers or intend to build toward the MASTER in successive stages, via P-S-E.

Mahogany \$125.00 net. Blond \$130.50 net. Unfinished \$102.00 net.

### THE P-S-E STORY

P-S-E-Progressive Speaker Expansion plan (a concept first introduced by University) is the most revolutionary development in speaker history.

University speaker components, enclosures and networks have been so uniquely designed that it is possible to start an excellent basic system at low cost, and add to it later—while enjoying immediate listening satisfaction.

P-S-E makes it possible to build up to the MASTER (or any other fine system) in successive, inexpensive steps, using the KEN-15 KwiKit and EN-15.

*For the complete, fascinating story of P-S-E please send for FREE illustrated brochure.*



University offers the largest selection of speakers and components to meet every size and budget requirement



UNIVERSITY LOUDSPEAKERS, INC., 80 SOUTH KENSICO AVENUE, WHITE PLAINS, N. Y.

LISTEN

*University sounds better*



**50 hi-fi watts**  
... ONLY **\$74.50**



the superb new **HF-50K**  
**POWER AMPLIFIER KIT**

from **Regency**

**YOU ASSEMBLE IT  
YOURSELF AND SAVE \$100!**

If you know how to solder two wires together, you can now enjoy matchless amplifier performance—50 of the cleanest watts you've ever heard—for the price of an ordinary 20-watt unit!

Words can only feebly suggest the breath-taking realism of sound produced by the **REGENCY HF-50K**. There is plenty of reserve power to handle the increased dynamic range of present day program sources and to drive low efficiency, wide range speakers. High stability and low phase shift prevent bounce or flutter when amplifier is pulsed. Frequency response:  $\pm 0.2$  db, 20 to 20,000 cps. IM and harmonic distortion: less than 1% at 50 watts. Damping factor: 15.

The **HF-50K** is easy on the eyes, too. Striking black and gold exterior provides "show piece" styling that makes cabinet mounting a needless extravagance.

Putting the unit together is an entertaining 4-hour job. No shock hazard. Easy to follow directions make every step crystal clear.

Compare the **HF-50K** specs with those of any other amplifier; then compare the price and see if you don't agree that this **REGENCY Kit** is truly the amplifier buy of a lifetime... only \$74.50 complete! See it at your distributor, or write:

**REGENCY** Division, I.D.E.A., Inc

Dept. F • 7900 Pendleton Pike  
**INDIANAPOLIS 26, IND.**

## RIVAL VISITORS

*Continued from page 71*

tras on the one hand and to semi-amateur orchestras of private clubs on the other. To both, Brahms and von Bülow demonstrated that a higher standard of music-making was possible.

At that moment the musicians of the Royal Prussian Court Orchestra and their "Musical Sergeant", Benjamin Bilse, had come to a parting of the ways over a matter of money. Roller-skating had passed its peak as a fad, but Berlin boasted the largest skating rink in Europe, which the musicians now took over. On the advice of Joseph Joachim, they engaged von Bülow as conductor. Famous world over the conductor of the premières of "Tristan" and "Die Meistersinger", von Bülow turned to champion Brahms after his wife Cosima (daughter of Franz Liszt) ran off with and eventually married Wagner. But he continued to champion young musicians. It was he, for example, who gave the young Richard Strauss his first symphonic hearing. For him, as for Nikisch who succeeded him, his appointment as musical director of the Berlin Philharmonic was the last and highest honor of his life.

Arthur Nikisch was forty in 1895 when he succeeded von Bülow; posts in Leipzig, Boston and Pest were already behind him. Nikisch brought Berlin audiences such moderns as Bruckner, Tchaikovsky and Richard Strauss (a frequent and welcome guest as conductor of his own works). Under his direction the orchestra traveled to Moscow in 1896 for the Coronation of the Tsar, beginning its now traditional tours of Europe.

Third of four permanent conductors in the orchestra's seventy-four years was Wilhelm Furtwängler (1886-1954) who, in more than thirty years on its podium, extended the orchestra's range, expanded its seasons and its tours, and covered the musical greats from Bach to Schönberg, Stravinsky, and Hindemith. Under Furtwängler the orchestra survived the ruinous inflation which followed the first World War, but the worst was yet to come with Hitler's Third Reich. In January of 1944, Allied bombs reduced its home—the famous Philharmonie—to rubble. Many of the players lost their lives in action or air-raids; their library suffered irreparable losses from flames and water; many of their instruments were lost, destroyed, or stolen. But seven weeks after they gave their last concert in the Beethovensaal, before the fall of the German Government, sixty players somehow reassembled in a wasteland of a city where all normal means of communication were disrupted, for a concert in the Tatiana Palast, a former movie theatre. Tickets were handwritten, the programs typewritten, but beleaguered Berlin was happy to have the orchestra back at all costs.

The costs were heavy indeed. An hour's

*Continued on page 73*

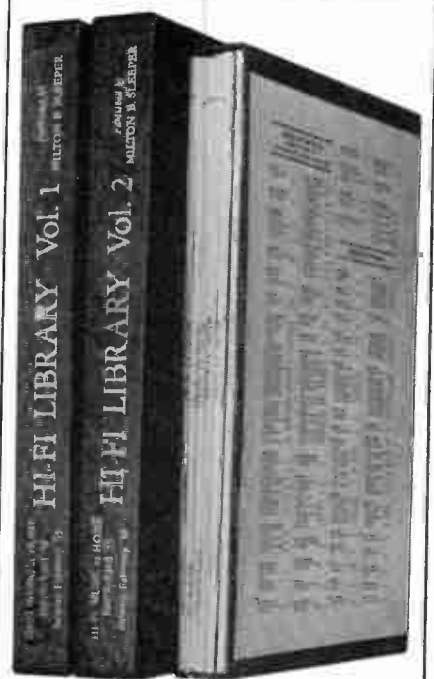

Double Slipcase, Vol 1 \$1.50

Double Slipcase, Vol 2 \$1.50

ADD 25¢ FOR FOREIGN DELIVERY

**HI-FI MUSIC**

207 East 37th St., New York 16

**FREE**  
ANY **398**  
long playing  
**RECORD**  
of your choice

choose from these famous labels  
**RCA VICTOR  
LONDON · EPIC  
COLUMBIA · Etc.**

select 3 records—  
and pay only for 2  
add 25¢ ea. record  
for ship.

**ACCEPT THIS AMAZING TRIAL OFFER! LEARN ABOUT THE RECORD DIVIDEND CLUB'S PROFIT SHARING PLAN & DIVIDEND POLICY**

**RDA Dividend #1** many free records earned throughout the year—the more records you buy the more you receive FREE.

**RDA Dividend #2** FREE catalog every month—keep up with all the new releases.

**RDA Dividend #3** FREE protective covers—every record shipped in a polyethylene bag.

**RDA Dividend #4** planned for perfectionists 'mint' records inspected before shipping.

**EXTRA BONUS** 1 year FREE subscription to Hi-Fi Music At Home

**RECORD DIVIDEND CLUB, INC.**  
445 W. 50th St., Dept. C, New York 19, N. Y.

Please enroll me as a trial member of The RDA. I am to receive FREE with my first two selections (at \$3.98 or more each) one DIVIDEND record (list price \$3.98). In addition I am to receive FREE a long playing record catalog... a brochure explaining the RDA in greater detail.

1 \_\_\_\_\_ \$ \_\_\_\_\_ plus 25¢ shipping  
2 \_\_\_\_\_ \$ \_\_\_\_\_ plus 25¢ shipping

Dividend \_\_\_\_\_ FREE (pay only) 25¢ shipping

NAME \_\_\_\_\_  
ADDRESS \_\_\_\_\_  
CITY \_\_\_\_\_ ZONE No. \_\_\_\_\_ STATE \_\_\_\_\_  
Enclosed find Check for \$ \_\_\_\_\_ to cover cost

## RIVAL VISITORS

*Continued from page 72*

trip on foot or by bicycle to a concert was a commonplace for orchestra and audience alike; for both, malnutrition or the threat of it was a constant problem. The orchestra has been literally homeless since 1944, playing in the Berlin Cathedral; the Hochschule für Musik where most of its concerts are now given; out of doors at the Grunewald Hunting Lodge; in the Auditorium Maximum of the Free University built by the Ford Foundation; and on special occasions at the Berlin Sports-Palast. This nomadic existence will end with the completion, scheduled for autumn of 1957, of a new home in the Bundesallee, behind the façade of the partially destroyed Joachimsthal High School.

Late in 1954, on the eve of its first American tour, the Berlin Philharmonic suffered an even more serious blow than the loss of its material treasures. This was the sudden death of Furtwängler. Facing the necessity of producing a conductor of approximately equal calibre or cancellation of the tour, vice president André Mertens of Columbia Artists Management turned to Herbert von Karajan. Musicians in the Berlin Philharmonic, like the members of the Vienna, have a vote in the selection of their leader; thus it was at Pittsburgh, Pa., of all places, that they elected Karajan the fourth permanent leader in the orchestra's history — a lifetime post.

"Two households, both alike in dignity" said Shakespeare of the Montagues and the Capulets — a phrase which might fairly be applied to the Vienna Philharmonic and the Berlin Philharmonic orchestras. Comparisons may be odious, but the knowledge that they will surely be made seems certain to keep the musicians in both orchestras on their toes.

**STATEMENT REQUIRED BY THE ACT OF AUGUST 24, 1912, AS AMENDED BY THE ACTS OF MARCH 3, 1933, AND JULY 2, 1946 (Title 39, United States Code, Section 233) SHOWING THE OWNERSHIP, MANAGEMENT, AND CIRCULATION OF**

MUSIC AT HOME Magazine published bimonthly at New York City, N. Y., and Concord, N. H. for October 1, 1956.

1. The names and addresses of the publisher, editor, managing editor, and business managers are: Publisher: Milton B. Sleeper, Monterey, Mass.; Editor: Milton B. Sleeper, Monterey, Mass.; Managing Editor: None; Business Manager: None.

2. The owners are: Sleeper Publications, Inc., 207 E. 37th St., New York 16, N. Y.; Ethel V. Sleeper, Monterey, Mass.; Milton B. Sleeper, Monterey, Mass.

3. The known bondholders, mortgagees, and other security holders owning or holding 1 percent or more of total amount of bonds, mortgages, or other securities are: None.

4. Paragraphs 2 and 3 include, in cases where the stockholder or security holder appears upon the books of the company as trustee or in any other fiduciary relation, the name of the person or corporation for whom such trustee is acting; also the statements in the two paragraphs show the affiant's full knowledge and belief as to the circumstances and conditions under which stockholders and security holders who do not appear upon the books of the company as trustees, hold stock and securities in a capacity other than that of a bona fide owner.

MILTON B. SLEEPER, *Publisher*

Sworn to and subscribed before me this 4th day of September, 1956.

[SEAL] CECIL BRATHWAITE, *Notary Public*  
(My commission expires Mar. 30, 1957)

# THE NEWCOMB

 Royal 712

A CROWNING ACHIEVEMENT IN THE DISTINGUISHED COMPACT SERIES

Combining unbelievable tonal realism with beautiful decorator styling, this newest in the Newcomb Compact series brings together in one single unit a balanced-design audio amplifier and a fine FM-AM tuner . . . plus complete preamplifier and controls. With the Newcomb Royal 712 Compact, your system is assured the correct matching of the three most important parts of a hi-fi system, for they are factory-designed into one assembly. All of this crowning achievement comes from the laboratories of Newcomb . . . the sound of quality since 1937.



### Newcomb Royal 712:

Combining advanced electronics into a single high fidelity unit. Extremely sensitive FM and AM tuner. Special multiplex output jack for easy adaptation to stereophonic or binaural broadcasts. Temperature-controlled oscillators and A.F.C. on FM. Amplifier has inputs for every type of pickup, for tape, and for auxiliary equipment such as TV sound and microphone. Crystal-clear, distortion-free 12 watt amplifier matched to the tuner and pre-amp. Controls for level and loudness, and 6-position record response control.

For Complete Details, Newcomb Audio Products Co., Dept. MH-11, 6824 Lexington Avenue, Hollywood 38, Calif.

A N O T H E R

# BOZAK

F I R S T . . .

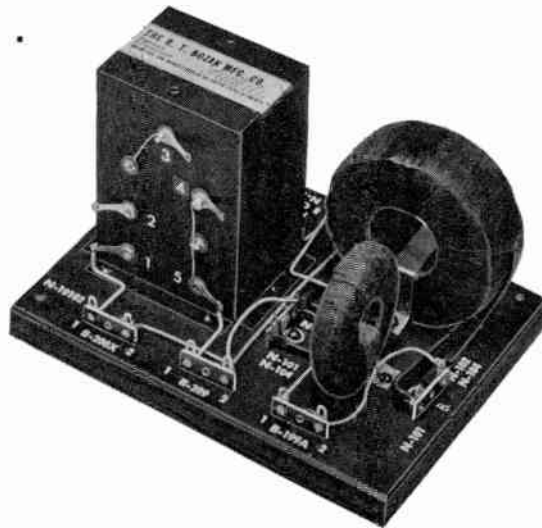

## the N-10102 Convertible Crossover Network

*Grows with your Bozak Speaker System*

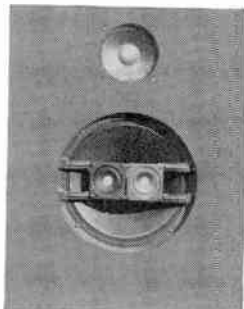

Wired as an N-101 it has an 8-Ohm Impedance and the slow 6-db-per-octave Crossovers at 800 and 2500 cycles for the one-woofer Bozak B-302 Speaker System.

when your B-302 grows into a two-woofer B-305

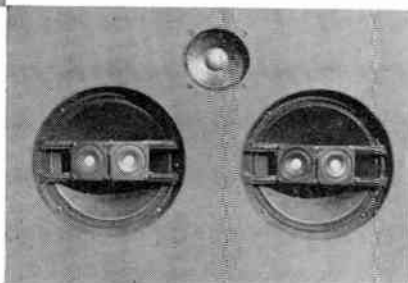

just remove two leads and transfer two others, and you have the 16-Ohm Impedance and the same slow Crossovers at 800 and 2500 cycles needed for this outstanding System.

For the magnificent four-woofer B-310 and B-400 . . . add a condenser bank and change four leads for the 8-Ohm Impedance and slow Crossovers at 400 and 2500 cycles.

The N-10102 Crossover Network, like Bozak Loudspeakers, is never outgrown . . . never becomes obsolete. Together they mean

*The Very Best in Sound*

**THE R. T. BOZAK SALES COMPANY**



BOX 966 • DARIEN • CONNECTICUT  
EXPORTS: ELECTRONICS MANUFACTURERS' EXPORT COMPANY, PLAINVIEW, NEW YORK

## READERS' ROUNDTABLE

*Continued from page 63*

the men at the control board apparently having done some fast finger work, the orchestra of the day proceeds to sound more like the real article than any other aggregation to be heard on the air. True, there is often imbalance, with the bass fiddle, for instance, making more noise than the massed brass. But each of the guest bands presumably varies in manpower and deployment thereof, and obviously no one mike setting could do justice to every number.

Over-all, just the same, this show offers as much real "presence" as the most carp-ing critic would demand. The unanswered question is: Why can't we get reproduction of this quality on FM *all* the time?

Less wealthy stations can be equally careful about these controllable factors, and some are, but of necessity there is a certain lack of effortless-seeming professionalism in the casually organized pur-lieus. So that voices frequently sound natural and just as frequently do not, and the recordings played often are unworthy of FM — either because they are worn out or because they were not very good in the first place. I must say that WWRL and WBAI are at pains to excel as to the quality of their recorded music. Also WFUV.

The "big fellows" are just as variable as their nominal competitors, as indicated. WRCA's "Music Through the Night" is first class, largely because the disc jockey (Harry Fleetwood) is knowledgeable at a microphone and because he is given new pressings for the most part. Still, the sound is not consistently what it might be.

There is much rumor about a new hi-fi studio at WOR, but as yet this project has not shaped up audibly.

Perhaps the most unforgivable offender is WCBS, which pays no attention to quality where it would count most. I mean its Sunday afternoon New York Philharmonic concerts of past seasons. It is a scandal that the most important live FM broadcast of good music on the air should sound like AM. — *James Lyons*

H. Peter Meissinger, Washington, D. C. — The FCC quite properly requires each FM broadcast station in this Country to submit a "Proof of Performance". The Proof of Performance consists of electrical measurements made from the station's audio input channels through each and every circuit up to and including the antenna. This is a very fine thing as far as it goes. However, the FCC regulations do not preclude the use of inferior microphones and phono cartridges. No measurements of the performance characteristics of these vital elements are required, and FCC standards for approved transducers have never been established.

It should be pointed out that microphone and phono pickup characteristics are invariably the weak link in the trans-

*Continued on page 76*

*Hi-Fi Music at Home*

**CLASS OF SERVICE**  
 This is a fast message unless its deferred character is indicated by the proper symbol.

# WESTERN UNION TELEGRAM

W. P. MARSHALL, PRESIDENT

**SYMBOLS**  
 DL = Day Letter  
 NL = Night Letter  
 LT = International Letter Telegram

The filing time shown in the date line on domestic telegrams is STANDARD TIME at point of origin. Time of receipt is STANDARD TIME at point of destination.

1956 OCT 4 PM 2 07 (06)

CA081 PD=0A CHICAGO ILL 4 1143AMG=  
 JIM CODY, ADVERTISING=  
 166 EAST SUPERIOR =

RELEASE IMMEDIATELY THIS INFORMATION RE NEW SHERWOOD S-3000 FM ONLY TUNER -- HAVE JUST ACHIEVED UNDER ONE MICROVOLT SENSITIVITY -- 0.95 UV FOR 20 DB QUIETING INCREASES FM STATION RANGE TO OVER 100 MILES. FEATURE TO BE STANDARD IN ALL MODEL FM-AM AND FM TUNERS. S-3000 ALSO FEATURES NEW FEATHER-RAY TUNING EYE -- LOCAL DISTANT SWITCH, FLY WHEEL TUNING \$99.50 NET=  
 EDWARD S. MILLER SHERWOOD ELECTRONIC LABORATORIES INC 2802 WEST CULLOM CHGO=

THE COMPANY WILL APPRECIATE SUGGESTIONS FROM ITS PATRONS CONCERNING ITS SERVICE

*The Perfect Gift for Those*

## PEOPLE WHO HAVE EVERYTHING

Having trouble choosing gifts for people who have everything already? Well, here's an answer that will reflect your good taste and judgment:

1. Order gift subscriptions to Hi-Fi Music for those difficult people.
2. You will receive promptly a corresponding number of handsome, 4-color gift-announcement cards and envelopes to sign and address yourself.
3. You can be sure that such a gift will be welcome because everyone, from the boy or girl at school to your bachelor uncle or rich aunt, is interested in music, and Hi-Fi Music contains lavishly illustrated articles that appeal to all tastes.
4. There is no charge for the very beautiful 4-color gift-announcement cards reproducing the front cover of this issue but without the magazine name. (See illustration opposite.)

But please send in your order at once, while the cards and envelopes are still available. Subscriptions will include the extra Hi-Fi YEARBOOK issue to be published in October.



**GIFT RATES FOR ONE YEAR**  
 7 issues, including the HI-FI YEARBOOK

One subscription.....	\$5.00
Two subscriptions.....	9.00
Three subscriptions.....	13.00
Four subscriptions.....	17.00
Five subscriptions.....	21.00

add \$1.00 for each foreign subscription

For Return-Mail service, address  
 GIFT SUBSCRIPTION DEPT.

**HI-FI MUSIC MAGAZINE**

207 EAST 37th STREET  
 NEW YORK 16, NEW YORK



# DOUBLE YOUR LISTENING PLEASURE!

## FOR JUST A FEW DOLLARS

Your FM receiver is no better than the signal delivered to the antenna terminals. It costs little to add a good FM antenna to your system, yet it makes a big difference! All stations sound better, and you get dependable, day-in and day-out reception from stations you never heard before.

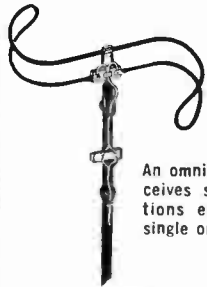

No. 624L  
FOR AVERAGE  
INSTALLATIONS . . .

An omnidirectional antenna. Receives stations from all directions equally well. Available single or stacked from \$7.15

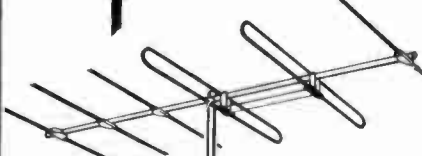

No. 644 FOR  
WEAK SIGNAL  
INSTALLATIONS . . .

A directional, high-gain yagi antenna for high signal-to-noise ratio. Available single or stacked from \$19.00

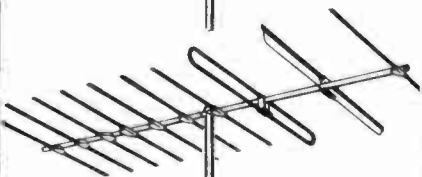

No. 610 FOR  
FRINGE AREA  
INSTALLATIONS . . .

Most powerful FM antenna. Makes FM possible in otherwise out-of-range locations. Highly directional \$27.50

(All prices are list—Taco antennas are available locally. See your dealer.)

**Write . . .** Get the complete story. Write for FM bulletin and complete information on FM accessory items . . .

**TACO**  
TECHNICAL APPLIANCE  
CORPORATION  
SHERBURNE, N. Y.

In Canada: Hackbusch Electronics Ltd., Toronto, Ont.

### READERS' ROUNDTABLE

Continued from page 74

mission chain. The station audio channels and radio transmitter require only the comparatively simple and well established control of electrical characteristics, contrasted to a phono cartridge or microphone where not only electrical characteristics are involved but in addition to this the far more complex mechanical and acoustical parameters compound the problem. It seems to me that the current FCC Proof of Performance policy is akin to setting up detailed specifications for keeping a crank case clean, while permitting the use of low-grade gasoline in cars operated under Government supervision.

A radio station meeting all radio and audio-frequency Proof of Performance requirements can still transmit unacceptable signals if inferior microphones and cartridges are used. One need only tune across the FM band to notice the vast difference in tone quality from station to station; quality varies from boomy to thin, reverberant to dead, scratchy to muffled, distorted to clean. If the FCC requirements were to be extended to include microphone and phono cartridge characteristics, these differences would be greatly reduced and the overall quality would be greatly improved.

There are several possible steps that the FCC might take to correct this situation. One plan might be to have a Government laboratory, possibly the National Bureau of Standards, establish a list of approved input terminating equipments. If periodic calibrations are to be required, this can be accomplished by either a Government or approved independent testing laboratory. Broadcast stations invariably have the necessary equipment on hand to make the required electrical measurements. Proper mechanical and acoustical equipment is rarely available to the broadcast engineer; hence the suggestion that microphones and pickups be sent to a laboratory for measurement.

It is my earnest hope that, in the interest of realizing the full potentialities of FM broadcasting, full consideration be given to the problems enumerated above. — *H. Peter Meissinger.*

#### What Have You Observed?

What has been your listening experience with FM? How do you rate the stations in your area as to audio quality? Does the quality vary during the day? If you have talked to engineers at your local stations, what information did they give you? Are they really interested in the quality of their FM programs; do you feel that they are quality-conscious; or are they completely indifferent? Or do they think their listeners are satisfied with ordinary AM quality on FM?

Let's see if, from the letters on this subject, we can get an overall picture of the status of FM broadcasting.

**LECTRONICS . . . your  
guaranteed source for  
the world's finest  
High Fidelity products  
recommends the  
premium kit for the  
audio perfectionist—  
available now!**

GUARANTEED  
2 YEARS



# DYNAKIT

## Mark II

### 50 Watt Power Amplifier Kit

The DYNAKIT combines unequalled quality with economy and simplicity. You'll find it sounds better because it is designed for outstanding transient response and stability, for high power at low distortion, and for complete and accurate reproduction. It features the finest of parts including the superb Dynaco A-430 output transformer. Construction is greatly simplified by the Dynaco preassembled printed circuit which includes a major portion of the wiring.

LECTRONICS unqualifiedly stands behind the Dynakit Mark II. We've pretested them ourselves—in the home, away from the manufacturers "ideal" lab conditions. We found that complete assembly can be made in less than 3 hours by the average audio novice, aided by the printed circuit assembly which is standard with Dynakit. Complete Kit . . .

**\$69.75**

**LECTRONICS**  
CITY LINE CENTER, PHILA. 31, PA.

TO: LECTRONICS  
City Line Center, Phila. 31, Pa.  
Gentlemen: I wish to order the Dynakit  
Mark II 50 Watt Power Amplifier Kit @ only \$69.75

Name \_\_\_\_\_

Address \_\_\_\_\_

City \_\_\_\_\_ Zone \_\_\_\_\_ State \_\_\_\_\_

Check or money order enclosed.

Please ship C.O.D. (25% down enclosed;

balance C.O.D.)

Price F.O.B. Philadelphia

## SCHUMANN

Continued from page 36

who would stand for no nonsense where Schumann was involved, declared that "Schumann's instrumental lyrics contain some of the finest and most highly organized texture to be found in any art. This texture was made possible by the work of Haydn, Mozart, and Beethoven in the direction of reconciling the epigrammatic and rich texture of Bach and Handel with the necessary broad and open devices of modern form." It was Tovey, also, who spiked the guns of the pedantic attackers of Schumann's sense of form by pointing out that "while the large formal analysis of a work of Schumann's reveals nothing but the most coarse-grained and obvious organization, there really is this extremely minute and perfect organization behind it and maintained by it."

One needs only to delve into the *Arabeske*, the *Kinderscenen*, the *Nachtstücke*, the *Waldscenen*, the *Fantasiestücke* to discover the riches of Schumann the lyric poet. And in the *Humoreske*, the *Novelletten*, the *Davidsbündlertänze*, and the *Kreisleriana* we find just as many treasures as in the more popular *Études symphoniques*, *Carnaval*, and *Papillons*. It is time for a rediscovery of the Schumann *Studies after Capricci* by Paganini, too.

Since Bach reigns supreme today, let us not forget that Schumann was not only one of the greatest critics of Bach but also one of his most ardent students. Wherever we look in Schumann's music we can find the imprint of the great master; most vividly, perhaps, in such works as the enchanting *Six Studies* for pedal-piano, *Op. 56*, arranged with consummate skill for two pianos by Claude Debussy, the *Four Sketches* for pedal piano, *Op. 58*, and the *Fugues on B-A-C-H*, *Op. 60*. But the *Piano Quintet* with its fugal finale, the piano trios, and the string quartets are also full of reminders of Schumann the master contrapuntist. The finale of the *First String Quartet* combines the rhythmic élan of a Strauss with the structural power of a Beethoven, although it has not escaped the strictures of academic perfectionists.

Schumann the rhapsodist, the most spontaneous composer since Schubert, emerges most clearly in the songs. He who has heard Povla Frijsch sing the *Schöne Fremde* from the Eichendorff settings of the "Liederkreis", *Op. 39*, could never forget its fantastic intensity and intoxicating rapture. Nor could Lotte Lehmann's singing of *An den Sonnenschein*, from *Op. 36*, with its glorious simplicity, or of the mischievous *Die Kartenlegerin*, from *Op. 40*, ever lose its flavor in memory. Equally unique in charm and immediacy are such songs as the *Viel Glück zur Reise*, from *Op. 104*, and the *Marienwürmchen*, of *Op. 79*. In tragic moods, Schumann is quite as great. Not merely in the masterpieces of the "Frauenliebe und Leben" and "Dich-

Continued on page 78

# Klipschorn®

CORNER HORN  
LOUDSPEAKER SYSTEM

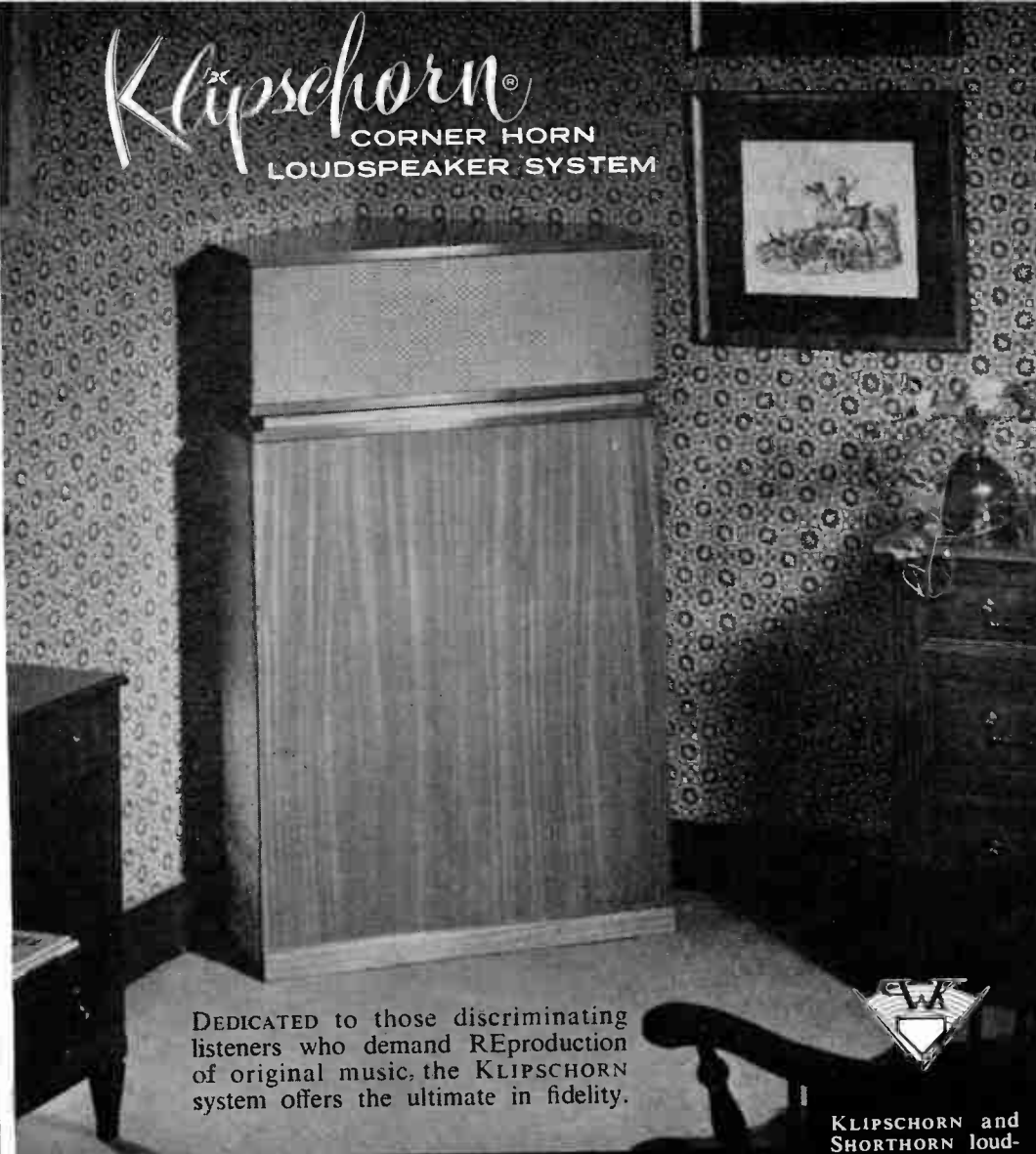

DEDICATED to those discriminating listeners who demand REproduction of original music, the KLIPSCHORN system offers the ultimate in fidelity.



KLIPSCHORN and SHORTHORN loudspeaker systems are manufactured only by their designer, Paul W. Klipsch. Write for our latest literature.

KLIPSCH AND ASSOCIATES  
HOPE, ARKANSAS



SHORTHORN®

CORNER HORN LOUDSPEAKER SYSTEM

MODERATELY sized — moderately priced, the SHORTHORN system approaches the KLIPSCHORN system in fidelity of music REproduction.



# AR-1

Report from the  
**LABORATORY**  
*The Audio League Report\**

Fig. 5  
Acoustic Output at 30 CPS

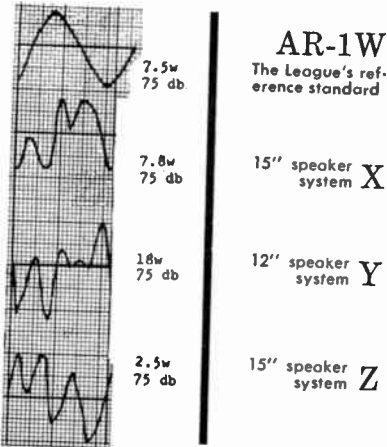

\*Vol. 1 No. 9, Oct., '55. Authorized quotation #28. For the complete technical and subjective report on the AR-1 consult Vol. 1 No. 11, The Audio League Report, Pleasantville, N. Y.

## Report from the **WORLD OF MUSIC**



The Aeolian-Skinner Organ Co. uses an AR woofer (with a Janszen electrostatic tweeter) in their sound studio. Joseph S. Whiteford, vice-pres., writes us:

"Your AR-1W speaker has been of inestimable value in the production of our recording series 'The King of Instruments'. No other system I have ever heard does justice to the intent of our recordings. Your speaker, with its even bass line and lack of distortion, has so closely approached 'the truth' that it validates itself immediately to those who are concerned with musical values."

AR speaker systems (2-way, or woofer-only) are priced from \$132 to \$185. Cabinet size 14" x 11 1/2" x 25"; suggested driving power 30 watts or more. Illustrated brochure on request.

**ACOUSTIC RESEARCH, INC.**  
24 Thorndike St., Cambridge 41, Mass.

## SCHUMANN

Continued from page 77

terliebe" cycles, but in at least a dozen of the other songs, he reaches out and seizes us with a peculiar directness. What a world of moods, emotions, and experiences his hundreds of songs express!

In the symphonies, the concertos, and the choral works, we find another Schumann, struggling, often successfully, to carry on the grander traditions. Less often than Brahms did Schumann make the mistake of being dutifully heroic. His music is more frankly personal and intimate; his greatest troubles are with form and development. But these flaws have been too often emphasized at the expense of the marvelous ideas and the emotional power of this music in larger forms.

In the piano pieces and songs of Schumann we can find consummate mastery of form united with the greatest spontaneity of expression. In the chamber music his contrapuntal skill takes inspired forms. The symphonic works abound in passages of unique splendor, such as the fourth movement of the "Rhenish" Symphony, rightly characterized by Tovey as "one of the finest examples of ecclesiastical polyphony since Bach". Let us seek out, therefore, the elements in Schumann that link him with Bach and Beethoven and Schubert. And let us not neglect a man who was on fire with beauty.

### A SELECTED SCHUMANN DISCOGRAPHY

- Bunte Blätter, Op. 99 . . . . .Epic LC-3031
- Carnaval, Op. 9 . . . . .Vox PL-7830
- Concerto for 'Cello & Orchestra, Op. 129  
Col. ML-4926
- Concerto for Piano & Orchestra, Op. 54  
Col. ML-4041
- Concerto for Violin & Orchestra, Op. 134  
C. H. S. 1128
- Dauidsbüandler Dances, Op. 6 . . . . .Vox PL-8860
- Fantasia in C, Op. 17 . . . . .Lon. LL-1009
- Fantasiestücke, Op. 12 . . . . .Vic. LM-1072
- Frauenliebe und Leben . . . . .Col. ML-4788
- Kinderscenen, Op. 15 . . . . .Lon. LL-1009
- Kreiseriana, Op. 16 . . . . .Urania C-7107
- Liederkreis, Op. 39 . . . . .Vic. LM-6036
- Manfred Overture . . . . .Vic. LHMV-1023
- Noveletten, Op. 21 . . . . .Lon. LL-1266
- Papillons, Op. 2 . . . . .Vox PL-7830
- Piano Music . . . . .West. 18061
- Quartet in A Minor, Op. 41, No. 1  
West. 5166
- Quartet in F, Op. 41, No. 2 . . . . .Ccl. ML-4982
- Quintet in E Flat for piano and strings, Op. 44  
Col. ML-4711
- Six Concert Studies on Caprices by  
Paganini, Op. 10 . . . . .Vox PL-8850
- Sketches for Pedal Piano, Op. 58  
MGM 3007
- Symphonic Etudes, Op. 13 . . . . .Ang. 35046
- Symphony No. 1 in B flat, Op. 38, "Spring"  
Vic. LM-1190
- Symphony No. 2 in C, Op. 61 . . . . .Mer. 50102
- Symphony No. 3 in E flat, "Rhenish"

Continued on page 79

# IMMEDIATE DELIVERY!

# DYNAKIT

Mark II

## 50 WATT POWER AMPLIFIER KIT



**\$69<sup>75</sup>** complete  
when ordered by mail

DOUBLE the power and quality on  
your present Williamson type ampli-  
fier with DYNACO A-430 transformer.

**\$29<sup>95</sup>**  
when ordered by mail

HI-FI COMPONENTS EXCLUSIVELY

## HOLLYWOOD ELECTRONICS

7460 MELROSE AVE.  
HOLLYWOOD 46  
CALIFORNIA  
WEBSTER 3-8208

**HOLLYWOOD ELECTRONICS**

7460 Melrose Ave., Hollywood 46, Calif.  
Please ship the following:

- DYNAKIT Mark II — \$69.75
- DYNACO A-430 Transformer — \$29.95

— Check, — Money Order for \$\_\_\_\_\_ enclosed.  
In California add 4% sales tax — Shipping  
charges C.O.D.

Name \_\_\_\_\_

Address \_\_\_\_\_

City \_\_\_\_\_ Zone \_\_\_\_\_ State \_\_\_\_\_





**QUOTE**

"Startling, full-bodied bass . . . crisp, clear mid-range . . . vibrant shimmering treble."  
Leading Hi-Fi Magazines, May 1956

**NEW! TRI-CHANNEL HI-FI Sound System**

Frankly, only about 12 people who read this ad will be interested enough in the majestic sound reproduction to plunk down \$795.00 for the unit. You are one of them . . . only if you sincerely want the truest depth and dimension possible in an audio system. This is a radical departure from conventional Hi-Fi . . . featuring a 3 channel Tone Colour mixer (preamp) feeding 3 separate amplifiers and driving 4 speakers—all acoustically matched! Flat frequency response from below 25 to above 25,000 cycles. Distortion below recordable measurement.

Don't get excited about it unless you can afford the price. Have your sound specialist arrange a demonstration . . . write today for independent, unbiased performance test reports.

**ERCONA CORPORATION**  
(Electronic Division)  
551 Fifth Ave., Dept. M-26, New York 17

If You're a Connoisseur...  
you'll want a  
**Connoisseur**  
**TURNTABLE**



\$110.00

Compare the Connoisseur with any turntable and you'll marvel at its performance. Non-magnetic, 12" lathe-turned table; precision ground spindle; phosphor bronze turntable bearing.  $\pm 2\%$  variation provided for all 3 speeds; hysteresis motor.

**TURNTABLE:** Rumble—better than 50 db down; Wow—less than 0.15% of rated speed; Dimensions:  $13\frac{1}{2} \times 15\frac{1}{4}$ "

**PICKUP:** Frequency Response — 20-20,000 cps  $\pm 2$  db at 33 $\frac{1}{3}$  rpm; Effective Mass—4 mg; Impedance—400 ohms at 1000 cps.



"Dynabanced" tone arm with Mark II super-lightweight pickup w/diamond stylus \$49.50 . . . w/sapphire stylus \$34.50.

**ERCONA CORPORATION**  
(Electronic Division)  
551 Fifth Ave., Dept. 26, New York 17  
In Canada, write Astral Electric Company Limited, 44 Danforth Road, Toronto 13

## SCHUMANN

Continued from page 78

Lon. LL-1037  
Symphony No. 4 in D Minor, Op. 120  
Dec. 9767  
Trio No. 1 for Violin, 'Cello, Piano, Op. 63  
Col. ML-4718  
Trio No. 2 for Violin, 'Cello, Piano, Op. 80  
Vcx PL-8480

## COLLECTOR'S CORNER

Continued from page 40

of these works adds much to our knowledge of this composer, but they pinpoint minor facets of his genius, and are very agreeable in their own right.

One of the great services made by recording companies to the recent history of music, is their rediscovery of Vivaldi. Vox, in particular, having issued two complete sets of his concertos, now follow up with a third, *Il Cimento dell' Armonia e dell' Invenzione, Op. 8*, beautifully played by Reinhold Barchet (violin) and the Stuttgart Pro Musica String Orchestra under Rolf Reinhardt. Like the earlier series, some have marvelously evocative programmatic titles such as "Pleasure and Storm at Sea." In strong contrast, Mendelssohn's piano concertos have today a rather faded but still elegant charm, coolly and perfectly caught by Peter Katin accompanied by Collins and the L.S.O. on Decca.

Instrumental discs: a selection of César Franck's organ music played on the Cavaillé-Coll instrument in Ste. Clotilde in Paris, which he himself used to play, sounds authentic down to the last detail of registration; a clear, well-balanced recording and admirable playing from Jean Langlais.

Solomon plays Brahms' *F minor Sonata* with breadth, drama and evident enjoyment in his latest issue on H.M.V. Sharing with Boult a strong feeling for the architecture of music, it is the firm basis which here enables one to get past occasional tempo idiosyncrasies. Finally from Decca comes Volume 1 of an "Anthology of English Song" — Elizabethan Lute Songs — sung with superb artistry by Peter Pears (tenor) to the sensitive lute accompaniment of Julian Bream. History without tears indeed.

These days of rocketing costs and musical fashion conspire to favor the small orchestra. Mahlerians should be more than ordinarily grateful, therefore, to Phillips, to Eduard Flipse, and the Rotterdam Philharmonic Orchestra for their excellent recordings of two of Mahler's major works — major in size as well as value. The first to appear was the *Symphony of a Thousand* — the *Eighth*. Now follows the *Tragic*, both sensibly and very well recorded during public performances at the Holland Festival.

Personally, whilst admiring the grand design and noble architectural proportions of this symphony, and wallowing in its

Continued on page 80

# AR-2

The AR-1 acoustic suspension\* speaker system is now widely recognized as reproducing the cleanest, most extended, and most uniform bass at the present state of the art. It is employed as a reference testing standard, as a broadcast and recording studio monitor, as an acoustical laboratory test instrument, and in thousands of music lovers' homes.

The AR-2, our second model, is a two-way speaker system (10 in. acoustic suspension woofer and newly developed tweeter assembly), in a cabinet slightly smaller than that of the AR-1— $13\frac{1}{2} \times 24 \times 11\frac{3}{8}$ ". It is suitable for use with any high quality amplifier which supplies 10 or more clean watts over the entire audio range.

# AR-2

The price of the AR-2 in hardwood veneer is \$96.00, compared to the AR-1's \$185.00. Nevertheless we invite you to judge it directly, at your sound dealer's, against conventional bass-reflex or horn systems. The design sacrifices in the AR-2, comparatively small, have mainly to do with giving up some of the AR-1's performance in the nether low-frequency regions, performance which is most costly to come by. The AR-2 can radiate a clean, relatively full signal at 30 cycles.

The AR-2 speaker was designed as the standard for medium-cost high fidelity systems. Our tests have shown it to be so far ahead of its price class that we think it will come to be regarded as such a standard within its first year.

# AR-2

Literature, including complete performance specifications, available on request from:

**ACOUSTIC RESEARCH, INC.**  
24 Thorndike St., Cambridge 41, Mass.

\* Pat. pending and copr., Acoustic Research, Inc.

- **SELECTOR ARM** easily glides to record desired—moves it out
- **INDEX NUMBERS** top and bottom make filing easy

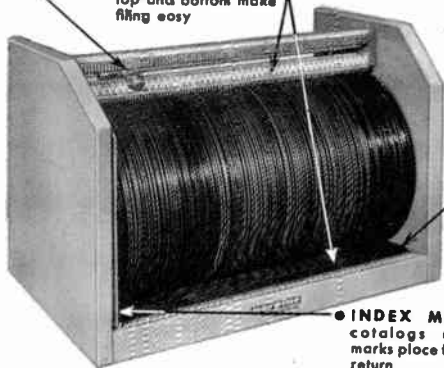

**AT LAST! YOUR PRECIOUS RECORDS  
SAFE, CLEAN, VERTICAL, IN A  
MINIMUM OF SPACE...**

**Instantly available—  
Re-filed in seconds!**

- **GUIDES** of firm rubber—hold records securely

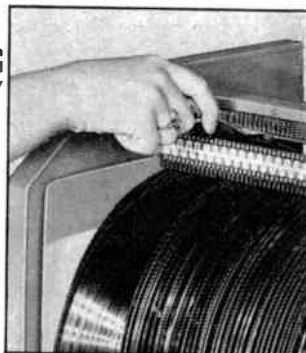

- **INDEX MARKER** catalogs records, marks place for record return

- **EASY OPERATION** slight lift gently moves out record

The Norpine Selector Record File holds 100 LP 12" records in a minimum of space—with a maximum of availability. Skillfully designed firm rubber grooves touch only non-playing surfaces. Records are filed by number and selected by means of a sliding arm engaging a notched index. A slight lift of the selector arm moves out the record desired. Re-filing is a matter of seconds! Gummed numbers to apply to your records, handy index marker card and transparent, plastic dust cover provided. Fits standard 16"x16"x24" cabinet.

Frame is strongly built of steel, beautifully finished in gray, ivory, green or tan. Specify color desired. Sold direct to you only. Send your check or M.O. for \$59.95 (plus \$1.80 sales tax if you live in Penna.) for immediate shipment—express charges collect; weight approx. 25 lbs. (try it for 10 days—if not satisfied, return it for immediate refund). Also 10" size—\$54.95.



**NORPINE CORPORATION**

Dept. C — P.O. Box 129, Chambersburg, Pa.

**GRAY ANNOUNCES**

**The most important Hi-Fi Turntable development in 10 years...**

**MASSIVE TURNTABLE AND MOTORBOARD**

Imagine—a 1/4" steel motorboard for rumble-proof, noise-proof performances. But that's only part of the new, Gray Hi-Fi turntable story. A feature is the long, tapered turntable bearing which assures precision fit forever. Other features: Viscous-Damped Tone Arm, shock mounted assembly and many more. See it, today!

**EASY INSTALLATION**

Anyone can install a Gray turntable... it's easy as pie. Pick-up lead furnished with phono-jack, A.C. plug-in power cord.



**BATTLESHIP CONSTRUCTION PREVENTS RUMBLE AND NOISE**

**GRAY RESEARCH & DEVELOPMENT CO., INC.**  
MANCHESTER, CONNECTICUT

Subsidiary of The Gray Manufacturing Company

**COLLECTOR'S CORNER**

*Continued from page 79*

bitter-sweet lyricism, I find much of the writing either empty bombastic or quietly undistinguished. All the same, a really worthwhile issue.

Reasons for the neglect of certain music are as varied as the music itself, and incidental music, by its very appellation, starts off with a sizable handicap. Nevertheless some wins through in spite of it. Witness Mendelssohn's *Midsummer Night's Dream*, and Beethoven's overture to "Egmont". But how many of us have heard the entr'acte music or the *Symphony of Victory* that Beethoven also wrote for this play by Goethe? Hermann Scherchen and the Vienna State Opera Orchestra have now lightened our darkness with an exciting first recording of this music in its entirety—music inspired by the same love of freedom that brought forth "Fidelio" and the *Eroica Symphony*, music that enriches our experience beyond measure. Admirably performed and recorded with soprano Magda Laszlo and Fred Liewehr, an actor from the Vienna Burgtheater, it is released on London Ducretet-Thomson DTL 93085; a stirring discovery!

**RECORD COLLECTING**

*Continued from page 37*

Each installment of the "Guide to Record Collecting" will add up to a chapter of music history that can be re-lived in your living room—not only with a stack of recordings but also with a few books of collateral interest, and not necessarily books on music at that.

This is an ambitious undertaking, to be sure, but we feel that it will be far more valuable as a guide to record collecting than any typical discography ever could be. A collector should have a reason for owning each record in his library. This is the identification of a collector who is an enthusiast in the fullest sense, in contrast to the customers of record shops who are dutiful purchasers of such recordings as they think others will expect them to own. For we hold that the more you know about the music in your collection, the greater its value to you, and the more enjoyment you will have from it.

**DO YOU REMEMBER**

*Continued from page 53*

discs stored in a warehouse on 52nd Street in New York City, at the cost of many hours spent by the program producer amid coils of discarded tape, in a little windowless room jammed with recording apparatus. From these comes the program "Recollections at Thirty", bringing voices out of the past and history into the present.

Two important facts supported Mr. Wogan's idea. First, NBC will soon be celebrating its thirtieth birthday; second, since the early days of its broadcasting, the

*Continued on page 81*

## DO YOU REMEMBER

*Continued from page 80*

Network has made recordings of its programs as they went out over the air. These records now total somewhere close to 300,000 — an irreplaceable storehouse of American humor, music, politics, news events, and personalities. Why not bring some of these gems to light once again?

All that remained, after the initial idea was conceived, was to browse through this vast collection of records and choose the items of greatest interest. Not so simple a task, when you consider that NBC began recording its programs in 1933, and in the first three years alone ran up a total of more than thirteen hundred shows. The man for the job was Robert Maurer, who has produced "Recollections" since its start on June 20th. He is handy with a stopwatch, has a quick ear and a capacity for airtight concentration, and is unfazed by miles of tape and mountains of records. It is he who decides what to put on each week's program. His choice, he says, is now largely determined by requests from listeners, who remember a particular performer or even a particular show from years past.

A trip to the files of the program analysis department tells Mr. Maurer the dates and names of the shows on which a singer, for example, appeared. An order for the record is sent over to the warehouse. There, thanks to NBC's careful cataloguing, from along the avenues of storage shelves comes the disc in its cardboard box. It is of the standard broadcast type, 16-in. micro-groove, 78 rpm., with an aluminum base (or wartime glass) coated with acetate. Even the oldest records in the collection sound surprisingly good when played on up-to-date equipment.

Back at NBC studios, with possibly a dozen of these records stacked in front of him, Bob Maurer's fun begins. How reduce three or four hours of broadcast material to 24 minutes and 40-odd seconds? How arrange a program with a balance of the serious and the light, the spoken and the musical, the theatrical and the factual? These are the questions that confront him. After a listening session — of how many hours only he can say — the first big job of editing is done. A 1935 song by Bing Crosby is brought into the lineup with an Ed Wynn comedy scene and a twenty-year-old *Ab, Sweet Mystery of Life* by Nelson Eddy; three minutes of a former U. S. President's speech are chosen to precede the thick German accent of Walter Damrosch, explaining Saint-Saëns' *Carnival of Animals* before he turns to conduct the orchestra during one of his famous "Music Appreciation Hour" programs. And so it goes. The parts of the master records to be used are recorded on tape, and all is ready, then, for the most delicate part of the whittling-down process. Up to this point, only a rough approximation of the broadcast

*Continued on page 82*



*Where light and shade repose, where  
music dwells  
Lingering—and wandering  
on as loathe to die;  
—William Wordsworth  
"Inside King's College Chapel, Cambridge"*

## Quality Amplifier

Made in CAMBRIDGE, ENGLAND

The center of scientific research

*For Those Who Will Have Nothing But The Finest*  
New Wide-band amplifier, superbly crafted in the  
grand tradition for sound reproduction.

**MAIN AMPLIFIER** Type HF25  
Power output 35 watts. Output impedances 4, 7, 15 and 60  $\Omega$ . Noise and hum -90 db from full output. Harmonic Distortion less than 0.1% at 15 watts, 0.3% at 35 watts. I.M. Distortion 0.4% at 25 watts, 0.5 at 30 watts, 0.72% at 35 watts. Damping Factor adjustable from 35 to infinity. Negative feed-back 25 db round amplifier. **\$139.50**

**CONTROL UNIT** Type HF25/A  
*Controls:* Bass, Treble, Low Pass Filter, Volume, Selector for tape, radio and microphone inputs and all standard recording characteristics. Low noise circuitry. Cathode follower output to power amplifier allows remote control up to 20 feet. **\$59.50**

Harvey Radio and Liberty Music Shops New York Distributors  
*For complete equipment and local dealer information write to:*

**BRITISH RADIO ELECTRONICS, LTD.**  
1833 Jefferson Place N.W. Washington 6, D. C.

# NOTICE!

**DON'T BUY** any High Fidelity equipment—until you have heard and seen the breath-taking new **VANGUARD SERIES** by **INTERELECTRONICS**. Bold and pioneering in concept as the Earth Satellite Project itself, these superb new instruments offer design achievements found only in the Vanguard.

Among the many revolutionary features, never before realized and found only in Interelectronics Vanguard series—Nickel Alloy Toroidal Output Transformers—Nickel Alloy Toroidal Power Transformers—Ultra-high permeance, new design power output tubes—Semiconductor tubeless power supply—Unlimited multi-impedance outputs for absolute speaker matching—Transistor wide-band feedback circuitry—Circuitry never before realized and many, many other new features that only the complete brochure can describe.

Obsoletes all present day equipment. **DON'T BUY OBSOLETE EQUIPMENT—WAIT FOR THE NEW INTERELECTRONICS VANGUARD SERIES.**

At your favorite High Fidelity dealer by November 1st, 1956. Be sure to write for the complete brochure that describes this exciting new series.

Interelectronics Corporation,  
Dept. M, 2432 Grand Con-  
course, N. Y. 58, N. Y.

## DO YOU REMEMBER

*Continued from page 81*

time has been made. Now comes the stopwatch phase.

Announcer Ed Herlihy's script has been recorded on a separate tape before the final editing session begins. Now Bob Maurer, sitting close to the speaker in the small tape-recording room, directs his assistant, operating the tape machine, in the splicing-in of the script at the appropriate moments in the program—a simple scissors-and-patching-tape procedure. Then a speeded up run-through shows, by means of a time meter on the machine, that there are perhaps ten minutes of overtime; the material must be cut by almost one third. Out come the scissors to eliminate the verse of a song here, a bit of the announcer's monologue there, a comedian's joke that shows its age anyway. Sometimes a helping hand is given to a performer by trimming out a stumble in speech or an unintended cough. Still fifteen seconds of overtime. A pause between numbers is tightened up; the rustle of the orchestra as Damrosch turns toward it is eliminated. The 24 minutes, 40-odd seconds are finally achieved after several hours of paring.

Two fresh tapes are made from the much-cut, much-spliced original. The second is to run simultaneously, though silently, with the first as it is played over the air, to be switched on in case of an accident with hardly a noticeable loss of time. Bob Maurer's job is done, and he wades out of the room through piles of tape, to begin work on next week's "Recollections at Thirty".

Like a book or a movie, a radio program has a great deal to tell about the time in which it was produced. However, an old book takes refuge in the library and is available to anyone who wants it; the best of the old films are shown occasionally as long as their condition permits. To radio, Time deals a harder blow for, ordinarily, once 'tis done, 'tis done. The voice of Alice Brady went out over the airways, to be heard no more; the young Lillian Gish played in a radio drama, complete with costume, and that was that. Old methods of broadcasting, old broadcasters give way to new, and silence descends over yesterday.

But let the past be recalled, and a thousand memories respond. It was not, after all, so very long ago that singer Helen Graves, as she is pictured here, made the first full evening broadcast that was ever carried over Station WEAf, or that Jim and Marion Jordan became radio's Fibber McGee and Molly. Many changes have taken place, as the accompanying photograph of a 1926 sound effects crew testifies, but such well known figures as Rudy Vallee, the late Major Bowes, Bobby Clark and the Bud Abbott and Lou Costello team are fondly remembered by radio's faithful listeners.

*Continued on page 83*

Hi . . . Mr. Hi Fi

This is It . . .

## The BRADFORD Perfect BAFFLE\*

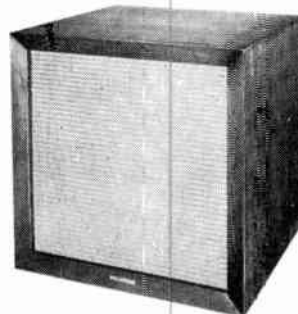

**Radically new idea in loudspeaker enclosures. Not a bass reflex or folded horn.**

The primary purpose of a loudspeaker enclosure is to prevent destructive sound cancellation that takes place at low frequencies, when the front and rear waves, emanating from both sides of the speaker cone, merge.

It is obvious that no rear waves can escape through a totally enclosed cabinet, and it would be the perfect baffle, except for one reason. The air pressure within the cabinet acts as a cushion upon, and therefore restricts, cone movement. This causes loss of life and color.

**The BRADFORD Perfect BAFFLE is totally enclosed, yet it relieves cone pressure by an ingenious device that operates in unison with cone movement.**

*Since this action conforms to an ultimate scientific principle, the BRADFORD Perfect BAFFLE is the only enclosure that can give you the utmost in sound reproduction.*

**And that, specifically, is . . .**

**ALL THE BASS.** Full, rich, clean bass, clearly distinguishing each contributing instrument, down to the lowest speaker frequency.

**NO BOOM.** Absolutely no boom. Boom, or "one note" bass, is not high fidelity.

**NO FALSE PEAKS.** Does not "angment" bass by false peaks that are really distortions.

**ANY SPEAKER.** Accommodates any speaker . . . any size, weight, shape or make.

**NO TUNING.** No port tuning or speaker matching.

**ANY POSITION.** Operates in any room position.

**NO RESONANCES.** No false cabinet or air resonances.

**COMPACT.** Sizes for 8" & 10" speakers, 12" x 12" x 9"; 12" & 15" speakers, 17" x 17" x 14". Prices: finished \$39.50 & \$69.50 respectively. Unfinished Birch \$34.50 & \$59.50.

**REAL HARDWOODS.** In all popular finishes . . . mahogany, blond, ebony, walnut.

**INCOMPARABLE CONSTRUCTION.** Hand made, hand finished . . . by master craftsmen. All walls 1/4" thick.

**GUARANTEED.** Unconditionally guaranteed to out-perform any other enclosure now available regardless of size, weight or price.

**If you want the very best speaker enclosure and will not be misled as to real performance by deceptive size or price, see your audio dealer at once. A demonstration will convince you. Or write for literature.**

\* Patent pending.

**BRADFORD**

*Perfect* **BAFFLE**

**BRADFORD & COMPANY**

27 East 38th Street New York 16, N. Y.

*Hi-Fi Music at Home*

## DO YOU REMEMBER

Continued from page 82

The mail received by NBC about "Recollections at Thirty" has been prodigious and shows no sign of lessening. The pleasure of the older generation is matched by the curiosity of the younger, for many teen-agers have written to say they enjoy glimpses of radio as it was before they were around to hear it. Which goes to show that radio, given a chance to reminisce, has many a story to tell.

## CARUSO'S VOICE

Continued from page 61

was. Since even the recordists at the time were never quite sure, we felt that our best clue was the score of the music being performed. Slick and I began with the assumption that the music was always performed in the key as originally written, and our job then was simply to adjust our turntable speed until Caruso was singing in that key.

But two hitches soon showed up in this procedure. First, the album included a number of simple songs which could have been sung in almost any key. Second, when complying with the scores on the standard works, we found that there were tremendous discrepancies in sound quality from record to record. And even though we could assume that there had been improvements with advancing technology, still we often had the feeling that we were working with a half-dozen different tenors instead of just one. It was at this point that I made my classic remark about the Caruso record which sounded better, but didn't sound like Caruso.

We were working on the famous *Bois Epais*, which at 78 rpm. is pitched somewhere between the keys of *A-flat* and *A-natural*. Increasing the speed to reproduce in the key of *A* rendered a sound which we have come to think of as the Caruso voice, but it sounded tinny and unnatural. When we lowered the pitch a half-tone, the voice took on an amazingly life-like quality, with better balance, presence, and a natural vibrato. Now the question simply was, do we make it sound "like Caruso" or do we make it sound natural?

At this point we were beginning to feel unsure of ourselves in the entire project, and felt the need of some expert opinion. We therefore consulted with musicologists, veteran Victor Talking Machine recordists, a musician who had worked in the Caruso recording orchestra, and record collectors who specialized in Caruso. But memories fade with passing time and opinions can vary widely. Evaluating the results of our survey, we still felt that we lacked a conclusive answer. But we were determined that somewhere that answer was to be found.

### We Found a Rosetta Stone

Plunging back into the work, we next discovered three different recordings, all of

Continued on page 84

The magic word in speakers!

# ELECTROSTATIC

...product of 9 years

of JansZen  
research

and backed by an unprecedented



With the JansZen 1-30 Electrostatic speaker you can sit in *any* part of the room and still get nothing but pure, even, undistorted sound. Unlike paper-cone speakers, this revolutionary method of reproduction transforms electrical energy *directly* into sound... eliminates breakup and audible resonances... gives 500-30,000 cycle response with an unbelievable 120 degree dispersion!

Exclusive electrostatic radiators are the key to JansZen's audio achievement. Each of the four radiators incorporates a virtually massless, stretched diaphragm, driven over its entire surface by an electrostatic field. The result is completely uncolored sound for the first time in speaker development. These radiators are unaffected by temperature and humidity changes... so stable and dependable we guarantee them two full years.

\*Radiators guaranteed 2 years;  
Balance of speaker guaranteed 1  
year. Based on a remarkable new  
principle in the transmission  
of sound.

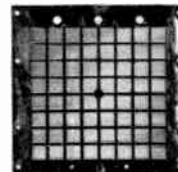

Mahogany,  
Birch, Walnut  
and Utility  
finishes available  
on request.

# JansZen ELECTROSTATIC

Loudspeaker



Send for complete literature on the JansZen 1-30 Electrostatic  
as well as the name of your nearest dealer!

Product of NESHAMINY ELECTRONIC CORP., Neshaminy, Pa.  
Export Division: 25 Warren St., New York 7, N. Y. Cable: Simontrice, N. Y.

**marantz**

write for literature

...the ultimate goal  
of the  
critical listener

*Audio Console*

preamplifier with cabinet \$168\*

*Power Amplifier*

\$198

\*slightly higher west of the Mississippi

**marantz company**

44-15 Vernon Boulevard, Long Island City 1, N. Y.

## CARUSO'S VOICE

Continued from page 83

which were made on the same day and at the same session. In each of these three recordings there appeared a high C as originally written, but in order to reproduce that high C, we had to run two of the records at a much faster speed than the other one. And when we did so the voice quality became very strained and artificial. But when we slowed down those two recordings to the speed of the third one, thus lowering the C to a B, the voice became more natural, and the quality and balance on the three matched perfectly. The only trouble was that two of the recordings were no longer in the keys as written.

So if we put all of the performances into the correct keys, we were admitting the simultaneous occurrence of two highly unlikely events at that original recording session: 1) *The voice of Caruso must have changed dramatically right in the middle of the session, or the characteristics of the record cutter must have varied erratically;* and 2) *the speed of the recording turntable must have suddenly changed similarly.* And that just didn't add up.

By this time then we were like a couple of bird dogs on the scent of a big kill. Our faith in our opinions was strengthened when we recalled that Caruso was said not to be particularly proud of his high C, and he avoided it whenever possible. Some say that he began his career as a baritone, and he even recorded a bass aria, *Vecchia Zimarra*. Contemporary writers often referred to his baritone-like quality. From all of this, coupled with our own careful experiments, we concluded that Caruso did on occasion transpose downward so that a composition might fit his range more comfortably. And we felt that we had rediscovered the true baritone-like character of the fine Caruso voice.

So we started all over again, throwing out everything we had done. The musical scores henceforth became only guides, while our ears and our reasoning told us the ultimate course to follow. The further we progressed the more convinced we became of the correctness of our position. Everything began to fit into place. Seeming inconsistencies in speed and pitch disappeared. Most important of all, it was possible to trace the development of this magnificent voice, with no difficulty in identifying it as the same singer. Even the orchestra sounded like an orchestra instead of a thirsty *Biergarten* band.

This explains why, on the re-recorded Caruso LP's, you will hear his great voice as a richer, rounder, deeper, more natural one. It is a quality which has caused several critics to remark that only now do they appreciate the reasons for the acclaim he had in his own time. At RCA Victor we are convinced that we are presenting the truest picture of the Caruso voice ever heard on records. And unless you heard him in person, this is truly the Caruso you've never heard before.

the cartridge that scores **100%**

The Recoton-Goldring cartridge was acclaimed the best by a national independent research organization, because it passed all tests with flying colors!

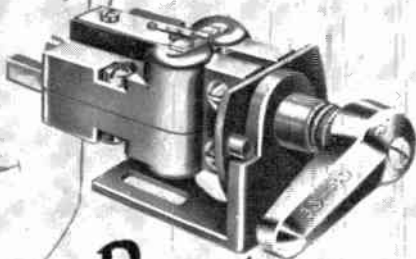

- Performance uniformly excellent.
- Cantilever stylus armature construction capable of rougher treatment than most moving-coil mechanisms.
- Will fit just about any American-made arm.
- Smooth and free of strain even on heavily recorded passages.
- Gives you more for your money. (Only \$9.90 including 2 synthetic sapphire styli).

**Recoton-Goldring**

"500" MAGNETIC TURNOVER  
CARTRIDGE

At leading hi-fi distributors,  
write for descriptive literature to:

RECOTON CORPORATION, 52-35 Barnett Ave., Long Island City 4, N. Y.

Manufacturers of Weid-Finow's Phonograph Styli.

BUY HI-FI HERE

**4 ALLIED HIGH FIDELITY STUDIOS**  
**ALLIED RADIO CORP.**  
 100 N. Western Ave., Chicago 90, Ill., Haymarket 1-6800  
**ALLIED HIGH FIDELITY STORES, INC.**  
 602 Davis St., Evanston, Ill., DAVis 8-8822  
**EVERGREEN ALLIED HIGH FIDELITY, INC.**  
 2025 W. 95th St., Chicago 43, Ill., BEVERly 8-1067  
**WEST SUBURBAN ALLIED HIGH FIDELITY, INC.**  
 7055 W. North Ave., Oak Park, Ill., ESTabrook 9-4281

**FM/Q**  
**antenna systems**  
  
 High gain Broadband Yagi for max. sensitivity to both 72 and 300 ohm tuner input. Designed for fringe FM.  
**APPARATUS DEVELOPMENT CO.**  
 FM Dept. Wethersfield 9, Connecticut

**EVERYTHING IN HIGH FIDELITY . . .**  
 from pickup to speaker. Try and compare your choice of hi-fi components on the "AUDIOMAT" in ASCO's air-conditioned demonstration studio.  
**ASCO SOUND CORPORATION**  
 115 W. 45th St., 3rd floor, New York 36, N. Y.  
 Write for free catalog, or phone JUdsan 2-1750

**AUDIO EXCHANGE**  
 The Trading Organization in the HI-FI FIELD  
 Write department MH-1 for free catalog of used, fully-guaranteed equipment  
 159-19 Hillside Ave., Jamaica 32, N. Y. AXtel 7-7577  
 367 Mamaroneck Ave., White Plains WH 8-3380

**STEREOPHONIC TAPES**  
 Now in stock (all of them) send 30 cents for tape catalog. Latest stereo equipment lists and details of stereo conversion kits. See our ad on next page.  
**BOSLEY HI FI AND STEREOPHONIC**  
 316 N. Glendale Ave., Glendale 6, Calif.

**LISTEN TO POLICE & FIRE CALLS**  
 Complete Registry of police and fire radio stations in the U. S., showing location, call letters, and frequencies—Postpaid, \$2.00  
**COMMUNICATION ENGINEERING BOOKS**  
 Radio Hill, Monterey, Massachusetts

**PROFESSIONAL RECORDING SERVICE**  
 Tapes made, copied, masters cut, processed, pressings made — short runs our specialty — all AMPEX 300's Telefunken & Altec, HYDROFEED Lathes, monofusion presses. Components Corporation, 106 Main St., Denville, N. J. Phone: Rockaway 9-0290

**IN CANADA —**  
 There's one place where you can find — and hear — all your high-fidelity equipment needs. We carry a complete stock . . . come in, or write in, for a chat, a look, and a listen.  
**ELECTRO-VOICE**  
**SOUND SYSTEMS**  
 141 Dundas St., West, TORONTO

**HIGH-FIDELITY HOUSE**  
 Largest distributor in the West specializing in custom sound equipment  
 Phone: RYan 1-8171  
 536 S. Fair Oaks, Pasadena 1, Calif.

**HOLLYWOOD ELECTRONICS**  
 "HI-FI COMPONENTS EXCLUSIVELY"  
 Since 1944  
 7460 MELROSE AVE., L. A. 46. WEB 3-8208

# INDEX of ADVERTISERS

Acoustic Research, Inc.	78, 79
Allied High Fidelity Studios	85
Allied Radio Corp.	30
American Electronics	24, 25
AMI, Incorporated	20
Apparatus Development Co.	85
Asco Sound Corp.	85
Audio Exchange	85
Bogen Co., David	26, 27
Bosley Hi-Fi & Stereo	85, 86
Bozak Speakers	74
Bradford & Company	82
British Industries	2
Capitol Records, Inc.	9
Collaro	28
Components Corporation	85
Columbia Records	7
Cook Laboratories	14
Decca Records	16
Electro Sonic Laboratories	13
Electro-Voice, Inc.	15, 18, 19, Back Cover
Electro-Voice Sound Systems	85
Ercono Corp.	79
Garrand Changers	2
Gellar, Marvin	86
Gray Research & Development Co.	80
Harvey Radio Co.	85
Heath Company	66, 67
High Fidelity House	85
Hollywood Electronics	78, 85
Interelectronics	82
Janszen Speakers	83
Jensen Mfg. Co.	1
Kierulff Sound Corp.	85
Klipsch Associates	77
Laboratory of Electronics Engineering	11
Lonsing Sound, Inc., J. B.	8
Lectronics	76
Leslie Creations	85
Livingston Electronics Corp.	16
Louisville Philharmonic Society	86
Marantz Company	84
Mercury Records	4
Neshaminy Electronic Corp.	83
Newcomb Audio Products Co.	73
Norpine Corporation	80
North American Philips Co.	23
Orradio Industries, Inc.	6
Ortho-Sonic Instruments, Inc.	86
Pickering & Co., Inc.	32
Pilot Radio Corp.	21, 22
Presto Recording Corp.	Inside Back Cover
Pye, Ltd.	81
Radio Corporation of America	85
Radio Electric Service Co. (Pa.)	85
Radio Shack, Inc.	85
RCA Victor Records	12
Recoton Corp.	84
Reeves Soundcraft Corp.	17
Regency Division, J.D.E.A.	72
Rockbar Corporation	28
Scott, Inc., Herman Hosmer	29
Sherwood Electronics Lab.	75
Shure Bros., Inc.	14
Sonotape Corp.	86
Stephens Manufacturing Co.	5
Stereophonic Music Society	10
Technical Appliance Corp.	76
University Loudspeakers	70, 71
Westminster Recording Co., Inc.	Inside Front Cover
Wholesale Supply Co.	85

BUY HI-FI HERE

EVERYTHING IN **Electro-Voice**.  
 HI-FI EQUIPMENT & SOUND SYSTEMS  
**KIERULFF SOUND CORP.**  
 820 W. Olympic Blvd., Los Angeles 15  
 Tel. Richmond 7-0271

**RECORD CABINET**  
 Wrought-Iron; holds over 200 albums in 10 sections. 25" x 22" x 10". Please remit \$9.95, express charges collect. Money-Back-Guarantee  
 © LESLIE CREATIONS  
 Lafayette Hill 6, Pa.

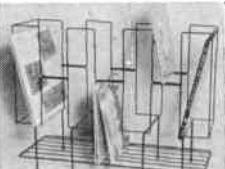

In the PHILADELPHIA area  
**YOUR COMPLETE SUPPLIER IS**  
**Radio Electric SERVICE CO. OF PENNA., INC.**  
 HI-FI & COMMERCIAL SOUND STUDIO  
 709 Arch Street, Philadelphia 6, Pennsylvania  
 Phone: LOmbard 3-7390

**FREE 224-PAGE CATALOG**  
**LARGEST STOCKS in the EAST**  
 Cook and Audiophile Records, Too  
**RADIO SHACK CORPORATION**  
 Boston 8, Mass., 167 Washington St.  
 New Haven 10, Conn., 230 Crown St.

**FM RECEIVING ANTENNAS**  
 Standard and Special Designs  
**WHOLESALE SUPPLY CO.**  
 Lunenburg, Mass.



**Now! New RCA Victor superstrength, extra-long play Hi-Fi "Mylar"\* tape!**

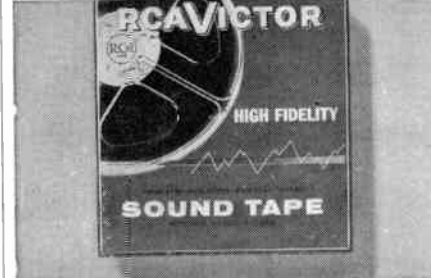

Plays 50% longer! Not 1200 feet, but 1800 feet on a 7" reel! Extra-thin—superstrong! Costs \$7.50 per 7-inch reel. Also available: new RCA Victor acetate tape with full frequency performance — at a special low price! And RCA Victor acetate tape with full High Fidelity response. The same tape used for professional recordings—\$3.50 for 7-inch reel.

\*"Mylar" is a registered Dupont trademark for its polyester film. Nationally advertised list prices shown, subject to change.  
**RCA VICTOR**  
 RADIO CORPORATION OF AMERICA  
 CAMDEN 8, NEW JERSEY



**Ortho-sonic V/4**  
TRACKS COURSE OF ORIGINAL RECORDING STYLUS

**NEW 7/4" ARM (Model #100)**

RETAINS 10 INCOMPARABLE FEATURES OF PROFESSIONAL TRANSCRIPTION MODEL #200 **ONLY \$35.95**  
**PLAYS ALL RECORDS UP TO AND INCLUDING 12"**

Embodies ALL the revolutionary ORTHO-SONIC V-4 engineering principles which eliminate distortion due to tracking error.

**MAKES WORN RECORDS SOUND LIKE NEW!**  
The ORTHO-SONIC V-4 is for those who want perfection in sound reproduction.

Model #100 \$35.95 Model #200 \$44.50  
If Your Hi-Fi Dealer Cannot Supply You Order Direct From

**ORTHO-SONIC INSTRUMENTS, Inc.**  
66E Mechanic Street, New Rochelle, N. Y.

**NEW!—  
The HI-FI  
SENSATION  
of the YEAR!**

**ENJOY** fine music at its high-fidelity best . . . brilliantly played . . . flawlessly recorded. . . and interpreted as the composer intended.

This is a rare opportunity to possess exclusive **FIRST EDITION RECORDS**—first recordings of newly commissioned works by outstanding composers, played superbly by the renowned

**LOUISVILLE ORCHESTRA**  
Robert Whitney, Conductor

These "collector's item" recordings are made in consultation with the composer and are engineered by Columbia Masterworks technicians. Available for a limited time, from the Society only, they represent a priceless collection of new, exciting music . . . the finest expressions of living composers the world over.

- "Splendid sound."  
—Cleveland Plain Dealer
- "... a service to music unequalled."  
—Christian Science Monitor
- "... the reproduction is a model of clarity."  
—St. Louis Globe-Democrat
- "... recording and performances, excellent."  
—Pittsburgh Post-Gazette

**OFFER LIMITED—SEND TODAY FOR INFORMATION ON FREE TRIAL RECORDS**

.....  
**Louisville Philharmonic Society**  
Dept. F, 830 S. FOURTH ST., LOUISVILLE 3, KY.  
Please send me free, complete information on exclusive First Edition Records and free record offer.

Name \_\_\_\_\_  
Address \_\_\_\_\_  
City \_\_\_\_\_ State \_\_\_\_\_

**BUY, SELL or SWAP**

The opportunity to buy, sell, or swap items of equipment or records through the use of this department is made available as a service to readers of MUSIC at HOME without charge.

Copy should be limited to 35 words. Items are not accepted from business firms. The Publisher reserves the right to reject copy which, in his opinion, does not conform with the standards of this Magazine. No box numbers, please.

**SELL:** Have 10,000 records on 78 rpm from 1915 to 1945. Popular dance bands, vocalists, stage, screen and radio stars, jazz, blues, and opera. Bing Crosby, Whiteman, Jolson, Goodman, Miller, Dorsey's. Send for list. Walter Dymit, 2323 N. 77th Court, Elmwood Park 35, Ill.

**SELL:** Altec A433A preamp and power amplifier A333A \$35; Fisher 50 PR \$10; Jensen 15-in. type H coaxial in type "D" imperial walnut cabinet \$65; G.A. Air Coupler \$15; Altec 600B speaker \$20. Willis M. Morrisette, Box 554, Enfield, N. C.

**SELL:** Two Baldwin electronic organ amplifying systems. Each consists of 40-watt amplifier with four matching 15-in. speakers. In excellent condition. Best offer over \$200 each system. Joseph T. Mock, 615 12th St., Ashland, Ky.

**SELL:** Very reasonable, one 20-watt Craftsman T amplifier used a couple years; top condition. Arthur Wise, Stratford Drive, Philadelphia 11, Pa.

**SELL:** Pickering D120 and D140 cartridges (both with diamond styli, just back from factory overhaul) \$20 each; Garrard RC80 with base \$30; Sargent Rayment SR98 Williamson amplifier \$70; Sargent Rayment SR38 preamplifier \$40; Baruch Lang loudspeaker system \$15. Inspection invited. D. Shultz, 10820 Burl Ave., Inglewood, Calif.

**SELL:** H. H. Scott 121-B preamp with cabinet \$110. McIntosh C-8P preamp with mahogany cabinet \$60. Fisher 80-AZ amplifier \$55. All in excellent condition. Will consider trades. John Haner, 815 N. Henderson, Galesburg, Ill.

**BUY, SWAP, SELL:** Private collector wishes to purchase, exchange, or sell collectors items (vocal) and LPs with colleagues, in the States. Correspondence and lists appreciated. H. Richmond, 16 Sedgley Ave., Prestwich, Lancashire, Eng.

**SELL:** Bozak speakers B199A woofer and B200X tweeter pair in Cabinet Klipsch Rebel IV-12 lined oak cabinet. Retail value \$153.35. Excellent condition. Price \$95. Robert Silverman, 15-12 Chandler Drive, Fairlawn, N. J. Fairlawn 4-7821.

**SELL:** Altec Lansing 820C theater speaker system, perfect condition, 9 months old \$330. McIntosh C-8 preamp and MC-30 amplifier, 6 months old \$185. A. Buonocore, 80-30 235th St., Queens Village 27, N. Y. Hollis 5-4717

**SELL:** Midgetape portable recorder (miniature) self-contained batteries 1/2 hr. each direction, excellent voice quality, complete in original carton including shoulder holster, mike 4 1-hr. cartridges. New cost \$249.50 sacrifice \$105.00. Gordon, Box 68, Whitestone 57, N. Y.

**BUY:** Presto 6-N recorder, or equivalent, including amplifier, if available. J. Henry O'Shea, 3751 Lakeshore Ave., Oakland 10, Calif.

**SELL:** Garrard automatic mixed turntable, model RC60, 78 rpm only. Good condition. Best offer. Seymour B. Hall, 24 Morton Rd., Quincy 69, Mass.

**SELL:** Karlson enclosure, for 15-in. speaker, mahogany, acoustically lined, A-1 condition \$45. James Metanias, 312 Mason Terr., Brookline, Mass. BE 2-4450.

**SELL:** Hi-fi phono network-components; 165 12-in. classical LP's; 20 12-in. jazz LP's. Everything like new. R. Femano, 372 Davis Avenue, Kearny, N. J.

**SELL:** New, unused GE diamond replacement styli RPJ003, RPJ004, RPJ913A \$8 each; New G.E. 12-in. tone arm, model A1-500 \$15. B.C. Pehrehouse, 1930 22nd Ave., San Francisco 16, Calif.

**SELL:** Stereo system. Cook control unit for tape, disc and multiplex FM, with Scott power supply, Livingston dual arm, 22 different stereo recordings. Guaranteed. \$75. Elliott, 45 Sicketown Road, Pearl River, N. Y.

**ALL STEREO  
TAPES NOW IN STOCK**

(Send \$2.00 per tape with order (balance C.O.D.). See catalog for selections and prices. Monoral tapes also available.

**STEREO  
CONVERSION KITS**

CONVERT YOUR RECORDER  
TO PLAY STEREO

- Stereo Kit for V.M. Recorders (Staggered).....\$16.95
  - Stereo Kit for most other recorders (Stacked)..... 68.00
  - Stereophonic Dual Pre-amplifier (in case) with balance controls..... 38.00
  - Stereophonic 2 channel Amplifier..... 149.95
  - Viking Playing Deck, Stacked and Staggered..... 97.65
  - 10,000 Cycle Tweeter Crossover..... 16.00
- (Send 25% with Kit or Amplifier orders, Balance C.O.D.)

Send 30 cents for tape catalog and latest stereo reports  
We ship anywhere. We pay the freight.  
All correspondence answered.

**Bosley Hi Fi & Stereo**  
316 N. Glendale Ave., Glendale 6, Calif.  
OPEN EVERY NIGHT UNTIL MIDNITE

**SONOTAPE**  
THE FINEST IN PRE-RECORDED TAPES...  
MADE FROM MASTERS BY Westminster HI-FI  
Write for listing.  
**SONOTAPE CORPORATION**  
185 Madison Ave.  
New York 16, N. Y.

**VINYL COVERS**

Custom-Made for Your  
HI-FI EQUIPMENT

Heavy 16-gauge clear vinyl plastic covers for all types of changers, turntables, and hi-fi equipment. Made to your specifications. Sold only by mail. Money-back guarantee.

**\$2.95 each**

For sizes up to 21 ins. Small additional charge for larger sizes. Add 25c for mailing.

Send width, height, and depth dimensions. Free sample of material sent on request.

**MARVIN GELLAR**  
118 Main St., Poughkeepsie, N. Y.





## SKITCH... on his Presto Turntable

"MY CUSTOM HI-FI OUTFIT is as important to me as my Mercedes-Benz sports car," says *Skitch Henderson*, pianist, TV musical director and audiophile. "That's why I chose a PRESTO turntable to spin my records. In my many years working with radio and recording studios I've never seen engineers play back records on anything but a *turntable*—and it's usually a PRESTO turntable.

"My own experience backs up the conclusion of the engineers: for absolutely constant turntable speed with no annoying 'Wow' and 'Flutter,' especially at critical 33½ and 45 rpm speeds, for complete elimination of motor noise and 'rumble,' I've found nothing equals a PRESTO turntable. It's heavy... it's brilliantly machined... it's the only instrument on which the genuine audiophile should ever allow his records to be played."

Visit the Hi-Fi Sound Salon nearest you to verify Mr. Henderson's comments. Whether you currently own a conventional "one-piece" phonograph—or custom components—we think you'll be gratified with the difference you'll hear when you play your records through custom hi-fi components teamed with a PRESTO turntable. Write for free brochure, "*Skitch, on Pitch*," to Dept. 7YY, Presto Recording Corporation, P.O. Box 500, Paramus, N. J.



MODEL T-2 12" "Promenade" turntable (33½ and 45) four pole motor, \$49.50

MODEL T-18 12" "Pirouette" turntable (33½, 45 and 78) four pole motor, \$75.00; with Hysteresis motor (Model T-18H), \$131.00

MODEL T-68 16" "Pirouette" turntable (33½, 45 and 78) four pole motor, \$99.00; with Hysteresis motor (Model T-68H), \$170.00

WALNUT "PANDORA" Turntable Cabinet by Robert W. Fuldner, \$42.50

Hear the difference when you play your records on

# PRESTO TURNTABLES

A UNITRONICS CORPORATION AFFILIATE

WorldRadioHistory

NOW... superb 15 inch High Fidelity — AT LESS COST

ENCHANTING NEW



# Empire

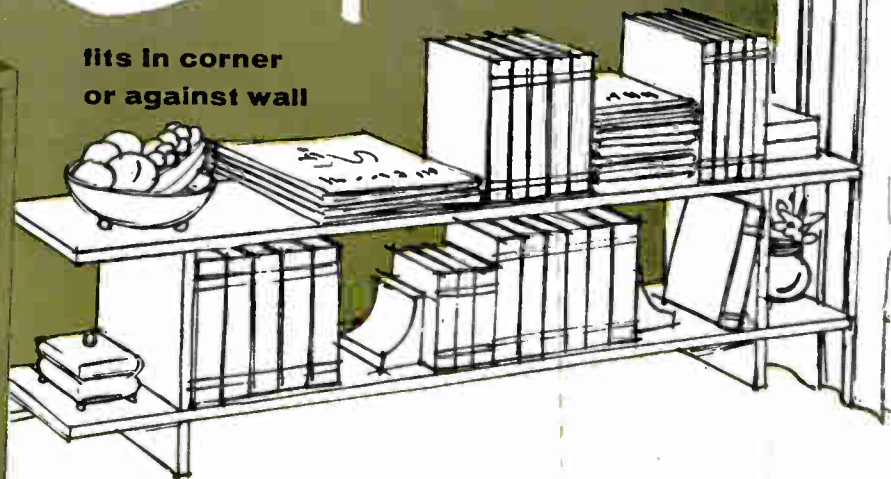
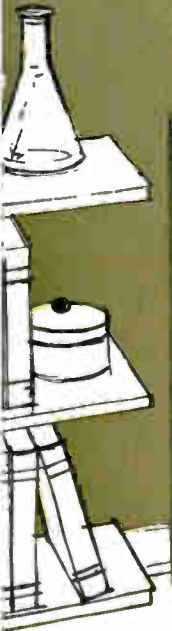

fits in corner  
or against wall



Specially designed **BLS\* ENCLOSURE**  
for new economy series 15-inch Speakers  
or separate 2- and 3-way Speaker Systems

You can economically enjoy true high-fidelity reproduction of music with the enchanting new EMPIRE. This low-boy enclosure with "built-in" corner fits anywhere in the room—flat against the wall or in a corner. Increases the efficiency of 15-in. coaxial or triaxial speakers, or separate 2-way and 3-way speaker systems. Gives smooth, extended bass response without displeasing peaks and valleys. Provides proper tonal balance of the lows and highs. The modern simplicity of its styling blends with any decor. Selected hardwood veneers are hand-rubbed to a lustrous mirror finish on all exposed surfaces. Here is beauty in appearance as well as performance.

*Look and listen . . . at your E-V High-Fidelity Distributor.*

NO FINER CHOICE THAN

## Electro-Voice®



New Catalog-Guide gives quick facts on Speaker Systems for true high fidelity. Send 25¢ for No. 117-H612

**ELECTRO-VOICE, INC.**  
BUCHANAN, MICH.

CANADA: E-V of Canada Ltd., 1908  
Avenue Road, Toronto, Ontario  
EXPORT: 13 East 40th Street,  
New York 16, U.S.A.  
Cables: ARLAB

\*Bilinear Lenticular Slot Enclosure. Employs two vertical parallel porting slots to extend and augment lower bass range.

WorldRadioHistory

**EMPIRE 1A.** Complete 3-way 15-in. speaker system with E-V 116A package of driver components installed in enclosure. Mahogany, Net \$250.00 Blonde, Net \$256.00 Walnut, Net \$260.55

**EMPIRE.** Enclosure only. Size: 29½ in. high, 32 in. wide, 16 in. deep Mahogany, Net \$85.00 Blonde, Net \$91.00 Walnut, Net \$95.55

**EMPIRE KD5 KIT.** Do-it-Yourself Enclosure Kit. Every piece precut. Hardwood exterior surfaces. Net \$51.00

**E-V Model 116.** Separate 2-way System only. Has 15BW, T10A with 8HD, X825, AT37 and mounting board. Net \$125.00

**E-V Model 116A.** Separate 3-way System only. Has 116 system plus T35B, X36 and additional AT37. Net \$161.00



For utmost economy with efficiency, use an E-V 15-in. coaxial or tri-axial speaker in the Empire enclosure.

**Model SP15B Radax Coaxial.** 15-in. 2-way speaker. Response 30-13,000 cps. Can be used instead of 15BW when expanding to 116 or 116A system. Net \$43.00

**Model 15TRXB Triaxial.** 15-in. 3-way speaker. Combines T35B VHF Driver, Radax Propagator and large bass cone in one integral assembly. Response 30-15,000 eps. Net \$79.00

The Empire also can be used with Model 114A, or 114B Separate Systems, or with Model SP15 or 15TRX Integrated Speaker.

