

EQ

Defining
the Future
of Recording

www.eqmag.com

8

**STUNNING
PRODUCT
REVIEWS**

How To Record TV ON THE RADIO!!!



CMP

Customer Service

716.555.005



- ALL NAMM NITTY GRITTY, ALL THE TIME
- GETTING A GRIP ON LATENCY

ENHANCED MIDI PROGRAMMING

Tracktion 2 features a fully revamped MIDI editor with faster note entry, quicker editing, more intuitive keyboard control, and improved viewing of notes and controllers simultaneously.

EASIER RECORDING

Tracktion 2 lets you record your ideas as fast as they come. Just drag the audio or MIDI input icon to whatever track you like and hit record.

DRAG-A-FILTER

Wanna add a VST plug-in, pull up a VSTi instrument, route to an Aux send or add some EQ? Just drag a filter to the track you want to effect. It's really that simple.

OVER \$500 OF BUNDLED PLUG-INS

T2 gives you all your basic music-making and mixing tools right out of the box — including Amplitube LE, Samplitude SE, the legendary LinPlug RMIV drum sampler and a full suite of Mackie Mixing and Mastering plug-ins.



INSTANT INFO

Tracktion follows your every move with its Properties Panel. Click on an audio clip and see its fade-out curve; click on a MIDI clip and quantise away; click on a reverb plug-in filter and fine-tune the pre-delay. The relevant info is always at your fingertips.

IMPROVED METERING

When setting levels, T2 can turn the full screen into a giant meter bridge with the press of a button.

QUICKTIME SUPPORT

Tracktion 2 supports Quicktime™ video playback. Select a movie and start composing music, add effects, replace your dialog, and win your Oscar®.



EXTERNAL SYNC

In addition to Tracktion's ReWire host functionality for use with applications like Reason, T2 supports MIDI Time Code (MTC) and MIDI Machine Control (MMC) input/output, plus MIDI Clock output.



● use 64-bit math when mixing tracks

SUPERIOR 64-BIT, 192KHZ MIX ENGINE

Much has been made about the "summing bus" in DAW software. Tracktion 2 features a new high-definition 64-bit mixing engine for uncompromising sound.

☎ 800.898.3211 (Toll free within U.S.) ☎ 425.487.4333 (Outside U.S.) ✉ info@mackie.com

© 2005 LOUD TECHNOLOGIES INC. ALL RIGHTS RESERVED. "MACKIE," AND THE "RUMMIN' MAN" FIGURE ARE REGISTERED TRADEMARKS OF LOUD TECHNOLOGIES INC. ALL OTHER TRADEMARKS ARE PROPERTY OF THEIR RESPECTIVE OWNERS. ALL SPECIFICATIONS SUBJECT TO CHANGE. THE TRUTH IS OUT THERE... LIKE, OH, WAY OUT THERE.

World Radio History

IF YOUR MUSIC SUCKS, IT WILL STILL SUCK. YOU'LL JUST MAKE IT A WHOLE LOT FASTER.



If you enjoy clicking through layers of windows to create music, then Traktion software is definitely not for you. It won't pretend to be a mixing console... It doesn't have cute 3D racks or patch cables... It doesn't contain a single instrument icon.

Instead, Traktion lets you get right to the business of making music using a single screen for everything from audio recording and MIDI production to mixing and mastering. It's simple-yet-powerful software, with thousands of fervent users and dozens of glowing reviews.

And now with Traktion 2, we've added more than 100 new features and a full suite of high-quality plug-ins — while maintaining the original's legendary simplicity and a reasonable price.

Visit the left hand page, then visit mackie.com for your free Traktion 2 demo. It won't make better music for you, but it will sure let you make it faster and easier.

→ **SIMPLE. POWERFUL. REVOLUTIONARY. TRACKTION 2.**

For a limited time, get a FREE artist website and 6 months of hosting from www.broadjam.com when you buy and register Traktion 2.

MACKIE®
www.mackie.com

CONTENTS

APRIL 2005

FEATURES

- 16 Hot Damn! It's NAMM!!!**
The sprawling Anderton-esque grandeur of *EQ*'s post-show coverage runs the gamut of all the goods and goodies that are fit to print.
- 36 It's TV On The Radio**
Winners of Plug's Album of the Year award and nominated in the Best Musician category at the *Wired* Rave awards, TVOTR are here: and we got them.
- 46 Tempus? Fugit!**
Latency issues are a hallmark of DAW living. Solutions? Damn right there are.
- 54 Myths Revealed**
Does phantom power solve problems or just create crippling compromises? What? You don't know?

THE ART OF RECORDING

- 60 How Are Things Panning Out?**
The laws governing the moving of a monaural sound from left to right in the stereo field will, if ignored, destroy...your...world.

DEPARTMENTS

- 4 Talk Box/Bandstand**
- 6 Punch-In**
- 12 Session File:**
John Feldmann
- 14 Success Story:**
Steve Syatt
- 96 Room With A Vu:**
Electrokitty Recording,
Seattle, WA

EQ REVIEWS

- 66 WAVE ARTS**
We got the POWER!!!
- 72 TASCAM FW-1082**
DAW-based studio owners rejoice. Rejoice.
- 74 BLUE Robbie**
Preamp done the old-fashioned way: creatively.
- 76 IK Multimedia Sonik Synth 2**
A synth workstation plug-in? Oh yeah...
- 78 Peterson VS-S Strobostomp**
Start your virtual strobe tuner engines.
- 78 Audio-Technica Pro 70**
Newscasters worldwide will thank you.

SOUNDS

- 80 Sony**
Chicago Fire: Dance Music Anthology
- 82 Cycling '74**
Cycles: 03-Incidental Gesture

COLUMNS

- 84 TECH BENCH**
Managing Latency

POWER APP ALLEY

- 86 Propellerhead Reason**
Assigning individual outputs for multisamples



36

74



16

FW Series

Firewire audio/MIDI Interfaces

Grande, vente or rackiatto...how do you want your FW interface?

FW-1884. Designed for large home or project studios, our flagship FW-1884 is perfect for serious DAW users or anyone who needs lots of microphone inputs and/or high productivity via editing shortcuts. Expandable via FE-8 sidecars as your studio needs grow. Includes Cubase™ LE with 48-track recording capability at 96kHz (versus Pro Tools® LE with just 32 tracks at 48kHz) and the LE version of GigaStudio™ 3, world's most powerful software sampler.

FW-1082. Why pay far more for a Yamaha® 01x, Digidesign® Command | 8™ or 002? Why pay more and give up I/O with a Mackie® Control™? The new

FW-1802 is designed for the home studio who wants an affordable control surface with touch-sensitive moving faders and the simplicity of a 1-cable FireWire interface. All in a compact, portable unit that doesn't take up an acre of space. Four pristine mic preamps with phantom power, 4 bal. TRS line inputs and S/PDIF digital I/O give you everything you need to build a hit in the privacy of your own home. Cubase™ LE and GigaStudio™ LE included.

FW-1804 If you use a dedicated mixer or already have a control surface, you can still take advantage of TASCAM's superb sound quality and FireWire interface. Four phantom-powered mic preamps, 4 bal. TRS inputs, S/PDIF and ADAT® I/O, inserts on 4 chs., bal. monitor outputs and headphone output. Plus GigaStudio™ LE and Steinberg® Cubase™ LE software!

Two new FireWire® audio/MIDI interfaces from TASCAM!

Wake up to the stimulating sound quality of our rave-reviewed FW-1884

Firewire audio/MIDI interface.

Now it's also brewed in new FW-1804 rack-mount and low-fat FW-1082 versions.

Pour over the hot details at your TASCAM dealer today.



	I/O @ 48kHz	I/O @ 96kHz	MIDI I/O	XLR Mic inputs	Digital I/O	Motorized Faders	Encoders
NEW! FW-1804	18 in / 12 out	14 in / 8 out	2 in / 4 out	4	S/PDIF & ADAT	9 • 60mm	pan, aux & EQ
NEW! FW-1082	10 in / 4 out	10 in / 4 out	2 in / 2 out	4	S/PDIF	9 • 100mm	pan, aux & EQ
FW-1884	18 in / 18 out	14 in / 14 out	4 in / 4 out	8	S/PDIF & ADAT	9 • 100mm	pan, aux & EQ



TASCAM

©2004 TASCAM All Rights Reserved. All specifications are subject to change without notice. All trademarks are the property of their respective holders. The caffeinated folks at TASCAM apologize for the mocha tinged ad theme. A new Starbucks® just opened across the street from our building in Sunny Montebello.

CONTRACTOR
World Radio History

www.tascam.com

DJ AND PRODUCER

PERSONAL CREATIVITY

Talk Box



Vol. 16, No. 4
April 2005

www.eqmag.com



AN EARTH-SHATTERING ANNOUNCEMENT OF STAGGERING PROPORTIONS . . .

Due to an exceedingly generous grant from a one MR. LEONARD PINTH GARNELL, our fair magazine, *EQ*, finds itself in the wholly enviable position of being able to offer, for a limited time only a few NEVE consoles, a few SSLs, to your tastes, some G5s, about \$500,000 of outboard gear, plus a dinner date with the editor of your choosing and the ability to conquer the very fabric of space and time, FREE with every subscription.

We know, we know: it's this kind of selfless giving that makes *EQ* one of the cooler reads around. And for the meager price of a stamp and an investment in the ink and all the elbow grease it takes to scribble your name on a sheet of paper, you can also be the proud owner of The Cool Stuff.

Add to this about a month of master lessons from the estimable EDDIE KRAMER and you have a clear-cut situation of you staring at the calendar to make sure that you haven't stumbled into an elaborate April Fool's joke.

Which, of course, you have.

Coffee beans and nostril insertion charts included. No extra charge.

And when the laughter, stunned silence, or appalling shock slightly subsides a bit you'll take stock of April in all the other ways we're actually managing to play it.

To whit: With Williamsburg's own masters of downtown cool, TV ON THE RADIO, and their story take on making music make budget sense. The most muscular post-NAMM coverage around. MITCH GALLAGHER on latency issues galore, NEAL POGUE on the 10th anniversary of his award-winning hit and how he produced it, plus: reviews, reviews, and reviews of just about everything you could ever want reviewed.

No joke.

Cheers,

The BAND STAND

Your most significant, and heretofore unrevealed, time saving secret.



**Craig Anderton,
Editor-at-Large**

Presets, baby, presets. Whenever you come up with something good, from synth patch to effects setting, save it. That way you won't have to reinvent the wheel later on. And when someone says "Hey, can you give me that effect you got before?," you can say yes.



**Tal Herzberg
Producer**

Call it superstition but I want my whole set-up to be done before the artist gets in studio. Mics, recording chain, everything I can so that he just walks in and starts. This significantly lessens whining time.



**Steph Jorgl
Contributor**

Create a good template for your DAW and then save 20 copies of it. Creating your own template that you use every time you start a song will save you having to spend an hour setting up the initial technical parameters for every project.



**John Krogh,
Technical Editor**

Ignore email. I've found I don't need to check it all the time, and when I'm away from the In box, I have way more time to get REAL work done.

Editor in Chief: Eugene Robinson, erobinson@musicplayer.com
Managing Editor: Debbie Greenberg, dgreenberg@musicplayer.com
Editor at Large: Craig Anderton, canderton@musicplayer.com
Technical Editor: John Krogh, jkrogh@musicplayer.com
Group Copy Chief: Kevin Owens, kowens@musicplayer.com
Contributors: Lynn Fuston, Mitch Gallagher, Garrett Haines, Steph Jorgl, Kevin Madden, Barry Rudolph, Jeff Szymanski, Todd G. Tatnall

Art Director: Doug Gordon, dgordon@musicplayer.com
Staff Photographer: Paul Haggard, phaggard@musicplayer.com

Publisher: Valerie Pippin, vpippin@musicplayer.com
Associate Publisher/Northwest Advertising Sales: Dan Hernandez, Tel: 650-513-4253, Fax: 650-513-4646, dhernandez@musicplayer.com
East Coast/Europe Advertising Sales: Joe McDonough, Tel: 212-378-0492, Fax: 212-378-2158, jmcDonough@musicplayer.com
Southwest Advertising Sales: Pete Sembler, Tel: 650-513-4544, Fax: 650-513-4646; psembler@musicplayer.com
Northeast Advertising Sales: Gary Ciocci, Tel: 603-924-9141, Fax: 603-924-9209; gciocci@musicplayer.com
Manager of Specialty Sales: Joanne McGowan, Tel: 650-513-4376, Fax: 650-513-4646, jmcgowan@musicplayer.com
Specialty Sales Representative: Derick Joy, Tel: 650-513-4403, Fax: 650-513-4646; djoy@musicplayer.com
Specialty Sales Asst.: Darlene Labrecque
Production Manager: Amy Santana
Imaging Technicians: Joe Ging, Martin Ruiz

MUSIC PLAYER NETWORK

Vice President: Louise Rogers
Editorial Director: Michael Molenda
Marketing Manager: Laney Erokani
Sales Administration Manager: Lauren Gerber
Sales Assistant: Molly Corman
Circulation Manager: Heather Harmon
Newsstand Sales & Marketing Manager: Pam Santoro
Assistant Circulation Managers: Rosario Perez, Maribel Aleman
Web Editor: Max Sidman
Graphic Designer: Damien Castenada
Reprint Coordinator: Cindy Zauss, Tel: 909-698-1780



CMP Information, Inc.

President: Tony Keefe
Controller: Doug Krainman

Please direct all advertising and editorial inquiries to:
EQ, 2800 Campus Drive, San Mateo, CA 94403
(650) 513-4400; Fax (650) 513-4661; eq@musicplayer.com

Please direct all subscription orders, inquiries, and address changes to: 888-266-5828, outside the U.S. 937-280-0011, eqmag@sfsdayton.com

Back Issues: Back Issues are available for \$10 each by calling (800) 444-4881, outside the US call (785) 841-1631

EQ (ISSN 1050-7868) is published monthly by CMP Information, Inc. EQ is a trademark of CMP Information, Inc. All material published in EQ is copyrighted (©) 2005 by CMP Information, Inc. All rights reserved. Reproduction of material appearing in EQ is prohibited without written permission. POSTMASTER: Send address changes to EQ, P.O. Box 369, Vandalia OH 45377-0369. Publisher assumes no responsibility for return of unsolicited manuscripts, photos, or artwork. All product information is subject to change; publisher assumes no responsibility for such changes. All listed model numbers and product names are manufacturers registered trademarks.

Periodicals postage paid at San Mateo, CA and at additional mailing offices.





At any volume, everywhere

RELIABLE

Genelec, the benchmark in active reference monitoring, offers the most complete line of active reference monitors for professional audio, no matter what type of audio you are producing.

The new pathbreaking 8000 MDE™ Series deliver powerful, extended resolution and realism - from electrical signal to acoustic event. With extended frequency response and lower distortion across their entire bandwidth, the 8000 Series offer monitoring precision with no tolerance for error.

Combined with Genelec's 7000 LSE™ Series subwoofers, accurate reference systems can be easily integrated into nearly any environment, whether you are working in stereo or surround.

Contact us for system specification and a demonstration using the complete range of Genelec 7000 and 8000 Series monitoring solutions in your room.

www.genelecusa.com

8000 Series



8030A's shown in optional silver finish

International inquiries: Genelec Oy, Olvitie 5, FIN-74100, Iisalmi, Finland
 T +358-17-83881, F +358-17-812267 Email genelec@genelec.com
 In the USA: Genelec Inc., 7 Tech Circle, Natick, MA 01760
 T 508.652.0900, F 508.652.0909 Email genelec.usa@genelec.com
 In China: Genelec China Rep. Office, SOHO New Town,
 88 Jianguo Road, D-1504, Chaoyang District, Beijing 100 022, China
 T +86 10 8580 2180, F +86 10 8580 2181 Email genelec.china@genelec.com

World Radio History

GENELEC®

Punch-In

Tips & News You Can Use
BY THE EQ STAFF

HOW THE HELL I DID IT

WHO: NEAL POGUE

WHAT: On its 10th anniversary: TLC's "Waterfalls"

HOW: I was asked to track and mix TLC's "Waterfalls" (La Face Records) after I had just finished working on Outkast's "Southernplayalisticadillacmuzik" and a TLC Christmas song, which were on La Face as well.

Organized Noize (Rico Wade, Raymond Murray, and Pat "Sleepy" Brown) was asked to produce a hit single for TLC's second album, so we gathered a group of musicians and went into Bosstown Studios in Atlanta, which was then owned by Bobby Brown (the studio is now called Stankonia and is owned by

Outkast), and laid it all down on a **Solid State Logic G+** console. Ray Murray came up with what I thought at the time was a very odd sort of drumbeat that he had mixed on an **MPC 3000** and an **E-mu SP-12**. It had this loud snare roll that you can hear about every fourth bar, and it was very unique.

We had Kenny Wright playing a **Wurlitzer** electric piano, Edward Stroud on guitar, and LaMarquis Jefferson on bass. They were given the basic chord progressions from Organized Noize, and then they just vibed from there.



tip

VOCAL REVERBERY

Nothing gift wraps a vocal better than some tasty reverb. My favorite reverb for voice is a natural acoustic space. But, as reverb rooms are an endangered species, you'll likely use a digital reverb. Reverb settings are a matter of taste, but two parameters are particularly important: diffusion and predelay. Low diffusion on vocals with its sparser reflections, prevents the voice from being overwhelmed by too lush a reverb sound. And predelay works well in the 50-100 ms range. The delay lets the first part of the vocal punch through without reverb, while the more sustained parts get the full benefit of the reverberated sound. —Craig Anderton

THE EQ LETTER OF THE MONTH CLUB

Dear EQ editors:

I was reading your "100 tips" article with great interest and delight until I got to #100: "The key to home recording is marijuana." I was astounded when I read this. Yes, marijuana use may lead to short term creative boosts, but in the long run is always unhealthy, saps motivation and perseverance, and leads to memory loss, not to mention being illegal! What about the young musicians and engineers reading your magazine? Hello?? Advocating drug use, even in jest, shows an appalling lack of editorial judgment. As the tip ironically stated "... you can and will make mistakes, but you learn from 'em. Just go for it." Please take your own advice and retract this "tip" in your next edition.

Ray Lyon
Waynesville, NC

Editor's reply: We have tried, repeatedly, to get the author of the tip, MR. LES CLAYPOOL, to alter his position regarding narcotics placement in his signal chain, to absolutely no avail.

So we laid all that down and then had Tionne "T-Boz" Watkins come in to lay down the basic guts to the vocal track. Marquez Ethridge had come up with the lyrics and the melody. We used one of my mics, which is an **Audio-Technica AT4033**, and it came out great. I love that mic: It's really an all-around type of microphone, but I find that everything I use it for comes out sounding great.

A few days later, we recorded Rozanda "Chilli" Thomas' ad libs for the end of the song at Doppler Studios, and the rap vocals by the late Lisa "Left Eye" Lopes at Darp Studios. In addition, we added the background vocals of Cee-Lo Green (from the famed hip-hop group Goodie Mob) and Debra Killings, who was kind of the silent fourth member of TLC. I later added a **Focusrite EQ** to the stereo pair of their blended background vocals.

At that point, we brought in a horn section called The Atlanta Horns, and it was very rare back then for a hip-hop/R&B band to use live horns. We couldn't really decide how to incorporate the horns, so I just took over and came up with the horn parts, sampled them, and then moved them around where I wanted them in the song. We had two trumpets and a saxophone. I used **Neumann's U47** and **U67** on the trumpets, because that is usually a very bright instrument. For the saxophone, I used a **Neumann U87**.

When it was time to mix, I went into Darp studios in Atlanta and mixed the song on an **SSL G+** console. No one really came in to listen as I was mixing, so I just worked on the song all day by myself and mixed it the way I thought it should be mixed. Lisa didn't like her original vocals, so I had to recall the mix later at LaCocoa Studios, L.A. Reid's personal home studio.

The drums I pretty much left alone. The snare and the snare roll were on the same track, which I could have separated, but I thought it was better to keep the vibe that Ray had originally. I liked having that snare roll right in your face. I added some low end to the kick, boosting the 80Hz frequency by about 3dB. I also added an **API 550A** to the kick to add even more vibe.

For the guitars, I used the EQs on the SSL console. I added some highs, bumping them up at 8k by about 1dB-2dB. I like

the sound of the SSL EQs, and I wanted to brighten up the guitars a bit.

The bass was a little different for a couple of reasons. One, he was playing a five-string bass, which has that low B string on it. That made the bass a little lower than usual. Two, he had an effect on his bass that was similar to a Mu-tron, like Bootsy Collins used to use. You can hear that odd, wah-like sound during the intro of the song. It doesn't really sound like a bass, but it is. Despite the low sound of his bass, I still added more lows to his track. I went in around 75Hz-100Hz and added about 2dB.

For the horns, I wanted them to stick out and be harsher. I was going for a Michael Jackson "Thriller" type sound that Jerry Hey always puts on his tracks. Usually, I don't like to add more than 2dB to anything, because it just adds too much. But for these horns, which really create the dynamic for the song, I added about 3dB at 8k so they would hit harder. I also went in and tweaked the lows and dropped those a bit too.

On Tionne's vocals, which are the bulk of the track, I used an **AMS DMX** harmonizer on her lead vocal. I wanted to make her voice much wider in the song. She has a naturally raspy, original voice, so I wanted that to stick out as well. Another thing I did on her vocals that I usually don't do, is bump up the 5k frequency by about 0.5dB. I also used the SSL compressors a bit, but not too much. I went about 4:1 and didn't push the threshold very much.

For Chilli's adlib vocals at the end, I didn't do much, they went in pretty flat. I added about 8k-10k at about 0.5dB-2dB. I try not to mess with a track just for the sake of doing so. If it doesn't need it, don't do it.

So, I was able to blend all of that together and everyone, including myself, was very happy with the end result. Usually, when I hear a song on the radio that I did, I think, 'Oh man, I could have changed this or that.' But with "Waterfalls," I'm really very pleased by the end result. I wouldn't change anything, I'm really proud of it. I think the biggest reward is hearing someone singing along to it in their car!

For the horns, I wanted them to stick out and be harsher. I was going for a Michael Jackson "Thriller" type sound that Jerry Hey always puts on his tracks.

QUANTEGY? SAY WHAT?



It was one of those Where Were You? moments. In January 2005, Quantegy—the last existing manufacturer of tape—announced that it was shuttering its tape-making ops. Studio jocks were envisioning making payments on machines they could no longer use and hardcore analog heads were calling all over trying to snag most of what little remained.

Irrational exuberance? Or well-placed paranoia? And more importantly, what's the *next* step for those for whom an analogless world is no workable option at all?

Producer/engineer **JIMMY DOUGLASS** [Missy Elliott, Jay-Z, Lil' Kim, Timbaland]: "I am still gonna use the tape I've got. All the old reels will be seeing new life. I'll dump to digital media, and start again...two or three times a reel."



JACK DANGERS [Father of the breakbeat, Meat Beat Manifesto, Tino Corp.]: "I use my old Revox 2-track to master on for the main reason that it can't be emulated."

Mastering engineer **EMILY LAZAR** [Sonic Youth, Nada Surf, Jeff Buckley]: "The closing of the Quantegy plant is VERY, VERY upsetting to say the least, but I've still got my fingers crossed that there will be a revival of sorts. I am most certainly an analog 'tape head,' but also have witnessed some digital formats that have come quite a long way! I don't think that there is a 'replacement' for tape per se, but rather that there are now a lot of options out there."

Musician/producer/remixer **BT** [Madonna, Seal, N'Sync]: "My fav is recording to a 4-track. I do that all the time. But for live drums, I record ALWAYS to 2" and bounce to 1/4" at 15ips. But to add warmth and color without tape, I use valve gear: Neve pre's, tube compressors, etc."

Producer, remixer, and recording artist **CARMEN RIZZO** [Paul Oakenfold, BT, Seal, Esthero]: "The plug-in I use that helps me feel warm and fuzzy is the 'Smack' plug-in—it's my current favorite. That, and the T-Racks stuff, gives good warmth."

Supah Engineer **DURO** [The Beastie Boys, Jay-Z, DMX, Ja Rule, Will Smith] is a serious tape diehard. In serious denial: "It's tape 'till the end!!!!!!!!!!!"

Tape fiend producer, **MALCOLM BURN** [Daniel Lanois, Iggy Pop, Emmylou Harris] also seems to be in denial about the end of tape: "It's not gone, it's just hiding."



Producer/remixer/video game soundtrack composer **CHRIS VRENNA**: "I like processing sounds through pedals and outboard effects. I never wanted or expected any DAW to attempt to 'sound like tape'. And the new Digidesign HD Accel rig sounds so good and so clean that digital just sounds great."

Producer **JASON SLATER** [Queensryche, Twisted Method, Slaves on Dope]: "Without a doubt, the best thing I've heard is the Crane Song Phoenix TDM plug-in. It emulates tape compression better than anything I have heard. It adds amazing warmth to bass tracks, kick drums, and vocals. I was very skeptical at first, as I am not a huge fan of compression-type plug-ins on drums, but it has proved to be an amazing tool in a sea of worthless distortion generating 'emulators.' It's a great product. Download the demo and throw it on a bass track and you'll be sold." —Steph Jorgl

Listen Hear

Since there's no accounting for taste then there's probably no accounting for why we haven't been able to get this stuff out of our heads this past month.

DIAMANDA GALAS' DEFIXIONES: WILL AND TESTAMENT (Produced by Blaise Dupuy, Diamanda Galas)

You ever get in one of those moods where happy stuff makes you sad? Where you'll be totally wrecked on hearing KATRINA & THE WAVES singing about walking on sunshine? Well this is like that. Only totally the opposite. Galas' singing about death and destruction, in a live production



recording that can only be described as celestial, dips into the classical and classically rendered paeans to sorrow. Which we've found unreasonably cheering this month of the April Fools. Now don't you feel just fine?

PLAYBOY: THE MANSION (Mixed by Felix da Housecat)

There had been a time when an invite to the aforementioned Mansion was the *sine qua non* for any self-respecting, cravat-wearing, Hai Karate-slathered cat worth his razorbladed medallion. But that was then and this is now. Now specifically being dance/electronic shizznit produced by the Madonna remixer DJ/producer Felix da Housecat. Comfortably capturing the zeitgeist of better days, this comp takes us via the wayback machine to dance floors filled with low-end boom and euro glissandos. A dubious achievement? Not if you can dance to it.

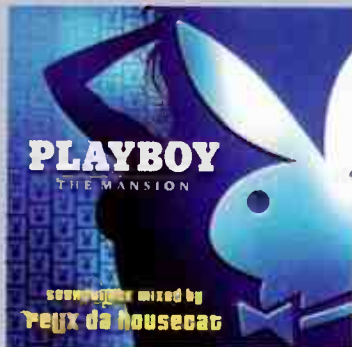



DVD of the Month

Reel Girlz Real Skilz

First Ever All Female How to DJ Video Hitgirl!

\$19.95, www.thedju.com

REEL GIRLZ REAL SKILZ, in a made-you-look moment to end all such like moments, is a DVD that features two Thundra-esque, record-spinning, turntable-toting warrior princesses above a legend that starts out "First Ever All Female...."

We're in.

Whatever they were selling, we were buying. And as luck would have it, it was something that actually stood a chance of being used for more than three minutes at a time.

"We just wanted to do a really cool curriculum on how to do everything from how to do a mix with Final Scratch to mastering EQs," says creator LA Kendall from her Seattle redoubt. "And there was nothing out there, outside of DJ Shorty's DVD, that was just good and all-around and featured women to any great degree. So we did it." We in this instance being Kendall and DJ Girl 6.

Our disappointment at the squandered cover promise of Amazonian warriors duking it out aside, the absolute coolest moment on this DVD is not the tech primers, the technique tips, or the theory and equipment coverage. It's the interview section. To wit, "Embarrassing Moments," wherein DJs discuss that exactly: Promoters that steal your cigarettes and then run down the street in order to avoid paying you?

Genius.

OVERRATED?

Lo-fi recordings

by Nick Blakey

Hate 'em or love 'em, lo-fi recordings have been with us since Thomas Edison first figured out how to retain sound in wax cylinders over 100 years ago. Now, bootlegs are one thing: you can forgive them under the idea that they are documenting a moment in time or are strictly for "historical interest."

Jon Landau's treble-to-the-max mixing mess on the MC5's *Back In The USA* is another, as is the coke-fueled original gonzo mix of *Raw Power*. Those are curios, but in this day and age, there is simply no excuse.

So, why then have we been subjected to indie rock's flood of lo-fi waste starting in the late 1980's? The sudden availability of affordable and easy to use recording equipment in the market, along with the upsurge in independent music, was definitely a double-edged sword. Now anyone with a few extra bucks could record whatever and whenever they wanted, and it could (emphasis on *could*) come out sounding pretty decent. You'd no longer have to get on your knees to a record company and beg for studio time, let alone work with a producer who might not "get" you, nor an engineer who might try and muck with your sound, man. The future looked bright indeed, but the idea that releasing badly recorded music was cool was a major blow to the progress of modern sound.

Would-be Phil Spectors and Martin Hannetts could now experiment freely and cheaply, even open their own studios if they felt like it. "Hey man, all you gotta do is plug in the mic and hit record, right? And who needs EQ? It sounds so much better before all that mastering crap anyways. This is how music was *meant* to sound, man!" Support D.I.Y., sure, but there was far less good than there was a landfill of just plain bad and extraordinary ugly. Recordings that were often more effective as blackmail material were called innovative. "Hey, if Fleetwood Mac and The Monkees can record their vocals in bathrooms, so can I." Wrong. Guitars tend to not sound exactly great when they appear to be broadcasting from inside a trash can underwater, as do distorted drums bleeding onto every single track. Many of the artists themselves, in attempt to dumbstruck their listeners, often admittedly deemed their recordings "crappy" (*i.e.* Space Needle), but still passed it off as inspired experimentation. Recording a demo on your front porch on a cheap Realistic cassette recorder with a faulty mic for your own reference purposes is one thing, but releasing it and calling it genius is another. Please, did you really think that you could pass yourself off as the next Alan Lomax?

The latest chapter in this charade is eBay, which allows any stooge with extra cash and a subscription to *TapeOp* to now own the Neve console of his dreams. However, despite the endless re-reading of *Recording For Dummies* and a minute duplication of the mic placement chart for *Sticky Fingers*, the recordings still come out sounding like an old 8-track that was left on the dashboard of your car too long. You may have even used the same kind of amplifiers and vintage cables, but, surprise, you're not Jimmy Miller, your studio is not Olympic, and your band is not the Rolling Stones.

I suppose this follows the same mindset that if one drops acid while mixing, your recordings will instantly sound like Funkadelic's. Um, when was the last time you listened to *Free Your Mind* and noticed its incredible absence of mid-range?

Free your mind and bad recordings will follow.

Nick Blakey is a freelance writer and musician from Boston whose work has appeared in The Noise, Chunklet Mag, and The Middle East Monthly. He once toured with SEBADOH. An experience he now only hints at darkly. If at all.

Know any Tips, Trick, Techniques, People, Places that you think are OVERRATED? Go ahead. Let us know. Your secret is safe with us. eq@musicplayer.com



SURFBOARD

As we peruse and cruise the inner recesses, nooks, and crannies of the web, we're constantly flagging sites, news items, and useful tidbits that have almost *nothing* to do with pom, a-hem, and that we feel will be of interest to you.

■ www.spars.com

There are two types of people in the world: those who whine and those who try to stop the whining. The folks at the Society of Professional Audio Recording Services (SPARS) are throwing their lot in with the latter by getting analog tape back in the pipeline as quickly as possible and keeping tape "available and affordable as a creative tool for our profession." Check it out.

■ www.loc.gov/rr/record/nrpb

GEORGE MASSENBURG and PHIL RAMONE, as members of the National Recording Preservation Board of the Library of Congress, are trying to do for music what the Film Board did when they preserved *Citizen Kane*: identify, list, and preserve culturally significant audio recordings. You want to help? Of course, you do.



■ www.sonicbids.com

In this magical modern world where you can have too much of everything as soon as you want it, two things remain in short supply: time and money. Sonicbids' whole trip is based on the understood assumption that you will not have enough of either. Hooking up working musicians (you know any of those?) with people who want them to work for less than a 5 spot and 20 minutes, makes damned good sense to us.

EQ RADIO, RADIO

I've actually been listening to XM Satellite Radio more than CDs recently. I really dig the "celestial jukebox" concept. So I figured I'd hip you to the three channels I've listened to the most this month.

CHANNEL 82: The System. Great trance and electronica, particularly the "Oslo Nights" continuous trance mixes that run twice a week. Whenever I need a shot of energy, this is the place.

CHANNEL 102: Ngoma. I have a soft spot for Afropop, and despite the intrusion of an occasional sappy ballad, there's a fine range of singer/songwriter and dance-oriented material. This channel could also be prescribed as an anti-depressant.

CHANNEL 77: Audio Visions. This is your basic new age zone, and a fitting nightcap. It's actually pretty good, not the usual "happy arpeggios meets Zamfir" music that makes you want to throw things. —*Craig Anderton*



His name is **SPENCE PEPPARD**. (No relation to George.) He is the engineer at **Encore Studios** in the Nacogdoches, of Willie Nelson fame. He records mostly hard rock and country stuff. He's a hell of a guy. A hell of an angry guy. A hell of a guy angry in the way that only an engineer can be: at the world.

So as an addendum to February's *EQ Guide to Getting It's 100* tips he offered his following five cents.

- 1) One of us is not talented, and it's not me.
- 2) ProTools will allow me to build a decent-sounding guitar solo for you even though you can only play three notes of it at a time. Your "Frankenstein" solo will sound good on the CD, but you will still suck live. One of us is supposed to have lightning-fast fingers, and it's not me.
- 3) If you want to use the studio as a \$125-an-hour rehearsal space, fine. Bands used to come to the studio ready to record, but whatever. I can fix all sorts of mistakes with Pro Tools. One of us is totally unprepared, and it's not me.
- 4) You planned to do the entire rhythm section of your recording with loops. Now you don't like that it sounds *canned*? One of us is an idiot.

ENGINEER THIS!

That would be the part of US that doesn't include me.

5) A little compression makes music sound better. A lot of compression can make a CD sound better when played in a loud environment. I would like to produce just one recording where the client doesn't insist on every meter being a solid bar, where there are some dynamics, and where everything isn't compressed into a big, fat crap-cake. One of us will do that every time they're given the chance. Can you guess which one of us that would be?

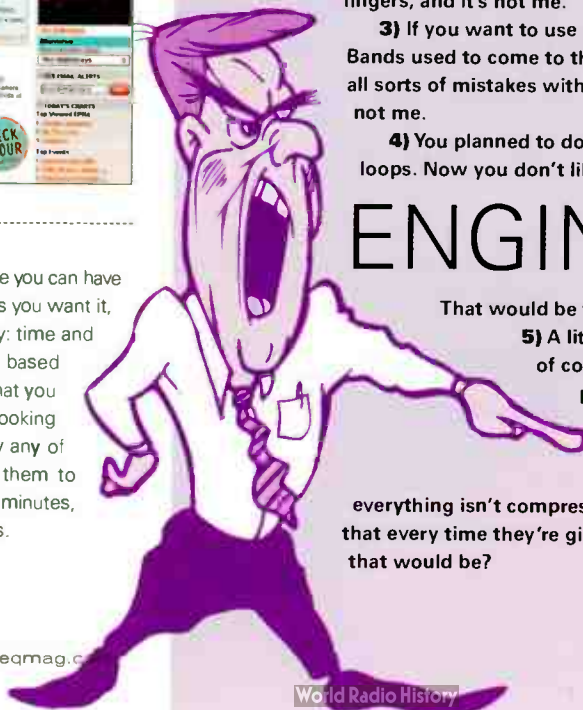

Beyond Massive.

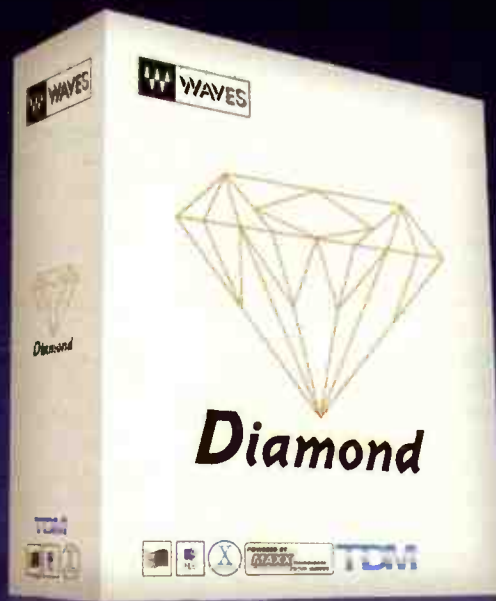

Waves Diamond Bundle: 35 world-class plug-ins. No filler • No gaps • All pro

Get Waves for these unmatched features:

- **All Pro** Waves plug-ins are used on more hit records and soundtracks than any other.
- **All Usable** Every Waves plug-in is world-class—there's no filler.
- **Versatile** Waves works with Pro Tools, Logic, Digital Performer, Cubase, Nuendo, Sonar, and more.
- **Upgradeable** Waves lets you move up to a larger bundle for just the cost of an upgrade.
- **Support** With Waves you work with one company for support and upgrades instead of a pack of different companies.



Waves huge selection of bundles lets you pick the pack that fits your needs and budget and our Free Demo lets you try before you buy!

14 day demo available at your Waves dealer or www.waves.com





John Feldmann

There's a connect-a-dot game that could be played here with John Feldmann, his fingers and the various pies within which they might reside. A game that starts with Goldfinger, moves on through The Used and Good Charlotte, and tallies major label success after major label success before screeching to a halt on Easy Street: that is, Feldmann being one of the most in-demand rock producers around. Now ramping up to tour in support of the latest Goldfinger release, Feldmann talked to *EQ* about the bass and guitar tracks he produced for The Used's second record, *In Love and Death*.

DATE: March – June 2004
STUDIO: Foxy Studios
LOCATION: Los Angeles, CA
ARTIST: The Used
PROJECT: Recording bass and guitars
ALBUM: "In Love and Death"
PRODUCER: John Feldmann
ENGINEER: Mark Blewett and Allan Hessler

SIGNAL PATH

"For the first The Used record, we used this Warwick bass that had a really great bottom end to it," says Feldmann. "But on the last record, we used a Wahl bass that the bass player had borrowed from a friend." A Hughes & Kettner Duotone, and a lot of vintage Hiwatt were also deployed in the making of this record.

The guitar tracks for *In Love and Death* were done using two Ernie Ball guitars (including an Ernie Ball Baritone), and a Schecter Baritone. An additional axe—a Baritone Les Paul—was also

"But I tend to use the L1 limiter in Pro Tools for most of the real squashing. I also really like the Vintech X73s on guitars for their lower midrange, because they have this really cool *growl*."

MIC POSITION

For the record, Feldmann mic'd things up using a Sennheiser 609, a Shure Beta 57, and a Shure SM-57. "I set up the mics on my old Marshall cabinet with green backs in it," he says. "Then I ran the two Shures through the X73, and the 609 through the 473, and just blended them together to get the sound I was looking for."

"It took a while to go around the cones and figure out what part of the cone to mic up," he says. But finally Feldmann found some sweet spots. "One spot was right above the center, off to the left, so that's where I put the Beta 57," he adds. "And I put the regular SM-57 in the middle. I put the 609 on the upper left as well, but on the bottom speaker, because every speaker has a different sound, just like every cabinet does."

PROCESSING

"I use the Alan Smart C2 as a bus compressor," says Feldmann. But he relies way more on Pro Tools plug-ins than outboard gear. "I've used EchoFarm on everything, I just love the way it sounds," he says. "I like to automate it and make it all screwed up. And I used the Waves Doubler a lot

to get that fake stereo image on the background vocals and stuff."

"As far as bass effects go, I think Amplitube has a pretty realistic amp sound, and it just really fits well in the mix," says Feldmann. "When you solo it up, you can kind of tell what's going on, you know, with the modeling effect. But in the mix it just seems to sit really well and I can keep the grit of the pick. For me, it's all about where the pick hits the string above the pick-up to get that real *attack* of the bass."

TRACK NOTES

For The Used's *In Love and Death*, the band had nothing written before going into the studio. "I set the guys up downstairs with their own cues and their own mixes, so they could just jam ideas out for hours and I just recorded everything," says Feldmann. "I've got probably 40 hours of just them jamming.

Then the band would come upstairs and I could tell them—with a little perspective—'Okay, in *this* part maybe we could modulate it, or cut out *this*.' Or 'That part's the best part of the song, let's make that the chorus,'" says Feldmann. "So we could really look at it, then I could just go *do it* in Pro Tools." **EQ**

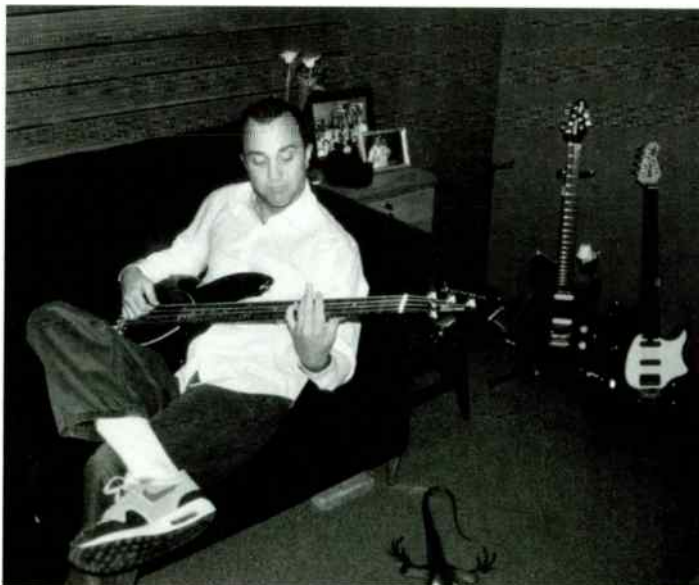

John Feldmann, in his studio, taps into the low-end with his Bongo bass.

brought in to double the bass parts. "Quinn was really stoked about using that one for that really low-end kind of grid," says Feldmann.

The band jacked into Feldmann's Universal Audio 6176 for DI. "I used the 610 part as a preamp, and the 1176 side for just a little compression," explains Feldmann.

Photo by Steph Jorgi

INTRODUCING 64-BIT AUDIO PROCESSING

iZotope's 64-bit audio processors represent a new level of performance for effects and mastering compared to other software—and hardware. By integrating several effects into one processing system with pristine 64-bit fidelity, each iZotope plug-in replaces several competing tools, optimizes workflow, and maximizes signal quality. Most importantly, these incredible-sounding processors expand your creative palette with unique effects that simply aren't available anywhere else. These tools make it easy to bring your mixes that intangible professional quality that's hard to achieve. Download audio demos and trial versions of the ultimate in audio processing today.

ozone 3 64-bit Integrated Mastering System with Analog Modeling



Hear them now!
www.m-audio.com/izotope

spectron 64-bit Spectral Domain Effects Processing



developed by
iZotope
an M-Audio partner

trash Complete 64-bit Distortion Processor

M-AUDIO

recording interfaces | USB keyboards | studio monitors | microphones | preamps | sound libraries | music software

www.m-audio.com

World Radio History

Success Story

COMPANY: The Shushybye Company

CONTACT: www.shushybye.com

LOCATION: Los Angeles, CA

KEY CREW: Steve Syatt

by Mitch Gallagher

There are a lot of things you can do with your studio to earn a living: record bands, score films, create sample and loop libraries, or put together jingles and ad spots. There are other possibilities, too: You could, for example, record kids' music.

Kids' music?

But kids these days . . . who the hell understands them and what they want? Well, Steve Syatt and his SSA Public Relations firm, that's who. The firm was responsible for launching children's brand successes you might have stumbled on even if you don't have kids of your own:

Berenstain Bears: The Animated Series, *Pokemon*, and *Bob the Builder* to name just a few from a very long list.

While being the success behind the story was cool, what Syatt *really* wanted to do was direct...his own children's brand. So 15 years ago he began writing bedtime stories and songs about the "Shushies," who live in "Shushyland" and make the dreams kids dream at night. His son and daughter were both the inspiration and testing ground for his ideas.

And Steve's vision of the Shushyland book series and musical entertainment brand is gathering serious steam: A 32-page large format book entitled *Shushybye: Snoozles Saves The Night*

While being the success behind the story was cool, what Syatt really wanted to do was direct . . . his own children's brand.

together with a music CD of original songs is presently seeing a nationwide release. Live reading/music appearances have been conducted in 40 Borders stores in California and Nevada. Licensees, including toy manufacturers, book publishers, and children's bedding and apparel manufacturers, have all signed on. Work on a live action television show has begun, and a



nationwide tour of the Shushybye Dream Band is in the works.

But it took a lot of work to get to this point — writing the book and songs was just the tip of the iceberg. Syatt saved money for five years in a "Shushy Fund" to finance an initial printing of books and CDs, manufacturing plush toys, and creating costumes for performers to wear at live gigs.

And Syatt, to help realize his dream, also built what he calls his "music room" — a well-equipped recording studio — in his house, where the Shushybye CD was recorded, mixed, and mastered. The studio is based around a Digidesign Pro Tools HD3 Accel system with a ProControl, KRK monitors, SSL, Groove Tubes, Avalon, Trident, and PreSonus preamps, dynamics from Universal Audio and Empirical Labs, Apogee converters, Neumann, Blue, Shure, and Octava mics, loads of plug-ins, keyboards, guitars, and more. Steve is particularly proud of his Ampex 1/2" analog deck featuring updates by ATR Services/Michael Spitts.

While the Shushies are the brainchild of Syatt — he conceived the idea, wrote the text, and composed the songs — the production of the products was a team effort, including the contributions of artist/illustrator Frank Caruso, producer/arranger Gerald O'Brien, engineer Robb Zenn, vocalist Michael North, and second vocalist Randi Soyland.

Music plays a central role in the Shushybye success; Syatt composed the songs to appeal to both children and adults. As one parenting publication said, "These are songs you will want to keep listening to after the children are asleep in the car seat."

As we went to press, Steve Syatt told us that he'd been notified that Big Blue Dot, which does forecast surveys for the entertainment industry, placed Shushybye on their top 10 list of children's brands to watch out for in 2005. Proof positive there's nothing childish about using your studio to record music for children. **EQ**

Are You a Success Story?

Listen up EQ readers: Have you found a unique way to turn your home or project studio into a profitable business? If so, we want to feature you as a Success Story. Send an email letting us know why you should appear to eq@musicplayer.com.

World Radio History

cakewalk

SONAR4

“

SONAR 4 Producer Edition is simply stunning. Surround is logically integrated in a way that keeps the creative flow and mixing moving fast. And SurroundBridge is brilliant!

”



Rob King Producer and composer for TV, Video Games, Popular Music
Sony's Everquest series, Billboard charting dance singles, Dawson's Creek, CBS, NBC

cutting edge
environment



Version 4 transforms SONAR into a robust mixing environment, suitable for both surround and stereo, with exclusive features not found in any other applications. In addition, SONAR 4 delivers 32-bit floating point digital mixing and bussing technology with full delay compensation throughout the signal path. Combined with its enhanced video support, you'll find SONAR 4 offers a superior solution for scoring and post production.

Learn more about SONAR 4's cutting edge mix environment at www.sonar4.com/mix

Hot

Damn! It's

by Craig Anderton

78 seconds.

That's how much time you'd have at each NAMM exhibitor if you visited every booth and didn't eat. Or go to the bathroom. Or could instantly teleport yourself from one booth to the next.

54 people.

That's how many people would be at each booth if all attendees were distributed evenly among the 1,428 exhibitors at any given moment.

In a word, NAMM was *packed*. Like "it took me 20 minutes to get from Hall E to Hall A" packed. Thursday and Sunday, normally "dead" days, were as busy as the busiest days of previous shows. The numbers tell the story: 78,091 registered attendees (with 8,416 from outside the US — up 10% over last year — so I guess the weak dollar is good for something).

We'll let the retailers and manufacturers decide what this means about the MI climate in 2005. But hey, we're gear slob! Is it NEW? Is it HOT? And will it make our lives easier without breaking the bank?

Enter EQ.

We combed the floor, and found . . . well, a lot of missing contact lenses and cell phones. But when we raised our sights a little higher, we found some fascinating technology that'll be blowing minds and busting budgets in the year ahead.

Oh yes, the standard caveats: We didn't see everything, some of the following is utter fiction, and prices, features, and the very fabric of all space and time itself are all subject to change without notice.

NAMM BUZZ BOX:

THE 11 PRODUCTS PEOPLE SAID I HAD TO SEE

As I walked the halls of NAMM . . . well, actually I don't walk the halls, I kind of lurch from booth to booth while trying not to knock people over. While I'm at it, I always ask "Hey, what's hot at the show?"

The answers? Well, while I usually I restrict it to only 10 products, these 11 kept popping up. So?

Apple GarageBand 2. Apple was pushing not just Logic 7, but putting the make on attendees with GarageBand 2. It records up to 8 tracks simultaneously, displays music notation in real time, fixes pitches, tightens timing, and can apply "elastic audio" to fit audio to tempo. That's a pretty sophisticated garage, if you ask me. www.apple.com

Blue Microphones Snowball USB Mic. It wasn't

Blue Microphones
Snowball USB Mic

Sandwiched between Tomorrowland and Fantasyland, and jam-packed with Big Gear Fun, the secret story of this most recent NAMM? One word, Thrilla, baby! OK, that was two words, but the point remains: more gear than you could shake a stick at. And an EQ guide to navigating what you missed.

the only USB mic; Samson (www.samsontech.com) showed the C01U USB cardioid Studio Condenser Mic. But Blue's Snowball dynamic mic (\$139) has a unique dual-capsule design — one tailored for vocals, the other for instruments. A three-position switch selects one, the other, or both. Works with PC or Mac, too. So, how long before Monster sells a boutique USB mic cable? www.blueemic.com

Cakewalk Project5 Version 2. The original Project5 didn't exactly take over the world, but folks were wowed by V2. It's a different type of program, aimed at executing ideas as smoothly as possible. V2 adds integrated multitrack audio, pattern triggering, dynamic arpeggiation, track inspector, in-track automation, and loop reconstruction. There's also a new multimode sampling synthesizer that looks pretty darn cool. www.cakewalk.com

EastWest Symphonic Choirs. It ain't cheap (\$995), but you get five choirs (boys, alto female, soprano female, basses male, tenors male, and solo singers) with three simultaneous microphone setups (close, stage, and hall) across 37GB of samples — mix any combination of mics together to alter tone and concert hall ambience. But the tech mindboggler is a word-building utility for Mac/PC, with text editor. And



Cakewalk Project5 Version 2



NAMM!!!



Korg Kontrol49



Focusrite Saffire



M-Audio Black Box



Native Instruments Kontakt 2



Mindprint Trio

yes, you can *type in the words* you want the choirs to sing. www.soundsonline.com

Focusrite Saffire. The Focusrite Saffire FireWire interface offers 4 ins (2 S/PDIF digital), 8 balanced outs, S/PDIF out, and MIDI I/O. So what? Here's what: Built-in DSP with compression, EQ, amp modeling, and reverb software. And, all four are available as a plug-in suite from within the host-recording platform. Furthermore, you can create up to five separate user-defined stereo mixes of all incoming signals and recorded tracks from the recording platform. www.focusrite.com

Korg Kontrol49. Korg's OASYS got the big buzz, but recording-savvy EQ types pointed me toward the Kontrol49 MIDI Studio Controller (\$500). This box combines 49 full-size keys with 40 assignable performance controls, including a vector joystick and eight pairs of assignable sliders and rotary encoders. The encoders feature individual color-coded backlit LCDs that display each controller's user-defined function name and parameter value. There's also a Mac/PC editor/librarian, and a ton of bundled software. www.korg.com

M-Audio Black Box. Designed with Roger Linn, the Black Box do-all recording dookie for guitarists combines 12 virtual guitar amp models, 43 beat-synced effects based on AdrenaLinn technology, 99 built-in drum patterns with tap tempo, mic preamp, 24/44.1 USB audio interface, S/PDIF digital out, headphone jack, tuner, and a mic stand adapter for easy mounting. It bundles a special edition of Ableton Live, too. www.m-audio.com

Mindprint Trio. This sub-\$500 box is the home recordist's buddy. It includes a channel strip with mic/instrument class A preamp and phantom power, analog EQ, analog insert, and analog compressor. You can also mix the mic/instrument, stereo line in (with EQ), stereo aux, and DAW returns simultaneously. There's a latency-free monitoring mixer with dedicated controls, dual headphone amp, monitoring section with talkback, mono/dim/mute functions, outputs for three speaker pairs, 24/96 S/PDIF, and master volume; besides, it's cute and red. www.mindprint.com

Native Instruments Kontakt 2. Hey, it doesn't look that different from Kontakt 1. Well, except for lotsa different surround options. And really flexible effects placement. Oh yes, and scripting that lets you manipulate incoming data — create arpeggiations, harp emulations, "virtual guitarist" type programs, and more. And the ability to import just about any format known to humans, the improved browser, the 64 MIDI channels, all the extra content, and . . . well, maybe it is really different from Kontakt 1. www.native-instruments.com

Synful. Synful (\$479) does orchestration, but it's not a sample library — it's a resynthesis-based instrument for Windows VST/DXi that stores articulations, transitions, and other elements that "humanize" a part. Synful looks at a MIDI file, then resynthesizes an orchestral score that includes these additional elements. The demos were impressive, though some who've used the program say it's harder to get results out of it than they'd hoped. Regardless, as Synful gets more refined it may do to orchestral sample libraries what those libraries did to real orchestras. www.synful.com

Waves Q-Clone. You have one classic hardware EQ, and wish you could apply it to a bunch of tracks. *Calling Q-Clone!* It consists of two components: Q-Capture and Q-Clone itself. Q-Capture sends a signal to the outboard EQ; you adjust the settings on the outboard EQ for the desired sound, and Q-Capture analyzes the processed signal's shape and phase response. Next, you open Q-Clone on a track, and it applies that response. The process happens in real time, reacting to the adjustments made on the outboard EQ unit itself; think of the

Hot Damn! It's NAMM!!!

EQ unit as a control surface that can be switched from one channel to another using Q-Clone. You can always go back to a particular track, adjust the EQ settings, and capture the new sound. Q-Clone comes with a library of equalization presets captured from world-class hardware equalizers. Wild, eh?

www.waves.com

The 8 Big Trends

TREND #1: MASTERING SUITES + RESTORATION

Go figure: After spending a few years putting vinyl crackles and lo-fi into digital audio, now the trend is all about taking out the garbage.

Creamware's REstore is an audio restoration package for Windows with hardware (SCOPE home DSP board) and software (DeClicker, DeCrackler, DeNoiser, Psy-Q psycho-acoustic processor, and TripleLE audio editor, which includes MP3 and CDR support). The noise reduction software, as well as tripleLE, is available separately for existing SCOPE owners . . . **scopeFX**, a low-priced DSP system derived from the SCOPE platform, concentrates on mixing, effects, and mastering. The scalable system consists of a 6-DSP PCI card with 20 ins and 20 outs as well as MIDI I/O. Processors include a library of over 50 effects, which can also operate as VST effects within Cubase and Nuendo. scopeFX contains software mixers for all available audio sources, whether computer internal (ASIO, GSIF, and Windows drivers) or from external sources (via card I/Os).

www.creamware.com

M-Audio got a mastering suite with the stroke of a pen by becoming the distributor for iZotope's excellent **Ozone3** mastering suite. Way to go, guys, it's good stuff. www.m-audio.com

Nomad Factory's Essential Studio Suite plug-in bundle includes Multiband Compressor, Essential Channel, Essential Graphic EQ, Essential Compressor, Essential Gate Expander, Multiband Loudness Maximizer, Loudness Maximizer, Tube/Tape Warmer, and Retro-Vox. It supports sample rates up to 192kHz and automation. www.tascam.com



Nomad Factory Essential Studio Suite



Propellerhead Reason 3.0

Propellerheads' Reason 3.0 stresses the Combinator module's live performance aspects — it's a way to load a bunch of instruments into the software equivalent of a "multi." But equally important is the built-in "mastering suite" that provides tasty EQ, stereo imaging, compression, and maximization. Yes, even software studios are getting into mastering. www.propellerhead.se

Sony's presenting the **Oxford Restoration Tools Suite** (\$1,195; DeClick, DeBuzz, DeNoise) for Pro Tools RTAS/Audiosuite on OS X and XP. www.sony.com/professional

Universal Audio got into the act with the **Precision Equalizer** (\$199), an up-sampled (192kHz) stereo or dual mono 4-band EQ and high-pass filter made primarily for program material and mastering. It's available as part of the v3.8 software upgrade for UAD-1, downloadable from the UA web site. Want more? Intended for industrial-strength mixing and mastering applications, the **Ultra Pak** (\$1,495; Windows/Mac) includes the UAD-1 DSP card and a suite of 24 powered plug-ins including the classic UA vintage emulations, Precision Limiter, and Precision Equalizer. www.uaudio.com

TREND #2: RECORDING STUDIO OR KEYBOARD?

First it was synthesis. Then sampling. Then looooooog samples, and then — hey, why not? — hard disk tracks. Now any workstation worth its black and whites better do some serious recording, too.

Korg led the charge with the **OASYS** 16-track hard disk recorder. Oh, our friends at *Keyboard* will tell you it's a keyboard workstation, but look under the hood: It's an audio-meets-MIDI studio with a ton o' synthesis that just happens to look like a keyboard. Then again, look at that ultra-sexy color touch screen, and maybe it's really a computer. Whatever, it's way costly — about \$8K — but way cool.

www.korg.com

Or what about the Alesis **Fusion 8HD**, another stealth studio disguised as a keyboard? This expandable 88-note workstation/8-track hard disk recorder can record up to



Korg OASYS

Expert Sales Staff, Toll-Free Tech Support **and Great Prices?** Only at Sweetwater!

Ever notice how most music retailers' ads have begun to look like supermarket ads ... special on aisle five and so forth? Musicians need to save money. We get it. But buying audio gear also requires highly specialized knowledge and very special service. We get that too, and that's what makes Sweetwater different. So different, in fact, that thousands of people turn to Sweetwater every day for their music needs.

What is the Sweetwater Difference? It's giving you the care, support, and expertise of a neighborhood music store with all the advantages of a national dealer, plus features that even the biggest chains can't provide like:



HUGE SELECTION

Great prices, special package deals, rebates, and **FREE SHIPPING** on almost everything we stock.



EXPERT SALES STAFF

An enormous inventory means whatever you want, chances are we have it in stock.



**FACTORY-AUTHORIZED
REPAIR CENTER**

The most knowledgeable and qualified Sales Staff in the industry — a one-on-one relationship with an audio professional.



**AWARD-WINNING
TECH SUPPORT**

FREE unlimited tech support and award-winning Service Center.

The largest website in music retail with online buying guides, in-depth product information, 24-hour online tech support, and more.

We do whatever it takes to keep you happy. That's what the Sweetwater Difference is. When you think about it, the Sweetwater Difference isn't about us...

It's all about YOU!

Sweetwater

music technology direct™

(800) 222-4700

www.sweetwater.com



NO Minimum Purchase • Expedited Delivery • Most Orders Ship Same Day

World Radio History

8 simultaneous inputs and features a 32-track MIDI sequencer. Synthesis types include sample playback, FM, virtual analog, and physical modeling — and at \$2,999, it's also less than half the price of the OASYS. Or spring for even less with the 61-note **Fusion 6HD**. www.alesis.com

Roland got into the act with their **Fantom-X** Audio Track Expansion OS upgrade (for Fantom-X6, X7, or X8). This adds 8 stereo linear audio tracks to the Fantom-X's sequencer; the upgrade kit includes a CompactFlash card with installer software and PC card adaptor. Clever, clever. www.rolandus.com

And if you like software workstations more than hardware, that's okay. **IK Multimedia's Sonik Synth 2** offers a "can you top this?" 5,391 sounds (8GB). IK says it's a "complete songwriting, producing, and arranging supertool" . . . actually, that's a pretty good description. www.ikmultimedia.com

TREND #3: INVASION OF THE SOFT ORKS

Plug-ins made classic analog sounds available to the masses. Next up: Everybody's gonna have an orchestra on their hard drive. Here's the proof.

Garritan Personal Orchestra Advanced Edition (\$499) offers more solo strings, brass, and woodwind instruments, as well as new articulations compared to the original GPO . . . The **Garritan Stradivari Violin Sample Library** (\$199) uses "sonic morphing" to align samples. Thus, users hear a single instrument during transitions (e.g., dynamic changes, vibrato) instead of two, producing a much higher level of realism. . . . And speaking of GPO, **Richard Birdsa** is the winner of Garritan's 2004 Orchestration Competition, and will have his work performed by the Moravian Philharmonic Orchestra in the great country



IK Multimedia Miroslav Philharmonik



IK Multimedia Sonik Synth 2

of Moravia . . . okay, whatever. Runners-up are Kentaro Sato, William Pearson, and Craig Reeves. Congrats! www.garritan.com

IK Multimedia's Miroslav Philharmonik, an "orchestral workstation," folds orchestral and choir samples into a plug-in instrument tailored toward classical sounds and arrangements. www.ikmultimedia.com

MOTU Symphonic Instrument (\$295) is a cross-platform instrument plug-in (VST, Audio Units, DXi, MAS and RTAS) with an 8GB library of orchestral sounds and built-in convolution reverb. Instruments include strings, brass, woodwinds, orchestral percussion, male and female choirs, pipe organs, period instruments, and pianos. www.motu.com

Sonic Implants completed the **Orchestral Solution** series with the **Percussion** (\$695) and **Woodwinds** (\$995) libraries, which join their acclaimed Brass and Strings libraries. www.sonicimplants.com

TREND #4: USB ROOLZ

USB keyboards. USB interfaces. USB control surfaces. Even press kits on USB memory sticks (pioneered by EQ magazine a few years ago, but what the heck, we've always been ahead of the curve). NAMM 2005 put the "universal" in Universal Serial Bus; here are a few examples.

Peavey's FX Series mixing consoles, available in 16-, 24- and 32-channel versions, have an interesting claim to fame: Dual USB ports, which allow streaming digital audio directly to a computer-based recording/editing program or memory stick, and the inclusion of built-in MP3 compression for direct audio export. Performers can rip a live performance or rehearsal directly to MP3 (or other digital format), or even save demos to memory stick and bring song ideas to rehearsal. The FX series can also act like an audio interface for your computer. The other mixer features are cool, too, like dual DSP engines that allow multiple simultaneous effects (reverb, delay, compression, de-esser, chorus and gate/expander) as well as additional processing such as Feedback Ferret, delay, limiter, and 31-band graphic or seven-band parametric EQ. There's a lot more, but you get the idea. www.peavey.com



MOTU Symphonic Instrument



Lexicon MX200

The **Mariani UCON CX** (\$899) USB2 audio interface for Windows has four balanced mic/line ins, four line ins, one stereo

S/PDIF or ADAT I/O, MIDI I/O, eight balanced outs, and headphone output. An integrated DSP mixer allows mixing all available signals to one dedicated out for latency-free monitoring. The UCON CX also works as a standalone 8-channel ADAT converter.

www.plus24.net

Also in interface-land, the **Alesis Iol2** is a portable two-channel 24/96 USB audio interface with two XLR ins with +48V phantom power and two balanced line ins. Other features are S/PDIF I/O, headphone amp, TRS input channel inserts, MIDI I/O, low power drain for laptop applications. . . . Crossing over to keyboards, the **Photon X49** is a 49-key velocity-sensitive USB/MIDI keyboard controller with airFX-type controller dome, 60 assignable controls, mod/pitch wheels, and multiple power options.

www.alesis.com

E-Mu Systems' Xboard 25 and Xboard 49

USB/MIDI Controllers for PC and Mac feature full-size velocity sensitive keyboards with aftertouch, 16 programmable realtime controllers, Xboard Control editing software, and E-MU's new Proteus X LE Desktop Sound Module with over 1,000 sounds. Both Xboard models can run on USB, battery, or AC power.

www.e-mu.com

Still like vinyl? Well, we admit we do too. And we like USB. So . . . ART's **USB MicroPRE** (\$99) is a USB audio interface phono preamp and line level I/O for Windows 98/2000/ME/XP and Mac OS 9/X. It also includes optical TOSLINK I/O and coaxial S/PDIF ins for S/PDIF-to-USB conversion. www.artproaudio.com

The **Lexicon MX200** hardware signal processor (reverb, delays, effects, and dbx dynamics) provides a USB interface with a cross-platform VST plug-in window, allowing the MX200 to function as a "hardware plug-in" within any VST-compatible workstation environment. For live performance, three control knobs for each processor offer hands-on control. www.lexiconpro.com

We're not done yet: **Brian Moore's iGuitar.USB** is a guitar that offers onboard, bus-powered, class-compliant USB



Hercules 16/12 FW

audio. Yes, the audio can flow out of the guitar and right into your computer, delivering a line-level signal with no preamp or impedance-matching issues. Darn clever, these guitarists.

www.brianmooreguitars.com

TREND #5: FIREWIRE'S ON FIRE

It's an old protocol by computer standards, and it used to be just an Apple thing — but no more. FireWire has sparked people's interest, and is blazing a path in the audio world. And there's going to be more, so let's start with the reason why.

Wavefront Semiconductor has an audio evaluation module for their DICE II FireWire chip. It sports multiple audio interfaces (AES/EBU, S/PDIF, ADAT optical, TDIF, MIDI, and RS232); but note that DICE II is unique among FireWire chips aimed at audio applications because its software is open source. Translation: Faster time to market for FireWire-based audio products. www.wavefrontsemi.com

Glyph Technologies is deep into FireWire-based storage subsystems. Their GT 060 has two fixed-mount FireWire drives, while the GT 061 is a tabletop enclosure for one fixed-mount FireWire drive and one hot-swappable drive. The GT 062 allows for two hot-swappable GT Key drives in one tabletop enclosure, and the GT 060BR is a FireWire 800, hardware RAID 0 solution with two drives. www.glyphtech.com

Got interface? **Hercules' 16/12 FW** is a FireWire 24-bit/96kHz, 16-in/12-out audio and MIDI interface for Mac/PC. There are also 2 mic/instrument pres with switchable 48-volt phantom power, 2 x 2 MIDI interface, word clock I/O, zero-latency direct monitoring, and drivers for Mac OS X Core Audio and Windows (ASIO2.0, GSIF, WAV, DirectSound). www.hercules.com

Edrol's FA-66 (\$495) is a 6-channel FireWire audio interface that supports OS X and WDM/ASIO2.0 drivers for Windows



Edrol FA-66

Glyph Technologies



E-Mu Systems Xboard 49 & Xboard 25

Hot Damn! It's NAMM!!!

XP. It can record up to 6 channels of audio simultaneously at 24-bit/96kHz, or up to 4 channels of audio at 24-bit/192kHz. Record two microphones directly into the FA-66 via the included phantom power mic preamps, or line-level devices through stereo RCA inputs. Other features include zero latency monitoring, MIDI I/O, a built in limiter, and optical S/PDIF. www.edirol.com

Alesis Multimix mixers double as analog mixers and FireWire interfaces for computer-based recording. The line includes the **Multimix 8FireWire** (8-channel analog mixer), **Multimix 12FireWire** (12 channels), and **Multimix 16FireWire** (16 channels). All offer 100 onboard preset effects, are OS X/XP compatible, and come bundled with Cubase LE. www.alesis.com

TREND #6: GENDER CONFUSION

We have audio interfaces that drive sound modules, guitar processors with recorders, recorders with guitar processors . . . and as mentioned previously, keyboards that think they're recording studios. If the question in the '60s was, "Are you a boy or are you a girl?," it seems the question for 2005 is, "Is there anything you don't do?"

Take **M-Audio's Ozonic**. Is it a keyboard controller? Yes, it has 3 octaves with velocity and aftertouch response. Or is it a MIDI interface? Uh . . . well, yes, it's a MIDI interface that connects via FireWire. Or is it an audio interface? You could certainly say that, it's 24/96 and has an XLR mic preamp. Or is it a control surface? After all, it has 40 assignable MIDI controllers (including transport buttons). Answer: (e), all of the above. www.m-audio.com

Another example: Hot on the heels of the GNX4, **DigiTech's GNX2000 Guitar Workstation** is . . . well, it seems like an "all of the above" kinda thang as well. It's a digital effects processor, a USB audio interface, a mic preamp, and a drum machine. What's more, they support each other, so it's not like a separate collection of modules. www.digitech.com

TREND #7: BIG HUGE SOUND LIBRARIES

Give sound developers big hard drives and DVD storage, and they'll take the bait. Here are just a few of the big sound libraries that, perhaps not coincidentally, make pretty big sounds.

EastWest. RA (\$995) is a 14GB orgy of ethnic sounds from Africa, the Americas, Australia, Europe, the Far East, India, the Middle East, and the Turkish Empire — and I loved it. Every instrument is heavily articulated, and can be played very expressively . . . Also

based on the Kontakt audio engine, **COLOSSUS** (\$995) is a massive 32-gigabyte virtual instrument that includes all of the instruments and SFX in the GM specification, yet offers more detail than would could expect from any GM synth. www.soundsonline.com

Ilio Entertainments. Talk about oldies but goodies: The **Origins** 3.5GB sample library by Dirk Campbell (\$349; for Giga 3.0 and EXS24 mk II) covers ancient winds, percussion, and voices (Greek aulos, Roman war horns, animal horns, ambient ethnic drums and cymbals, tribal drums, group vocal notes, vocal clusters, and Shamanic circular breathing songs). We're definitely not talking about another dose of pianos and French horns. In addition to multisamples presented in a variety of different dynamics and articulations, the library features phrases and performances. www.ilio.com

Sony. Steve Ferrone & Greg Ladanyi: Drums from the Big Room (\$249.95) is a 5-CD "acidized" collection of mixable, multitrack drum performances in 24-bit format. The collection features rock, pop, R&B, jazz, and reggae . . . **Chicago Fire, A Dance Music Anthology** (\$249.95), produced by Vince Lawrence, is also an acidized 5-CD collection that covers deep house, electro, old school, progressive, and drum 'n' bass. www.sony.com

TREND #8: TECHNOLOGICAL DESENSITIZATION

Quite a few people said there was nothing really new at NAMM. There are only two possible explanations: There's a parallel universe where they attended a totally different NAMM, or as Mitch Gallagher and David Bryce theorize, they've become numb to the rate of technological change.

What's happened in music technology over the past few years is nothing short of miraculous, but apparently people have gotten used to miracles. Think about it: When you can buy an 8-track hard disk recorder with mixer for under \$400, an 88-key keyboard for \$500, a complete orchestra on a few CD-ROMs, or plug-ins that compete with the best analog could offer at a fraction of the cost, that's pretty effing amazing.

The Goods, the Goodies & Everything In Between

AIR MOTION CAPTURE DEVICES

Well, I just didn't want to say "mics." There were, like the jokes in my repertoire, a zillion of them, and so here are a few for your viewing pleasure. Don't say we never gave you nothing.

AKG Acoustics' C 542 BL Boundary Layer Microphone (\$320) is small, unobtrusive, and designed to be placed on a large, acoustically reflective surface (such as the studio's walls, ceiling, floor, or the lid or back of a piano) to record sources that benefit from an acoustic space's "room sound."

www.akeg.com >

AKG Acoustics C 542 BL



M-Audio Ozonic



© 02/05. Digidesign, Digidesign ICON, and Pro Tools | HD Accel are trademarks or registered trademarks of Avid Technology, Inc. or its subsidiaries or divisions. All other trademarks are the property of their respective holders.

DIGIDESIGN | **ICON**
INTEGRATED CONSOLE



Music Technology Studios, Ball State University, Muncie, IN

The staff at Ball State University settle for nothing less than the very best tools to train their students. That's why they chose to outfit their Music Technology Studios with two Digidesign® ICON consoles. Now ICON-empowered, the students in their Music Technology program can look forward to graduating with a highly marketable understanding of the latest advances in professional audio production.

"Offering our students training and experience working with the latest in industry-standard systems helps them make a successful transition to the job market in the outside world."

— Keith Kothman | Director of Music Technology



Visit www.digidesign.com/icon to learn more about the ICON integrated console. For more information on Ball State University's Music Technology program, visit www.bsu.edu/met. For ICON inquiries, email ICONinfo@digidesign.com.



Anglia TV
Norwich, UK



Bionic Media
New York, USA



The Inside Track
Auckland, New Zealand



Mike Shipley Studios
Studio City, USA



Silicone
Paris, France

Fully modular, state-of-the-art console control • Pro Tools | HD Accel DSP and I/O resources • 192 kHz sample rate support
Industry's finest plug-in options • Automatic Delay Compensation • Integrated video and delivery • Total session recall

Behringer's Studio Condenser Mics C-2 is a set of two condenser mics, sold as a stereo pair. They feature a cardioid pattern, low-mass diaphragm, and transformerless FET input. www.behringer.com

Beyerdynamic's Opus Series Mics target drums, percussion, instruments and boundary applications. The percussive series includes the Opus 53 (condenser mic with tight cardioid pattern), Opus 83 (condenser cardioid mic), Opus 88 (cardioid condenser mic mounted on a short gooseneck), and Opus 99 (optimized for miking bass drums). The Opus 51 acoustic boundary microphone integrates the mic element into a solid metal plate with a heavy-duty protective surface. www.beyerdynamic.com

Blue Microphones' Kickball is optimized for recording kick drums. www.bluemic.com

Peavey's Studio Pro CM1 (\$199.99), a handheld cardioid condenser microphone, handles SPL levels up to 136dB. It features a transformer FET circuit, built-in shockmount, and a dual-layer pop filter . . . the **PV MSP1** (\$59.95) is a mic/accessory package with a PVi 100 dynamic cardioid mic, tripod-style boom stand, XLR-to-XLR or XLR-to-1/4" cable, mic stand clip, protective nylon mic bag, and zippered gig bag. www.peavey.com

Red's Type B (\$699) is a Class A discrete solid-state mic that accommodates interchangeable capsules, including classic Neumann-Gefell capsules and Blue's Bottle Caps line. The Type B comes with the versatile Red Lollipop Capsule and Type B Accessory Pak (mic cable and shockmount). www.vintagemicrophone.com

Roland has introduced three new mics. The **DR-80C** is a large-diaphragm studio mic, the **DR-30** is a handheld cardioid mic, and the **DR-50** is hyper-cardioid handheld mic with enhanced shock absorption. www.rolandus.com

SE Electronics' Titan (\$1,499) features a titanium



Beyerdynamic Opus 88

diaphragm, transformerless active balanced output, three patterns (cardioid, omni, and figure of 8), 100Hz filter, 10dB pad, and a deluxe aluminum flight case . . . A matched pair of **SE3** mics (\$749) features a heavy duty adjustable stereo bar and custom aluminum flight case . . . The **Ghost Studio Boom Stand** has all-metal construction, locking height and angle, and an included sandbag for maximum stability. Large size \$399, medium \$299. www.sonic-distribution.com

Studio Projects' CS1 is a single-pattern (cardioid) large diaphragm condenser. Three thumb-wheels control highpass filters, lowpass filters, and pad . . . The **CS3** is a dual diaphragm multi-pattern large diaphragm condenser. It combines the CS1's features with a fourth thumb-wheel that adjusts the mic pickup pattern. www.pmiaudio.com

Telefunken North America's Ela M 16 (\$1,399) is a hand-built, 9-pattern tube mic with shockmount that breaks the price barrier compared to other mics in the same line. www.telefunkenusa.com

SOFTWARE PLUG-INS

Plug-in companies have been battered by theft, but the survivors continue to deliver great stuff. Let's hope they do. Survive, that is.

Cycling '74's HIPNO 1.0 (\$199) is a suite of over 40 effects and instrument VST plug-ins for VST/AU/RTAS Mac OS X hosts (Windows XP is next). The package includes a mix of granular, spectral, and filter/delay-based plug-ins, modulator plug-ins, and a set of processors that use live video input as a control source. . . . The plug-in suites **Pluggo** and **Mode** (\$199 each) are now available for Windows. . . . Cycling '74 will distribute JazzMutant's **Lemur** multitouch control surface (\$2,495), a sleek portable controller for live performance computer music applications. It features a 12" LCD and touchscreen interface that can simultaneously track multiple fingers. Users configure the Lemur using an editor application. . . . **Octirama** is a multi-band surround dynamics processor for the Digidesign TDM environment. Over 40 simultaneous meters provide detailed operational feedback. www.cycling74.com

Eventide's Anthology bundle (\$1,195) for Pro Tools TDM systems offers all nine Eventide TDM plug-ins, including the H3000 Factory, and all five plug-ins from Clockworks Legacy. www.eventide.com

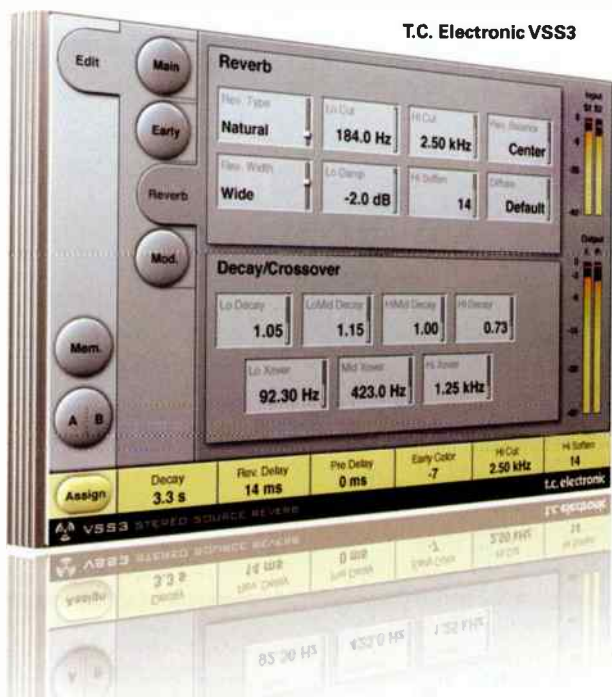

T.C. Electronic VSS3



Wizoo Wizooverb W2



Hartman Neuron VS

T.C. Electronic V553 Stereo Source Reverb for PowerCore (\$625) has been ported directly from the System 6000. Want to tweak? The almost 800 parameters should keep you off the streets and out of trouble. www.tcelectronic.com

Wizoo wanted me to come to their suite and see their new W2 (stereo) and W5 (surround) digital reverbs. I'm generally not a huge fan of digital reverbs, but the W2 sounded astonishingly realistic, even though they let me set the parameters for "wrong" sounds just to see what would happen. Apparently convolution is only one of several components used to create the sound. www.wizoo.com

VIRTUAL INSTRUMENTS

Hey, remember when your studio's space was taken up by all those keyboards? Now instruments just take up a lot of space on your monitor — and they continue to get smarter, better, and offer higher fidelity.

Ableton's Operator (\$149) incorporates four oscillators and a resonant multimode filter to provide both subtractive and frequency modulation (FM) synthesis. Also, every Operator parameter can be automated or remote-controlled via MIDI. www.ableton.com

Applied Acoustics' String Studio (\$249) isn't an ork thing, but a virtual string synthesizer, from plucked to bowed. Cool stuff. www.applied-acoustics.com

Arturia. The **ARP 2600V** soft synth emulates the original 2600 but adds MIDI control, polyphony, tracking generators, and additional effects. It comes with over 400 presets. www.arturia.com

Fxpansion. Drag a drum loop into **Guru** (OS X/XP); it automatically slices the beat and maps the slices onto 16 drum pads. Tweak slice points, automate volume/filter/pitch, etc. for each pad, layer sounds, add effects, and use the internal step sequencer to create new grooves. www.fxpansion.com

Gforce's Minimonsta (\$199.95) is another Minimoog tribute, but with a few wrinkles. It does VST and RTAS with Mac/PC, as well as MAS and AU. www.m-audio.com



Steinberg Groove Agent 2

Giaresoft iDrum is an AU drum machine, but also works standalone in OS X and Windows. Use the existing library of patterns, or load samples up to 2MB. www.m-audio.com

Hartmann's Neuron VS (\$999) is a VST/AU, Mac/Windows software version of the Neuron synthesizer. Cool feature: The **Nuke** remote control unit, which connects to the computer via USB and is designed to give the human touch to software synthesizers. It even has an upholstered hand rest. www.hartmann-music.com

Steinberg Groove Agent 2 (\$249, update \$79.99) folds in new styles (including punk, grunge, old skool hip hop, and retro rock) and nine new drum sounds. Other refinements include added output buses (up to eight stereo outs, an overhauled GUI, and a "Save to MIDI file" feature. www.steinberg.net

Way Out Ware TimewARP 2600. And way out they were, in possibly the most remote part of the convention center that could still be considered part of the United States. But that didn't deter those who wanted to check out this virtual ARP 2600, which has the blessing of Alan R. Perlman (ARP) himself. www.wayoutware.com

Wizoo teamed up with **M-Audio** for the **Key Rig** plug-in, with four virtual modules: stage piano, poly synth, electromagnetic organ, and general MIDI. The related **Drum & Bass Rig** isn't so much about RONI SIZE but a plug-in/standalone device with a drum module, electric bass, loop creator, and bassline. www.m-audio.com ►



Way Out Ware TimewARP 2600

SOFTWARE PROGRAMS

Chicken Systems' Constructor lets you create platform-independent sampled instruments, and save them to dozens of standard formats. Edit wavesamples with external editor or basic internal editor, import samples or whole or partial programs from any source, and do batch processing. . . . **Sample Manage** provides a central location for sampled sounds, as a floating desktop utility. Access databases of sound by keyboard or location, then drag-and-drop into your sampler; supports virtual drives and all pro sampler formats. . . . **Translator Pro 6** is a universal file converter and sampler tool. It features integrated search and database functions, batch conversion, VST hosting, and a 50 x 50 matrix of sampler format sources and destinations. www.chickensystems.com

Circular Logic InTime 1.1. This tempo tracking system lets sequencers and drum machines follow your playing, not the other way around. Of particular interest: When you record with InTime, it can create a tempo map that's written out to a MIDI file. Load it into a host sequencer, then sync up MIDI tracks to the original feel. www.circularlogic.com

Immersive Media Research. All programs are for OS X, with XP support slated. **Vortex Surround Mixer** (\$300, OS X/XP) is a multichannel sound-file mixer (with ReWire host capability) that spatializes eight or more ReWire channels or mono sound files to eight output channels. Supports seven surround configs (from 4.0 to 8.0), VST plug-ins, automation, loop-based spatial path control, etc. . . . **Vortex Surround Designer** (\$400, OSX/XP) spatializes mono or stereo signals to up to eight surround channels, and serves as a ReWire client. Sound paths can be saved independently of the sound file itself, creating a library of spatial paths that can be re-used for any mono sound file. . . .

Vortex Surround Encoder (\$200) DTS, binaural encoding) encodes several individual sound files into a single multichannel master file. www.vortexsurround.com

Magix Samplitude Professional 8.0. Is this the year that Magix Samplitude breaks out from cult status to mainstream? Sure, it supports surround, including a surround effects package with EQ and dynamics, along with a surround-friendly convolution reverb. But project management has also been greatly improved, and new effects include an analog modeling suite with tape saturation and transient designer. Other features include "elastic audio," Melodyne-like pitch editing, a drum editor, advanced MIDI editing, enhanced video sync, ReWire support, and the Robota Pro virtual analog synthesizer with integrated step

sequencer. This baby is picked to click. www.synthax.com

Sony Sound Forge 8 (\$399.95) integrates CD Architect for advanced CD burning, application scripting and batch processing, support for ASIO and VST plug-ins, and direct track export functionality. www.sony.com/mediasoftware

SMALLER HARDWARE GOODIES

A Designs. The **ATTY** dual passive audio level control with mute switch, for example between mixer and powered monitor. www.adesignsaudio.com

AP Audio. The **ABR-22** mobile recording package combines a cardioid condenser mic with 1" diaphragm, monitoring headphones with soft carry pouch, mic shockmount, XLR mic cable, and a gig bag. www.aceproducts.com

ART. The single rack space **T8** (Transformer 8; \$179) with all-steel case is a passive audio interface with eight transformers. These separate input and output signal grounds, which isolates two systems to reduce hum and ground loop noise. www.artproaudio.com

Behringer. The **BCN-44** is a compact MIDI controller with four assignable push encoders, four assignable buttons, learn mode, and downloadable editor/librarian software. www.behringer.com

E-Mu. The **1616** (\$399) is a PCMCIA card with onboard DSP and headphone amp; it can also be combined with the MicroDock interface to create the **CardBus Digital Audio System** (\$499), which provides 16 ins and outs with MIDI I/O. It offers ASIO2 and WDM drivers for Win2000/XP, and a software bundle. www.emu.com

Graph Tech. The **Ghost Modular Pickup System** is designed for MIDI guitar and features a user-adjustable tracking curve, as well as the ability to optimize the hex output signal for the best match with particular guitars and playing styles. www.ghostinside.com

Radial Engineering. The **Tonebone Classic Tri-Mode** is a 12AX7-equipped tube distortion pedal. There's true bypass clean tone, two distorted channels with separate input drive and output level controls, effects loop on channel 2, master bass and treble equalization, and independent mid boost on each channel. . . .

The **JDX** direct box connects between the guitar amplifier head and the speaker cabinet to capture the full guitar amp sound. Use alone or combine with a mic, as you can time-align the miked and direct signals.

Dual ground lift and transformer isolation help eliminate ground loops. . . . The



Radial Tonebone Pro-D2

Behringer BCN-44

Radial Tonebone Classic Tri-Mode

NEW! Sound Forge 8



your favorite audio-editing software
JUST GOT TASTIER!



Bite into Sound Forge® 8 software, and enjoy the full-bodied production experience that only the industry's leading digital audio editor can deliver. Savor its extensive feature set and relax knowing you're using the audio editor that sets the standard for power, efficiency, and rich wholesome goodness. Version 8's new bold flavor comes from an exclusive blend of down-home scripting functionality, sweet VST effect and ASIO driver support, satisfying batch processing and other secret ingredients.

To further tempt your palate, Sound Forge 8 now comes with a heaping side of CD Architect™ 5.2, freshly spiced with CD-text support. The industry's leading audio editor coupled with the industry's favorite CD creation and mastering application - it's a tantalizing taste combination that's tough to beat.

LIKE NO OTHER™

Hot Damn! It's NAMM!!!

THE UNSUNG HERO GUY

Question: What do Arturia's CS-80V, Propellerhead's Reason 1.0 and 1.5, Cakewalk's PSYN synth (and the new one in Project5), Digidesign's Venue Live Sound Environment OS, rgc:audio's z3ta+ and sfz+, and Universal Audio's Precision Limiter, Precision Equalizer, and Plate 140 Reverb all have in common?

Answer: A talented graphic designer named THOMAS MERKLE. He really does exist, because I met him at NAMM. Talk about about a behind-the-scenes kinda guy ... does great work, though.

WHEN I'M 64 (BITS)

Cakewalk announced a 64-bit version of Sonar ... does it matter? Well, the x64 architecture can address more physical memory — up to 1 Terabyte (1,024GB). You can thus store more data in RAM instead of on disk, so the software can access it more quickly. And if you use projects with large sample sets, you'll be able to use more of them at a time and not worry about hard drive streaming.

x64 processors also have an increased number of registers and different FPU design. When

Cakewalk tested Sonar x64 vs. the standard 32-bit version, performance gains were typically around 20-30%. Bottom line: A 3GHz processor will feel like it mutated into a 3.6 to 4GHz model.

However, *everything* in a 64-bit environment must be 64 bit — processor, operating system,

SONAR X64 TECHNOLOGY PREVIEW

drivers, and plug-ins. Edirol, Creative, and M-Audio have 64-bit drivers; a stable beta of the Windows x64 OS is available as

a free download at www.microsoft.com/windowsxp/64bit. And, the Sonar x64 technology preview (download for free from www.cakewalk.com/x64) contains 64-bit versions of the Sonitus:fx suite, as well as five softsynths.

The next step: Building 64-bit data paths within a mixing engine to put the word length of host-based systems *beyond* that of DSP-based systems. Also, both Intel and AMD have announced plans for dual core, 64-bit processors, which would come close to doubling a host sequencer's performance.

Pro-D2 passive stereo direct box (\$149) uses a proprietary custom-made transformer for each channel and features heavy-duty steel construction. www.cabletek.ca

Roland. The **CD-2** records directly to CD or CompactFlash media (up to 2GB capacity) for hours of recording time. Once recorded, audio can be edited, processed, and burned to CD. The CD-2 includes a stereo mic, or you can plug external mics in via the CD-2's two XLR inputs, complete with phantom power. RCA phono and 1/4" I/O is also provided; a variety of audio effects are available. www.rolandus.com

SM Pro Audio's A08 is a compact, half-rack sized 8-channel analog to ADAT format converter with 24-bit/96kHz A/D conversion. www.smpaudio.com

Terratec Producer. HI JACK is a front-end preamp with a high-impedance FET input that's optimized for electric guitars and acoustic instruments with magnetic or piezo pickups. It has a balanced out and provides up to 40dB gain ... The **SINE MLM 62** is a 1U, compact six-channel stereo mixer that has two mic pres with two-band EQ, four line ins, effect insert options, and gain controls. www.terratec.com

THAT Corporation. The **InGenius IC** is a balanced line receiver, available with three different gain options, that claims to include patented circuitry to improve noise- and interference-canceling characteristics. www.thatcorp.com

VTG. Want a CAT5e Ethernet cable that meets rock and roll specs? The **Dura-Cat** can be ordered with Neutrik EtherCon series housing for RJ45 connectors, which protects the connector with an XLR-type housing. www.horizonmusic.com

XP Sound. The **XP202 USB audio interface** for Mac or Windows features two onboard mic preamps with phantom power, stereo line in, stereo phono pre with RIAA equalization, stereo headphone amp, and two parallel stereo outputs (one front, one rear). www.xpsound.com

Zoom. The compact **RT-223 RhythmTrak** incorporates 70 drum kits, including an analog set and "human beatbox" samples. The bass machine offers several different electric bass styles, and trigger pads are velocity-sensitive. www.zoomfx.com

LARGER HARDWARE GOODIES

Audient. The **Sumo High Resolution Balanced Summing Amplifier**, an external analog summing mixer,



Roland CD-2

XP Sound XP-202

UPDATES

What's old is new again, at least in the world of software. Change a significant digit, kick in a few bucks (or maybe even get it for free), and you have the equivalent of a new product. Ain't software grand?

Apogee Electronics' V2 firmware update provides Advanced Option Routing for the AD-16X and the DA-16X with X-HD or X-FireWire option cards installed. www.apogeedigital.com

Celemony Melodyne V2.6 enhances handling of keys and scales, compatibility with Apple Logic 7 and DP4.5, and pitch recognition. Free to registered users from www.celemony.com

IK Multimedia AmpliTube V2's theme is more — more amp combinations, chains, preamps, modeled stomp boxes — just plain more of everything. Also, SampleTank 2.1 now offers an enhanced pitch-shift/time-stretch engine, an expanded collection of sounds on two DVDs, more outs (up to 16 stereo), and the ability to create more complex combis. www.ikmultimedia.com

Lynx Studio Technology V2 Windows Driver for the

LynxTWO line supports WDM (does Microsoft Multimedia Extensions, Direct Kernel Streaming and Direct Sound), ASIO 2.0, and GSIF 2.0. Download for free from www.lynxstudio.com.

Mackie's Traktion 2.0 has a mo' better MIDI editor, aux sends and returns, QuickTime support, improved sync options, a 64-bit mix bus to shut up people who complain about digital summing buses, easy MIDI controller mapping, resizeable main window, loop recording, integrated Mackie Control support, improved metering, mucho bundled plug-ins, and a Very Nice Brochure. www.mackie.com



IK Multimedia AmpliTube V2

Manifold Labs. Plugzilla now has a realtime analyzer with

up to 1/12th octave resolution, emphasizing its positioning as a live performance/front-of-house tool as well as a mixing and mastering processor. www.plugzilla.com

MOTU. MachFive V2 sampler includes unlimited parts per instance, modular synthesis architecture, keygroup layering with rule-based switching, built-in mixer, LoopLab groove slice engine for ReCycle-type editing, and sample time-stretching. It can do standalone, too. And their MX4 V2 (\$295) hybrid synth adds more effects, more presets, and additional modulation sources — pattern gate, arpeggiator, pattern sequencer/quantizer, envelope

follower, lag processor, etc. . . And speaking of MOTU, they showed

pitch-stretching/retuning features that will be added to the next rev of Digital Performer. Cool beans. www.motu.com

Muse Research's V1.2 software upgrade for Receptor offers ADAT output support (for a total of 10 outs), "Z-Load" technology to reduce plug-in load time, and new MIDI mapping features with zone/layer support. www.museresearch.com

Spectrasonics V1.2 of Stylus RMX adds over a dozen new features including three new effect modules ("radio" delay, pro reverb, spring reverb), as well as enhanced compatibility with major host applications. Free to registered users from www.spectrasonics.com

Terratec Producer has introduced a Mac/Windows-compatible firmware upgrade for the PHASE 88 Rack FireWire and EWS MiC 2/MiC 8 FireWire Audio Systems to allow MIDI remote control over audio routing and levels. The ASIO implementation is also enhanced. www.terratec.com

Universal Audio. Their plug-ins now support TDM for Windows. www.uaudio.com

delivers the sound of an Audient large-frame console in a single rack space. It offers 16 paired input channels through DA88 (DTRS) standard D-Sub connectors. Mix inserts on balanced TRS jacks are available on each input for external processing units such as EQ or channel compressor/limiter. An optional AES/EBU output card can be externally clocked via a rear-panel BNC connection. www.axidistribution.com

Brainstorm Electronics. The **SR-8000** is multiple-machine remote control device. It provides track arming, transport control, 100 locator points, ADR beeps, pre-and after roll, automatic looping, and more for up to eight audio/video recorders or DAWs via serial Sony 9 pin or MIDI interface. www.plus24.net

CME. The self-powered **UF8** master keyboard offers 88 keys with weighted hammer action and aftertouch, a breath control interface, eight knobs, nine sliders, a USB interface for MIDI data transfer, pitch bend and mod wheels, and it features metal construction for durability. A FireWire expansion board (\$299) provides digital audio I/O capabilities (two 24/192 balanced ins and outs, mic in with preamp, MIDI interface, FireWire port, and headphone out). Other models (the **UF5/6/7**) are available with 49/61/76 keys respectively, and have a semi-weighted action keyboard with aftertouch. *Keyboard* dude Ken Hughes (no relation to Howard) applied the famous "Hughes Torture Twist Test" for master controllers, and walked away impressed. They're inexpensive and even look cool, too. www.kaysound.com

Focusrite. The **TrakMaster Pro** mic pre/compressor includes front panel DI, impedance switch, mid-scoop EQ with two different cut depths and an adjustable frequency control, optical Class A compression, and latency-free monitoring. TrakMaster Pro also accepts the Platinum Pro 24-bit, 96kHz stereo Analog to Digital converter, providing a direct digital route from the TrakMaster Pro to the DAW . . . **OctoPre LE** includes eight preamps, including two "super channels" with instrument input and switchable impedance. 8 channels of 24-bit A/D and D/A converters, with ADAT I/O, make for easy interface with ADAT-compatible devices. www.focusrite.com

OpenLabs. mFusion is a set of software technologies along with a control panel that allows users to navigate, access, and remap control surfaces with ease for all OpenLabs control panels, as well as 3rd-party MIDI control devices. Once the mapping process begins, a button can send a note-on, program change, or launch an application. This versatility extends to encoders, knobs, faders, drum pads, and other common control types, and can address and remap up to thousands of controllers simultaneously. . . . The **NoKo GS** keyboard workstation (\$4,995) integrates mFusion with a high-end Pentium 4-based system to control TASCAM's GigaStudio3, Pro Tools, E-Mu's Proteus X, and other digital music systems. www.openlabs.com

Roland's V-Synth Version 2 has a new set of patches, additional analog-modeled oscillators, and a Rhythm Set function, which deploys V-Synthesis power separately to each key for

Hot Damn! It's NAMM!!!

THE URGE TO MERGE



Cakewalk has acquired rgc:audio, makers of really cool soft synths. The first collaboration is a new instrument for Project5. Cakewalk is also partnering with ProMedia Training to create training courses for those who want to become Sonar *cognoscenti*. www.cakewalk.com

M-Audio seemed to be partnering with 1/3 of all companies on the show floor. They now distribute GLaresoft iDrum, an Audio Units drum machine that works standalone in OS X and Windows; GForce Minimonsta, another Minimoog tribute, but with a few innovations; and the most excellent iZotope line of plug-ins is, including the Ozone3 mastering suite, Trash multi-band distortion, and Spectron signal processor. www.m-audio.com



Roland and Universal Audio have agreed that UA will develop, market, and sell plug-in emulations of classic Roland processors for UA's UAD-1 DSP card. The first three releases are the Dimension D Chorus, CE-1 Chorus, and RE-201 Space Echo. www.uaudio.com



IK Multimedia has collaborated with Ampeg to create the Ampeg SVX plug-in, which emulates 20 Ampeg bass amps and also incorporates a configurable stompbox pedalboard. IK products are also being bundled with E-Mu's digital audio systems for PC desktops and laptops, as well as Mackie's Tracktion software. www.ikmultimedia.com



Roland V-Synth XT

complex drum kits. Furthermore, a new Sound Shaper function simplifies complex editing. V-Synths can be upgraded to V2 via free download. . . . But the big news is the **V-Synth XT** (\$2499), a portable, rack-mountable V-Synth that can be positioned flush or tilted and locked at an angle, or taken out of the rack and placed

on a flat surface. The XT comes pre-installed with Roland's VC-1 (D-50 emulator) and VC-2 (Vocal Designer), and has everything that made the original V-Synth rock.

www.rolandus.com

TASCAM's DM-3200 is a 48-channel, surround-compatible digital console. With the IF/FW-DM FireWire Interface card, the DM-3200 provides pro functions like eight aux buses, talkback and monitoring sections, automation, and 16 buses — along with 24-channel audio interfacing and surface control of DAW mixing features. Other features include 96kHz resolution, 4-band parametric EQ and dynamics on each of the 32 channels, 4 stereo effects or two surround effects (8-in/8-out), 17 touch sensitive 100mm motorized faders, driverless USB 1.1 connection to computer for data backup, and TASCAM Mixer Companion

TASCAM DM-3200

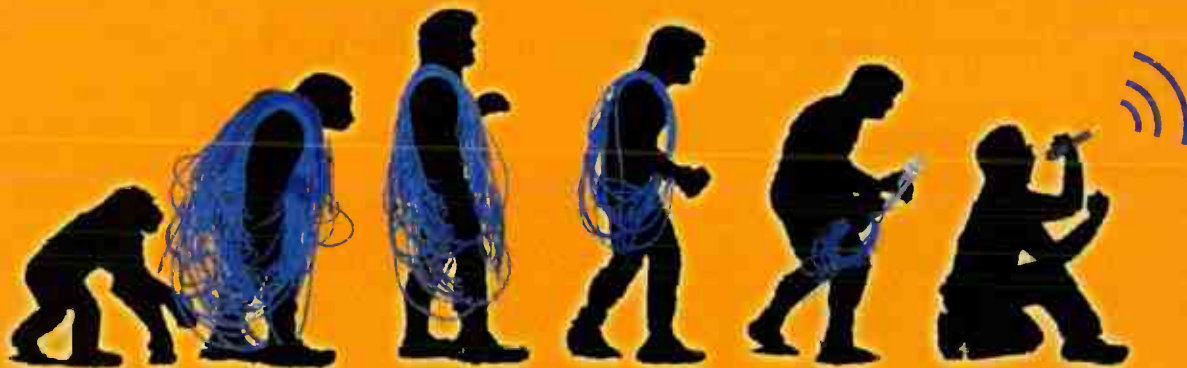

WIRELESS EVOLUTION

Go completely wireless from mixer to speaker, speaker to speaker, microphone to speaker.

Flexibility

Wireless transmission from speaker to speaker



Choose between laying speaker cable or go completely cable-free. Performer Active Speakers utilize 2.4 GHz wireless modules to communicate with other Performer speakers up to 100 ft away. Place speakers wherever you want and move them on a moments notice. And don't worry about sound quality. Wireless delivers the same crisp highs, punchy mids and tight steel-fisted bass that you get with cable.

Convenience

Wireless transmission from microphone to speaker



Performer Active Speakers work together with wireless mics up to 300 ft away. Install a Phonic UHF wireless microphone module in the compartment on top and you're ready to go. Installation is quick and easy and there are no cables or bulky receivers. Setting up a speaker and wireless microphone has never been this easy!

Simplicity

Wireless transmission from mixer to speaker



Lose the cables and transmit wirelessly from mixer to speaker. You select mono or stereo transmission and the Stand-Alone Wireless Transmission Module does the rest. Place your speakers anywhere up to 100 ft away from the mixer and get crystal clear sound - wirelessly. Why didn't someone think of this sooner?



WWW.PHONIC.COM 800.430.7222

PERFORMER



PHONIC

- Wireless modules eliminate need to lay speaker cable - making setup faster and easier
- Wide dispersion horns give wide audience coverage for highs and lows
- Speaker protection circuitry and transducer-matched HF and LF amps drive speakers at maximum levels without burning them out
- Works in all sound reinforcement applications and as a floor monitor
- Durable, lightweight, impact-resistant plastic enclosure
- Active speaker technology means higher sound quality with lower distortion

Hot Damn! It's NAMM!!!



TC-Helicon VoicePro

software for Windows /Mac OS X for project management along with time code and meter displays. It's pretty amazing. www.tascam.com

TC-Helicon. The **VoicePro** (\$3,495) does for voice processing what the System 6000 did for general signal processing. You'll find pitch shifting, voice modeling, harmony generation, transducer emulation, multieffects, EQ, dynamics, and more, all

wrapped in a dead-simple user interface that makes it easy to create presets, as well as access loads of factory presets. Good stuff if your budget can take the hit. www.tc-helicon.com

Yamaha. Despite being busy buying Steinberg, Yamaha found time to

introduce the Motif-Rack ES. Okay, it's not

as sexy as an \$8,000 workstation, but it's affordable, proven, and falls under the category of "why-mess-with-success." It was also demoed working with Studio Manager . . . impressive. www.yamaha.com

NEARFIELD MONITORS

The **Alesis M1 Active 520** is a two-way, 75W, magnetically shielded, active nearfield reference monitor with 5" woofer



Yamaha Motif-Rack ES

m902 | reference headphone amplifier

The **m902** is the proud successor to our venerable model 901 reference headphone amplifier, updated with many new and essential features designed to make it an even more powerful tool for all audio monitoring applications.

At the core is our meticulously designed amplifier circuitry, which effortlessly drives even the lowest impedance headphones, while delivering the same high-resolution audio performance for which all our products are famous. Familiar recorded material becomes at once **transparent and alive**, making critical details in editing and mastering obvious and easy to manipulate.

Professionals and audiophiles alike will simply be floored by the **m902's** latest generation high performance 24/192 DAC, which includes our remarkable 5-Lock™ dual stage PLL for extremely low intrinsic jitter and rock solid digital performance.

The **m902** also cleverly adds stereo analog line outputs for connection to studio monitors, allowing it to double as an elegantly simple monitor controller or purist audiophile preamplifier/DAC.

The **m902** reference headphone amplifier stakes its claim as the final word in reference headphone amplification and as the new **must have** tool for audio playback in any environment.



high fidelity by

GRACE

d e s i g n

for complete information, visit www.gracedesign.com or call 303.443.7454

Proteus X

Desktop Sound Module

E-MU Systems brings the power and sounds of the world's most popular sound module line to your desktop with Proteus X – a 24-bit/192 kHz desktop sound module that delivers all of the filters, effects and pristine sounds of E-MU's rackmount modules to your PC. Proteus X ships with over 2 GB of sounds, including every last sample from E-MU's Proteus 2000 sound module, and can be expanded with the original soundsets from E-MU's legendary modules like Mo'Phatt, Planet Earth and Virtuoso 2000. Want even more sounds? Proteus X lets you load your favorite sound libraries (Emulator X, EOS, GigaSampler, Akai, and many more) and play them back with Proteus X's powerful streaming engine. And, unlike other software instruments, Proteus X's audio/MIDI interface is optimized to deliver ultra-low latency performance with unmatched fidelity – Proteus X actually plays and sounds like a real hardware instrument.



Only E-MU could deliver a desktop sound module this good.

\$149.99*

- Powerful Synth Engine
- Streaming and RAM Playback
- Over 50 Z-Plane Filters
- Integrated Hardware and Software Effects
- Standalone and VSTi
- Over 2 GB of Sounds Included
- Expandable Sound Library

Mo'Phatt, Planet Earth and Virtuoso 2000 expansion soundsets available, plus many more

CREATIVE
PROFESSIONAL



POWER FX
Hardware Accelerated
VST Effects

*Estimated street price

©2004 E-MU is a registered trademark of E-MU Systems, Inc. in the US and other countries. All other brand names are the property of their respective owners.

E-MU

www.emu.com
877-742-6084

Hot Damn! It's NAMM!!!



Dynaudio Acoustics BM 5A

and 1" silk dome tweeter. The **M1 Active 620** is rated at 100W and has a 6.5" woofer. www.alesis.com



TASCAM VL-X5

Dynaudio Acoustics' BM 5A active nearfield monitor (\$1,250/pair) features a 6.9" woofer and a very compact size. The BM 9S (\$1,245) is an active subwoofer with a 10" woofer that complements the BM 5A, as well as other products in the BM series. www.dynaudioacoustics.com

TASCAM's VL-X5 home studio powered-monitor system features 5-1/4" woofers, silk-dome tweeters and a 60+30-watt bi-amplified active power amp. www.tascam.com

The **MA-15D** digital stereo monitors from **Edirol** are a 2-way bass reflex system. The monitors are shielded for placement near a computer and offer both 1/4" and RCA inputs with independent volume control. The MA-15Ds also host S/PDIF coax and optical inputs to play audio directly from digital sources up to 24-Bit/192 kHz. The MA-15D also comes with a built-in "bass enhancer" which uses psychoacoustic principles, causing the user to perceive accentuated low-end signals without over-driving the 100mm woofers. www.edirol.com 

wireless DAW control



TRANSPORT™
... it's a control thing

- ⌘ 2-way RF for wireless, through-the-wall communication with your DAW
 - ⌘ Presets for Pro Tools®, Digital Performer®, Sonar®, Cubase® and other DAW apps
 - ⌘ Easy setup, fast access to your most often-used functions
 - ⌘ Remote control of transport, mutes, solos, punches, markers, loops and more
 - ⌘ Onboard metering, time display, track info, footswitch jack
 - ⌘ Compatible with Mac® OS X and Windows® 2000/XP

FRONTIER
DESIGN
GROUP

www.frontierdesign.com



REASON

REASON

It has arrived.

Reason 3.0 is here. With one-step loading of complex, customizable instruments and effect setups, a new expanded soundbank, instant integration with hardware control surfaces, a new intuitive file browser and a set of class A mastering devices, this upgrade is extra loud, extra large and extra live-friendly.



More Reason 3.0 info
www.propellerheads.se

New in Reason 3.0:

The Combinator

The Combinator lets you create and save combinations of multiple Reason devices, allowing you to load up huge chains of instruments and effects in one single click.

Create instruments splits and layers. Build intricate instrument and effect combinations. Create complex routings with CV control over any parameter. Then save it all as an instantly loadable, playable Combinator patch. Only with the Combinator. Only in Reason 3.0.

MClass Mastering Suite

MClass – a suite of expensive sounding, professional mastering tools – adds punch, sheen, width and volume to your mixes. The MClass package includes:

- **MClass Equalizer** – a parametric mastering EQ for surgically precise frequency adjustments
- **MClass Stereo Imager** – for fully controlling the stereo width of your mix
- **MClass Compressor** – gives your tracks bite and definition
- **MClass Maximizer** – a high-quality loudness maximizer designed to make your Reason tracks sound as loud as you intended them to.

- **Remote** – Thanks to the Remote technology, Reason now integrates even more seamlessly with external MIDI controllers, with full support for motorized faders and control surface displays – right out of the box, no configuration needed
- **The Reason 3.0 Sound Bank** – the new sound bank adds a huge selection of multi-sampled instruments as well as fresh synth patches, loops, samples, and combinator patches to Reason's already massive library.
- **The Reason 3.0 Browser** – surf through Reason's massive soundbank in new intuitive ways, easily locate, audition and organize sounds and patches from all over the library.
- **Line Mixer 6:2** – 6-channel stereo line mixer for easy sub mixing. Use with the Combinator or insert anywhere in Reason.
- **Record automation on multiple tracks.**
- **Warp speed sample loading.**

Ready to upgrade?

If you already own a previous version of Reason, go to www.propellerheads.se/get3 for more info on how to get this massive upgrade at a ridiculously low price.

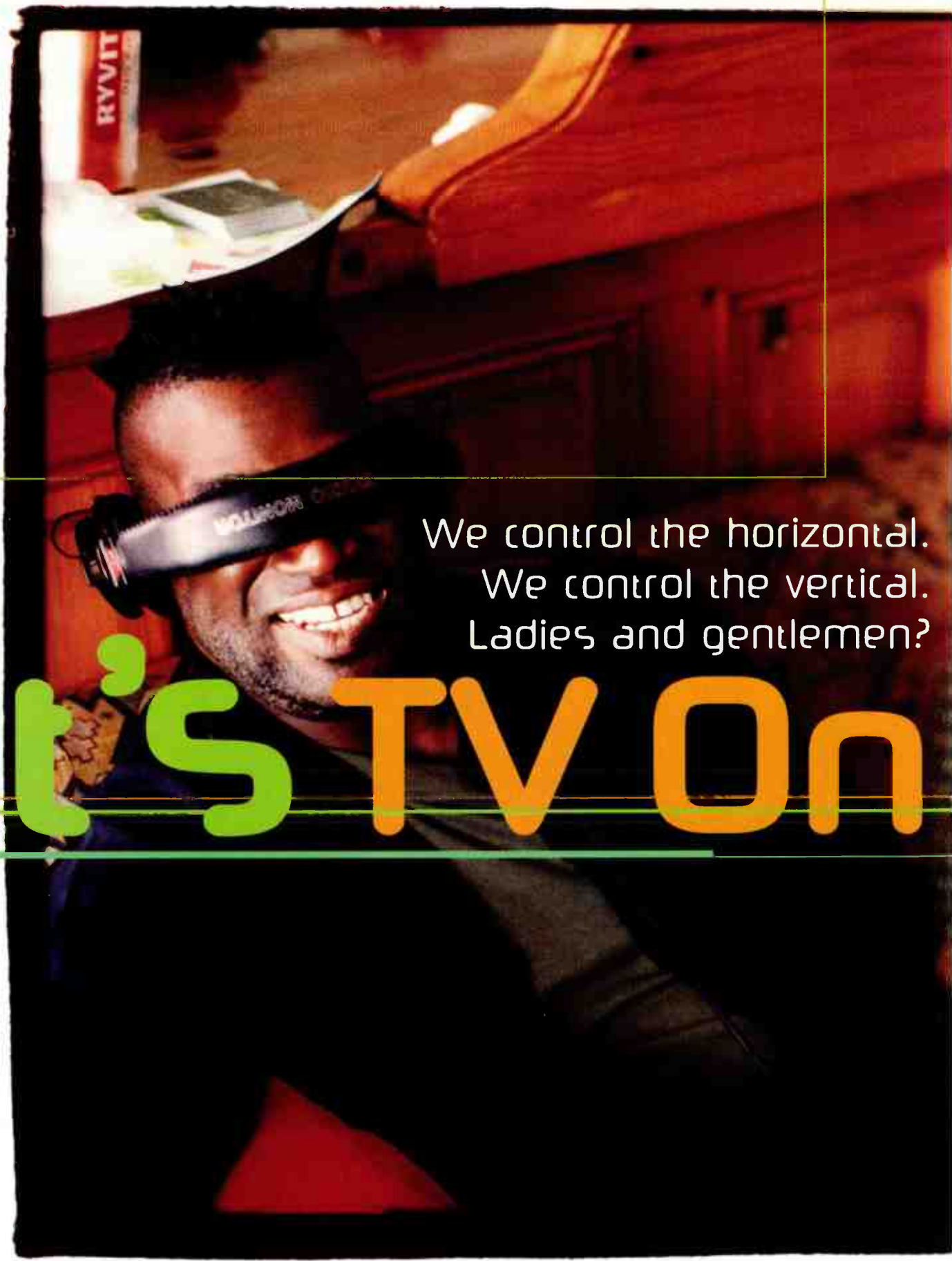

We control the horizontal.
We control the vertical.
Ladies and gentlemen?

It's TV On



The Radio

Brooklyn's finest manage
right time-right place production
to place themselves soundly in
the frothy mix of music, magic,
and maximal rock and roll.

Photography: Steve Gullick

by Stevie Chick

TV On The Radio

Circling a threadbare lampshade in an apartment in Wandsworth, five houseflies buzz lazily in random formations, cruising the dead heat of a late afternoon.

About the room are strewn clothes, magazines, and a Ziploc bag bustling with weed, discarded half-smoked roaches resting on every surface, evidence of scattered minds at work. Oh, and musical equipment. Lots and lots of it.

We're in the Beggars Banquet apartment, where the label's overseas artists crash when in London. It's a featureless, beaten room, like a chalet in a rundown holiday park. Mostly, its transient residents litter the rooms with porn and chocolate wrappers; not so with these current guests. Anyone wanting access to the kitchenette has to negotiate a mountain of gear, amplifiers and speakers and guitars and computers flickering with pulsing VU levels.

A shaven-headed, sideburnt Craig Wedren, formerly of Shudder To Think and passing momentarily through town, passes David Andrew Sitek a CD of his new band, Baby, by way of farewell. After he's left the apartment, Sitek walks over to the computer and plays a track, a technicolor splash of twisted pop, jagged soul, and fluid acid beats. His stare follows one of the flies, his face impassive. In one corner of the room, behind a prodigious beard and moustache topped off with a mighty topiary of a hairdo, Kyp Malone leans against a hulking amplifier, looking aghast. Peering out a window at the pale suburban gardens of their neighbors, Tunde Adebimpe rubs his jaw, an infectious grin erupting across, enveloping his face.

"It's good..." says Adebimpe, as the track ends.

"Shit..." murmurs Malone, absently. "I mean... Shit... It's *so* good."

Sitek sighs silently, then punches into a laptop, a Pro Tools file reflecting off the panes of his glasses. A low-frequency hum crackles from the sub-woofers, then a looped drone of guitar, then a muted drum machine pulse. A subterranean soul growl dissolves into view, accented by a feline high-register harmony, the two voices twisting within each other as the loops and drones shift and shimmer. Kyp leans across and punches a key on the computer, and a loop falls away. Tunde starts to hum another melody, entwining it with the voices drifting across the room. Dave tweaks several more switches, and the humming frequency contorts and contracts.

The dead heat remains. The flies buzz, aimless, regardless. But 3449 miles from Brooklyn, TV On The Radio are making their new music. Dark, unfamiliar sounds, potent with menace and mystery, but echoing with warmth and wisdom.

David Andrew Sitek, who sat across from us behind a wooden bench on a bar, is a jumble of restless, fitful energy, like he knows time spent talking is time *not* spent making music, but he has so much to say; like the ideas are percolating like lethally strong coffee in his head, and they're going to tumble out of him *somehow*. He has that hard-edged staccato bullet-train delivery down pat, the manic



Home Alone with Kyp Malone.

motorspiel of Denis Leary in stand-up, spitting words at an impassive rate, his brow focusing a stare so intense it could fuse bone tissue. His glasses are a pair of heavy, black Ray Charles frames, shades popped to accommodate lenses that shrink Sitek's face, so his eyes growl at you from a safe distance. His breath is pure coffee'n'cigarettes. His clothes, Fred Perry chic with a thrift store twist — a worn lime-green polo shirt, slacks, and lime green no-name skippies.

TV On The Radio are no single artist's vision, but Sitek's voice will dominate this feature. In some ways Sitek is the 'silent' voice in TV On The Radio, the only member who doesn't sing. And the singing is what strikes you first, upon entry to TV On The Radio's world, maybe because they feel like vibrant wells of human-ness laid on the band's mostly technoid barren landscapes, eerie and soulful expressions of pain and joy in isolation. It's these

voices that influence comparisons to Peter Dinklage, even if these comparisons themselves misunderstand that Tunde Adebimpe and Kyp Malone's strangled midnight tones bear more than the cosmetic trace of Dinklage's vocal.

There's an echo also in the sense of dis-context and collision, Dinklage (playing diverse roles with each song) most anticipating TV On The Radio when he occupies a voice he identifies with 'soulfulness', with an artistic 'blackness', fictionalized or real, positive or negative (and all the social misconceptions that suggests). The most electrifying moments in Dinklage's catalogue are where Dinklage's consciously soulful impulses jar hardest with the band's self-conscious, quasi-folk/classical complexity and willingness to perform songs about Giant Hogweeds while wearing theatrical fox-heads. And so it is with TV On The Radio, Kyp and Tunde's vocals jarringly adrift, soulful signifiers inhabiting an aggressively "cerebral" musical world (though in reality the soulful voices are every bit as cerebral as the textures behind them, and vice versa), reassuring or misplaced passages of 'familiar' pop in a most "unfamiliar" avant-garde context.

It's Dave Sitek who'll be doing most of the talking, mostly because he *did* most of the talking. But there is a sense of Sitek speaking safely for the band, in the sense of a shared creative outlook, a similar passion, for all that he states that a vast Venn diagram charting all their various influences would share a surprisingly paltry number of points. And the story begins with Sitek, so let us tell it.

Baltimore, several years ago. Following crazy events in his private life, Sitek moves in with his brother Jason, in a loft in Brooklyn. He had no money, he had no furniture, but he had his paintings, quasi-children's art, set in an adult context; one depicted a matador falling in love with a bull, which, he explains, "explores the weird relationship between masculine and feminine, nature taking over and putting humanity back in its place". He also had a ton of musical equipment, which robbed his bare room like sofas, chairs, or a bed might have.

His Spartan existence amused Dave's brother's other housemate, Tunde Adebimpe. He was also a painter, though he subsidized



PREMIUM ANALOG MIXING GOES DIGITAL

ONLY ONYX LETS YOU PLUG IN 16 MICS AND STREAM THEM DIRECTLY TO YOUR MAC OR PC.

Mackie's new Onyx series premium analog mixers don't just raise the bar—they completely change the game. That's because, once equipped with the optional FireWire card, Onyx mixers let you plug in up to 16 mics and record them as Individual 24-bit/96kHz tracks directly to your Mac or PC with a single FireWire cable... Not to mention being able to mix and EQ a live show in the process.

And what about sound quality? Glad you asked. Built upon our new flagship Onyx mic preamps, warm "British" style 3- and 4-band Perkins EQ, and premium analog circuitry, the Onyx series easily makes the best-sounding analog-to-digital interface at anywhere near its price.

To get you going, we also bundled a fully licensed copy of our acclaimed "no-fuss" Traktion music production software, so you can be up and running on your latest smash-hit in no time at all.

ONYX

Sure, you can opt to spend your cash on dedicated FireWire I/O boxes, outboard studio mic preamps, outboard British-style EQ processing, plus a mixer and recording software. Or you can just visit your local Mackie dealer and check out the much simpler Onyx solution.

Onyx—it's superior sound quality, single-cable FireWire connectivity and a powerful recording application, all packaged into a premium analog mixer.



info@mackie.com 425.487.4333 (Outside U.S.) 800.898.3211 (Toll free within U.S.)

MACKIE®

www.mackie.com

World Radio History

TV On The Radio

TV On The Radio? Really?

his art through freelance animation jobs. He stared through Dave's doorway the day he moved in, at the array of musical gear, and chuckled. "Oh, you're one of *those* people." The thing was, Tunde was one of *those* people as well; he'd bought a four-track some months before, and he used it like his ever-present sketchbook, as a place to explore ideas. "I'd be scribbling out drawings, and sometimes an idea would make a better song than a picture, you know? It was nice to find a comrade in Dave."

Sitek describes the duo as "Functionally unemployable. So we'd set up and sell our paintings in the street. We'd sit out there all day and beatbox, and improvise what would become our songs. We wound up going to a karaoke night at the Stinger Bar, which our friends owned, doing our beatbox stuff. Then we'd go home and play each other tapes. We started writing down the stuff we were joking around with, and a couple came out way better than we imagined they would. It didn't seem like such a big joke anymore. So we went back to the Stinger bar and put on a regular night."

Drunk and high, they made stuff up as they went along, performed bizarre covers, and reproduced their now-infamous Karaoke performances. As weeks passed, to their amazement, they began to draw a loyal following.

"Finally, we decided, 'okay, we're a band,'" remembers Sitek. "We compiled all the stuff we'd recorded and put 'em on a disk we passed out at shows."

That CD, *OK Calculator*, is an intriguing snapshot of a nascent TV On The Radio, the kind of four-track slacker experimentalism that exploded in the aftermath of Pavement, Sebadoh, and Guided By Voices, crossed with cLOUDDEAD's fluid-rubber delivery and sense of dank surrealism. Some, like the bawdy rap "Buffalo Girls" and the poppy "Me - I", beam and bustle like early Beck or De La Soul: lackadaisical, loose and literate. Others, like the brooding "Hurt You" or the haunting "Say You Do," come from a darker place. Others still, like "On A Train" (revived as B-Side to their new single, "Staring At The Sun"), reveal the nascent TV On The Radio creative ethic in full bloom.

"Dave had been tapping a water glass, recorded it and then started chopping it up as a rhythm track, and played it to me," recalls Tunde. "I went for a walk, came back, and he was still tinkering with it. I said, 'Slow it down.' So he did, and it worked. It was totally haphazard, we didn't go in with any ideas written down, but... It worked. If the experience of TV On The Radio has taught me anything, it's that chance is an important force."

And chance was just about to deal TV On The Radio a rather impressive hand: a flush of friends and contacts who would ultimately deliver the band from obscurity.

Dave Sitek met Corey Rusk, honcho of legendary indie/hardcore label Touch & Go, through the Yeah Yeah Yeahs. Sitek met the Yeah Yeah Yeahs, whose debut singles he had produced, through his work

Matching TVOTR's easy-does-it deal, Dave Sitek uses a Pro-Tools TDM system, sucking sound in through an AKG C12 mic and a Tubetech multiband compressor. A Roland SP808 snuggles up to an MPC 2000XL sequencer and percussion sampler, and Dave wields a Focusrite Channelstrip producer pack and a Memorymoog.

And central to their sound are a pile of drum machines, which Dave specifies as "crappy", a Death By Audio overdrive pedal and a DL4 pedal. Stringed instruments number a Fender Teleplus, sporting a number of home-made mods, and 1973 Fender P-Bass. They also use a broken piano for a little analog ambience. This whole noise churned through a set of Genelec 1093 monitors. From this set-up, they recorded the new song *Province*, which is slated for their second album, due later this year.

with Lovelife. A harrowing post-punk quartet, Sitek loved Lovelife's squall so much that he bought a proper 16-track deck, to record their debut LP, *The Rose He Lied By*, in an abandoned carpet warehouse. The Yeah Yeah Yeahs adored the album, and Sitek soon joined the band for their first tour across America, handing Rusk a copy of *OK Calculator* along the way. "I thought, I'm nuts, you're nuts, here's some

lunatic music you might appreciate. I didn't think anything else of it."

Next, he went into the studio to record *Fever To Tell*, YYYs' debut. While there, Karen O's paramour Angus Andrew approached Sitek to produce their forthcoming album, the spooked avant-funk meisterwerk *They Were Wrong, So We Drowned*. Purchasing a Pro Tools rig, he decided to get the feel for the machine beforehand by recording some of TV On The Radio's material, an experiment to see how far they could push it. Halfway through finishing "Staring At The Sun," Tunde's soulhowls prowling a most soothing My Bloody Valentine throb, they realized their joke-y intentions to make a "big, slick record" for peanuts was somehow coming together.

It's easy to see why *Young Liars*, TV On The Radio's first EP, sparked such fevered early interest; from the squalling glam-pop of "Satellite," through the eerie, somnambulist soul of "Staring At The Sun," the crawling paranoia of "Blind" and the icy grandeur of the title track, to the hidden *a cappella* take of Pixies' "Mr Grieves," the record oozed confidence and audacity, and a sheen that belied its ludicrously modest budget. "They can do *anything* they want," enthused their 4AD A&R to me, recently, and *Young Liars* confirms this, teeming with the bandmates' near-viral creativity and Sitek's considerable technical skills.

His production career is a crucial symbiote to TV On The Radio's music, sharing ethos and approach, and a sense of hungry liberation. "I always thought you had to have strippers and money and cocaine to make records," he laughs, "until I heard Minor Threat and Bad Brains and thought, 'wait a minute, I can make records?' And then I got a four-track and could play a drum part and then a guitar part over the top of it. I'm fascinated by having the ability to make a record without resources. The people who have all the resources generally don't make the music that I like. The most important piece of equipment for me is courage - all this equipment will only make a great record if the mindset is right."

"If Jimi Hendrix had Pro Tools... That's where music *should* be going," he chuckles. "I was listening to The Beatles' *Revolver* yesterday, thinking, 'Jesus Christ, they did this on a 4-track?!?' And now there are 16-year-old kids taking ecstasy with 36-track Pro Tools rigs at their fingertips. Since the advent of the home studio, there's a tremendous amount of freedom. And the price of that freedom is you don't get to live in some coked-out, stripper-laden Dave Lee Roth fantasy, but since when has that been the goal of genuinely creative people,

WHEN STUDIOS MAKE THE MOVE TO **DIGIDESIGN** **ICON** THEY COUNT ON **SWEETWATER**

ICON
INTEGRATED CONSOLE

We've helped university recording programs, post-production houses and commercial recording studios revolutionize the way they work with Pro Tools.

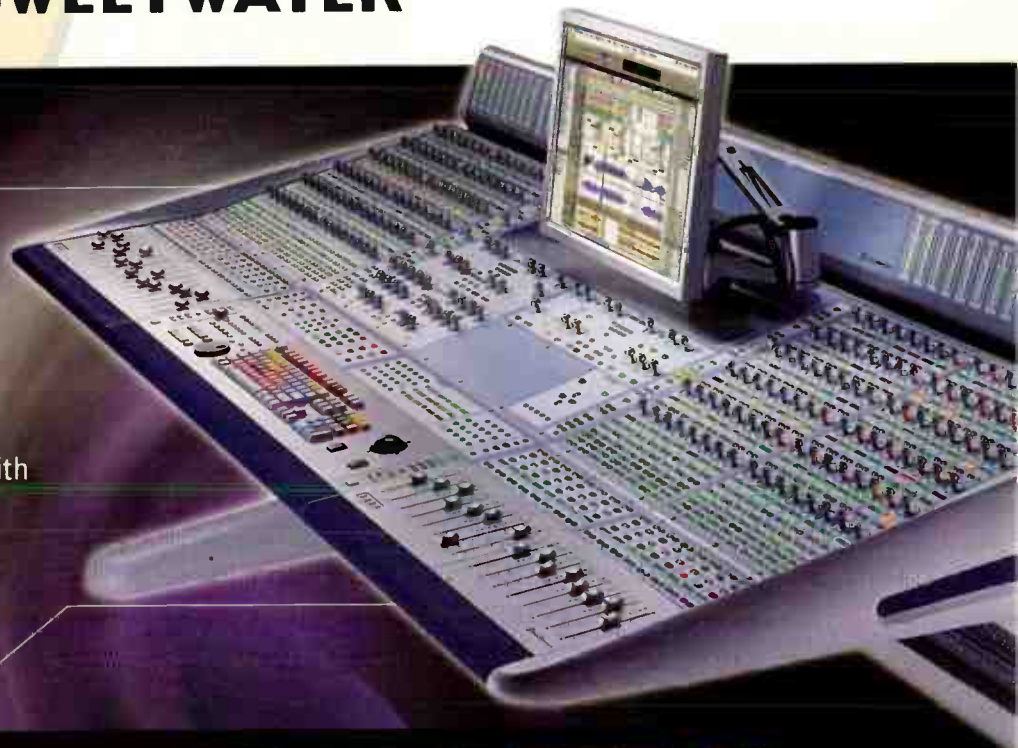

BALL STATE UNIVERSITY
MUNCIE, INDIANA



AUDIO RECORDING UNLIMITED
CHICAGO, ILLINOIS



CUTTERS CHICAGO
CHICAGO, ILLINOIS



SWEETWATER PRODUCTIONS
FORT WAYNE, INDIANA

ICON has changed the way digital music production is handled in studios across the country, and Sweetwater has helped facilities of all kinds put this powerful system to work. Digidesign's integrated Pro Tools console is built around the revolutionary D-Control work surface and is one of the most significant improvements in digital recording. Post-production facilities like Cutters Chicago and Audio Recording Unlimited, state-of-the-art Music Technology Departments at universities like Ball State, and commercial recording studios including our own Sweetwater Productions have relied on us to configure and install an **ICON** system custom-fit to their particular needs.

Why? Because Sweetwater has configured more Pro Tools setups than anyone in the business. Our Sales Engineers are Digidesign-certified Pro Tools users themselves and have extensive experience with large-format consoles. We can put our firsthand knowledge to work for your studio.



Sweetwater understands the complexities of integrating Pro Tools systems into existing recording, mixing and editing environments.

We're uniquely qualified to

design, configure, install and test a Digidesign system that is tailored to your situation. If you'd like to find out more about how Sweetwater can help you take advantage of **ICON** — including some attractive leasing options — call us today. Moving up to **ICON** is easier than you might think.

Sweetwater[®]
music technology direct™

(800) 222-4700
www.sweetwater.com

Territorial restrictions apply. Please call for information.

World Radio History

TV On The Radio

"Young Liars sounds like it was recorded in a hovercraft on the top of some Scottish mountainside, so far out of the realm of possibility," laughs Sitek, "intentionally overproduced. Then we moved to a proper studio, and I wanted to make it sound like a bedroom."

anyway? I don't think even Dave Lee Roth had that dream, I think he just found himself jumping up and down, high on cocaine, thinking, 'this is entirely crazy'. I don't think he sat down and said, 'I want to be high on cocaine and jumping around in a pair of tight pants. . . . Maybe he did, I dunno. The whole point should be to make great, great stuff. How many people made great works of art through history and never got any credit for it? For you to have access to 32 tracks means you're light years ahead of where Van Gogh was in his painting, in terms of accessibility."

Sitek met Rusk once again, on the *YYYs* duty, and handed him a copy of *Young Liars*. Instantly, he asked to release it on Touch & Go, to Sitek's amusement.

"When *Young Liars* came out, we couldn't imagine anyone would hear it. I still can't believe we're signed to Touch & Go. People liked *Young Liars* so much, so many people. Like, over 20 people."

Sitek is being overly modest here. At the peak of Brooklyn district Williamsburg's notoriety as International Hipster Hideout, *Young Liars*' sprawling inventiveness went some way to artistically redeeming the district after the fallow stream of identikit post-punk chancers hitching up to its fleetingly lucrative, fashionable bandwagon. Sitek wasn't around to bathe in local adoration, having just been evicted from the loft for noise violations. Karen O had the answer for Sitek's housing woes: moving to the rickety house in the haunted wilds of New Jersey she'd just snatched for herself and Angus, and recording *They Were Wrong, So We Drowned* in their basement.

The moment recording with *Liars* ceased, work on TV On The Radio's keenly anticipated debut LP began. Tunde moved into the house, along with a new member, Kyp Malone, an old friend added to the line-up because, explains Sitek of their Oblique Strategies, "We didn't know how it would work out. We don't do deliberate things, and

If you're serious about a career in audio recording, you need to attend a school that is as committed to your success as you are:

The Conservatory of Recording Arts & Sciences

Conservatory students work with cutting-edge equipment in world-class studios. They study under seasoned instructors with industry experience who know what it takes to succeed.

An internship is mandatory for graduation, and our students choose where they go to do it.

Conservatory graduates have earned hundreds of Gold and Platinum records and even Grammy awards. They record music with the world's top recording artists. If you're willing to put in the work, and if you meet our requirements, we can help you make your mark in the business too.

To find out more, call the Conservatory at 800-562-6383 today.

Learn Audio
Serious school. Serious students.
Serious success.

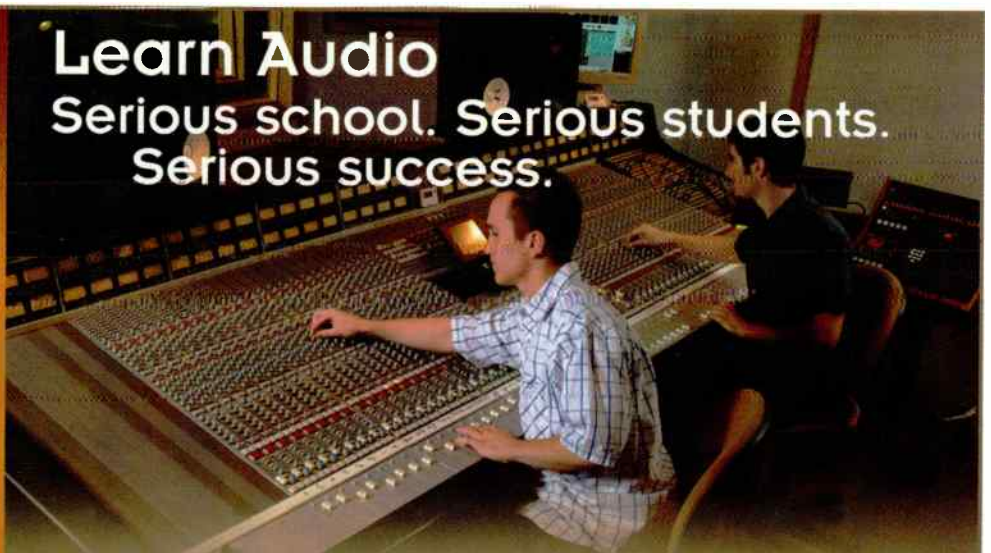

Conservatory of Recording Arts & Sciences

2300 E. Broadway Rd. | Tempe, AZ 85282
1205 N. Fiesta Blvd. | Gilbert, AZ 85233

800-562-6383

www.audiorecordingschool.com/eq.html

Nationally Accredited by ACCSCT
Financial Aid available to those who qualify





Legendary Reverb now for your DAW



System 6000 Reverb powered by PowerCore

VSS3, the legendary reverb from System 6000 is now available for PowerCore, TC's hardware powered plug-in platform. Arguably the first truly high-end VST/AU reverb available for DAWs, the Virtual Space Simulation (VSS) process uses chaotic response algorithms and sophisticated modulation patterns to create the most realistic reverbs. We've even ported over the industry-standard preset package, so you'll be up and running in an instant.

Reverbs from System 6000 can be heard on thousands of albums and films. Now with PowerCore, they can be heard on yours.



The Innovation Continues...

t.c. electronic

TC ELECTRONIC A/S DENMARK • ☎ + 45 8742 7000
TC ELECTRONIC INC USA • ☎ (818) 665 4900 • [MAIL] INFO@TCELECTRONIC.COM

WWW.TCELECTRONIC.COM

World Radio History

TV On The Radio

if we ever get comfortable, we change things. We play 'inconsistency'. That's what keeps things interesting for us.

"Tunde, Kyp, and I would walk half an hour in the middle of the night to the grocery store," he continues, of the sessions that would deliver *Desperate Youth, Bloodthirsty Babes*. "We'd smoke a ton of pot and be beatboxing, just making stuff up. A lot of times we'd be working on something, and then we'd go out and sing an *a cappella* version of it. If it still held water, we know the song's okay. We sat with our microphones and our loop pedals and put the songs together that way."

The results echoed *Another Green World*-era Eno, *Riot*-period Sly Stone and MBV's walls of texture; intimate, almost womblike bedroom music, mysterious and potent. A departure from *Young Liars* in many ways, it purposefully eschewed the colorful breadth of that EP in favor of exploring what might arguably be described as Songs In The Key Of 'Staring At The Sun', so influential seems that track's elemental voodoo over the album.

"*Young Liars* sounds like it was recorded in a hovercraft on the top of some Scottish mountainside, so far out of the realm of possibility," laughs Sitek, "intentionally overproduced. Then we moved to a proper studio, and I wanted to make it sound like a bedroom. I wanted to reveal the *process* behind it all. Like if you listen to "Poppy," when it goes into the vocal breakdown you hear the finger-snaps, a cue for when the music was going to change. We left the cue in there, because it sounded cool. To give a dog like me a bone. I want

people to hear that you *can* just drop random vocal breakdowns into a piece of music. Anyone can do whatever they want."

This seems to be the essence of TV On The Radio, if you can express it in words at all: freedom and creativity, and both in boundless quantities. Sitek talks breathlessly, impatiently, of the music he's heard and not heard, of the "exponential" villainy of the Bush regime in relation to the Reagan era and how punk should've served us "*Extreme Dead Kennedys*" by now.

"I'm pro-evolution," he buzzes. "I'm sick of the whole creation process — or the way the creative process is constantly overshadowed by the exploitation that follows it. I'm obsessed only with that first part. I could sit here and make all my plans for the future, and be only two Pepsis and a cigarette from being creamed by a bus. I want to be spending my time in the process of *developing myself*. I don't see any interest in leaving any footprints or building any monuments, let me just make things, and if this is supposed to happen it'll happen. I have this universal faith in the whole order of things, I'm supposed to make things, I'm not supposed to relax. I'm not a very relaxed person, y'know?! Not in a bad way, but my enthusiasms are always for something new..."

"Did I answer your question?" **ED**

Stevie Chick is a freelance writer and a real mensch and his work in everything from CARELESS TALK COSTS LIVES to LOOSE LIPS SINK SHIPS and a host of other great Euro-music mags makes him . . . you got it . . . just about the menschiest mensch ever.

www.mindprint.com

Plug In—Sound Pro

All Essential Studio Recording Features In One Box:

- Class A MIC Pre
- Analog Compressor
- Analog Vocal EQ
- Hughes & Kettner® Instrument Input
- Compact Mixer
- Dual Headphone Amp
- Mixer Master Section
- 24/96 Digital Interface

T.R.I.O.
TOTAL RECORDING SOLUTION



Hughes & Kettner Inc., Mt. Prospect/USA
Phone: (847) 439-6771, www.guitaramps.com

mm music marketing, Toronto/CA
Phone: (416) 646-0900, www.musicmarketing.ca
World Radio History

 **MindPrint**
ADVANCED RECORDING DEVICES

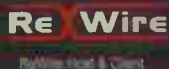

The most popular software studio ... one step further

Step Sequencer
The FL Studio Step Sequencer is without competition the fastest way to quickly compose a tune, drumtrack or bassline.

64 channel mixer
Mix your tracks using the 64 channel mixer using over 25 built-in high quality effects and countless VST and DX effects.



Pianoroll
Our pianoroll is widely acclaimed as being the most flexible and featured way to refine your melodies.

Record & edit
Record, edit & process any ASIO input and arrange the result using our new audio and automation clips.

New In FL Studio 5

Time stretching



High quality time-stretching and pitch-shifting (Elastic). Just 'drag' your clips to the desired length.

Automation clips



Automate any parameter using our multi-point automation (envelope & LFO) clips.

VIDEO PLAYER

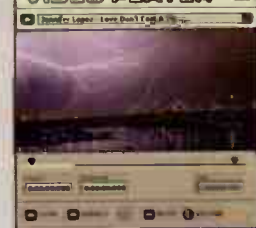

Our **Video Player** (included in FL XXL) plays any video or **Flash** file in sync with your song for perfect scoring.



Hook up any midi controller or use the pianoroll to play our multi-velocity drummachine.

FL STUDIO 5

compose record edit mix



Mike Oldfield
(Composer)

"I am using FL Studio as more than a scratchpad for the new album. The quick recording abilities mean that it can completely replace the studio next door."

FL Studio **Fruityloops** Edition : \$139
FL Studio **Producer** Edition : \$209
FL Studio **XXL** Edition : \$399
SRP of the boxed versions

Available in all major music outlets
(check at www.flstudio.com/shops)



TEMPUS? FUGIT!

The dread evil of latency lurks and skulks through our vale, dragging time to a standstill and marking a greater darkness.

DEFEAT IT?

WE SHALL TRY. WE SHALL TRY.

by Mitch Gallagher

"It don't mean a thing, if it ain't got that swing. . . ."

So sang one of the great masters. And this maxim is never truer than when you're recording music. And it ain't going to swing — or even be in rhythm — if what the performers are hearing as they record doesn't relate in time to what's actually being stored on the hard disk platters.

We're talking about one of the great Tolkien-grade evils of the digital recording age: *latency*. Unfortunately, we don't have noble Hobbits to undertake a quest to

defeat this evil. But on the plus side, it won't require a great wizard to vanquish this foe in your studio, either.

Here's the deal: When you're recording to most computer-based DAWs, the sources that you are recording are sent through an audio interface, into the computer, recorded to hard disk, sent back through the audio interface, and routed out to headphones or speakers for monitoring.

Easy enough.

The problem is that, as fast as today's CPUs are, routing through the

interface/computer/interface chain takes *time*. A small amount of time in real world terms, but time nonetheless. In many cases, enough time that there will be an audible rhythmic offset in the signal compared to previously recorded sounds that are playing from the DAW. Swing as hard as you want; if your overdubbed tracks are always playing several milliseconds late, the final result is going to sound like orc crap.

AVOIDANCE

Perhaps the easiest way to deal with audio interface latency is to avoid the problem entirely. A variety of audio interfaces now include the ability to mix live incoming signals with audio coming from the computer, then send that mixed signal back out for the performers to monitor without passing the live signal through the computer; the incoming signals are simultaneously routed through the interface to the computer to be recorded to your DAW software. Many of MOTU's interfaces, two examples being the 896HD and the Traveler, feature "CueMix DSP" which essentially puts an 8-bus mixer into the interface, allowing you to monitor "live" inputs with no latency. MOTU isn't alone in providing interfaces with zero-latency hardware monitoring features: PreSonus, M-Audio, TASCAM, Aardvark, E-mu, Digidesign, Edirol, Lexicon, and other manufacturers offer such capabilities on their boxes, too.

MIX IT UP

If your audio interface doesn't offer latency-free monitoring, and purchasing a

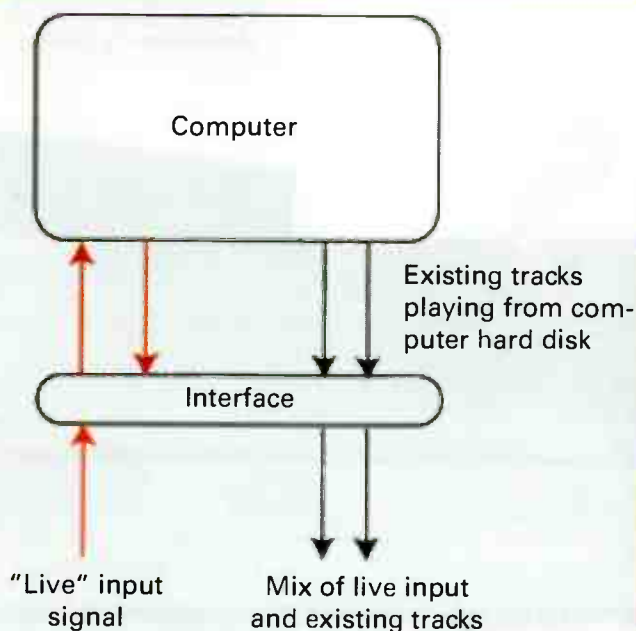

Fig. 1. "Live" input signals (red) feed through an interface, into the computer, and back out through the interface. Existing tracks (black) play from the computer hard disk through the interface. When the mix of live input and existing tracks is output from the interface, the live tracks sound out of time (late) compared to the existing tracks.

Hearing is believing, so listen to this:

GC PRO ACCOUNT MANAGERS

New England:
PK Pandey
508.341.3499
pk@gcpro.com

New York:
Blue Wilding
917.297.7675
blue@gcpro.com

New Jersey (North):
Steve Jacobson
201.294.5366
steve@gcpro.com

New Jersey (South):
Rick Rivera
732.829.6389
rick@gcpro.com

Maryland & D.C.:
Mitch Shiavitz
410.935.3428
mitch@gcpro.com

Georgia:
Jason Block
678.641.0244
jason@gcpro.com

Florida:
John Sawyer
954.629.6346
john@gcpro.com

Texas (Houston):
Ron Shelton
713.992.4332
ron@gcpro.com

Texas (Austin):
Adrian Peritore
512.632.0581
adrian@gcpro.com

Minnesota:
Paul Henry
952.297.5984
paul@gcpro.com

Illinois:
Dan Scalpone
773.600.1216
dan@gcpro.com

Pacific Northwest:
Steve Palermo
206.953.8885
steve@gcpro.com

Northern California:
Shaun Robinson
415.999.0045
shaun@gcpro.com

Southern California:
Donovan Stark
951.318.0285
donovan@gcpro.com



"It's nice to finally have a console that seamlessly blends the analog and digital studio worlds. The AWS 900 sounds wide, open, and punchy like an SSL should. We are loving it!"

- Jimmy Jam & Terry Lewis

Legendary production team — Janet Jackson, Gwen Stefani, Mary J. Blige, Usher, many more. Owners of five AWS 900's.



"With the AWS 900, we get the features and sonic quality found on large format SSL consoles, as well as complete integration with Pro Tools®. This is the perfect console for today's recording studio."

- Ann Mincieli

Grammy® nominated engineer for "The Diary of Alicia Keys". Other credits include Mariah Carey, Dru Hill, and Yoko Ono.



"I think this board is going to revolutionize the entire recording process. The AWS 900 will enable facilities like ours to produce materials on par with the million dollar studios at a fraction of the cost — and that's good for everyone."

- Alonzo "Zo" Lee Jr. & Shamar "Sham" Daugherty

The "Trak Starz" — credits include Chingy's multiplatinum debut, Ludacris, Britney Spears/Madonna. AWS 900 owners.

Ready to make a serious upgrade to your studio? GC Pro has the winning combination of expertise, excellent pricing and extraordinary service you need. From SSL's revolutionary AWS 900 Analogue Workstation System to the world's finest outboard gear, high-end mics, and sophisticated DAWs, GC Pro is your one-stop solution.



Music • Post • Live Sound • Lighting



GC PRO

www.gcpro.com

© 2005 Guitar Center, Inc. All rights reserved.
All images and trademarks are property of their respective holders.

TEMPUS? FUGIT!

That's Not All Folks

Paint, gloves, condoms, these are all examples of . . . wait, those are *latex*, not *latency*. Sorry 'bout that. But there are other sources of latency that we face in the studio. For example, virtually any device that converts analog into digital will have at least a small delay — fortunately, not really a big enough discrepancy for us to worry much about.

However, one area you do want to be wary of is the mixer inside your DAW software. Many programs now feature built-in automatic delay compensation for many or all aspects of the mixer and processing — if your DAW does this, congratulations; advance to Go and collect \$200. (Check your manual or ask the software manufacturer to verify.)

Until all DAW software mixers compensate for all sources of delay, the rest of us need to remain vigilant. A common problem is delay from plug-ins. Even if uncompensated, most plug-in delays are small enough to go unnoticed, except in a few instances. One is when you're processing one channel (or more) of a multichannel signal but not all of them. A second example would be when you're adding parallel processing to a signal by multing channels together.

There are several examples of the first case: A common scenario is adding plug-in processing to some drum tracks on a multi-miked drumkit and not to others. Another is when you use two mics on a guitar amp, or take both a direct feed and a microphone feed from an electric bass, and only process one signal.

In the second case, you might have, say a dry snare track, then Y or copy that track to a second track that has a compressor plug-in applied.

In both cases, the addition of a plug-in (or multiple plug-ins) to one signal path and not to the other(s) will result in phase issues; the track with the added processing will be delayed compared to the unprocessed tracks.

One cure is to slip the *unprocessed* tracks back (later) in time until the signals line up — conversely, you could slip the *processed* tracks forward (earlier) in time to make up for the delay.

or three channels. Any mixer that's set up to handle multitrack recording will work for this application. But manufacturers have stepped up, and you can get by without a multi-bus mixer. Small-format mixers, such as the Soundcraft Compact 4 we reviewed back in the January '05 issue, are designed specifically to defeat interface latency right out of the box. The Compact 4 mixer has dedicated recording outs for feeding live inputs to your soundcard or DAW, and dedicated "playback" inputs, which would be fed from your soundcard or DAW outputs. The signal from your DAW is blended with the live inputs for monitoring using a cleverly labeled "Mix" control.

But even if your mixer doesn't come from the factory with connections labeled for connection to your computer, you can still probably figure out a way to make it work. The key is finding a separate output from the main outs for your live input signal to use to feed your DAW; some mixers have direct outs on each channel, others have insert jacks that can be pressed into service, and as a last resort, you could use an aux or effects send. Here's how it works:

1. Route the signal you want to record into a channel or channels of the mixer.

2. Now we want to find an output to carry that signal to your DAW. You don't want to use the mixer's main outputs, since we'll be using those to carry the blended mix of our live input and the DAW's output. Check the jackfield of your mixer, looking for a direct output that corresponds to the input you're using. If you spot one, you're golden; simply connect it to your DAW input.

If there's no direct out for the channel, look for an insert jack. An insert jack provides a send (output) and return (input) for the channel where a processor, such as a compressor, can be connected. We'll use the "send" portion of the insert to serve as a direct out for our channel.

But wait: Most inserts have both send and return connections carried on a single TRS jack. How do we get a separate send connection? There's a tricky solution: on many mixers (Mackies being a prime example), there are two "clicks" as you push a 1/4" connector into the insert jack. If you push a cable in so it "clicks" just once, you can use the jack as a send (direct out), allowing you to feed a DAW input from the channel. Check your mixer's owner's manual or check with the manufacturer to determine if this will work for your particular board. ▶

new one isn't in the budget, there's still a solution for avoiding the latency issue: use an external hardware mixer. You don't have to have a massive room-filling Neve

console to turn this trick; depending on how many sources you need to record simultaneously and monitor from your DAW, you could get by with as few as two

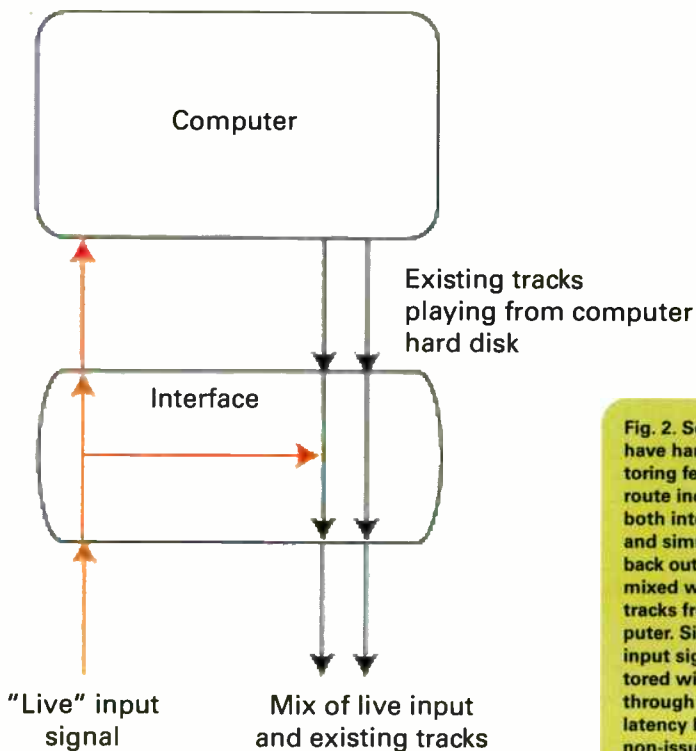

Fig. 2. Some interfaces have hardware monitoring features that route incoming signals both into the computer and simultaneously back out of the interface mixed with existing tracks from the computer. Since the live input signal is monitored without passing through the computer, latency becomes a non-issue.

FOR OVER 30 YEARS LEXICON HAS BEEN IN WORLD-CLASS RECORDING STUDIOS...



ΩMEGA™ DESKTOP RECORDING STUDIO

...NOW YOUR HOME CAN BE ONE OF THEM.



OMEGA DESKTOP RECORDING STUDIO™ INCLUDES:

- Steinberg® Cubase LE® – Multi-Track Recording Software
- Lexicon® Omega – 8 Input x 4 Bus x 2 Output USB I/O Mixer
- Lexicon® Pantheon™ – World Class VST Reverb Plug-In

More than 30 years ago, when Lexicon invented digital reverb, most recording studios were multi-million dollar rooms occupied only by famous rock stars and big record labels. And while Lexicon still lives in that rarified air of stardom with the world's most sought-after reverbs, now you can find us a lot closer to home.

Now Lexicon brings you the Omega Desktop Recording Studio, a completely integrated recording system with everything you need to transform your computer into a full-on professional 24-bit digital studio, all in one box. In addition to Steinberg Cubase LE® recording and production software, you'll get an 8-input, 4-Bus, 2-output USB I/O mixer with inserts, instrument input, MIDI I/O and complete metering and monitoring functions. Record up to 4 tracks at once from 8 audio sources, and mix up to 48 audio and 64 MIDI tracks almost anywhere...with the lush, exquisitely rich reverbs that made Lexicon famous in a VST version of Lexicon's Pantheon® reverb plug-in.

Pick up an Omega Studio at your Lexicon Pro dealer today, and discover for yourself why that famed "Lexicon Sound" has been on the majority of hit recordings since 1971. Who knows? Maybe the next one will be yours.

lexicon PRO

COMPLETE RECORDING SOLUTION

CONTAINS ALL THE COMPONENTS NECESSARY TO TRANSFORM YOUR COMPUTER INTO A PROFESSIONAL 24-BIT RECORDING STUDIO.



www.mogamicable.com

In the Professional world there can be no compromise. That's why the cable of choice is Mogami. We don't use a bunch of Consumer Marketing hype to try and justify why our cable is better. Just ask any recording engineer or studio owner and you'll find out why. It is simply the finest, most neutral sounding cable available, at any price. At one time if you wanted a Mogami Cable it was only available in bulk through Professional Channels. Finally, "The Gold Series" by Mogami, packaged and configured for Live Performance or Project Recording. No magic, no hype, just the best at a price you can afford. Visit your local music retailer and experience Mogami, "The cable of the Pros"

NOW Available at a Guitar Center near you!

MOGAMI

The Cable of the Pros

Toll Free: 800-800-6608

TEMPUS? FUGIT!

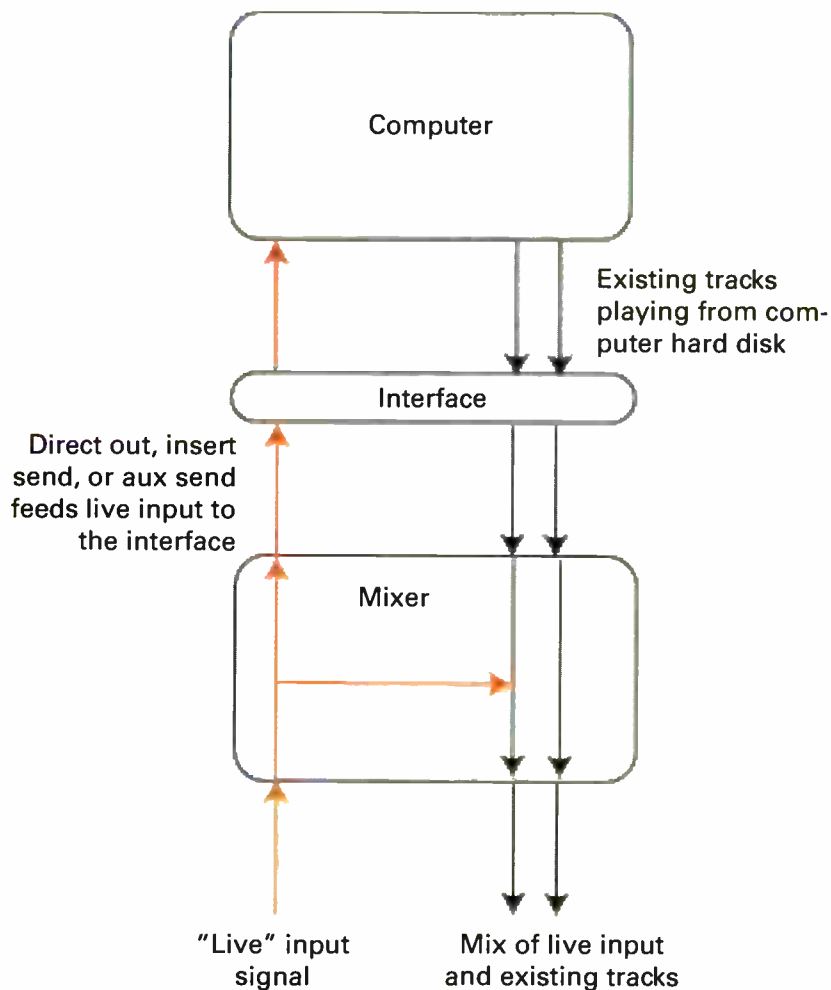

Fig. 3. Just about any mixer can be used to route signals to defeat latency. The live input channel is routed to the DAW interface using a direct out, insert send, or aux send. The live input signal is also blended in the mixer with the existing tracks from the DAW for monitoring.

Can't find a direct out or an insert on your mixer channel? All is not yet lost! If your mixer has an aux send that can feed external devices, you can still get by. Connect the aux send output to your DAW input. Turn up the aux send on the channel you're recording, and turn up the master aux send level as well.

3. Connect the outputs of your DAW to input channels on the mixer.

Now, when you record, the live signal feeding into the mixer will be routed out to your soundcard or DAW through the direct out/insert send/aux send we set up in step 2. That channel's output will

also feed the mixer's main outs, where it can be monitored. The outputs from your DAW will also feed through to the mixer's main outs, and can be blended with the live input so you can monitor the whole works.

One caveat: Depending on whether you are using a direct out, insert send, or aux send, moving the fader on your live input channel(s) may also change the level being recorded to your DAW. Set the gain staging on this channel for the best recording level, then use the faders on the channels being fed from your DAW to adjust the blend in the monitors to taste.

BUFFER THE LATENCY SLAYER

There are other tools you can use to combat input/output latency. Among the most

What the critics say:

"Sonically the M930 delivers. The mics are small and light enough to be positioned anywhere and the mounting hardware allows you to exactly set the angles. Brilliant! I really liked the M930s on every source I tried and in every case they came through with fine imaging and open sound. Give them a try. You'll be convinced. I was; I bought them."

~ Mitch Gallagher
EQ Magazine



"Honey they shrunk my M49! Compared to my \$10,000 reference, both had that big bold Neumann sound, yet the M930 seemed to have a deeper low end and was definitely quieter. Wow was I impressed! Despite its diminutive size, the M930 contains a full 1" diaphragm and amazingly hip electronics. The tiny form factor makes various stereo arrangements easy to accomplish and the M930 is the quietest mic I have ever used. I liked them so much, I bought them."

~ Dr. Fred Bashour
Pro Audio Review



"The compact size of the M930 is very useful when trying to get a mic into a tight space. It is smaller, lighter and has greater headroom than others. It acquitted itself very well indeed in all cases, including all forms of human voice, capturing lots of detail, but in a fairly neutral way. The M930 matches or exceeds the performance of alternatives costing substantially more."

~ Hugh Robjohns
Sound on Sound



"In all of the applications, the M930's small size was an asset. I found myself writing the word superb over and over. The M930 gave me lovely, unblemished signals, that were easy to mix and required little or no EQ. The M930 is a rare critter. In short, a superb professional microphone, among the best I've used. I bought them."

~ Paul Stamler
Recording



Get Real

Real History

Since 1928, Gefell has led the world in microphone technology starting with the world's first condenser. In 1935 the remarkable M7 capsule was introduced that led to the legendary sound of the U47, the U49 and in 1957, the UM57 – the first ever multi-pattern microphone.

Today, Gefell continues the tradition under the direction of Mr. Kühnast Jr. with the original M7 capsule featured in the UM75 and UM92.1S tube microphones.



Georg Neumann with Chief Engineer Mr. Kühnast Sr. – circa 1933

Real Quality

Quality comes with the desire to do it right. For over 75 years Gefell has built microphones by hand in order to achieve the highest standards possible. From precision machining raw metal stock to hand stretching the diaphragms and individually testing each microphone in an anechoic chamber, Gefell sets a standard that is simply higher than any other.



2004 – Hand drilling an M930 back plate

Real Innovation

Introducing the M930 – the most advanced condenser microphone made today. Compact for easy placement, the M930 features a full-size 1" diaphragm mounted on a triangulated pedestal to diffract body reflections away from the capsule and minimize acoustic field disturbance. Inside, the M930's optical power isolation lowers self-noise to a mere 7dB while providing 80 Volts to the capsule for an unprecedented 142dB signal handling. The results are stunning: that 'big bold German sound' without compromising sensitivity, articulation or tonal structure. No other microphone comes close.



M930 matched stereo pair with SH93 X/Y bracket

Gefell is the Real Thing

www.gefell-mics.com

Gefell™
the original hand-made German microphone

WE WILL BEAT ANY DEAL!

EVERY MAJOR BRAND~IN STOCK!

Guitars • Amps • Drums • Keyboards • Synthesizers • Samplers
Sound Systems • Recording Equipment • Software • Accessories



Bassist Nathan East with West L.A. Music's Rick Waite

Singer Don Dokken with West L.A. Music's Neal Gould

West L.A. Music's Bob Gsellman with R&B singer Mya

West L.A. Music staff member with Earth, Wind & Fire keyboardist Larry Dunn



Outkast's Andre 3000 with West L.A. Music's Damon Gladden

West L.A. Music staff member with Goo Goo Dolls singer Johnny Rzeznik

West L.A. Music's Dan Griffin with the legendary Willie Nelson

West L.A. Music's Glenn Noyes with legendary actor Dustin Hoffman

Shop Where the Pros Shop • Call Us Today!



West L.A. Music

call now: 310-477-1945 • sales@westlamusic.com

We will beat any price from any authorized stocking dealer anywhere in the United States

TEMPUS? FUGIT!

important are settings within your DAW software for reducing the buffer size used by the program. In general, smaller buffer sizes equal smaller latency, in other words, shorter delays.

Almost all software allows you to reduce buffer settings for better latency performance. Some audio drivers/protocols also allow you to fine tune settings to reduce or nearly remove latency from the picture. Where you'll find this setting depends on your software; it may be in the preferences, under a menu that deals with tweaky audio system settings, or hiding in another menu. Consult your owner's manual or contact your software's manufacturer for detailed instructions on where to access this setting, and how to set it. (See also Tech Bench on page 84, where Todd Tatnall gets into how to change buffer settings in several programs.)

One word of warning: Reducing the buffer size your software is using generally increases the load that's placed on your computer's central processor. In fact, with some software-based methods for reducing latency you may limit the number of plug-ins you can use — if you can use any at all. It may require some trial and error to find the ideal buffer settings for your system. And you may find that you set the buffers to one value when tracking and another when mixing — when you're mixing and editing, input/output latency is far less of an issue.

The good news is that changes you make to buffer settings can be easily restored — you're not permanently altering anything. Just be sure to note the default buffer settings so that you can restore them if your computer or software starts acting up. And please, experiment with buffer settings on your own time, and always make some test recordings with material you don't care about before committing to fooling with buffers on a major session. Nothing kills an artist's creativity more than tech problems in the studio.

ON TIME

The digital age has provided us with amazing new tools, capable of almost miraculous recording feats. And with all that power have come a few difficulties to surmount, including latency. But there's no reason your tracks have to suffer from delay-induced arrhythmia. Whether you use an interface capable of no-latency monitoring, an external mixer, or optimized buffer settings, your tracks will arrive on time, in the groove, and in the pocket — *swingin'*. EQ

Your Studio Is Not Complete Without

CLARION
ASSOCIATES, INC.
MUSICAL INSTRUMENT INSURANCE

1711 New York Avenue
Huntington Station, NY 11746
1-800-Vivaldi
www.ClarionIns.com

Relationships are for everyone else.

Are You Good Enough For Neutrik?



The Mark of a
Lifetime Performance Guarantee.

World Radio History

Myths Revealed

Beware The Phantom

Is phantom power a simple solution or a convenient compromise?

Any engineer who has hooked up a tube mic to a power supply realizes what a time-saver phantom power can be. It's convenient to plug in a mic and have it immediately powered up. What an ingenious solution, using the mic cable to carry power to the mic. It seems like a perfect system. Or is it?

From whence came the phantom?

Phantom power, or simplex power as it was called, originated back in the early days of the telegraph industry. According to Chris Woolf of Rycote Microphone Windshields (www.microphone-data.com), "Telegraph engineers realized that they could treat a balanced pair as a single conductor and, using a separate ground, create an additional circuit without any extra wires." Pretty neat trick, eh?

According to Greg Gualtieri of Pendulum Audio (www.pendulumaudio.com), Bell then adapted this system to power the carbon mics and ringers in original telephones. The beauty of the system was that it worked with only two wires coming into a home, no separate ground was needed, and the voltage was low enough not to pose a threat to customers.

Fast-forward to 1966. Ribbon, dynamic, and powered tube mics are mainstays of the recording industry. But a new type of mic, the solid-state mic, appeared on the scene. In order to power these mics without using a separate supply, Neumann GmbH considered two alternatives: T-power (or AB or parallel power) and phantom power. It should be pretty evident which system won. (A-B Power, which uses 12V, is still common in the television and motion picture industries.) While experimenting with powering systems, Neumann considered different voltage standards as well. Oliver Archut, of AMI Tab-Funkenwerk (www.tab-funkenwerk.com) says that Neumann considered many different voltages, all the way up to 103V. The goal was to implement the new standard without having to change the existing cables, connectors, and so on. The design engineers realized that higher voltages would be better, but an order from the Norwegian Broadcasting Network cinched the standard. The Norwegians were changing all their mics to solid-state and wanted to power them with their existing 48V system. Neumann filled that order and we've had 48V phantom power ever since.

Convenience or Fidelity?

To many preamp and microphone designers, the decision to use 48V phantom was a "compromise of convenience," not sonic fidelity. According to Archut, the German Institute of Broadcast Technology (IRT or Institut für Rundfunk GmbH, the audio gurus in Germany from 1940 to 1975), rejected Neumann's +48V phantom system because it was a sonic compromise. Ever heard of a Neumann U 77 or KM 74? They were non-phantom powered versions of the ubiquitous U 87 and KM 84 that used standalone power supplies.

There are several problems with the phantom powering system. First 48V is too low. The original preference from Neumann was a system with 70-80V. 48 volts, in the opinion of many mic manu-

facturers, is inadequate for the polarization voltage of (non-electret) condenser mics. While 48V is considered adequate for the head amp (the amp inside the mic that interfaces the mic element with the outside world), it doesn't have enough juice for the capsule.

Standard? Which one?

Another problem is that some manufacturers don't adhere to the 48V standard for phantom power. Phantom voltages of 12, 15, 18, or 24V aren't uncommon. One of the most prolific console manufacturers has a phantom system that only puts out 41V. Why is that a big deal? If manufacturers are making consoles with 12V phantom, then mic manufacturers are compelled to make sure their mics work at 12V in order to not lose sales, so they aim for the lowest common denominator. That in turn means compromises in the design stage.

Why would a console manufacturer have a 41V phantom supply instead of 48V? Instead of spending another \$10 for a transformer with a 48V tap, they use an inexpensive voltage-doubler circuit on

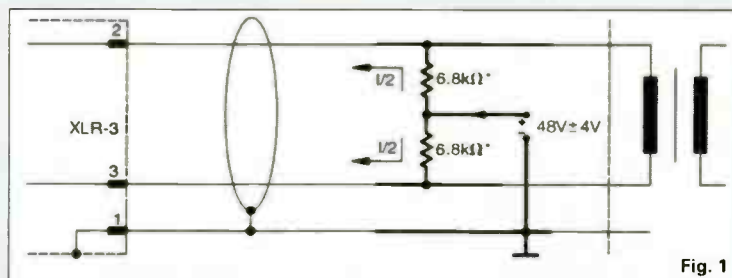

the AC voltage used for the +15V supply so that it can also be used for phantom, which results in 41V.

Greg Gualtieri comments, "I don't know any recording gear manufacturer that would allow a third party to design the power supply for their gear. It's simply too important to the sound. Why should condenser microphones be any different?"

So if the power supply is running at a lower voltage, what impact does that have? First, headroom of the mic will be compromised. Distortion will likely increase. Noise figures may increase. The overall capabilities of the mic will be compromised.

Strong Reservations

Then there's the power supply design: Does it have adequate reserves to handle as many condensers as you might plug in? When phantom power was first standardized, an upper limit of 2mA (milliAmps) of current was established as the guideline, but some mics today can draw as much as 10 mA. What if the designer spec'd the system to provide current for 20 condensers at 2mA each (40 mA), but you plug in eight mics that each draw 10 mA? In a situation like a big explosive drum hit with kick, snare, and cymbals, will that supply be able to provide all the current the mics need to keep up with the dynamics of the drummer? Maybe, maybe not.

The channels of a mixer can also interact. If one channel is shorted, say, by a bad cable or mic, what happens to the current avail-



Magic Wand

The cold, hard facts of room acoustics challenge every studio, large and small. JBL engineers thought it was time for a little magic. Introducing the LSR6300 Studio Monitors, the first reliable solution for tackling the real-world problems inherent in every room. Featuring the exclusive JBL RMC™ Room Mode Correction system, you can accurately measure boundary-induced low frequency modes with the included hand-held acoustic analyzer and then adjust each speaker's 1/10th octave parametric equalizer to correct problems in your room. Designed from the ground up, the LSR6300's uncompromising specs and features give you total control of your music production. See your JBL Dealer today and experience the power of LSR6300 Studio Monitors with RMC - magic you can really put your hands on.

LSR6300 Studio Monitors – Mix Without Boundaries.

Learn more about the power of the LSR6300 Studio Monitors and RMC at www.jblpro.com/LSR



© 2004 JBL Professional

JBL
PROFESSIONAL
A Harman International Company

World Radio History

Myths Revealed

able to the other mics? If the power supply isn't hefty enough to keep up, then every mic's performance will be compromised. Even if you aren't using that mic or that channel. It's just sitting there draining the power supply reserve.

Blasting Zone

Did you know every time a condenser mic is plugged into a phantom-powered input with a transformer that there's a short microblast of voltage that's destroying the insulation of the transformer's secondary? According to Archut, the transformer dies over time because of this action. He should know. He rewinds transformers for vintage preamps, like the Telefunken V72 and V76. "People buy these vintage modules and strap a phantom supply on them (since they were designed without phantom) and then wonder why they have to have the transformers replaced or rewound. I see it all the time."

What's a mic to do?

The good news is that there are options. Probably the biggest proponent of increasing power voltage for mics is DPA Microphones (www.dpamicrophones.com) with their 130V system. All of their stu-

DISSENTING OPINION

Chris Woolf says: "The 48V system is a compromise, but no more so than almost everything in electronics. 48V phantom is remarkably good but, yes, you can pick a few holes if you want to."

"The compromise of 48V isn't as severe as all that. Capsules are rarely biased directly. In practice, a DC converter provides the 60V or whatever that's required, allowing a well-stabilized supply that's not dependent on the actual volts delivered at the mic."

"The existence of consoles not providing adequate voltage or current to cope is a failure of customers as much as manufacturers. Buyers often display appalling judgment and don't read specs or demand them — this sort of thing is an excellent case in point. If buyers only bought mixers that had AES-standard phantom power there wouldn't be any rubbish ones on the market. They buy cheap instead of wise, and they pay the price."

"Damaging transformers with phantom isn't that big of a problem. It's true that very old mic transformers with very fragile shellac insulation never expected to have any voltage stress on their windings. But this really only applies to a handful of antiques. 48V isn't a vicious voltage and, delivered via current-limiting resistors, it doesn't strain many things. Indeed there's a marked ramping effect due to the mic-powering capacitors charging."

"The 5-pin approach doesn't fill me with much joy. I think it's better to use a good 48V supply than to modify the mic to use an external supply with all the problems of grounds at different references."

"You can certainly find instances when mic powering is a problem — you can also find myriad ones where the phantom is fine, but the way the mic is cabled or split is actually causing the audible effects. As with all these things there is no better solution than to understand properly!"

dio mics use a 200V backplate voltage for the capsules, and some use a 130V supply for the head amp. By increasing the voltage available to the mic, DPA is able to take the already impressive specs for their 48V 4006 mic and make them even better in their 130V 4003 (for example, headroom up from 14 to 25dB, and maximum SPL handling up from 143 to 154dB SPL). According to DPA's Bruce Myers, DPA is the only manufacturer in the world making 130V mics. Many engineers who hear the difference become high-voltage converts and they've convinced several preamp manufacturers

SUPERIOR POWER CONDITIONING GIVES YOU SUPERIOR EQUIPMENT PERFORMANCE

LiFT

NOTHING DELIVERS CLEANER AC POWER

Linear Filtering Technology (LiFT) reduces AC line noise, providing clean power and ensuring optimum performance.



SMP+

NOTHING PROTECTS EQUIPMENT BETTER

Series mode protection plus (SMP+) provides the highest level of power protection with an unlimited joule rating and features extreme voltage shutdown (E.V.S.) with the lowest clamping voltage available (168V).



PL-3 Pro II 20 Amp Power Conditioner with lights



P-5 Pro II 20 Amp Power Conditioner



PF-Pro R Power Conditioner with Power Factor correction

Furman Sound, Inc. • www.FurmanSound.com

FURMAN
PURIFY YOUR POWER

SOME DRUGS ARE LEGAL

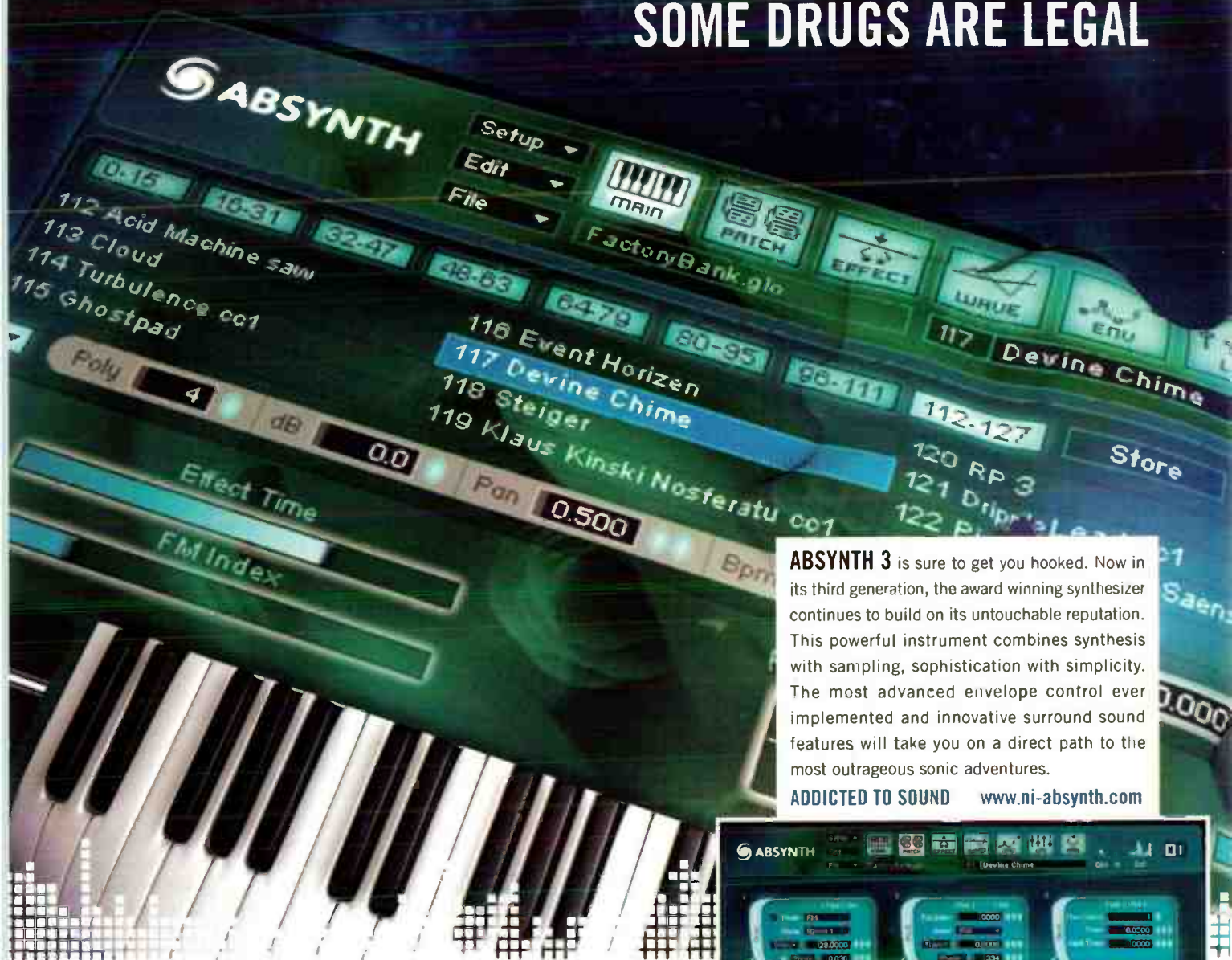

ABSYNTH 3 is sure to get you hooked. Now in its third generation, the award winning synthesizer continues to build on its untouchable reputation. This powerful instrument combines synthesis with sampling, sophistication with simplicity. The most advanced envelope control ever implemented and innovative surround sound features will take you on a direct path to the most outrageous sonic adventures.

ADDICTED TO SOUND www.ni-absynth.com



"This synth is a sound programmer's delight."
Electronic Musician, USA, 01/2004

"A unique sonic flavour that's not available elsewhere."
Mix Magazine, USA, 02/2004



Future Music
UK, 10/2003



Computer Music
UK, 10/2003



Electronic Musician
USA, 01/2004



EQ Magazine
USA, 02/2004



Music Tech
UK, 09/2003



NATIVE INSTRUMENTS
SOFTWARE SYNTHESIS

GENERATE THE FUTURE OF SOUND

www.native-instruments.com

(Millennia, Grace, Avalon, along with DPA) to make preamps capable of 130V power for these mics. DPA uses a modified 3-pin XLR so you can't plug in a standard XLR cable and destroy 48V mics. DPA also uses a 6-pin system for their 4041 series (130V pre-amp/200V backplate), which allows the audio to travel on dedicated lines while keeping the supply voltages on separate lines.

But are there other options, short of replacing your mics? Greg Gualtieri rebuilds his mics so that they use 5-pin XLRs, so the power supply voltage doesn't have to piggyback on the audio lines. He also makes dedicated power supplies

Phantom Basics

Balanced mics carry audio signal on pins 2 and 3, with the ground on pin 1. The preamp adds the opposite polarity audio signals from pins 2 and 3, which cancels any noise. Phantom power applies +48V to both pins 2 and 3 through 6.81k Ω resistors. When pins 2 and 3 are added, the +48V is cancelled out — just as with noise — leaving just the audio.

It won't be able to power some mics, and manufacturers would have to put in solid 48V supplies.

Oliver Archut's solution for transformer corruption, which he has adopted in all his preamps, uses a 48V power supply that ramps up slowly on power up and helps extend transformer life. "\$25 worth of parts can save you a \$300 rewinding fee." One other benefit is that you don't hear that huge pop in the speakers when you turn on phantom. He just wishes everyone else would follow his lead.

What about budget solutions?

So, you're convinced that the current phantom system is insufficient but you don't have the money to replace or rebuild your mics, or buy or rebuild your preamp collection. What can you do?

There are three solutions: The first is using standalone preamps with sufficient phantom powering. A second option is to have a technician build a solid, high-current capacity +48V power supply that can be added to your existing console. It will require some modifying of the internal wiring and another plug in the back of the console for the external phantom to come in. I've done this before; it's a good option and not terribly time consuming or expensive. Finding someone qualified to do it shouldn't be that difficult.

The third choice is to buy an external phantom supply for your mics. Standalone phantom supplies are available from companies such as Audio-Technica, AKG, Shure, Neumann, Rolls, ART, and Crown for as little as \$35, although the cheaper ones might not be an improvement over existing powering. (Some use 9V batteries for power.) This is probably the easiest and cheapest solution.

In the end, only your ears can tell you if phantom power problems are compromising your recordings. Try it for yourself: make two identical (as close as possible, anyway) recordings; one with poor phantom, the other with a known good phantom supply. Can you hear the difference?

Look and sound like a million bucks. Pay only \$990.

DISC MAKERS® CD AND DVD MANUFACTURING MADE EASY



1,000 CDs in jackets for only \$990.

Package includes our award-winning, three-color on-disc printing, and full-color jackets with high-gloss UV coating.

You'll be thrilled with how incredible your CDs look and sound when you choose Disc Makers. You get 1,000 CDs in full-color jackets for the remarkable price of only \$990. And you get them super quick. Complete your package by adding our affordable award-winning graphic design, mastering services, and promotional resources such as posters and postcards.

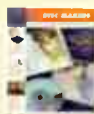

GET OUR FREE FACTORY-DIRECT CATALOG
1-866-294-8829 • www.discmakers.com/eq

Audio Urban Legends

If you've encountered audio myths you'd like to see exposed, email them to Lynn Fuston at go3daudio@aol.com

smokin'



Your hottest performance to date



Whether you're looking to improve the quality of your band's performance, or bring something more to your live recordings, you owe it to yourself and your band to check out the **OctoPre LE™**.

Eight Focusrite world-class preamps will inject professional quality into your Live performances. Two 'Super Channels' are included with quality D.I. and switchable impedance for further sonic enhancement, plus dBFS peak level input metering throughout. With eight channels of 24-bit A/D and D/A conversion (with performance well beyond anything in their class), you also have all you need to record and monitor your performances via ADAT. Finally, with simple and intuitive controls on the front fascia, you can keep your attention where it matters most – on the band.

Contact your local dealer now and ask how the OctoPre LE™ could make your gig the hottest show in town.

DON'T LET YOUR ADATS
GO TO WASTE



Want Focusrite compression and limiting on every channel?

Need 96kHz A/D conversion and AES/EBU or SPDIF outputs?

If so, be sure to check out the original OctoPre™.



You owe it to yourself, your band & your audience

PLATINUM
OCTOPRE
LE

Focusrite®



For further information email focusrite@americanmusicsound.com or simply visit www.focusrite.com

World Radio History

The Art of Recording:

How Are Things Panning Out?

It's not just a good idea — it's the law.

by Craig Anderton

Can you possibly imagine a more boring topic for an Art of Recording article than panning? I mean, what's the big deal — you twist the friggin' knob, real or virtual, and put the sound somewhere in the stereo field. Done. In fact, I'm sure some of you are thinking: "Jeez, how stupid do you think I am?"

But ignorance of the law is no excuse. The panning law, that is. Panning laws have nothing to do with laws laid down by the music arm of the Fashion Police; instead, they govern exactly what happens when a monaural sound moves from left to right in the stereo field.

That may seem cut and dried, but it's not — especially in the world of DAWs. As a matter of fact, not knowing about panning laws can create some real issues — significant issues — if you need to move a project from one host to another. Panning laws may even account for some of the online foolishness where people argue about one host sounding "punchier" or "wimpier" than another when they loaded the same project into different hosts. It's the same project, right? So it should sound the same, right?

Ha. Read on.

HOW IT ALL STARTED

Panning laws came about because back in the days of analog mixers, if there was a linear gain increase in one channel and a linear gain decrease in the other channel to change the stereo position, at the center position the sum of the two channels sounded louder than if the signal was panned full left or full right.

Well, that didn't seem right, so it became common to use a logarithmic gain-change taper to drop the signal by -3dB RMS at the center. You could do this by using dual pots for panning with log/antilog tapers, but as those could be hard to find, you could do

pretty much the same thing by adding tapering resistors to standard linear potentiometers. Thus, even though signals were being added together from the left and right channels, the *apparent* level was the same when centered because they had equal power.

But it turned out this "law" was not a standard. Some engineers preferred to drop the center level a bit more, either because they liked the signal to seem louder as it moved out of the main center zone, or because signals that "clumped up" around the center tended to "monoize" the signal. So, dropping the centered level a little further

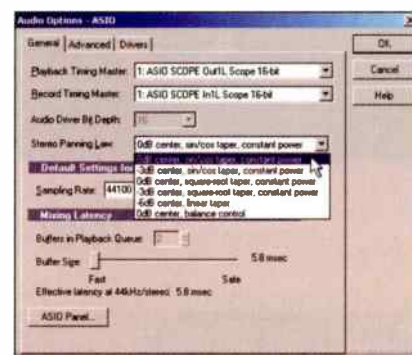

Fig. 3: Sonar has six different pan laws.

emphasized the stereo effect somewhat. Some of the people using analog consoles had their own little secret tweaks to change the panning characteristics, which became part of their "secret sauce."

ENTER THE DAW

With virtual mixers we don't have to worry about dual-ganged panpots, and can create any panning characteristic we want. That's a good thing. Well, I think it's a good thing, but it's also added a degree of chaos that we really didn't need.

For example, Cubase SX3 has four panning laws in the Project Setup dialog (Figure 1); you get there by going *Project > Project Setup*. Setting the value to 0dB eliminates constant-power panning, and gives you the old school, center-channel-louder effect. Since we tried so hard to get away from that, it's not surprising that Cubase defaults to using the "drop the center by -3dB" classic equal power setting. But you can also choose to drop the center by -4.5dB or -6dB if you want to hype up/widen the stereo field somewhat, and make the center a bit more demure. Fair enough, it's nice to have options.

Adobe Audition has two panning options in multitrack mode, accessed by going *View > Advanced Session Properties* (Figure 2). L/R Cut Logarithmic is the default, and pans to the left by reducing the right channel volume, and conversely, pans to the right by reducing the left channel volume. As the panning gets closer to hard left or right, the channel being panned to doesn't increase past what its volume would be when centered. The Equal Power Sinusoidal option maintains



Fig. 1: Cubase offers four different pan law options.

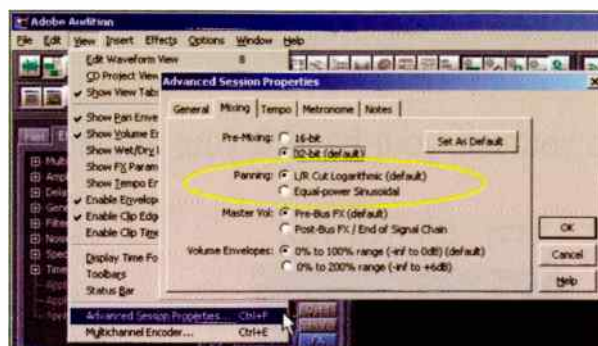

Fig. 2: Adobe Audition allows two different pan laws, accessed under Advanced Session Properties.

Thinking TAPCO? Think Sweetwater.



S•5 Active
Studio Monitor
~~\$349.97~~ each
MSRP \$ 499.00

"Clear and focused."

– EQ

"Impressive evenness."

– Electronic Musician

SW•10
Active
Subwoofer

NEW!
Call for details

"Beautifully designed."

– Sound on Sound



S•8 Active
Studio Monitor
~~\$449.00~~ each
MSRP \$ 749.00

Judging from recent magazine reviews, if you're thinking about buying a new set of studio monitors, you should be thinking about the TAPCO S-Series. With their genuine Mackie-designed pedigree and top-notch components, the TAPCO S•5 and S•8 nearfield monitors and new SW•10 subwoofer are being praised as the best in their class. Need a second opinion? Give your Sweetwater sales engineers a call and ask 'em what they think. That should say it all.



Sweetwater
music technology direct™

1-800-222-4700 • www.sweetwater.com • 5335 Bass Road, Fort Wayne, IN 46808

The Art of Recording: How Are Things Panning Out?

constant power by *amplifying* hard pans to left or right by +3dB, which is conceptually similar to dropping the two channels by -3dB when the signal is centered.

Sonar takes the whole process further with six different panning options (Figure 3), which you can find by going *Options > Audio*. In the descriptions below, "taper" refers to the curve of the gain and doesn't have too radical an effect on the sound. The six options are:

- 0dB center, sin/cos taper, constant power. The signal level stays at 0dB when centered, and increases by +3dB when panned left or right. Although this is the default, I don't recommend it because of the possibility of clipping if you pan a full-level signal off center.
- 0dB center, square root taper, constant power. This is similar, but the gain change taper is different.
- -3dB center, sin/cos taper, constant power.



Fig. 4: Note the difference in the center channel signal level between the Balance and -6dB center options.

The signal level stays at 0dB when panned right or left, but drops by -3dB in each channel when centered. This is the same as the Cubase SX default panning law.

- -3dB center, square root taper, constant power. This is similar, but the gain change taper is different.
- -6dB center, linear taper. The signal level stays at 0dB when panned left or right, but drops by -6dB when centered. This is for those who

like to hype up the sides a bit at the expense of the center.

- 0dB center, balance control. The signal level stays constant whether the signal is in the left channel, right channel, or set to the middle.

You can actually see the results of choosing different pan options. Figure 4 shows meter settings in Sonar for two different settings. (Note that pan law is a global setting and can't be set individually for each track; this illustration was created by grabbing two screen shots and combining them.)

The top meter shows a centered mono signal, while the second meter down shows the same signal panned full right, using the 0dB center, balance control option. The RMS level is the same when the signal is centered as when it's panned full right.

The third meter down shows the same signal centered, but subjected to the -6dB

"When I started RIT, almost 2 years ago, I didn't have any knowledge of computer editing/recording, signal processing, consoles and outboard gear or even the recording process. It was a shame for me, because being a musician myself, I realize now how important it all is!

Now, thanks to my education at RIT, not only have I worked with Steve Vai, Eddie Kramer, Paul Gilbert, Jeff Peters, Yardbirds etc., I also know what I need to attain my own personal musical goals. Thank you guys at RIT."

- Enrico Sesselego
RIT Graduate

RIT

RECORDING INSTITUTE OF TECHNOLOGY



CALL USA/CANADA: 800.255.PLAY
INTERNATIONAL: 323.462.1384
6750 Hollywood Blvd, Hollywood CA 90028
Fax: 323.462.6978 WWW.MI.EDU

Hands On! Experience
Saturday, April 23 2005 10:45 am
For reservation, call 1-800-255-7529 ext. 151



Thomas Williams



Mandy Adams

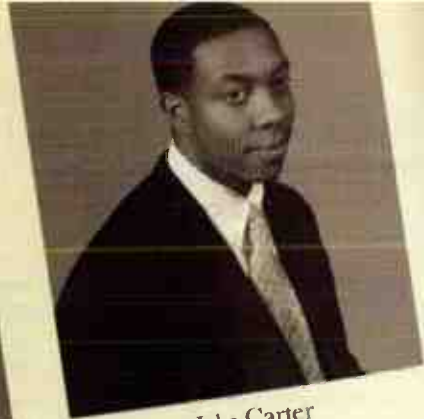

Jake Carter



Jenny Smith



Eddy Lin



Walter Nemoy

J.F.K. High School 2004

SOME PEOPLE WERE BORN FOR THIS.

THE SOUND ARTS DEGREE FROM EX'PRESSION

You've got the desire, the drive, and maybe even the ears for a career in audio. Maybe you should check out the Sound Arts degree program from Ex'pression College for Digital Arts. You'll learn music recording, engineering and sound for film and even video games. You'll have 24/7 access to professional grade studios and equipment. And you can earn a Bachelor's degree in about 2 1/2 years. Curious? Visit expression.edu for more details.

**Ex'pression College
For Digital Arts**
Emeryville, CA
(San Francisco Bay)
877.833.8800

The Art of Recording: How Are Things Panning Out?

center, linear taper law. Note how it's playing back at -9dB (the meters are set to show RMS readings over a 24dB range), while the fourth meter down shows what happens when the same signal is panned full right: It registers exactly 6dB higher (-3dB).

SO WHICH ONE DO YOU CHOOSE?

Well, as we've noted, this particular law is

pretty unspecific. Note that if you compare the three programs mentioned above, *they all default to a different law!* But here's the rub: When you move a project from one host sequencer to another, unless the selected panning laws match, look out. I often wonder if when some people say a particular host sounds "punchier" than another, the "punchy" one boosts the level when signals

are panned hard left or right, while the "unpunchy" one uses the law that drops the level of the center instead.

For example, suppose you move a Sonar project to Cubase SX. It will likely sound softer, because Cubase drops the center channel to compensate, while Sonar raises the left and right channels to compensate. Conversely, if you move a Cubase SX project to Sonar, you might have to deal with distortion issues and reduce a few levels here and there, because signals panned hard left and hard right will now be louder.

But where these laws really come into play is with surround, because here you're talking about spatial changes between more than just two speakers. Bottom line: Be consistent in the panning law you use, and document it with the file if a project needs to be moved from one platform to another.

Personally, I go for the tried-and-true "-3dB down in the center" option. I designed analog mixers to have that response, and so I'm more than happy to continue that tradition within the virtual world of sequencer hosts. Also, this is one option that just about every host provides, whereas some of the more esoteric ones may not be supported by other hosts.

SO WHAT DOES IT ALL MEAN?

There, now aren't you glad you read this article after all? But we can't sign off without mentioning one more thing: The pan law you choose isn't just a matter of convenience or compatibility, although I've stressed the importance of being compatible if you want a "transportable" file. The law you choose can also make a difference in the overall sound of a mix.

This is less of an issue if you use mostly stereo tracks, as panning in that case is really more of a balance control. But for many of us, "multitrack" still means recording at least some mono tracks. I tend to record a mono source (voice, guitar, bass) in mono, unless it's important to capture the room ambience — and even then, I'm more likely to capture the main sound in mono, and use a stereo pair of room mics that go to their own tracks. And if you pan that mono track, you're going to have to deal with the panning laws. It's up to you to decide which law sounds best for the project you're doing.

In any event, you now know enough about those laws to make sure you don't get cited in contempt of recording court. Happy panning! **EQ**

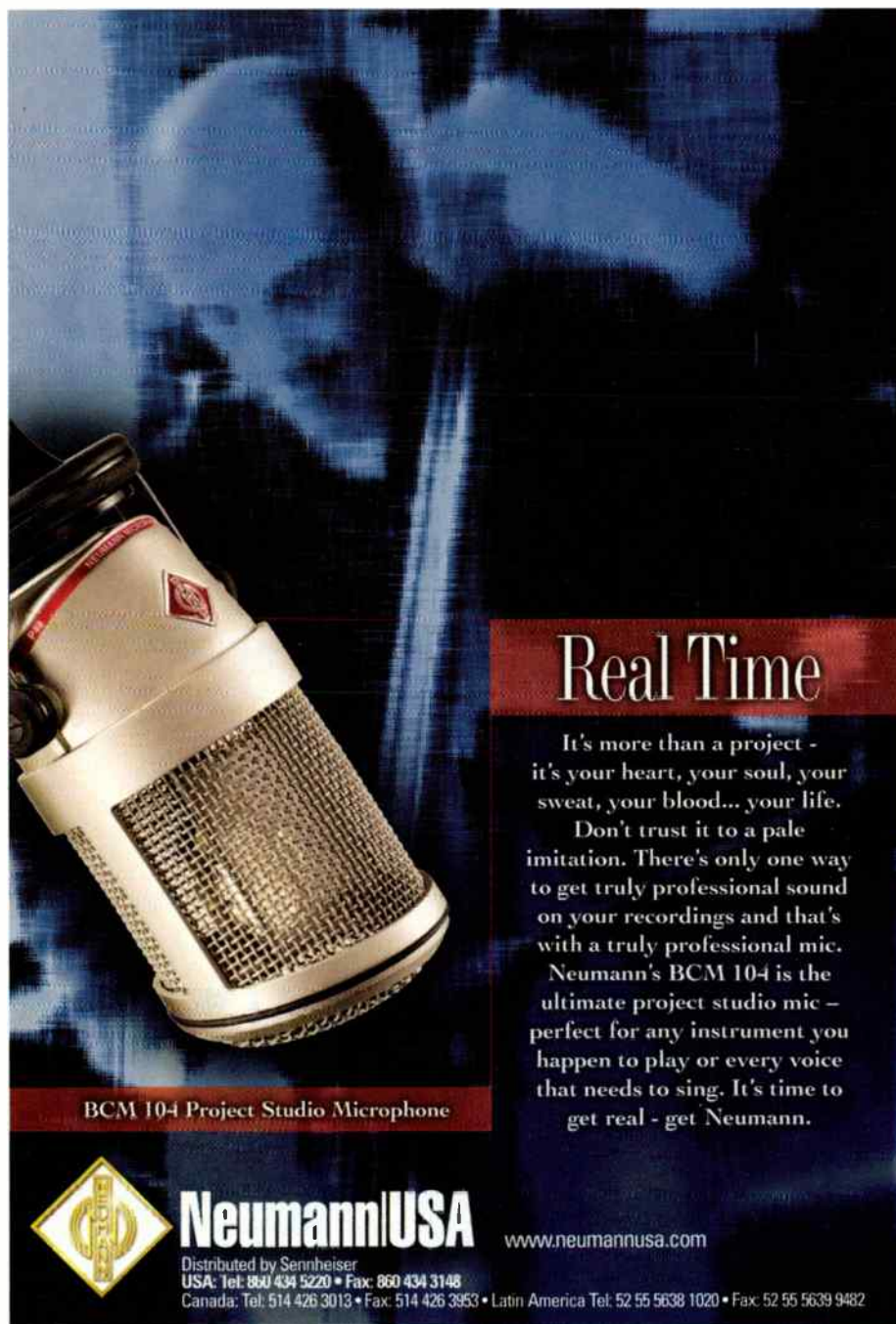

Real Time

It's more than a project - it's your heart, your soul, your sweat, your blood... your life. Don't trust it to a pale imitation. There's only one way to get truly professional sound on your recordings and that's with a truly professional mic. Neumann's BCM 104 is the ultimate project studio mic - perfect for any instrument you happen to play or every voice that needs to sing. It's time to get real - get Neumann.

BCM 104 Project Studio Microphone



Neumann|USA

Distributed by Sennheiser
USA: Tel: 860 434 5220 • Fax: 860 434 3148
Canada: Tel: 514 426 3013 • Fax: 514 426 3953 • Latin America Tel: 52 55 5638 1020 • Fax: 52 55 5639 9482

www.neumannusa.com

TOOLS OF INSPIRATION



CREATE ION

ION is for Invention, Imagination, Analog artistry. Thirty endless analog knobs, for flawless precision and effortless tweakability. Sixty-nine buttons, to leave no parameter out of reach. And a high-resolution graphic display, so there's no aspect of the sound that you can't see, shape, and sculpt.



PERFORM MICRON

MICRON is the feisty kid brother with BPM on the brain. All of Ion's brawn, but a style all its own. Powerful sequencing and arpeggiation. A full-blown analog drum machine. Real-time phrase capturing. Limitless splits and layers. All in a portable package that lets you bring the beat to the street.

Alesis ION & MICRON Analog Modeling Synths

IT'S HOW YOU FEEL.

Searing leads. Earthshaking bass lines. Immersive and seductive pads. There's never been anything quite like that true, fat analog sound. Until now.

Introducing the Alesis ION and MICRON analog modeling synthesizers. We started with an unprecedented amount of raw processing power and a no-compromises attitude, and came out with the most stunningly realistic virtual analog sound available. We don't mean "wannabe" analog. Try "I-can't-believe-it's-not" analog.

IT'S HOW YOU THINK.

Your own musical vision is what matters. Bring it to life with three morphable oscillators, twenty types of filters, multiple LFOs and envelopes, and a rich complement of multi-effects. Start from scratch, or tweak over 500 presets from some of the best sound designers in the industry. Plug in a mic for mind-bending results from the 40-band vocoder.

Yesterday, analog modeling of this quality was just a dream. Today, it's within your grasp. Because not only are these the world's most powerful analog modeling synths, they're also the world's most affordable.

ALESIS Everybody Listens

www.alesis.com

by Craig Anderton

Wave Arts Power Suite

It's a sweet suite, indeed

Type: Audio processing plug-in bundle

Price: Power Suite (all plug-ins) \$499.95; Power Couple (TrackPlug and MasterVerb bundle) \$249.95; MultiDynamics, TrackPlug, MasterVerb, and FinalPlug, \$149.95 each; WaveSurround \$99.95

Contact: www.wavearts.com

Platforms/formats: Mac OS X 10.2 or later (AU, MAS, VST, RTAS), OS 9.1 or later (MAS, VST, RTAS), Windows 2000/XP or later (DX, VST, RTAS).

Copy protection: Serial number provided with program; program generates machine ID. Send both to Wave Arts and receive unlock code.

Demo: 30-day unlimited functionality.

Manual: 68-page paper manual with boxed version; PDF with download.

Sample rates: 192kHz (FinalPlug), 96kHz (all others)

Bit resolution: 32-bit internal processing, 64-bit processing for EQ (in TrackPlug and MultiDynamics)

“Waves.” Okay, now that’s out of the way . . .

Seriously, in any industry, few companies have been able to carve out the kind of niche that Waves has. They were one of the first, if not the first, third-party plug-in companies, and few would disagree that they do awesome work.

Yes, this is an odd way to start a review about a non-Waves product. But bear with me. Waves’ plug-ins are expensive, so recording engineers on a tight budget have been searching for a Waves-style experience, but at an affordable price. Does Wave Arts deliver that Holy Grail?

Well, I’m not going to tell you, and here’s why: You can download a fully functional

version of Power Suite and use it for 30 days. Try it with some tracks, and find out for yourself. What I will do, though, is tell you why I think the Wave Arts plug-ins are on the short list of plug-in excellence . . . specifically, *affordable* plug-in excellence.

Power Suite is a bundle of several Wave Arts products, but each one is available separately. So, we’ll cover each plug-in, then consider the suite as a whole — is it worth getting the package, or will individual plugs do it for you?

GETTING STARTED

You can download the Suite (it’s under 10MB), or buy a boxed version. As one of the few people who actually reads End User License Agreements, I found this little gem: You can install the program on three computers, as long as you’re the only user. Hallelujah! I can put the plugs on my Mac and Windows desktop machines, and my notebook, without having to beg for additional registrations. Cool.

Okay, let’s look at the plugs.

MASTERVERB

I first reviewed MasterVerb back in January 2002, and said

“This reverb offers a lush, enveloping sound — perfect for adding reverb to program material. But it does a lot more, and works well on individual tracks. Unlike some reverbs, it seems particularly well suited to delicate instruments such as acoustic guitar because of the sweet decay and warm (not muffled — warm!) sound quality. Despite being a single-algorithm reverb, it’s flexible enough to provide a variety of very useful effects. The fact that it requires very little CPU power is the icing on the cake.”

Those opinions remain valid.

I did complain about the lack of a diffusion control and a bit of “flutter” on the early reflections. Well, now there’s a diffusion control, and the early reflections sound smoother. I have several reverbs, but I must say I reach for this one often. It’s still a single-algorithm reverb, but being raised on acoustic reverb, that doesn’t bother me — particularly because the MasterVerb controls can wring out a variety of sounds.

Compared to other plugs I have, only the Waves TrueVerb has a slightly more consistent, smooth tail. However, the reason I know this was because in context, it was hard to tell the two apart, so I ended up soloing each reverb track with a single percussion track. Bottom line: MasterVerb is a fine, CPU-friendly, realistic reverb.

TRACKPLUG

This is a 10-band EQ with compressor and gate. I got turned on to it before Cakewalk had folded the Sonitus:fx EQs into Sonar, and found — much to my surprise — that I could load



NOTE MASTERVERB’S 3-D DISPLAY, WHICH PROVIDES A VISUAL REPRESENTATION OF TIME AND FREQUENCY RESPONSE.



YOU CAN THINK OF TRACKPLUG AS A VIRTUAL CHANNEL STRIP WITH EQ AND DYNAMICS.

INTEGRATED

Pro Audio Solutions



**Desktop Audio • Live Sound/PA • Pro Recording
• Broadcast/ENG • Electronic Field Production**

420 Ninth Ave., NYC 10001
www.bhproaudio.com

800-947-5518
We Ship Worldwide



Wave Arts Power Suite

SF-24 Phantom-Powered Stereo Ribbon



"For any seeker of scintillating sound, the SF-24 is a true find."
Mix

"The SF-24 is one beautiful-sounding microphone."
Recording Magazine

"Its low noise level and superb ambience pickup was just perfect..."
Pro Audio Review

www.royerlabs.com
818.760.8472 • Burbank, CA.

a ton of these things without distressing the CPU.

Each stage of EQ can have any one of seven responses (including parametric), and the EQ as a whole can go pre- or post-compressor. Controls are standard, although a useful "band" control disables a band without deleting it — good for judging how different bands affect the sound.

The compressor is also straightforward, but very complete with parameters for knee, makeup gain on/off, attack, release, peak or RMS detection, and lookahead on/off and time (1, 2, or 5 ms). The superb metering keeps you apprised of variants in input signal power, the amount of compression and gating being applied, and the output peak and average levels.

As most hosts come with their own EQ and dynamics plug-ins, this would likely not be your first choice. But few offer 10 bands of EQ, and the sound quality belies the low CPU drain. TrackPlug's most striking characteristic is that you don't hear it working; you have to *really* push the parameters to get it to sound artificial.

MULTIDYNAMICS

A good multiband dynamics processor is a joy. The biggest problem is the user interface: Adjusting multiple bands of compression can be a pain in the butt, especially as you're adjusting both EQ and dynamics to get the desired sound. Wave Arts hasn't really solved the adjustment problem (although it's equally easy to make a parameter change to all six bands as it is to one band), but they've made *huge* strides in letting you see the results of those adjustments.

The coolest aspect is that the display gives equal weight to displaying what's happening to the frequency response. The left pane shows the current frequency response (the green line) and threshold (the orange line); the right side shows what's happening with the dynamics.

The way EQ is handled is a little hard to explain, but the basic idea is that you can set not only a particular frequency range for each band, but also determine how much gain will be applied when the signal is above the threshold, and how much when it's below. This makes it easy to compress some bands while expanding others, but also makes it easier to see how compression will affect the frequency response.

There's more — the crossover between bands can be set to 18 or



THE UNUSUAL WAVESURROUND PLUG-IN CAN GIVE, AMONG OTHER EFFECTS, STEREO THAT'S WIDER THAN WIDE

30dB/octave, and the transitions sound very seamless. Overall, this plug-in is a home run; run through the presets, and you'll hear everything from hard sounds without harshness to gentle tone-shaping with a dynamics lift. This is one hot plug.

FINALPLUG

Here's your basic "output-limiter-designed-to-kill-all-traces-of-dynamics-to-conform-to-current-pop-music-standards" type of device; it also includes dithering and noise shaping. So, I immediately A/B'd it with the Waves L1 Ultramaximizer+ (okay, so I'm not totally up to date), which is what I generally use for this type of application.

There was a definite difference between the two. Given equal threshold and release settings (with dynamic equivalency checked by listening and observing meters), FinalPlug sounded thicker, fatter, and "smeared" the signal more. The L1 preserved a sense of dynamics better, and also sounded a bit brighter; however, the limiting action seemed a bit more ragged. These differences were fairly minor with moderate amounts of limiting, but showed up more at settings that frankly, I wouldn't use anyway.

For most material, I'd give the L1 a slight edge — because I'm not a huge fan of output limiting, so I'd rather have a bit better dynamic preservation. However, I can guarantee some people would A/B the two and choose FinalPlug because of its fatter, less clinical sound.

I guess if I had to summarize, I'd say the L1 is the Beatles, and FinalPlug is the Stones. Another example: I'd use FinalPlug on house music, but the L1 on drum 'n' bass.

WAVESURROUND

This plug-in gives stereo material increased sound localization. Think of it

Keyboard

MAGAZINE



SUBSCRIBE NOW!

www.keyboardmag.com

CALL TOLL FREE 1.800.289.9919

OUTSIDE U.S. 1.937.853.2345

Wave Arts
Power Suite

as panning on steroids: Instead of just blasting sounds between right or left front speakers, sounds can seem to come from the sides, or even behind you. It does this with sophisticated filtering and crosstalk cancellation; there's also reverb if you want to tart things up a little further.

I haven't worked much with 3-D audio spatialization, so I went through the presets . . . and was just about ready to write it off. The sound was gimmicky, and I couldn't imagine subjecting program material to this kind of effect. Wrong! When I started really digging into it, and scaling back the effects (e.g., turning off reverb) for some more subtle results, I was impressed. Before long, imaging sounded wider, there was a certain precision to the sound, and yes, it was an improvement. Not a huge improvement, mind you, but the whole track sounded as if someone had added a "lively and sparkly" control, then turned it up 15 percent.

Encouraged, I tried it on individual tracks. Percussion sounded awesome, and drums perked up too. Distorted guitars sounded *too* big, though. This is something you want to use sparingly, but it's a real "secret weapon" kinda plug that I'm sure will have many people saying, "How did you get *that* sound?"

THE THRILLING CONCLUSION

Clearly, buying the Power Suite is more cost-effective than going *à la carte*, assuming you want all the plugs. But you have the option of just cherry-picking the ones you want, which is a Good Thing. However, each plug does have its own merits, so if you can afford the whole package, that's probably the best way to go.

As I said at the beginning, download the bundle and decide for yourself. I've made my decision: Power Suite has joined my plug-in A-list. **EQ**

Strengths:

- Clean, precise sound quality
- Low CPU consumption
- Supports multiple hosts
- Great multidynamics processor
- WaveSurround provides unique, useful effects
- Automatable parameters

Limitations:

- No native external MIDI parameter control
- Single-algorithm, albeit flexible, reverb

Great gear and great tracks...**BUT...**
your mix doesn't sound the same in the car?
Tune Your Room!

Citywalk Studios • Branson, MO

If you think it's the gear, think again.
Your sound is only as good as the
acoustics in your room!

Visit **Auralex.com** or call
1•800•95•WEDGE for your
FREE Room Analysis.

After 25 years and over 10,000 studios,
we're the experts at helping you achieve
TOTAL SOUND CONTROL™.

Total Sound Control
Auralex
acoustics
www.auralex.com

**Learn
the Art of
Recording**

**Powerful
Practical
Professional**

- World-class (yet affordable) education in Recording Engineering & Music Production
- Full-time, two month experience to chart your career and change your life

Recording Workshop
www.recordingworkshop.com
info@recw.com
800-848-9900
740-663-1000 outside US

REC
Founded 1971 • 455 Massesville Rd., Chillicothe, Ohio 45601
Licensed by State Board of Career Colleges and Schools

**EXTREME
DIGITAL
AUDIO
MANAGEMENT
TOOLS**

Clocks
AD/DA Conversion
Digital Distribution
Sample Rate Conversion

lucid
www.lucidaudio.com



NOW - reduced pricing!

You've probably already heard about the best place to manufacture your disc

So c'mon — give us a call!

You've more than likely already heard—from your fellow musicians, the BBB, and independent reviewers—that Oasis offers the most reliable and innovative CD and DVD manufacturing and marketing services.

So isn't it time for you to give us a call?

We think it is—if you've put your heart and soul into your project. And you want the discs and packaging you send out into the world to truly reflect (or even improve upon) your original vision. And you need help with the crucial task of getting people out there to actually hear your music.

Because if that describes your situation, may we suggest what it calls for?

It calls for Oasis.



web oasisCD.com
tel (888) 296-2747, (540) 987-8810
email info@oasisCD.com



Oasis is the only national disc manufacturing company certified by both The Better Business Bureau and BBBOnline.



FREE: New 64 page Full-Color catalog!

Call us now at (888)296-2747 or visit oasisCD.com/catalog for your copy.

INCLUDED WITH YOUR CD or DVD PROJECT—THE OASIS TOP™ TOOLS OF PROMOTION:

Your Music on an OasisSampler™ Distributed to Radio Nationwide



XM Satellite Radio Airplay for Oasis Clients



Galaris/Oasis CD-ROM with 14,000+ Music Industry Contacts



Distribution for your CD or DVD: iTunes Music Store



amazon.com



BORDERS.com
Waldenbooks.com

A Full Year of Electronic Press Kit® Service and Exclusive Live Performance Opportunities:



SoundScan®, Music-Career Software, Retail Cases, Barcodes



by Mitch Gallagher

TASCAM FW-1082

Life just got easier for DAW-based studio owners

Type: Control surface/FireWire audio interface/MIDI interface/digital mixer

Price: \$999

Contact: TASCAM, www.tascam.com

Channel controls: mic preamp trim; channel select, solo, and mute switches; 60-mm motorized touch-sensitive fader

Encoder section: Pan, and EQ Gain, Frequency, and Q rotary encoders; High, Hi-mid, Low-mid, and Low band selector switches

Analog inputs: 4 balanced XLR mic with 48V phantom power, eight 1/4" balanced line inputs

Analog inserts: two 1/4"

Analog outputs: two balanced 1/4" line level, 1/4" headphone

Digital I/O: 2-channel S/PDIF coaxial (RCA)

MIDI I/O: 2 independent MIDI inputs and outputs

Other connections: two 6-pin FireWire, 1/4" assignable footswitch

Simultaneous external I/O channels: 10 in/4 out

Sample rates: 44.1, 48, 88.2, 96kHz

Resolution: 24-bit

Frequency response: 20Hz to 20kHz, ± 1.0 dB (44.1 or 48kHz), 20Hz to 40kHz, $+0.5/-2.0$ dB (88.2 or 96kHz); line in to monitor out

Noise: <-128 dBu (mic in to insert send), <-64 dBu (line in to stereo out or surround monitor out)

Minimum requirements: Computer running Windows 2000/XP with 6-pin FireWire port; Mac G3 or better with FireWire port running OS X 10.2.8 or above.

Host support: Any host software with support for FW-1082, Mackie Control, HUI, or MIDI control

Bundled software: SoftLCD, Cubase LE, GigaStudio 3 LE, and Nomad Factory plug-in demos

Newsflash: Computers? Have you heard? Well, they're being used in studios now. Surprise, surprise. But, you know, it takes more than just a computer to make music. You need an audio interface, a MIDI interface, some way to control monitor levels, and if you're of the hands-on persuasion, a control surface. And TASCAM's FW-1884 was the company's entree into designing a single FireWire unit comprising all these capabilities — check out my review in the February 2004 issue. Then the family expanded with the rackmount FW-1804 interface. And now TASCAM strikes again with the FW-1082, a scaled down version of the FW-1884.

WHAT IT IS

The idea behind this FireWire control surface/audio-MIDI interface is to package everything you need into one convenient, easy-to-use package.

The FW-1082 has a small footprint: 19" wide, 15" deep. It fit perfectly on my desk in front of my Apple Cinema display.

The FW-1082 is capable of 10 input channels (eight analog, two S/PDIF) and four channels out (two monitor outs and two S/PDIF). Four of the analog channels have mic preamps; all eight sport TRS line ins. Channel 8 can be switched to accept guitar-level signals.

The unit can operate in one of three modes: In computer mode, its knobs, switches, and faders function as a control surface for your DAW. In MIDI mode, they send MIDI messages. In Monitor Mix mode, the unit becomes a standalone mixer.

The big advantage to Monitor Mix is latency-free operation. In this mode, the FW-1082 can monitor incoming audio and previously recorded tracks from the DAW, simultaneously.

As a control surface, the FW-1082 is directly supported in "native" mode by DAWs such as Cakewalk Sonar and MOTU Digital Performer. Apps that don't offer native support can be controlled using Mackie Control or HUI emulation. In MIDI mode, most of the surface's

Digital Performer, there's native support for the FW-1082 (via a plug-in supplied with the unit), so support is complete — though some controls weren't working, such as the Function keys. (TASCAM says this will be fixed by the time you read this.) Sonar also offers native support of the FW-1082.

With Reason 2.5, I was able to program MIDI commands to make support fairly comprehensive. In some programs I could get the faders and transport

controls happening; support for other controls varied. In Nuendo/Cubase SX, everything worked perfectly. Comprehensive Logic support is on the way.

TAKE CONTROL

As an audio interface, standalone mixer, MIDI interface, and monitor level controller, the FW-1082 worked well for me. As a control surface,

results varied from good to excellent. Taken as a whole, the package offers good value in an easy-to-use format. If you're looking to consolidate the hardware front-end of your DAW, TASCAM's FW-1082 is a strong contender. **EQ**



controls can be programmed to send MIDI messages.

HOW IT WORKS

Installation couldn't be easier: just hook up one power and one FireWire cable. The preamps sound good, the mixer is clean, and the monitor section does the job.

I used the FW-1082 on an Apple PowerBook G4 running OS X 10.3.5 and on a dual-G5 running OS X 10.2.8. As an audio interface it worked flawlessly with Digital Performer, Nuendo, Logic, Live, Reason, Peak, DSP-Quattro, and various software instruments. As a control surface, the capabilities you have depend on the support offered by your application. With

Strengths:

- Stereo monitor control
- 2-in/2-out MIDI interface
- Near-universal software compatibility
- Good audio quality
- Latency-free overdubbing
- Standalone mixer mode
- 10 audio inputs, 4 mic preamps

Limitations:

- No meters or position counter

Power Tools for power players

One performance. Get it right.
Pros demand the best from the tools they use.
Power Tools... by Radial.



Radial JD7 Injector - suggested list \$849 US

Guitar freaks rejoice! Drive up to 7 amplifiers at the same time without changing the original tone of the guitar and do it without buzz or hum caused by ground loops. Record a dry track with the built-in DI and send the signal back to the JD7 and re-amplify it to 7 amps and effect pedals. Addictive.

Radial J48 Active DI - suggested list \$199 US

For great sound without choking, look no further than the Radial J48. Features a 48V phantom supplied active drive circuit with a unique DC-to-DC transformer isolated switching power supply to provide amazing headroom while eliminating hum and buzz caused ground loops. Radial.

Radial JDI Passive DI - suggested list \$199 US

Jensen Transformer equipped, the Radial JDI has become the standard passive DI in the business. Exceptional noise rejection eliminates troublesome ground loops and virtually zero phase distortion at any level makes the JDI a must have for studio and stage. Available in single, stereo or 6-pack. Magic.

Radial X-Amp Re-Amplifier - suggested list \$199 US

Ever wish you could go back and change the sound of a pre-recorded guitar track? Now you can with X-Amp. When tracking, record a spare dry track and play it back through the X-amp after the guitarist has gone home. Two outputs lets you drive amps and pedals to create thick new textures. X-plosive.

Radial JPC Stereo DI - suggested list \$199 US

Designed specifically for PC sound cards, DVD players and all those cool consumer devices that cause nothing but havoc, the JPC is 100% transformer isolated to eliminate nasty ground loops and equipped with a 48V active drive circuit for long cables. Easy to use. Great sounding. Indispensable.

Radial JDV Super DI - suggested list \$449 US

There is no finer DI than the Radial JDV. 100% discreet Class-A topology with a feed forward design that sounds so true, it'll make the hair on your arms twitch. Drag™ Control pick-up load correction, A or B inputs, 4 instrument amp outputs, hi-lo filters and amazing headroom combine for the most powerful DI ever made. Unbeatable.

Radial...The world's finest direct boxes



www.radialeng.com

1638 Kebet Way, Port Coquitlam BC V3C 5W9 tel: 604-942-1001 email: info@radialeng.com

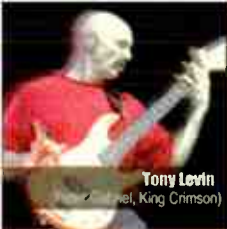

Tony Levin
(Metal, King Crimson)



Billy Sheehan
(Mr. Bungle)



Joe Perry
(The Aerosmith)



Jimmy Hasty
(John Seals, Robben Ford)



Mark Howard
(Bob Dylan, REM, U2)

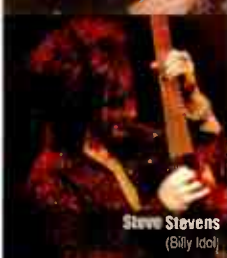

Steve Stevens
(Billy Idol)



Chuck Rainey
(Queen, Dick, Barbra Streisand)



Howard Stern
(Tom Petty, Rush, Meco)

by Mitch Gallagher

BLUE Robbie

Take a break from black box mania with this new BLUE preamp

Type: Class-A discrete tube preamp

Price: \$1,299

Contact: www.bluemic.com

Controls: Gain, Polarity, Pad, Mic/Inst, Phantom

Inputs: 1/4" instrument (front), XLR mic (rear)

Outputs: XLR line

Minimum gain: 8dB

Maximum gain: 68dB

Frequency response: 10Hz to 100kHz, ±2dB

Noise: -131dB (60dB gain, 10Hz to 30kHz, 50 ohm source)

Mic input impedance: 5k-ohm (20Hz to 20kHz)

Instrument input impedance: 1M-ohm

Why is so much studio gear constrained to the black box motif? We're creative people, yes? Pursuing a creative endeavor, right? You'd think we'd want our gear to reflect our personalities more, looks-wise. Yes, yes, I understand that black boxes seem "professional," and I'll also admit the obvious: they stack nicely in a rack. But it's still a relief to see something come along now and then that breaks the black box mold.

BLUE has never been a company to follow the "me-too" appearance policy to which many gear manufacturers adhere. Their mics look different, so it's only natural that their other hardware looks different, too. And Robbie, the company's discrete class-A tube preamp, is one cool looking customer — no one will mistake this for an average, everyday preamp.

Robbie's glowing ECC88 tube protrudes into a bay window on the left of the front panel. To the right is a large backlit gain knob. The only other thing on the front panel is a 1/4" instrument level input jack.

Everything else lives around back, which is just as spartan as the front panel. There are five switches: polarity reverse, 20dB pad, mic/inst input selector, phantom power on/off,

and power. If you choose to rackmount a Robbie or two using the optional adapter, then the back-panel location of those controls will likely be a problem. An XLR mic in, XLR line out, and locking AC jack for the external power supply round things out. When you plug Robbie in, the tube enters "standby" mode, sort of like a guitar amp, so it's warm and ready to go.

IN USE

There's one word that can be used to describe using Robbie: simple. Plug it in, turn up the gain. Maybe set a switch or two. That's it. There are no metering nor even an overload light on Robbie — you'll just have to use your ears to detect distortion, or watch the levels in your recorder. Given that the preamp is spec'd with 34dB of headroom, you'll probably overload the next stage in your recording chain before you do Robbie.

BLUE aimed Robbie at pure, audiophile quality, using no integrated circuits. There's discrete components from input to output, with ultra low-noise metal film resistors, polystyrene caps, electronically balanced input and output stages, and, of course, the ECC88 twin-triode tube gain stage.

The result of the use of those discrete components is a round, fat sound without hype on the top or bottom. On vocals, Robbie fills in the bottom nicely. The midrange is full but not overly present. Tracks recorded through Robbie tend to sit right where they should in the mix. I found no need to EQ the mids to tame harshness.

The top end is smooth and detailed, without being hard or

"spitty." On one male vocal passage, Robbie smoothed out the excess sibilance perfectly. All the detail and clarity was there, but the "s's" weren't over-emphasized.

On acoustic guitar, both nylon and steel-string, I was thrilled with Robbie's top end — it was open and clear, very natural sounding. You could easily hear fingers on strings and fret/string contact, and harmonics rang clear and true. I feared Robbie's low end might make acoustic guitars sound boomy or muddy, but this wasn't an issue. The lows were full, but stayed tight and "real."

MORE THAN JUST A PRETTY FACE

I found Robbie to be an excellent complement to solid-state designs like the Focusrite ISA series, as well as to Neve/Neve-clone designs. It has a clean, unique sound that blends well, sits well in a mix, and doesn't strain to achieve clarity and presence. At \$1,300 per channel retail, it sits in the mid-price range for tube preamps, but it performs like it costs much more.

Yes, Robbie looks cool. But it also delivers excellent audio quality. An outstanding combination. 

Strengths:

- Couldn't be simpler
- Cool tabletop unit
- Audiophile design
- Fat bottom-end
- Round midrange
- Smooth extended top-end

Limitations:

- No metering
- Rear-panel location of most controls problematic when rackmounting



GXL Studio Packs

Just add inspiration



GXL3000 Stereo Studio Pack One GXL3000, Two GXL1200s & One EPF15A Pop Filter

GXL3000 Studio Pack One GXL3000, One GXL1200 & One EPF15A Pop Filter

GXL 2200 Stereo Studio Pack One GXL2200, Two GXL1200s & One EPF15A Pop Filter

GXL 2200 Studio Pack One GXL2200, One GXL1200 & One EPF15A Pop Filter



www.cadmics.com

800-762-9266

World Radio History



by Craig Anderton

IK Multimedia Sonik Synth 2

Son of SampleTank 2? Well, yes. But mostly no...

Type: Synth "workstation" plug-in
Price: \$399, (\$199 crossgrade from SampleTank 2.0 XL/L)
Contact: www.ikmultimedia.com

Platforms/formats: Mac OS X 10.2.8 or later (AU, VST, RTAS), Windows 2000/XP or later (DXi, VST, RTAS).

Copy protection: Serial number provided with program; program generates machine ID. Register to receive unlock code.

Demo: 10-day unlimited functionality

Manual: Printed manual for program and sounds, with PDFs on distribution media.

Supported sample rates: Up to 96kHz

Sonik Synth 2 uses SampleTank 2's audio engine, the same (excellent) suite of effects, and even has a very similar interface. SampleTank 2 is a multitimbral workstation with lots of sounds and multiple outputs, whereas Sonik Synth 2 is . . . a multitimbral workstation with lots of sounds and multiple outputs. So, aren't we talking, uh, "redundant" here?

Nope. The emphasis of the two instruments is very different. Whereas ST2 (reviewed 1/04) specializes in acoustic and electric instruments, with synths and keys to round out the collection, SS2 specializes in synths and keys, with acoustic and electric instruments to round out the collection. And, areas that overlap aren't the same, so combining the two gives a wider range of options.

Another factor is that Sonik Synth's collection is pretty cutting-edge. Just as ST2's instruments bested ST1's, SS2's set takes advantage of what the Sonic Reality people have learned about sampling over the past few years. Judging on the sounds, they've learned quite a bit. And they've also been doing a lot of sampling.

The *characters* are quite different too, and this is key. ST2 tends toward the natural and realistic, whereas SS2 wraps itself with the sonic equivalent of lipstick and eyeliner to often produce larger-than-life sounds. For example, I innocently called up the Romance Strings patch, expecting some syrupy string ensemble. Wrong. The strings had rosin and spit, with a nicely developed midrange. If we're talking romance, it's with someone who's not shy about walking across the room and asking for your number.

The stars of the show are synths — vintage synths, synth pads, new synths, synth basses and leads, synth FX, you name it — and keys, including tasty stacks, Mellotron samples, clavs, pianos, and more. But that's not to diminish the brass, guitars, drums, effects, vocal textures, orchestra sounds, and "elements" (everything from looped grooves to strange noises). There are 8GB of samples and over 5,000 sounds — whew.

Which brings up a potential problem: Including creative, "left field" sounds is welcome, but by nature, these work in specific contexts. With a "workstation" you want to find needed sounds fast. SS2 has, for example, hundreds of synth basses, so it takes time to find just the right patch. But here's the *great* news: The instruments don't come as one huge data file, so you can move/copy them into custom directories, and point SS2 toward these as defaults. Or, create a folder for sounds you don't care for, thus slimming down the library to your favorites. While this program

just about screams for a simple "favorites" function, what's offered does the job. The keyword-based search function helps, too.

Best of all, the sounds are highly editable. For example, I liked one bass except for some excessive filter resonance — so I just turned it down. To my ears, some sounds go over the top on effects, while others don't add enough. But it doesn't matter, because I can tweak 'em the way I want anyway. Or the wonderful MotionsyFMHrmnx patch that was perfect except it didn't have enough release time — a quick trip to the amp envelope, and problem solved. Yet editability isn't just for tweaks; you can get pretty creative.

I really wanted to review SS2, because what I heard at NAMM was impressive — and I remain very impressed. Just remember that SS2 is all about tweaking it for your own use, from organization to parameters. This is a plug-in that wants you to, well, not be shy about walking across the room and asking for its number.

Strengths:

- So many sounds you're bound to find ones you like
- Extreme cost-effectiveness
- Well-recorded, quality sounds
- Plentiful effects
- Good MIDI control
- Can re-organize library to suit your needs
- Very editable

Limitations:

- So many sounds you're bound to find ones you don't like
- Some aliasing in highest keyboard octaves
- Effects sync, but LFOs don't





Create.

You supply the inspiration.

We'll supply the gear.

Finding that precise musical nuance to evoke your mood. Nailing the exact phrase that gives voice to your feelings. Searching for a tone that expresses your vision. That's the creative process. And it doesn't come easy.

At Musician's Friend we have the tools to fuel your creativity. Our enormous selection of instruments, recording gear, software, and other music tools offers the building blocks to bring your musical inspirations into reality.

Visit us online to discover over 30,000 creative tools at the lowest prices anyplace, guaranteed. You'll also find countless product reviews, tips, articles, and fun stuff. Call us to receive our catalogs brimming with the gear to give voice to your ideas.

Find out what millions of musicians already know—when that moment of inspiration arrives, we're here with the tools to help you give it full expression.



Musician's Friend

The World's Largest Music Gear Company

For Your **FREE** Catalogs

800-436-6981 • musiciansfriend.com/free

Source Code: EQED

- Lowest Price Guarantee • Satisfaction Guarantee
- Free Shipping on Most Orders Over \$199* • Call or Click 24/7
- Huge Inventory of In-Stock Gear Ready for Immediate Delivery

Limited to stock on hand; prices subject to change; standard catalog shipping rates apply.
*Some exceptions apply, call or go online for details; limited time only.

World Radio History



Peterson VS-S Strobostomp

by Mitch Gallagher

Price: \$309

Contact: Peterson Electro-Musical Products,

www.petersontuners.com or
www.strobostomp.com

Strengths:

- Built-in DI
- True Bypass
- DC power through
- 10 preset, 2 user temperments
- Capo/drop-tuning
- Easy to read display

Limitations:

- None to speak of



Looks can be deceiving. Good things come in small packages.

You can apply both sayings to the Peterson VS-S Strobostomp. The Strobostomp is a "virtual" strobe tuner, accurate to 1/10 cent, and a DI. Its case is lightweight, and feels like plastic. In fact, it's made of aluminum — and there are pictures on the Peterson site of a Strobostomp being run over, dragged behind a vehicle, then tossed in the air to be hit by a baseball bat before finally landing on the pavement. The scarred box is then shown to be working after this "demo."

You can adjust concert pitch from 433 to 447Hz, and there are 10 preset and two

user temperments. The entire temperament can be shifted in semitones to support capo (up to five frets) or drop tunings (as far as four semitones).

The Strobostomp can run off a 9v battery or an external wallwart. A DC power out jack lets you daisychain other pedals from the same power supply. There are 1/4" input and output jacks, and an XLR for DI output. A DIP switch inside the battery compartment controls ground lift for the DI and two monitoring modes. In Tuner Monitoring + DI Output mode, incoming signal is routed to both the 1/4" and XLR outs, and the tuner is active all the time. Step on the footswitch and the outputs are muted for silent tuning. In 100% True Bypass

mode, the incoming signal goes through the tuner only when the footswitch is off, which also mutes the outputs. With the footswitch on, the tuner is off and the signal flows straight from input to outputs.

In use, this thing works great. The backlit LCD "strobe" is easy to read, and the DI is clean and uncolored. Tuning is straightforward and accurate: the Strobostomp worked well on electric and acoustic guitars (with pickups), as well as electric basses.

At \$309, the Strobostomp isn't a bargain basement tuner. But for the price you get an excellent, lasts-a-lifetime tuner and DI that offers features not found on any other stompbox. Highly recommended for stage and studio.

Audio-Technica Pro 70

by Mitch Gallagher

Price: \$179

Contact: Audio-Technica,

www.audio-technica.com

Strengths:

- Tiny
- Includes instrument and clothing clips
- Phantom or battery power
- Good noise rejection
- Highpass filter

Limitations:

- Requires EQ for best sound



Lavalier microphones don't find much use in recording studios —

the diminutive "lapel" mics are much more common on stage. And generally not on "music" stages — usually they're used for lectures, plays, that sort of application. But before pigeonholing all lavaliers, you should check out Audio-Technica's Pro 70, which is categorized by the company as a "lavalier/instrument" mic. It was the "instrument" part that caught our eye at last year's Summer NAMM show.

The Pro 70 capsule/element is tiny; it's permanently connected with a 6' cable to a "power module" that's roughly 3" x 2" x 1". The power module can hold a battery for powering the mic — or use

phantom power, if you prefer — and has an XLR jack for a standard mic cable.

The Pro 70 comes with two mounts. One is for clipping the mic to clothing. The other can slip onto the edge of a guitar soundhole. An adjustment screw positions the mic nearer to or farther from the strings.

I tried the Pro 70 on both a Taylor steel-string and a Rodriguez nylon-string classical guitar. The mount slips onto the soundhole easily and securely, and is padded to prevent marring the guitar's finish. The mic is small enough to be unobtrusive to the player.

Positioning any mic near a guitar soundhole invites excess "boom," and as expected, the Pro 70 picks up a lot of bottom. By adjusting it as far as possible from the hole, you can control this a bit.

There's also an 80Hz highpass filter, switchable from the power module. But even with the filter engaged, you're probably going to need EQ to get the tone you want.

The mids and highs are far better than any pickup can deliver — more natural and smooth. I expected to hear a lot of pick or fingernail attack, but was pleased to find that assumption invalid. A big plus was the focused polar pattern: Noise rejection was excellent, making the Pro 70 useful for tracking acoustic guitars along with other instruments and vocals.

The Pro 70 proved very functional in the studio: It works well for isolating an instrument, and provides a much more natural tone than any pickup I've heard. You'll probably need some EQ to get the sound you want, but the benefits are well worth it.

INTEGRATION

Live Sound & PA
Solutions

Desktop Audio • Live Sound/PA • Pro Recording
• Broadcast/ENG • Electronic Field Production

420 Ninth Ave., NYC 10001
www.bhproaudio.com
800-947-5518

B&H
PHOTO - VIDEO - PRO AUDIO

Sounds



SONY
Chicago Fire: Dance Music Anthology

Contact: Sony,
www.sony.com/mediasoftware
Format: Five CD-ROMs (44.1kHz/16-bit Acidized WAV)
Price: \$249.95

The video producer calls. "We're doing a movie where this senator's daughter is on the run, and melts into the underground club scene.

We need a bunch of music — some deep house, some electro, drum 'n' bass for the big car chase, a little progressive, and some old school for a couple love scenes. We need it in a week. Whaddya say?"

If you have Vince Lawrence's Chicago Fire, *take the gig*. This ambitious, beautifully packaged boxed set has one CD-ROM for each of the musical styles just mentioned. The CDs average around a couple dozen "themes" (except for progressive, with a whopping 73), which are basic construction kits. Each kit has at least one full mix, which makes auditioning easy. But you'll also find lots of additional sounds in other folders, like looped licks and phrases, some vocals, and one-shots

(mostly drum sounds and effects) so you can throw in your own accents. Acidization is up to Sony's usual high standards, so mix and match is a given. Even the example files, which include additional "promo" loops, provide value.

Deep House and Progressive are outstanding. Give me Ableton Live, the Progressive CD, and a laptop, and I bet I could keep a clubful of dance fanatics entertained for hours. Electro is a little house-ish for my taste; I prefer the harder, Kraftwerk-style machine soul. But once I accepted it wasn't as robotic as I'd hoped, I could make some fine music on its own terms.

Drum 'n' Bass is the least consistent. It has its moments; when it's on, it's *really* on — I just don't quite

feel it like the others, which pretty much hit a home run every time up to the plate. On the other hand Old School is sheer delight, especially the vocal phrases (which work pretty well with the other genres, too). While House lays the groundwork for mating ritual mode and Progressive oozes late night club vibe, Old School is just plain feel-good irresistible.

You might blink at \$249.95, but this set is great value for money if you need all the genres represented. Even if you just need some of them, the quality of the individual CDs make the entire package a cost-effective contender.

Bottom line: A lot of my other sample CDs just got retired. —CRAIG ANDERTON

It's Not Rocket Science

(well, maybe a little)

You don't have to be a "Rocket Scientist" to design and build great analog gear. We've spent 150 years doing just that. That's why our engineers can't wait to help you develop the next generation of gear.

The Joemeek A/D & D/A converter module is now the only digital module with just one thing in mind: so that when you plug in a 1/4" mic, you can hear it.

Find more about the twinQ and other products at www.joemeek.com

JOEME EK
If it sounds right, it IS right!

AdIndex

These companies would be very happy to assist you in obtaining more information about their products and services. Please contact them via phone or online. For a better response, tell them "I saw it in EQ!"

COMPANY	PHONE	WEB	PAGE #
Alesis	401-658-5760	www.alesis.com	65
Auralex Acoustics	800-95-WEDGE	www.auralex.com	70
B&H Pro Audio	800-947-5518	www.bhproaudio.com	67, 79
Broadcast Supply Worldwide (BSW)	800-426-8434	www.bswusa.com	83
CAD	800-762-9266	www.cadmics.com	75
Cakewalk	888-CAKEWALK	www.sonar4.com/mix	15
Clarion	800-Vivaldi	www.ClarionIns.com	52
Conservatory Of Recording Arts & Sciences	800-562-6383	www.audiorecordingschool.com/eq.html	42
Digidesign	650-731-6300	www.digidesign.com/icon	23
Disc Makers	866-294-8829	www.discmakers.com/eq	58
E-MU	877-742-6084	www.emu.com	33
Ex'pression College for Digital Arts	877-833-8800	www.expression.edu	63
Focusrite		www.focusrite.com	59
Frontier Design Group	800-928-3236	www.frontierdesign.com	34
Furman Sound	707-763-1010	www.FurmanSound.com	56
GC Pro		www.gcpro	47
Gefell	604-942-1001	www.gefell-mics.com	51
Genelec	508-652-0900	www.genelecusa.com	5
Grace Design	303-443-7454	www.gracedesign.com	32
Image-Line Software		www.image-line.com	45
JBL Professional	818-894-8850	www.jblpro.com/SLR	55
Lexicon Pro	801-568-7567	www.lexiconpro.com	49
Lucid Audio	425-778-7728	www.lucidaudio.com	70
M-Audio	626-633-9050	www.m-audio.com	13
Mackie	800-898-3211	www.mackie.com	C2-1, 39
Mark Of The Unicorn		www.motu.com	C4
Marshall Electronics / Mogami	800-800-6608	www.mogamicable.com	50
MindPrint		www.mindprint.com	44
Musician's Friend	800-436-6981	www.musiciansfriend.com/free	77
Musicians Institute	800-255-7529 ext151	www.mi.edu	62
Native Instruments	866-566-6487	www.ni-absynth.com	57
Neumann USA	860-434-5220	www.neumannusa.com	64
Neutrik		www.neutrik.com	53
Oasis CD Manufacturing	888-296-2747	www.oasisCD.com	71
Phonic	800-430-7222	www.phonic.com	31
PMI Audio Group	877-563-6335	www.joemeek.com	80
Propellerhead Software		www.propellerheads.se	35
Radial Engineering	604-942-1001	www.radialeng.com	73
Recording Workshop	800-848-9900	www.recordingworkshop.com	70
Royer Labs	818-760-8472	www.royerlabs.com	68
Sonic Circus	888-SC4-GEAR	www.soniccircus.com	82
Sony Pictures Digital	800-577-6642	www.sony.com/mediasoftware	27
Sweetwater Sound	800-222-4700	www.sweetwater.com	19
Sweetwater Sound / Digidesign	800-222-4700	www.sweetwater.com	41
Sweetwater Sound / MOTU	800-222-4700	www.sweetwater.com	92-93, 94-95
Sweetwater Sound / Tapco	800-222-4700	www.sweetwater.com	61
Tascam		www.tascam.com	3
T.C. Electronic	818-665-4900	www.tcelectronic.com	43
Vintech	877-4-MIC-PRE	www.vintech-audio.com	82
Waves	865-909-9200	www.waves.com	11
West L.A. Music	310-477-1945	www.westlamusic.com	52
Yamaha Corporation of America	877-YAMAHA5	www.yamaha.com, www.01xray.com	C3

Sounds



CYCLING '74

Cycles :03 — Incidental Gesture

Contact: Cycling '74,
www.cycling74.com

Format: 1 audio CD, 1 DVD-ROM
Price: \$99

Sound designer Ron MacLeod has been hard at work. In less than a year he's cranked out three volumes of his *Cycles* series of "audio source libraries" for

Cycling '74: :01 — Sustained Encounters (long evolving textures; reviewed April '04), :02 — *Unnatural Rhythms* (mechanical, electronic, found sound loops; reviewed September '04), and now :03 — *Incidental Gesture* ("active" sonic textures and melodic meanderings; reviewed, um, here). Each volume includes two discs: One is a DVD-ROM of the files presented at 44.1 and 48kHz sample rates; in both cases the resolution is 24 bits. At 44.1kHz, there's 1.6GB of data, at 48kHz, 1.8GB. The other disc is an audio CD for auditioning, or for ripping. DVD file index and CD track index documentation are provided in PDF and Excel spreadsheet formats. Tempo, bar length,

and key are indicated where appropriate — although many of the files have none of those attributes. As with the previous two volumes, this one is recorded and edited with exemplary quality. And the amount of material you get makes the \$99 price tag a steal.

Five broad sonic categories are included on *Incidental Gesture*: Horn-based Gestures, Melodic Meanderings, Moody Incidentals, Narrative Expressions, and Rhythmic Beds. The sounds tend toward heavily processed sonic events, unusual electronic sounds, sweeps and glides, eerie textures — in all cases, there's lots of atmospheric *vibe*. What you won't find are "mainstream"

drum loops, instrument samples, and so on — this volume focuses on long mood-generating tones, dark background effects, dissonance, and atonal melodic phrases.

Many listeners will automatically think "film score" when they hear *Incidental Gesture* (check out the demo at the *Cycling '74* site for a taste); but this collection is capable of much more than just movie backgrounds. Use it any time you need to inject unique sonic spice into a production. —MITCH GALLAGHER



SONIC CIRCUS
Serious Studio Infrastructure

The most comprehensive selection of recording equipment in the world.

www.soniccircus.com
1-888-SC4-GEAR

SONIC CIRCUS

Vintech
Introduces the X73i!

We put this piece head to head with vintage Neve 1073's at this year's AES show. It is 100% guaranteed to meet your expectations and is an incredible value. List price \$1595 **Special \$1375**

The X73
The Vintech X73 features custom hand wired concentric style switches with gold plated pins. Swiss made military grade attenuator switch. List price \$1995 **Special \$1795**

The "X81 CLASS A"

The Model 473

www.vintech-audio.com
1-877-4-MIC-PRE

NEW!!

BSW Presents Shure's New Performance Gear Wireless!

For \$399 you can have a world-class handheld wireless system.



Shure PGX24-SM58 Handheld Wireless System

It's never been easier to go wireless and sound like a pro. Shure's new Performance Gear Wireless brings the road-tested sound of Shure microphones together with innovative automatic setup features for worry-free performance, every time. Performance Gear Wireless systems feature Shure's patented Audio Reference Companding for crystal-clear sound. The PGX24-SM58 features the popular SM58 cardioid mic cartridge with its vocal-tailored 50 Hz-15 kHz frequency response and durable construction, with the PGX2 handheld transmitter and PGX4 diversity receiver.

PGX2 Transmitter Features:

- Automatic transmitter setup
- Multi-function LED indicator (power, lockout, mute, low battery)
- -10 dB pad
- 2 AA batteries provide 8 hours of continuous use
- 18 MHz operating range

PGX4 Receiver Features:

- Automatic frequency selection
- 90 selectable frequencies across 18 MHz bandwidth
- 1/4 wave antennas
- Microprocessor-controlled diversity
- Channel display LED
- XLR and 1/4" outputs

LowestPrice@bswusa.com System Only \$399!

List \$558 - you Save \$159 AND get FREE SHIPPING when you order on the web • Order Item Number: PGX24SM58

Systems also available in these handheld mic configurations:

w/ Beta 58 Capsule PGX24BETA58 List \$638 **SALE \$449** • w/ PG58 Capsule PGX24PG58 List \$530 **SALE \$379**

NEW!!



BBE MaxCom Multiprocessor



Now you can easily get a live or recorded mix with the clean, clear punch that only a truly professional dynamics controller can, with the added benefit of the enhanced sound delivered by BBE processing. The MaxCom is a dual-channel compressor and limiter with gate which features an onboard **BBE Sonic Maximizer** circuit, all housed in a compact and easy-to-use TRU package.

MAXCOM List \$329.99 **LowestPrice Only \$199⁹⁹!!!**



Tascam Mastering Recorder TASCAM DSD and Standard Format to DVD/CD

NEW!!

Introducing the new standard for stereo audio recording: DSD (the Super Audio CD audiophile standard) in an affordable DVD+R/RW recorder. The DV-RA1000 records standard CD audio to CDs or DVDs at up to 192 kHz/24-bit resolution, as well as recording in the DSD format. Multiband compression and 3-band EQ mixdown effects make it IDEAL for digital mastering. It features a user-friendly front panel interface, wired remote and professional connections including USB 2.0 port and RS-232 serial control, as well as balanced XLR and unbalanced RCA input/output connections. The DV-RA1000 supports UDF disk format for cross-platform computer compatibility.

DVRA1000 List \$1,499 **LowestPrice@bswusa.com**

M-Audio Solaris Large Capsule Multi-Pattern Condenser Mic



A great all-around studio mic for an incredibly low price! Vintage design principles merge with incredibly tight manufacturing standards to yield no more than +/-1 dB variation from mic to mic, meaning any two Solaris mics are a matched pair. The industry-thinnest evaporated gold diaphragm also delivers incredible sensitivity. Multi-pattern architecture provides flexibility that makes it ideal for just about any mixing situation—including capturing vocals, guitar, piano, drums and live events.

M-AUDIO

SOLARIS List \$349.95 **LowestPrice@bswusa.com**



Incredible Value Headphones

Five Sennheiser HD202 headphones for \$89.00? We're not kidding! These durable, sealed-ear headphones provide crisp bass response and good isolation. Powerful neodymium magnets offer high sound levels with 18 Hz-18 kHz frequency response. Impedance 32 ohms. BSW has sold over 10,000 of these popular headphones! **HD202PKG List \$149.75**

LowestPrice 5 for only \$89!!!

M-Audio DX4 Powered Studio Monitors

Perfect for desktop monitoring where space is at a premium, the DX4's optimized drivers and advanced crossover technology insure the highest-fidelity sound. "OptiImage" wave guide technology assures improved stereo imaging. Features: 4" LF driver/1" HF drivers, 18 watts/channel amplification, volume control, 1/8" headphone jack, mid-cut switch optimizes tuning, connectors: 1/4" TRS, RCA. Sold as pair.



M-AUDIO

DX4 List \$199.95 pair **LowestPrice only \$149 pr!**

Mackie Onyx 1640 Mixer

Mackie's Onyx Series mixers have it all: newly-designed high-end preamps and EQ, and balanced direct outputs on every channel via dual DB-25 connectors (a first for any small-format mixer). And here's a first: an optional FireWire I/O card lets you stream 18 independent channels of 24-bit/96 kHz audio, plus a stereo mix, directly to your Mac or PC. Incredible!



ONYX1640 List \$1,539 **LowestPrice@bswusa.com**

FREE SHIPPING ON ORDERS OVER \$189!!! Just make your purchase on our website and we'll cover the shipping!

Lowest Prices at: www.bswusa.com



1-800-475-8384 World Radio History

Same Day Shipping

BSW offers a huge selection of products. Five days a week, we'll ship your order the same day. Subject to 10:00 AM Eastern Time.

Free Shipping on Web orders over \$189

For a limited time, all web orders over \$189 will receive ground shipping delivery at no charge. All orders are subject to product availability.

Knowledgeable Staff

Our staff has over 20 years of experience in the audio field. We will give you the best advice possible.

LowestPrice@bswusa.com

We will beat any price on any item you can find. We will also provide you with the best service possible. Visit us at www.bswusa.com or call 1-800-475-8384.



Managing Latency

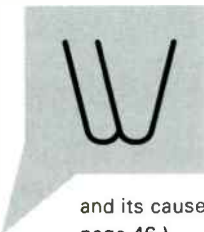

Want great results with your DAW? Then you're going to need to get latency, or timing delays, under control. For our part, we're going to be looking at some specific examples of how to manage and reduce latency using software settings. (For an in-depth discussion of latency and its causes, check out Mitch Gallagher's article on page 46.)

Even with software, though, hardware buffer size has the most direct effect on latency, so this should/must be the first thing you check.

PRO TOOLS

Using Pro Tools LE 6 (6.7) as an example, we can see that the Playback Engine window (found in the Setups menu) contains the "H/W Buffer Size" setting.

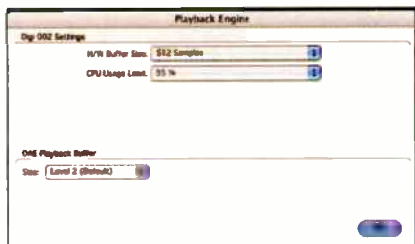

Lowering the H/W Buffer Size will reduce the delay experienced when monitoring audio when recording tracks, and with auxiliary and instrument tracks. Users generally find that with the H/W Buffer Size at 128 samples they don't perceive noticeable delay (at 44.1kHz, that's approximately 3 milliseconds). Remember that a smaller H/W Buffer Size will increase strain on your host CPU. So watch the CPU meters, and don't reduce the buffer size so much that you run out of computer power.

Note that Pro Tools' Playback Engine window contains some additional parameters, including the "DAE Playback Buffer." Be careful not to confuse this with the Hardware Buffer above. Adjusting the DAE Playback Buffer will not reduce latency, and can in fact hinder performance when improperly adjusted.

DIGITAL PERFORMER

With Digital Performer 4.5, we'll see a similar parameter in the "Configure Hardware Driver Window" (*Setup menu > Configure Audio System*).

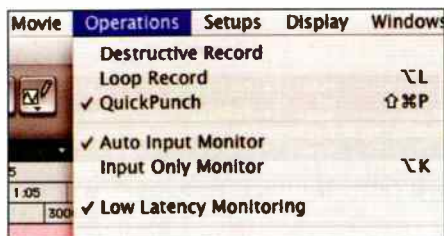

The "Buffer Size" parameter can be raised or lowered to reduce latency. (Note the "Host Buffer Multiplier" setting below Buffer Size. This setting won't directly affect latency, and should be kept at level 1 unless you're using multiple CoreAudio devices at the same time.)

SPECIAL FEATURES

Several applications, including Digital Performer and Pro Tools, have added software features to manage latency so that you don't have to struggle with hardware buffers. When using Pro Tools with the Digi002 (or Digi002R), "Low Latency Monitoring" can be employed while recording audio.



When enabled, the audio being recorded "takes a shortcut" and uses the internal hardware mixing features in the Digi002 to send input directly to output (as well as the computer), resulting in zero latency. One catch is that any plug-ins inserted on the record tracks will be bypassed while recording. And this feature won't reduce latency on instrument/aux tracks.

Taking a different approach, Digital Performer 4.5 adds a new feature called "Automatic Plug-in Latency Compensation" (found in *Setups > Configure Audio System > Configure Studio Settings*).

This option is designed to deal with the latency resulting from instrument tracks, powered plug-ins (such as the TC Electronic PowerCore or Universal Audio UAD1), and certain native plug-ins. By "looking ahead," Digital Performer can anticipate plug-in delays and adjust the entire song to compensate.

(While we're looking at this "Configure Studio Settings" window, it's important to note that adjusting the "Buffer size per voice" won't affect latency.)

Most audio recording apps have some kind of buffer size setting you can adjust to reduce latency. Some also have "low latency" or "latency compensation" features, as in the examples above. Be sure to check documentation for your software to make sure you're making the proper adjustments. EQ

Todd G. Tatnall is the Senior Tech in Sweetwater's Technical Support department.



**Expansion Tank™
SampleTank® 2 LE
Sound Modules**

IK Multimedia

Now Available

Expansion Tank™ is a powerful new sound module plug-in series of over 20 titles. It combines SampleTank® 2 LE with sample libraries from world-class sound designers, AMG, Sonic Reality and more.

SRP: \$99, \$249 3-Packs

www.sampletank.com

954-846-9101

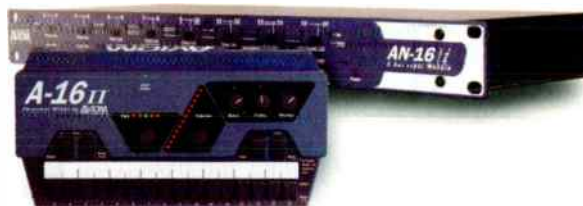

Aviom Monitor Mixing System™

Aviom, Inc.

Now Available

Aviom solves monitoring problems by giving performers control of their monitor mix. Sixteen digital audio channels are delivered to a compact controller that drives earbuds, headphones, or powered speakers and can save sixteen mixes.

SRP: A-16II Personal Mixer \$499.95, AN-16/i Input Module \$899.95

www.Aviom.com

610-738-9005

B24 ELITE™ ProPanels™

Auralex Acoustics, Inc.

Now Available

B24 ProPanels are 2'x4'x1" fabric-covered acoustic absorptive panels designed to absorb slap and flutter echo while providing an aesthetically pleasing listening environment.

SRP: \$149 per panel

www.auralex.com

317-842-2600

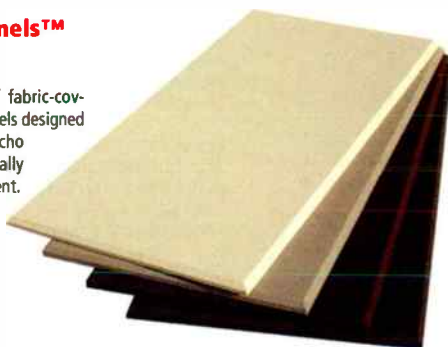

EC1 Channel Strip & DC2 Dual Compressor

Toft Audio Designs

Now Available

The EC1 & DC2 continue the legacy of Malcolm Toft, legendary UK console designer. The EC1 Channel Strip combines Mic Pre, FET Compressor, and EQ into a compact 1ru unit. The DC2 packs two channels of FET Compressor into a single rack space.

SRP: \$799 (each)

<http://toftaudiodesigns.com/>

877-563-6335 (toll free)

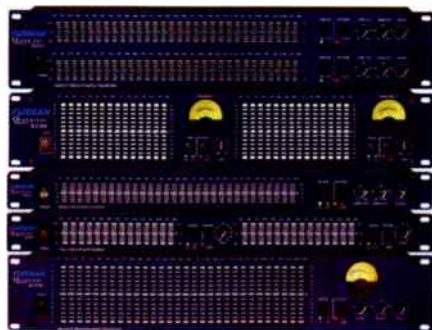

Q Series Equalizers

Furman Sound, Inc.

Now Available

The Q-Series equalizers includes 5 different models to suite various needs. All feature constant Q circuitry with 4% center frequency accuracy; 1/4" TRS and XLR balanced I/Os; and RCA unbalanced I/Os for maximum interface flexibility.

SRP: \$179 - \$299

www.FurmanSound.com

707-763-1010



**RSM-2 Ribbon Studio
Microphone**

Nady Systems

Now Available

Breakthrough affordability, with the uncompromised performance of a classic ribbon mic: figure-8 pattern, smooth audio with natural low and high ends, ultra-high SPL capability, unmatched transient response and stunning realism.

SRP: \$349.95

www.nady.com

510-652-2411

To advertise in this section of EQ contact Derick Joy at 650-513-4403 djoy@musicplayer.com
For more information about these products, visit www.eqmag.com



Propellerhead Reason

Assigning Individual Outputs for Rex and NN-XT Multisamples

Objective: Route individual drum or other samples to individual NN-XT outputs for discrete effects processing.

Background: Reason has two instruments that sport multiple outputs: ReDrum and NN-XT. Processing individual drums through ReDrum is simple: Connect each of its outputs to its own mixer input. However, ReDrum doesn't support velocity-switched multisamples or feature sophisticated sound sculpting tools (LFOs, multimode filters, etc.) like the NN-XT does. The advantages to using the NN-XT are numerous, but routing individual samples to separate outputs isn't as easy as patching a drum module to a mixer channel. You'll need to open up the keymap editor and make sample-specific changes. Here's how:

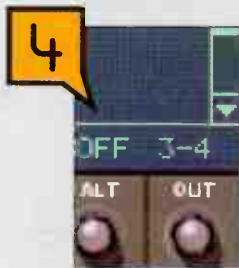

- 1 With a mixer already loaded, create an NN-XT sampler in Reason's rack, then choose a patch with drum sounds or other samples that you'd like to process individually. For example purposes, I chose a Ludwig kit from Sonic Reality's Vintage Drums refill.
- 2 Expand the NN-XT module by clicking the small triangle on the Remote Editor (left-hand side). The Remote Editor will expand to reveal the keymap and synthesis parameters.
- 3 Select a sample; here I chose "LSN2F," a snare sample that I'll process individually with effects.
- 4 From the lower right-hand corner of the keymap display, select an output pair (for example, I selected output 3-4). The selected sample will now be available on the assigned output.
- 5 Flip the rack around, and patch the output pair into the mixer. Now, you're free to add aux or insert effects as you normally would to any other signal.

tips

- To process individual slices of a Rex file, load it into the NN-XT, then follow the steps above.
- For parallel effect processing, first route an output pair into a Spider audio merger/splitter, then out to the desired effects.

MARKETPLACE

To Advertise in Marketplace please contact Derick Joy at 650.513.4403 or djoy@musicplayer.com

CRANE SONG LTD.

Putting music back into digital recording

www.cranesong.com
715 398 3627

pcAudioLabs
<http://www.pcaudioLabs.com>



Custom Digital Audio Workstations

ROCK SOLID.

info@pcaudioLabs.com

818.986.2673

Great Exposure

Manufacture your CD at Oasis and get all of these promotional services—FREE:

- OasisSampler™ Radio Promotion
- Distribution: CD Baby, Borders.com, CD Now, Amazon.com, Virginmega, Waldenbooks
- XM Satellite Radio Airplay
- Sonicbids® Electronic Press Kit
- CD-ROM of 14,000 Music Industry Contacts
- Direct SoundScan® Upload
- Patent-Pending Retail Display Racks

OASIS
CD MANUFACTURING
www.oasisCD.com

tel (888) 296-2747, (540) 987-8810
email info@oasisCD.com

...“The sound was perfect: huge, creamy and tightly focused...the sound was so rich and full that I would’ve sworn that this was a tube pre, except that the sound also had a solid-state focus.”

—PEQ1/PEQ1R review, Mix June '04

PEQ1 CM7 CM12

PEQ1R i wunder

W wunder audio

main number 512.338-6777 new york 516.505-0544
wunderaudio.com

SALE! PLUS FREE ADHESIVE!

MARKERFOAM™ ACOUSTIC FOAM
GIANT 54"x54" • \$21.99
IMMEDIATE SHIPPING

Kill Noise Quick! Maximum density sheets of Markerfoam mount easy & look professional. A low cost, super-effective sound absorption solution that's proven in studios worldwide. Request Foam Catalog & free samples today. Blue or gray available.
2" Reg. \$29.95 Now \$21.99 • 3" Reg. \$39.95 Now \$29.99

MARKERTEK BLADE TILES™
America's Best Acoustic Tile Value!
High Performance...Low, Low Cost!

BT2 16"x16"x2", charcoal or blue ...\$4.99 ea.
BT3 16"x16"x3", charcoal or blue ...\$6.49 ea.
BT4 16"x16"x4", charcoal\$7.99 ea.

BASS TRAPS
Serious Low Frequency Absorption!
Triangular design to fit the corners of your room!
23.5" H x 11" D. Charcoal Gray.
MF-BT1 • \$22.99 Ea.

FREE Foam Adhesive with any Purchase of 6 or more foam sheets! Promo Code # EQFA

MARKERTEK JUMBO SOUND ABSORB BLANKETS
Heavy-duty 76"x68" padded blankets absorb sound wherever they're hung or draped. Fabulous for stage, studio and field use. Top professional quality at a super saver price!
Weight: 6 lbs. Black. SAB-1 • \$19.99

markertek.com
MARKERTEK VIDEO SUPPLY
www.markertek.com • 800-522-2025

All foam products shown above meet UL94 HF-1 flame retardancy. Check your local building & fire codes.

MARKETPLACE

To Advertise in Marketplace please contact Derick Joy at 650.513.4403 or djoy@musicplayer.com

GET CONTROL!



Quick and Easy Isolation
Portable and Free-Standing
CLEARSONIC PANEL
Drum Shields
LID SYSTEM
with AX12 Height Extenders
SORBER
Absorption Baffles

1.800.888.6360
 clearsonic.com



OMNIRAX

60% CIRCULARITY WITH
 ENHANCED AND 30% A.B.

The Industry Leader in Studio Furniture

Synergy XL Series

Synergy S6DXB XL



Synergy S6DXB XL
 60% Circular with 30% A.B.

equipped with optional
 solid multipoint "shocks"



Synergy S6DXB XL

The Synergy XLs are designed to provide beautiful and ergonomic console housings for all the popular mixers, providing you with optimum functionality to accommodate these mixers and associated peripherals.

P. O. Box 1792 Sausalito, CA 94966
 800.332.3393 415.332.3392 FAX 415.332.2607
 www.omnirax.com info@omnirax.com

MASTERING YOURSELF?

THAT'S LIKE HOME DENTISTRY!



TREELADY STUDIOS

www.treelady.com

412-816-0300

WhisperRoom INC

SOUND ISOLATION ENCLOSURES

Celebrating over 14 years of reducing sound to a Whisper!
 Recording, Broadcasting, Practicing



MDL 102126S
 (8'5"X10'5")

19 Sizes and 2 Levels of Isolation Available
 New! SoundWave Deflection System
 (Change parallel walls to non-parallel)
 Immediate Shipping!

www.whisperroom.com

PH: 423-585-5827 FX: 423-585-5831

VocalBooth.com

MODULAR SOUND REDUCTION SYSTEMS



Listen to your dreams.
 Follow your heart.
 Don't ever stop.

— Calvin Mann

541-330-6045

WWW.VOCALBOOTH.COM

CharterOak Acoustic Devices

Clean and simple electronic design.

Gorgeous sounding, dependable & consistent vacuum tube condenser microphones.



We're not emulating the old classics...
 we are creating the classics of tomorrow.

www.charteroakacousticdevices.com

PROSCREEN XL

NEW!



EXTENDED CLAMP
 ADVANCED DESIGN
 6 INCH DIA. SCREEN

STEDMAN

888-629-5960

www.stedmancorp.com

Made
 In
 USA

To Advertise in Marketplace please
 contact Derick Joy at 650.513.4403
 djoy@musicplayer.com

CATEGORIES

- DUPLICATION
- GEAR FOR SALE
- EDUCATION AND TUTORIAL
- STUDIO FURNISHINGS
- TALENT AND EMPLOYMENT
- ACCESSORIES
- ACOUSTIC PRODUCTS AND SERVICES
- SOUND/SEQUENCERS/SOFTWARE
- MASTERING

DUPLICATION

You should care who makes your CD.

We do.

- the best customer service in the business*
- instant online quote
- inhouse mastering, design & multimedia
- quality finished CDs, DVDs & vinyl



www.musicmanufacturing.com

US: 1-800-293-2075

Canada: 1-800-667-4237

New York • Toronto • Montreal • St. Johns

*Read our client survey results to find out more.



CD & DVD Manufacturing
10% National Price Guarantee



99¢
Retail Ready
CD Package

PRINTING
GRAPHIC DESIGN
AUDIO MASTERING
DVD AUTHORIZING
POSTERS
BUSINESS CARDS
POSTCARDS
BARCODES
AND MORE

Get a **FREE** Catalog
1.800.409.8513
www.lonelyrecords.com



100 FULL RETAIL READY CDs \$244.00!

Includes 4/0 Full Color Cover and 4/0 Full Color Traycard, Assembly and Shrink Wrap!

Quality CD Duplication 50 to 500 copies in 24 to 48 hours!

VISIT US ON THE WEB
www.elsproductions.com

1-800-927-3472

Call for more info or free sample packet

CD • DVD • CD-ROM • SHAPED CD • CASSETTE • PACKAGING

NEED CDs?

the choice is

CRYSTAL CLEAR

DISC & TAPE

Trusted experience for over 30 years.

SPECIALS

1000 CDs • \$999! (complete! Retail Ready)

1000 Promo CD Pack • \$599!

1000 DVDs • \$1899! (complete! Retail Ready)

1-800-880-0073

www.crystalclearcds.com



Complete CD Packages in Just 7-10 Days!

- CD & DVD Manufacturing
- Short-Run CD/DVD Duplication
- Commercial Printing
- Full-Service Prepress

800-964-DISC

fax 714 704-1733 • web <http://newsongmedia.com>

Mastertrack FREE BARCODE!

RETAIL READY CD PACKAGES
Price includes replicated "stamped" disc NOT CD-R!

300	500	1000
\$835	\$950	\$1095

888.551.3348 www.mastertrack.com

EDUCATION AND TUTORIAL

BE A RECORDING ENGINEER

★ **TRAIN AT HOME** with **AVA**

Easy Home-Study practical training in Multi-track Recording. Join our successful working graduates or build your own studio.

FREE INFORMATION:
Audio Institute of America
814 4th Avenue, Suite A, San Francisco, CA 94112
Or Visit us at www.audioinstitute.com

www.yourmusiconcd.com

100 BULK CDRS	\$59
100 BASIC CDRS	\$99
100 FULL COLOR CDR PACKAGE	\$199
500 FULL COLOR CDR PACKAGE	\$824
1000 FULL COLOR CDR PACKAGE	\$1174

300 FULL COLOR PACKAGE \$549

ATLANTA 678-442-0933
TOLL FREE 1-877-442-0933

Odds ON
CD & DVD Manufacturing

2500 CD's Only \$1999

Includes: On Disc Printing • Bar Code
Full Color Printed Booklets • Cello Wrapping

1-877-633-7661
www.OddsOnRecording.com
Visa • Mastercard • Amex • Discover

www.EQmag.com

TALENT AND EMPLOYMENT

SALES ENGINEERS WANTED

PASSIONATE. DRIVEN. COMMITTED. MOTIVATED. WINNER. Does this describe you? Then team up with Sweetwater Sound, the nation's top professional audio retailer.

We are currently seeking qualified candidates to join our elite and award-winning team of Sales Engineers. As a Sales Engineer, you will be working in a very fast-paced, high energy environment in Fort Wayne, Indiana. Working with the leading retailer of music technology, you will have the rewarding task of helping the "Who's who" in music with all of their music technology needs. Sales Engineers at Sweetwater are not just order takers — they're sales professionals who have a passion and strong knowledge of the gear, consultants, and friends of our customers. If you're a self-starter with a musical background and a strong customer service ethic, then Sweetwater is the right place for you.

Sweetwater Sales Engineers have the best compensation package in the industry, plus other great benefits like 401K, profit sharing, health and dental insurance, cash incentives, and the best training program of any retailer. Additionally, Fort Wayne is a vibrant city with a strong arts scene, great schools, a low cost of living and much, much more.

If you're interested in putting your talents to work, then contact Kristine Haas, Director of Human Resources at 1-800-222-4700, ext. 1050 or by e-mail at careers@sweetwater.com.

Sweetwater
music technology direct™
800-222-4700

5335 Bass Road, Fort Wayne, IN 46808 • FAX 260-432-1758
www.sweetwater.com/careers



STUDIO FURNISHINGS

Technical Furniture
argosyconsole.com
800.315.0678



Gear racks, media drawers and more
The RACKIT™ System
Factory direct since 1984
Free brochure (please mention EQ)
Per Madsen Design (800) 821-4883
www.rackittm.com



Record, Mix, Master...
Think in peace.
www.silencecases.com
510-282-7867
Starting at \$429

Silence Cases

ACOUSTIC PRODUCTS AND SERVICES

REALTRAPS®
MINI TRAPS — Affordable Acoustic Treatment

Rave Reviews From Top Pros

"Our control room at Le Crib Studios needed serious help. After installing MiniTraps the room sounds better than we believed possible, with clear, round bottom and vastly improved imaging. Fantastic product, great company."
—Nile Rodgers

Toll Free: 866-732-5872 www.RealTRAPS.com

www.eqmag.com

ACOUSTIC
Design Consulting Products
www.soundcontrolroom.com
toll free 866-788-1238

AcousticsFirst™
Toll-Free Number: **888-765-2900**
Full product line for sound control and noise elimination.
Web: <http://www.acousticsfirst.com>

Visit www.midi-classics.com helping musicians since 1993

Low prices, Selection, Service
Pro audio, software, samples
Call 800-787-6434 NOW!



EVERY MAJOR BRAND OF EVERYTHING.
MILLIONS OF DOLLARS OF MUSICAL GEAR IN STOCK.
ALTO MUSIC

Guitars, recording, keyboards, amplifiers, drums, pro sound, new & used. One of the largest selections in the country.
We ship everywhere.

(845) 692-6922 • sales@altomusic.com
180 Carpenter Ave., Middletown, NY 10940
Ask for Uncle Freddy — He loves Ya!

Auralex® www.auralex.com
acoustics 1-800-95WEDGE
• FREE Acoustical Room Analysis • Widest Range of Sound Control Products • Exceptional Customer Service
TOTAL SOUND CONTROL™

SILENT INFO (413) 584-7944 FAX (413) 584-2377
58 Norotuck St., Northampton, MA 01062
ORDER (800) 583-7174
info@silentsource.com • www.silentsource.com
Acousticore Fabric Panels • Sound Barrier Isolation Hangers • A.S.C. Tube Traps
Silence Wallcovering • WhisperWedge Melaflex • S.D.G. Systems • Technifoam R.P.G. Diffusers • Sonex • Sound Quilt

WHAT PART OF THE WORD **AGONIZER** DON'T YOU GET, MONKEYBOY??
WWW.METASONIX.COM

GEAR FOR SALE

Advanced polymer fretboard.
Lights up chords, scales & songs.
USB connection to PC.
Cool.



OPTEK
MUSIC SYSTEMS
www.optekmusic.com
1-800-575-6511

Place a print ad in EQ and it
will appear on EQmag.com
for free!

ACCESSORIES

hearing is believing

Extreme Isolation Headphones™

Why Extreme Isolation for HOME STUDIOS?

- Will not leak sound during recording
- Record "LOUD" instruments next to your multi-track in the same room
- Record "LIVE" drums next to your multi-track
- Great for microphone placement to find the sweet spots of instruments

www.extremehdphones.com
or search the web

Toll Free 1-877-962-2832



Model EX-29

MASTERING

MASTERING

"BIG LABEL" Sound...Guaranteed!

Located in New York
Serving the U.S.
Since 1989

Complete
Album Deal!
\$475.

1-800-692-1210

www.musichousemastering.com

Limited Time Offer \$36 a Song Per Album

**World
Class
Mastering**

www.WorldClassMastering.com
CALL TOLL FREE 1.877.507.0130

JustStrings.com

World's Largest Selection of Guitar & Bass Strings!
www.juststrings.com (800) 822-3953

DRT Mastering
the Analog Specialist

You will have the fat, slamin' major-label
sound that sells discs... or the work is free.
Custom gear. First-class results. Free 16-pg brochure
800-884-2576 www.drtmastering.com

ACCESSORIES

SOUNDS / SEQUENCES / SOFTWARE



11 FUNCTION TEST GENERATOR

11Function Test Instrument built in an XLR mic connector.
5 Sine Wave Test Tones, Amplitude and Frequency Sweeps
Bursts, VLF Test, Trace Tone, LED Indicator, Phantom Powered.

NOISE PLUG - PINK NOISE GENERATOR

Precision Pink Noise Generator in an XLR mic connector.
True 3dB per octave roll off. LED Phantom Power Indicator.
(630) 369-9815 www.toneplug.com

Drum samples for Drumagog:

Large collection of high quality samples, ideal
for rock and metal. Produced by engineers
who understand the essence of drums.
www.farviewrecording.com

Dopest Hip-Hop/R&B

sound libraries on floppy disks. MPC-
2000, MPC-2000xl, MPC-3000, ASR, EPS,
SP1200 and .WAV. (310) 842-7670.
www.soundsforsamplers.com.

QUALITY CD MASTERING

30+ years experience / Big Sound

All styles - Complete / CD \$400

1- 816-221- 4300 www.brcaudio.com

"One Minute Free" Mastering

www.audiorecordingandservices.com

GET IT SOLD!

Contact Derick Joy at 650.513.4403
djoy@musicplayer.com

Want the ultimate studio-to-go?



Apple 17-inch PowerBook G4™

The most powerful PowerBook ever

More power. More speed. More Digital Performer.

As in more tracks, more plug-ins and more virtual instruments. The breathtaking 17-inch PowerBook has just been speed-bumped. Again. To a blazing 1.67GHz. The PowerBook is the ideal platform for DP, the all-new Traveler, and a host of third-party plug-ins and add-ons.



MOTU Traveler™

Bus-powered high definition FireWire audio

The first bus-powered FireWire audio interface to offer four mic inputs and exceptionally high-quality high definition analog recording and playback. Just plug in the FireWire cable and power everything off the battery in your computer — you can operate your studio anywhere! Slides easily into your knapsack or bag, next to your PowerBook.



Alesis Photon™ X25

Portable 25-Key USB MIDI Controller / Audio Interface

Looking for the ultimate compact keyboard controller for your MOTU studio-to-go? The Photon X25 delivers the revolutionary Alesis Axyz controller dome and ten 360-degree rotary knobs, giving you powerful hands-on MIDI control of your Digital Performer studio and software plug-ins. Advanced features include 24-Bit 44.1/48 kHz USB audio I/O with balanced stereo audio inputs and outputs, 25 key, velocity sensitive keyboard, full-size pitch and modulation wheels, and an LCD screen with dedicated controls for fast and easy set-up.

Call the DP 4.5 and MOTU experts.



Waves IR Convolution Reverb Series

Stunningly realistic acoustic environment simulation

The new Waves IR convolution reverb series brings unprecedented realism to your MOTU studio, while also offering the flexibility of traditional parameter control not found in other convolution reverb systems. IR-L lets you start with exact reproductions of well over 50 acoustic environments, and then tweak things like pre-delay and reverb time while maintaining the character of the original space. IR-1 V2 adds even more parameter control, plus the ability to sample your own acoustic spaces. No matter where you track, Waves can put you in control of your aural environment!

Native Instruments **Komplete™ 2**

Software Bundle with 11 Standalone or Plug-in Instruments/ Effects

For DP4 users who want it all: the legendary sound of the B4 Organ, the endless possibilities of REAKTOR 4, the incredibly unique ABSYNTH, the futuristic power of FM7T — KOMplete 2 delivers an infinite universe of sound, uniting every essential type of instrument and effect in a 10 gig sonic workstation for your DP4 desktop studio. Komplete 2 is also an amazing value: for less than the combined retail price of Kontakt 2 and Reaktor 4 you also get Absynth 3, Battery 2, B4, FM7, Pro-53, Kompakt, Intakt, Vokator and Spektral Delay. Expand your Digital Performer studio today!



Spectrasonics **Stylus™ RMX**

The power of groove production

Stylus RMX is the first product to offer the combined power of Groove Control™ with Spectrasonics Advanced Groove Engine (S.A.G.E.™) giving you dramatic new control over groove production. Dozens of new features include a completely redesigned interface, a new 7.4 GB core library of cutting edge grooves and sounds produced by Eric Persing, and the ground-breaking, always changing Chaos Designer™. Expand Stylus RMX with 9 new S.A.G.E. Xpanders, featuring live drums, percussion, remix elements, and more. The ultimate real-time groove module for DP!

IK Multimedia **Sonik Synth™ 2.0**

Software Sound Creation Tool with 8GB Sample Library

Imagine creating new and unique sounds from a combination of traditional instruments, one-of-a-kind acoustic textures and classic synth sounds, all in a plug-in. Sonik Synth 2 gives you hundreds of samples from its 8GB Sonic Reality collection, plus the flexible synthesis and effects capabilities of IK Multimedia's SampleTank engine. Includes orchestral soundscapes, ethereal vocal layers and wine glass, plus traditional keyboards, guitars, drums and ethnic instruments and a comprehensive selection of analog and digital synth sounds. Sonik Synth is the perfect way to bring sound of a powerful synth workstation to your Digital Performer desktop.



(800) 222-4700

www.sweetwater.com



World Radio History

Sweetwater

music technology direct

Want to expand your MOTU studio?

BIAS Peak 4.1

Mastering and Restoration Edition

Peak 4.1 Plus SoundSoap Pro and SuperFreq. Imagine the world's most popular stereo audio editing, processing, and CD mastering program for the Mac, combined with unparalleled noise reduction and restoration technology — all at a jaw dropping low price. You get Peak 4.1 (including ImpulseVerb, Squeeze, Vbox SE, Jam 6, SFX Machine LT, and more), SoundSoap Pro (combines four state of the art restoration and noise reduction tools in a single plug-in), and the SuperFreq suite of mastering EQs all in one great package. Launch Peak directly from DP4 for more editing and processing power. Run SoundSoap Pro within DP4 or in Peak as an AU plug-in. For the very best in sample editing, batch processing, file conversions, loop creation, sound design, restoration, and Redbook CD mastering on DS X, pick up the Peak 4.1 Mastering and Restoration Edition today — the perfect mastering and restoration companion for DP4!



Glyph GT 051™

High Performance Desktop Hot Swap FireWire Hard Drive

Perfect storage for a PowerBook/Traveler-based studio, the GT 051 tabletop chassis works with highly portable, Seagate 7200 RPM-equipped GT Key hot-swappable drives, available in capacities up to 400GB. Using Integrity™, Glyph's proprietary FireWire hot-swap technology, you can swap drives without rebooting your computer or restarting drives. GT Keys are housed in sound-dampening metal for ultra quiet operation. With a stainless steel fan-cooled enclosure, the GT 051 has a built-in power supply and is rack-mountable. The GT 051 comes standard with a three-year warranty, while GT Keys carry an additional overnight advanced replacement warranty for the first year.



PreSonus Central Station™ A Console Master Section Without the Console!

The PreSonus Central Station is the missing link between your MOTU recording interface, studio monitors, input sources and the artist. Featuring 5 sets of stereo inputs (3 analog and 2 digital with 192kHz D/A conversion), the Central Station allows you to switch between 3 different sets of studio monitor outputs while maintaining a purely passive signal path. The main audio path uses no amplifier stages including op amps, active IC's or chips. This eliminates coloration, noise and distortion, enabling you to hear your mixes more clearly and minimize ear fatigue. In addition, the Central Station features a

complete studio communication solution with built-in condenser talkback microphone, MUTE, DIM, two separate headphone outputs plus a cue output to enhance the creative process. A fast-acting 30 segment LED is also supplied for flawless visual metering of levels both in dBu and dBfs mode. Communicate with the artist via talkback. Send a headphone mix to the artist while listening to the main mix in the control room and more. The Central Station brings all of your inputs and outputs together to work in harmony to enhance the creative process and ease mixing and music production.



Gator GRC-Studio-2-Go™

Road-worthy case for your MOTU gear

The GRC Studio-2-Go is a road ready, ATA style 2U rack case constructed of rugged Polyethylene with an extra, plush adjustable laptop compartment with web strap tie-downs for extra protection. Permanently connect your PowerBook, Traveler and rack gear through an accessory hole between compartments — convenient!



Apple AppleCare™

Extend the life of your PowerBook

Of course, the best support wizard at Sweetwater can help you with any operational issues you might encounter, but if you want complete peace of mind, the AppleCare Protection Plan is the perfect insurance policy. No matter what dangers may meet your portable rig on the road, with AppleCare, you're totally protected.



Call the DP 4.5 and MOTU experts.

Mackie Onyx Mixers with Optional Firewire Interface

High-quality compact mixers with direct connection to your studio

When you're on the road and looking to record a full band, the Onyx series of mixers from Mackie is the perfect complement to your MOTU Traveler. Whisper quiet and built like a tank, Onyx mixers feature an all-new mic preamp design capable of handling virtually any microphone. With the optional Firewire card, you can connect an Onyx mixer to your laptop with a single Firewire cable and have all the extra mic preamps and line inputs you need to capture every drum mic, vocal mic, individual synth output and DI the band throws at you. Since Digital Performer works seamlessly with multiple Core Audio devices, configuring a Traveler/Onyx system is a snap.



Mackie HR-series Active Studio Monitors

Nearfield monitors for your MOTU studio

Mackie's HR-Series Active Studio Monitors are considered some of the most loved and trusted nearfield studio monitors of all time, and with good reason. These award-winning bi-amplified monitors offer a performance that rivals monitors costing two or three times their price. Namely, a stereo field that's wide, deep and incredibly detailed. Low frequencies that are no more or less than what you've recorded. High and mid-range frequencies that are clean and articulated. Plus the sweetest of sweet spots. Whether it's the 6-inch HR-624, 8-inch HR-824 or dual 6-inch 626, there's an HR Series monitor that will tell you the truth, the whole truth, and nothing but the truth.

Mackie Control Universal and Extender

Automated hands-on control for the DP studio

Imagine the feeling of touch-sensitive, automated Penny & Gites faders under your hands, and the fine-tuned twist of a V-Pol™ between your fingers. You adjust plug-in settings, automate filter sweeps in real-time, and trim individual track levels. Your hands fly over responsive controls, perfecting your mix — free from the solitary confinement of your mouse. Mackie Control delivers all this in an expandable, compact, desktop-style design forged by the combined talents of Mackie manufacturing and the MOTU Digital Performer engineering team. Mackie Control brings large-console, Studio A prowess to your Digital Performer desktop studio, with a wide range of customized control features that go well beyond mixing. It's like putting your hands on Digital Performer itself.



Authorized Reseller

Your personal Sweetwater Sales Engineer offers much more than just a great price. They do the research, day in and day out, to ensure that you'll fine-tune your system to fit your exact needs.



Sweetwater

music technology direct™

Fax (260) 432-1758 • 5335 Bass Road, Fort Wayne, IN 46808

(800) 222-4700

www.sweetwater.com

FREE SHIPPING!
NO MINIMUM PURCHASE! NEARLY EVERY ITEM QUALIFIES



World Radio History



Room with a VU

by Eugene Robinson

STUDIO NAME: Electrokitty Recording

LOCATION: Seattle, WA

CONTACT: www.electrokitty.com

KEY CREW: Gary Reynolds, Nick Holman, Justin Friesen

CONSOLE: Neve 8128 (56 channels) with Flying Fader automation

RECORDERS: Studer A-827 2" 24-track, Ampex ATR-102 1/2" 2-track, TASCAM CD A-500, Panasonic SV-3800

MONITORS: Genelec 1032a, Yamaha NS-10s, Bryston 4b, Auratone, Event 20/20

EFFECTS: Lexicon 480L, PCM 70, PCM 42, Prime Time II; Ursa Major Stargate 626, Klark Tech 780, Yamaha SPX 90 [2], Eventide H-3000

OUTBOARD: Alan Smart C2, Neve 33609/C, UREI 1176 [3], LA-4 [2]; ADL 1500, Demeter VTCL-2, dbx 160 vu [2], 120x, 160x [2]; API 550b [2], 560 [2]; Aphex EQF-2 [2], Pultec MEQ5, Neve 81 Series console EQs, TLA Dual Valve, Symetrix 544, SPL De-Esser, Korg DT1000 tuner

MICROPHONE PREAMPS: API 3124 [4], Telefunken V72 PR, Neve 81 Series console mic pres

MICROPHONES: Neumann M149, U 87 [2], U 47 FET, UM 57, KM 184 [2]; AKG C 61 [2], C 28 [2], 451 E [2], 414 B-ULS, D 112e; BIUE C 12 capsules [2], Soundelux U95s, Royer 121, EV RE-20, Sennheiser MD421 [4], MD441; Sony C37T, Shure SM7, SM57 [8], SM58

COMPUTERS: Apple PoweMac G4/dual 1.25GHz

DAW: Digidesign Pro Tools HD3 Accel

SOFTWARE: Digidesign Pro Tools 6.4, BIAS Peak, Roxio Toast, Jam; Propellerhead Reason 2.5

ACOUSTIC DESIGN: Ric Vaughan, Gary Reynolds

STUDIO NOTES: There's this Snoopy doghouse moment on entering Electrokitty when the words of the immortal sage Willie Dixon find their way back to you, more true than ever: You

can't judge a book by looking at the cover. The cover, in this instance, a modest 2-story house in Seattle's Wallingford district, about a jog and a jump from downtown, sporting sort of typical suburban detritus, from baby strollers to, well, more baby strollers. And cushioned below the front porch is a Hobbit door, and ducking our heads as we enter it feels like studio owner Gary Reynolds should say something like *Voila* in the face of a highly unlikely studio spread.

"People will walk up to it," says the laughing Reynolds, "and be, like, 'What is this?' I mean it's kind of like a speakeasy but, despite what people think when I say that we're right next to a clinic, it's clearly not your average basement studio." Clearly. Boasting a clientele that includes everyone from Joe Chiccarelli (Rufus Wainwright, Beck) to Bob Power (Erykah Badu, De La Soul) to indie monsters Mastodon with Matt Bayles, Electrokitty almost just *happens* to be beneath a house. And that's just about where the basement comparisons end.

"We recorded this band that just wanted our room for drums. Now our live room is only about 20' x 20'," Reynolds says, warming into the story. "So they do their drums here and take them off to a very big, well-known studio. Well, we get this email from the guys there and they wanted to know what the hell we did to the drums."

They sucked?

"Nooo. They kicked ass on their drum sound he said and they're recording in a 50' x 40' room. But our live room is great. It sounds like a castle."

And the very big, well-known studio?

"I ain't telling," says Reynolds.

Well we are: Electrokitty's live room is killer. Check it out.

HEY, EQ READERS. WANT US TO FEATURE YOUR STUDIO? SEND PICS AND INFO TO eq@musicplayer.com.

Listen to the XPERTS!



THE O1X

All the Hardware you need for your SOFTWARE based studio



:: Aug. 2004

The Yamaha O1x is the answer to all my needs for integrating everything I do with audio and music. Its bargain price makes it a no-brainer purchase for anyone who wants a DAW control surface, high-quality audio interface and, of course, a hardware digital mixer.

Macworld :: Oct. 2004



KEYBOARD :: Jan. 2004

After using the O1x for a few months, the coolest aspect is that it blurs the lines between a traditional digital mixer, control surface and audio/MIDI interface — it's all three.

Electronic Musician :: Nov. 2004

Considering all the functionality packed into the O1x's silver-gray front panel, its user interface is a miracle of modern ergonomics.

RECORDING

The Magazine for the recording musician :: Dec. 2004

Quality inputs and effects and the ability to integrate into your computer setup could make it the perfect centerpiece for your project studio.

REMIX :: Dec. 2004

The converters are great, and the subsequent digital signal processing is fantastic, including the EQs and, particularly, the compressors.

NEW LOW PRICE

See your authorized Yamaha dealer for details.

The O1x now features  STUDIO CONNECTIONS

For more details go to
www.studioconnections.org

RECALL

www.yamaha.com | www.O1xray.com



© 2005 Yamaha Corporation of America



Record anywhere.

TRAVELER™

BUS-POWERED HIGH-DEFINITION FIREWIRE AUDIO INTERFACE



MOTU
motu.com