

TAPE RECORDING

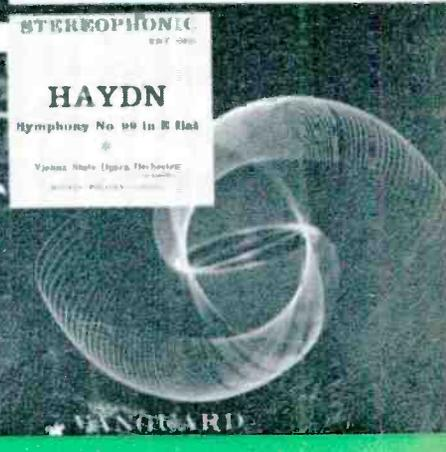
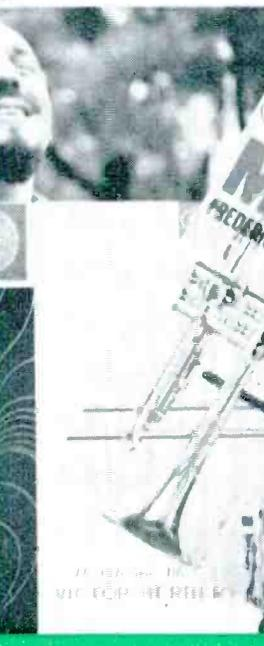
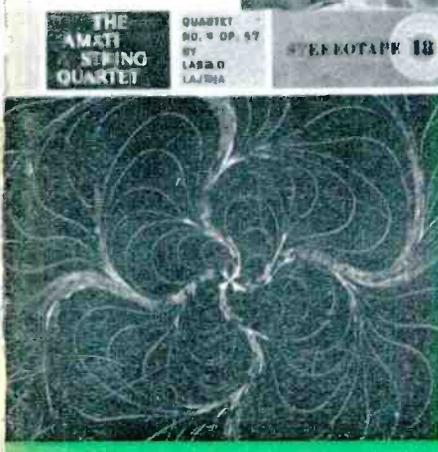
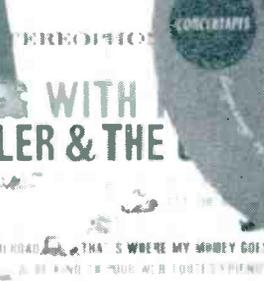
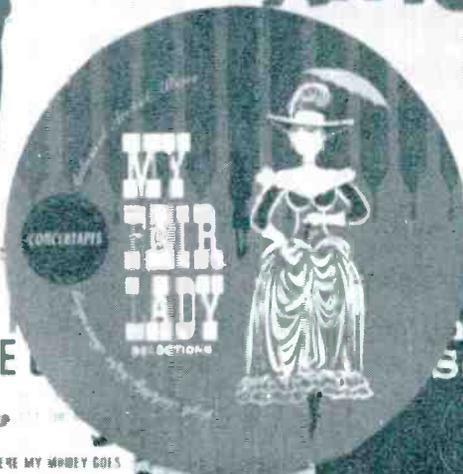
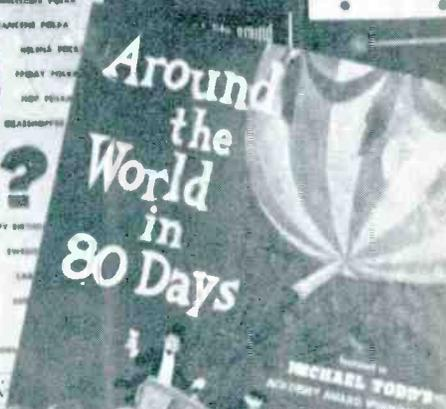
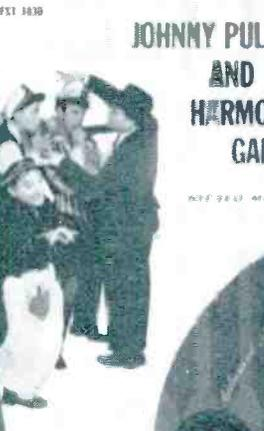
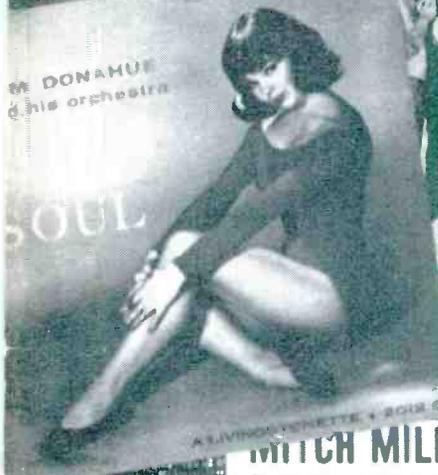
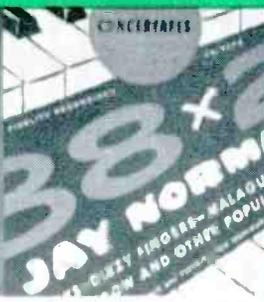

Model EL 3516/G53
Technical Specifications

Three Tape Speeds—7½, 3¾, and 1⅞ ips

Tracks—Dual

Heads—Stacked

Head-Gap—0.0002 Inches

Frequency Response—at 7½ ips; 50 to 16,000 cps
at 3¾ ips; 60 to 10,000 cps
at 1⅞ ips; 50 to 5,000 cps

Wow and Flutter—0.15% at 7½ ips
0.2% at 3¾ ips
0.35% at 1⅞ ips

Volume Indicator—Magic Eye (Type EM-84)

Loudspeaker—Integrated, heavy magnet,
wide range

Controls—Piano-key pushbutton



Fast Forward and Reverse—Less than 2 minutes for
1200 ft. of tape

Automatic Stop—At ends of reel (with metalized
strips)

Program Indicator—Built-in, adjustable

Inputs—(1) radio/phono; (1) microphone (with mixing
facilities)

Outputs—(1) for external speaker; (2) for external
amplifiers with controls; (1) for external amplifier
without controls; (1) for headphone monitoring
recording circuit

Microphone—High-Impedance Dynamic

Tubes—EF-86 (2), ECC83 (2), ECL82 (1), EZ90 (1),
EM84 (1)

Line Voltage—117 volts AC 60 cycles

Power Consumption—80 watts

Dimensions—15¾" x 13" x 8"

Weight 32 lbs.

Case—Rugged, European-designed, portable carrying
case (internally designed for optimum acoustic
baffling)

A matching companion piece, identical in ap-
pearance, containing a second amplifier and
speaker, is available to those who seek the
convenience of a complete portable stereo-
tape playback system

YOU
ARE LOOKING
AT A
Modern
Dutch
Masterpiece

The
STEREO
version of the
Norelco 'Continental'
TAPE RECORDER
Developed & Guild-Crafted
by
Philips
of the
Netherlands

We feel that the Stereo version of the Norelco 'Continental' is the ideal tape recorder for those recordists, high fidelity enthusiasts and music lovers who seek a professional quality machine at a truly modest price. The data listed here, represent painstaking, conservative and substantiated laboratory measurements. If you find that these data satisfy your technical requirements, and reflect those qualities that you consider mandatory in *your* stereo equipment, by all means listen to the Stereo version of the Norelco 'Continental' at your favorite HI-FI center or Camera store. There, we feel sure, you will agree with us that the Norelco Stereo 'Continental' is, indeed, a modern masterpiece . . .

Norelco

For further descriptive literature write to:
NORTH AMERICAN PHILIPS CO., INC.
High Fidelity Products Division
230 Duffy Avenue, Hicksville, L. I., N. Y.



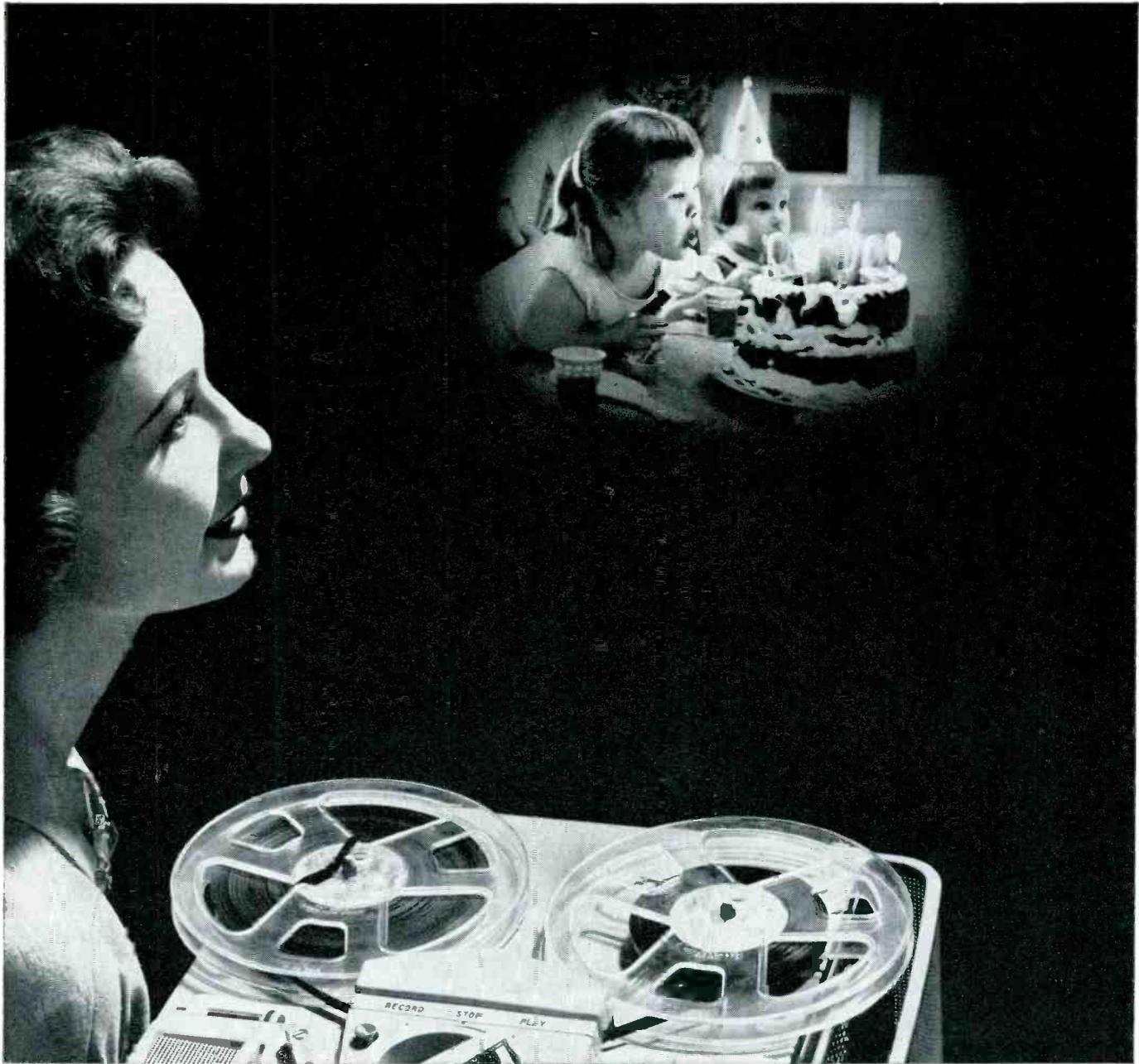

**Cherished moments last through the years
when you record on tapes of Du Pont "Mylar"®**

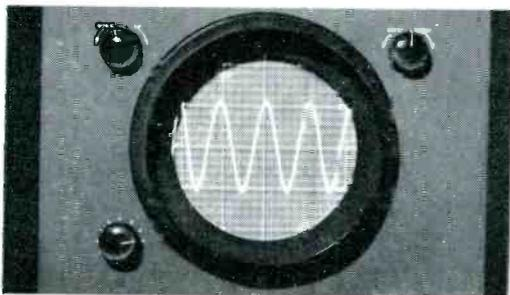

LASTING FIDELITY. Test on oscilloscope shows that even after years of playing, tape of "Mylar" has no flattened-out sounds . . . retains its flawless fidelity.

Your cherished "family albums" and favorite performances of classical music and jazz sound vibrant and new through the years on trouble-free tapes of Du Pont "Mylar"* polyester film.

Here's why: Tapes of "Mylar" can not dry out or become brittle with age . . . offer an extra safety margin against stretching . . . are unaffected by changes in temperature and humidity. What's more, you get 50% or more longer playing time plus superior performance. So next time you buy, be sure to ask your dealer for a reel of your favorite brand of tape—make it two reels—made of "Mylar".

*Du Pont manufactures "Mylar", not finished magnetic recording tape. "Mylar" is a registered trademark for Du Pont's brand of polyester film.



Better Things for Better Living...through Chemistry



FOR THE BEST IN TAPE, LOOK FOR THE NAME "MYLAR" ON THE BOX

Operate your...

- tape recorder
- P. A. system
- portable TV set
- hand tools

FROM YOUR CAR, Boat or Plane!

with



INVERTERS

FOR CHANGING YOUR STORAGE BATTERY CURRENT TO

A.C. HOUSEHOLD ELECTRICITY ANYWHERE... in your own CAR, Boat or Plane!



OPERATES
PORTABLE TV SET
directly from your car!

OPERATES

- TAPE RECORDERS
- DICTATING MACHINES
- PUBLIC ADDRESS SYSTEMS
- ELECTRIC SHAVERS



MAKE YOUR CAR, BOAT OR PLANE "A ROLLING OFFICE!"



OPERATES
• RADIOS
• RECORD PLAYERS
• MIXMASTERS, ETC.
directly from your car!

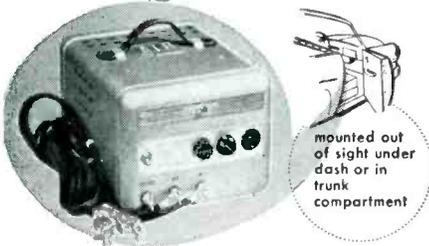

ATR UNIVERSAL INVERTERS

Especially designed to change 6 or 12 volt D.C. to 110 volt A.C. 60 cycles. for...

- EXECUTIVES
- SALESMEN
- OUTDOOR MEN
- POLICEMEN
- REPORTERS
- FIREMEN
- PUBLIC OFFICIALS

MODELS 6U-RHG (6 volts) 125 to 150 watts. Shipping weight 27 lbs. List price... \$89.95

DEALER NET PRICE... \$59.97

12U-RHG (12 volts) 150 to 175 watts. Shipping weight 27 lbs. List price... \$89.95

DEALER NET PRICE... \$59.97

Write for literature on other Sizes and Models of ATR INVERTERS, priced as low as \$9.95 list.

SEE YOUR JOBBER OR WRITE FACTORY

- ✓ NEW MODELS ✓ NEW DESIGNS ✓ NEW LITERATURE
- "A" Battery Eliminators • DC-AC Inverters • Auto Radio Vibrators



AMERICAN TELEVISION & RADIO CO.
Quality Products Since 1931,
SAINT PAUL 1, MINNESOTA, U. S. A.

HI-FI

TAPE RECORDING

VOL. 6 NO. 5

APRIL 1959

MARK MOONEY, JR.
Editor and Publisher

JOHN L. ALLEN
Circulation Manager

JEAN COVER
Assistant Editor

ROBERT W. LAPHAM
Art Director

JAMES H. MILLS, SR.
Technical Consultant

ANTHONY J. MORIN, JR.
National Advertising Manager
274 Madison Ave., New York 16, N. Y.

GEORGIE SIGSBEE
Music Editor

IN THIS ISSUE

ONCE UPON A TAPE	Edwin F. Wirsing	20
WE BUILT OUR OWN SMALL STUDIO	John W. Berridge	24
DO YOU REALLY HAVE A LIBRARY?	Tony Schwartz	29
NEW TAPES	Georgie Sigsbee	6
CROSSTALK		10
TAPE IN EDUCATION	Maj. Joseph J. Kramp	12
BOOK REVIEWS		13
TEEN TAPERS	Jerry L. Heisler	14
NEW PRODUCTS		15
TAPES TO THE EDITOR		16
TAPE CLUB NEWS		18
QUESTIONS AND ANSWERS		19
NEW PRODUCT REPORT: IRISH TAPE STROBOSCOPE		33



HI-FI TAPE RECORDING is published monthly by Mooney-Rowan Publications, Inc., Severna Park, Md. (Severna Park 548). Entered as second class matter January 7, 1954 at the Postoffice, Severna Park, Md., under the Act of March 3, 1879. National Advertising Representative: J. V. Associates, 274 Madison Ave., New York 16, N. Y. (ORegon 9-0030). Subscriptions, U. S. and Possessions, Canada and Mexico, \$3.75 for one year, all others add \$1.00 a year. Two years \$7.00. Contents copyrighted by Mooney-Rowan Publications, Inc., 1959. Printed in U. S. A.
POSTMASTER—Send all address labels clipped from undeliverable copies with Form 3579 to Hi-Fi Tape Recording, Severna Park, Md.

Exciting New Living Sound

Revere

STEREOPHONIC TAPE RECORDER WITH BUILT-IN PRE-AMPLIFIER

Providing true In-Line Hi-Fidelity Stereophonic Sound on tape, these magnificent instruments enable you to enjoy the true realism and depth of a full orchestra—feel the impact of percussion instruments on one side of the room in contrast to soft sounds of string and wood instruments on the other side. Using two separate In-Line sound channels, the Revere Stereophonic system enables recording and playing back monaurally on the upper channel, while the lower channel is designed to plug directly into phono input of your phonograph, radio or television receiver. No auxiliary pre-amplifier is necessary as the pre-amp is already built-in. See your authorized Revere dealer for a demonstration now! *Experience the thrill of 3D sound!*

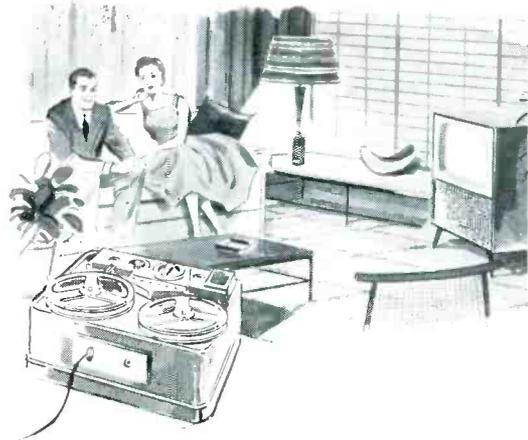

T-1120—HIGH FIDELITY DUAL SPEED STEREOPHONIC TAPE RECORDER

Among the advanced features embodied in this striking model are: Dual IN LINE Stereophonic sound channels; balanced tone (loudness control); real portability with molded glass and steel case; 360° sound distribution with two self-contained speakers; single knob control; precision index counter; public address system; input switches automatically for mike or phono; instant stop button; self-adjusting disc brakes; tape speeds, 3.75 and 7.5 i.p.s. With microphone, 2 reels, tape and cords.

\$199.50

GUARANTEED SPECIFICATIONS — Frequency Response: 75-13,000 c.p.s. ±3db at 7½ i.p.s. (Both Channels); 85-7,000 c.p.s. ±3db at 3¾ i.p.s. Signal to noise ratio greater than 48db at both speeds. Wow and flutter less than 0.3% at both speeds. More than 50db isolation between stereo channels. NARTB equalization for optimum playback of pre-recorded tapes.

T-1100 Dual-Speed Hi-Fidelity Tape Recorder—Single knob control. Tape speeds of 3.75 and 7.5 i.p.s.; records up to three hours with new long-play tape. Durable fibre-glass case; two acoustically matched excursion speakers. With microphone, radio-TV attach. cord, 2 reels (one with tape) and case... **\$169.50**
TR-1200—Same with built-in radio. **\$219.50**

SK-707 Stereophonic Kit—Converts all Revere T-11, T-1100 series and keyboard tape recorders to IN LINE High Fidelity Stereophonic playback and monaural recording. Simple installation; uses phono amplifier for record channel. Exceptional specifications. **\$34.50**



CLASSICAL

SYMPHONY BEETHOVEN

Symphony # 2 in D, Op. 36, Egmont
Overture (34:40 mins.)
Miltiades Caridis, Conductor
The Graz Philharmonic
LIVINGSTON 4003K
\$17.95... 43:23 mins.

This young Polish conductor proceeds to give a very satisfactory account of himself and Beethoven in this recording. His craftsmanship is of high quality and the Graz Philharmonic sounds like a fine well-integrated orchestra.

The reproduction has well-balanced dimensionality. The recording may strike some as just slightly heavy on the bass side but running the treble control up a little will compensate.

A very fine offering.

ORCHESTRAL

WAGNER

Dawn and Siegfried's Rhine Journey—
Siegfried Idyll
Paul Paray, Conductor
Detroit Symphony Orchestra
MERCURY MAS 5-20
\$9.95... 24 mins.

From the standpoint of interpretation, orchestral tone, beautifully controlled pick-up of individual sections and solo instruments—this release takes the cake. So, for the good. However, when this was first checked out I was shocked at the abundance of hiss on this copy. Because a reviewer often detects flaws which may not bother a person with a less dissecting attitude, I managed to check this out on not only the Viking rig but two different Ampex units. Still hiss. So another copy was "rented"—it, too, had the same hiss throughout. More the pity as this is a truly fine recording of a great composer who has been somewhat ignored in the tape field. This is the first "goof" Mercury has had and it is hoped they can correct this intolerable flaw by re-issuing a cleaner recording. Perhaps the trouble came in transfer from the 3-channel master tapes to 2-channel mas-

ters, but whatever the error, I am sure Mercury will rectify the matter.

Paray's directing is crisp while maintaining a songlike quality to these lovely selections from the "Ring."

Translucent strings, crystal tones of triangle, horns, and percussion coupled with exceptionally excellent depth and directionality of (i.e. horn calls)—all make this a fine musical production—save for the hiss.

POPULAR

THE THINGS I LOVE IN HI-FI

Louisiana Hayride
Linger Awhile
Them There Eyes
Carioca
Playing Leapfrog
The Things I Love
Music, Music, Music
Cachita
Indian Summer
The Three Suns with
Alfredo Mendez, Pipe Organ
RCA CPS-130
\$8.95... 25:10 mins.

A catchy beat is prevalent throughout this release and you'll find your feet keeping time either on the dance floor or as you sit and listen. A mammoth Wurlitzer theater pipe organ is used in contrast to the Three Suns' familiar Hammond electric organ, electric guitar and accordion. The arrangements, musicians and reproduction are above reproach. They close the tape with a dreamy version of "Indian Summer."

HAVE A WONDERFUL WEEKEND

If You Were Only Mine
Taking A Chance On Love
Medley: Snuggled On Your Shoulder;
Mighty Lak' A Rose; Did I Remember
Through The Years
Medley: Just You, Just Me; Rain; Alouette
A Handful of Stars
You Stepped Out of A Dream
I Never Knew
Mitchell Ayres and His Orchestra
RCA CPS-131
\$8.95... 26:45 mins.

Mitch Ayres, who has become familiar to so many people as Perry Como's right-hand music man, presents an album of nostalgic old-timers beamed for dancing or listening. The arrangements supplied by Jack Andrews and Joe Lipman are varied; the music stretches from very old to not-so-long-ago and the net result is a very good pop tape.

Spread, rich sound... cleanly recorded.

DANCING ON PARK AVENUE

Love Is the Reason
This Can't Be Love
C'est magnifique
September Song, etc.
Tony Cabot and His Orchestra
RCA BPS-117
\$6.95... 20 mins.

This society orchestra provides a lively beat for the dance and in this recording concentrates on show tunes. Cabot tosses in one of his numbers, "Park Avenue Samba" to add a Latin feeling.

A clean recording of an experienced and adept dance orchestra.

DOOR OF DREAMS

Door of Dreams
El Dorado
Covered Wagon
Mi Corazon
Mi Vida
Front Row Center
Joe Reisman and His Orchestra
RCA APS-115
\$4.95... 15:55 mins.

Reisman has really been kept busy with recording sessions and it is no wonder as he has a mighty talented group of musicians. According to the notes these tunes have never been heard before, that is, all but the title number. The selections vary from soft and slow to the Latin-American, vivacious, racing rhythms.

In the opening number *Romeo Penque* is featured on alto flute and a skilled instrumentalist he is as you will hear. In the quickly-paced "El Dorado" Jimmy Maxwell gives forth in a trumpet solo and Billy Mure does a fancy job on mandolin. A wide-open haunting effect is used in catching the harmonica work of Eddie Manson in "Covered Wagon." The closing number composed by Reisman is sparkling and stimulating, filled with plucking strings, etc.

Beautifully engineered with clarity of detail, this recording is bound to pick up any lagging spirits for the dreams behind this musical door are happy ones.

BIG BAND STEREO

Billy May: Tri-Fi Drums
Harry James: Cotton Pickin'
Ray Anthony: My Foolish Heart
Les Brown: How Now Brown Cow
Stan Kenton: Concerto to End All
Concertos
Glen Gray: Marian the Librarian
Alvino Rey: Little White Lies
Johnny Richards: Omo Ado
CAPITOL ZD-74
\$12.95... 33:29 mins.

A good hi-fi stereo showpiece for those who like big bands and uptempo music. Featuring some of the big name bands recording for Capitol label, this tape is jammed with some mighty fine, top-ranking musicians.

The lover of drums will thoroughly enjoy the first number and you may not get him beyond that to the James selection. You might want to hike the treble just a little on #1.

The guitar break in the James selection is a bit weak too... not as closely miked as I would wish. Anthony and Gray add the only mellow flavor and, other than that, this recording is filled with exciting, rhythmic byplays and fast instrumental work.

A good wide-range stereo recording.

USED STEREO TAPES 1/2 PRICE

Used for broadcast, demonstration, etc., but guaranteed good condition, or money refunded. 7 1/2 ips, 2-track, in-line only. Over 600 tapes in stock. Send for free lists. Shipped postpaid in U. S. and Possessions only.

CAL-WESTERN STEREO
1544 Cross Way
San Jose 25, Calif.

BETWEEN 18TH AND 19TH ON ANY STREET

Strutting With Some Barbeque
Undecided
Between 18th and 19th on Chestnut Street
The Five Piece Band
Medley: Whistling in the Dark; My
Extraordinary Girl
Little Girl
Cake Walking Babies From Home
Woodchopper's Ball
Bob Scobey's Frisco Jazz Band with Clancy
Hayes
RCA BPS-128
\$6.95 ... 20:52 mins.

Culling up the past (which seems to be *the* thing to do today both in dress and music) this top jazz combo cuts loose with an excellent recording session. A steady beat is provided by Drummer Black while the rest of the crew jams it out. Keen instrumental work is the case here with Scobey on trumpet and Pete Donidio on clarinet showcasing their talents in the slow, blues arrangement of "Whistling in the Dark." The other selections, except "Undecided" and "Woodchopper's Ball," feature Clancy Hayes' vocalizing. Hayes is at his vocal best.

The recording is close-in, good instrumental by-play is well-engineered and overall fidelity rating is of top grade.

MUCHO PUENTE

Mambo Beat
The Late, Late Scene
Lullaby of the Leaves
Duerme (Time Was)
Tea for Two
Poor Butterfly
Night Ritual
Tito Puente and His Orchestra
RCA CPS-110
\$8.95 ... 24:40 mins.

Puente races off on the first two numbers and then simmers down to a surprisingly slow dance beat until the final tune. Vibes, strings and sax take an active part throughout but it is the drums which are the main feature. "Night Ritual" is a showpiece for the bongo man. "Tea for Two" is given quite an offbeat arrangement.

The recording leans a little on the bass side but it is good, clear stereo.

TAP PERCUSSION

Ti Mon Bo
Mon-Ti
Hot Timbales
Four by Two (Part I)
Tito Puente
RCA APS-120
\$4.95 ... 16 mins.

It's all in the way you look at a thing. For me this is repetitious, splashing, cacophonous sound. For others it will prove percussively fascinating and invigorating. If you are young, or young in heart, the chances are you will be more "for" than "against." I had fun renaming the tape—"Music for a Nervous Breakdown," or "Music To Take Bufferin By," etc.

The first piece could be titled "Over and Over," the second, "This or That" (with a little of this overlapping that) and so on! Seriously. Puente features "advanced

STEREO WEBCOR

All-new 1959 Webcor Stereofonic Tape Recorders outperform the field!

Never before has Webcor offered such a wide variety of both stereo and monaural tape recorders. New Webcor Stereofonic Tape Recorders play back recorded stereo tapes with unmatched realism . . . record and play back monaurally. They're packed with the kind of exclusives and advantages you've been waiting for!

See and hear the new 1959 Webcor Tape Recorders at your dealer's now!

Regent Stereofonic Tape Recorder—Model 2820—The featherweight marvel in the stereo tape recorder field! Plays in vertical or horizontal position—stereofonic playback—three speed operation for monaural record and playback—power amplifier and stereo pre-amplifier—wide-range 5" x 7" PM speaker—edit key—Webcor-built recording head—Ext. Amplifier, Ext. Speaker, Input provisions. Ebony. Designed for use with 3-Speaker Stereo Sound System, Model 4820 (optional).



Royal Stereofonic Tape Recorder—Model 2821—New 1959 stereo version of the world's most popular tape recorder! Stereofonic playback—"no reel-turnover" feature for monaural record and playback—powerful amplifier and stereo pre-amplifier—one 5" x 7" woofer, one 4" tweeter—co-linear (stacked) stereo playback heads—automatic shut-off—Ext. Amplifier, Ext. Speaker, Input provisions. Ebony or White. For use with 3-Speaker Stereo Sound System, Model 4820 (optional).

LISTEN! ALL MUSIC SOUNDS BETTER ON A WEBCOR!

PRESENTING . . .

.. THE WORLD'S FIRST

TAPE BOOK®

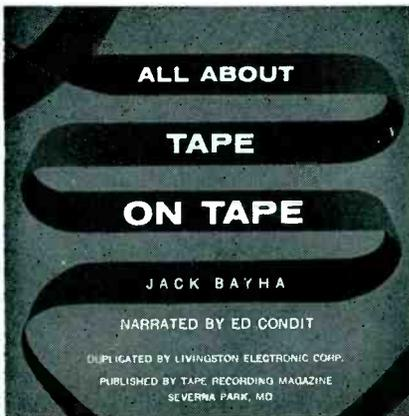

ALL ABOUT TAPE— ON TAPE

Will give you the information
you need in sound, not in
the written word. A new
first in publishing history.

... authored by Jack Bayha ... a book to which you listen ... the first book specifically designed and produced on tape instead of the printed page. ... Now you can actually HEAR what good recording, over-recording, wow, flutter, distortion, wrong mike placement, etc., sound like. A test section allows you to adjust the head of your recorder for best results. Chapters include: How a Tape Recorder Works, A Demonstrated Glossary, Recorder Operation, Home Recording, Field Recording, Low Impedance, Microphones, Recorder Maintenance and Testing. ... Playing time of the Tapebook is one hour. Accompanying each reel is a 28 page booklet containing 80 illustrations to supplement the spoken word. It is unique, enjoyable and instructive.

7½ IPS, 7" Reel, Dual Track
\$6.95 postpaid

3¾ IPS, 5" Reel, Dual Track
\$5.95 postpaid

Including a 28 page manual of
illustrations

Ask your dealer
or order direct

TAPE BOOK DEPT.
MOONEY-ROWAN PUBLICATIONS
SEVERNA PARK, MD.

popular Latin rhythms" working out particularly on timbales with conebells thrown in. Throughout the recording he works with various drummers and a bass man.

For what it is—it's good. If you don't picture a tin can tied to a dog's tail—with the canine being chased down a narrow alley lined with telephone poles—then you'll enjoy this recording. I'm getting too old!

HOORAY FOR BIX!

Love Nest
Clementine
Oh, Miss Hannah
Lonely Melody
I'm Gonna Meet My Sweetie Now
Wa Da Da
For No Reason At All in C
Because My Baby Don't Mean Maybe
Now

Marty Grosz and his Honoris Causa Jazz
Band
LIVINGTON EM 1076 F
\$11.95 ... 30:21 mins.

Obviously done as a memorial to the famous "Young Man With A Horn," Bix Beiderbecke, this group turns in a fine performance. Their presentations are delivered in a good modern jazz style mixed with a Dixie beat that really swings out. They have chosen some excellent, though obscure tunes, from the Beiderbecke repertoire; deliberately and wisely avoiding Bix's more familiar numbers.

Performance and recording are first-rate.—J. L.

VIVA STEREO!

Quien Cera—
Perhaps, Perhaps
Park Avenue Mambo
Mambo Cien
Piel Canella—
Isle of Capri
Mambo Gallega

Henry King, His Piano and His Orchestra
BEL CANTO STC 41
\$7.95 ... 15 mins.

The suave stylings of Henry King, His Piano and Orchestra have made him a favorite in many of this country's top night-spots since the days when the rumba was beginning to lead the invasion of the Latin beat into American dance music. While Henry King has featured virtually every tempo to gain popularity in this era, his Latin rhythms have particularly delighted his audiences. This recording spotlights his skillful treatment of music with a South of the Border flavor. The recording is up to Russ Molloy's usual high standards with excellent instrumental balance and enough reverberation to create a ballroom effect.—J. L.

PLAIN VANILLA

Charleston Forever
Driftwood
Chicken Rag
Plain Vanilla
Buskin' on Beale Street
Monkey Shines
Steamboat Rag
Red Cat
Cryin' Blues
Martha My Martha

Larry Fotine and The Beale Street Buskers

BEL CANTO STB 38
\$9.95 ... 25 mins.

This is a very smooth recording of "polished" Dixieland styling. The tunes are delightful; the performance excellent; and a really superb example of stereophonic recording completes the picture.

LATIN

BRUTE FORCE STEEL BANDS OF ANTIGUA
BWI

Mambo Jambo
Mambo No. 5
Alec Betsa
Del Magreto Del Batey
Hold 'em Joe
Jingle Bells
Brown Skinned Gal

Under the Double Eagle March
55 gallon drums, 16 men, maracas and a gourd

Calypso vocals by Herbert Howard
COOK 1042 st Vol. I
\$12.95 ... 24 mins.

If you have never heard the unusual sound a gallon drum emits when struck with a rubbered or padded stick, you are due for a surprise. By hammering in the ends of these steel oil drums, a metallic version of the tympani is achieved. Notes are distributed around the head of the drum. One end of the drum is cut off, and the resulting length and diameter determine whether it is tenor pan, alto, baritone or bass-boom. Brute force steel bands are popular in Antigua, a small island in the British West Indies, and they are increasing in popularity in this country.

Of the selections on this tape, I liked "Under the Double Eagle March" best, although they all have good Latin rhythm. I personally prefer not to hear "Jingle Bells" played in this manner and do not quite see why this was chosen for this tape.

Herbert Howard and his accompanying singers are average for calypso renditions, but in most instances the music almost drowns them out.

Quite a bit of background murmurings are sometimes almost too distinguishable on this tape, but all in all it is certainly something different for a tape collector's library. If you like a Latin beat and have a liking also for the unusual steel band sound, you will want a copy of this one.

I believe there was more concentration on the authenticity of recording the bands themselves, rather than on reproduction possibilities and the fidelity is not the same as if recorded in a nearly acoustically-perfect studio, but it is nevertheless easy to listen to.

MUSICALS

SOUTH PACIFIC—GEORGE FEYER
RCA BPS-146

\$6.95 ... 19:15 mins.

Feyer's special kind of keyboard magic lends a refreshing, scintillating touch to the Rodgers-Hammerstein's tunes from "South Pacific." Feyer does not just sit at the piano and whip them off ... he gives them a full-fledged, skilled production. In this album, which marks his debut under the RCA label, he is backed with rhythm accompaniment in lieu of full orchestra and thus his artistry shines forth with greater clarity.

Accorded very live stereo reproduction.

MY FAIR LADY
THE KING AND I
BEL CANTO ST-19
\$9.95 . . . 25 mins.

Tunes from Broadway musicals continue to provide excellent material for recording companies and their artists. Their popularity is not to be denied and "My Fair Lady" has rated high of late. Joining the ranks alongside Mr. Melachrino (RCA CP 52, Sept. 1957) et al., is the seventy-piece New World Theatre orchestra playing symphonic impressions of the familiar tunes of Lerner-Loewe as well as some of the Rodgers-Hammerstein numbers from "The King and I."

On this tape the spirited rendition of "Why Can't the English?" and the smooth delivery of "Getting to Know You" are particularly good.

The stereo reproduction is fine.

MARCHES

THE BAND OF THE COLDSTREAM
GUARDS

Conducted by Major Douglas A. Pope

Anchors Aweigh
Entry Of The Gladiators
Cobenhavner March
Radetzky March
A Frangesa
El Abanico
National Emblem

RCA BPS-112

\$6.95 . . . 19:40 mins.

This is a fine item for connoisseurs of march music. Boasting clean, crisp sound, the reproduction is lighter in texture than most recorded band music. The distant miking affords big open sound, which further enhances the out-of-doors atmosphere of this recording. The selections are interesting and meticulously performed.—
J. L.

MISCELLANEOUS

DESTINATION MOON

Earth
In Outer Space
On the Surface of the Moon
Finale

Heinz Sandauer, Conductor

The Omega Orchestra
OMEGATAPE ST-3015

\$14.95 . . . 43 mins.

In 1950 Leith Stevens composed the score for George Pal's motion picture, "Destination Moon." Here Omega presents this unusual, picturesque composition which depicts man's flight to the moon. It is hard to describe this music to anyone . . . basically it is quiet, roaming, different, out-of-this world . . . sort of a seeking but not finding kind of music. There are no definitive themes to latch on to and I found my mind would tend to wander . . . just as the music seems to. The various orchestral voices are nicely brought out in stereo reproduction and the engineering of this record is accomplished with polish.

Certainly recommended if you are a space bug, or like something that is different in the way of mood music.

Are you a recording engineer?

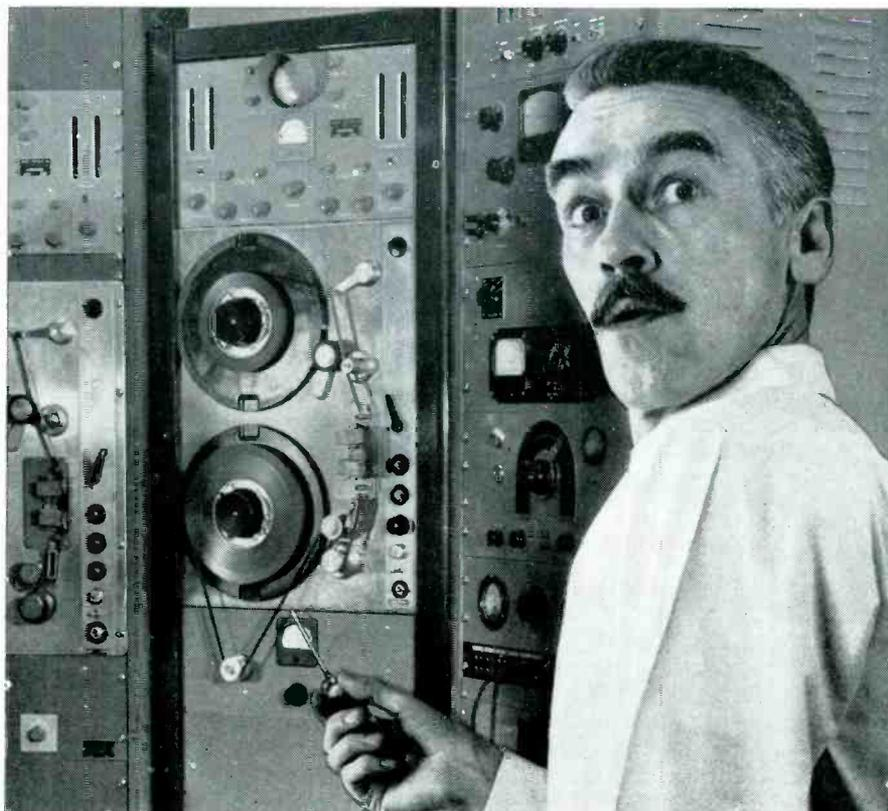

"No, I'm a plumber

...but I know good recording tape"

AUDIOTAPE, the thinking recordist's tape, gives you the full, rich reproduction so satisfying to the happy audiophile — be he doctor, lawyer or Indian chief. Because behind every reel of Audiotape are two decades of research and development in sound recording.

When you buy a reel of Audiotape you're getting the tape that's the professionals' choice. Why? For example, the machines that coat the oxides onto the base material are unique in this field — designed and built by Audio engineers who couldn't find commercial machines that met their rigid specifications. Then there's the C-slot reel — the fastest-threading reel ever developed. For that matter, there's the oxide itself — blended and combined with a special binder that eliminates oxide rub-off.

There are many more reasons why the professionals insist on Audiotape. They know that there is only one quality of Audiotape. And this single top quality standard is maintained throughout each reel, and from reel to reel — for all eight types of Audiotape. That's what makes Audiotape the world's finest magnetic recording tape. For recording engineers, doctors, garbage men, investment brokers, sculptors . . . and plumbers!



Manufactured by AUDIO DEVICES, INC.
444 Madison Ave., New York 22, New York
Offices in Hollywood & Chicago

audiotape

TRADE MARK

CROSTALK

from the Editors

NO CARTRIDGE this year from Ampex. So says an announcement sent to all Ampex dealers by Ampex Audio president Phil Gundy. While Ampex has been working on a cartridge machine, as have other machine manufacturers, they feel that further developments of the mechanical and electrical systems, the tape itself and the techniques used in recording and duplication will be necessary before satisfactory quality is assured for discriminating listeners. They do not expect to find the solution to the problems this year and this goes for the parent Ampex firm who makes the professional and duplicating equipment as well.

* * * * *

WHILE FEW have heard the cartridge playing, those who have have been critical of it, placing it in quality below that of the stereo disc. Critics still rank 7 1/2 ips stereo tape at top for finest and most consistent reproduction of stereo.

* * * * *

THIS LEADS us to wonder if the stereo disc is the last dying gasp of the disc industry seems that this might be a foolish question at moment considering momentum stereo disc has gained but fact remains that unless stereo disc is greatly improved, and rapidly, tape may prove such a strong competitor that disc stereo will fade and die. Reason . . . stereo disc cartridges in tone arms are delicate and will not tolerate mishandling. We have broken two in our own shop already while exercising reasonable care. Other faults of discs that have been mentioned include wear with ultimate loss of highs and stereo effect and channel shifting of sound. Tape has none of these faults and will ultimately emerge as the means of sound reproduction in the home. Not only that but in the future are such items as a home TV recorder at a reasonable price and an electronic home movie camera that will make pictures on tape and show them through the TV set. In all these applications, tape will be the central item. If disc stereo fades it will carry phono industry with it for almost all manufacturers are switching to stereo models.

* * * * *

WE GOT A big charge out of a flyer put out by the True Recordings Co., of Oakland 11, California, a real dyed-in-the-wool tape and recorder dealer. On his mailing piece, along with ads for recorded monophonic and stereo tapes was his slogan, "Help Stamp Out Phonographs."

* * * * *

ACTUALLY, right now, we are going through a technological revolution of a magnitude greater than that which occurred when the LP disc made its appearance some 10 years ago and made the 78's obsolete. 78's were a long while dying, in fact there is still some life in them yet, but not much, the 33 1/3rd and 45 rpm discs forced them into the discard. Now it is stereo sound which is putting monaural in the shade.

* * * * *

WITH ALL THE TALK of stereo, the tape recorder industry must not forget monaural. Almost all recording that is done in the home is monaural and the monaural uses of the machine are so many that they beggar description. While stereo playback is the ultimate in music, the use of a recorder for music is far from the end of its usefulness.

TAPE RECORDING PLEASURE FOR THE ENTIRE FAMILY!

Sensational V-M
"Family Pleasure Package"

Available with Every
V-M Stereo-play
'tape-o-matic'[®]
Tape Recorder!



A complete kit of interesting and entertaining "things-to-do" with your family tape recorder including a **BIG** "How-To-Do-It" Manual! **This wonderful kit can be YOURS when you purchase your amazing new V-M Stereo-Play Tape Recorder!**

- You 'Co-Star' on Tape with Hollywood Actors!
- "Add-the-Melody" Tape Recorded Accompaniment!
- Stereophonic Concert! A Pleasing Variety of Selections!
- Four Puppets — a 'TV Theatre' and Stage with Tape Recorded Puppet Plays for Family Shows!
- A Zany Play Script to Tape Record!
- A Record of Unusual Sound Effects!
- Classic Literature Read by Famous Stars!
- Children's Stories on Tape!
- Square Dances on Tape (With Printed Instructions)!
- TV Programming Cover
- Instruction Manual

TAPE RECORDING IS FOR EVERYONE!
Here Are Hours And Hours Of Pleasure For
The Whole Family — Entertainment for
Young And Old!

**V-M "FAMILY PLEASURE PACKAGE"
IS AN INCOMPARABLE VALUE YOU
WILL CHERISH FOR MANY, MANY YEARS!**

*Slightly higher in the West

**SEE YOUR V-M DEALER TODAY FOR A THRILLING
DEMONSTRATION OF THIS AND OTHER
MAGNIFICENT V-M TAPE RECORDERS!**



**V-M 'tape-o-matic'[®] PORTABLE TAPE
RECORDER WITH STEREOPHONIC PLAYBACK**
• Records and Plays Back Monophonically
• Plays Stereophonic Recorded Tapes
• Simple Push-Button Controls
• Powerful Speaker System
• Microphone and accessories included.

Model 714 \$225.00*

the Voice of Music

V-M CORPORATION • BENTON HARBOR, MICHIGAN
World Famous for the Finest in Phonographs,
Tape Recorders and Record Changers

WIDE LATITUDE
SONORAMIC
RECORDING TAPE

THE CASE FOR BETTER SOUND

Why settle for ordinary tape when Sonoramic gives you so many exclusive extras—brilliant reproduction, permanent plastic container, 3-way indexing system with pressure sensitive labels and V-slot self threading Selection Finder reel.

ON WALL FOR QUICK ACCESS

STORES LIKE PRECIOUS BOOKS

FREE Tape-time ruler. Gives you footage and recording time on reel. Write Dept. R4

Aerodynamics CORPORATION
LODI, NEW JERSEY

He's **CARRYING** His **PROFESSIONAL STANDARD RECORDING STUDIO**

Here is England's Newest, Most advanced addition to a tradition of unsurpassed quality... THE "TRUVOX-TWIN" STEREO RECORDER-PLAYBACK.

Now! Build your own professional quality stereo and monaural tape library from FM, Discs, and live performances. It's portable... easy to operate... yet gives you unmatched performance with absolutely no degradation or change of original sound.

Inquire for Full Details & Specifications.

TRUVOX Dept. TH-4
275 Seventh Ave.
New York 1, N. Y.

TAPE IN EDUCATION

By MAJOR JOSEPH J. KRAMP, USAF, RET.

THE National Defense Education Act of 1958 has made available large sums of money for aid to the various states in the purchase of equipment and facilities. These funds will be given to the states when the state plan has been approved and matching funds have been appropriated by the state. The states have great latitude in their use of these funds provided they meet certain requirements. In general a state plan will be approved if it: (1) sets forth a program under which the funds will be expended solely for projects approved by the state educational agency for (A) the acquisition of laboratory and other special equipment, including audio-visual materials and equipment and printed materials (other than text books), suitable for use in providing education in science, mathematics and modern foreign languages, in public elementary or secondary schools, or both, and (B) minor remodeling of laboratory and other space used for such materials or equipment;

(2) Sets forth principles for determining the priority of such projects in the state for assistance from these funds and provides for undertaking such projects, insofar as financial resources available therefore make possible, in the order determined by the application of such principles;

(3) provides an opportunity for a hearing before the state education agency to any applicant for a project under this program;

(4) provides for the establishment of standards on a state level for laboratory and other special equipment acquired with assistance by these funds;

(5) sets forth a program for the use of funds earmarked for administration of the plan and improvement of supervisory and related services, to insure that they are used within the intent of the law.

The law authorizes \$70 million for each of four years beginning with 1959 or \$280 million in all. This must of course be matched by a like sum by the various states. If all of the states participate to the full extent, over half a billion dollars will be spent.

Many states have started preparation of their plans and are establishing the standards for laboratory and special equipment. Now is the time to bring your ideas to the attention of the state educational agencies. The law provides that you must be heard. Your ideas on language laboratories and combinations of equipment to use in teaching should be considered before the state plans are approved. It may be rather difficult to change the standards after they have been adopted. It seems reasonable, however, to assume that the programs and standards adopted will make provision for the incorporation of the new equipment and techniques to be developed under the research programs of the National Defense Education Act.

We have had a number of inquiries regarding equipment for classroom use, par-

ticularly for language teaching. There appears to be an impression that wide frequency response is not required for language training because of the limited frequency range of the spoken voice. In our opinion, wide frequency response of any recording system used for language training is an absolute must. Although the fundamental frequencies of speech do have a limited range, speech also contains many harmonics which give it a specific quality. The presence or absence of these harmonics contribute a great deal to the correct pronunciation of foreign words and the production of the characteristic sounds of a language. Equipment which does not faithfully reproduce all of the fundamentals and harmonics, therefore, cannot be as effective in language teaching as we require. We must endeavor to pattern our pronunciation after a good standard prepared by a native voiced speaker and reproduced with all of the characteristic color that is inherent to the language.

The setting of these standards for equipment has been left in the hands of the states. With it goes a great responsibility to see that the proper types of equipment are not only specified but purchased by the individual school districts and schools.

As mentioned, several states have set equipment standards which must be followed by the individual schools in making purchases.

One state took the following course in determining what the needs should be. First they called in a panel of language teachers from various school districts and they, together with officers familiar with language teaching problems at state and national levels spelled out what they felt was needed to speed up and improve language teaching.

The state then called in a group of experts in the field of language equipment who took the specs as laid down by the first group and translated them into actual machine and lab specifications which purchasing agents could use. This is an intelligent approach to the problem.

We have just received an announcement from Campus World, Inc., 3449 McClintock Avenue, Los Angeles 7, California, introducing their new Campus Library Series. This is a collection of 2-hour tape-recorded summaries of selected courses and supplementary materials prepared by outstanding professors throughout the nation.

Series of tapes are offered in Economics, English, Geography, Greek, History, International Relations, Latin, Music, Philosophy, Political Science, Sociology and Speech. A total of thirty-five tapes is offered. All of these tapes are dual track 3¾ IPS, 2 hours playing time. No prices were quoted in the announcement which we received.

I have not reviewed any of these tapes as yet but the subject titles and the names of the professors who prepared them are very impressive indeed. I will endeavor to review some of these tapes and report upon them in a forthcoming issue.

BOOK REVIEWS

The Sound of High Fidelity by Robert Oakes Jordan and James Cunningham, 808 pages, 7"x9 1/2", cloth bound, Windsor Press, Chicago 11, Ill. \$3.95.

Those of our readers who read the series of articles on stereo sound by these co-authors which appeared in previous issues of HI-FI TAPE RECORDING will have some idea of the excellence of this book.

The volume includes 9 chapters: Sound, Hearing, Sound in History, Amplification, Loudspeakers, Disc Records, Tuners, Tape Recording and Microphones. In addition there is a table of abbreviations and a table of schematic symbols.

One of the nicest things about this book is the profusion of illustrations in the form of photographs, drawings and charts, most of the latter being in two colors.

The text is tightly written and lucid. While not overly burdened with technical terms their use is not avoided where they are necessary. Explanations of all points are well done. The chapter on hearing is an important one for, after all, hearing is the basis of all sound and the more people who understand the part of human hearing in high fidelity, the better.

As the authors state in their brief foreword, "With this, we offer our book as a primer for the novice, a guide for the buyer and interesting reading for the 'old hand'." The authors have succeeded admirably in their purpose. The book is excellent and we do not hesitate to recommend it.

Magnetic Tape Recording by H. G. M. Spratt, B.Sc. (Eng.), M.I.E.E. 319 pages, inc. index, 5 3/4"x8 3/4", cloth bound, \$8.50, The Macmillan Company, New York 11, N. Y.

This volume is not for the beginner in tape recording as it goes rather thoroughly into the engineering aspects in several places. It does not restrict its coverage to audio applications either for it covers fringe uses and instrumentation.

Its chapters include: Principles of Magnetism, Sound Reproduction and Electro-Acoustics, Principles of Magnetic Recording, Tape Manufacturing Materials, Tape Manufacture, Tape Testing, Tape Recording Machines, Recording and Reproducing Machines for Music and Speech, Testing of Machines, Applications of Magnetic Recording, Present Trends and New Developments, Recording Standardization.

Because the volume discusses wide applications of tape, people who must build machines for special purposes will find it especially valuable. The information is of a basic nature on both processes and machines hence it may be quickly applied to the particular problem at hand. Each chapter has a Bibliography and the Appendix lists the standards.

While based largely on British methods and machines, the volume is general enough to be of value to anyone seriously interested in the magnetic recording field as a whole. Engineers should find this book worthwhile for the reference library.

save \$3.95

...with RCA's "Fabulous Bonus" Tape Offer!!!



Buy four 7-inch reels of *RCA Sound Tape*...and get one RCA Victor pre-recorded stereo tape for just \$1.00 more!

Here's your chance to stock up on the world's finest magnetic recording tape...and receive a fabulous bonus at the same time! *RCA Sound Tape* is famous for superb high-fidelity reproduction, long life and dependability. With the purchase of every four 7" reels of this premium quality tape you will receive a coupon. This coupon is worth \$3.95 toward the cost of a popular \$4.95 value RCA Victor tape recording in "Stereo Orthophonic" High-Fidelity Sound.

BETTER HURRY! Offer is for a limited time only. Selections are listed

on the coupon. Simply mail the coupon with \$1.00 to RCA Victor Records. The Stereo Tape of your choice will be forwarded to you by return mail.

For the finest in magnetic recording tape, RCA makes available a wide selection of *Sound Tape* on the popular 5" and 7" reels, on splice-free Mylar* and acetate bases. Also look for these popular tape recording accessories: Tape Storage Chest, Splicer, Leader and Timing Tape. Available wherever superior tape recording products are sold.

*DuPont Reg. TM



RADIO CORPORATION OF AMERICA
Electron Tube Division
Harrison, N. J.

Chamber Music
Superbly
Performed by the
**FINE ARTS
QUARTET**

On Critic-Acclaimed
CONCERTAPES
Stereo Tape Recordings

MOZART: CLARINET QUINTET IN A MAJOR,
K. 581, Reginald Kell and The Fine Arts
Quartet. Cat. No. 25-3.

BRAHMS: CLARINET QUINTET IN B MINOR,
Opus 115, Reginald Kell and The Fine
Arts Quartet. Cat. No. 25-4.

NEW from Concertapes . . .

BORODIN: POLOVETSIAN DANCES; GLINKA:
RUSSLAN AND LUDMILLA OVERTURE, Leon-
nard Sorkin, the Musical Arts Symphony
Orchestra. Cat. No. 514.

For a complete catalog, write dept. H94
Concertapes also offers a complete library
of quality CONCERT-DISC Stereo and Mon-
ophonic record albums.

See your dealer Today!

CONCERTAPES, Inc.

'Sound in the Round'®
BALANCED ACOUSTIC STEREO
P.O. Box 88, Wilmette, Illinois

**ROBINS
TAPE-KARE KIT**

Take Care With TAPE-KARE

- ★ Cuts wow and flutter
- ★ Increases frequency response
- ★ Eliminates squeal
- ★ Cleans, lubricates, revitalizes
and protects with SILICONE



Now! ROBINS TAPE-KARE

Rolling head cleaner, tape and head lubricant
TAPE CARE WITH TAPE-KARE CLEAN - PROTECT - PRESERVE

\$2.00 List

AT DEALERS EVERYWHERE
Write for FREE Catalog of ROBINS'
Phono and Tape Accessories!



ROBINS
INDUSTRIES CORP.
FLUSHING 54 • NEW YORK

TEEN TAPERS

BY JERRY HEISLER

TWO items that we found in the mail bag opened our thoughts for this month. First a letter from a young fellow in England. Rigel Rees, 14 years-old, from Liverpool, England, wrote in expressing a desire to correspond via tape with tape clubs here in the United States. He will be glad to exchange items of interest which he records in his own studio. Anyone who wants to get in touch with Rigel may reach him at the following address: Rigel Rees, 25 College Road, North, Blundellsands, Liverpool 23, Lancashire, England.

Second item comes from Mr. Donald J. Slattery, Minnesota Mining and Manufacturing Company Sales Representative in Chicago. Mr. Slattery calls our attention to a former item appearing in this column recently, in which we mentioned the fact that 1/2 mil mylar tapes might be hard to handle. Mr. Slattery informs us that these tapes were made to overcome the previous thinness of the acetate base and the low breaking point.

Perhaps there was some ambiguity in our comments so I would like to clear them up right off. The difficulty I referred to in the 1/2 mil mylar tape was the fact that these tapes, while having a high breaking point, do tend to stretch under extreme tension. Where a regular tape would just have a clean break that could be spliced, mylar tapes will stretch and cause distortion that cannot be corrected. I must add that this will only occur under extreme tension, but the unexperienced home recording fan might have some trouble. Under ordinary use these tapes are excellent, but unless the length is needed, we repeat, they are not necessary. We hope that this clears everyone up, and no offense meant to Minnesota Mining or the other tape companies, all of whom are our good and valued friends.

With Spring almost upon us once again our thoughts turn again to the outside. There are a good many projects that teens and school groups can undertake. Many schools will be having "spring carnivals," track meets, and other outdoor events. These all provide excellent footage for the tape recorder. If any of you have any interesting projects that you either have tried or would like to try, please let us know about them.

Patch cords have long been a topic of question to both teens and adults. What are they? What are they used for? and how many do we need? These are questions which we see in the mail bag and in Tapes to the Editor, very often. So, for those of you who like to tinker, I thought I'd give you a few hints.

Patch cords are short lengths of cable for interconnecting various pieces of equipment. Common uses would involve connecting a radio tuner to an amplifier or a recorder; connecting the recorder to the hi-fi system; connecting two recorders together to copy tape, and a number of other uses

all depending upon the type of equipment that you might have.

These cords can be made very easily and with a minimum of expense. Practically every recorder is furnished with a patch cord containing two clips on one end, and a plug that fits the microphone or radio jack of the recorder. This cord is used to tap the speaker of a radio or tv set. If you do not have one of these you can make one by getting several feet of ordinary lamp wire, two alligator clips, and a plug that will fit your particular brand of recorder. The clips go on one end, the plug on the other.

For other types of cords you will usually need to use shielded cable. We make it a practice to have at least a dozen cords on hand to interconnect practically every type of recorder. The average user will not need more than 2 or 3, but since we use many different kinds of equipment we find a large variety very time saving.

There are several types of ready made patch cords available for those of you who don't like to tinker. The cost is very nominal; the use great.

We are pleased to note the variety of do-it-yourself equipment being introduced into the field. We feel that this is of special interest to teens inasmuch as this type of equipment provides an opportunity to enlarge your audio and tape system at a nominal cost, while having fun.

Items worth mention are the Heath line and the Viking line of tape decks, which can be used with do-it-yourself amplifiers. If any of you have done anything with these kits please let us hear from you.

We would like to see more progress being made in the pre-recorded tape field.

I saw a dandy hi-fi system suited for a typical teenage room and using a tape recorder as the central unit. All that was added to the recorder was an external speaker costing about \$30 complete with baffle, plus a turntable with a ceramic cartridge costing about \$35. The tape unit was used as the amplifier and the whole system when connected together, was capable of playing tapes, records, recording and playing records at the same time, or just plain recording. The addition of an FM tuner would have made this system complete. If you have a good recorder try this inexpensive hi-fi rig. The amplifiers included in current tape recorders are capable of doing some fantastic things. You'd be surprised what can happen by improving the speaker a little bit.

By the way, if you have an old 78 floor phonograph that you're about to throw out, take the liberty of removing the speaker. You might find that you'll get a pretty good 12" or 14" speaker that will work quite well in your tape rig.

More next time, and we hope to get our hands on another inverter and go "mobile" again.

NEW PRODUCTS

NEW AM-FM TUNER



Harman-Kardon, Westbury, N.Y., has announced a new AM-FM tuner called the Ode, Model T250, which is designed as a completely integrated multiplex receiver. It provides built-in signal, power supply and space within the chassis to accommodate and operate a new multiplex adapter. In order to convert to multiplex, the Harman-Kardon MA250 multiplex adapter plugs directly into the tuner chassis. With this installed, the tuner becomes a one piece instrument providing complete single channel plus compatible multiplex stereo reception. The FM front end is a new "Shaded Grid" VHF tetrode which combines the low noise characteristics of a triode with the great sensitivity of a pentode. Model T250 is priced at \$149.95. The multiplex adapter is \$49.95. Contact the manufacturer for more information.

TAPE DEGAUSSER



The Aerovox Corp., New Bedford, Mass., is marketing a magnetic tape degausser which is professional-grade equipment and is widely used by broadcasters, recording studios, industrial tape users and other professionals. While it weighs considerably more than usual degaussers, and puts out several times the demagnetizing flux, it sells for just \$49.95 list. This instrument restores used tape to its normal virgin state. There is no residual noise, and it handles any sized reel up to 10", and any width of tape. For more information, write for literature to the Distributor Division, Aerovox Corp.

KNIGHT PREAMP KIT

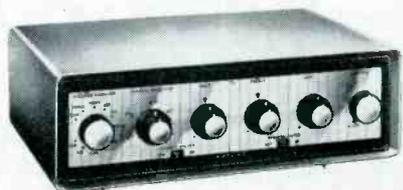

Allied Radio Corp., 100 N. Western Ave., Chicago 80, Illinois, is marketing the new Knight stereo preamplifier kit. The unit is designed for complete, highly flexible control of any stereophonic or monaural high fidelity system. Features include five pairs of stereo inputs; four monaural inputs, concentric clutch-type bass, treble and volume controls which permit adjustment of each channel separately or both channels simultaneously. Printed-circuit boards as well as an exclusive printed circuit "plug-in" switch greatly simplify assembly by reducing wiring time by 90%. Frequency response of this new preamp is plus or minus .5 db. from 7 to 20,000 cps. The Allied Knight-Kit is complete with tubes, all parts, solder, wire, and step-by-step instructions. It is priced at \$62.50. Contact Allied for further information.

NEW IRISH SERIES

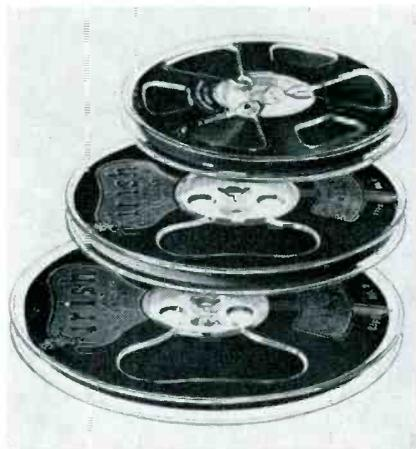

A new "Continental Series" has been added to the Irish brand line of magnetic tape. This series offers the 5 3/4" reel, an exclusive feature of the Irish line, with longer lengths of tape. This was designed especially for the many European recorders now being imported, but the new lengths can be used also on practically all American-made recorders. This series is available in the following tape line numbers: No. 195, 850' Brown Band; No. 211, 850' Green Band; No. 300, 850' Shamrock; No. 601, 1150' Long Play (Mylar); No. 602, 1150' Long Play (acetate); and No. 724, 1650' Double-Play. For the names of dealers who stock the "Continental Series", drop a postcard to Nat Welch, Vice President for Sales, ORRadio Industries, Inc., Shamrock Circle, Opelika, Ala.

UPSA-DAISY

If you are wondering whether or not we intentionally wanted you to turn page 13 of the last issue upsidedown to view the Stereo-X recorder, let us relieve your wonderment. Nope—we just weren't focusing the eyeballs when proofing and the pix slipped by in the wrong position. With hanging head, we offer our apologies both to International Radio & Electronics Corp. and to our readers.

COMPARE these performance specifications

- Sensitivity -57 db
- Response 60-13,000 c.p.s.

COMPARE the price \$57⁰⁰

with any other lavalier and you'll know why Turner's Model No. 58 Dynamic is the **LARGEST SELLING LAVALIER**



Prove it yourself. Try it in your studio subject to your own work conditions, your own recorder, your own performance standards. You'll see why no other lavalier microphone can match it.

Model 58 wired for selection of high or low impedance; Model 58A wired for selection of 50 or 200 ohms impedance.

Weight—3 1/2 oz. (less cable)
Cable—25 ft. attached
Price—Model nos. 58 and 58A (including lavalier accessories) \$57.00

Write today for complete literature

THE TURNER COMPANY
900 17th St. N.E.
Cedar Rapids, Iowa



Converts to a desk microphone when used with matching stand. G-4 Stand \$5.75

WOLLENSAK OWNERS

RECORD STEREO

- Tapes
- Records
- Live Performances

using the

HARTLEY STEREO DUPLICATOR

and any stereo playback Recorder

\$19.95

Just plug it in

write for free information

HARTLEY MFG. CO.

10133 S.E. 8th

Bellevue, Washington

4 TRACK STEREO TAPE ON REELS

1st RELEASE!

JACK KELLER TRIO — 30 minutes of sparkling piano & rhythm, includes Tenderly, Them There Eyes, Paper Moon, Shine & 5 others. Order Now!

4 Track.....3¾ ips.....	\$4.95
4 Track.....7½ ips.....	6.95
2 Track.....7½ ips.....	8.95

artcorde®

RECORDED TAPES

Box 561

Huntington, N. Y.

RECORDS FROM YOUR TAPES

Meetings, concerts, training aids, etc economically re-recorded on permanent hi-fidelity discs. Professional quality —overnight service—all speeds—any quantity. Write for Free Folder and Prices.

RECORDED PUBLICATIONS LABS.
1568-1580 Pierce Ave., Camden 5, N.J.

TAPE RECORDERS



**HI-FI COMPONENTS
SLEEP LEARN KITS**

MERITAPE
Low cost, high quality
recording tape, in boxes
or cans. **FREE**
1959 CATALOG

DRESSNER, 69-02 AA, 174 St., Flushing 65, N. Y.

TAPES TO THE EDITOR

When sending tapes to the editor please use the 3" reel and indicate the speed at which it was recorded and whether it is dual or single track. We will listen to your tape, make notes from it for use in this column and then reply on your tape. Please keep tapes reasonably brief.

If you do not own a recorder, a letter will be acceptable. Address tapes or letters to: The Editor, Hi-Fi TAPE RECORDING, Severna Park, Md.

Recorded Tape-Dealer's View

To the Editor:

I am quite concerned about the situation on pre-recorded tape. Since the advent of stereo records about six months ago, there have been no significant new releases on stereo tape. No one, apparently, has taken a definite stand as to what is going to happen. The tape industry especially seems somewhat in a panic so I wanted to present my views on the subject, not that these views will solve the problems but it might at least get the people who do solve the problems to hurry a little.

We sell stereo tape and stereo tape recorders. We have only sold tape recorders since 1955 in enough quantity to make them worth mentioning. Due to the fact that we are primarily interested in the finest reproduction of recorded music, upon the first Victor release we realized that stereo tape definitely had something to offer that no other medium did, and although we pointed out the many other uses of tape recorders, we sold them primarily as stereo tape players.

When stereo records hit, we, like everyone else, were quite concerned about the situation on tape. We did not stock tape recorders as heavily and we quit ordering stereo tape. The main reason we quit ordering stereo tape was that we believed that when the records came out that the price on tape would be reduced. The first few months, until London released their stereo records, the quality of the average stereo record was so poor that I felt it in no way compared in over-all sound with the average LP regardless of the equipment used to play it. When London records came out, this showed that there was definite possibility of getting at least good sound from stereo records, but still not as good as the better stereo tapes.

In the late fall of 1958 I was amazed at the amount of sales we made of stereo recorders and stereo tape players and stereo tape. I thought this was probably just a Christmas surge and would die out after Christmas, but it has not died out. We have sold approximately twice as many tape recorders and stereo tape recorders in the last three months as we have in any previous three months' period, enough that, for the first time, it has become a significant part of our business.

Around Christmas time we found ourselves having to reorder stereo tape, even at the regular price or very near to it. I feel that stereo tape offers many definite advantages over stereo records and always will. I feel that as the high fidelity industry grows there will be many people who want to improve their present systems and equipment. Many people will have to go to tape to get any important

improvement. Prospects of lower priced tape, of course, will help this.

But the way it looks right now, the tape manufacturers are discontinuing production of tape and are closing out their stocks, and of course no information is forwarded to the dealers. There are thousands of tape machines in operation now that play standard 7½-inch stacked two-track tape and these people will continue to want to buy tapes for their machines. There are many machines still in production that play only two-track tapes.

There has been a proposed change to 3¾ four-track tape. From what I have seen and heard of this medium the quality is not superior to that of London stereo records. I feel people who are going to tape are after something better. I do believe, however, that 7½ inch four-track tape would be quite satisfactory, would allow the manufacturer to reduce the price some, and if the tape recorder manufacturers want to see a continued boom in the sale of tape recorders they should do everything possible to see that an adequate supply of recorded tape of the highest quality is available. I feel this can be done partly by supplying the tape manufacturers with conversion head assemblies, spare parts, service, etc., at little or no cost, and bulk tape manufacturers should supply them with bulk tape at the very lowest possible price, possibly with a tie-in as to the name of the tape. If the record distributors don't want to mess with the small volume involved, it might be distributed through some of the leading tape recorder manufacturers handling it at a minimum of cost.

I think the tape should be made to play as long as possible rather than come out with the very lowest priced tapes. I definitely do not believe that the tape cartridge should be adopted as No. 1, it won't play too long; No. 2, it won't fit any of the standard recorders that are now in use, and certainly can't be any cheaper to produce than the standard reel. It would just add additional confusion, as it already has, to the industry. Most people who have mentioned the tape cartridge at all feel the only thing about it is that the tapes can be spooled off onto a standard reel and played. I, for one, certainly wouldn't handle a machine that would not play the standard tapes.

I feel that the only change that I can see in the tape recorders might be one that automatically reverses at the end of the tape and plays the tape back the other direction.

I feel that there are many people who want something better than what they have and they are willing to pay for it. I think tape offers this improvement.—David Betty, Kansas City, Mo.

Recorded Tape-Customer's View

To the Editor:

Some reports in hi-fi magazines explain that lack of demand by dealers is the reason many manufacturers have discontinued stereo tape in preference to emphasis on discs.

It is understandable that some dealers have been unwilling to risk maintaining adequate tape stocks in past several months, due to the confusion created by the disc landslide and the premature tape cartridge announcements.

However, as a stereo tape enthusiast who has been buying tape over one and one-half years and will continue to buy as long as it is available, I believe there may be some other valid reasons why retailers in my city (Atlanta) have not sold more tape.

For example, a few stores have not marked down their year-old prices even in face of recent factory announcements of reductions being made available at retail level.

It is a dealer's privilege, of course, to ask any price the traffic will bear. But a stereo tape hobbyist, familiar with mail order houses, would not often be desperate enough to choose from a limited stock and pay a year-old high price when he can order any tape on the market by mail at current retail price with an extra 23% reduction to boot!

One dealer here continues storing most of his tape under the counter almost out of sight, making sales possible only to regular customers who already know where to hunt. A buyer in this store must also bring his own dust rag.

Still another retailer returns played tape in frayed boxes to his display shelf marked at their original retail prices.

If these store owners practiced the same kind of merchandising with their other hi-fi lines, would they be able to stay in business? If there are other tape shops throughout the country guilty of these practices, NO WONDER demand for tape has been reduced!

I believe there would have been more tape sales in this city if dealers had introduced and continued to promote stereo tape the same way they would have handled any other new product.

As for the present, my stereo tape friends are still interested in new releases and we are still ordering by mail. So, RCA, Capitol, Columbia, etcetera, *PUH-LEEZE keep issuing new tapes!*—*Dick Gore, Decatur, Ala.*

And Another

To the Editor:

I am extremely disturbed at the lack of new 7½ ips stereo tapes and am almost sick with fear that this category of sound, unsurpassed for quality, will be abandoned by the inferior (sound-wise) discs, or the 3¾ tapes. I don't intend to buy a new Ampex to save a few bucks on future purchases, or an RCA cartridge player; and further I have no confidence in 3¾ tape quality-wise.

Because of your position I hope you will exert every effort to convince the producers of tapes a market for 7½" ips stereo tapes still exists. In your great intelligence (certainly more than mine, I

am just an average music lover out of touch with the tape market), I am sure you will think of efficient ways to do this. However, if I might make a suggestion, print a hard-hitting article in your magazine outlining the present danger, suggesting your readers write the tape companies requesting a resumption of new releases, and printing the addresses of the people (companies) to write to. I think it would help.—*Walter J. Sandberg, Whitehall, Mich.*

Chief difficulty seems to be reluctance of dealers and distributors to order. Tape companies are ready to go.—Ed.

Religious Tapespondence

To the Editor:

We are among the people who derive most of their pleasure from things spiritual or of a religious nature. Would there be among your readers others who would desire to correspond by means of tape recordings on this subject? If so, a tape or letter to the following address would be much appreciated and would receive a prompt reply.

We enjoy the articles in your magazine, especially the new items.—*W. H. Price, R.D. #1, Oberlin, Ohio.*

Program Wanted

To the Editor:

Could you tell me where I might get a tape of that January 7 jazz program MC'd by Gleason?—*Max I. Ellis, 5560 Woolworth Ave., Omaha 6, Nebr.*

Can anyone help Mr. Ellis?

Helpful Hint

To the Editor:

I have just received the first copy of your magazine which I find most interesting.

The letter from Irving Pollack about overheating recalls an experience I had along this line, the telling of which might be helpful to other amateur tape enthusiasts. My trouble was not due to faulty construction but to faulty operation.

I don't know how many recorders are bottom ventilated, but mine is and I think a word of warning might not be amiss in the manufacturer's instruction manual. In operating a portable recorder it is often necessary to set it on whatever is available. Once, without thinking, I set mine on a chair with a slightly padded seat which the feet straddled. After about a half hour's play it started to give out with some strange groans and when I went over to investigate it was almost smoking. The chair pad had cut off all ventilation. I was fearful that the machine was ruined but so far no ill effects have shown up.

One question please. Does a tape recorder require any lubrication or are the bearings packed in oil? My manual is mum on this subject also.—*C. D. Arnold, Santa Barbara, Cal.*

The point made by reader Arnold is a very important one and one frequently overlooked.

Oil should be used exceedingly sparingly on recorders and never should be applied to any point where it might get on drive rollers or belts. Motors are generally equipped with bearings which require no oil during their lifetime.

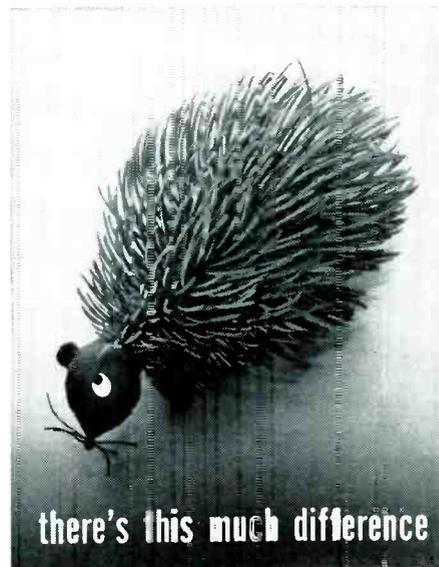

there's this much difference

in tape surface too!

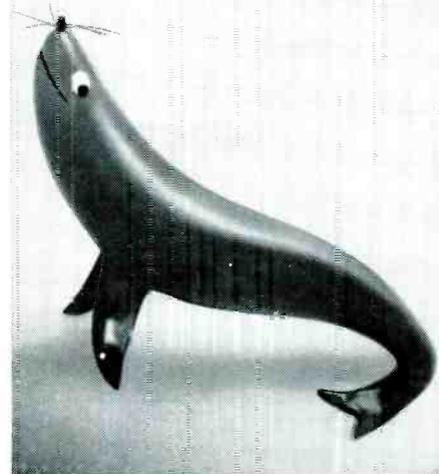

ONLY SOUNDCRAFT TAPES ARE MICROPOLISHED SMOOTH

Unpolished tape surfaces contain microscopic irregularities which prevent intimate tape to head contact. It takes about 10 plays before these irregularities are smoothed out. During this period you lose high frequencies and force your recorder head to do the job of polishing the tape surface. This results in excessive head wear. Only Soundcraft Tapes are MICROPOLISHED to assure a mirror-smooth surface. The tape makes immediate intimate contact with your recorder head, guaranteeing high frequency response *right from the first play!* Only Soundcraft Tapes are MICROPOLISHED for your protection. Buy Soundcraft Tape—write for free catalog RS58-10R.

Ask About Soundcraft's 2-Reel Premium Pack—at your dealer now!

REEVES

SOUNDCRAFT

CORP.

Dept. B, Great Pasture Rd., Danbury, Conn.
342 N. La Brea, Los Angeles 36, Calif.
Canada: 700 Weston Rd., Toronto 9, Ont.

A SOUND INVESTMENT

When we find one we don't hesitate. Hi-Fi TAPE RECORDING magazine will pay many future dividends in recording and listening pleasure.

Where else can you invest at no risk. TAPE RECORDING's time honored "money-back guarantee" makes this investment the bluest of blue chips.

This practical magazine will bring you each month:

- Consumer new product reports of recorders and equipment tested by our staff
- New products
- Newest developments in techniques which will improve your results
- The experience of recordists from all over the world.
- Plus—questions & answers—tapes to the editor—tape club news—classified section, etc.

Fill out the coupon below and drop it in the mail today. If your check book isn't handy we'll be glad to bill you later.

2 Years\$7.00
1 Year\$3.75

HI-FI TAPE RECORDING Severna Park, Md.

Please enter or renew my subscription as indicated below:

2 years\$7.00

1 year 3.75

Payment enclosed. Bill me later.

Name

Address

CityZoneState

TAPE CLUB NEWS

Peace Pageant

On December 22, 1958 a tremendous demonstration for peace was held on the steps of City Hall in Los Angeles, and many World Tape Pals members attended, together with ministers of many faiths, city officials and dignitaries, Boy Scouts, and many others.

The pageant was written, produced and directed by Sarah F. Page, author-playwright. Rev. Leland P. Stewart, minister of the Universalist Church of Hollywood, acted as coordinator and spoke on world peace. Sy and Jill Miller, authors of "Let There Be Peace on Earth and Let It Begin with Me," the WTP peace song, assisted throughout the production.

A "Dream To Remember" tableau was narrated by movie stars, Mitzi Gaynor and Marsha Hunt, after which children dressed in the costumes of each country of the United Nations released white doves of peace. Hotel magnate Conrad Hilton then offered a prayer for peace. This was followed by a dialogue by Mrs. Page and Rev. Dr. John F. B. Carruthers entitled "Flanders Field." The World Tape Pals' peace song was sung by Jack Smith, TV personality.

WTP Dale Weaver made an official tape recording of the event for use on the KFI Night Owls program and for distribution through the club.

The event was covered by three newspapers, four TV stations, and one radio station. World Tape Pals has contributed much to helping promote such affairs and is to be congratulated on its fine work.

South African Rep

Max Nicholls, who has so ably represented World Tape Pals in South Africa for several years, tendered his resignation from this post recently due to other commitments. The position has been accepted by John J. Albertse, P.O. Box 48, Beaconsfield, Cape Province.

John's work as a welfare officer at a large native hostel of the DeBeers Consolidated Mines, Ltd., gives him use of extensive audio equipment. He plays tapes and music received from over the world for the enjoyment of native workers. At some of these listening sessions up to 3200 are in the audience, in addition to hundreds of white people who have listened to the tapes. In the hostels, the taped programs are broadcast over a 50-speaker system.

World Tape Pals welcomes Johnny as its newest representative.

B.T.R.S. Membership

Anyone interested in joining the British Tape Recording Society may now apply for membership through B.T.R.S.'s New York representative, Peter M. Bardach (see address in box listing). This saves weeks in American members receiving club correspondence. Old members wishing to renew their dues should send their \$1.50 to

Peter who will mail them an official club receipt in return.

The next publication of the Society to be issued from the U.K. will be B.T.R.S. Call Book Supplement Vol. 1, No. 3, and it will include the second edition of the Society's new house journal, The Recordist.

Reading For Blind

Member Vance Van Deusen, who was in charge of the reader service for the Voicespondence Club recently resigned because of a change in his working hours. Oscar Kiger, 6812 Ontario Avenue, Hammond, Indiana, has now taken over the job.

At present, Oscar is very much disturbed because the supply of volunteer readers is exhausted and requests from blind folks are still coming in. Why not send your name and address, or a short tape, to Oscar and volunteer your services.

Then when a request comes in, he will notify you and all you have to do is send a short get-acquainted tape to the blind member and ask what type of thing he wants read. The blind member will supply the tape and reading matter if you do not have access to it.

Reading is not restricted to male members and in many cases a female voice is requested. Perhaps some husband-wife or brother-sister reader combinations can be worked out. At any rate, come on Voicespondence members—contact Oscar and volunteer.

JOIN A CLUB

TAPE RESPONDENTS INTERNATIONAL
Jim Greene, Secretary
P. O. Box 416, Dept. T, St. Louis 66, Mo.

THE VOICESPONDENCE CLUB
Charles Owen, Secretary
Noel, Virginia

WORLD TAPE PALS, Inc.
Marjorie Matthews, Secretary
P. O. Box 9211, Dallas 15, Texas

AUSTRALIAN TAPE RECORDISTS ASSOC.
Jack A. Ferry, Federal President
Springbank Rd., Clapham, S. Australia

UNITED RECORDING CLUB
Richard L. Marshall, President
2516 S. Austin Boulevard
Chicago 50, Ill.

BRITISH TAPE RECORDING SOCIETY
Peter M. Bardach, New York Representative
210-16 Grand Central Parkway
Queens Village 27, N. Y.

AMERICAN TAPE EXCHANGE
Stuart Crouner, Secretary
181 E. Main St.
Gouverneur, N. Y.

BILINGUAL RECORDING CLUB OF CANADA
J. P. Paquette, Recruiter
1993 Morgan Boulevard
Montreal, Quebec, Canada

CLUB DU RUBAN SONORE
John-Paul Barabe, Publicity
1274 St. Elizabeth St.
Montreal, P. Quebec, Canada

AURORA SCIENCE TAPE SOCIETY
Walt Richard Sheasby, Jr.
215 North Baldwin Ave.
Sierra Madre, Calif.

Please enclose self addressed, stamped envelope when writing to the clubs.

QUESTIONS AND ANSWERS

Questions for this department may be sent on tape or by means of a postcard or letter. Please address your queries to, "Questions and Answers," HI-FI TAPE RECORDING, Severna Park, Maryland. The most interesting and widely applicable questions will be used in this department and all inquiries will receive a tape or letter reply.

Equalization—Portable Recorders

Q—The first question concerns the so-called NARTB equalization in recording amplifiers. How widely is the standard recognized and adhered to? i. e., how many makers of recording amplifiers for professional and amateur use employ the NARTB standard? And how feasible would it be, to attempt filtering the recording signal, for instance of a Magnecord amplifier to produce a tape conforming to the NARTB standard? This question has arisen in the course of producing, playing and copying tapes recently with Ampex, Viking and Magnecord equipment: when the Magnecord comes into the picture, trouble arises.

My second question has to do with battery powered recorders. I've never used this type of recorder but have considered the use of one in areas where electric current is either unavailable or unsuitable for use with the conventional recorder. However, I notice on radio broadcasts of tapes recorded on such equipment that there is almost invariably a distinctly audible hum or other noise present and I wonder whether such hum is unavoidable with these recorders or is it simply the result of field recording techniques that involve too close proximity of the microphone to the motor mechanism? I suppose my question resolves into this: under similar conditions, is it possible to produce as good tapes with the battery powered (or battery and spring powered) portables as with the conventional portable machines?—H. F. Davidson, North Carolina.

A—The NARTB standard is rather widely recognized in the industry although not all manufacturers follow it. It is more than likely that the higher-priced machines will have NARTB equalization. We do not have an actual count on how many do and do not. The specification sheets furnished with recorders will generally state whether or not the NARTB equalization is used. Regarding the Magnecord, to the best of our knowledge the present models do conform to NARTB standards. The older models do not but a kit was made by Magnecord to convert these older units to NARTB standards. We would suggest that you write to Magnecord, 41st and Sheridan Road, Tulsa, Oklahoma concerning this.

Any signal can be filtered before being recorded and a device such as the Audio Baton mentioned in the last issue will give wide control. Of course, the signal will be altered by the recording characteristics of the recording amplifier and this must be taken into account.

Regarding portables, most of the trouble stems from the recording conditions in the

field where you will encounter such things as wind noise across the mike, pickup of the car engine running or of nearby autos or other sounds of a similar nature. Usually these on-the-spot recordings are made at disaster scenes where confusion and noise are very much in evidence. Take the same portable into the radio studio broadcast room and the results should be of professional quality. Inadequately filtered power supply, if the unit is run from a car generator and battery can produce hum.

The portables which we tested and reported on in previous issues (Stancil-Hoffman Miniatape, Butaba, E. M. 1. and Magne-mite) all produced very clean recordings and we would not hesitate to recommend their use.

Powdered Splices

Q—In the article "Impact" on page 19 of the February issue it was mentioned that they "scrupulously powdered all splices." Powdering splices I have not heard of. Could you enlighten me?—T. B., Cleveland, Ohio.

A—Powdering a splice is just a form of insurance and the custom probably stems from the old days when splicing tapes were not as good as they are now. Powder applied to a splice will adhere to any of the sticky substance used to hold the splicing tape to the recording tape and thus prevent its being transferred to the recording head or guides. Should this occur, then wow and flutter may be introduced as the tape sticks and unsticks, imparting an unwanted jerky motion. Powdering a splice just makes doubly sure that this will not happen. A smooth running tape is of greatest importance where the tape is commercially duplicated as the "Impact" masters are.

Four Tracks

Q—I am about to buy my first tape recorder although I have read your excellent magazine for over a year. I own a large collection of complete operas and wish to transfer them to 2400 ft., 4 track, a total of 8 hours or about four complete operas per reel. As far as stereo, I'm from Missouri but I try to keep an open mind.

If I buy a stereo recorder with a four track head will I also be able to use it monaurally for record/playback on all four tracks? When purchasing a recorder with four track heads is the above mentioned feature automatic or must I ask for 4 track monaural record and playback?

A—Specify 4 track record and playback. To the best of our knowledge the new Tandberg Quadruple is the only recorder on the market at the present time which will record and play back 4 tracks separately.

THIS SHURE MICROPHONE
IS THE WORLD STANDARD



...AND YOUR BEST
MICROPHONE CHOICE



The Shure Unidyne has achieved a position of pre-eminence that is absolutely unrivalled. It is specified by leading sound engineers; it is requested by outstanding celebrities. The Shure Development Laboratories have continued to make the Unidyne a finer and still finer microphone, creating and reflecting new advances in electronic technology.

When you select the Unidyne for any installation, you are assured of consistent dependability. The most difficult acoustic situations yield to the efficiency of the uni-directional, ultra-cardioid pickup pattern of this rugged dynamic microphone. The Unidyne suppresses feedback, cuts the pickup of random noise energy by 67% and permits maximum freedom of the performer. Its high output makes it ideal for use with low-gain tape recorders and p.a. systems.

THE UNIDYNE IS THE ACCEPTED
STANDARD FOR FINE QUALITY

- public address
- theatre-stage sound systems
- recording
- remote broadcasting
- fixed-station use in police, fire, and commercial communications systems

For durability, versatility, quality and fidelity, the Unidyne is your finest microphone choice.

SHURE *The Mark of Quality*

IN ELECTRONICS SINCE 1925

SHURE BROTHERS, INC., 222 HARTREY AVENUE, EVANSTON, ILL.



Photo by Dick Reid

Rehearsal of Santa Fe Suite for Los Angeles performance takes place in the Shrine Auditorium. The orchestra is the Glendale Symphony, made up of movie and tv studio musicians. Note the engineer behind conductor Dragon; also, the speaker units at stage left and right.

Once Upon A Tape

by Edwin F. Wirsing

... Composer-conductor mixes tape recorded sounds with chorus and orchestra for unusual composition.

Unless otherwise credited, photos courtesy of Santa Fe Railway.

THERE is a tape which runs all the way from Chicago to Los Angeles, figuratively speaking, and it furnishes the basis for one of the most exciting new developments in the art of magnetic tape recording to come along in some time.

Carmen Dragon, internationally known conductor, composer and arranger has dramatically opened a new era in sound with his composition "Santa Fe Suite" in which recorded tapes become integrated with chorus and orchestra.

The "Santa Fe Suite" was premiered last year in Washington, D. C. and performed again last November in the Shrine Auditorium, Los Angeles with the Glendale Sym-

phony Orchestra and a combined 200 member chorus. Mr. Dragon, who personally conducted the composition on both occasions, has stated that the "Santa Fe Suite" is scheduled for presentation in other cities throughout the country during 1959. Working in connection with James B. Lansing Sound, Inc., Mr. Dragon plans a custom-made reproduction system which will be used in all subsequent performances. The traveling sound system will be modeled after the one JBL created for the Los Angeles performance and will include amplifiers, tape machines and stereophonic speaker systems plus standby units and accessories.

Before getting into the "how" of the "Santa Fe Suite," the

The explosion of a powder charge in uranium mining operations in New Mexico is recorded on tape by Carmen Dragon in his quest for authentic sounds along the Old Santa Fe Trail to be included in his composition, "Santa Fe Suite."



following provides a fairly accurate idea of what the composition has to offer during performance:

In four movements, *The Trail*, *Fiesta*, *Panorama* and *Super Chief*, the composition runs a complete gamut of orchestral, vocal and recorded sound.

The opening movement, *The Trail*, furnishes a nostalgic setting for the Santa Fe Trail of the Old West. Themes by Chorus and Orchestra depict the barren wilderness of the great plains; the lonesomeness and hardships of the pioneer; the familiar "Indian" themes, including an attack; and strains expressive of the grandeur of America.

The first recorded sound occurs as Dragon provides a chronological sequence of locomotive sounds, from the early steam engines to today's great diesels. The music

bridges each progression as the first movement ends boldly with Chorus and Orchestra.

The second movement, *Fiesta*, deals with the festive side of early Western life; there are Spanish dances from early New Mexico, marching brass and drum bands and a liberal sprinkling of spirited crowd noises which carry out the flavor of the old times out West.

Panorama, the third movement, provides the broad stroke of pure creativity by Mr. Dragon as it first establishes a nostalgic mood with voices and strings followed by a series of recorded sound montages over the music: A distant locomotive's whistle blends into the exciting sound of a lone cowboy riding alongside the train as it draws nearer—galloping horse and train rhythm blend into a pulsating beat which the Chorus and Orchestra answer with the music of a true Western "hoe down."

The second recorded sound montage of this movement begins with crickets, prairie dogs, train whistles, frogs, coyotes speaking out of the night to blend with the sounds of a real honky-tonk barroom piano; the Orchestra provides the accompaniment. Then a huge thunderstorm (on tape) unleashes its fury and the listener is carried off into the great timber country. The speakers echo the sounds of the axes and crosscut saws of the woodsmen as a giant tree falls to earth. The movement ends as it started with the distant, soulful sounds of a locomotive.

Super Chief, the final movement of the composition, actually recreates a trip from Chicago to Los Angeles via one of today's modern streamliners, the Super Chief. In Chicago we hear the station master's voice announce the departure of the train and the journey begins. Features of the trip, geographically, are highlighted as the Orchestra and Chorus provide the musical setting which depicts the great plains of Kansas, Dodge City, Indian Reservations, uranium mining, etc. The tape offers the sounds from within the traveling train; things heard from the Dome Lounge and the Dining Car, including the familiar chimes announcing dinner.

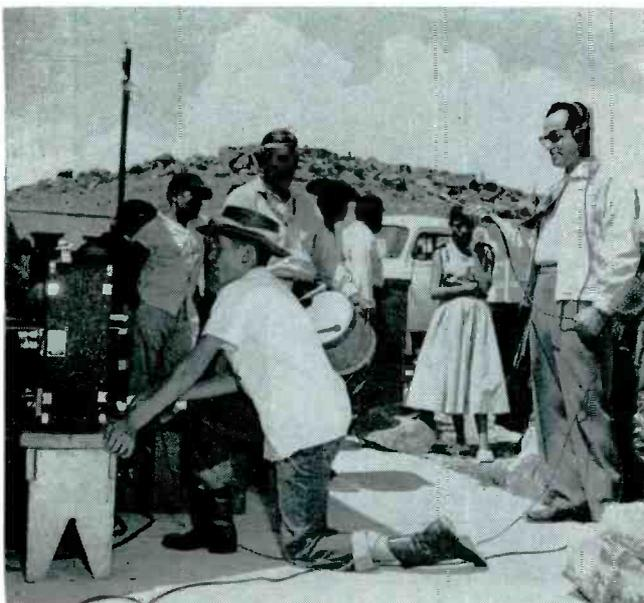

An authentic Indian tom-tom is tape recorded near Gallup. The onlookers, in spite of their aboriginal character seem not at all abashed by the modern tape recording apparatus.



Activity developing a full range of sound from trees hitting the ground to the "plop" of sawn lumber being stacked were recorded on tape by Mr. Dragon. Here he and his son are pictured in the tall-timber area as workmen ready a pine for felling.

The composition ends with the arrival of the Super Chief in Los Angeles; the mighty diesel horn builds to an exciting crescendo as Chorus and Orchestra join to imitate its dramatic "honk."

Needless to say, such a prodigious task as getting the true sounds used in the Suite on tape required Mr. Dragon's enlisting the assistance of many people. Quite naturally the Santa Fe Railway literally rolled out the carpet during the weeks of preparation. Since all the sounds were *real* (Mr. Dragon prides himself on the fact that this was no "studio creation," but the real thing), one can imagine the hundreds of hours of on-the-spot recording necessary to gather the material used. The accompanying pictures provide a general idea of the scope and detail which were required in preparing the tape for the Santa Fe Suite.

Using Ampex 600 tape recorders, Mr. Dragon, an advanced audiophile as well as an accomplished musician, set out to capture as many types and varieties of sounds as possible. As a consequence, not a note of music was set to paper until many hours of editing many reels of tape had passed. The recording of the sounds required using numerous models and makes of microphones; Telefunken, American, Electro-Voice and RCA mikes were all used, at one time or another.

Once the final tape containing the sounds was finished, the music was composed "around it." The next project was to put together a system for reproducing the tape which would be free of all bugs. If a musical portion of the composition is wrongly timed during performance, an adjustment can be made. A tape machine, however, is quite inanimate and unflexible. Therefore, Mr. Dragon, with the help of Edward A. May, engineer of James B. Lansing Sound, Inc. designed a parallel sound system; in other words, two tape machines running simultaneously, each using a perfect dub of the master tape. Although only one was heard at a time, the second or standby unit continued to run during the performance. In this way a break in the tape, a power failure (two separate electrical power sources were used too), or any other unforeseen occurrences could be overcome by simply turning up the gain on the standby unit. In effect this provided insurance against interruption of the

critically-timed tape. Mr. Dragon wears earphones during the performance to be constantly cued on the tape. Minor adjustments for timing are then made as a result of what he hears through the earphones.

The engineer running the tape machine becomes a member of the orchestra, for he has to adjust and balance on cue from the conductor. He is actually playing a new, electronic musical instrument . . . the tape machine.

The reproduction set-up employed for the performance of the Santa Fe Suite included four 60-watt McIntosh am-



Composer-conductor Dragon adjusts a highly sensitive Ampex tape recorder used in capturing the authentic sounds he wanted for his spectacularly novel composition.



Left: Texas and Texas cattle are an important part of any Santa Fe story, and Carmen Dragon is shown here making arrangements to record the variety of sounds which originate at the stockyards in Fort Worth. Right: He prepares to record the throbbing sound of a mighty Santa Fe diesel to be included in the composition.

plifiers (two for each of two JBL Ranger Paragon speaker systems), two Ampex tape machines running duplicate tapes feeding the amplifiers, two to each speaker unit—the second being the standby unit. In other words, there was complete duplication of the system, right down to the speaker systems themselves which were stereo units. The result was that even though it looked like a set of speakers with sound coming out of each, because they were stereo units there were actually *four* speaker systems; two were heard at a time on either side of the stage and two standby units always running but not being heard.

This ingenious system was the prototype for one which Mr. Dragon will use in subsequent performances of the Santa Fe Suite.

Perhaps the most significant part of the Santa Fe Suite is the opening of new areas of musical composition

through the imaginative use of recorded tape. This work is truly a product of the "audio" age; it takes a new and potentially limitless step in the direction of broadening the contemporary composition through the use of tape, and it firmly establishes the versatility as well as the accuracy of the science of tape recording. Mr. Dragon should be commended for his enlightened approach to the use of tape in the realm of entertainment.

Those who will not have the opportunity to hear the Santa Fe Suite performed this year may look forward to the time when Capitol Records, under which Carmen Dragon is contracted, will see fit to record and release a stereophonic version of the Santa Fe Suite. At that time the medium of recorded entertainment for the home will be opened up to all sorts of new and exciting possibilities, thanks to Carmen Dragon and his farsighted use of magnetic tape recording.



Mr. Dragon and his son, Douglas, are pictured at Flagstaff, Arizona, as they catch on tape the sound of a truckload of logs newly arrived from the mountains being offloaded into a mill pond.

We Built Our Own Small Studio

by John W. Berridge



The EMI L2B portable recorder is checked out by program director, Mike Roberts, before being taken out to record a program. A check is always made before any recording is done to avoid losing material available only once.

Below: The operator's position in the control room shortly before the finishing touches were added. The bulk eraser can be seen just to the right of the Ferrograph recorder, as can various interconnecting cables, conveniently at hand, next to the monitor speaker.

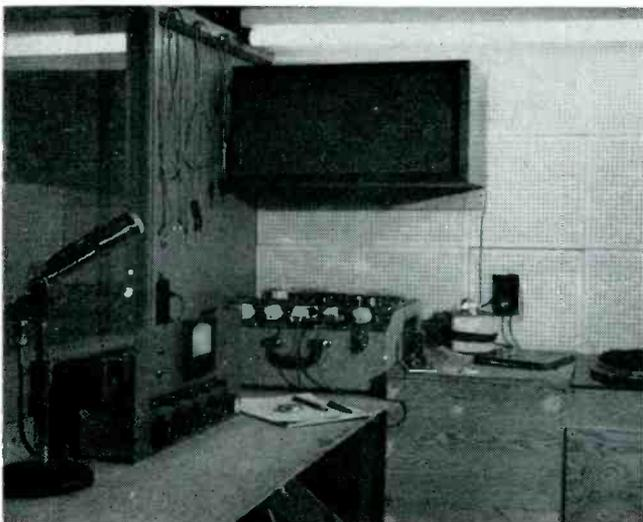

... when a group of Toronto Boy Scouts were offered free radio air time, it snowballed into a studio construction project which has proved its merit by the production of some worthy Scouting programs.

“I WISH we had somewhere half decent to record this program.”

These words, spoken just before Christmas 1957, started a chain reaction which still seems to be gathering momentum. About 9 months previously, Radio Station

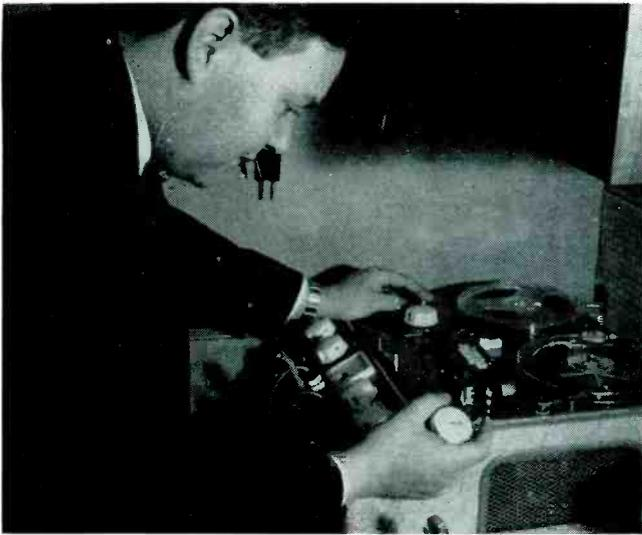

Above: Timing the final program is essential to make sure that it does not exceed the radio station's time allowance. The recorder can be used either with its internal speaker or the monitor speaker directly overhead. Right: Block Schematic of studio interconnections. Much of the design and construction was completed by the author, together with some friends who are enthusiastic Scout rosters, not excluding the Scouts themselves.

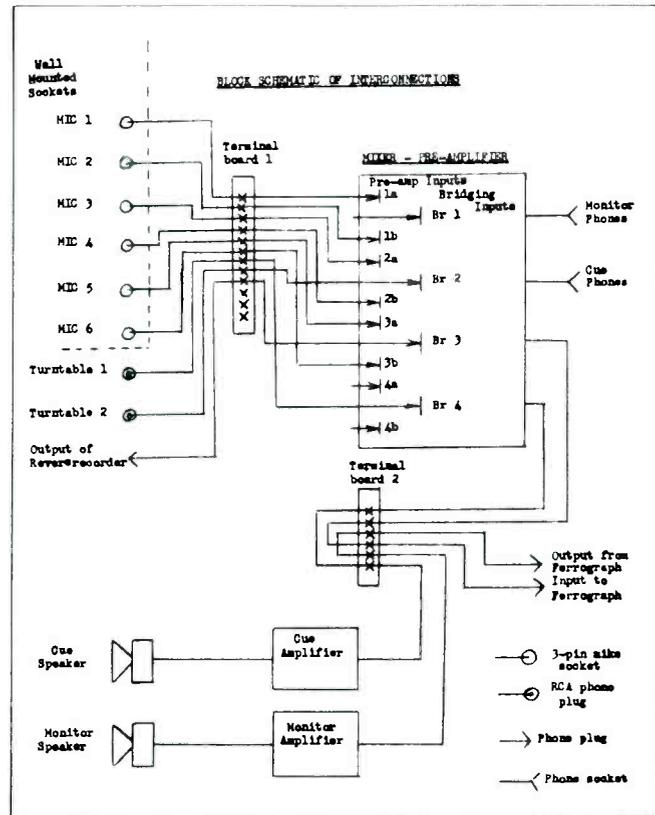

CHUM in Toronto had offered the Toronto Boy Scouts some 15 minutes of air time, free of charge, every Sunday evening for the purpose of producing their own program. They did so as a community service.

Nine months of endeavoring to produce this program with only a Revere T1100 recorder, two crystal mikes and rooms which reverberated like crazy convinced Public Relations Director Mike Roberts that his budget could stand some new equipment, something long overdue. It was about this time that I came into the picture. I'd heard about the program and that Mike was looking for help. Being in the TV industry, I had a good idea of what equipment we'd need and, since I work irregular hours, I'd be able to get in during the day when Mike was in his office. But first we needed somewhere to do our recording, somewhere where we wouldn't disturb anyone else and, more important, somewhere that was reasonably soundproof.

None of the existing rooms in the Scout Building was suitable but we did find an unused corner of the basement which could, at a pinch, serve the purpose. Two big disadvantages were apparent at once. The first was the lack of space. Headroom overall was not much more than 6 feet and at one point part of the room above projected downward into the basement cutting back the headroom by another 9 inches. The space we had available was only 8 feet by 14 feet and we'd already decided that we'd need to split the area into two, one half as a miking area, the other as a control room to house the operator and his equipment. Things promised to be overcrowded!

What complicated the issue still further was that concrete ledges stuck out almost 3 feet from both the corner walls. It looked as though these were going to encroach upon our limited space quite seriously, until we realized that we could use the ledges as seating space in the recording booth and working surfaces in the control room.

As often happens in Scouting, lots of help came along just when we needed it most. There was enough lumber around the building for the complete framing for our studio, including the partition dividing the two halves and battens for the surfaces of the existing walls. Jack, an actor friend and an enthusiastic Scouter, supplied all the tools and most of the know-how with which to erect the framing and we had that part of the job done in a very short space of time.

Our aim was to provide ourselves with a studio which was proof against people walking around overhead and also acoustically dead enough to give us good broadcast quality. This meant soundproofing rather heavily and here the generosity of local businessmen saved us what might have been a heavy expense. One company presented us with the fibre-board for both sides of the framing and the wall battens, another with fibreglass soundproofing to go inside the framing and overhead, and a third with enough acoustic tile to cover the whole of the inside of the recording booth and more than half the control room (we've since been promised more tile to complete the control room). The fluorescent lighting fixtures we were able to buy at cost, and another member of the Scouting fraternity installed these and several power outlets in his spare time. The only other expenditure, aside from the equipment, was for some 3/4-inch plywood sheet for the turntable cabinet and a table to run the whole length of the control room side of the partition.

Several thoughts had occurred to us while we were building the studio and readers might find them useful for their own arrangements. The recording booth door was fitted with a bolt which could be slipped from the inside so that anyone working there wouldn't be disturbed. To make double sure we added an "ON AIR" light over this door and switched from the control room. In the general flurry we sometimes forget to turn it on but we'll get used to the idea!

For general peace of mind (or as a counter to claustro-



The control-room of the Toronto Boy Scouts radio studio, here in use by Mike Roberts, program director and the man responsible for the project. All equipment and library tapes and discs are within easy reach of the operator.

phobia) and also to help everyone see what was going on, we installed two windows, one in the partition separating the two halves of the studio, the other in the outside wall with half looking into the booth and half into the control room. The windows were soundproofed by using two panes of glass in each of them, separated by about 4 inches. This dead space is excellent acoustic insulation but doing this has, not altogether unexpectedly, involved us in some future expense. About the only way to communicate between the two halves of the studio is by shouting and we'll have to install an intercom system before long. We foresaw the need for this and a small intercom speaker is built into the recording booth, but other equipment came first and the intercom will have to wait.

All tape, disc and equipment storage has been confined to the control room and we've tried to keep the recording booth as free from unessential items as possible. This is the only way we could be sure that the acoustics of the booth were kept reasonably constant. If anything, our recordings are now a little too dead but the mike pickup is much cleaner and of far higher quality.

As for the equipment itself, several heavy thinking sessions were necessary before we finally decided which gear would suit our needs best. The Revere we unanimously decided to keep since we would still have need for a recorder for odd committee meetings and such. In addition, though the overall quality from record to playback of a domestic recorder is not very high, the Revere gave sufficiently good results on playback only to make it extremely valuable for dubbing from one tape to another. Having a second recorder has since proved a great help, as it has enabled us to record any part of the program we wish and then add to it, either live or from disc, at a later date.

The main recorder itself presented little difficulty, contrary to our expectations. We had to limit ourselves to \$500 and the recorder had to produce broadcast results,

with a meter for reading the level, and yet it must be exceedingly reliable in operation, something which would be fairly simple to use and which could be used anywhere without too much extraneous equipment. Also it should preferably have a monitor speaker for playback on the spot. The only recorder which came anywhere near to satisfying these conditions was the Ferrogaph 3A, N. We weren't altogether surprised to find that we'd have to wait several weeks after we'd ordered one before we could get it. This merely served to confirm the wisdom of our choice, particularly when we found out that we weren't the only ones requiring this particular machine for broadcast purposes.

Because of the lack of space, any monitor speaker we considered would have to be bookshelf size and yet still produce a good bass response. In addition since the budget wouldn't stand the cost of a separate monitor amplifier, it had to be efficient enough to be driven by the output of the Ferrogaph without overloading the output. For monitor purposes the Ferrogaph is rated at 2.5 watts, though as is usual with British equipment this is probably a conservative estimate. The only available speaker which would meet our demands was a Stephens "Tru-Sonic" and we've been well satisfied with it. If we turn the gain of the Ferrogaph up to catch weak background sounds, distortion sets in in the output stage, but by this time the level of sound is unbearable anyway. We've found that, working in a confined space, it isn't necessary to use high-powered amplifiers to give undistorted sound for monitoring purposes.

Buying a suitable turntable promised us some expense but here we were very lucky. A new 12-inch turntable with a hysteresis motor (for speed stability) powerful enough to let us cue up discs successfully would have cost us nearly \$150. As it happened, the dealer from whom we bought the equipment had gotten hold of two 16-inch transcription turntables designed for broadcast use. They were Micro turntables made right in Toronto and at that time the

Micro Company had just been taken over by another manufacturer in town, making all their stock obsolete. This dealer was able to offer us a brand new turntable normally costing over \$300 for only \$150. With the deck drilled and tapped for the Gray 108B arm, which we used, we were able to get broadcast equipment for domestic price.

The Gray tone arm is not too easily fitted with a turn-over cartridge and anyway microgroove and standard cartridges need different counterweights. We decided to use two General Electric single cartridges with one 3 mil and one 1 mil stylus. The pre-amp is the one available for these cartridges. It was cheap (\$11) and produced good enough results with no knobs or switches to confuse the uninitiated. Some of our discs are pretty scratchy so we plan to install a low-pass filter as soon as the budget allows. The pre-amp has been mounted right inside the cabinet which we built to house the turntable and need never be touched except for occasional servicing.

The one item of equipment which proved a real headache was the mixer. This is the most essential item in any recording set-up since without it, it would be impossible to do any cross-fades or use more than one sound source at a time. In addition it was desirable that we should be able to tap off any of the mixer inputs for cueing purposes. Furthermore, for ease of fading all sound sources simultaneously, the mixer would need a master gain control. The snag was that no such piece of equipment was available in Toronto without going to considerable trouble and expense. The only answer was to design and build one ourselves.

Designing the mixer was less of a problem than it appeared to be. Several good mixer designs have appeared in magazines and books in the last few years and the author has filed most of the articles in question. It was only necessary to base the design on features found in these articles and the result is a composite of many other designs. Most equipment is designed by this method anyway with facilities added to suit the demands of the particular set-up used. A



Editing is facilitated by using a Robins "Gibson-Girl" splicer, and Mike Roberts has become adept at assembling programs from items of various lengths. The splicer can either be used as shown here or placed to one side and the tape pulled out to reach it.

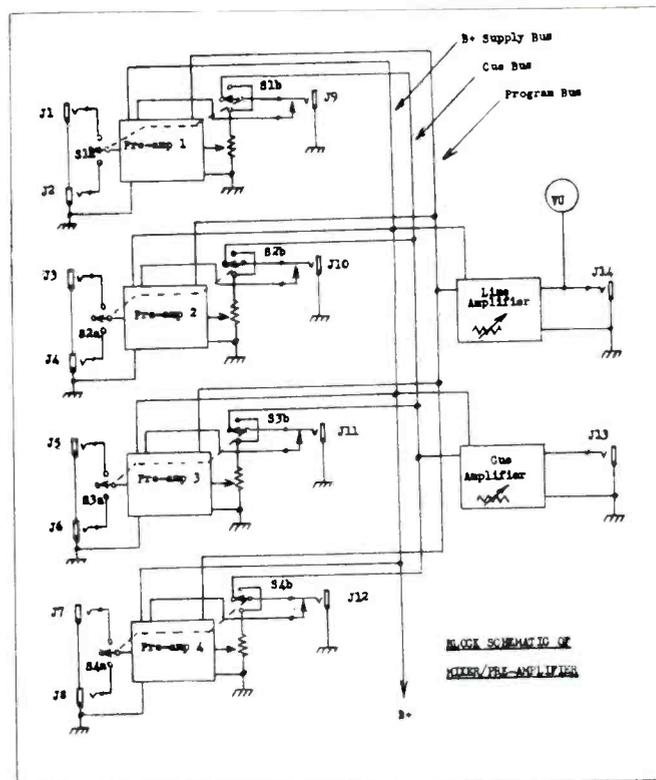

Block schematic of mixer and pre-amplifier. The author had filed away several mixer designs and articles which had appeared in magazines and the resultant design shown above is a composite of these. Certain items were added to fit in with the demands of the particular set-up used.

block diagram of the mixer appears with this article and the reader will be able to see for himself what facilities were built in and their intended use.

Getting the mechanical work done on the chassis and front panel was also a problem since the author has few tools of his own (a penalty of living in rooms) and no access to a tool-room. Jack came to the rescue again however and a few nights' work in his basement workshop got the hardest part of the job done. No trouble was anticipated nor experienced in mounting the components, since we'd used manufacturing practice and made up machine drawings for all the mechanical work involved. Only one minor change from the drawings was made.

Lack of test instruments forced us into wiring the mixer by stages and testing each stage thoroughly before we went on to the next. This delayed the finish of the job considerably and since I could only work on the wiring whenever I had any spare time available, the others showed a certain impatience at the apparent slowness of the operation. However, the thorough approach paid off, since the first mike pre-amp stage had to be re-wired after checking as I was encountering feedback from the parts layout I'd used. Had I gone ahead and done all the wiring at once, re-wiring would have been a major operation and the delay would have been twice as great. If you plan anything of this sort yourself, I'd definitely suggest you go about the job methodically. You'll save yourself a lot of time and effort in the long run.

The only concession we made to expense was to install a 4½-inch VU meter in the cathode follower output of the mixer. The level meter on the Ferrograph is small and of the peak-reading variety. A VU meter gives a truer indi-

cation of instantaneous peaks and is generally much easier for any operator to read.

Most of the remainder of the work has consisted of installing cables permanently in the studio and control room so that the equipment when used in the studio would be reasonably permanently installed. All cables for the turntable could be wired in permanently, together with the speaker which has been mounted on the end wall. Neither of these items is ever likely to be used outside of the studio. In addition to the original crystal microphone we've also added two Electro-Voice 644 dynamics used on low impedance with Electro-Voice Cable Transformers to match them to the high impedance inputs of the mixer and the recorder. One of the microphones is used in the recording booth (which has had two mike sockets permanently wired in) on a floor stand, and the other is kept in the control room for those occasions when one person has to do both operating and announcing. In the latter case, the speaker is disconnected from the recorder to avoid feedback. For monitoring purposes under these conditions and when we do any recording elsewhere, we use Telex Twinstests which are light, comfortable and have excellent frequency response and sensitivity. The author has used them a number of times for monitoring during professional recording assignments and has found them ideal for the purpose.

Even after only two months of operating with this set-up we've started expanding our facilities. The first addition was a bulk eraser (made from an AC transformer) and the first thing we do before using a tape is to bulk erase it. Just to make sure that we don't erase wanted program material, we've instituted a filing system for tapes and discs. This is open to abuse of course, but learning how to use this studio of ours is largely a matter of time.

The other addition has been an E.M.I. L2B battery-operated portable recorder. Boy Scouts hold a large part of their activities in the open air, away from any suitable power supply. They frequently hold camping rallies in areas where it isn't even possible to take an automobile. This is a good thing since it teaches us all to be independent of

outside help, but as far as our program is concerned it has prevented us from recording anything at such gatherings. The E.M.I. recorder has enabled us to produce some excellent programs from these affairs and has already proved its worth. However, it is a difficult machine to use, being designed specifically for one-man interviewing purposes. It produces results well above that of any other portable recorder the author has used, but a stern self-discipline is necessary when using it. Batteries are not yet inexhaustible and the recordist has to resist the natural tendency to play back what he has just recorded. Also a certain amount of planning is necessary in order to avoid discharging the batteries by unnecessary recording.

One of our biggest difficulties lies in the fact that only the author has had any technical training, and most of the persons who volunteered to help with production of radio programs or in handling any equipment of this type have had none at all. We make many mistakes, a lot of them silly ones, but we're learning rapidly. We're endeavoring to make up a complete file on all the equipment, with as much servicing and operating data as possible. The main reason for this is to help anyone who has to service or modify the gear after the author leaves Toronto. However, it will be as non-technical as possible as a guide to those who are having difficulty with operating the present set-up, or newcomers who are unfamiliar with the studio. In addition we intend to start a loose-leaf file containing notes on operating the gear and hints toward producing programs.

All this started from small beginnings and several radio stations have expressed interest in our programs. Eventually we can foresee the program becoming a full-time occupation for someone. In the meantime, our program has provided the lads themselves with an excellent source of information and education, and has done much to bring Scouting into the public eye in this city. In the process it has done much to clear up misunderstandings about Scouting. It's also been the means by which we've become the proud users of what must surely be the smallest studio in the world.

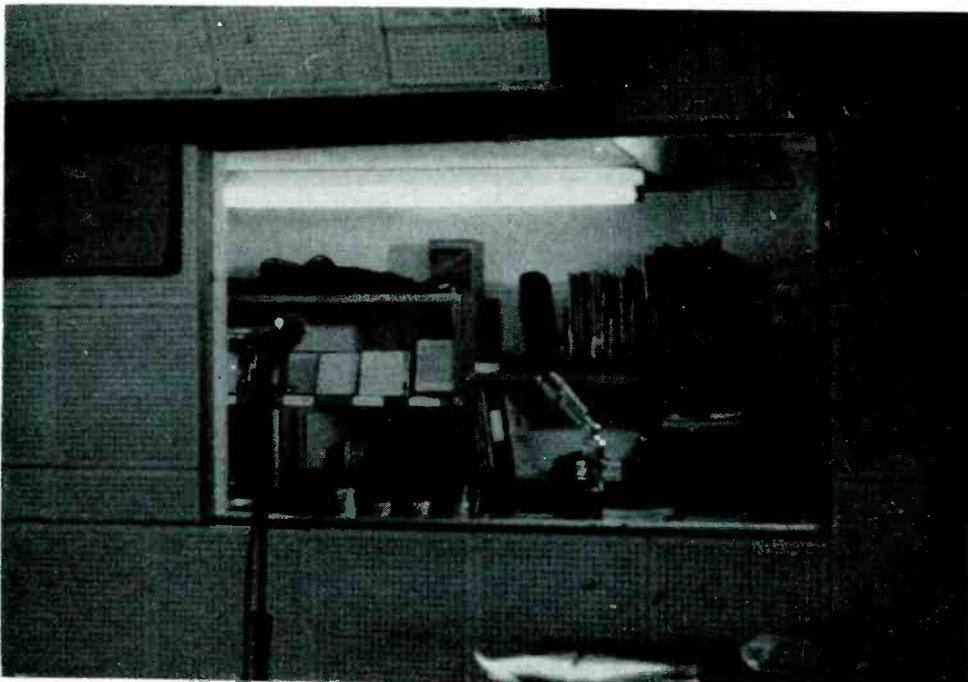

The control-room as seen from the recording booth. The producer and operator in the control-room both have a clear view of the performers. The window dividing the two areas has two panes of glass to provide sound-proofing.

Do You Really Have A Library?

by Tony Schwartz

... if it's housecleaning time for your tapes, here are some suggestions which will be helpful.



When you edit and index your tapes you will really have a tape "library," not just a melee of recordings. Editing is simple and can be fun, not just a chore. The first step in the editing process is clipping segments from the original reel of tape. Above, author Tony Schwartz listens to locate spot for cutting. After separation, you will want to group certain segments together, which will be divided by leader tape.

(Note: For years Tony Schwartz has been collecting sounds on tape as a hobby, as a profession, and as an art. Described by *The New York Times* as a "creative tape reporter," he has used his tremendous tape collection as the basis for 15 records including "Sounds of My City," which won first place in the World Radio Festival, Rimini, Italy.)

If you're the average amateur tape recordist, your collection isn't a "library" at all, even though you do call it that. It's a jumbled stack of reels, unsorted and unidentified.

When you play back a tape, there's no break between Brahms and baby's cute sayings. Guests yawn as you search endlessly for the bit you've bragged about. Tapes dry out and break because you leave them on radiators or simply because of old age.

And you're missing half the fun of recording.

It needn't be that way at all—not if you edit and index and take some simple steps to preserve your recordings. It's easy to do, takes a little time, not much equipment. It's not a chore but a pleasure, and you'll find, as I did, that it will do more than convert your collection into a library that

can be used conveniently. Your tapes will take on a new personal meaning. You'll have a purpose and direction for all your future recording. Editing will automatically show you what you want to record and how to put it together so that it has significance to you.

I have 200 miles of tape in my workroom. Much of it was recorded years ago; all of it I expect to be using for another 20 or 30 years. With this much tape and with my urgent need to refer to it often, I've had to edit and index and develop a system that will work. Your problem may be very different, but some of the tricks I've learned will work for a 20-reel—or even a two-reel collection.

First of all, ask yourself, "Why do I record?" You may be assembling a musical album, or building a family scrapbook in sound, or preserving noises you like or speeches that interest you. Or you may be doing all these things. You don't have to answer the question in so many words now or any time. Just keep asking it as you go along and you'll stay on the track.

Now let's look at the mechanics. Suppose you have a reel with a jazz number from radio, 10 minutes of Junior's Christmas morning, a classical excerpt you like, and some

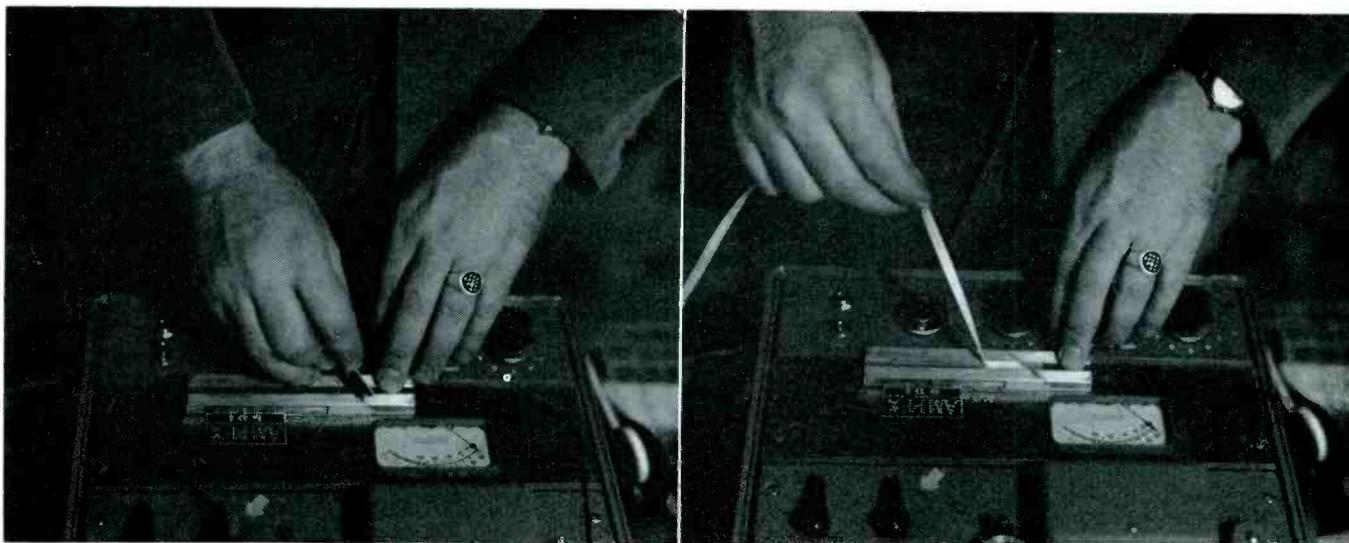

Left: Desired section of tape is cut. Notice that the author has the splicing block mounted on the recorder. Tape can be cut and spliced without removing reels from the spindles. Right: Leader tape is spliced to the separated section and it is now ready for transfer to the proper storage reel. Special splicing tape should always be used to avoid adhesive difficulties.

good party talk. That's a typical assortment for a home recordist and a good place to start organizing.

Get a few empty reels, a splicer and splicing tape, some leader tape—and you're in business.

Now—you'll probably want to separate jazz and classical music. You'll be recording a lot of Junior, so Christmas exclamations are just a starter. The party conversation is a beginning, too. You'll build it up later—with some other conversation, with more from the same people, with more on the same subject, with more parties. Which way you go depends on your interest—that's the beauty of editing.

Take your tape and clip off the first segment. Add a couple of feet of leader and wind it on one of the empty reels. Then do the same for the second segment and the others in order. When you're finished, your "library" is started.

The next time you record jazz selections, add them to the first one. As they accumulate, you may want to juggle the order for a more polished repertory. When you get quite a few, you may want to subdivide your original jazz reel into several others, based on artist or style or some criterion of your own. Easy to do, and you'll find your jazz collection growing not indiscriminately but according to your editing and planning.

You work the other reels the same way, of course, and set up new ones as your collection expands.

When you add a new number to a reel, separate it from the previous one with leader tape. I use enough to run for two seconds on the recorder. That's plenty for quick visual identification of the segments on the reel, and it provides a break that's distinct but not annoying. You may want to use a little more when separating conversations so that one doesn't spill over into the next.

Splicing, by the way, is easy enough when you use one of the inexpensive splicers on the market. Don't ever use ordinary tape for the job, though. Adhesive will ooze out. I use the special splicing tape and never have any trouble.

When putting on leader tape, don't forget that it's available in colors. You can use it to color-code your reels—yellow for family recordings, blue for jazz, red for classical

music, green for special sounds, etc. This is a refinement you may find useful for quick identification.

Editing tape when you use double-track recording is something of a problem. Try it after you've recorded both tracks, and you'll invariably find that cutting for one track destroys the continuity of the other one. There's no need for giving up either editing or double-track recording, though. Take a fresh reel, record one track, then edit it and splice it on the proper reels in your library.

Make a note of where each segment is and how long it runs. Then you'll know how many minutes of tape with one blank track you have and where it is. Suppose then you want to record an eight-minute selection. Instead of using a fresh reel, check your list and find a segment with an open track about that long. Pull out the reel and record the piece there. Don't worry if the new addition is a jazz number and the main track of the reel it goes on is devoted to Junior's sayings. You can take care of its location in your index and find it quickly even if it is in strange surroundings.

And that brings us to the subject of cataloguing your reels after they're edited. Perhaps the simplest way to do it is to number every reel as you put it on the shelf. Then use an alphabetical card index. Under "J," it will show you that recordings of Junior are on reel four. Open that box and look at the card you've kept up to date each time you added some tape. You'll see that the piece between the third and fourth leader tapes is the one you made on his fourth birthday. That's what you wanted the guests to hear, and you've found it while their interest was still fresh.

If you followed my suggestion and used part of the other track for a musical selection, you'll have noted "reel four, track B" on the card for the number's heading in the index.

When your collection begins to stretch out on the shelf, you may want to follow my system. By using alphabetical dividers between the reels, I let the shelf itself be my card index. If I want to hear Patti Page, I look between the cardboards marked "P" and "Q" and find her tape without going first to a card and then to a number. The card inside

lists the titles in order, of course, and I can spin to the one I want to hear quickly.

If the cataloguing seems complex as I've described it, remember two things. First, it's easier than it sounds, especially when you do it with your own system. Secondly, if something is worth recording, it's worth hearing, and you can't hear it if you can't find it.

There are some problems in storing tapes, but I avoid practically all of them by using tape based on "Mylar" polyester film. My recordings are valuable, and I've spent a lot of time and effort not only in getting them but also in the editing and indexing. I expect to be listening to them 30 years from now, and I want to know that they'll last at least that long without any worrying or special effort on my part. That's why I've been using tapes based on "Mylar" since I first learned about their toughness and durability.

If you use acetate-based tapes, they're fine, but you have to remember that temperature and humidity will affect them. They'll become brittle enough to splinter if the plasticizer dries out. Normal household conditions are usually satisfactory, but keep acetate tapes away from radiators and don't put them in the attic during the summer. I'd suggest you not leave them on window sills in direct sunlight or on the shelf behind the back seat of a car.

They need relatively high humidity to prevent drying out and embrittlement, a point to be watched during the furnace season. Storing in cans is sometimes helpful, but don't make the mistake of putting in a blotter, as people who should know better have sometimes done.

Regardless of what base your tape uses, keep it clean. Dusty tapes will eventually harm your recorder and at best will make you work harder at cleaning it. I store all my tape in boxes and never leave a reel in the open except when I'm actually using it. Houses are dustier than you think no matter how good the housekeeping is. You can buy extra boxes. I pick one up every time I buy an empty reel—and use it.

Magnetic forces make tapes work, but they can ruin them, too. Store your tapes near a strong magnetic field—like a motor—and your beautiful music ends up as static. I may bend over backwards about this, but I don't put reels near the telephone, any equipment with motors, or even near a coiled wire.

Some experts suggest that stored reels should be rewound at fairly frequent intervals. I've never found this necessary. I've run tapes that haven't been touched for years and noticed no difficulty at all. It's best to be sure that reels aren't wound too tightly, but if your machine is adjusted right, they won't be. There's a theoretical advantage in storing reels on their side—when they are on edge, weight is concentrated at one point with possibly more danger of print-through. Again I don't think this is a practical matter, and upright storage is far more convenient. I try to avoid any print-through problems at all by recording at the lowest level consistent with good playback, paying special attention to this when I'm using very thin tapes.

Speaking of thin tapes—which offer extra playing time per reel—I find that those based on "Mylar" polyester film don't sacrifice adequate strength for the sake of length and are very useful for some types of recording. That extra time is a big help on some occasions.

As long as you have less than a couple of dozen reels in your library, you probably won't be worrying much about a special rack since a bookcase will do. After that point,



With a large tape collection, Tony Schwartz uses his shelves as an indexing system. Lettered dividers make it easy to locate alphabetically arranged reels. He records on tapes made of "Mylar" polyester film to bypass storage problems, eliminate chance of tape deterioration.

you might think about building a special case. I did. The shelves are eight inches deep and eight inches high so they'll accommodate a seven-inch reel box comfortably but without wasting space. The width and height of the rack is tailored to the space available. If I ever move from my apartment, I'll tack a cardboard or plywood cover on the rack's face and turn it into a packing box. You might use this idea to make your racks portable so they can be put in a back room temporarily. Make them small, add a hinged or removable cover, and put a handle on top.

Regardless of the suggestions you get, storage is mostly a matter of common sense and your own situation. Remember some of the main precautions, and you can't go wrong.

Sure—editing, indexing, and storing tapes right take a little time and planning, but if you're like I am, you'll find great fun in doing them. And when you have a real "library," tape recording will be a much more rewarding hobby, both for you and the people you share it with.

One indexing method utilizes a file card system. Selections are listed under artist, author, style or other appropriate classifications. Index cards show reel numbers, may also indicate sequence of selections on the reel.





SUCCESS IS WONDERFUL—BUT CAN YOU QUALIFY?

THERE is no monopoly on success. You have within you the power to be successful if you will unleash it. When your golden opportunity comes, as it will, are you going to be able to qualify?

Hundreds of thousands of men have become successful. You'll find them in all walks of life, successful teachers, successful businessmen, successful lawyers, machinists, doctors, designers, production men, engineers—you name it.

Their race, religion or nationality has had nothing to do with their success. There are successful men in every nation the world over.

All of them have one trait in common. *They know how to speak well*, dynamically, positively and with sincerity.

They are the ones who head committees, have a full life, fine possessions, who enjoy prestige in their communities, who are ad-

mired—and envied by those who could be every bit as effective themselves.

THERE IS NO SECRET

Theirs is no occult or mysterious power. It is something that can be learned by those who *want* success in life.

To bring this vital knowledge to the greatest number is the work of the Institute of Human Communication. With all the lessons on tape, there is no need to attend inconvenient classroom sessions. You can learn, at home, and in your spare time how to speak effectively. You'll be amazed how simple and easy it is. You learn to speak by speaking, you learn by hearing actual speakers and our instructors coach you to achieve the results you want. The methods have been developed by people with years of experience in teaching public speaking and voice, and experience in radio, TV

and on the platform.

There is no need to envy those who have the "gift of gab." Frequently those who have the most reticence turn out to be better speakers than the so-called "natural speakers."

TAILORED TO FIT YOUR NEEDS

Because all instruction is on tape, it is possible to give individualized, *private instruction* to every student. The assignments will be tailored to fit your needs and interests, to help you accomplish what you want to do. Sympathetic helpful instructors will guide your progress and work with you to develop your abilities to the fullest. You will suffer no embarrassment such as you might in a group.

HERE IS WHAT YOU'LL LEARN

The Art of Communication, How to Develop Your Hi-Fi Voice, How to Organize Material, Effective Communication, How to Prove What You Say, How to Dramatize Ideas, How to Sell Your Ideas, How to Make a Speech of Introduction, Making a Speech to Inform, How to Hold an Audience in the Palm of Your Hand, How to Handle a Controversial Subject, How to Read a Radio Script, How to Stir Your Audience, etc.

FREE SPEECH TEST

Get set to grasp your opportunity when it comes. Use the coupon at left to get your free speech test. We will give you an honest appraisal without obligation and tell you frankly how much this course can help you. Do it today—your big chance may be closer than you think.

SEND FOR FREE SPEECH TEST

**Director
Institute of Human Communication
Severna Park 1, Maryland**

Please rush me the FREE SPEECH TEST. I will be under no obligation and no salesman will call.

NAME

ADDRESS

CITY ZONE STATE

OCCUPATION

MAKE AND MODEL OF RECORDER

Institute of Human Communication, Inc.
Box 35, Severna Park, Md.

NEW PRODUCT REPORT

STAFKSTED

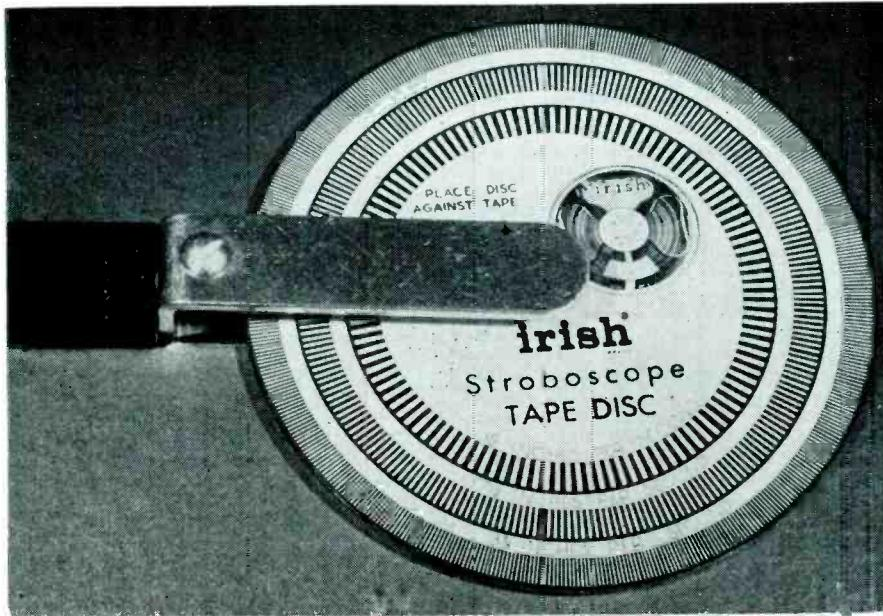

IRISH TAPE STROBOSCOPE

... with this handy gadget you can check the speed of your recorder.

THE Irish Tape Stroboscope is a very simple yet effective device. It consists of a rubber handle on which is mounted a $4\frac{3}{4}$ inch strobe disc calibrated in the three most commonly used recording speeds, $3\frac{3}{4}$ ips, $7\frac{1}{2}$ ips and 15 ips. The disc has needle-type bearings which are virtually frictionless. The unit is ruggedly constructed, yet is light in weight.

To check the recorder for proper speed, the disc is placed against the tape while the machine is running. It is best to place it on the tape on the supply reel rather than on the takeup reel. The pressure should be firm enough to make the disc rotate as the tape is pulled off the reel. It will rotate at the same speed as the tape motion.

For easiest viewing, the light source should be a fluorescent one as the lines on the disc are designed to "stand still" at the proper speed in conjunction with the flickering of the 60 cycle household current. It may be used with an ordinary incandescent light but the strobe effect is not so pronounced.

The disc should be held steadily against the tape without too much

pressure.

If the recorder is running at the correct speed, the set of lines marked with that speed will appear to stand still. If the speed is too high the lines will appear to drift forward. If the speed is too slow, they will appear to drift slowly backward.

The speed of the recorder actually is most important when commercially recorded tapes are used. Because these are made on machines with a very close speed tolerance, a home recorder

Product: Stroboscopic Tape Disc

Manufacturer: ORRadio Industries, Opelika, Alabama

Price: \$4.95

that is fast or slow will change the pitch or tempo slightly.

If a recorder runs a bit fast or slow and the only tapes played upon it are those recorded by it, then the recordings will sound proper. You will simply be recording at an off speed. If, however, tapes made on a slow machine are played on one that is fast, or correct, they will tend to sound lower in pitch than they should.

Because of the different diameters of tape on the supply and takeup reels as a recorder runs, there may be a change in speed, becoming slightly lower as the takeup reel fills. This is especially true of recorders with non-synchronous motors and on these machines all you can check is the average speed by using the strobe disc when there is a similar amount of tape on each reel.

If a recorder checks out slow, a cleaning of the heads and guides, and a renewal of the pressure pads will be helpful in bringing it up to proper speed. If the machine is consistently fast, an increase in the clutch pressure or pressure pad action may bring it down to proper speed. Any other parts requiring cleaning and lubricating should be checked and all work done should follow the directions given in the service manual covering the machine.

The Irish Tape Stroboscope worked as specified in our tests and it does provide a quick check on recorder performance.

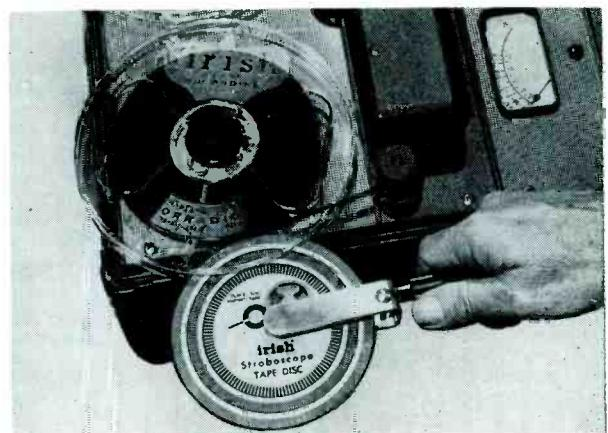

To check the recorder speed the strobe disc is held against the tape on the supply spool. The disc should be viewed under fluorescent light for best results.

Record Anything, Anywhere with "The Magnemite"



Battery-operated, spring-motor tape recorder designed for professional field use. Assures complete independence from AC power. Meets National Association of Radio and Television Broadcasters standards. 60 Models available.

Write for free literature and direct factory prices to Dept. TR.

AMPLIFIER CORP. OF AMERICA
398 Broadway • New York 13, N. Y.

Reg. Pat. Pend.

RECORDS, Masters, Pressings, and TAPES All Speeds; All Sizes; Quantity Discounts, Specialized Services, Labels, etc. Write—

MERLE ENTERPRISES
Box 145, Lombard, Illinois

STEREO BROADCAST TAPES "AROUND THE WORLD IN 80 DAYS"

32 minutes **\$5.95** 7 1/2 ips

Only a limited number available on 1st come, 1st serve basis. These original tapes were used for broadcasting and are guaranteed to be in excellent condition. Your money refunded if we are out of section or not satisfied. Sent \$5.95 to STEREO BROADCASTING SERVICE, P. O. Box 3822, Detroit 37, Michigan.

We specialize in TRADE-INS — highest allowances — Ampex, Bell, Concertone, Crown, Ferrograph, Presto, Tandberg, Hi-Fi components, accessories. Catalog.

BOYNTON STUDIO
10 Pennsylvania Ave., Dept. TR
Tuckahoe, N. Y. Tel. SP. 9-5278

SHOP OR SWAP

Advertising in this section is open to both amateur and commercial ads. HI-FI TAPE RECORDING does not guarantee any offer advertised in this column and all swaps, etc. are strictly between individuals.

RATES: Commercial ads, \$.30 per word. Individual ads, non-commercial, \$.05 a word.

Remittances in full should accompany copy. Ads will be inserted in next available issue. Please print or type your copy to avoid error. Address ad to: Shop or Swap, Hi-Fi Tape Recording Magazine, Severna Park, Md.

LEARN HYPNOTISM, SELF-HYPNOSIS from recorded tapes! Other helpful "Mind-Power" Tapes, Books, Recordings! Free Catalog. Write Philanthropic Library, Drawer TR697, Ruidoso, New Mexico.

RECORD CUTTING SERVICE: Tape to disc. All sizes & speeds. Highest quality. Low cost. Quantity discounts. Write for literature and prices. Electronic Associates, Box 91, Marion Station, Pa.

LEARN WHILE ASLEEP with your recorder. Amazing 100 page book gives full instructions. \$2.00. Satisfaction guaranteed. Sleep-Learning Research Association, Box 24-TR, Olympia, Washington.

FOR SALE: Tapesonic 70-A, 3 speed, 12 watt amp, 10 1/2" reels. \$200 shipped prepaid. Wm. F. McIntyre, 64 E. Main, New Concord, Ohio.

STEREO CARTRIDGES, G.E. GC-7, \$18, Pickering 371, \$22. RPI-003 needle \$5. New—sealed packages. B. C. Pevehouse, 3801 University, Montreal, Canada.

TAPE RENTALS! Monaural and stereophonic, commercial releases only. For full details and price lists, write National Rent-A-Tape Service, Dept. T, P. O. Drawer 1, Winnetka, Illinois.

HI-FI TAPE BUY. Splice free, permanently lubricated, 40/15,000 cps. Money back guarantee. 7" boxed reels. Acetate, 1200', 1 1/2 mil, 4/\$5.20. 1800', 1 mil, 4/\$6.75. Mylar, 1800', 1 mil, 4/\$9.00. 2400', 1/2 mil, 4/\$13.00. Postage 15c per reel. Hi-Sonic, Box 86DD, New York 63, N. Y.

FOR SALE: Professional Roberts stereo recorder with multi erase head. Used less than 20 hrs. Guaranteed to be in perfect condition. Original cost \$349 will sell for \$235. Recorder will be shipped in original carton. Going overseas. Herman Eggers, Box 172, Bismarck, North Dakota.

IMPROVE YOUR LIFE while you sleep! Foolproof sleep learning techniques word for word. Control tension, insomnia, stop smoking, improve personality. Send for "Transitional Sleep Education" \$3.00. ASR Foundation, Box 21 Henry Clay Sta., Dept. R, Lexington, Ky.

WANTED: Crestwood Model 404 portable tape recorder. Must be perfect condition. L. Schissler, 115 King Court, Elmont, L. I., N. Y.

SELL: Bogen 5-station master intercom, \$15; Webcor record changer, GE RPX-050-A cartridge, \$15; hearing aid, \$10. Carolyn Barga, 3007 Rice Ave., Rockford, Illinois.

WANTED: Radio transcriptions, tapes, unreleased recordings, TV and Film soundtracks of Bill Harris-Woody Herman Orchestra. Robert J. Neu, 2233 W. Roosevelt Drive, Milwaukee 9, Wisconsin.

FOR SALE: Professional tape recorder, Revere Model T-11, portable case, stacked stereophonic playback head, takes 10 1/2" reels, over \$350 invested, new condition, \$175. V. R. Hein, 418 Gregory, Rockford, Illinois.

RECORD CUTTING for every occasion from your tape to unbreakable disc. Weddings, socials, lectures, schools. Free information. Albero Recording Studio, 121-18 Rockaway Blvd., South Ozone Park 20, N. Y.

NEW REVERE RECORDER Model T-1100, \$60; Model T-700, excellent condition, \$40; Minifon wire recorder (old model), \$25, with case, etc. W. F. Murphy, 1 Concord Road, South Lincoln, Massachusetts.

UNUSUAL VALUES. Hi-Fi components, tapes and tape recorders. Free catalogue TR. Stereo Center, 51 W. 35 St., NYC 1.

Tapebook #2

HOW'S YOUR HEARING?

by James M. Laing, M. Ed.

Are You Getting The Most Out of Your Hi-Fi or Stereo?
Can You Understand Speakers? Hear Lyrics Plainly?

Protected hearing is the key to your listening enjoyment.

Hearing is one of your most precious human possessions. It, however, like every other precious possession, requires protective care. Without proper protection your hearing can leave you completely, and without warning.

To properly protect your hearing there are two things you must do: (1.) test your hearing periodically, and (2.) seek early medical guidance as soon as a hearing test indicates a possible hearing loss.

Periodical hearing tests are important because, unlike most other ailments, a hearing loss gives you little positive warning. A hearing loss can creep into your life so gradually that you can be completely unaware of its presence.

Test your hearing . . . and be sure!

To help you check your hearing periodically is the purpose of this "hearing check recording."

TAPE CONTAINS

30 minutes of music by the famous Lenny Herman Orchestra — good for listening or dancing as well as screen testing of hearing. Specially monitored.

33 tone pairs to test musical discrimination

75 word pairs to test speech discrimination

Full 7" 7 1/2 IPS
dual track reel
full direction booklet
Only \$9.95

Postpaid

ASK YOUR DEALER OR ORDER FROM
TAPEBOOK DEPT.
Mooney-Rowan Publications
Severna Park, Md.

HAVE FUN AT YOUR NEXT PARTY

Tape record this old fashioned melodrama and play it back. Good for a hundred laughs. Five parts, three male, two female . . . and a donkey. Full directions for sound effects. Complete set of scripts (six copies) as presented on air—only \$2.95 postpaid.

HI-FI TAPE RECORDING

Severna Park, Md.

MAIL ORDER HI-FI
You can now purchase all your Hi-Fi from one reliable source and be assured of perfect delivery. Carston makes delivery from NY stock on most Hi-Fi. Records and Tape within 24 hours. SEND US A LIST OF YOUR HI-FI REQUIREMENTS FOR OUR WHOLESALE QUOTATION and our FREE wholesale catalogue.
CARSTON STUDIOS
215-C East 88 St. New York 28, N. Y.

FOR YOUR AUDIO BOOKSHELF



YOUR TAPE RECORDER

by Robert and Mary Marshall

This is the first book for nonprofessional users and includes the photographs and specifications of 55 recorders as a guide to selecting the proper machine for various uses. The book does not deal with technicalities. It was written after some 2500 experiments had been conducted, using recorders in the fields of education, camps, meetings, business and the home. Part of the book is devoted to an explanation of hi-fi principles and terminology.

5 7/8" x 8", cloth bound, 288 pp. Illustrated.

\$4.95

TAPE RECORDERS AND TAPE RECORDING

by Harold D. Weiler

The latest book by the well known author of "Hi-Fi Simplified" which has sold over 65,000 copies. Written so that anyone can understand it the book covers Room Acoustics; Microphone Techniques; Recording From Records; Radio and TV; Sound Effects; Tape Recorder Maintenance; and Adding Sound to Slides and Movies. Over 100 illustrations and diagrams in 13 chapters of practical down-to-earth suggestions make this book the beginners bible.

5 1/2 x 8 1/4 — 190 pages — illustrated — paper bound.....

\$2.95

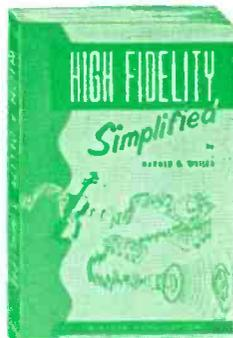

HIGH FIDELITY SIMPLIFIED

by Harold D. Weiler

This book has sold more than 65,000 copies and is one of the most popular books on the subject. It covers the How, What, Why and Where of Hi-Fi. Sound, Acoustics, The Simple Loudspeaker, The High-Fidelity Loudspeaker, Loudspeaker Enclosures, The Basic Amplifier, The Amplifier, The Record Player, Tuners, Use of a Home Music System, and Tape Recorders. It is illustrated with numerous drawings, charts and pictures. While authoritative, it is written in an easy-to-read style.

5 1/2" x 8 1/2", paper bound, 208 pp. Illustrated.

\$2.50

HOW TO MAKE GOOD TAPE RECORDINGS

by C. J. Le Bel, Vice President Audio Devices, Inc.

A complete handbook of tape recording containing 150 pages of up-to-the-minute information of practical value to every tape recordist. Easy reading for the most inexperienced of home recordists.

Sections include: How A Tape Recorder Works, Characteristics of a Tape Recorder, Selecting A Tape Recorder, Selecting A Recording Tape, Using the Tape Recorder, Making A Microphone Recording, Acoustically Treating the Studio, Tape Editing, Binaural or Stereophonic Recording, Putting Together A Recording Show, and a Glossary of Tape Recording Terms.

5 1/4" x 8", 150 pp., paper bound, illustrated

\$1.50

TECHNIQUES OF MAGNETIC RECORDING

by Joel Tall

This book translates the complexities of a science into practical, easy-to-follow techniques. It is a book for the professional who wants new ideas, new standards of excellence, and a book for the amateur just introduced to magnetic recording. Beginning with a description of Poulsen's invention of magnetic recording, the author presents a condensed history of developments since 1900. Then he treats the many problems that arise in magnetic recording. Individual chapters are devoted to recording in such areas as medicine, education, and public entertainment and advertising. The inclusion of descriptions written by the originators of various techniques, extensive quotation from the laboratory notes of pioneers, an extensive glossary, and a comprehensive bibliography make this book invaluable to the amateur and to the professional.

8 1/2" x 5 1/2", 472 pp., cloth bound, illustrated

\$7.95

BASIC ELECTRICITY

by Van Valkenburgh, Nooger and Neville, Inc.

These five volumes, and the five listed below on Basic Electronics are the texts of those subjects as currently taught at Navy Specialty Schools. They are simplified, clearly illustrated and one basic concept is explained at a time without the use of complicated mathematics. Vol. 1—Where Electricity Comes From, Electricity in Action, Current Flow, Voltage and Resistance, Magnetism, DC Meters. Vol. 2—DC Circuits, Ohm's and Kirchoff's Laws, Electric Power. Vol. 3—Alternating Current, AC Resistance, Capacitance and Inductance, Reactance, AC Meters. Vol. 4—Impedance, AC Circuits, Resonance, Transformers. Vol. 5—DC Generators and Motors, Alternators.

BASIC ELECTRONICS

Vol. 1—Introduction to Electronics, Diode Vacuum Tubes, Dry Metal Rectifiers, Power Supplies, Filters, Voltage Regulators. Vol. 2—Introduction to Amplifiers, Triode Tubes, Tetrodes and Pentodes, Audio Voltage and Power Amplifiers. Vol. 3—Video Amplifiers, RF Amplifiers, Oscillators. Vol. 4—Transmitters, Transmission Lines & Antennas, CW Transmission and Amplitude Modulation. Vol. 5—Receiver Antennas, Detectors and Mixers, TRF Receivers, Superhets.

6" x 9", 128 pp. Each Volume \$2.25.

Complete set, 5 volumes

\$10.00

BOOK DEPARTMENT

HI-FI TAPE RECORDING MAGAZINE

Severna Park, Md.

Please ship immediately the books checked.

I enclose

NAME

ADDRESS

CITY..... ZONE.... STATE.....

All books shipped postpaid from stock same day order is received. If not satisfied return books within 5 days and money will be refunded.

- Tape Recorders and Tape Recording
- Techniques of Magnetic Recording
- How To Make Good Tape Recordings
- High Fidelity Simplified
- Your Tape Recorder
- Basic Electricity Vols. Set
- Basic Electronics Vols. Set

THE WORLD'S GREATEST MUSICAL ARTISTS
TAPE THEIR OWN RECORDINGS ON

irish
BRAND

FERRO-SHEEN® RECORDING TAPE:



Renata Tebaldi



Claudio Arrau



Roberta Peters



Isaac Stern

THAT ALONE IS NOT THE REASON WHY YOU SHOULD USE

irish
BRAND

FERRO-SHEEN RECORDING TAPE:



Richard Tucker



Joseph Szigeti



Regina Resnik



Leonard Rose



George London

HERE'S WHY YOU SHOULD USE

irish
BRAND

FERRO-SHEEN RECORDING TAPE:



It's the best-engineered tape in the world . . . gives you better highs . . . better lows . . . better sound all around! Saves your tape recorder, too — because the **irish** FERRO-SHEEN process results in smoother tape . . . tape that can't sand down your magnetic heads or shed oxide powder into your machine. Price? Same as ordinary tape!

ORRadio Industries, Inc.
Opelika, Alabama

World's Largest Exclusive Magnetic Tape Manufacturer

Export: Morhan Exporting Corp., New York, N.Y.
Canada: Atlas Radio Corp., Ltd., Toronto, Ontario