

FEBRUARY 1996 \$5.75 £2.00

Studio Sound



THE INTERNATIONAL TECHNICAL MAGAZINE
FOR PRO AUDIO, POSTPRODUCTION & BROADCAST

The Joe Meek Story

ISDN

Getting set up Network coding systems

20-bit
A-D conversion
SYMETRIX 620

CD-R
How it works
and where it's going





**The CS3 Console.
Featuring a guaranteed advantage.**

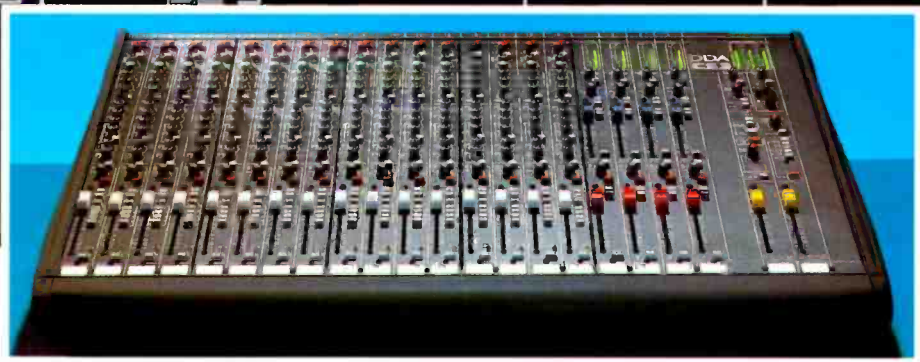

When you choose a compact console as versatile as the CS3, it's good to know your investment is assured a safe future.

To match DDA's proven durability, with each console exhaustively tested before delivery, we include a comprehensive Three Year Warranty.

This special guarantee of long-term reliability and back-up service is another unique advantage of the CS3 alongside many more innovations.

The console combines sonic transparency with simple operation – ideal for demanding live installations and concert and theatre applications.

A semi modular layout in 16, 24, 32 and 40 input frames, is configurable to meet your needs precisely.

Heading the facilities are LCR (left/centre/right) panning, flexible discrete group bus assignment,

Solo-in Place system, three band input EQ with fully parametric mid-band, six aux sends, four stereo inputs, four group outputs and stereo master modules and direct outputs for multi track recording.

Because we believe that "less equals more" where audio electronics are concerned, we use "minimal signal path" topology and state-of-the-art chips for accuracy. Precision components and controls, distributed decoupling and gold plated connectors improve noise, RF immunity and crosstalk. An elegant gain structure gives you generous headroom at every stage for better dynamics.

And with our 3-Year Warranty, the CS3 is guaranteed to keep you working with confidence. That's the DDA Advantage.



- CS3 Features**
- ▶ 40 Input Module Frame available
 - ▶ Stereo and Left/Centre/Right Panning Modes
 - ▶ Individual Routing to Groups



16, 24, 32, 40 Channels

- ▶ Solo In Place Mode in addition to PFL and AFL
- ▶ Parametric Mid Frequency Equaliser
- ▶ Remote Mute Switch Access
- ▶ 4 Stereo Inputs on each Console



Contents

FEBRUARY 1996

5 Editorial Tim Goodyer questions the purpose of audio recording

NEWS

8 Soundings Pro-audio happenings at Livingstone studios accompany business developments at Euphonix, and news from NAIM

13 International Columns Reports from Studio Sound's columnist in Europe, America and the Far East

82 World Events The only exhaustive show and convention listing for audio, postproduction, broadcast, and communications

FEATURES

40 Multichannel/Postproduction

Tom Holman provides an historical overview of cinema multichannel audio

44 ISDN and audio / ISDN

Getting the studio onto the Integrated Services Digital Network

49 Audio Coding/ISDN

Compressing audio signals for ISDN transmission

58 Abbey Road Interactive

Multimedia and audio—Abbey Road and Apple Computer join forces

62 Allen Sides/Recording

A successful producer and engineer turns his hand to design

77 CD-R/Technology

Explaining the convenience, controversy and future of recordable CDs

COMMENT

11 John Watkinson

Measuring speaker cables is impressive but is it necessary?

57 Broadcast

The power struggle for control over the future of digital broadcasting takes shape—and it's ugly

67 Rocket Science

IEEE 1394, ATM and MADI audition for parts in the future of broadcasting

90 Open Mic The talking is over: the fighting is about to start. EMC has arrived



London's Livingstone studios has been extensively refitted and equipped with an Amek Rembrandt console. For the whole story, see page 8

REVIEW SECTION

24 Yamaha EQs

Graphic and parametric equalisation moves upstate with 20-bit I-O

26 Symetrix 620

The latest in American 20-bit stand alone conversion technology

28 API Lunchbox

API breaks its classic console modules out of the desk and into the rack

33 New Technologies

From TimeLine, Sonifex, Lexicon, Whirlwind, Waves, Studiomaster, Tactile Technology, MotU, Peavey, ASC, Koss and others



JOE MEEK

The life of eccentric engineer, producer, project studio pioneer and audio innovator



20 TL Audio Classic Console
Classic audio technology meets modern studio functionality

START PAGE 20



For some studio owners, only one console is good enough.



"I have recorded over 400 albums in the last 25 years and in that time I have worked on virtually every console imaginable. To me, sound quality is everything. Great low end impact, effortless open top end and exceptional overall clarity are not qualities I normally associate with modern consoles. I am not easily impressed, but to my amazement, the SL 9000 exhibits all these attributes. The second I put up a multitrack tape I was familiar with, I was knocked out."

"The SL 9000 just sounds great, period."

Allen Sides, Ocean Way Recording, Hollywood.



SL 9000

Solid State Logic

International Headquarters: Begbroke, Oxford OX5 1RU, England · Tel: (01865) 842300 Fax: (01865) 842118
Paris (1) 34 60 46 66 · Milan (2) 262 24956 · Tokyo (3) 54 74 11 44 · New York (212) 315 1111 · Los Angeles (213) 463 4444

THIS EDITION'S CONTRIBUTORS



TOMLINSON HOLMAN

is President of TMH Corporation. He was Technical Director of Lucasfilm's Skywalker Ranch and set the standards for all THX business. Twice AES Governor, he holds six audio and video patents, lectures worldwide and teaches in Los Angeles.



DENNIS DIKEN is the drummer of The Smithereens, a card-carrying member of the Joe Meek Appreciation Society, and a compiler of prime CD collections including *It's Hard to Believe: The Amazing World of Joe Meek*. He is also a writer for our sister publication *EQ*.



MEL LAMBERT is a consultant to the pro-audio and multimedia industries as well as a working journalist. He has served as a radio producer, currently runs his own PR company and is a member of the AES and the SMPTE at whose conventions he has presented technical papers.

On record: off track

Bought a record lately? What was it—a dental record, a police record, a car's service record? Maybe it was a music record. You see, you've become so used to using the word 'record' that you've started to forget what it really means.

It's actually more than a trivial word game, more than a matter of semantics, because the 'record' has evolved from its conception as a means of documenting an acoustic event into a format which dictates many aspects of the information it holds. But let's hang on to our origins for a moment...

People had conceived of a means of recording before its invention in the same way they had conceived of flight and continue to entertain the conception of time travel. Without such a system, societies were obliged to preserve their musical traditions by passing them from generation to generation—not such a bad system, we'd surely agree, but its susceptibility to distortion is as obvious as it is inevitable. And how do you preserve aspects of a musical culture in which there is passingly no interest? (A question left unanswered by the 'talking books' of Ray Bradbury's novel *Fahrenheit 451*, where The State controls printed material and literature is preserved as an oral tradition.)

Logically, reasonably, enough, the conception of a recording machine was of a means of capturing and reproducing speech and music in a manner representative of its real-world nature. But the realisation of a documentary recording system became the first step in a completely new process. We all recognise—and casually accept—the construction of a few minutes of music taking many hours and utilising techniques quite impossible in the prerecording world.

LIBERATING IN MANY respects, recording systems are inherently limiting in others. Beyond the artistic consequences of the limited playing times of EPs, LPs, cassettes and CDs, the limitations of professional recording systems have made themselves felt—if not always acknowledged—in the pursuit of documenting musical tradition.

I think it was 1985 when Stewart Copeland told me of his frustration over the inability of his location recorders to adequately capture African ethnic rituals whose music regularly ran for 12 hours or more at a stretch. And I think it was 1992 when I followed the theme up with Peter Gabriel. His suggestion that while multitrack machines might be unsuited to working with protracted ethnic music, DAT machines were not was either ill-considered or evasive. Perhaps I chose the wrong moment to challenge him; perhaps the challenge was misdirected as he (and Copeland) use the equipment rather than design it. What is certain is that recording capacities have remained pretty static throughout not only this period, but since David Fanshawe dragged his Uher 4200 and Stellavox around Africa back in 1969.

A couple of months ago I watched a documentary television programme on Irish traditional music. The director's task of relating modern forms (through the likes of Van Morrison and Paul Brady) to historical forms inadvertently offered a unique recording history lesson.

Where Morrison was able to illustrate his comments by singing and playing (since parts of the programme had been recorded in recording studios), older illustrations were drawn from progressively poorer quality recordings and film which gave way to accounts of parents' and grandparents' repertoires which had been lost in all but memory.

With questions about the durability of our recording media regularly raised in the pro-audio press, it is reassuring that increasing efforts are now being made to preserve our recorded heritage. But perhaps this is only part of the story. Should someone somewhere be scouring the Earth for music in danger of extinction? Should music be afforded some of the status enjoyed by animals and architecture?

If so, who should take on the job? And who should pay for it?



Tom Goodyer
editor

The OXF-R3 Digital Mixing Console.
The design is only the design.
Until you use it.



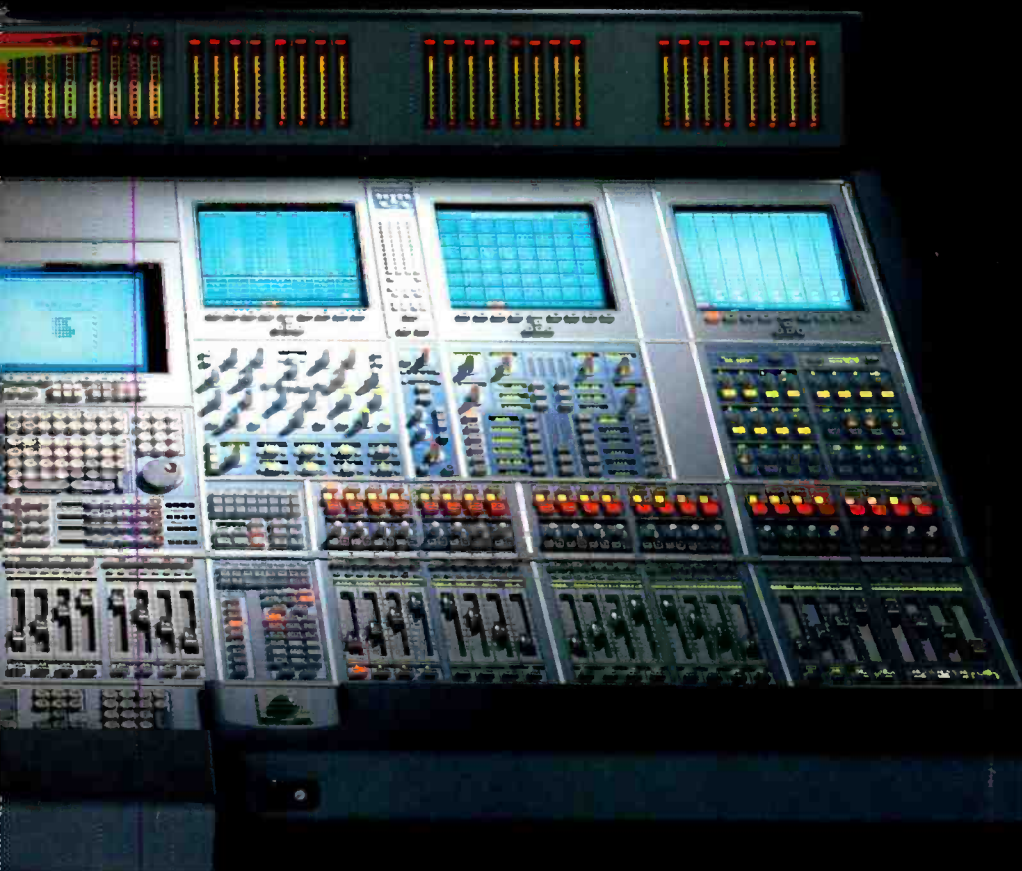

SONY

Sound

WITH 1996's NAMM Show boasting over 1,000 exhibitors, the 26th episode of America's premier trade music exhibition was an eventful one. Spread over all five halls of the Anaheim Convention Center, 50,000 visitors travelled from over 80 countries to gen up on products for the coming year.

The most interesting entry into this market was Roland's VS-880, a personal studio-based hard-disk recorder with an optional expansion board offering 100 digital effects—a nice preproduction machine. With company expansion underway, Korg introduced four peripherals for its SoundLink DAW including the 168RC recording console, a fully digital 16:8:2 device with two ADAT optical inputs, and the 1212 I-O PCI multichannel audio interface with DECK II and a dozen each of inputs and outputs.

Classic rivalry was renewed in the guise of budget 8-track digital multitracking with the Tascam DA-38, a non-modular version of the DA-88, and Fostex CX-8, based on the ADAT format but offering faster rewind and fast-forwarding

plus 18-bit, 128x oversampling A-D and 20-bit 8x oversampling D-A.

Having dominated the sampler market for ten years, Akai presented the new XL-series with four independent channels of effects, SIMM memory expansion and Flash Memory boards for presets. The MESA Macintosh editing system is supplied free of charge. And it was interesting to see Fairlight's Dali-2T twin-track system, which includes time compression-expansion, real-time EQ and dynamic range processing, and Kurzweil's DMTi, the interface for connecting its K2500 to a number of digital multitrack machines.

As expected, Windows 95-based software appeared. Top of the list was Digital Wings for Audio from MSI, a complete 32-bit hard-disk recording system using a card with a nanoprocessor. Non-destructive real-time editing with multiple undo levels and numerous real-time effects are just two of the impressive features. Hot from acquiring Music Quest, Opcode launched its integrated MIDI solution—Vision 2.5 sequencer, OMS 2.0

software interface and Galaxy 2.0 librarian along with the 8Port-SE card for 128 MIDI channels and SMPTE. Steinberg was showing WaveLab, an ultra-fast sound editor including time correction and spectrum analyser, while Mackie is porting its Ultramix automation system and EMagic will be offering Logic extensions for Soundscape and Yamaha's ProMix 01 and CBX D3/5.

There's still life in the Mac and Windows platforms though. Steinberg's ReCycle, the audio loop-slicing program, is now up to v1.5 with support for more samplers, and PC Cubase Audio 1.6 now supports DigiDesign's AudioMedia III PCI card. Talking of the latter, Pro Tools 4 isn't too far off and has some tasty new visual features such as grouping tracks and nesting groups like folders. Opcode's Studio Vision 3 now supports Apple's Sound Manager extension, so providing hard disk recording without



Company for Lexicon's PCM80—the PCM90 appeared at NAMM

additional hardware, Cakewalk Pro Audio offers an elegant sequencing and recording solution for the PC, and Soundscape should have its reverb-delay and time compression software plug-ins available shortly. Even JL Cooper got in on the act with the WB3 a QuickTime jog-shuttle controller for the Mac.

Over a dozen new audio processors appeared at NAMM, the bread and butter side of compressors, limiters and gates boasting five new entries. The Aphex 108 Easyrider features two channels of auto compression through the company's highly-rated VCA 1001 chip, the dbx 1046 offers four channels of compression while

the Symetrix 422 is a stereo leveller and automatic gain controller for use in line-level audio. For those who need eight channels of compression in a neat 1U unit, ARX showed its ULTM-8 (which included a pair of 25-pin ADAT connectors on the rear) and ProSonus launched its DCP-8—eight channels each with an individual compressor, gate, limiter and mute.

The multieffects line also had some impressive additions in the shape of Ditech's 4-channel Studio Quad, tc electronic's Wizard M2000 (with digital inputs and outputs), and Behringer's innovative stereo Ultra Curve DSP 8000 featuring a real-time analyser, feedback exterminator, 31-band EQ and comprehensive filter section.

Aphex further increased its range with the 109 Parametric Equalizer, using the Tubessence circuitry first seen in its 107 mic preamp, and Roland launched the SN-700 noise and hum eliminator. Celebrating 25

LONDON'S LIVINGSTONE STUDIOS reopened its Studio 2 at the beginning of the year with an Amek Rembrandt console, a newly refurbished control room and a rebuilt studio area. It's the first UK placement, and one of the first in Europe, for the Amek desk which combines SuperTrue automation of 80 faders on the 40-frame Livingstone desk along with automated switches, Recall and Virtual Dynamics. The new console replaces an Amek Angela but similarities between the Rembrandt and the old desk played a role in the decision according to Livingstone's Jerry Boys. 'From a sound and EQ point of view it is very similar,' he says. 'I've always felt that the Angela EQ is particularly good and the Rembrandt's EQ has very similar qualities. Even so it's a lot cleaner and quieter than an Angela but it has the same character.' 'Primarily we wanted something with automation on it so we could extend it into cheaper mixing work,' Jerry Boys says in conclusion.

Plans at Livingstone had originally been made for the new desk, a little more outboard, some redecoration and to conjure up a bit of extra space to make a small lounge area. However, the result was a modern looking control room mated to a still-popular but decidedly 1970s looking studio area. KFA who had done the control room refit were asked to come up with some ideas and the go ahead was given to effectively rebuild the area.

'It's a similar shape to what it was but we've made better use of the space and it now has three distinct areas including a reasonably sized live area all separated by patio-type doors so you can run all your worst nightmares in there and still get good separation,' says Boys. 'I know a lot of people say no one does sessions like that any more—well it seems to me that they're starting to again and we get an awful lot of them.'

Recent artists using the facility include Russian star Boris Grebenshikov, who has completed an album with Boys engineering, Richard Thomson and Norwegian singer Anja. The room remains a tracking area but now with the option to progress to automated mixing as an adjunct to Livingstone's SSL in Studio 1.

'It's for people who want automated mixing and can't afford the SSL room,' he continues. 'The board is a lot of value for money and unlike some Amek's it's very easy to use, it looks good too which is important. It's an alternative to the SSL that doesn't mean you have to go out and spend half a million pounds.'

ZENON SCHOEPE



years in the audio business, Lexicon debuted the PCM90, a dedicated reverb partner for the PCM80 which in turn had four cards added to its armoury: Dual FX, Pitch FX, and a pair of 'artist' preset cards. Everyone and their dog launched a Web site including BSS Audio, Kurzweil, Opcode, Peavey and Roland. The Internet—man's ultimate inhumanity to man, especially when you try to get on your server during the day.

Finally, it had to happen: someone's written a murder by MIDI thriller. Entitled Show Control, by Keith Snyder, it carries the inimitable line: 'are you familiar with the MIDI Show Control protocol?'. Join the family...

VIC LENNARD

ANOTHER 'STRATEGIC ALLIANCE' will be formalised on 6th February when Euphonix \$9m purchase of fellow American company Spectral is to be approved by shareholders. Announcing the move to a particularly select group of journalists, Euphonix CEO, Jim Dobbie, claimed to 'want to lead a change we see coming in the audio and post industries'. That change will have people moving part-completed projects into a

hybrid mixing and editing system—typically from Fairlight and Sonic Solutions systems to a Euphonix system. Admitting that Spectral first approached Euphonix on the buy out, Dobbie said that there were other runners but that the shared PC platform and perceived excellence of Spectral's products were decisive factors.

The new-look company aims to offer a production system that 'is an investment because it is can be expanded rather than superseded. Dobbie further identified price-performance as a critical issue—'Statistics tell you what the cost issues are'. Recognising that the DAW market is already crowded, Dobbie was uncompromising in identifying underfunding as a past weakness of Spectral and promising further development and full support for the system bringing the company 'again to the forefront of the industry'. Combining the two companies' lines, he promised a series of 'break-out' units heralded by a synchronisation interface and translation system, the Time Transporter. **TIM GOODYER**



Effects mixer Tennyson Sebastian (rear) dubbed the recently released vampire movie, *From Dusk Till Dawn* on Solid State Logic's Axiom Film console and utilised its integrated DiskTrack system for all the film's effects.

The film's director, Robert Rodriguez, is also pictured at the console at 20th Century Fox, in Beverly Hills, CA. Quentin Tarantino wrote the screenplay and stars in the movie.

News in brief

◆ Berlin's News & Talk Radio has adopted a Klotz' Vadis 40 x 64 digital matrix system. The station is Germany's first radio station to employ 24-hour, 7-day per week broadcasting of news and entertainment programming. Klotz, Germany.

Tel: +49 89 46 23 3826.

◆ American Doppler Studios has opened a new audio post room: Studio G. Designed by George Augspurger, the new room houses a Euphonix CS2000 console and TimeLine DAW-80 DAW with surround sound monitoring using Genelec speakers.

Doppler, US. Tel: +1 404 875 6941.

Euphonix, US. Tel: +1 415 855 0400.

WWW: <http://www.euphonix.com>

Genelec, Finland. Tel: +358 77 133 11.

◆ Wanchai's Post Production Shop has now completed commissioning a new 16-output AudioFile for its Studio C. The latest of three rooms at the Hong Kong facility, Studio C's AudioFile joins Studio A and B's Logic 2 consoles and was chosen to ensure complete compatibility.

AMS Neve, UK. Tel: +44 1282 457011.

WWW: <http://www.ams-neve.com>

Siemens Audio, US.

Tel: +1 212 949 2324.

General Traders, Tokyo 101.

Tel: +81 3 3291 2761.

Audio Consultants, Kowloon.

Tel: +852 351 3628.



◆ US multimedia and CD-ROM house 7th Level has recently installed its eighth Spectral Prisma-Prismatica Workstation. The PC-based system has been in steady use in the North Hollywood facility on such projects as Monty Python's *Complete Waste of Time* CD-ROM and *Battle Beast*.

Spectral, US. Tel: +1 206 487 2931.

◆ Australian entertainment TV empire, Foxtel, has installed a Fairlight MFX3 DAW. The broadcaster intends to use the MFX3 in the production of its own television programmes which accompany varied outsourced programmes including international sport, documentaries and classic movies.

Fairlight, Australia.

Tel: +61 2 975 1230.

Fairlight ESP, UK.

Tel: +44 171 267 3323.

◆ British post house Phase Two has invested in a new 16-channel Avid AudioVision system for its Studio 1. The DAWN system previously used in Studio 1 has subsequently been resited in the facility's Studio 2.

Phase Two, UK. Tel: +44 181 741 9696.

Avid, US. Tel: +1 508 640 3158.

Avid, Europe. Tel: +44 1753 655999.

Avid Japan KK. Tel: +81 33 505 7937.

◆ Frankfurt's FUXX 95 3-hour live show was transmitted via SAT1 and viewed by some 12 million Europeans. The show, along with the UK's Big Twix live event, represented extensive use of Sony radio mics supplied by Raycom. Between them, these shows hosted the likes of Diana Ross, Eternal and D-Ream.

Raycom, UK. Tel: +44 1789 400600.

Sony Broadcast & Professional

Europe. Tel: +44 1256 55011.

Sony Corporation, America.

Tel: 201 930 1000.

◆ The Californian WB Television Network has installed a Soundcraft DC2020 with C3 moving fader automation. The broadcaster's new audio and video post facility is engaged in production of WB TV's promo spots though, while surround ready, has yet to make the jump to multichannel operation.

Soundcraft, UK. Tel: +44 1707 665000.

◆ London's Eden Studios have opted for Audio Kinetics' ES.Lock machine control systems for three of its five studios. Recent sessions involving the AK system include Whitney Houston, Wet Wet Wet and Terrorvision.

Eden Studios, UK.

Tel: +44 181 995 5432.

Audio Kinetics, UK.

Tel: +44 181 953 8118.

◆ The French independent television broadcaster, France 3 TV, has purchased six Optifile Tetra console automation systems for installation in regional news departments. France 3 TV's commitment to the Optifile system endorses French interest as it accompanies an order for three Optifile Tetras (to operate with Sony MXP300 consoles) from one of France's largest independent broadcasters, NRJ Radio.

Ad Systeme, France.

Tel: +33 1 42 53 3118.

Tula Audio, US. Tel: +1 617 859 0992.

The Home Service, UK.

Tel: +44 181 543 4949.

◆ 20th Century Fox are set to install an SSL 9000j console at its Stage 1 in Los Angeles. The installation—by noted LA-based design group studio bau:ton—is part of a major renovation of the historic facility which will see the stage restored to its original size and able to accommodate over 120 musicians. Still one of America's largest sound stages, Stage 1 was originally built in 1928 as the first of its kind and hosted The King & I, Cleopatra and The Sound of Music as well as the recording of 20th Century Fox' signature fanfare in 1935.

20th Century Fox, US.

Tel: +1 310 369 1000.

Solid State Logic, UK.

Tel: +44 1865 842300.

SSL, US. Tel: +1 212 315 1111.

Studio bau:ton, US.

Tel: +1 213 251 9791.

The Ultimate Analogue Console

9098

by Rupert Neve the designer



Photo courtesy Lisa Stansfield's Gracieland Studio, Rochdale, UK.
Configuration shown has 40 Mono inputs, 24 DUAL Mono inputs, 24 DUAL Dual Mono inputs and 4 9098 Stereo inputs. Console has full complement of AMEK SUPERMOVE automation controlling 106 servo faders, 116 channels of VIRTUAL DYNAMICS and comprehensive SYSTEM RECALL.

AMEK

Rupert Neve's 9098 console is manufactured in the UK by

Head Office, Factory & Sales:
New Islington Mill,
Oldfield Road,
Salford, M5 4SX, U.K.
Tel: 0161 834 6747
Fax: 0161 834 0593

AMEK US Operations, Inc.:
Tel: 818 508 9788
Fax: 818 508 8619

AMEK Asia, Singapore:
Tel: 65 251 1629
Fax: 65 251 1297

AMEK South America:
Tel: 55 21 437 6329

AMEK Germany:
Tel: 06721 2636
Fax: 06721 13537





Tabling the cable fable

Learning to measure speaker cable performance is a commendable exercise but it may be made redundant with of good engineering practice

Recently published work shows a measured difference between the waveforms at the two ends of a loudspeaker cable. So there are, although it's hardly news.

Such old news, in fact, that I forget how many decades have elapsed since the relevant theory was first taught widely. The voltage difference is entirely predictable from established physics and so, should it be necessary, is the solution.

Loudspeakers cannot and do not present a resistive load to amplifiers; they present an impedance which is highly frequency dependent. In multiway speakers the impedance often wanders around quite spectacularly due to the crossover design (or lack of it). Once an impedance replaces a resistance, much greater currents flow for a given amount of power transferred. A good amplifier delivers these currents; a poor one limits. Anything between the amplifier and the speaker—including cable—has to pass these currents and any series impedance will cause voltages to be developed. So the presence of a waveform discrepancy across a speaker cable is no surprise.

I have several reasons for making this statement. Firstly, just knowing the effect exists doesn't prove that it's audible or inaudible. I believe the unbiased jury is still out on cable audibility. Even the finest loudspeakers are ghastly things which do a pretty serious mangling job on the input waveform as any delayed resonance (waterfall) plot will illustrate. Measuring the error between the amplifier input terminal waveform and the acoustic waveform from the loudspeaker would be more relevant, and the discrepancies will dwarf those due to the cable.

IN FACT, it's surprising that speakers can sound so good. The reason they do is that the human hearing mechanism does a similar mangling job, depending as it does on a vibrating basilar membrane. Delayed resonance in the basilar membrane causes auditory masking and stops us hearing a lot of the gunge that comes out of a loudspeaker along with the wanted

audio. In my view, a loudspeaker and its associated amplifier and cable have a measurable noise-to-masking ratio. I formed this view after discovering that some loudspeakers reveal the use of compression better than others. I argued that if the loudspeaker is producing more gunge than the compressor, the compression artifacts will be masked by the speaker, not our hearing. This concept has consequences for compressor design as well as for speaker design and I intend to explore the idea further in the future.

If, and only if, discrepancies between the amplifier input and acoustic output remain below the masking threshold on all programme material we can be happy that this aspect of speaker fidelity is beyond the acuity of our hearing. I don't think that we reach that stage very often yet because most of today's amplifier-loudspeaker systems are so primitive. Much of the blame is due to passive crossovers. With high quadrature currents shoving a woofer in and out against a reactive cabinet, it makes no sense to pass the smaller tweeter currents down the same cable. Any common impedance could modify the tweeter waveform. As the frequencies concerned can be far apart, masking is not going to work. Bi-wiring is a long established antidote to this problem. Bi-amping is even better. An active crossover better still. The fact that bi-wiring and bi-amping work without special cable illustrate that attention to good engineering is all that is needed.

Another approach is the use of conjugate impedance correction. Extra reactive components are fitted in the crossover which reduce impedance variations and the magnitude of the quadrature currents giving a speaker which amplifiers find easier to drive. A further consequence of quadrature current reduction is that common cable impedance effects are reduced.

If speaker cable discrepancies had not been common knowledge way back, why would bi-wiring or impedance compensation have come about?

Looked at from another direction, I believe that we could say that if a loudspeaker-amplifier combination is improved by using an exotic cable, the

amplifier or the speaker or both may not be well engineered. The loudspeaker impedance may be too variable. The amplifier may have a stability or current limiting problem. The engineering fix might well come cheaper than the cable.

ONE PROBLEM I have with exotic cables is the pseudoscientific justification, often couched in transmission-line terminology. A quick calculation shows that you need around 40m of cable to get a phase shift of one degree at 20kHz. Consequently, with all practicable lengths of speaker cable, transmission line theory is irrelevant. The propagation delay down the cable is so short that the cable can be modelled as a set of lumped R, L, C parameters which would predict its behaviour over the audio band. Knowledge of the relevant parameters of the amplifier, cable and speaker would allow a half-decent simulator program to compute the cable error. Outside the audio band, the amplifier needs to act as a load which attenuates any RF picked up on the cable for EMC reasons.

Of course, if a problem is hard to solve, why not bypass it? If we can't decide whether speaker cables are audible, we eliminate the worry when we eliminate the cable. A properly engineered active speaker dispenses with the cable debate completely. Feedback to the amplifier can be taken straight off the speaker terminals, putting what little wiring there is inside the feedback loop. Designing an integrated system in this way ensures that the speaker and the amplifier can work together. Alternatively, a general purpose amplifier of unknown stability and reactive current capability connected to a passive speaker of unknown impedance variation is more a gamble than good engineering.

Trying to fix it with exotic cables seems like throwing good money after bad. The active speaker would sound better if it had an exotic mains cable—but only one sold by me, of course.

John Watkinson

SUCCESS BREEDS SUCCESS

Soundtracs Solitaire - The most successful production console of 1995

With over 100 sold in its first 12 months, Soundtracs Solitaire console has set the standard in quality, innovation and value, meeting the needs of today's bands, songwriters, music producers and post-production houses.

And it's easy to see what has generated this success.

Features like the assignable dual inputs (max 88), designed around ultra low noise large junction transistors to minimise distortion levels and maximise signal to noise ratios, each with mute and level automation options, flexible EQ, 8 AUX sends (+24!) plus ADP.

The acclaimed FdB™ Parametric Equaliser provides precise control of all channel frequencies while the monitors have a punchy 2 band EQ with additional access to the mid-band FdB™ Parametrics.

The unique ADP system provides a comprehensive range of gating (5µsec attack), compression, expansion, limiting, modulation, auto and triggered pan, with side-chair keying possible on every channel.

Two high-speed automation systems; VCA on both channels and monitor faders, or Moving Faders on channels and VCA automation on monitor faders are complimented by the option of PC based visual monitoring for display and off line editing.

The Solitaire encompasses the very best automation and ADP without any compromise on the analogue facilities.

Success, after all breeds success.

MIXING WITH THE PROFESSIONALS



The Levellers



Gemini Audio Production



Nik Kershaw

SOUNDTRACS
SOLITAIRE

LARKING AUDIO
LIMITED

Distributed in the UK by Larking Audio Ltd.
15 Cam Square, Wilbury Way
Hitchin, Herts, SG4 0TZ
Tel: 01462 422466 . Fax: 01462 421171

SOUNDTRACS

Unit 21-D, Blenheim Road, Longmead Industrial Estate, Epsom, Surrey KT19 9XN, England, Telephone: (+44) (0)181 888 5000, Fax: (+44) (0)181 388 5050

www.americanradiohistory.com

Take it to the limit



Producers' and engineers' political alliances are fragile at best, but in the current working climate they may have a greater importance than ever before writes **DAN DALEY**

The lyrics of US rock legends, the Eagles seem a particularly appropriate way to open this month's letter from America. As I recall, I used them in trying to explain to some folks from RePro, the UK producers' guild, why US producers were so reluctant to organise themselves. Actually, 'to be organised' is a better way to phrase it; American producers and engineers have subliminally embraced the myths and idiomatic of the American West: 'Don't fence me in' is a virtual tattoo upon their souls and sensibilities, scribbled in just below 'Mom,' 'Harley Davidson' and '(insert ex-wife's name).'

American producers are hardly desperate Desperados, but they are loners both by nature and by practice. Aside from the long hours under the tanning lamps of LEDs, the most recent identifiable trend in the US has been a consistent one towards freelance operation. Even at the audio postproduction houses (where staff positions have long been the tradition) and at broadcast facilities (where union membership is still often *de rigueur*) freelancers have been making their presence felt.

It is a valid and relevant observation that the union experience in the States—from audio on through steel workers—has soured in the minds of many. Those who once saw security in unions now often regard them as regressive and responsible for the nation's loss of prosperity rather than its increase. As a direct consequence, less than 20% of Americans are now union members; a figure which can be compared to one of 50% 30 years ago.

New York City's audio-for-film community was nearly strangled by union demands until the unions underwent a change of heart two years ago as a result of Hollywood producers threatening to boycott the city. And every pro-audio manufacturer who ever attended a trade show at the Jacob Javits Centre knows how many union members it takes to move a two-pound box off a loading dock: As many as possible, paid at time-and-a-half in case the box has no handles.

American producers and engineers operate in a market-driven perceptual meritocracy that evolved more or less on its own. Those at the top have a vested interest in maintaining a perceptual basis of their worth. Those on the way up understand this and accept that the inherent inequities in such a system are more than counterbalanced by the fact that the system also has central to it the axiom, 'You're only as good as your last hit.' Anyone who follows American major league sports will appreciate the concept of fame and fortune being fleeting accolades—so you get as much as you can while the getting's good.

ALL THIS SAID, however, free-market arrangements are by nature non-ideological, and there has been room within the American system for organisation. In the best style of the American West, it has been grass-roots in origin, essence and temperament. In New York, Engineer-Mixer Tony

Maserati formed the Allied Pool two years ago, an attempt to voluntarily organise area engineers as a database from, and into, which they could share references, gigs and information about such things as rates and working conditions. He's gotten about a dozen members thus far, and several times that number who regularly log onto the Pool's on-line BBS system.

In Chicago a group of studio owners and engineers have formed EARS, another regional organisation with as much a social intention as a pragmatic one. In Nashville a group of studios owners—and remember that in Music City a significant percentage of major studios are owned in part or in whole by producers and engineers—formed NAPRS, the Nashville Association of Professional Recording Studios, in 1995 as a common forum to discuss rates and other shared issues.

Then there is the famous or infamous HARP, the Hollywood Association of Recording Professionals, formed in 1989 as a bulwark against the encroachment of personal recording studios. HARP's mission in that regard failed, but it, like the



others, was regional in focus and nature. This is not to say national organisations like SPARS are ineffective, but, as I stated in this column some months ago, America at some levels has increasingly become a loosely unified concatenation of regional interests, culture and thinking, and I, and many others, find such parochialism refreshing after decades of bland cultural MacDonaldisation. And so it is with the producers and engineers here.

THE INABILITY to create a comprehensive national organisation is as much innate as it is purposeful. When one incorporates the vague but vast vistas of multimedia into the landscape of the entertainment industry within which we and they work, the corporate organisation of that business offers a million footholds for enterprising individuals who are willing to go it alone or with only their collegial desperados nearby. It's rare these days when we don't agree that things could be better, but just as rare when we find an existing arrangement that works just fine as it is.

Maybe in this instance a quote from Groucho Marx is more apt than one from Glenn Frey: 'I'd never belong to any club that would have me as a member.' ☺

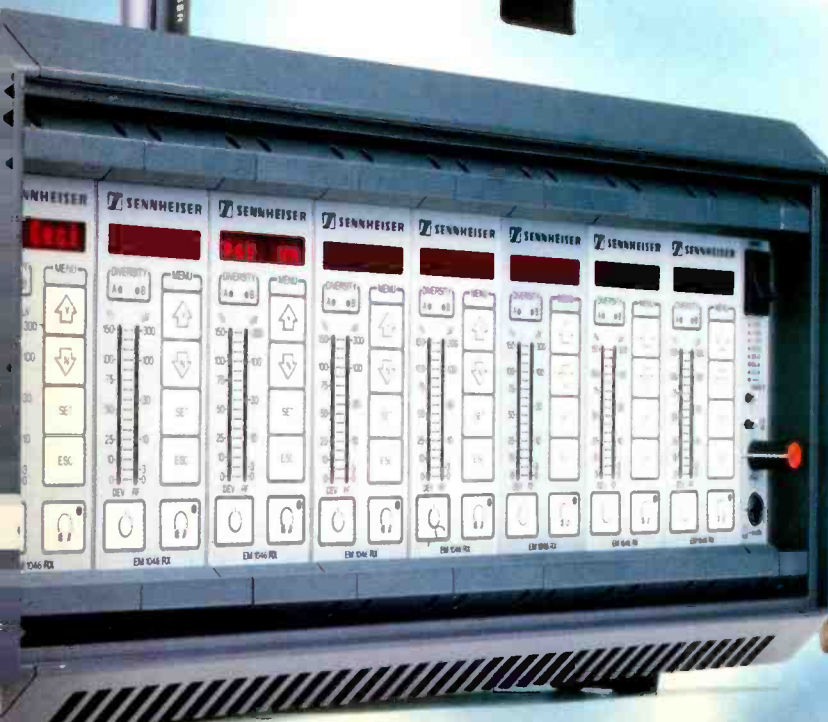
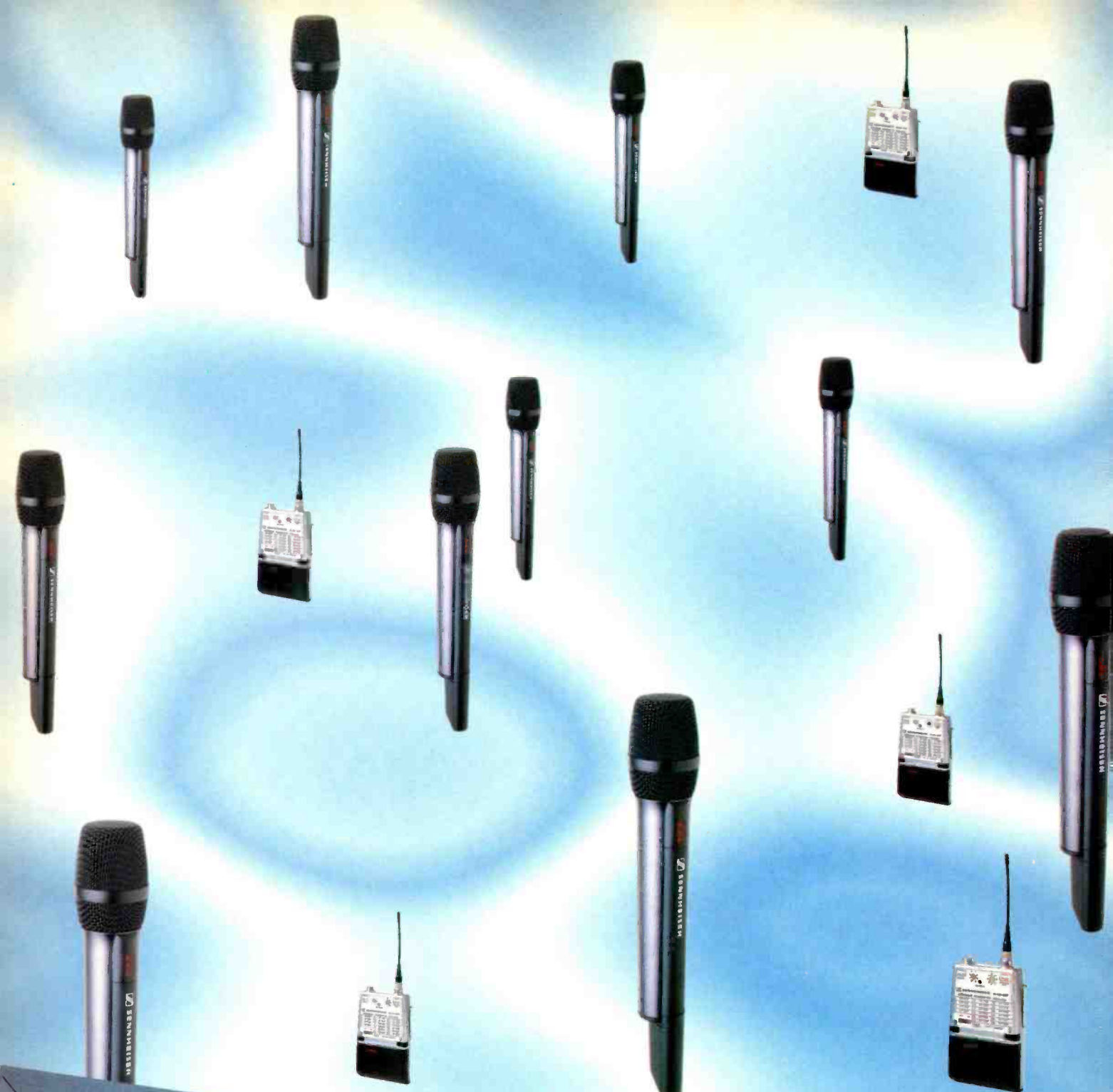

In art and technology the wildest imagination of the past becomes the reality of today. Sennheiser's 16 channel switchable frequency radio systems bring complete artistic freedom to theatre, stage, and broadcast.

No constraint in performance. No compromise in style. Our transmitters and receivers set new standards in the interaction between computerised mixing and RF technologies. With supreme sound quality and total reliability.

Realistically Sennheiser radio systems are the ultimate choice. Surrealistically of course, they're a fish.

SENNHEISER

Sennheiser UK Ltd, Freepost, Loudwater, High Wycombe, Bucks HP10 8BR.
Telephone: 0628 850811. Fax: 0628 850958.

The soft option



Educational options fly in the face of nineties economics while too many coding options confound DVD writes **BARRY FOX**

Europe used to have several 'unofficial universities' for engineers; Philips in Holland, and EMI, Decca, the BBC and IBA in the UK. Despite cutbacks, Philips still leads Europe in research as the economic climate—which demands jam today and hang tomorrow—keeps Decca and EMI under pressure to increase profits.

The British government privatised the IBA's Labs, at NTL, in October 1991 selling them off to the highest bidder in the money market. In late 1995 NTL's owner, Mercury Asset Management (nothing to do with Mercury telecoms), sold off the Advanced Products Division, which handled all NTL's work on MPEG digital technology, to Rupert Murdoch's News International. NI, which owns Sky, may be hugely successful. But an engineering university it ain't.

The BBC has no shareholders, just bean-counters who seem quite happy to sacrifice long-term engineering assets to pay their own high salaries. Staff morale is now so low that even *Ariel*, the Pravda puff which the BBC publishes weekly to make its management feel warm and cosy, is starting to address serious problems. A recent issue carries several letters from staff which raise awkward questions on the pension fund, plans to sell off the transmitter network and resource starvation in the local radio stations. Another BBC publication, *Around Resources*, is even more revealing.

The front page carries a letter from the BBC's Pebble Mill studios which reports 'mass resignations due to staff demoralisation and disillusionment'. It is signed by 30 members of staff because 'sending critical mail leaves us open to pressure and discrimination from management'.

'I am concerned to hear yet again that staff are worried that voicing their honestly held views will cause discrimination', writes the Editor. Significantly there is no clear assurance that this is not the case, just an admission that the staff are right in claiming that a studio in Manchester had to be closed because the wrong equipment was installed.

Elsewhere in the same issue, a studio manager warns that, 'Original well-designed sites for studios in Broadcasting House are being knocked through and studios are being created out of offices which cannot provide adequate isolation or suitable acoustics'. Refurbishing existing basement studios in BH (B12-16) has had a 'disastrous effect' on the acoustics. Three more studios in the sub-basement (S1-3) are 'very poor'.

The same issue carries a telling correction. The Resources editor apologises for suggesting that the BBC 'does not produce programmes in Dolby surround'. There are at least six Dolby encode-decode systems in BBC studios and a lot of material imported from the USA and mainland Europe for transmission in the UK is Dolby-encoded.

PHILIPS AND SONY shook hands in Tokyo with rivals Toshiba, Panasonic, Time-Warner, Pioneer, JVC, Hitachi and Mitsubishi in December over a single standard for DVD. This now stands for Digital Versatile Disc, as well as Digital Video Disc, in recognition of the fact that high-density CD is more likely to appeal to the computer market than movie viewers already equipped with VCRs and Laser Disc players.

The single standard for DVD is in fact not a single standard. There is an international split on the digital multichannel sound system to be used. Most companies wanted to use Dolby's AC-3 but Philips wanted European MPEG Musicam.

The DVD group compromised by specifying AC-3 for the US and Japan, and MPEG for Europe.

This means that discs sold in the US will not play in Europe. And this suits the Hollywood movie studios because it lets them continue their current policy of releasing movies to North American US cinemas ahead of Europe, with a big saving on 35mm film prints. The staggered cinema release requires a similar stagger on video release.

Dolby now attacks MPEG audio as 'ill-suited' and questions Philips' claim that comparative listening tests prove that MPEG sounds better than AC-3. 'We don't know how these "tests" could have been conducted', says Ed Schummer, Vice President of Dolby Laboratories. 'We know the location of all 14 of our encoders'.

Quite separate from this squabble there is now a major industry split on plans for an audio-only version of DVD, which delivers super fidelity and plays for longer than an ordinary CD. In Tokyo the quasi-official Audio Association has formed an Advanced Digital Audio committee which will compare all proposed systems and recommend a winner within the next six months.

The Acoustic Renaissance for Audio, is an international group without any corporate axe to grind. Chairman Bob Stuart, of British hi-fi company Meridian, has already been to Tokyo to address the ADA.

The ARA is opposed to any form of lossy compression, so it rejects AC-3 and MPEG Musicam. The ARA is also lobbying for 5-channel surround sound with height, ideally using Ambisonics. The ARA proposes PCM coding, but with the sampling frequency doubled to 88.2kHz or 96kHz. Each sample will then be coded in digital words of up to 24 bits. Playing time ranges up to six hours, depending on the number of channels and the coding standard.

Pioneer has been in favour of 96kHz, but with stereo on a 3-inch, high-density, CD for portable use, and surround on a 5-inch version. Philips has a system called Omnidisc.

The real sticking point, however, is Sony's push for a completely different system, called Direct Stream Digital Audio. Instead of using PCM words of fixed length, DSD is a bitstream system of 1-bit delta modulation. Sony will sample the sound at 64 x the normal speed for CD, to generate a stream of over 2.8 million bits per second.

Dolby and dbx both used very similar systems in the early days of digital audio. Delta modulation is an easy way to handle high-quality audio with a simple decoder and as such it is ideal for low-cost portables. But, as Professor Malcolm Hawksford of the University of Essex writes in a recent White Paper on Bitstream versus PCM, DSD is 'not an efficient code and extremely wasteful of disc storage'. DSD uses so many bits per second that there is not room on the disc for multichannel surround.

Sony in Europe is playing the dangerous game of supposing it can railroad through the system without opening it up to serious debate. When the time comes the questions to ask are these. What playing times will DSD deliver when used to code multichannel surround? How will it cope with jitter? And will it allow for Digital Signal Processing?

As news of DSD broke, Sony Music in the UK 'hastily arranged' the first European demonstrations for the AES Technical Committee and company's own staff. They are scheduled for mid-January at Alan Winstanley's West Side studio. More extensive demonstrations, with a live band to compare with recordings, are planned for mid-February. **Ⓢ**

Starting over



A New Year signals a new start—and some of this year's 'new starts' are destined to be made in the Far East writes **JIM JAMES**

Very early in January—around 3am on the first day—I received a phone call from a friend in Los Angeles. After I'd put him straight, he apologised and explained that he though it was three o'clock in the afternoon. I suppose it's an easy mistake to make, after all just how many hours or days out of sync are the Californians?

'It's pretty dead over here, you know,' he explained as an overture to breaking some news. 'Guess what?' I couldn't.

'My New Year resolution is to move to Asia, move to where the things are really happening.'

'That'll be nice, er... That'll be good. Hmm... So, er... Do you mind if I go back to bed?' I enthused.

Later I felt bad that I hadn't sounded too encouraging but one of my New Year's Resolutions was to stop talking in my sleep. Besides, I've lost track of the number of times someone has told me that they were moving East and then didn't follow through; not that I blame them because it is a huge upheaval and doesn't work out for everyone.

One of the places people move to is Singapore. As one of the most attractive and well organised, it has been chosen by hordes of multinationals as the Asian beachhead because offers the sometimes intrusive discipline and cleanliness of the old empire, moderate temperatures year round, an

attractive lifestyle including good outdoor restaurants, clubs and for those blessed with families, international schools and a safe place for their kids to grow up.

Hong Kong is the other obvious spot. Altogether more Chinese (and becoming inexorably more so) the pace of life is such that you feel that if you stand still the masses will simply pour over you. They're ready and keen to make money out of your hesitation. The free port of Hong Kong boasts extremely attractive corporate and personal tax rates, has

thriving music, postproduction and film markets, and has long been the centre for shipping goods in and out of China and the northern part of the Asian region.

The recent assurance of the Chinese Government that the HK dollar will remain pegged to the US dollar after 1997 has calmed some of the fears about convertibility of earnings, but this being weighed against the news that Chinese militia will be the law enforcers on the island and New Territories.

DOES UNCERTAINTY over post-1997 Hong Kong make Singapore an inevitable choice of Asian headquarters for Western companies?

Certainly, a number of significant broadcasters are establishing uplink centres here, (MTV, ABN, ESPN) but there is also a steady stream of new postproduction houses being set up in the region's capitals, and I suspect that both of these trends are probably as much a recognition of the maturing local markets and requirement for domestic product as a phobia about Chinese rule in HK.

According to Penny Westlake, Business Development Manager of Tektronix Asia Pacific (based in Hong Kong), it is a 'tougher place to live, but then that keeps you on your toes'. Westlake holds a Hong Kong and British passport but intends

to stay in Hong Kong, covering as she does from there a parallelogram from India through to New Zealand, Korea and of course China. Her main concern is the threat of economic migration from mainland China to the economic free zones in the New Territories but she sees the transition to Chinese rule as not changing the way she works.

'There is one similarity throughout Asia, and that is you that have to go out and get the business.' As with any new market, there is no repeat business, so it's all about investment of time, energy and money with a view to building brand awareness now and sales a little later.

One company that has found that investment has paid off is console manufacturer, Amek. The Regional Sales Manager is Henry Goodman who came to settle in Singapore in 1994, and says that since then the company's sales have more than doubled in Asia. 'Communication with distributors is so much easier being in the same time zone,' he explains.

Amek took on Singapore because of the ease of setting up, and whole the Lion City was recently ranked by the SRG researcher as the 16th most expensive in the world. London was in the comparatively cheap twenties, Amek found the prevalence of English, and the general professional business policies of the Government attractive.

When I was looking to set up East-West Communications in Asia, I looked at these two cities, and opted for Singapore for similar reasons, and because I believe that the hinterland of the Asian nations offers signification and more immediate business opportunities without some of the risks associated with doing business in China.

A CITY jostling for recognition is Kuala Lumpur, an hour's flight north of Singapore and with a bustling economy, Malaysia is hosting the Commonwealth games in 1998, is building a new international airport, and has a new generation of new studios and facilities (that are certain to be fuelled by the launch of Measat this year), and a new privately financed RM50 million (US\$19m) satellite park.

Malaysia has more land and subsequently offers lower space costs, has lower labour costs that Hong Kong or Singapore, and the Ringgit is a weaker currency than the HK\$ or Sing\$ making startup comparatively cheap but perhaps one of the more difficult issues is the requirement for a local partner to establish a Limited company.

The other half of the equation is the 'Made in Malaysia' legislation, the country of 19m is one of the most rapidly advancing Asian nations and represents a large domestic market, good value for money, and now a legal requirement for as much production to take place there as possible for domestic consumption.

This type of protectionism is a formal reminder that 'being there' is part of the key to success in Asia where a good deal has to do with personal contact and showing respect, both of which require a presence in the region either directly or through reliable distributors and agents.

The audio industry is well supported by a developed infrastructure of professional companies which can represent manufacturers, but as companies such as Tektronix and Amek have found, a resolution to invest in the Asian market and support distributors and their clients can be rewarding. With the Chinese New Year on February 19th perhaps there is time for one more resolution in 1996. ☺

Penny Westlake:
'Hong Kong is a
tougher place to live,
but then that keeps
you on your toes'

Creative control, superlative sound and uncompromising support — Lexicon's commitment to the audio professional.

The New 300L with LARC: The World Class Touch.



Introducing the *Lexicon 300L*, the newest addition to Lexicon's world-class digital effects systems. It's a new version of the award-winning Model 300 — with LARC control. Offering analog/digital mixing, timecode automation, compression, unique mastering tools and a full complement of Lexicon's finest reverb and effects programs. And if you already own a Lexicon 300, you can upgrade.



Lexicon Alphanumeric Remote Control
Bring your favorite effects processors under total control.

Lexicon

Heard In All The Right Places

If you own a 300L, 480L or 224XL, you can now have multi-machine LARC control via the LR-4 FrameLink — genuine examples of Lexicon's professional commitment. Few studio tools are as familiar as the LARC — putting you in touch with the sounds the competition imitates but never duplicates, without ever leaving the sweet spot. Call your Lexicon dealer for full details.

Contact: 100 Beaver Street, Waltham, MA 02154 Tel: 617/736-0300 Fax: 617/891-0340 E-Mail: 71333_434@compuserve.com

 **Stirling**

Stirling Audio Systems, Kimberley Road, London NW6 7SF, England Tel: 0171 624 6000 Fax: 0171 372 6370



The sheer force of pure sound is intensely powerful. It is majestic and exquisite. When precisely engineered to perfection,

it mesmerizes. So we designed and integrated components that now add a new meaning to the concept of power.

With Meyer Sound, you only have to listen.

{To arrange an audition, call Meyer Sound Europe at +44-1734-755533}

TL Audio CLASSIC 1000

Bringing the essential elements of a 'vintage' console into the 1990s was the basis of the Classic 1000's brief. **PATRICK STAPLEY** takes a look at a near-complete model and assesses its potential

VINTAGE CONSOLES tend to elicit one of two responses from pro-audio people: they either go into esoteric raptures about classic circuitry, the forgotten art of console design and purity of sound or they question the place of a console designed for the age of 8-track in today's recording studio.

Tony Larking, MD of UK-based TL Audio, is probably more aware of this than most. Not only has he been selling vintage consoles for many years, but his company has also gained an excellent reputation for its range of competitively priced valve outboard gear. It is perhaps not surprising then to find that TL Audio has ventured into console design, taking the same approach as with its range of 'retro-board' gear, of blending together classic technology with 1990s design flexibility.

'I think we've identified a gap in the market for an affordably priced, great sounding console based on classic design principals but with up-to-date facilities,' says Larking. 'Having already produced a small 8:2 valve mixer, which evolved directly from our valve units, a full-size recording console was the logical next step.'

Larking has not just identified his market, but has shrewdly produced a console with the potential to appeal to as many analogue console buyers as possible.

The Classic 1000 console achieves this firstly by offering three types of module technology—valve, discrete Class-A transistor, and IC—that between them span 40 years of console design. These three module types can be mixed-and-matched to suit the customer, or alternatively the whole console can be supplied based on just one technology.

The second way the Classic's appeal is maximised is by offering both in-line and split operation or a hybrid of the two. This is done by providing the option of a dual Group-Monitor module which can be used in conjunction with the standard in-line Input module. A spin-off of this arrangement is the enormous number of inputs it creates, which again fits in very well with present day working. For example, a 32-input console fitted with group-monitors can provide an impressive total of 144 line inputs.

The desk is built on the old Neve idea of 8-channel buckets and consequently there is no restriction on size—if another eight channels are required, you simply bolt on another block. This arrangement also makes it very easy to install in awkward locations, and if need be the desk can be delivered in 8-channel sections and assembled on site. The channels themselves are split into two modules and it is up to the customer when specifying the console to decide whether auxiliaries or EQ modules are positioned nearest to the engineer. The three types of input channel (valve, discrete, IC) can be fitted in any position to suit the customer.

With 50% of TL Audio's sales currently going to America, Larking sees the US as the strongest market for the Classic, and claims to have received an encouraging response to the prototype shown at last year's New York AES show. He also says that the console's price has attracted a lot of attention: 'We've been able to keep the cost of the console down by keeping our overheads low, and efficiency high.'

'We could quite easily have doubled its retail price but we don't need to. The same thing applies to our units, bearing in mind



the quality that's on offer. In America, this caused us a slight problem, because top-end studios didn't believe that units at this price could offer very high quality, and it took us a bit of time to convince them. However, a lot of interest in the Classic console has come directly from people using TL Audio outboard units who have been really impressed with the kind of quality on offer.'

Larking envisages the desk being adopted by all areas of music recording from classical to dance, and thinks most desks will be supplied with all three module technologies.

'With our outboard equipment we've found that different users tend to use a specific unit for a specific function. In the same way we expect people to specify certain channels of the desk for particular applications—such as valve channels for vocals, discrete channels for drums, and IC channels for some synth sounds—it will of course vary from user to user, but we expect most of the consoles we sell to include all three module types rather than being based around one technology.'

INPUT CHANNELS are in-line designs and comprise two modules, which can be positioned top or bottom depending on user preference—there is also a separate fader module fitted with a Penny & Giles fader as standard. The Auxiliary

The Classic 1000's modules benefit from the use of valve, discrete class-A and IC technologies





The Classic is a unique concept in analogue console design, which is bound to appeal to studios looking for something a little different

The marriage of 'classic' performance and modern facilities is at the heart of the Classic 1000's design

Monitor module is common in facilities to all three channel types, while the Input-EQ module is configured identically for the valve and discrete channels, but differently for the more featured IC channels.

All channels have familiar input switching for mic-line, phase reverse, phantom power, and tape-channel and include variable high-pass and low-pass filters. Mic and line gain is controlled from a common LEVEL control which is centre detented to mark 0dB line level.

Two facilities that appear only on IC channels are a noise gate and a second line input. This Line 2 input is equipped with separate ON-OFF, SOLO GAIN and PAN controls and normally mixes-in with the main mic-line signal following channel routing. However, it may also be independently routed to the LR Mix bus thus providing three discrete inputs per IC channel.

Another variation between IC channels and the other two formats is the equaliser

arrangement. The IC equaliser is a fully parametric 4-band design operating at ± 15 dB, while both the valve and discrete versions are 4-band fixed with four turnover frequencies per band operating at ± 12 dB.

The IC parametric equaliser covers a range of 30Hz–20kHz, offering a good deal of overlap between bands with the choice of peak or shelving characteristics on the HF and LF bands. The fixed-frequency versions are organised identically for valve and discrete channels with turnover frequencies being broadly spread out over their 60Hz–12kHz range, apart from the High Mids which tend to be quite closely bunched to cater for vocal frequencies. A wide Q is also used (0.5) to mimic the curve of early equaliser designs, so the effect is more one of broadband sweetening compared to the pin point correction that is possible with the parametrics. The valve equaliser circuitry is based on TL Audio's EQ 1 valve unit, while the input section is taken directly from the Pentode valve

preamplifier unit.

All three equalisers include split switching. In the case of the parametric, this allows the LF-HF and LM-HM bands to be separately switched between channel and monitor paths. While for the fixed equalisers, just the LM-HM bands can be split into the monitor path. Switchable insert points are also provided for all channels with pre-post EQ selection.

The auxiliary capability remains the same irrespective of channel type and offers 12 sends per channel. The first eight buses are mono, with individual gain and on-off switching while the remaining four are organised into two stereo pairs. Paired pre-post switching is provided for Aux 1-2, 3-4 and for the two stereo sends, while Aux 5-6, 7-8 remain permanently post fader (although they may be switched between signal paths). This switching differs slightly between modules: for valve-discrete versions standard chan/mon switching is provided on both pairs, but for the IC version Aux 7-8 are switched Chan-Line 2. The first four auxiliaries remain permanently fixed in the channel path.

The two stereo auxes are also signal path fixed so that 9-10 source the channel while 11-12 pick up the monitor. Both stereo sends also feature a routing button that disconnects the send from the auxiliary bus and directs it to the routing matrix. This offers a great deal of flexibility allowing either or both paths to access routing via separate level and pan controls opening up many interesting possibilities.

The routing keys are arranged in a column next to the small monitor fader, each providing access to an odd-even pair following channel pan. If no selections are made the signal automatically bypasses all the mix buses and is sent straight to the direct output via the group TRIM pot—

cleverly doing away with the need for an additional switch. Where the desk is configured as a split console with additional Group-Monitor modules, the group trim acts permanently as a direct output gain control.

The module does not include any tape-group monitor switching or track arming buttons—this is left to the multitrack machine remote. Other facilities include fader reverse, independently selectable solo modes for monitor and channel paths, and channel mute groups.

Optional Group-Monitor modules required for split operation are dual-channel designs, and consequently take up a relatively small amount of console space—12 channel positions for 24-track operation. The modules may also be used as subgroups and to provide additional inputs, so in this respect it is not essential to have the full complement bearing in mind the console's in-line monitoring capability. Like the in-line channels, the Group-Monitors are also available in the three technologies although each is identical in facilities and operation. Each module offers 4-band continuously variable EQ and sends to mono Auxes 1-6. Flexibility has been introduced to allow EQ and auxiliaries to be accessed from both signal paths, which is particularly important during mixdown where both monitors and groups may be used to return additional inputs to the mix bus. However, not having access to Aux 7-12 will undoubtedly be restrictive especially as stereo Auxes 11-12 would be an obvious choice for foldback. However, this situation is currently under review and TL Audio says that the production console will offer a more versatile arrangement. In common with the Input module, signal paths may be reversed allowing large fader control of the monitor.

MONITOR AND CHANNEL paths can be separately selected between three solo modes—APL (After Pan Listen), PFL and SIP (Solo In Place)—and selections can be globally cleared via a master solo reset. APL also features a Lift facility that adjusts the relative level of the mix against the soloed signal, allowing context monitoring. For SIP channels, a Solo Safe mode may be assigned with indication being shown by an LED on each Fader module. This facility is not extended to the monitors which is a pity because it is more likely that they will be used as additional effects returns than the long throw faders. Dedicated effects returns, on the other hand, are not affected by SIP muting.

Solo safe assignment is made from a Master Assign section which is also used to set up two mute groups for channels (not monitors). The procedure makes use of the channel solo button to select, deselect or identify channels. This, again, eliminates the need for additional local switches. Three control room speaker circuits are provided each with a trim to prevent level jumps during switchover. MUTE, and DIM and MONO switches are all included and there is a separate headphone output with its own gain control. Control room source selector buttons



give access to the main desk output, the 12 auxiliaries in pairs, and four external stereo sources. A similar arrangement is used to feed the studio loudspeakers. Two stereo phones circuits Cue 1 and Cue 2 are provided with level and mute. These will normally be fed from a stereo aux, but can also have other sources assigned to them—just how this is going to be achieved is not completely clear at this stage, but a likely method is to involve the control room monitor or studio loudspeaker source selectors as double function controls.

The aux masters include AFL and mute switching with a balance control included for the stereo pairs. An additional Link facility allows certain aux sends to be linked from the monitor and channel paths of the same Input module to

Tony Larking has achieved what he set out to do by combining the best elements of vintage and modern console design

provide a combined output which is a novel idea, and makes up for the fact that not every aux send has mon-chan switching. The output from each pair of aux buses can also be metered on a dedicated pair of vu meters via a 6-position selector knob. Six stereo effects returns are provided as standard but this may be extended to suit the customer. Each return includes basic high and low EQ, BALANCE and LEVEL pots, AFL and mute. Routing is direct to the Mix bus, and as mentioned earlier returns are immune to SIP muting.

Talkback can be selected additively to 11 different sources: Cue 1, Cue 2, studio loudspeakers, stereo bus, the 24 groups, and the 12 auxiliaries in pairs.

A reverse talkback facility is also included.

Two additional modules are currently being developed for the console—a stereo input module, and dual mic-line Input module that doubles the number of inputs per channel width although features are reduced. The Classic console is also fully equipped for Recall and this facility should be completely operational when the production console is finally launched at the Copenhagen AES in May. TL Audio has decided against developing an automation system of its own simply because it feels customers would prefer to retrofit a system of their choice—whether it be moving fader or VCA. Also the amount of R&D time required to produce a system from scratch would be prohibitive. At the moment, modules are not equipped to deal with switch automation, so a third party system will control just fader and mutes.

Being launched at the same time as the Classic, is the Classic Gold console which is a scaled down, lower cost version also offering the choice of IC, discrete and valve modules. For the future, TL Audio has confirmed it will be producing broadcast and film versions of the Classic.

THE CLASSIC 1000 is a unique concept in analogue console design, which is bound to appeal to studios looking for something a little different. Indeed TL Audio reports strong interest from both sides of the Atlantic and claims that major studios in London and Los Angeles are poised with cheque books at the ready.

For the money (under £100k fully featured), the console represents extremely good value, particularly when one considers the degree of flexibility on offer: not only can the Classic be configured with three generations of audio technology but it can be operated in-line, split or using a mix of the two. This kind of versatility gives the console the very broadest appeal and as far as the studio is concerned its 'something for everybody' design should in theory make it a potential client puller. Tony Larking has achieved what he set out to do by combining the best elements of vintage and modern console design. In the process he has perhaps unwittingly reduced the need for so much studio outboard by including classic mic amps and equalisers as part of the package. Finally it should be stressed that the Classic console being examined here was not a production model, and that certain design elements may change when the desk is released in a few months time. 

CONTACTS

TONY LARKING PROFESSIONAL SALES,

Letchworth, Herts SG6 1AN, UK Tel: +44 1462 490600. Fax: +44 1462 490700.

US: Sascom Marketing Group. Tel: +1 905 469 8080. Fax: +1 905 469 1129.

Germany: SEA, Auf dem Diek, 6, 48488 Emsbüren. Tel: +49 5903 9388 0. Fax: +49 5903 6141.



S Series

The new Calrec S Series has all the big sound quality of Calrec's big desks, but in a smaller frame. And, because performing to an audience is second nature to Calrec, it includes all of the characteristics that have made the Calrec name famous in broadcasting today.

**Even if space is limited,
your choices aren't.**

If you have limited studio space, but still appreciate the quality of Calrec, that means your choices aren't limited too.

With up to 72 stereo channels, eight groups, and 32 track outputs, the Calrec S Series is fully featured with no compromises - ensuring you get a first class performance every time.



Another first class performance from Calrec

Calrec Audio Ltd, Nutclough Mill, Hebden Bridge, West Yorkshire HX7 8EZ Tel: 01422 842159 Fax: 01422 845244

Yamaha YDP2005 and YDG2030

As the assault on the 16-bit digital standard continues, more manufacturers are exploring the opportunities offered by 'high-bit kit'. **ZENON SCHOEPE** checks out Yamaha's latest equalisers

HAVING ESTABLISHED a track record in digital outboard equalisation, Yamaha's latest processors bring 20-bit A-D/D-A performance to programmable graphic and parametric EQ. The graphic offers 30 bands available as dual or stereo linkable paths with high and low-pass sweepable filters and four notch filters. The parametric offers six bands in the same format but with the added benefit of a mono mode that chains the channels together. Both have switchable 6/12dB gain ranges. MIDI control is offered for bank and program change commands from the units' 40 internal presets along with bulk dump. Extended multi-unit control for large installations is via Y485 through a Mac or PC fitted with an IFU485 interface running QS1 control software.

Visually, the two units are almost indistinguishable and can be traced in origin back to the SPX90. The only deviation is in three assignable dials labelled F, G and Q to correspond to frequency, gain and bandwidth for the majority of functions. There are also six buttons beneath the dials (with associated LEDs) which activate filters in various modes. Matters start with the traditional dual-concentric input level pot, Yamaha's usual solid metering, an LED display for program numbers and a 56 x 128 pixel LCD which unfortunately doesn't have a contrast control making it hard to read from above in the traditional under-the-desk theatre rack location. Yamaha's standard increment-decrement program buttons are as usual accompanied by STORE and RECALL keys and in both units are followed by a cluster of six function switches. Both have a UTILITIES MENU switch, illuminated BYPASS and individual left and right channel switches for selecting the required channel(s). Simultaneous stereo processing is achieved by pressing both buttons together. The only differences between the two units are the FLAT and DISPLAY switches on the graphic and PEQ and NOTCH switches on the parametric. DISPLAY changes the LCD to show some of the other aspects of the graphic, such as notch filtering and frequency sweeping, while FLAT flattens a curve without interfering with notch filter and high and low-pass filter settings. On the parametric the PEQ switch alternates the LCD between graphical and numerical displays of filter settings while. The NOTCH key does the same for the notch filters.

Both units share almost identical Utilities menus, including the setting of channel delays, and as will have been gathered by now, acquainting yourself with one of these boxes means you will feel immediately comfortable with the other.

OPERATIONALLY, THE YDG2030

graphic centres for the most part around the F and G dials as these are the ones that select the frequency band to be tweaked and the amount by which it is tweaked. Setting is by no means as natural a procedure as using a traditional slider graphic but it's one of the things we have to live with these days.

The Q knob only comes into action when a Sweep mode is operating, in which it sweeps a given cut across the frequency spectrum to eliminate feedback, for example.

The four notches can be adjusted for frequency, cut and bandwidth and supplemented on the same screen by the sweepable high and low-pass filters either graphically or numerically. Filter and notch control is excellent and both lend themselves better to the adopted method of adjustment than the graphic does which certainly requires patience.

THE YDP2006 parametric is a fiendishly powerful tool by virtue of offering a Mono mode of operation the parametric—it is particularly powerful when you also apply the eight notch filters and high and low-pass filters. Operation via the three dials is very satisfying especially as they are spaced to enable two-handed operation—something your average analogue EQ arrangement won't permit. It's very useful to be able to adjust bandwidth and boosts simultaneously, for example. The only thing that needs a little getting used to is having bell shelves depicted graphically on the LCD because, while this is very informative, it requires a different sort of discipline to that applied when mapping a strip of pot positions against what you're hearing.

Both units as delivered arrived completely empty of any presets. While it is difficult to get excited about someone else's EQ curves a couple dropped into memory purely for reference wouldn't have been a bad idea to act as an illustration of what the display will look like once the units have been programmed. Knowing this makes getting to it that much simpler.

I consider the lack of any sort of digital I-Os an unfortunate omission as I believe this would have really spread the appeal of both these boxes given the variety of environments in which they could then be used.

The LCD on the parametric does not have the resolution to show 0.5dB lift or cuts at the narrowest bandwidth settings. This is not likely to prove to be a major practical problem but it is a little irritating when the screen tells you that you've flattened everything off when to be precise you haven't. There is no option to view a

'what you see is what you get' type of curve which takes in to account the interaction between adjacent bands and gives a visual indication of what the cumulative effect of all this equalisation is. Unlike the BSS Varicurve, the graphic shows an equivalent of band slider position only.

Given the commonality of the two operating systems and the obvious shared technology involved, the temptation for combining these units into one capable of parametric and graphic equalisation must have been strong. To Yamaha's credit they have resisted and this is only right because such a monster would undoubtedly compromise the clarity of these units and would miss the point that the target applications or the two modes of equalisation can be quite distinctly different and in many cases not in the least bit related.

Of the two, the parametric undoubtedly has the greater must-have appeal. Graphics are not as inspiring because they are by definition always fixed to a degree in comparison to the custom rolled approach of any setup on a parametric. Parametrics are equally as able as graphics for room equalisation purposes as BSS has proved with its Varicurve. Indeed, I would say that parametrics are better suited to the job, providing you have enough bands to play with of course, because they're faster to set up roughly and more precise in their fine tuning.

These EQs are fine-sounding, clean and quiet bits of kit that do a very good job of answering the need for programmable equalisers in large rigs that can be controlled remotely. The 6dB setting on both units is excellent for gentle tweaking. The parametric deserves special mention mostly because its method of adjustment is more closely related to the analogue equivalent. The graphic will also appeal even though it is less immediate to set up because graphics are popular because they're easier to understand and the Yamaha box has the added benefit of notches and pass filters. Good solid engineering and very able performance presented in an easy to use package. **S**

CONTACTS

YAMAHA-KEMBLE MUSIC (UK) LTD, Sherbourne Drive, Tilbrook, Milton Keynes MK7 8BL.

Tel: +44 1908 366700.

Fax: +44 1908368872.

YAMAHA CORPORATION OF AMERICA, 6600 Orangethorpe Avenue, Buena Park, CA 90620.

Tel: +1 714 522 9011.

Fax: +1 714 739 2680.

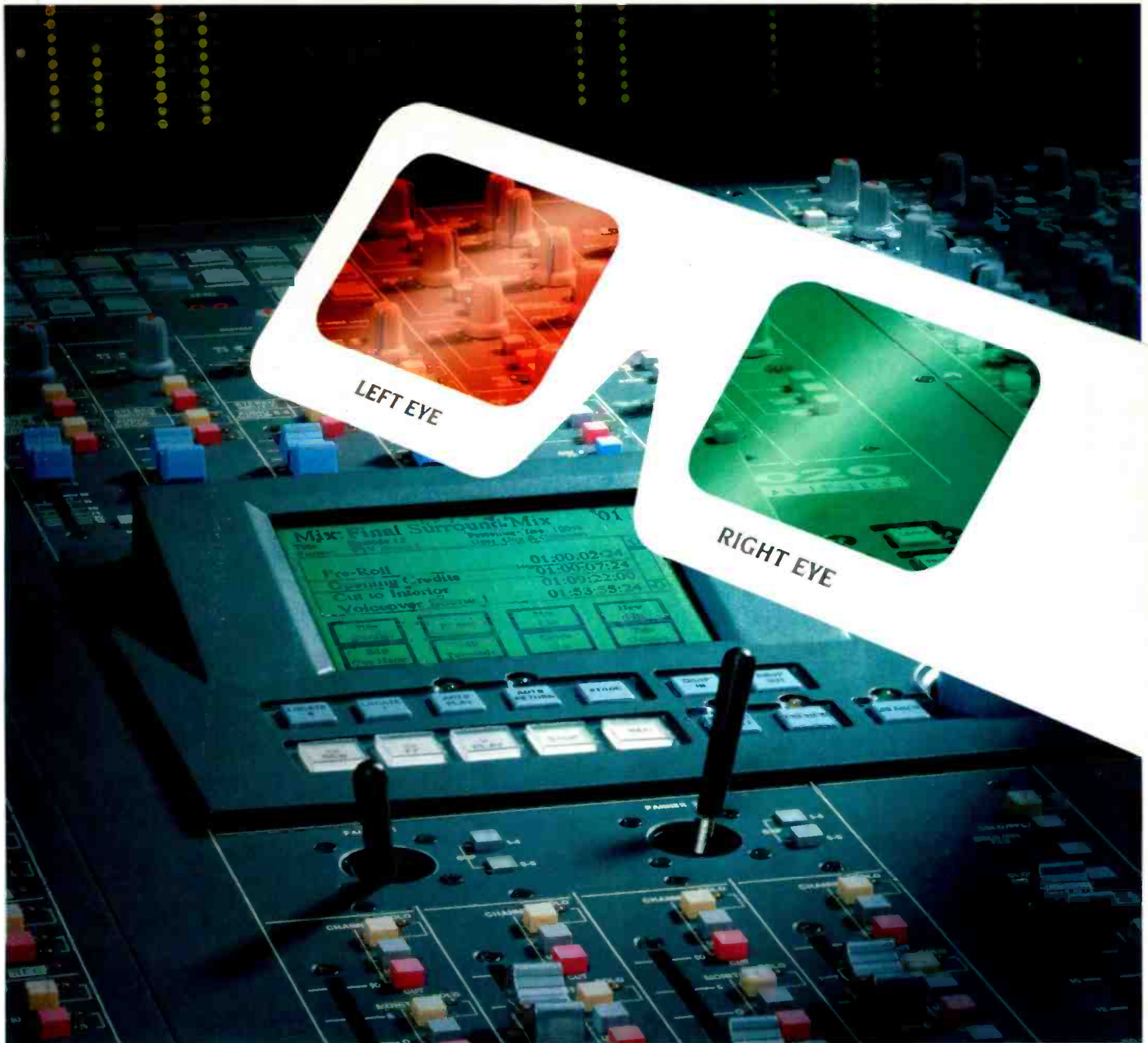

The Soundcraft DC2020 (Now available in 3D)

DC2020
SURROUND

Already making a name for itself in the world of post production,

Meanwhile, a compact external rack interface handles all additional audio connections without the need for re-patching.

our DC2020 just gained a whole new dimension. Surround Sound.

Thanks to a brilliantly integrated



version of the renowned Magtrax™ system, the DC2020

Surround provides fingertip control of up to 24 record/replay channels plus dedicated mix channel monitoring and metering.

And all this in addition to the moving fader automation, touchscreen driven machine control, video sync and

on-board hard disk storage.

Discover more about the DC2020 and DC2020 Surround by calling +44(0)1707-668143 today.

HARMAN INTERNATIONAL INDUSTRIES LTD., CRANBORNE HOUSE, CRANBORNE INDUSTRIAL ESTATE, CRANBORNE RD., POTTERS BAR, HERTS. EN6 3JN, ENGLAND. TEL: +44 (0)1707 665000 FAX: +44 (0)1707 660482

 **Soundcraft**
A Harman International Company

Symetrix 620

As we become more comfortable with digital recording equipment, the temptation to explore alternative convertors grows. **DAVE FOISTER** evaluates a new American 20-bit unit

SYMETRIX HAS often come across as a bit of a jack-of-all-trades. Its willingness to put a toe into the water in almost any area of processing has made its position in the market hard to identify, with some products clearly pitched at the lower end of the market while others have far higher aspirations. With the Model 620 A-D convertor it seems Symetrix is making a clear bid for the higher ground, offering a highly specialised convertor to interest the purist.

The 620 is a stand-alone 20-bit A-D, apparently targeted at the same market as those few sought-after convertors from the likes of Apogee, Prism Sound and dCS. Its operation is as simple as one would expect, but it does have a few user options and one or two functions above and beyond the obvious ones.

Analogue inputs are on both XLRs and balanced TRS jacks, and input gain is controlled from the front panel. The unit can be left calibrated to a +4dBm reference or separate left and right gain controls can be switched in—interestingly, these provide a range from a few dB below the calibrated setting to substantially higher, not being intended as possible faders as they do not go anywhere near taking the signal out altogether.

Four sample rates are supported: 48kHz, 44.1kHz, 32kHz and, for reasons which will become clear later, 22.05kHz.

A digital input is provided, allowing the 620 to convert bit rates, and with this in use the unit locks to the incoming clock, with the further possibility of down-converting 44.1kHz to 22.05kHz.

Huge LED level (or more accurately headroom) meters are provided for the analogue input, with 23 LEDs which turn from green to amber 6dB below peak and then proceed in 1dB increments to a single red at 0.

THE HEART of the convertor, of course, is its variety of word lengths. It is a true 20-bit convertor, with obvious applications in conjunction with those recorders which have the capacity to record 20 bits but are fitted with lower bit-rate convertors as standard—the Nagra D being the most familiar example. Its other main use, however, is as a high-grade front end for a 16-bit system such as DAT, and it delivers 16 bits in two different ways.

The first is a straightforward dithered signal, and on the machines I used it with the improvement in quality over the built-in convertors was quite distinct. It goes



further, however, with a noise-shaped 16-bit output, which provides a quite startling improvement over either. Even with a reasonable amount of ambient and system noise in the input signal, the extra clarity and openness of the noise-shaped signal was surprisingly evident. Symetrix makes it clear in the manual that this mode is not to be used if further digital processing is envisaged, as the advantage will be lost and the process may even produce a worse result than if noise shaping had not been used.

With an eye on the growing multimedia and CD-ROM markets, the 620 also offers conversion to 8 bits, again using either dither or noise shaping, and this of course is where the 22.05kHz sample rate comes in. The results are no more pleasant than one would expect, but no doubt making the best of a very limited potential. Both the sample rate and the number of bits (and the other functions) are selected with big positive push buttons which step through the possible options.

Both AES-EBU and IEC outputs are provided, but even though signal is delivered to both sockets all the time it is only ever one format or the other, so this must be switched at the rear panel. I have other machines which I believe spit out both formats simultaneously on their respective connectors, so this seems a surprising limitation. Either way, a further useful function is an output mute, which is a convenient way of generating digital silence or 'black' when required.

I ENCOUNTERED only one hiccup in using the 620: an early DAT machine of mine (a 1989 Technics SV-360) refused to record the Symetrix' output even though it

Eager to make friends with 16-bit DAT machines —Symetrix' new 20-bit convertor presents an attractive option

was showing on its meters and appeared to pass through the machine intact.

Symetrix' Alan Goldsmith tells me that the company has fallen over such problems in during previous A-D development, where early recorders have non-standard treatments of various copy prohibit flags and so on. Since I mention it to him, he has sorted out the situation with the Technics machine so that, by the time you read this, new EPROMs should be available.

The Symetrix 620 is a convertor well worth looking at, as it addresses the needs of both the high-bit enthusiast and the low-bit multimedia developer in a format which is well laid out and straightforward to operate. Its audio quality leaves nothing to be desired, and its noise shaping system works extremely well, providing significant benefits over straight 16-bit encoding. It should make a significant improvement to virtually any DAT machine or other 16-bit recorder, particularly for the purposes of final mastering, at a price substantially lower than other high-end outboard convertors. **£**

CONTACT

SYMETRIX INC, 14926 35th Avenue West, Lynnwood, Washington 98037, US.
Tel: +1 206 787 3222.
Fax: +1 206 787 3211.
UK: Sound Technology, Letchworth Point, Letchworth, Herts SG6 1ND.
Tel: +44 1462 480000.
Fax: +44 1462 480800.

24 BIT DIGITAL, 100% MUSICAL.

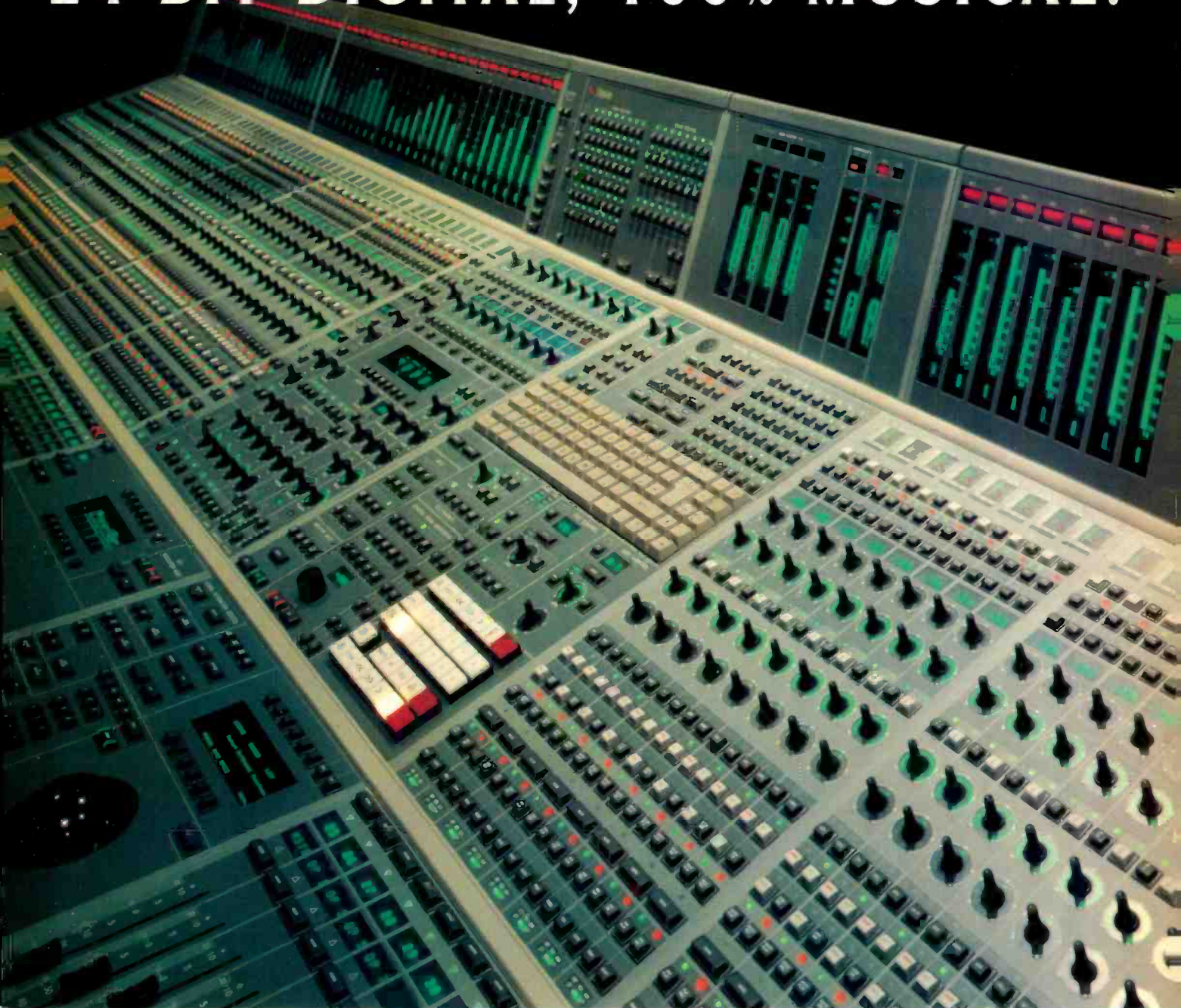

You've been using digital tape for years. Now digital mastering makes your final CD sound even better. But often it doesn't sound like your studio mix — the one you love, the one the artist approved.

The advantages of staying digital in the mix are obvious — you avoid multiple analog and digital conversions. CAPRICORN, the digital mixing console proven around the world, keeps

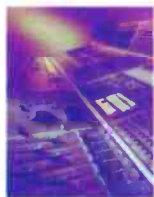

your mix digital and the sound — phenomenal. For the warmth and depth your projects have been missing, it's time to get the Capricorn edge.

<http://www.ams-neve.com>

UK Head Office Tel: (44) 1282 457011 Fax: (44) 1282 39542 **USA** Siemens Audio Inc., Hollywood, CA. Tel: (213) 461-6383 Fax: (213) 461-1620 New York, NY. Tel: (212) 949-2324 Fax: (212) 450-7339

CANADA Rupert Neve Inc., Toronto Tel: (416) 365-3363 Fax: (416) 365-1044

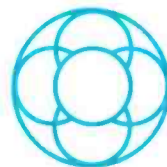

**AMS
NEVE**

A SIEMENS COMPANY

API MODEL 500-B6

Playing up its classic heritage, API has devised a method of allowing its console modules to be carried and used independently. **DAVE FOISTER** packs the Lunchbox and Sixpack, and goes for an audio picnic

CLASSIC EQUIPMENT is back, offering a fashionable adjunct to the clinical digit. In the area of consoles—where, for many, a refurbished classic console with retrofitted automation is preferable to a new one—a pattern of manufacturers' names is emerging. Often, the manufacturers of these same consoles are able to build on the foundation of the past and meet the continuing demand for high-quality analogue signal paths, musical EQ and all the other attributes of a top-end vintage analogue board.

One such manufacturer is API, whose Legacy console falls into precisely this bracket and whose earlier consoles are still used with pride in many US facilities. Particularly sought-after is the 550a equaliser, one of a series of API modules designed to a standard physical format (5½-inch x 1½-inch) and edge connector layout which other manufacturers have also adopted. This is the standard format for the console modules, and the logical next step is to allow the same units to be used as outboards: to which end, API makes a 3U-high rack holding ten such modules and a 1U-high rack holding two, mounted horizontally. API's latest move is to provide a means of carrying a few modules around in a convenient form from studio to studio.

The new package is a rack-type box into which a selection of these modules fit, and two basic configurations are available. The simpler is the Lunchbox, which has a built-in power supply and space for four modules. The other, identical in size, is the Sixpack, which uses an outboard supply which frees up space for two more modules. The selection of modules is entirely up to the user, as the pin-outs are all standard and the units are interchangeable.

The choice from API themselves consists of three units, which in themselves are by no means new although a quick rundown may be in order.

Perhaps the most attractive is the 550b equaliser, which is a development of the classic 550a, and adds an extra band and 11 additional frequencies. This is a really old-fashioned EQ, with switched frequency selection, switched gain in each band and no Q control, although the high and low bands are switchable between peak and shelf behaviour. It is easy to see why these EQs should be so highly prized; the sound is quite special, with a warmth and naturalness that more

than compensates for the relatively unsophisticated control possibilities. For a different approach to EQ, the 560b provides a 10-band graphic, with tiny horizontal sliders giving $\pm 12\text{dB}$ of gain in each band. These are fiddly to use, but worth the effort, as the smooth sound of the EQ belies the rather basic appearance of the module.

The final module is the 512b microphone preamplifier, again derived from the consoles themselves, and again simply furnished and heavy on the quality. Gain setting is on a rotary switch, with a push-button pad, and the only other facilities are phantom-power switching and an unbalanced, front-panel, line-level jack input. The preamp, again, sounds superb, with an open transparency matched by phenomenal headroom—an important boast of all the API modules, with drive capabilities of +30dBm.

THE REASONING behind the Lunchbox-Sixpack arrangements is that any four or six of these modules can be fitted into one box and all the inputs and outputs then appear on the rear panel of the rack (on both 316/GPO/B-type jacks and Bantams). This should make it simple to patch the modules into virtually any studio jackfield for quick access to your chosen EQ. The kit could also be used as a complete front end for simple digital recording; two preamps and two equalisers would make an extremely attractive signal path from microphones to recorder. With this in mind, the input to the microphone preamp is duplicated on a front-panel XLR. Note that using this setup would require the use of patch cords across the back of the box—there is no internal connection or busing between modules within the rack other than the power-supply rails.

The box itself has a carrying handle on one end, and is light and portable although the controls may be a little



Packing a punch—classic processing from API

vulnerable—less of a problem for these modules than for some as the big dual-centric knobs are all metal. One thing I would have found useful is a scribble strip, perhaps stuck to the top of the box, as a reminder of which module is patched where and what each is doing.

There are many instances where third parties have made a killing by refurbishing and repackaging classic EQs, and where manufacturers have repackaged their own console EQs as outboards to meet a demand. API has perhaps gone one better by using the original console modules as elements of a portable outboard system, which will surely appeal to all API adherents and allow them to get the sound only API can deliver wherever they go. ☺

CONTACTS

API AUDIO PRODUCTS,
1100 Wheaton Oaks Court,
Wheaton, Illinois 60187-3051, US.
Tel: +1 708 653 4544.
Fax: +1 708 665 4966.
UK: The Sound Network,
Box Manor, Box, Corsham, Wilts
SN13 8NF. Tel: +44 1225 743848.
Fax: +44 1225 742155.
Compuserve: 100 347,774

VS-880

DIGITAL STUDIO WORKSTATION

How much?
For Digital?

64 Tracks

Having a digital studio in your home has been the dream of many musicians for years. Now Roland has fulfilled that dream with the VS-880 Digital Studio Workstation.

Digital Mixer incorporating 14 input channels, digital EQ, 2 stereo busses and 8 recording busses.

64 TRACKS (8 tracks x 8 virtual tracks) of 16 Bit CD quality 44.1kHz direct to disk recording technology with full digital mixing capability, automation, optional built-in digital FX processing, storage to either internal IDE or external SCSI drive and back-up to DAT in only 1.5 times actual recording time. All for just...

£1499 inc VAT!

All fader movements, pan and mixer parameters can be controlled and automated by MIDI.

Large music friendly transport controls including locator, marker and tempo map options

Comprehensive cut, copy, paste, exchange, insert, erase and scrub preview for fast non-destructive editing.

Data Stream...

8 Physical Tracks x 8 Virtual Tracks (Total 64 tracks). Sample Rates of 48kHz, 44.1kHz and 32kHz. 3-DAC A/D 16 bit B 1 Stream D/A 16 Bit 8 times oversampling. Typical recording time is 25.6 minutes (all 8 tracks) on a 540MB HD at 44.1kHz. (Non-destructive).

Digital Mixer with 14 channels, 2 AUX, 2 Master, 8 Recording Buss, 2-point digital EQ (High + Low) or 3-point digital EQ configuration with only 8 channels, 4 Analogue and 4 Digital inputs (SPDIF), 2 Analogue outputs, 1 Digital Output, 24 bit internal processing (EQ, Fader, etc).

Internal IDE interface for 2.5-inch HD as well as SCSI I/O for external recording or storage to MD, Imega Zip or Syquest drives. Back-Up to audio DAT in only 1.5 times actual recording time. Full synchronisation to MIDI Time Code and MIDI Machine Control as either Master or Slave.

Optional Effects Expansion Board (E349) incorporating 100 patches of Stereo Compression/Limiter, Reverb, Delay, Chorus, Pitch Shifter, RSS 3D, Vocoder, Rotary, Gated Reverb, Multi Tap Delay, etc... (20 different algorithms in total).

For further information on the Roland VS-880 DIGITAL STUDIO WORKSTATION contact: Roland (UK) Ltd, Atlantic Close, Swansea Enterprise Park, Swansea, West Glamorgan SA7 9FJ. Tel (01792) 742701

Roland



Introducing the coolest upgrade path in all of digital audio

Here's news for every musician, editor, producer, and engineer: The industry standard digital audio workstation—Pro Tools from Digidesign—now comes in a range of products tailored to your needs and budget. Now you can start with the all new Pro Tools with DAE PowerMix™ for just £599 (EX VAT)*. As your needs grow, you can climb all the way to the world's

Pro Tools Project™

Pro Tools with AudioMedia II™

Pro Tools Software with DAE PowerMix™

New. Turn your Power Macintosh or Mac-OS clone into a multitrack digital workstation with no additional hardware - Pro Tools interface. Random access non-destructive editing. Up to 16 tracks of playback, Automated digital mixing with 2 bands of EQ per track.

This audio card adds 2 channels of high-quality analog and digital I/O, and comes with industry standard Sound Designer II software and entry to its family of DSP Plug-Ins.

New. Pro Tools software and Pro Tools Project Audio Card. Adds 8 tracks of simultaneous record/playback. Up to 8 channels of analog and digital I/O. Supports Sound Designer II and DSP Plug-Ins.

best-selling workstation, Pro Tools III, with mountains of record tracks, I/O, and real-time effects and mixing. Each step of the way, you'll learn and grow with Pro Tools software, share work



between systems, and take an upgrade path that lets you build on the value of your investment. Audio professionals now have more choices and flexibility than ever before. And getting started couldn't be easier. To learn more about the clearest path to the best in digital audio, call 01753 653322.

Pro Tools III™



The ultimate workstation. TDM virtual digital mixing and processing environment accommodates a wide variety of real-time Plug-Ins. 16-48 tracks of record/playback. 8-64 channels of high-quality analog and digital I/O. New for '96: ProControl,™ an advanced tactile control surface with dedicated controls for mixing and editing, plus high-quality moving faders.

For audio professionals and musicians, as well as for more than 100 Digidesign Development Partners, Pro Tools is the industry standard. That's why more audio professionals use Pro Tools than all other digital audio workstations combined.

digidesign

Avid Audio Division



©1996 Digidesign, Inc. Digidesign is an Avid company. All features and specifications subject to change without notice. Digidesign and Pro Tools are registered trademarks of Digidesign, Inc.

*Retail price including VAT £703.83

Paddy Kingsland • David Dundas • Alan Hawkshaw • Brian Bennett • Peter Lawler (Stiltskin) • Gary Stevenson Rick Wright (Pink Floyd) • GMG Music • Rooster Studios Nigel Lewis • Gary Barlow (Take That) • Chris Porter • University of Westminster • Skratch Music • Rokstone Studios • Sound to Picture • Kevin de las Casas (MC Rex) • Mcasso Music • Esselle Beat Co. • George Michael • Trevor Horn • Strongroom Studios

WHAT DO THEY ALL HAVE IN COMMON?



THEY'RE ALL OTARI RADAR USERS

"Radar is the digital 24-track that *everybody* is talking about, and everybody wants to use. Over 720 tracks of Radar have already been installed. Call me now to book your demo on the recording system of the decade."

Garry Robson, Stirling Audio Systems

 **Stirling**

Stirling Audio Systems Ltd., Kimberley Road, London NW6 7SF
Tel: 0171 624 6000 • Fax: 0171 372 6370
Internet: <http://www.millhouse.co.uk/~stirling> • e-mail: stirlingsales@channel.co.uk



New technologies

Hot on the trail of all the broadcast, post and multimedia kit that's new and newsworthy, **DAVE FOISTER** files another roundup of product profiles

Lexicon PCM 90

Lexicon has launched the PCM 90 digital reverberator, specifically intended as a companion to the established PCM 80 digital effects processor. The new model's range of reverberation programs is derived from Lexicon's top-end 480L and Model 300 processors. It uses two of Lexicon's proprietary Lexichip II DSP ICs, and shares with the PCM 80 true stereo capability, 18-bit A-D convertors and a 24-bit internal bus. It provides 250 all-new presets; and to help find the type of effect required there is a keyword-search facility, including 50 preset keyword groupings and four further user-definable groups. Besides the algorithms inherited from the larger Lexicon processors there are several unique algorithms, including a Concert Hall with Spatial EQ and compression. Programmable soft keys allow individually scalable groups of parameters to be controlled by four Custom Controllers, and a card slot allows user configurations to be stored and future Lexicon presets to be added.

- ◆ Lexicon, US. Tel: +1 615 848 5321.
- ◆ Stirling Audio Systems, UK. Tel: +44 171 624 6000.

7-space script tray; 21 channels can be accommodated if this is not required. All input channels have fader-controlled VCAs, and stereo channels are equipped with configurable remotes for control of CD players, cart machines, turntables and so on. Broadcast-specific options abound, such as external cough-mute inputs, reverse talk-back on the channels, and telco channels producing independent clean feeds and allowing studio guests to talk to incoming callers without involving the PFL bus or the presenter. With the Sovereign comes another new Sonifex offering, the Micro-Cart digital cartridge machine, following on from the successful Discart (Disktrak in the US) machines. The recorder-player allows up to eight tracks to be recorded on standard HD or ED computer diskettes, complete with titles and other information which can be entered either using the front-panel buttons or an optional qwerty keyboard and shown on a 32-character display. Audio is 16-bit, data compressed using Codec as standard with apt-X as an option. Ins and outs are balanced on XLRs and record functions can be disabled for on-air use.

- ◆ Sonifex, UK. Tel: +44 1933 650700.

Sonifex make a return to broadcast console manufacture with the Sovereign

EZCD Plus CD-ROM drive

Amacom Technologies, specialist supplier of portable data storage, has released the EZCD Plus, external, dual-speed, PCMCIA-based, CD-ROM drive and portable audio CD player. The drive can add CD-ROM capability to any PCMCIA-equipped notebook or desktop PC, and also doubles up as a CD portable. While in use with a computer it can be powered from the PCMCIA slot or by an external supply or batteries.

- ◆ Amacom Technologies, UK. Tel: +44 181 810 7585.

TimeLine MMR-8

Shown at the New York AES and scheduled for delivery in the spring is the MMR-8. It is a major departure for TimeLine from the familiar workstations. The MMR-8 Modular Multitrack Recorder is a disk-based, 8-track recorder, using either M-O or hard-disk storage, designed to tempt tape-based 8-track users away to the advantages of disk-based operation. Tape-style transport controls are complemented by event location, nine locate memories, jog-shuttle wheel, record and rehearse functions, and unlimited track slip capability. Its main use is to replace magnetic tape dubbers, and has four biphasic inputs and a biphasic generator as well as full time-code chase facilities. It is eventually planned to support OMF and to integrate with virtually all-digital editing systems, but initially it will obviously work with TimeLine's own

Soundcraft Spirit 8

The Spirit 8 is an 8-bus console intended for live applications but fitted with features to enable its use as a recording console in the smaller project studio. Available in frame sizes from 16 to 40 channels, the desk will handle up to 64 inputs with the use of stereo channels. A full meter bridge is standard, along with eight group buses, four mute groups and a 10 x 2 matrix. The 4-band EQ has two swept midsections, and every channel has a direct output.

- ◆ Soundcraft, UK. Tel: +44 1707 665000

Sonifex Sovereign broadcast console

Sonifex, a broadcast equipment manufacturer for over 26 years, made its name with industry-standard cart machines, but has also produced broadcast consoles, the last being the RB102 in the late-1970s. Sonifex is now returning to the console market with Sovereign, designed for local radio stations and self-op studios and intended to provide the flexibility of larger consoles at a reduced price. Two frame sizes are available, the MX10 and the MX14s with up to 10 and up to 14-input modules respectively assuming a



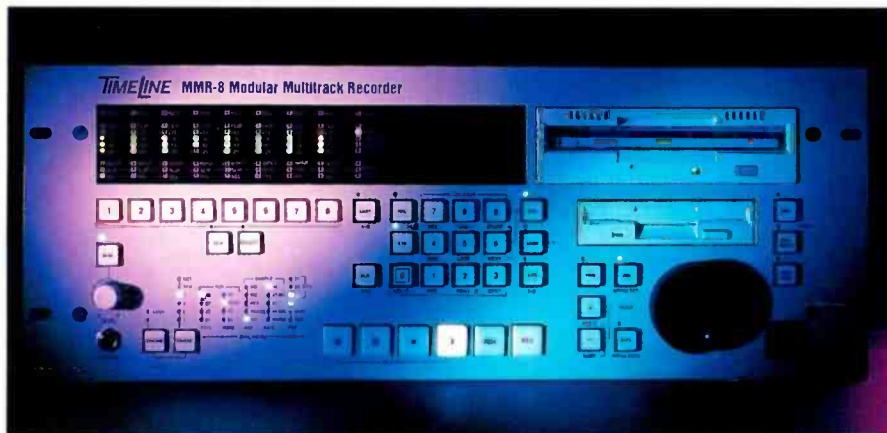

Timeline's MMR-8 modular digital multitrack is expected to ship in the spring

👉 Studioframe workstation.

- ◆ *TimeLine Vista, US.*
Tel: +1 619 727 3300.
- ◆ *TimeLine, Europe.*
Tel: +44 1491 826889.

Veratec Data Gard

Of interest to CD replicating facilities is Data Gard from Veratec, a multilayer material specifically designed for CD packaging. It combines the advantages of bleached boardstock and nonwovens to provide printability and durability together with greatly reduced disc damage, with the ability to wipe the disc and remove most particles from the surface.

- ◆ *Veratec, US.* Tel: +1 508 660 3300.

NVision data router

NVision's new NV3256D is a machine control routing system designed for flexible configuration of up to 256 machines. Unlike 'square' crosspoint matrix type routers, the NVision unit is based on machine ports which

can be configured dynamically to act as master or slave devices. Using both RS232 and RS422 serial interfaces with on-board conversion, the system will accommodate conventional edit suites as well as PC or Mac based nonlinear editing systems.

- ◆ *NVision, US.* Tel: +1 916 265 1000.

Waves plug-ins for Macromedia packages

Waves, European specialists in software for multimedia and other professional audio areas, has announced an alliance with Macromedia, producer of established multimedia design and development packages, which has recently acquired OSC. The alliance will be backed up with a suite of Plug-Ins v2.0 from Waves to complement the Macromedia multitrack music and sound production software Deck II. Further audio plug-ins to be known as Xtras are in the pipeline for Macromedia's SoundEdit 16.

- ◆ *Waves, Israel.* Tel: +972 3 510 7667.
- ◆ *Waves, US.* Tel: +1 423 588 9307. 📞

IN BRIEF

Tactile Technology M4000 v2.1

The Tactile Technology M4000 automated mixing system now has new hardware and software available. The mix software now allows fader moves, either for a whole track or between selected time-code points, to be copied and pasted to another mix or another fader, and expands the Stereo Link function to include the linking across two channels of fader moves, mutes, solos, EQ and mirror pan, where panning one channel hard left sends the linked channel hard right and vice versa. The LCD screen can now display Channel Status, showing numerical values of various channel parameters, and can be duplicated on an outboard computer screen. Hardware updates include a choice of pan characteristics and a larger meter bridge with full scale LED bar graphs on all inputs and outputs.

- ◆ *Tactile Technology, US.*
Tel: +1 310 802 1500.
- ◆ *Stirling Audio Systems, UK.*
Tel: +44 171 624 6000.

Mark of the Unicorn Digital Performer 1.7

A new version of Mark of the Unicorn's Digital

Performer system is scheduled for release about now. Version 1.7 includes DSP functions, including time stretching and pitch shifting, which are claimed to go 'way beyond what is currently possible in other digital audio software'. Support for Digidesign's Session 8 system is incorporated, and to demonstrate the possibilities MotU has produced an audio CD, available in the UK from Musictrack.

- ◆ *MotU, US.* Tel: +1 617 576 2760.
- ◆ *Musictrack, UK.* Tel: +44 1462 733390.

ASC MD-Report kit

At Birmingham's SBES show ASC introduced a kit for providing professional reporters' features for the Sony MZ-R3 portable MiniDisc recorder-player. The kit is built into a rugged chassis which accepts the recorder itself in a recessed bay and is in turn enclosed in a carrying case. The case gives access to the inputs and outputs, which are XLR for mono line and microphone inputs and output together with a 1/4-inch-jack headphone socket. The chassis carries a Sonnenschein battery similar to those used in Uher analogue machines, giving a battery life of 4-6 hours, and there is still room in the case for an accessories pocket.

- ◆ *ASC, UK.* Tel: +44 1734 811000.

INTERNATIONAL DISTRIBUTORS

AUSTRALIA

Amber Technology Pty Ltd.
Tel. (02) 9751211 Fax (02) 9751368

AUSTRIA

Audio Sales Ges.m.b.H.
Tel. (02236) 26123-22 Fax (02236) 43232

BELGIUM

A. Prevost S.A.
Tel. (02) 2168025 Fax (02) 2167064

CANADA

TC Electronics Canada Ltd.
Tel. (514) 457-4044 Fax (514) 457-5524

DENMARK

John Peschardt A/S
Tel. (86) 240000 Fax (86) 240471

FINLAND

Moderato Oy
Tel. 90 340 4077 Fax 90 340 4082

GREECE

Bon Studios
Tel. (01) 3809605 Fax (01) 3845755

HONG KONG

Dah Chong Hong Ltd.
Tel. 28086111 Fax 28733911

INDONESIA

Multi Audio Perkasa
Tel. (021) 6296009-Fax (021) 6298453

ISRAEL

More Audio Professional
Tel. (03) 69656367 Fax (03) 6965007

ITALY

Audium S.r.l.
Tel. (02) 27304242 Fax (02) 27309018

JAPAN

MTC Japan Ltd.
Tel. (03) 5280-0251 Fax (03) 5280-0254

KOREA

Young Nak So Ri Sa
Tel. (02) 5144567 Fax (02) 5140193

LEBANON & SYRIA

AMAC S.r.a.l.
Tel. (06) 430363 Fax (+1 212) 478-1989 (US#)

MALAYSIA

Eastland Trading (M) SDN BHD
Tel. (03) 9845789 Fax (03) 9842288

MEXICO

Electroingenierria en Precision S.A.
Tel. (5) 5597677 Fax (5) 5753381

NETHERLANDS

Electric Sound B.V.
Tel. (036) 5366555 Fax (036) 5368742

NEW ZEALAND

South Pacific Music Distributors
Tel. (09) 4431233 Fax (09) 4432529

NORWAY

Englund Musik A/S
Tel. (047) 67148090 Fax (047) 67113509

PORTUGAL

Audio Cientifico
Tel. (01) 47543488 Fax (01) 4754373

SAUDI ARABIA

Halwini Audio
Tel.+ Fax (02) 6691252

SINGAPORE

Eastland Trading (S) Pte Ltd.
Tel. 3371021 Fax 3383883

SOUTH AFRICA

EMS
Tel. (011) 482 4470 Fax (011) 726 2552

SPAIN

Media-Sys S.L.
Tel. (93) 4266500 Fax (93) 4247337

SWITZERLAND

Audio Bauer Pro AG
Tel. (01) 4323230 Fax (01) 4326558

TAIWAN

Linfair Engineering & Trading Ltd.
Tel. 2 321 4454 Fax 2 393 2914

THAILAND

Lucky Musical Instruments Co. Ltd.
Tel. 251 3319 Fax 255 2597

WHICH PICTURE DO YOU PREFER?

Unless you want to look like Cyberman or a tank commander, it's got to be the new DT 200 series from beyerdynamic.

The designer styling and super comfort cushioning systems, combined with beyerdynamic's legendary transducer technology, keeps you in touch with your audience, in real style.

And to keep the Engineering department happy, the DT 200 series packs a multitude of impressive features:— rugged construction, high performance earmonitors and a choice of really great sounding microphones.

Pictured: DT 291

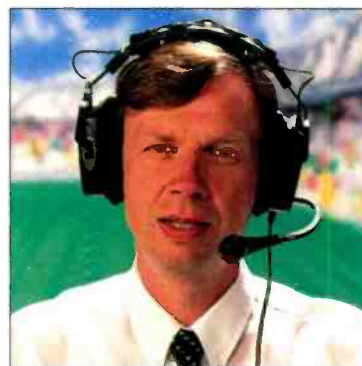
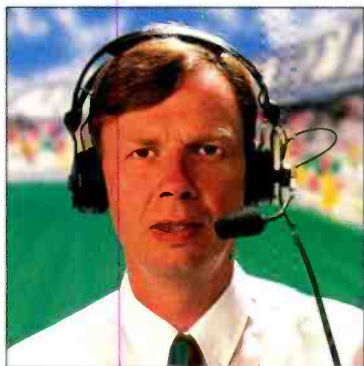

Just take a look at our competition and imagine what you might look like when *you're* giving it your best shot! The only thing you have to look for now is your beyerdynamic dealer. They'll be happy to put you in the right picture.

For more information, call our freephone 0800 374994

beyerdynamic, UK Lewes BN 8 6 JL
Int.l: Thersienstr. 8, 74072 Heilbronn, Germany Tel 7131.617.125

beyerdynamic

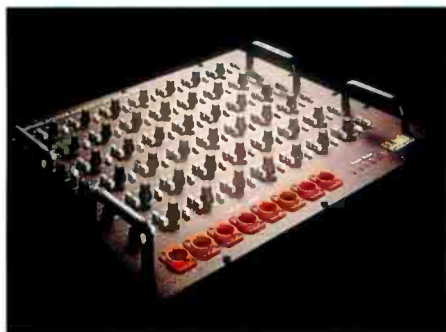

Whirlwind's Active Concert Series mic splitter

Studiomaster power amps

Studiomaster's latest amplifiers are the 700D and 1200D, both numbered to indicate total power output (350W per channel and 600W per channel respectively). Ruggedly constructed to withstand touring use, the designs are also equipped with Studio-master's Amplifier Management Control System (AMCS) to protect both amplifier and speaker and to optimise performance. The system includes signal limiting, thermal and load-sensing fan-cooling which anticipates temperature rises and increases cooling ahead of problems, an electronically-gated power stage replacing power-up relays and crowbar speaker protection.

◆ *Studiomaster, UK. Tel: +44 1582 570370.*

Whirlwind microphone accessories

Whirlwind has introduced a versatile microphone splitting system, the Active Concert Series. Available in 32-channel and 48-channel configurations, the system provides 4-way splitting of an incoming microphone signal, with a laser-trimmed, ultra low noise, front end, feeding one direct output, two transformer-isolated fixed outputs and a variable-gain active output intended for recording purposes or other line feeds. Each channel has a three-LED headroom indicator, gain switch, ground-lift switches for the transformer outputs and a gain control for the active path, with inputs on individual XLRs and

Peavey PRM 26i and 28i

Peavey's newest loudspeakers are two models of 2-way design intended for use as close-field monitors. Fitted with a 6½-inch and an 8-inch LF unit respectively, the PRM 26i and 28i are designed to provide a high degree of accuracy in frequency response, phase response, and time domain. Peavey claims exceptional imaging and low-frequency response for monitors of their size and price.

Peavey, US. Tel: +1 601 486 1408.

Peavey, UK. Tel: +44 1536 461234.

Koss 3-D headphones

Long-established US headphone manufacturer Koss has introduced a range of three new models featuring 3-dimensional sound enhancement. The enhancement circuitry is contained within a control box in the signal lead, which carries two Panoramic Source Control sliders, an Ambience Expander switch and a Comparator switch. Details of the process are not given, but the intention is to create 3-dimensional out of head localisation and to give control over the listening perspective. One model, the Pro/405, is intended for the studio professional user and is a circumaural design with oxygen free copper

IN BRIEF

voice-coils and a quoted frequency response of 20Hz–20,000Hz.

Koss, US. Tel: +1 414 964 5000.

Emulator software v1.20d

E-mu Systems' Emulator IV and e64 samplers now run version 1.20d of the software, available free to all existing users and fitted as standard in new units. Features include SMDI (SCSI Musical Data Interchange) for quick file transfers, eight solo modes, support for drives larger than 4Gb, six additional MIDI controller inputs, modulation and destination processors and a view screen for Multimode.

◆ *E-mu Systems, US. Tel: +1 408 438 1921*

Sennheiser MD504 shockmount

The Sennheiser MD504 'thumb microphone' (*Studio Sound*, April 1995) can now be mounted directly on to an instrument using the new rubberised shockmount clips. These allow the already small and unobtrusive microphones to be attached to, for instance, the rim of a drum, removing the need for multiple microphone stands around a kit.

◆ *Sennheiser Electronic, Germany.*

Tel: +49 51 30 600 366.

outputs on MASS multipin connectors. The power supply is separate, and includes dual independent supplies (right down to the AC inlet cables) for redundancy. Launched alongside the splitters is a new contender in the market for reproducing amplified guitar sounds without the need for an amplifier. The Mic Eliminator is effectively a direct box with special frequency tailoring intended to match the contour of a close-miked guitar amp without the problems the conventional setup can entail. It has an extremely high input impedance to get the best out of the source pickup, and a BRITE-DARK switch claims to

offer a choice between the frequency curves to be expected on and off axis. Besides its use directly between guitar and console, it can accept line-level and speaker-level signals from an existing rig and has a ground-lift switch for the purpose.

◆ *Whirlwind, US. Tel: +1 716 663 8820.*

Furman IT-1220 isolation transformer

Furman known for power conditioning and regulation, has introduced a 20A isolation transformer designed to reduce buzz and hum in

E = MC 26



FOCAL
PROLINE
MONITORS

**No
relativity.**

FOCAL S.A - BP 201 - 42013 ST-ETIENNE CEDEX 2 - FRANCE - Tél. (33) 77 43 16 16 - Fax (33) 77 37 65 87
FOCAL PROLINE - 173, rue Charenton - 75012 PARIS - FRANCE - Tél. (33-1) 43 43 96 33 - Fax (33-1) 43 46 18 96

SUCCESS BREEDS SUCCESS

Soundtracs Solitaire - The most successful production console of 1995

With over 100 sold in its first 12 months, Soundtracs Solitaire console has set the standard in quality, innovation and value, meeting the needs of today's bands, songwriters, music producers and post-production houses.

And it's easy to see what has generated this success.

Features like the assignable dual inputs (max 88), designed around ultra low noise large junction transistors to minimise distortion levels and maximise signal to noise ratios each with mute and level automation options, flexible EQ, 8 AUX sends (+2e!) plus ADP.

The acclaimed FdB™ Parametric Equaliser provides precise control of all channel frequencies while the monitors have a punchy 2 band EQ with additional access to the mid-band FdB™ Parametrics.

The unique ADP system provides a comprehensive range of gating (5µsec attack), compressor, expansion, limiting, modulation, auto and triggered pan, with side-chain keying possible on every channel.

Two high-speed automation systems; VCA on both channels and monitor faders, or Moving Faders on channels and VCA automation on monitor faders are complemented by the option of PC based visual monitoring for display and off line editing.

The Solitaire encompasses the very best automator and ADP without any compromise on the analogue facilities.

Success, after all breeds success.

MIXING WITH THE PROFESSIONALS



The Levellers



Gemini Audio Production



Nik Kershaw

SOUNDTRACS
SOLITAIRE

LARKING AUDIO
LIMITED

Distributed in the UK by Larking Audio Ltd.
15 Cam Square, Wilbury Way
Hitchin, Herts, SG4 0TZ
Tel: 01462 422466 Fax: 01462 421171

SOUNDTRACS

Unit 21-C, Blenheim Road, Longmead Industrial Estate, Epsom, Surrey KT9 9XN, England. Telephone: (+44) (0)181 388 5000 Fax: (+44) (0)181 388 5050

INTERNATIONAL DISTRIBUTORS

Installations where ultra-low noise performance is required. Twelve isolated power outlets on the back panel are augmented by two more on the front, plus a 3-colour meter for monitoring incoming mains voltage. Inside is a specially wound and shielded toroidal isolation transformer which provides balanced AC power with a centre-tapped secondary. Furman claims that use of the IT-1220 (which is only available for 120V at present) can achieve hum reductions of 10dB-15dB without the use of complex star earth systems or massive earth-bus bars and without compromising safety. The use of this kind of balanced power supply arrangement for noise reduction in studio locations is authorised, according to Furman, by the latest version of the US National Electrical Code.

◆ *Furman Sound, US. Tel: +1 415 927 1225.*

Rockwool acoustic floor system

Intended for use in general building work but potentially of interest to studio constructors is a new acoustic flooring system from insulation specialist Rockwool. The system consists of floor panels incorporating 25mm high-density mineral wool bonded to high density tongue and groove cement-particle board, and is installed with Rockwool RW2 slab between the floor joists. The result is effectively a floating floor, both absorbing impact sound and isolating against airborne sound. The quoted specifications for the finished floor (installed with timber joists) include a weighted, sound-reduction index of 53dB and a weighted, normalised, sound-pressure level of 62dB, as well as satisfying relevant standards in terms of fire resistance and having good dimensional stability and thermal insulation properties.

◆ *Rockwool, UK. Tel: +44 1656 862621.*

DDA CS3

Also aimed at live applications is the new CS3 from DDA, with frame sizes from 16 to 40 channels and special features including LCR panning and solo-in-place. Six aux sends are fitted along with 3-band EQ incorporating a fully parametric mid.

◆ *Mark IV Pro Audio Group, UK. Tel: +44 1562 741515.*

Tyrell Tapemaster software

The Tyrell Corporation has released its first software product, a logging and management system for Sonic Solutions users. TapeMaster provides on-screen machine control and comprehensive session-logging facilities so that the information needed for transferring the required material automatically into the Sonic system (the Sonic Source Log) is ready at the end of the session without having to tie up workstation time to review all the tapes afterwards. Takes are logged against time code live on-the-fly, with buttons for marking false starts and location facilities for playback.

◆ *Tyrell Corporation, UK. Tel: +44 171 287 1515.*

WinSpeakerz 95

True Image Audio's package for loudspeaker design, MacSpeakerz, is now available for Windows 95. This design toolbox can show the performance to be expected from a given combination of driver and enclosure type, and provides calculators for designing passive

IN BRIEF

BPM microphones

BPM Studiotechnik has introduced two microphone models, both multipattern, large-diaphragm, dual-capsule, studio condensers. The CR-95 provides omni, cardioid and figure-of-eight patterns with a frequency response of 20Hz-20,000Hz, while the TB-95 offers similar specs with a valve preamp run from a separate power supply. Both come with a flexible suspension and cable packaged in a flightcase. Also available: BPM the Roadstar battery-powered, two-channel, microphone preamp, offering phantom power, 60dB gain and phase reverse and giving 10 hours use from two 9V batteries.

◆ *BPM Studiotechnik, Germany. Tel: +49 030 4631169.*

Cubase 2.8 for Windows

Cubase has been updated to include the user-interface recently introduced with Cubase Score v2.0. New colour implementation gives a clearer overview of the musical arrangement, and facilities include a large SMPTE/song-position display, AVI video support and a MIDI processor allowing MIDI delays and arpeggios to be generated simply.

◆ *Steinberg, Germany. Tel: +49 30 211594.*

Orban DSE 7000 network support

Orban has added high-speed computer network support for both the Broadcast Electronics AudioVAULT and ENCO DAD 486X digital-audio systems to its established DSE 7000 workstation. This provides a means of transferring mono and stereo productions to either system for on-air playback. The systems are separate and quite different, as the BE uses a distributive system without a central file server while the ENCO uses a Novell server, but both interfaces are built round a new bidirectional communications system.

◆ *Orban, US. Tel: +1 510 351 3500.*

Sabine ADF upgrades

The ADF workstation, Sabine's user-adjustable system based on the FBX feedback exterminators, has two new versions, the ADF-1201 and 2402, allowing filter editing in graphic-display screens. They include an improved real-time analyser feature, automatic filter tracking, a new 'lock fixed' filter option, a pink noise generator and a bright LCD screen. A Windows remote control disk is provided with the ADF-2402.

◆ *Sabine, US. Tel: +1 904 371 3829.*

crossovers, phase compensation networks and attenuators as well as various cabinet types. A Driver Database is included, with over 90 different parameters available for each driver, and driver records can be added, deleted and amended.

A demo version of the package is available for downloading from America On Line using the AOL keyword 'TIA' to access True Image Audio's speaker design forum and software library.

◆ *True Image Audio, US. Tel: +1 619 480 8961.*

AUSTRALIA: AUDIO SOUND CENTRE
Tel: 02 9901 4455 Fax: 02 9901 4229
Contact: Geoff Grist

AUSTRIA: AKG ACOUSTICS
Tel: 01 866 54 256 Fax: 01 866 54 549
Contact: Reinhold Fliedl

BELGIUM: T.E.M. S.A.
Tel: 2 466 5010 Fax: 2 466 3082
Contact: Guido Van De Vijver

CANADA: STUDDER CANADA LTD
Tel: 416 510 1347 Fax: 416 510 1294
Contact: Dave Dysart

CZECH REPUBLIC: AUDIOPOLIS
Tel: 42 2 322 552 Fax: 42 2 323 069
Contact: Jan Adam

DENMARK: INTERSTAGE
Tel: 39 62 00 26 Fax: 39 62 06 40
Contact: Finn Juul

FINLAND: STUDIOTEC
Tel: 90 592055 Fax: 90 592090
Contact: Peter Strahman

FRANCE: S.A.V.
Tel: 1 42 40 55 22 Fax: 1 42 40 47 80
Contact: Philippe Desgué

GERMANY: MEDIACOM
Tel: 05451 94690 Fax: 05451 946919
Contact: Uwe Seyfert

GREECE: KEM ELECTRONICS
Tel: 01 647 8514 Fax: 01 647 6384
Contact: Thimios Kolikotsis

HOLLAND: K&O PROFESSIONELE
Tel: 2526 87889 Fax: 2526 87362
Contact: Daan Verschoor

HONG KONG: DIGITAL MEDIA TECHNOLOGY
Tel: 2 721 0343 Fax: 2 366 6883
Contact: Wilson Choi

INDIA: P A C E LTD
Tel: 22 633 5450 Fax: 22 633 5450
Contact: Joe Gonsalves

ISRAEL: BANO-PRO FIM/VIDEO INC
Tel: 03 673 1891 Fax: 03 673 1894
Contact: Shai Danieli

ITALY: AUDIO EQUIPMENT
Tel: 039 212 221 Fax: 039 214 0011
Contact: Donatella Quadrio

KOREA: DAI KYUNG ELECTRONIC
Tel: 2 747 6187 Fax: 2 766 8504
Contact: Dae Hyun Han

NEW ZEALAND: AUDIO VIDEO WHOLESALEERS
Tel: 07 847 3414 Fax: 07 847 3412
Contact: Murray D. Hunt

NORWAY: SIV. ING BENUM A/S
Tel: 22 1 45460 Fax: 22 1 48259
Contact: Egil Eide

POLAND: STUDIO DAVE
Tel: 2 226 4912 Fax: 2 635 5262
Contact: Bogdan Wojciechowski

PORTUGAL: ESTEREDSDM LOA
Tel: 01 354 4029 Fax: 01 357 2981
Contact: Jorge Goncalves

RUSSIA: ABV COMPANY
Tel: 95 192 8101 Fax: 95 233 6019
Contact: Boris Nekrasov

SINGAPORE: TEAM 108 PTE LTD
Tel: 65 748 9333 Fax: 65 747 7273
Contact: Helena Lim

SOUTH AFRICA: EMS LTD
Tel: 011 482 4470 Fax: 011 726 2552
Contact: Dennis Feldman

SPAIN: KASH PRODUCTIONS
Tel: 91 367 5222 / 91 377 0068 Fax: 91 367 5209
Contact: Jim or Carmen

SWEDEN: INTERSTAGE
Tel: 020 79 70 99 Fax: 020 79 77 09
Contact: Finn Juul

SWITZERLAND: DR. W.A. GUNTHER AG
Tel: (1) 910 4141 Fax: (1) 910 3544
Contact: Nicola Boehmer

TAIWAN: ADVANCETEK INT'L CO LTD
Tel: 886 2 719 2388 Fax: 886 2 716 0043
Contact: Julian Lin

USA: HHB COMMUNICATIONS INC
Tel: 207 773 2424 Fax: 207 773 2422
Contact: Fraser Jones



HHB Communications Limited

73-75 Scrubs Lane · London NW10 6QU · UK
Tel: 0181 962 5000 Fax: 0181 962 5050 E-Mail: sales@hhb.co.uk

PORTADAT

SERIOUSLY PROFESSIONAL PORTABLE DAT

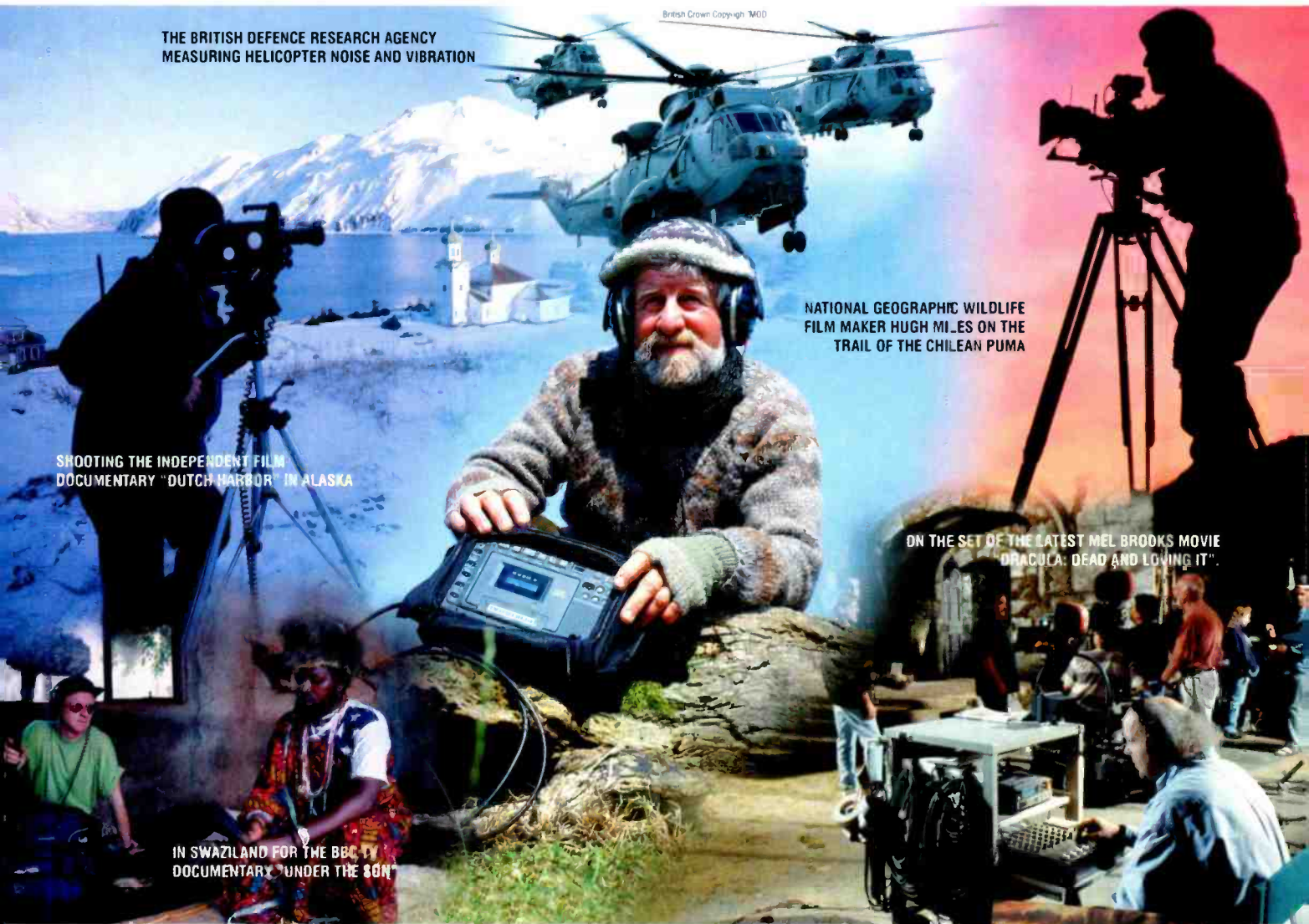

THE BRITISH DEFENCE RESEARCH AGENCY
MEASURING HELICOPTER NOISE AND VIBRATION

British Crown Copyright MOD

NATIONAL GEOGRAPHIC WILDLIFE
FILM MAKER HUGH MILES ON THE
TRAIL OF THE CHILEAN PUMA

SHOOTING THE INDEPENDENT FILM
DOCUMENTARY "DUTCH HARBOR" IN ALASKA

ON THE SET OF THE LATEST MEL BROOKS MOVIE
"DRACULA: DEAD AND LOVING IT"

IN SWAZILAND FOR THE BBC TV
DOCUMENTARY "UNDER THE SON"



PORTADAT
PDR1000



TIMECODE-EQUIPPED
PORTADAT PDR1000TC

Superior sound quality, great handling and all the right features have rapidly established the PORTADAT professional portable DAT recorder as an international industry standard, with thousands of machines already hard at work around the world. Now you can get the full PORTADAT story direct from the professionals in **The PORTADAT News Bulletin** – 16 pages packed full with PORTADAT information, user interviews, accessories, updates and useful hints and tips. Call HHB today on 0181 962 5000 for your free copy.

**PORTADAT
NEWS BULLETIN**
Call HHB for your free copy



Channel crossing

To open a series of articles dedicated to postproduction sound, **TOM HOLMAN**, the man behind Lucasfilm's THX and TMH systems, provides an historical overview of multichannel audio

A SHORT HISTORY of multichannel sound shows 2-channel stereo to be a latter-day invention, not at the heart of stereophony. Given a blank slate, engineers and psychoacousticians have come up time and time again with more channels. This article gives a brief historical introduction to multichannel sound, ending with the emergence of multichannel stereo at home. Further articles in this series will deal with this hot emerging field, including methods of recording and delivering multichannel.

The US branch of stereophony began in the 1930s at Bell Labs, where a group under W B Snow investigated methods of pickup and reproduction culminating in a live demonstration in 1934. The Philadelphia Orchestra played in its home and was relayed over wide-band phone lines and newly developed amplifiers and loudspeakers to an exhibition in Washington, DC.

Snow used a 'curtain of sound' approach, with multiple, spaced, omnidirectional microphones, and loudspeakers in one-to-one correspondence with the microphones. He concluded that while an infinite number of channels was best, that infinity in this case could be represented practically by three channels, left, centre, and right (LCR). His original work showed that such a system could reproduce lateralisation as well as depth, through 'triangulation'.

Walt Disney Studios employed 3-channel stereo in front for its recording of *Fantasia* in the late-1930s. A fourth recorded channel on the film carried both companding and 'steering' information. For certain scenes in the original, the three tracks were steered to alternative loudspeakers in the auditorium permitting the sound to originate in the rear of the theatre and progress towards the screen through amplitude panning. This was doubtlessly one of the wonders of the sound world of the 1930s. It is the first known example of breaking the curtain of sound into a surround experience.

When 20th Century Fox found the film business to have a strong new competitor in television during the early 1950s, it advanced the theatrical experience beyond the borders of the television box (that is, in sheer size and in the widening of the aspect ratio of both picture and sound images) by adding Cinemascope and stereophonic sound to film. The Fox development team is credited with adding the 'effects' channel – what we today call the surround channel – as a completely separate discrete channel to increase the involvement of the audience.

Michael Todd developed his own format, Todd AO, in the mid-1950s. Large screens,

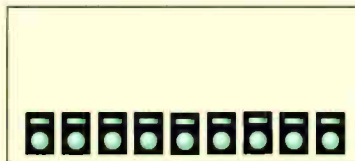

Fig.1: Infinite front loudspeaker array. Snow's 'curtain of sound', with loudspeakers in 1:1 correspondence with microphones

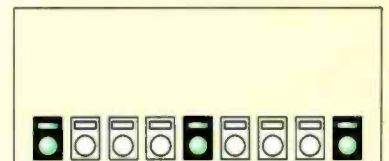

Fig.2: Three-channel simplification. Snow's 'practical' approach to the curtain of sound using three channels

up to 80 feet wide were employed, which resulted in such a large angular displacement from, say, left to centre, for listeners seated in the audience, that a 'hole' between them could be heard. The problem was attacked by adding left centre and right centre loudspeaker channels to the mix, for five front channels. These solidified the sound images at the loudspeaker locations, for if a signal is sent to only one loudspeaker channel, then everyone in the audience, despite their seated location, will hear the direction correctly—there is no reliance on unstable 'phantom images' formed between two loudspeakers.

Also, the channels were not particularly well matched (this is in the days before equalisation became routine), and would let an actor enter as a tenor on one side of the screen and exit the other side a baritone due to the timbre shift occurring with differing spectral tilts across the channels. Helping to correct for the shift in equalisation as the sound is panned across mismatched speakers was an invention called 'divergence'. This is a knob added to pan circuits which leaks some signal from the 'panned-to' location into adjacent locations. The original idea apparently was to simply smooth out the panning changes by adding these deliberate leaks. With a more modern knowledge of psychoacoustics we can see in hindsight that divergence controls were the wrong way to attack the problem. What was not known at the time of their invention was that the precedence effect (aka Haas effect, or Law of the First Wavefront) is quite strong: we hear localisation based on the first arriving sound, unless a later sound is actually stronger than the first.

For a sound in a 3-front-channel system sent to centre, with divergence set high, the leak into left and right means that for listeners seated along the outer aisles of the theatre the, supposedly, centre sound-image

is actually heard at the left or right sides of the picture. This is still true today—I have just heard a digital discrete film mix where such a problem was in abundant evidence. So in my opinion divergence controls should be banned as being based on bad psychoacoustics.

In the late 1950s, Westrex (among others) invented 45-45, stereo, 2-channel recording, making use of the two groove walls of the phonograph record and a phantom centre. Stereo at home was thus standardised around two channels, as other media copied the capability of LPs.

There are some severe problems with 2-channel stereo. The first is the well-known imaging problem, that when we move across the listening area sound images meant to stay centred move with us. Thus the application of the precedence effect to 2-channel stereo: the earlier arriving sound dominates. The only real way out of this is to add more channels, although there have been patented and marketed solutions which trade off level against time by sending more sound energy from the right loudspeaker, say, to its left, so that as one moves off the centre line to the left one gets a stronger right-channel signal, so that the earlier time of the left-channel arrival can be compensated by the stronger right channel, for a phantom image meant to be centred between them.

A second problem is caused by 'acoustic crosstalk' in which the left loudspeaker sound addresses both the left and the right ears, and the right loudspeaker sound does the same. The time delay between the left sound arriving at the left ear, and the right sound arriving at the left ear, combined with the head more 'in the way' of the right-channel sound than the left, causes problems for phantom-image sound made by producing equal output from the two loudspeakers. The result is a frequency-response dip around 2kHz, and response

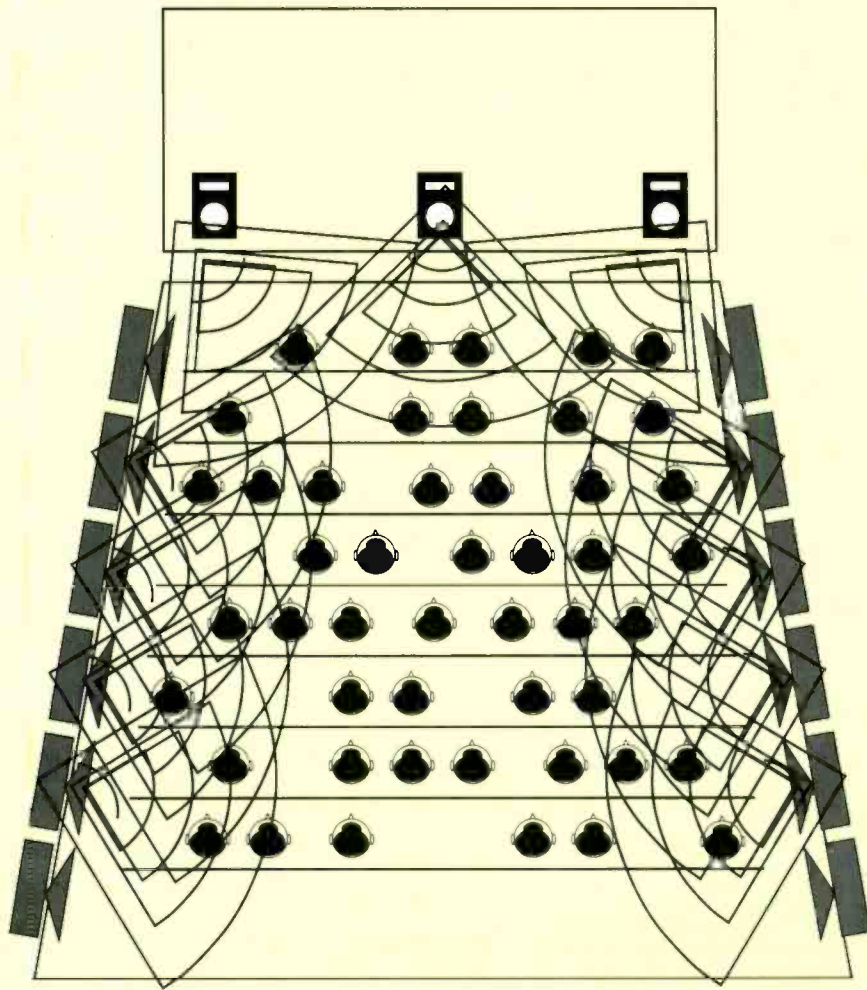

Fig.4: Surround Array. The surround array followed the use of effects speakers, simply to cover the audience more uniformly

ripples at higher frequencies. This means that when you are working in 2-channel stereo, the best procedure is always to pan first, then equalise, since panning across the front stereo stage does not result in equal performance, even if the loudspeakers are perfectly matched.

THE MOST LASTING legacy of the first attempts to get multichannel sound into the home was the development of amplitude-phase matrix technology for storing four-channels worth of information in two tracks. Competing system formats and lack of a clear aesthetic vision of what to do with the medium killed quad, and this death was lamented by few. For the non-musician, sitting inside the band was an unnatural experience.

In the 1970s, Dolby Laboratories pioneered the application of amplitude-phase matrix stereo derived from the late quad era on optical soundtracks. The well-known Dolby Stereo promulgated into thousands of theatres in this form, with one of the principal reasons being that it could be printed at high speed on existing optical printers, and thus could appear on all prints of a film easily. Probably the least-known part of their effort was to equalise the

theatres to a standard, so that the perceived frequency response varied much less from room to room than it did in earlier times. Stereophonically, the older quad matrices were reoriented for this system, with three screen channels and one surround channel, rather than the square format of quad.

Used first for fly-over effects, but wise beyond its ways, *Superman* marked the introduction of stereo surround for film. Probably the intent was to produce flying effects 'over the head' of the audience, panning from one side to the other, but this system was wise because it allowed for spaciousness to be available in the surrounds. Previous discrete 4-track Cinemascope, Dolby Stereo 35mm, and even 70mm only had one channel devoted to the surrounds. This is a sort of oxymoron: one channel devoted to the surround function. What will happen is that you will localise the sound field in mono surround systems either to the closest loudspeaker if you are off-centre, or if you are on-centre and the loudspeakers and acoustics are well matched, you will hear a 'centre of the head' sound like headphones driven in mono produce. So stereo surround was an important improvement.

When digital sound for film was studied by an SMPTE group in 1987, debate raged

over the number of channels a new system should have. Among all the round numbers being put forth I said, almost in jest, that the correct number of channels should be 5.1. The number stuck, partly because it was memorable. Three screen-channels were the minimum number, and the number had to be odd because a centre was essential, so that while three and five front-channel systems were useful, three met Snow's criteria: it was practical. Two surround channels were the minimum number, because nothing less could produce genuine spaciousness and left-right directionality.

The '0.1' channel came from the observation that systems having a flat overload characteristic with respect to frequency for low frequencies, such as linear PCM and 35mm mag film, seemed to overload first in the bass when filled up with programme material. Since large low frequencies also tend to intermodulate with the other programme material in a channel, and since localisation fails at low frequencies, a single low-frequency-only channel (called Low Frequency Enhancement, LFE) is useful. The bandwidth is only DC-120Hz so the 0.1 in only a designator: in actual fact only 0.005 of a main channel is used for this addition. The level is standardised to produce a 10dB greater headroom capacity in this channel than in the main ones. The 5.1 channel system was adopted by US advanced television efforts so that television could be transparent to Hollywood production-sound mixes, since film is expected to play a big role in any advanced television system.

This would not have happened without a perceptually coded, bit-rate reduction system because the old rule that sound can take up about 10% of an audio-video medium still applies, and so much is taken up by getting decent pictures that sound still occupies only that part of a channel. After listening tests, Dolby AC-3

Fig.3: Two rear effects speakers. Early Fox added effects loudspeakers in the auditorium to Snow's three front channels

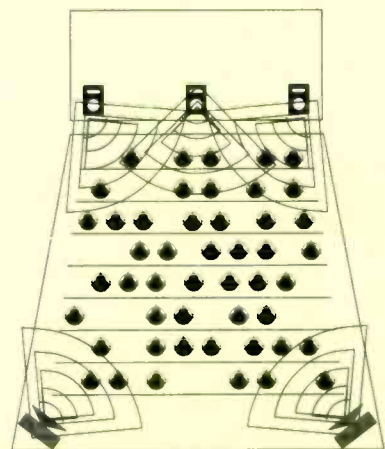

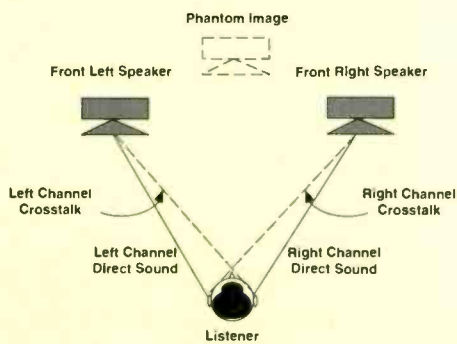

Fig.5: How acoustic crosstalk arises for a phantom image

It was chosen as the low-bit-rate system for US broadcasting.

The old CCIR, now ITU-R, conducted its own tests on the number of audio channels needed in a new system. Among front channels, there was less 'warping' of frontal sounds, that is, misrepresentation as to position, as the number of channels was increased from two through three to four. Still, it was felt desirable to have a hard centre since so much produced programme material is, and will be, available in that form, so that three channels won out, substantiating Snow's findings once again.

In surround-channel testing, there was a large step in going from one to two channels, and another noticeable but not so large step in going from two to three channels, and thus two won the day as also practical. The 0.1 channel was adopted as well since it uses such small resources and having it provides a benefit in transparency to source material.

Currently there are about 10,000 cinemas world-wide equipped with at least one of three competing multichannel sound systems. There are two primary sound-on-film systems, and one system which uses a type of time-code track on the film and CD-ROM technology to store the audio. Dolby's entry is SR-D, which stores 5.1 channels of information between the perforations, an unusual and heretofore unused piece of turf on the film. Sony's entry, SDDS, uses both left and right sides of the film outside the perforations, and it is implemented in theatres as either a 7.1 channel system, with five screen channels, or as a more conventional three screen channels.

Another entry is from Digital Theatre Systems whose time code lies between the analogue sound track and the picture. DTS is a 5.1 channel system which uses the follower CD idea. One interesting point is that all three are recorded on different spots of the film, and that all three are used in conjunction with a conventional analogue track, which they fall back on if the digital systems fail. This means that there literally can be prints which contain all four sound tracks, and there have been on at least one film, *Strange Days*.

THE INTRODUCTION OF DVD dominated the Winter CES in Las Vegas. The Digital Versatile Disc, as it is now called in some quarters, can use up to

eight separate 5.1 channel tracks, although playing time would be reduced with such a large number. Five version discs with English, French, German, Italian, and Spanish are likely though. The 5.1 channel system may already be seen as dominating the world of multichannel sound but it should be pointed out that it was developed with a very special purpose in mind: sound accompanying a frontal picture. Thus there is an emphasis on sound imaging in front, and of sound envelopment from the surround

channels. How many channels are really needed for a system that can produce both sound images in any location in 3-dimensional space, and produce good sound envelopment as well, is the subject of on-going work to be taken up later in this series. One thing is for sure. Any multichannel system to be introduced must be backwards compatible with 5.1 channel sound, since there are now some 20 million Dolby Surround or ProLogic decoders present in homes, most presumably with surround speakers, and a large portion with centre speakers.

Quad failed not only due to its being driven by hardware developers who had competing systems, but also because it failed to put forth an aesthetic vision. Revisiting quad is not what we are suggesting with the development of multichannel sound, but a thorough examination of both aesthetics of music recording, and psychoacoustics of listening.

It is an exciting future for audio. **S**

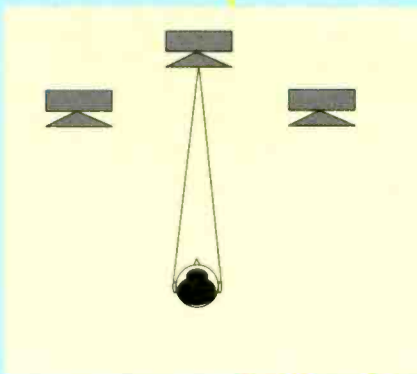

Fig.6: An actual centre speaker produces a flatter reference response due to its lack of acoustic crosstalk

Multichannel Audio alliance Conference, March 29th and 30th, 1996 Los Angeles, CA.
Tel: +1 213-743-1759.
Web: www.tmhlab.com/tmhlab

John Eargle, Tom Holman, Hans Zimmer and others introduce the best music-only uses of high-capacity carriers such as DVD, satellite, and broadband cable to an international group of professionals

Focusrite audio engineers WORLDWIDE

Austria: ATEC GmbH
Tel: 02234 74004
Fax: 02234 74074

Australia: AR AUDIO ENGINEERING
Tel: 02 299 3666
Fax: 02 299 2240

Belgium: TBM
Tel: 02 466 5010
Fax: 02 466 3082

Canada: SONOTECHNIQUE
Tel: 416 947 9112
Fax: 416 947 9369

Denmark: NEW MUSIK AG
Tel: 086 19 08 99
Fax: 086 19 31 99

France: MILLE ET UN SONS
Tel: 1 46 67 02 10
Fax: 1 47 89 81 71

Germany: SOUND SERVICE GmbH
Tel: 030 850 89 50
Fax: 030 850 89 589

Holland: TM AUDIO
Tel: 030 414 070
Fax: 030 410 002

Hong Kong: DIGITAL MEDIA
Tel: (852) 721 0343
Fax: (852) 366 6883

Ireland: CTI
Tel: 01 545400
Fax: 01 545 726

Japan: OTARITEC
Tel: 03 3332 3211
Fax: 03 3332 3214

Italy: GRISBY MUSIC
Tel: 710 8471
Fax: 710 8477

Korea: Beat Logic
Tel: 02 741 7385
Fax: 02 741 7387

Norway: LYDROMMET
Tel: 22 37 02 10
Fax: 22 37 87 90

Portugal: CAIUS TECHNOLOGIAS
Tel: 02 208 4456
Fax: 02 314 760

Russia: ISPA
Tel: 503 966 1826
Fax: 503 966 2309

Singapore: TEAM 108
Tel: 748 9333
Fax: 747 7273

Southern Africa: SOUND FUSION
Tel: 011 447 13 15
Fax: 011 673 35 91

Spain: MEDIA SYS.
Tel: 03 426 6500
Fax: 03 424 7337

Switzerland: STUDIO M & M
Tel: 064 415 722
Fax: 064 413 830

Taiwan: ADVANCE TECH
Tel: 02 716 8896
Fax: 02 716 0043

Thailand: KEC
Tel: 02 222 8613-4
Fax: 02 225 3173

UK: STIRLING AUDIO
Tel: 0171 624 6000
Fax: 0171 372 6370

HMB COMMUNICATIONS
Tel: 0181 960 2144
Fax: 0181 960 1160

USA: GROUP ONE
Tel: 310 306 8823
Fax: 516 753 1020



Focusrite
Mic-pre & Equaliser

Make Your Studio World Class



Focusrite
Mic-pre & Dynamics

For Under £1,500



Focusrite
Stereo Mic-pre

Thousands of project studios equipped with ADAT or DA-88 digital recorders are discovering that recording direct through one of the Focusrite Reds enables recording quality the equal of the world's finest studios.

Each of the Reds featured here include the premier outboard microphone preamplifier, the classic Rupert Neve designed Focusrite Mic-Pre Transformer coupled for optimum impedance matching, this classic delivers all the performance of your chosen microphone, direct to the recorder (RED 8) or via a subsequent processing stage.

Recording direct, with optimised signal level, is inevitably superior to going through a mixer, the performance of which is compromised by the design budget.

Each of these Reds enable you to match the level to the recorder, getting the best performance from the A-D converter, without compromise.

RED 6 combines the classic mic-pre with the equally classic Focusrite EC: High and low pass filters, high and low frequency shelving controls and two parametric bands. Also featured are balanced line input, VU metering and output fader. **£1,425***

RED 7 is similar, but features dynamic control instead of EQ. The mic-pre is followed by a compressor, (Similar to the TEC Award winning RED 3) and de-esser / exciter stage. This is the best vocal front end in the business (in our humble opinion!). **£1,495***

RED 8 simply provides two channels of the Focusrite mic-pre. If you've never had the chance to use one, you'll be amazed when you do! Your microphone will reveal hidden qualities whether it's a condenser, ribbon or dynamic. **£1,225***

*Suggested retail price.

The Red Range – World Class.

Focusrite

RED RANGE

Made in the United Kingdom by: Focusrite Audio Engineering Ltd. 2 Bourne End Business Centre, Bourne End, Bucks, SL8 5AS England. Tel: +44 1528 819456 Fax: +44 1628 819443

Distributed by: Group One Ltd. 201 Wilshire Blvd. # A18 Santa Monica CA. 90401 Tel: 310 656 2521 Fax: 310 656 2524 In Canada: Sonotechnique Tel: 416 947 9112 Ontario Tel: 514 739 8731 Quebec



ISDN in

IT IS LITTLE more than six months since I last wrote in these pages on the subject of the Integrated Services Digital Network (*Studio Sound*, July 1995), but this relatively short space of time has seen a number of my predictions become fact—and others begin to look decidedly shaky.

Few would argue that using the ISDN for the transmission of audio is now in most cases as simple as falling off the proverbial log. Admittedly, there remain some pitfalls to trap the unwary—a prime example being the incompatibility between the 64kbit/s based ISDN and the Switched 56 service still found in far too many parts of North America. But, generally speaking, a dial-up connection between any of the 30 or so countries currently served by the network is now as easy as picking up the telephone.

The result is that news editors no longer 'hold the front page' every time Frankie or Gloria, sitting in their bathtubs in Malibu or Aspen, are linked together with a group of backing singers in Memphis while Phil Ramone sits in a New York studio listening to the mix. In fairness to Mr Ramone, he probably doesn't consider it newsworthy any more either: as far as he, and many others like him are concerned, the ISDN is just another studio tool designed to make artists' and producers' lives easier.

Nevertheless, some significant advances in codec design and coding technology have taken place, while new services from the telcos are making things viable that would not until now have been worth considering.

Of prime importance to many is the continuing reduction in call charges from most of the major telcos. As an example, in 1992 an ISDN data call from the UK to the US cost UK£1.40 per 'B' channel per minute, but increased demand (not to mention competition from Mercury) has now reduced this to £0.65.

On the subject of call charges, in 1946 a 3-minute voice call from the US to the UK cost almost \$640, while today it is priced at under \$1.50. According to the telecomms industry magazine, *Telecommunications*, this trend is likely to accelerate and by 2005 a one hour video-conference call could cost just \$0.03.

NEW CODING technology has also been helping to improve audio quality without increasing data bandwidth. This is especially important for the broadcast industry where budgetary constraints frequently limit a connection to a single 'B' channel.

Until recently there were very few audio coding schemes that could operate successfully in real time at a data rate of 64kbit/s,

and these all limited the bandwidth to 7kHz. However, enhancements to the ISO-MPEG Layer II specification now allow a mono signal with a frequency response up to 10kHz to be coded, while at the AES in New York APT demonstrated a new algorithm they are developing in collaboration with AT&T which can transmit quite acceptable stereo signals at data rates down to 56kbit/s.

Another solution to the problem of transmitting high-quality signals where only a limited amount of data bandwidth is available is to use a technique known as 'store and forward'. This involves recording an audio or video file onto hard disk, or even RAM, and then playing out the file at whatever data rate can be accommodated by the network. This technique has already been successfully used for the non-real time transfer of audio files between Sound Tools workstations, and by a handful of computer-based video systems. The latter are capable of sending 'VHS quality' pictures over two ISDN 'B' channels at about one tenth of real-time speed.

Using store-and-forward technology, Canadian company Digital Courier International has developed a system for distributing radio spots automatically using computers linked to the North American telecomms network. Audio is encoded as an ISO-MPEG Layer II stereo file at 256Mbit/s, and then transmitted to radio stations over ISDN, Switched 56 or conventional telephone lines along with the script and scheduling information. ISDN is naturally the method of choice, but even a 9,600kbit/s modem can be used in extreme circumstances.

Of the real-time audio coding and distribution technology available today, ISO-MPEG Layer III is the most powerful, capable of delivering a single channel of 15kHz audio over one 'B' channel—or a discrete stereo pair using the two channels provided by one ISDN line. Although Layer III has been provided by a few codec manufacturers for quite some time, activity in this sector of the market has increased significantly in recent months. This can be largely attributed to the arrival of switchable Layer II-Layer III codecs (often with G.722 as well) which allow broadcasters a far greater level of connectivity without a significant increase in hardware cost.

One company to have opted for a switchable codec is Telos Systems. The Telos Zephyr was originally Layer III and G.722 only, which restricted its sales potential somewhat, but the addition of Layer II and also interoperability with CCS' 'CDQ' codecs appears to have opened up the market for this product enormously.

PHOTOGRAPHS COURTESY OF BT CORPORATE PICTURES



audio

Rapidly gaining recognition as an essential part of the next generation of audio and video working, application of the ISDN is still widely misunderstood. **BILL FOSTER** explains the essentials

To their credit, and through sheer hard work and an unshakeable belief in the benefits of Layer II coding, CCS (now also known as MUSICAM USA) has built up a huge installed base of systems throughout the world. However, on the debit side, the company used a proprietary method of multiplexing the ISDN 'B' channels which prevented their codecs from being connected to other Layer II devices of different manufacture.

Interoperability with CCS codecs has been a stated goal of all the other Layer II manufacturers for some time, but it was Vancouver-based MPR Teltech who were the first to publicly demonstrate a connection to a CCS CDQ2000 (at the AES in Paris last year). Now most of the other Layer II people have also achieved this interoperability, but rather than reduce CCS' sales this move actually seems to have increased the overall usage of Layer II codecs worldwide, thereby creating a bigger market for everyone.

IN THE FUTURE, all codec manufacturers will hopefully move over to a common multiplexing standard, after which any compatibility issues should gradually die away. And it is the ability to transmit wide data bandwidths over the telecommunications network without the need for multiplexing equipment that will, I believe, be the key to a widespread adoption of this technology by the audio and video industries.

To date, all the audio coding systems used by studios and broadcasters outside North America have been designed to operate on the Basic Rate ISDN service (BRI). Each BRI provides two 64kbit/s data channels, with a number of these being multiplexed to give data rates of 128kbit/s, 256kbit/s, or 384kbit/s when 'high-quality' audio (a stereo signal with 15Hz–20kHz bandwidth) is required.

There is a point at around 384kbit/s, though, where the cost of leasing multiple BRI lines becomes uneconomic compared to the installation of a Primary Rate line (PRI). In most parts of the world a PRI, or E1, delivers 30 x 64kbit/s ISDN 'B' channels using a single co-ax or fibre-optic cable, while in North America they use a configuration known as T1 which provides 23 or 24 x 64bit/s channels.

However, an E1 or T1 service as provided by the public switched network is still made up of individual 64kbit/s 'B' channels, and it is the devices used to multiplex these into wider bandwidths—inverse multiplexers, or I-MUXs—which have historically been the most expensive link in the chain.

In fact, it was the lack of wider

contiguous bandwidths over the dial-up network, coupled with the high cost of multiplexing equipment, that led EDnet—the pioneering San Francisco-based studio network—to chose the WilTel private fibre T1 network for their original Dolby-based DMS service. WilTel were able to provide a 1.5Mbit/s bandwidth without the need for an I-MUX, which enabled EDnet to offer their film-industry clients a cost-effective audio link of up to six channels with time code by using three Dolby Fax units and a proprietary synchronising system.

But one drawback of the WilTel T1 service was the need to set up each connection individually. This meant that studios had to prebook time slots in a similar way to satellite links, requiring a great deal of extra administration effort if the allocated times had to be changed. As ISDN has become more readily available in the key US recording centres, and the cost of I-MUXing equipment has gone down, EDnet has been changing their

of I-MUX, the setup call channel has a 'follow me' flag attached to it which ensures that all the other channels are routed via the same path, thus avoiding any timing discrepancies. At present this service is only offered within the US, and although there are tentative plans to provide a node in a few major cities on other continents, Multirate is unlikely to be generally available elsewhere for some time yet.

EDnet has been one of the first to take advantage of 'Multirate', which it is using to provide a new service called ZeroC (for Zero Compression)—a totally linear 16-bit PCM link aimed primarily at record companies, CD pressing plants and mastering facilities.

SENDING ACCEPTABLE VIDEO

over the ISDN will probably never be economic—or so I observed last July. But, bearing in mind the aforementioned projection that within ten years a one hour video-conference call could cost \$0.03, I may have to revise that statement.

Savings of this magnitude are being made possible by the sheer volume of fibre-optic capacity that is being planned for the next decade. By way of an example, once a new 10-million-voice circuit link between the UK and the US has been completed in the year 2000 it will be theoretically possible for every person in New York to call someone in London at the same time.

Many TV networks already use fibre-optic lines leased from a telco to link their studio and transmitter sites. In Europe, the signals are compressed to 34Mbit/s (E3), while North American stations use 45Mbit/s (DS3) links. The compression algorithm is not particularly severe and to the home viewer the picture is still 'broadcast quality'.

From my own experiments, the lowest data rate that can be used to transmit video in real time for ADR work or the viewing of rushes is around 1Mit/s—although this is right on the edge of acceptability. An E1 or T1 link should, however, offer enough bandwidth for these purposes.

Unfortunately, the deployment of these circuits is far from commonplace outside the US, and even those companies which have E1 laid to their door are unlikely to find the high cost of a 30-line I-MUX particularly attractive. For the time being, therefore, real-time video at anything other than video-conference quality will probably remain a technical possibility but a commercial unreality.

Unless, that is, you're based in London's Soho area, where something much bigger is happening.

Working in conjunction with a group of

In the year 2000 it will be theoretically possible for every person in New York to call someone in London at the same time

member studios over to this service. Each studio is supplied with a programmable dialling system which can set up the call from a menu of studio names, thus avoiding the need to look up another studio's ISDN numbers or system configuration.

In fact, provision already exists within the telecomms standards to synchronise multiple 64kbit/s data channels within the network, but in order to do so the telcos must undertake some fairly major reprogramming of their networks.

A 384kbit/s service—designated H0 and targeted principally at the video conferencing market—is now offered by one or two of the North American long-distance carriers, while higher contiguous bandwidths up to 1.5Mbit/s are just becoming available—initially from MCI, who are marketing the service as 'Multirate'.

Details of exactly how Multirate works have been difficult to obtain from MCI, but I understand that instead of using any form



the UK's largest film-and-video facility houses, British Telecom has set up a pilot scheme known as SohoNet.

This experiment follows on from a previous pilot (and now a commercial reality) called Facility Line—a dedicated fibre optic network offering subscribers (again mainly in Soho) a 270Mbit/s digital video link conforming to the Serial Digital Interface standard. The service enables a facility house to feed the digital output from a D1, Digital Betacam or D5 machine directly to another facility or TV station, and in one instance, an advertising agency on the edge of town.

Facility Line is, however, somewhat limited because its signal format does not conform to any telco standard and so it must be carried on dedicated circuits. SohoNet, on the other hand, is based on the ATM format (see side bar), which will soon be available wherever digital telecommunications services are provided.

The SohoNet pilot currently links four facilities that regularly exchange work: two specialising in the high-resolution transfer of film images to video and two that create special effects in the video domain. Until now, it has been necessary to either physically transport the hard disks on which the film scans—up to 50Mb per frame—are stored, or make a tape transfer to send to the video facility. After the job is finished the process must be repeated in reverse.

Each facility taking part in the SohoNet trial has a fibre-optic cable linked directly to a dedicated ATM switch at the local exchange (central office). Using software in their terminal equipment, the video facilities can access either of the film house's hard disks directly and load the data into their system at a speed of around 100Mbit/s. When the work has been completed the material is returned in the same manner.

Once BT has tied up a few loose ends—how to charge for the service being one of their key concerns—it is likely that all the major companies in Soho will be linked into the service. The next stage will be to create similar 'hubs' in other production centres such as Los Angeles, and then link these using transcontinental ATM circuits.

It is, in fact, unlikely that an ATM connection at 155Mbit/s will be available

between different countries for some time to come, but because this service has been designed for file transfer rather than real time video, the 45Mbit/s DS3 circuits which already operate across the Atlantic can, in the interim, provide a link that is still considerably faster than a courier.

MANY WOULD argue that data rates of this magnitude are irrelevant for the audio industry, but a number of recent developments would seem to indicate that this may not be the case.

Studio Audio has already announced its support for ATM in order to create a local area network for their *SADiE* workstations ('The New Net', *Studio Sound*, September 1995) and this could easily become a wide area network once switchable ATM is available from the telcos. Because ATM supports other protocols, workstations using FDDI-CDDI will also benefit from the availability of this technology.

Another future use for wide area ATM could be the transfer of material from CD mastering facilities to the manufacturing plants. Sonopress in Germany is already planning a mass-storage library system for their entire CD archive, which includes the option to download the complete contents of a CD (typically 500/600Mb) directly from the library to a server attached to the glass mastering system. Using ATM this can be done in one or two minutes, and therefore when an international ATM service becomes a reality there will be no reason why the storage device and the mastering equipment cannot be several thousand miles apart. In the future there may be no need for copy tapes or production masters.

In the shorter term, and once call costs have dropped a little further, the audio industry may well be satisfied with a 1.5Mbit/s–2Mbit/s link that allows 16-bit linear audio to be transmitted in real time, or workstation files to be exchanged between remote sites.

Film and TV people could also use these links to send multiple data-reduced audio channels simultaneously. Both Audio Processing Technology (apt) and AlgoRhythmic Technology have developed codecs which can transmit 8-channels of 20kHz bandwidth over a 1.5Mbit/s–2Mbit/s

link. Their systems use 4:1 ADPCM coding, which provides the capability to send and receive eight analogue channels or four AES-EBU stereo pairs over an E1-T1 PRI. One application identified by the manufacturer is the transmission of a 5.1 surround mix together with time code and talkback feeds.

AlgoRhythmic Technology also manufacture a device that can send a 20-bit AES-EBU format stereo signal over the ISDN. Depending on the wordlength of the material being sent, this unit employs a 'gentle' compression algorithm in order to fit the signal within the ISDN bandwidth available.

I MADE MENTION in my last article of a wireless modem system which enables the data output from a codec at a remote site to be sent to a receiver connected to an ISDN socket. This prompted a significant amount of correspondence, mainly from radio stations seeking further information. Regrettably the system I was referring to is currently licensed only in the US and a few other territories, and it appears that the manufacturer does not consider the relatively small broadcast and recording markets sufficiently attractive to warrant the time and expense that would be required to modify the units' operating frequencies so as to obtain approvals elsewhere. ☹

ASYNCHRONOUS TRANSFER MODE (ATM)

ATM—sometimes referred to as **Broadband ISDN**—is a standard from the telecommunications industry that allows data to be moved through a digital network in a common format. Data is placed into 48byte packets, known as cells, and to the network these cells are all identical, irrespective of their content. ATM is not a point-to-point system but is routed according to instructions given by the transmitting terminal, in a similar way to ethernet or other LAN protocol. The technology can also support point-to-multipoint; the switch simply duplicates the data as many times as required. Although the bandwidth most commonly associated with ATM is 155Mbit/s, ATM cells can be distributed over any digital data circuit—even a single 64kbit/s ISDN channel. Multiple 155Mbit/s ATM streams can be passed over the larger SDH (Synchronous Digital Hierarchy) circuits, which in the future will form the backbone of the world's telecommunications networks. In the computer environment, bandwidth allocation within the ATM system is usually dynamic, depending on the amount of data that is being transmitted. However, provision exists to secure a fixed bandwidth, and it is this feature, coupled with the format independence of the system's cell structure, that makes ATM such an ideal medium for the distribution of real-time video or audio—either linear or data reduced.

High-quality audio transmission •



But low ISDN transmission

costs • Interface to all existing equipment • And networks • IRT approved

• Supports all six sampling frequencies



• G.722 capability •

No need to reconfigure the decoder • Ever • Wherever •



Save time • And money • Easy-to-read displays • Ideal for

reporters in the field



• No need for trained technicians •

No audio delay when monitoring over headphones



• It's the

RE 662/63 Layer II digital audio codec • Call!



RE UK LTD. • Telephone: (+44) (0)1734 731119 • Telefax: (+44) (0)1734 731190 • RE AMERICA, INC. • Telephone: (+1) (216) 871-7617 • Telefax: (+1) (216) 871-4303 •
RE JAPAN CO., LTD. • Telephone: (+81) 03-3320-0460 • Telefax: (+81) 03-3320-0497 • RE DEUTSCHLAND GMBH • Telephone: (+49) 02461-6503-0 • Telefax:
(+49) 02461-56531 • RE INTERNATIONAL AS • Telephone: (+45) 39 17 00 00 • Telefax: (+45) 39 17 00 10 • Plus 30 authorized distributors worldwide.

Third Annual Latin-American Pro Audio & Music Expo



MEXICO '96

WORLD TRADE CENTER

June 5 - 8, 1996

Mexico City

Mexico.

This leading Latin-American country which is part of NAFTA will finally host an international pro audio & music exposition.

Studio Sound International's acclaimed pro audio expo will now expand to cover exhibitions of musical instruments, equipment and accessories, for what is Latin-America's music industry capital of the world.

Seminars and Clinics will continue to drive SSI's exposition, so that the latest products and information can be shared with this continuously growing market.

Do not miss the opportunity to be present at the new beginning of this economic giant, in what will be Latin America's premier Pro Audio & Music Expo.

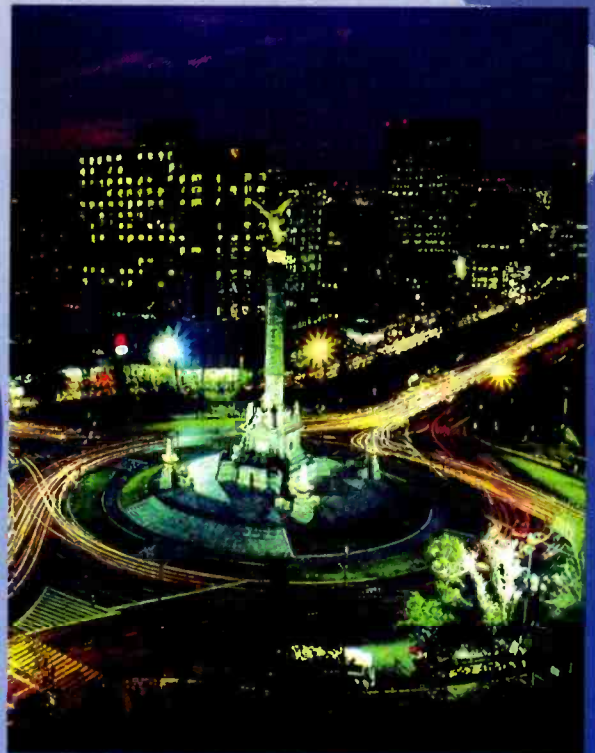

Official Hotel:



THE WESTIN GALERIA PLAZA
Mexico City

Contact: Chris Adams

400G High Point Dr. Hartsdale, NY 10530 USA · Tel: (914) 993-0489 Fax: (914) 328-8819

Specify if Exhibitor or Visitor Information



An introduction to audio compression

The relatively new technology of audio compression is here to stay—simple economics ensure its future. **JOHN WATKINSON** sets out the basics and shows what compression can offer

AUDIO COMPRESSION—as distinct from dynamic compression—techniques have been around for a long time and have been used in many different industries. However, compression requires complex processing and its widespread adoption had to wait until the availability of low-cost digital LSI chips. Once these had been developed, compression products appeared virtually overnight. However, compression does not have to be digital; it has been seen in the analogue domain as well.

Compression is a technique which allows an audio signal to be sent down a channel of restricted information capacity with less impairment than it would suffer without compression. I prefer this general definition because it includes more practical applications. These applications can be split into two main subgroups:

- (i) Increasing the dynamic range of the overall system beyond that allowed by the channel alone.
- (ii) Keeping the dynamic range the same but allowing the use of a more economical channel.

The well-known Dolby systems are an example of the first approach. By compressing the dynamic range of the signal at the encoder in a way which can be reversed at the decoder, the Dolby systems allow an increased signal-to-noise ratio from an existing tape-recording channel. Few would argue that the use of Dolby systems was not an improvement. Compression is not necessarily a bad thing. As an analogue system, Dolby was limited to using the replay signal itself to drive the expander. Errors in replay level caused by dropouts would be expanded. From this follows another important truth which is that compressed signals are more sensitive to error.

The compression used in DCC (Digital Compact Cassette) also belongs to the first category. The use of compression in DCC allows the overall system to have 18-bit dynamic range while retaining the same tape consumption as an analogue cassette.

Most digital-compression systems fall in the second category. Audio is converted to conventional PCM having a bit rate equal to the product of the sampling rate and the wordlength. Compression is used to reduce this bit rate. The reduced bit rate offers a number of advantages:

- (i) a channel of reduced bandwidth can be used for transmission (DAB).
- (ii) the playing time of a given storage medium is extended in proportion to the compression factor (disks).
- (iii) the cost of storing a given length of programme falls in proportion to the compression factor (archiving).
- (iv) the access time of a storage medium falls in proportion to the compression factor (tape storage).

COMPRESSION WORKS by identifying the meaningful information in the audio. This is known as the entropy. Entropy is that part of a signal which was surprising or unpredictable. The remainder is predictable and is called redundancy. Take the case of a sine wave. All cycles look the same so it's totally predictable and therefore carries no information. This follows from the fact that it has zero bandwidth.

Information in audio is unpredictable—transients are a good example. Fig.1 shows a simple example. The information capacity of a normal PCM system can be represented

by an area which is the product of the bandwidth and the wordlength. The full area is transmitted at all times in a PCM system, whereas only part of it is occupied by entropy. The remainder is redundancy. If a hypothetical ideal compressor is used which can perfectly separate the entropy from the redundancy, only the entropy need be sent and the quality will not be impaired. However, if less than the entropy is sent, impairment is inevitable.

It follows from this that for all audio sources there will be a critical compression factor below which there is no perceivable loss of quality. Going beyond this factor is bound to cause quality loss. In MPEG-2 a bit rate of 384 kilobits/sec for stereo is generally considered to be transparent. This corresponds to a compression factor of 4:1 with respect to 48kHz 16-bit PCM.

IN PRACTICE, an ideal compressor will be infinitely complex and real compressors will not be able to identify the redundancy perfectly. Consequently the compression factor has to be reduced to give a safety

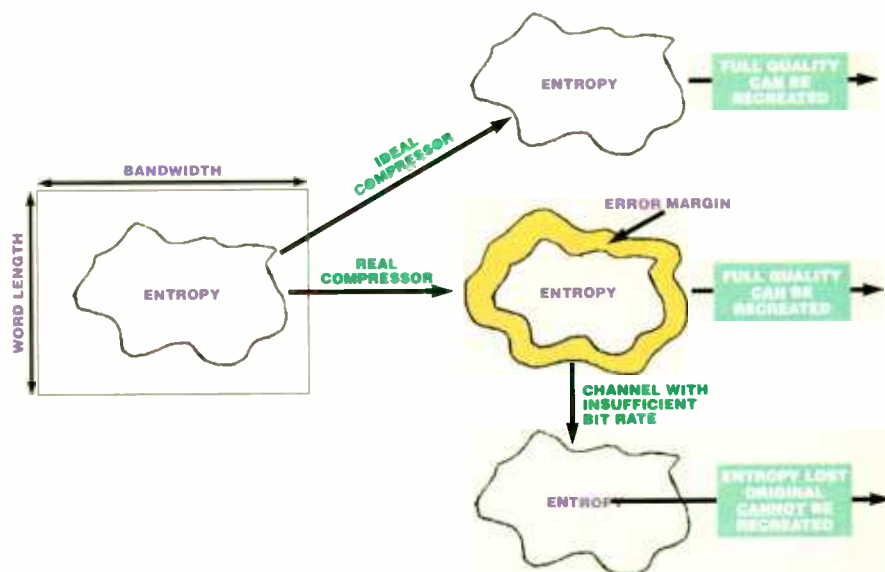

Fig.1: Encoding audio information (entropy)—errors and recoverability

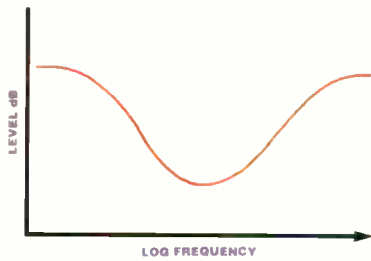

Fig.2a: Human hearing threshold

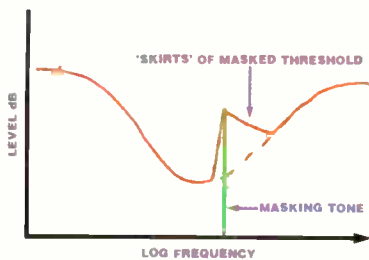

Fig.2b: Threshold raised by single tone



Fig.2c: Sub-band coding mimicking human masking threshold

Each alone can only deliver a certain amount of compression, but used in combination higher compression factors can be achieved.

Companding reduces the dynamic range of the input signal just like a Dolby system. It can then be sent through a noisier system (one with shorter wordlength). In two's complement audio coding, every 6dB reduction in level from peak means that a high-order bit copies the sign bit. This is the phenomenon of sign extension.

Consequently, at low levels, high-order bits in the samples are completely predictable and need not be sent. For example at -24dBFS there are four redundant bits in each sample and a lossless compression is possible by removing them. However, at high levels, bits must be removed from the low order end of the samples. This effectively raises the size of the quantising step, hence the term requantising. The consequence is quantising error which is only allowable if it is masked by higher programme level.

Sub-band coding splits the audio spectrum into a number of smaller bands. In much programme material most energy is present in only a few bands and the remainder contain relatively low levels, thus companding is particularly useful when combined with bandsplitting. The noise floor can be individually raised in each band in order to more closely approximate the masking threshold as Fig.2c shows. This figure also introduces the concept of the Noise-to-Masking Ratio (NMR) which is a measure of the tolerance band between the noise floor and the masking threshold. In all quality systems a positive NMR must be maintained. Transform coding converts time-domain signals into

frequency-domain coefficients. This in itself does not achieve any compression, but in the frequency domain, the spectrum often changes quite slowly and the coefficients don't need to be sent very often. Clearly this approach falls down in the presence of transients and an adaptive approach will be needed.

Predictive coding uses a matched pair of predicting circuits at encoder and decoder as shown in Fig.3. A predictor is basically a device which looks at a run of previous samples and from them attempts to establish the value of the next sample. Think of it as a lop-sided interpolator. The prediction is then

subtracted from the actual input sample to determine the prediction error which is actually transmitted. The decoder makes the same prediction and adds the error to correct it. Predictive coders have the advantage that they use the history of the signal and can therefore operate with only a small processing delay. However, they cannot, of course, see transients coming and these cause very large errors. In practice the error needs to be companded to handle transients.

Compressors have to identify and transmit the unpredictable part of an input signal. Unfortunately, noise is also unpredictable and a compressor cannot tell noise from entropy and will attempt to code it. This uses up valuable bit rate which is not then available for the genuine audio. Paradoxically, then, signals which are destined to be compressed must be created to a very high standard with a low noise-floor.

Compressors actually raise the noise floor. Consequently, a second compressor will have difficulty due to the noise caused by the first compressor. Thus, cascading codecs is a bad idea and if it must be done a comfortable NMR must be maintained on the first compression.

MANY OF TODAY'S quality audio-compression systems use the principle of sub-band coding in which the audio spectrum is divided up into a large number of frequency bands. One method which is often used the quadrature mirror (QMF) which converts a PCM sample stream into two sample streams of half the input-sampling rate, so that the output-data rate is equal to the input-data rate. The frequencies in the lower half of the audio spectrum are carried in one sample stream, and those in the upper half of the spectrum are carried in the other. The lower frequency output is a PCM band-limited representation of the input waveform and can be reconstructed with a low-pass filter. However, the upper frequency output is down-sampled or aliased and can only be reconstructed by an interpolator having a band-pass response, also known as a synthesis filter. As only signals within the pass band can be output, the original waveform will result as the aliased version lies outside the pass band. The audio band can be split into as many bands as required by cascading QMFs in a tree.

Fig.4 shows that in ISO-MPEG audio compression 32 sub-bands are used. The decomposed sub-band data are then assembled into blocks of 12 samples each, 

 margin. The simpler (and cheaper) the compression equipment, the larger the safety margin has to be. This is why ISO-MPEG audio compression is available in three levels: each gives a different balance between cost-complexity and compression factor.

Compression would not be possible were it not for the phenomenon of auditory masking which is the reduced ability to detect one sound in the presence of another. The threshold of human hearing is a function of frequency and reaches a minimum in the speech band as shown in Fig.2a. In the presence of a single tone, shown in Fig.2b the threshold is raised over a range of frequencies, most noticeably above the frequency of the masker. This is due to the finite Q-factor of the basilar membrane. Any signal below the new threshold will not be heard. This is why you never hear tape hiss during a loud passage in a recording. A compressor has to analyse the input audio spectrum and determine the masked threshold of hearing from time to time. Once this is done the noise floor of the audio can be raised, for example, by reducing the sample wordlength. Provided the increased noise does not rise above the masked threshold it will be inaudible. The popular description of compressors 'throwing away stuff you can't hear' is wrong. In practice nothing is thrown away. Instead the noise floor is raised, but in areas where it is inaudible.

Four major tools are used in compression.

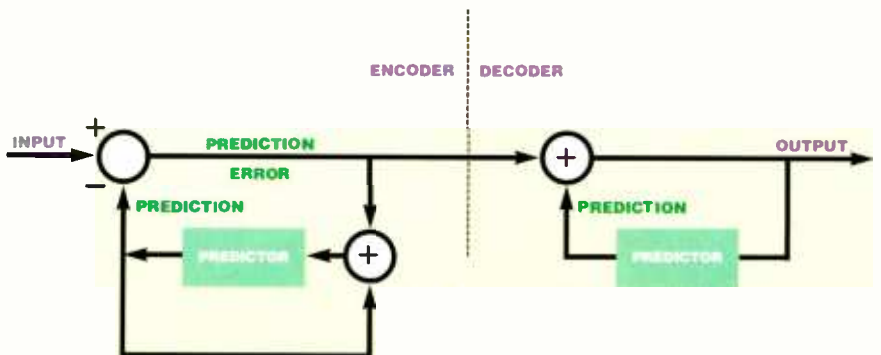

Fig.3: Predictive coding schematic

...how times change ...



Equalisation
that thinks and learns
from experience



Experience intelligent EQ by VARICURVE™



BSS Audio. Linkside House, Summit Road, Potters Bar, Herts, EN6 3JB
Telephone: +44 (0)1707 660667, Fax: +44 (0)1707 660755. E-Mail: 00046.3321@compuserve.com
H A Division of Harman International Industries Ltd.

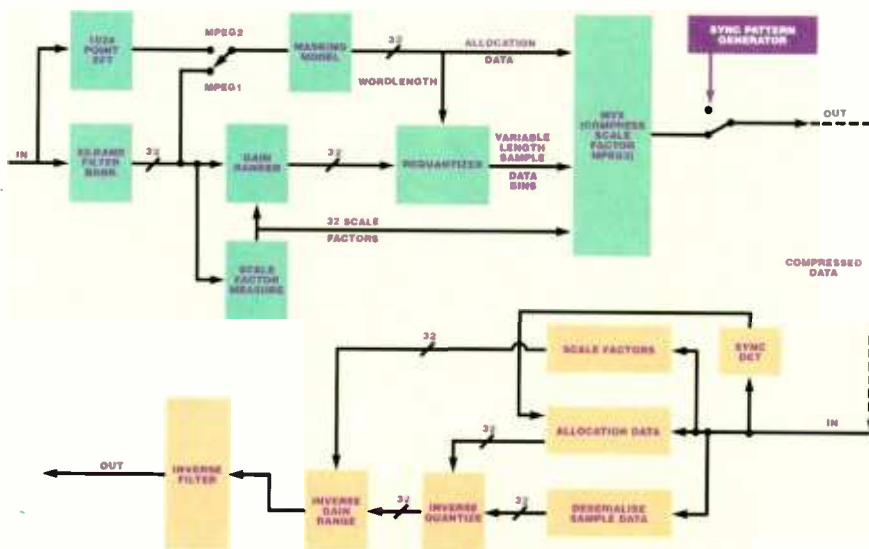

Fig.4 A sub-band coder. The bit allocation may come from analysis of the sub-band energy, or, for a greater compression factor, from a spectral analysis in a side chain

prior to compression. Sub-band blocks are also referred to as 'frequency bins'. Coding in each bin is by a combination of gain ranging and requantising. The gain ranging is achieved by multiplying the sample values by a scale factor and requantising is by rounding off LSBs to the required wordlength. For example, if the waveform amplitude is 36dB less than maximum, there will be at least six bits in each sample which copy the sign bit. Multiplying by 64, the equivalent of a 6-bit shift, will bring the high-order bits of the sample into use, allowing LSBs to be lost by rounding. The shorter the wordlength, the greater the coding gain, but the coarser the quantisation steps and therefore the level of quantisation error. In this example, rounding off six bits would not affect the signal quality at all. Losing more than six bits could raise the noise level compared to that in the input signal and can only be done if that noise will be masked. In addition to the companded requantised samples, the scale factor must be sent so that the decoder can divide by the correct value to get the level correct.

A fixed compression factor will set the overall size of the coded output block. Some bins can have long wordlengths if others have short wordlengths. The process of sharing wordlengths between the sub-bands is known as bit allocation. To help the decoder to deserialise the bitstream, it will be necessary to transmit an allocation table specifying the wordlength in each bin. The allocation process compares the spectral content of the input with an auditory masking model to determine the degree of masking which is taking place. Where masking takes place, more LSBs can be removed provided the quantising noise remains below the masking level. The bit allocation may be performed crudely by analysing the power in each sub-band, or by a side chain which performs a spectral analysis or transform of the audio. The bit allocation may be

iterative as wordlengths are traded to obtain the best result. The compression factor is controlled by changing the block-size parameter. The bit allocator simply iterates until the new block size is filled. The decoder will automatically deserialise any size block using the allocation table. Consequently, it is easy to change the compression factor for different jobs without modifying the hardware.

ISO-MPEG LAYER I is designed to be simple and inexpensive and so the sub-bands themselves are used as a spectral analysis of the input in order to determine the bit allocation.

In Layer II the same filterbank as Layer I is used, and the blocks are the same size. The same block-companding scheme is used. A side-chain FFT performs an analysis of the audio spectrum eight times more accurate than the sub-band filter. This allows higher compression factors to be obtained. With a higher compression factor, the allocation table and the scale factors form an increasing proportion of the message. The scale factor of successive blocks in the same band differs by 2dB less than 10% of the time, and advantage is taken of this redundancy by analysing sets of three successive scale factors. On stationary programme, only one scale factor out of three is sent. As transient content increases in a given sub-band, two or three scale factors will be sent.

Layer III is the most complex layer of the ISO-MPEG standard, and is only really necessary when very high compression factors must be used. It is not considered here for space reasons.

A COMPRESSED TRANSMISSION consists of samples in bins and a scale factor and wordlength relating to each bin. Some synchronising means is needed to allow the beginning of the block to be identified. Demultiplexing is done using the allocation data. Once all of the

- ↓
- AUSTRALIA Australian Audio Supplies
Tel# 011-61-4-329-1711
- AUSTRIA Music Import Herbert
Tel# 011-43-55-224-2124
- BALTIC STATES A&T Trade Music
Tel# 011-371-2-37-11-41
- BENELUX Voerman Amersfoort
Tel# 011-31-33-612-908
- BULGARIA Factor-TC
Tel# 011-359-2-463-057
- C.I.S. A&T Trade, Inc.
Tel# 011-7-095-229-7516
- CANARY ISLANDS Music-Accord
Tel# 011-34-22-283-150
- CROATIA Rainbow Music Shops
Tel# 011-385-1-449-074
- CYPRUS Empire Music House
Tel# 011-357-2-490-472
- CZECH REP Inton GmbH
Tel# 011-42-2-533-237
- DENMARK Soundware A/S
Tel# 011-45-86-132-400
- FINLAND Sound Media
Tel# 011-358-0-510-2355
- FRANCE ALD, S.A.
Tel# 011-33-1-6037-3803
- GERMANY Musik & Technik
Tel# 011-49-642-0561
- GREECE Music Center A. Liolios
Tel# 011-30-31-267-604
- HUNGARY Intermusica Ltd.
Tel# 011-36-23-338-041
- ISRAEL RBX International Co.
Tel# 011-972-36-29-8251
- ITALY Entel S.R.L.
Tel# 011-39-51-768-576
- LEBANON Amac S.A.R.L.
Fax# 011-961-1651-754
- NEW ZEALAND Accusound Pacific NZ
Tel# 011-64-9-815-0258
- NORWAY Siv. Ing. Benum A/S
Tel# 011-47-22-1454-60
- POLAND Hexagon
Tel# 011-48-22-646-699
- PORTUGAL Daniel Ruvina Suc. LDA
Tel# 011-351-2-315-585
- ROMANIA EST. S.R.L.
Tel# 011-40-1-250-5156
- SLOVENIA NOVA D.O.O.
Tel# 011-386-61-263-260
- SPAIN Letusa SA
Tel# 011-341-641-0182
- SWEDEN Luthman Scandinavia AB
Tel# 011-46-8-640-4242
- SWITZERLAND Gallien + Krueger AG
Tel# 011-41-42-23-95-20
- TURKEY Yapali Group
Tel# 011-90-212-259-4687
- U.K. Key Audio Systems
Tel# 011-44-1245-344-001



Mackie
Designs
International
Department
Fax# 206-485-1152

THE ORIGINAL MS1202 TOOK SMALL MIXERS IN A NEW DIRECTION. JUST THINK OF WHERE YOU CAN GO NOW THAT WE'VE ADDED A DOZEN NEW FEATURES.



1 3-BAND EQ on all channels, PLUS...

2 LO CUT FILTER (Chs. 1-4), dramatically extends usable bass EQ by cutting stage rumble, mic thumps, etc. just like on our 8•Bus and SR Series. **VERY IMPORTANT!**

3 60dB GAIN on on first 4 channels via balanced mic inputs.

4 VIRTUAL PAD on first 4 channels (line inputs only). 10dB attenuation with trim all the way down; Unity at 9:00 so you can add even more EQ to already-hot signals.

5 -10dBV RCA TAPE OUT INTERFACE

6 ALL INPUTS & OUTPUTS BALANCED (except RCA-type tape inputs)

4 mono mic/line chs.

For 5 years, our Micro Series 1202 12-ch. mixer has toured with superstars, gathered network news, pinch hit next to mega-consoles... and has been the main mixer in a lot of home studios.

All that time, we've been reading warranty cards for suggestions on how we could improve the MS1202.

This is the result. Same great value. Same built-like-a-tank construction. But with some exquisitely handy new goodies that make it an even more effective tool for recording and live performance. Including 3-band EQ, balanced XLR outputs, PFL Solo, channel mutes (with Alt 3-4 bus) and multi-source Control Room monitoring.

Visit your Mackie dealer (the MS1202 VLZ's in stock right now) or call your Mackie distributor for detailed information.

studio-grade mic preamps

4 stereo line chs.

2 aux sends per ch.

2 stereo aux returns

Efx return to monitor

Aux 1 Pre/Post switch

3-band EQ w/LoCut filter

Mutes on every channel

4 buses via Mute/ALT 3-4

Easy metering via PFL Solo

Control Room monitoring

Headphone output

4 channel inserts

XLR & 1/4" outputs

Multi-way metering

Sealed rotary controls

Built-in power supply



7 PFL SOLO on all channels makes level-setting via meters easy, Interrupts Control Room/Phones selection & ignites Rude Sco LED.

8 VLZ (Very Low Impedance) circuitry for pristine sound.

10 AUX 1 PRE/POST global switch.

11 EFFECTS TO MONITOR lets you add reverb to your stage monitor mix, just like with our SR Series.

12 CONTROL ROOM/PHONES MONITORING w/level control lets you select any combination of Main Mix, Tape In and Alt 3-4 signals for Phones, Control Room & meters. Plus you can re-route it back to the main mix!

13 MUTE/ALT 3-4 routes main mix to separate stereo bus.

9 BALANCED XLR MAIN OUTPUTS with switchable 30dB pad for connecting to Mic Level inputs.

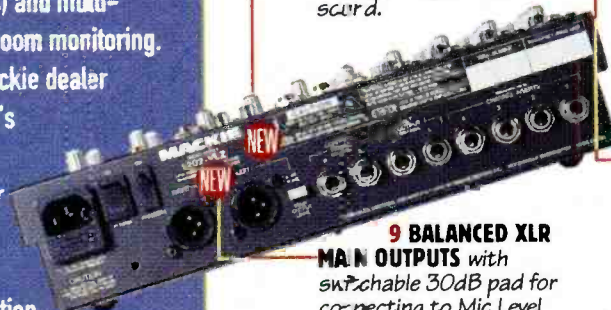

STUDER D19 Series Mic VALVE

Valve Dignified Digital Mic Preamp

- Top MIC and LINE Preamps • High performance modular 20-bit A/D converters • Switchable Valve Dignifier stage • 3 adjustable valve sound parameters: Bass Warmth, Angel Zoom & Valve Drive • Highest Audio Quality & Individual Valve Sound Tuning • DSP Dithering and Noise Shaping for best quality on 16-bit media • Analogue and AES/EBU outputs • balanced pre/post valve inserts • Optional ADAT™ or TDM™ 8-CH outputs with output routing • A harmonious combination of traditional preamplifier circuitry, valve technology and state-of-the-art digital techniques !

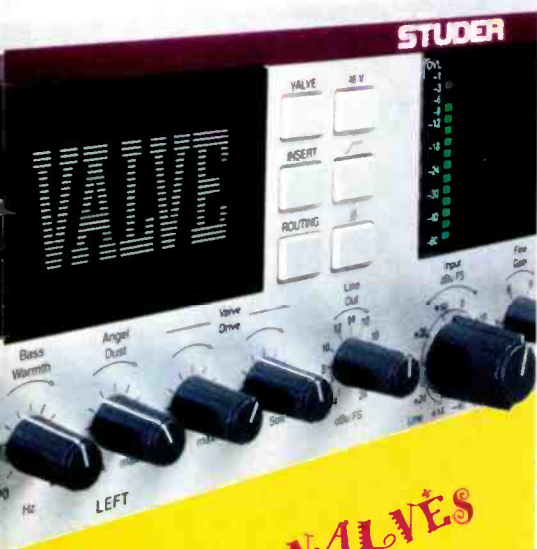

dances with the VALVES

for more information call:

- Switzerland (worldwide) +41 1 870 75 11, Austria +43 1 866 54-0,
- France +33 1 45 14 47 86, Germany +49 30 72 39 34-0,
- UK +44 1 707 66 50 00, Canada +1 416 510 13 47,
- Japan +81 3 34 65 22 11, Singapore +65 481 56 88,
- USA +1 615 391 33 99

STUDER
PROFESSIONAL AUDIO EQUIPMENT

H A Harman International Company

ISDN

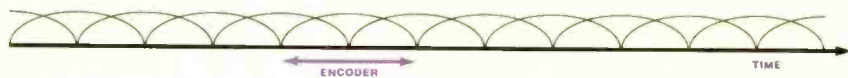

Fig.5 Transforms can only work on finite blocks of samples. Overlapping windows are used to break the continuous audio up into such blocks

As samples are back in their respective frequency bins, the level of each bin is returned to the original value. This is achieved by using the scale factor to oppose the gain applied in the coder. The sub-bands can then be recombined into a continuous audio spectrum in the output filter which produces conventional PCM.

Frequency analysis or transform coding allows any repetitive waveform to be represented by coefficients describing a set of harmonically related components of suitable amplitude and phase. The transform of a typical audio waveform changes relatively slowly. The slow speech of an organ pipe or a violin string, or the slow decay of most musical sounds allow the rate at which the transform is sampled to be reduced, and a coding gain results. Not all frequencies are simultaneously in real audio, and so not all coefficients need be sent. A further coding gain will be achieved if the components which will experience masking are quantised more coarsely.

Transforms require blocks of samples and a practical solution, used in Dolby AC-3, is to cut the waveform into short overlapping windows and then to transform each individually (Fig.5). Every input sample appears in two windows with variable weighting depending upon its position along the time axis.

The DFT (Discrete Frequency Transform) requires intensive computation, owing to the requirement to use complex arithmetic to render the phase of the components as well as the amplitude. An alternative is to use the Discrete Cosine Transform (DCT). In the DCT a time-mirrored version of the window block is placed in front of the

original block before the transform process. All sinusoidal components then cancel out and only cosine coefficients are computed. In the modified discrete cosine transform (MDCT), windows with 50% overlap are used, producing twice as many coefficients as necessary. These are subsampled by a factor of two to give a critically sampled transform, which results in potential aliasing in the frequency domain. However, by modifying the transform, the alias products in the second half of a given window are equal in size but of opposite polarity to the alias products in the first half of the next window, and so will be cancelled on reconstruction. This is the principle of time domain aliasing cancellation (TDAC).

The coefficient requantising in the coder raises the quantising noise in the frequency bin, but it does so over the entire duration of the block. Fig.6 shows that if a transient occurs towards the end of a block, the decoder will reproduce the waveform correctly, but the quantising noise will start at the beginning of the block and may result in a pre-echo where the noise is audible before the transient.

This can be avoided using a variable time window according to the transient content of the audio waveform. When musical transients occur, short blocks are necessary and the frequency resolution and hence the coding gain will be low. At other times the blocks become longer and the frequency resolution of the transform rises, allowing a greater coding gain.

The transform of an audio signal is computed in the main signal path in a transform coder, and has sufficient frequency resolution to drive the masking model directly. Ⓢ

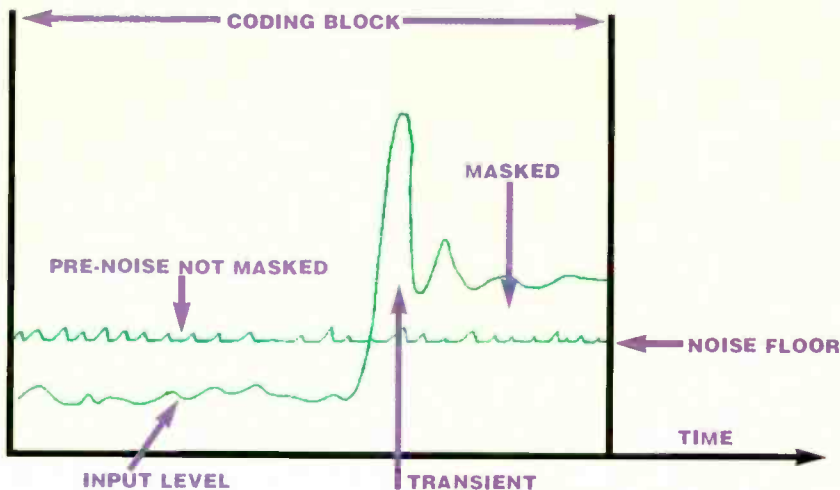
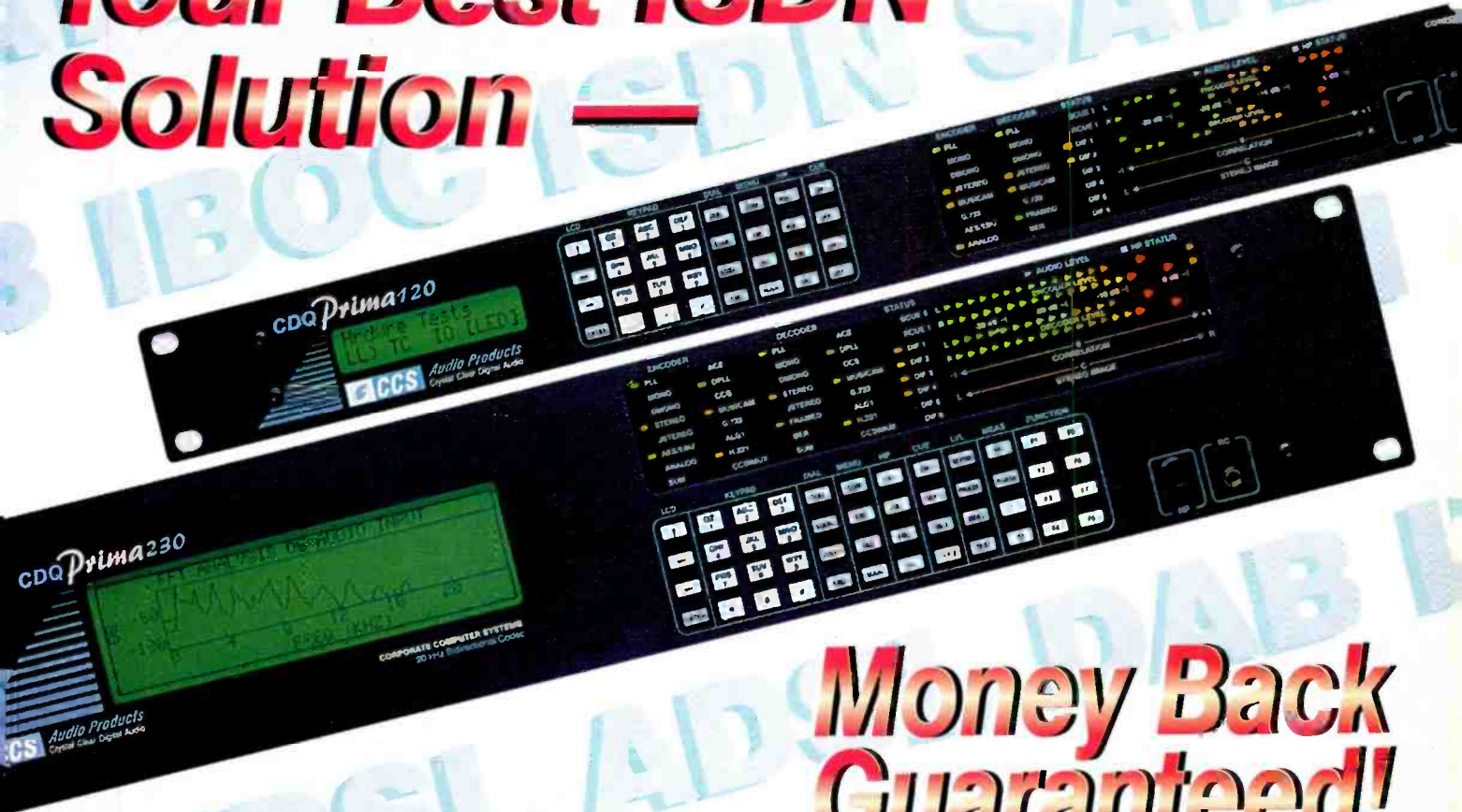

Fig.6 A transient which occurs towards the end of a block may not mask the raised noise if the block is too long. Often the block length has to be adaptive so that it shortens as the signal becomes transient rich

Your Best ISDN Solution —



Money Back Guaranteed!

Only CDQPrima™ with CCS MUSICAM® is guaranteed to make your ISDN digital audio sound the best

MUSICAM® is today's digital audio standard. Only CCS MUSICAM® has enhancements designed to sound best over ISDN phone lines. Only CCS gives you a 30-day money back guarantee. MPEG and ADR implementation approved by IRT.

Don't just take our word...

- ▶ Ask over 10,000 CCS MUSICAM® codec users worldwide
- ▶ Ask USA Digital Radio DAB
- ▶ Ask Swedish Broadcasting
- ▶ Ask RCA, LucasFilms and Top Recording Studios

We guarantee compatibility. Prima will even make your other brand decoder sound great!

Don't stake your next ISDN remote on five-year old Layer III or Layer II technology. And don't fall for any "hot air" product.

Call CCS for the facts.



MUSICAM.

MUSICAM USA

670 N. Beers Street, Building 4
Holmdel, New Jersey 07733 USA
Tel: 908-739-5600 Fax: 908-739-1818



CCS EUROPE GmbH

Ludwigstrasse 45
D-85399 Halbergmoos Germany
+49 8 11/55 16-0 Fax-55

ATH-M40

with flat, extended response for exact reproduction of the original mix.



Two high-performance acoustic designs

Great headphones need to be comfortable and reliable, but not everyone prefers the same sound.

Power and Precision

Both models provide the same 1,600 mW of power handling with high efficiency. And both maintain exceptional clarity and linearity, even at high SPLs.

ONE LOOK TWO CURVES

Comfort and convenience

A-T Precision Studiophones provide superb comfort, plus rotating earpieces for one-ear listening and a single-exit cable.

The sound you want

Compare your present 'phones to both new Precision Studiophones at your dealer, or contact us directly for further information.

ATH-D40

with enhanced low-frequency response for extra punch from the bass and drums.

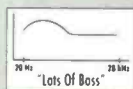

audio-technica®

□ INNOVATION □ PRECISION □ INTEGRITY

SINCE 1962

Technica House, Royal London Industrial Estate, Old Lane, Leeds LS11 8AG
Tel: 0113 277 1441 Fax: 0113 270 4836

ATH-004

NEVE 8068. CONFIGURED 32/16/32 REMOTE PATCHBAY FITTED 32 x 31102's, 8 x 33264A COMP/LIMITERS 24 METERBRIDGE.

NEVE 8036. CONFIGURED 24/8/16 R/PATCHBAY FITTED 24 x 1064's, GRP MODULES 1943/1's 4 REV RTNS 2 x 2254A COMP/LIMITERS. 16 METERBRIDGE.

NEVE 8058. CONFIGURED 28/16/24 REMOTE PATCHBAY (PRESENTLY UNDER FULL REFURBISHMENT) FITTED 1073 EQ's.

NEVE 5305. CONFIGURED 36/8/2 REMOTE PATCHBAY FITTED 30 x 33114's (MORE AVAILABLE), 36 x 33752's, SEPARATE 24 TRACK NEVE MONITOR BOARD AVAILABLE WITH IT.

NEVE 12/8 SUB FRAME FITTED 12 x 33114's AND 12 x 33752's INBUILT LINE AMPS AND PATCHBAY.

NEVE BCM10 FRAME FITTED 10 x 1073 EQ's.

NEVE BCM10 FRAME FITTED 10 x 1066 EQ's.

2 x NEVE 8/2 (THE SUITCASE CONSOLE) FITTED. EACH FITTED 8 x 34128 MODULES.

NEVE 5402B BROADCAST CONSOLES BOTH FITTED 6 x 34133's AND 3 x 34132's, ONE CONSOLE FITTED 33141 STEREO MODULES.

NORMALLY IN STOCK: A LARGE RANGE OF NEVE EQ's.

NEVE 1081's/NEVE 1064's/NEVE 1066's/NEVE 33114's/NEVE 33115's.

COMPRESSOR/LIMITERS NEVE 2254/2254A/2254E's.

LARGE STOCK OF NEVE SPARES.

SSL4040E FITTED 30 x 611E MODULES. VU METERING. TOTAL RECALL. E SERIES COMPUTER (WILL UPGRADE TO G SERIES AT CUSTOMER'S REQUEST) SUPPLIED WITH ALL MANUALS AND TEST JIG. LEFTHAND PATCHBAY.

LARGE SELECTION OF SSL SPARES AND POWER SUPPLIES IN STOCK.

PLEASE NOTE ALL STOCK IS OWNED BY AES PRO AUDIO - WE DO NOT BROKER.



TELEPHONE: 01932 872672
FAX: 01932 874364
TEL: INTERNATIONAL 44 1932 872672
FAX: INTERNATIONAL 44 1932 874364

A UNITED KINGDOM BASED COMPANY



RICHMOND FILM SERVICES

Tel: +44 (0)181 940 6077 Fax: +44 (0)181 948 8326

THE HIRE COMPANY
OTHER HIRE COMPANIES HIRE FROM !

NAGRA-D

Only
£60
per day



£240 per
week

**THE BEST NEED NOT BE
EXPENSIVE !**



Setting up for the set-top

There will come a time when we watch TV with the aid of a supercomputer sitting on top of the gogglebox writes telly addict **KEVIN HILTON**

When I was a kid, the phrase 'set-top box' merely meant some poorly made and almost completely pointless souvenir of a faded, seaside resort that sat on top of a TV owned by elderly relatives.

Despite the previous wisdom that nothing should be stored on such delicate electronic equipment (which never stopped my gran, who used to keep vases of flowers on her aging, teak veneered telly until we convinced her otherwise, although she still papers the kitchen ceiling by standing on the cooker), we are now being told that no set will be complete without a receiving appendage. The reason? The mighty digit and the European Union.

The Digital Video Broadcasting (DVB) Project has now published the specification for terrestrial digital broadcasting (DVB-T), which is set to get its first implementation in the UK next year as the Government here pushes through its updated Broadcasting Bill. The UK Government quickly published its proposals for DTT, as if to say that the rest of Europe is simply lagging behind the independently minded, go-ahead Brits. All this before anything had gone through Parliament and without any firm guidelines from the DVB Project, although it was thought—correctly as it turns out—that these new specifications are closely related to those for digital satellite and cable.

DVB-T is based on Coded Orthogonal Frequency Division Multiplexing (COFDM) for its transmission method and is similar to the system used for the Eureka 147 DAB project. The specification document identifies two separate systems, one set at 2k, employing 1,704 individual carriers, the other pegged at 8k, using 6816.

It all gets a bit Open University here, involving the use of echoes, increased power, grossing up the signal and a hugely complicated mathematical process called the Fast Fourier Transform. (Mathematicians should excuse me because I was taught using the School Maths Project, which my old-style physics teacher dismissed at the Stupid Maths Project.) The result is that DVB-T can cope with unsuitable terrain

because of this, although 8k technology is better for more extreme situations. A 2k system has several options for guard intervals, which deal with transmission echoes, but 8k offers a more complete solution and is designed for single frequency network applications.

The UK Broadcasting Bill is due to be passed this year, which would open the way for DTT by the middle of 1997. These systems will use 2k technology, something that is workable in this country due to nearly total coverage of the four main channels and a fairly consistent terrain. Problems arise in countries like Spain, where 2k would be totally inadequate because the country has real mountains. This means that Spanish broadcasters will have to wait until the year 2000 at least for affordable 8k chips to become available. The two technologies are said to be compatible but only in the sense that 8k receivers will be able to pick up both 2k and 8k signals—existing 2k devices will be unable to receive 8k pictures. Now that specifications have been agreed, the next move is for manufacturers to produce the necessary equipment in both the professional and consumer domains. This is where things take a slightly sinister turn.

The turn in this case rests on patents. The concept for COFDM comes from research into digital radio by CCETT, France Telecom's research department. Other bodies and manufacturers took this up and in a spirit of co-operation produced the overall specifications and elements we see now.

There was the fear that one body or company would control important parts of the patent, allowing them to control who did what with whom and when. The DVB Project spokesperson assured me that care had been taken to ensure that no one organisation 'held the lion's share of the patent'. This sounds all fine and dandy, until you consider that someone only needs to hold one or two important parts of the patent to virtually control it. If I open the X-file that I instigated in this column a few months ago, who should leap out but our old friend Rupert Murdoch. When Murdoch's News Corp bought the Advanced Products Division of NTL in

October 1995, some missed the point. Now it becomes glaringly clear: in the purchase News Corp also gained 70 international patent applications made by NTL and the IBA pertaining to digital coding. Two of these involve COFDM and concern how the system deals with interference and tuning carriers in close proximity. Rather like the old farmer who is swinging shut the stable door only to discover that his prize Suffolk Punch has done a runner, on 11th January this year the UK Government issued a document on the regulation of conditional access services for digital television, one of the crucial parts of the new technology. Among all the talk of encryption, scrambling and subscriber management services, the document is adamant that no one manufacturer or organisation should be in a dominant position regarding the

Problems arise in Spain, where 2k would be inadequate because the country has real mountains. This means that the Spanish will have to wait for affordable 8k chips

provision of CAS technology and that particular broadcasters or multiplex providers should not be favoured by CAS manufacturers. It is too easy to cast Rupert Murdoch as a villain. After all, the patents held by Digi-Media Vision (a News Corp company) may not add up to much but old Rupe has still blagged his way to the party, in that he has an in to the Digital TV Alliance, which means he has a say in DTT transmission and receiving hardware.

If that's the case then I'd rather have a sea-shell sculpture sitting on my telly than one of his boxes.

Kevin Hilton

Abbey Road

The world's most famous recording studio is now leading the way into the multimedia age. **PATRICK STAPLEY** reports

IT IS PERHAPS fitting, as well as oddly reassuring, that the world's most venerable recording studio, Abbey Road, should become the first to seriously embark on multimedia. Having recently been in the news for installing a full 1960s vintage remix setup for the Beatles *Anthology* project (*Studio Sound*, October 1995), Abbey Road has now and shown its versatility by building an Interactive Studio.

Abbey Road Interactive has been put together with the close collaboration of Apple Computer—not the first time that the name Apple has played a significant part in the studios' history. Apple has not only brought its multimedia expertise to Abbey Road, but has also supplied and helped install a full Macintosh multimedia package—estimated to be worth in excess of £100k.

Jim Cook, Market Development Manager for Apple New Media Europe, believes that up until now there has been a gulf between

multimedia and music, and sees the alliance addressing the situation.

'With the opening of Abbey Road Interactive, the two worlds have now come firmly together which is very exciting,' he says. 'Apple has the leading edge in the multimedia development community while Abbey Road is regarded as one of the top—if not the top—music studio in the world, so it makes a perfect match.'

Work began on the new room in October last year with a first floor office and ladies' bathroom being demolished to provide a 30 square meter space. All design and installation work was carried out in-house with two Abbey Road staff—studio service manager Alan Brown and technical engineer Mark Rogers—heading the project. Two Apple personnel provided key advice and assistance throughout.

'The challenge was to provide the flexibility for a huge variety of applications,'

states Mark Rogers. 'It's obviously a completely new field for us, so we wanted to make absolutely sure that we designed-in as much flexibility as we could.'

'It's a unique facility for Abbey Road, and quite different from any of our other rooms,' comments Alan Brown. 'With a control room or a postproduction room, you have a front end and a back end with a centrally placed console. With this room we had to cater for multiple workstations, multiple operators and also allow for clients. You have to remember that several jobs can be on the go at the same time, it's not like a recording studio where you deal with one project at a time, here you can have video editing for one project, graphics creation for another and sound editing for a third.'

Consequently the room has been designed to maximise on available space with one laminate work surface running around three walls. To retain flexibility, workstations and furniture can be moved around without any difficulty aided by the fact that all cabling is kept accessible, although hidden, in a large cable tray at the back of the desktop. The only fixed item is a large double-fronted rack in one corner of the room containing VTRs, DAT machines, and patchbays for audio, video and data.

By concentrating the operational activity around the room's perimeter, space is retained centrally for clients and Brown estimates the room can comfortably accommodate up to 10 people without feeling cramped. See Fig.1.

ACOUSTICALLY, THE ROOM has been treated evenly and quite simply. Because all the audio monitoring is close-field and, of course, distributed around the room, the acoustic treatment is not nearly as elaborate as some of Abbey Road's other rooms. Also the requirement for isolation is not so critical, firstly because the sound levels being produced are relatively low, and secondly because there are no other operational areas in close proximity.

Loudspeakers have been provided for every workstation but quality varies depending on the application, the Graphics Station for example is fitted with fairly good, but not top-end, multimedia speakers, while the Audio Station is equipped with specially screened B&W designed Solid speakers which include a sub woofer unit under the desk. An obvious question with so much activity centred in one room, is how can three operators monitor at once without causing an appalling cacophony? The answer is simply the provision of top-end Sennheiser headphones for each workstation—it remains to be seen who uses what.

'Our main aim was to produce an even acoustic across the whole room,' says Brown of the acoustic treatment. 'There's a certain amount of natural bass absorption from the

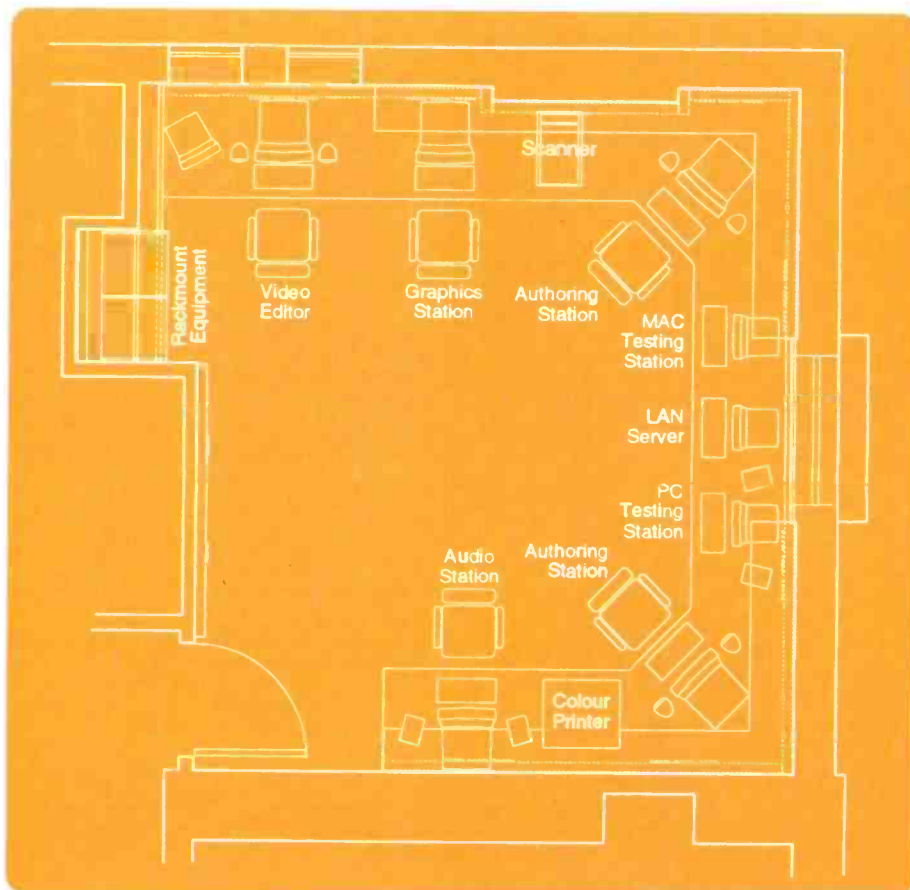

Fig.1: Floor plan of Abbey Road Interactive: by concentrating operations around the periphery, space is created for inquisitive clients

Interactive

'With this room we had to cater for multiple workstations, multiple operators, and also allow for clients. You have to remember that several jobs can be on the go at the same time'

suspended floor and suspended ceiling.' However we've controlled the amount of bass absorption in the ceiling area by introducing a perimeter gap which is filled with an open cellular tile. The high frequencies tend to be dealt with by the carpet and other soft surfaces, although we've been careful not to remove too much high-end by keeping the ceiling hard.

'To maintain the overall balance we've included over 20 mid-band absorbers around the wall surfaces. These are simple, 600mm surface mounted designs that we've used many times before at Abbey Road, consisting of semi-rigid Rockwool, perforated hardboard and looped nylon to provide a decorative finish. Apart from their acoustic function, they also add splashes of colour (turquoise, blue, red and yellow).'

Abbey Road Interactive is equipped with

six workstations based exclusively around Apple Power Macintosh computers. These comprise a Graphics Station for producing and editing computer graphic images, animations and virtual reality scenes; a Video Station for digitising and editing video footage and special effects; an Audio Station for bringing audio material into computer formats with full provision for editing and processing; two Media Authoring Stations for integration and final assembly of projects; and a Server Station equipped with DAT backup to provide file sharing for all the other stations. In addition, there are two Testing Stations (Macintosh and Windows) that enable projects to be checked during development.

'It's important to be able to test the CD on domestic machines for both Mac and Windows platforms,' explains Rogers. 'All the machines used for production are so high-powered and fast that they don't necessarily give a good indication if things are going to work on a consumer machine. So we have the facility to blow a Gold reference CD, using the Yamaha CD Writer with Toast software, which we can then check back on Mac and PC consumer machines.'

At the heart of the interactive system is Apple's QuickTime software which provides the multimedia architecture for integrating all the hardware and software components. Apple was responsible for guiding Abbey Road through the myriad

EQUIPMENT

MEDIA AUTHORING STATIONS (x2)

COMPUTER HARDWARE:

Power Macintosh 8500/120 48Mb of RAM; Apple Multiple Scan 20 display; Apple Multiple Scan 14 display; Iomega Jaz 1Gb removable hard disk drive; Yamaha CDE 100 II 4x CD ROM writer

SPECIALISED SOFTWARE:

Apple Media Tool; Apple CD Plus Tools; Macromedia Director; Asarte Toast Pro CD-ROM

GRAPHICS STATION

Computer Hardware:

Power Macintosh 8500/120 80Mb of RAM; Apple Multiple Scan 20 display; Graphics Tablet; Flat Bed Scanner; Iomega Jaz 1Gb removable hard disk drive

Specialised Software:

Macromedia Director; Adobe Illustrator; Adobe Photoshop; Adobe /CoSa After FX; Adobe Paint Programme; Equilibrium deBabelizer; RayDream JAG; HSC Kai's Photoshop Tools; Kaos Tools; Apple QuickTime VR (Virtual Reality) Authoring Tools; Specular Infini D; Strata 3D Modeller; Macromedia MacroModeler; KPT Bryce

VIDEO STATION

Computer Hardware:

Power Macintosh 9500 80Mb of RAM; Apple Multiple Scan 20 Display; Sony PVM-1454QM multi-standard broadcast monitor; Data Translation Media 100 Video Digitising Solution; Tyrestor 4Gb RAID hard drive; Iomega Jaz 1Gb removable hard disk drive

AUDIO STATION

Computer Hardware:

Power Macintosh 8100/80 40Mb of RAM; Apple Multiple Scan 20 display; Sonic Solutions SSP 3 card; Sonic Solutions Media Net Card; Digidesign ProTools 3.1; Digidesign DSP Farm card; Iomega Jaz 1Gb removable hard disk drive

Audio Hardware:

Audio & Design Probox 12; Akai DP88 AES-EBU digital audio router; Sony PCM-2700 DAT Recorder; Genesis Genius 20-bit A-D, D-A converter; Sennheiser HD580 headphones; B&W Solid Verticale and HCM1 loudspeakers

Specialised Software:

Waves L1 Limiter and C1 compressor; Digidesign DINR Noise reduction

SERVER STATION AND NETWORK

Computer Hardware:

Power Macintosh 8150 Workgroup Server with DAT backup; Specialised

Software:

AppleShare; AppleTalk Remote Access; Retrospect Remote

Networking:

Ethernet; Sonic Solutions Sonic Net Card; Apple Internet Router

TESTING STATIONS

MACINTOSH PERFORMA 5300; VIGLEN 486-66 PC



Milab

MICROPHONE LABORATORIES



Contact Your Dealer or

Milab Microphones AB

P.O.Box 1342

S-251 13 Helsingborg, Sweden

Fax: Int. +4642136350

FACILITY

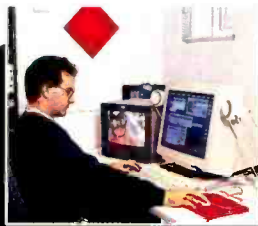

THE APPLE ALLIANCE AND CD-PLUS

THE RELATIONSHIP between Apple and EMI began a year ago when both companies recognised they had common objectives—Apple was keen to improve its profile in the music related media market, while EMI was equally keen to start promoting its

artists with interactive content on CD. Out of this came a strategic alliance which spawned the idea of a multimedia centre of excellence at EMI's Abbey Road with the primary objective of producing CD-Plus.

CD-Plus, or Enhanced CD, is the new media format that combines an audio track and a data track on a standard CD. This allows the disc to be played on a CD player as normal, but also means that it can be played on a CD-ROM drive allowing interactive data to be accessed together with the music tracks. The only constraint is that the disc must have sufficient room to allow the data track to be recorded—discs that have a full 80 minutes of music are not suitable.

At the moment the CD-Plus format is pretty well unknown in Europe and in America it's beginning to show signs of taking off. So far there have been over 20 CD-Plus titles released in the US, whereas in the UK there are just 5—the best known perhaps being the Rolling Stones 'Stripped' album. However, with the worldwide CD-ROM market expected to grow ten-fold by the year 2000, EMI intends to give the format an aggressive push and have set up an International New Media division to help make this happen.

of third-party multimedia products, recommending what it considered best for the job. However when it came to audio, Abbey Road had no hesitation in choosing two names—Sonic Solutions and Digidesign.

'Each system has its own strengths,' comments Rogers. 'Sonic Solutions is a good editing system which we know well, while ProTools is better on the processing side—particularly with all the third-party TDM plug-in tools. Also for more pop orientated multitrack work and spinning-in effects, ProTools is probably better although for straight editing we still prefer the Sonic Solutions system.'

All the computers are connected via Ethernet, and the room itself is interfaced to Abbey Road's extensive fibre-optic network linking all main production and postproduction areas. This in particular gives access, via Media Net, to the studio's impressive arsenal of eight Sonic Solutions systems. Additionally, conventional audio and video tie-lines running throughout the building are accessible from the comprehensive patchbay.

Video monitors have also been chosen specifically for each application, as Mark Rogers points out. 'One has to remember that the ultimate destination for viewing the product is a computer screen; because of the limitations of CD-ROM no one expects broadcast-quality video on CD at the moment. But having said that, we have considered it important to include an additional Sony multistandard monitor for the Video Station that allows us to see what the system is doing to the picture.'

An important consideration with a room full of video monitors is lighting, and great care has been taken to avoid screen reflections and to minimise eye fatigue. 'We've used two concentric lighting rings in the room, both of which are on dimmers,' explains Brown. 'Above each workstation area we've fitted eyeball spots which have been set up to produce a narrow window of light between the operator and the screen thus reducing to a minimum any reflections. The second ring provides low-level lighting to the central part of the room without affecting localised areas. The room

also benefits from natural light.'

A BOLD AND uncharted venture for Abbey Road, one of the major aims of the project has been to raise the quality of audio in multimedia productions. In this respect the new facility is seen as building on Abbey Road's core business of music production, and Martin Benge is confident that multimedia will in no way detract from this.

'A lot of people are worried that audio will be threatened by multimedia but I don't see this at all because the important thing as far as we're concerned is the music. All the multimedia work we do will be music related. With media converging, we will be able to offer our clients a new avenue of creativity.'

'Having a facility like this within a musical environment is very important and will make artists feel more comfortable,' continues Benge. 'They'll know that the importance of the music will never be underestimated, which is not something that can be guaranteed if they go to a computer company.'

Benge views multimedia as pioneering territory and admits that there will be a huge learning curve for all involved when the facility finally opens this month. However, he's confident that it's the right direction for Abbey Road and is excited by its potential, although he does not believe multimedia is currently for everyone.

'For us it's obviously very new ground and we've yet to determine how successful it's going to be on a business level. I certainly don't see other recording studios rushing into this though—I expect a lot will wait and see how the market develops, and also keep a close eye on how we fare before they follow suit.' **S**

CONTACTS

ABBEY ROAD STUDIOS,
3 Abbey Road, London NW8 9AY, UK.
Tel: +44 171 266 7000.
Fax: +44 171 266 7250.

THE LEGEND CONTINUES

We will take you to a new dimension of sound.

No more noise or hum.

We create the new standard in microphone technology - pure on stage, perfect in the studio and best precision for broadcasting.

You just concentrate on singing, speaking, playing - we take care of the rest.

Check them - they offer spectacular value for money!



Z.B.

CR-79

CR-73-II

CR-4

CR-73

CR-76



Come and visit us
at Booth
5-1C 30
MUSIK MESSE
FRANKFURT

TB - 94 the tube

"AS REVIEWED IN STUDIO SOUND APRIL 1995"

The first tube mic without any unwanted noise.

Featuring a new designed valve with high performance, high output and the richest sound a tube mic can offer.

Comes complete in aluminium flight case with cut - foam interiors, flexible suspension, power supply and cable.

CONTACT YOUR LOCAL DEALER OR SEND YOUR REQUIREMENTS DIRECT TO OUR SERVICE DEPARTMENT. DISTRIBUTORS FOR SEVERAL COUNTRIES DESIRED

B.P.M.- STUDIOTECHNIK

WATTSTRASSE 11 - 13, 13355 BERLIN

TEL: + 4930/4631169 FAX: + 4930/4631216

B.P.M.
STUDIO
TECHNIK

IT IS NO exaggeration to say that Allen Sides has done just about everything there is to do in the music business. His recording successes include projects with legends such as Count Basie, Frank Sinatra, Ella Fitzgerald, Neil Diamond, John Williams, Quincy Jones, André Previn, Linda Ronstadt, James Ingram, George Benson, Natalie Cole, and the late Frank Zappa. And among the film scores recorded at his Ocean Way facility are *Aladdin*, *Beauty and the Beast* and *Toy Story*; on top of which the facility has also handled sessions with Green Day, REM and Counting Crows.

Sides is more than an engineer; more than a producer. Currently he owns a collection of seven—soon to be ten—recording spaces; he designs highly regarded, custom monitoring systems; and has an enviable reputation for recording virtually all types of music.

In 1978 Allen Sides relocated his fledgling Ocean Way facility to the former United Western Studios on Sunset Boulevard in the heart of Los Angeles' recording community. The facility now comprises five tracking, scoring and mixing rooms in Hollywood, plus a pair of studio suites at Record One in the nearby San Fernando Valley. This year sees the opening of an ambitious new complex in Nashville, where three new state-of-the-art rooms have been built in a former church and rectory building on Music Row.

Most recently, Sides installed a 100-input SSL SL8000 G-series console in Record One's Studio A (the largest music console Solid State Logic has ever built) and a brand new 80-input SSL 9000j with Ultimotion in Studio B. 'Without reservation,' he confides, 'the SL9000 is the best modern console I have heard.'

Reflecting upon his career, Sides considers himself fortunate to enjoy what he does so well. 'I have a fasci-nation with great sound that's larger than life—sound that creates a thrill in the listener. That's the type of sound I strive to achieve, and it was the underlying theme in creating our studios. Since great sound cannot be compromised, we have custom built many of our consoles to exacting sonic standards, while providing the features that engineers expect.'

Sides reckons to have built Ocean Way to suite his exacting requirements as a producer and musician. 'I understand what's required to get what I want. When I build a room, the basic concept is that the space should be easy for me to use. My seconds are generally quite good engineers on their own. When we have a client who doesn't know the room, and we're having a problem getting any particular sound, the second can be very helpful. We'd never push anything on anyone, but we'll give them options that they may like.'

'I like things to be fun to listen to, and interesting; it doesn't matter what kind of music it is. I don't care if I'm doing symphonic, pop, or straight-ahead rock 'n' roll—I enjoy all of it.'

Sides has just completed producing an album of songs from *Cinderella*. 'Caroline

Taking

Allen Sides' success as a producer and engineer is matched by that of his design work and his recording studios. **MEL LAMBERT** explores his achievements and philosophy

Mayer Beug, President of Disney Records, had a concept to release an updated version of the songs from [the film],' he explains. 'It's an album of pop renditions, including the original score. It was fun because I was able to bring some of my favourite artists that I've worked with before.' Linda Ronstadt performed 'A Dream is a Wish Your Heart Makes' in both Spanish and English; James Ingram added 'So This is Love'; Bobby McFerrin performed 'Bibbidi-Bobbidi-Bo [The Magic Song]'; and Take Six did 'The Work Song'. Sides also rerecorded the original 1951 score with a large orchestra.

OCEAN WAY'S involvement in music production, film scoring, and mixing to picture, necessitates that its rooms be versatile. 'Yes,' Sides concedes, 'we deal almost entirely with mainstream producers, so that in the quiet times we are still fairly busy. Record companies cut back on projects a year or two ago; yet when things were really quiet, we came through quite well. And a lot of our clients have home studios, many of which we have designed and built for them. They'll often come and cut basic tracks at our studio; make more recording and overdubs at home; then they'll come back and mix.'

One of the most complex sessions at Record One's Studio A was for Michael Jackson's latest album, *HIStory*. Producer Bruce Swedien remixed many of the tracks through the room's massive SL8000 console. 'In addition to booking two of our rooms—Studio A and Studio 1 at Ocean Way—they had about five or six other rooms booked for a long period of time,' Sides recalls. 'For those sessions with Michael, they had two 48-tracks, a 24-track and a 16-track.'

'Large-format consoles are becoming increasingly important, mainly because of the sheer quantity of inputs we're using for various projects. Obviously, automation becomes important with complex mixes. I prefer moving faders. We're going to make additional changes in the Ultimotion

software that will make it even easier to use.'

Sides' latest venture, Ocean Way To Go, provides a complete turnkey service for project studios. 'Basically,' he begins, 'we provide the crew and the equipment package—consoles, portable air conditioning, power drops. We treat the rooms acoustically; we provide second engineers, runner staff, full-time maintenance—anywhere you want.'

In this way, Sides offers, a client knows that they will receive the level of technical and creative support enjoyed by professional facilities. 'There's no such thing as down time because the level of maintenance that we provide is exceptional, to say the least. When you set up a home environment, there's always the question of systems working.'

'A while ago,' he says, by way of example, 'we did the Little Village album with Ry Cooder at his house involving a fairly complex system, including consoles, tape machines, a lot of outboard equipment, and four cue systems.'

Cooder's film-scoring sessions have brought him into contact with other aspects of Sides operation. 'During postproduction of *Geronimo*,' Sides recalls, 'the film was being recut constantly; it started out at two and a half hours, and went down to an hour and three-quarters. We'd scored it here with everything from a 100-piece orchestra down to a small period ensemble lead by Ry Cooder.'

Music tracks were recorded on a pair of Sony PCM-3348 digital multitracks; a third 48-track was available for making a dub copies on the rerecording stage. 'We took a 48-track down to the dub stage,' Sides continues, 'and made A and B sets. The second they'd make a picture edit, we would make a B set that conformed to that change with crossfades. We were never more than one D-to-D from the source; the sonic quality was stunning!'

REGARDING EQUIPMENT selection, Sides' reputation for seeking out custom-designed consoles, has been tempered by his interest in newer designs.

'We do have a mixture of highly modified, large-format boards with moving-fader automation,' he agrees. 'We took a long time in selecting our first SSL: the 100-input SL8000 G Plus that we have in Studio A at Record One. To be honest, for years I was adverse to putting in an SSL because I wasn't fond of the early series consoles. 🎛️'

'Large-format consoles are becoming increasingly important, mainly because of the sheer quantity of inputs we're using for various projects'



👉 'Then came the G Plus, which resulted from SSL working on some of the parameters I'd requested. The G Plus was a significant improvement.

'In Studio B at Record One I've installed a custom 80-input SL9000j with Ultimation and Total Recall. It sounds very good. I delineate that from discrete consoles, because it's hard for any IC-based console to compete with an exceptionally well maintained, totally discrete vintage board. However, the SSL 9000j console has some things that are better than some older boards, because SSL has eliminated all the capacitors in the signal path; it's one of the quietest console I've ever heard.

'To me, one of the most important things on any recording console is the equaliser. I like the particular version of E-series EQ we have in our SL8000 G Plus. And I like the new 9000's equalisers, especially the G version of the 9000 EQ, which previously I didn't care for on the 8000. The mic preamps in the 9000 are also quite good.'

Back on the alternative track, Sides has opted to design his own large-format monitoring systems—such as the multiway system with subwoofers currently installed in Record One's Studio A control room.

'Big speakers are very, very important to me,' he offers. 'A's system is stunning sonically. It's wonderful to put up a great

'If it's a choice between having the ultimate discrete module, or working on a stock console where the musicians are comfortable, I'll make it work for them'

mic—such as an AKG C251 or a C12—in front of a singer, listen to what they sound like. And then to walk in the control room, pull up a fader, and have it sound like you're standing in front of them.

'Conventional speaker systems utilise a horn and a woofer in the same cabinet but with two totally different dispersion characteristics. We have a front-loaded low-frequency horn and a midrange horn that have the same dispersion characteristics: 40° by 90°.'

According to Sides, this configuration results in a uniform response over a wide area of the console. 'Our midrange horn on-axis at one foot, from 400Hz–16kHz, falls within about 3dB of the envelope, which is pretty darn good. But if you go 40° off-axis from centre on that same horn, its response is identical to that on-axis—which is stunning!'

The MF horn is based on a Harry Olson design, with a 30°–40° vertical dispersion. Frequencies above 10kHz are produced from a direct-radiating component, because of its inherent lower distortion. 'The HF driver we use has a 2mm aluminium dome with a Milar surround,' Sides explains. 'The difficulty is finding a tweeter that will deliver the SPL I need; these [proprietary] tweeters are very smooth out to about 26kHz.

'The system has the most defined, clearest bass I've ever heard in a loud speaker; these big front-loaded horns go down to around 37Hz. We have a sub-bass system mounted above that which has four additional woofers; it gets down to 18Hz.'

All of Ocean Way-Record One's other rooms feature more 'moderate' versions of Sides' large-format system, but one that is based on the same design concepts. They incorporate the same mid-frequency and HF drivers but, because of space limitations, utilise different LF units.

'However, all three rooms in Nashville will feature our big monitor systems,' he stresses.

Sides has also designed monitor systems for other studios, including Lucasfilm's Skywalker Ranch Scoring Stage, and two systems for Royaltone Studios' new \$6m complex in North Hollywood, California. But custom technology doesn't come cheap. 'A 3-channel system like the one I designed for Ocean Way Studio A, with separate left, centre and right cabinets—complete with amplifiers, crossovers and EQs, would probably be sell for around \$110,000,' Sides reflects. 'I've done quite a few monitor installations, and I'm probably going to do more. What I usually do is to determine what architectural changes we need to make; how to treat it in the most cost-effective manner.'

Sides prefers to work with familiar equipment but considers the sound of a room to be more important than any specific equipment. 'Sound is very important to me,' he says. 'I'll defer to musical performance and what's required to make the musicians happy, rather than focus too much on the hardware. If it's a choice between having the ultimate discrete module, or working on a stock console where the musicians are comfortable, I'll make it work for them.'

OVER IN NASHVILLE, a renaissance is under way. In addition to its role with country music, the city is also attracting a growing number of artists, engineers and producers that are moving to the heartland in search of alternative environments to the traditional East coast and West coast communities. And several new rooms are being opened to take advantage of the new influx of talent. Masterfonics recently opened a new tracking room, and two new rooms at planned for Starstruck.

How does Allen Sides plan to create a niche among such competition?

'It will help the Nashville marketplace having some very high-end rooms in town,' he concedes. 'We've bought an 1850s grey-stone church and rectory building right on Music Row,' he says. 'It's

WEST 'SIDES STORY': A TRIBUTE TO LEONARD BERNSTEIN

One recent project was a BMG tribute album to Leonard Bernstein, featuring music from *West Side Story*. David Pack served as Producer, working with Executive Producer Michael Greene. Profits from the project will be donated to the Kids in Music foundation.

'We recorded a number of pop artists doing Bernstein's songs,' Sides recalls. 'The first song we did was 'Maria' with Michael McDonald, James Ingram and David Pack. Then we did 'Tonight' with Kenny Loggins and Wynonna Judd, and 'I Feel Pretty' with Little Richard!'

'We recorded 'Rumble' with Chick Corea and his entire band, and Toto. Just before her tragic death, Selena recorded 'A Boy Like That'—a phenomenal song.

'The comedy song 'Officer Krupke' was done as a funny rap version with Salt-N-Pepa, Heavy D, Lisa Lopes and The Jerky Boys. Phil Collins recorded a great version of 'Somewhere'; Aretha Franklin also did a killer version of 'Somewhere', the last orchestration that Marty Paich produced before he died. Brian Setzer did a great version of the 'Jet Song' with his rock 'n' roll big band. It was a great project.'



a mix of modern and old; we have worked hard to maintain the original architecture. We're hoping to be up and running air early this year.' Glass corridors will connect the two buildings together.

In total, the new Nashville facility will offer three music recording rooms. The main room will measure approximately 80 feet by 50 feet, with 30-foot ceilings, plus five isolation booths. All rooms will offer large tracking spaces. We have one tracking room that is like a huge living room with a fireplace—where you can record vocals—with a separate control room.'

An ambitious project in the hands of an ambitious man. But Sides' varied career and impressive track record suggests that it's likely to be the beginning of another success story. His sights are set high: 'Even our smallest studio is big by Nashville standards,' he says. 📍



Peter Gabriel



Pink Floyd



Eros Ramazzotti

IT'S ALL IN THE COMPANY WE KEEP



Duran Duran



Meat Loaf

From **Pink Floyd** to **Peter Gabriel**; **Depêche Mode** to **Duran Duran**; **Meat Loaf** to **Randy Travis**; **Eros Ramazzotti** to **Bryan Ferry**; **Simply Red** to the artist formerly known as... more major artists tour with **Turbosound Flashlight & Floodlight** systems than any other turnkey sound system.

These prestigious artists all rely on companies recognised as industry leaders in both service and sound quality.

Companies that understand the advantages offered by **Turbosound's** exclusive designs: the finest available audio quality, labour efficiency and trucking economy of any system. **Flashlight & Floodlight** rigs are supplied as complete systems – including loudspeakers, digital system control, amplification, cabling and certified flying

hardware – resulting in a coherent package with optimised system performance, industry-leading reliability and ease of transport. You owe it to your clients to offer them the finest sound reinforcement system available – You owe it to your company to offer them **Flashlight & Floodlight**



Duran Duran



Simply Red

Turbosound
Once Heard, Never Forgotten

H A Harman International Company

Turbosound Ltd., Star Road, Partridge Green, West Sussex RH13 8RY, England Tel: +44 (0) 1403 711447 Fax: +44 (0) 1403 710155
Turbosound wishes to thank the artists and Britannia Row Productions, Ltd; Eighth Day Sound Systems, Inc.; Nuovo Service srl; and BBI Inc.
Use of artist names does not imply product endorsement. Floodlight is manufactured under licence from Funktion One.

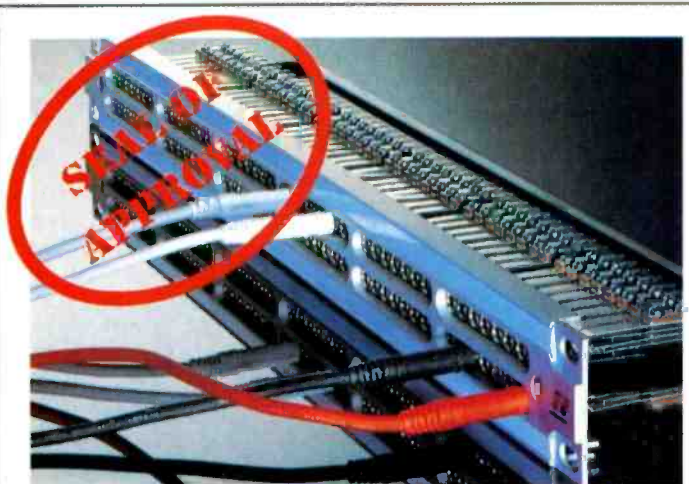

Re'an
 Re'an Products
 YOUR BEST CONNECTION

25 years experience in the Audio Industry coupled with intensive use of current technology means that Re'an offers engineers a 96 way Bantam style Patch Bay of unrivalled quality at a highly competitive price. The Re'an range of patching products also include, Musa style Video Patch Bays, Patch Cords, MA Jacks and PatchLabel labelling Software. For further information contact: Re'an Products.

Springhead Enterprise Park, Northfleet, Kent,
 DA11 8HB, England
 Tel: 44 (0) 1474 328 807 Fax: 44 (0) 1474 320 285

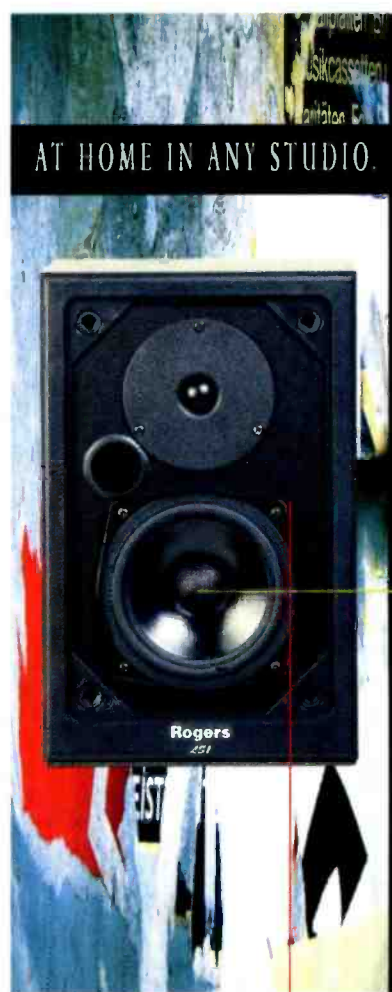

AT HOME IN ANY STUDIO.

If you are looking for near-field monitors, look no further, check out Rogers LSI's.

50 years of loudspeaker know-how ensures that Rogers LSI's deliver the goodies...solid detailed sound that will bring out the best in your recording.

Whether for professional studio, home studio or editing suite, the Rogers LSI just has to be the soundest investment.

Get Real. Get Rogers.

"At the asking price, the LSI's offer that rare combination of good value and quality"

Paul White - SOUND ON SOUND, Jan 1986.

Rogers
 BRITISH STUDIO MONITORS

For a limited period only, we are offering LSI's for only £149 per pair (rrp £199). Call our direct line on: 0181 640 2172 NOW!

HAND HELD AUDIO



The Radio Microphone Specialists

SENNHEISER

SONY

IN-EAR MONITOR SYSTEMS by



SHURE

SAMSON

Frequency Planning and Licensing Service

Rental • Sales • Service

Unit 2, 12-48 Northumberland Park, London N17 0TX
 Tel: 0181 880 3243 Fax: 0181 365 1131

Back to analogue . . . exactly



dCS discrete multi-bit oversampled D/A converter

Discrete 'Class A' balanced analogue output with adjustable level

Fixed level unbalanced monitor output

Dual bandwidth PLL for ultimate data recovery

AES/EBU, SDIF-2 & SPDIF inputs

Remote operation capability

dCS 950 Digital to Analogue Converter



Data Conversion Systems Limited

PO Box 250, Cambridge, CB4 4AZ, England
 Telephone: +44 (0) 1223 423299
 Fax: +44 (0) 1223 423281
 Email: dcs950@dcsstd.co.uk



Drowning in the aether

Future broadcasting developments and the rise of multichannel audio systems threaten to complicate audio in more ways than the average engineer yet imagines writes **CHRIS EDWARDS**

As radio broadcast networks move to digital transmission services (such as DAB) and the work begins to get new surround-sound audio tracks produced for digital video, the monitoring and off-air listening environment is going to become a lot more complicated.

Whether the end product is a digital video disc, direct broadcast by satellite, cable TV or the eventual terrestrial video networks, it adds up to a lot of sound that needs to be recast for as many as six audio channels. The situation is further complicated by the fact that not all receivers will be able to cope with all six channels and will need to be able to extract simple stereo from the signal without noticeable degradation when compared with a 'straight' stereo signal. Then consider that there are two competing systems: Dolby's AC-3 and the three layers of MPEG.

Some work involved may consist of a straightforward conversion job; other projects may call for much more delicate reprocessing to get decent surround-sound effects and to ensure that low frequencies are mixed properly to the subwoofer channel that is generally present in multichannel systems.

Because all of the new systems are digital, there is no great need to convert the source to analogue in order to reprocess it into the final, digital transmission format. There are pretty strong arguments for keeping everything digital once converted from analogue and only convert back to analogue for monitoring.

Instead of monitoring for just one output medium, you may have to deal with a combination of them to ensure that mixing for one does not compromise the apparent quality of another. So, in a monitoring room you might have a selection of conversion boxes in the same way that people use different monitor speakers today to check for colouring effects.

For sports broadcasting, you can contemplate the audio channel changing in real time as a camera zooms in—to

ensure that the surround-sound illusion stays intact. This means taking more channels into the conversion equipment than you really need so that it can be mixed down to a five-plus-one digital audio output.

Now all you have to do is find a decent digital interface that can handle multiple audio channels. There is an existing way to hook up multichannel audio devices digitally: the multichannel form of the AES-EBU serial link known as MADI. Although it has the resolution and support for the key pro-audio sample rates, as well as the ability to carry as many as 56 channels, it can only pass audio data. You are also restricted to one sample rate across all channels which is great for connecting mixing desks up to multitrack recorders but can cramp your style when trying to manipulate different streams of digital audio.

SOME ASPECTS of this coming technology can be borrowed from the world of personal computing which is where a lot of these multichannel audio systems will end up being heard. For relatively short distances—10m instead of the 100m possible with MADI—a relatively new standard that goes under the forbidding title of IEEE 1394 is just beginning to creep out into the market. It has the unfortunate problem of being associated with consumer electronics as it is being positioned as a way of linking PCs to satellite receivers, CD players and games consoles. But it can support the data rates needed by multichannel digital audio.

It runs at speeds from 100Mbit/s and there are plans to go up to 1Gbit/s, which provides plenty of headroom. With all 56 channels running flat out and passing 24-bit samples, MADI has a data rate of around 75Mbit/s. IEEE 1394 also has the benefits of being cheap to implement, supports real-time audio directly and is highly likely to turn up on PCI add-in cards for PCs and Macintoshes. It also has a tag bestowed on it by one supplier working in the pro-audio and consumer worlds of being 'the MIDI of the future'.

Being more of a computer bus running over a twisted-pair cable than a

simple serial link, it can be used to pass more than real-time audio. Commands and other data can go down the same link to control remote devices such as disc storage or tape transports.

As the distances involved in studios can be a lot more than 10m, there is an alternative that is not a million miles from IEEE 1394 in terms of the way it works. That is a relatively new networking system known as ATM. It comes in a variety of flavours, getting progressively more expensive as you crank up the speed. At 25Mbit/s, ATM is not that expensive and works over ordinary telephone wiring. This sort of data rate will also allow for around 20 channels with room to spare for overhead.

The next important speed for ATM is 155Mbit/s but this is much more likely

Instead of monitoring for just one output medium, you may have to deal with a combination of them to ensure that mixing for one does not compromise the apparent quality of another

to be used in the transmission stages of a broadcast network as it still costs several thousand dollars to implement per node and is arguable overkill for many audio applications.

However, the link between ATM and MADI is closer than you might think. An early version of ATM running at 100Mbit/s uses the same TAXI interface chips as those employed by MADI.

The Meek

Two of the most colorful audio innovators of all time, Joe Meek laboured feverishly in his pioneering London-based project studio.

DENNIS DENEN revisits his strange, painful and creative world.

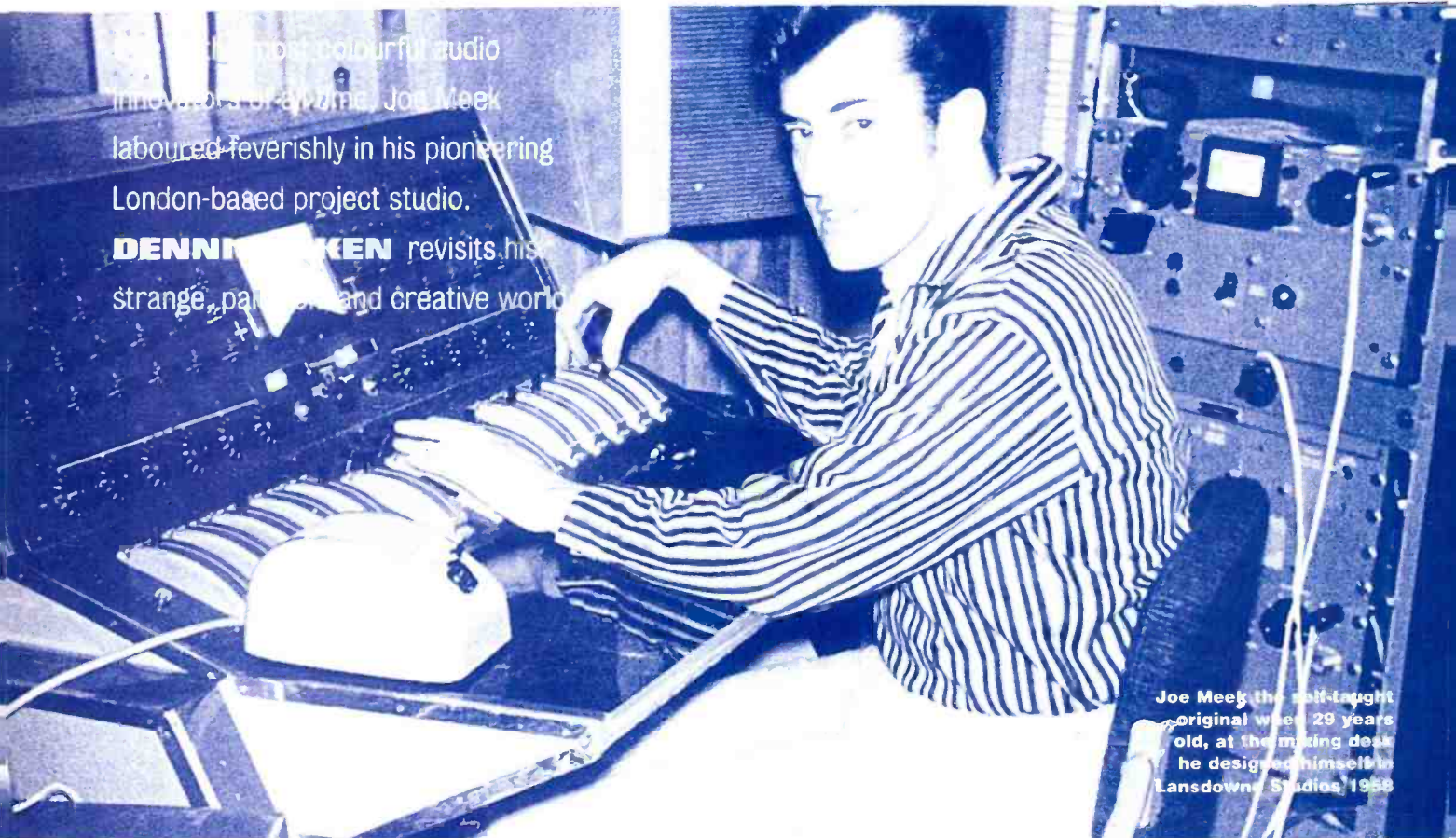

Joe Meek, the self-taught original when 29 years old, at the mixing desk he designed himself in Lansdowne Studios, 1958

IF YOU WANT something done right, do it yourself. We've all heard it before but it's true—and it often goes double when it comes to recording. How many home demos have lost something special in the hands of a misguided producer? How many great ideas have been lost when a lacklustre engineer declared, 'It can't be done'?

'They' told Joe Meek that it couldn't be done but he still managed to blast off some of the most weirdly delightful and original records ever cut. Ultimately it was Meek who told 'Them' where to get off.

Joe Meek: Britain's first independent record producer, self-taught and later schooled in the arid 1950s British pop-studio scene where his revolutionary ideas and recording techniques turned heads and strained Vu meters. He went on to write, engineer, and produce a slew of diverse recordings distinguished by the use of echo, reverb, compression, limiting and distortion—and featuring an assortment of bizarre and macabre themes.

He recorded Tom Jones' first discs and rejected both the Beatles and Bowie, yet some sanely and soberly call him a genius—the British Phil Spector. Other artists he worked with were a mixed bag of

body-builders, actors, pop combos, pretty-boy crooners, talented instrumentalists, and screaming loons. His songs celebrated Buddy Holly, Eddie Cochran, coffins and life on the moon. He racked up 45 UK Top 50 hits but only two releases made it in the US: 'Telstar' by the Tornados (the first single by an English group to break the US Top 10, let alone No 1 on the pre-Beatles American charts) and 'Have I the Right' by the Honeycombs (No 5 in 1964). All were recorded in a tiny flat in London where, if he was unable to create a sound he 'heard' in his head, he'd invent the device to deliver it.

Robert George Meek (b. April 5, 1929 in Newent, Gloucestershire, England) was captivated by wires, cast-off recorders, radios, and any electronic junk he could drag into the family shed. He effectively grew up teaching himself the art of recording—building and modifying the gear he needed dedication that precluded other interests. Through his formative years, he built crystal and TV sets, experimented with sound effects, overdubbing, tape editing and recorded local talent onto acetate discs.

By 1953, he was ready for the black smoke of London and the world of professional recording. The prestigious IBC

Studios hired him; first for location recording of the Radio Luxembourg Shows, then as a balance engineer at their busy London facility during the heyday of skiffle and traditional jazz. Daily contact with the cream of British stardom and a wide range of musical styles schooled him in the makings of a pop record.

By the mid-1950s, the US was waking from half a decade of lightweight pop. Despite pervasive white 'cover' versions of R&B hits, diverse and vital production camps (such as Sam Phillips in Memphis; Specialty in New Orleans; and Vee Jay and Chess in Chicago) could no longer be held down. Concurrently, England's pop scene

He recorded Tom Jones' first discs
and rejected both the Beatles
and Bowie, yet some sanely
and soberly call him a genius
—the British Phil Spector

inheritance

was static. Engineers maintained a strict regime of white lab coats at sessions, and tried-and-true recording 'rules' were not to be questioned. But rules are made to be broken—and Meek was born for the job.

On leaving IBC, Meek set up at his tiny Arundal Gardens flat and began planning and recording a 'Stereo Fantasy extravaganza'. According to the sleeve notes, the production was to 'create a picture in music of what could be up there in outer space... from the studies I have made'. *I Hear a New World, Part 1*—a four-song EP and one of the world's first concept albums—was issued as a highly limited release in 1960 and promoted as a demonstration record for in-store play to sell stereo equipment. The liner notes of the reissue CD offer a listing of implements employed in the recording process: '...the sound of running water, bubbles blown through drinking straws, half-filled milk bottles being banged by spoons, the teeth of a comb drawn across the serrated edge of an ashtray, electrical circuits being shorted together, clockwork toys, the bog being flushed, steel washers rattled together, heavy breathing phased across the mics, vibrating cutlery, reversed tapes, a spot of radio interference, some quirky percussion, and the odd burst of music'.

Another 'voice' on the album is Meek's Clavioline. David Amels, President of Voce and a vintage keyboard collector, offers a first-hand account of this curious instrument: 'The Clavioline is detectable on various 1960s pop classics such as 'Runaway' by Del Shannon and 'Baby You're a Rich Man' by the Beatles. It's a small, transistorised, monophonic keyboard instrument made in France and extremely expressive in imitating violins, oboes, and horns.

'Manual vibrato can be achieved by wiggling the keyboard subassembly from side to side. Where Moog added voltage-controlled filters, the Clavioline has fixed imitative filters. It even has a built-in 15W valve amp in the carrying case-stand. Tailor-made for a wiggly guy like Joe Meek'.

For those curious about the album's sequel, *Part 2* remained in the can (aside from white-label test pressings and bootlegs) until ambitious Meek aficionados saw to the entire project's CD issue in England in 1991. The odd music was performed by a transmuted skiffle group christened The Blue Men, and featured sped up 'creature voices' gimmicky stereo separation, and Meek's trademark sound effects.

In addition to his engineering talents, Meek helped design and build one of England's most enduring state-of-the-art studios. Lansdowne came to be known as The House of Shattering Glass in tribute to the clarity of its recordings. Bolstered by the success and royalties of his composition 'Put a Ring On Her Finger' by Les Paul and Mary

Ford (US) and Tommy Steele (UK), Meek cultivated a stable of artists and became partners in Triumph Records. Pitching a good fight against the powerful British majors, he scored a Top 10 hit with 'Angela Jones' by Michael Cox in May 1960 before the tiny independent succumbed to smothering distribution problems. But the real fun was about to begin.

Major Banks, Meek's Triumph partner, bankrolled a new operation that gave Meek his own studio and complete creative control in the production of masters to be leased to the British majors (Decca, Pye, EMI). This new empire was christened RGM Sound.

One might expect a visionary to chart his world domination in a cavernous studio with natural room reverb and space to accommodate a host of musicians. But Meek knew the true merit of project recording decades before the term was coined: he built his studio in a small, 3-bedroom apartment dwelling above a leather goods shop on London's busy Holloway Road. In a surprising lack of creativity, he named the studio 304 Holloway after the address.

MEEK'S STUDIO TECHNIQUES are legendary. His powers of isolation in a tiny room were said to be unfathomable. And if a bass drum sound wasn't cutting it in the track, he might just stomp out the beat on an exposed floor board or instruct the drummer to play on an empty packing case instead. The 4/4 rhythm of the chorus on 'Have I the Right' by The Honeycombs is

'The permutations were endless.

Technically, it meant the maximum utilisation of the minimum components, which, in engineering terms, means efficiency'

the sound of the group lined up on the indoor stairwell stomping out an overdub. Meek swears that a visitor at the session from the Dave Clark 5's organisation stole this idea and used it for their smash 'Bits and Pieces'. Both records were big hits although this is one instance of Meek's rampant paranoia being justified.

Meek's early *modus operandi* consisted of vigorous bouncing on the EMI TR50 and TR51 mono recorders, and a Lyrec stereo twin track (presumably a TR16). Ultimately, the track would wind up on one of the tracks on the Lyrec with the vocals added to the other. Then both tracks were mixed down to mono.

Ken Brown writes in *Thunderbolt* (the magazine of the Joe Meek Appreciation Society) on the EMI TR50 and TR51: 'Many 1950s hits were mastered on these machines but they were fiddly, needing constant tweaking to keep them on spec.

Mechanically, they weren't up to the Lyrec, and the 8-inch spool capacity was only good for 20 minutes or so, running standard play tape at 15ips. The TR50 was only a 2-head machine, robbing Joe of his beloved doubling, 



THE TORNADOS: 'DANCING ABOUT ARCHITECTURE'

IT WAS AT 304
Holloway Road that
Meek recorded his most
well-known work—the

Tornados' 'Telstar'. By today's communication standards, the quality of the original **Telstar** satellite transmissions of July 1962 is prehistoric but the spectre of the then-new technology and its implications gave Meek the jolt he needed to creation his most legendary work. When the Tornados cut the basic track before driving to their evening gig, they had no idea of what Meek and Geoff Goddard (his writing partner) would deliver on the final cut. When unleashed, this astounding production presented a sound picture unheard of before.

A book could be written about this disc alone, but confining this masterpiece to the printed word would be like 'dancing about architecture' as Jake Riviera once said.

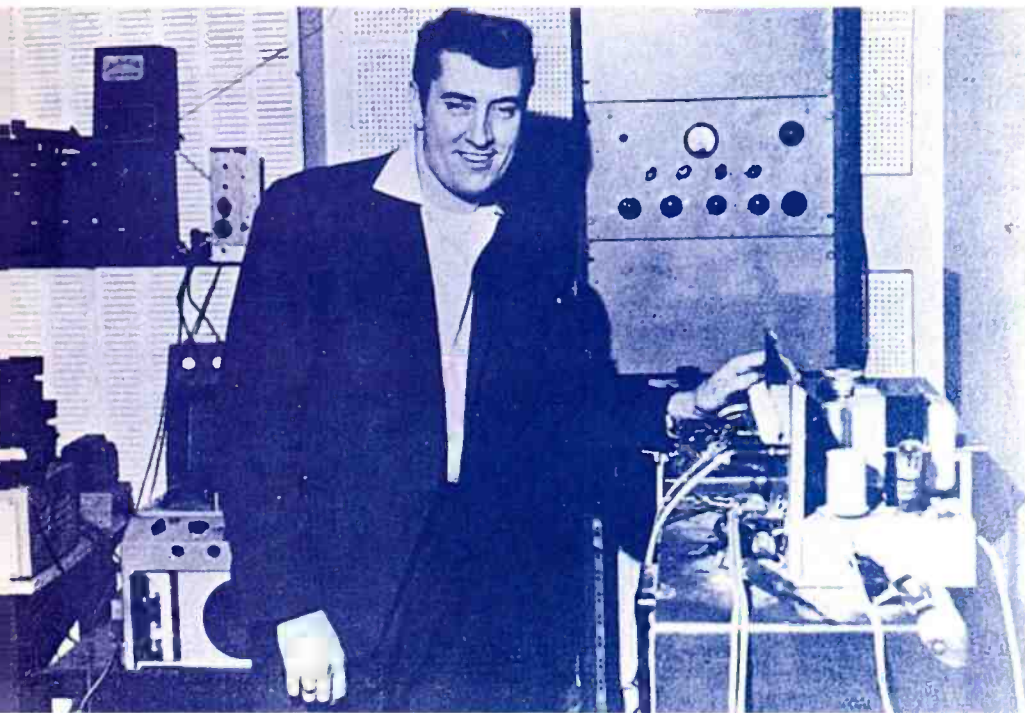

Meek in the control room at 304 Holloway Road in 1962

👉 tape delay, and tape echo when recording on it. For this, we know, he hooked a Vortexion recorder in. The TR51 was a 3-head machine, mechanically similar to the TR50. It is safe to say that the TR50 series machines would have set the limit on both noise build and wow and flutter during his overdubs!

Mixers were either self-fashioned or small Vortexions 4-15 and 3-15M. This was a brand of choice by the BBC and other British studios and labs. Ken Brown continues: 'Joe would have presumably been combining [the mixers'] outputs, perhaps in a simple resistive network, in order to attain the number of microphone or other inputs needed for the session.'

'The Vortexion units offered high quality, low noise, and distortion. The 3-channel version had a peak programme meter (PPM), which is a bit like a Vu, but faster and responds better to transients. Cleverly, the makers allowed the units to be interconnected, giving seven mic inputs, all metered, mixing down to one input! Not far removed from Abbey Road's 8 inputs and Decca's 12.'

Brown claims that Meek could connect a 4-channel Vortexion to a home-made 3-channel unit to 'give him 11 basic inputs, but he could easily have stretched the hook-up to include a few line-level feeds straight to the mixer outputs to mix in off-tape echoes or other high-level sources'. Using several mixers like this sounds primitive now but it would have offered Meek flexibility. Taking separate feeds from mixers before combining outputs would have enabled him to add effects selectively to mics or groups of mics and he could send or return his effects to some groups while omitting others. Mixers today feature comprehensive facilities for routing but in the early 1960s very few manufacturers of large recording mixers existed. In the majority of studios, the mixer was built by the technical staff to their own requirements—usually very different requirements to Joe's!

Eventually, Meek upgraded to the EMI

BTR/2. Ken Brown recalls the bulky machine:

'In this pre quartz-locked, servo-control era, tape drive meant huge precision motors driving an enormous, but beautifully engineered, tape deck. Mechanical engineering at its very best, complemented by "conservative" circuitry, heavily underrated for stability and reliability. The steel cabinet (specially made for EMI by Morris Motors) housed the tape deck in the top, and amplifiers, power units, and oscillators behind two doors below. It had 3 heads, 11-inch reels, and two speeds (15/30 ips) if it was the high-speed model!'



Meek soon ran this in conjunction with the Ampex 300 IC (console) recorder. According to Brown, compared to the BTR, this less cumbersome unit 'was slightly more modern, featured better heads, and had a really warm American sound to it. With a few changes, the original 'three-ton' deck would still be around for a couple of decades through the 300, 350, 351, and 440 series machines progressing from mono up to 8-track. Meek's Ampex-BTR combination, both running full track and, hopefully, at 15/30 ips, would have boosted his overdubbing capacity tremendously.

'Instead of hopping from the questionable TR50 to a mere 1/2-track on the Lyrec and back again, he now had two full-blown, high-speed, full-trackers do the job. They were both 3-head machines, offering splendid off-tape effects, and he would save noise by not having to go down to 1/2-track on every Lyrec bounce, and reduce wow and flutter by avoiding several degradations on the TR50. He could now bounce a completely finished rhythm track onto the Lyrec once only, leaving the other track free for vocal or lead instrument as he wished.'

'This new freedom could also be turned around for other effects. He could, for instance, record a split mix live onto both tracks of the Lyrec, equalise, echo, and compress each separately, then bounce them onto mono onto the BTR or Ampex, then back to one Lyrec track with something new added... and all this via his

ultraflexible free-access mixing network, including effects inserted wherever. The permutations were endless. Technically, it meant the maximum utilisation of the minimum components, which, in engineering terms, means efficiency! Meek cut with his levels as hot as possible and utilised distortion when it fitted his needs. He saturated the tape with as much signal as it could 🎧

MASTERING MEEK:

CD REISSUES VERSUS VINYL ORIGINALS

AS DENSE AND hot as the Meek singles sounded, it's possible that CD reissues of his work give a more realistic rendering of what he had intended for the end product. John O'Kill discusses the mastering process in *Thunderbolt*:

'Although we all loved and enjoyed our vinyl records in the 1960s, the truth is it was often a monumental struggle to get the disc cut to equal the master tape when the tape was finally transferred to disc. I suspect that much of the distortion for which Joe was so often accused was not there in his tapes, but occurred because of the inability of cutter heads of the day to handle his over-the-top productions and carve them for all time onto a revolving disc of cellulose acetate.'

'The 1960s setup [for mastering was] a Scully lathe fitted with a dubious Westox cutter head, driven by a Leak TL10 10W amplifier, cutting into a disc of cellulose acetate, which would still undergo endless generations of electroplating until the final stamper was mounted in the record-pressing machine. CDs cut from original tapes or good copies reveal like never before how brilliant some of Meek's recordings were'. Tell that to the Decca engineers of 1962, who, upon monitoring the master tape of 'Telstar,' were 'horrified at its unheard of levels of limiting and compression'. Or to the dim bulb in the sales department who thought the record was scratched at the beginning.'



Digigram

Create your own universe...



Xtrack S11

The entry point to the galaxy
Xtrack S11 is propelled by the full power of Xtrack software using simplified audio interfaces.

*System configurations:
2 up to 8 input/outputs.*



Xtrack S9

The studio tool
Xtrack S9 provides balanced analog and digital input/outputs, combined with the best audio quality.

*System configurations:
2 up to 8 input/outputs.*



Xtrack S80

The compact studio
Xtrack S80 fuses the audio quality of Xtrack S9 with the power inherent in 8 balanced analog outputs.

*System configurations:
2 inputs/8 outputs.*

Post-production

With the benefit of the PCXS option Digigram's digital audio workstations are broadcast format post-production machines. New features, like synchronisation with video stored on magneto optical drive, or picture insertion on the workstation's control screen, enhance the different synchronisation modes. The Xtrack galaxy workstations retain their lead in ergonomics and productivity.

Xtrack digital audio workstations A unique technology in 3 configurations

NEW XTRACK WINDOWS VERSION TO BE SHOWN AT NAB. BOOTH 768.



Simply digital

Parc de Pré Milliet
38330 MONTBONNOT - FRANCE
Tel. : (33) 76.52.47.47.
Fax : (33) 76.52.18.44.



RECORDING

withstand. Brown assures us that Meek monitored full tilt, as well: 'Quad preamps feeding Quad II power amps driving 15-inch Tannoy dual-concentric Reds in Lockwood cabinets. Definitely not a setup for anyone of a nervous disposition!'

Meek probably moved up to 4-track sometime in the 1960s as evidenced by some later Honeycombs recordings that were issued in stereo. But Meek's masterworks shine for their monophonic majesty and unique quality that only his bouncing and individual source compression could conjure. Some cuts ooze an inherent essence not unlike many 4-track bounced home demos we've all had experience with. Certain individually dubbed sounds fall into an eerie, surreal setting. Where Meek was concerned some of these moments may have been intentionally placed; the fuzz-guitar lick following the verse lines on 'I Take It That We're Through' by the Riot Squad being one example.

Brown also notes that in March 1963 Meek 'added two Altec compressors, a 436A and a 436B, to his arsenal, together with a new tone control unit, and a 220/110-volt step-down transformer to power them all! Later, in September of that year he brought in a Fairchild Dynalizer 673, limiters 660 and 661, and a compact compressor 663.

Meek's mic selection included some Neumann condensers, Telefunks, and the Webtrex Ribbon a piece not found in many British studios but no doubt appealing to Meek, as it was seen in some photos from Buddy Holly vocal sessions. (Meek was a rabid Buddy Holly fan.) He also employed the ribbon Reslo RBT, used for the bass drum and occasional group vocals.

On occasions, Meek cut vocals at Abbey Road, Decca, or Pye to use their echo chambers. Nevertheless, the delay sounds he achieved at 304 Holloway are astonishing. Geoff Goddard has made references to 'a combination of tape delay echo (Vortexion) and 'something up in the attic'. One can only guess that Meek had a concealed echo chamber up there.

Among Meek's most precious and shielded inventions were the true secrets of his success. Two echo units—one bolt with a spring from a garden gate, the other with a broken fan-heater's springs—inside a metal box taped hermetically shut. This knowledge was unravelled when brave IBC studio assistant (now CTS owner) Adrian Kerridge meticulously untaped the sacred container one night in Meek's absence. Surely there would have been hell to pay had its creator popped in during the proceedings.

Yes, the RGM domain was primitive by today's standards, as well as those of some of his contemporaries—though not as crude as pundits previously presented. Maybe the lack of cosmetic couching and photos of a battery of tangled wires



One of the last photos taken of Joe Meek in 1966



In the control room, with secretary Terry O'Neil in 1964

and reels with tape strewn about helped perpetuate this idea.

AS THE SIXTIES swung on, Meek was not able to maintain the momentum created by 'Telstar' and 'Have I the Right,' though the quality of his work never diminished. With poor cashflow, the problems befalling the undercapitalised independent writer-engineer-designer-producer hawking master recordings to callous A&R men became insurmountable. Toss in his blinding paranoia, barbiturates, insomnia, haunting 'spirit voices,' an endless legal case over 'Telstar,' other nagging lawsuits from artists, a legal bust for 'persistently importuning for an immoral purpose,' and the looming possibility of eviction from 304 Holloway Road. On top of all this, Meek, along with other known 'gay offenders' was to be investigated as a suspect in the murder of a teenage boy whose body was found dismembered and placed in several suitcases about the countryside.

On the morning of February 3, 1967, Joe Meek took a shotgun, 'wasted' his landlady, and blew his own brains out as she tumbled down the stairs. It was the eighth anniversary of the death of Buddy Holly.

Meek opened doors for the British recording world and waxed sounds that did not exist on record before—anywhere. Sonically ahead of his time, he was every inch a visionary and conditioned our collective ears for what was to come and

made it possible for future generations to explore further. And Ted Fletcher, former session singer for Meek and one of the anointed with whom Meek actually shared technical data, has recently developed and marketed the JOEMEEK Compressor (*Studio Sound*, January 1995).

Comparisons to Phil Spector abound. Both men are certainly giants in audio, but did Spector ever design and build his own equipment? Some may go on about Meek's schlockier tendencies (ditto for Spector), but he radiated them with such style. Just listen to the stuff on 'It's Hard to Believe It'... The man had a rock 'n' roll heart, and kicked pop music into orbit. And he did it his way. **S**

CONTACTS

THE JOE MEEK APPRECIATION SOCIETY, c/o Woodford House Publishing, 110 Chertsey Court, Clifford Avenue, London SW14 7BX

ACKNOWLEDGMENTS AND SOURCES:

The Legendary Joe Meek by John Repsch; *Thunderbolt* (The Joe Meek Appreciation Society magazine); John O'Kill; Ken Brown; Paul Verna; Bruce Harris and Mike Starr of *Ugly Things* magazine

From Studiospares

A bit of this

and that..

and plenty of the other

LOW-PASS **E.Q.** **POWER**

Acoustic Analysers
Acoustic Treatment
A-DAT Tapes
Amalgamating Tape
Amplifiers
Batteries
Books

FREQUENCY
Cables
Cassettes
CD Players
CD-R
Compressors
Connectors
DI Boxes
Effects Units
Equipment Stands

VACUUM TUBE EQUALISER

Glands
Goosenecks
Graphic Equalisers
Headphone Amps
Headphones/Headsets
Heatshrink
Infra Red Headphone
Isopropyl Alcohol
Littlelites
Leads
Looms
Meters (Volt Amps)
Microphones
Microphone Stands
MIDI Accessories
MiniDiscs
MiniDisc Recorders
Music Stands

Plastic Spoons
Plugs
Pop Screens
Porta Studios
Power Amps
Pre Amps
Racks Lights
Racks Strip
Racks Trays
Radiomics
R-DAT Tapes
Reverbs
RFI Filters
Roadcases
Rockwool
Sleeving
Snakes
Solder and Irons

Speakers
Stack Rack
Stage Boxes
Stools
Strato Rack
Syquest
Tape
Tape Recorders
Tools
Transformers
Turntables
Vent Panels
Wall Boxes
Windshields
Zimmer Rack
Zip Drive Carts

Fibre Optical Leads
Fish Poles
Floppy Discs
Fuses
Patch Cords
Patch Panels
Phantom Power Sup

Studiospares



ACTIVE MONITORING WITH THE NEW GENELEC 1030A.
THE SMALL WAY TO MAKE A BIG IMPROVEMENT.

GENELEC®

OLVITIE 5
FIN -74100 IISALMI, FINLAND
TEL +358-77-13311
FAX +358-77-12267

Alongside consoles and processors, digital technology has brought us a variety of recorder
TIM GOODYER explores the convenience and the controversy that surround recording

The recording revolution

DEMAND FOR a recordable CD format dates back almost to the invention of the compact disc itself. That for the first six or seven years of its life the CD was a playback-only medium gave supporters of the old audio cassette format a case to argue. And when a recordable CD variant did finally appear, its detractors were quick to point out that it could be recorded to just once.

Yet from these fragile beginnings, CD-R has steadily gained importance. Within the recording and broadcast fields, CD-R is proving popular for short-run audio duties such as prerelease promotional copies, artists' and producers' reference copies, sound effects libraries and for general library duties including tapeless archiving.

The first working CD-R system—Yamaha's PDS or Programmable Disc System—was launched in 1988. It comprised two 3U-high 19-inch rackmounted units; one containing the EFM encoding electronics, the other housing the CD writer. Early CD-R discs (which were manufactured by Fuji) did not have a 'wobble groove' and so the drive needed a fairly sophisticated servo mechanism to keep the laser on track. Also, although the discs conformed to most of the Red Book parameters, they could not be read by all CD players.

Meridian Data, a company making premastering software for the CD-ROM industry, was the first to market the Yamaha PDS system outside Japan, but its

implementation would only produce CD-ROM format discs. Realising the enormous potential within the record industry for a recordable compact disc, American pro-audio supplier Gotham Audio developed a customised software front end to enable the production of audio CDs. Major mastering facilities like Sterling Sound and Masterdisk were early US customers, while Tape One Studios brought the technology to Europe at the end of 1989.

Although the idea of having an 'instant' demo of their new album was highly attractive to major recording artists, the cost of the discs (initially around \$80, US) excluded the use of CD-R for many day-to-day applications. Fortunately, by the end of 1990 a solution had been found in the shape of a new type of disc from Taiyo Yuden. 'That's' CDs, as they were known, had been shown as a viable technology back in 1988, but Taiyo Yuden had developed only the dye formulation, with no recorder upon which to write the disc. It was not until 1990 that Sony launched a writer for the Taiyo Yuden CDs—which

were somewhat cheaper than the Fuji product. At about the same time Yamaha also announced a modification that allowed these discs to be used on the PDS system.

Up until this point, the data written to a CD-R by either the Yamaha or Sony writers were, as far as content was concerned, compliant with the Red Book format. Also, because the systems were 'single session' the programme had to be precompiled onto tape or on a digital audio workstation. It was quickly realised that there would be a significant advantage if tracks could be added as required and as a result a multisession format was devised (which ultimately became the Orange Book).

This subset of the Red Book defines a method of adding tracks one at a time before the disc is 'fixed up'—the stage at which it can be played on a conventional audio CD player.

In 1991 Philips announced a 'consumer' CD recorder priced at around £3,000 (UK) 

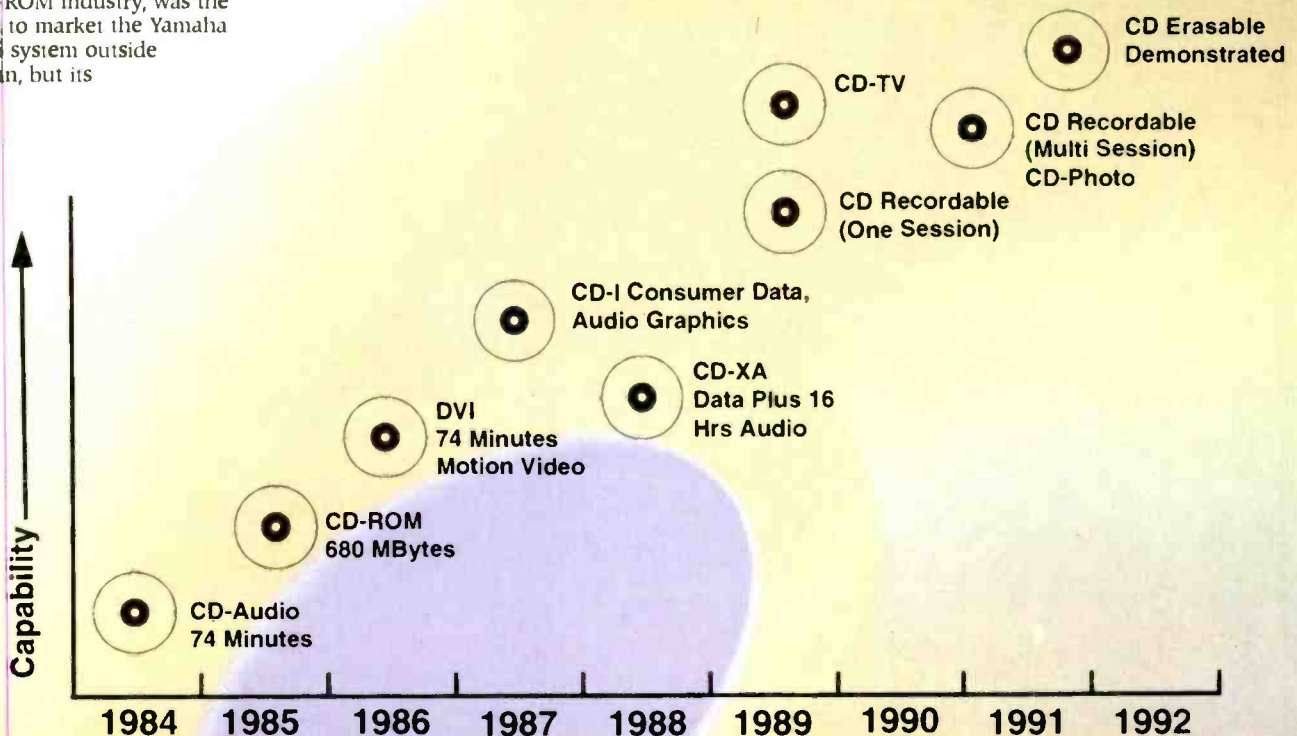

—about one tenth the price of the Gotham-Yamaha system. Machines began to appear at the end of that year under the Marantz brand (starting with the CDR-1) and others soon followed. Many of them used the Philips engine.

The difference between the Orange Book consumer machines and the larger Yamaha and Sony writers is their inability to write discs to the Red Book standard. In most cases this is not actually a problem, unless the disc is to be used as a master for the production of audio CDs.

It was, in fact, the CD-ROM industry that first identified the potential for using CD-R as a premastering medium. A writable CD gives developers the opportunity to more accurately test a program on the computer for which it is intended, rather than having to create a simulation on hard disk. Once CD-R replay equipment had been installed at most of the major CD plants, it was a logical step for them to accept material for other formats; CD-DA (digital audio) and Video CD, for example.

However, the Orange Book format does not provide a full subcode track and this can result in some difficulties at the glass mastering stage. CD plants therefore prefer discs written in the Red Book format, although most of them also accept Orange Book discs which they will then transfer to either a Red Book CD-R or Exabyte tape, adding the necessary subcodes.

MANUFACTURING BLANK CD-Rs differs somewhat from that of pressed discs. While the polycarbonate substrate is moulded on the same type of machine as a conventional CD, the temperature and clamping force of the mould is higher, and moulding and cooling times are usually longer in order to ensure a high degree of flatness and optimum groove reproduction.

A coating of dye is then applied to the substrate and baked, after which a thin gold reflective layer is added. Finally, a lacquer coating is applied and cured, forming a protective layer over the coating.

On some CD-Rs this protective layer has shown a susceptibility to damage from the inks used in many felt pens. The fact that

most users wish to label their discs, and searching out a special pen each time is an added inconvenience, has led KAO to develop a hard coating material for their discs. This allows almost any felt or soft, oil-based pen to be used without risk of harming the recording surface beneath. Another solution is to add further layers of protective resin and is offered by Kodak (called InfoGuard) and Mitsui Toatsu. In its literature, 3M is eager also to highlight the dangers of applying adhesive labels to CD-Rs as adhesive components may interact with the disc, damaging the reflective layer and causing loss of data, and labels can peel at the edges, causing damage to the drive itself. Labels can also have an adverse effect on the rotational stability of a drive.

THE ISSUE OF DURABILITY of the resin layer of CD-R is modest when compared to that of the dyes used to record data.

The CD-R format utilises a high-intensity laser process to write the data onto the disc—a 780nm pulsed 35mW laser heats areas of a thermally-sensitive opaque dye, which become translucent. During the read process, light from a low-intensity 2.5mW laser is reflected from the light and dark areas of the dye to retrieve the data.

Regular users of recordable CDs will have noticed that some discs are gold in colour while others have a distinctly green hue. This is because of the different formulations used for the dye coating—cyanine's natural blue appearing green on the gold layer and phthalocyanine's natural yellow remaining so.

The original commercial formulation was cyanine-based, distinguished by its green colour from the gold phthalocyanine (the 'p' is silent, as in pterodactyl), which is far more resistant to heat, humidity and bright light, and is expected to offer a much longer archiving life than cyanine.

A drawback of phthalocyanine, however, is that it is significantly less tolerant to variations in laser power. While many CD-R recorders automatically adjust power to match the disc being written, not all drives do so—including one of the market's largest selling 4x writers.

Cyanine, meanwhile, remains stable over a wide laser power range, and at all writing speeds up to 6x. This ensures compatibility with a wide range CD writers and players. Cyanine discs have also performed better in the Time Interleave Analysis (TIA) test—one of the key measurements used to establish whether a CD-R conforms to the Orange Book specification.

Development work on phthalocyanine dyes has continued and has already resulted in a number of improvements to existing ranges of CD-R blanks—giving them many of the beneficial properties offered by phthalocyanine discs. KAO claims that its research has culminated in a new phthalocyanine dye which offers both a long archiving life and compatibility with a wide range of CD-R drives. This is expected to be launched within a few months, once trials intended to ensure complete reliability at write speeds of up to 6x have been completed.

The issue of dyes remains a controversial one, however, since an American journalist and a Japanese media manufacturer locked horns over criticism of the reliability of cyanine. The dye was assessed as being unduly sensitive to light and heat and consequently of having an unacceptably short lifespan. In the real world both cyanine and phthalocyanine appear to have their place as long as they are treated with sufficient respect—a situation long recognised in pro-audio circles over the treatment of magnetic tape. And CD-R offers responsible users a considerably better return in terms of longevity than mag tape has delivered.

Typically, 3M recommends that CD-Rs should be stored away from a direct light source and in a typical office environment of 20°C and 45% RH (relative humidity). Stored under these conditions for two and a half years, 3M found that the mean Block Error Rate remained unchanged at a level of 1.3 counts per second. A level of 50 counts per second can be considered good, with the format's error correction system capable of functioning up to around 220 counts per second. Fingerprints, scratches and adverse environmental conditions will all increase the error count. With this data

BRIDGE UNDER CONSTRUCTION

Dolby[®] FAX[™]
DIGITAL AUDIO TELECOMMUNICATIONS

DICTATOR PEAK PROGRAM LIMITER

PROTECTIVE AND FRIENDLY, YET RUTHLESS...!



- RELIABLE LEVEL PROTECTION
- UNIQUE ILP FUNCTION TO PREVENT PUMPING
- SWITCHABLE SOFTKNEE & BRICKWALL' CLIPPER CIRCUIT
- FULLY BALANCED INPUTS AND OUTPUTS
- INTELLIGENT AUTO RELEASE FUNCTION
- AVAILABLE IN STUDIO AND BROADCAST VERSION



DNA Professional Audio Devices
 P.O. Box 1027
 8300 BA Emmeloord
 The Netherlands
 Tel: +31 (0)527 - 620060
 Fax: +31 (0)527 - 616396

Distributed in the UK by:
 Project Audio
 Unit 1, 321 Essex Road
 London N1 3PS
 Tel: 0171 359 0400
 Fax: 0171 359 3393



Analog & Digital A2-D Audio Measurement System

*The affordable instrument
 Designed to meet the challenges
 of tomorrow's testing needs*



- Analog & Digital Generator and Analyzer
- User friendly front panel
- Stand-alone or remote control via RS-232 or IEEE-488
- Portable

We set the standard in making audio testing AFFORDABLE

NEUTRIK AG Lichtentstein Tel: 0751 237 24 24 Fax: 0751 232 53 93	NEUTRIK Instrumentation USA / Canada Tel: 0514 344 5220 Fax: 0514 344 5221	NCV Germany Tel: 09411 980411 Fax: 09411 99 97 72	NEUTRIK UK Great Britain Tel: 0983 811 441 Fax: 0983 811 439	NEUTRIK Zurich AG Switzerland Tel: 01 734 0400 Fax: 01 734 3891
---	---	--	---	--

NEUTRIK®

CONNECTING THE WORLD

in mind, 3M suggests that it is reasonable to expect a CD-R life-span of up to 100 years, provided that the disks have been stored and handled carefully.

KAO, for one, considers both dye formulations to be essential because of the large number of different machines in daily use—many of them designed before CD-Rs were introduced. The relative merits of cyanine and phthalocyanine are further recognised by HHB, whose successful phthalocyanine-based (and double-coated) branded CD-R medium is soon to be accompanied by a cyanine-based line.

Data recovery and media longevity are important issues and are recognised outside pro-audio. The Special Interest Group for CD-ROM Applications and Technology (SIGCAT) of the American Jet Propulsion Laboratory, for example, undertook an extensive research programme based on 250 discs submitted by all manufacturers active in the field. In the light of large anticipated US government investment in CD-R, the Group reported such findings as lower BLER for 63-minute discs than for 74-minute discs; incompatibilities between 1x recorders and phthalocyanine-based discs, and between high-speed recorders and cyanine-based discs; and (perhaps most sinister) orders of magnitude in differences between its own test results and subsequent retests by media vendors.

While concluding that CD-ROM and CD-R are 'quite different media types' the Group also expressed great concern over wide-ranging results obtained from CD-ROM readers reading CD-R media and reservations over whether certain CD-ROM readers were even incorporating layered error correction in their software. Ultimately, SIGCAT is 'concerned that the interplay of CD-ROM readers and CD-R media is not well understood' but that 'CD-R media is robust' and displays lower block error rates than pressed CD-ROM. Among other recommendations, the group suggest the establish-

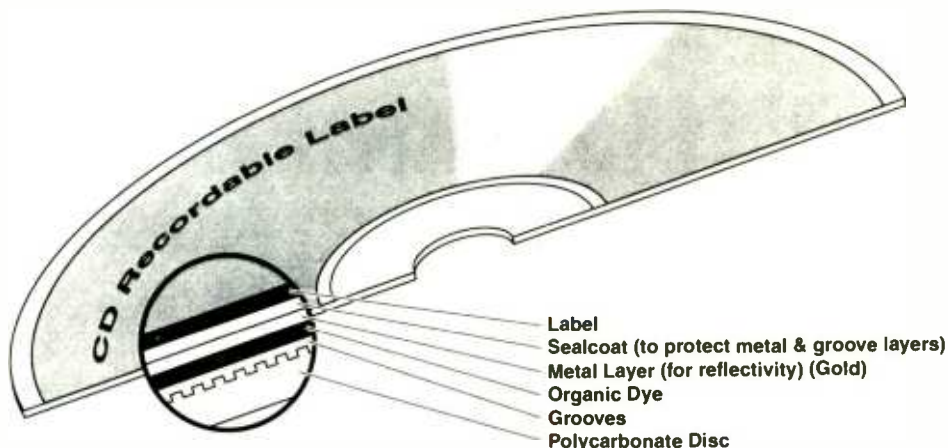

ment of a specification for a 'robust CD-R reader for use in archival situations'.

Research into the area of CD-R longevity is on-going in a variety of areas and with more data, life-expectancy figures are likely to be revised. Presently, manufacturers claims—even if disputed—are typically between 10 and 100 years, although Mitsui Toatsu's own extrapolated ageing tests suggest that 95% of its discs will still be readable after 145 years while Kodak's claim is for 95% at 217 years. As a comparison, stamped CD-ROMs do not suffer from the potential degradation of organic dye and have a suggested life-expectancy of more than 100 years.

CD-ERASABLE —a rerecordable CD format—was actually first announced before the launch of CD-R. In a highly publicised move, Tandy Corporation unveiled THOR back 1988; an erasable/re-recordable disc that Tandy reckoned to make available in 1990, along with a companion CD recorder. Unfortunately it proved impossible to turn the theory into a marketable product and after several delays the project quietly died.

But the ability to over-write and update the data on a CD-R remains an attractive proposition for many applications.

CD-E technology itself has been proven to be viable and the market is currently awaiting the final specifications for a standard to be established. This has to be universally acceptable to all drive and media manufacturers, and has still to be set and adhered to. As an indication, 3M expects to have media products available in time for the launch of suitable drives, with migration to the high-density variants of both CD-R and CD-E—offering storage capacities in the region of 7Gb—taking place during 1997. KAO also has a fully-working CD-E product which is currently undergoing trials. However, no one has yet announced the launch of a CD-E drive—which in the case of companies with software catalogues to protect may be as much for political as technical reasons. Arguably, then, there may be no opportunity in the marketplace for an erasable disc at this time.

A frequently asked question is why erasable CDs cannot be manufactured



Ram Peripherals Ltd
Riverside Business Park
Lyon Road
Merton
London
SW19 2RL

For dealer information or
to become a dealer
please call our trade sales
department

0181 543 9696
Fax 0181 543 3419

All A CD Maker and Rimage are copyrighted trade marks



CD-Maker

Duplicate any CD without changing the original PQ codes
Built in CUE SHEET editor to allow manipulation of time codes
T.A.O. to D.A.O. conversion for Glass Master ready CD's
Convert time edited DAT into Glass Master ready CD's
Yamaha 4x speed technology



CD PRINTER

Laser quality print
10-20 second print speed
On-demand, desktop convenience
Prints on lacquer or matte finish media
Eliminates adhesive labels and hand handwriting
Create custom label designs



BASF CD-R MASTER

Digital goes Gold



1996

Special dye
for longer life
...up to 100 YEARS!

DATA SEAL
The protective lacquer for CD-R Master
is very hard and suitable for printing.
Insensitive to solvents.

Simply call sales at
London 0 81 908 8340
Paris (0)14 964 5796
Ludwigshafen (0)621 5920 220
København (0)31 57 00 11
Arnhem (0)263 717 320
Madrid (0)1 562 7845
Milano (0)2 66 216 315
Zürich (0)1 781 9313
Wien (0)1 87 890 314

- Writable up to 5 years after manufacture
- Wide area of applications: for Audio and Data recording; for recording in radio stations, studios, in the office and also for archival of recordings with documentary value
- Availability:
63 minutes / 660 MB, 74 minutes / 780 MB

PROFESSIONAL AUDIO VIDEO

ADDED VALUE BY BASF



BASF

using the same magneto-optical technology as that used for 5.25-inch computer discs and MiniDisc. In fact, there is absolutely no reason why a CD-sized disc could not be made in this way—the problem is that the discs would not replay on a standard CD player. A MiniDisc player was designed from the outset to replay both pressed discs, which have the same properties as a CD, and M-O discs which have quite different reflective properties.

To their credit, Philips and Sony have (with the possible exception of CD-Video) succeeded in maintaining backwards compatibility with all the new CD formats they have introduced. For example, the CD-R process, as defined by the Orange Book, requires a number of additional steps during recording but this is to ensure that to any CD player they look exactly like a standard pressed CD. The same will have to be true of CD-Es.

As far as the pro-audio industry goes, there is the additional question of whether an erasable disc is actually necessary. How many studios re-use their tapes? Currently, the majority of CD-Rs are being used to make reference copies for artists and producers, or as premasters for CD manufacture. In the former case, it is unlikely that an artist or producer would return a disc after listening to it—and even if they did, could a heavily played, finger marked disc be re-used anyway? In the latter instance, a CD premaster is normally archived in case further masters are needed.

This latter point also raises another issue: if it is subsequently decided that the material recorded on an erasable CD is to be retained, what is the best method of protecting the disc from being accidentally overwritten?

The write-many capability of CD-E does, however, offer increased convenience in applications where updating data is more useful than complete replacement, particularly for project-in-progress reference copies. The high-density variants of CD-R will benefit the interactive and multimedia market especially, for training and teaching programmes, interactive operational and service manuals, and software development.

One of the areas where erasable discs could conceivably find favour is in broadcasting, where a particular set of music cues or sound effects may only be needed once, or a programme transcription, once transmitted the disc can be returned for re-use. Even then, if the current downward trend in CD-R pricing is followed by CD-E, the return shipping cost may exceed that of the raw material.

When they arrive, the first generation of CD-E recorders will be 4x speed, and will be able to read existing CD-ROMs, with read-write capability for both CD-Rs and CD-Es. Future generations of CD-ROM drives will also read CD-R and CD-E, whereas the current CD-ROM drives are regarded to be incompatible with CD-E and will be unable to read the discs.

IN THE 13 or so years since CD was first introduced in Japan, the market for recordable CDs has been growing at a

steadily accelerating pace, both within pro-audio and across the computer industry in general. Hardware costs have now ducked under the £1000 retail level, with drives expected to become still more economical during the next 12 months. The growth curve for the spread of CD-R drives, for example, is predicted to keep rising for the next few years and is not showing any signs of having reached a saturation plateau. The commercial availability of CD-E would help sustain the slope of this growth curve still further.

At present, the running time of an Orange Book compliant CD-R is limited to 74 minutes. Discs offering up to 80 minutes are available from some sources, but these are outside the current specification and this can lead to problems when they are used on some drives.

Producing an 80-minute disc is technically possible using today's manufacturing technology, and should Philips and Sony decide to change the Orange Book specification at some time in the future, KAO is confident that it can meet this challenge and produce a consistently reliable product. But in the meantime the company will continue to make only discs that are guaranteed to conform fully with the current Orange Book standards.

Also hovering not far below the 12-month horizon is DVD, the high-capacity Digital Versatile Disc (formerly Digital Video Disc) format being developed by Philips and Sony in conjunction with 3M, who is helping to provide the dual-layer disc technology. With the experience gained from standard density CD-E, an erasable DVD will probably appear soon afterwards.

In fact, it is quite likely that the introduction of DVD will eliminate the need for both 80-minute discs and read-write speeds higher than 6x. KAO believe that DVD will be the next major development in the CD market and working demonstrations of these high density 4.7Gb discs have already been given by the various signatories to the format. 8.5Gb dual-layer discs are promised soon.

But 3M presently sees CD-R and its derivatives as having a market lifespan extending well into the next millennium. Probably beyond yours and mine. ☺

THANKS TO

Richard Keaney, KAO Infosystems UK plc,
Quay West, Salamander Quay, Park Lane,
Harefield, Middlesex UB9 6NY, UK.
E-mail: rkeaney@kao.ie

Simon Harvey, 3M UK plc, 3M House,
Bracknell, Berkshire RG12 1JU, UK.
Tel: +44 1344 858 810.
Fax: +44 1344 858493.
E-mail: sharvey@mmm.com

Steve Angel and David Beesley, HHB
Communications Ltd, 73-75 Scrubbs
Lane, London NW10 6QU.
Tel: +44 181 962 5000.
Fax: +44 181 962 5050.
E-mail: sales@hbb.co.uk



ADVANCED MEDIA PRODUCTS

INTERNATIONAL DISTRIBUTORS

AUSTRALIA: AUDIO SOUND CENTRE
Tel: 02 9901 4455 Fax: 02 9901 4229
Contact: Geoff Grist

AUSTRIA: AKG ACOUSTICS
Tel: 01 866 54 256 Fax: 01 866 54 549
Contact: Reinhold Fliedl

BELGIUM: T.E.M. S.A.
Tel: 2 466 5010 Fax: 2 466 3082
Contact: Guido Van De Vijver

CANADA: STUDER CANADA LTD
Tel: 416 510 1347 Fax: 416 510 1294
Contact: Dave Dysart

CZECH REPUBLIC: AUDIOPOLIS
Tel: 42 2 322 552 Fax: 42 2 323 069
Contact: Jan Adam

DENMARK: INTERSTAGE
Tel: 39 62 00 26 Fax: 39 62 06 40
Contact: Finn Juul

FRANCE: MILLE ET UN SONS
Tel: 1 46 67 02 10 Fax: 1 47 89 81 71
Contact: Didier Rupin

GERMANY: TRIUS
Tel: 05451 940840 Fax: 05451 78049
Contact: Hubert Overesch

GREECE: KEM ELECTRONICS
Tel: 01 647 8514 Fax: 01 647 6384
Contact: Thimios Kolikotsis

HOLLAND: K&D PROFESSIONELE
Tel: 2526 87889 Fax: 2526 87362
Contact: Daan Verschoor

HONG KONG: DIGITAL MEDIA TECHNOLOGY
Tel: 2 721 0343 Fax: 2 366 6883
Contact: Wilson Choi

INDIA: P A C E LTD
Tel: 22 633 5450 Fax: 22 633 5450
Contact: Joe Gonsalves

IRELAND: BIG BEAR SOUND LTD
Tel: 01 662 3411 Fax: 01 622 3412
Contact: Julian Douglas

ISRAEL: BAND-PRO FIM/VIDEO INC
Tel: 03 673 1891 Fax: 03 673 1894
Contact: Shai Danieli

ITALY: AUDIO EQUIPMENT
Tel: 039 212 221 Fax: 039 214 0011
Contact: Donatella Quadrio

JAPAN: SOUNDHOUSE
Tel: 476 22 9333 Fax: 476 22 9334
Contact: Rick Nakajima

KOREA: DAI KYUNG ELECTRONIC
Tel: 2 747 6187 Fax: 2 766 8504
Contact: Dae Hyun Han

NEW ZEALAND: AUDIO VIDEO WHOLESALEERS
Tel: 07 847 3414 Fax: 07 847 3412
Contact: Murray D. Hunt

NORWAY: SIV. ING BENUM A/S
Tel: 22 1 45460 Fax: 22 1 48259
Contact: Wenche Gronvold

POLAND: STUDIO DAVE
Tel: 2 226 4912 Fax: 2 635 5262
Contact: Bogdan Wojciechowski

PORTUGAL: ESTEREOSOM LDA
Tel: 01 354 4029 Fax: 01 357 2981
Contact: Jorge Goncalves

RUSSIA: ABV COMPANY
Tel: 95 233 6017 Fax: 95 233 6019
Contact: Boris Nekrasov

SINGAPORE: TEAM 108 PTE LTD
Tel: 065 748 9333 Fax: 065 747 7273
Contact: Helena Lim

SOUTH AFRICA: MASTERDISC PTY LTD
Tel: 012 804 2470 Fax: 012 804 2819
Contact: Gerald Prins

SPAIN: KASH PRODUCTIONS
Tel: 91 367 5222 / 91 377 0668 Fax: 91 367 5209
Contact: Jim or Carmen

SWEDEN: INTERSTAGE
Tel: 020 79 70 99 Fax: 020 79 77 09
Contact: Finn Juul

SWITZERLAND: DR. W.A. GUNTHER AG
Tel: 01 910 4141 Fax: 01 910 3544
Contact: Monika Lindegger

TAIWAN: ADVANCETEK INT'L CO LTD
Tel: 2 719 2388 Fax: 2 716 0043
Contact: Julian Lin

USA: HHB COMMUNICATIONS INC
Tel: 207 773 2424 Fax: 207 773 2422
Contact: Fraser Jones



HHB Communications Limited

73-75 Scrubbs Lane · London NW10 6QU · UK
Tel: 0181 962 5000 Fax: 0181 962 5050 E-Mail: sales@hbb.co.uk

HHB ADVANCED MEDIA PRODUCTS THE FUTURE IS SECURE



DAT
Digital Audio Tape

Three years ago at HHB Communications, the world's leading independent supplier of DAT technology, we set ourselves the challenge of developing the world's most technically advanced DAT tape. Naturally we were delighted when, less than a year later, HHB DAT Tape came out on top in the detailed testing of seven leading DAT tape brands, conducted independently by Studio Sound magazine.

Well now there's more good news for discerning audio

professionals everywhere.

Announcing the HHB CDR74 Recordable CD – the latest of HHB's Advanced Media Products.



COMPACT disc
Recordable

Once again, we set out to be the best. Fully compatible with the new generation of high speed writers, the 74 minute / 680MB disc employs a revolutionary Phthalocyanine organic dye recording layer to ensure a secure archiving period well in excess of 100 years. What's more, the HHB CDR74 is "Double Coated" for further protection against scratches, fingerprints, humidity and light.

Also new to the HHB Advanced Media Products range is the

DDS Digital Data Storage
Media Recognition System

DDS90M, a high performance 90 metre data DAT cartridge incorporating many of the design innovations already proven in HHB audio DAT tape.

At HHB, we know that your recordings are valuable. Thanks to HHB Advanced Media Products, the future is secure.

For full details of HHB Advanced Media Products, please mail this coupon to HHB Communications Limited

Name: _____

Address: _____

Tel: _____

HHB Communications Ltd · 73-75 Scrubs Lane, London NW10 6OU, UK · Tel: 0181 962 5000 · Fax: 0181 962 5050 · E-Mail: sales@hhb.co.uk
Independent Audio Inc · 295 Forest Avenue Suite 121, Portland, Maine 04101-2000, USA · Tel: 207 773 2424 · Fax: 207 773 2422 · 75671.3316@compuserve.com

SS



World events

January 1996

◆ January 5th-7th

Showbiz Expo East
New York Hilton & Towers, New York, US. Tel: +1 513 8400.

◆ January 9th

UK AES Conference: Putting the Acoustics Back in Loudspeaker Design

Imperial College, London, UK. Tel: +44 1628 663725.

◆ January 9th-12th

MacWorld Expo
Las Vegas, US.

◆ January 9th-12th and February 20th-23rd

Internet and System Security: Attacks and Countermeasures

Learning Tree Education Centre, London, UK. Tel: +44 800 282353.

◆ January 15th-16th

The Live! Show
London, UK.

Tel: +44 1322 660070.

◆ January 17th-18th

Computer Virus Workshops

Abingdon, Oxford, UK. Tel: +44 1235 559933.

◆ January 18th-21st

NAMM Convention
Anaheim, USA.

◆ January 21st-25th

Midem

Cannes, France. Tel: +33 1 44 3444 93.

◆ January 30th to February 1st

SortExpo 95

Santa Clara Convention Centre, Santa Clara, US.

Fax: +1 303 745 5712.

February 1996

◆ February 6th-8th

The ISDN & Broadband User Show

Olympia 2, London, UK. Tel: +44 1733 394304.

◆ February 9th-12th

Mila, Cannes, France.

◆ February 11th-14th

SIEL 96, Paris, France.

Tel: +33 1 45 22 35 40.

◆ February 13th-14th

Live Virus Workshop

Latimer House, Bucks, UK.

Tel: +44 1296 318700.

◆ February 13th-15th

Video Forum 96

Wembley Conference and Exhibition Centre, London, UK.

Tel: +44 1273 857800.

◆ February 13th-16th

Expo Comm Mexico 96 including Wireless Technologies Mexico 96

World Trade Centre, Mexico City, Mexico.

Tel: +1 301 986 7800.

◆ February 15th-18th

World Audio Visual Entertainment Fair

Bangkok Convention Centre, Bangkok, Thailand.

Tel: +662 95066014.

◆ February 20th-13rd

Internet and System Security: Attacks and Countermeasures (Part 2)

Learning Tree Education Centre, London, UK.

Tel: +44 800 282353.

March 1996

◆ March 11th-14th

DSPx 96

San Jose Convention Centre, San Jose, US.

Tel: +1 203 840 5652.

◆ March 12th-15th

Aseanplas 96

Jakarta, Indonesia.

◆ March 13th-15th

The Television Show

Business Design Centre, London, UK.

Tel: +44 171 344 3861.

◆ March 13th-17th

Musikmesse and Pro Light & Sound

Messe, Frankfurt, Germany.

Tel: +49 69 7575 6662.

◆ March 26th-30th

The Pro Audio Show

The Holiday Inn Crown Plaza, Karachi, Pakistan.

Tel: +9921 498 4012.

April 1996

◆ April 4th-7th

Broadcast Thailand

Queen Sirikit National Convention Centre, Bangkok, Thailand. Tel: +66 2 503 2199.

◆ April 14th-18th

NAB Radio 96

Los Angeles, California, US. Tel: +1 202 429 5350.

◆ April 16th-18th

REPLITech Europe 96

Jaarbeurs Congress and Convention Centre, Utrecht, The Netherlands.

Tel: +1 914 328 9157.

◆ April 21st-23rd,

Midcab & Midsat 96

Abu Dhabi Exhibition Centre, UAE. Tel: +971 4 310551.

◆ April 23rd-25th

Entech 1996

Sydney Exhibition Centre, Sydney City, Australia.

Tel: +61 2 876 3530.

◆ April 23rd-27th

SuperHighway China 96

Beijing Exhibition Centre, China.

Tel: +86 841 5250.

May 1996

◆ May 11th-14th

100th AES Convention

Bella Centre, Copenhagen, Denmark. Tel: +45 9785 1122.

◆ May 12th-14th

NSCA, St Louis, USA.

◆ May 14th-16th

Midem Asia, Hong Kong.

Tel: +33 1 44 34 454 44.

◆ May 17th-20th

BTV China, China Foreign

Trade Centre, Guangzhou, China. Tel: +852 2862 3460.

◆ May 25th-28th

Pro Audio Light & Music China 96, Beijing Exhibition

Centre, Beijing, China.

Tel: +852 2861 3331.

◆ May 28th-30th

7th Conference and Exhibition on Television and Audio

Technologies Thermal Hotel

Helia, Budapest, Hungary.

Tel: +36 1 153 0127.

◆ May 29th-June 1st

Expo Show 96

St Petersburg, Russia.

Tel: +7 812 119 6245.

June 1996

◆ June 1st-4th

Nightwave 96, Exhibition Centre, Rimini, Italy.

Tel: +39 541 711249.

◆ June 4th-6th

REPLITech, San Jose, US.

Tel: +1 914 328 9157.

◆ June 4th-7th

Broadcast Asia, World

Trade Centre, Singapore.

Tel: +65 338 4747.

◆ June 5th-8th

Third Annual Latin American Pro

Audio & Music Expo. World Trade Centre, Mexico.

Tel: +541 864 4036.

◆ June 6th-9th

Montreux International Radio Symposium and

Technical Exhibition including 1st Interactive Media Symposium and

Exhibition, Montreux, Switzerland.

Tel: +41 21 963 52 08.

◆ June 10th-15th

Americas TELECOM 96,

Rio de Janeiro, Brazil.

Tel: +41 22 730 6161.

◆ June 19th-21st

Audio 96: Technology & New Media (APRS)

Olympia, London, UK.

Tel: +44 1734 756218.

◆ June 20th-22nd

World Lighting Fair 96

Pacifico Yokohama Exhibition

Hall, Yokohama, Japan.

Tel: +81 3 3706 5687.

July 1996

◆ July 10th-12th

Pro Audio & Light Asia 96

World Trade Centre, Singapore.

Tel: +65 227 0688.

◆ July 12th-14th

Summer NAMM

Nashville, US.

August 1996

◆ August 7th-10th

MacWorld Expo

Boston, USA.

◆ August 15th-18th

Popkomm, Cologne, Germany. Tel: +49 221 8210.

◆ August 26th-29th

Windows Solutions Expo & Conference

San Francisco, US.

September 1996

◆ September 4th-8th

CEDIA, Dallas, Texas, US.

◆ September 7th-10th

British Music Fair, Earls

Court, London, UK.

Tel: +44 1442 215435.

◆ September 12th-16th

IBC 96, RAI, Amsterdam,

The Netherlands.

Tel: +44 171 240 3839.

◆ September 17th-19th

Interactive Multimedia Association Expo

New York, US.

◆ September 18th-23rd

photokina, KölnMesse,

Cologne, Germany.

Tel: +49 221 821-0.

◆ September 21st-23rd

cones, MOC Events Centre,

Munich, Germany.

Tel: +49 89 51070.

◆ September 24th-29th

Live 96, Earls Court, London,

UK. Tel: +44 181 233 9306.

October 1996

◆ October 24th-26th

Broadcast India 96: Exhibition & Symposium

World Trade Centre, Bombay,

India. Tel: +91 22 215 1396.

November 1996

◆ November 5th-9th

PTIExpo Comm China

China International Exhibition

Centre, Beijing, Peoples

Republic of China.

Tel: +52 525 592 3257, US.

Tel: +1 301 986 7800.

Studio sound

February 1996. Vol 38. No 2.
ISSN 0144 5944

EDITORIAL Editor: Tim Goodyer Production Editor: Peter Stanbury Editorial Secretary: Deborah Harris US Representative: Debra Pagan
Consultants: Francis Rumsey; John Watkinson Columnists: Dan Daley; Chris Edwards; Barry Fox; Kevin Hilton; Jim James Regular Contributors:
Jim Betteridge; Simon Croft; James Douglas; Ben Duncan; Dave Foister; Tim Frost; Yasmin Hashmi; Philip Newell; Terry Nelson; Stella Plumbridge;
Martin Polon; Zenon Schoepe; Keith Spencer-Allen; Patrick Stapley; Simon Trask; Andy Wood Publishing Editor: Joe Hosken Executive Editor: Nick Smith
ADVERTISMENT SALES Executive Ad Manager: Steve Grice Deputy Ad Manager: Phil Bourne Business Development Manager: Georgie Lee
Advertisement Production: Mark Trainer PA to the Publisher: Lianne Davey Managing Director: Doug Shuard Publisher: Steve Haysom.

Miller Freeman Entertainment Ltd, 8th Floor, Ludgate House, 245 Blackfriars Road, London SE1 9UR, UK. Tel: +44 171 620 3636. Fax: +44 171 401 8036. E-Mail: cz73@cityscape.co.uk

© Miller Freeman plc. 1996. All rights reserved. No part of this publication may be reproduced or transmitted in any form or by any means, electronic or mechanical including photocopying, recording or any information storage or retrieval system without the express prior written consent of the publisher. The contents of Studio Sound and Broadcast Engineering are subject to reproduction in information storage and retrieval systems. Studio Sound and Broadcast Engineering incorporates Sound International and Beat Instrumental. Studio Sound and Broadcast Engineering is published monthly. The magazine is available on a rigidly controlled requested basis, only to qualified personnel. The publisher may pass suitable reader addresses to other relevant suppliers. If you do not wish to receive sales information from other companies, please write to Circulation and subscription at the address below. **Subscription Rates.** UK annual: £36.00. Europe: £50.00/US\$80.00. Overseas airmail. American continent: £62.50/US\$100.00. Rest of the World: £62.50/US\$100.00. Refunds on canceled subscriptions will only be provided at the publisher's discretion, unless specifically guaranteed within the terms of the subscription offer. Circulation and subscription Assistant Circulation Manager: Joanna Southward UK: Miller Freeman Entertainment Ltd, Royal Sovereign House, 40 Beresford Street, London SE18 6BQ. Tel: 0181 855 7777. Fax: 0181 317 3938. US: Studio Sound and Broadcast Engineering Magazine, 2 Park Avenue, 18th Floor, New York NY 10016. US Postmaster Please send address corrections to: Studio Sound and Broadcast Engineering Magazine, c/o Mercury Airfreight International Ltd Inc, 2323 Randolph Avenue, Avenel, New Jersey NJ 07001. US second class postage paid at Rahway, NJ. Originated by Craftsmen Colour Reproductions Ltd, Unit 1, James Street, Maidstone, Kent ME14 2UR, UK. Printed in England by St Ives (Gillingham) Ltd, 2 Grant Close, Gillingham Business Park, Gillingham, Kent ME8 0QB, UK. Newstrade Distribution (UK) UMD, 1 Benwell Road, London N7 7AX, UK. Tel: 0171 700 4600. Fax: 0171 607 3352.

ABC
AUDIT BUREAU OF CIRCULATIONS
BUSINESS PRESS

Total average net circulation of 18,981 copies
July 1994-June 1995.
(UK: 6,917. Overseas: 12,064. (ABC audited)

BPA INTERNATIONAL
MEMBERSHIP APPLIED
FOR SEPTEMBER 1995

Miller Freeman
A United News & Media publication

Advertisers Index

AES	56	FOCAL PROLINE	36	ROGERS	72
AMEK	10	FOCUSRITE	42,43	ROLAND	29
AMS NEVE	27	GENELEC	74	SENNHEISER	14
APHEX	OBC	HAND HELD AUDIO	72	SONY	6,7
AUDIO TECHNICA	56	HNB	38,39,80,81	SOUNDCRAFT	25
BASF	79	LEXICON	17	SOUNDTRACS	37
BEYERDYNAMIC	34,35	MACKIE	52,53	SSI	48
BPM	61	MEYER	18,19	SSL	4
BSS	51	MILAB	60	STIRLING AUDIO	32
CALREC	23	NEUTRIK	77	STUDER	54
CCS-MUSICAM	55	RAM	78	STUDIO SPARES	69
DCS	72	RE BROADCAST	47	TL AUDIO	12
DDA	IFC	RE'AN	72	TONNMEISTER	83
DIGIDESIGN	30,31	RICHMOND FILM	56	TURBOSOUND	65
DIGIGRAM	71				
DNA	77				
DOLBY	76				
DYNAUDIOACOUSTICS	91				

Wir geben
den Ton an.
We call
the tune.



19. Tonmeistertagung

International Convention on Sound Design

Karlsruhe 15.-18. Nov. 1996

Bildungswerk des VDT · Organisationsbüro

Am Zaarshäuschen 9 · 51427 Bergisch Gladbach

Telefon 02204-23 595 · Fax 02204-21 584

<http://www.bkm.net/vdt>

RATES: All sections £30 per single column centimetre (minimum 2cm X 1)

Box number £10 extra per insertion

Published: monthly

Copy deadlines: contact John French

To place an advertisement contact: Studio Sound (Classified),
Miller Freeman House, Sovereign Way, Tonbridge, Kent, UK, TN9 1RW
International tel: +44 1732 377421

Fax: +44 1732 368210

All box numbers reply to the address above

APPOINTMENTS

Sony is a leading manufacturer of broadcast video, professional audio and business communications products. Our operation in Basingstoke houses specialist functions such as Strategic Marketing, Broadcast Systems Integration and R&D. We are the headquarters for East and Western Europe, the CIS, Africa and the Middle East.

International Manager Business & Applications Development

Professional Audio - Hampshire based

We are continuing to strengthen our international audio team to meet the growing challenges and opportunities of our marketplace.

Consequently we are looking for a dynamic self-starter who will play a key commercial role within our headquarters team to develop the market.

Reporting to the General Manager your role will be to increase our professional audio business, developing and executing market strategies through:

- **Developing a clear understanding of the various market sectors including recording studios, radio and TV applications, TV and film post-production.**
- **Monitoring the business by market sector, product and application.**
- **Identifying new initiatives and promotions.**
- **Building strong relationships with our Sales Companies, Product Managers, Systems division and manufacturing centres.**

To meet this challenge you will already possess a good knowledge of the products, technologies and markets within a pan-European business environment. Although an engineering and/or marketing qualification is an advantage, your strong sales and commercial background within professional audio will be essential. Of course this will be complemented by your excellent interpersonal and communication skills, PC literacy and financial awareness. Finally – irrespective of your mother tongue – you will be fluent in English and, preferably, one other European language:

This position carries the generous rewards you would expect from a successful organisation for the right applicant, including relocation and a fully expensed car. If you feel that you are ready for this next step, please write with a full CV to Lynda Magee, Human Resources, Sony Broadcast & Professional Europe, Jays Close, Viables, Basingstoke, Hampshire RG22 4SB, UK.

We are an equal opportunities employer. Applications are encouraged from all people, irrespective of sex, race or disability.

SONY

Sony is a trademark of the Sony Corporation, Japan.

UNIVERSITY OF SURREY

Department of
Music

LECTURER IN AUDIO

The Music Department wishes to appoint a Lecturer in Audio, capable of contributing to teaching, research and administration. The Department has established a world-wide reputation for its *Tonmeister* degree course in Music and Sound Recording, which successfully integrates academic study with practical experience and professional training, and it is expanding both its research and taught postgraduate activity in the field of audio. Applicants should possess a Bachelor's or Master's degree in a relevant field. It is not necessary for applicants to have gained a research degree, but they should have research interests and be motivated towards establishing a research record. No field of specialism is excluded, and applicants with broad-based audio industry experience will be welcomed.

Informal enquiries may be directed to David Fisher or Francis Rumsey, telephone 01483 259317, email: d.fisher@surrey.ac.uk or f.rumsey@surrey.ac.uk. Worldwide Web: <http://www.mus.surrey.ac.uk>.

Salary will be on the Lecturer Grade A salary scale (£15,154-\$19,848 per annum) according to age, qualifications and experience. Superannuation under USS conditions.

Further particulars are available from the Personnel Office (CVC/mah), University of Surrey, Guildford, GU2 5XH, telephone (01483) 259279. Applications in the form of a CV (2 copies), which should include the names and addresses of three referees, should be sent to the same address by 22 March 1996, quoting reference number 447.

The University is committed to an Equal Opportunities Policy: Promoting excellence in education and research.

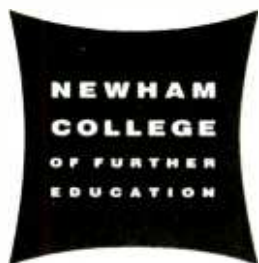

As one of London's largest colleges, we provide further education and training on an open-access basis to more than 14,000 students a year. We are ambitious, progressive and expanding well ahead of our targets. We offer excellent conditions of employment and are looking for applicants with the enthusiasm and commitment to work with us to provide the highest quality service.

Faculty of Technology
Instructor for Music Technology
 up to £15,800 or £17,300* pa
 Ref: T215

To supervise and instruct students in practical skills relating to all aspects of music technology and to assist in the organisation and maintenance of equipment and learning resources. You will be responsible for preparing and clearing areas for practical work. Experience of training, advising or demonstrating within a learning environment is essential along with practical skills in music technology. (*) depending upon qualifications.

You must be committed to the College's policy of customer care, flexibility in service delivery and open-access for all communities.

For further details ring:

0181-470 5047

(answerphone after 5pm) or write to the Human Resources Division, Newham College of Further Education, East Ham Campus, High Street South, London E6 4ER.

Please quote reference number in all communications.

Closing date: 1st March 1996.

Get Ahead

STRIVING FOR EQUAL OPPORTUNITIES IN EMPLOYMENT AND SERVICE DELIVERY



Sony Music Sony Music Sony

WHITFIELD STREET Recording Studios

The Whitfield Street Recording Studios is one of the leading recording and post production studios in the UK and is a subsidiary of Sony Music Entertainment (UK) Limited. It attracts a diverse spectrum of Sony Music and other major labels' artists and projects from around the world including Madonna, Simply Red, Bjork and a host of orchestral film score recordings for composers such as Jerry Goldsmith, Michael Kamen and Rachel Portman.

We are presently undergoing a major renovation and expansion programme to service in-house and third party labels requirements in all aspects of classical post production.

We are, therefore, recruiting and are seeking applications from experienced

CLASSICAL: EDITORS, MASTERING ENGINEERS AND FACILITY MANAGERS

Applicants will need to demonstrate an interest and extensive knowledge of classical music.

Editors and Engineers should provide a CV and covering letter which illustrates classical projects undertaken, technical expertise and a knowledge of Sonic Solutions systems.

Facility Managers should provide a CV and covering letter which details the experience and skills gained with the management of a post production facility.

MAINTENANCE ENGINEERS

Due to the expansion, we are also increasing the Maintenance Department who provide "around the clock" technical support to all areas of the studio.

Maintenance Engineers who are prepared to work a shift system should send a CV with covering letter; it will detail at least one years experience in a sound studio environment and technical expertise which includes a working knowledge of SSL and/or Neve consoles, analogue and digital multitrack, film sound, DAW's, disc cutting and present day digital mastering.

Successful candidates will be rewarded with a competitive salary and a comprehensive range of benefits linked to working within a major music company.

If you are interested in becoming part of this exciting venture, please send your CV, covering letter and salary expectations to Jackie McGee, Human Resources Manager, Sony Music Entertainment (UK) Limited, 10 Great Marlborough Street, London W1V 2LP.



TRANS WORLD INTERNATIONAL
 the world's largest independent Sports Production Company requires

HEAD OF SOUND

with broad knowledge of both production and post-production sound techniques and ability to manage the day to day administration of the sound department. The post involves close co-operation with production departments and the responsibility for technical standards. Some operation of dubbing suites and occasional overseas travel should be expected. Attractive salary for suitable applicant.

DUBBING MIXER

preferably with AudioFile and Logic 1 experience to work on wide variety of programmes including live-to-VT voice-overs and complex creation of effects tracks for mute material. Ability to work to tight deadlines and irregular hours essential. Attractive salary for suitable applicant.

Please apply in confidence including CV and current salary details to Karen Mullings, TWI House, 23 Eyot Gardens, London W6 9TR.

SALES AND ENGINEERING

A number of excellent opportunities have arisen as a result of our clients' planned expansion in 1996. Vacancies exist NOW in

- International Sales,
- Field Engineering,
- Projects/Systems,
- Software Development,
- Hardware Design,
- Service and Test Engineering.

You should be educated to HNC/Degree level electronics and possess relevant industry-related experience.

To discuss your next career step please telephone or write to Emma Wharton or Mike Jones, Broadcast & Communications Professionals, Unit 9B, Intec 2, Wade Road, Basingstoke, Hampshire RG24 8NE.

Tel: 01256 470704. Fax: 01256 844054.
 E-Mail: 100754.3571@Compuserve.com

SERVICE ENGINEER

Salary Negotiable

Due to the expansion of our service facility in High Wycombe we now require additional Service Engineers. Knowledge of radio microphones and multi-channel radio installations highly desirable, as well as an understanding of all things audio related. Qualifications to HNC or equivalent. Driving licence.

Applications in writing with CV to:

Ian Smale, Service Manager



3 Century Point, Haliiax Road
 High Wycombe, Bucks, HP12 3SL

SALE BY AUCTION

By order of Royscot Trust plc and others
At the former BBC Engineering Workshops, Power Road, Chiswick, London W4, UK

On **TUESDAY 27th FEBRUARY** at 10.30 am

IMPORTANT SALE BY AUCTION

OVER 2,000 LOTS OF STUDIO AND LOCATION LIGHTING, TV STUDIO, POST-PRODUCTION AND AUDIO EQUIPMENT, COMPUTERS AND OFFICE FURNITURE

Over 1200 items of Studio and Location Lighting, including lights from Ianiro. CCT. Ballancroft, Lee. Strand, sizes from 0.8kW to 10kW, stands, cables, ballasts, dimmers, etc.
TV Studio and Post Production Equipment including Tripods, Heads, Film Editing and Processing Equipment, Video cameras. BVW-75 and other Video Recorders, Grass Valley and other Vision Mixers, Digital Video Effects and Post Production Equipment.

Audio Equipment including Audio Mixing Desks, Sound Recorders, Amplifiers, etc.
Computers and Office Furniture including Apple, Pentium and Multimedia computers, Laser Printers and Peripherals, Office furniture and Equipment, and General Equipment.
Viewing on Monday 26th from 9am to 4.30pm, and from 9am on the morning of sale.



HENRY BUTCHER

BROWNLOW HOUSE, 50/51 HIGH HOLBORN,
LONDON WC1V 6EG
TEL: 0171-405 8411. FAX: 0171-405 9772



**digidesign
PRO SCHOOL**

Official digidesign training
**ProTools, Samplecell,
Sound Designer**

Call for free brochure
(Int. +44 171) **609 2653**

DUPLICATING & MASTERING

Compact Discs - Pro-Mastering - Digibin Cassettes - Reprographics - Print 32 Bit Technology - ISDN Lines - MD2 - 3 Band DSP - One-off CDs

HILTONGROVE
where sound advice counts . . .

Tel: 0181 521 2424 <http://www.knowledge.co.uk/xxx/hiltongrove/> Fax: 0181 521 4343
Alpha Business Centre, 60 South Grove, Walthamstow, London E17 7NX

ONE OFF CD's £20.00 + VAT
Up to 74 Mins

500 CD Singles Complete £690 + VAT. 1000 CD Singles Complete £995 + VAT
500 CD Albums Complete £820 + VAT. 1000 CD Albums Complete £1190 + VAT

Sadie Digital Editing (over 3hrs storage), Editing To Score, Post Mastering, Artwork, PQ Encoding.

Telephone **C.R.S.** 01424 436426

- Hard disk CD mastering
- One-off CDs from £10.00
- Real time cassette copying
- Copy masters, digital editing
- Laser printed labels and inlays
- Every copy individually checked
- Excellent quality and presentation
- Unparalleled service, best prices
- Fast turnaround - hours not days



Magnetic Image
Mastering
0181-960-7222

Our clients tell us our CDs & Cassettes
Sound Better !
It's all down to the mastering!

CD Mastering to Exabyte
One off CDs & replication
Real Time Cassette duplication

DTP design service
short run printing in colour / monochrome
600 sq. ft recording studio
Full location recording service
Fast turnaround - overnight delivery



K.G.
DIGITAL MASTERING
01803 813833

Make it with us . . .
**Sound
Recording
TECHNOLOGY**

• D • I • R • E • C • T •

- COMPACT DISCS
- HIGH END MASTERING
- LATEST 32-BIT DSP
- SUPER BIT MAPPING
- 20 BIT DIGITAL RECORDING STUDIO
- 20 BIT EDITING
- SOUND RESTORATION, DE-CLICK etc
- COPY MASTERS
- DIGITALLY DUPLICATED CASSETTES
- PRINT/REPROGRAPHICS

MARKET LEADERS
☎ 0181 446 3218 LONDON
☎ 01480 461880 CAMBRIDGE

Panton Music

Audio Cassette & CD Duplication Services including
Blanks - Compilation Editing - Printing etc.

Call Dave Panton
+ 44 (0) 121 558 8338
between 10am-1pm Mon-Sat



THE CASSETTE DUPLICATING SPECIALISTS
Real time & high speed loop bin duplication,
printing & packaging. Blanks wound to length.
TEL: 0161 973 1884 FAX: 0161 905 2171

**jbs records
MUSIC and SPEECH**

REAL-TIME/HIGHER-SPEED Quality Cassette
Duplication and Blanks from 1-1000.
Computer printed Labels.
Solo, ¼" reel, Sony Betamax or R-DAT
recording. Fast Security Delivery service.
FILTERBOND LTD, jbs records div, FREEPOST
19 SADLERS WAY, HERTFORD, SG14 2BR
01992-500101

PAUL LIBSON AUDIO SERVICES
SADiE digital post-pro

NEW! Up to 17 hours hard-disk storage
NEW! EXABYTE
THE Post Production Service for your
project at our premises of yours.
Hire also available.
Tel: 0378 060646 or 0171 428 0381

EQUIPMENT FOR SALE



Sounds Incorporated

☎ 44 (0) 1892 861099

nick ryan

fax: 44 (0) 1892 863485

Re-selling Quality Recording Equipment
to Studios throughout the World

COFFEE'S
Leading
Used
Equipment
Specialists
THRESHOLD
Suppliers
of the
Best in
New's
Equipment
Worldwide
Export
RECOVERY
Facilities



CONSOLES

- SSL 4056G+ 1992. Ultimatum, b/g, immaculate £165k
 SSL 5336 16 mono, 4 stereo. Instant reset, dynamics, bar-graphs, 1989, spares kit £95k new £19k
 Neve BCM 10 fitted 10 x 1073's Completely refurbished by ourselves £call
 Neve VRP Legend 48 channels in 48 frame, flying faders, dynamic metering. Latest model 1993 £129k
 Neve DSP 48 48/48 all digital console with 48 A-D, D-A, AES/EBU digital interface. Immaculate £call
 Neve 54 Series 12/2/1 quality, compact 12 channel Neve + mono output £2,995
 Neve 8108 56 channels, in line, bar graphs £40,000
 Amek Hendrix 56 channel, Supermove (flying faders), 15m old, £107k new, interesting history! £55,000
 Amek Mozart 56 frame, loaded 37. 33x MX11's + 4 MZ15RN's. Pristine condition £40,000
 Amek Mozart 40 frame, Supertrue £37,000
 Amek 2500 48 + 4 stereo, private use only one of the best. Mastermix automation £22,500
 DDA AMR 24 44 frame loaded 24, 4 years old, latest model £17,500
 Midas Pro 5 recording console 24/4/16. Immaculate, great sound p/b £4,995
 Midas 24/8 theatre console, ext. p/b, superb £2,500
 TAC Scorpion 24/16/2 £2,500
 Soundcraft 200B 8/4/2 rack mount, blue, very good condition £595
 Tweed Audio 12/2 broadcast console £1,750
 Yamaha DMP 7 digi console, 1 left £450
AMEK MODULES FOR Recall, 501, Magnum, SR 9000/6000 and Scorpion in stock - brand new & bargain prices!!!

ANALOGUE TAPE MACHINES

- Studer A 800 Mk 2/3 loc/rem trolley £13,500
 Studer A 80 MK2 24 track, rem/loc £6,500

USED EQUIPMENT LIST

PHONE +44 (0) 1225 447222 • FAX +44 (0) 1225 447333

- Studer A 80 MK2 8 track, 16 frame £1,500
 Studer A 810 + sync box excellent £1,150
 Studer B62 2 in stock £375
 Otari MTR 90 Mk 2 rem/loc 3,500h £11,500
 Otari MTR 90 Mk 2 remote only v. low hours £10,000
 Otari MX 5050 1/4" 2T, good condition £495
 Ampex ATR 800 1/4" £500
 Dolby SP 8 8 tracks of Dolby A £495
 Audio Kinetics Pacer & Pad £750
 SRC AT+ The best SMPTE-MIDI sync box, 1 left £450

DIGITAL RECORDERS

- AMS AudioFile head ideal for sharing 2 rooms with 1 AudioFile £750
 Mitsubishi X850 full remote etc. £call
 Alesis ADAT v4, few hours use, as new £1,495
 Alesis BRC condition as above £795
 Studer Dyaxis System with synchroniser 2 T can use any format, excellent quality £1,250
 Panasonic SV3700 brand new £call
 HNB PRO 1 DAT portable £call

OUTBOARD

- Fairchild 696 The beast!, immaculate £call
 Neve Classic rack 6 x 33135 + 2 x 33314 compressors racked in blue with all psu's, refurbished and MINT of course! £4,500
 Neve 2253 pair of limiters in rack, psu £795
 RCA BA 86A This is the next Fairchild. Only 100 or so ever made, built in the 40's, refurbished in the 90's with MIT, Wonder Caps, all new tubes etc. + spare set all NOS. Try this one on your vocal - fasten your seat belt and grease your walleye! £call
 RCA BA6 pair, similar to above, mounted in rack with stereo link. Seriously immense stereo limiters! £call
 Neve/Amek 9098 £call
 Neve spares psu, modules etc., loads £call
 Neumann V 72 valve mic amp, 14 in stock £295

- Neumann PV 76 discrete mic amps, 14 in stock £175
 Neumann PEV 1 discrete eq's, rare 5 in stock £350
 Focusrite ISA 115 just serviced £1,695
 Calrec PQ 1161-02 eq mic amps, very similar to Neve £call
 Audio & Design Scamp call for details £495
 MXR Mini Limiters very rare and fierce! £200
 Valley Autogate like Drawmer 2001 but goes faster! £350
 Aitec 436 'John Lennon' valve compressor £795
 TC 1128 with all options fitted £795
 TC 1128+1128X bang prog. graphic + slave unit £1,500 pr
 Symetrix 528 Voice Processor does everything! £295
 Urel 537 27 band graphics, pair in stock £395 pr
 BSS DPR 502 dual MIDI gate £325
 Aphex Expresor psycho compressor £395
 Aphex Expander Gate stereo, excellent £295
 White 4000 eq 3 in stock £195
 MXR Dual Limiter pumps like hell!

MICROPHONES

- Telefunken ELAM 251 the dcgs bollocks! Rare opportunity £call
 AKG C12 excellent condition, amazing sound £call
 AKG C 24 stereo version of above, mint £call
 Neumann U 47 fet AS NEW!! £1,250
 Neumann SM 69 stereo £995
 Neumann UM 57 all original tube £1,400
 Neumann KM 64 2 in stock 701 valve £750
 RCA 77 DX good condition £call
 RCA 44 big and lovely £295
 Neumann KM 74 MINT £1,400
 Calrec CB20c w. CC50 caps £195
 AKG C 26C £350
 AKG C 30 MINT, case £395
 AKG D202 1 in stock £125
 AKG D900 like a 202 w. CK9 shotgun £225
 Ecall £275
 AKG 451EB/CK9 big brother shotgun £19.99
 AKG D58 buckets of them, cheap!

- AKG D541 on gooseneck £55
 AKG D190 E & C £65
 AKG C567 Lavalier mics £95
 Sennheiser MKH 815 long shotgun £395
 Sennheiser MKH 40 rail £495
 Sony C 47 with psu, f/c £495
 Amcrown 30GPD PZM one left £95
 Audio & Design Scamp call for details £125
 Shure SM 87 in stock £75
 Shure SM 62 baby £75
 Shure SM 76 £90
 Shure SM57 NEW £60
 Shure 6M 57 3 in stock £90

FX

- Lexicon 200 MINT condition £1,495
 AMS RMX 16 remote, 2 in stock £250
 RSP Technologies Intellverb £550
 EMT 140 Valve classic plate £950
 MDB Window Recorder fast, simple sampler £450
 SPL Vitaliser pro balanced SX2 model £495
 TC M 5000 IN STOCK, on demo £call
 TC ATAC IN STOCK £call
 TC 2290 IN STOCK £call
 Yamaha R 1000 crusty! £120
 AKG BX 20 spring reverb 2 in stock £295

VARIOUS

- Quested UM-3 2x15, 3 way monitor £3,500
 360 Systems MIDI Bass American bass box Midi £150
 Akai XE 8 MIDI drum expander £95
 Otari EC 101 MTR 90 synchroniser £250
 Neve/Coutant psu's in stock large range £call

Prices exclude VAT • E.&O.E.

This is only a selection of the equipment we have in stock. Call to receive our regular mail shots. Similar equipment wanted for cash. Part exchange welcome. Government & Educational orders welcome.



EQUIPMENT FOR SALE



505-507 LIVERPOOL ROAD,
LONDON N7 8NS
Tel: 44 (0) 171 609 5479
Fax: 44 (0) 171 609 5483

Mark Thompson
Helen Rider
Steve Lane
Clive Richards

FINALLY OPEN: OUR NEW 2500 SQUARE FEET OF DISPLAY AND DEMONSTRATION SPACE

Used Equipment in stock includes:

DESKS

SOUNDCRAFT 3200/Optifile automation.....£19,000
SOUNDCRAFT DC2000 moving fader automation.....£8,500
MCI/SONY JH600 36 input with automation.....£9,950
NEVE 5106 24/8 with dynamics.....£11,500

TAPE MACHINES

OTARI MTR90/2 (1989) with remote.....£12,000
TASCAM ATR80 remote/locate.....£7,000
MCI JH114 2" 24tr c/w remote.....£2,750
FOSTEX G24S with sync card.....£3,250
TASCAM DA88/SY88 sync card.....£2,500
TASCAM RC88 remote.....£700
OTARI MX70 1" 16tr with remote.....£2,750
STUDER A80 Mk4 1" 8tr c/w dolby/synchroniser.....£1,950

OUTBOARD/MICS

LEXICON 224XL/224/PCM80/PCM70/PCM60
DRAWMER 1960 tube comp/1961 tube eq/DS 201/DL 231/DL221
DOLBY XP24SR/XP24A/SP24A/363 SR/A/361SR/361 A
COMPRESSORS: Audio Design/Orban/Aphex/Electrospare
REVERBS AKG/Ursa Major/Great Brit Spring/Yamaha
SUNDRY Symetrix/Rane/Bel/AMS/Lang/Fairchild/ and loads more
MIDI/KEYBOARDS Prophet/Akai (S1000/1100/3000) Roland/Yamaha/Korg
TWO TRACKS Ampex/Studer/Revox/MCI etc
MICS Neumann U87/U89/KM83/KM84 AKG 414/451 SHURE/BEYER/SENNHEISER
Plus much, much more; spares, amps, monitors, cans, CD's, DATS

NEW EQUIPMENT ON DEMONSTRATION AND IN STOCK INCLUDES:

JOE MEEK Stereo compressor/Voice channel/Tube compressor
FOCUSRITE ISA 215/RED2/Red 3/Red 7 Mastering range
TTC M5000/ATAC, 2290, Spacial expander etc
TLA Dual Tube compressor, eq, mic amp, DI etc
GENELEC Nearfield and main monitors
ALESIS ADAT XT, BRC and peripherals, ALESIS monitors/outboard

CALL FOR OUR LATEST THREE PAGE FAX LIST OF GUARANTEED USED STOCK

All major credit cards accepted :: Prices exclude VAT :: Carriage at cost
Brokerage on large desks and multitracks: Buyers waiting

"IF THE TEA DON' SLAY YA, THE PRICES WILL . . ."

TONY LARKING

PROFESSIONAL SALES LIMITED

WORLDWIDE DELIVERY

ENGLAND'S LARGEST STOCKIST OF
NEW & USED
PRO-AUDIO EQUIPMENT

CALL TEL: 01462 490600
NOW! FAX: 01462 490700

DIAL A FAX

FOR A COMPLETE UP TO DATE EQUIPMENT LIST ON YOUR FAX

Dial 0336 413 733 on your fax machine & press start when instructed. Some machines may need to be switched to polling mode to use this service. Calls @ 39p per minute cheap rate and 49p per minute all other times.



USED GEAR WANTED

CONSOLES - 16 TRACK - 24 TRACK - ADAT - OUTBOARD

MONITORS - STUDIO MICROPHONES - PRO VIDEO

Why continue on with your old equipment when Tony Larking Professional Sales can give you a (or a king good) part exchange deal or purchase your unwanted equipment for cash?

PLUS: FINANCE AVAILABLE - USE YOUR EXISTING EQUIPMENT AS A DEPOSIT!

GM STUDIO equipment

YAMAHA DMR 8 DIGITAL MIXER/RECORDER (88 hours used).....£16,000
YAMAHA DRU 8 DIGITAL RECORDER (30 hours used).....£7,000
YAMAHA RC 8 REMOTE CONTROLLER/LOCATOR.....£1,000
YAMAHA PROMIX 1 DIGITAL MIXER (new).....£1,500
YAMAHA YPDR601 PROFESSIONAL DISC RECORDER.....£5,000
YAMAHA RC601 REMOTE CONTROLLER FOR YPDR.....£1,000
YAMAHA AD8X ANALOG-TO-DIGITAL CONVERTER.....£1,500
YAMAHA P4050 4 CHANNEL POWER AMPLIFIER.....£600
YAMAHA S450S SPEAKER SYSTEM (pair).....£2000
YAMAHA Y10 ACTIVE SERVO-PROCESSOR FOR S450S.....£600
YAMAHA NS10M STUDIO MONITORS (pair).....£300
YAMAHA SY99 SYNTHESIZER (two pieces new).....£3,500
YAMAHA SAMPLE DISCS FOR SY99 (10 pieces).....£300
YAMAHA TG500 SOUND MODULE (64 poly voices).....£400
MIDI EXPRESS MARK OF UNICORN (4in-6out).....£200

ALL CABLES, RACK KITS, EXPANSION BOARDS, LIBRARIES
40 pieces YODR63 DISCS and 10 pieces MPX20 TAPES INCLUDED

The equipment has been used only in the studio and has a
ONE YEAR GUARANTEE by YAMAHA PROFESSIONAL DIVISION WORLDWIDE.

Contact Gabriel Mendez

Tel: Home 358.72.5562294 (after 6 pm CET); Studio 358.72.5523705, 358.72.5523709
Fax: 358.72.5523712 Monday to Friday 10 am - 5 pm (CET)

OTARI MTR90 2" 24 TRACK
exceptionally good condition, low hours, with
AUTOLOCATOR and REMOTE; also

OTARI MTR 12 1/2" TWO TRACK
as new; plus various outboard, plugs and cables.

Phone for price list (0)181 671 6759

WAY OUT WEST MUSIC COMPANY

THE UK'S BEST UP-AND-COMING
PRO-AUDIO DEALER

Call for price list

47 London Road, Twickenham, Middlesex TW1 3SA
TEL: 44 (0) 181-744-1040/50 FAX: +44 (0) 181-744-1095

EQUIPMENT WANTED

3 CAMERA STUDIO SET-UPS REQUIRED

Should include:

MODEL	BRAND	DESCRIPTION	QTY
DXC 327AFK		CAMERA	3
DXF 50 CE	SONY	VIEWFINDER	3
CA 5379	SONY	CAMERA ADAPTOR	3
CCU-M7	SONY	CAMERA CONTROL	3
DR-100	SONY	INTER-COMM SET	3
LD-23	SONY	SERVO ZOOM	3
PVM 1440 DM	SONY	MONITORS	4
CCZ-A50	SONY	CAMERA-CCU CABLE	3
VIDEO 18	SACHTLER	TRIPOD - DOLLY	3
READ HEADS	ARRI	LIGHTING BODW FULL	8
		KIT-BLONDS	
PWV-2800*	SONY	BETASP RECORDER	1
BVU-850p*	SONY	HB-UMATIC SP RECORDER	1
MXp 210	SONY	AUDIO MIXER	1
ECM 776	SONY	'LAVALIER MICS	6
ECM 672	SONY	CONDENSER MIC	2
GP-5	SONY	HAND GRIP	1
SC72	SONY	CARRYING CASE	1
		ELM 672	1
CAC 12	SONY	MIC HOLDER	1
NP18	SONY	NICAD BATTERIES	8
BC-1WB	SONY	BATTERY CHARGER	1
CMA-BACE	SONY	AC POWER ADAPTOR	1
BNC RG59		VIDEO CABLE	80 m
		AUDIO CABLE	80 m
		8 CHANNEL VISION MIXER WITH OVE PLUS INTERCOM	1
		FACILITY COMPOSITE COMPONENT: BVW 50P*	1
		MATE BOXES	
		4-4 FILTERS	

*NOT MORE THAN 5000 HRS - 3 CAMERA - PREVIOUSLY ENJOYED SYSTEMS

TEL: 44 (0)1628 825793 FAX: 44 (0)1628 829197

PRODUCTS & SERVICES

Mark Griffin Furniture CUSTOM STUDIO FURNITURE



Design and installation of racking, storage & accessories

Please call for a brochure.

Contact: **MARK GRIFFIN**
Byrebrook Studios, (Lower Farm),
Northmoor, Oxford OX8 1AU, UK.
Tel/Fax: 01865 300171

AIR CONDITIONING & VENTILATION TO SOUND STUDIOS IS OUR SPECIALITY

We provide design only or design and installation for many well known clients. Whether it be for displacement, free cooling, V.A.V., V.R.V., split, unitary or centralised call Mike Hardy of

Ambthair Services Ltd on
01403 250306 or Fax 01403 211269

Web: <http://www.pncl.co.uk/~mhardy/as.html>
Email: mhardy@pncl.co.uk



40 Clarendon Rd West, Chorlton, Manchester M21 0RL

A New Control Room?

- Whatever the scale of your project, almost any control room can benefit from the design principles of the Early Sound Scattering room.
- Instead of relying on creating a reflection free zone, in this new configuration of room the unwanted reflections are masked by many randomized low level reflections from the front of the room, allowing consistently accurate response and imaging throughout the room regardless of equipment layout.
- This means that very different rooms can be made subjectively identical, providing the closest thing yet to absolute reference monitoring.

If you're serious about your new control room,

you should be talking to **Andrew J PARRY**

on 0161 861 0857

ELECTROACOUSTIC SYSTEM SPECIALISTS

STUDIOHIRE

0171 - 431 - 0212
0171 - 431 - 0212

- ★ PROTOOLS 3 NOW AVAILABLE FOR HIRE.
- ★ ONLY £200 PER DAY, £800 PER WEEK.
- ★ DENON DN990R MINIDISC RECORDER £60.

MOBILE

2 mobiles • 48 channels • 32 digital tracks (TASCAM DAB8) • digital edit system (AKAI DD1000) • GUANTEC, ENAT, DBX, ... • air condition • more than 80 microphones (NEUMANN, AKG, etc.)

HEINEN *Studio*

Professional Audio Engineering
BROADCAST • LIVE-RECORDING • PRODUCTION

Telefon 0049 (0) 271 332042 • Fax 0049 (0) 271 336914
Rodschiele 27 • 57074 Siegen • Germany

KEYBOARD STUDIO

0181 361 0949

24 TRACK RECORDING STUDIO

★ GREAT DEALS NOW AVAILABLE! ★

★ CALL NOW FOR FURTHER SPACE IN THE DIARY! ★

VIDEO CLIPS

Music demos filmed using the latest technology and providing cost effectiveness beyond your wildest dreams by award-winning English and Russian film directors in Russia.

Also: highly competitive quality sound recording, photos & publishing. Call us!

OMEGA PLUS

TV & Advertising Production, Moscow, Russia.

Tel: 7(095)298-4833, 298-4822, 298-4360

Fax: 7(095)913-6955

EPICA award winner 1995

48 TRACK MOBILE

The Van
LIVE RECORDING
STUDIO
TEL: 0031 (0)33 2983150
FAX: 0031 (0)33 2987246

JOEMEER Tel: +44 181 446 5298
Voice Channel Fax: +44 181 446 6035
Email: sales@interstudio.co.uk



The essential, rich, super-full voice sound that will survive the mix!

InterStudio Limited
<http://www.interstudio.co.uk/is/>

FOR ALL YOUR RECORDING NEEDS

AMPEX-BASF-MAXELL-3M-SONY-KAO
AUTHORISED NATIONAL DISTRIBUTOR
Spools, boxes, blades, splicing and leader tape
Custom wound cassettes C1 120, labels, library cases, inlay cards.
Bulk audio C-Os, cases, pancake, broadcast cartridges.



SOUND & VIDEO SERVICES
Shentonfield Road, Sharston Industrial Estate,
Manchester M22 4RW. Tel: 0161 491 6660
FOR QUALITY PRICE AND SERVICE

SPECIALIST LABEL MANUFACTURERS TO THE RECORDING INDUSTRY STOCK LABELS FOR COMPACT DISK VHS VIDEO & AUDIO CASSETTE

- On A4 sheets for computer printing by laser printer.
- As continuous roll with holes for dot-matrix printers.
- Supplied blank white with next day delivery from stock.
- 48 hour delivery on a wide range of coloured labels.
- Custom printed labels supplied to client specification.

Superfast Labels Ltd

Unit 15, Church Road Business Centre
Sittingbourne, Kent ME10 3RS England
(01795) 428425 Fax (01795) 422365

Accusound

CLOSE MICROPHONE SYSTEMS FOR ALL ACOUSTIC INSTRUMENTS

AS USED BY: BALAN-SCU QUARTET, CHRIS LAWRENCE, RONNIE SCOTTS CLUB, STEVE PHILLIPS, NIGEL FATON, NIGEL KENNEDY, SUNSHINE MUSIC, JOHN TRINITY, BROMPTON, ACUSTIC SOUND MICROPHONES SYSTEMS
TEL/FAX: +44 (0) 1455-552306
19 Blitwell Road, Lutterworth, LE17 4EL, UK

[EUROPE AUDIO RENT BV]

we rent out recording equipment for:

- music production
 - broadcast
 - filmsound
 - AV-projects
- Sony-DASH 24 & 48, ADAT, DAB8, DAT, Otari, HNB, Betacam, DDA, Studer, SSL, Lexicon, Eventide, TC, Neumann, Schoeps, B&K, Tubetech, Focusrite, Drawmer, Orban, Dolby, Genelec, Akai, Emu, Harddisks, etc etc

Phone Holland (31) 3465.70670 - or Fax (31) 3465.72707

Lockwood Audio

THE TANNØY Specialists

SPARES AND REPAIRS

Long established dealer in used equipment and records

Phone: +44 (0) 181 - 207 4472
Fax: +44 (0) 181 - 207 5283



Panic Music Services

AUTHORISED HI-TECH SERVICE CENTRE FOR AKAI TEAC - TASCAM
REPAIRS TO ALL MAKES OF KEYBOARDS - SYNTHIS MODULES - SAMPLES AND AMPLIFICATION.
REPAIRS TO ALL TAPE MACHINES
DAT, DIGITAL SYSTEMS & ALL STUDIO EQUIPMENT
ALL WORK TO BS750 QUALITY INSPECTED
CALL us on 01954 231348 or Fax 01954 231806

CRYSTAL WHY PAY MORE FOR DATS?

ALL DATS ARE NOT THE SAME - SOME COST TWICE AS MUCH!

DAT STORAGE RACK-13.50+VAT! HOLDS 10 DATS - LOCKS TOGETHER! -FREE STANDING OR WALL MOUNTED!	DATR30 FROM £2.75 + VAT!
COMPACT 1U PATCH BAYS ONLY 35.99+VAT!	DATR46 FROM £2.95 + VAT!
32 WAY JACK/JACK	DATR61 FROM £3.20 + VAT!
24 WAY JACK / 8 WAY MIDI	DATR92 FROM £3.70 + VAT!
EASILY REVERSIBLE NORMALISING	DATR122 FROM £4.19 + VAT!

TEL/FAX 01223 208937 CREDIT CARDS ACCEPTED

NORTH ROAD WENDY ROYSTON HERTS SG8 0AB

MLSSA room analysis .. Studio design & build

We have the expertise and equipment to solve all your isolation and acoustic problems.

Our facilities include:
• Construction teams
• Air conditioning install
• Audio/Video wiring

SM acoustics
Tel: 01952 510508 Mob: 0850 292440

Call us now for a complete solution or just a little advice!

Pro Tools, Sonic Solutions Editing & Hire

Contact: Digital Gratification
Tel: 0171 483 3506

USED EQUIPMENT WANTED: BEST PRICES PAID

LEXICON AMS EVENTIDE VALVE ADAT
River
PRO-AUDIO
NEUMANN STUDER AKG DIGITAL OTARI

TEL: 0171-237 1424

NEUMANN MICROPHONE CAPSULES

U47, U67, U87, M49, SM69
Nickel: KM54, KM56, SM2
Re-diaphragmed to the highest standards
Tel/Fax: 44 (0) 171 231 5989

EMC: crossing all borders

Here's a new one for you: just because you've got your CE mark from one testing laboratory, it doesn't necessarily follow that you'd have got it from another, writes **CHRIS EDWARDS**

IT'S TOO LATE NOW, you missed it. They are on your case waiting to pounce on any piece of non-compliant piece of equipment and you are going to jail.

OK, you're not. They are too busy dealing with the sack of complaints from PC companies about all of their competitors. Yes, it's that EMC Directive again. You know the one that says 'get everything CE marked by the 1st January 1996 or be sorry'. There are plenty of people out there for whom the sky did not fall in because they did not have a particular logo etched on their equipment. Why? Because, like most legislation, the EMC regulations are difficult to enforce. Having draughted legislation that effectively outlaws anything electronic that is uncertified, the powers that be conveniently forgot to implement a consistent way of enforcing it.

In the UK at least, the legislation is considered to be 'complaints driven'. What this means is that your competitors denounce you to the local trading standard bodies who then investigate, when they get the time.

Seizing on this idea, a number of large PC manufacturers decided that a good way of getting their garageland competition was to test their products in accredited labs and file complaints about any that did not pass. Late last year, you could not get into an accredited test lab for companies putting their competitor's PCs through the EMC test.

Unfortunately, it turned out that many of these PCs were failing even though they already had CE marks from testing in other labs. It turns out that EMC is an insidious thing. A product that checks out OK in one lab can turn out to be a turkey in another, even though both are accredited by the same standards body. And any investigation of complaints is going to have to take account of that fact.

That's PCs, what happens in the pro-audio world? The same, except that it does not suffer from the same cut-throat competition. Unless you have a particularly difficult competitor, nobody will have noticed that you do not have a CE mark. Until you try exporting your piece of equipment: border controls turn out to be a much better way of enforcing legislation than domestic penalties.

The EMC Directive was based heavily on regulations that already existed within Europe, especially in Germany where TÜV approval was vital to selling anything in that territory. The CE marking system was originally designed to prevent the situation where, in a single European market, manufacturers had to get separate approvals for each country.

From the 1st January 1996, if you have a CE mark, you are automatically allowed to export to Germany without needing separate approval from TÜV.

The argument for the EMC Directive was that if TÜV could prevent cheap imports to Germany, a European-wide version could do the same for all of the other countries in the EU. Seeing this, other countries have decided that this sort of import restriction is a great idea. And the Far Eastern countries have set about implementing similar legislation with gusto.

As for the US? The FCC has already come up with similar standards and the EMC Directive is not much more stringent than those.

So, even though the local authorities are not beating down your door, there is no cause for celebration in having saved a few pennies to get equipment CE certified. Because, if you try to export it, it is going to come back.

In the case of pro-audio equipment, this stuff is probably going to pass a test quite easily. The radiation curves for emissions are not that draconian and any piece of good studio equipment is going to pass. Not because it has been designed for the Directive but because people are going to notice something in the studio that radiates electrical interference like a washing

machine on full spin.

However, emissions are only one half of the story. Immunity is a bigger problem. Although it is not unreasonable to assume that a piece of equipment with low emissions will also be pretty immune from electrical interference, it is also not completely reasonable.

In the tests, people attack the connectors with static zap guns and various other troublesome devices. If it fails, your equipment may not be hurting anyone, but it will also fail to get a CE mark. So, you need to get equipment tested, even you think it has the protection built in. Pro-audio equipment should not fall over when presented with a little static, but the immunity tests are more stringent than that, often calling for changes to connectors to prevent conducted noise from getting into the internals.

So, even though a piece of studio equipment should pass emissions without problems, there are other areas that you need to test for to get a CE mark. And, even if you feel that a CE mark is not important, you may find the places that you can sell your equipment are very restricted.

However, if you avoid that stage, you can ring me and I can give you a CE mark. It's not legal, it's not useful, but it is a CE signature all the same. **S**

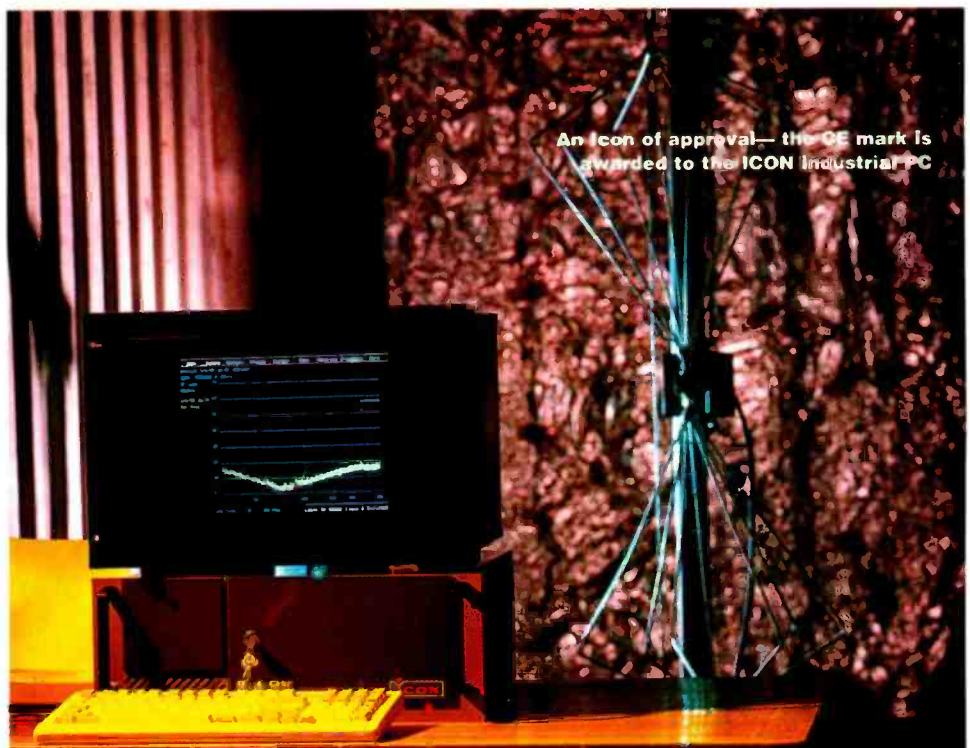

An icon of approval—the CE mark is awarded to the ICON Industrial PC

SURROUND

Full surround formats require properly implemented **Left-Centre-Right** monitoring together with a separate sub woofer channel. Dynaudio Acoustics ABES based systems offer the perfect solution, but at a fraction of the cost and inconvenience of conventional systems.



Total Flexibility

Your choice of satellite speakers combined with one or two ABES units offers system capability of up to 130 dB with a frequency response of 35 Hz to the upper limit of your satellites.

Perfect L-C-R Matching

Satellite speakers may be optimally positioned independently of the ABES. The omni-directional characteristic of sub-bass frequencies allows great freedom in location of the ABES itself.

Low Installation Cost

Using small satellites and a flexibly located ABES means less spent on redesigning your room to accommodate three separate full range speakers plus an extra sub woofer.

Minimum Space Overhead

Small satellites mean more space at the front of the control room for film/video/computer screens.

dynaudioacoustics®

Active Bass Extension Systems

Dynaudio Acoustics
The Studio,
Unit 21 Riverside Workshops,
28 Park Street,
London SE1 9EQ
Tel: +44 (0)171 403 3808
Fax: +44 (0)171 403 0957

APHEX TUBE COMPRESSOR

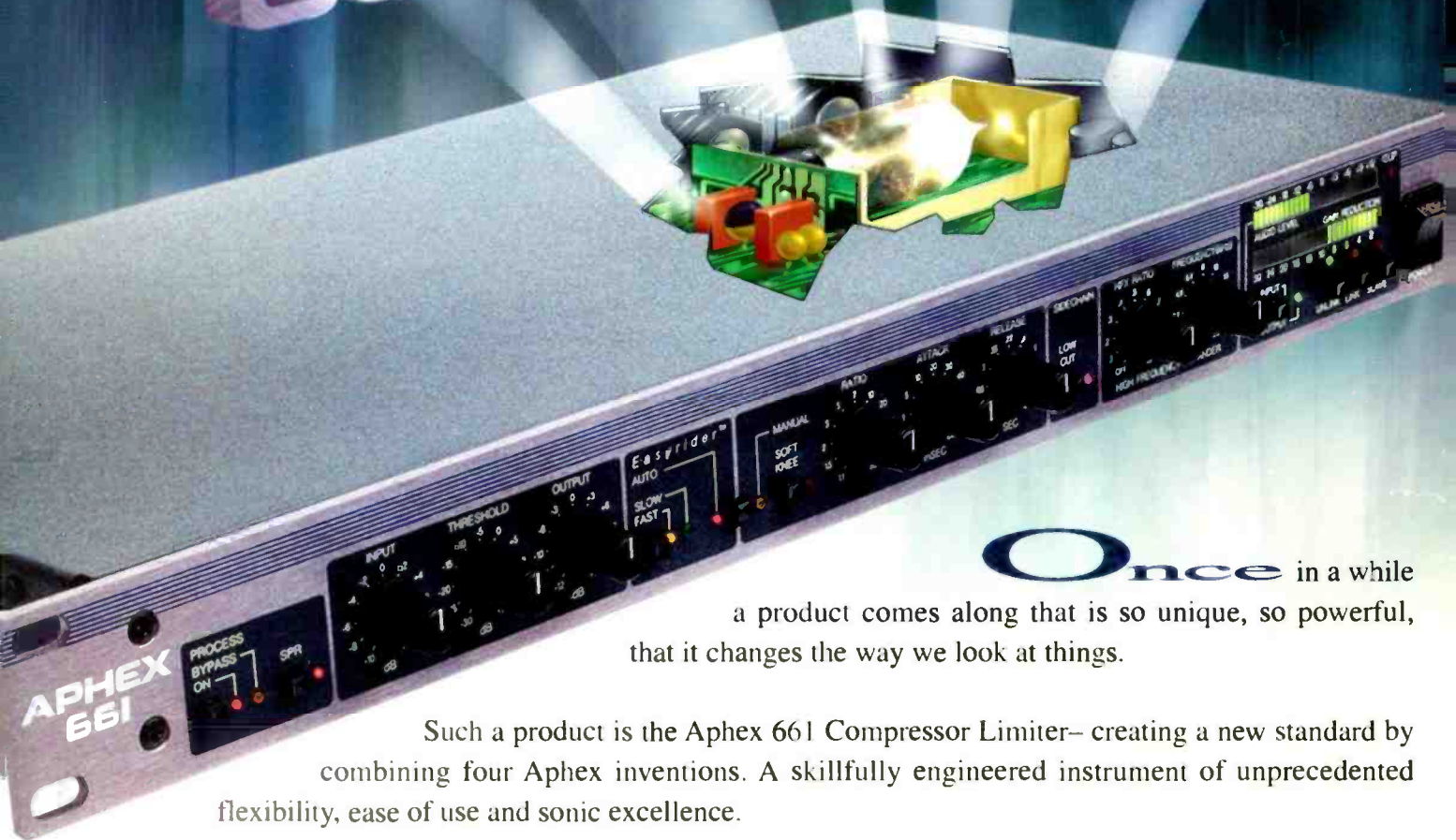

Once in a while
a product comes along that is so unique, so powerful,
that it changes the way we look at things.

Such a product is the ApheX 661 Compressor Limiter— creating a new standard by combining four ApheX inventions. A skillfully engineered instrument of unprecedented flexibility, ease of use and sonic excellence.

Tubessence[®] - true vacuum tube technology and warmth; High Frequency Expander (HFX)[™] for automatically retaining the high frequencies lost during compression; Easyrider[®] circuitry for an Auto mode that really works; and the world's best VCA - the ApheX 1001, the fastest, most accurate and transparent available.

The ApheX Model 661 - another revolutionary step toward improving the way the world sounds.

APHEX
SYSTEMS

Improving the way the world soundsSM

11068 Randall Street, Sun Valley, CA 91352 • Tel: 818-767-2929, Fax: 818-767-2641