

September 1990

\$5.00 £2.00

STUDIO SOUND

AND BROADCAST ENGINEERING

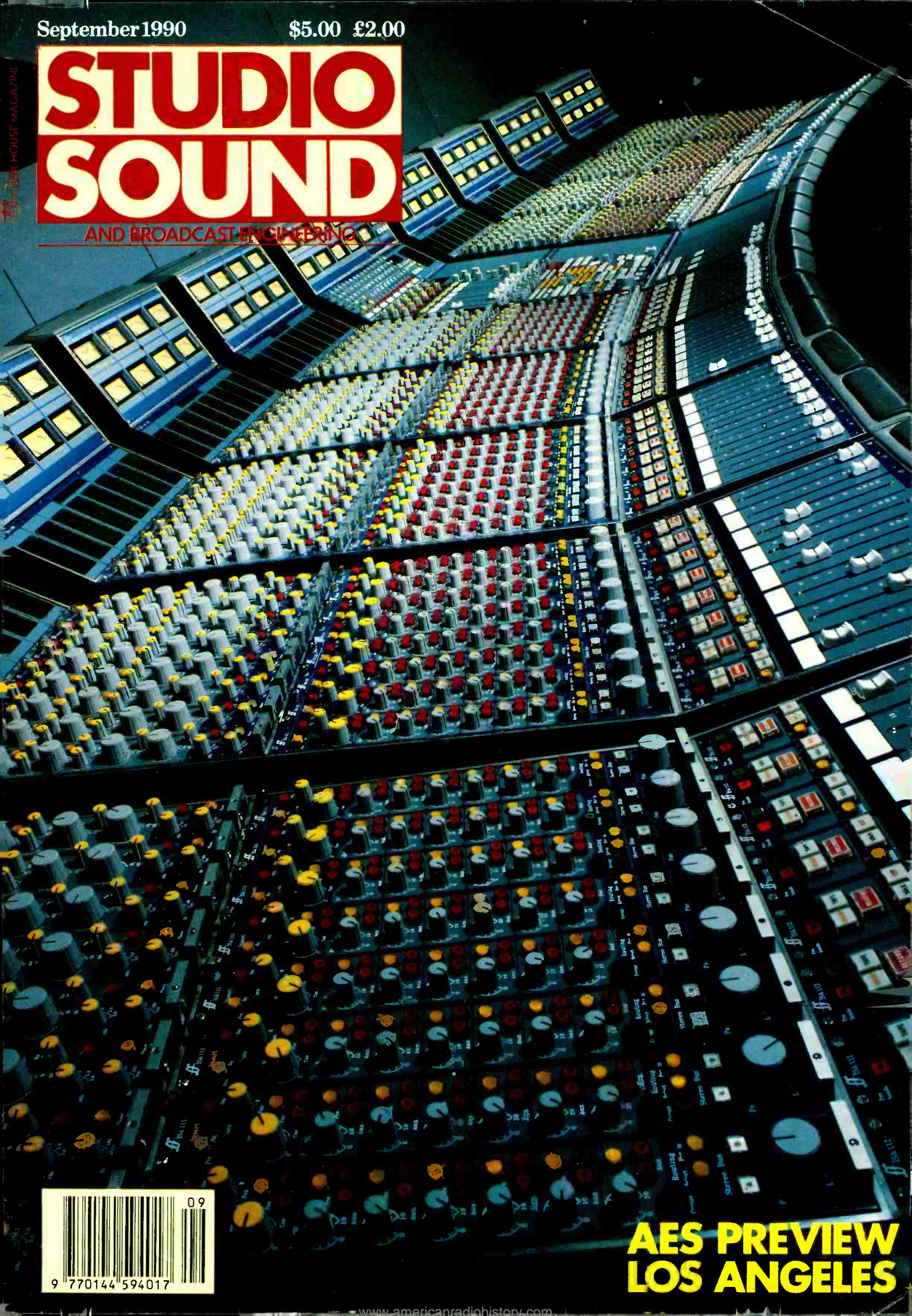

09

**AES PREVIEW
LOS ANGELES**

With the revolutionary 1" format, 24 track is now an affordable reality.

The next step is a recording console that's equipped to do it full justice.

The Soundcraft Series 6000.

Already an established performer with 2" multitrack, the Series 6000 has been heralded as the most comprehensive production console in its class. ■ ■

A full 16 or 24 bus mixer, its sonic performance is truly outstanding. The proprietary circuit designs afford stunning clarity and precision, yet without the heavy cost of its nearest rivals.

With enough buses and routing options to make adventurous production a pleasure, the uncompromising array of facilities puts you in total command of

the mix.

We've provided six independent auxiliary sends for added versatility and the option to find extra inputs with EQ'd monitor returns. ■

You'll even find true Solo-In-Place, programmable mutes and Soundcraft's renowned 4 band sweep EQ fitted as standard - combining flexibility with impeccable signal integrity.

It's every bit as advanced as the new format. And every bit as affordable.

Ask your dealer about the Soundcraft Series 6000 today.

And see how far we're thinking ahead. ●

Soundcraft
6000



**You'd think one inch
24 track tape was made for it.**

STUDIO SOUND

AND BROADCAST ENGINEERING



Producer Mike Hedges' home studio, see Vintage Recording

Editorial:	We were lucky. Keith Spencer-Allen comments on the role of DAT	5
News:	Events, news, moves and comment from inside and outside the recording industry	10
Products:	Information on new products, developments, upgrades and software updates	16
AES Preview:	A list of exhibitors who will appear in Los Angeles together with a brief description of their displays	22
Vintage Recording:	Ralph Denyer visits producer Mike Hedges who is going back to the 'good old days'	38
CEDAR:	After a lot of discussion on the effectiveness of this noise removal system David Mellor went to see for himself	46
Focusrite Tracked:	Patrick Stapley visits Focusrite and discusses the design of their new Studio Console	58
Imagination:	Tim Leigh Smith visits a London, UK, design and communication company who are now taking bookings for their sound studio	62
Evaluating Audio Op Amps:	In the final part of his series, Ben Duncan sets down the results of fundamental performance tests	70
Fixing It Outside the Mix:	Michael Gerzon discusses methods for repairing damaged stereo recordings prior to mastering	78
Business:	Tracing the acceptance of CEDAR and NoNoise, and Sony sued over DAT. By Barry Fox	94
Perspective:	US columnist Martin Polon airs a few more poignant comments on the audio industry	96
Fostex D-20 Editor:	Francis Rumsey reviews the editor control software	101

ScreenSound. A fully integrated audio for video editing suite



Post production facilities need to take advantage of the efficiency offered by today's technology. Speed and creative flexibility are essential to commercial success. Digital sound quality is no longer a luxury.

ScreenSound is a fully integrated audio for video editing suite. It combines digital audio storage and editing with machine control of multiple VTRs, Laserdisc or film reproducers. It also interfaces with Quantel's digital video editor, Harry.

Simple to learn and fast to use, a cordless pen, tablet and RGB monitor provide control of all ScreenSound functions.

Multiple sound reels enable music,

dialogue and effects to be laid back to picture and synchronised to the exact video frame.

Edit, review, time offset, track slipping, cross fades and many other production techniques are available at the touch of a pen. Gain and stereo pan controls can be automated to timecode.

AES/EBU interfacing keeps digital audio transfers free of analogue distortions and losses, preserving the highest audio integrity through to the final format.

Above all, ScreenSound is a dedicated system - purpose-built to bring the advantages of hard disk sound manipulation to audio post production.

AUDIO STORE

The hard disk store of sound clips gives title and duration, in addition to powerful search and sort routines.



SCRUB EDITOR

Provides accurate edit marking and scrub of audio waveform.

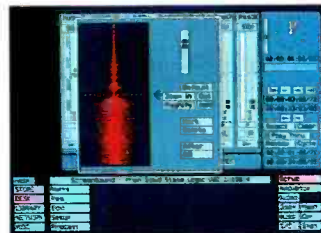

OPTICAL LIBRARY

An off-line library of sound clips and effects can be compiled on a Write Once Read Many (WORM) optical disc.



MACHINE CONTROL

For control of multiple VTRs, laserdisc or film reproducers.



SSL DIGITAL
Solid State Logic

Begbroke, Oxford, England OX5 1RU (0865) 842300

London (01) 706 4948 • Paris (1) 34 60 46 66 • Milan (2) 612 17 20 • New York (212) 315 1111 • Los Angeles (213) 463 4444

• Toronto (416) 363 0101 • Tokyo (03) 5474 1144

STUDIO SOUND

AND BROADCAST ENGINEERING

September 1990
Volume 32 Number 9
ISSN 0144 5944

EDITORIAL

Editor: Keith Spencer-Allen
Assistant Editor: Julian Mitchell
Co-ordinating Editor: Ann Lowe
Production Assistant: Dawn Boulwood
Secretary: Elaine Sweeney
Consultant: Sam Wise
Columnists: Barry Fox, Martin Polon (US)

Regular Contributors:

Janet Angus	David Hastilov
James Betteridge	Mike Lethby
Mike Collins	David Mellor
Ben Duncan	Terry Nelson
Dave Foister	Francis Rumsey
Yasmin Hashmi	Patrick Stapley

ADVERTISEMENTS

Advertisement Manager: Steve Grice
Display Sales: Phil Salmon
Copy Controller: Jill Griffiths
Advertisement Production: Mark Trainer
Secretary: Lianne Davey

CIRCULATION

Circulation and Development Manager:
Colin Enderson
Controlled Circulation Manager:
Maria Udy
Enquiries: See classified advertisement

Director: Doug Shuard
Publisher: Steve Haysom

EDITORIAL & ADVERTISING OFFICES

Link House, Dingwall Avenue, Croydon CR9 2TA,
UK. Tel: 081-686 2599. Telex: 947709. E-mail:
78:DGS1071. ESI: STUDIO SOUND-UK/US.
Fax: 081-760 5154/0973.

AMERICAN OFFICE

Publishing Services Manager: Fred Vega
Studio Sound, 2 Park Avenue, 18th Floor,
New York, NY 10016, USA. Tel: (212) 779-1212.
Fax: (212) 213-3484.

JAPAN & FAR EAST AGENT

Contact: Mikio Tsuchiya, Media Sales Japan Inc.
Tamuracho Bldg 3 3 14, Shimbashi, Minato-Ku,
Tokyo, Japan. Tel: (03) 504-1925. Telex: J25666.
Fax: (03) 595-1709.

© Link House Publications plc 1990 all
rights reserved

Printed in England by Lawrence-Allen
(Colour Printers) Ltd, Gloucester Street,
Weston-super-Mare, Avon BS23 1TB



A LINK HOUSE
PUBLICATION

Studio Sound and Broadcast Engineering
incorporates Sound International and Beat
Instrumental

Studio Sound is published on the third Friday of
the month preceding the cover date. The
magazine is available on a rigidly controlled
requested basis, only to qualified personnel (see
classified advertisement for terms)



MEMBER OF THE AUDIT
BUREAU OF CIRCULATIONS

Total average net circulation of 19,169 per issue
during 1989.
UK: 5,272. Overseas: 13,897.
(ABC audited)



We were lucky

Experience comes by learning from your mistakes. A professional is one who is experienced in a chosen profession. By inference a professional must therefore be someone who has either a great deal of learning or has made a lot of mistakes! As an industry we often seem to be diverted from the task in hand by the assumption that equipment gets cheaper and better in proportion, leading to the belief that somewhere just around the corner is the ultimate performer at a knockdown price.

This said we have, however, been very lucky. We were able to hijack two rather good consumer digital recording formats at what are, in pro terms, giveaway prices—and we learnt from them. The Sony *PCM-F1* system that piggy-backed on a VCR was a curiosity and initially not a lot was expected of it. We learnt and profited finding that, with care, good results were possible. But there were problems—ask any mastering engineer.

A couple of years later along came DAT, a much trailed consumer format with a dedicated audio role that found itself with difficulties in the consumer market. The recording industry embraced it widely as it appeared to offer everything for next-to-nothing. But it is far from quite such a simple situation. Over the past year we have had well known recording engineers speaking out against it for mechanical and sound reasons. We have critical reports from European broadcast institutions. We have caution recommended by the APRS Producers Guild suggesting that analogue copies of DAT should be held as back-up—and so on.

To counter this there are many users who have found positive benefits from DAT and use it heavily. Harman UK have run extensive tests on DAT reliability. Panasonic in the US have run booth demos at AES Conventions with a short section of recorded DAT material being cycled repeatedly and the drop-out rate counted—plays of several thousand being achieved with no significant increase in error rate. We have two sides to this argument and, as in almost all aspects of digital audio, they are highly polarised.

There is nothing wrong with the DAT format. The only problem is with our expectations. Why should it be perfect? To my knowledge no one has claimed it to be perfect or to be a professional format. Sony have gone on record as saying that if they were designing a dedicated audio cassette professional format it would not have looked like DAT. In subsequent marketing of the new professional DAT players Sony have never claimed it to be a replacement for the *1630* mastering system. Among many manufacturers is the attitude that DAT was developed as a domestic format, turned out better than expected and the pros have adopted it. For many applications it is ideal and with care meets almost any expectation.

To criticise DAT for not being professionally suitable is wrong. Why criticise it for not being something it was never intended to be? To use DAT for its undoubted advantages in portability and low cost is wise. To depend on a low cost domestic format to provide a panacea for all pro problems is not an experienced attitude.

In Barry Fox's Business column (page 94) he refers to a recent US legal action against Sony by a collection of music publishing interests over the launch of DAT on the domestic market and how over the long term it could be good for the medium. I see a similar advantage for the pro market, whichever way the judgement should eventually go. If the case is thrown out there will be widespread marketing of DAT and hence more R&D with the subsequent spin-offs for the pros. Should it be upheld companies currently producing pro DAT equipment will have to decide if they can make it work just as a professional standard or start running it down and go back to the development that would have produced the format that would have been here without the sidetracking of DAT.

Time has elapsed and future formats may not be anything at all to do with tape. But we all know enough about digital audio now to guide manufacturers towards what we want and perhaps we will not go through the problems that have occurred with other formats. If we partake in the development then we can expect a suitable tool we will not need to question. With the right development from the pro manufacturers we will not need the lucky break of hijacking suitable domestic formats but we will have to come to terms with our experience as professionals that tells us you don't get anything for nothing.

Keith Spencer-Allen

Cover: Focusrite Studio Console. Photography by Phil Dodds

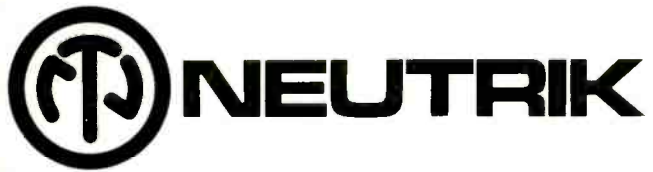

The Popular
Connectors
in
"MUSIC
MAKING"

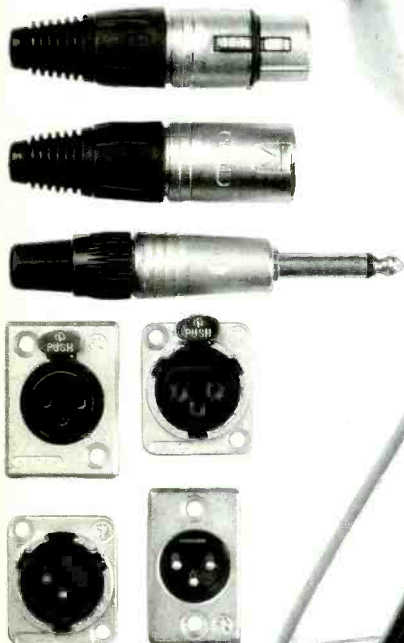

Sound Equipment
Courtesy of
AKG Acoustics
London



Sole Agent U.K.
**Eardley
Electronics
Limited**
Eardley House
182-134 Campden Hill Road
Kensington, London W8 7AS
Telephone
071-221 0606/071-727 0711
Telex: 23894
Telefax: 071-727 9556



Original design NC3FC

Current design NC3FX

HEAVY DUTY VERSION
FOR HOSTILE
ENVIRONMENTS

'D' SERIES CONNECTOR
WITH SOLDER BUCKET
TERMINATIONS

NEW FEMALE PANEL SOCKET
WITH SHORTEST
POSSIBLE DEPTH



NC3MXHD

NC3FXHD

NC3FDL1

NC3FP1

NC3FG
ONE PIECE
NEW PCB CONNECTOR WITH
M3 THREADS, PLASTIC BODY
WITH STEEL PLATE AT REAR
OF MOUNTING FACE



LOCKING JACK SOCKET
NJ3FP6C

NA2MPNF
'XLR' MALE TO
PHONO JACK

NA3MF
'XLR' MALE TO
'XLR' FEMALE

NA2FBNC
'XLR' FEMALE
TO BNC SOCKET

NC3MRC
RIGHT ANGLE
CONNECTOR



NF2C2B
PROFESSIONAL
PHONO PLUGS.
PIN CONTACT
IN GOLD



NP3TTB 4.4mm JACK PLUG WITH
CRIMP CONTACTS

NP3TTA
NEW 4.4mm JACK PLUG WITH
SOLDER CONTACTS



NP3TB 'B' GAUGE JACK PLUG

A selection of the latest range



Sole Agent UK

**Eardley
Electronics Ltd**

Eardley House, 182-184 Campden Hill Road,
Kensington, London W8 7AS

Telephone: 071-221 0606/071-727 0711
Telex: 23894 Telefax: 071-727 9556

Media

14 The Markham Centre, Station Road,
Theale, Berkshire RG7 4PE,
United Kingdom.
Telephone: (0734) 303800
Fax: (0734) 323121
(IDD +44 734)
Telex: 858893 FLETEL G

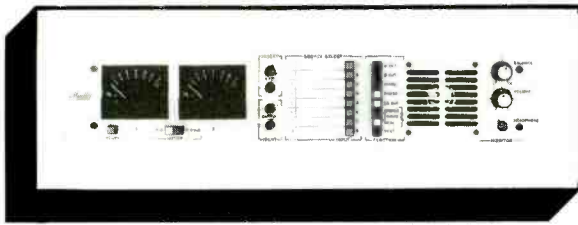

AMU 8S

Audio Monitoring Unit

- Can monitor up to 8 stereo lines
- Integral multi-standard ident generator
- Dual P.P.M.'s and integral speaker
- Stereo speaker and line level outputs
- Compact 2U high rack mounting
- Full remote control facility

Media

14 The Markham Centre, Station Road,
Theale, Berkshire RG7 4PE,
United Kingdom.
Telephone: (0734) 303800
Fax: (0734) 323121
(IDD +44 734)
Telex: 858893 FLETEL G

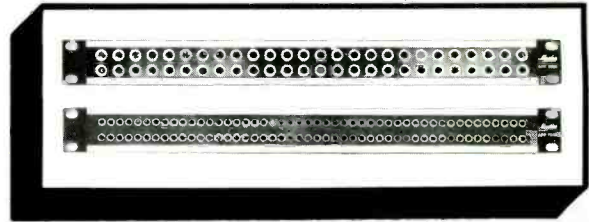

APP SERIES

Audio Patch Panels

- Wide range of 20, 24, 26 Ways with 1/4" BPO Jacks
- 2 or 3 Rows of 1/4" BPO Jacks, in 2 U Height
- High Density version has 2 Rows of 1/4" BPO Jacks in 1 U Height
- 2 Rows of 48 and 52 Ways of Bantam Jacks in 1 U Height
- Stereo Spacing of Jacks as standard
- Can be supplied Connectorised with choice of Rear Connector
- Combined Audio+Video Format also available

The Future is within reach

... Introducing a revolutionary advance in audio technology that will change your world ... from ANALOG to LIGHTWAVE



The DIGITAL AUDIO SYSTEM DAS 2000™ series from LAL is a fully integrated "smart" audio system. It provides multipoint-to-multipoint fiber optic sound transmission, distribution and routing with automated SOFT PATCH™ programmable memory control for both real time and pre-programmed changeovers.

The DAS 2000 advanced system technology automates previously manual processes, greatly reduces set-up time, improves sound quality and is compatible with existing analog equipment. This compact, self-diagnostic, modular system features:

- 15,000 ft. Fiber Transmission Distance
- Modular System in 19" Rack Mount
- Expandable to 64 Channels [8 ch./exp. board]
- 16 Return Lines, [optional - 8 ch./exp. board]
- A/D Converter - 16 BIT Delta Sigma
- D/A Converter - 18 BIT PCM
- 94dB Dynamic Range
- Frequency Response 10Hz - 22KHz
- REMOTE CONTROL FEATURES...
"Soft Patch™" 64 x 64 Routing/Patching,
Large LCD Backlite Display, 40x8 char., 6 Step Gain Control,
48V Phantom Powering

Call today (214) 637 9311 or FAX (214) 637 9314

Discover how DAS 2000 can revolutionize your world.

LAL
LESTER AUDIO
LABORATORIES

Exclusive European Distributors: Plasmec Systems Ltd. Tel: 0252 721236. Fax: 0252 712718

The Future is Now!

Time Is Money.



*The Harrison
Series Ten B
by GLW*

Time is important to you and your customer. So we have developed a console and automation system which allows you to minimize your efforts while maximizing your efficiency, no matter whether you are using tape machines or disk based systems.

Want to know how we do it? Call Martin, Brad, or Gary at 615-331-8800.

 **Harrison** by GLW
SERIESTEN

GLW, INC. • Manufacturers of Harrison Consoles • 437 Atlas Drive,
Nashville, Tennessee 37211 USA • Telephone (615) 331-8800 • Facsimile (615)
331-8883 • Telex 413838 (GLW.NASH)

The Lansdowne Group and an Academy award

An award organised by the Royal Academy of Music in London and sponsored by the Lansdowne Group of companies has been presented to a third year student at the Royal Academy.

The award, the first of its kind, is called 'The Lansdowne Award' as the prize is a day recording at Lansdowne's CTS studios near Wembley Stadium. Dan Farrant, the third year winner, had to submit his own composition or an arrangement of another student's work. The composition had to be not more than 15 minutes long and the composer was required to organise an ensemble to perform the work on the day of recording.

The idea behind organising such a scheme comes from the Head of Rock and Commercial Music studies at the Royal Academy, Nick Ingman, who on the day produced the session.

"We wanted to give the students a taste of working in a real, pressurised commercial situation halfway through their course.

"Adrian Kerridge, chairman of the Lansdowne Group, said, "We've been closely involved with Nick Ingman for many years now and we are delighted that we will be able to

contribute on a regular basis to the musical education of the students at the Royal Academy."

The Lansdowne Award is to be held as an annual event and is open to any Academy student at any level.

Sony sued over domestic DAT players

As we go to press we hear that music publishers in America, including Sammy Cahn Music, have filed a class action lawsuit against the Sony Corporation, claiming the manufacturer's digital audio tape

machines promote illegal home taping of music. The lawsuit seeks to block the importation and sale of the Sony DAT equipment, which have only recently gone on sale to the public in America.

Marvin Frankel, an attorney representing the music publishers, claimed, "This equipment was truly designed and intended for the purpose of infringing copyrights, virtually everybody who is likely to buy this equipment will be using it for infringement purposes." The suit alleges that Sony, although recent buyers of CBS music publishing, is actively promoting the ability of DAT recorders to make perfect digital copies of compact discs.

The announcement of the lawsuit's filing was made at the annual meeting of the National Music Publishers' Association. Ed Murphy, president of the organisation, said the group will offer assistance to the plaintiffs in the lawsuit.



Keith Tomlin, resident organist playing the specially renovated Wurlitzer organ at the National Motorcycle Museum in Birmingham. Full story of the big organ that wanted to sound bigger in next month's issue

'Dick Tracy' uncovers digital debut

A new system for incorporating digital sound in the cinema has been used for the first time on the recent Touchstone Pictures film release *Dick Tracy*. Cinema Digital Sound or CDS has been developed jointly by Kodak and the Optical Radiation Corporation in America and produces CD quality 16 bit audio.

Most attempts, to date, to bring digital sound to cinemas have relied on synchronising CD players or digital video recorders with film projectors but have proved complex and less than ideal as there would be a chance that the soundtrack might

become separated from the film. CDS, however, records the digital audio optically and in the conventional position for optical soundtracks on 35 mm or 70 mm film.

The CDS system uses an 0.1 inch wide optical digital soundtrack capable of encoding five audio signals plus a sub-woofer channel. There's also a MIDI event stream, which can be used, for example, to select language tracks, dim the house lights, roll back curtains or fire off effects. Each of the six channels in the system features a custom digitally controlled analogue attenuator made by Apogee Electronics of California, these allow level information encoded on the

film's MIDI data stream to be used to adjust the channel output levels.

Compatibility with existing cinema systems shouldn't be a problem as the only adaptation needed is a CDS head on the projector and a CDS processor. The same projector can still show conventional films by automatically switching to the optical head.

Both Kodak and The Optical Radiation Corporation were working on their own digital systems before they joined forces in 1988. Now Optical Radiation is setting up a special facility in Hollywood where analogue sound will be converted to digital sound negatives; a similar facility will be provided in Europe.

Guild warns on DAT

The British Record Producers Guild is warning the music recording industry to take care when mastering important material onto digital audio tape because the medium is still too new to be trusted. BRPG council member Tony Swain has been researching the viability of DAT as a mastering medium on behalf of the Guild and has spoken at length to tape manufacturers to determine DAT's safety for long term archiving.

As a result of his research he concludes that it is better to be safe than sorry, and that although DAT is absolutely fine in the short term, an analogue copy should always be made if recording is to be archived for any length of time. Swain also adds that the tape manufacturers he has spoken to admit even they don't know how reliable DAT tapes will be after 5 years. They know the metal particle tape will last up to 12 years but it is the mechanics of the actual cassette that are likely to cause problems.

PHONE
FOR SPECIAL
SEPTEMBER PRICES

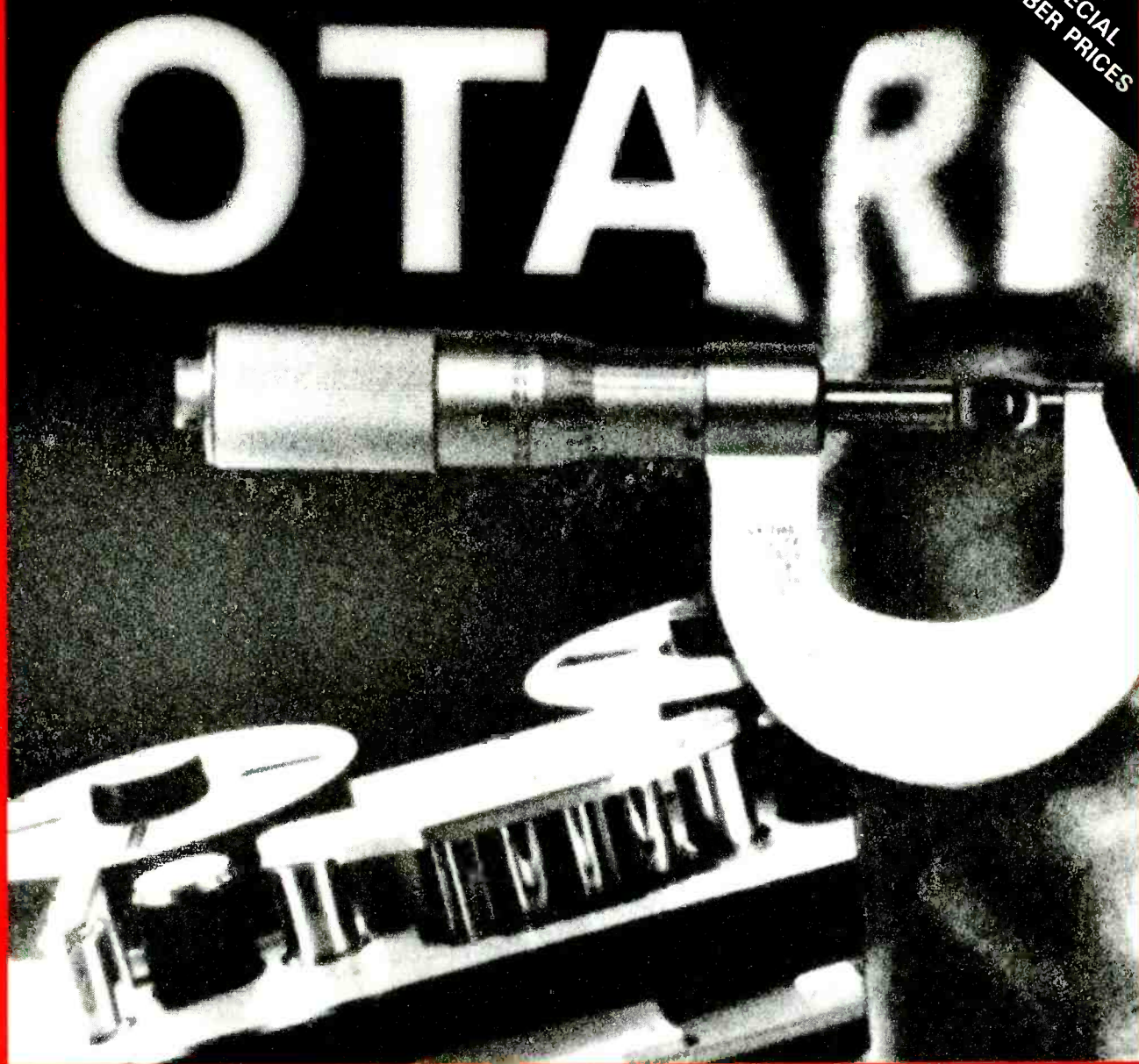

Precision is the quality that separates the exceptional from the

average. From the creative process to the technology that brings it all together. Otari's obsessive dedication to precision is what sets their tape machines apart. That's why the standards set by the MTR90 are taken further in the MX80 and the

MTR100A. As a reliable, cost-effective tape machine with a great sound, the MX80 has established itself as unbeatable; and the new MTR100A is simply the ultimate analogue multitrack. Most importantly, both give you Otari's unparalleled tape handling. Since you'll also demand precision when it comes to back-up, Stirling's reputation for reliable and accurate service and technical expertise is second to none. Precisely the qualities that make us no ordinary dealer.



 **Stirling**

Technology Embraces Art.

There was a time when these words were seldom used together. The disciplines necessary to produce *art* had little patience for technology. *Today* the union is prerequisite. With this fusion in mind, Trident engineers set out to combine vintage sonics with adaptable studio integration and control.

The Vector 432 in-line console. Featuring balanced bussing, 32 groups, 4 stereo mix busses, 4 band equalizer splittable between channel and monitor and 8 auxiliary send busses. The 16 mute groups, fader automation, and multiple machine control are all accessible from our Central Command Panel.

With Audio specifications straining theoretical limits and sonics that can only be described as Trident, the Vector 432 is clearly the console for the creative. Audition a Vector and hear for yourself. After all, you've been listening to us for years.

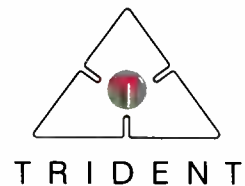

News from the AES

Our next evening meeting will be held on Tuesday September 11th, when the AES is the guest of the BBC for a combined lecture and technical visit to BBC Broadcasting House.

George Legg, Head of Studio and Network Resources (Radio), BBC, will start the meeting with a talk followed by a visit to various facilities including the Engineering Operations Centre, the new Radio 5 area and studios. Numbers for this meeting are strictly limited and visitors will need to obtain a ticket in advance from the AES Secretariat.

To help future planning, the dates, speakers and titles of our forthcoming monthly meetings are listed below (more details will be available on each nearer the time).

Sept 11th
BBC Control Room at BH
 George Legg
 Oct 9th
AGM & Annual Dinner
 Nov 13th
Digital Audio in Professional Video Recorders
 John Watkinson
 Dec 11th
Room & Loudspeaker

Correction using Digital Equalisation

Peter Craven

Also in the autumn one of the major audio events of the calendar takes place—the **US AES Convention**. This is being held in Los Angeles between 21st and 25th September 1990 at the Los Angeles Convention Center. A full programme of Papers and Workshops is promised, together with a large exhibition of the latest in audio technology.

The Papers are now available from the last AES UK Conference which was on the subject of **Hard Disk Recording**. This brings the number of Proceedings from AES UK Conferences to four. These are **Sound with Pictures** (May 1988), **Sound Reinforcement** (May 1989), **AES-EBU Interface** (Sept 1989) and **Hard Disk Recording** (May 1990). They are priced between £10 and £20.

For further details on any of the above or information on joining the AES, please contact: **Heather Lane, AES British Section, Lent Rise Road, Burnham, Slough SL1 7NY, UK. Tel: 0628 663725. Fax: 0628 667002.**

Address changes

- **Apogee Electronics Corp**, 2108 Main Street, Santa Monica, CA 90405, USA. Tel: (213) 399-2991. Fax: (213) 399-7665.
- **Akai's Electronic Musical Instrument Division** have moved

offices. Full address is now Akai (UK) Ltd, Haslemere Heathrow Estate, Silver Jubilee Way, Parkway, Hounslow, Middlesex TW4 6NQ. Tel: 081-897 6388. Fax: 081-759 8268 (only Fax number changes).

Exhibitions and conventions

September 9th to 12th 90 Light and Sound Show, Olympia 2, London, UK.
September 21st to 25th International Broadcasting Convention, Metropole Conference Centre, Brighton, UK.
September 21st to 25th AES 89th Convention, Los Angeles Convention Center, Los Angeles, CA, USA.
September 24th to 25th Speech Intelligibility and Sound Reinforcement Systems, City University, London, UK.
October 3rd to 9th Photokina, Cologne Fair Ground, West Germany.
October 4th Sound Broadcasting

Equipment Show, Albany Hotel, Birmingham, UK.
October 13th to 17th SMPTE, Los Angeles, CA, USA.
November 7th to 9th InterBEE, Nippon Exhibition Centre, Makuhari, Japan.

1991

February 19th to 22nd AES 90th Convention, Palais des Congres, Paris, France.
April 15th to 18th NAB, Las Vegas.
June 13th to 18th International Television Symposium, Centre de Congres, Montreux, Switzerland.

First meeting for PAD

PAD, the new APRS off-shoot for the pressing and duplication industry, have held their first AGM in London. PAD was borne out of the new APRS initiative to produce specialised groups from the whole APRS membership. So far there is a group for pressers and duplicators, manufacturers and recording studios.

The first pressers and duplicators meeting was ostensibly to promote membership among an audience of mostly non-members and to cite reasons why the group should exist. Such reasons were to retain and in some cases improve standards of quality as competition and new

technology increases.

PAD also thought that joining the group would benefit those companies who were having problems with credit control, a kind of 'blacklist' could be built up to prevent unscrupulous companies winning credit from more than one member of PAD. There was also a feeling that as a group they could fight piracy and bootlegging hand in hand with the BPI.

Other subjects under the group's scrutiny are MCPS and the new Copyright Act, together with the new Codes of Conduct now being agreed by APRS with MCPS.

Agencies

- **DACS Ltd** have become the sole UK distributor for the German mixer automation system *C-MIX* made by **Jellinghaus Musik Systeme**. Digital Audio and Computer Systems, Stonehills Complex, Shields Road, Pelaw, Tyne and Wear NE10 0HW, UK. Tel: 091-438 5585.
- **EMO Systems** have announced the appointment of two overseas distributors for their products. In Switzerland the distributor is Audio Rent and in Greece Athens-based Alpha Sound have been appointed. Contact for both companies is Audio Rent, Werbhollenstrasse 54, CH-4143 Dornach, Switzerland. Tel: 061 701 5515. Fax: 061 701 2947.
- **ARX Systems** of Victoria, Australia have announced the appointment of PACE (Pro Audio

Consultants and Engineers) as their distributors for India. PACE Tel: 91 22 261 0766.

- **Innovative Electronic Designs** of Louisville, KY, have appointed the Sound Department as UK distributors. The Sound Department, Askew Crescent Workshops, Askew Crescent, London W12 9DP. Tel: 081-749 2124. Fax: 081-749 8789.
- **TubeTech** manufacturers of signal processing equipment, and **MLE** power amp manufacturers have appointed to electronic as UK and Eire distributors. to UK, 24 Church Street, Oswestry SY11 2SP, UK. Tel: 0691 658550. Fax: 0691 658549.
- **Soundtracs** have announced the appointment of Audiatur AB as their exclusive distributor for their console range in Sweden. Carl-Eric Modin, Sales Manager, Audiatur AB, Box 1196, S-161 111 Bromma, Sweden. Tel: 8 262720. Fax: 8 800243.

People

- **Pete Wandless** has joined **Focusrite Audio Engineering**, Bucks, UK, as sales manager, responsible for managing the Focusrite distribution network throughout Europe, Japan, Australasia and the US. Wandless was formerly with SSL and most recently with Harris, Grant Associates.
- **Racom Broadcast Ltd**, Berks, UK, manufacturer and supplier of the DAMS system have recently appointed Catherine Oates (formerly Claridge) as European sales manager.
- **Patrick Stapley** has been appointed production manager of **Falconer Studios** London UK. Stapley, formerly freelance after a long period

at Abbey Road, is joined in a management restructuring by Chris Baker previously at the Chocolate factory, and Amanda Richardson moving from Westheath.

- **Mike Reay** has been appointed sales and marketing manager with **EMO Systems**, Durham, UK, manufacturer of professional audio equipment. Reay comes from a background in live music and the recording industry.
- **Digidesign**, CA, USA, have announced the appointment of M3 Sweatt as director of international sales and marketing. M3 comes from a similar position held at Opcode Systems.
- **DAR** have appointed John Wase sales executive covering the UK, Ireland, Switzerland, Italy and the Benelux countries.

Letter: Pinewood console

Dear Sir, Thank you for the interesting article on Pinewood Studios' new SSL film post-production console (*Studio Sound*, June 1990). It was gratifying to see mention of their last new console, built by Theatre Projects in 1981. If the customer is still satisfied, what more can one ask. It was certainly one of my most enjoyable projects working with Geoff Labram and others at Pinewood. However, most good jobs are not one man's effort but a result of teamwork. In this case we had an eminently sensible customer and the

resulting console was a joint design effort between Dave Higton (now of Neutrik (UK) AG) and myself. Dave was in particular almost exclusively responsible for the circuit design. One other minor error was the cost. It was actually £115,000 for a totally bespoke 60-channel, 32-group automated console with six or more programmable panners. And we made a profit.

Sam Wise, Island Acoustics, 25 Crosfield Avenue, Cowes, Isle of Wight PO31 8HN, UK.

Contracts

- Video Village, Bristol, has commissioned a Soundcraft 3200 mixing console in its new video dubbing theatre.
- Clive Green & Co have announced the installation of its A type desk for the new Chicago production of *Phantom of the Opera*. This latest contract represents the seventh international production of the musical to use Cadac consoles.
- Sam Therapy Studios, London, have announced the opening of their track laying/pre-production Studio Two. Equipment includes a 56-channel DDA DCM desk and Quedsted monitoring.
- Mersey TV have announced their decision to buy an AMS *AudioFile* system for use on the production of *Brookside*, Channel 4's leading soap opera. Other recent *AudioFile* contracts include Magmasters studios, London, who have ordered three systems, which brings their number at Magmasters to six. London film house DB Post Productions have taken delivery of a

2 hr *AudioFile* system.

- Livingston studios, North London, have announced the completion of their first pre-production and programming suite. To be known as Suite One, the room is equipped with an Atari *Mega 2* computer with C-Lab Unitor software and an Akai *S1000HD* sampler.

- Amek have been awarded the contract for supply and installation of a 48-channel mixing console for the St Davids Hall in Cardiff, Wales.

- Lillie Yard studios, London, have recently bought a second Otari 24-track tape machine allowing synchronisation via *Q.Lock* of 48 tracks.

- Kajem Studios, Philadelphia, PA, have added an NED *Synclavier* to their studio.

- Recent completed studios by the Acoustics Design Group include the second phase of the Metropolis studios complex in London; a new music to picture audio post-production studio for Eurosonic SA and the completion of the new Kyoto studio for Eurosonics in Madrid; reconstruction of No 1 studio at EMI Electrola's Maarweg studios in

In-brief

- Isleworth, Middlesex: Southbrook Group has announced that it has purchased the assets and business of Isleworth Studios, 484 London Road, Isleworth, London. Isleworth Studios were placed into receivership on May 1st this year.

- Middlesex, UK: Akai have announced a price reduction on the *DD1000* Digital Magneto Optical Disk Recorder. Due to lower component costs the price will be £7,750 excluding VAT.

- West Midlands, UK: The Systems People are a new company

Cologne, Germany. Seven major studio projects on Tokyo, one in Osaka and one in Seoul, Korea. Projects currently under construction include a new studio within a new residential complex for LA Sounds in Trinidad.

- RO Studios of Concord, CA, have announced the acquisition and installation of Otari's first *Sound Workshop* series 54 console. RO's series 54 is configured with 40 dual path modules automated by Otari's *Diskmix 3* moving fader automation system.

- Recent Nexo sales through they Spanish distributor 220 include the sale of a large Nexo *PC Line* speaker system to government-sponsored La Compania Nacional de Teatro Clasico (National Classical Theatre Company) in Madrid, which will use the system on tour.

- Television and music production company, JSM in New York, USA, have bought a DDA *AMR24* console to handle all their recording and mixing duties. The Trump Castle Entertainment Division have bought a Q series console to be installed in their Atlantic City Casino showroom.

specialising in technical support to the pro audio/music industry. Their services range from wiring looms to total studio installation and technical support. For the sound reinforcement side services include pre/post tour rig checks, custom modifications and emergency support. Tel: 021-505 1684.

Correction

In our June issue we said that Hans Zimmer had taken delivery of a Soundtracs 3200. In reality it was a Soundcraft 3200 console. Apologies to all concerned.

- The Virgin Group of studios have bought another Mitsubishi X-880 digital multitrack. The machine will be going into Olympic studios but will be available to all Virgin's other recording facilities including Townhouse, The Manor and the Manor Mobile.

- Recent contracts for Mitsubishi 20-bit ready X-86 machines were Ridge Farm and recording artist Enya.

- Hire company Dreamhire have bought their second X-880 32-track digital recorder bringing their total of Mitsubishi multitracks to four.

- The new UK-based country and blues band The Notting Hillbillies recorded their debut album on the Soundtracs *IL 3632* production console.

- Entercom, Philadelphia, PA, have recently purchased four TAC *Bullet* compact-format mixing consoles, through Bruce Coffman at LD Systems, Houston, Texas. The consoles will be installed at KITS, San Francisco; KLXX/WAYL, Minnesota; KLDE, Houston and EXCR/WYUU, Clearwater, Florida, USA.

The sheer cost of purchasing new equipment is always a bitter pill to swallow. Add a fast-moving marketplace – and choosing the right technology becomes a major headache. Fortunately, a perfect antidote is now available: Hilton Sound's hire service.

With over ten years behind us – and the biggest selection of equipment in Europe – we make it our business to know everything about audio. So give Hilton Sound a call. Check out the options before you apply the cure.

HILTON SOUND

HILTON SOUND PLC
10 Steedman Street London SE17 3AF. Tel: 071-708 0483
Hilton Sound sari 2 Villa Ghis 92400 Paris. Tel: +33 1 46 67 02 10

PIONEERS IN AUDIO ACCESSIBILITY



CREATIVE STANDARDS



The AMS range of digital processors is designed to deliver creative audio solutions.

From the same family of products as the AudioFile, the world's leading hard disc editor and the SoundField surround sound microphone, their pedigree is guaranteed.

Happily these digital processors are now so widely used, they have become standards in more ways than one. Perhaps that's because we apply only one standard ... excellence.

- (A) TimeFlex Digital Audio Time Compressor/Expander
- (B) S-DMX Digital Audio Delay and Pitch Changer
- (C) RMX 16 Digital Reverberator
- (D) A/V Sync Auto Compensating Audio-for-Video Delay



For information and literature contact...

AMS Industries plc
Billington Road, Burnley BB11 5ES, UK
Tel: (0282) 57011 Fax: (0282) 39542

AMS Industries Inc
1180 Holm Road, Suite C, Petaluma, CA 94954, USA
Tel: (707) 762 4840 Fax: (707) 762 4811

SOUND ISOLATION

The acoustic technology proven by The Box, KFA Associates' successful modular studio system, is now available in a smaller format.

For voice-over and single instrument isolation, the Voice-Box provides a simple, rapid and economical solution. The choice of modules includes a variety of sizes and types which allow fine tailoring of the specification. Compatible with modules from The Box range, the Voice-Box system permits expansion, adaption and upgrading as required.

Telephone Ian Rich on 081-881 2239 for your sound isolation information.



SOUND DESIGN & CONSTRUCTION

1/2 Guillemot Place, Clarendon Road, Wood Green, London N22 6XG
Tel. 081-881 2239/081-888 0067 Fax: 081-888 2133

With 48 years' experience in the design and manufacture of several hundred thousand transformers we can supply:

AUDIO FREQUENCY TRANSFORMERS OF EVERY TYPE

YOU NAME IT! WE MAKE IT!

OUR RANGE INCLUDES:

Microphone transformers (all types). Microphone Splitter/Combiner transformers. Input and Output transformers. Direct Injection transformers for Guitars. Multi-Secondary output transformers. Bridging transformers. Line transformers. Line transformers to B.T. Isolating Test Specification. Tapped impedance matching transformers. Gramophone Pickup transformers. Audio Mixing Desk transformers (all types). Miniature transformers. Microminiature transformers for PCB mounting. Experimental transformers. Ultra low frequency transformers. Ultra linear and other transformers for Valve Amplifiers up to 500 watts. Inductive Loop transformers. Smoothing Chokes. Filter. Inductors. Amplifiers to 100 volt line transformers (from a few watts up to 1,000 watts). 100 volt line transformers to speakers. Speaker matching transformers (all powers). Column Loud-speaker transformers up to 300 watts or more.

We can design for RECORDING QUALITY, STUDIO QUALITY, HI-FI QUALITY OR P.A. QUALITY. OUR PRICES ARE HIGHLY COMPETITIVE AND WE SUPPLY LARGE OR SMALL QUANTITIES AND EVEN SINGLE TRANSFORMERS. Many standard types are in stock and normal dispatch times are short and sensible.

OUR CLIENTS COVER A LARGE NUMBER OF BROADCASTING AUTHORITIES, MIXING DESK MANUFACTURERS, RECORDING STUDIOS HI-FI ENTHUSIASTS, BAND GROUPS AND PUBLIC ADDRESS FIRMS Export is a speciality and we have overseas clients in the COMMONWEALTH EEC, USA, MIDDLE EAST, etc.

Send for our questionnaire which, when completed, enables us to post quotations by return.



PO Box 36, Ipswich IP1 2EL, England.
Phone: 0473 252794 & 0473 219390 -
Telex: 987703G Fax: 0473 236188



360 Systems digital cart machine

360 Systems have launched a random access, cart-style recorder/player based around a removable magnetic hard disk. The *DigiCart* will allow storage of up to 10 minutes of stereo audio in 16 bit with 15 kHz bandwidth or 20 minutes mono. The *DigiCart* is also able to record 20 kHz bandwidth at 44.1 or 48 kHz sampling rate.

The disks are housed in rigid cases similar in size to a CD 'jewel box'.

Production features include non-destructive editing and sequencing of

titles with instantaneous start of a cued title. Automation is possible via the rear EIA-232 port. An option is available for internal fixed hard disk with an hour of additional storage time as well as a SCSI port for access of external hard disk drives.

360 Systems, 18740 Oxnard Street, Tarzana, CA 91356, USA. Tel: (818) 342-3127.

UK: Plasmeq Systems Ltd, Weydon Lane, Farnham, Surrey GU9 8QL. Tel: 0252 721236. Fax: 0252 712718.

Audio Animation Muse

Audio Animation now have the release version of *The Muse* digital mastering console in production. Featuring two stereo input channels each with 5-band EQ and dynamics processing mixing to a main stereo output. *The Muse* offers 24 to 56 bit realtime processing, over 80 minutes of automatic updating of control functions at 100 times/sec and high resolution graphics.

Audio Animation describe *The Muse* as having been designed for

sonic purity employing FIR filtering, proprietary architecture and algorithms. Other features include AES/EBU, SDIF-2 and RS-232 interfaces, variable sampling rates from 30 kHz to 100 kHz and automated faders.

Audio Animation Inc, 6632 Central Avenue Pike, Knoxville, TN 37912, USA. Tel: (615) 689-2500.

Worldwide: Redwood Marketing Inc, PO Box 270007, Nashville, TN 37227-0007, USA. Tel: (615) 254-7400.

tc 6032 remote controller

tc electronic are to market the *TC6032* remote controller for the *1128* graphic equaliser that was developed in conjunction with Clair Brothers. Up to 32 units can be controlled and features are motorised linear faders for controlling and displaying settings on single or groups of equalisers. In addition to the fader bank, a CRT screen displays the curve of the *1128(s)* selected and up to 100 settings can be stored into each unit.

Equalisers can be selected singly, in pile-on mode (ie added as required) or all together. Multiple modes allow quick overall settings to be made before fine-tuning individual units.

tc electronic, Grimhojvej 3, DK-8220 Brabrand, Denmark. Tel: 86 26 28 00. Fax: 86 26 29 28.

UK: tc UK, Oswestry. Tel: 0691 658550.

USA: tc electronic USA Inc, North Hollywood, CA 91605. Tel: (818) 503-0404.

Furman compact amps

Furman have introduced a compact half-rack stereo power amplifier. Rated at 20 W channel, the *SP-20* may be switched for stereo, dual-channel mono or bridged 40 W mono. Features include stereo input level control, signal present and overload control and speaker mute switch. Mechanically the unit meets the Half-Rack standard allowing two HR units to be mounted in 1 U rack space side by side.

Manufacturer's quoted specification

includes THD of 0.01% at 1 kHz at full rated output and 0.05% THD from 20 Hz to 20 kHz. The unit also includes protection against thermal overload and short-circuit. Available as *SP-20B* with *XLR* balanced inputs with additional option of *HRKIT-2* rackmounting kit.

Furman Sound Inc, 30 Rich Street, Greenbrae, CA 94904, USA. Tel: (415) 927-1225.

UK: Shuttlesound Ltd, Unit 15, Osiers Estate, Osiers Road, London SW18 1EJ. Tel: 081-871 0966.

ASC Studio Traps

Acoustic Sciences Corp have introduced a portable free-standing version of the *Tube Trap* acoustic baffle. This is a 9 inch diameter tube mounted on a tripod with a floating suspension for height and rotational adjustment. Acoustically half of the *Studio Trap* is midrange reflective with a sound diffusion panel active over 440 Hz while the other half is absorptive. Rotating the *Trap* turns these panels towards or away from the sound source changing the character of the sound field. Vertical adjustment of height is from 6 inches

to 6½ feet from the floor. ASC have suggested their use in groups for the creation of iso booths, acoustic screening or acoustic treatment in temporary control rooms, etc.

Acoustic Sciences Corporation, PO Box 1189, Eugene, OR 97440, USA. Tel: (503) 343-9727.

UK: Adrian Walker, Deltec Precision Audio Ltd, Unit 7, East Moors Business Park, East Moors Road, Cardiff CF1 5EE. Tel: 0222 482818.

Europe: Sound & Music srl, Via Mazzarosa, 125-55100 Lucca, Italy. Tel: 0583 581327.

ARX signal processors

The *Sixgate* is a 6-channel noise gate with each channel featuring Release, Attenuation and Attack controls, Key input and Detector loop insert.

The *Quadcomp* is a 4-channel compressor/limiter, each channel being provided with Threshold, Ratio and Output controls and 10 LED gain reduction meter. Channels 3 and 4 can be switched for stereo link operation and each channel uses a class 'A' VCA.

The *DI-6* combines the functions of 6-channel DI box with that of a 6/1 line mixer. Each channel features in/out ¼ inch jacks and balanced output via *XLR* together with earth (ground) lift switch and LED, a level control and clip LED. The Master section has a master level control and headphone output, together with balanced and unbalanced outputs.

The *EC-1* Phase Correct electronic crossover can be used in stereo 2-way or mono 3-way modes and provides Linkwitz-Riley 4th order filtering. Each output has 6 dB of gain with level control and crossover frequencies selected by four resistors on the main circuit board.

The *Multi Q* is a 6-channel parametric equaliser with each channel featuring Frequency, Q and Cut/Boost controls, ×10 Frequency switch, EQ in/out switch and clip LED. An unusual feature is that each channel has its own in/out jacks allowing for various user configurations, eg six single-band EQs, two 3-band EQs or a 6-band equaliser. An 'Auto Patch' facility automatically links channels unless a lead is inserted.

The *EQ 30* and *EQ 60* are single- and dual-channel 30-band graphic equalisers with switchable 6/15 dB ranges. Other controls per channel include gain control (∞ to +6 dB), 30 Hz highpass filter, EQ in/out switch and clip LED. Inputs and outputs are balanced on *XLR*-type and ¼ inch connectors.

ARX Systems, Audio Research & Technology Pty Ltd, PO Box 15, Cheltenham 3192, Victoria, Australia. Tel: (03) 555 7859. Fax: (03) 555 6747.

UK: MTR Ltd, Ford House, 58 Cross Road, Bushey, Herts WD1 4DQ. Tel: 0923 34050. Fax: 081-671 7306.

The
Good Food
Guide 1990



NEW EDITOR
Tom Jaine

THE 1990
GOOD PUB GUIDE

Edited by **Alfredair Aird**



GOOD HOTEL
GUIDE · 1990 ·



A Selective Guide to Products & Services



Professional Audio · Broadcast Audio & Video Technology
Applications Advice · Service Support · Project Management
Systems Design & Build · Installation · Digital Audio Master

Audio professionals have been coming to HHB for over fourteen years – ever-hungry for applications advice and service support. That's why HHB has decided to invest a great deal of time and effort to make that knowledge and

At last, a guide that caters for the real needs of the industry.

experience available on a much broader scale.

In sixty full-colour pages, we've produced the definitive guide to the best and most popular choices in professional audio and video equipment.

On a worldwide basis, HHB is continually researching thousands of products from hundreds of manufacturers. But we've only selected the finest and most relevant for our guide. So you can be confident that every product featured is reliable, cost-effective

and capable of performing effectively in demanding professional environments.

And while you'll find useful specification details, the HHB Selective Guide is certainly a great deal more than a mere product catalogue. It's the essential reference source for anyone working with professional audio and video technology.

Be sure to send off for your own free copy, right away.

*I'm hungry to know more. Please send me a **FREE** copy of HHB Communications: A Selective Guide To Products & Services*

Name _____

Position _____ Company _____

Address _____

Phone No. _____

HHB COMMUNICATIONS LIMITED, 73-75 SCRUBS LANE, LONDON NW10 6QU PHONE 081-960 2144 TELEX 923393 FAX 081-960 1160.

www.americanradiohistory.com



ADT 5MT production system

The ADT 5MT production system is the latest version of the ADT recording console and is available in frame sizes of up to 56 input channels. The console is fully modular and features five different channel modules: 105-S, 105-AT, 105-B, 10-ST and 105-E.

105-S features three inputs (mic/line/tape), 3-band parametric EQ and sweep highpass filter, six auxiliary sends plus stereo cue and independent record and tape replay paths. 105-AT features 4-band parametric EQ that can be split between the record and tape paths, sweep high- and lowpass filters, additional line input (switchable between tape return), dynamics section with comprehensive compressor and gate and side chain routing to the dynamics section from both the filter and EQ section. An extra stereo auxiliary with pan is also provided, which can be assigned as an extra output or input from or to the channel. 105-B is as the AT module but without the dynamics section. 105-ST is a stereo line input module with all facilities and a simplified EQ section. The 105-E is designated an 'economy' version of the 105-S module.

General features include fader reverse, optional VCA grouping and

automation, two mute buses, comprehensive insert points with switching for both channel paths, 24-track routing plus direct output and switchable audio subgrouping to record sends (SUB function).

The console can also be supplied with what is known as the AT master section, which provides further sophistication over the standard section such as fully routable stereo returns with EQ and auxiliaries, advanced talkback, master mix output with stereo dynamics and 'elliptical equaliser' and more monitor inputs.

The ADT 5MT console can be supplied with nine VCA groups and an SMPTE/EBU-based automation system (25-frame standard, 30-frame optional). Loosely described as a 'Console Management System', the AMC automation provides locator functions (Adams-Smith), multitrack control, automation of both the first and second faders (ie main and monitor/secondary) plus mutes and an information menu, which contains pages such as a Cue List Editor, track sheets, session details, etc. **ADT, UNB Elektronik, Kolner Strasse 201-203, 5000 Koln 90, West Germany. Tel: 02203 16414. Fax: 02203 17108.**

Europe: Electro-Voice SA, CH-Ipsach, Switzerland. Tel: 032 51 68 33. Fax: 032 51 12 21.

UK: Shuttlesound, London. Tel: 081-871 0966. Fax: 081-870 9300.

• Akai Sampler Memory

Expansion: Akai have announced that EXM-008 8 meg memory expansion boards for the S1000 series samplers are now available. Up to four EXM-008 boards can be installed giving 32 meg of memory allowing 3 minutes of stereo sampling time at 44.1 kHz and 6½ mins in mono. The EXM-008 boards can also be used in conjunction with EXM-005 2 meg boards but Akai advise that it is not possible to use more than two EXM-005 boards in combination.

• **Fabritrak Fabrics** have launched a new collection of fabrics used for internal finishing within the studio. All are flameproofed to Class 1 and are available in widths of 1680 mm and 2650 mm. **Fabritrak Fabrics, Fabritrak House, 21 High Street, Redbourn, St Albans, Herts AL3 7LE, UK. Tel: 0582 79462.**

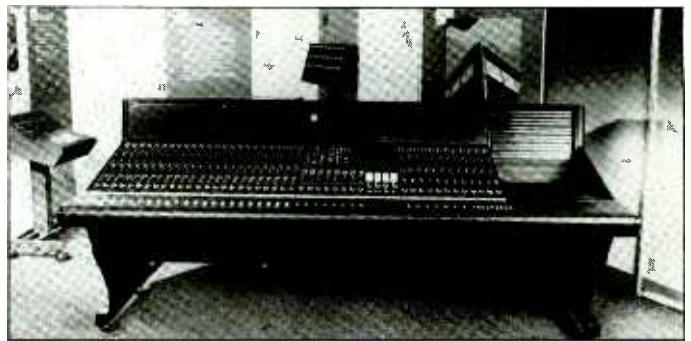

Drake stereo TV console

Philip Drake Electronics have launched a console designed especially for production for stereo TV. The 2000 Production console is a flexible system that allows choice from a selection of modules such as mono or stereo inputs and multitrack in-line types. The console also offers multiple clean feed system, internal linking to offer custom configuration,

balanced busing and 12 stereo groups/outputs.

Philip Drake Electronics Ltd, 37 Broadwater Road, Welwyn Garden City, Herts AL7 3AX, UK. Tel: 0707 333866.

USA: RTS Systems Inc, 1100 West Chestnut Street, Burbank, CA 91506. Tel: (818) 566-6700. Fax: (818) 843-7953.

Cadac E-type software

Cadac have released a new software controlled system for the E-type theatre console featuring colour graphics, channel muting, VCA grouping, MIDI commands, events control, a programmable routing matrix and control of up to 128 motorised faders.

Cadac have also developed a MIDI-controlled moving fader system, which can be used with the E-type theatre console or as a standalone package. Available in groups of eight

faders, the MIDI Fader Stream features touch sensitive fader knobs and is controlled by a MIDI sequencer to provide level automation for such applications as snapshot mixes, effects sequences, etc.

Clive Green & Co Ltd, 1 New Street, Luton LU1 5DX, UK. Tel: 0582 404202.

Europe: Autograph Sales, 102 Grafton Road, London NW5 4BA. Tel: 071-485 3749. Fax: 071-485 0681.

Sound Creators VMX console

Sound Creators Inc have launched the VMX series monitor console, which is designed to provide add-on monitoring where the studio console has run out of monitor channels or as an effects submixer. The console is divided into the audio rack and the fader block allowing the operator section of the console to be small and keeping the main electronics in the studio racking.

The input rack will accept up to 16 input modules plus a bus switching module while the master rack contains eight input modules plus the master and oscillator modules. The fader section is made up from fader block modules (eight in each) and the master module, which contains the output masters and oscillator. A mixer can be configured with eight to 56 inputs.

Each channel of the VMX comprises of linear fader, solo and on/off switches, pan control, two auxiliary send controls and pre/post switches. The master module consists of four group masters, four auxiliary send masters, a 2T master fader and a 2T cue master, solo level control, monitor level controls, oscillator section and monitoring switches. The routing of the input channels is accomplished on the input modules in the audio racks, which also have switching to two direct output buses.

Other features include Solo Interlock with the main console and interface to console automation systems.

Sound Creators Inc, 4-7-6 Akasaka, Minato-Ku, Tokyo, Japan. Tel: 3 505 2071. Fax: 3 505 2203.

In brief

• **TAM CD ref system:** Mastering facility TAM studio have developed their own CD reference system to provide one off CDs from any tape format. The system includes a Yamaha CD recorder from Philips IMS, Sony PCM 1610/1630 processors and recorders together with specially modified equipment from Audio Design and others. **TAM Studio, London, UK. Tel: 081-345 0033.**

• **Electro-Voice** have released the MTS-1 full range speaker system using manifold technology. The MTS-1 is intended for bi-amplification and employs two DH-1A HF drivers manifolded or to an HP940 constant directivity horn and two DL15X 15 inch (38 cm) LF drivers in a vented chamber. Frequency response is quoted as 53 Hz to 20 kHz. The loudspeaker is equipped with two Neutrik Speakon NLAMP connectors per section and max recommended amplifier power is 300 W (HF) and 1000 W (LF). **Electro-Voice Inc, MI, USA. Tel: (616) 695-6831.**

There are now several companies making a name with DAT. (Luckily, you need only remember one.)



AIWA
HD X1



FOSTEX
D20



SONY
TCD-D10PRO



TECHNICS
SV-260A



SONY
DTC-1000ES



RS-DAT
RS1000

Take a closer look at some star performers from the world's foremost supplier of DAT equipment.

Consider the palm-sized Aiwa HDX1. Specially imported from Japan, only HHB can offer this tiny portable complete with detachable A to D convertor, European power supply and an English language manual.

We're leading stockists of the Fostex D20. Already hugely popular amongst broadcast and video-post engineers, this four-head machine not only records digital time-code, but can be adapted to accept the forthcoming IEC time-code standard.

Sony's rugged TCD-D10 Pro is in great demand. Equipped with digital I/Os and XLR connectors, we can provide portable 'Pro' users with an exclusive 48 volt phantom power modification. The Technics portable DAT has already won wide acclaim for its excellent record quality, thanks largely to a unique 64 times oversampling 'MASH' A to D. The new 'A'

version of the SV-260 not only features a refined tape transport, but a higher specification mic input.

As the industry standard, our best-selling Sony DTC-1000ES needs little introduction. Not only have we been able to secure plentiful supplies, but every unit leaving HHB carries the company's famous



44.1 kHz modification. Underlining the versatility of the DTC-1000ES is the remarkable digital cart device, RS-DAT. Simple to operate and externally controllable, RS-DAT is now a firm favourite with our many broadcast and live sound clients.

Visit Scrubs Lane and you can evaluate HHB's full DAT range in Britain's finest demo-facility. But ask our customers. Buy from HHB and you also tap into technical advice and service support that's second to none. And if you're based outside the UK, don't despair. As the world's number one source for DAT, we now have a global network of leading agents.

TCD is the new digital division of Thatched Cottage Audio based in a brand new 5,000 sq.ft. complex adjoining the present Royston site. Having become Europe's largest 8 and 16 track specialist, the time had to be right to move into the completely professional domain, whilst continuing to provide the same quality of friendly efficient service combined with a comprehensive range of equipment kept permanently in stock and on demonstration. You may have not realised that although we are not based in a major city we CAN deliver goods the same day anywhere in the UK. Why not give TCD a try? Regular clientele include Sarm West, PWL, Real World, Eel Pie, Swanyard, Bros, Erasure, Iron Maiden, UB40, and the Who - shouldn't you be on this list?

SECOND HAND & EX-DEMO UNITS

Acoustic Energy AE2 ex-demo	£499
Waldorf Microwave amazing analogue synth	£799
Proteus XR mint	£865
Drawmer 231 Compressor/Limiter	£350
Neve 8108 48 channel-in-line with Necam 96	£55,000
Sony DTC1000ES	£899
Beyer MC740	£599
Atari 1040 & monitor & C-Lab Notator	£750
Akai S950 memory expansion	£125
Drawmer DS201 gate	£250
Yamaha SPX1000 multiprocessor	£599
Fostex 4030 synchroniser	£750
Aphex 612 Expander/Gate	£399
Korg M1	£850
Akai S1000 2 Meg expansion boards	£199
BSS DPR402 Compressor/Limiter/De-esser	£399
Tascam ATR60 2-track 1/2" inc. trolley, mint	£1500
ElectroSpace Time Matrix - 6 delays in one	£299
TC Electronic 2290	£999
Fostex 4010 Time code read/gen	£499
Fostex 4011 Character generator/VTSSE unit	£399
TC Electronic 1210 Spatial expander/chorus	£399
Fostex 4050 remote/autolocate/SMPTe for E16	£399
Yamaha KX88 mother keyboard	£899
Fostex 4020 events controller	£399
Sony PCM501 digital mastering	£299
Teac 3440 4-track 1/4"	£399
Tascam 38	£899
Proteus I	£599
Tascam MSR24	£599
Yamaha SY55 (smaller SY77)	£599
Tannoy Little Gold Monitors	£499
Allen & Heath System 8 24:8:16	£1499
Akai S1000 KB (full S1000 + keyboard)	£2499
Tascam MS16 (1" 16+) mint	£3499
Tannoy Super Golds (15")	£1299
Allen & Heath Saber 24:16:24	£5999
Tascam MSR16	£2999
Allen & Heath Saber 24:16 VU	£4750
Aiwa DAT	£499
Tascam ATR80 2" 24 track including autolocate - mint	£14999

This is a small selection from our current stock - give us a call and we will be happy to send you a full up-to-date list. All prices exclude VAT.

The latest issue of our 40 page full colour magazine is now available along with our current price list. Write or telephone for your free copy.

If you require any further information on any of the services which we can provide give us a call on 0223 208110 or on the main TCA number 0223 207979 (11 lines) for full details and brochures. The faxpack, which gives details of installation facilities, the service department, demonstration facilities and the equipment we can promise should answer any questions. If you are converting any kind of audio purchase, why not give us a call - you have nothing to lose! We didn't become the largest pro-audio retailer in EUROPE without being the best!

THE SAME AMAZING SERVICE AND CHOICE BUT NOW DIGITAL

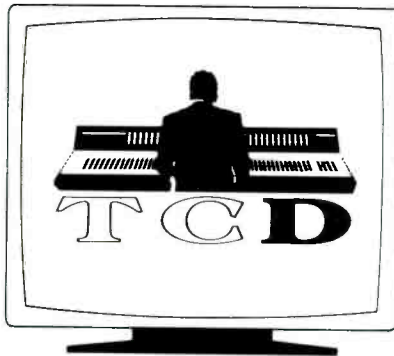

WE SELL KEYBOARDS!

Despite our prominence in the pro-audio market some people still don't realise we sell keyboards! In fact, our dealerships include Yamaha, Emu, Roland pro-audio, Akai, Korg, Waldorf, and Casio, with all popular models in stock (along with staff who know how to use them). Next time you need a keyboard, sampler or expander why not give us a call?

PACKAGES

At Thatched Cottage we have put together a number of packages based upon complete systems, each offering compatible items with substantial discounts (although it is possible to change them within a given package). Whole studio systems are available for 8, 16 and 24 track, and we have faxpaks on 4 & 8 recording, MIDI, our Thatched Cottage school and finally financial advice (loan and leasing schemes available). All the details are free - just give us a call.

DAT MACHINES

As well as Denon, Tascam, Technics and Aiwa DAT machines, we also sell the brand new Sony DTC55. A rack size, multi function DAT, with digital, audio and optical inputs and outputs, switchable 32 khz, 44.14 & 48 khz and all the functions of its big brother for an incredible £699 + VAT. Amazed? You should be! We have full details.

SPECIAL OFFERS (all new)

Revox B77	£999
Korg M3R	£499
2 meg expansion for S1000	£199
Seck 12:8:2 desk	£699
Sony DTC55	£699
Revox PR99	£1499
Function Junction Plus	£550
Alesis Microverb II	£99
Alesis Midiverb III	£199
Drawmer DS201 gates	
(unbalanced)	£250
EVS1 expander	£259

All prices exclude VAT

IN BRIEF

Recent agencies include TAC (look at the Magnum console), Amek, Neve, Tannoy professional, Focusrite and AMS. We are still waiting for the new Yamaha Digital Workstation, but the Akai Adam 12 track is selling well (we have deals on fully loaded S1000 + disk drives as well). We can package the Tascam MSR24 1" 24 track with most desks. Computerwise, C-Lab and Cubase are still most popular and the Proteus II full orchestra module is simply stunning.

Recent visitors to our 24 track studios include Ches Hawkes working on Sonys for his new film with Roger Daltrey and Nik Kershaw, and several new MIDI courses have been added to the school prospectus. Finally, last month's complete studio installations included Neneh Cherry, David Sylvian, Barry Upton (Brotherhood of Man), LA Mix and Amazon.

ATARI SOUND TOOLS PACKAGE

Digidesign Sound Tools for Atari, Atari Mega 4 inc monitor and mouse. DAC 200 meg. R/M Hard drive (+ interface) £3750 + VAT

AKAI MG140 - £1799 + VAT

A rack mount twelve track recorder, with an additional two tracks for synchronisation, the MG140 is a superb quality recording tool. Balanced/unbalanced connections, a full autolocate/remote available, and noise reductions built in, give totally professional quality at an amazing price (autolocate/remote - £299 + VAT). Limited stocks available.



TASCAM MSR 24 plus A&H SABER
At last - a fully professional 24-track system
for only
£13,500 + VAT

Combining the best selling A&H SABER in a 24:16:24 format (no repatching required) and the brand new Tascam MSR24 1" 24 track recorder. Complete with a full jack patchbay and all plugs and cables.

Call for full information and demonstration.



STOP PRESS.....

TCA Travel..... In case you didn't know our fully equipped ABTA/ATA Thatched Cottage travel agency has been up and running for some time now, expanding our high standards of service and great value into the travel industry. Whether you are organising a tour, visiting a trade show or simply booking a holiday, give us a call, what have you got to lose? Contact Gill Scott or Glen Bagnell on 0223 314577 or 0860 450499 (mobile). ABTA No: 89156

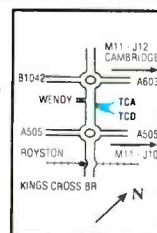

North Road, Wendy,
Nr. Royston, Herts

TEL: 0223 208110
FAX: 0223 207952
24 HRS: 0860 445172



TCD

THATCHED COTTAGE DIGITAL



Kenwood recordable CD system

The Kenwood Corporation have recently introduced a CD recording system—they refer to it as the *CD-WO* (Write Once) system. The principal items are the *DD-7200* CD Writer and the *DA-7000* CD Encoder and requires the use of system controller in the form of a PC to run the system Programme Software. The system was demonstrated using Taiyo Yuden recordable blank CDs but is apparently capable of recording on other similar CD blanks that may come available due to the self-calibrating recording laser system within the CD Writer.

The CD Encoder is a compact unit with Kenwood having managed to reduce the actual encoder section to a single LSI chip. This leaves room for three other boards within the unit. This means that following the availability of the necessary boards and the optional *U-71* CD-ROM/I Formatter the same unit will be able to produce all the major CD formats

including the CD single and CD Graphics (when the Graphics generator is completed). There is also an optional A/D converter board.

In use the Encoder can feed up to 32 Writers as well as the ability to only partially record a CD—writing a temporary table of contents that will only be finalised when all the recording is completed. The system automatically generates Sub-Code information through the editing software although precise requirements would have to be entered manually.

The cost of the system quoted is under £13,000 (\$24,000) without the PC and Kenwood are targeting studios, broadcasters, etc, rather than mastering facilities.

UK: Kenwood UK Ltd, Kenwood House, Dwight Road, Watford, Herts WD1 8EB. Tel: 0923 816444.

USA: Kenwood US, 2201 E Dominguez Street, Long Beach, CA 90810. Tel: (213) 639-9000.

SPL Procom headphone monitors

The SPL *Procom* professional headphone monitor system consists of a central 1U rack distribution unit and two satellite boxes, each satellite box handling two separate headphone feeds. In addition there are four auxiliary inputs (typically, aux sends from the console) with level controls and a microphone input for intercom purposes.

The system basically allows monitor and playback mixes to be

sent across a 4-way matrix together with the possibility of individual communications. The satellite boxes also enable musicians to adjust their individual headphone mix and overall level.

SPL, Hauptstrasse 59A, D-4055, Niederkrüchten 1, West Germany. Tel: 02163 8761. Fax: 02163 83028.

UK: Audio Design, Unit 3, Horseshoe Park, Pangbourne, Berks RG8 7JW. **UK:** Tel: 0734 844545.

Intelix remote controls

The Intelix *MIND Control* system provides remote control, from one central point, for audio systems in installations such as theatres, broadcast and A/V complexes; broadcast routing systems; lighting systems and electrical installations.

The system comprises a central card frame controlling a number of remote control processors, the mainframe containing the CPU and standard control cards for audio gain, contact closure, matrix relay, voltage conversion, etc.

There are eight standard modules for the remote controllers and a version is available with an LCD for status readout and parameter.

The system is programmed via the serial port of any MS-DOS computer, including laptops.

Also from Intelix, the *Studio Psychologist* is a remote control studio and live performance matrix

mixing system that permits musicians to make their own mixes via mix control units (beltpack or standmounted) that are connected to the audio mainframe. Channels are expandable from eight to 32 channels, mono or stereo.

The Intelix *AutoCue* adapts to any tape recorder and allows tapes to be cued up correctly at the end of each cue point separated by leader tape, eg sound effects tapes for broadcast and theatre. Once a cue has been played, the *AutoCue* sensor cues the tape up to the start of the next one and puts the machine into Stop mode.

Intelix, 5618 Odana Road, Madison, WI 53719, USA. Tel: (608) 273-6333. Fax: (608) 273-5483.

UK: Shuttlesound, Unit 15, Osiers Estate, Osiers Road, London SW18 1EJ. Tel: 081-871 0966. Fax: 081-870 9300.



If you use Stevens & Billington's 7-point service plan:

1. Samples normally supplied in 7 days.
2. Individually designed to your exact needs.
3. Precision quality for high performance.
4. Quick reliable deliveries.
5. 'Mumetal' shielding cans for excellent 'hum' rejection.
6. Flexible call-off arrangement to suit you.
7. Competitive prices.

'Phone (0825) 890111 now - Get your sample next week

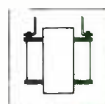

**STEVENS &
BILLINGTON
LIMITED**



Unit B2,
Bird In eye Farm,
Uckfield,
East Sussex
TN22 5HA.

Specialists in miniature transformers

AES PREVIEW

The 89th Convention of the Audio Engineering Society will be held at the Los Angeles Convention Center during September 21st to 25th, 1990. As usual the convention will consist of a wide range of technical papers with an associated exhibition. We have compiled this preview from details available to us at the time of writing

A

● **AB International:** range of power amplifiers and sound reinforcement equipment. ● **Accurate Sound Corp:** tape duplication products. ● **ACO Pacific:** several ranges of measurement and music recording microphones. ● **Acoustic Design Group:** photographs and drawings of completed

studio design projects, as well as drawings of current projects. ● **Acoustical Physics Labs:** studio monitor systems. ● **ACT III Publishing:** *The Mix*, US recording magazine. ● **Adams-Smith:** among other products, the model 2600 A/V audio editing system, featuring full list management for MIDI operations, and varispeed synchronisation. Also featured will be the *Zeta*

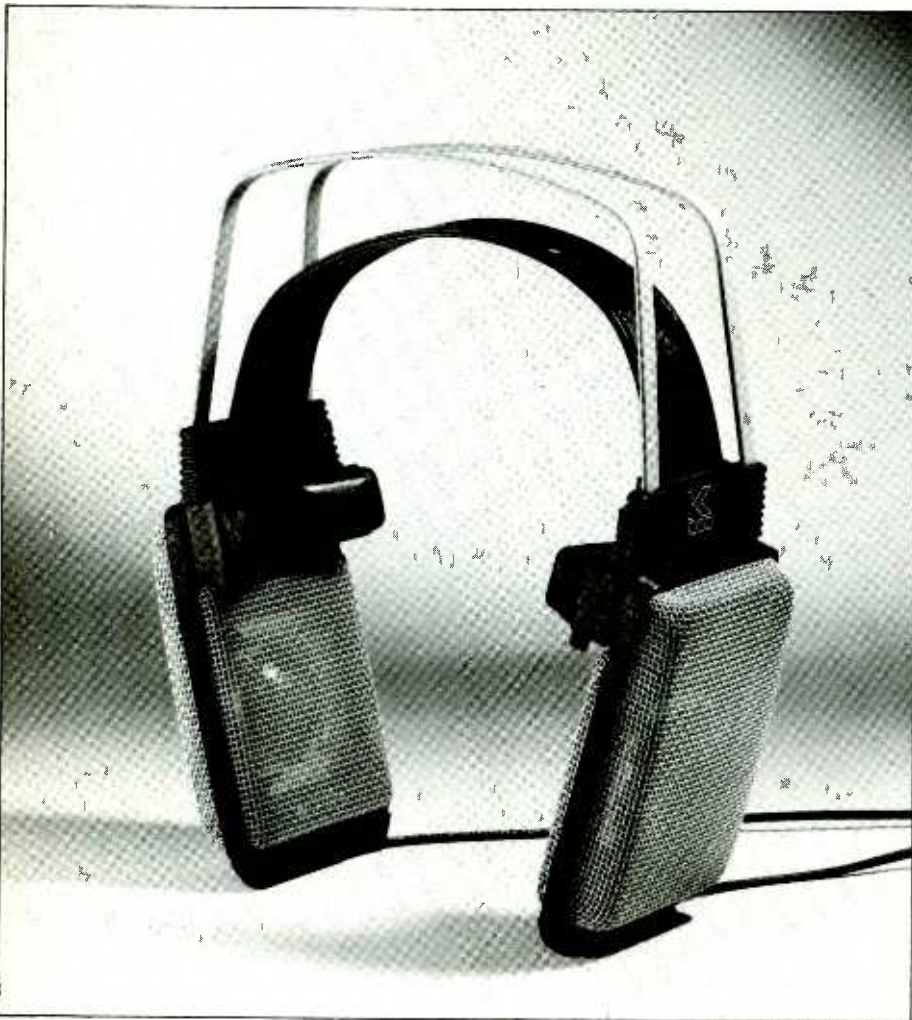

AKG Acoustics K1000 reference listening system

Three B synchroniser. ● **Adamson Acoustic Design:** featuring their range of concert loudspeaker systems. ● **AEG:** tape duplication equipment. ● **Agfa:** full range of audio, video and duplicating tape and cassette products. ● **Akai International Music Co:** featured will be the *DD1000* optical disk recording system. ● **AKG Acoustics:** will be featuring the *K1000* Reference Listening System. This headphone design allows personal listening with a natural acoustic perspective. They offer a claimed radical improvement over existing headphone designs. Also featured will be the *K270 HC* headset which combines the *K270S* headphones with the *C410* headset vocal mic. New products in the *Micromic* series include the *C406* a hypercardioid mini gooseneck-mic. ● **Alesis:** full range of digital signal processing, analogue processing, compact mixing console and MIDI based products. ● **Allen and Heath:** featuring the *SC* series of consoles; *Saber* and *Sigma* consoles and *Scepter* rack mixers. ● **Alpha Audio:** featuring the *Boss/2* Automated Audio Editor; the *DR-2* digital audio hard disk recorder and the *DR-2* Edit Controller. ● **Amber Electro Design Inc:** automated audio measurement systems. ● **Amek Systems & Controls/TAC:** showing the *Mozart* console with Amek/Steinberg *Supertrue* automation; the *Classic* broadcast console; the *BCII* broadcast console and the *G2520* console designed specifically for multitrack recording and video post-production. Also on show is the Amek *Medici* equaliser designed in conjunction with Rupert Neve featuring separate control paths each containing a 4-band parametric equaliser. TAC have new options for their *Bullet* consoles. Versions now available include a 30/4/2, a 28/8/2 and a free mounting 10/4/2. The AES will be the launch for the recording version of the *Bullet* specifically designed for 16-track work in 24/8/2+16. The *ES8* serial interface is designed to work in conjunction with the *Bullet* 10/4/2 AFV. Also on show is the *Magnum* in-line recording console and *Scorpion* sound reinforcement console. The *Magnum* will demonstrate MICE, a 1U high rackmounting Multiple Interface Control Element used to control mute switches using MIDI codes to turn them on and off. ● **American Helix:** details of their compact disc production and manufacturing services. ● **Ampex:** full line of professional audio tape products including *456 Grand Master*, *467* digital open reel and cassettes and *478* low print tape. ● **AMS:** featuring the *AudioFile Plus* with faster operation, eight simultaneous inputs, 16 outputs and read/write optical drives. Also featured is the *Logic 1* digital mixing console demonstrated with the *AudioFile Plus*; *S-DMS* stereo digital delay line; *Timeflex* time compression/expansion device; *RMX 16* digital reverb; and the *ST250* stereo mic. ● **Analog Devices:** introducing a dual 18 bit D/A converter designed specifically for high-performance multichannel digital audio applications such as electronic musical instruments, CD players, digital mixing/editing systems and multimedia workstations. ● **Apex Machine Company:** introducing their new *CA-20* on-cassette printer using the new *Apex 3000* print heads, which allows the operator to adjust rapidly the print heads for fine tune adjustment left and right and up and down, by the use of an automatic phasing device. ● **Aphex Systems:** full range of audio processing equipment and interfaces. ● **Apogee Electronics:** featuring *D160* dithering module as part of Apogee's *AD1000* analogue to digital converter. The *D160* can operate as a standalone dithering system or part of an A/D conversion system; *C384* low jitter

AKG
ACOUSTICS

ADVANCED MICROPHONE TECHNOLOGY

The C747 comb. is one of a new generation of miniaturised microphones developed by AKG for professional recording purposes.

Although only the size of a pen overall, the C747's tuned acoustic tube, in front of the transducer, provides uniform frequency response and high sensitivity, and its hypercardioid polar pattern makes it an ideal microphone for spot recording of individual instruments.

In the studio, its compact design allows easy and varied adjustments for any recording situation. On stage the C747 is virtually invisible to the audience. As with all AKG miniaturised microphones, for the C747 small is beautiful, for the engineer, the performer and the audience.

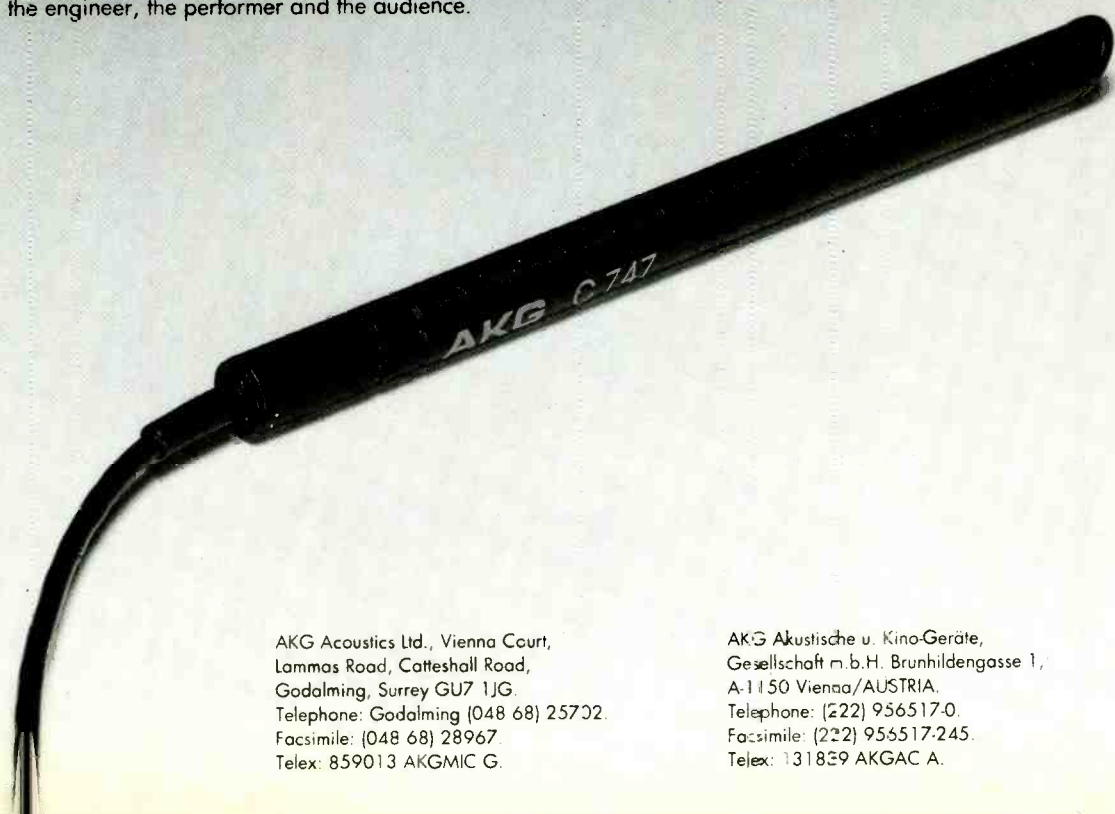

AKG Acoustics Ltd., Vienna Court,
Lammas Road, Catteshall Road,
Godalming, Surrey GU7 1JG
Telephone: Godalming (048 68) 25702.
Facsimile: (048 68) 28967
Telex: 859013 AKGMIC G.

AKG Akustische u. Kino-Geräte,
Gesellschaft m.b.H. Brunhildengasse 1,
A-1150 Vienna/AUSTRIA.
Telephone: (222) 956517-0.
Facsimile: (222) 956517-245.
Telex: 131839 AKGAC A.



Amek Medici equaliser



Dolby AC-2 digital audio encoder/decoders

slaving clock regenerator delivering accurate timing for A/D and D/A converters. ● **Apogee Sound Inc:** full range of loudspeaker products. ● **Archon:** no information available. ● **Ariel Corporation:** range of PC-related digital products for measurement, DSP and audio recording. ● **ARSONic:** wide range of signal processing equipment. ● **ART:** range of signal processing equipment. ● **Ashly Audio:** wide range of signal processing equipment and power amplifiers. ● **Audio Accessories:** range of jackplugs, sockets and cords, plus range of prewired audio patch panels, either standard or custom built. ● **Audio Action:** no information available. ● **Audio Animation:** showing *The Muse* fully digital automated console designed for CD mastering and digital tape preparation. ● **Audio Control Industrial:** realtime spectrum analyser. ● **Audio Precision:** *System One* automated test system with latest software/hardware updates. ● **Audio Services Corp/Pro Sound:** equipment supply

company. ● **Audio Technica:** featuring the *AT4031* cardioid capacitor microphone, designed to be phantom powered. Also the *AT 4051* cardioid capacitor microphone which is a transformerless externally-polarised capacitor studio mic. ● **Audiotechniques/Tube Tech:** TubeTech signal processing and products of their own manufacture. ● **Audio Teknology:** no information available. ● **Audio Video Consultants:** no information available. ● **Audix:** musical instrument microphones. ● **Australian Monitor:** range of power amplifiers for live sound applications.

B

● **BASE:** featuring their stereo sound processor, an audio spatial controller/enhancer that creates spatial dimension. ● **BASF:** full range of magnetic tape products. ● **BEC Technologies:** no information available. ● **Berklee College of**

Music: with details of their music recording courses. ● **BeyerDynamic:** showing the *MC 742* stereo condenser mic for applications including all stereo, mid-side and XY recording configurations. Offers five manually adjustable polar patterns. Also on show the *M59* vocal dynamic microphone. ● **BGW:** range of power amplifiers. ● **Bose:** wide range of loudspeaker systems. ● **Brainstorm Electronics:** display includes infra red remotes for talkback systems allowing the producer to activate the talkback system from anywhere in the room; an interface for the Sony *JH-24* tape machine allowing its autolocator and a synchroniser to be used simultaneously; remotable talkback retrofit for Trident consoles. ● **Broadcast Electronics:** will display a fully operational broadcast studio featuring the *Mix Trax 90* modular console, *Phase Trak 90* cartridge machines and *DV2A* digital record/playback machine. ● **Bruel & Kjaer Pro-Audio:** range of microphones and their portable digital R-DAT recording kit. ● **Bryston:** range of power amps, preamps and crossovers. ● **BSS Audio:** new products for AES are the *DPR-901* Dynamic equaliser which effectively integrates parametric equalisation with dynamic expansion and compression processes. The *TCS-803* Multitap Time Corrector, BSS's first digital product implements their own converter technology, also the *TCS-804* Dual Time Corrector with stereo, dual-tap delay processing and automatic venue ambient temperature control; the *DPR-404* 4-channel compressor/de-esser. Display also includes the *DPR-502* and *DPR-504* dual and quad noise gates and AR-series of DI units and accessories.

C

● **California Switch & Signal:** no information available. ● **Cambridge Digital Tech:** no information available. ● **Capri Digital Studios srl:** no information available. ● **Carver:** their range of power amplifiers and other pro products. ● **Cerwin-Vega:** sound reinforcement products. ● **Cipher Digital:** introducing the *CDI-328* Random Access Recorder. The *328*, a digital recorder using hard and magneto-optical media, will be the first new product produced at Cipher Digital's new facility. The *328* is available in 2- or 4-track versions and samples at 48, 44.1 and 32 kHz. ● **Clear-Com systems:** no information available. ● **Community Light & Sound:** new for the show are *CSX* loudspeakers that range in size from the compact *CSX25* to the full-range *CSX70*. ● **Concept Design Electronics:** will be showing the *CD 9000* cassette loader; the *DAAD* Type R digital duplication system; and the *QC Panel*, a system which allows up to 10 playback sources to be connected to one output for monitoring. ● **Conneaut Technologies:** wide range of products from mixing consoles to microphones. ● **Connectronics:** wide variety of cable reels and range of patchbays, stagelinks systems and assemblies. Also the complete range of cables and ancillary hardware for pro-audio,



BSS Audio TCS-804 dual time corrector

The Future. We've Been There Before.



The DSP Option, a 24-bit digital mixer/digital signal processor.

This is not the first time we've introduced a revolutionary new digital audio product today with the promise of a long and profitable future.

As a matter of fact, as the company that started it all, we've made our share of promises. But a look at our track record (at right) shows we've delivered on those promises — and in the process changed the way the industry works. At the same time, customers who bought systems even way back in 1977 have

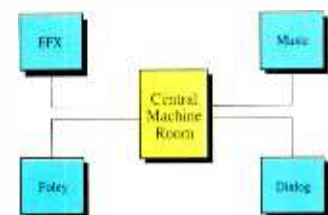

With MultiArc™ multiple users user share processing and storage resources from a central machine room.

been able to upgrade every step of the way.

Take, for example, our latest breakthrough, the

DSP Option. It's a 24-bit, multitasking mixer/digital signal processor that provides 5-band EQ, automated level control, multitrack digital I/O, plus sample rate conversion. And it's compatible with all current Synclavier and PostPro systems.

What's more, the new DSP Option eliminates the Achilles' heel of digital audio: back-up. Loading and saving can occur in the background while you continue working.

Synclavier, Sample-to-Disk, The Tapeless Studio, and the New England Digital logo are registered trademarks of New England Digital. Direct-to-Disk, PostPro, EditView, AudiMation and MultiArc are trademarks of New England Digital. Apple and Macintosh are registered trademarks of Apple Computer, Inc. SoundDroid is a trademark of Lucasfilm Entertainment.

© 1990 New England Digital. Product specifications are subject to change without notice.

1977
We make history with the introduction of the first digital synthesizer/sequencer — the Synclavier®.

1980
A new Synclavier keyboard design accompanies powerful new features like sound layering and real-time digital effects.

1982
New England Digital introduces the first commercially available disk recorder, Sample-to-Disk.®

1985
Presenting the new polyphonic sampling Synclavier and the first multitrack disk recorder/editor, Direct-to-Disk™ — The Tapeless Studio!®

1988
New England Digital goes Macintosh,® paving the way for new, easy-to-use screens like our own EditView™ and third-party software like SoundDroid.™

1990
Enhanced with the new DSP Option, today's Synclavier and PostPro™ workstations revolutionize the industry again as multiuser systems.

Our commitment to third-party software development ensures the widest variety of user interfaces. For example, with our EditView window and Lucasfilm's new SoundDroid Audio Editing System, you now have your choice of tape- or film-style editing.

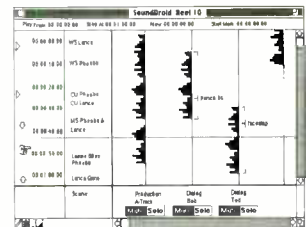

Lucasfilm's SoundDroid is the first in a series of third party user interfaces created for NED.

And here's a look at the future: because the DSP Option incorporates our new MultiArc platform, it provides for a true multiuser system tomorrow, where multiple users will share the same disk and processing resources.



Our AudiMation™ virtual mixer gives you fast, intuitive control over EQ, levels, routing, and other system parameters.

By investing today, you can take advantage of such powerful features as 24-bit signal processing and multitasking. What's more, your investment will be rewarded in the future, as true multiuser operation becomes a profitable reality.

To find out more, send for a complete brochure package on the DSP Option and MultiArc.



Elsinore House
77 Fulham Palace Road
Hammersmith
London W6 8JA
011-44-81-741-8811

See us at IBC Brighton, England on Stand P22

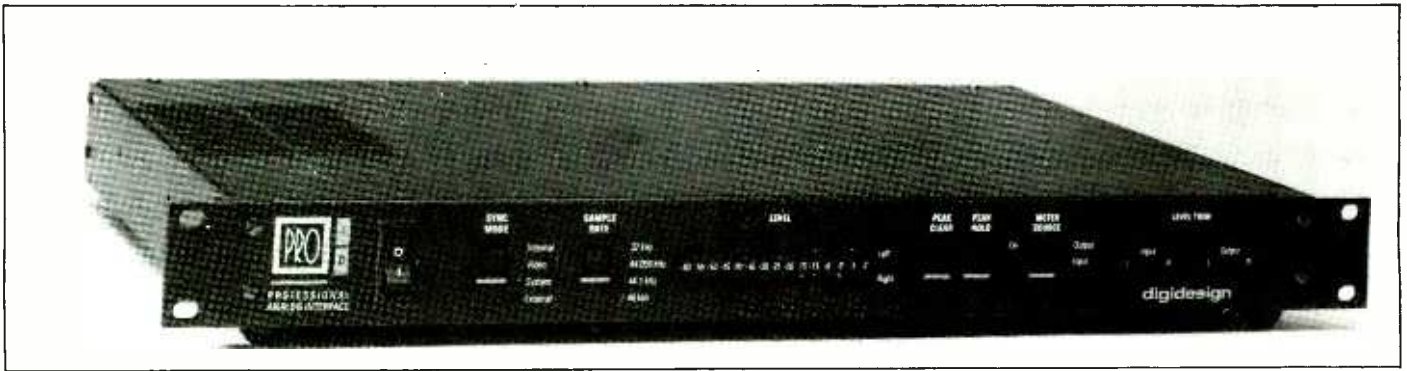

DigiDesign Pro I/O professional analogue interface

music and broadcast applications. ● **Countryman Associates:** *Isomax* series microphones; precision electret condenser mics. ● **Creation Technologies:** no information available. ● **Crest Audio:** wide range of power amplifiers. ● **Crown International:** new for the show is the *Macro Reference 750* W/ch amplifier featuring convection

cooling, and bridged mono and parallel mono modes. ● **Crystal Semiconductor:** featuring the *CS8401* AES/EBU Interface Line Driver used to encode and transmit audio data according to those standards. The *CS4328* 18 bit stereo D/A converter; and the *CS5336* 16 bit stereo A/D converter. ● **CST Manufacturing:** cassette

duplication products including labelling and printing equipment.

D

● **dbx Professional Products:** featuring compressor/limiters, noise reduction units, gated compressors, de-essers, hiss reducers, graphic and parametric equalisers. ● **DDA:** featuring the US debut of the *DMR12* a new 24-track recording console aimed at the small 24-track studio, programming suite or private studio. It features 56 modules and patchbay that take up only 2.2 m (85 inches). Also an AES debut for the *DCM224V*, which is a development of the *DCM232* aimed specifically at the post-production market. The console will be shown with the Alpha Audio *BOSS 2* editor system. Other consoles on display include the *AMR24*, the *S* and *D* series, and the *Arena* sound reinforcement console. ● **DIC Digital:** complete line of DAT and 8 mm video cassettes). ● **Digital Audio Research:** will be introducing two new products at the show and will be demonstrating advances to the *SoundStation II* editing and production system. The *SoundStation/DSP* adds digital signal processing and audio parameter automation, allowing the user to assign settings for digital 4-band parametric EQ, gain and panning to every individual audio segment. The *DASS 100* is a standalone, multifunction digital audio interface providing sampling frequency conversion, format conversion and other functions for connecting digital audio devices. ● **DigiDesign:** featuring the *Pro I/O* Professional Analogue Interface, which is an option to the *SoundTools* system. The design includes oversampling converters with Apogee anti-aliasing filters. Also on display is DigiDesign's full range of software. ● **Digital Dynamics:** showing the *ProDisk-464* hard disk digital audio recording and editing system and accessories. Available in configurations from four to 64 tracks, the *ProDisk-464* offers a multitrack mode and a cue editor/EDL mode. Recent enhancements include waveform editing and new erasable magneto-optical storage capabilities. ● **DLC Design:** no information available. ● **DOD Electronics:** display includes the *IPS 33B* Super Harmony Machine; 10 new Audio Logic products for studio, pro-audio, broadcast, and sound contractor markets; *MEQ 7*, *MEQ 14* and *MEQ 28* MIDI Programmable Graphic Equalisers; *RDS 1000*, *2000* and *4000* Time Machines. ● **Dolby Electronics:** featuring the *MT* series, up to 24 channels of switchable Dolby *SR* and *A*-type noise reduction; *DP501/502* 2-channel data compression encode/decoders for digital audio transmission. Also featured is the model *422* Reference Encoder/Decoder, which provides four channels of Dolby *B*, *C*- and *S*-type noise reduction in a 1U high frame. ● **Doremi Labs:** no information

TC 1280/1380

Give us an inch...

... a foot or a meter and the new TC digital audio delays will give you precisely calculated delay times. Of course you can enter delay times as you would on any delay, choosing increments clear down to 5 microseconds. The group delay and Left-Right phase linearity are absolutely outstanding.



The TC 1280 (Stereo) and TC 1380 (3 Tap) delays are based on the technology that made the TC 2290 the most sought after delay unit in the recording industry. We have kept the superb frequency response, low distortion and noise free signal path and added the features most needed in critical applications.



Frequency response: 20-20 KHz +0/-0.5 dB 25 KHz -3dB, Dynamic range: > 100 dB, THD: < 0.05 % 1 KHz, Analog group delay: 20-20KHz (30 microS, Group delay linearity: 20-20 KHz +/- 5 microS, Stereo synchronization: +/- 1 microS (1280), Max output: +22 dBm.

... If you are a professional in the disc mastering, broadcasting, sound reinforcement or recording fields check out these latest additions to the TC family. Call for the location of your nearest TC dealer.

OF DENMARK

t.c. electronic

INTERNATIONAL HEADOFFICE: T.C. Electronic A/S, Grimhøjvej 3, DK-8220 Brabrand, Denmark, Ph. 45 86 262800, Fax 45 86 262928 • **USA:** T.C. Electronic USA Inc., North Hollywood, 818 503 0404 • **UK:** T.C. Electronic UK Ltd, Oswestry, 691 658 550 • **GERMANY:** T.C. Electronic of Denmark GmbH, Detmold 05231 32972 • **AUSTRIA:** T.C. Electronic of Denmark GmbH, Detmold, 49 523 132972 • **AUSTRALIA:** East Coast Audio, Melbourne, 03 241 2244 • **BELGIUM:** James B. International, LE Cap af IJsel (HOLLAND), 0031 10 4588166 • **CANADA:** T.C. Electronic USA Inc., North Hollywood, 818 503 0404 • **FINLAND:** Studiotec, Espoo, 90 592055 • **FRANCE:** Phase Acoustic, Marseille, 91 498728 • **GREECE:** Lyrikon, Athens, 3628541 • **HONG KONG:** Jolly Sound Ltd., Kowloon, 3620202-5 • **HOLLAND:** James B. International, LE Cap af IJsel, 010 4588166 • **ITALY:** CD Videosuono S.P.A., Milano, 02 50841 • **JAPAN:** Otartec corp., Tokyo, 03 332 3211 • **NORWAY:** Musikk og Elektronikk A/S, Tønsberg 033 26798 • **SINGAPORE:** Team 108, Singapore, 748 9333 • **SWEDEN:** Efla Studio AB, Solna, 08 734 0750 • **SPAIN:** Ear Pro SA, Barcelona, 93 212 7050 • **SWITZERLAND:** Riverside Music, Losone, 093 352794

available. ● **Dorrough Electronics:** featuring the *Dorrough Loudness Meter*, which offers precise measurement of peak and average simultaneously. Scale adaptations have added two new meters to the Dorrough line, the Telecine Transfer Level meter model 40-C and the Digital Transfer Meter model 60-D. ● **D&R** showing the *Stylyx* console, which can now be ordered with in-line modules and a redesigned master section. New product is the *Marilon* series consoles, which has the same basic features as the old *Dayner* series but with the addition of 24 buses, extended EQ features, slide faders in the monitor section and optional patchbay. Also new is the *Avalon* series which offers 32 bus, 4-band parametric EQ and automation. ● **Drawmer Distribution:** new products for the AES are the *DL241* auto compressor/limiter with many automatic functions like an auto-attack expander/gate, a full auto-attack/release 'soft knee' compressor, and a peak level section providing 'zero overshoot' limiting; also the *DS301* dual expander/noise gate with MIDI facilities. ● **Duplication Equip Brokerage:** no information available. ● **Duplitrronics:** master digital tape duplication equipment. ● **Dwight Cavendish:** range of audio and video duplication equipment. ● **Dynacord:** signal processing equipment and musical products.

E

● **E-mu Systems:** *Emulator Three* Digital Sound Production System and sound modules. ● **East-West Communications:** no information available. ● **Eastern Acoustic Works:** full range of loudspeaker systems for live sound applications. ● **Ediflex Systems:** film editing systems. ● **Electronic Architecture Tech:** no information available. ● **Electro-Voice:** featuring the *Vega T-89* handheld wireless microphone, offering a supercardioid pattern and designed specifically for concert applications; the *Vega Pro Plus* UHF system, which includes the *R-662* receiver and *T-677* transmitter; and the *R-42A* wireless microphone receiver. ● **Electro Sound:** high speed audio tape duplicating equipment. ● **Enterprise Corp of America:** no information available. ● **Euphonix:** the *Crescendo* digital mixing system. ● **Eventide:** the *H3000* studio enhanced *Ultra-Harmonizer* and the new sampling option.

F

● **Fairlight:** showing recent developments for the CMI system. ● **Feltway SA:** no information available. ● **Ferrofluidics:** no information available. ● **Focusrite:** the new *Studio Console* featured on the stand is a 64-channel desk with GML automation, which after the show is headed for Conway Studios in LA. Also featured is Focusrite's range of *ISA* outboard modules and the launch of a new stereo compressor. ● **Fostex:** featuring the entire range of products, including

the *D-20* DAT player with accessories. ● **Fuji:** magnetic media products. ● **Full Sail Recorders:** full details of their music technology and recording courses. ● **Furman Sound:** full range of signal processors.

G

● **Gauss:** full range of speaker systems and drivers. ● **Gefen Systems:** *Filemaster* offering *AudioFile* remote capabilities for the *M&E Organizer* system; and the *SoundTouch* Music System, music selection for the playback of CDs. ● **Genelec:** range of speaker systems for studio use. ● **Gentner Electronics:** patch panels, audio distribution equipment and telephone interfaces. ● **Geppo International:** no information available. ● **GML:** the GML console automation system with latest hardware and software. ● **Goldline:** range of products including 10-band 1/2-octave realtime analysers, crossovers, gates, limiters and audio test sets. ● **Gotham:** range of cables. ● **Gotham Audio Corp:** featuring both their *CDR 90* Reference system and the *SPOT 90* compact disc production system. Also featuring the *GFM-132* boundary layer mic from Neumann and latest products from Harmonia Mundi Acustica, Audio Design and SPL. ● **Goutam Elect Products:** ranges of mixing consoles.

H

● **The John Hardy Company:** mic preamplifier specialists. ● **Harrison by GLW:** featuring the *SeriesTen* console and introducing the *Harrison ARS-9* Audio Routing Switcher which has been designed for multiroom recording, video post, broadcast and film. Also new is the *Harrison PRO-790* console which includes 12 to 32 mono or stereo inputs, two stereo programmes as well as two aux sends with level trims. ● **HEDCO:** no information available. ● **Hybrid Arts:** featuring *ADAP II* hard disk based recording system. ● **Heino Ilseman:** music cassette packaging equipment.

I

● **ILP Manufacturing:** audio amplifier modules and terminal transformers. ● **Industrial Strength Industries:** range of products including mixers, digital effects processors, parametric equalisers and power amps. ● **Innovative Electronic Designs:** computer controlled audio system designs for convention centres, airports and other large installations. ● **Institute of Audio Research:** recording technology school. ● **Intelix:** audio remote control systems.

J

● **Japan America Electronics:** wide range of DAT players. ● **JBL:** represented on the JBL

TONY LARKING AUDIO SALES

used consoles

Amek 2520 40 frame fitted 36 channels + Mastermix 2 yrs. Excellent	EPOA
Amek 2500 36 channels + mastermix	£24,950
Allen & Heath Sigma 44 frame fitted 32 channels NEW	£15,950
Neve 8108 32 channels, 8 VCA sub groups + patchbay VGC	£29,950
Neve 8068 32 frame fitted 28 channels + patchbay (2 available)	@£29,950
Neve V-3 48 frame fitted 36 channels, 18 months VGC	EPOA
Neve V-3 60 frame fitted 48 channels	EPOA
SSL E-Series 40 channel	EPOA
SSL 6000E 48 channel with G-Series computer + total recall	EPOA
Soundtracs IL48/32 96 line inputs with eq. 1 years private use	£23,950
Soundtracs CMX4400 32/24 + patchbay	£8,450
Soundtracs PC MIDI 24 3 months use only, as new	£4,450
Soundcraft 600 24/8/16 unused, as new	£4,950
TAC Matchless 26/24 + patchbay, private use only, VGC	£7,450
Trident A range 30/16/24 nice condition	£19,950
Neve 5316 36 channel broadcast console. Immaculate	EPOA

used multitracks

Otari MTR90 Mk 2 24 track, SSL interface available, 1 owner, well maintained, VGC	£14,500
Otari MTR90 Mk 2 24 track, with remote/autolocate, one owner, well maintained, VGC	£16,950
Saturn 24 track, ex demonstration, VGC	£16,950
Sony 3324 24 track digital, remote/autolocate, service history	£39,500
Tascam ATR80 24 track, remote/autolocate, excellent condition	£14,950
Mitsubishi X850 32 track digital, 2 1/2 years, refurbished	£59,950
Mitsubishi X86 2 track, ex demonstration	£7,950
Otari MTR12 with time code centre track. Unused!	£Offers

used outboard

Focusrite 1154HD dual Eq, as new	£2,500
Drawmer 221 comp/limiter as new	£275
Sanken CU-41 Mic, as new	£900
Neumann U87 mic with shock mount as new. (4 available)	@£900
Pultech EQ1A valve Eq (2 available)	@£1,495
Fairchild 670 dual valve compressor	£3,495

urgently wanted

Used Equipment for CASH!!

AJ
Studio
Furniture

Call 0462 490125
for our FREE
used equipment list

Tel:
0462 490125
Fax:
0462 490126

Prices do not include VAT



Klark-Teknik DN735 solid state recorder

INCH AFTER INCH,

SESSION AFTER SESSION,

THRILL AFTER THRILL.

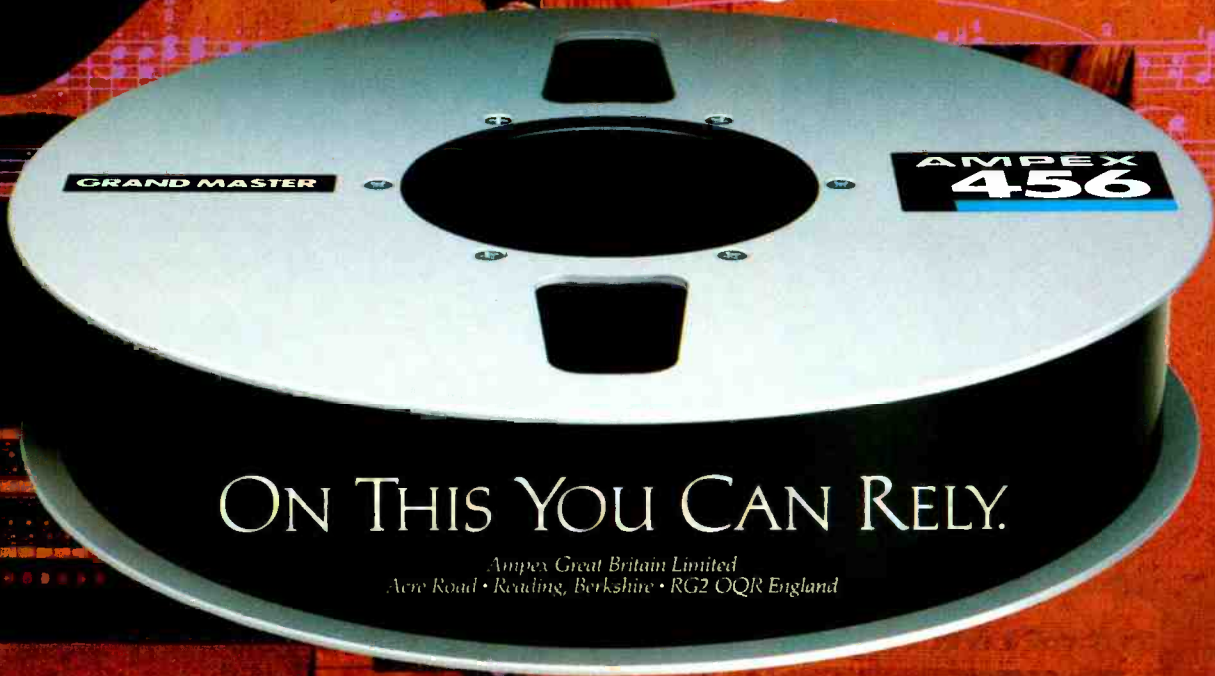

ON THIS YOU CAN RELY.

*Ampex Great Britain Limited
Acce Road • Reading, Berkshire • RG2 0QR England*

Spiritos

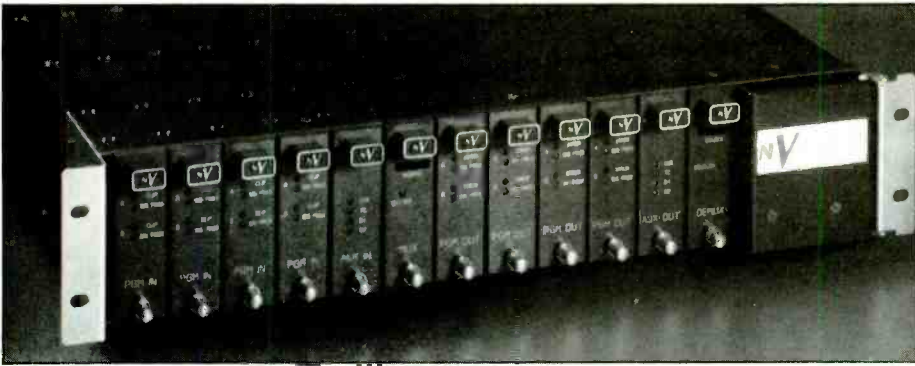

NVision NV2000 high definition audio system

stand will be products from JBL, Soundcraft, UREI, and Seck. JBL will be introducing the SR6600 series amplifiers featuring high frequency power conversion technology; ES series amplifiers; SR4700 series loudspeaker system portable sound reinforcement system with vented gap cooling; Control SB-1 and Control SB-5 subwoofers. Soundcraft will introduce the Delta series, a new 8 bus recording version will be shown. The Delta is available with up to 36 inputs with 4-band EQ and six discrete auxiliary sends along with 16 monitor returns. Also featured is the 3200 console with integrated moving fader automation. Also the 8000 production console will be shown with a specially designed control room output section for use in live TV and production applications. Seck will feature the model 1882 compact mixing console for recording and mixing purposes.

● **Jensen Transformers:** full range of transformer products. ● **Josephson Engineering:** range of microphones and accessories. ● **JRF Magnetic Sciences:** will exhibit new additions to their TC-50 centre-track timecode conversion kits. New is the TC-50 with EC-BII option for easy conversion of the Otari MX5050 BII to timecode capability. JRF will also be showing a long awaited addition to their range of MRL Alignment Tapes. ● **JVC:** digital mastering system, digital audio mixer, equaliser and DAT recorders.

K

● **KABA:** duplication systems. ● **Kenwood USA:** demonstrating their recordable CD system and other CD mastering equipment. ● **King Instrument:** cassette loaders. ● **Klark-Teknik:** exhibiting the recently launched series 500 dynamics including a Quad compressor/limiter/expander, a dual compressor/limiter/expander, a dual noise gate and a quad auto gate, each in only 1U of rack space. Also on show are series 700 digital delay lines and the DN735 Solid State Recorder which adds two tracks of digital audio to standard VTR machines. Being launched at the show is the Midas XL3 live performance console. ● **Klipsch:** complete line of loudspeakers. ● **Korg:** musical instrument and digital signal processing.

L

● **Lester Audio:** fibre optic transmission systems. ● **Lexicon:** introducing the 300 digital effects system. Features include oversampling techniques to minimise low level distortion. Dynamic MIDI is included for realtime performance control and effects automation. All parameters in the 300 can be patched to most MIDI controllers allowing full control from remote devices. ● **Lindos:** range of

test equipment. ● **Lone Wolf:** MIDI Local Area Network system.

M

● **Mag-Zon:** Zonal magnetic recording products. ● **Magnefax International:** cassette duplication systems. ● **Mark of the Unicorn:** music software. ● **Marshall Electronic:** Quantec products and software controllers. ● **Marshall Electronics:** will be displaying the Mogami range

of wire and cable products. New products will be the dual MIDI cable; snake cable directly assembled with bantam plugs at one end; variations of audio/video interconnection cable assembled with RCA phono plugs. ● **Martin America/Martin Audio:** sound reinforcement speaker systems. ● **McCauley Sound:** no information available. ● **Meyer Sound Labs:** monitor systems including the HD-1 high definition monitor live sound speaker systems. ● **MicroAudio:** automated equalisation systems. ● **Minim Electronics:** range of presenter clocks, studio clock systems and Ambisonic decoding systems. ● **Monster Cable Products:** range of cable and patch products. ● **Morenz Development:** no information available. ● **Motionworks:** introducing two new products for the show, the *Midiworker* a MIDI event controller aimed initially at SSL users and *Perfectworker* which is effectively a stripped down *Motionworker*. *Midiworker* allows event firing via the SSL *Event* software; *Perfectworker* offers *Motionworker*'s virtual machine control which allows control of console automation systems from an external timecode or MIDI timecode source. ● **Motorola Semiconductor:** details of DSP and processing chips including the new 32 bit floating point 96002 chip.

THE SOLUTION TO DIGITAL AUDIO INTERFACING PROBLEMS DASS 100 DIGITAL AUDIO SYNCHRONISING SYSTEM

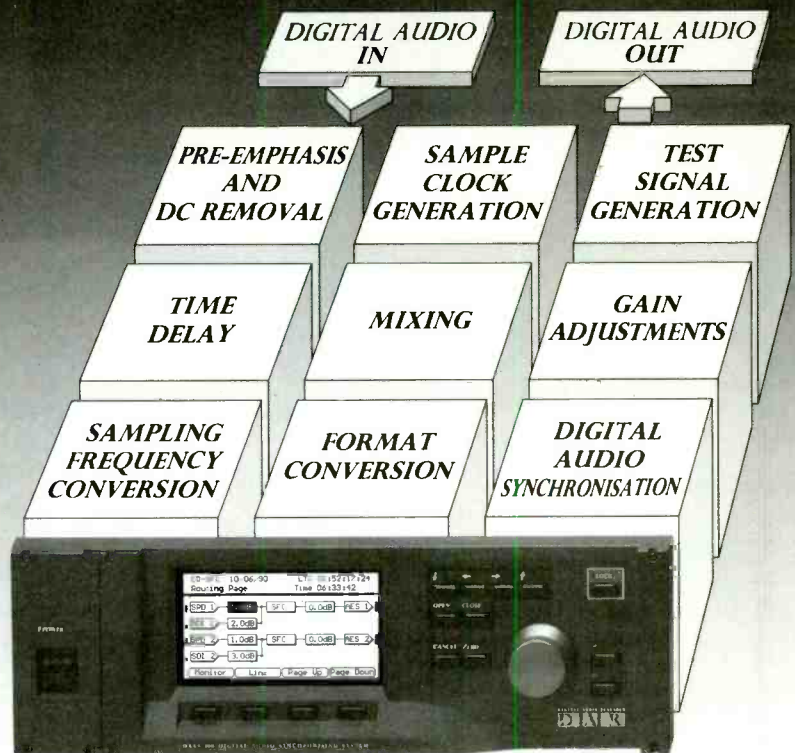

DASS 100 keeps digital audio signals in the digital domain and is essential for transferring between different pieces of professional audio and video equipment.

DIGITAL AUDIO RESEARCH

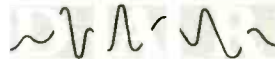

DIGITAL AUDIO RESEARCH LIMITED
2 SILVERGLADE BUSINESS PARK · LEATHERHEAD ROAD
CHESSINGTON · SURREY KT9 2QL · ENGLAND
TELEPHONE (0372) 742848 · FAX (0372) 743532

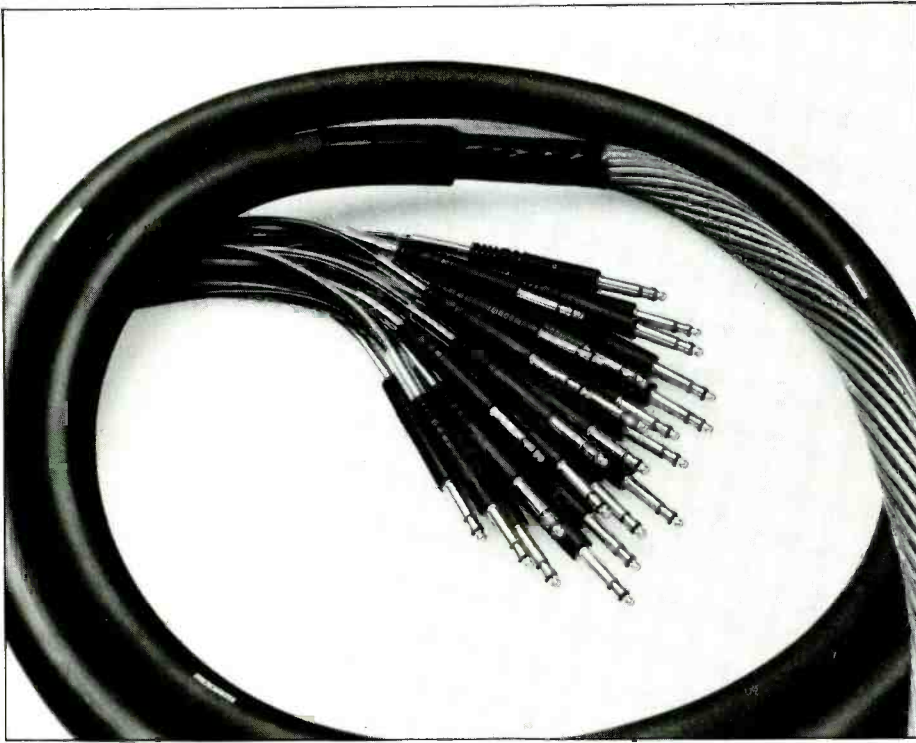

Mogami range of wire and cable products from Marshall Electronics

N

• **Nady Systems:** featuring 1200 VHF wireless system with claimed 120 dB dynamic range; and 650 VHF wireless system. • **Nagra:** featuring the

Nagra D digital recorder. • **Nakamichi:** range of cassette and DAT players. • **Neotek:** will be introducing the new *Encore* console series for film dubbing and TV post-production. Available in both 4-track and 6-track formats with automation

options. • **Neutrik:** wide range of audio connectors and test equipment. • **Neve:** new for AES is an updated version of the Neve *DTC-1*. New EQ consists of two pairs of selections for LF and HF, with a full range of peak/shelf responses on both sections. New Neve A/D and D/A converters include special anti-aliasing and anti-imaging filters resulting in claimed S/N ratio figures exceeding 102 dB. Also featured are the Neve *VR60* series console with *Flying Faders* automation; *Prism* series of signal processor modules; Mitsubishi *X-880* 32-channel digital tape recorder; *X-86* 2-channel 20 bit ready digital tape recorder; and *X-86 HS* (High Sampling) 2-channel digital tape recorder. • **New England Digital:** introducing the new DSP Option for their line of *PostPro* and *Synclavier* workstation, featuring on-board mixing, multitasking and multitrack digital I/Os permitting realtime sample rate conversion. NED will also introduce the *SoundDroid* audio editing system, a computer-assisted editing software package for motion picture, video and TV production. Designed at Skywalker Sound by LucasArts, *SoundDroid* handles dialogue, effects and Foley applications, while automatically generating cuesheets, logs and other reports. • **NVision:** introducing the *NV2000* High Definition Audio System, which offers an integrated approach to multichannel distribution. Up to 10 channels of 20 bit audio can be routed throughout a facility with the same switch and cable space required for one analogue channel. So one deck of a video routing switch can be used to carry all programme audio, timecode, and cue information. *NV2000* also offers an optional fibre optic interface, channel pair assignability and a secondary AES/EBU output.

Digital Audio: Design for Quality

Over the past few years, we've made a name for ourselves making filters to suit a wide range of digital audio products. Now, in addition to our well-known 944 and 924 filter systems, we've introduced a new range of 'digital building blocks' for OEM applications, enabling you to bring Apogee performance to your own products. The **C384 Low-Jitter Clock Regenerator** — with unprecedented timing accuracy and less than 2 picoseconds RMS jitter, for lower noise and distortion; the **F964-IV Current-to-Voltage Converter and Ultra-Linear Phase Filter** — discrete open-loop I to V replaces op-amps for transparent sound in oversampling DACs; the **D160 Dither Engine** — packs unequalled sonic detail into 16-bit systems with Power Spectrum Dither™, a proprietary sequence tailored to music, not just test tones; and the **P818Q Quad DC-DC Converter** — putting clean, convenient, isolated power where you need it.



Apogee

2103 Main Street Santa Monica California 90405.
Tel: (213) 399 2991 Fax: (213) 399 7665.

Call us for details.
And design Apogee quality
into your system from the start.

Sheer Opulence of Sound

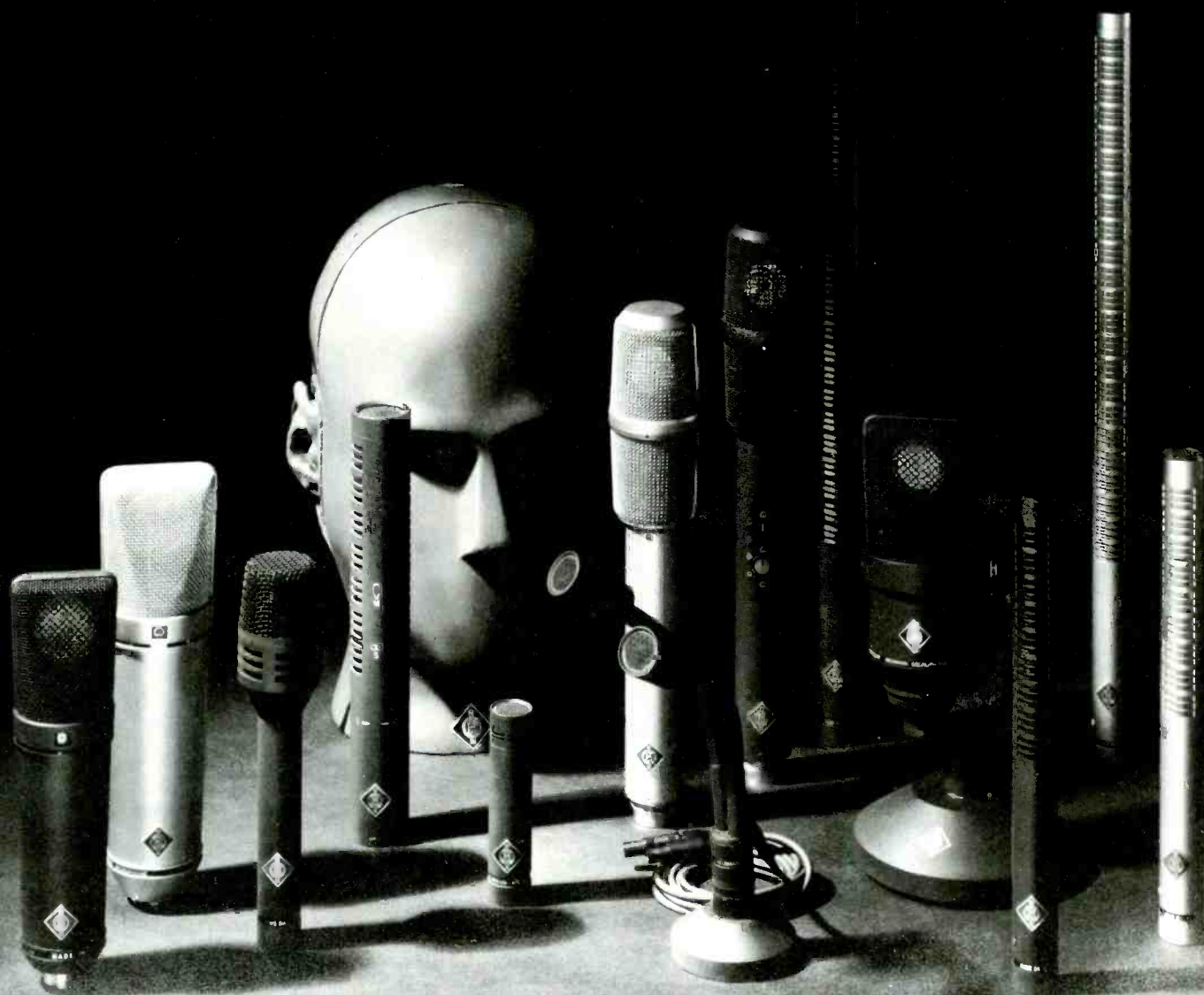

The Neumann-Family

The studio microphones which achieve that elusive perfection.
There is no comparison. Each one handcrafted by NEUMANN — the world
leader in microphone technology for over half a century.

Distributors: Argentina: (041) 3129968/3112574 · Austria: (0222) 487741 · Australia: (02) 9751211 · Belgium: (02) 7352193
Brazil: (011) 5425534 · Canada: (0416) 6652660 · Danmark: (02) 648522 · Finland: (0) 8381 · UK: (01) 9530091 · France: (01)
45302123 · Italy: (02) 25390121 · Japan: (03) 9506266 · Netherlands: (020) 5105911 · Spain: (01) 5210187 · Sweden: (08) 7340750
Switzerland: (01) 3913939 · Turkey: (04) 1262919 · USA NY: (0212) 7653410 · USA CA: (0818) 7852211 · Taiwan: (02) 3214454 - 6

O

- **Opcode Systems:** range of music software.
- **Optical Disc Corporation:** CD mastering equipment.
- **Orban:** range of signal processing.
- **Otari:** full range of tape machines, tape duplication equipment and mixing consoles with automation.
- **Oxmoor:** will be showing the *MDA-16* and *MDA-26* Distribution amplifiers; the *RMX-44* and *RMX-61* mixing matrix; the *DCA-2* Digital Control Attenuator and *RC-16* Remote Control; the 4×4 Buffer amplifier; and the *DEQ-29* Programmable 1/3-octave equaliser.

P

- **Paktec Automation:** cassette packaging equipment.
- **Panasonic:** range of DAT players and Ramsa products.
- **Passport Designs:** music software.
- **Peavey:** introducing a new software update for the *SyncController*, a SMPTE-based synchroniser with event control programming and MIDI capabilities. Full chase lock is now available along with tempo mapping to enhance available features.
- **Penny & Giles:** complete range of studio faders and other audio/video controls.
- **Pinc Link:** no information available.
- **Pioneer Electronics:** no information available.
- **Precision Monolithics:** range of processing chips.
- **Pro Co Sound:** multichannel patchbay systems, a wide range of interface boxes, mic splitters, audio/visual interfaces, DI boxes and a wide range of cables.
- **Professional Audio Systems:** range of studio monitoring systems.
- **Pygmy Computer Systems:** no information available.

Q

- **QSC:** range of power amps.
- **Quad Eight Electronics:** range of mixing consoles.
- **Quested Monitoring:** range of monitoring systems.

R

- **Radian:** compact speaker systems.
- **Rane:** introducing for the show for the *Flex* series will be the *FPL 44* Quad Limiter which like all *Flex* units conforms to the Half Rack (HR) standard. Each of the four limiter sections may be slaved to others so that if one limiter begins to attenuate others follow proportionately, useful when the product in use is connected to several outputs on



Nady 650 VHF wireless system

an active crossover. Also new for the show is the *MPE* software which will run on any IBM compatible computer and is designed for use with Rane's series of three MIDI programmable equalisers. The screen display shows conventional graphic EQ sliders on the lower portion of the screen and the resultant frequency response of the *MPE* on the upper. Communication with equalisers is through MIDI System Exclusive.

- **Recording Engineer Producer:** US recording magazine.
- **Renkus-Heinz:** introducing additions to the *CM* Series Cluster Module loudspeaker range. The new *CM121* with a 12 inch woofer, 1 inch high frequency driver and constant beamwidth horn. The *CM61* is a 6.5 inch two-way speaker with a full range performance for application in boardroom, small clubs and the like.
- **Roland:** musical instruments and digital signal processing.
- **Roldex Industries:** audio cassette printing systems.
- **Rolls Corp:** power amplifier, phantom power mic mixer, mic processor, spectrum analyser adapter.
- **RPG Diffusor Systems:** will introduce a complete line of modular acoustical ceiling lay-in panels for

standard suspended ceiling systems. The modules include a 1-dimensional *QRD* Diffusor for controlled diffusion, a 2-dimensional *QRD* Diffusor for omnidirectional diffusion, an *Abffusor* for broad-bandwidth absorption with diffusion and an *Absorber* for broad-bandwidth absorption.

S

- **Saki Magnetics:** replacement tape heads.
- **Samson/Soundtracs:** Soundtracs will be showing the *Quartz* in-line console with computer mute automation of channels and auxiliaries; the new *Sequel* sound reinforcement console seeks to bridge the gap between the *MX* range and the *SPA* range; also new is the *PC32* series console which is a follow on from the *PC* MIDI range providing 72 line inputs on mixdown with MIDI control of muting on inputs, monitors, auxiliaries and effects returns.
- **Sanken microphones/Dev Tech:** will be featuring the lavalier microphone *COS-11* with an overall size of 4×11.5 mm. The *COS-11* is an electret condenser type suited for voice or instruments in live broadcasting, location

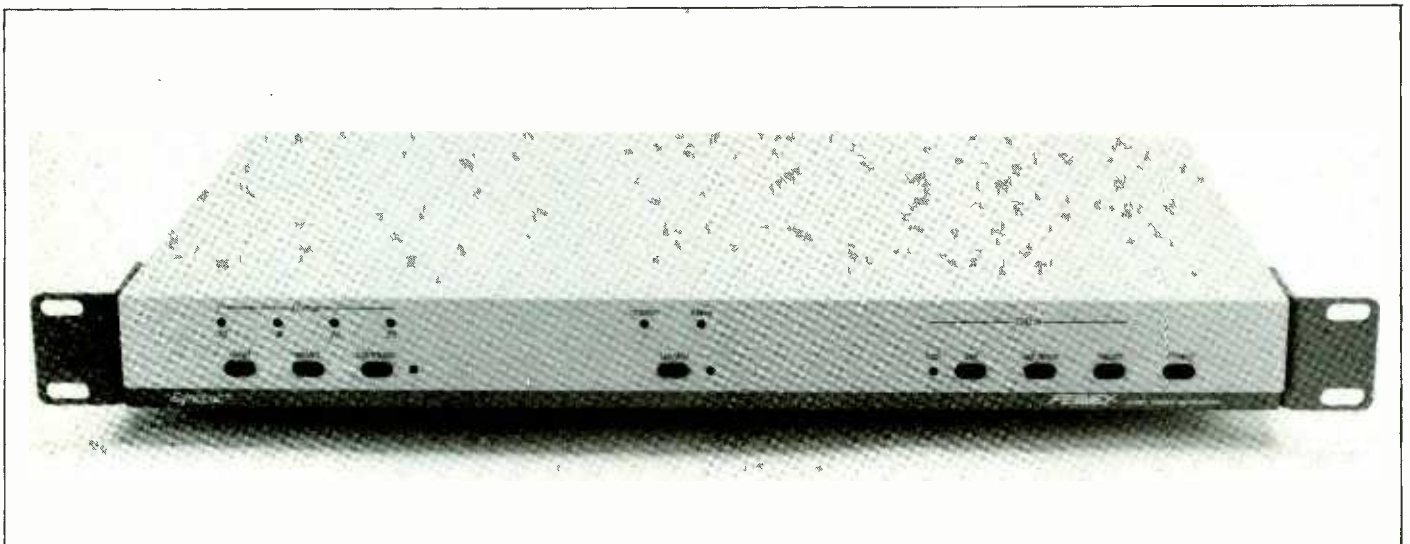

Peavey SyncLoc

AMS AUDIOFILE.. THE PLUS POINT



During the 1980's, one hard disc recorder both established and dominated the market - AMS AudioFile.TM

AMS now announce AudioFile PLUSTM as part of a continuing policy of upgrades that take AudioFile into the 90's and beyond.

With a transfer of operating software to the latest technology 32 bit, 4 Megabyte transputer platform, AudioFile PLUSTM offers yet faster operation and the ability to accommodate a range of major new features - further distancing AudioFile from other disc based recorders.

Extended System Architecture also provides for 8 simultaneous inputs/outputs, in analogue and/or several digital formats.

Whether you have yet to make up your mind about hard disc recording or you already own an AudioFile, you'll find it comforting to learn that this system upgrade is once again available for all existing AudioFiles.



Setting the pace for hard disc recording

AMS Industries plc
Billington Road, Burnley,
Lanes, BB11 5ES, UK
Tel: (0282) 57011 Fax: (0282) 39542

AMS London: (01) 722 3925 AMS USA: (707) 762 4840

New York: (212) 586 7376 Chicago: (312) 527 4569
LA: (818) 845 0199 Seattle: (206) 842 7182

See us at:
IBC booth number F7 and
AES booth number 336 and 338

STUDIO SYSTEMS

FROM

4 TO 48 TRACK

TWENTY FOUR TRACK PACKAGE

This system truly is a breakthrough in terms of cost, features found on the console and sonic purity throughout. And all for a lot less than you'd imagine.

Typical package configuration:

TASCAM MSR-24 + ALLEN & HEATH SABER 28-16:24 and KLOTZ Professional wiring loom £14,750

Financing and leasing terms arranged. Demonstration by appointment.

AIWA HD-XI DAT RECORDER
HDA-1 A/D CONVERTER
 Including: Remote Control, Carry Case & strap, P.S.U., all leads, battery and English manual.
£629 + VAT
 * Digital in/out INC. FREE DAT TAPE

NEW EQUIPMENT AVAILABLE

Forget the 'hash' Japanese units - if you want master quality, warm, natural reverb it must be LEXICON. Axis are main agents for the full range.

LEXICON LXP-1 Reverb & FX	£434
LEXICON LXP-5 Multi FX & Harmoniser	£434
LEXICON MRC Remote control	£320
LEXICON PCM-7D	£1,599
LEXICON 480L with LARC	£7,067
LEXICON Super Package comprising: LXP-1, LXP-5, MRC & Rack Tray	£995
ALLEN & HEATH SABER - New mid-price console prices from	£6,899
ALLEN & HEATH SIGMA In Line consoles. We have a 32-24 in our showroom.	

Please telephone for an appointment to view.

SIGMA In line prices from	£16,829
TASCAM M500 24/24 Recording console	£4,995
TASCAM 32 1/2" Two Track Recorder	£865
TASCAM MS-16 16 Track 1"	£5,500
TASCAM MSR-16 16 Track c/w dB+	£4,344
TASCAM MSR-24 1" 24 tk Recorder	£7,300
TASCAM "SR-8 1/2" eight tk with dBx	£1,999
TASCAM DA-30 DAT Recorder	£1,179
XRI Systems XR-300 SMPTE/Midi Synchroniser	£239
XRI Systems XR-400 Midi Mate	£173
SONY DTC-1000S DAT Recorder	£1,130
CASIO DA-2 Portable DAT Recorder	£649
DBX 160X Ultimate Super Smooth Compressor	£359
AIWA HD-XI Portable DAT	£629

MICROPHONES BY SENNEHEISER, BEYER ELECTRO VOICE, NEUMANN, AKG, SHURE

ALLEN & HEATH SIGMA We are selling off our showroom model - This is a unique opportunity to acquire a big console for small potatoes! Configured as 32-24 in line large frame with space for patchbay and 12 extra modules. List price over £26,000 special offer **£11,500**

FOSTEX G-16
 Features include optional built-in SMPTE synchroniser
PRICE AROUND £4,300

DIGIDESIGN SOUND TOOLS
 Complete ready-to-run Package!
 *ATARI MEGA 4 incl. monitor & mouse
 *DAC 200mb (20 mins) hard disk drive
 *Sound Tools System, plus all necessary interfaces & cables
£4,200 other disk drives available up to 2.4 gigabytes! P.O.A.

AKAI DD-1000 Direct to Disk Magneto Optical Disk Recorder, expected delivery end of '90	£7,750
AKAI S-1006 + SCSI BOARD + Disk Devices 44Mb removable disk drive	£3,395

2mb expansion boards for S-1000 **£225**

Complete AKAI Sample Library available on removable hard disks for copying P.O.C. to customers.

COURSES IN SOUND RECORDING
 In association with the School of Sound Recording - we are pleased to announce the availability of sound recording courses covering many different aspects. Please write or call for prospectus and further information.

SECONDHAND EQUIPMENT AVAILABLE

AKAI MG 14D - 35 new	£1,795
TASCAM 22 2B Two track - immac	£450
JBL 4435 Monitors - brand new, special offer	£1,950
TASCAM 22 Two track 2hrs old	£395
TASCAM 38 Bragan	£895
SOUNDRAFT SCM-381 8tk 1"	£895
YAMAHA REV-1 RCR-1 Remote - Mint	£295
QUAD Mono Amp	£99
RODME 100Mb SCSI drive for Sound Tools	£595
NEUMIS CDD Parameter EQ	£395
FOSTEX AB with new heads - pristine	£550
AMEK BC II 14-2 Broadcast Desk	£3,950
REVOX 877 Mail - As New	£695
AKAI MG-1212 Twelve Tracks & Mixer	£2,350
TC Electronic 1210 Sdpatial Expander	£495
RAM RM-16 16:4:8	£475
ROLAND U20 Synth - ex demo	£895
YAMAHA SPX-1000 As New	£750
TC Electronic 2300 with 8 Sacs	£1,100
APHEX Aural Exciter Type C, New, Special Offer	£195
STUDIOMASTER Series II 24:8 2 as new	£2,950
CASIO DA-2 - new box only	£599
KAWAI MX BSR 16:2 Rack Mount Keyboard Mixer	£295
TEAC 80 8 1/2" Eight Track, Immac	£795
YAMAHA PRS drum machine	£350
SONY DTC-1000ES - as new	£895
AUDIO DESIGN E900 RS sweep eq	£450
AMS AUDIOFILE with version 8 software	
2hrs record time	£35,000
AKAI S-612 Sampler + disk drive	£295
AMEK 2500 36 1/2" x stereo & patchbay pristine cond	£27,500
STUDIOMASTER Series II 16:16 ex-demo	£2,975
STUDER A820 24tk with Dolby SR c/w Full Autocorator and remote FSH	£38,000
1700 hrs, immac	
ALLEN & HEATH SIGMA 32:24 & Patchbay (see box above)	£11,500
hh-V-500 Power amp	£275
HH Vx-200 Power amp - mint	£295
PASSPORT Mastertracks pro software	£195

Hours of business: Mon - Fri 9.30 - 6.00, Sat 11.00 - 2.00

PLEASE ADD VAT TO ALL PRICES

AMPEX AUDIO and FUJII DAT Cassettes available at super-low prices
 * MAIL ORDER * BULK DISCOUNT * SEND FOR OUR TAPE PRICE LIST

AXIS audio SYSTEMS

EXPORT SERVICE: We can quote a delivered price anywhere in the world within minutes.
 Please contact: Tim Eastwood or John Moulds with any query you may have. Our price list will be sent at your request by First Class Post.

3 AXIS AUDIO SYSTEMS,
 3 Waterloo Road, Stockport SK1 2BD. Fax: 061-474 7619
 After Office Hours: 061-474 7626

TELEPHONE: 061-474 7626



Studer D820-48 DASH digital multichannel recorder

recording and studio applications.

- **Schoeps/Posthorn Recordings:** will introduce a miniature stereo microphone system with remote box. Any pair of *Colette*-series Schoeps capsules can be mounted by the user in a coincidental stereo configuration to form the pick-up element. This connects to the remote box which amplifies the signals to line level and provides a mid-side matrix for use as an auxiliary output pair for stereo monitoring from the headphone jack.
- **Selco/Sifam:** will be showing full spec vu and ppm meters. Also on display control collet and push-on knobs; new two colour soft touch knobs.
- **Sellmark:** on the Sellmark stand Audiomation are introducing the 1000 moving fader automation system. Each channel fader has its own on-board microprocessor which increases individual channel facilities. Four SMPTE triggered switches on each channel; touch sensitive fader knobs; MIDI control; machine control; XT/AT compatible multi-tasking central computer; and as options individual channel noise gates and SSL & Neve data conversion.
- **Sennheiser:** wide range of microphones and headphones.
- **Sescom:** range of audio accessories including signal processing, audio transformers.
- **Shure:** showing the VP88 stereo microphone, the first model in a new line of video production mics. The VP88 is a single point stereo condenser mic using two independent mic elements to produce the MS stereo signal. Applications include heavy ENG work.
- **Singular Solutions:** no information available.
- **Solid State Logic:** showing *ScreenSound*, audio-for-video digital editor, mixing and recording system. *ScreenSound* machine control is allowing users to control multiple machines, from BVU and betacam VCRs to D1 and D2 mastering machines. Many US users are integrating *ScreenSound* with TEAC's laserdisc player and recorder for more rapid access to picture; also on show the *SL 4000 G* series console; *G* series computer; the *Logic FX* range of 1U 10 inch dual mic amplifier, equaliser and compressor; and *APT-X 100* data compression system.
- **Sonex Acoustic:** acoustic treatment products.
- **Sony:** new for the show will be four-head DAT products with timecode; two new mixers the *MPX-210* and *MPX-290*; the *BVG-200* portable timecode reader/generator and the *MPX-2900* series console. Also showing the 24-track and 48-track digital multitracks; CD mastering equipment; the *PCM-3402* digital 2-track recorder; the *APR-5003V* analogue 2-track recorder with centre-track timecode; wireless UHF/VHF mics.
- **Sound Ideas:** showing examples of their sound effects libraries including the exclusive release of the Lucasfilm library. These CDs have been produced by the sound designers of Skywalker Sound out of Skywalker Ranch, the headquarters of Lucasfilm. This is the first time Lucasfilm have released their sound effects for commercial use.
- **Soundcraftsmen:**

Just when you thought you'd heard it all..

DPR-901 DYNAMIC EQUALISER



From beyond the limits of convention comes a totally new approach to creative signal processing.

Four parametric bands of frequency - selective compression or expansion, each with the facility to operate below - threshold on quieter phrases only.

Enabling level dependent equalisation, dynamic loudness contouring, mix enhancement, noise reduction, excitation, broadcast limiting, transfer sweetening, softening, hardening, de-essing, de-effing, de-ditching and de-popping....

.....and just about anything else you'd care to try.

BSS Audio Ltd
Unit 5, Merlin Centre,
Acrewood Way,
St. Albans, Herts
AL4 0JY.
Tel: (0727) 45242
Fax: (0727) 45277
Telex: 265612 BSS G



an EdgeTech company
LONDON • NEW YORK • TOKYO

signal processing equipment and amplifiers.

● **Soundmaster International:** featuring the Soundmaster integrated audio editing system, which combines audio editing, machine control, random access digital editing and direct to disk recording, all in one system. The system runs on the Soundmaster CPU (Intel 386 based) or an IBM 286 based computer. ● **Soundtracker Pty:** no information available. ● **SPARS:** Society of Professional Audio Recording Studios. ● **Spatial Sound:** *Spatial Sound Processor* for moving sound in stereo or with multi speaker systems. ● **Spectral Synthesis:** no information available. ● **Spectrum Signal Processing:** no information available. ● **Star Case:** flight cases. ● **Stellavox:** R-DAT portable tape recorder. ● **Stewart Electronics:** range of products including distribution amps, line mixers, pre-amps etc. ● **Strand Magnetics:** displaying their videocassette shell range. ● **Studer Revox:** showing the *Dyaxis* digital recording system, now with overdub, multi-take record and programmable in/out. Also with new System Synchroniser and timecode options, *Dyaxis* can

lock to SMPTE, EBU, VITC, video and film. There is also an integrated R-DAT subsystem that stores all soundfiles along with editing instructions so the user can effectively resume their project exactly where they left off; also on display are the *D820-48* DASH digital multitrack; *A829* and *A827* 24-track recorders. ● **Studio Magazine:** UK recording studio news magazine. ● **Success Speciality Sales:** no information available. ● **Summit Audio:** valve/tube signal processing equipment. ● **Sunkyong Magnetic:** will display their full range of duplication tape. ● **Swire Magnetics:** duplication accessories. ● **Switchcraft:** ranges of connectors and patchfields. ● **Symetrix:** featuring the *DPR-100* Digital Audio Workplace that provides multitrack recording and playback of 40 channels, in blocks of eight, with realtime level control, EQ, compression, limiting and gating. The *DPR-100* uses an Apple *Mac II* series and also an option of the Dedicated Control Surface which features eight moving faders, plus a stereo master, with solo, mute and pan controls for each channel. Also on display is a combination 4-track random access

recorder, editor, mixer and signal processor for full function editing. The system is completely compatible with the *DPR-100* and so projects started on the Recording and Editing Station can be completed on the full function, multi-channel *DPR-100*.

T

● **tc electronics:** range of signal processing equipment. ● **Tannoy-TGI:** Tannoy's exhibit will centre on their new monitor range designed using modern CAD/CAM techniques and retaining the dual concentric design. The *Monitor* series range from the *215 DMT* to the smallest the *System 2 NFM*. ● **Tape Automation:** featuring their VHS Video Tape Loader range. ● **Tascam:** wide range of tape machines, mixing consoles and DAT players. ● **TDK:** wide range of tape and magnetic media products. ● **Techron:** *TEF* family of acoustic analysers and room measurement systems. ● **Telex Communications:** range of wireless microphones. ● **THAT Corp:** signal processing ICs. ● **Theatre Crafts:** no information available. ● **3M:** magnetic tape products and accessories. ● **360 Systems:** digital message repeaters and audio routing switchers. ● **TimeLine:** *Lynx* Keyboard Control unit, *Lynx* System Supervisor and *Lynx* timecode modules. ● **TOA:** digital signal processing system, *Soari*, consisting of DSP modules, EQ, for sound reinforcement and concert sound. ● **Trident Audio:** range of mixing consoles, including the *Vector*. ● **21st Century:** no information available.

U

● **UltraAnalog:** range of A/D and D/A converters. ● **UREI:** complete range of UREI products including monitor systems. ● **US Audio:** full range of signal processing units.

V

● **Vacuum Tube Logic:** range of products including power amplifiers, equalisers and microphones. ● **Valentino:** compact disc music library. ● **Vega:** full range of radio mic systems. ● **Versadyne International:** high speed cassette duplication systems.

W

● **WaveFrame:** showing the *AudioFrame* workstation with latest software/hardware, and the *CyberFrame* film workstation. ● **Westlake:** full range of studio monitoring systems. ● **Whirlwind:** cables and cable accessory products. ● **Wireworks:** cables and cable accessories.

Y/Z

● **Yamaha:** wide range of products including *DMR* digital recording/processing/mixing system using 8-track digital format. ● **Zoom:** digital effects systems for musical instruments.

●
Studio Sound will be exhibiting at the convention with copies of the latest issue together with our sister publications *One To One* and *Broadcast Systems International*. Editorial and advertising staff will be in attendance at the stand or around the Convention and we look forward to meeting anyone who wishes to drop by. □



A symphony from Raindirk

"A lot of desks have a sound of their own, the Symphony doesn't, the sound is so natural, no artificial colouring or noise."

— Gary Jones, *Coconut Recording (Germany)*

"Beautiful, clean-sounding, brilliant e.g., effortless"

— John Hiseman, *Producer, Temple Music*

"The best-sounding desk I've heard for nearly 10 years"

— Paul Libson, *Producer*

Experience the flexibility of the Symphony LN with unparalleled clarity and dynamic range – 36 channels open, mixed to stereo, noise output – 94dbvu – dynamic range 110 db, (1 channel 121 db.)



raindirk audio

Unit 2, 10 William Road, London NW1 3EN.
Tel: 071 388 1820/071 387 1262. Fax: 071 388 0339

THE A-DAM CHOICE: ANDY LONGHURST

Andy Longhurst is a highly respected Producer and Engineer whose previous projects have included work with Womack & Womack, Maxi Priest, and Mike Oldfield. He is a recent convert to Akai's A-DAM multi-track recording system, and here he talks about his experience with it.

Having worked with Akai equipment in the past, Andy found that trying out the A-DAM system to see how it performed was a natural progression. His verdict: "It performed flawlessly".

His initial impressions of the system dealt mainly with the immediately noticeable sound quality. "I've used the Sony and Mitsubishi digital machines in the past, and I could discern, to all intents and purposes, no real difference in quality between A-DAM and these machines. The Akai is astoundingly good quality."

But this was not all: "The DL1200 auto-locator is one of the best I've ever used, and the transport is incredibly fast. One of the strange things was that at first I thought it was taking a long time to rewind and wind forward. In actual fact, when I had it synchronised up with Otaris and such, I realised that the converse was true, it's just that I wasn't hearing any tape run on it.

It's also very, very user friendly; you can plug it in and you're ready to go almost immediately: everything on the front panel is patently clear, and you don't have to do a lot of reading of manuals. The tendency with technology at the moment is to really over-complicate things, but this is a nice, simple package."

With more extended use of A-DAM, Andy was able to evaluate the system comprehensively in relation to both the digital and analogue machines he had worked with in the past. "A-DAM has lots



Producer and engineer Andy Longhurst with a 24 track A-DAM system.

of advantages over other multi-track machines, and although some might view the recording time as a limitation, I've never found it to be a problem. After all, over the last ten years, the emphasis has been on three or four minute singles, with maybe a seven or eight minute 12" remix; with that in mind, the 17 minute tape is fine.

"In terms of comparisons with other systems, I can't see the point of buying an analogue machine with this quality of digital sound at this price. And, to a great extent, there's a much bigger need for maintenance on analogue machines — which is fine in a professional recording studio situation, but for people working out of home or with very quick through-put productions, you don't want to have to worry about that. Digital is not the same; different people have different ideas about it,

it's a very personal thing. Compared to other digital machines, there is very little difference in the quality of the sound — virtually none, in fact.

What is interesting is the delay on each channel available on the Akai. They're fabulous, especially in a live situation, or one in which you're having to work very fast, as with something I did on the machine for TVS during the ITV Telethon. But of course the major difference is in the cost. It's the old thing about affordability versus performance, and as far as that goes, A-DAM is streets ahead of anything else."

Perhaps the most telling comment Andy made about the system was the way in which many have viewed it over the last year. "One of the reasons why there has been a reluctance amongst some people to buy the machine is this perceived

value for money. If there is a 32-track system on the market for about £130K, and which has all these great features, everyone thinks they *must* have one; it *must* be very good. Then if Akai bring out a 36-track system, which costs around £45K, your first reaction is that this isn't quite right. People think that, for some reason, because it's cheaper, it can't be as good. It's a very grave underestimation of the system on their part."

Our interview was rounded off with a prophecy. "Professional studios, indeed the professional audio world generally, hasn't really taken A-DAM as seriously as it should have done, yet. I think that is going to change very, very shortly."

For more information on A-DAM contact Akai Digital Division on 081-897 6388.

Mike Hedges has always had a passion for both classic vintage equipment and new technology. Over the years he has built up a collection that started with a couple of vintage valve mics and has now grown to the extent that he is operating a mobile recording system and private home studio. At the time of writing the home studio has virtually taken over his North London home to the extent that he's acquiring a chateau in Normandy, northern France, where he intends to operate as a residential studio in the near future.

Until 18 months ago Hedges used his home

studio mainly for trying out various ideas and for experimentation with samplers, sequencers, signal processors and recording equipment. Since then the mobile system has been used to record The La's *Timeless Melody* single in a house in deepest Devon, The Creatures' *Boomerang* album in a bodega in Spain, and the well received A House album *I Want Too Much* in a small hotel on the remote Irish Atlantic island of Inishbofin. The latter was recorded using the mobile and mixed at Abbey Road.

During the past year most of his pre-production work has been carried out at the home studio. The only band he has produced working exclusively in

major studios is The Beautiful South.

During the '80s Hedges worked quite frequently at Abbey Road, developing a good working relationship with staff and engineers there. Senior engineer Haydn Bendall has worked on several Hedges' productions and the two have become close friends. And it was the two '70s EMI mixing consoles Mike bought from Abbey Road that turned his collection of favourite and useful pieces of equipment into the basis for two complete recording systems.

Hedges: "The reason for buying the older equipment was simply the love of the sound of it that a lot of people have. It has a sound that modern equipment doesn't seem to have. Manufacturers have been so intent, over the past two decades or so I suppose, in making equipment with a clean as possible signal path, which also means as uncoloured as possible. Obviously the new equipment is technically better but the actual sound is not as good as the older pieces. Therefore lots of producers and engineers like to use older pieces of equipment in their signal paths; valve mics, valve preamps and, if they can get them, valve compressor/limiters. Everyone knows about the whole valve thing but some early transistor equipment sounds equally as great."

While working at Abbey Road using their SSL and Calrec consoles, Bendall introduced Hedges to

VINTAGE RECORDING

Mike Hedges reveals why he has been surrounding himself with classic vintage recording equipment. By Ralph Denyer



Photo: Ralph Denyer

EMI TG1234 Mk II console, 3K monitor system on location

TANNOY
MONITOR
SERIES

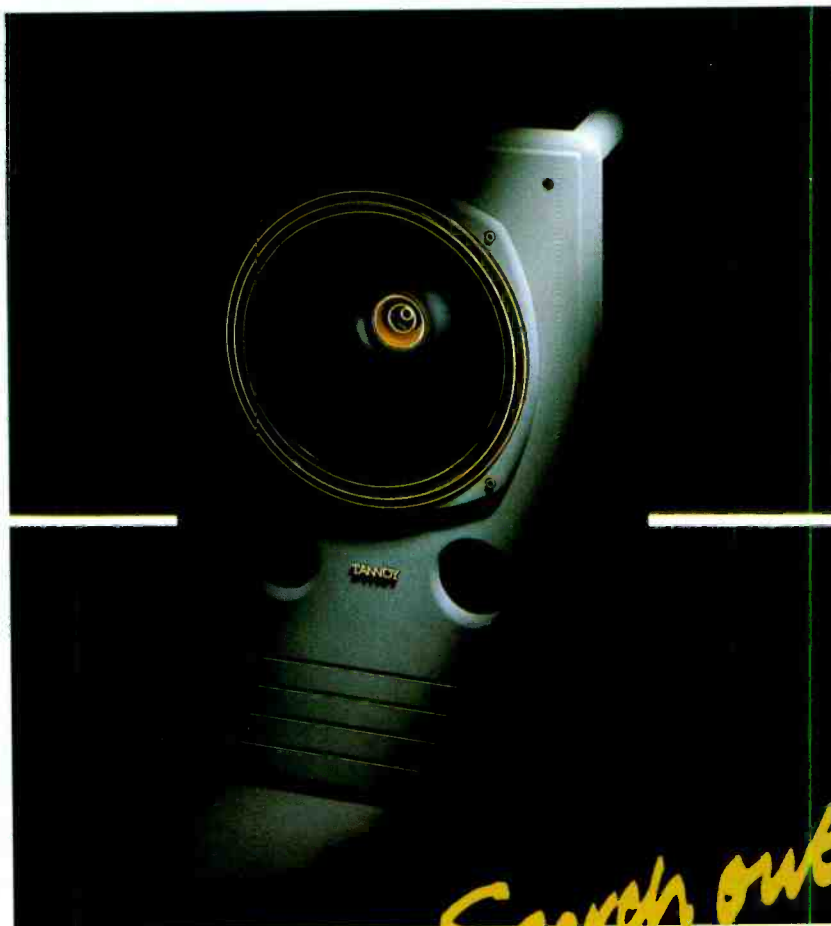

*Search out the
Gray and Gold*



TANNOY LTD., ROSEHALL INDUSTRIAL ESTATE, COATBRIDGE, STRATHCLYDE ML5 4TF, SCOTLAND.
TEL: (0236) 20199. TLX: 778621 TANMFGG. FAX: (0236) 28230.

TGI/TANNOY, 300 GAGE AVENUE, KITCHENER, ONTARIO, CANADA N2M 2C8.
TEL: (519) 745 1158. FAX: (519) 745 2364.

www.americanradiohistory.com

For over a decade Mike Hedges has maintained a strength of commitment to music that has gained him a reputation as one of the UK's most individual record producers. He began working in pro-audio at Morgan Studios (now the site of Battery Studios and The Power Plant) as a house engineer. He moved into production working initially with the Cure. Robert Smith's connections with Siouxsie and the Banshees led to Hedges producing the Banshees spin off, The Creatures, and subsequently the Banshees themselves. The first Creatures tracks were recorded in the early '80s at Mike's own Andy Munro designed Playground Studio, an innovatively live studio for its day. Those first Creatures tracks themselves were fresh and new, consisting only of Siouxsie's vocals and Budgie playing an assortment of drums and percussion.

Hedges has sustained a long and musically successful relationship with the Banshees and The Creatures resulting in some classics such as The Creatures' *Miss the Girl* and The



Banshees' *Peek-A-Boo*, the latter being one of the cleverest record productions in recent years. With a list of credits that includes Marc Almond and The Associates, Mike gained an enviable reputation for producing acts whose music is far from tailored for a mass market

yet who still enjoy healthy album sales and frequent Top 20 singles chart placings. Then last year he produced the highly successful *Welcome To The Beautiful South* debut album for The Beautiful South. Three singles from the album charted, including *Song for Whoever*, which reached No. 2. Just when everyone tagged him as a producer of idiosyncratic and left-of-centre bands, he successfully produced an album in the Top 20 mainstream.

EMI equalisers. Many had simply been removed from redundant cutting consoles and the like and housed in 3U rackmounting units.

"When we were after a particular sound—a warmer bass sound or something—Haydn would say: 'Oh, let's use one of the old EMI EQs,' got it out and the sound was far superior. So we'd get another one out of the store and use it on the vocal. I'd end up using racks of them."

Though highly regarded, the EMI equipment used at Abbey Road until the early '70s was custom made for EMI studios.

"I saw the console in one of the studios and just

thought it was one of the most beautiful pieces of equipment I'd ever seen. It was the look of it that attracted me more than anything."

Most of the '70s EMI equipment that was replaced when studios were refitted was sold at knockdown prices to engineers and people who had worked at the studios. Hedges had seen an EMI TG1234 Mk II 28-channel console made for location recording, mainly of classical music but when he bought it a module and some wiring had gone missing so some replacement parts were needed.

It happened that there was another console in

pieces in a garage at the back of Abbey Road with modules that would fit. It had been taken to pieces, unsuccessfully sent for sale and kept in storage for a year or two, and eventually brought back to Abbey Road. For a total of 7 years it had been in pieces and moved back and forth.

"I was very eager to get the second desk for spares and it was only when I saw it a little later that I realised it was the one from Studio Two. Because it was such a prestigious desk I had assumed it would have been sold either at *The Sale of the Century* at Abbey Road (a major clearout sale organised by Malcolm Jackson during the mid '80s where much '60s and '70s recording equipment was disposed of) or just as soon as it was for sale.

"It was much later that I discovered from Alan Parsons that the first album recorded on the Mk IV was *Dark Side of the Moon* which he engineered and is without question one of the best sounding albums ever."

Though, of course, Studio Two is generally known as 'The Beatles' studio,' as they made most of their records there, the console was installed early in the '70s just after the group broke up. But throughout most of the '70s and up to 1982 many of the most illustrious rock and pop albums recorded at Abbey Road were made using the EMI Mk IV 44-channel console. The modules were the same TG1234 series as used for the Mk II mobile desk. With the help of Ken Townsend, Phil Hancock, Haydn Bendall and others, Hedges has been able to bring both the Mk II and Mk IV up to working specification. The Mk II is used for the mobile system and the Mk IV is still in his private home studio.

When he acquired the consoles Hedges was still only intending to use them during his own time in his own studio and not as major work tools.

"They were for a collection. I wanted these consoles because I love them. I like everything about them: the sound, the look of them, the smell of them, everything about them. Obviously they are beautifully built. To me the Mk IV is the most beautifully thought out console that I've ever worked on, even including the most modern consoles. It's just the way it was designed to be used.

"The design team's only idea on how it should sound was that in audio terms it should be as accurate as possible and therefore it's built like a piece of test equipment. The oscillator can be tapped into any of the channels to check that the input to the channels is exactly nought, and you can send that to any channel, to any of the tracks. And as long as the fader is on nought, the line gain on the channel is nought, then it will go to the track on nought. And you can send the signal through channel after channel and it doesn't compromise the signal at all. The level stays completely accurate. Obviously when you go through several channels the distortion starts to build up. I'm sure the distortion is measurable on a test instrument but you can't hear it."

Abbey Road Studios' reputation for maintenance has always been second to none and frequently equipment has been kept up to new specification during an exceptionally long working life. So Hedges was more than happy to buy two analogue Studer machines with Mk I 8-track heads as part of a package with the Mk II console. These two particular Studers were probably the best kept machines of their era. With their own flight cases they were actually used with the console mainly for location classical recordings. As these sessions involve symphony orchestras, top soloists and major concert venues, which can be booked up for months or even years, the machines had to be as



EMI TG1234 Mk IV console at Mike Hedges' home studio

Photos: Ralph Denyer

0 TO 256 IN ONE SECOND!

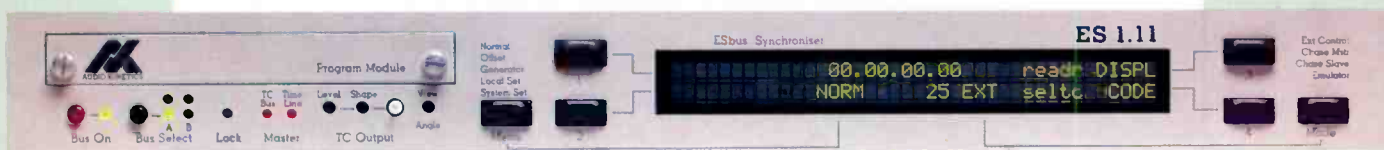

ES.Lock: the best audio-video-film-digital workstation synchroniser in the world

Audio Kinetics UK Ltd, Kinetic Centre, Theobald Street, Borehamwood, Herts, England WD6 4PJ.
Tel: 081-953-8118. Fax: 081-953-1118.

ES.Lock 1.11 and ES.Lock Controllers are installed in 22 countries worldwide: **Australia**, Maser, 2-958-6700. **Austria**, Grothusen, 22-297-2529. **Belgium**, Heynen, 1152-5757. **Canada**, Sonotechnique, 514-739-3368. **Denmark**, Interstage, 31-620026. **Eastern Europe**, Sondor (Switzerland), 1-391-3122. **Finland**, Studiotec, 0-592055. **France**, Audio Kinetics, UK-81-953-8118. **Germany**, STK, 40-690-1044. **Holland**, Heynen, 8851-96111. **Ireland**, Audio Kinetics, UK-81-953-8118. **Italy**, Audio International, 2-253-90121. **Japan**, General Traders, 3-293-2274. **New Zealand**, Maser - Auckland 9-479-7889. **Norway**, Siv. Ing. Benum, 2-135-460. **Singapore**, Team 108, 748-9333. **Spain**, Teico, 1-231-7840. **Sweden**, Proab, 760-19863. **Switzerland**, Studio World, 56-271233. **Taiwan**, Acesonic, 271-68896. **USA**, 21st Century, 213-463-4718.

reliable as humanly possible and more.

Hedges acquired *Mk I* 16-track heads and started to experiment.

"Because the equipment worked so well having been meticulously maintained and because it sounded so good I made a conscious decision that it had to be used. I prefer to use this equipment to anything else. It sounds better than anything I can find anywhere else. I didn't expect to become so addicted to the sound of the equipment or that after using it I would feel so let down by modern equipment."

He finds that the *TG1234* series modules have proved surprisingly useful. He has not used outboard EQ or compression/limiting as the in-built facilities have always given him the sounds he wants. Initially the EQ may appear limited

channel inputs are MIC GAINS -15 dB to $+45$ dB and the FINE LEVEL adjustment is in $\frac{1}{2}$ dB steps, which Mike also has found more than adequate for dealing with any line level inputs. An AUXILIARY section has a series of highpass filters that go from LOW, which sounds to Hedges like a fixed 35 Hz option, and then 70, 160, 360 Hz plus a HIGHPASS. Then there is yet another bass EQ with narrow bandwidth, which gives a ± 20 dB at 70, 100, 150, 200, 300, 400 and 600 Hz. The *Mk IV* console has 44 channels, six echo sends and four returns, 16 monitor returns, 32-track routing with 44 compressor/limiters. The mobile *Mk II* has 28 channels, 16-track routing, and is configured to double up on all outputs to tape for live recording.

All this equipment was working rather well with Hedges' monitor system, which had been

power approx 3.6 kHz) 25 Hz to 20 kHz stereo midfield monitor system with quite complicated electronic control. Each side of the system consists of two separate speaker enclosures. The top cabinet is positioned at the normal midfield position, just above the top of the console. This is based on the Munro-designed Klark-Teknik *Jade 2* midfield enclosure. With the *3K* system, the *Jade 2* two 8 inch bass speakers are just used for the upper part of the bass and the additional fourth crossover directs frequencies between 100 Hz and 25 Hz to the 15 inch subwoofer cabinet, which provides the bottom end power and movement of air.

Because the more usual 3-way electronic crossover unit is replaced by a 4-way, all the low end characteristics of the upper enclosure are different and it is tuned completely differently from the standard *Jade 2*. So the *3K* midfield enclosures have more efficient tuning and the subwoofer system has to deliver just two octaves basically from around 25 Hz to 100 Hz with maximum efficiency. The system is powered by four stereo Carver amplifiers. Every component in the system is modified or specially made to a Munro specification—hence the price tag.

So with a complete mobile system consisting of the *EMI Mk II* console, two 16-track Studers, the Munro *3K* monitor system all fitting in flight cases, Mike began to see the commercial possibilities.

"Andy MacDonald at Go Discs was the catalyst in turning the whole thing into a commercial venture. He wanted to essentially get a '60s sound for The La's, a band on his label. He knew I had all the equipment and that the band had not functioned well in modern recording studios. They just didn't enjoy it. If it hadn't been for Andy MacDonald I doubt if I would have got the mobile off the ground."

Hedges had been operating all the equipment at home having cobbled together the wiring himself. Andy MacDonald said he would pay to get the equipment working 100% as a mobile. In return Hedges hired the equipment to him for a nominal low fee for The La's session in Devon.

With record company limitations on budgets for some projects, Hedges also saw the mobile allowing him to offer a better deal for some bands. They could spend several weeks track laying and doing basic recording in a location of their choice—providing a building with suitable acoustics could be located—and then spend say a couple of weeks mixing at a major studio stacked with racks of sound processing, delay and reverb units.

Of one thing Hedges was sure. To his ears, Studer 16-track *Mk I* head analogue 15 in/s recordings with Dolby *SR* sounded best, including the better known digital multitracks. Hedges had sought out Studer *Mk I* 16-track heads rumoured to sound better than *Mk II* or *Mk III* models. The word is that the *Mk I* heads were modified as the composite used was proving too hard-wearing on the oxide coating on tape. New heads were marketed using a softer composite, which were kinder to tape but didn't sound quite as good. However, 20 years on, tape manufacturing techniques having improved greatly, the *Mk I* heads were no longer problematic in this respect. But there was still a problem.

"I do find that the *Mk I* heads sound better than the *Mk II* or *Mk III*. But the *Mk I* headblocks do have a very large gap between the record and erase stack so you need a considerable gap in a musical performance when dropping in or out."

Though Hedges did not find this a problem for



Photo: Ralph Denyer

Vintage Studer machines on location

marked BASS and PRESENCE. BASS is wideband and ± 10 dB. PRESENCE is selectable frequency, preset curve and bandwidth, ± 10 dB. Selectable frequencies are 500, 800, 1.2k, 1.8k, 2.8k, 4.2k, 6.5k and 10k Hz. Though 10k may seem a bit on the low side Hedges says the bandwidth is quite wide. He estimates the spread being in the region of between 4k to 16k. He describes the console as having a tendency to, "take care of the higher frequencies" and so they don't use the 10k adjustment a great deal.

Also as the desk allows virtually any signal path routing, a sound can be processed through the EQ on several channels without significant or indeed noticeable degradation. The faders are the curved (radial) type, which adds greatly to the vintage feel of the console. And, ergonomically speaking, the general feel of the console controls is quite alluring. Compression and limiting work on the same switch and levels are shown on the input meter for the channel in question. The

built and designed for him by Andy Munro during 1988. Hedges' specification for the system he required was simple in principle. He did not want any compromise in sound quality and the system had to be transportable for use in any recording environment. When he was working in the studio he would set up his own monitoring and also use the system at home. In short, a transportable no-compromise best that money can buy pro-audio monitor system.

The system had to be capable of delivering the highest sound level required with the lowest possible distortion, flattest response, fullest bandwidth, etc. In general the system had to be able to handle all the demands made on full size studio monitors, with all the cleanliness and fidelity of a small domestic or broadcast type of monitor setup at lower general working levels.

The end result—with a price approximately twice that of existing studio flush mounting monitor systems—was a 4-way 3 kHz (total peak

The drive units at the heart of every new Turbosound enclosure are built by Precision Devices Ltd.

A company specifically established by our parent company, Edge Technology Group, to develop drive units with unsurpassed reliability and audio performance.

DEVELOPING THE CONE AND COIL.

Particular attention has been paid to designing each cone's profile and materials for its intended application.

The voice coils are wound with pure copper for long term strength and reliability, coated with high temperature enamel, onto an epoxy resin-impregnated woven fibreglass former.

The whole assembly is cured at high temperature to give it a completely rigid, integrated structure for greater strength and energy transmission abilities.

AN ADVANCED MAGNET ASSEMBLY.

The magnet assemblies are of the traditional iron and ceramic 'sandwich' type. The difference lies in our attention to detail and the quality of materials.

Top quality low-carbon steel is machined to very fine tolerances to maximise contact between plates. And as tight a magnetic gap as possible in turn gives greater magnetic power and increased cooling for the coil. (In our larger drivers, we also bolt the parts together for extra strength).

Finally, the loudspeakers' frame designs are based on the soundest of

engineering principles, with generous use of die-cast aluminium alloy to ensure their indestructibility on the road. In fact, our frames weigh twice as much as most other manufacturers'.

Guaranteeing that even under massive physical shock, the assembly won't suffer.

ATTENTION TO DETAIL.

All this attention to detail means that every step in the manufacturing chain is designed to enhance our enclosures' performance.

Finally, the components come together in a modular assembly process, with testing at every step, before being fitted into enclosures that have been built with equal precision.

The result is a finished product that produces accurate, natural sound simply through the precise matching of its components. Which means that, more than ever, there is no need for external electronic compensation.

So that's a breakdown of what Precision Devices will mean to you. And what makes Turbosound enclosures so exceptionally reliable.



TURBOSOUND LIMITED, STAR ROAD, PARTRIDGE GREEN, WEST SUSSEX RH13 5EZ. TEL: (0403) 710447. TELEX: 878723 TURSD G. FAX: (0403) 710155. INC. TURSD-UK

HOW DO PRECISION DEVICES MAKE OUR SPEAKERS SO RELIABLE? HERE'S A BREAKDOWN.

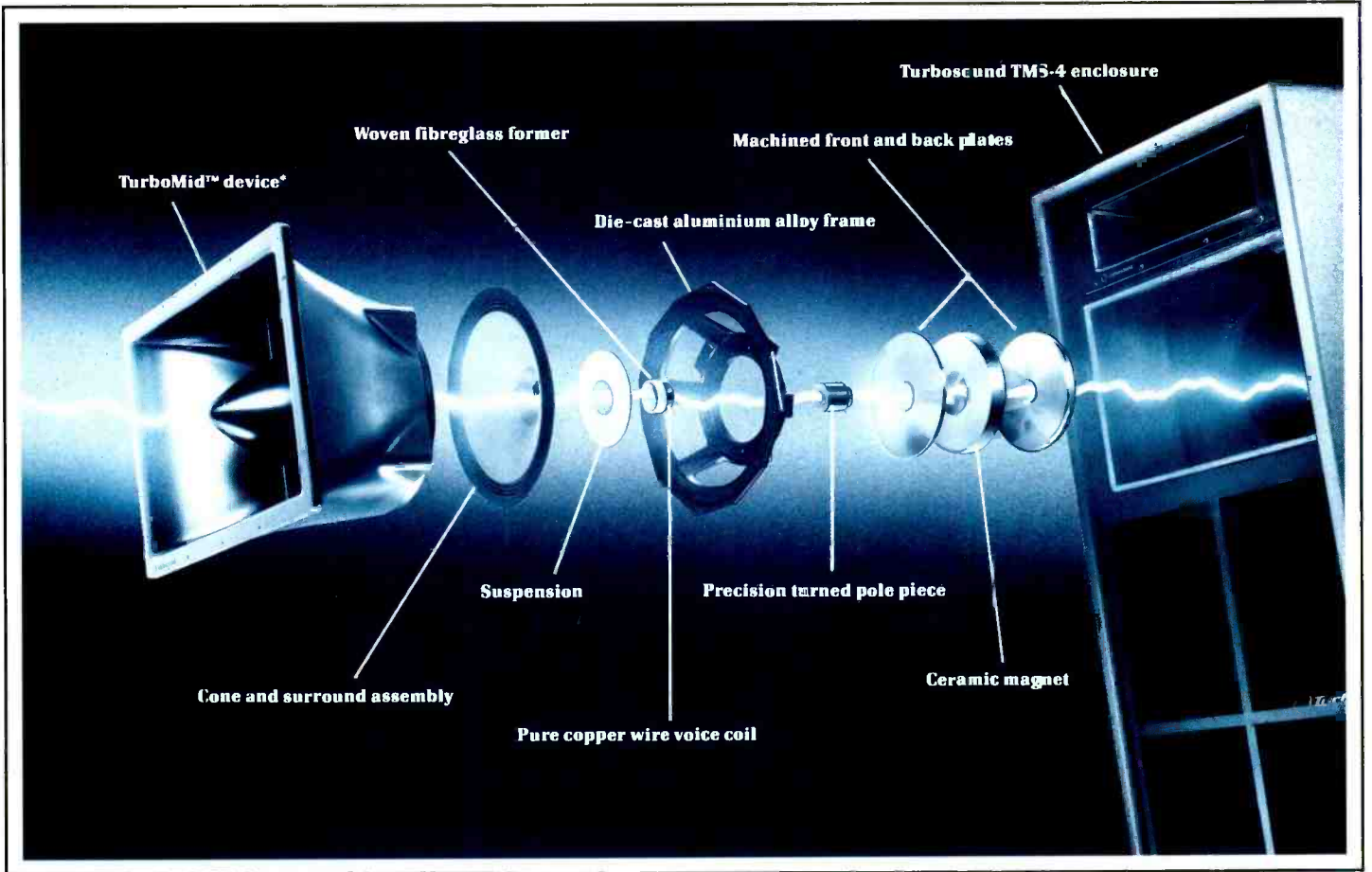

WORLDWIDE AGENTS: AUSTRALIA: A T T AUDIO CONTROLS PTY LTD MELBOURNE (03) 278-4511 **AUSTRIA:** AUDIO SALES MÖBICHING (02236) 26123 **BELGIUM:** T E M ZELLER (02) 466-5000 **CANADA:** OMNIMEDIA CORP MONTREAL (514) 636-9971 **DENMARK:** PERMEISTER PRODUKTIONSKARLSLEJDE (42) 151300 **FRANCE:** REGISCENE PARIS (01) 4396-5050 **GREECE:** ALPHA SOUNDATHENS (01) 363-8317 **HOLLAND:** T E M BREDA (076) 812872 **HONG KONG/CHINA:** TOM LEE MUSIC LTD HONG KONG (0) 730-1090 **INDONESIA:** BAWI SUTERHA & ASSOCIATES JAKARTA (21) 4512617 **ISRAEL:** BARKAI RAMAT (03) 735770 **ITALY:** AUDIO LINK PARMA (0521) 598723/4 **JAPAN:** EDGETECH (JAPAN) LTD TOKYO (03) 295-4731 **KOREA:** YUNG SAK SU RI SA CO. SEOUL (02) 267-9097 **NORWAY:** SOROTEK EQUIPMENT OSLO (02) 231590 **PHILIPPINES:** STAGE CRAFT INTERNATIONAL INC MANILA (02) 834-0539 **PORTUGAL:** CASA CAVALS ARTIGOS MISCHEIS LTD OPORTO (02) 0884456 **SINGAPORE/MALAYSIA:** SWEE LEE SINGAPORE (04) 336-2307 **SPAIN:** LEXON BARCELONA (03) 203-4804 **SWEDEN:** INTERSONIC STOCKHOLM (08) 744-5654 **SWITZERLAND:** SINTEC SUHRIN WERD (04) 43747 **TAIWAN:** PROSOUND INC TAIPEI (4) 235-1873 **THAILAND:** BANGKOK LINE GRAPHIC CENTRE BANGKOK (02) 314-3570 K C M BANGKOK (02) 222-4712 **TURKEY:** NEFYS ISTANBUL (01) 160-4514 **UK:** FIRST AUDIO LTD BRIGHTON (0273) 693610 **U.S.A.:** GROUP ONE INC NEW YORK (516) 249-3880 **WEST GERMANY:** ADAM HALL USINGEN (608) 16031

*Turbosound Patent Information: Australia: 515, 535 Canada: 1,076,033 Japan: X113424/77 UK: 1,582,246 & 1,598,310 U.S.: 4,215,761 & RE. 32,183 West Germany: P2742600/2 Other patents pending

an **EdgeTech** company
LONDON • NEW YORK • TOKYO

BC1204

A UNIQUE BROADCAST CONSOLE

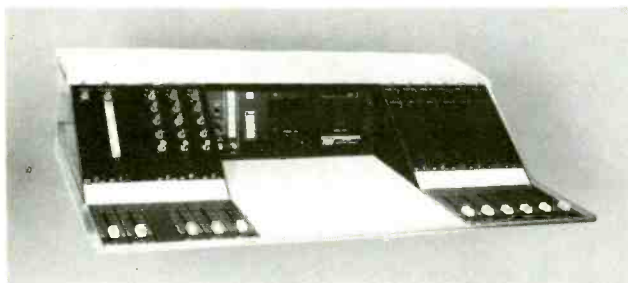

*Long life top quality components throughout.
High quality Broadcast specification.
Low cost for radio in the 1990's.*

Despite its low cost, the BC1204 is purpose built for broadcast applications. Commonly used facilities are provided as standard with numerous options available for future expansion. Don't be misled into choosing a mass production mixer which will neither suit your needs nor survive in the arduous on-air environment. The BC1204 will reliably serve your broadcast needs for 10-15 years.

Call us today for further information

KW ELECTRONICS
LIMITED

UNIT A8, PINFOLD INDUSTRIAL ESTATE
PFORD DERWEN, RHYL, CLWYD LL18 2YR, NORTH WALES
Telephone: 0745 338864 Fax No. 0745 343693

M R L TEST TAPES

When considering which make of Calibration Tape to choose for your tape machines, there is really only one choice, MRL.

MRL manufacture a range of more than 160 different types, which are widely used in the design, manufacture and maintenance of tape recorders in studio, broadcasting, duplicating and consumer applications.

When considering where to buy MRL tapes, there is also only one choice, F.W.O. Bauch.

Call today.

BAUCH
Solutions

F. W. O. Bauch Limited
49 Theobald Street, Borehamwood, Herts, WD6 4RZ
Tel: 081-953 0091 Fax: 081-207 5970

Rycote

Beware
imitations!

The result of continual
original research

**WINDSHIELDS,
SHOCKMOUNTS
WINDJAMMERS**

Rycote Microphone Windshields Ltd
Unit 6, New Mills
Slad Road, Stroud
Glos. GL5 1RN England
Tel: (0453) 759338
Fax: (0453) 764249

ocals and some instruments, when there is virtually continuous performance—as with live drums for example—drop-ins and outs were just not on. You end up with a clearly audible gap.

What to do? Hedges looked at various possibilities. A new Otari *MX80* 16-track analogue was light and sounded good. An attractively priced second-hand Sony *3324* 24-track digital was a proposition being an accepted industry tool but could hardly be called easily transportable. He needed a machine that would overcome the drop-in question, would be transportable and would not rocket recording budget levels. Then he tried and subsequently bought an Akai *A-DAM DR1200* 12-track digital machine.

“A lot of digital machines sound digital; they have a digital ‘zing’ to them. And if, with the Sony for example, you put in Apogee filters it does actually sound better to me. Less digital and more acceptable. But like a lot of modern machines that are technically correct and technically near perfect, they don’t necessarily sound any better than the old ones. And because of the tape saturation with 16-track analogue and the lack of crosstalk compared to 24-track analogue, 16-track analogue sounds better than any other machine to me. I love the fact that digital is hiss-free but analogue with Dolby *SR* is hiss-free as well and it sounds better.

“And so we tried the Akai and it didn’t sound ‘digital’ at all. Why I don’t know. I would agree with Pip Williams when he says that the original 3M digital system is still the best he’s ever heard. The 3M had a warmer, less digital sound than any of the modern systems. The *DR1200* is not very far off that. It has a warm digital sound if such a thing is possible.”

Hedges is enthusiastic about the operational characteristics of the *DR1200* system. Not only does the machine overcome the drop-in problem for him, it out-performs every other digital multitrack in this respect. He describes the remote as, “incredibly sophisticated with several functions that you normally only get with the most expensive machines”. The synchronisation duties are left to an Adams-Smith *Zeta 3* unit.

A method of recording Hedges employs is to record a basic backing track either on the Studer or the *DR1200* and put a slave mix on to the other machine. If the track requires a lot of complicated drop-ins by the artist, it will always be the *DR1200* machine. Using this system he can, and has eventually ended up with two analogue 16-track tapes and two digital 12-track tapes all with tracks for the same version of a song. The rule of thumb is never to go through more than one generation on the 16-track analogue. In practical terms he has not experienced any limitations regarding several generation takes on the *DR1200*. He generally hopes to end up recording submixes either on one 16-track analogue or one 12-track digital master from which to do the final mix.

Hedges uses compiling quite a lot so he can record say three takes of a vocal on his beloved Studer and then compile them into a stereo master vocal on the *DR1200* using the machine’s editing facilities.

Hedges says he is not a fan of automated or multi-hands-on mixing and hopes that he will not have to automate his consoles in any way.

“I think there should just be one person mixing, not two. It’s usually just the engineer I’m working with for the project. I work with high quality engineers and believe that if they’re doing the mix, they’re doing the mix. They should try and do the mix all themselves and it usually

sounds better if they do.

“We did still have the problem of ending up with several mixes of a song and wanting the intro from one, a verse from another and four bars from another. Obviously we could put it together using the old fashioned way of cutting and editing the analogue stereo master which is something we’ve been doing for years but that can be quite tedious, although that’s not always true. It can also be fun.

“We wanted a way of editing stereo mixes together and by chance some time ago I was put on to Digidesign’s *SoundTools* hard disk editing system, by Curtis Schwartz, a friend of mine who also has a studio. He found that *SoundTools* was a perfect way round not having automation. You mix everything down to the *SoundTools* hard disk, tell it where your edit points are and instantly hear the results. Suddenly, we don’t need automation.”□

Availability

At the time of writing Mike was in the middle of recording the new Beautiful South album and had not had time to fully consider hiring the chateau or the mobile other than to close friends and colleagues. He will, however, consider the possibility and interested parties might like to contact

Peter Hedges,
4 Warrenwood Cottages,
North Chailey,
Sussex,
BN8 4JA,
UK.
Tel: 0825 723881.
Fax: 0825 724157.

ProBox 1™
 Domestic SP to be Converted to EBU, and EBU to be transferred to a SP domestic format. The unit also provides for a word-clock output which can act as a house master-synch, or enables locked operation with other equipment. A further important feature is that it will allow the transfer of CD digital code, to be read in EBU/SP format. ‘Good lock’ and emphasis indicators. Sampling frequencies: 48, 44.1 and 32 kHz.

ProBox 2™
 ProBox 2 provides a full interface between the FI format and EBU (both send and return). It is necessary to fit a small interface board to the FI format processor (PCM701 or 501) to provide a digital input/output. CD digital code can be converted to AES/SP as in Pro-Box 1 and ‘Good Lock’ and emphasis indicators are provided.

ProBox 3™
 ProBox 3 provides a full send and return interface between Sdiff 2 and EBU with slaving capability, having separate word-clock IN and OUT. The system is in a 1u rackmount case.

Level ModeDefier™
 This unit provides all the functions available in ProBox1 (the ModeDefier function), plus a dithered real-time fader for use on EBU/SP lines. A studio law fader offers gain scales switchable between unity and a +12dB range; channel balance has a ±6dB range; phase and channels can be reversed. The unit is a 1u rackmount format with a slim-line fader control box that can be extended by 15 meters from the processor unit.

Error Status Report Writer™
 This is a small computer system which interlinks with PRODAT series of R/DAT recorders. It will provide a full hard-copy of various combinations of error correction flags against time. Intended for quality assurance of master tapes.

U.K. Broadcast and Export Sales
 Unit 3, Horseshoe Park, Pangbourne
 Berks. RG8 7JW U.K. Tel. 0734 844545
 Fax 0734 842604

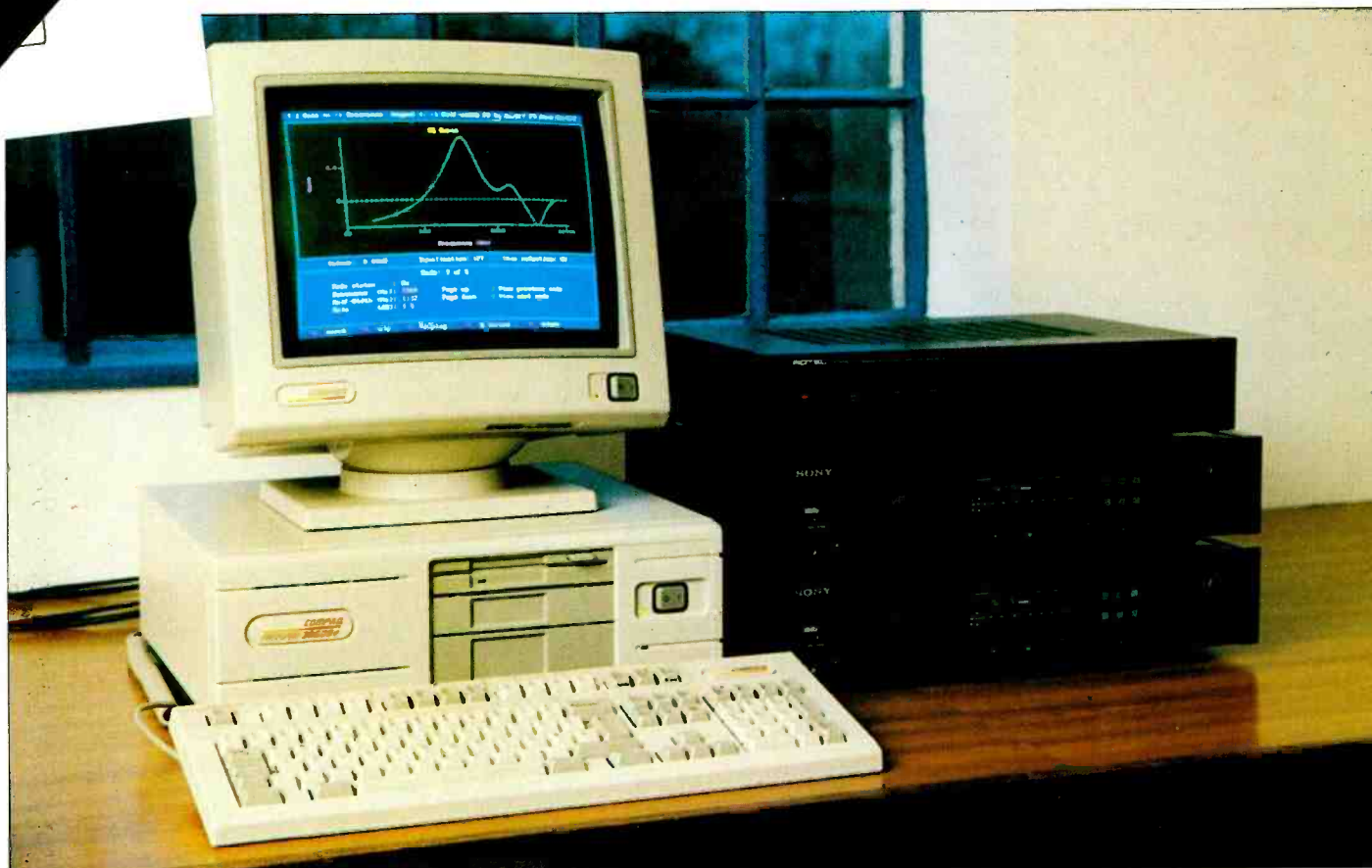

CEDAR System showing EQ curve

How fortunate we are to have today's audio recording media: analogue tape with Dolby SR noise reduction or DAT, PCM-1630 and the various other digital formats currently available. We can capture sound with an almost incredible accuracy and, with due care and attention, be sure that no intrusive background noises, other than an almost non-existent hiss, will mar our listening pleasure. And with CD this degree of perfection extends right down the audio chain to the domestic and even to in-car and personal stereo users. Things haven't always been so good.

Over the last couple of years we have been hearing about a process known as CEDAR, which claims to remove clicks and other non-musical events from old recordings and there has been some interesting discussion in *Studio Sound* recently (May and July 1990). This article will describe what CEDAR is and what it does, and give a personal impression on how well it performs. The precise details of how the process works involve high flying mathematics, which must wait for another day.

Applications

It will not have escaped anyone's attention that there is a sizable market for 'antique' recordings transcribed onto CD. It's a pity no-one thought of this when the CD specification was drawn up otherwise Philips and Sony might have included a mono standard to allow the discs to play for twice as long. These antique recordings date as far back as the acoustic gramophone and even back to cylinders, although mainly for their curiosity rather than musical value. There is a vast archive of material on acoustically and electrically produced 78 rpm records, which covers a very important period in the development of

CEDAR

David Mellor investigates the method and operation of this digital noise processing system



Screen display of noise reduction menu

performance styles. Many of the artists involved in making these 78s had a very close musical connection either with the composers of 19th century repertoire, or people who followed closely in their musical tradition. As we move further and further away in time we inevitably lose perspective and old recordings provide a valuable educational resource.

Also on 78 rpm discs is an equally vast repertoire of jazz recordings. Jazz, more than any other type of music, is ephemeral in its nature unless captured in a recording. Once again, the catalogue of 78s holds important information, this time on the development of a musical style. These old recordings need to be available. Modern re-recordings may be technically perfect but can somehow never capture the excitement and vigour of the originals.

The application of some type of restoration process to scratched and noisy 78 rpm records is self evident. Slightly less so is the need to improve the quality of 33 $\frac{1}{3}$ rpm long playing records. After all, if you want to release '60s or '70s material on CD, it's best to go back to the original master tape if you can find it, and if it is still in a playable condition. It seems more and more horror stories concerning the longevity—or rather lack of it—of ¼ inch tapes are coming to light. If you have an old tape which sheds oxide, sticks to the heads or is otherwise difficult to play, the first course of action is to consult the tape's manufacturer who may have a fix. If the master tape cannot provide usable results, then the only thing to do is to find a good copy of the LP to transcribe onto CD.

Another source of noise-ridden dialogue and music is the optical film soundtrack. Once again, this is a very 'clicky' medium, any scratch on the film is interpreted as a noise impulse, and these scratches are bound to occur through repeated spooling of the film print.

An improvement on the MTR 90 Mk2? Who on earth could have managed that?



Many an envious glance has been cast in the direction of an MTR-90 Mk.2.

No wonder. With its pinch-rollerless transport, its user-friendly control and its faultless reliability, the MTR-90 Mk.2 has been known as the king of 2-inch multitrack.

But now, it shares its crown with a newcomer. A machine with all its advantages, plus faster wind and rewind, auto alignment on record and repro and frame-accurate mini-locator.

A machine that offers even better audio quality than the MTR-90 Mk.2, but retains all its vital portability.

A machine that even features an optional inboard Dolby* Rack, ready to accept your choice of SR cards or Otari's unique, switchable A/SR combination cards. As well as a host of detail features aimed at helping the skilled engineer to do a better, faster job.

The name of this marvel is the MTR-100A. And if you're still in the dark as to its maker, wonder no more.

Because there's only one machine that can top an Otari. Another Otari.

*Dolby and the DD are trademarks of the Dolby Laboratories Licensing Corporation

OTARI

Otari (UK) Limited, 22 Church Street, Slough, Berkshire SL1 1PT. Telephone: (0753) 822381. Telefax: (0753) 823707. Otari Deutschland GmbH, Rudolf Diesel Strasse 12, D-4005 Meerbusch 2, West Germany. Telephone: 010 49/2159/50-861-862 or 863. Telefax: 010 49 2159 1778 • UK: Stirling (071) 624 6000; NORWAY: Benum 2-145460 • SWEDEN: Intersonic 8-7445853 • FINLAND: Studiotec (9) 0-592 055 • DENMARK: S.C. Sound 42 99 88 77 • FRANCE: S.C.V. (1) 48632211 • ITALY: T.D.S. (2) 33 40 03 50 • GREECE: Bon Studio (1) 3602942 • SPAIN: Fading (1) 4086700 • PORTUGAL: Amperel (1) 532227 • BELGIUM: T.E.M. (2) 4665010 • AUSTRIA: Siemens 222-717115255 • SWITZERLAND: Audio Bauer (1) 4323230.



Screen showing noise reduction curve



Screen display of logo

Restoration, CEDAR Audio Ltd's subsidiary company, or running it through your own CEDAR processor.

In the case of 78 rpm records, the first thing to do is get hold of the best possible copy of the recording. Obviously, it makes sense to start with as few problems as you can but even simply playing a 78 is not as straightforward as it might seem, not if you want to get the best results. Once you have a clean copy, the next problem is almost bound to be that the hole isn't central, causing wow. CEDAR can do nothing about this, so the disc has to be correctly centred on the turntable. Next question: At what speed should the turntable run? Unfortunately, 78 rpm is not always the correct answer and the label is not likely to be very informative on the subject. The speed could easily be 10% out and you'll have to judge it for yourself. If these problems are not enough, there's plenty of work left in finding the correct stylus to get the most music out of the disc with the least noise.

Once the optimum playing conditions have been found, the disc can be transcribed to a digital medium such as DAT. After this stage, things become more straightforward.

Ethics

The restoration and enhancement of audio is as tricky an ethical problem as the colourisation of old black and white films. A modern film in full colour with Dolby Stereo is very much an interpretation of real life, and when the director has chosen to shoot in black and white that is part of his artistic interpretation. But there is a world of difference between restoration, which means making something as good as it once was, and enhancement, which means making it 'better'. CEDAR can do both and it is very important to make a distinction between the two processes.

If one is going to put the ethical position under a microscope, however, then it would be possible to say that it's not right to transcribe an original 78 rpm recording onto another medium such as CD anyway. Maybe it should be played on the type of equipment it was made for. I had the opportunity of listening to several types of wind-up gramophone recently, and although by no stretch of the imagination was the sound high quality, it was very exciting sound and in some ways preferable to how it would be hearing the same recordings played over speakers.

Another point to be considered is whether or not there was ever any 'approved' version of a recording. Gradually in the history of recording techniques there has been a shift of emphasis from 'let's get the best recording we can', to a position where a producer, in conjunction with his engineer, put together a sound which is thought to be artistically good. In the former case, there is no 'correct' sound a restoration should aim to copy and a full effort can be applied to making the recording sound as good as possible to modern ears. In the second case the recording passed through a stage where its creator said 'it's right', and subsequent copies and restorations must aim to imitate that.

Preparation

The CEDAR process works from a digital copy of the recording to be restored or enhanced. This means that there is some work to be done before sending the material to Cambridge Sound

The system

The hardware part of the CEDAR system doesn't take up much desk space. In fact just enough for a Compaq Deskpro personal computer, monitor and keyboard, fitted with a large hard disk drive and the all-important CEDAR digital signal processing boards; the rest is in the software. The software currently has four modules, a one-pass scratch remover, a two-pass scratch remover, a 512 band equaliser (yes, 512 bands) and a noise reducer with equalisation of the noise-free signal.

The first step in restoring a recording is to load it in from a DAT master over the SPDIF digital interface (there is also AES/EBU). CEDAR includes a hard disk recorder, which stores audio segments as files on the disk. The presentation is very straightforward and I was able to operate it immediately. Once the file is on the disk, it can be Descratched to remove the major clicks. This is not a realtime process: the software looks at the material and builds up a model of what the music should be like, and then takes away anything it regards as not being music. The gaps where the

clicks had been are filled by interpolation, resynthesis or adaptive splicing. The two adjustable parameters are 'Order', which roughly speaking is the 'power' of the system, and 'Threshold', which represents the degree to which a noise must deviate from the 'model' of the music to be considered a candidate for removal. There are two ways to set these parameters: trial-and-error and experience. Setting the Order is fairly simple because if you make it too high, all you lose is time—the process takes longer. If the Threshold is set too high, however, then the process may develop an appetite for music as well as scratches. After processing with the Descratcher, which might typically take twice as long as realtime, there should be no major clicks, although 'ticks', surface noise and hiss will remain.

The second level of operation is the two-pass process, which can be done after Descratching. This will remove all the remaining impulsive noises. How it actually works, it seems, is too mathematical to be fully comprehended by anyone with less than an infinite IQ, but Fig 1 describes the process. First the signal is split into two parts—one containing 90% of the signal and no noise, the other the remaining 10% of the signal and all the noise. This Splitter level is set by the operator while listening to the signal in realtime. It is not a critical operation as long as all the noise goes into the portion to be processed. In this portion, the noise is very much more prevalent than the signal so a Descratch process, similar to the original Descratch, can be applied to root out nearly all the noise. This final Descratching is incorporated into the Recombine procedure, which puts the two parts of the signal back together, hopefully resulting in all the signal that there ever was but with none of the noise. Like Descratch, there are two adjustable parameters: Order and Threshold.

After the one-pass and two-pass scratch removal procedures there should remain only the signal and non-impulsive noise. It's probably fair to say that up to this point CEDAR is purely attempting to restore the signal to its original state.

The next step along the road to enhancement is Dehiss, where the operator's judgement is critical to the results from the process. Fortunately, Dehiss works in realtime, so given a keen ear and

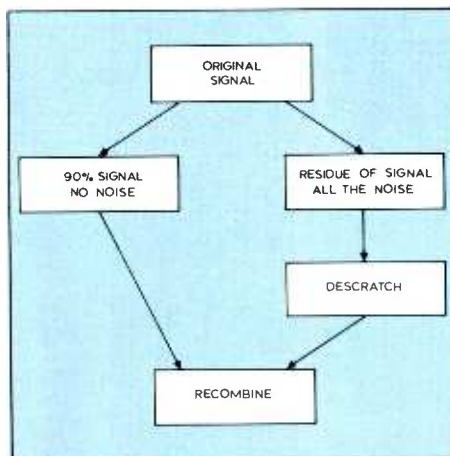

The screen displays shown are from the prototype version and following feedback from beta test sites have been changed in content. For example all four screens now appear on single screen but can be selected for whole screen display as required.

T

OP MARK'S



Mark Knopfler & Guy Fletcher pictured in their London studio

Launching a new band with a unique style requires talent.

Capturing that talent direct to disc requires experience.

Mark Knopfler and Guy Fletcher have both that talent and experience.

Experience dictated the choice of console for Mark's private studio.

Their new band "The Notting Hillbillies" recorded their first album on the IL3632 and as with many albums recorded on Soundtracs consoles, theirs has been an immediate success.

The Soundtracs IL 3632 is a compact, sonically pure console with multiple inputs (76) each with access to an exceptional equaliser. It enables production of either analogue or digital recordings of a standard demanded by the most discerning engineers, artistes and producers.

Soundtracs – combining talent with experience.

SOUNDTRACS

IL3632



UK Distributor: Larking Audio Tel 0462 422466 Fax 0462 421171

91 EWELL ROAD, SURBITON, SURREY, KT6 6AH, ENGLAND

TEL: 081-399 3392, 081-390 8101

FAX: 081-399 6821 TELEX: 8951073 STRACS G

FREEDOM OF CHOICE

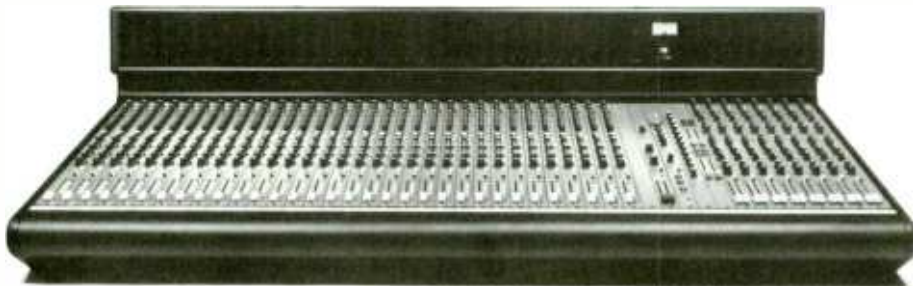

Concept Series Modular Mixing Consoles

Among the standard options available on the Concept series of mixing consoles are choices of: Eq type, frame size, subgroup type, number of aux sends, type of metering, degree of mute and fader automation. Special requirements can also usually be accommodated. The consoles can be configured for film or sound recording, theatre applications, broadcast and live sound reinforcement. You have the freedom of choice over the facilities you want. One thing is always standard however – the transparency of sound and technical excellence that the Concept series has become renowned for.



Hill Audio Ltd., Hollingbourne House Hollingbourne, Maidstone, Kent ME17 1QJ England. Telephone: (0622) 880555 Telex: 966641 Hill G Fax: (0622) 880550
Hill Audio Inc., 5002B N. Royal Atlanta Dr. Tucker, GA 30084 USA. Telephone: (404) 934 1851 Fax: (404) 934 1840 Telex: 293827 HLAD

a good acoustic environment it should be possible to find an optimum point where all the bath water has been thrown away but the baby has been wholly left behind.

Firstly, a 'fingerprint' is taken of the noise spectrum, from a section of the recording without signal. Then, during processing, the software decides on a moment-to-moment basis whether or not noise is present, and if it is, it is removed. Note that this is not done by equalising with the inverse of the noise curve. EQ in CEDAR is a separate process. There are two main parameters the operator must adjust correctly: the Multiplier, which sets the decision level, at which CEDAR will detect signal to noise, and the Attenuation, which defines the residual noise level after processing. Roughly speaking, Multiplier adjusts the effect between 'hissy' and 'dry', and Attenuation adjusts between 'Warbly' and 'sounds OK'. The range of defects it is possible for the process to produce is some way removed from the conventional boundaries of audio malaise so description is difficult but for any recording there should hopefully be a combination of parameters that has a solely beneficial effect.

Once Dehissed, the recording can be Equalised with CEDAR's 512-band EQ. Referring back to Fig 1, an interesting feature is the ability to split the signal into 90% signal/no-noise and 10% signal/100% noise components. If the portion that contains only the signal is equalised, then it is apparently possible to get 30 dB to 50 dB of noise-free equalisation!

Bureau service

Until recently CEDAR has been operated purely as a bureau service, and this facility is still available from Cambridge Sound Restoration. A potential user of this service may either send up a DAT cassette, which Cambridge Sound Restoration will Descratch using either the one-pass or two-pass process. If the DAT is accompanied by an engineer, the Dehiss and EQ, which need subjective decisions, can also be done.

The environment in Cambridge Sound Restoration's headquarters is far removed from what a studio engineer might expect, appearing more like a cross between computer dealer and hi-fi demonstration room. For the standard unassisted bureau service the operator works with headphone monitoring which, although good for hearing clicks, is perhaps not entirely adequate for evaluation of audio quality. In the more normal audio domain it is well known that some

things, such as pitch-related phenomena, while clearly audible on speakers are difficult to hear on headphones. Both the one-pass and two-pass scratch removal processes can have a damaging effect on the music if taken too far and correct judgement is essential.

Dehissing and EQ can be done using Cambridge Sound Restoration's monitoring system, which offers a choice of small Rogers loudspeakers or (original) Quad electrostatics in an, as yet, acoustically untreated space. I was disturbed that the left and right channels of one of my test pieces were treated with casually set different parameters, even though I was 'assured' that this would only result in a slight imbalance in the distortion in the two channels.

But despite these points, the proof of the pudding is in the eating and I was able to take home the CEDAR demo DAT and another DAT of some tracks that were processed during my visit. One of the most remarkable examples on the demo is a jazz 78, which had been broken and glued together—glued together amazingly well but still with some horrendous scratches. On this example, processing has wholly beneficial effects. Another example is a recording that had scratches, so I am told, occurring at a rate of around 2500/sec. There is no doubt that CEDAR can produce very listenable results from previously unlistenable discs.

When the scratches on a disc are less major, some possible doubts about CEDARisation might set in, such as that there might seem to be less top end, and there might appear to be some slight compression. This is very difficult to judge, one has to be very aware that the ear is so easily fooled into thinking that artifacts such as scratches and crackles are part of the music that taking them away inevitably results in a sense of loss. On balance, I think that for declipping 78 rpm records the system works well.

When it comes to Dehissing I was less happy. There are two very illuminating examples on the demo DAT. One is a fairly noisy recording of Schumann's *Piano Concerto*, probably 1950s, which after Dehissing is as silent as a modern digital recording, apart from a little modulation noise. Perhaps it's a matter of aural education but there is such a contradiction between the restricted frequency range of the recording combined with high distortion levels and the almost digital silence, that it somehow just doesn't sound right. Maybe it has been overprocessed and with a little noise left in it would have been OK. The other example is a stereo recording of Prokofiev's *Classical*

Symphony, which in its original form is very present and vivid but loses sparkle along with the noise in the processing. A very successful example, however, is a live recording that was rendered unusable by dimmer noise. CEDAR was able to eliminate this problem completely.

The last track on the demo DAT is a recording of Noel Coward which has been Descratched, Dehissed and EQ'ed. This presents a good opportunity to hear the effects of overprocessing. On the CEDAR version there is an effect very similar to the phasing of a poorly aligned NAB cartridge, which is definitely not on the original. If you get a chance to hear the demo it's very clear just after the words 'What avails the sceptred race'. (No blame is attached to Cambridge Sound Restoration's judgement on the degree of processing applied as the customer's engineer was present during the restoration.)

My tests on tracks I had taken along to Cambridge Sound Restoration confirmed that the demonstration tracks were typical examples of CEDAR at work and not tracks that had happened by chance to work particularly well. My personal conclusions are that Descratching is excellent and has a lot of potential. Dehissing definitely works but it is not without side effects and needs to be carried out with extreme care.

CEDAR for sale

Perhaps a better idea than using a bureau service for such a critical application as the restoration of artistically and commercially valuable archive material is the possibility of buying a CEDAR system. Installed in a studio with good acoustics and operated by an experienced sound engineer there is every possibility of excellent results. At present, CEDAR seems to be in a transitional phase between the theoreticians who devised the process, the computer experts who implemented the system and the sound engineers and other musically aware people who ought to be in charge of its use.

If CEDAR's past has not exactly been ideal in terms of a product launch, this is no reason to suppose that its future may not be very bright. Arguments about restoration and enhancement will no doubt continue but if CEDAR is placed in the hands of audio professionals and seen as a tool to be used rather than a total solution, then it has every chance of success. □

CEDAR Audio Ltd, 5 Glisson Road,
Cambridge CB1 2HA, UK. Tel: 0223 464117.

For your reference below is a list of some commercially available CEDAR processed recordings (some older releases are not up to CEDAR's current standard)

Albert Lee Hiding (A&M 394750-2)

The Best of the Big Bands

Benny Goodman (CBS CK 45338)

Glen Gray (CBS CK 45345)

Woody Herman (CBS CK 45340Z)

Les Brown (CBS CK 45344)

Cab Calloway (CBS CK 45336)

Kay Kyser (CBS CK 45343)

Hal Kemp (CBS CK 45346)

Columbia Jazz Masterpieces

Gene Krupa (CBS CK 45448)

Billie Holiday Vol 6 (CBS CK 45449)

Bix Beiderbecke (CBS CK 45450)

Noel Coward Noel 1928-1938 (Conifer CDHD 168)

Jack Buchanan This'll Make You Whistle (Conifer CMSCD 010)

Elizabeth Schwarzkopf Recital (EMI CDH 7 63201 2)

Rudolf Serkin Bach/Beethoven (EMI CDH 7 63494 2)

Dinu Lipatti Chopin/Grieg concerti (EMI CDH 7 63497 2)

Pablo Casals Dvorak/Elgar/Bruch (EMI CDH 7 63498 2)

Roger Whittaker Live at the Tivoli (Polygram Music Video 081 1843)

Holst The Planets (NIXA CD6013)

Various

The Bing Crosby Years (Reader's Digest Records RDCD 121-6)

The George Formby Years (Grosvenor Records CDGRS 1224)

Unfortunately, while CEDAR Audio Ltd require the CEDAR logo to be included in the CD booklet, it is not always present on the cover, which is the only place it would be seen in the shop if the product were shrink-wrapped. Just as many people would be unhappy about buying a mono recording, which had been artificially processed into stereo, there is a distinct need for restoration and enhancement processes, CEDAR and others, to be identified so the customer has the opportunity of judging which process they think is best. Obviously, people who like what they hear will want to buy more, those who don't will vote with their wallets.

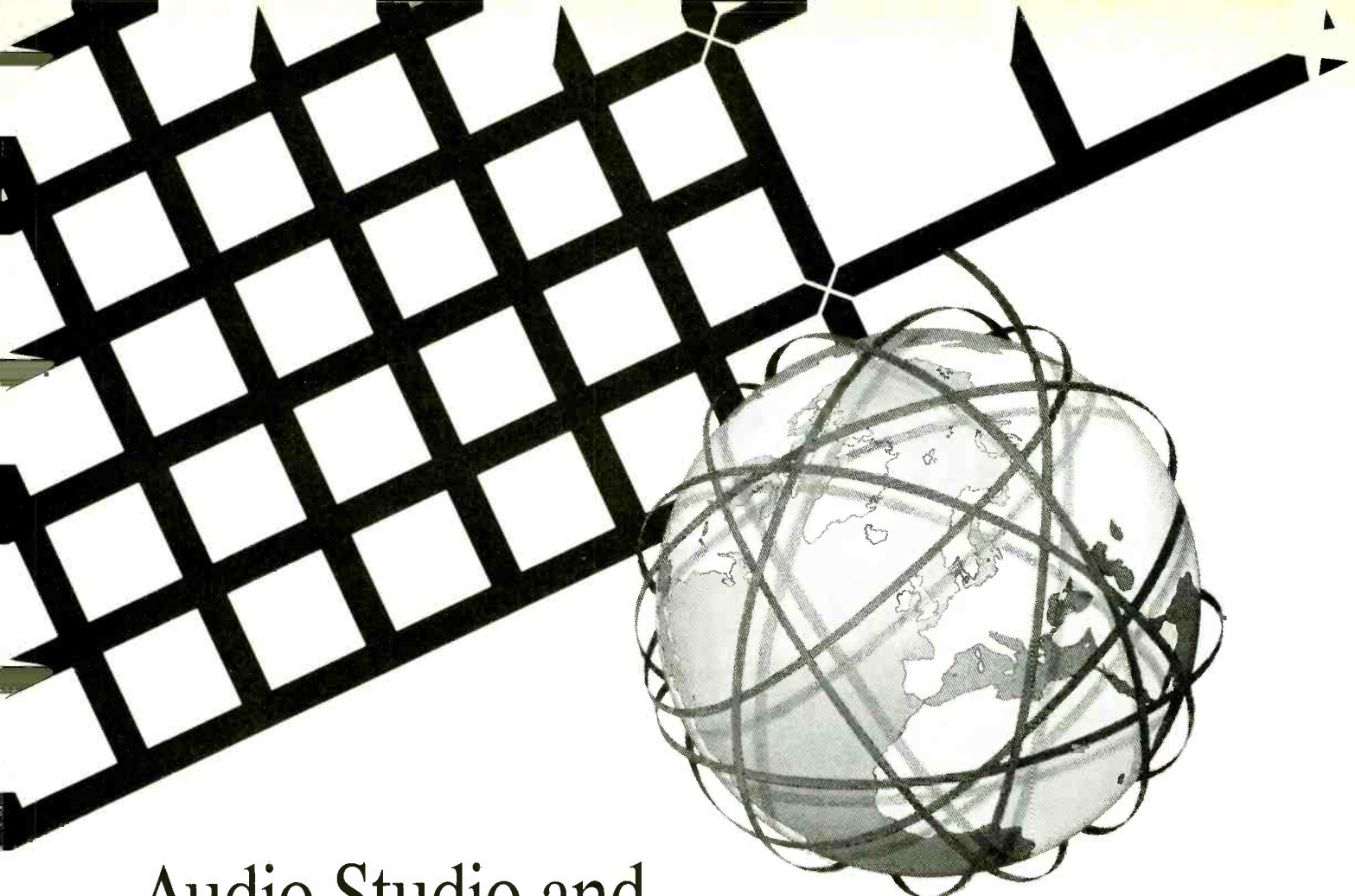

Audio Studio and Broadcast Engineers

YOUR PROBLEM:

Abandoning backward and forward tape mailing by:

- Real time transmission
- Analog or digital AES/EBU sound transmission
- Using H11 or H12 connections

without diminishing production quality even over long distances.

OUR SOLUTION:

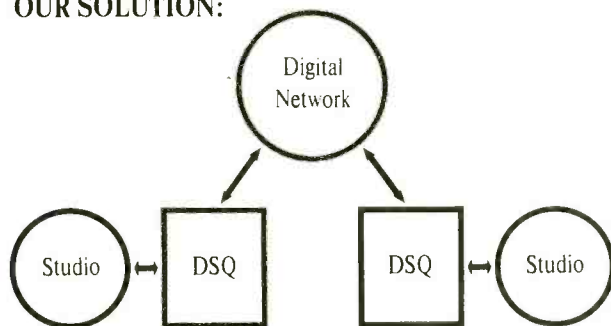

High quality sound transmission needs AT&T's DSQ to fulfill all studio standards.

SOON ON STAGE:

- Digital audio AES/EBU interface
- Analog audio studio interface
- 2048 (1544) Kbit/s G.703 interface
- Various clock possibilities
- Bit error and frame slip protection
- 19" construction
- 230 VAC or 48 VDC power supply
- According to the latest CCIR and CCITT recommendations

Please call for further information:



AT&T
Network Systems AG
Schweiz

Binzstrasse 17
8045 Zurich Switzerland
Tel: +411 488 45 14
Fax: +411 463 55 13

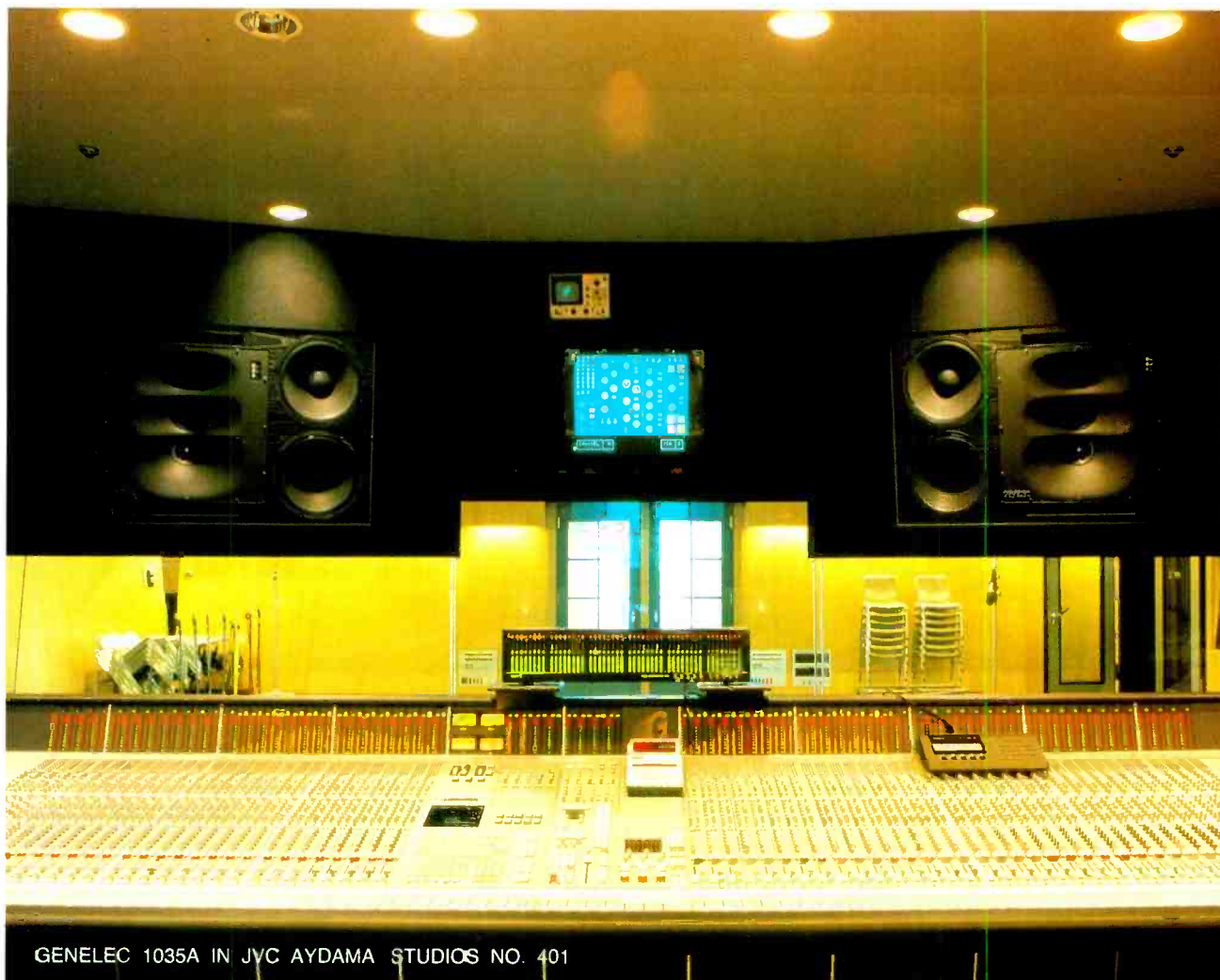

GENELEC®

ANYTHING ELSE WOULD BE SECOND BEST

FINLAND: Tehtaantie 17, SF-74100 Iisalmi, tel. 77-13311 fax 77-12267, AUSTRIA: Audio Sales tel. 02236-26123, BELGIUM: Hes Electronics tel. 02-466 81 80, KOREA: Seoul Sound Technology tel. 2-584 4311, FRANCE: Publison Audio Professional tel. 1-43608464, GREECE: Kem Electronics tel. 081-687 8514, HONG KONG: Power Source Development tel. 3-7456189, ITALY: Audio Equipment S.R.L. tel. 039-2000312, JAPAN: Otari/lec Corporation tel. 03-332 3211, THE NETHERLANDS: Audioscript B.V. tel. 02155-20400, NORWAY: Siv. Ing. Benum A/S tel. 02-145460, SPAIN: Promovisa tel. 081-535 20 17, SWEDEN: Intersonic AB tel. 08-7445850, SWITZERLAND: RTG Akustik AG tel. 061-231912, TURKEY: Omer Trade & Representation tel. 90(4)-1380296, UK: SSE Marketing tel. 071-387 1262, USA: Quest Marketing tel. 617-964 9466, WEST GERMANY: Audio Export Georg Neumann & Co. GmbH tel. 07131-62470.

**Our advertising agency said
 "You can't say everything about
 the PCM-3348 in one ad."
 ...this time they were right.**

ADVERTISING BRIEF PCM 3348

OBJECTIVES

- ① ESTABLISH 3348 AS ULTIMATE MOST DESIRABLE MULTI-TRACK.
- ② DEMONSTRATE 3348 AS A CREATIVE TOOL (NOT JUST A RECORDER).
- ③ POSITION 3348 AS PREFERRED ALTERNATIVE TO 32 TRACK RECORDERS.
- ④ REINFORCE SONY POSITION AS MARKET LEADER.
- ⑤ EMPHASISE COMPATIBILITY WITH OTHER DASH DEVICES.

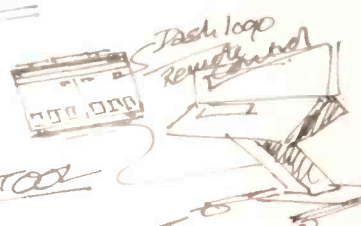

PCM 3348

- * 48 track digital audio
- * DASH format
- * Most sophisticated on market
- * The only 48 track production model.
- * Market: AUDIO RECORDING STUDIOS (SONY is the major supplier of Digital recorders)

KEY FEATURES

- * Outstanding high-speed transport system (mechanical clutch between capstan motor)
- * Digital 'ping pong' (u)
- * Sound memory (u)

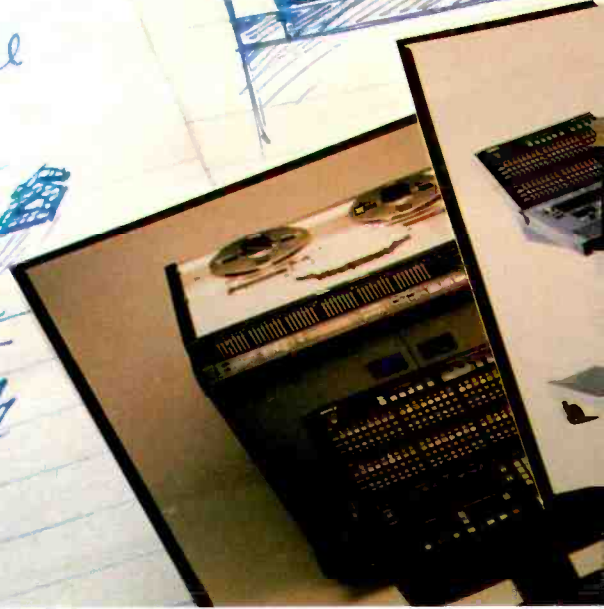
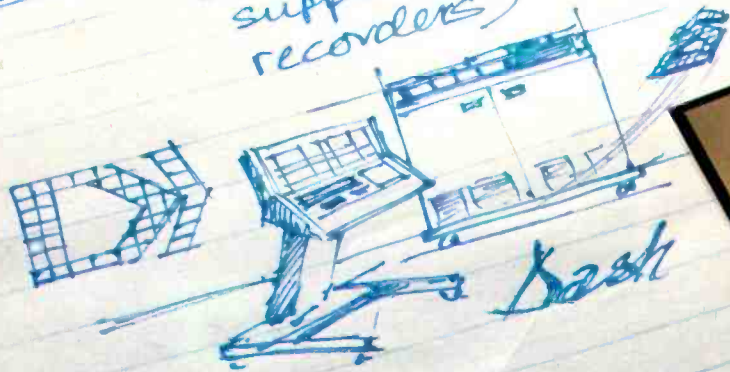

SONY

For further information contact:
 Athens 2818273 Basingstoke, UK 0256 474011 Brussels 7241711 Cologne 59660 Copenhagen 995100 Dubai 04-373472
 Helsinki 50291 Jeddah 6440837 Lisbon 573046 Madrid 7290988 Milan 02 6128221 Netherlands 02968 81215 Oslo 303530
 Paris 49454000 Rome 06 5920139 Stockholm 7736100 Vienna 61051 Zurich 7333311 Eastern Europe - Vienna 554606
 Middle East - Geneva 336350 Africa - UK 0256 55011 Headquarters - Basingstoke, UK 0256 55011

DASH WORLD

SH climbs

of 'DASH WORLD' confirmed that...
had sourced most...

SONY
PCM 3348

RECORDER OUTSELL OTHER MAJOR
WAYS BY 3 TO 1.
48 HAS MORE FEATURES, FASTER, BETTER SANG
PERFORMANCE, MORE TRACKS THAN COMPETITION.
UNRIVALLED REPRESENTATION IN PRO AUDIO (& VIDEO)

SONY DEDICATED TO PRO AUDIO
SONY COMMITTED TO DASH (LONG TERM)

AESTHETICS: 3348 IS & LOOKS THE BEST.

RESPOND FOR DEMO

IMPORTANT

USER BENEFITS

1. Faster throughput
2. Full compatibility with other 24/48 track machines.
3. Creative tool for innovative engineers.
4. Revenue earning investment.

ape
single
caption
... to SONY)
...s.

348



Digital Audio Products
PCM-3348 Digital Audio Recorder
Multi-channel Recorder



TRUTH...

OR
CONSEQUENCES.

If you haven't heard JBL's new generation of Studio Monitors, you haven't heard the "truth" about your sound.

TRUTH: A lot of monitors "color" their sound. They don't deliver truly flat response. Their technology is full of compromises. Their components are from a variety of sources, and not designed to precisely integrate with each other.

CONSEQUENCES: Bad mixes. Re-mixes. Having to "trash" an entire session. Or worst of all, no mixes because clients simply don't come back.

TRUTH: JBL eliminates these consequences by achieving a new "truth" in sound: JBL's remarkable new 4400 Series. The design, size, and materials have been specifically tailored to each monitor's function. For example, the 2-way 4406 6" Monitor is ideally designed for console or close-in listening. While the 2-way 8" 4408 is ideal for broadcast applications. The 3-way 10" 4410 Monitor captures maximum spatial detail at greater listening distances. And the 3-way 12" 4412 Monitor is mounted with a tight-cluster arrangement for close-in monitoring.

CONSEQUENCES: "Universal" monitors, those not specifically designed for a precise application or environment, invariably compromise technology, with inferior sound the result.

TRUTH: JBL's 4400 Series Studio Monitors achieve a new "truth" in sound with

an extended high frequency response that remains effortlessly smooth through the critical 3,000 to 20,000 Hz range. And even extends beyond audibility to 27 kHz, reducing phase shift within the audible band for a more open and natural sound. The 4400 Series' incomparable high end clarity is the result of JBL's use of pure titanium for its unique ribbed-dome tweeter and diamond surround, capable of withstanding forces surpassing a phenomenal 1000 G's.

CONSEQUENCES: When pushed hard, most tweeters simply fail. Transient detail blurs, and the material itself deforms and breaks down. Other materials can't take the stress, and crack under pressure.

TRUTH: The Frequency Dividing Network in each 4400 Series monitor allows optimum transitions between drivers in both amplitude and phase. The precisely calibrated reference controls let you adjust for personal preferences, room variations, and specific equalization.

CONSEQUENCES: When the interaction between drivers is not carefully orchestrated, the results can be edgy, indistinctive, or simply "false" sound.

TRUTH: All 4400 Studio Monitors feature JBL's exclusive Symmetrical Field Geometry magnetic structure, which dramatically reduces second harmonic

distortion, and is key in producing the 4400's deep, powerful, clean bass.

CONSEQUENCES: Conventional magnetic structures utilize non-symmetrical magnetic fields, which add significantly to distortion due to a nonlinear pull on the voice coil.

TRUTH: 4400 Series monitors also feature special low diffraction grill frame designs, which reduce time delay distortion. Extra-large voice coils and ultrarigid cast frames result in both mechanical and thermal stability under heavy professional use.

CONSEQUENCES: For reasons of economics, monitors will often use stamped rather than cast frames, resulting in both mechanical distortion and power compression.

TRUTH: The JBL 4400 Studio Monitor Series captures the full dynamic range, extended high frequency, and precise character of your sound as no other monitors in the business. Experience the 4400 Series Studio Monitors at your JBL dealer's today.

CONSEQUENCES: You'll never know the "truth" until you do.



JBL Professional
8500 Balboa Boulevard
Northridge, CA 91329

Treatment e	ROCKFLEX RYCOTE SENNHEISER SHAPE	Leads LED Bargraph Mains Cable	Acoustic Treatment Acoustifile Aerosols AGFA AKG ALESIS AMPEX Audio Oscillators Bantam Plugs BASF BEYER Blanking Panels Boom Arms BRADY BSS Bulk Erasers Cables Cable Drums Cable Markers Cable Ties Cage Nuts CALREC Cassettes Cassette Deck Cassette Label C.D. Players Chinographs Compressors CONNECTOR DAT DBX De-gaussers DENON D.I.Boxes DRAWMFL EDAC EDITALL Effects Un Editing B ELECTRO Empty S Fishpole F.M.Tun FOSTER Gaffer Tape Goosenecks G.W.INSTRUMENTS Headphones Headphone Amp Headphone Splitter Headsets	ROCKFLEX RYCOTE RYCOTE	Leads LED Bargraph Mains Cable
----------------	---	--------------------------------------	---	------------------------------	--------------------------------------

Chrome & Ferric Mastering Cassettes
 BASF tape in Swiss ICM bodies. C5-C90.5 We supply over 250,000 a year at easily the UK's lowest prices Library case included.

Acoustifiles
 The UK's most popular acoustic tile.

NEWS UPDATE
 50 thousand customers cant be wrong.
 Mr D K Pritchard of Truro is our 50,000th customer. His order for cassettes included our complimentary magnum of champagne
 The 1990 catalogue is out, 68 pages of equipment, wiring, connectors, mics, cassettes, tape, acoustic treatment accessories etc.
 Incoming orders processed immediately for same day or next day delivery.
 Practically every major studio has an account at Studiospares. Do you ?

Tascam DA30 DAT Recorder. Designed specifically for the studio at under £1200.

WE DIDN'T REACH NO. 1 BY BEING OUT OF STOCK OR EXPENSIVE

D.I.Boxes DRAWMFL EDAC EDITALL Effects Units Editing Blades ELECTRO Empty Spools Fishpoles F.M.Tuners Gaffer Tape Goosenecks G.W.INSTRUMENTS Headphones Headphone Amp	VIDEO CABLE WEBBER Wireless Mics YAMAHA Acoustic Treatment Acoustic Tiles ALESIS AMPEX Audio Oscillators Bantam Plugs BASF	MIXERS NEUMANN NEURON Noise Gates Noise Reduction Oscillators Oscillator Oxygen Free Cable Patch Leads	D.I.Boxes DRAWMFL EDAC EDITALL Effects Units Editing Blades ELECTRO Empty Spools Fishpoles F.M.Tuners Gaffer Tape Goosenecks G.W.INSTRUMENTS Headphones Headphone Amp	VIDEO CABLE WEBBER WHARFEDALE Wireless Mics YAMAHA Acoustic Treatment Acoustic Tiles ALESIS AMPEX Audio Oscillators Bantam Plugs BASF
---	--	--	---	--

Save time-phone

Studiospares

61/63 Rochester Place, London NW1 9JU
 tel 071-482 1692 FAX 071-485 4168

first

Please send free 68 page catalogue
 Please send account application form
 NAME
 ADDRESS

FOCUSRITE TRACKED

Patrick Stapley visits Focusrite and discusses the design of their new Studio Console

Focusrite's new console on first appearances looks very similar to the old—with its vivid colour scheme, curved bays and castellated penthouse—however, it is soon obvious that the new company have been busy and the *Focusrite Studio Console* is very different to the *Forte* console.

When Phil Dudderidge took over the company in April last year, the first 6 months were taken up as a market research and fermentation period. Through exhaustive research the company built up an accurate idea of how potential clients worked and what they were looking for in a console, in terms of facilities and cost. Why wasn't it just a simple matter of continuing production of the original console that went to *Master Rock* in the UK and *Electric Lady* in the US? Focusrite's development director, Richard Salter explains:

"When the assets of the company were acquired we obviously looked seriously at the commercial viability of producing the console as it had been designed. It very quickly became obvious that we would have to re-engineer the logic if we were to produce the console at a realistic price. The principal reason for the company's original failure was attributed to a cash shortage due to development delays and the principal delay cited by Rupert Neve was the design of the logic and its architectural structure within the console, which was messy and, by Rupert's own admission, way outside his area of previous experience. We costed the true commercial price to manufacture the console as it stood doing it Rupert's way, and were astonished to find it in the region of £350,000 to £400,000. We then went and talked to a large number of studios and came to the very firm conclusion that there was not a market sufficiently large for that sort of console, at that kind of price, at the present time—it simply did not exist. The reason that there had been apparent interest in the console while the old company was trading was that the price was not sufficient to justify its commercial production."

A fundamental philosophy of the new company was that no changes should be made that could degrade the quality or performance of the audio circuitry, which by any standards is exemplary, and the philosophy of good old fashioned engineering is still very much adhered to.

Through researching the ways engineers were using the big in-line consoles, it soon became clear that in the majority of cases the second signal path in the module was being grossly under-used. In-line consoles were in effect being set up in a split configuration and the secondary signal path was only being used once all the primary paths had been filled. This prompted the idea that the 'all singing all dancing' I/O module was not the way to proceed and perhaps the industry could do with something simpler.

"We started off by looking at the things we had inherited that were of clear value and the first thing was the *ISA 110* module with its amazing performance both in terms of EQ and amplification. Perhaps we should try structuring a console beginning with the *110* module as it stood, try and mimic the best of a split console but allowing the logic to provide the kind of flexibility people are used to on in-line consoles. We came up with what in an architectural sense is a cross between the two in terms of block layout and switching functions. All the channels are the same right across the board and have the ability to function as either an input or a monitor channel. They are grouped in bays of eight and each bay is logically one function—either an input bay or a monitor bay, in the traditional split

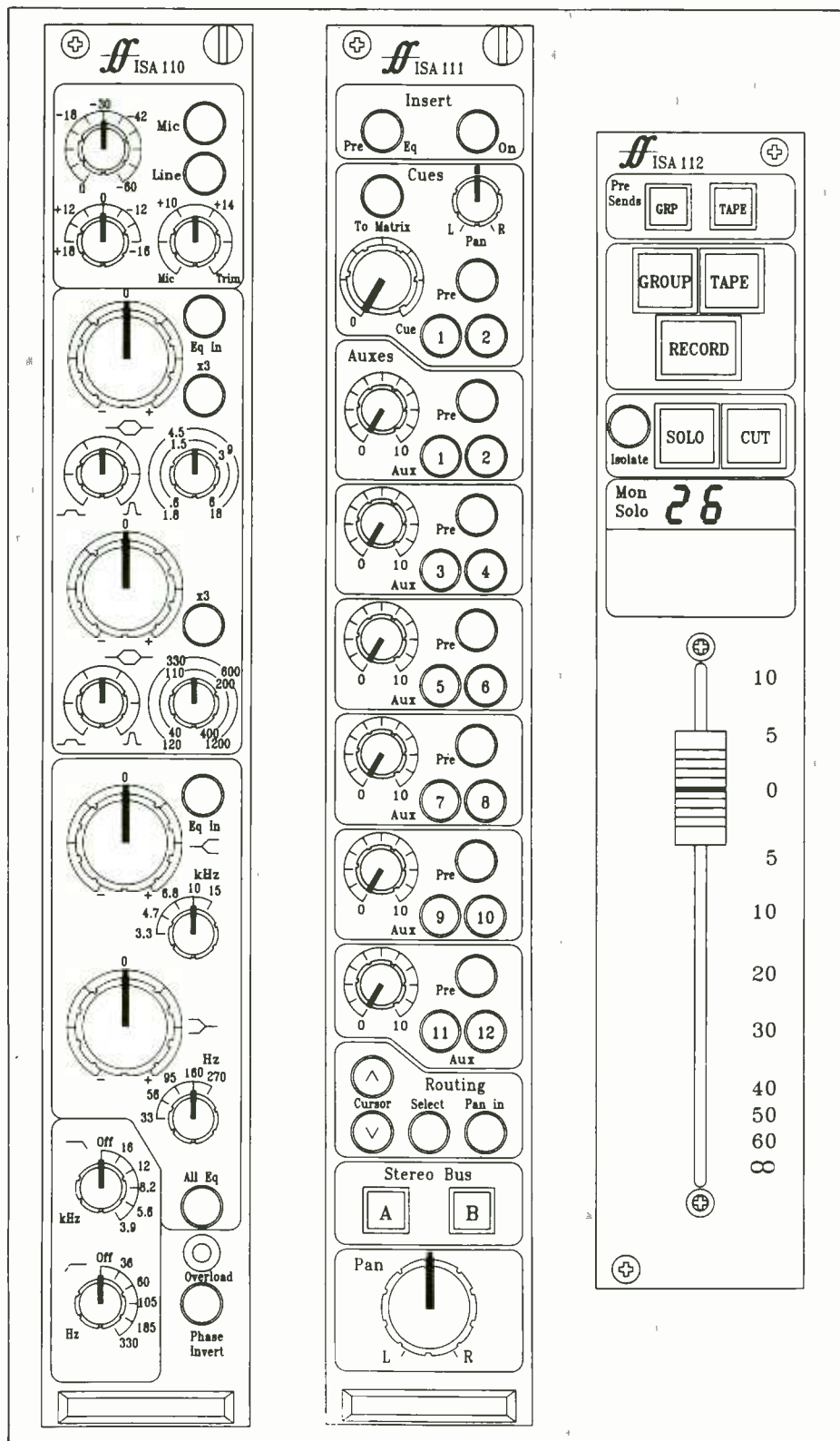

The ISA 110, ISA 111 and ISA 112 channel modules



Shure Field Products, get you on the spot.

Wherever your job takes you, and whatever your special demands, Shure have a range of FP amps and mixers to get you out of trouble. Built specifically for ENG, EFP, film and video work, Shure FP products have built-in ruggedness and reliability which won't fail, in any predicament.



FP32

For Stereo Remotes

The FP32 Stereo Mixer is comparable in size and features to our famous FP31. Its stereo capability, light weight, easy-to-use controls and convenient shoulder harness make it the first choice of field crews. Our FP42 Stereo Mixer simplifies mic cueing, so important in situations like sports remotes. Plus it enables you to easily mix down stereo in



FP42

your post production booth. It offers all the features of the popular M267 plus stereo capability and a stereo headphone amp.

The Industry Standards

The FP31 is Shure's original field production mixer. Thousands bet their audio on it worldwide. The FP16, a one-by-six distribution amp with transformer balancing and link jacks, outperforms all competition. It's also ideal as a portable press bridge.



FP31

For Long Yardage Situations

The FP11 Mic-to-Line Amp provides freedom from noise in long line situations, with up to 84 dB of gain in 15 6-dB steps. It converts any mic to line level and includes an invaluable limiter circuit. The FP12 Headphone Bridging Amp is a must for shotgun and boom operators. It keeps them on target without need for a return line.



FP11



FP12

It's ideal for multiple headphone feeds, troubleshooting, and as an intercom.

SHURE

For Further Information Contact: HW International, 3/5 Eden Grove, London N7 8EQ. Tel: 071-607 2717.

view. Thus the desk can be configured to suit the user moving bays from place to place logically, allowing enormous flexibility."

The channel strip comprises three modules and a routing indicator, apart from the *ISA 110* module there is the *ISA 111* cue, aux, routing and pan module, and the *ISA 112* fader and status module. The auxiliaries have been simplified to offer two buses per send by pushbutton selection, giving a total of 12 mono sends and two stereo cues. The routing is still cursor controlled but now offers a maximum of 48 groups rather than 32, plus two monitor buses. The familiar GROUP, TAPE and RECORD buttons are part of the *112* module but a new feature is the inclusion of two smaller GROUP and TAPE buttons that control the pre-send feed, which has been designed to separate the headphone mix from the monitor mix. Displays within the channel indicate whether it is acting as an input or a monitor and show the channel number, which will change depending on how the bays have been assigned. The audio circuits from the mic input through to the mix bus are identical to the equivalent stages in the original console, although they should perform slightly better as each module is now separately screened with a steel cover. A change has been made, though, to the routing electronics.

"In the early days of the new company we spent a lot of time examining the technical performance of the *Forte*, and we were quite surprised to discover that FETs had been used in the mix bus structure. We went back to the people involved in the design and discovered that the choice of FETs had been one of economics and space, and that there was in fact an original design that specified relays. All the other switching throughout the console is by relay, so we repeated the topology of the *Forte* circuit using relays rather than FETs with the effect of further improving the already impressive noise figures."

The front-to-back depth of the original console is vast, making for an awkward stretch to the furthest controls. This has now been reduced by making the buffer shallower, by the overall simplification of the channel strip, due to the absence of a secondary signal path and by the removal of the dynamics section.

Why had the dynamics section been left off?

"Two major reasons—firstly, it appears that most people don't use built-in compressors and limiters very much, they tend to use gates more just to tidy up extraneous noise, so there didn't seem a great deal of point providing a comprehensive dynamics section on each channel. Secondly, the cost would have considerably bumped up the total price of the desk, so we decided it was preferable to provide insert switching to a bank of optional dynamics modules, sited either in the master bay of the desk or rackmounted."

Switching throughout the console is soft, and every switch has its unique function, never doubling up with other switches to produce a secondary function. Master switching is extremely comprehensive, providing the Input/Monitor switching for individual bays as well as master switching for individual functions in selected bays—so for example operations like switching all the cues on the input bays off, or switching in the EQ for a particular monitor bay, or clearing down the routing, can be done by simply pressing a few MASTER buttons, although care has been taken to ensure that accidents don't occur by building in a SET button, which makes the Master Switching active for just 3 seconds—important when one considers that the entire console can be reset by the INITIALIZE button. Other master controls are,

Master status (REC, O'DUB, MIX), global control of Group/Tape status, including separate control over the pre-send feeds, and masters for the input and monitor solo paths with four types of solo for each including the Focusrite 'Up Front' system, where a user determined proportion of the mix signal is mixed into the AFL path.

An impressive selection of talkback and listen facilities are provided in the communications module, along with two source matrices for CANS 1 and CANS 2. A nice touch has been built into the

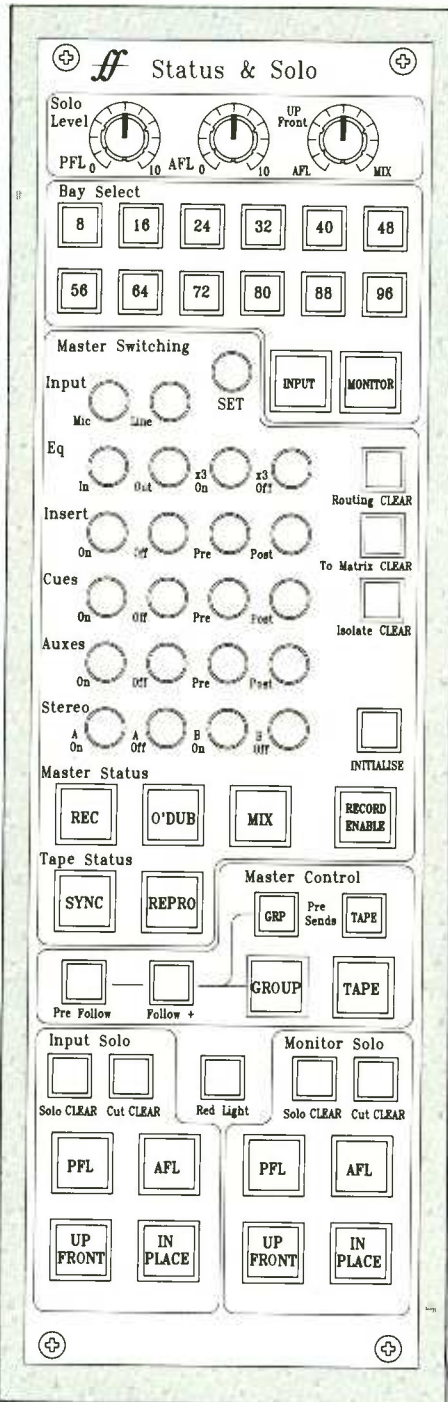

Status and solo module

talkback buttons, making them operate as momentary switches with a prolonged push, but as latching switches with a short hit.

Three sets of monitors are catered for—main, middle and mini—and each has a level and dim control pre the main gain pot to guard against level jumps or dips. The traditional arrangement of separate internal and external source selectors has been abandoned in favour of a combined

panel, which apart from feeding the control room monitors also supplies the SLS and ELS circuits.

The two stereo buses, A and B, can be summed to the other or to the final bus F providing mix subgroups, or can be used as two discrete outputs. The 48 group trims are also sited in the master bay of the console along with the cue and aux masters.

Options that can be added to the master bay include a range of Focusrite mono or stereo signal processors, rev return modules and tape remote panels. Another option that has just recently become available is the factory installation of GML automation.

"We considered developing our own automation system but it seemed a bit like re-inventing the wheel and quite honestly the last thing people need at the moment is yet another automation system. GML have a very similar philosophy to their product as we do to ours and the two complement each other extremely well. We will also be working with GML on further developments to enhance the console automation system."

The curved shape of the console is certainly one of the features that make it visually interesting and very individual but it also has the operational advantage of helping to avoid parallax, and the acoustic advantage of creating a more diffuse surface than a conventionally shaped desk. Salter described how the construction has changed.

"A curved console is a nightmare for the draughtsman and the original desk was a curved console on a straight leg frame, which is very difficult to interface. Interlinking between bays, although mechanically sound, was very difficult and costly to implement, so we made a decision early on to build curved legs to match the top. We also decided to structure the bays so they were completely independent units, which could be built in a production line of bays—all connections between bays are via umbilicals at the back; it's not loomed together in the traditional sense, it's all connectorised. Because of this arrangement the console can be transported in sections making it extremely easy to install and, of course, re-install."

Although the Focusrite console has undergone radical changes since its takeover, the original philosophies still remain firmly intact.

"Pervading are two overriding features apart from the performance of the audio. Firstly, the standard of engineering: we never use PC mounted pots, etc—hand wiring costs more and takes longer but it's much more reliable. Secondly, we over-engineer wherever it makes sense, irrespective of whether we're designing a power supply or a console leg.

"If you look back to the days when in-line consoles were rare, the audio quality was the paramount concern of just about every manufacturer. The days of the early automated consoles seemed to bring about a change and we suddenly started seeing a lot of switch elements in the signal paths, with the result that the audio quality suffered. Of course, the ergonomics and slickness of use improved rapidly but the quality of the audio no longer seemed to be the main parameter. This, I think, has been the case for a long time. What the old company started and we're continuing is to say that all these facilities can be offered without degrading the audio—OK it costs a bit more and needs a bit of care but the end result is crystal clear audio."

Future plans are indeed positive: by the autumn Focusrite intend to be producing one desk each month. □

INCOMPARABLE PERFORMANCE.
CONSISTENTLY ACHIEVED.



In the 43 years Crown has been creating amplifiers, we have also created the industry standards for sound amplification. In doing so, we have captured the imaginations of thousands of performers, contractors, engineers, dealers – even other amplifier manufacturers – across the country and around the world.

A recent survey by *Sound & Video Contractor* identified Crown as the world's leading name in amplifiers. With this in mind, we might have rested on our laurels. But we haven't. Because Crown's standards of

excellence demand constant evaluation. And ongoing, systematic evolution. Evolution which has resulted in patented technologies that protect our amplifiers from damage. That keep distortion to the absolute minimum. And that eliminates obsolescence. Together, these are advantages no other amplifier possesses.

Add to this a transferable three year no-fault warranty... a warranty which can be extended to a full six years... and, comparing apples to apples, there simply is no comparison.

Of course, to some, the ongoing evolution of Crown amplifiers – already the best available – seems unnecessary. But judging by the growing number of people who recognize Crown as the leader – those who use Crown amplifiers and those whose goal is someday to be able to – this ongoing evolution, in large part, means incomparable performance. Consistently achieved.

For more information and detailed specifications on our amplifier line, pick up our literature at the Crown dealer nearest you. Or call Crown direct at 1-800-535-6289.

GUARANTEED EXCELLENCE



crown®

Made in America

Exported as Amcron

Anyone who has visited the *Royal Britain* exhibition at the Barbican, London (*Studio Sound*, December 1988), or seen the striking lighting of the nearby Lloyd's Building, or witnessed the spectacular illumination of the British Telecom Tower in May when the London telephone codes changed, has experienced work of Imagination.

The company began in 1978 with a staff of 15 handling exhibition and conference work from offices in London's Covent Garden. Major expansion followed a long term contract to handle product launches, motor shows and dealer relations presentations for the Ford Motor Company. It was about this time that Julian Scott came to Imagination. He had been a technical operator in BBC London Control Room, the main sound switching centre at Broadcasting House, beginning his career with 3 months training at the BBC Evesham engineering school. The following 3 years were spent working on balance and control in the network continuity suites, effectively on-air studios for Radio 1, 2, 3 and 4. Then, with a colleague, Neil Espley, he set up a company covering location recording and freelance studio work. Having delivered a hi-fi system to Imagination's founder and creative director Gary Withers, Scott was shown an audio-visual presentation on Imagination's work.

He felt he could improve the music track and did so. This led to more work for Imagination, typically using pop tracks where other people were still using library mood music.

Eventually Scott and Espley set up in-house facilities in the basement at Imagination with a Studer A80 8-track, an A80 2-track and two B67's, a full set of Dolby A, AKG BX15 spring reverb and a Raindirk Series 3 (18/16) console in a room about 14x7 ft (4x2 m). Most of the work here was compiling pre-recorded music, creating special effects and adding voices, radio style. Mics could be set up in the A/V programming room, which had minimal acoustic treatment or a 'broom closet' treated as a voice booth. "We put some baffle boxes in and we actually got a very acceptable voice sound in there. You'd never know it was recorded in a box," Julian Scott recalls.

A major Ford presentation at the Barbican Centre began with a live 60-piece orchestra playing to a clicktrack in sync with a visual presentation. Then came a ride through an exhibition in the car park on a miniature railway with an ITC cart machine in each vehicle, which automatically replayed a description of the exhibits it was passing. Every part of the exhibition had its own static sound system providing music and effects—a total of 168 channels of sound. One piece of music was played from 8-track so several exhibits shared the same theme and rhythm track but with different instrumentation for each part of the display.

In 1984 Imagination moved to larger premises nearby with more space for A/V programming, off-line video editing and sound recording studios.

The existing voiceover studio with its Raindirk desk was given proper space and about £200,000 was available for design, construction and equipment of a multitrack music studio. "We decided to blow nearly all the money on buying a desk because it's the most difficult thing to change." Neve was a promising contender but the decision went for SSL. Imagination ordered an SL 6000 E series post-production console just before SSL became a buzzword and flavour of the decade. "We prided ourselves on being the only 8-track SSL studio in the country because we hadn't been able to afford the 24-track."

Acoustic design by David Hawkins of Eastlake Audio was co-ordinated with the overall Imagination image by designer Tom Law.

At APRS '86 Dolby demonstrated *Spectral Recording* and Imagination ordered one of the first 24-track SR units to go with a brand new Studer A800 MkIII. There were a few teething troubles but Dolby soon got them sorted out.

"At that point we really changed from using pre-recorded music and started thinking about commissioning our own. Our budgets were getting bigger and bigger, which made an enormous difference, and within 3 years we were recording lots of music."

The company was still growing, 1985 had brought a major long term contract with British Telecom and 1987 one with truck makers Iveco Ford. By 1988 there were 160 staff handling a turnover of around £40 million and it was time to move again.

Old school

Imagination acquired a former Edwardian school in London's Bloomsbury area. After considerable structural work the building was occupied in late August 1989. 70,000 ft² (6,500 m²) of space is in two blocks separated by an open courtyard. The front block is six storeys and the rear block, with five storeys, used to have a playground on its flat roof.

Architect Ron Herron enclosed the courtyard with a tent-like fabric roof to create a tall central atrium. The roof extends over the former playground, which now has glazed walls to become a bright roof gallery for exhibitions and presentations. The whole building is very attractive.

In the basement are a gymnasium, two A/V programming suites, photographic studio, model shop (many large projects are first modelled and photographed for client approval), video off-line edit suite and two sound studios.

Once again studio installation was by Eastlake Audio with acoustic design by David Hawkins, the interior design again being integrated with the Imagination style for the rest of the building.

The proximity of Tottenham Court Road, which has heavy

IMAGINATION

UK design and communication company Imagination have had substantial in-house studios for several years but only last year began to offer them to outside clients. Tim Leigh Smith reports



The main control room with Harrison Series Ten desk

Sound sense

The 4104b microphone



The workhorse of the outside broadcast world. BBC designed and recommended and used throughout the world for all broadcasts where there is a high degree of background noise. Even in a video editing suite for voice overs the 4104b is unsurpassed.

Bi-directional 60 HZ to 12,000 HZ F.R.
300Ω - 70db ref. IV, +12db 8PL SPL

Rispoli
LTD

Sole distributors
Rispoli Ltd
The Paddocks
Frith Lane
Mill Hill, London N.W.7.
Tel: 01-346 9271
Fax: 01-346 3932

The GOLD BOOK

4 Published Jan 1st 1991

Tel: +44 81 686 2599

Fax: +44 81 760 5154

THE DEFINITIVE GUIDE FOR
MASTERING PRESSING &
DUPLICATION:

CALL

CHRIS BAILLIE

FOR ADVERTISING INFORMATION

ONE to ONE

THE INTERNATIONAL MAGAZINE FOR MASTERING, PRESSING & DUPLICATION

EASTLAKE AUDIO

The standard of studio excellence in
thirty countries
worldwide

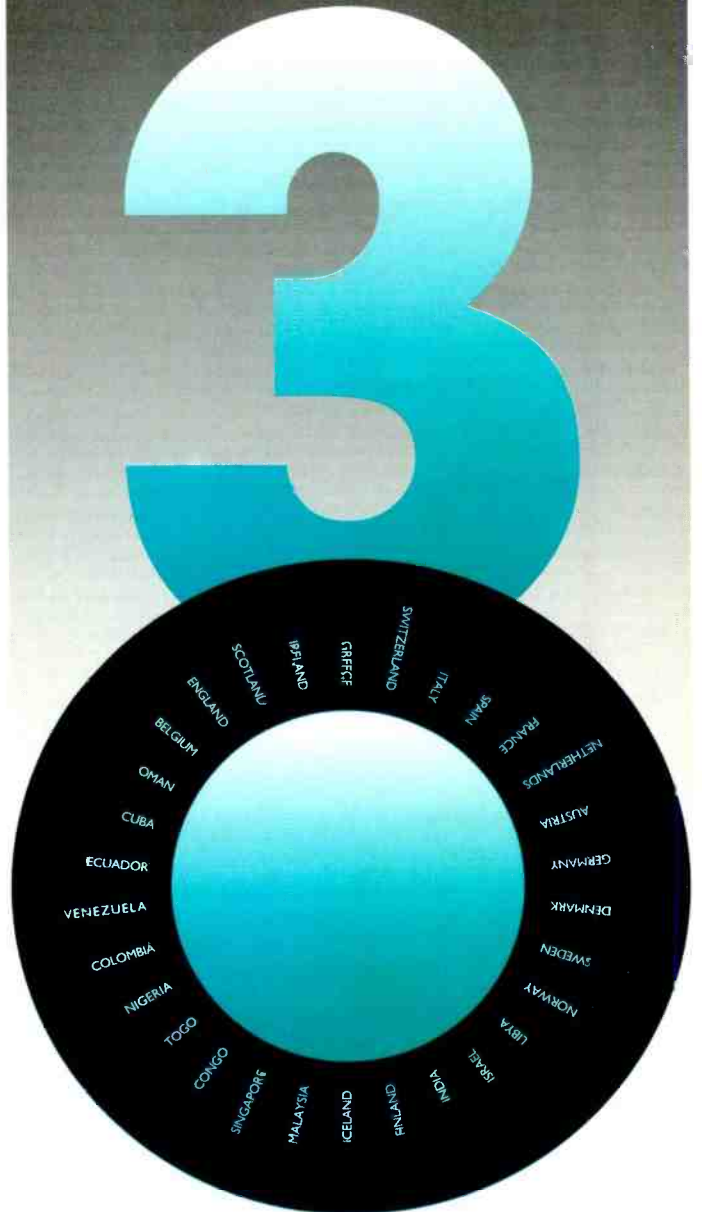

Eastlake Audio (UK) Limited
Unit 2, 10 William Road
London NW1 3EN
Telephone: 071-262 3198
Fax: 071-706 1918
Telex: 94012979 EL UK G



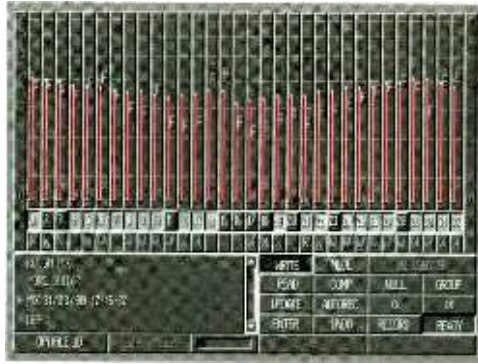

FOR PROFESSIONAL CONSOLE AUTOMATION
OPT FOR

OPTIFILE

(over 200 others have)

Optifile 3D is a pro smpte system that can easily be fitted to any mixing console. It is very user friendly: ask Marcus Studios, Steve Levine or Dave Gilmour and of course it's competitively priced. Call the Home Service or your local dealer for more information.

- Smpte driven.
- Over 200 existing Optifile users.
- THE standard for desk manufacturers.
- Very user friendly with full colour graphics
- For music, A/V, broadcast & theatre.
- Uses existing faders and mutes



MANUFACTURED BY AD SYSTEMS. INTERNATIONAL REPRESENTATION: THE HOME SERVICE
Unit 2, 10 William Road, London NW1 3EN. Tel: 071 388 1820. Fax: 071 388 0339



D E A I L E R S W O R L D W I D E :
 Australia : Greater Union Village Technology - (02) 550 54 88 • Belgium : FMI - (011) 41 52 78
 France : AD Système - (1) 42 53 31 18 • Hong Kong : Audio Consultants Co Ltd - (852) 351 36 28
 Italy : Audio Palombi - (02) 254 07 21 • Malaysia : Meteor Sound & Lighting Systems - (03) 291 65 59
 Norway : Audiotron A/S - (02) 35 20 96 • Switzerland : Decibel SA - 021/921 75 93
 Sweden : Soundtrade AB - (08) 730 04 00 • Spain : Rafael Campos Royo - (03) 675 50 11
 Singapore: Swee Lee Co. - 336 78 86 • UK : Studio Timeline - 081 994 44 33
 Venezuela : Acoustilab - (02) 987 48 45 • W.Germany : Mega Audio - (067) 21 26 36

traffic above and Northern Line tube trains below, required good isolation so each room is a floating box. Eastlake had recently done work at CBS Studios, also close to Tottenham Court Road, but Imagination was subject to much higher levels of impact noise as heavily laden rush-hour trains rattled over older rail joints below.

A conventional floating floor using a concrete mass on mineral fibre mounts is effective against middle frequency vibration but less so at lower frequencies. Rubber mounts are effective down to 100 Hz and below that spring mounts are needed. The Northern Line noise was centred around 42 Hz so the Imagination studios are mounted on springs.

The floor springs support a steel framework made of 75x50 mm box section, which is loaded with two layers of concrete paving slabs with staggered joints and covered by tongue-and-groove chipboard. Paving slabs are much easier to remove than reinforced concrete if the studio is redeveloped in the future. The stud partition walls are mounted on springs, which also have to take the weight of the ceiling and the slight gap between floor and walls is plugged with rubber.

"The building moves, the movement is lost in the springs, the walls and the floor effectively stay still so there is absolutely no penetration anymore of 42 Hz vibration," Dave Hawkins reports. The effectiveness of a floating floor is determined by a combination of the size of air gap below and the mass above. The trick is keeping both to a minimum where there is limited headroom.

Studio time was always charged to in-house projects but with the new facilities it was felt that outside work could also be accommodated. The main difference being that for in-house sessions the studio books the artists whereas with outside artists it is the other way round. Larry Bartlett joined Imagination as studio manager to handle both aspects. His career began at Pye Recording Studios as a trainee tape op and he worked his way up to chief recording engineer. For 2 years he worked as writer/producer/artist with ATV Music. He spent 8 years at Marquee Studios as studio manager and a couple of years as a freelance engineer, including work on live television for ITN, before joining Imagination.

"With the expertise that Julian and I have, we can cover the whole spectrum," says Bartlett. Likewise the two studios can handle anything from speech for radio to a sizable orchestra for multitrack music to picture. There are literally thousands of short sessions for Imagination each year but bookings are taken on a first come, first served basis whether in-house or external.

"Obviously short term outside work is easier to handle. Because of the commitment to Imagination taking a 3 week block booking has to be carefully planned, balancing one against the other." So Imagination has been doing theme music for TV shows and a lot of jingle sessions for the likes of McDonald's. This is an area Bartlett got to know well in the '80s. "In the punk era when the bottom just fell out of the recording studio industry we kept Marquee going on the jingle work."

Both Scott and Bartlett produce in-house sessions, sometimes engineering for each other. Scott has also composed and arranged music for several Imagination projects with the aid of an Atari computer running C-Lab *Notator* software. A theme played on a musical keyboard appears on screen on staves. Up to 32 parts can be scored and printed out for real live musicians to perform. The system also provides a MIDI controlled click or guide track.

Room for Imagination

The larger studio is 710 ft² (66 m²) with a bare wooden floor and a live acoustic. It has a Yamaha grand piano (well liked by users) and has been known to accommodate 27 string players in comfort. The smaller studio is 345 ft² (32 m²) and fully carpeted with a well padded narrator's table. It's designed mainly for speech but can take up to 10 musicians. Mics are the usual range, mainly condensers: AKG C414, C451 and C460 with CK1 and CK8 (shotgun) capsules, Calrec 1050, Neumann U89 and TLM170i ("a lovely microphone"); plus AKG D224 and Beyer M201 dynamics.

Wall panels provide 30 mic lines, 15 tie lines, three foldback, one playback and three video feeds in each studio and the air



lock entrance lobby to the main studio has a couple of mic lines for use as a separation booth. Either or both of the studios can work to either control room with video and headphone feeds changing on a single switch. A massive load-bearing wall between the studios contributes towards better than 80 dB separation although triple-glazed windows provide visual contact.

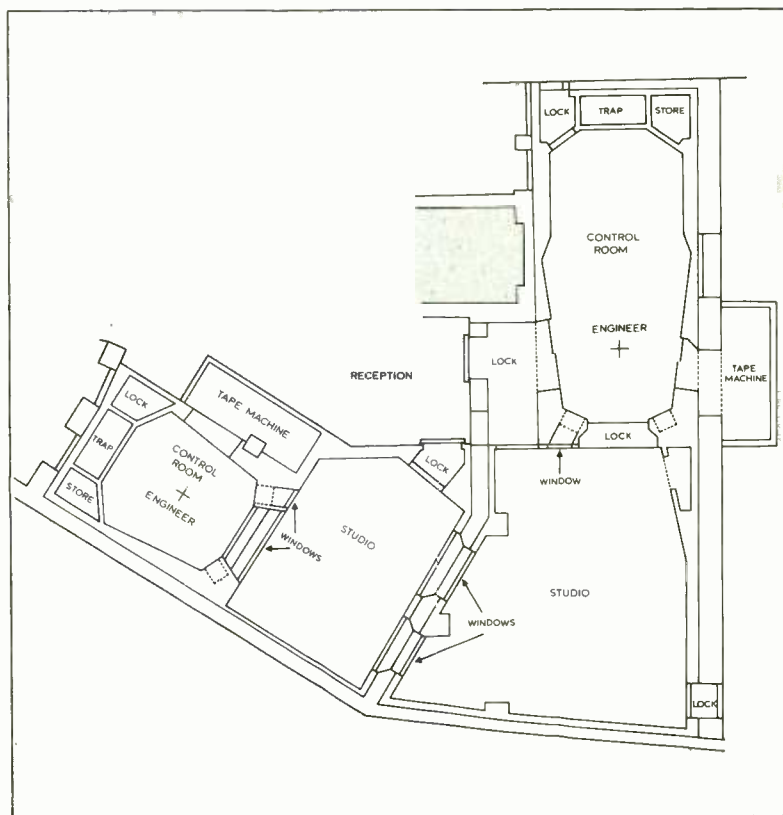



The smaller control room is 366 ft² (34 m²) and has a double patio door air lock through to the smaller studio with the doors on the studio side leaning into the room at an angle to minimise reflexion for the dead acoustic. Main monitors on either side of these doors are the Rogers version of the BBC designed *LS5/8* and nearfield monitors are *LS3/5A*. The console is the *SSL SL 6000 E* desk from the previous studio with 24 mono and eight stereo channels and eight VCA groups.

At present this area is used mainly for compilation of recorded material. There is a trolley fitted with two Studer *A725* CD players and two *A710* cassette machines plus space for outboard equipment. To the left of the console is a machine room enclosed by patio doors, which houses *Dolby SR*, a couple of 2-track Studer *B67* and the trusty 8-track *A80*. A 24-track purchase is planned, not only for music but also for preparing 4-, 6- or 8-channel audio presentations and for video presentations that may have eight different language versions.

The larger control room is 680 ft² (63 m²), roughly three times as long as it is wide, with a double patio door air lock through to the larger studio. Above is a screen which lets down for pictures from a ceiling-mounted *Sony 900* high resolution video projector. On either side is a Rogers *Studio Monitor* with twin bass drivers, 12 in mid-range and soft-dome tweeter. Nearfield monitors are Rogers *LS3/5A*.

The console is a Harrison *SeriesTen*, one of the first desks to combine analogue signal paths with digital control. Bartlett was involved in the initial design discussions for the *SeriesTen* while he was at Marquee and one of the first four was installed there in 1986. When the studio closed he arranged to buy the console for Imagination. "It's ideal for the way we work, short term jobs. Because of the total reset on the console our turnaround time is seconds, rather than having to spend hours resetting the desk."

Harrison total dynamic realtime automation covers every function on the desk: equalisation, dynamics, auxiliary sends, inserts, levels, muting, panning, routing and the 'slate' legend on each channel module. Most controls are pushbutton and a

few rotary controls cover several functions so the status of any control can be shown on the slate alphanumeric display. Touch sensitive motorised faders by Penny & Giles allow instant override for level adjustments.

Each channel module is designed for stereo with a choice of three pairs of inputs (A, B and MT) but controls may be assigned to left or right for two separate mono signals. Thus Imagination has a 38-channel desk but 76 sets of inputs with mics on Left A, direct inject on Left B, and tape returns on Right B, leaving three inputs spare. Any channel may be used as a group and there are eight 'Remote' faders that function like 16 VCA groups.

Automation data is held on a Winchester hard disk for save/recall of basic configurations, or a sequence of snapshots for manually cued dynamic changes if there is no timecode available, or full timecode referenced dynamic automation. Long term data storage is on floppy disks.

The *SeriesTen* has distributed intelligence, high speed microprocessors in every channel module, so that saving the present settings and recalling a previous set up is very fast. "While I take a break for lunch, Larry could come in and do a voiceover session or a quick remix or whatever, calling up his

own settings. Sometimes the schedules are such that we have to do that," says Scott. "Imagination has got a reputation for doing huge jobs at very silly short notice."

The Harrison allows total flexibility of track usage. For example an instrument that only makes isolated contributions to the orchestration can be dropped into unused sections on recorded tracks using completely different EQ, dynamics, etc. In mixdown the automation will instantly reset the channel for each instrument. When a complex mix is running the slate legends keep changing as different instruments, effects or voices pop up all over the desk.

Behind the console are trolleys, which form a producer's desk. One of these has outboard gear built into its front panel: *Bel BD-2400* delay, *Klark-Teknik DN60* realtime spectrum analyser, *Lexicon PCM70* digital effects processor, *Yamaha REV7* and a couple of *SPX90s*. Others carry source equipment: two *Sony SL-HF100UB* Betamax and *PCM-501* digital audio processors, two *EMT 948* turntable units, two Studer *A725* CD players and two *A710* cassette machines. Video comes from a *Sony VO-5850* U-matic or on tie lines from the in-house video edit suite. Synthesisers can also be accommodated on top of these trolleys, which include a panel of DI sockets (to console Left B inputs).

Through patio doors to the left of the console is the machine room with 24-track Studer *A800 MkIII* plus 2-track *A820* and *A810*, both with centre-track timecode, and 2-track *A80*. *Dolby XP* series provides 24-track *Dolby SR* and there are six *Dolby 361* units with both A and SR cards. All machines can be locked to a central *Time Line* from an Audio Kinetics *ES 1.11* ESbus synchroniser with *ES Penta* controller and autolocator.

The back of the room is arranged like a video edit suite having a raised dais with audio and video monitors where clients can sit and survey the scene well out of the way. If they want to get further away there is the well-equipped gym in the basement, or *Gary's*, the stylish self-service restaurant which opens onto the covered courtyard. □

Imagination Ltd, 25 Stone Street, South Crescent, London WC1E 7BL, UK. Tel: 071-323 3300.

THE NORTHERN ALTERNATIVE

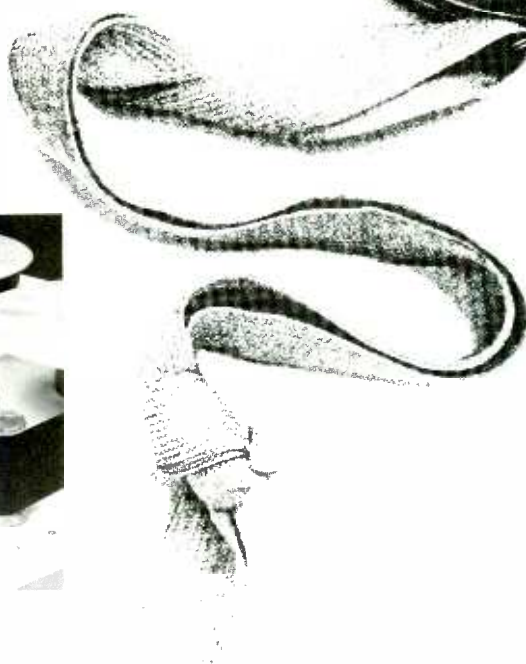
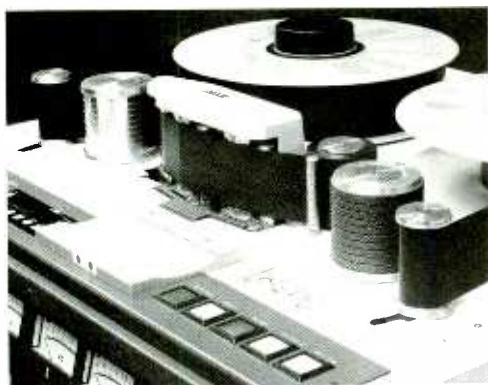
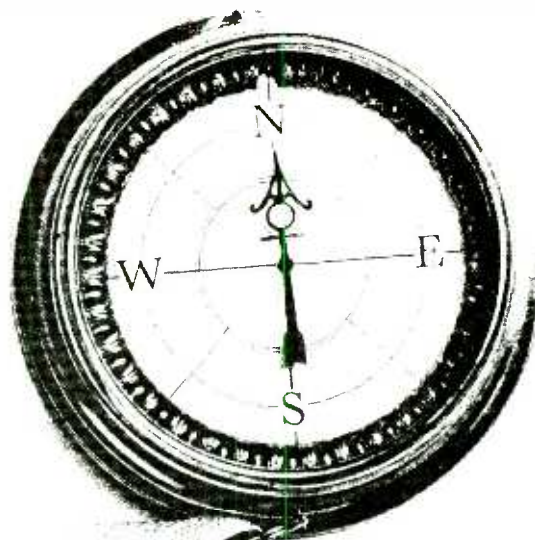

ANALOGUE or DIGITAL?

In a rapidly changing recording environment the choice between analogue or digital isn't easy. Both formats now bear a similar price tag.

However, as the only Northern appointed agent for Otari and Akai digital products we can highlight the advantages of both recording formats in a "side by side" demonstration to make that decision a little easier.

With a manufacturer trained service department and sixteen years experience in professional audio sales we can offer the best in before and after sales service.

Whether you're in the market for a complete studio package or just the latest in signal processing – we'd like to talk to you.

KG M
studio specialists

18/42 Charlotte Street, Wakefield,
West Yorkshire WF1 1UH, England.
Tel: 0924 371766 Telex: 556649
Fax: 0924 290460

WHEN YOU WANT SOMETHING BETTER

D&R's Dayner series offers more inputs in less space than any other console. Up to 56 input modules (112 mix inputs) in less than 1.85 m. Ideal for space limited control rooms and MIDI oriented studios.

Yet despite its compactness, the Dayner is long on features. Split EQ, Floating Subgroup System, 8 aux send busses and digital quality specs are just a few.

Whether you have 8, 16, 24, or 32 tracks and the most elaborate MIDI set up, the Dayner is all the recording mixer you'll need for years to come.

If you prefer the traditional split format, the innovative in-line format or both, your Dayner can be custom configured to fit your particular needs in just minutes.

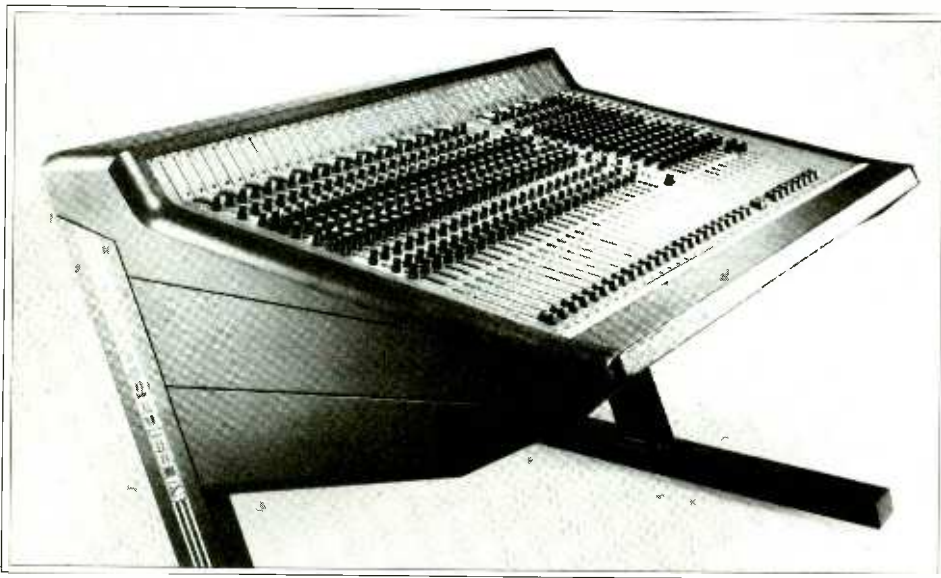

Dayner 42 studio console

D&R Electronica b.v.
rijnkade 15B
1382 GS WEESP
the Netherlands
Phone: --31 2940 18014*
Fax: --31 2940 16987

D&R USA
Montgomery TX 77356
Rt. 3 Box 184-A.
USA
Phone: (409) 588-3411
Fax: (409) 588-3299

Check out the DAYNER

D&R

TOTAL CONTROL

AUSTRALIA, AUDIO&RECORDING, 2019 Sydney, 36-38 Daphne St Botany, Phone: (02) 6669935. **AUSTRIA**, KÜNL & WURZER, A 4020 Linz, Waldeggstrasse 68, Phone: 732668125. **BELGIUM**, D&R Electronica b.v., 1382 GS WEESP, Holland, Phone: 0031-2940-18014. **CANADA**, J-MAR, M4H 1E9 Ontario, 6 Banigan Drive, Toronto, Phone: 4164219080. **DENMARK**, P.S.S. DK 2400 Kobenhavn, Gørtlervej 4, Phone: (01) 821582. **EGYPT**, Alpha Audio, 6 Mahmoud Hafez St suite 905, Safir square, Heliopolis, Phone: 245 6199. **FINLAND**, S.L.O. OY, 01301 Vantaa 30, P.O. Box 88 Sahkometsä, Phone: 908381. **FRANCE**, METTLER AUDIO, 75009 Paris, 1-3-5 Blvd de Clichy, Phone: 148782911. **GERMANY**, J. Isler GmbH, Paul-Ehrlichstrasse 28-30, D-6074 Rödermark, Phone 06074-94086. **GREECE**, Omikron, 20 Salomou Street 147, Athens 106-82, Phone: 3631066. **HONGKONG**, JOLLY SOUND Ltd, Tower B, RM 1214-1215, Hunghom comm, centre 37-39, Ma Tau Wei Rd KLN H.K., Phone: 36202025. **ICELAND**, RADIO STOFAN HF, 130 Reykjavik, P.O. Box: 10340, Phone: 354-1673737. **ISLAND**, CANARIAS, MUSIC ACCORD, S. Cruz de Tenerife Puerta Causeco 35, Phone: 22-289506. **ITALY North**, Musica-In S.R.L., Corso di Porta Romana 132, 20122 Milan, Phone: 02-5488171. **ITALY South**, Syncom, S.r.l., Via Fabio Massimo 34 00192 Rome, Phone: 6-3581296. **NEW ZEALAND**, Accusound NZ Ltd, Auckland 3, Linwood industrial park, unit 12, 43A Linwood Avenue, Phone: (09) 8150258. **NORWAY**, VEDUM ELEKTRONIKK, N-1381 Heggedal, Aamotveien 2, Phone: 2798990. **PORTUGAL**, JORSOM AUDIO VISUAL, 1000 Lisboa, Rue Eca de Queiroz 20-3 Phone: 19562850. **SPAIN**, Audio Sintesis, 08007 Barcelona S, Ronda Universidad W, 19, Phone: (93) 4171340-212891. **SWEDEN**, ALLBA LJUD AB, Gelbgjutarevägen 4, 17148 Solna, Phone: 087300280. **SWITZERLAND**, ISLER AG, 8048 Zurich, Badenerstrasse 808-810, Phone: 14321444. **U.K.**, Palm Audio Systems, 16/17 Caroline street, B3 1 TR Birmingham, Phone: 0212001771. **VENEZUELA**, SOUND AND POWER, 1070 Caracas, P.O. box 76766, Phone: 2223201.

AES Booth No. 2940

Dual Domain Audio Testing

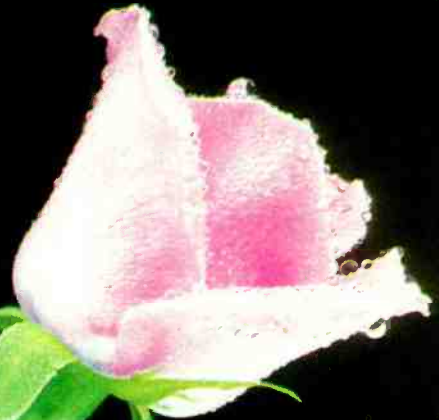

Analog and Digital

There are two worlds of audio ... analog and digital. These two domains share many basic attributes but when it comes to audio testing, they're distinctly different. Until now custom hardware was needed to test digital audio devices in their own domain. Now the System One Dual Domain combines both analog and digital testing capability in one unit.

ANALOG audio testing with System One Dual Domain is even more comprehensive than before. Data acquired can be further analyzed using the Digital Signal Processor, which adds harmonic analysis, waveform display and FFT spectrum analysis to the already extensive list of System One's capabilities. New version system software supports color VGA graphics and on-screen cursor function with numeric readouts.

DIGITAL audio testing directly in the digital domain is available for the first time. System One Dual Domain provides signal generation, analysis and Input/Output capability and also mirrors familiar analog measurement techniques, now implemented digitally. The multiple-DSP architecture supports both AES/EBU serial and two-channel parallel inputs and outputs at a variety of sampling rates.

Integrated analog and digital domain audio testing... only from Audio Precision.

System One

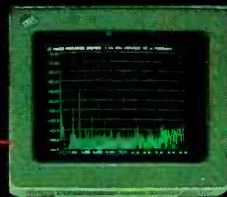

Audio precision

PO. Box 2209, Beaverton, OR 97075
503/627-0832 1-800/231-7350
FAX: 503/641-8906, TELEX: 283957 AUDIO UR



INTERNATIONAL DISTRIBUTORS: Austria, Eastern Europe: ELSINCO elektron GmbH 222871751 Benelux: Trans European Music NV, Brussels (02) 4665010 Canada: Glentronix Ltd. (416) 4758494 China, Mainland: Harvest Scientific and Technology Company Ltd. Hong Kong 5-742983 Denmark: nbn Elektrik ApS 86-57 15 11 Finland: into OY 0 755 7711 France: ETS Mesureur (1) 45 83 66 41 Germany, West: RTW GmbH 221709130 Hong Kong: TRP Consumer Electronics, Ltd 5-887 2008 Italy: Medea S.r.l. 24453828 Japan: TOYO Corporation 32790771 Korea: Myoung Corporation 784 9942 Mexico: VARI S.A. 250 7394 New Zealand: Audio & Video Wholesalers, Ltd. 7173414 Norway: Lydconsult (09) 19 03 81 Portugal: Acufon ELA 251 40 87 Singapore & Malaysia: TME Systems PTE Ltd 286 4608 Spain: Telco Electronics, S.A. 231 7840 Sweden: Tal & Ton AB 31803620 Switzerland: Tecnad SA (021) 806 06 06 Taiwan: Litz Technologies Ltd 703 6280 U.K.: SSE Marketing Ltd 13871262

EVALUATING AUDIO OP AMPS PART THREE

Ben Duncan sets down the results of fundamental performance tests

A compact op-amp testbed complete with local, low noise power regulation, programmable gain and optimal conductor layout was arranged by adopting AOM, a Eurocard module that's part of a pro-standard preamplifier designed by the author and colleagues to demonstrate the capabilities of modern op-amps¹. Measurements were carried out with Audio Precision's *System One*. Large amounts of negative feedback tends to make very different op-amp models perform almost identically for low gains at audio frequencies. High gain settings are needed to bring out the differences.

Bandwidth measure

It's a universal law that the gain produced by electronic devices is ultimately eroded with ascending frequency. In circuits employing NFB, it has to happen eventually, as inevitable stray reactances progressively shift the phase of the output at high frequencies, until the feedback eventually becomes positive. The high gains inherent in modern op-amps (typically 500,000× for Bi-FET op-amps like *OP44* and *AD845* and even higher, around 20 to 45 million, for *LT1028* and *TLE2037* respectively) are steadily reducing above a few 10s or 100s of Hz. Negative feedback pushes out the limits of HF roll-off. Bandwidth is expanded in return for trading off most of this raw, open loop gain for the much smaller, friendly and conveniently-sized 'closed loop' gain needed for everyday audio purposes. To show the process at work, circuit designers can plot the bandwidth of various stage gains (A_{VCL}) beside the curve of open-loop gain (A_{VOL}), against frequency (Fig 1).

Gain Bandwidth Product (GBP or GBWP) is a standard op-amp parameter, prominently cited in every data sheet. It directly indicates the bandwidth when the operating gain is set at unity, while for any other gain setting, the bandwidth is reduced pro rata. GBWP also partially indicates the amount of feedback that's available for error correction. Fig 2 shows the test circuit. The DUT (Device Under Test) is set for a gain of +60 dB (×1000). A high gain is necessary to enable the op-amps with the highest GBWPs to be plotted using the Audio Precision test set, which is limited to 200 kHz. 60 dB is a realistic worst case condition for mic amps. It's also numerically convenient, as the -3 dB roll-off then directly converts into GBWP simply by reading kHz as MHz! Looking at Fig 3 some op-amps are rolling-off within the audio band. The results affirm the need for op-amp GBWPs, which at first sight seem enormous, ranging up to VHF frequencies. Well before it muffles the HF response, premature roll off means that error correction at mid to high audio frequencies is mediocre, while ultrasonic distortion is left wholly devoid of feedback correction. The majority of op-amps, with less than 100 MHz GBWP, are frankly unsuited to use as high gain mic amps and in equalisers.

The method used to derive the GBWP from the measured bandwidth relies on some assumptions about the open loop gain curve. For most op-amps, open loop gain starts falling off at between 10 and

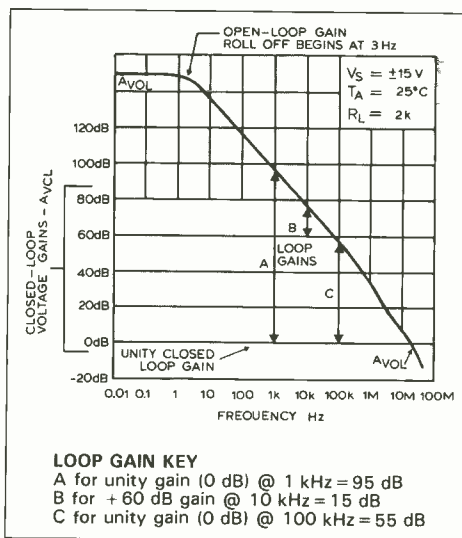

FIG 1: Assessing loop gain
 For high gains (>+30 dB), even a very high GBWP op-amp like the *LT1028* shown here has only moderate loop gain at high frequencies (>20 kHz)

30 Hz, before the music even begins. A few designs (most notably the *NE5534*) retain their initial DC open loop gain figure up to nearly 1 kHz. Thus the *5534*'s open loop gain at 20 kHz can end up being higher than op-amps having a far higher initial gain (at DC), owing to the way the latter's gain rolls-off earlier. This explains the large discrepancy in the computed figures compared to the manufacturer's 10 MHz specification. SSM's *2016* GBWP (not measured) would also appear to be adrift because it relies partly on current feedback, which sidesteps the conventional gain-bandwidth relationship. Even higher GBWPs are possible with specialised current feedback devices like *AD846*. The remaining, much smaller differences reinforce the fact that GBW is quite a loose specification (±130% is typical). As one *raison d'être* of op-amps is that unit-to-unit variations are smoothed out by employing large amounts of feedback, one can hardly complain.

Harmonic distortion

The difference between the open and closed loop gain plots in Fig 1 gives an immediate visual rendition of the loop gain—the 'spare gain' that's available for error correction. A loop gain of 20 dB (10×) broadly corresponds to an error reduction capacity of 10

times. The *μA741*'s GBWP was 1 MHz. The 100-fold increase in GBW over 20 years broadly means there's been a commensurate increase in the error correction that's available at any given frequency and gain setting. Except at the highest gain needed for mic amplifiers, circa +60 dB modern high specification op-amps shouldn't produce any of the 'gritty', 'hard' or 'grainy' qualities caused by high order harmonic distortion and/or HF intermodulation—some of the attributes that initially gave IC op-amps a bad name.

The table in Fig 2 shows how RA to D in the test circuit were adjusted to assess harmonic distortion (et seq for the subsequent tests). The DUT gain is judiciously set at 40 dB to be reasonably taxing without letting the inadequate bandwidth of some of the op-amps complicate the picture above 3 kHz. An input L pad attenuator network placed adjacent to the op-amp provides 20 dB of attenuation, so the unbalanced input drive can be reasonably high (0 dBu), which helps to overcome extraneous noise pickup, notably around 50/100 Hz. Drive at the DUT's input is -20 dBu. The test bed is expressly a non-inverting configuration so that common mode distortion (a progressive kind of input malfunction that only afflicts op-amps with bi-polar input stages) is included. Output is +20 dBu, corresponding to rated worst case peak operating levels for line level equipment. The output is lightly loaded by 100 kΩ. For best THD resolution, the AP's bandwidth is -3 dB at 22 kHz. Wider bandwidth settings obscured some of the differences between the best op-amps, by introducing noise.

The results are tabled in Fig 4 according to the highest THD in the audio band (in the third column), rather than the 1 kHz figure in the second column. While the differences will remain much the same, the absolute THD figures will be much lower in low gain circuits (most line stages) and somewhat higher in mic amps run at maximum gain. Fig 4 gives examples of the graphs from which the figures have been derived. Many of the op-amps display increasing THD+N towards the upper end of the audio band. The ultimate curve shape is disguised by the measurements' -3 dB roll-off at 22 kHz. For many op-amps, even low noise types, some of the increase is '+N', ie down to an increasing noise density at frequencies above the audio range. For others, the rising THD is a reminder of the effects of incipient slew limiting. +20 dBu is almost 11 V, and allowing a conservative 1 V/μs per peak output volt at 20 kHz (five times more than the minimum theoretical figure), some op-amps with maximum slew rates under 15 V/μs are seeing their limits approached if not encroached. Without exception, the lowest THD+N figures relate to quiet op-amps with bi-polar front ends. There are two clear reasons why this should be so. First, their '+N' contribution is less. Second, the much higher transconductance of bipolar input stages leads to loop gains that are one or two orders greater than Bi-FET types, giving more scope for overcoming a given amount of open loop distortion.

What do the THD figures all mean? Beyond the subjectivist vs objectivist divide, few would disagree that distortion is error and that significant distortion has no place in equipment that's ultimately used to archive, mass produce and broadcast (in the widest sense) speech and music. The dispute arises in knowing where and how to draw the line that divides

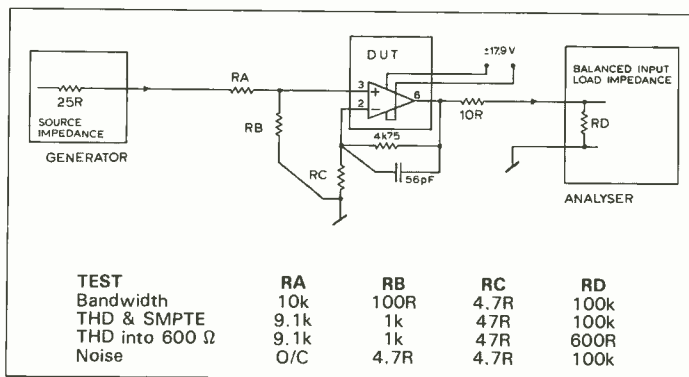

FIG 2: Generic test circuit



DENON



Over the last few years, the CD has gradually replaced vinyl as the most popular sound source in studios. The CD is small, light and easy to use. Now Denon has made the CD even more convenient than before.

The DN-950FA is a state of the art player that accepts CDs inside a special library case, so once the CD is loaded it never needs to be touched again.

Features of the DN-950FA include:

- Instant cueing – straight to chosen track
- Fast search – allows chosen passage to be selected quickly
- Easy auditioning – backwards and forwards
- Digital Display – remaining or elapsed time
- Adjustable EOM timing – 5 to 35 secs
- Remote operation – switchable remote operation
- Solid construction – built for professional usage

For more information and to arrange for a demonstration, contact Hayden Pro-Audio.

THE QUALITY- AUDIO CART MACHINE

**Hayden
Pro-Audio**



HAYDEN HOUSE
CHILTERN HILL
CHALFONT ST. PETER
BUCKS SL9 9UG
TEL: (0753) 888447
FAX: (0753) 880109

M.S. AUDIO OPEN NEW STUDIO COMPLEX

M.S. Audio are pleased to announce the forthcoming opening of their new studio complex offering full demonstration facilities for all used and new equipment. Currently the world's leader in secondhand pro-audio equipment, M.S. Audio is situated only 10 minutes from Heathrow Airport, 2 minutes from the M25 and 30 minutes from central London. Offering ample free parking with no traffic jams in sight, we are simply the U.K.'s most accessible pro-audio dealer.

STARTING UP / UPGRADING ?

To anyone considering the starting up or the upgrading of a studio, not only can we supply all new and secondhand equipment that you require, we can also arrange finance, subject to usual terms and conditions.

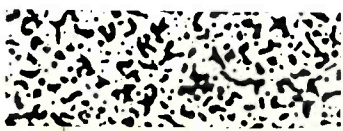

ALWAYS A GREAT DEAL ON OFFER

.. IF YOU DON'T SEE WHAT YOU WANT
PLEASE RING MIKE OR JENNY..

MULTITRACK MACHINES

MITSUBISHI X850 32 track digital.	£P.O.A.
SONY 3324 remote/auto.	£39,250.00
OTARI 32 track digital.	£P.O.A.
OTARI MTR90 MkII auto, v.g.c.	£17,850.00
OTARI MX80 auto, v.g.c.	£16,750.00
STUDER A820 with SR cards, auto/remote.	£35,000.00
STUDER A80 MkIV auto/remote.	£P.O.A.
STUDER A80 MkII with MkIII h/b, auto/remote, v.g.c.	£14,500.00
STUDER A80 MkII auto/remote, v.g.c.	£12,500.00
SOUNDCRAFT SATURN auto/remote.	£16,950.00
SOUNDCRAFT 762 MkIII 9 memory auto.	£9,000.00
SOUNDCRAFT 762 MkII with MkIII updates, 9 memory auto.	£8,500.00
MCI JH24 Auto 3, v.g.c.	£12,500.00
LYREC 532 16 memory, auto, v.g.c.	£8,500.00
3M-79 XT24 auto.	£7,500.00
OTARI MTR90 MkI auto.	£9,500.00

MIXING CONSOLES

SSL 4046E with G series modules, G series computer, T/R producers desk, patchbay.	£P.O.A.
SSL 6048E with G series computer, T/R, producers desk, p/b.	£P.O.A.
SSL 4072E with G series computer, T/R, producers desk, p/b.	£P.O.A.
SSL 4048E with E series computer, T/R, producers desk, p/b.	£P.O.A.
SSL 4032E with E series computer, T/R, producers desk, p/b.	£P.O.A.
MCI 556C JH50 auto.	£P.O.A.
MCI 500H series 42 frame 42 ch, patchbay.	£P.O.A.
MITSUBISHI WESTSTAR 44 frame, 44 ch, 4 band eq, automated.	£39,950.00
NEVE V3 60 frame 48 ch, Necam 96, automation.	£P.O.A.
NEVE 8068 32 frame 32 ch.	£P.O.A.
NEVE 8078 40 ch, melquist automation.	£P.O.A.
NEVE 8108 32 ch.	£34,750.00
NEVE 8108 48 ch, Necam 96.	£54,500.00
NEVE V2 48 ch with Necam 96.	£P.O.A.
We also have available 4 more smaller NEVES - please phone for details	
TRIDENT TSM 40 frame 40 ch, patchbay, 32 track monitoring, v.g.c.	£21,000.00
TRIDENT TSM 32 frame 32 ch, 24 out, patchbay, v.g.c.	£16,000.00
TRIDENT Series 80B 32/24, P/B, Optimix automation, Exc. cond.	£P.O.A.
DDA 56 frame, 48 channel, Optifile automation, immac. con.	£P.O.A.
DDA AMR24 44 frame 36 channel P/B 64 ch. of Optifile automation	£P.O.A.
CADAC 28/24, P/B many extras, excellent condition. Phone for details	£P.O.A.
AMEK M2500 48 frame 36 mic/line inputs, 12 stereo inputs, LED metering switchable, righthand patchbay with Mastermix automation.	£P.O.A.
AMEK M2500 36 frame 24 mono ch, 12 stereo ch, patchbay, LED meters, v.g.c.	£P.O.A.
AMEK Angela 36 frame 36 input, patchbay, Mastermix automation.	£P.O.A.
AMEK Angela 36 frame 36 input, patchbay.	£P.O.A.
SOUNDCRAFT TS24 56 frame 48 ch, Mastermix automation, v.g.c.	£P.O.A.
SOUNDCRAFT TS24 32 frame 28 ch, patchbay, v.g.c.	£P.O.A.
SOUNDCRAFT 200/200B/400/800B consoles. Phone for details	£P.O.A.
HARRISON MR4 36 frame 36 ch, patchbay, Mastermix automation.	£P.O.A.
HARRISON Series 28 40 frame 40 ch.	£P.O.A.
TAC Matchless 26/24, patchbay.	£P.O.A.
TAC Matchless 36 frame 36 ch, patchbay.	£P.O.A.

OUTBOARD EQUIPMENT

LEXICON 480L with Larc.	£4,950.00
LEXICON 224XL remote.	£4,500.00
LEXICON 224 with remote.	£2,250.00
LEXICON 200.	£P.O.A.
LEXICON PCM42	£495.00
LEXICON PCM60	£575.00
AMS RMX16	£2,750.00
AMS 15-80s Choice of 2.	£P.O.A.
UREI 1178	£495.00
YAMAHA Rev 7	£450.00
YAMAHA Rev 5	£650.00
YAMAHA SPX 90	£325.00
DBX 900 Rack/903/904 modules	£P.O.A.
2 x SCAMP Racks - phone for details	£P.O.A.

2 TRACK MACHINES

OTARI MTR12H 15/30ips, 1/2 inch.	£P.O.A.
OTARI MTR10 15/30ips, 1/4 inch.	£2,750.00
STUDER A820 1/2 inch and 1/4 inch.	£P.O.A.
MITSUBISHI X80 low hours.	£3,450.00
SONY 701	£575.00
SONY 501	£295.00

- We also have numerous other mastering machines - please phone for details.
- Please note this is only a small selection of items available. We are also happy to part-exchange your old studio equipment, if you so wish.
- Shipping, freighting and insurance arranged worldwide to customer's specifications.

VIEWING BY APPOINTMENT ONLY

ALL PRICES SUBJECT TO V.A.T.

M.S.
AUDIO
IS A SUBSIDIARY OF M.S. MANAGERIAL SERVICES LIMITED

NORTH LODGE, STONEHILL ROAD, OTTERSHAW, SURREY KT16 0AQ
TELEPHONE: 0932 872672 INTERNATIONAL: +44 932 872672 FAX: 44(0) 932 874364

RING NOW
ON
(0932)
872672/874768
FOR MONTHLY
MAILSHOT

the acceptable from the unacceptable. By themselves, THD figures normally hide the harmonic structure, which has a large bearing on whether a given % THD is euphonic, objectionable, or plain inaudible. Traditionally, THD figures held below 0.1% across the audio band have been regarded as safe. But let's not forget that the valve (tube) powered equipment used to arrive at such conclusions employed small amounts of negative feedback and had no appreciable slewing limitations. With large amounts of Negative FeedBack (NFB), residuals are correspondingly very much smaller but very likely highly anti-euphonic. The majority of op-amps listed could be operated (as mic amps) at +60 dB while comfortably exceeding the traditional specification. And when used at or near unity gain (0 dB), all the devices tested would display THD figures two or three orders of magnitude better than the traditional minimum. At these levels, THD+N figures have little to say about which devices will sound OK and which won't. The only substantial, objective clue to sonic performance is the incipient sign of slew limiting or other large signal problems registered in the plots, which are rising with frequency.

Large signals, loads and outputs

The op-amps' THD was retested after loading their outputs with 600 Ω (Fig 2), a move designed to evaluate their load driving capability. More precisely, the test demonstrates the way their performance ranking changes with heavy loading at high drive levels. The distortion-raising effects of cable and equipment loading are especially important in op-amps driving multiple, paralleled crossover and EQ circuits, as well as outputs. Compared to the test, operating gains in equipment are almost always lower, usually between unity and +10 dB, so THD figures would be 30 to 100× smaller in practice—always assuming all the other conditions were identical.

Even in their hypothetical open loop condition, the majority of op-amps have low output (source) impedances ranging between 20 and 70 Ω. Liberal use of NFB reduces source impedance to a tiny fraction, generally a few mΩ at DC, rising with increasing frequency. Across the audio range, and for gains of

+40 dB or less, most op-amps' source impedance (Z_o) is purely resistive and well below 1 Ω. For low level signals, the output level is then almost independent of equipment and cable loading. Passing beyond the audio band, Z_o ultimately reaches the open loop value at the unity gain frequency. Meanwhile, at moderate radio frequencies, the op-amp's output is reasonably resistant to RFI, by virtue of its low impedance compared to the interference. What happens when op-amp outputs are attacked by even higher RF frequencies is highly dependent on the equipment's circuit and layout design.

The output drive capability of op-amps is an altogether different matter from Z_o . The minimum impedance an op-amp can drive is (as with power amplifiers) principally dependent on the phase angle of the load and the output transistors' dissipation limits. Capacitive loads are the toughest test. Most op-amps are rated at between ±20 and ±60 mA. Output stage protection is universal and prevents immediate damage when driven into shorted cables, though the resulting high temperatures may shorten the lifespan if abusive loading is sustained. A factor that's seen increasing attention in more recent op-amp designs is thermal modulation, where programme-induced 'wiggles' in the output transistor's temperature set up a cascade

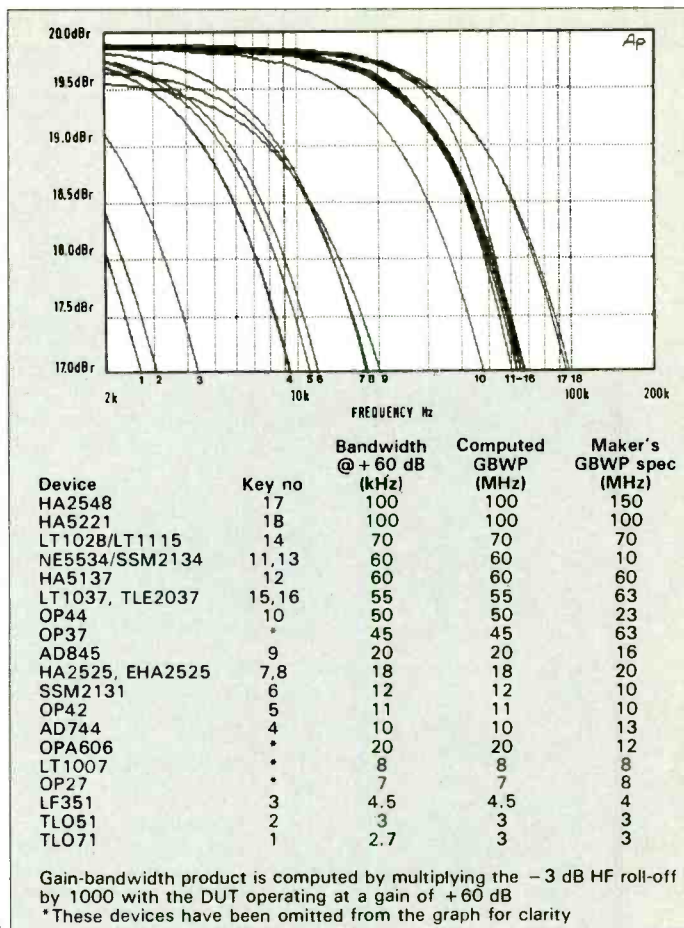

FIG 3: Bandwidths +60 dB gain with 100k load

of incremental changes in the remainder of the chip, as successive heat 'waves' spread. It's the kind of behaviour that severely confuses the servoing of the error correction, by introducing a parallel positive feedback loop. A tell-tale sign is increasing THD at low frequencies but near open loop conditions are needed to unveil the effect with steady state

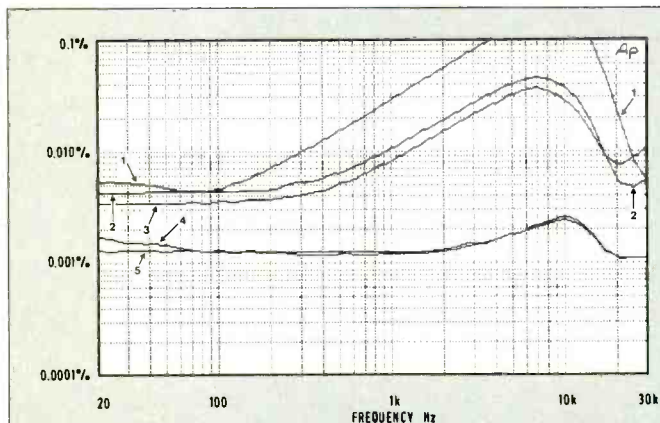

Fig 4a: Industry standard op-amps

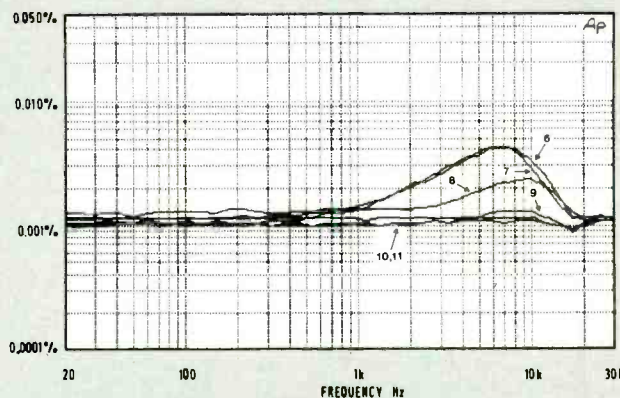

Fig 4b: High Specification bi-polar op-amps

Model	Key no	THD @ 1 kHz	THD max 20 Hz-20 kHz	Device type
LT1028/1115	11	0.001	0.001	Bi-polar LN
HA5221	9	0.001	0.001	Bi-polar F + LN
TLE2037	10	0.001	0.001	Bi-polar LN
HA5137	8	0.0013	0.0025	Bi-polar LN
NE5534	5	0.0012	0.0025	Bi-polar LN
SSM2134	4	0.0012	0.0025	Bi-polar LN
HA2548	*	0.0016	0.003	Darlington F
AD845	*	0.003	0.003	Bi-FET F
LT1037	7	0.0013	0.004	Bi-polar LN
OP37	6	0.0013	0.004	Bi-polar LN

Model	Key no	THD @ 1 kHz	THD max 20 Hz-20 kHz	Device type
OP44	*	0.004	0.016	Bi-FET F
OPA606	*	0.0025	0.018	Bi-FET
AD744	*	0.0035	0.02	Bi-FET
EHA2525	*	0.013	0.02	Darlington F
SSM2131	*	0.005	0.035	Bi-FET
OP42	*	0.005	0.035	Bi-FET
TLO51	3	0.0035	0.035	Bi-FET
TLO71	2	0.0045	0.045	Bi-FET
LF351	1	0.0055	>0.15	Bi-FET

LN = Low Noise

F = Fast (>75 V/μs)

* These devices have been omitted from the graph for clarity

FIG 4: THD vs frequency @ +20 dBu @ +40 dB gain into 100k load

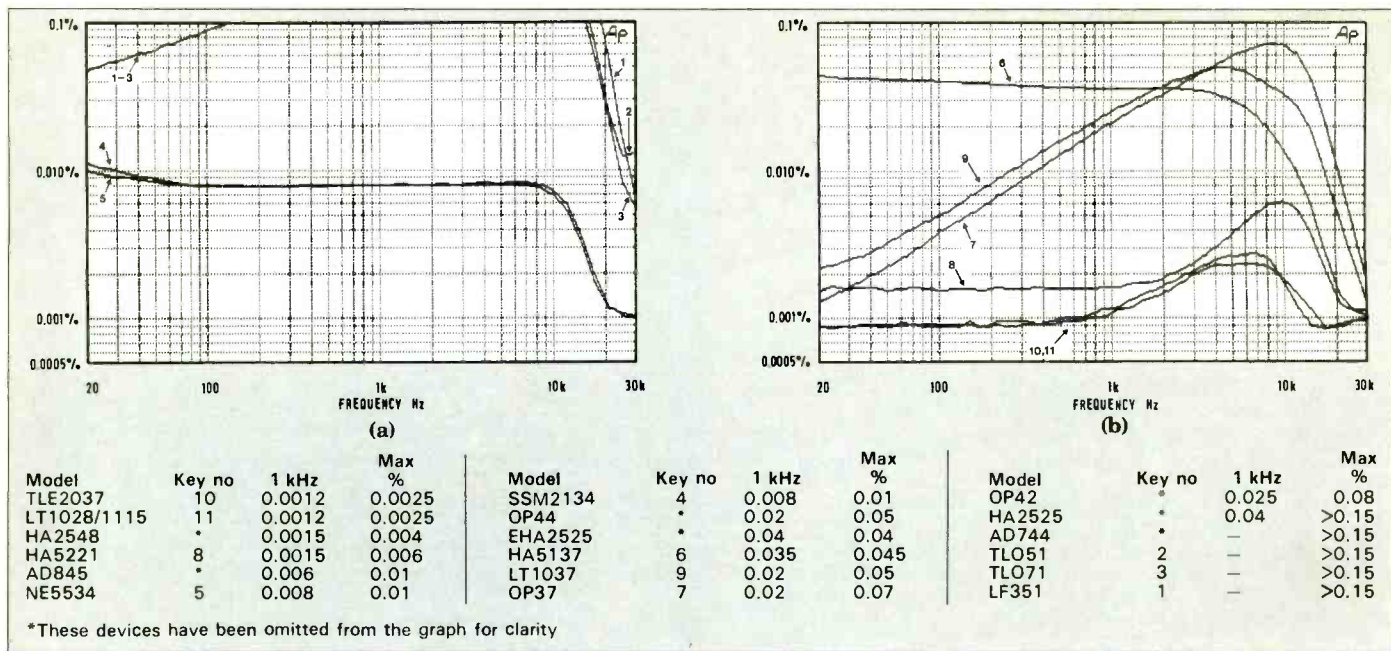

FIG 5: Industry standard op-amps—THD vs frequency into 600 Ω @ +20 dBu @ +40 dB gain

measurements. With everyday closed loop tests, THD in op-amp stages is normally solidly on the baseline in the DC-to-100 Hz region, as this is the loop gain's apogee.

The table in Fig 5 ranks the op-amps for lowest THD with the DUT driving a 600 Ω resistive load at +20 dBu, again with a gain of +40 dB. Although the ranking has changed, the leaders are still the bi-polar types with the highest GBWPs. Fig 5b shows some aspects of performance when compared to Fig 4b. The LT1028's THD is scarcely affected, except the mild HF rise in Fig 4b is now much bigger. The HA5137's THD has trebled but it's no longer rising around

IM and noise comparisons

Table 1 ranks the op-amps for intermod distortion, using the industry standard and readily reproduced (if rather dated) SMPTE method. On balance, this is not an ideal choice for devices with very low residuals like op-amps, as measurements are restricted to frequencies above 3 kHz. Go much higher and noise and HF roll-off are apt to confuse the results. As a compromise, spot figures were taken at 3.5 kHz, irrespective of different rankings at much higher frequencies. In this arena, the high GBWP bi-polar devices (even OP37 and LT1037) retain their lead. Noise appears to handicap the Bi-FET types but there's evidence of a quantum step down in intermodulation nasties for some of the newer generation of FET-input op-amps, eg AD 744, 845 and OPA606.

The first IC op-amps were undeniably noisy. Some of the noise particularly at low frequencies, was down to imperfect processing. With cleaner processing (which also brings higher reliability and longevity), the fundamental physical mechanisms are left to dominate. For low impedance sources, lowest noise requires a high input stage current, which modern op-amps can manage without excess bias currents and related DC imbalances. The quietest op-amps employ Bi-Polar Transistors (BJTs), and give their best performance when coupled to a low source impedance around 10 to 200 Ω, ie dynamic and ribbon mic capsules and moving-coil cartridges. Op-amps optimised for high speed employ J-FET or (bi-polar) Darlington inputs. These are noisier unless they're interfacing a high impedance source >30 kΩ eg guitar pickups, but for a minimum number of line level

stages working at unity gain or thereabouts, the amount of hiss they generate is barely audible, even over a high power (>120 dB_{SPL}) monitoring system in a quiet control room. The hiss from Bi-FET op-amps gets to be more of an embarrassment when a dozen or more are cascaded in an active crossover and/or other loudspeaker processing, upstream of the system's main fader.

The spectral characteristics of op-amp noise has long been neglected. The figures presented in Table 2 centre on 1 kHz. This is fine for straight amplification, mixing and buffering, however, when op-amps are used in EQ circuits, particularly for pre-

TABLE 1 SMPTE IMD @ 3 kHz

Model	% IMD	Model	% IMD
HA5221	0.0016	AD744	0.005
LT1028/1115	0.0016	AD845	0.005
TLE2037	0.0016	OP44	0.01
LT1037	0.0016	TLO51	0.01
OP37	0.0016	SSM2131	0.013
SSM2134	0.002	TLO71	0.013
NE5534	0.002	OP42	0.015
HA2548	0.0025	LF351	0.02
HA5137	0.003	EHA2525	0.045
OPA606	0.004	HA2525	0.06

7 kHz and is clearly under control. The LT1037 and OP37's plots provide vivid contrast, rising steeply from the lowest frequencies, indicating that these devices aren't suited to driving 600 Ω (or highly capacitive cables), at least at high (+20 dBu) levels. It's the outcome of crossover distortion, as the devices switch into Class B operation above 20 mA output current. The modern OP27 has 'mask revision' to correct this problem. Turning to the industry standard op-amps charted in Fig 5a, the clear upturn in the NE5534 and SSM2134's THD below 100 Hz is suggestive of thermal distortion.

TABLE 3 Common mode rejection @ 10 kHz

Model	CMR (-dB)	Model	CMR (-dB)
LT1007, LT1037	130	OPA606	85
OP27, OP37	110	HA2548	82
AD845	107	HA5221	78
LT1028, LT1115	100	HA5137	78
SSM2131	98	AD744	76
OP42, OP44	98	TLE2037	74
LF351	93		

TLO71, NE5534, HA2525 omitted due to inadequate data

and de-emphasis tasks (the sort of EQ you can't 'take out' if it proves too noisy) noise performance at one or other end of the spectrum will also need examining'. In particular, most Bi-FET op-amps and some nominally low-noise bi-polar units (notably the NE5534) become increasingly noisier in the 2½ octaves below 200 Hz, giving rise to a rumbling or burbling, especially when low frequencies are being boosted. The character of impure semiconductor noise and its subliminal psychoacoustic effects deserve more investigation. My own, very ad-hoc investigations have revealed that some chips used for power

TABLE 2 Op-amp noise

Noise at 1 kHz taken from noise spectra measured with the test circuit in Fig 2. The noise figure shows the SNR if the DUT (Device Under Test) were used in a microphone amp, with a gain of +60 dB (1000×). The EIN figure subtracts the gain to depict the raw noise generated in the op-amp's input stage, independent of gain

Device	Input stage description	Noise (dBu)	EIN (dBu)	EIN (nV)	Device	Input stage description	Noise (dBu)	EIN (dBu)	EIN (nV)
SSM2016	BJT, LG	-96	-156	16	OP44 (OP42)	Bi-FET	-73	-133	220
LT1028	BJT, LG	-95	-155	18	OPA606	Di-FET	-72	-132	250
LT1037 (1007)	BJT, MG	-88	-148	40	EHA2525	BJT, D	-72	-132	250
HA5137	BJT, MG	-86	-146	50	AD744	Bi-FET	-70	-130	316
OP27, OP37	BJT, MG	-83	-143	71	HA2525	BJT, D	-68	-128	398
NE5534, SSM2134	BJT, MG	-82	-142	79	AD845	Bi-FET	-67	-127	442
TLO51, 71	Bi-FET	-73	-133	220	LF351N	Bi-FET	-66	-126	500

Abbreviations

BJT=Bi-polar (Junction) Transistor
D=Bi-polar Darlington
Bi-FET=J-FET

Size

MG=Medium Geometry
LG=Large Geometry

Notes

500 nV=0.5 μV
Some devices are omitted, due to late arrival

HARDWARE HOUSE

**10 YEARS EXPERIENCE
IN LIVE PERFORMANCE SOUND**

- Equipment Rental and Sales •
- Specialist Radio Mic Applications •
- Sound Design and Engineering •

Share our experience · Contact us on:

01-986 6111

WestWorks Chalgrove Road
London E9 6PB
Telex 265871 Attn. DGS 2220
E-Mail Hardware-UK

A member of the Association of
Professional Entertainment Hire
Companies

Distributor for
The Hackney
Cab speaker
system



Dealer for AKG, Amcrn, Bever,
Countryman, Electrovoice, JBL,
Samson, Sennheiser, Shure, Yamaha.

SPA-1

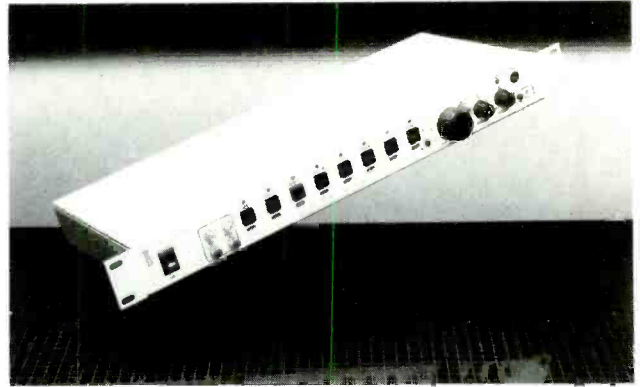

THE PRE-AMPLIFIER WITH A DIFFERENCE . . .

The professional and economical way to interface up to eight unbalanced semi-pro or domestic machines in both record and playback directions, including RIAA/Line channel.

An essential item for all types of Copying Suites, Control Rooms, Quality Control, Editing Facilities and Audio for Video Transcriptions.

TOTALSYSTEMS



41 Windermere Avenue
Basingstoke, Hants RG22 5JH, UK

Phone: 0256 468555

Benelux Agent: Auvio Holland, Tel: 31-71-313642

Fax: 31-71-318904

NORTHERN AUDIO

SECONDHAND CONSOLES

- 1 SSL6040 40 frame 38 mono channels fitted with Total recall VU meters L/H patchbay, R/H producer desk, 5 years old in line condition, available June 90 **£65,000.00**
- 2 SSL E Series production desk 40 frame 32 mono channels 'G' Series E/Q 'G' Series preamps primary computer (no recall), 12 months old Immaculate **£72,500.00**
- 3 Neve 8103 48 input console with Necam automation 4 rev returns R/H patchbay and PSU's and manuals Etc. **£49,500.00**
- 4 Soundcraft 2400 32 frame and fitted V/U meters patch PSU's **£10,250.00**
- 5 Soundcraft TS24 32 frame 28 fitted patch, stand PSU's **£9,750.00**
- 6 AMEK 2500 36 frame 36 fitted with patchbay PSU's also fitted Mastermix One automation 8/10 years old in superb shape **£22,500.00**
- 7 Soundcraft 8000 PA desk 40/8/2 PA, 12 months old P/case **£8,885.00**
- 8 DDA AMR 24 44 frame 36 fitted with patch and stand 18 months fitted with Optiflex H/D2 Automation in superb order **£32,500.00**
- 10 Trident TSM 32/32, custom built 3 years ago to clients specifications LED on each channel PPM/VU meters New patchbay altogether a superb console **£27,500.00**
- 11 Trident 70 series 28/16/24 patchbay, stand superb order **£11,500.00**
- 12 Yamaha DMP7 digital mixer 8/2 hardly used 12 months old **£1,100.00**
- 13 Trident Series 80 32/24/2 patch, stand and PSU's 8 years **£13,500.00**
- 14 Amek 2520 40 frame 36 input with Mastermix 2 years old **£39,500.00**
- 15 Soundcraft CM4400 32 input 6 years old 6.700 00 16 Trident Series 80 32/24/2 patch PSU's, etc **£13,500.00**
- 16 SSL6000e 40 frame 32 fitted total recall Patchbay RH no producer desk 5/6 years old **£65,000.00**

USED TAPE RECORDERS

- 1 Mitsubishi X850 32-track digital machine, 3 years old, full remote and meter bridge **£52,500.00**
- 2 Sony 3321A 24-track with locator and remote, 14 months old, approx. 1,200 hrs in superb order **£44,500.00**
- 3 Studer A820 24-track with remote and auto (new machine) **£37,500.00**
- 4 Studer A80 Mk2 3 headblock auto and remote narrow body **£11,500.00**

WE ARE CONSTANTLY ON THE LOOKOUT FOR USED EQUIPMENT . . .
NOTICE

We also act for studios as selling agents, let us handle the hassle of getting rid of unwanted items, it does not matter where you are in the world, why not drop us a line listing your equipment or ring us on the numbers below for the best rates. We assure you of our best attention and service plus the utmost confidentiality at all times.

- 5 Studer A80 Mk2 V/U k* in good shape 15/30 ips **£2,500.00**
- 6 Ampex ATR 100 1/2" and 1/4" machines, 2 machines each **£3,500.00**
- 7 Otari M50/50 Mk3 8 track with CD110 remote and stand 1 year **£3,500.00**
- 8 Otari MX80 24-track with remote and autolocator **£15,500.00**
- 9 Lyrec TR55 3 speed master recorder **£0Offers**
- 10 Nagra 4.2 stereo J recorders 2 units with every extra **£3,000.00**
- 11 Fostex E16 recorder 1 year old hardly used **£2,700.00**
- 12 Tascam ATR 80 24 track with remote and auto 18 months old **£17,500.00**
- 13 Tascam ATR 60 two track 18 months old **£2,500.00**
- 14 Mitsubishi X850 32-track digital with remote 3 years old **£55,000.00**
- 15 Otari DTR900 Digital machine, 1 year old latest update this machine has only 800hrs use **£POA**
- 16 2x Akai MG14/D recorders with Fostex 4030 synchroniser **£4,000.00**
- 17 Akai MC12 14 Digital recorder 1 year old **£3,000.00**
- 18 Fostex E16 1 year old **£2,600.00**
- 19 Studer A80 Mk1 16-track narrow new heads 2000 hrs **£4,000.00**
- 20 Otari MTR 90 Mk2 auto and remote 5 years old 2000 hrs **£16,500.00**

SECONDHAND EFFECTS

- Neumann SM2 stereo capsule only **£0Offers**
- Ursa Major Stargate 323 **£525.00**
- Focusrone E/Q system 2 E/Q and 2 Dynamic E/Q PSU and cases **£5,500.00**
- Dolby SP Rack 24 CATT 22 cards and PSU excellent shape **£4,500.00**
- Adam Smith 2600 synchronizers 4 units each **£1,800.00**
- Sony 701 Digital processor **£450.00**
- Westlake HR1 system complete system with amps and covers **£6,000.00**
- Publishon I190 infernal machine **£3,500.00**
- Urei LA3a compressors **£400.00**
- Lexicon PCM 70 version 2 software **£895.00**
- Applied Microsystems CM250 synchronizer **£2,200.00**
- Linn 9000 drum machine reasonable **£0Offers**
- Eastlake monitor system TAD loaded with white graphics **£3,500.00**
- Wellard mid field monitors self powered (soft dome) stands **£1,250.00**
- Hir XR 1200 600x600 watts **£550.00**
- Scamp racks fully fitted PSU's etc please apply details **£0Offers**

FOR A COMPLETE STOCK LIST WRITE OR
RING TONY BAYLEY ON

0565-830005

GREYLANDS STUDIOS, MERESIDE ROAD, MERE, KNUTSFORD, CHESHIRE WA16 6QQ. TELEFAX: 0565-830405. TELEX: 666597 NAUDIOG

regulation produce noises that sound like a primal howling Arctic wind, hardly a welcome addition if it ever surfaced in the quiet passages of a mix.

CMR and PSR

Common mode rejection is a measure of the best rejection you can expect to get when the op-amp is configured as a simple balanced input stage. In practice, deficiencies in cables, short cuts in circuit design and manufacturing processes are liable to degrade the equipment's CMR below the op-amp's potential. Intrinsic CMR depends on the topology of the op-amp's input stage and the ability of the monolithic process to ensure precise, multi-dimensional matching between critical components. A good figure is made even better at low frequencies by high loop-gain. CMR's roll-off with increasing frequency commonly follows the open-loop gain curve. Table 3 ranks CMR specifications at 10 kHz. If CMR falls below -40 dB by the upper reaches of the audio band, it becomes comparable to the effects of cable balance and circuit implementation. This is clearly not a problem with IC op-amps, though it might be with discrete circuitry.

PSR (Power Supply Rejection) is another dead ringer for the open-loop gain response. You can think of PSR as a special kind of CMR, aimed at cancelling garbage on the (symmetrical) power rails. When op-amps were first used for audio, power supply filtering requirements needed to obviate 100/120 Hz hums were all of a sudden less stringent. Even the lowliest op-amp built from discrete transistors can manage 40 dB of PSR at low frequencies enough to reduce ripple 100-fold. This feature has led to a false sense of security, as higher frequency supply garbage is much less well rejected and also less easily tracked down. Usually one or other supply rail has better rejection and holds it up to higher frequencies. Which rail depends on the op-amp's input stage topology. Table 4 cites rejection figures for both power rail inputs at 10 kHz, ranking the tested op-amps in order of the highest weaker rejection figure of the pair.

Slewing and settling

Whenever static audio distortion measurements fail to corroborate with sonic results, it's time to look at the DUT's dynamic characteristics. Slew rate (strictly a limit, as the rate of slew is a quality of the signal itself) indicates the maximum acceleration of components in the signal beyond which error-correction breaks down. Walt Jung calls the unpleasant harmonic and intermod distortion produced by this event SID¹, alias slewing induced distortion. NFB should make the slew limit a hard one (conceptually like an audio limiter) but the maximum slew rate for some op-amps has a 'soft-knee', meaning harmonic distortion begins to creep up well before the official limit (Fig 4a). Seeing that high level (>+10 dBu), high frequency (>20 kHz) signals are needed to approach or exceed the moderate (all 13 V/μs) slewing capabilities of the industry standard op-amps, it's easy to under-rate the relevance of SID. But what about when ultrasonic frequencies are boosted to high levels by carelessly designed equalisers? Or when a series of RF noise spikes received by the console frame are injected into the mixing bus, superimposing 200 mV steps at 10 MHz on the audio waveform? Or when a DAC spews out fast transitions ranging up to 100 mV at 10 MHz? Once slew limiting has corrupted the signal, the damage is so global that no amount of post processing or face paint can hide the deformity. For conservative slewing 'headroom', real-world operating

conditions like these seem to require slew limits that are an order of magnitude greater than the so called (and laughable) 'high' slew limit circa 2 to 10 V/μs cited by the industry standard devices. Monolithic op-amps capable of slewing at 1000 V/μs have been available for some years but being largely intended for video, many of their parameters are optimised relative to 12 MHz+ bandwidths, leaving them with 'not so good' specs for audio use. At the time of writing, the latest conventional voltage feedback op-amps with kosher audio specifications attain slew limits ranging between 100 and 200 V/μs, while current-mode types can reach to 450 V/μs.

Slewing performance of the tested op-amps is given in Table 1 part two (*Studio Sound*, August 1990). When comparing the figures, output drive capability has to be taken into account, as failings in this area—particularly into capacitive loads—doubly penalises the servoing accuracy by establishing a second point of rate-dependent current starvation. In recent years, veteran op-amp aficionado Walt Jung has promoted a simple formula that enables op-amp slewing limitations to be seen in the context of open-

have fast slewing Bi-FET inputs. The best exponents (eg AD846) employ current feedback. Beyond this, the performance (and sonics) of the finished equipment is largely dependent on suitable RFRADAR-based circuit design, layout and component choice.

Conclusions

Most of the op-amps we've tested seem remote and esoteric to an industry obsessed for 13 years with the NE5534 and to a lesser extent, the TLO71. The op-amps that have come to challenge it are, for the most part, presently more costly but they wouldn't be if they usurped the 5534 and were manufactured in high volumes. Snag 1 is knowing which device(s) to choose to be the standard for future equipment designs when there is no consensus on which (if any) of the conventionally measured parameters are relevant to sonic quality. Snag 2 is deciding on any standard amidst rapid technological change. The life of equipment designers (as well as buyers intent on the economies of volume) is made easiest by living

with one op-amp as a do-all device. This was an original reason for using op-amps but it has yet to become a practical reality. The diversity of audio applications is too wide for blanket standardisation to be possible without serious compromises in one or other direction. With present technology at least two op-amp models will be needed. The measurements reinforce this, while unveiling the devices that excel in each category; all is revealed in the final scorecard in Table 6. □

TABLE 4 Power supply rejection at 10 kHz

Model	Rejection (dB) +ve/-ve	Model	Rejection (dB) +ve/-ve
HA5137	80/100	OP42/SSM2131	105/65
HA5221	80/90	AD845	65/80
HA2548	85/75	AD744	60/90
LT1028/1115	75/80	TLE2037	60/65
OP44	95/70	LT1007/1037	55/65
OPA606	90/70	OP27/37	55/60
HA2525	70/75	LF351	80/45

All dB figures are negative (-), typical and rounded down to the nearest 5 dB. Ranking is in ascending order of the lowest of the figures for + and -ve. NE5534, SSM2016, TLO51 and TLO71 omitted due to inadequate data.

TABLE 5 V_{th}—The slewing threshold

Model	V _{th} (V)	Model	V _{th} (V)
AD845	1	OPA606	0.49
EHA2525, HA2525	1	HA2548	0.13
TLO51	1	LT1007	0.05
AD744	0.96	OP27	0.05
OP44	0.86	HA5137	0.05
OP42	0.83	OP37	0.045
TLO71	0.72	HA5221	0.04
SSM2131	0.67	LT1028, 1115	0.036
LF351	0.54	NE5534*	0.036

*60 MHz effective GBWP assumed

TABLE 6 End-of-play scoreboard

Application	Foremost, Runner up
Quietest mic amp	SSM2016/2017, LT1028/1115
Fastest UGS buffer	AD845
Quietest UGS buffer	HA5221
Lowest THD op-amp	LT1028
Lowest THD line driver*	LT1028, HA5221, TLE2037
Highest V _{th} line level stage	AD845, EHA2525, HA2525, TLO51

*Driving into 600 Ω

loop linearity, as a maximum differential input voltage he calls V_{th}. V_{th} is ideally computed by dividing the input stage's emitter current (I_E) by its transconductance (g_m). It can equally be calculated with reasonable accuracy and without any internal knowledge of the black box, by dividing the slew limit by the gain-bandwidth.

$$V_{th} = SR / (2 \times \pi \times GBWP)$$

Table 5 shows what happens when op-amps are ranked by V_{th}. The high transconductance, bipolar-input types drop to the bottom of the list, with the Bi-FET types taking the lead. The ranking shows a strong correlation with successive subjective evaluations carried out by the author and colleagues over the past 7 years, notably when op-amps are driven at line (0 to +10 dBu) levels.

Settling times are most significant in DACs. Most of the fast DACs employed for audio have current (I) outputs. They could very well have voltage outputs, except the monolithic processes needed to fabricate a good op-amp are very likely incompatible with the processing steps for a DAC. In turn, the hazards of accurate I-to-V conversion are shifted over to the circuit designer. Rapid settling op-amps invariably

Abbreviations

GBWP: Gain Bandwidth Product
Mask Revision: Revision to an IC's circuit
NFB: Negative Feedback
UGS: Unity Gain Stable
Zo: Output Impedance

References

- 1 Ben Duncan, 'AMP-02 state-of-the-art preamplifier', Pts 1, 3, 4 & 5, *Hi-Fi News*, Oct 1989 to May 1990
- 2 Wilfried Adam, 'Designing low-noise audio amplifiers', *Electronics & Wireless World*, Jun 1989
- 3 Walt Jung, M L Stephens & C C Todd, 'Slewing induced distortion in audio amplifiers', Pts 1-4, *The Audio Amateur*, Feb to May 1977
- 4 Walt Jung, *Audio IC applications*, 3rd ed, Howard Sams, 1987

Further reading

- 1 J A S Angus, 'Open loop distortion of op-amps', *Proc IOA*, Vol 10, Pt 7,

1988

2 George Erdi, *Amplifier techniques for combining low noise, precision and high speed performance*, IEEE, 1981

3 George Erdi & Yury Cakhnokhi, *A Bipolar op-amp with noise resistance of less than 50 Ω*, IEEE international solid state circuits conference, 1986

4 R O Hamm, 'Tubes vs transistors—is there an audible difference?' *J AES*, May 1973

Acknowledgements

The author would like to thank the following for their assistance in researching and compiling this series:

Analog Devices Inc;
Burr-Brown Inc;
Terry Millward and Kevin Dale, Harris Semiconductor;
David Heaton;
Jerry Mead;
George Erdi, Linear Technology Corporation;
Dan Parks and Derek Bowers, SSM/PMI;
Harvey Reubens;
Steve Goacher, Texas Instruments.

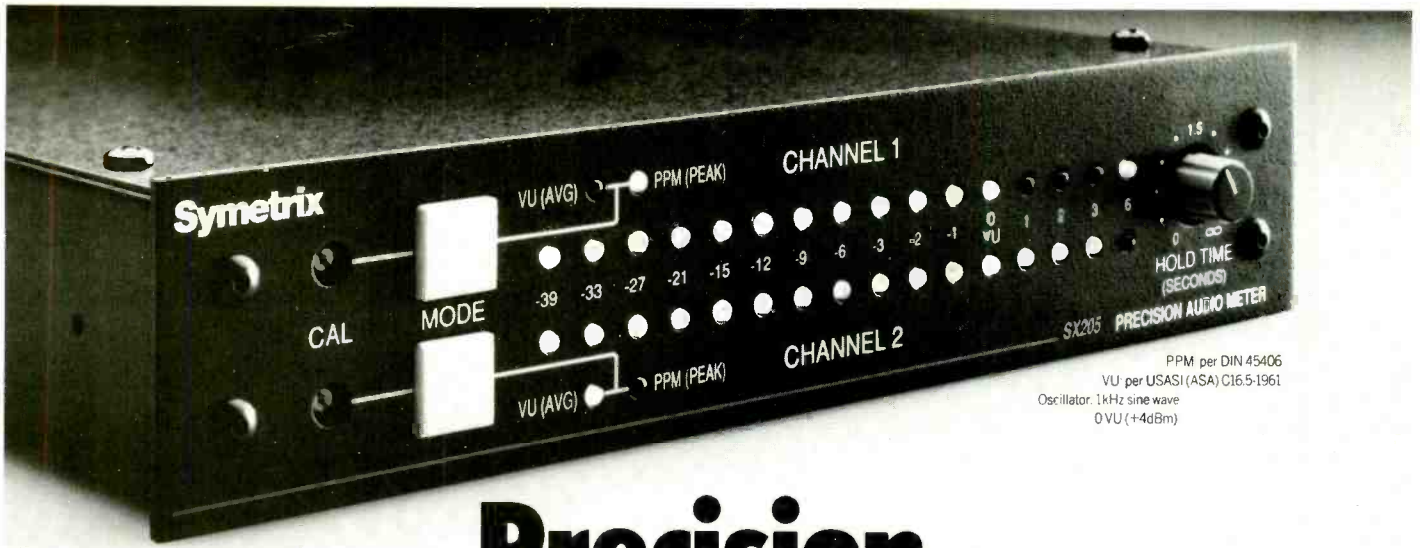

PPM per DIN 45406
 VU per USASI (ASA) C16.5-1961
 Oscillator: 1kHz sine wave
 0VU (+4dBm)

Precision.

The new reference standard. For CD mastering. Analog or digital recording. Concert sound and broadcast production.

Measure voltage and power. Pre-view levels with peak-hold time set to infinity. Measure peak-to-average ratio with concurrent PPM and VU displays.

Use the calibrated 1kHz oscillator to set the meter's line level 'zero' from -20dBv to +12dBv. Select a power 'zero' of 100W or 1,000W.

The microprocessor based SX205 Precision Audio Meter gives you repeatable 1/2dB accuracy. Please call or write for more information and a data sheet.

Symetrix

ignia processing at its best

International Representation:
 J.W.M. (M) Ltd.
 PO Box 115 • Swindon, Wilts
 SN2 1DA • UK

TEL: (0367) 52605
 FAX: (0367) 52614

In the UK:
 SOUND TECHNOLOGY plc
 17 Letchworth Point
 Dunhams Lane, Letchworth
 Herts, SG6 1ND UK
 TEL 0462 480000
 FAX 0462 480800
 Telex 826967 WILSON

Drawmer
Ingenuity

UNNERVING CAPABILITY

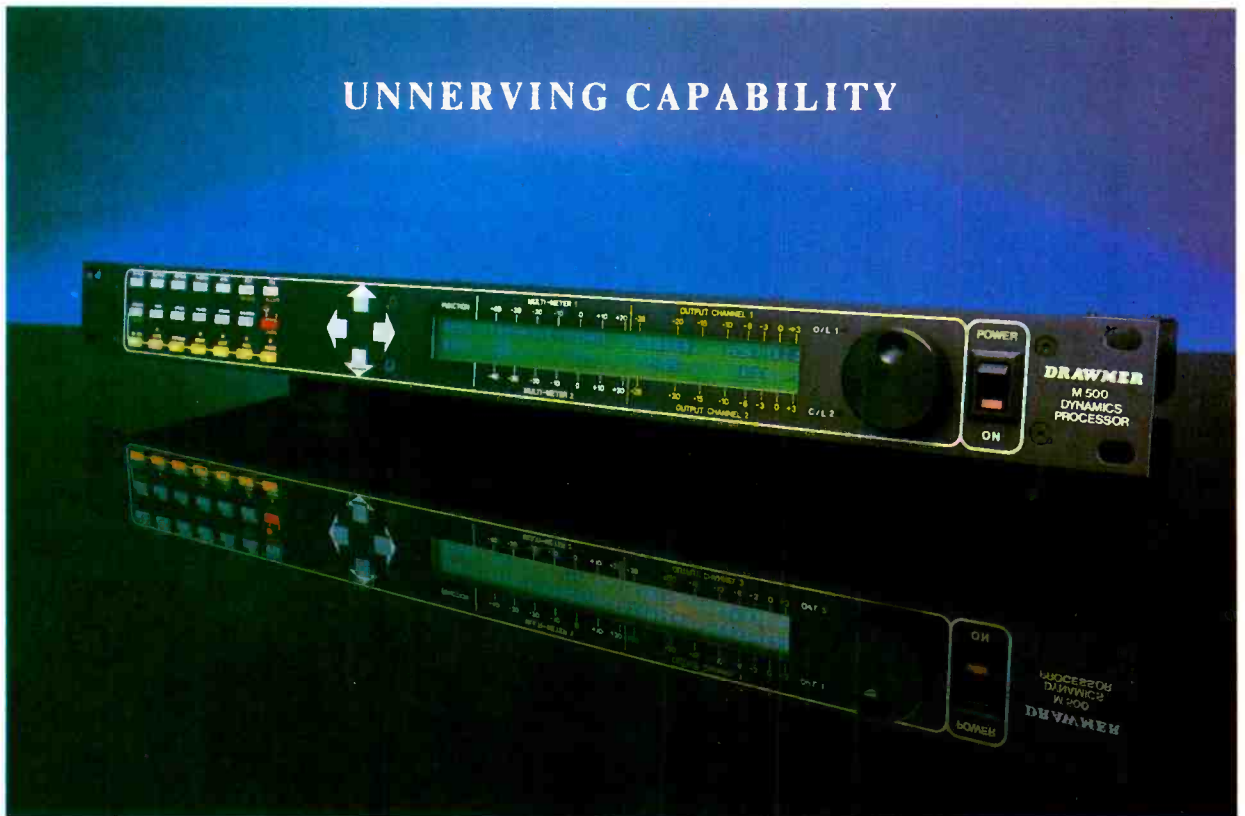

M500

DYNAMICS PROCESSOR — ALL YOU'LL EVER NEED

DRAWMER DISTRIBUTION CHARLOTTE ST. BUSINESS CENTRE CHARLOTTE ST. WAKEFIELD W. YORKSHIRE ENGLAND

TEL 0924 378669 TELEX 556649 FAX 0924 290460

FIXING IT OUTSIDE THE MIX

There are times when there is no alternative to mastering from a faulty stereo recording. Michael Gerzon describes a collection of practical techniques with available equipment that improve your chances of success

It is surprising how often defective recordings need to be released commercially. Perhaps it is a live stereo recording on cassette, or a straight-to-stereo digital recording with intermittent popping sounds, or the only surviving safety duplicate Japanese copy master of a long-lost classic recording that has developed a drop-out or flaky oxide on the right channel.

Maybe that classic once-in-a-lifetime performance only exists in a recording done on a personal stereo from the audience in a semi-illegal bootleg that the band was offered after the gig. Or an anonymous Dixon's cheapest cassette, in a misaligned domestic machine, taped from the PA desk as an afterthought. Or the technically beautiful stereo digital recording incorporating a technically perfect conversation on one side of the stereo image by a member of the audience about the outrageous price of beer at the venue during the climax of the gig.

Behind the industry facade of 48-track digital technical competence and solving all problems by expertise and wizardry, sad tales of sow's-ear recordings like this are commonplace. Often, such recordings are the ones that, for reasons of

historic importance, artistic excellence or uniqueness, need to be released on CD. Ask any mastering house how often such recordings are brought in needing a degree of 'fixing' to be acceptable for release and how often releases prove to be impossible. Fixing it in a mix is fine if one has a multitrack tape to mix from—but what about premixed stereo recordings with no multitrack fall-back in which the faults are inextricably already in the mix?

This article is about some techniques of fixing it outside the mix. Few mastering consoles are equipped with the facilities to do this properly—likewise most studios. Equipment designed for equalisation, processing and tinkering with multiple mono tracks is generally totally unsuitable for zapping faults buried in the middle of a complete stereo mix.

It is not my aim here to describe the use of well-known studio processes. Rather, we look at how to target faults that will respond to specific specialised treatments tailored to those faults. Nearly all these treatments involve subtractive or cancellation methods that cancel out faulty information from one part of a stereo mix by information taken from another part of the mix.

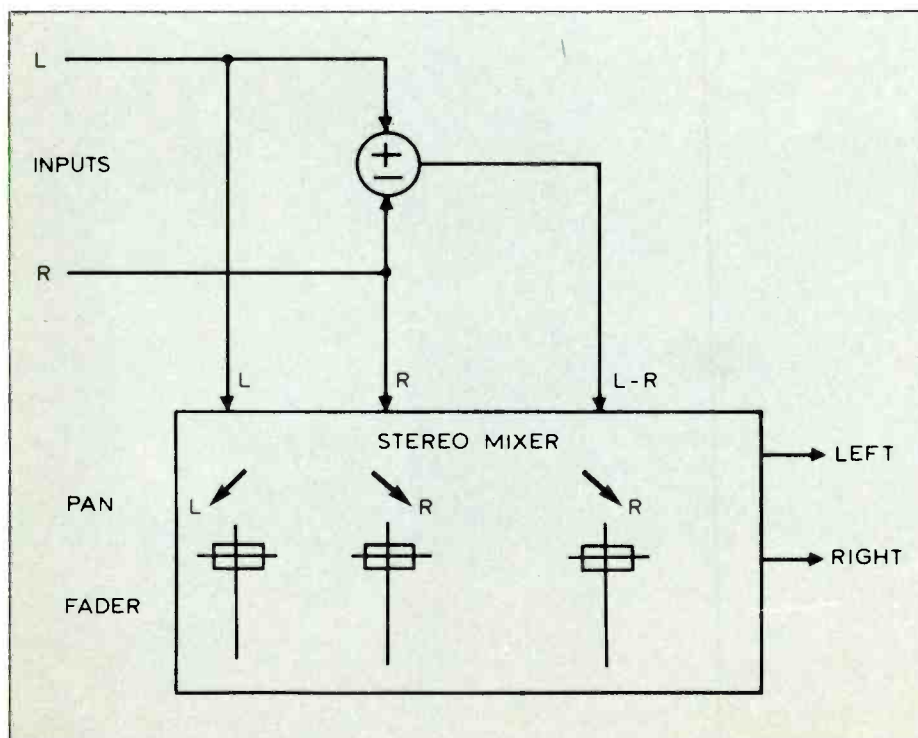

Fig 1: Processing a faulty right channel

Dodgy channels

One of the most common types of faults is a stereo recording in which one channel is OK and one is, intermittently or partially, faulty. There is a simple, if drastic, fix for such recordings—use the 'good' channel, and feed it to both left and right outputs. The result will be a technically good recording with no stereo effect and losing sounds predominantly in the faulty channel.

If the dodgy channel were sufficiently bad the whole time, then maybe this is all that can be done but, in most cases, there is still useful information from the dodgy channel that can be used to rescue some degree of genuine stereo effect.

Basically, we want to bring down the level of any fault in the dodgy channel to the point where the results are acceptable, while still preserving both the centring of the stereo and as much of the original stereoism as we can rescue. Also, if a fault is present or audible only some of the time, we want to have the full genuine stereo the rest of the time, with the ability to 'fade in' and 'fade out' the fault-removing processing only when needed.

The basic philosophy is 'if it ain't broke, don't fix it'. Any processing applied should be only to parts of the sound that need fixing, everything else should be left alone.

Suppose the left (L) channel is OK but the right (R) channel has a part-time fault. Then we want to crossfade between two situations: one in which the output stereo L_{out} , R_{out} is the same as the input stereo, ie

$$L_{out}=L \\ R_{out}=R$$

and the other in which the left input L is presented in mono at both outputs when R is totally unusable, ie

$$L_{out}=L \\ R_{out}=L$$

In order to crossfade between these two situations we put $L_{out}=L$ the whole time, and $R_{out}=R+k(L-R)$

where k is a gain that can be varied from 0 (for the original stereo) to 1 (for mono from the L channel). Alternatively, we could put

$$R_{out}=L+k'(R-L)$$

where the gain $k'=1-k$ varies from 1 to 0.

The basic processing setup required to crossfade between mono from the left channel input and true stereo is shown in Fig 1. Essentially, the left input L is fed to a channel of a stereo mixer and panned to left, the right input R is fed to a second channel and panned to right, the difference signal $L-R$ is derived by a subtraction network and fed to a third channel of the mixer, which is also panned to the right. The equalisers and faders on all three mixer channels are set to the same settings and levels. When the $L-R$ fader is at the same level as the other two faders, the right output becomes

$$R+(L-R)=L$$

and mono from the left input appears at both outputs. As the $L-R$ fader is pulled down, the output becomes the original true stereo.

Thus, varying the $L-R$ channel fader between the full level and zero allows a continuous crossfade between mono from the left input and full stereo. Because $L-R=0$ for mono central

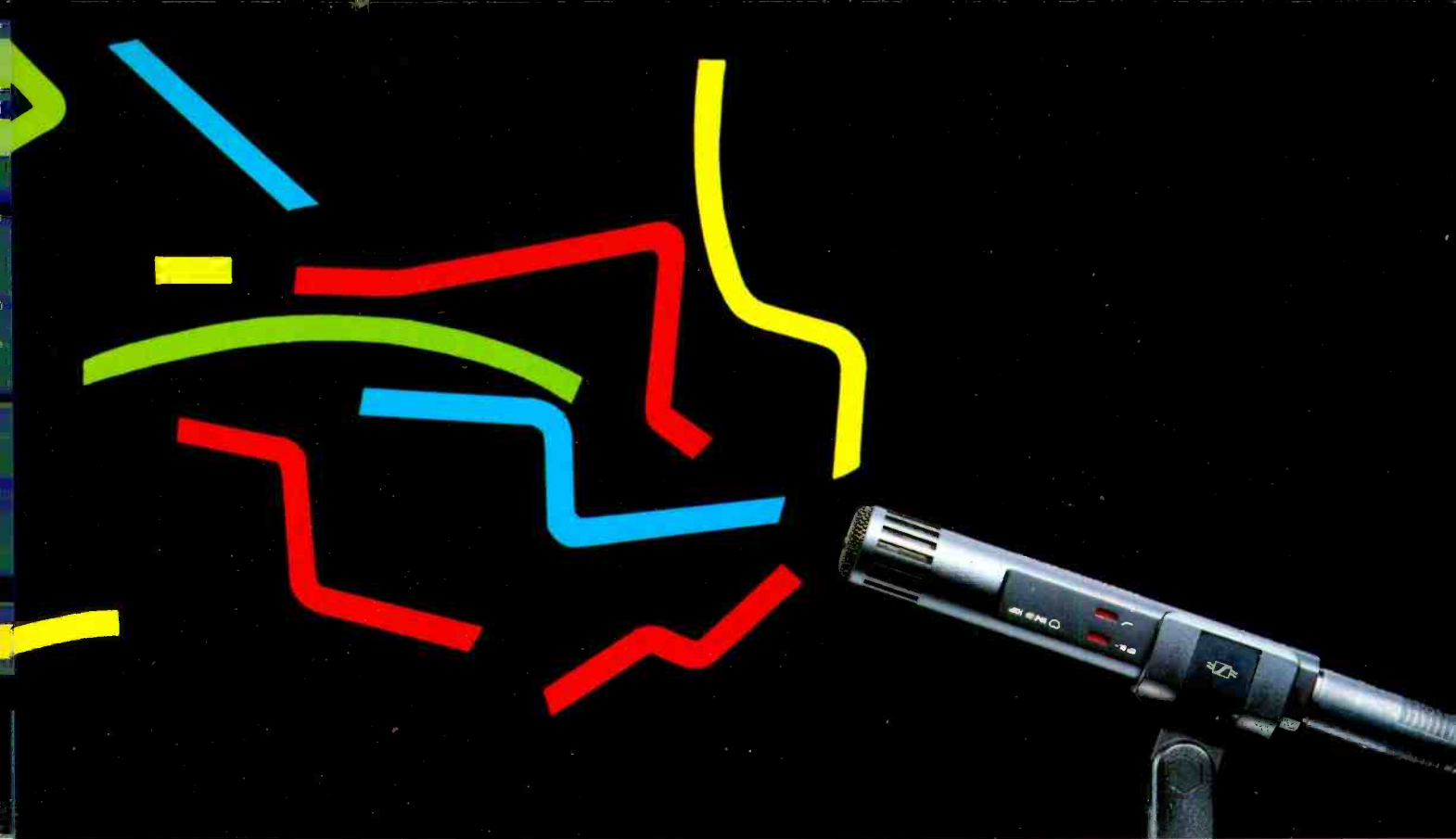

The Sennheiser MKH range of condenser microphones has been designed to capture sound with the detail and clarity demanded by today's advanced digital recording techniques.

The range which comprises omni, bilateral, cardioid and supercardioid and includes long and short shotguns features state of the art microphone technology. Use of a symmetrical push-pull transducer virtually

eliminates transducer distortion by creating a second identical air-gap acting in the opposite direction to the norm.

All the microphones possess an exceptionally low inherent noise level, high sensitivity, wide frequency response, and all still use the well-proven, Sennheiser-developed RF technology which gives remarkable performance under high humidity and moisture conditions. The MKH range is well suited to and widely used in a broad range of broadcast and music recording applications.

The MKH Range of condenser microphones firmly places Sennheiser at the leading edge of microphone technology.

For literature and technical specifications of the MKH range contact Hayden Pro-Audio.

SOUND AS AN ART FORM



SENNHEISER

**Hayden
Pro-Audio**



CHILTERN HILL
CHALFONT ST. PETER
BUCKS SL9 9UG
TEL: (0753) 888447
FAX: (0753) 880109

More Power To You

FET-1000, FET-1500, FET-2000. Introducing the latest series of professional power amplifiers from Ashly, featuring more models, with more power, than ever before. From movie theaters featuring the sonic excellence of Lucasfilm's THX™ sound reproduction systems to outdoor stadium events covering well over 80,000 satisfied audio enthusiasts, Ashly amplifiers have developed a solid reputation for rock steady performance and near-perfect reliability. And now that legendary Ashly power advantage is available in even more configurations to meet the needs of any amplification situation.

Ashly amplifiers utilize Power MOS-FET Technology to achieve superior overload and square wave response, with no ringing or unwanted transients that degrade program material. Ashly amplifiers are stable into virtually any load and deliver full output even under the most demanding circumstances. Unrestrained, uncolored sound reproduction with remarkable accuracy is assured by choosing Ashly for all your power needs. All Ashly amplifiers are now backed by our exclusive **Five Year Worry-Free Warranty**.

**RATING
ASHLY'S
FET SERIES**

MODEL	PER-CHANNEL WATTS		TOTAL WATTS MONO-BRIDGED
	STEREO	8Ω	
FET-2000	300	300	1000
FET-1500	200	200	600
FET-1000	150	150	380

EIA Specification

**5
YEAR
WARRANTY**

**UL LISTED 35E5
COMMERCIAL
SOUND EQUIPMENT**

ASHLY

Lucasfilm
and THX are
trademarks of
Lucasfilm Ltd.

Ashly Audio Inc. 100 Fernwood Ave. Rochester, NY 14621
Toll Free (800) 828-6308 In NYS (716) 544-5191
In Canada: Gerraudio Dist. 363 Adelaide St. E. Toronto, M5A 1N3 (416) 361-1667



BEHRINGER®

It is not often that new products arrive which are of such exceptional quality that every single item carries a full 5-YEAR WARRANTY. We guarantee you won't find better value. Call us now for full colour brochure.

STUDIO EXCITER TYPE F.....	£225.00
PROFESSIONAL EXCITER TYPE F, XLR's, +21 dBm.....	£280.00
STUDIO DENOISER, 8 CHANNEL, JACK.....	£450.00
PROF. DENOISER, 8 CHANNEL, XLR's, +21 dBm.....	£570.00
STUDIO DENOISER, 2 CHANNEL, JACKS.....	£210.00
PROF. DENOISER, 2 CHANNEL, XLR's, +21 dBm.....	£245.00
STUDIO COMPRESSOR/LIMITER, JACKS.....	£315.00
PROFESSIONAL COMPRESSOR/LIMITER, XLR's.....	£350.00
BEHRINGER 5-BAND PARAMETRIC EQUALISER.....	£350.00
MULTIBAND DENOISER.....	£690.00
MULTIBAND EXPANDER/GATE.....	£690.00
PROFESSIONAL HEADPHONE AMPLIFIER.....	£340.00
STUDIO GATE.....	£315.00
PROFESSIONAL GATE.....	£350.00
SOUND MACHINE EXCITER/PREAMP.....	£135.00
BALANCED O/P T/F/M'R (FOR PRO MODELS).....	£52.00

- PROFESSIONAL MODELS ARE XLR BALANCED INPUT
- STUDIO MODELS ARE JACK CONNECTORS

Fostex The New G16

Superb new 1/2", 16-track machine, with detachable front control panel, designed for the future. Many features controllable from the desktop. It features extensive mechanical and electronic re-design, over its predecessor, the enormously popular E16. Optional built-in synchroniser to feed SMPTE to an external machine, or to read, chase and lock to time code at high speed. Plus the G16 will respond to MIDI time code if required. Can be linked to external computer and software.

Synchronisers and accessories available

AKAI ADAM DR1200 & THE NEW DD1000

DR1200 — (Akai Digital Audio Multitrack) 12-channel digital recording onto 8mm video cassette, r/c auto locator and meter units.

DD1000 — Optical Disc Recorder — up to 50 minutes (25m/disc side) stereo recording at max 48kHz bandwidth, for digital mastering, editing, AV post production. Together they represent the very latest in recording technology. And you can see them here. We offer very favourable new lease purchase terms on recorder/console packages. You may be surprised to find the system is technically AND financially more attractive than you thought. Call for demonstration appointment.

E-mu Emax II

Giving you sounds so dynamic, they're alive, with 32 audio channels, 8 Polyphonic outputs with integral effects sends/returns, and an arsenal of 16 bit DSP functions.

PROTEUS/2 AVAILABLE NOW — 8MB of superb 16-bit sounds from the Emulator III library + onboard digital waveforms for limitless sound creations. 32-voice polyphony, 16 channel multi-tilrality, 6 polyphonic outputs. Integral effects send/returns and "one of the clearest and most straightforward user interfaces on any programmable electronic musical instrument."

TANNOY MONITOR SERIES

A completely new range from Tannoy. Rugged cabinet styling, superb spec and a 5-year warranty. You really should find out more...

- 2 NFM 6.5" DRIVER, 150 WATT
- 8 NFM 8" DRIVER, DUAL CONCENTRIC 200W
- 10 DTM 10" DRIVER, DUAL CONCENTRIC 250W
- 12 DTM 12" DRIVER, DUAL CONCENTRIC 450W
- 15 DTM 15" DRIVER, DUAL CONCENTRIC 600W
- 215 DTM 2x15" DVR DUAL CONCENTRIC 750W

Soundcraft 6000

... Simply the most comprehensive production console in its class... with enough busses and routing options to make adventurous production a pleasure rather than a chore...

DELTA 200

Its combination of new technology and the Series 200B heritage provides unrivalled facilities for anyone who needs professional standards in a compact console. A modular system providing the potential to use the console as a straight stereo mixer, or to choose a configuration using up to four group modules. Frame sizes available 8, 16, 24 or 32 channels giving unparalleled versatility.

AMPSOUND

PRICES EXCLUDE VAT. LEASE PURCHASE AVAILABLE. PLEASE CALL FOR NEW & EX-DEMONSTRATION LISTS 153A VICTORIA STREET, ST ALBANS, HERTS AL1 3TA TELEPHONE 0727 50075 ★ FACSIMILE 0727 58977

WE SUPPLY ACORN, ACOUSTIC ENERGY, AWA, AKAI, AKG, ALLEN, ALLEN & HEATH, AMPEN, APHEX, ASHLEY, ATARI, BEHRINGER, BNS, CABLE & CONNECTORS, CANON, CROW, CRY-DAT, DENON, DRAWMER, E.A.R., FOSTEX, HARRIS, INSTALLATIONS, JBL, KORG, MIDI SOFTWARE, MTR, NEUTRIK, OMNIPHONICS, ONSITE ENGINEERS, OTARI, RACKING, REVOX, ROLAND, SENNHEISER, SERVICE, SHURE, SONNIFEX, SOUNDRAFT, SOUNDTRACKS, STUDER, REVOX, STUDIOMASTER, SWITCHCRAFT, SYSTEMANNING, TANNOY, TASCAM, TC ELECTRONICS, TDK, TECHNICS, THALES, UREI, YAMAHA AND MANY MORE!

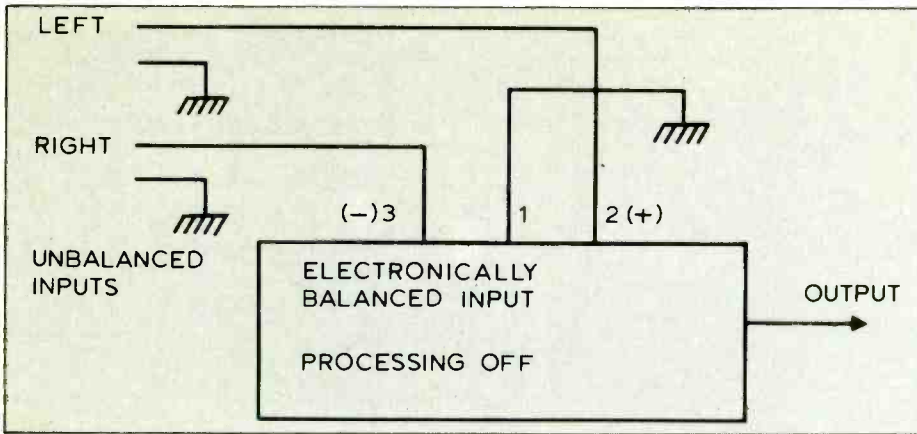

Fig 2: Use of equipment with an electronically balanced input as a subtraction network

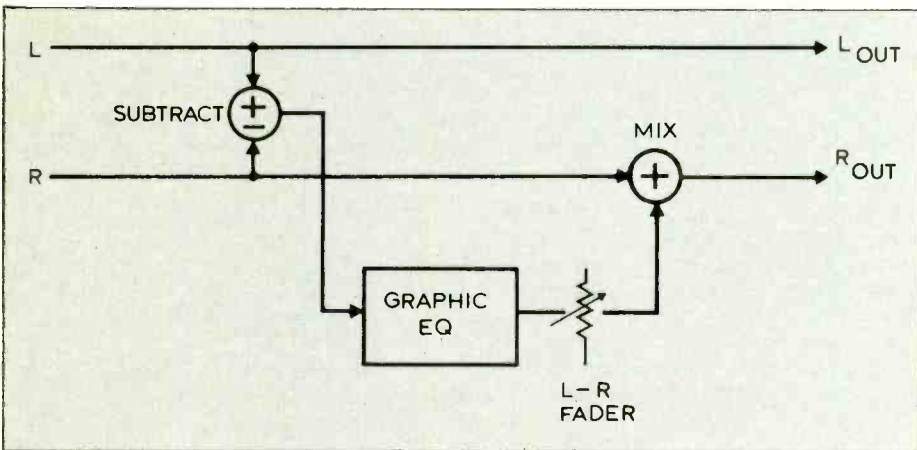

Fig 3: Inserting a graphic equaliser into the L-R path of Fig 1

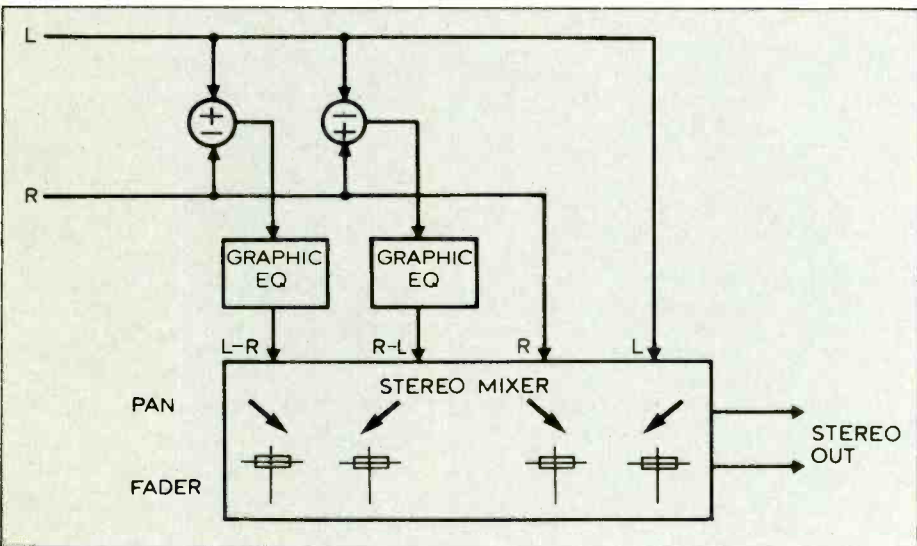

Fig 4: Processing for cancelling faults in the left or right channels

images at the input, operation of this fader has no effect whatsoever on the level or position of central mono images. Since most stereo programmes have the most important sound sources panned near centre, this means that operating the L-R fader gives minimal disturbances of the overall sound when crossfading is needed.

You may or may not realise it but your studio is likely to be full of subtraction networks that can be used in the arrangement of Fig 1. Every electronically balanced input to a piece of studio gear is effectively a subtraction network for the unbalanced signals going to the 'hot' and 'cold' sides of the balanced input. Thus, for example, the left input could be fed to pin 2 or the hot side

of such an input, and the right input could be fed to pin 3 or the cold side of such an input (or *vice-versa*, depending on the signal polarity of the equipment) with the processing of the piece of equipment switched off or bypassed. I use a spare channel of Symetrix 544 with the gate/expander switched out as a subtraction device (see Fig 2).

One may have to wire-up special leads or adaptors to derive the unbalanced feeds and to feed them to the two sides of an electronically balanced input. Also, one must use equipment that has unity gain and little phase shift in the audio band when its processing is switched out so the cancellation of L-R with R works well across the audio band. Also note that one should beware of 6 dB gain differences that can be caused in

Fig 1 if some signals are fed to the mixer in unbalanced form and some in balanced form. The acid test is to ensure, with the L-R fader at the same level as the other two, that a right-only input is cancelled out at the right output. Otherwise, one has to use a '0 dB reference level' for the L-R fader that differs by 6 dB from the other two.

If a fault on the right input is intermittent, one can fade the L-R fader up shortly before the fault starts and down again after it ends to preserve stereo for as much of the time as possible. Also, if the fault is at a lowish level, by fading up the L-R fader to a slightly lower level, one can preserve some of the stereoism while reducing the level of the fault significantly. Since the fading action is smoothly continuous, one can control the degree of processing in realtime, rather than having to edit between two dubs. It helps to have the master being processed in a form that has a precision time read-out so that the crossfades can be rehearsed.

A rather more sophisticated version of this processing is possible if the faults on the right channel only affect some frequencies. For example, a recording might have excessive hiss or rumble only in the right channel, or the interference or unwanted audience noises might be concentrated over a fairly well-defined frequency range, or the drop-outs might only affect the higher treble frequencies with little effect on bass frequencies. These are all quite typical situations encountered with faulty material. All one does is insert an equaliser (eg a graphic equaliser) in the L-R signal path of Fig 1, giving the schematic in Fig 3.

The equaliser used should be such that, when set out flat, it should have virtually no effect on polarity, amplitude or in-band phase response on the audio signal passing through it. (Digital equalisers invariably incorporate large time delays and so are totally unsuitable here. Also beware of polarity-inverting equalisers and of equalisers incorporating non-switchable lowpass and highpass filters, since these spoil the phase response at the flat setting.)

When set to flat, the modification of the right channel works just as before but if one cuts some frequencies on the graphic equaliser, the processed output reverts to stereo at those frequencies. For example, if one wishes to 'monoise' faulty treble frequencies only, then the bass frequencies on the equaliser should be cut. In practice, graphic equalisers are particularly suited for 'tuning' quite precisely what frequencies are monoised from the left input and what are allowed to remain in true stereo.

In general, only the most audibly disturbing frequencies should be highly processed. For example, if the problem is excessive hiss in the right channel, it may be enough to use the graphic to allow through a narrowish frequency band around 8 kHz, leaving both lower and higher frequencies (which contribute less to the audibility of hiss) in true stereo. Also, in passages where the fault is absent or masked by the wanted information, the L-R fader can still be pulled down to restore the original stereo at all frequencies.

Fig 4 shows a version of the processing that can be used to 'tune out' faults in the left or the right channel, using an R-L signal path panned to the left to provide a similar cancellation when the faults are in the left channel. Although, in general, faults in both channels at the same time are much more difficult to deal with, Fig 4 does allow processing of faults in one frequency band on the left channel while other faults in a non-

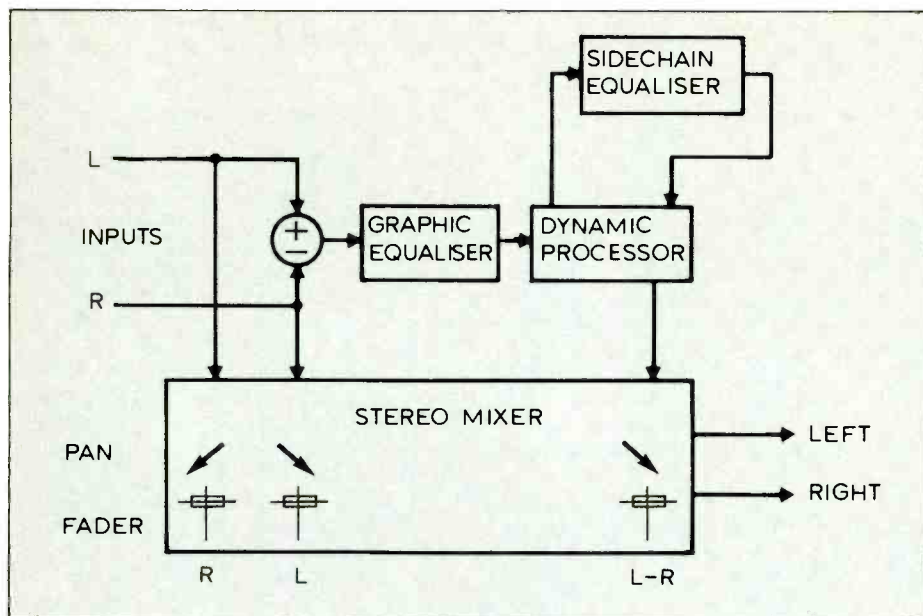

Fig 5: Removing R channel faults with dynamic processing of the L-R signal

overlapping frequency band occur on the right channel. This does not happen very often but Fig 4 allows processing of recordings where faults occur in both channels at different times without the need for any switching or rewiring.

More advanced stuff

The 'cancellation' processing for faults in one channel only as described above, where faults in say R are cancelled out by mixing it with variable amounts of L-R, can be extended to more sophisticated processing. For example, suppose that the fault is audible only at low levels and is masked by the wanted signal at higher levels. In this case, one wishes to switch off the processing at high levels. For example, one might have a low-level buzz, crackle, hum, rumble or hiss in the right channel that is masked when the music gets loud.

In this case the procedure is to insert a limiter in the L-R signal path of Fig 1 or Fig 3, with the usual provisos about the limiter being non-inverting with little phase shift in the audio band and having unity gain below the limiting threshold. Then, above the preset threshold level, the L-R signal is, in effect, attenuated, leaving a substantially full stereo effect without any cancellation. Only at low levels when L-R is below the threshold level will the partial (if a graphic is used) or total (if no graphic is used) cancellation of the R channel occur to a full extent.

This way, for example, one can tune the graphic equaliser to remove only the most audibly disturbing part of a buzz on the R channel, and then set the limiter threshold to remove the processing at higher music levels, leaving a minimally processed signal in which the buzz on the R channel is audibly suppressed. If the limiter is placed after the graphic equaliser, as in Fig 5, it will respond predominantly to music energy in the same frequency band as the frequencies of the buzz that is being suppressed, which are those components that will tend to mask the buzz best. An additional sidechain equaliser for the limiter, as shown in Fig 5, can emphasise the effect of those specific frequency components further—I have found that connecting the two channels of a consumer stereo graphic equaliser in series (with an attenuator between the two to prevent

overload) is necessary to achieve a sufficient boost of some frequencies and attenuation of others in such a sidechain equaliser, where emphasis of the desired band by up to 50 dB can be needed for best results.

The arrangement of Fig 5 can also be used to perform the reverse trick of getting rid of high-level occasional thumps or bangs in the right channel but replacing the limiter by a noise gate. In this case, one wishes to switch off the L-R signal except when the thump occurs. This is done by using a noise gate with a rapid attack time in the L-R path with the threshold set so the gate is permanently in the 'off' state except when the high level thump signal occurs. Since any central mono information is absent in L-R, the music-signal level it contains will often be quite low, making it easier to detect the presence of high-level thumps or bangs.

When such thumps or bangs do not have a much higher level than the music signal this processing becomes more difficult but two things can help increase the chances of it working. One is to use a sidechain equaliser for the noise gate that is flat at most frequencies (so that the start of the transient of the bang or thump is responded to fast) but with the highest-energy music signal components, ie those below 1 kHz, attenuated. The other thing one can do is use an expander rather than a gate, which gives a smoother transition between stereo and mono from the left channel at high signal levels, at the expense of a tendency for the signal to monoise during high level music. However, this problem can be minimised by manually adjusting the expander threshold immediately before and after each thump or bang.

The above examples should by now have given a general idea of how faults in only one channel can be processed away and only at frequencies and signal levels at which they are troublesome. Obviously, I can't cover all possible faults of this kind that might be encountered, but the general principles of processing *only* the L-R signal to cancel out faults in the R channel should allow many other cases to be dealt with without any disturbance of the central part of the stereo stage. It does not seem generally realised by recording and mastering engineers that processing of the difference signal L-R or R-L is the way to deal with faults on only one of the two stereo channels—but any processing that is to avoid

TASCAM European Distributors

Hi-Fi Stereo Center Kain
Muenchner Bundesstrasse 42,
5013 Salzburg,
AUSTRIA.
Tel: (0662) 37701

Beltronics
Rue de la Celidee Straat 29,
1080 Brussels,
BELGIUM.
Tel: (32) 2 424 0233

So and Hoyem A/S,
Bulowsgarden,
Bulowsvvej 3,
1870 Frederiksberg C,
DENMARK.
Tel: (031) 22 44 34

Studiovox Ky,
Atomitie 5C,
SF-00370 Helsinki,
FINLAND.
Tel: (80) 562 3411

Teac France Sa,
17 Rue Alexis de Torqueville,
92182 Antony,
FRANCE.
Tel: (01) 4237 0102

Elina SA,
59/59A Tritis Septemvrius St.,
Athens 103,
GREECE.
Tel: (01) 8220 037

Greenlands Radio Centre,
PO Box 119,
3900 Godthab,
GREENLAND.
Tel: 299 21347

GBC Italiana spa,
Viale Matteotti, 66,
Cinisello Balsamo, Milan,
ITALY.
Tel: (02) 618 1801

Hjodriti — Hot Ice,
PO Box 138,
Hafnarfirdi,
ICELAND.
Tel: (01) 53776

AEG Nederland NV,
Aletta Jacobslaan 7,
1066 BP Amsterdam,
NETHERLANDS.
Tel: (020) 5105 473

Audiotron A/S,
Seidduksgt. 25,
PO Box 2068 Grunerlokka,
0505 Oslo 6,
NORWAY.
Tel: (02) 352 096

Goncalves,
Avenida 5 de Outubro, 53, 1,
Lisboa 1,
PORTUGAL.
Tel: (01) 544029

Audio Professional SA,
New address for contact:
Auprosa,
Francisco Tarrega, 11,
08027 Barcelona,
SPAIN.
Tel: (93) 340 2504

Erato Audio Video AB,
Asogatan 115,
116 24 Stockholm,
SWEDEN.
Tel: (08) 743 0750

Telion AG,
Rutistrasse 26,
CH. 8010 Zurich,
SWITZERLAND.
Tel: (01) 732 1511

Teac Deutschland GmbH
Bahnstrasse 12,
6200 Wiesbaden-Erbenheim,
WEST GERMANY.
Tel: (06121) 71580

TASCAM



SERIOUSLY PROFESSIONAL

In recent years DAT has assumed a central role in professional stereo mastering. Until now, however, many studios wishing to enjoy the undoubted benefits of DAT recording technology had little choice other than a modified domestic unit.

Now TASCAM, one of the worlds leading manufacturers of digital and analogue tape recorders introduces the DA-30 Digital Audio tape recorder which has been designed specifically for the sophisticated needs of professional audio applications.

Our commitment to recording quality means that the DA-30 carries, as standard, features that on many machines either require modifications or are expensive options:

ADS/EBU and S/PDIF Digital Interfaces allowing direct connection to digital equipment from multitracks to domestic CD players.

44.1 and 48 KHz sampling rates (front panel switchable) and 32 KHz (digital input only)

1 Bit ($\Delta \Sigma$) A/D technology and 18 Bit 8x oversampling D/A converters for superior audio performance

Margin feature displaying the headroom remaining in dB

15 pin parallel interface, allowing external control of the DA-30's transport

Wired remote control

So, to get a serious professional in your studio, call into your local TASCAM dealer today.

TASCAM
the right track

The Medici Equalizer

"As the complexity and scope of modern recordings increases the essential need to define clarity, presence and naturalness in key sounds has become paramount.

Digital recording technology, advanced noise reduction techniques and the extensive use of Dynamics processing has done much to eliminate unwanted and residual signals.

Much less thought has gone into creating devices which can be used to enhance the inherent quality of signals, particularly through the medium of analogue processing which is still unsurpassed in the finesse and subtlety of its capabilities and probably will remain so into the next century.

Throughout my career I have been dedicated to obtaining what I regard to be the ultimate in equalization. The circuitry required to reach such a result cannot be separated from the highest standards in noise and distortion performance.



MR RUPERT NEVE

The Medici Equalizer is my newest creation. The curve shapes, slopes and turnover frequencies have been chosen most carefully, the result of many years experience, of listening to and serving the needs of top producers and engineers in the professional recording and music industry. My new Warmth control, as the name suggests, adds that elusive quality of fullness and presence without colouration.

On top of this accumulated knowledge, a years' further research and design work has gone into the development of this product. However the enthusiastic backing and resources of the AMEK team, who developed the digital control elements, was indispensable in bringing this product into being.

As a result, we believe the Medici Equalizer provides the most powerful yet subtle and musical sounding creative tool yet available".

The Medici Equalizer is manufactured in the UK by AMEK

Head Office, Factory and Sales: Amek Systems and Controls Ltd., New Islington Mill, Regent Trading Estate, Oldfield Road, Salford M5 4SA, England. Telephone: 061-834 6747. Telex: 668127. Fax: 061-834 0593.
AMEK/TAC US Operations: 10815 Burbank Blvd, North Hollywood, CA 91601. Telephone: 818/508 9788. Fax: 818/508 8619.



Medici

AMEK

disturbing the centre of the stereo stage must process only that signal that is always zero for such central stage images. The trick in all this processing is in how the processed L-R signal is mixed back into the stereo.

The processing described so far is certainly not the end of the story—just the start. Before looking at still more advanced tinkering, let's have a look at what can go wrong with what I have described so far.

Problems

The central images remain unaffected by the above processing because it only affects L-R, which equals zero for such images. However, this only applies if the two channels have substantially the same amplitude and phase response. With poorly adjusted analogue media, or with digital media without CTC correction, or with microphone techniques that are not precisely coincident or with mismatched microphones, this is not going to be the case. If there is a time delay between left and right, eg due to an azimuth error on tape or cassette, then L-R is no longer zero for central sounds and there will be some comb-filter colouration in the right output channel when the L-R gain k lies between 0 and 1.

One moral here is the need to adjust tape azimuth (and, in the case of copy tapes that may already incorporate recorded interchannel errors, the interchannel time delay) carefully before using the above processing, so as to maximise the cancellation of central sounds in the L-R signal. It should also go without saying that it is important to make sure that the two channels are not out-of-phase before processing. It helps to be able to monitor the L-R and L+R signals separately, or to examine the stereo signal on an XY oscilloscope display (or a similar display such as *The Box* or a phase meter).

Even when there are no interchannel gain or phase errors, a second problem is that the above processing causes a loss of stereo width, since whenever a fault occurs in the (say) right channel, the result tends towards mono derived from the left channel. In the extreme case when the right channel is being totally suppressed, such a reversion to mono is inevitable but there is no reason why we should accept the degree of loss of width that occurs when the right channel is only somewhat reduced rather than suppressed altogether.

Consider, for example, the case where a right channel defect is reduced by 6 dB rather than totally suppressed. This is the case for $k=1/2$, for which

$$L_{out}=L \\ R_{out}=R+\frac{1}{2}(L-R)=\frac{1}{2}L+\frac{1}{2}R$$

Here, any wanted sound on the right at the input still comes from the right (at a level of -6 dB) at the output, and any central sound $L=R=M$ still comes from the middle (with unaltered level) at the output. However, a sound coming from the left at the input now emerges (at a level of about +1 dB) from the output panned only about a third of the way over to the left, since $L_{out}=L$ and $R_{out}=1/2L$.

The subjective effect of this quite severe narrowing of the left side of the stereo image is a definite marked loss of stereo width. This loss of width can be compensated for by following the processing by a width control to increase the width again. Width control will be discussed more later but there is a simple trick to achieve an increase of width in the above situation without the use of any additional signal processing.

The trick is to pan the position of the L-R signal in Fig 1 to a position between right and centre, rather than to hard right as shown. This has the effect of introducing some antiphase crosstalk of the right input onto the left output, which has the effect of increasing the width at the expense of preventing a complete cancellation of the R signal at the full L-R fader gain. The operation of the panning of the L-R signal to half-right is not altogether obvious without looking at a detailed worked example.

By way of example, suppose the panpot has a constant power law, and the L-R signal is panned to half-right. Then the L-R signal is fed to the left output with gain $0.38k$, and with gain $0.92k$ to the right output, where, as before, k is the gain of the L-R fader. This gives

$$L_{out}=L+0.38k(L-R)=(1+0.38k)L-0.38kR \\ R_{out}=R+0.92k(L-R)=0.92kL+(1-0.92k)R$$

For example, if the L-R fader gain is -5 dB (ie $k=0.562$), then

$$L_{out}=1.22L-0.22R \\ R_{out}=0.52L+0.48R$$

which cuts the R gain by -5.6 dB and boosts the L gain by 2.4 dB. This also positions the L input rather further over to the left than before, and positions the R input beyond the right loudspeaker at the output due to the antiphase crosstalk of R onto the left output. This results in a wider overall image than before while still cutting the level of the R signal in the output.

Thus, although panning the L-R signal towards the centre prevents a complete cancellation of the R signal, it does allow an increased width when one only needs to reduce the R level to tame a fault rather than to eliminate it altogether. In general, when the L-R panpot is set to a position partway to the centre, the best subjective cancellation will be at a fader setting k less than the full gain $k=1$. For the half-right case considered above, setting k to a maximum of about -5 dB gives the best cancellation.

Do You Know these terms?

Monitor — a reference loudspeaker system for the mixing and mastering of recorded music.

Standard — a reference from which qualitative judgements can be made.

Tracks — (noun) channels on a multi-track recorder (verb) accurately reproduces the audio qualities of another transducer.

Monitor Standard™ — a close-field recording monitor system from RADIANT. *The only one which accurately tracks large recording monitors.*

What does all this mean?

RADIANT's new MM-8 Systems are the only close-field monitors to utilize *full-sized compression drivers*.

RADIANT's new MM-8 Systems reproduce explosive transients with clarity and ease. *No more distortion or break-up* from fragile domes and cone tweeters.

RADIANT's new MM-8 Systems provide *coherent, point-source* sound for superior stereo imaging.

RADIANT's new MM-8 Systems eliminate the "sweet spot." Their ultra wide-angle (120°) dispersion delivers *the same tonal balance* to everyone seated at the console.

Call, Write or Fax for Detailed Information

RADIANT
AUDIO ENGINEERING, INC.

4520 Eisenhower Circle, Anaheim CA 92670 USA TEL: 714 693-9277 FAX: 714-693-9278

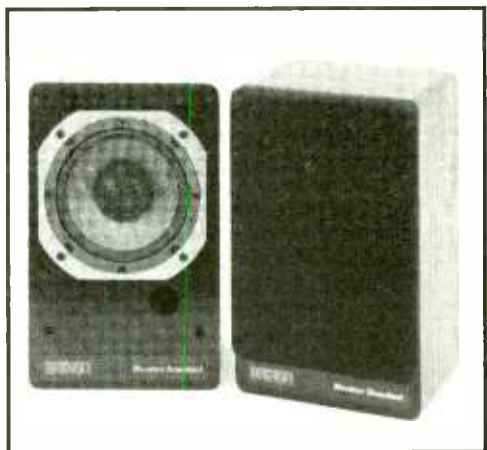

Model MM-8

One can still use all the techniques described—varying the L-R fader setting and using a graphic equaliser or dynamic processor to fade the reduction of the R-channel fault in and out. While this will no longer permit a complete cancellation of any R channel fault, it does permit a reduction of the fault still without affecting central images (since $L-R=0$ for such images) and with a reduced effect on the stereo width as compared with the processing described earlier. One now sets the L-R panpot position to achieve the desired maximum degree of R cancellation before switching in the other processing.

There is a bonus in panning the L-R signal partway to the centre. Earlier, I mentioned that timing or phase errors between the two channels, which are inevitable with some microphone techniques, caused comb filter colourations when k lies between 0 and 1. However, the effect of putting some antiphase crosstalk of R onto L is to cause the comb filter colourations on the two channels to be complementary, ie frequencies cut on one channel are boosted on the other and *vice-versa*, thereby making them much less audible. In particular, panning the L-R signal to half-right, and changing the L-R fader gain anywhere between zero ($-\infty$ dB) and -5 dB causes little colouration even when applied to stereo made with microphones having a significant spacing.

Besides its use in reducing faults on one channel, this kind of processing is equally applicable to altering the level balance between the left and right sides of a stereo image without affecting central images either in level or position. This kind of 'asymmetry control' is subjectively a better way of altering left/right level balance than ordinary balance controls when the problem is not caused by channel gain errors but by prior misjudged mixing decisions or by a natural imbalance of sound levels arriving at a well-adjusted stereo microphone. In particular, asymmetry control does not cause the 'lop-sided' ambience reproduction of natural acoustics when an ordinary balance control is used with a stereo microphone.

One application of asymmetry control is to reduce unwanted live sounds on one side of the stereo stage while still giving a reasonable portrayal of ambience.

To summarise the above, asymmetry control to reduce sounds from the right stereo channel can be achieved by using the arrangement of Fig 1 but setting the L-R pan control to half-right position and the L-R gain between zero ($-\infty$ dB) and -5 dB of the level of the left and right faders. Selective asymmetry control of only some frequencies can be achieved by inserting a (non-inverting) equaliser in the L-R signal path.

Faults on the left channel can be similarly controlled by using an R-L signal panned to half-left.

Crossfade techniques

The above techniques of reprocessing faults in one stereo channel are special cases of more general 'crossfade' reprocessing techniques that have many other uses. To consider the general case, suppose that a mono or stereo signal is to be reprocessed in two possible ways, which I shall refer to as A and B. A might consist of no processing whatsoever, whereas B might, say, consist of equalisation or dynamic processing, or something more complicated such as feeding the left input to both stereo outputs. Then often we wish to be able to crossfade for results between those of processes A and B. One way of doing this, shown in Fig 6a, is to have two sets of faders, one for A and the other for B, carefully matched and ganged so that their combined gains add up to unity at all settings, and to mix the resulting outputs together. Especially for stereo signal processing, this involves a largish number of ganged faders.

The same result can be achieved rather more simply as shown in Fig 6b, using the fact that $B=A+(B-A)$. Thus, as the fader gain k varies between 0 and 1 in Fig 6b, the output becomes

$A+k(B-A)=(1-k)A+kB$, which smoothly crossfades between process A and process B.

The technique of Fig 6b is widely useful for adjusting the degree of processing smoothly but does depend on processes A and B being generally matched in level polarity and phase so that the crossfading does not produce unwanted cancellations or comb-filter colourations. There are many different applications of the technique in Fig 6b that are useful in reprocessing and remastering applications, hopefully examples given will evoke other applications.

For example, if a signal requires a complicated equalisation for some of the time but should be flat at other times, then making A a straight-wire connection and B an equaliser (with the usual no inversion and no time-delay requirements satisfied) set to the required complicated equalisation allows a crossfade between flat (fader at zero) and full equalisation (fader at gain 1) without having to adjust 10 or 20 separate equalisation controls at the same time. This is very useful when a problem requiring corrective equalisation (eg hiss or an occasionally dominant badly-equalised instrument) varies in level from moment to moment, since one can continually vary the adjustment with one finger.

Also, the level adjustment need not be manual but can be via a dynamic signal processor. For example, in Fig 7, A is a graphic equaliser, B is a straight-wire connection, and the 'fader' is an expander with unit gain above its threshold. At low signal levels, when the expander acts as an 'off' switch, the output is the input passed through the graphic equaliser A, whereas at high signal levels, the gain k of the expander now equals one, so that the output equals the input passed through B, ie equals the unmodified input signal. Thus the circuit of Fig 7 acts as a completely adjustable dynamic filter for low level noise, tunable to any specific frequency band of noise. As earlier, the sidechain equaliser helps the chosen frequency band to more selectively operate the dynamic processing in order to aid masking.

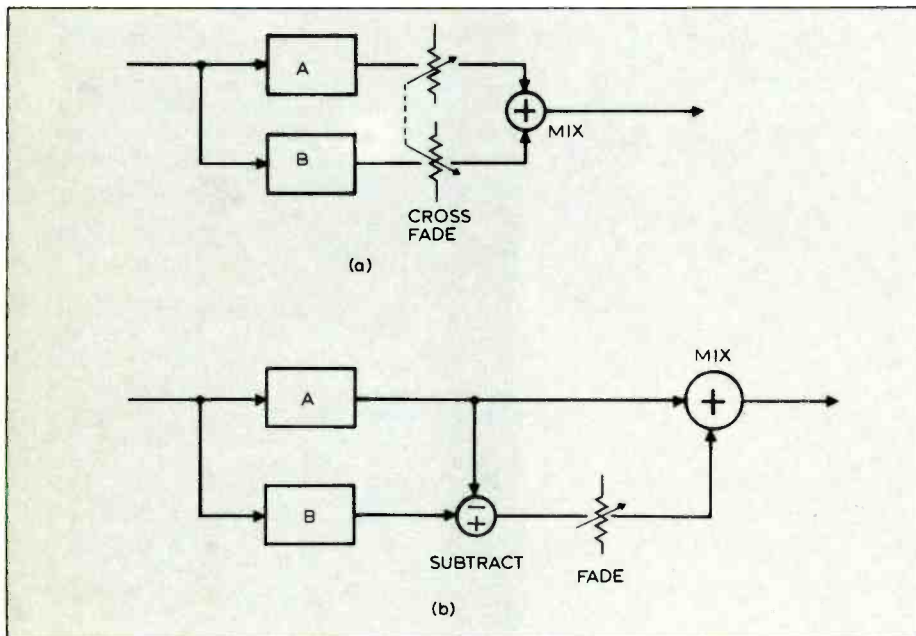

Fig 6: Two methods of crossfading between two different forms A and B of signal processing

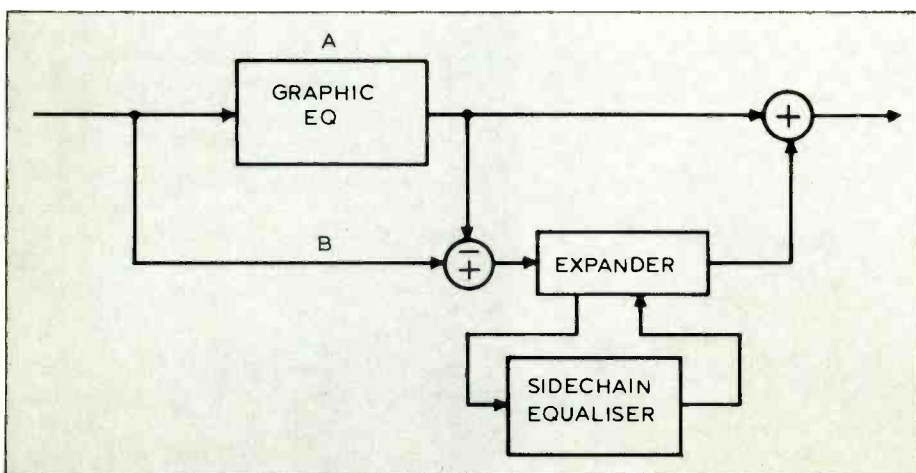

Fig 7: Fully adjustable dynamic filter based on Fig 6b



THINK OF US AS A UNITED NATIONS

OF SOUND

Anywhere you find MTE sound equipment — that's practically everywhere in the world — you'll find Magna-Tech service readily available. Not only when you buy your equipment, but for as long as you own it. Our service engineers are on the road virtually every day of the year, calling on customers, checking on equipment, working with local service people.

With sales offices on six continents, we can provide the right post production equipment from a full line that includes magnetic film recorders and reproducers, telecine magnetic followers, video tape-film interlocks, electronic looping systems, dubbing systems, 16-and-35mm electronic projectors. Or, we can provide total facility engi-

neering and consultation.

More awards have been won for theatrical and television films on MTE equipment than all others combined. We're ready to help you win some too.

Magna-Tech Electronic Co., Inc.
630 Ninth Ave., N.Y., NY 10036
Telephone 212-586-7240
Telex 126191. Cable "Magtech"
Fax 212-265-3638.

MAGNA-TECH AGENTS:

Belgium
ARC
Rue Dries 167
1200 Brussels
Telephone: (02) 770-9630
Fax: (02) 772-3388
Telex: 63765

England
Magna-Tech Limited
Unit 40
Sheraton Business Centre
26-28 Wadsworth Road
Perivale, Middlesex UB6 7JD
Telephone: (01) 991-9153
Fax: (01) 991-9391

France
High Fidelity Services SA
Rue Pierre Semard
75009 Paris
Telephone: (01) 285-0040
Fax: (01) 526-3705
Telex: 290585

West Germany
Zenon GMBH
Carl-Benz Strasse 16
PO. Box 1130, 7608 Willstatt
Telephone: (07) 852-7025
Fax: (07) 852-2077
Telex: 753537

Italy
Studio Sound System
Via Ostriana 11
00199 Roma
Telephone: (06) 834-481
Fax: (06) 839-5449

Sweden
Poi-Teknik Par Lindstrom
Gullrandsuagen 131
145 64 Norsborg
Telephone: 75374195
Fax: 75386834

Other agents located in:
Los Angeles, Montreal, Barcelona, Athens, Johannesburg, Hong Kong, Tokyo, Seoul, Taipei, Manila, Sydney, Auckland, Kuala Lumpur, Madras, Caracas.

MAGNA-TECH ELECTRONIC

The Sound Heard Round the World™



This circuit works particularly well for dynamically filtering rumble noises, by cutting the graphic equaliser only in the bass and boosting the sidechain equaliser by up to 25 dB at the most audible rumble frequencies and cutting it by 25 dB at other frequencies.

The subtraction network in Fig 7 may well already exist as the electronically balanced input of the expander. Thus, apart from some adaptors or Y splitter leads, Fig 7 requires nothing not already present in most studios. Manufacturers of expanders should consider incorporating all this circuitry, apart from the equalisers, into their expanders with an extra insert point for an external graphic equaliser A. This way their products could be turned into infinitely adjustable dynamic filters by the addition of such an external equaliser.

Putting the graphic equaliser at B rather than A converts the dynamic filter into one that is flat at low levels and equalised at high levels above the threshold. Such a dynamic filter might be used, for example, to 'brighten up' high level sound without bringing up low level hiss. Thus, in this configuration, the dynamic filter can be used to add 'excitement' if required, although it could equally be used to strengthen high level bass without bringing up low level rumble.

Incorporating a switch allowing the equaliser to be inserted either in the A or the B path allows the same equipment to be used for both low level and high level dynamic filtering. Equalising high level signals also permits, if required, high level distortion to be filtered without affecting the signal the rest of the time.

This kind of corrective dynamic noise filtering requires intelligent setting of the equaliser to minimise the tonal alteration of the wanted signal while taming any faults. The philosophy of 'if it ain't broke, don't fix it' applies here very strongly. For example, to tune out hiss, the naive reaction of most engineers is to filter out the treble above a given frequency but this causes excessive damage to sound quality. It is usually better to cut a fairly narrow band of frequencies at which the hiss is subjectively most audible (often centred around 6 to 10 kHz, being higher for cassette than for reel-to-reel tape or FM tuner noise) and to boost neighbouring frequency bands slightly to minimise the overall tonal alteration away from the band that is cut.

With a graphic equaliser, this usually means boosting adjacent band sliders by about one quarter the amount that the rejected band is cut, depending on the equaliser design. With parametric equalisers, one can use a fairly high Q cut and a series low Q (say $\frac{1}{3}$ of the high Q) boost by a small amount (say $\frac{1}{4}$ of the cut) centred at the same frequency. The aim is to achieve a frequency response somewhat as in Fig 8a. In such responses, if the cut is deep (say over 12 dB), then the measured boost adjacent to the cut band might be around 1.5 dB in order to preserve tonal quality, with a smaller boost adjacent to a shallower cut.

This kind of filtering strategy also reduces bass noises well with minimal tonal alteration. Even if it is necessary to cut the most extreme treble or bass frequencies, the general strategy of bringing the response up again beyond the maximally cut frequency band, as in Fig 8b for a hiss filter, still gives a better tonal quality than simply cutting out all the extreme frequencies. When used with the dynamic noise filter of Fig 7, these strategies achieve a reduction of the noise with a minimal audible effect on the wanted signal. Done carefully, the main effect of the dynamic noise filter is then on the noise and care in adjustment

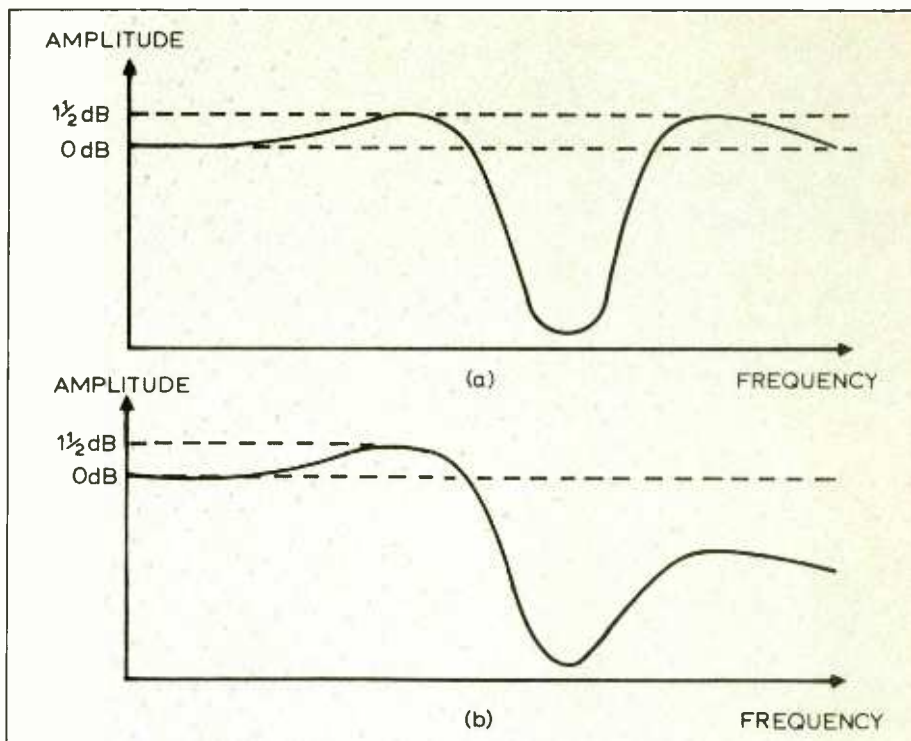

Fig 8: Typical preferred responses of noise filters

of thresholds, expansion ratios and sidechain equalisation is required to minimise the audible 'pumping' of noise levels.

The arrangement of Fig 7 can also be used for more specialised processing tasks. For example, in a live recording between musical numbers, a performer might speak 'off microphone'. Providing that the recording is on a low-noise medium (eg digital), such announcements can be brought up in level automatically by giving the graphic equaliser A a gain greater than one, possibly with a degree of hiss filtering to tame any resulting noise increase. This converts the expander to a device that brings up signals below the threshold level by a predetermined amount.

frequency bands are to be processed differently. If A is a graphic equaliser and B a straight-wire connection, then the outputs of A and of the subtraction network between them form a fully adjustable bandsplitting filter whose outputs sum back to the input signal.

For example, in the cancellation processing described earlier for reducing faults in (say) the right stereo channel, one can apply different degrees of processing in the two bands by putting an adjustable bandsplit in the L-R signal path, as shown in Fig 9. Different degrees of manual or dynamic control of faults can be done in the two frequency ranges, perhaps using a different setting of the L-R panpot controls in the two bands to obtain different compromises between maximum R rejection and width.

There is no need for either of the 'bands' in Fig 9 to be simple low- or highpass filters. For example, band 1 might well consist of all frequencies except those around the presence

Bandsplit methods

The schematic of Fig 6 can also be applied to processing on bandsplit signals, where the two

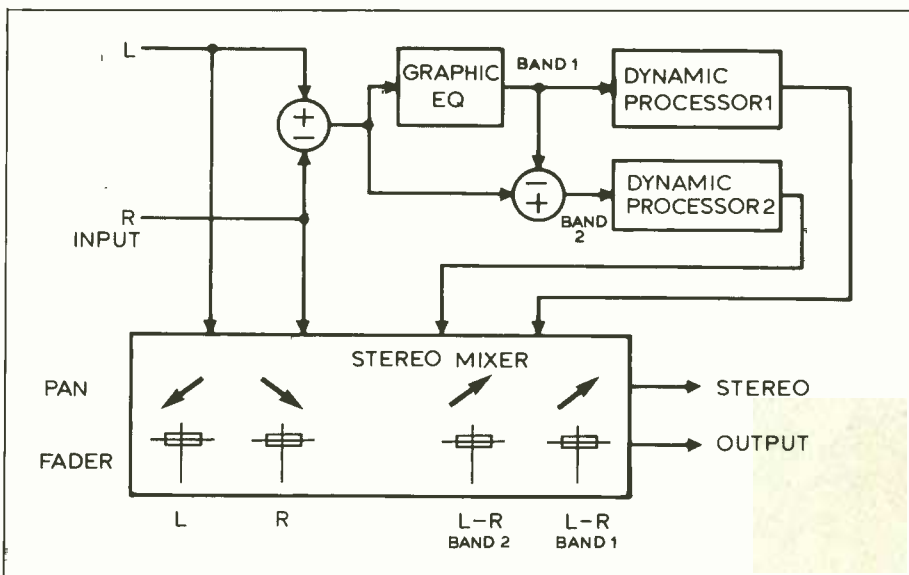

Fig 9: Example of use of bandsplitting for control of right channel faults

AT LAST. A MULTI-PURPOSE DIGITAL AUDIO PROBLEM-SOLVER THAT WON'T BREAK THE BANK.

Even in the most sophisticated digitally-equipped studio, transferring audio data within the digital domain can be fraught with problems. And not for the first time, it's taken application-led European design expertise to come up with a highly versatile solution. The FC1 from Audio Digital Technology.

The FC1 brings a new meaning to the phrase multi-purpose. Basic functions include format conversion and transfer between virtually any two channel, multi-track or hard disk digital recording system. But that's just part of the story. The device can not only add or strip emphasis from different incoming digital signals, but it's a natural link between digital recorders and the latest outboard processors.

Teamed with a useful remote unit option, the FC1 even provides digital level mixing and channel cross fading. Furthermore, all this takes place within a true 24 bit architecture, assuring the FC1 a sure place alongside tomorrow's recording technology.

Sheer practicality apart, the pleasant surprise about the FC1 and its remote partner is the cost, a fraction of what you might pay for technology that attempts to cover the same range of applications. If you're serious about digital audio and care about quality, contact ADT now and ask for further details.

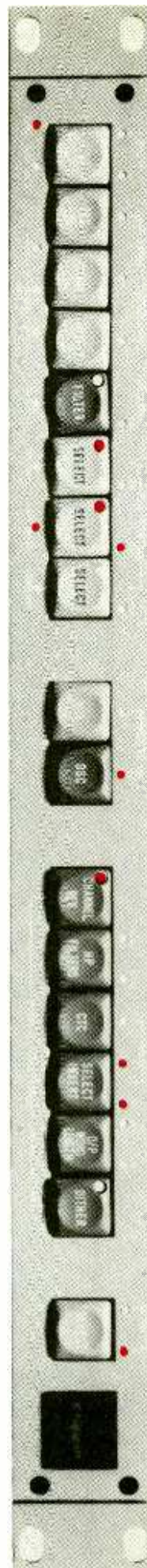
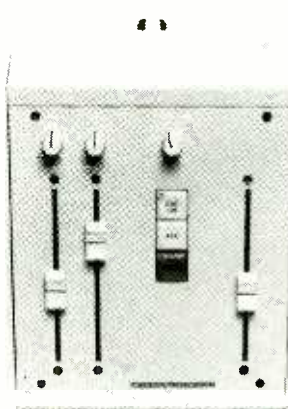

adt **AUDIO·DIGITAL·TECHNOLOGY**

The Coach House, Manor Road, Teddington TW11 8BG, England

Telephone: 081-977 4546 Facsimile: 081-943 1545

USA Audiotechniques. Tel: (212) 586-5989

SEE US AT BOOTH NUMBER 307 AES, LOS ANGELES

1990 NEWS FROM NTP

Come and visit us at IBC
in Brighton, and let us show
You our new products.
You will find us at

IBC Stand G3
in the Metropole.

612 Audio-Switcher

- Very compact design. 224 inputs by 192 outputs in only 12U of rackspace
- Outstanding audio performance.
- Output monitoring as an integral part of the system.
- Separate test input for test of unused audio paths.
- New balanced, floating output stage without conventional output transformer.
- 100% compatible with existing NTP control systems.
- Onboard testsockets and LED's for test and maintenance.
- Optional PC-based maintenance terminal.

The 477-100 PPM

- Multi-function display for simultaneous »Spot« and »Bar« display.
- Permanent highlighting of most significant scale marks.
- Triple coloured phase meter (compatibility meter).
- 6 front-selectable display modes with light indication.
- Front-selectable integration time, additional gain and digital peak memory.
- PC communication facility via D²B bus and PC plug-in card.
- High accuracy and long-term stability
- Auto stand-by for increased life-time
- High overload margin and extended scale for precise monitoring of fast peaks at high levels.
- 200-segment display.
- Standard 190 x 40 mm module.

NTP Elektronik A/S

Knapholm 7 Phone: +45 44 53 11 88
DK-2730 Herlev Fax: +45 44 53 11 70
Denmark Telex: 16378 ntp dk

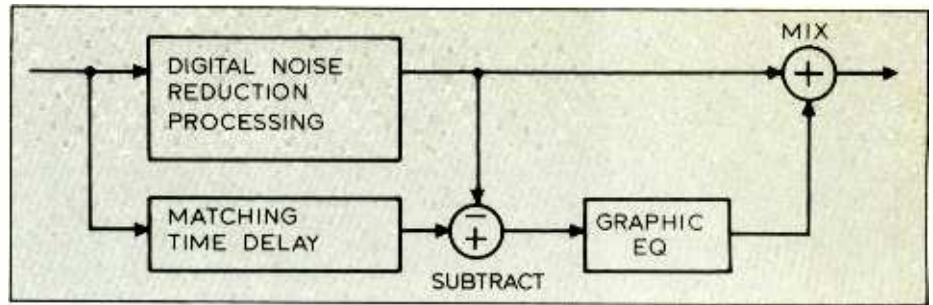

Fig 10: Control of digital noise reduction side effects

region of 2 to 4 kHz, whereas band 2 might consist just of the presence region. It is often best if the in-band sliders at the edges of the desired frequency band are slightly boosted (typically by 2 to 3 dB) above unity gain to compensate for the in-band effect of the 'cut' sliders just outside the band.

One should also be aware that a non-flat equaliser will not have a flat phase response so the signal going through different processing in the two bands will have varying phase shifts, especially around the crossover frequencies between the two bands. When using bandsplitting to process stereo signals, this can cause some degradation of the resulting stereo effect due to the 'phasiness' of the results in the crossover region. More advanced 'phase compensated' bandsplitting filters, such as used in the Audio Design *Filmex* processor, or digital linear-phase bandsplitting filter, can avoid this problem, at the expense of increased cost, reduced flexibility and possibly undesirable phase distortions.

Once one starts using processing with this degree of sophistication, it is obviously essential that the engineer has a very good theoretical understanding of what he/she is doing and a fair degree of practical experience of the precise subjective effects of the processing.

Noise reduction

Another application of the technique of Fig 6b is controlling the side effects of sophisticated digital single-ended processing and noise reduction systems such as *CEDAR* or *NoNoise*. These systems use expansion of the signal in a large number of narrow frequency bands and, like every dynamic filter expansion system, risk a degree of audible side effects. Although the user of such a system will make some of the subjective decisions about the trade-offs to be made at the time of processing, it is worth noting a technique of changing these trade-offs after the digital processing. One arranges that the processed and the unprocessed signals are recorded in precise time synchronism on parallel digital tracks. This can easily be done for mono source material using a stereo mastering medium but stereo source material requires the use of a 4-channel mastering medium.

One can then crossfade between the two signals either dynamically or in a frequency dependent way such as shown in Fig 10. This lets through the unprocessed signal when the graphic equaliser has unity gain with no phase shift but lets it through at frequencies where the equaliser has maximum cut. One starts by equalising the unprocessed signal until the noise is acceptably reduced (ignoring the effect on the wanted signal) and then inserts the same equaliser in the network of Fig 10.

The effect here is that only those frequencies that need the full processing have processing

artefacts. Thus the degree of processing and the trade-offs between audible faults and subtle side effects can be re-decided for different release markets, without having to re-do the digital processing each time.

This will work best if fully phase-compensated equalisers are used, and if the processing is used simply to reduce the annoyance value of noise, rather than to eliminate it altogether. I haven't been able to try out this proposal practically but it does suggest strongly that if processing of a type such as *NoNoise* is to be used for archiving historic mono material, it is wise to put the unprocessed source material in exact time synchronism on the other channel of a stereo mastering medium.

Stereo manipulation

Another aspect of remastering substandard material is the use of linear stereo-to-stereo processing, which manipulates stereoism. The best known process is width control. This can be implemented in a large number of ways, the best known (due to Alan Blumlein in 1931) using sum-and-difference processing as shown in Fig 11.

Here the stereo is converted into sum-and-difference (or mid/side) form

$$M = 2^{-1/2}(L+R)$$

$$S = 2^{-1/2}(L-R)$$

where the gain $2^{-1/2} = -3$ dB is chosen for convenience, the gain of the difference or 'side' signal *S* is adjusted by a gain *w* (width) between 0 for mono and about 2.5 or 3 for superwide stereo, being 1 for ordinary stereo, and the modified stereo *L_{out}* and *R_{out}* is then derived by a second sum-and-difference operation

$$L_{out} = 2^{-1/2}(M + wS)$$

$$R_{out} = 2^{-1/2}(M - wS)$$

Such width controls often help to provide a more satisfactory width for recordings, widening (for *w* > 1) over-narrow recordings or narrowing (for *w* < 1) over-wide ones. They can be used to alter the level-balance between the middle and the edges of a stereo recording. Since the difference or 'side' signal *S* has no energy from central sounds, increasing its gain, and hence the width, increases the reproduced stereo level of edge sounds relative to central sounds. Thus the relative level of an over-dominant central sound can be reduced by increasing the width.

If, as in Fig 12, a graphic equaliser is inserted into both the sum *M* and difference *S* signal paths, this can allow a useful degree of adjustment of both width and of centre-to-edge level-balance at different frequencies, although care is needed to prevent the resulting sound from being excessively 'monoish', when the difference gain is too small, or excessively 'phasey', when the difference gain is too large.

One can reduce noises concentrated in the

Peak Viewing

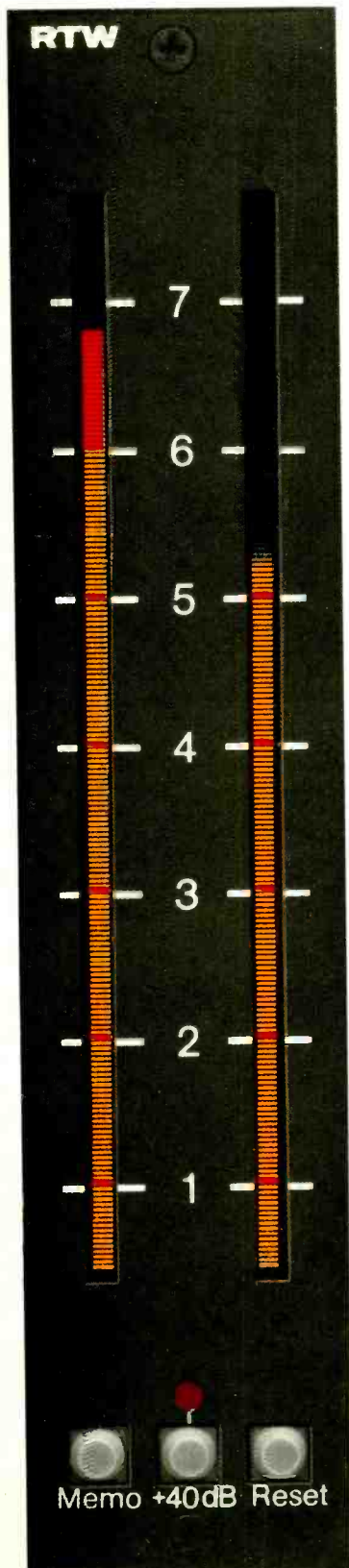

With the recent technological advances in the transmission and distribution of broadcast sound the accurate monitoring of signal level has never been more critical.

RTW PPM 1130E

Already in service with many U.K. broadcast organisations, the RTW PPM 1130E provides precise indication of even short transient peaks on a clearly readable neon-plasma display, designed to BS Standards*.

Information on the complete range of RTW Peak Programme and Phase Correlation Meters is available, on request, from Audio Design, Tel: (0734) 844545

Specify the RTW PPM 1130E and improve your peak viewing!

* B.S. 55428 Part 9.

AUDIO DESIGN

Unit 3, Horseshoe Park,
Pangbourne, RG8 7JW, U.K.
Tel: (0734) 844545
Fax: (0734) 842604



**MILLIONS
of knobs as
standard...**

**or manufactured
to your
custom design**

SIFAM FOR A COMPREHENSIVE RANGE OF COLLET, PUSH ON, SLIDER & PUSH BUTTON KNOBS.

A detailed and colourful catalogue is yours for the asking.

SIFAM LIMITEC - ACCESSORIES DIVISION
WOODLAND ROAD TCROQUAY
DEVON TQ2 7AY ENGLAND
Telephone: 0803 613822
Fax: 0803 613926. Telex: 42864



We could have...

But we didn't.

We've just replaced our popular BGW Professional Series power amplifier models 150 and 250 with the new, twice-as-powerful models 200 and 350.

In designing these new amps, we *could* have followed an industry trend by replacing our fully discrete circuitry with ICs. That would have reduced our costs significantly. But we didn't, because the best ICs available still fall short of our standards for sonic quality.

We *could* also have reduced the size and mass of our heat sinks. That would have saved money and still allowed us to meet published specifications with a comfortable margin. But we're not ready to shorten the life of BGW output devices by placing added thermal stress on them. Our standards for long term reliability won't allow it.

We *could* have replaced our expensive precision stepped input attenuators with less expensive detented pots. But we didn't want to give up the precise level control of precision stepped attenuators.

We *could* have used a thermal circuit

breaker rather than the costly magnetic breaker you'll find in every BGW Professional Series amp. But thermal breakers trip-off early in warm summer temperatures. To us, that's unacceptable.

For almost two decades, BGW Professional Series power amplifiers have been designed to meet the exacting performance and reliability criteria of the best facilities in the world. Other manufacturers may be willing to cut corners in order to cut costs. Not BGW. We hold firm in our dedication to building the very best. Not the very cheapest.

To find out exactly what our total quality commitment can mean to you, call us at 213-973-8090 (in the US, 800-468-AMPS toll free) for more information on the new 200 Watt* BGW 200 and 400 Watt* BGW 350/350A or the legendary 600 Watt* BGW 750F and 750G†. Then, for a limited time,

we'll triple our standard warranty at no extra charge when you decide to purchase one.

Thinking of settling for less than BGW?

Well, you *could*...

But you shouldn't.



*Both channels driven into 8 Ohm loads. †Studio version available with low-noise fan.

13130 Yukon Avenue • P.O. Box 5042 • Hawthorne, CA 90251-5042 • Fax 213-676-6713

INTERNATIONAL DISTRIBUTORS

Christopher Hawkins • 19 Tornciffe Court • Kings Avenue
London SW4 8EW, U.K. • (01) 671-9494

Groupe 38 • 14 Cour Saint Eloi • Paris, France 75012 • (01) 3430-3800
Ear Pro • C/Juan De La Cierva, 23 Nav. 2 • 08960-Sant Just D'Esvern
Barcelona, Spain • (03) 473-1143

Kenwood Linear S.P.A. • Via Arbe. 50 • 20125 Milano, Italy • (02) 688-4741
Invor Electronics S.A. • Fotografielaan 22 • B-2610 Wilrijk, Belgium • (03) 8300367
Audio Rent Sales • Werhollenstr. 54 • 4143 Dornach, Switzerland • (61) 702-5515
Has Audio Team • Hirsimetsantie 13 • Lahti, Finland SF-15200 • (18) 33234
Seki Electronics • C.P.O. Box 7760 • Seoul, Korea • (02) 756-3331

Audio Consultants Co. • 58 Pak Tai St. 9th Floor • To Kwa Wan, Kowloon
Hong Kong • 3513628

Trichord Corporation • Bunsei Bldg. #3 1st Floor • 8-8, 5 Chome, Toranomon
Minato-Ku, Tokyo • Japan 105 • (03) 433-2941

Hawko Trading Co. • 605 Macpherson Rd. #01-15 • Citimac Industrial Complex
Singapore 13360 • 278-0011

Linfair Engineering & Trading • 7th Floor 7 Jen Aid Rd. Sec. 2
Taipei, Taiwan R.O.C. • (02) 321-4454

Sea Power Company Ltd. • 8F, No. 23 Sec. 1 • Chung Hsiao W. Road
Taipei, Taiwan • (02) 314-3113

difference channel, such as rumble from vinyl record playback or wind noise from some stereo microphone systems, or hiss and interference on FM multiplex broadcast reception, by using a dynamic noise filter as described earlier with reference to Fig 7 in the difference channel S, without too much audible effect on the stereoism. Although it should be used with extreme care, a dynamic filter in the sum channel can sometimes help tame 'common-mode' sum noises in some stereo recordings, it should, however, be realised that excessive reduction of the sum gain can cause stereo that is largely out-of-phase at levels and frequencies at which such a filter is active.

Width control has the defect that, when used with non-coincident stereo microphone techniques or with tapes with significant azimuth errors, it can cause a lot of comb filter colouration. In such a case, it may be expedient to confine the action of the width control to lower frequencies only (say below 700 Hz), where this problem is likely to be less.

Besides width control, there are many other useful forms of stereo-to-stereo processing. I have

'rotation' of the stereo sound image. For $\theta=0^\circ$, we have normal stereo, for θ greater than zero, the stereo image is rotated to the left, and for θ less than 0, the stereo image is rotated to the right, all without any alteration of any sound level whatsoever.

In a practical stereo manipulation system, I have found it convenient to incorporate an adjustable bandsplitting of the input stereo as described earlier, so that the stereo-to-stereo processing can be separately adjusted for different frequency components of the sound. This enormously increases the ability to fine tune any corrective processing to different aspects of the input programme content.

Ergonomics and system design

The range of remastering techniques possible with what has been described earlier is enormous, and the techniques described really are very useful for

processing is to be used. Such a system design is, in itself a major task. Suffice it to say that conventional studio signal processing architectures are specifically designed for the separate processing of multiple mono signals, with relatively little thought given either to stereo-to-stereo processing or to cancellation or crossfade processing techniques.

No-one has yet designed a really appropriate stereo mastering console architecture to do this kind of reprocessing. I believe that one really does need a new architecture to cope with a wide range of problem recordings. In particular, one needs intuitive methods of setting up alternative signal flow architectures. This system design problem in some ways resembles that for early analogue synthesisers, where systems of patch cords or pin matrices were used to set up different configurations. In principle, digital mastering consoles could be reconfigurable under software control but designing such software is not the easiest of tasks.

The remastering problem is not confined to material in the form of mono or stereo masters, since even multitrack material often incorporates mono or stereo submixes that individually could be usefully reprocessed. A rethink of processing architectures could thus prove useful even in multitrack mixdown applications.

A good design of mastering console architecture requires a fundamental rethink to ensure an intuitive ease of control of several complex signal-processing chains that interact with one another. Although I have given quite a lot of thought to such systems design over the last 3 years, I see little prospect of any commercial product being developed unless and until a manufacturer or people in the industry perceive a need for a new approach to remastering work. By looking at some of the signal processing involved in remastering, at least this article may have helped to clarify some of the reasons why a new approach might be needed.

The methods described can be improved in the future in two main respects: first, improved control ergonomics so altering the adjustment of complex processing is easier; second, improved subjective performance. The areas of technical improvement include improved dynamic signal processing laws for specific applications and the avoidance of the undesirable subjective side effects of equaliser phase shifts in the above processing algorithms.

In conclusion, good reprocessing involves making sure that the source material is the best available (and it is worth seeking out the earliest-generation copies where possible, no matter how poor the basic recording quality) and is played back as carefully as possible, with attention paid to things like azimuth, speed, equalisation and noise reduction tracking—even if the source is a poor quality cassette recorded on a maladjusted domestic machine. No amount of clever reprocessing technology can properly compensate for carelessness in the original transcription of the source.

Ultimately, the results of any reprocessing involve the artistic judgement and 'golden ears' of the reprocessing engineer. All reprocessing ultimately involves a careful tailoring of the reprocessing to the original faults—and no magic 'automatic clean up' processing is ever likely to be developed—at least until machines develop intelligence and artistic judgement. □

Reference

1 Michael Gerzon, 'Stereo Shuffling: New Approach—Old Technique', *Studio Sound* July 1986, pages 122-130.

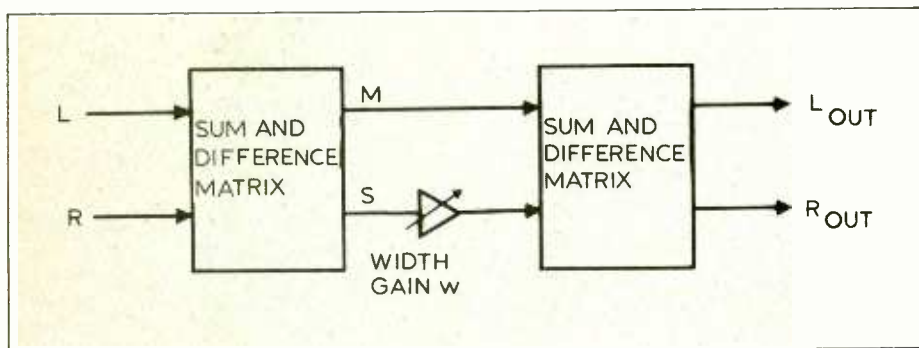

Fig 11: Schematic of width control

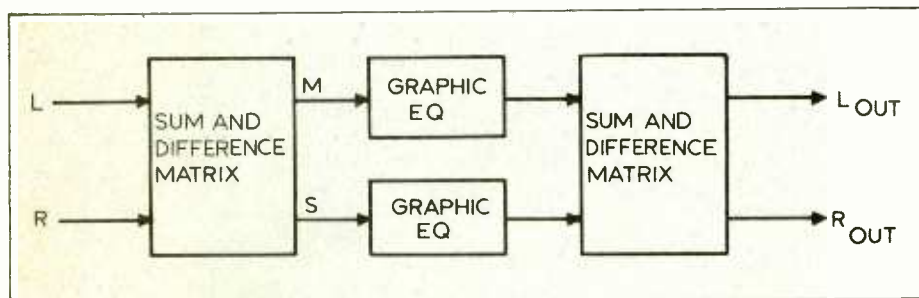

Fig 12: Frequency-dependent width control and edge-to-centre rebalancing system using graphic equalisers in the sum and difference channels

earlier described the use of asymmetry control to adjust left/right level-balance without altering central images. An opposite type of control is rotation control, which alters the centring of a stereo image without any alteration of the level-balance. Such a control was developed and marketed by Telefunken in the 1950s but is now virtually unknown outside German stereo broadcast mixing desks. It is particularly useful for re-centring off-centre live recordings made with stereo microphones without any unacceptable effect on the ambience pick-up and can be used to rescue live recordings that have a 'lop-sided' direct sound pick-up due to performers being at unexpected locations relative to the microphone position and direction.

It would lengthen this article too much to go into the full practical implementation of a rotation control but is described by the mathematical formula

$$L_{out} = L \cos \theta + R \sin \theta$$

$$R_{out} = R \cos \theta - L \sin \theta$$

where $-45^\circ \leq \theta \leq 45^\circ$ describes the degree of

remastering work. Unfortunately, using all these possibilities can be a bit of a nightmare, because equipment has to be constantly repatched and replugged in all kinds of non-standard ways. Although I hope that the above techniques will prove practically useful problem-solvers for remastering engineers, I can't pretend that using them together in different combinations is always easy.

Because of the non-standard wiring involved, one is very liable to get a rat's nest of connections that make no immediately obvious sense, and the controls are liable to be equally non-obvious without detailed crib sheets to remind one of their functions. My own reprocessing system, which I have built up over 2½ years, is still a rat's nest but I have found ways of organising the processing to make it much more ergonomic and easy to use.

Different kinds of processing interact with each other in different ways depending on which comes first. This necessitates a logical system design for organising the systems architecture of how the

I got my first ears- and hands-on demonstration of *CEDAR* at the APRS exhibition at London's Olympia. I also got clarification of *CEDAR*'s pricing and sales policy and a note of some of the CDs now in the shops that have been processed using the *CEDAR* system.

The demonstration at Olympia was impressive and accompanied by a very clear technical explanation by one of *CEDAR*'s sharp end engineers. But it was depressing to find that the engineers at *CEDAR*'s sharp end had never even heard of my offer to visit their facility at Cambridge over a weekend. The offer was made when I was running out of time on preparing articles recently published and had still not been sent the demonstration tape promised by *CEDAR*'s management.

APRS Olympia and a visit to Chop 'em Out in London to see how they were getting on with their *NoNoise* system, pointed out several things: the general similarity between the two technologies; the escalating price of *CEDAR*; and the difference in uses to which the systems are being put. Abbey Road now offers customers a choice of both. The Abbey Road system was built by EMI, rather than supplied by *CEDAR*, but after legal squabbles has been updated under licence. *CEDAR* has now sold two systems to Digipro for use in Brussels and Paris.

Both systems have moved on fast. When Sonic Solutions first started processing sound with *NoNoise* 2 years ago for the Philips record label, it used a Sun workstation computer. It took at least 10 minutes to process each minute's worth of music. Now Sonic use an Apple *Mac* computer and take 2 or 3x realtime to de-noise. But faced with *CEDAR*'s demonstration at Olympia of realtime de-noising, Sonic promises realtime 'soon'. The *NoNoise* de-clicker works at a similar speed to *CEDAR*'s, around 2x realtime. Both promise realtime de-clicking in the future but not at the same time as de-noising.

The real advantage of realtime processing is not so much the time saved but the freedom it gives the operator to tweak the controls while listening to the result. When processing takes longer than realtime, the snatches of music must be processed, then replayed, adjustments made, the music re-processed, played again and so on.

When Sonic Solutions asked Chop 'em Out whether they wanted realtime de-noising, the answer came back loud and clear: 'Yes, please.' The compromise will be no background processing while the system is de-noising.

The penalty of *CEDAR*'s move into rapid processing is a fast escalation of cost. The original concept was a low cost software package to run—very slowly—on a PC. "The price of a *CEDAR* processing system," wrote Gordon Reid, *CEDAR*'s general manager in an article published in *Hillandale News*, February 1990, "is currently about £13,000."

Now the price of *CEDAR* hardware (Compaq 386 computer with 110 Mbyte hard disk drive (capable of storing 20 minutes of mono sound) is £12,000, plus £27,000 for two-pass scratch removal software, £21,000 for realtime noise reduction with equalisation, plus the cost of two professional DAT recorders (because, like

Barry Fox

Tracing the acceptance of *CEDAR* and *NoNoise*; DAT injunction

NoNoise, *CEDAR* does not have on-board converters), plus the £10,000 a year *CEDAR* charges for a maintenance contract with software updates. This makes a total package price of over £70,000, with £10,000 payable every year thereafter. More disk storage, to hold more music for instant access costs more again. Digipro paid £160,000 for their two *CEDAR* systems.

CEDAR's current pricing structure narrows the gap with Sonic Solutions' *NoNoise* system, as currently used by London studio Chop 'em Out. Sonic quotes around £90,000 with *Mac* and 2 hours stereo disk storage, plus around £3,000 a year maintenance for software updates. But the Sonic *No Noise* system includes the full Sonic digital editing system (costing on its own between £30,000 and £40,000), which allows the operator to edit compilations and add the PQ timecodes needed for CD pressing.

Says Bernard Spratt of Chop 'em Out: "I wouldn't use a DAT deck DAC if you beat me over the head with it." So Chop 'em uses a DCS ADC (around £3,000) and a Digilog (D/A) at around £500.

CEDAR offers a bureau service for processing up to an hour of mono material, at a price of 'from £1,500'. Chop 'em Out offers a similar service with its *NoNoise* system for between £2,000 and £5,000 per CD. The big difference is that because the Sonic system functions as a digital editor it allows Chop 'em to provide the PQ codes needed for CD mastering. Because *CEDAR* offers no edit facility and has no PQ coding, *CEDAR*'s quote for the bureau service specifies 'without timecodes, etc'. The British Library now say *CEDAR* are 'considering' adding the edit and PQ coding facility in future versions of the system. *CEDAR*'s price list promises editing software 'winter 1990' and 'spring 1991'.

The least bitchy of studios, Chop 'em Out cannot resist making the obvious point: "That really says it all—the people behind *CEDAR* may know about computing but they don't know what the record industry needs."

Chop 'em Out did a mail shot to potential *NoNoise* customers and found few interested in cleaning up old 78s. And in Chop 'em Out's pragmatic view there is not much money in the restoration market. With specialist CDs selling only around 500 copies a time it is not cost effective for the record producer to use *NoNoise*.

Chop 'em's mail shot showed more interest, and money, in solving 'contemporary problems'; location recordings shot by TV and film companies, which are blemished with unforeseen noise, for instance the sound of a wind machine

motor intruding on actors' dialogue, noise from the engine of a boat on which drama scenes are shot and electrical interference (eg buzz on sound caused by lighting control circuits) and forensic work (eg removing background noise from bugging tapes needed for legal evidence).

Perhaps the supreme irony, Chop 'em Out even had to use the digital *NoNoise* system to remove a digital glitch from the master tape of recent Tears For Fears album *Seeds of Love*.

NoNoise was also used to remove the sound of crackle caused by a broken mic lead on the *Doors Live* video. A Thames TV recording of the Penguin Café Orchestra was badly undermodulated and thus needed de-noising.

The London studio has done some work on cleaning up old 78s, but 'mainly out of curiosity'. One job was for the Icelandic Broadcasting Company, with very old scratched acetate discs. They are finding that one of the main problems is that when the noise is removed, it may expose the poor quality of the original recording which was previously masked. Chop 'em Out also processed an old Ink Spots recording for the Dennis Potter TV drama series *Black Eyes*.

In general, though, Chop 'em Out refers 78 clean up enquiries to *CEDAR*.

As widely predicted, the muddle over Philips' 'secret' Digital Compact Cassette has fouled up plans for a new law in the USA to enable the sale of DAT decks by making SCMS copy-limiting circuitry obligatory. The DAT Bill was put on ice, because senators would not legislate for technology that Philips would not talk about or demonstrate.

Sony went ahead and launched a DAT deck with SCMS. So the National Music Publishers Association went ahead and sued Sony. The NMPA, and talkative spokesman Ed Murphy, reject the idea of SCMS copy control unless it is tied to a tax on tape. That way starving composers get a fair share of the cake.

Whatever, the rights or wrongs of this argument, was it smart of the publishers to announce their law suit at a conference held in the Four Seasons Hotel in Beverly Hills? This hotel is described by a colleague of mine who re-eyed to the conference from New York as "the most luxurious I have ever seen, and I've seen more than a few on press jollies".

The lawsuit names songwriter Sammy Cahn, composer of such classic works as *Love and Marriage* (which go together like a horse and carriage). Cahn, who has often been seen on TV chat programmes and in theatre shows, talking at length about himself, arrived in a fine car which looked a lot like a Rolls. Perhaps it would have been a bit smarter for the NMPA to wheel out a starving young newcomer.

As some of the less kind press later asked, "How many owners of DAT decks will use them to tape Sammy Cahn's songs?"

For the record, I reckon the publishers' lawsuit could be the best thing yet for DAT. The format had become a yawn as far as the public are concerned. What better way to rekindle public interest than to tell them it is so wonderful they shouldn't be allowed to buy it? □

SCHOEPS

Colette series with interchangeable capsules for a variety of applications

unequaled for expertise
in design and
engineering



with a
constantly
expanding
range of products



BLM 3
professional
boundary layer



BLM 03 C
professional
boundary layer



MK 2 S
special omni



MK 21
wide
cardioid

Contact

AUS Rebel Audio Pty. Ltd.
286 Great North Road,
Five Dock, N.S.W. 2046,
Tel.: (02) 713 6866

A Sluder Revox Wien
Ges. m. b. H., Ludwigsgasse 4,
1180 Wien, Tel.: (02 22) 47 33 09

B Heynen N.V., Bedrijfsstraat 2,
3500 Hasselt, Tel.: 011-22 96 64

CDN Elnove Ltd.,
325 Rue Clément Ouzet,
Lasalle, Quebec H8R 4B4,
Tel.: (001) 514-3 64 21 18

DK PSS, Aaboulevarden 38,
2200 Copenhagen N,
Tel.: 01-39 00 37

SF Lounamaa Electronics Oy,
Ulmänpolku 27 A, 00330 Hiet-
nikki 33, Tel.: 90-488 566

F ELINO S. A., 18-20, rue du
Val Notre Dame, 95100 Argen-
teuil, Tel.: (1) 39.82 29 73

HK Audio Consultants Co. Ltd.,
58 Pak Tai Street, Tokwawan,
Kowloon, Hong Kong B. C. C.,
Tel.: 3-712 52 51

I TDS - Tecniche del Suono
S. r. l., Via Dei Cignoli 9,
20151 Milano, Tel.: 33.40.03.50

IL Koinor Ltd., 18 Ha'arba'a
Street, Tel-Aviv, Tel.: 03 - 26 32 98

J Jma & Company Ltd.,
1-6 Tonrihsacho, Shinjuku Tokyo,
Tel.: (03) 357-0401

NL Heynen B.V.,
P.O. Box 10, 6590 AA Genneep,
Tel.: 08851-96111

N Siv Ing. Benum A/S, Boks
145 Vindleren, 0319 Oslo 3,
Tel.: (02) 14 54 60

P G. E. R. Av. Estados Unidos
da America, 51-5°, Dto.
1700 Lisboa, Tel.: 88 40 21

E Singleton Productions,
Via Augusta, 59, Desp. 804
Edif. Marcuno,
08006 Barcelona, Tel.: 2 37 70 60

S NATAB Akustik AB,
P.O. Box 6018, 55006 Jönköping,
Tel.: 036-14 24 80

CH TECNAD SA
- Au Glapin -
1162 ST-PREX,
Tel.: (021) 8 06 06 06

GB Scenic Sounds Equipment
Marketing Ltd., 10 William Rd,
London NW 1 3 EN,
Tel.: 01-387 1262

USA Posthorn Recordings,
142 West 26th Street, 10th Floor,
New York City, N.Y. 10001,
Tel.: (212) 242-3737

Schalltechnik Dr.-Ing. Schoeps GmbH P.O.B. 41 09 70 · Fax: (07 21) 49 57 50
7500 Karlsruhe · TX. 7 826 902 · Tel.: (07 21) 4 20 16

Sound Effects Software

Sound & Music Catalogging Professional Librarian

- Organizes Tapes, DATs, Samples, Floppy Disks, Compact Disks, Broadcast Carts & LPs.
- Contains presorted catalog listings of Compact Disk sound effects & production music libraries.
- Provides easy data entry for your own libraries, checks spelling and allows descriptions of virtually unlimited length.
- Searches library catalogs by sound, style, mood, category, title, synonym or description.
- Enables multiple word searches using AND, OR, ALSO & NOT to specify exceptions, alternatives.
- Sorts & Cross-references by Format, Length, Media, Project, Recordist or Source Roll.
- Allows unlimited number of custom categories.
- Controls Compact Disk playback via Sony CDK-006 60 disk multi-player "jukebox".
- Networks up to 32 stations and 16 jukeboxes.

Sound Effects Spotting Sound Supervisor

- Manages spotting lists referenced to reel, scene, time code or feet/frames.
- Provides search, copy & paste from library to spotting lists.

Dialogue (ADR) Spotting Spotmaker

- Organizes replacement dialogue lines, sorts by character, reel, scene & footage.
- Prints standard cue/line sheets as well as a variety of other forms
- Transfers data to Cueprinter for mixing cue sheets.

Cue Sheet Printing Cueprinter

- Prints standard re-recording cue sheets in feet/frames or timecode on any size paper.
- Conforms footages to picture changes.

LEONARDO

LEONARDO SOFTWARE

10378 Holman Avenue

Los Angeles, California 90024

PH: 213.277.5161 • FAX: 213.277.9086

Certain catchwords, supposed trends and several 'new directions' have been wending their selective way around the audio industry of late. Perhaps it is time to turn a jaundiced eye at this *pot-pourri* of business related impedimenta to clear the way for the real advances that will mark the '90s for the professional audio industry.

Nobody asked me but the current excitement about Eastern Europe has to be tempered with some common sense, at least as far as the audio aspects of 'Komsrade Kapitalism' are concerned. The giddy euphoria of Western audio capitalists will pass quickly, we hope. "Oh wow! They are coming. The audio contingent from the East. So long talked about only in hushed whispers, the Wall has fallen and they are soon to be part of us. Just think of the advantages. Unlimited supplies of Bulgarian 1-channel mixing consoles. All the Soviet ppm meters with 22 lb battery power supplies you could possibly want (and that's the portable version). Analogue DAT recorders from Albania. Polish combination tape splicers and fish scalers." The mind boggles at the bounty yet to come from the East.

But seriously, folks, the reality is quite different from the current perceptions. If you take a long hard look. 'Glasnost' is all about a realistic appraisal of the entire Eastern bloc assuming an economic position in the world order, of a series of fourth world powers. This is especially true *vis-à-vis* the incredible economic engine that is China. Many observers sense that Gorbachev has simply recognised the extreme peril to the Soviet bloc, of a world order in the next century based on economic rather than military prowess. With that as a given fact, the realisation that the 'East' will consume far more audio hardware and software than it will contribute is not necessarily all that positive.

With the extraordinary 'softness' of the Soviet rouble and other Eastern bloc currencies, barter is the current standard of commerce. All you audio manufacturers out there, I sure hope you like sour cherry jam, canned hams, and dill pickles. If you think you are going to get paid in greenbacks—think again. Large scale trading ventures have been forced to create elaborate schemes involving third and fourth parties exchanging a broad range of tradable commodities to finally achieve cash payment. For example, a US speaker maker fields a \$100,000 order for stadium arrays. The speakers are built, shipped and delivered. Initial payment is made in roubles, which are used to buy bottles of potato soup. The potato soup is shipped to Poland where it is traded for dill-flavoured vodka, which is shipped to Britain and paid for in pounds sterling. If all the calculations have been done correctly, there is minimum spoilage and the shipping costs have remained reasonable—some profit from the original transaction may be had. If not, good luck!

This will all change as the East embraces capitalism with longevity as well as with lust. There will be a very large market for 'Western' studio equipment, mastering equipment and eventually for pressing facilities. That will create

Martin Polon

Our US columnist airs a few more poignant comments on the audio business

or succour a concomitant market for CD players, stereo systems and, of course, musical software that will in turn... etc. The soft currencies of today will eventually give way to harder and more stable units of exchange to make this all possible. But the economic priorities of bringing the East 'kicking and screaming' into the 21st century (let alone the 20th) will necessarily focus on major financial areas before such discretionary issues as home entertainment are confronted and an awful lot of canned hams, sour cherry jam and pickled pig's knuckles will have to flow like water under the economic bridge first.

Nobody asked me but why is it that the newest, sexiest digital audio products almost require an engraved invitation before you can receive information and, perish the thought, pricing. To actually buy, in addition to a verified position on the next Queen's list, you must be able to lay hands on one of the precious units. Finding a dealer who will be approved and permitted to carry the unit is a fascinating exercise in corporate dynamics all by itself. Availability is but another of the fascinating dynamics of new products announced somewhat prematurely. If babies were announced the way high technology devices are heralded, then little Jennifer would be enrolled at Oxford University at her date of conception. Then, about 3 months after the digital wonder's initial introduction, the company puzzles the fact that no one has bought their shiny new toy. Reason: nobody in that self-same company has placed the sales staff and the marketing staff into the same orbit.

Verily, and no question about it, the Trendex 16000 represents the latest technology for the recording studio of today. Never mind the fact that yesterday the product did not exist and that tomorrow some other new technology hybrid will take its place as the product of the hour; the hot button of the minute. It's sizzling now. Try to find one to buy at any price. Once you have it, see if you can get it serviced. And most difficult of all, see if you can find out from the manufacturer any kind of application information out of the ordinary.

Nobody asked me but must we beat the DAT horse to death yet again? DAT, oh little DAT, where are you little tape? Will you love me in the summer like you did last fall? I mean, really. Here is

virtually the same cast of characters shuffling hat in hand up to the US Congress to bend suppliant and beg for forgiveness for past sins and the legislation necessary to complete the current DAT concordat. Sounds like the plot for a new Ludlum thriller: 'The DAT Concordat'. Have we all forgotten the last arrogant charge at Congress made by the record industry 2 years ago? Ah, yes, the Copycode scanner. Last seen in an electronic surplus store in Cleveland. This time around we are supposed to have a consensus of the record industry via the international IFPI and the US contingent via the RIAA. The Japanese and European consumer hardware makers are all waiting for a stabilisation of the US marketplace through legislation. The SCMS (Serial Copy Management System) has been accepted as a reasonable compromise by most parties, we are told. Lo and behold our surprise then, to find that immediately following official introduction of House Bill No 4096, the Digital Audio Tape Recorder Act of 1990, the music writing and composing community took to the streets with blood in their collective musical eyes.

The writers of music are contending that the compromise now accepted by the 'Record Industry' as well as the 'Consumer Electronics Industry' will inevitably cost them income as the public ends up with free copies of their work; not just the currently accepted practice of free access. They are incensed by the way an SCMS-equipped DAT machine could be used to reproduce copies from a CD, again and again and again. They feel that the SCMS limiting copying of first generation digital DAT copies, just does not buy them significant protection. They are communicating to Congress their strong feelings. With the House of Representatives Bill currently residing only in the Energy and Commerce Committee and the companion Senate version resting in the Commerce, Science and Transportation Committee, the songwriters and lyricists, operating under the blanket monicker of the Copyright Coalition, could well sway the outcome. Congress will also be influenced by the demands of an election year, in which members will want to avoid voting on any measure that could be construed as anti-consumer. The ugly visage of royalty payments is seen by some analysts as being part and parcel of the direction taken by the musical scribes.

Yet another lobby that could sway the proceedings on DAT legislation is the scientific and computer community, which could wave its billion billion dollar clout against the \$4 billion record industry. The concept of any controls being placed on current and developing technology is unlikely to sit well with the technocrats. The songwriters specifically spell out recording CDs as a developing technology to be regulated to prevent copyright abuse and use the terms equitable remuneration read 'royalties'. It is clear that the huge US computer marketplace would not like that one iota.

Last, but not least, you ask what has all this to do with the professional market in DAT machines that has flourished in most of the world's centres. One, the presence of a 'balls to the wall' consumer market in the US and elsewhere to

RELIABLE PLAYERS

SCOTT PAGE ON QSC.

"Powerful sounds and dynamic images are what make a live performance great.

On world tours with Supertramp,

Toto, and Pink Floyd there are no second chances on the bandstand.

I depend on my equipment to work every night."

QSC Power Amplifiers... as reliable as the players who use them.



QSC

A U D I O

QSC Audio Products, Inc.
1926 Placentia Ave., Costa Mesa, CA 92627
714-645-2540



drive the product development and maturation cycle is a must for the DAT system to continue to evolve fully. DAT is not going to happen unless there is product introduction in the US consumer marketplace—still the 'big coin' to the Japanese. Euro-consumers notwithstanding. Two, what happens in US markets can and will sway other

part of Federal regulators turning down the screws, credit ratings and past loan records have gone right out the window. This is especially true for any 'show biz' venture that looks to be less than rock solid. Even such lynch pins of the consumer finance scene as home equity loans and auto loans are being discouraged and/or called

The recording studios have rarely enjoyed the unmitigated confidence of their loan manager and these days are unlikely to have any kind of credit clout at all

world law makers in terms of royalties and DAT legislation. So it is not an exaggeration to say that DAT's future really is riding on the US Congress. And let's not forget the Dolby S consumer version of SR, which could well settle the DAT issue *de facto*. Needless to say, watch these pages for still more news on the anything but dull DAT arena.

Nobody asked me but it appears that the current credit tightening around the world has made life that much more perilous for the audio business—especially for the equipment maker, sound contractor and professional studio owner. In addition, it has left very little option for the small financially independent audio equipment maker who has always remained cash independent. The future of the audio business is very much in the hands of those who emphasise research and development and these days that takes very deep financial pockets indeed. That is one of the reasons that acquisition remains the most likely future for small and medium sized audio firms. The on-going consolidation of the professional audio marketplace can only continue as the need for cash to fill large orders and subsidise research continues. What is sad about all this is that in the past, manufacturers extended a kind of personal credit to well known studio owners and the studios in turn supported new product introduction by ordering everything that was made. But those were simpler, gentler times.

Today, as US banks try to cope with a combination of past poor judgement in real estate developments and a crisis of confidence on the

back by the lender. Imagine the credit bargaining position of a major studio owner trying to negotiate with the bank. Noticed first of all for his colourful business style, the studio owner soon finds that if he had Aids, he could not be more welcome. It is true that even in the best of times, loan officers would develop a way of keeping a healthy distance from any financial activity involving a recording studio.

Unfortunately, the major parts houses are also quite likely to be the ones who deny credit to the studios—so cutting off repair parts, cables, connectors and most important of all the provision of blank recording mediums. With the coming of digital recording, the cost of tape alone could prove to be prohibitive during a major session, unless existing credit arrangements were respected. Or consider a 48-track digital recorder grounded for the temporary lack of a \$2,000 part despite the tape unit's unique position as a business stimulator. In short, the recording studios have rarely enjoyed the unmitigated confidence of their loan manager and these days are unlikely to have any kind of credit clout at all, due to the nationwide credit scare.

Last but certainly not least, let us look for a moment at the perilous 'progress' made by stereo television. Now, nobody asked me but it seems that, at least in the United States, we are moving backwards as fast as we were moving forwards 5 years ago. And for better or worse, Hollywood TV programming, like McDonald's hamburgers, is an American export destined for and desired by the world over.

Despite the progress made by pioneering efforts under the aegis of producer Michael Mann—*Miami Vice*, *Crime Story* and several other similarly intentioned 'audio plus video' efforts from other sources—the view in the '90s is depressing at best. For stereo TV to work, the programming and its content has to have some redeeming social value. The current lamentations in the trade and public press about the loss of quality in films and television programmes, focuses on the 'deal' as the sole reason to produce anything today. One can only wonder what quality programming with stereo TV sound could do for the some 300 million 'kapitalistic' viewers in the Soviet Union and Eastern Europe who by the year 2000 will be viewing so much Hollywood product that TV and film production will become the number one US export, according to 'expert' predictions.

Consider these Hollywood TV pilots in stereo, already bought and paid for, being evaluated for the 1990's fall TV season by ABC, CBS, NBC and/or Fox:

Dad's A Dog (Universal) about a divorced actor with kids who portrays a dog (via voice) on a TV show. Good possibility of stereo dog barks.

Cop Rock (20th TV) has been labelled by the producers as 'part opera, part rock concert and part intense police drama'. What a place for stereo TV! Just think, a cop car chases crooks down the freeway while the Los Angeles Philharmonic under the baton of this month's permanent conductor trails in a large truck playing the *William Tell Overture*. Excellent! *Danger Team* (Lorimar) a ½ hour drama focusing on detectives, which combines live action with clay animation. Some real opportunities for audio excellence here.

Hit Man (MGM/UA TV) about a kindly filmmaker who uses his special moviemaking magic to help people in distress. Sort of a cross between Steven Spielberg and Mother Teresa.

Broken Badges (Cannell Productions) a compelling drama about a crack (or is that cracked) police squad made up exclusively of officers who have been placed on psychological leave. Perhaps we could use some of Bernard Hermann's landmark themes from Hitchcock's classic *Spellbound*.

Shangri-La Plaza (CBS) a ½ hour drama about the ebb and flow of life in a Los Angeles mini-mall, using music and dance exclusively to tell the stories. Boy oh boy, haul out the stereo surround encoders Martha, there will be a real LA ethnic hoedown tonight.

Poochinski (20th TV) the story of a big city cop and his dead partner, who has returned to life as a bulldog. The two fight crime and attempt to right the wrong done to the partner/bulldog. OK, dust off the theramim, add a diathermy machine and you have a sound track right from the veil of tears for this barnburner.

Honestly, I present these pilots to you just as they were listed recently in a TV/film industry publication. I have made some comments, primarily because I cannot keep a straight face every time I see the list. You can draw your own conclusions as to whether any of these will actually make it to the air and as to whether Jan Hammer should be warming up his synthesisers. □

TWIN PPM BOX

High quality TWIN movement in a mains-powered unit. The illuminated coaxially-mounted pointers of the TWIN offer an unrivalled method of monitoring stereo left and right or sum and difference controlled by a front panel switch. Meets IEC65-2, BS415 safety.

Ring or write for full specification of this or:

- ★ PPM3, PPM7 and PPM9 BBC-licensed digital stereo drivers
- ★ PPM8 IEC/DIN -50/+6dB
- ★ PPM5 20-pin DIL hybrid
- ★ TWIN TWIN RACK and movements
- ★ Peak Deviation Meter
- ★ Programme and Deviation Chart Recorders
- ★ Stereo Disc Amplifier 3 and 5
- ★ 10 Outlet Distribution Amplifier
- ★ Stabilizer and Fixed Shift Circuit Boards
- ★ Broadcast Monitor Receiver 150kHz-30MHz
- ★ Advanced Active Aerial
- ★ Stereo Microphone Amplifier
- ★ Stereo and Ambisonics Coder PPM10 In-Vision
- ★ Twin PPM and Charts

SURREY ELECTRONICS LTD

The Forge, Lucks Green, Cranleigh, Surrey GU6 7BG
Tel: 0483 275997 Fax: 0483 276477

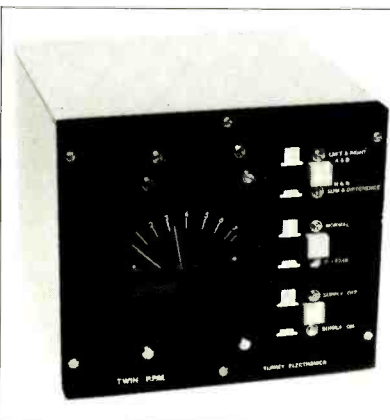

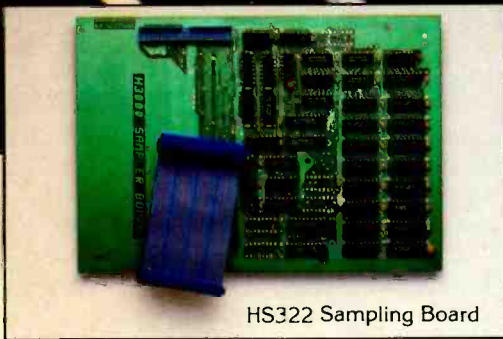
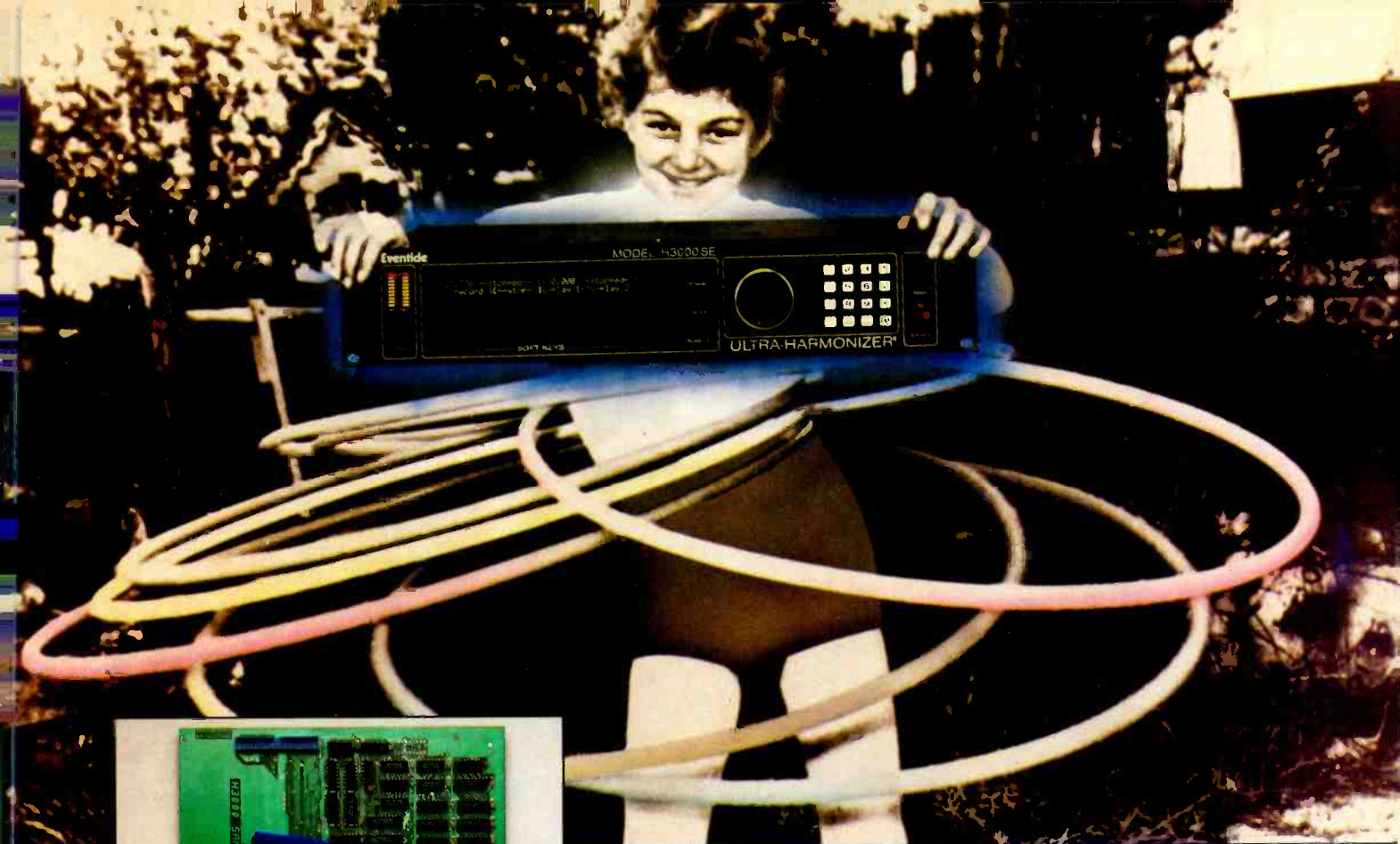

HS322 Sampling Board

Looping Is Only Our Newest Trick.

Eventide engineers just can't stop teaching the Ultra-Harmonizer® new tricks. First the eight new algorithms and 200 new presets in our SE ConKit. Now, 11.8 seconds of stereo or 23.7 seconds of mono sampling with the HS322 Internal Sampling Board option.

The HS322 adds 16 bit, 44.1 kHz sampling to any H3000 Ultra-Harmonizer's audio processing capabilities, at a surprisingly low cost. And Eventide's unique pitch change technology makes it easy to do things no ordinary sampler can. Change playback length on the fly without changing the pitch, to make rhythm loops that groove perfectly at any tempo. Or change playback pitch (from the front panel or any MIDI keyboard) without changing length, to transpose parts or tweak timbres without EQ-ing. The HS322 can also work like an ordinary sampler if you do want to change pitch and length simultaneously.

The HS322 board records two stereo or mono sounds, with the flawless audio quality that's

made the H3000 a studio favorite. You also get fast, flexible, precise control. Start recording and playback manually, via MIDI or audio trigger. Edit Start, Stop and Loop points using the famous Eventide Knob to "rock" audio, or enter locations on the keypad.

Impressed? Ultra-sampling is just part of the H3000's best trick—the way it keeps your original investment growing in power and performance, without making you buy a whole new box. If you're ready for the digital audio processor that's more than just another "fad box," it's time to visit your Eventide dealer. And sample the future.

Eventide®
the next step

One Alsan Way • Little Ferry, New Jersey 07643
Tel (201) 641-1200 • Fax (201) 641-1640

Sample responsibly: Credit and compensate your sources.

AUSTRIA Atec Audio Technology *Himberg* 02 234 8708
BELGIUM Trans European Music *Pontbeeklan* 02 466 5010
DENMARK Intersound *Arhus* 06 209 811
ENGLAND HHB Communications *London* 081 960 2144
FINLAND Studiotec *Espoo* 15 592 055
FRANCE Top Audio *Roissy En Brie* 1 60 28 23 62
GERMANY Sound Service GmbH *Berlin* 030 884 30346

GREECE Bon Studio *Athens* 1 3633572
ITALY Professional Equipment *Milano* 02 89 10241
NORWAY Siv Ing Benum A/S *Oslo* 02 145460
SPAIN Lexon *Barcelona* 3 203 48 04
SWEDEN Elfa Studio AB *Solna* 8 7340750
SWITZERLAND Studio M&M *Schönenwerd* 64 415 722
THE NETHERLANDS Cadac Holland *Amsterdam* 035 17722

FOR U.S., CANADA AND OTHER COUNTRIES, CALL
EVENTIDE U.S.
TEL: 201-641-1200
FAX: 201-641-1640



Dolby SR. The sound investment for analogue multitracks.

When everyone else was making noise about digital, we quietly developed Dolby SR. But it's no secret: Dolby SR makes analogue multitrack recording a cost-effective alternative to digital.

Improves the preferred sound of analogue

At both 15 and 30 ips, Dolby SR dramatically increases headroom, and virtually eliminates tape hiss and modulation noise. Dynamic range is improved by more than 25dB over unassisted analogue, preserving all the warmth and purity of the original sound.

Increases the return on your investment

Dolby SR upgrades your multitrack at a fraction of digital's cost. Add our Model XPSR (configured for up to 24 channels), or update an existing Dolby mainframe with plug-in SR modules. If you are in the market for a new multitrack, Otari and Studer offer models with Dolby SR built-in.



Simple to use

Set-up is quick and easy with Dolby SR. A unique Auto Compare feature lets you instantly verify frequency response and playback calibration.

And editing is as convenient as ever, with no need for special equipment.

Worldwide acceptance

Tapes recorded with Dolby SR can go anywhere, anytime. In fact, with more than 34,000 channels in over 30 countries, analogue with Dolby SR is a firmly-established format you can't afford to ignore.

Put it to the test

Call your Dolby dealer to arrange for a demo at your facility. Hear for yourself why Dolby SR is the sound investment for analogue multitracks in today's competitive marketplace.

Dolby Laboratories Inc., 346 Clapham Road, London SW9 9AP, Telephone 01-720-1111, Telex 919109 Facsimile 01-720-4118
 100 Potrero Avenue, San Francisco, CA 94103-4813 Telephone 415-558-0200 Telex 34409 Facsimile 415-863-1373
 Dolby and the Double-D symbol are trademarks of Dolby Laboratories Licensing Corporation © 1989 Dolby Laboratories Inc. S89/8810

 **Dolby®**

Fostex D-20 editor

Francis Rumsey reviews the Fostex D-20 edit control software

Since DAT recorders first appeared there has been a degree of speculation concerning their true rôle. Was DAT to be the digital replacement for the domestic compact cassette, or was it to become a professional format? Since it has not yet done the former, some Japanese manufacturers have been concerning themselves with the latter, particularly Fostex, whose *D-20* machine was the first fully professional DAT transport to appear on the market, having all the trappings of a professional tape recorder such as timecode implementation, a synchroniser interface, off-tape replay and punch-in/out facilities.

The question of whether DAT recordings would ever be able to be edited directly without copying to another format has refused to lie down (as one might have expected, considering the low price of DAT as a digital recording format). Fostex, not subject to the political difficulties of some of the larger Japanese companies, have shown that editing is possible with DAT, revealing their edit control system for the *D-20* at recent exhibitions. This review assesses Fostex's approach to editing on DAT, using a pre-release beta version (1.0.7B) of 'DES', the *D-20* Edit Control System. Fostex plan to sell the software from September so this beta version is very close to its final form.

The D-20

The *D-20* is a four-head DAT machine, allowing either for a second set of heads to 'read-after-write' in order to monitor a recording off-tape, or to 'read-modify-write' in order to allow for cross-fading between old and new material at a punch-in or -out. The heads are spaced apart at the distance required for off-tape data to be decoded, crossfaded and re-encoded, allowing for seamless joins between outgoing and incoming material with a fixed crossfade time of 15 ms. It is therefore clear that the *D-20* has always been able to allow editing, since electronic editing of digital audio tapes involves the same process as punching-in. The only difference between a punch-in and an electronic edit is the source of the new material to be recorded after the punch-in. In the

case of an edit, the source of new material is digital audio transferred from a second player machine, synchronised to the master recorder using the *D-20*'s timecode facility and an external synchroniser.

When the *D-20* is in its edit mode, the read (replay) heads lead the write (record) heads. At a punch-in, the audio is replayed from the leading heads, via the standard decoding process and fed into a crossfader. The crossfader has two inputs, one from an external input (either derived from the analogue or digital audio inputs of the machine) and the other from the off-tape signal. The output of the crossfader is routed back to the lagging record heads to allow the re-recording of the processed audio from the replay heads at the original point on the tape, crossfading to the externally input material at the designated point. The crossfade can begin at any point within the DAT frame so the punch-in or edit-in point is not restricted by the resolution of DAT frames. At a punch-out point the reverse process takes place, with the newly recorded material being crossfaded back to the old material. This is the basis of the 'read-modify-write' process and is used in many rotary head digital audio systems, including the audio tracks of *D-1* and *D-2* video machines.

Fostex editing

For editing between two *D-20*s, Fostex have chosen a *4030* synchroniser and an Apple *Macintosh* computer running custom designed software. The synchroniser deals with the locking and offsets between the DAT machines, as well as initiating record functions, monitoring modes and so forth, while an RS422 interface links the synchroniser with the *Mac*. Under command of the computer the synchroniser locks the DAT machines at the required offset and initiates both rehearsal and execute operations for any edits specified by the user. The *Mac* software is based around an environment called Hypercard, with which *Mac* users will be familiar, the DAT editing software simply being a Hypercard 'stack' and as such may be run on any *Mac* that has Hypercard version 1.2 or higher.

In order to allow customised communication with the *4030* synchroniser, some additional Hypercard XFCN's (external functions) have been written which convert timecode values into a format usable by Hypercard, and also communicate with the *4030* in its own protocol. The programming side of the system has intentionally been left open-ended, so users can develop their own DAT-based applications on the *Mac*. The software as supplied comes in two parts: the '*D-20* Edit' stack and the 'Auto Conform' stack, which are both fully working applications requiring no further user-programming to make the system operational. This is important, since it should be made clear that the software is not just a set of development tools but a working edit control system. The stacks are being made available at low cost to encourage the widespread use of the system, thus the cost of the system is not in the software, but the purchase of two *D-20*s, a synchroniser and a *Macintosh*. The system will run on any *Macintosh* able to run Hypercard (it will just be a bit slow to respond on *Macs* such as the *Plus* and *SE*).

D-20 edit stack

The *D-20* edit stack is an application for controlling two *D-20*s in an editing pair, for conventional copy editing, either insert or assembly fashion. A first point to be made is that the *Macintosh* simply acts as a machine controller, it does not process or handle audio in any way. All the crossfading and rehearsal functions are attributes of the *D-20*, thus fixing the crossfade at 15 ms. This imposes a few limitations on the system when compared with some hard disk systems and the Sony *DAE-3000* but one must remember the differences in cost. The main limitation is that of not being able to simulate 'reel-rocking' in order to locate edit points, these points being located by hitting a button on-the-fly and then being modified by nudging either way in small increments. Initially I found this annoying, being used to having the facility on more sophisticated editors but soon found that it was possible to manage without it. It should be remembered that all Decca's digital recordings for CD were edited in such a way until a few years ago, the operators having become increasingly skilled at anticipating their reaction times and knowing the effect of a certain number of ms offset on an edit point. After a day working with this system I was able to get the majority of edits in the right place at the first or second attempt without the need for modification, except the most difficult. More on this later.

The control screen is laid out in such a way as to show recorder and player controls each associated with a display that simulates tape motion over a period of time centred on the edit point (Fig 1). Both machines can be remotely controlled using conventional transport buttons, and the display shows arrows in the tape position to indicate whether the tape is playing, stopped, or fast winding. The resolution of the display can be altered to show between 60 secs and 1 frame, although I found that the standard 6 secs was normally adequate, since it is only a clue to the position and motion of the tape, and is a little too jerky (at least on a *Mac SE*) to be relied on for the visual estimation of the exact edit point.

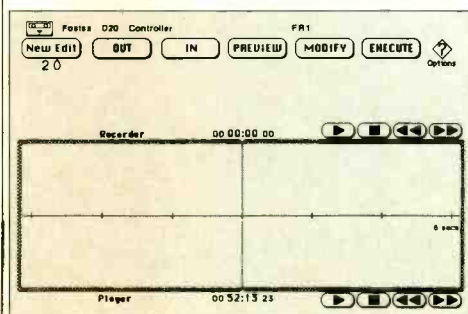

Fig 1: Main edit screen

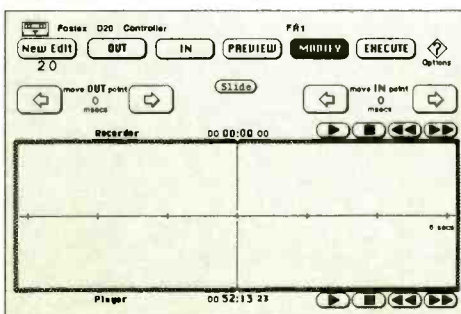

Fig 2: Edit screen in modify mode

Edit points are defined by selecting either IN or OUT points, playing the appropriate machine and hitting the mark button at the approximate point. The system then winds the machine back and plays again over the point selected, allowing the user to have another try if required, adding small arrows on the display at each point marked in this way. It is possible to select any one of the arrows as the point to be used as the current edit point, and then to modify it backwards and forwards using the modify button, which brings up controls for nudging the IN and OUT points backwards or forwards in small steps (default is 10 ms but can be made smaller or larger) (Fig 2). In practice I found that I hardly used the arrow selection facility because earlier attempts were nearly always worse than later ones and I simply tried a few times until I was happy, then nudged by a few ms either way.

Edit points can be previewed by playing either up to the edit point or from the edit point on either machine, as well as it being possible to do a full sync preview by running both machines locked together, with a dummy crossfade at the edit point. The modify function also allows for the edit point to be 'slid' either way, adjusting the point on both player and recorder at the same time to make the absolute edit point earlier or later. Since the edit can be previewed and modified infinitely until it is correct, there is no need to record anything until the last moment, getting round any worries people might have about dropping-in repeatedly at the same point on the tape (it can be found that repeated dropping-in at the same point on DAT tape will cause a drop-out).

Execution of the edit is performed in the same way as a preview, except that the recorder drops into record at the edit point, continuing to record from the player until told to stop. Audio is transferred between machines either via an AES/EBU digital link, or using analogue connections and the user is presented with the option to make the transfer using 'Digital Sync' (locked via wordclock) or using timecode lock. In the case of a digital sync transfer the machines are initially locked via timecode, switching over to wordclock after the edit point, for more stable speed lock. The pre-roll is variable over a wide range and I found that the machines locked extremely fast (often within a second), although working with a 3 sec pre-roll I found that there were occasions on which the first attempt at lock failed and it had to try again.

EDL functions

Edits may be reviewed once again and all the timecode locations are stored in an Edit Decision List so they may be recalled and modified at any time. This is a very powerful feature, since a facility is provided for automatically executing any pre-stored EDL without user intervention, making it possible to modify an earlier edit and update the EDL to accommodate the possible effect that might ripple through the subsequent edits if the modification caused the edit out point to change (this might occur if a new take, having a slightly different length, were inserted into the middle of a finished master). In such a case it would be possible to re-do the edit, update the EDL for all the subsequent takes and then

instruct the system to compile a new master automatically from the source takes while the editor was at lunch (or this could be performed on a second system set aside specifically for this purpose to serve time).

As well as it being possible to modify edit points after they have been executed (provided that you don't mind having to automatically re-assemble the master), it is possible to attach comments to each edit in the list, giving cues as to the section of music or programme involved. The cues are then shown on the main edit screen when the edit is being worked on. EDLs may be saved as projects, for recall at another time.

Timecode

It is necessary to pre-record timecode onto the recorder tape before editing can take place and this must be contiguous throughout the length of the tape otherwise problems with synchronisation and location arise. It is also preferable to have contiguous timecode throughout the length of the player tape as well, although I managed to work with discontinuous player timecode provided there was at least 10 secs of code prior to the in-point to allow for pre-rolls, overshoots and location.

Matters of synchronisation between timecode and wordclock are also important for digital transfers, since the system switches from timecode lock after initial synchronisation to wordclock lock. This is in order that the speed of the machines remains as stable as possible during transfer, not being subject to the speed correction whims of the timecode synchroniser. If conflicts are not to arise between the timecode and wordclock then timecode should be striped onto both tapes with reference to a stable source. The important point is not that recorder and player are striped at the same time with the same timecode referred to the same sync reference but that the timecode on each tape does not drift in relation to the digital audio. In other words, a recorded second in terms of timecode should be exactly the same as a second in terms of audio samples. In the *D-20*, a timecode generator is not integral with the system and thus an external generator (such as the Fostex 4010) is required. There are advantages and disadvantages to this approach, since it is dangerous for timecode and digital audio not to be referenced to the same clock in editing systems, yet there may be other applications in which the user specifically wants to record asynchronous timecode on a tape. The Fostex approach has been to make the *D-20* as similar to a ¼ inch analogue tape machine with centre timecode as possible, although it might be argued that this is not appropriate in a digital audio system because of the timing implications.

Sync between timecode and wordclock can be achieved in a number of ways depending on the operational situation. If the player and recorder tapes are being striped simultaneously then the two machines and the timecode generator could be locked to a source of video syncs (this will become a much more important factor in audio recording in the future). If the user is only worried about the relationship between the two tapes and not between timecode and wordclock, then he could use the wordclock output of the recorder to lock the player during striping, leaving the timecode generator to free-run but this is not ideal. If the

player tape is being made somewhere on location it is important that the timecode generator and the *D-20* are referenced to a common sync source (possibly a portable video sync pulse generator) in order to ensure that the two do not drift.

During play mode the software on the computer displays a moderately smooth continuous update of timecode location, although during long locate operations when the system cannot read timecode, quite large discrepancies sometimes build up between the displayed and the actual positions, resulting in a jump in displayed time when the machine goes back into play. Normally this is not a serious problem but it can be troublesome when only a short pre-roll is available before an edit and a fast locate operation overshoots the start of the timecode.

DES in action

Having worked with the system for a while, attempting to place it under considerable pressure, it is clear to me that it is possible to execute entirely musical edits, which can be made as inaudible as those performed on any other system, this naturally depending on the skill of the editor! This said, there are no gain correction facilities to allow for the adjustment of player level, an operation sometimes needed to match the levels of incoming and outgoing takes and to help in the manual 'hiding' of difficult edits. Furthermore, one cannot adjust the crossfade time, although the standard crossfade was acceptable in many cases. It is possible to adjust the location of the edit point in very small increments, this really only being limited by the accuracy with which the synchroniser can issue a record command to the *D-20*. The edit trim function allows for the user to enter any number in ms and fractions, although it becomes relatively meaningless to try changes of less than 1 ms since they are usually inaudible. Timecode values for commands can be issued to the synchroniser in hours, minutes, seconds, frames and a 16 bit hexadecimal extension to describe fractions of frames, thus the accuracy of the record command is only limited by the accuracy with which the timecode can be read by the synchroniser. There is a tendency in modern editing systems to allow editing accuracy down to one sample but users should question the real value of this, since it is probably more a case of 'specmanship' than necessity. One ms corresponds to a little over ¼₁₀₀ inch on analogue tape at 15 in/s, and one would need a very sharp razor blade to be that accurate! One sample corresponds to 20.8 µs at 48 kHz sampling rate, which would correspond to 0.0003 inches at 15 in/s.

Although not as feature-packed as some of the hard disk systems or Sony's *DAE-3000*, the Fostex system would be suitable for moderately intensive assembly editing work in a studio, or perhaps as a cost-effective solution for the self-employed recording engineer. There will also be applications in broadcasting for editing DAT tapes made on location and for conforming timecode DAT tapes to video edits (see Auto Conforming). If I were a full-time editor, I think I might get a bit frustrated with the relative slowness in operation (although this is not a major limitation), the lack of audible edit point search, the lack of an immediate memory preview facility and the lack

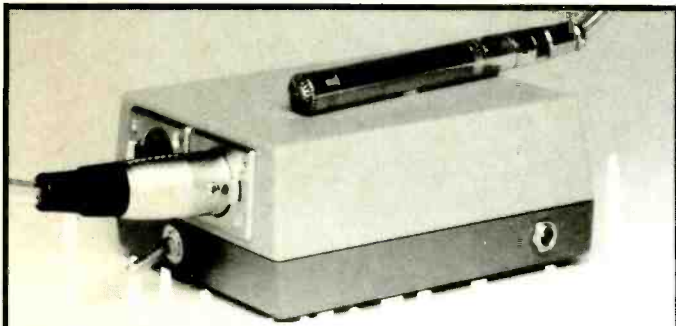

INTERFACE

- INCLUDES selection of Type 1 measurement mikes, pre-amps and power supplies.
- COMPATIBLE with your choice of acoustic analysis equipment
- PROVEN RELIABILITY in architecture, noise control, sound synthesis, life sciences, product development, earth sciences, and many more applications
- LONG TERM STABILITY for temperature and humidity
- COST COMPETITIVE

ACOustics begins with

For full facts, call or write:



ACO Pacific, Inc.
 2604 Read Avenue
 Belmont, CA 94002 USA
 (415) 595-8588 FAX: 591-2891

DACS MODULAR MONITOR SYSTEMS

The simple and effective choice for monitoring

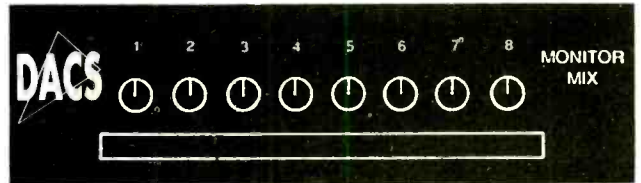

MONITOR MIX

Monitor Mix 1 - 8 into 1 audio (line or mic)
 Monitor Mix 2 - 4 into 2 (pan and vol per channel)



HEADPHONE AMPLIFIER

Stereo or 2 into 1 mixing, clean power to two pairs of stereo headphones
 Panel size - 5.2" by 1u high

Modules can be mounted in rack or free standing case.

Designed for simple, flexible and easily controllable headphone and on stage monitoring. Designed to give musicians the mix they want and engineers the quality they demand.

UK	DACS	for Retail Outlets, UK & foreign trade enquiries and further information	Tel: 091 438 5585	Fax: 091 438 6967
France	Decides		Tel: (33-160) 192 929	Fax: (33-160) 190 644
Spain	Ventamatic		Tel: (34-3) 230 97 90	Fax: (34-3) 321 21 73
Sweden	Handic		Tel: (46-31) 289 685	Fax: (46-31) 681 982

SEEPORT - THE PORTABLE AUDIO MIXER

There has never been anything like it!

Includes a variety of features for radio, TV, film and video.

YOU NEED IT!



SEEM AUDIO A/S Broadcast Telecommunication Audio/Video

P.O. Box 115, N-1380 HEGGEDAL, Norway
 Tel.: +47 2 79 77 30, Fax: +47 2 79 61 54, Telex 79 207 SA N

of level/crossfade control. People who make their money out of music editing have got used to being able to make edits where they might never have attempted them before, due to facilities on other systems such as variable crossfades (perhaps with out-slope different to in- and over several secs) and different crossfade laws (log, lin, cosine, etc). For such people, money tends not to be the primary factor, whereas creative flexibility and speed is more important. Fostex points out that they are not promoting the package as a full-blown 'editing system' but an 'edit control system'. It remains to be seen whether the customer will appreciate this semantic distinction!

During testing, which generally went very smoothly without the instances of software crashes and error messages that tend to plague new software, a few points arose that deserve comment. Firstly, during the execution of an edit the record machine drops into record at the chosen edit point but the computer display seems to wait about 3 secs before showing the message NOW RECORDING, which seemed a little too late for comfort. This message should really appear the instant after the drop-in. On termination of recording after an edit the user is presented with the possibility of setting up a new edit, the selection of which takes him back to the main edit screen and immediately starts playing the recorder from about 10 secs before the point at which the previous recording was stopped. This is fine if you are ready to hit the MARK OUT POINT button virtually immediately and provided that the next edit point is indeed within the last 10 secs but this is not always the case! The same happens when you try to mark the player in point, in that the player automatically begins to play from wherever it had stopped, which is rarely the place you want.

In terms of cueing and pre-rolling, the system is responsive and quite fast, since DAT transports can spool very quickly. The software is good at anticipating the next move in most cases, such that machines are re-cued to the pre-roll point without user intervention and one quickly gets used to what to expect. The display is good at keeping the user informed of the current action, such as LOCATING RECORDER, or LOCATING PLAYER, the only minor gripe being that the audio outputs of the machines are not muted during parking before pre-roll, resulting in bursts of loud music, which I would rather not hear. Because of the nature of a DAT transport, it is possible to go from play to slow wind in either direction and then back into play without a break for lacing and unlacing of tape (as would be the case with U-matic machines) and this can make for quick manual reviewing or cueing. There was the odd occasion when a button on the screen did not respond to a 'press' and I must assume that this is due to the relative slowness of Hypercard on the Mac SE.

It is possible to work with a pre-roll as short as 3 secs, although on occasions at this setting the machines didn't lock before the edit point. A short pre-roll is useful when there isn't much timecode prior to the edit point. Working with discontinuous timecode also proves possible for single manual edits but is problematical, since when the machines go into fast wind they tend to overshoot the change in timecode and get lost when they go into play again. Provided you stay within a short distance of your edit point and

don't go into the 100x wind speed mode (two clicks on the wind buttons) it is possible for the system not to get lost. Location over distances is difficult with discontinuous timecode, requiring that you also use the counter on the DAT transport for an absolute indication of running time and some of the EDL functions and automatic assembly from the edit list will get confused if the timecode is not contiguous throughout the length of the tape.

Making up for some of the limitations of the system are the excellent revision, reviewing and auto editing facilities, which allow for a quick review of any collection of edits from the EDL by playing the short section around the edit and then skipping on to the next one in the list. Any of the edits can then be revised, whereon the system will re-display all the original information for that take, offering options to update all or some of the succeeding edits to accommodate changes in length of earlier takes. The revised EDL can then be automatically executed without user intervention. A further useful facility is the 'sync copy' option, which allows the user to avoid having to copy long sections in between edits at the time of editing. It allows for sections of player material to be copied onto the recorder at the appropriate offsets for each edit, so that the edits may be rehearsed and previewed quickly, leaving the system to perform the long-winded job of assembly automatically at a convenient time.

The EDL aspects of the system are not designed to cope with multiple reels of tape, making the automatic assembly facilities difficult to use in cases such as the editing of classical music sessions where the source takes may be on more than one reel but manual edits can still be made in the case of multiple reels.

Software for automatically conforming DAT source tapes to an edited video master is also provided on a separate stack, this being able to read CMX compatible EDL's compiled during video editing. It is becoming common for DAT machines to be used for recording separate sound with timecode alongside video productions and the auto conform stack allows for these DAT source recordings to be conformed to the edited video tape by taking the edit commands relating to the appropriate video source reels (which should have the same timecode as the associated DAT source reel) and using them to layback the original audio to the audio tracks of the video master, thus avoiding the multiple generations of audio copying, which sometimes result in video editing.

To use this software, a video transport should be interfaced to the 4030 synchroniser as the master machine and a D-20 with the source audio as a slave. The user then reads in the EDL from a disk file and selects the appropriate source reel and which edit commands are to be acted upon (eg video, audio 1 or audio 2) after which, the system automatically runs through locating the takes on the DAT tape and editing them together onto the audio tracks of the VTR. A multitrack option is also provided, which allows for the DAT audio to be recorded to a multitrack tape with the same timecode as the master VTR, under control of the EDL. The software allows for overlaps to be recorded such that source audio from different reels can be recorded onto different tracks for crossfading in post-production.

CMX EDLs can be transferred to the Mac in a number of ways, one being to connect a 5.25 inch

MS-DOS compatible disk drive to the external disk drive port and use Apple File Exchange to read in the file (this utility converts MS-DOS files to Macintosh format). Recent Macs can also read 3.5 inch MS-DOS disks directly in their internal drives.

Suggestions

Since the design of software for this system is open-ended, it would be possible for me to begin to modify it to suit my needs by getting my nose into the Hypercard scripts and constructing my own system. This may appeal to some although third party developers may decide to produce other applications based around these tools.

If anything is to be changed, then, based on my week with the system, I would like to see a few things changed or corrected for music editing purposes. Firstly, I would like to be able to slide the edit point arrows backwards and forwards to adjust the edit point, rather than having to enter a number in ms, because there were times when I could see graphically where I wanted an edit (although the tape markers are a little too jerky particularly accurate visual estimation of edit points). Secondly, I would like the indication of record status to happen immediately at the edit point, just for a feeling of security! I would also like the MARK IN and MARK OUT buttons to disappear during previews, since they can't be pressed in this mode. Another thing that would be useful is for the transport buttons to remain highlighted to show the current transport status even though the tape markers have tiny arrows to show the status. I am used to looking at the transport status on transport buttons.

Two final adjustments might be the muting of audio outputs while searching and parking (already mentioned) and the possibility for entering a standard user reaction time for the MARK buttons, since this would increase the likelihood of marking the point correctly first time. I found that I was typically between 10 and 20 ms late, although I learnt to anticipate this.

Conclusion

I remain very impressed with the D-20 Edit Control System, despite my few criticisms. It would not be right to say that it threatens established editing systems such as Sony's DAE-3000, since those who edit music for CDs every day would probably stick with this industry standard system, or opt for hard disk editor for operational flexibility, speed and ruggedness in a high pressure environment. This system is specifically for editing DAT tapes, and, considering that many people previously thought this impossible, it is a great thing to have. I have not spent long enough editing DAT tapes to comment on the long term reliability of edits made on such a system but it is possible to say that after a week of testing I have not experienced a single drop-out at an edit point, although I have experienced one timecode drop-out and three audio drop-outs in other places.

It is likely, therefore that a DAT editor will open up the world of digital editing to a much larger number of people, rather than impacting established markets. □

total audio!



Canford Audio



A claim established over the past ten years and a reputation won by supplying a wide range of high quality audio equipment and accessories fast. Quite a claim, but whatever audio equipment you need, Canford is the name to turn to.

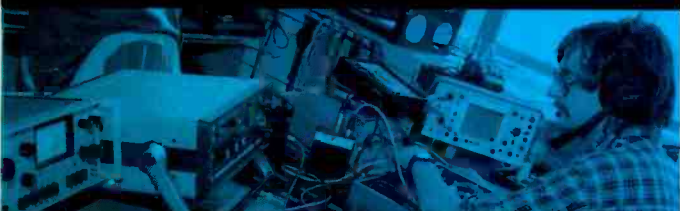

The reputation has been established on our ability to supply the right product at the right price and in the right time scale (next morning if you want). Our catalogue is issued twice a year and runs to over 300 pages. Its up-to-date and totally comprehensive.

So next time you need a connector or two or a kilometre of multipair cable - it's Canford of course.

Phone now for a catalogue.

CANFORD

■ ● *audio* ▶ ▶

CROWTHER ROAD, WASHINGTON
TYNE & WEAR, UNITED KINGDOM NE38 0BW
admin - (091) 417 0057 sales - (091) 415 0205
fax - (091) 416 0392 telex - 538202 CANFRD G

For peak performance from PPM Indicators vu Meters and AL Indicators...

Mixing complex audio signals from multiple sources is difficult enough, so you need to be sure of the meters.

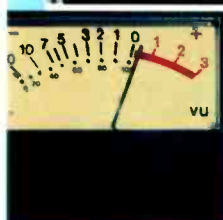

Are they accurate and reliable? Can you read them quickly and clearly?

Sifam is a world leader in meters and ancillary components for the professional broadcasting and audio industries - backed by more than sixty years experience.

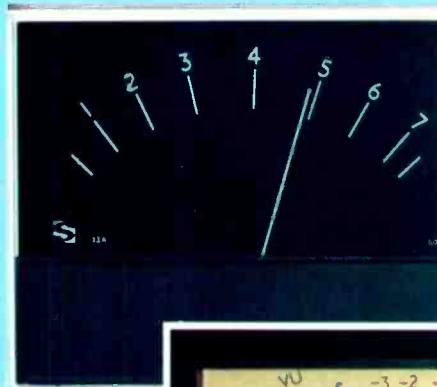

If you need vu meters or PPM indicators to the highest international standards - or something close, but less costly - then it's sure to be in the Sifam range, waiting to give you peak performance.

...Sifam meters

FOR LITERATURE ON OUR RANGE OF METERS, PLEASE CONTACT:

SIFAM LIMITED - METERS DIVISION
WOODLAND ROAD TORQUAY
DEVON TQ2 7AY ENGLAND
Telephone: 0803 613822
Fax: 0803 613926. Telex: 42864





COME AND VISIT US..

Why not come and visit us ? Here at Palm we have over 5000 square feet of show-room area dedicated to demonstrating the vast array of equipment we supply and install. So whether you are looking for a complete 24 Track studio, mixing desk or even a metre of cable! Come and visit us.....We have everything you want....

All Under One Roof!

RECORDING PACKAGES...

Here at Palm Audio Systems we have extensive experience in supplying and installing recording packages from 4 to 48 track. Call us now for more information.....

MIXING CONSOLES:

Soundtracs Quartz 32 - 32:24:32:2 Including Patchbay **£17900**

DR Electronica Mixing Consoles

D&R Dayner 32:32:2 Console (64 inputs) - Floating sub-group system - 8 Aux Sends - Four band splittable EQ - Can be configured as an In-line and a split format console - Ideal for MIDI & Tape based studios - Full fader & Mute Automation available - Prices start from as little as:- **£ 4890**

D&R Dayner 24:24:2 (48 Inputs) + Tascam MSR16 + Looms **£ 8100!!**

D&R Dayner 32:32:2 (64 Inputs!) + Tascam MSR24 + Looms **£ 12330!!**

ALL D&R CONSOLES ARE FULLY MODULAR AND CAN BE LOADED TO YOUR EXACT REQUIREMENTS.....

FOR MORE INFORMATION ON D&R CONSOLES AND RECORDING PACKAGES CALL US NOW ON (021) 200 1771.....!!



Exclusive Active monitor systems from Holland.....
If you simply require the best studio & PA monitoring systems that money can buy...contact us now for a demonstration of these incredible systems form Duran Audio in Holland.....



DIGIDESIGN SOUNDTOOLS....

Looking for a digital editing system for under £2500...Look no further!...Here at Palm we have the Digidesign Soundtools system for the Atari Mega 4 with systems start as little as £2490!..... Phone now for a complete demonstration...(021) 200 1771

EMU SYSTEMS

New PROTEUS 2 Orchestral module IN STOCK NOW!! **£1173!**

For a limited period only PROTEUS XR..... RRP **£1169** **£ 782!**

EMAX II 16 bit sampling keyboard & library...RRP **£2850** **£1899!**

Ex Demonstration EMU Proteus sample module RRP **£899** **£ 650!**

DAT RECORDERS..

Are you looking for a DAT Recorder? Look no further! Here at Palm we stock the full range of DAT recorders by Sony, Tascam and Fostex to name a few!!

Casio DA2 Portable DAT recorder
48Khz Sampling Rate **£ 610**

Sony DTC1000ES 44.1, 48 & 32Khz

Sampling rates **£1129**

Tascam DA30 DAT Recorder - 44.1, 48 & 32Khz sampling rates, Balanced XLR inputs & outputs, Dual standard digital inputs & outputs, Cable remote, 19" Rack mountable RRP **£1355** Stunning Price!!



TAPE & ACCESSORIES

We always carry large stocks of all tape formats including 1/4", 1/2", 1", 2", DAT Cassettes, Audio Cassettes etc.. and also supply splicing tape and blocks, leader tape, razor blades, chinagraph pencils etc.... Phone for a complete price list...

High Quality Audio Cable

Gotham GAC1 5.2mm Single Core (100m Reel) **£67.52**

Gotham GAC2 5.4mm Two Core (100m Reel) **£72.91**

Gotham GAC3 5.8mm Three Core (100m Reel) **£83.70**

Gotham GAC4 5.4mm Four Core (100m Reel) **£112.04**

Gotham GAC10 Muticore cable (100m) **£664.20**

Up to 34 Core available. Large discounts for bulk orders...Phone for more details.....

LOOMS MIC LEADS MIDI CABLES STANDS AUDIO CONNECTORS FLOPPY DISCS HEAD DE MAGS...Etc.....

EX-DEMO & SECOND USER EQUIPMENT..

We always have a large stock of ex-demo and second user equipment . Listed below is just a small selection of the items we have available, obviously our stock changes from day to day so if there is a particular piece of equipment you are looking for contact us at Palm to see if we have got what you are looking for...Ring us now for a complete list of used equipment on (021) 200 1771.....

□ MIXERS

Soundcraft 6000 32:16:2 Ex-Demo inc stand ~~£9510~~ **£6500**

Soundcraft 16:2 S/H Flightcased **£ 575**

Yamaha KM802 8:2 - Ideal Sub-Mixer **£ 200**

□ TAPE RECORDERS

Mitsubishi X850 Digital 32 track - Low Hours **£60000**

Mitsubishi X86 Digital Mastering machine - Low hours **£ 7500**

Tascam MSR24 - 1" 24 Track - Ex Demo **£ 6475**

Tascam MSR16 - 1/2" 16 Track - Ex Demo **£ 3599**

Tascam 52 1/4" Stereo Mastering Machine - S/H **£ 999**

Studio Magnetics SML1216 16 Track 30 ips S/H **£ 1800**

Teac X-3R 1/4" 1/4 track machine - S/H **£ 295**

Teac V270 Cassette machines - 2 Only **£ 59**

Sony DTC1000ES DAT Machine - Ex Demo - 1 Only **£ 999**

JVC U-Matic Video recorder & PSU - S/H **£ 350**

Fostex E16 - Ex Hire **£ 2750**

□ PROCESSORS

Digitech Smartshift Intelligent Harmoniser - Ex-Demo **£ 350**

Digitech 128 Digital multi-fx - Ex-Demo **£ 225**

Drawmer DL221 - 2 Only - Ex Display **£ 278**

Yamaha Q2031A Stereo 31 Band graphic EQ **£ 320**

Micro FX Noise Reduction unit **£ 70**

Dynacord EQ2215 Graphic EQ - New **£ 199**

Roland DEP3 Digital reverb etc.. **£ 299**

□ MICROPHONES

Large range of ex-demo mic's by Sennheiser, EV etc to clear - Phone For details

□ MONITORS

JBL 4411 S/H **£600** JBL Control 1 Ex Display **£125**

Yamaha NS10m's (3) **£199** Electrovoice Sentry 100A **£500**

□ KEYBOARDS & MIDI

Roland Juno 60 S/H **£175** Roland SH101 S/H **£ 85**

Korg M1r Ex Display **£870** Ensoniq mirage DSK Ex Display **£600**

Roland D20 New/boxed **£850** Alesis MMT8 8trk Sequencer **£175**

DACS Midi Patchbay **£ 75** Akai XE8 Drum Expander+cards **£175**

EMU proteus - Ex disp **£650** Korg SG1D Piano & Flight case **£1500**

Casio VZ10m Ex-Disp **£199** Kurzeil K1000 Keyboard **£1474**

Kurzeil 1000HX Horn **£1130** Kurzeil 1000GX Guitar Exp **£1130**

□ DRUM MACHINES

Roland TR606 Drumatix **£ 45** Yamaha RX11 **£ 75**

Yamaha RX21 **£ 50** Sequential TOM **£200**

HR16 - New **£200**

□ MICELLANEOUS

Groove tube Guitar pre-amp - Secondhand **£600**

Yamaha PD2500 Power Amplifier **£750**

Ensoniq EPS8 Output expander for EPS - 2 Only **£115**

Akai EXM005 2 Meg expansion for the S1000 **£430**

Akai EXM006 memory expansion for the S950 **£155**

NEW FOSTEX G16!!

Available NOW!!!

The new 16 track standard is here! 1/2" format with Dolby C™ Noise reduction. Internal remote and Synchronisation - Improved specification.....£4343

NEW TANNOY
GREY & GOLD
MONITORS
IN STOCK NOW

ROLAND FOSTEX TASCAM C-LAB DIGIDESIGN
KORG TANNOY JBL YAMAHA SOUNDTRACS
D&R AXYS AKAI STUDER-REVOX AKG BEYER
ALESIS SONY QUAD MACINTOSH OTARI.....



SALES HIRE EXPORT
INSTALLATION MAIL-ORDER



TEL: (021) 200 1771

FAX: (021) 200 2370

THE PACIFIC BUILDING -16/17 CAROLINE STREET
BIRMINGHAM B3 1TR

Back To Reality

Brüel & Kjær

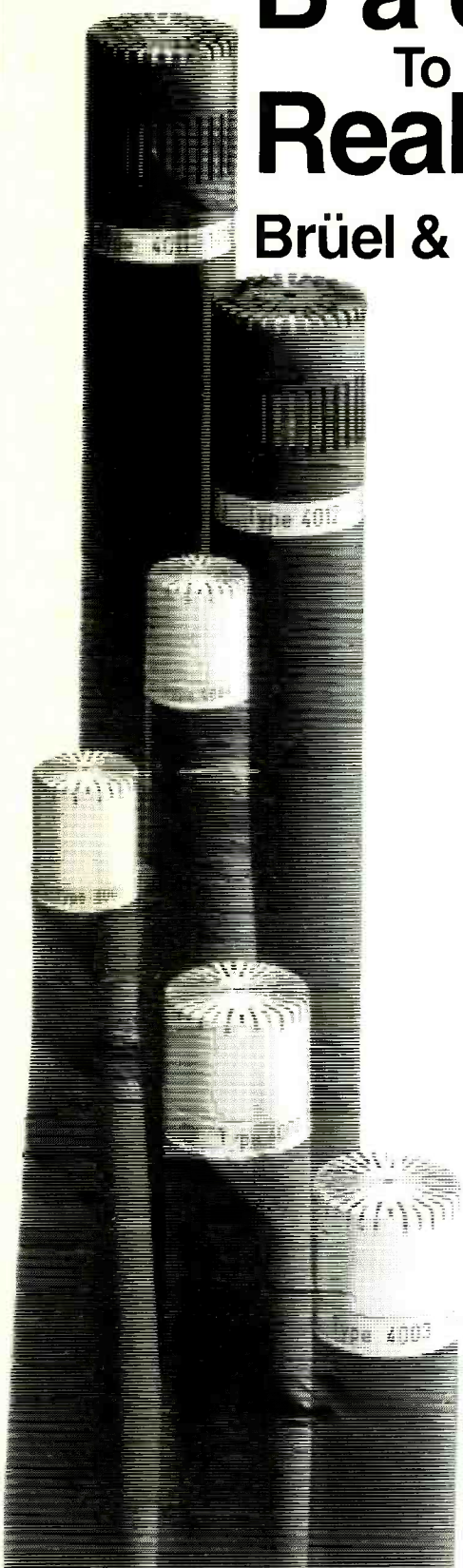

Series 4000 Microphones

FOR DETAILED
INFORMATION
FILL COUPON &
RETURN TO:

Brüel & Kjær
Pro Audio (UK)
Harrow Weald Lodge,
92 Uxbridge Road,
Harrow,
MIDDX HA3 6BZ.
Tel: 01-954 2366

Brüel & Kjær
Pro Audio
18 Nærum
Hovedgaade,
2850 Nærum,
Denmark
Tel: + 45 42 80 0500

Name _____
Address _____



More than one way...

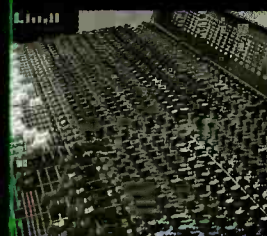

Tascam MSR24 + Soundcraft 6000

*1" 24-Track & 24/24/2 Desk complete with Remote Control and
Looks for fourteen thousand, nine hundred & ninety-five pounds.*

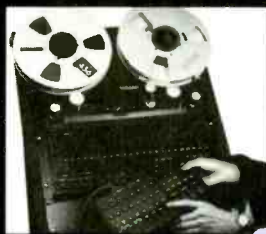

Tascam MSR24 + Allen & Heath Saber

*1" 24-Track & 24/16/24 Desk complete with Remote Control and
Looks for thirteen thousand, seven hundred & fifty pounds.*



Tascam MSR24 + Tascam M3500

*1" 24-Track & 24/8/24 Desk complete with Remote Control and
Looks for eleven thousand, five hundred pounds.*



Tascam MSR24 + Studiomaster Trackmix

*1" 24-Track & 24/12/24/2 Desk complete with Remote Control and
Looks for ten thousand, two hundred & ninety-five pounds.*

...to skin a cat.

RAPER & WAYMAN

Unit 3 ▲ Crusader Estate ▲ 167 Hermitage Road ▲ London N4 1LZ
Facsimile 081-809 1515 ▲ Telephone 081-800 8288

All four systems Guaranteed for 2 Years.

(Prices exclude VAT.)

Improve the Means to the End

Introducing Our New Extended Benefits Package:

Model MCE325 Programmable User Station



Think of it...

a versatile intercom user station with a wide range of operational and packaging formats.

Physical benefits include a five way modular packaging technique for permanent or portable applications. While headset operation comes standard, adding our MCS325 Speaker and a plug-in microphone supports an open-listening setting.

Operator benefits sport user-friendly software and hardware based programming; the MCE325 can be operationally and functionally configured to suit individual requirements.

As for the small print; the MCE325 works in conference-line or dedicated-line environments, with 2-channel split talk/listen or 4-channel combo talk/listen, in 2-wire or 4-wire line mode, or a combination of both. Also featured are two channels of IFB, two program inputs, and call signaling. Modular packaging includes: rack mount or portable headset station, rack mount or portable speaker station, or console mount headset station.

Please call or write for details.

The First Name In Intercommunications

Professional Intercommunications

Professional Audio Products

1988 - 1989

Engineering

Emmy Award



RTS SYSTEMS

A Telex Communications Company

1100 West Chestnut Street
Burbank, California 91506

Phone 818-566-6700
Fax 818-843-7953

INTERNATIONAL DISTRIBUTION

AUSTRALIA—PACOMM 61-2-638-6400 • BELGIUM—EML 32 (011) 41-52-78 • CANADA—Applied Electronics (416) 252-3761 • CHILE—Teknos Comunicaciones 2-556-8390
FINLAND—MS-Audiotron 90-5664644 • FRANCE—SCV Audio 33-1-48-63-22-11 • WEST GERMANY—Harman Deutschland 49-7131-4800 • GREECE—Bon Studio S.A. 3633572
HONG KONG—ACE 852-3-7452343 • ITALY—Audio Intl. 39-2-25390121 • JAPAN—Otaritec 03-332-3211 • KOREA—Sama Electronics (02) 271-2761/3 • MEXICO—Teknomerica 905-683-4399
NETHERLANDS—lemke Roos Audio (020) 97-21-21 • NEW ZEALAND—Audio & Video Wholesalers (071) 473-414 • NORWAY—Siv.ing Benum (02) 14-54-60 • SOUTH AFRICA—Prosound 2711-337-6556
SPAIN—Fading 408-67-00 • SWEDEN—Intersonic System 08-744-5853 • SWITZERLAND—Gotham AG 41-1-840-01-44 • U.K.—Elliot Bros. (0865) 798000 • VENEZUELA—Audio Rama 72-2256725025

www.americanradiohistory.com

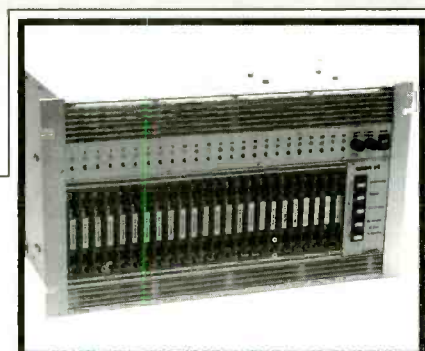
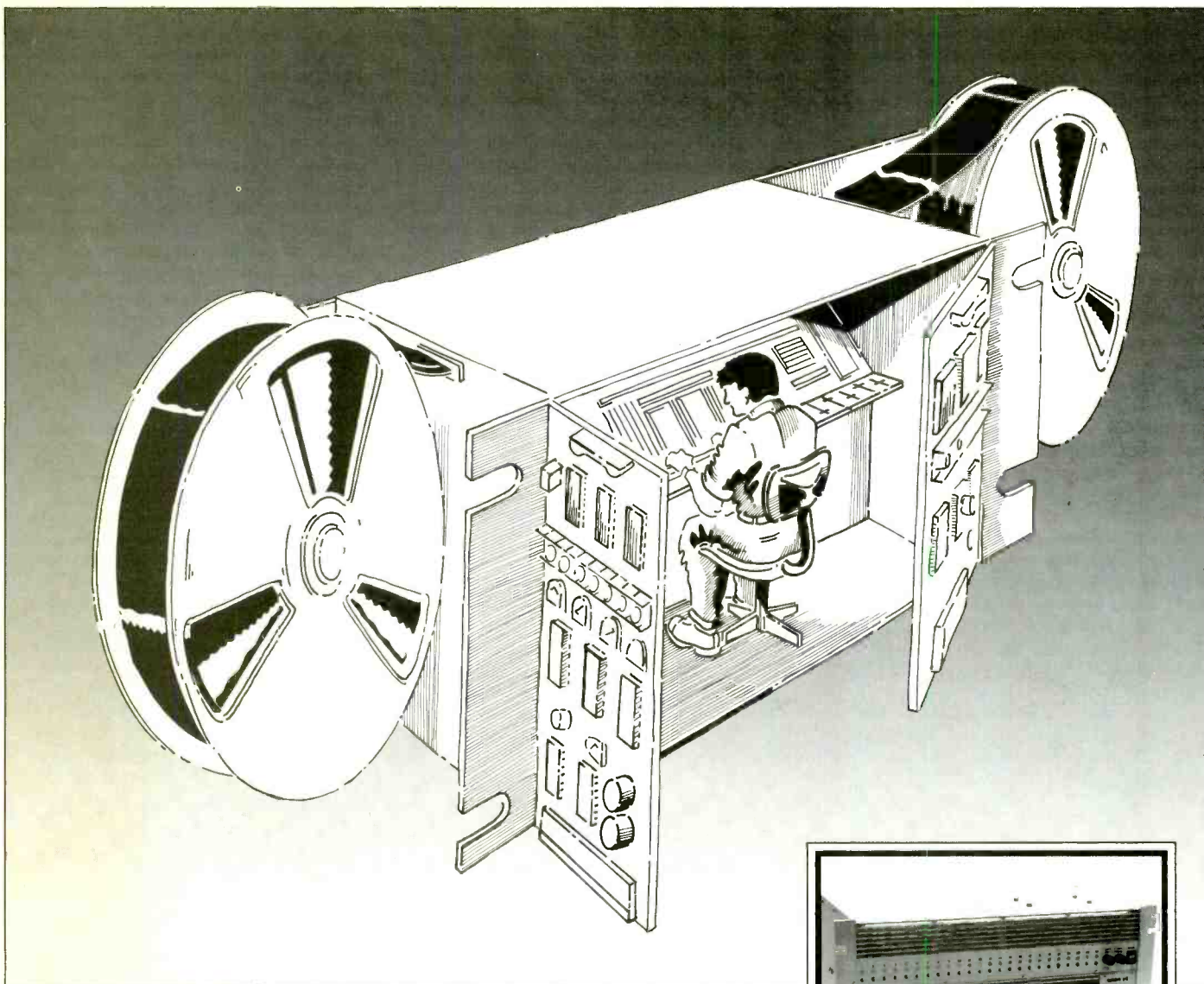

24-channel E413 c4 multitrack

The Best of both Worlds

Whether you are recording your hits on analogue or digital machines, telcom c4 offers you the best from a big noise in noise reduction.

This processing method requires no line-up procedures and provides a dynamic range of up to 118 dB.

It improves analogue recorders to 18-bit comparable performance with natural sound and low tape noise.

Digital recorders such as DASH, PD, R-DAT etc are improved to 20-bit comparable performance for more recording headroom and less quantisation noise.

Here are the latest additions to our DIAMOND EXCHANGE CARDS to fit a wide variety of machines:

telcom c4-300/350 SR
telcom c4-AC27 for BVH 2000/2500

Contact us and find out whether there is a CARD for your machine. In the UK: phone Tom Belshaw on 01 226 1226

I would like to learn more about telcom!

Address

UK: PRO-BRITRO LTD,
35 Britannia Row, London N1 8QH
ROBERT BOSCH GMBH
Lindener Str. 15, D-3340 Wolfenbüttel
Phone (0 53 31) 83-364, Telex 9 5 651 ant wf

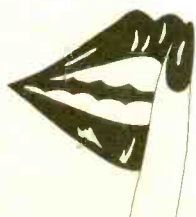

PSSshhh

telcom c4
Silence by Design

ANT
Bosch Telecom

COUNTRY & WESTERN Bangra NEW AGE House Salsa
 WORLD MUSIC HEAVY METAL RAP Rhythm & Blues
 OVERS ROCK BLUE BEAT Two Tone PSYCHEDELIC
 LE Opera POP Choral Cajun Zydeco COUNTRY
 NEW WAVE Swing Calypso Golden Oldies WORLD
 JU-JU CHAMBER MUSIC RARE GROOVE LOVE
 TIN Gospel PROGRESSIVE DUB SKIFFLE Opera P
 ASSICAL ROCK Jazz Ska BLUES NEW WAVE Sw
 tra BIG BAND Acid Jazz Jit Jive JU-JU CH
 -Motown ROCK & ROLL FUNK LATIN Gospel F
 REGGAE SOUL HIP HOP Soca CLASSICAL ROCK
 FOLK SAMBA Rai Light Orchestra BIG BAND Ac
 TEX MEX GARAGE Tamla-Motown ROCK &
 ngra NEW AGE House Salsa REGGAE SOUL HIP
 METAL RAP Rhythm & Blues FOLK SAMBA Rai
 AT Two Tone PSYCHEDELIC Indies TEX MEX
 n Zydeco COUNTRY & WESTERN Bangra NEW A
 den Oldies WORLD MUSIC HEAVY METAL RA
 UNTRY & WESTERN Bangra NEW AGE House Sa
 WORLD MUSIC HEAVY METAL RAP Rhythm & B
 OVERS ROCK BLUE BEAT Two Tone PSYCHEDE
 LE Opera POP Choral Cajun Zydeco COUNTRY
 NEW WAVE Swing Calypso Golden Oldies WORLD
 JU-JU CHAMBER MUSIC RARE GROOVE LOVE
 TIN Gospel PROGRESSIVE DUB SKIFFLE Opera P
 ASSICAL ROCK Jazz Ska BLUES NEW WAVE Sw
 tra BIG BAND Acid Jazz Jit Jive JU-JU CH
 -Motown ROCK & ROLL FUNK LATIN Gospel F
 REGGAE SOUL HIP HOP Soca CLASSICAL ROCK
 FOLK SAMBA Rai Light Orchestra BIG BAND Ac
 TEX MEX GARAGE Tamla-Motown ROCK &
 ngra NEW AGE House Salsa REGGAE SOUL HIP
 METAL RAP Rhythm & Blues FOLK SAMBA Rai
 AT Two Tone PSYCHEDELIC Indies TEX MEX
 n Zydeco COUNTRY & WESTERN Bangra NEW A
 den Oldies WORLD MUSIC HEAVY METAL RA
 UNTRY & WESTERN Bangra NEW AGE House Sa
 WORLD MUSIC HEAVY METAL RAP Rhythm & B
 OVERS ROCK BLUE BEAT Two Tone PSYCHEDE
 LE Opera POP Choral Cajun Zydeco COUNTRY
 NEW WAVE Swing Calypso Golden Oldies WORLD
 JU-JU CHAMBER MUSIC RARE GROOVE LOVE
 TIN Gospel PROGRESSIVE DUB SKIFFLE Opera P
 ASSICAL ROCK Jazz Ska BLUES NEW WAVE Sw
 tra BIG BAND Acid Jazz Jit Jive JU-JU CH
 -Motown ROCK & ROLL FUNK LATIN Gospel F
 REGGAE SOUL HIP HOP Soca CLASSICAL ROCK
 FOLK SAMBA Rai Light Orchestra BIG BAND Ac
 TEX MEX GARAGE Tamla-Motown ROCK &
 ngra NEW AGE House Salsa REGGAE SOUL HIP
 METAL RAP Rhythm & Blues FOLK SAMBA Rai
 AT Two Tone PSYCHEDELIC Indies TEX MEX
 n Zydeco COUNTRY & WESTERN Bangra NEW A
 den Oldies WORLD MUSIC HEAVY METAL RA
 UNTRY & WESTERN Bangra NEW AGE House Sa
 WORLD MUSIC HEAVY METAL RAP Rhythm & B
 OVERS ROCK BLUE BEAT Two Tone PSYCHEDE
 LE Opera POP Choral Cajun Zydeco COUNTRY
 NEW WAVE Swing Calypso Golden Oldies WOR



MIDEM THE MUSIC SHOW

PALAIS DES FESTIVALS, CANNES, FRANCE.

20-24 JANUARY 1991

Midem. The world's premier music market.

More business, more events, more participants, more concerts,
more breaking acts, more deals. And more music.

Pop, Rock, Jazz, Classical, Contemporary. From sound waves to new wave,
from studios to equipment, Midem is tuned
to your success.

Make the most of your participation.

A stand delivers high profile to your company and is the most efficient way
to do business.

**You may even qualify for a DTI subsidy
if you book by SEPT 30**

Advertise your product & promote your activities
in the Midem Guide, the industry's who's who.

The Midem Preview & Daily News keeps you up to the minute
on international music news. Book a page & make your mark
to a captive audience.

Contact Peter Rhodes today. Make the most
of the promotional opportunities.

And let Midem make it happen for you.

Midem 25 years of getting it right!

**PETER RHODES, INTERNATIONAL EXHIBITION ORGANISATION,
METROPOLIS HOUSE, 22 PERCY STREET, LONDON W1P 9FF.
TELEPHONE: 071 528 0086 FAX: 071 895 0949 TELEX: 920173**

Please rush me details of Midem '91.

I am interested in
exhibiting with a stand participating

Name _____

Company _____

Title _____

Address _____

Telephone _____

PETER RHODES, INTERNATIONAL EXHIBITION ORGANISATION,
METROPOLIS HOUSE, 22 PERCY STREET, LONDON W1P 9FF.
TELEPHONE: 071 528 0086 FAX: 071 895 0949 TELEX: 920173

CLASSIFIEDS

Advertisements for this section must be pre-paid. The rate is 70p+VAT per word, minimum £17.00+VAT. Box Nos. £6.00+VAT. VAT (UK only) \$ rate \$2.00 per word, minimum \$50.00, Box No. \$10.00 extra. Semi-display rates on application. Copy and remittance for advertisements in NOVEMBER issue must reach these offices by 20th SEPTEMBER addressed to: The Advertisement Manager, Studio Sound, Link House, Dingwall Avenue, Croydon CR9 2TA. Cheques made payable to Link House Publications (Croydon) Ltd. Note: Advertisement copy must be clearly printed in block capitals or typewritten.

Replies to Box Nos. should be addressed to the Advertisement Manager, Studio Sound, Link House, Dingwall Avenue, Croydon CR9 2TA, and the Box No. quoted on the outside of the envelope. The district after Box No. indicates its locality. **SEX DISCRIMINATION ACT 1975:** No job advertisement which indicates or can reasonably be understood as indicating an intention to discriminate on grounds of sex (e.g. by inviting applications only from males or only from females) may be accepted, unless (1) the job is for the purpose of a private household or (2) it is in a business employing less than six persons or (3) it is otherwise excepted from the requirements of the Sex Discrimination Act. A statement must be made at the time the advertisement is placed saying which of the exceptions in the Act is considered to apply.

The attention of advertisers is drawn to "The Business Advertisements (Disclosure) Order 1977", which requires that, from 1st January 1978, all advertisements by persons who seek to sell goods in the course of business must make that fact clear. From the above date consumers therefore should know whether an advertisement relates to a sale by a trader or a private seller.

SERVICES

CASSETTE DUPLICATING:
GAUSS Loop-Bin / TELEX In-Cassette
High Quality Blanks / Label Printing
OPEN REEL DUPLICATING
 (ANY SPEED - ALSO TO BROADCAST SPEC.)
SPEECH RECORDING
 (VOICE-OVERS; LANGUAGES; AUDIO-VISUALS)

SPEECH-PLUS RECORDINGS LTD.
 UNIT 32, NO. 19, PAGES WALK, LONDON SE1 4SB. TEL: 071-231 0961

FOR ALL YOUR RECORDING NEEDS

AMPEX · BASF · MAXELL · AGFA · JVC
 AUTHORISED NATIONAL AUDIO/VIDEO TAPE DISTRIBUTOR
 Spools, boxes, blades, splicing and leader tape. Blank custom wound cassettes C1-120, labels, library cases and cards, C-zeros, pancake, etc. Broadcast Cartridges.

SEVE 12 Britannia Road
 Sale, Cheshire M33 2AA
 Tel: 061-905 1127
FOR QUALITY, PRICE AND SERVICE

KLUNN

HAND BUILT STAINLESS STEEL MIC STANDS. EXCEPTIONAL STABILITY.
 CONSTANT ATTITUDE. FLOOR COMPENSATION.
 IMPECCABLE DESIGN GUARANTEED FOR LIFE.
 BROCHURE 0580 86266 • FAX 0424 715120 (HASTINGS)

TASCAM/SENN/BEYER, trade counter. Erricks VCD, Brighthouse 722121. (X)

THE COMPLETE SERVICE. Disc cutting, pressings, duplicated cassettes and blanks. Bin Masters. Location Recording. Free Brochure. Tam Studio, 13a Hamilton Way, London N3 1AN. Tel: 081-346 0033. (X)

QUALITY CASSETTE MASTERING AND COPYING, any quantity, Video duplication PAL/NTSC/SECAM transfers, 24 hour, seven days a week service. G.W.B.B. Audiovision, 42 Lancaster Gate, London W2 2NA. Tel: 071-723 5190.

LOCKWOOD, TANNOY, etc., new and used equipment always available and wanted, Lockwood Audio Sales 081-866 0671. (X)

DISC CUTTING EQUIPMENT and systems bought, sold, installed and manufactured by TAM/ENGLAND, 13a Hamilton Way, London N3 1AN. Telephone: 081-346 0033.

FREELANCE AUDIO EDITOR (BBC trained). Own machine. Box No. 123.

MASTERBYTE

DIGITAL AUDIO

DAT/PCM EDITS

ONE OFF
 CD MASTERING
 (0742) 550396

THE COMPLETE SERVICE.....

D.I.R.E.C.T.

- Record Pressings
- Cassette Duplication
- Compact Discs
- Post Mastering
- P.Q. Encoding
- Print & Reprographics
- Video Duplication
- Competitive Prices
- Free Quotations

*Make it with us
 We make the hits*

SRT

MARKET LEADERS

☎ 081-446 3218 LONDON
 ☎ 0480 61880 CAMBRIDGE



THE CASSETTE DUPLICATING SPECIALISTS

Real time & high speed loop bin duplication, printing & packaging. Blanks wound to length
 TEL: 061-973 1884

IRON WIND CASSETTE DUPLICATION

If you want cassette copies of the highest quality delivered on time at a price you can afford

Send for Our Brochure

Station House, Station Yard,
 Hinckley, Leicestershire LE10 1UE
 Tel: (0455) 251551

HIGH SPEED HIGH QUALITY LOOP-BIN DUPLICATING BY SRL TAPE SERVICES

REEL-REEL [DOLBY A, WAB, IEC] QUALITY CASSETTES
 F1 PCM DIGITAL [IN...OUT] QUALITY CASSETTES
 AUDIO CASSETTE [DOLBY C, DOLBY B] QUALITY CASSETTES

THE BETTER THE MASTER, THE BETTER THE COPY!
 HOW MANY WOULD YOU LIKE? 100 5000
 081 868 5555 081 866 5555 PHONE FOR PRICE CHECK.

jbs records

MUSIC-SPEECH-DATA

REAL-TIME/HIGHER-SPEED Quality Cassette
 Duplication and Blanks from 1-1000 Computer printed Labels. Solo, 1/4 Yeel, Sony Betamax or R-DAT recording. Fast Security Delivery service.
 FILTERBOND LTD, jbs records div, FREEPOST
 19 SADLERS WAY, HERTFORD, SG14 2BR 0992-500101

TAPELINE

- Blank & Duplicated Cassettes
- Real time cassette duplication
- From 1/2" reel, PCM Beta digital, DAT or cassette masters
- Custom Wound Ferric or Chrome Cassettes
- Labels & Inlays • Shrinkwrapping

Telephone (anytime)
 061-336 5438

High Quality, Low Cost, Express Service

53-55 CORPORATION ROAD, AUDENSHAW, MANCHESTER M34 5LY

RECORDING STUDIO WANTED

Looking to buy large package of studio equipment for one or more studios. All cash offer — also looking for unused pieces — Neve equipment, Valve microphones, outboard gear etc.
 Tel: USA (818) 346 9007, ask for Dave

FOR SALE

BOB TURNER

PRO SOUND & VISION SALES

1 SEAHILL ROAD
SAUGHALL, CHESTER
CHESHIRE CH1 6BJ
Tel: Chester (0244) 881708
Fax No: 0244 880538

NEW IN STOCK

All prices are exclusive of VAT

ART SGE (20K 20 Bit) Digital Analogue Effects Processor £425.00

ART EXT Reverb Multi Effects Sampler £445.00

ART Multiverb II £325.00

BSS DPR 504 Quad Gate £585.00

BSS DPR 502 MIDI Stereo Gate £585.00

BSS DPR 416 4 Ch. Active D.I. Box £395.00

BSS DPR 402 Stereo Comp/Lim/Exp/Gate/De-esser £658.00

BSS AR116 D.I. Boxes £75.00

JBL/UREI 7110 Comp. Limiter £440.00

JBL Control 10 Studio Monitors £666.00

Adam Smith Zeta 3 2 Machine Synchronizer £2,850.00

Valley People Range P.O.A.

Valley People 2 Ch. De-esser £495.00

Active-1 Powered Speakers a pair £260.00

Alesis Data Disc £375.00

Alesis Quadverb £370.00

Fostex E22 1/2" 2-track Master Recorder with Centre Timecode £2,250.00

Fostex E16 16-track £3,150.00

Fostex 4050 SMPTE MIDI Autolocator £600.00

Fostex RM765 Reference Monitors £245.00

Fostex T40 Headphones £65.00

Rotari RH310 Headphones £49.00

TC Electronics 2290 8 secs Sampler/Delay £2,451.00

TC Electronics 112S Programmable, SMPTE, MIDI, Pink Noise, EQ and Spectrum Analyser £1,795.00

TC Electronics 1280 Stereo Delay £1,025.00

TC Electronics 1380 Multitap Delay £1,025.00

TC Electronics 2240 Stereo 4-band Parametric EQ £576.00

TC Electronics 1140 Mono 4-band Parametric EQ £343.00

TC Electronics 1144 Bass Guitar Parametric Pre-amp £343.00

TC Electronics 1210 Spatial Expander £736.00

Seck 24.2 Desk £650.00

Seck 18.8.2 Desk £900.00

Tascam M3500 32 in line Console including stand £5,500.00

Tascam MSR24 24 track Recorder with dbx £8,395.00

Tascam AT880 24 track including remote/autolocate £26,000.00

Tascam DA-30 DAT Player £1,277.00

Soundtracs Quartz Console 32 in line £17,900.00

Soundtracs Quartz Console 48 in line £22,900.00

Sennheiser MKE212 Boundary Mic £450.00

Sennheiser 441 Mic £275.00

Sennheiser MD421 Mic £207.00

Sennheiser MD422 Mic £240.00

Sennheiser MD429 Mic £190.00

Sennheiser MD419 Mic £140.00

Neumann TLM170 Condenser Studio Mic £1,055.00

Neumann SM69 FET Condenser Studio Mic £1,827.00

Neumann USM69 Condenser Mic £2,027.00

Neumann KM564 Condenser Soloist Mic £367.00

Neumann U89 Condenser Mic £1,055.00

Neumann U87ai Condenser Mic £1,055.00

Revox & Studer (depending on model and spec) please ring for price!

Also in stock: Carver, JBL, Amcron & Denon Amps

EX-DEMO/SECONDHAND

Studer B20 + Dolby SR 24-track £36,000.00

Studer A80 16-track (completely overhauled) £5,500.00

Studer 810 MkII in console £4,500.00

Studer A62 in case (v.g.c.) £650.00

Studer B67 in console (mint) £2,300.00

Studer B62 in console (mint) £1,100.00

Studer A80 16-track MkII £5,650.00

Studer A80 Mk 3 24-track + auto/remote £14,000.00

Revox B77 Mk 2 H/S (mint) £725.00

Revox B77 Mk 2 H/S (domestic use only as new) £1,350.00

Fostex R8 8-track demo model £1,250.00

Fostex B16 + Autolocate (overhauled, new heads) £2,500.00

Fostex E16 + 4050 Autolocate £3,250.00

Fostex E2 2-track including stand £2,450.00

Fostex E22 1/2" 30 ips + centre timecode (as new) £2,650.00

Otari 1" 8-track £1,400.00

Otari 50/50 in desk top console £950.00

Tascam 22/2 2 track recorder (mint condition) £375.00

Soundcraft 1" 8-track + Autolocator £1,200.00

Soundtracs PC MIDI 24 in-line Desk, Effects Returns, 56 line Returns including full wiring loom and patchbay (3 months old) £5,500.00

Soundcraft 1600 24.16.2 Console £6,500.00

Trident TSM 32/24/2, recently refurbished, mint £18,500.00

Trident 1U 3-band parametric EQ £250.00

TC Electronics 2290 64 secs £3,600.00

TC Electronics 2290 8 secs £1,500.00

TC Electronics Spatial Expander (secondhand) £495.00

Marshall Time Modulator £200.00

Digitech Smart Shift £550.00

Digitech DSP256 Reverb £425.00

Digitech DSP128 Reverb £140.00

Lexicon 200 Reverb £1,295.00

Lexicon Super Prime Time £1,400.00

Lexicon LXP1/LXP5 + MRC Controller including rack £1,195.00

Publison 90 infernal, Reverb Processor, 2 x 21 secs sampling £4,250.00

Yamaha Rev 5 £575.00

dbx 160X £300.00

Aphex Compellor £650.00

Eventide SP2016 £2,950.00

Drawmer DS201 Gate £245.00

Drawmer 221 Comp £250.00

Drawmer LXP1 Comp £195.00

Drawmer 1960 Stereo/Valve/Comp £650.00

Drawmer M500 Stereo/Comp/Lim/Exp/De-esser £600.00

Audio Logic 7.6 Digital Delay Sampler £345.00

Audio Logic 4 Ch. Gate £240.00

Valley People Stereo Leveller £395.00

Valley People Stereo Autogate with filters £525.00

UREI 1178 Stereo Limiter £850.00

NTP Comp/Lim/Expander/Gate in stereo £1,195.00

BTX 4500 Synchronizer £500.00

Korg STD Digital Delay £255.00

Amcron DC300A MkII Amp £400.00

Court SN30 Monitors £1,100.00

Neumann SM2 Stereo Valve Mic £1,250.00

Neumann U67 Mic (inw capsules) £825.00

Neumann U67 Valve microphone + psu £1,750.00

AKG 414 £575.00

AKG D12 £120.00

AKG 451 Ck1 £200.00

AKG C12A Valve Microphone + psu £1,595.00

Sennheiser 441 £175.00

Q Lock 3 Machine Synchronizer £3,250.00

Akai S900 + Audio Trigger £800.00

We have various other microphones in stock such as... Sennheiser, B&K, Shure, Fostex, also in stock... DI Boxes etc.

Also Stand Easy pods for outboard etc. We specialise in installations from home studios to Radio Stations.

Some Clients this year: Vector TV, Brookside Productions, M.T.V., World Action Sports, Barcod TV, Liverpool University, Southport College, Pearl Studios, The Windings, Eden Studios, Rockfield Studios, Sain Studios, Pluto Studios, Square One

This equipment list is constantly being updated, so if the piece of equipment you are looking for is not listed then please contact us for further information.

TEL: Chester (0244) 881708
FAX: Chester (0244) 880538
1 Seahill Road, Saughall, Chester, Cheshire CH1 6BJ, UK

The new FOSTEX G16

1/2" 16-track tape recorder

NOW IN STOCK

Phone for details

061-873 7770

Fax: 061-872 4494



43A ELSINORE ROAD
OLD TRAFFORD
MANCHESTER
M16 0WG

"BULLETIN BOARD"

SSL 4000 48 frame fitted 48, in superb condition avail. NOW £78,000

SSL 4000 52 frame fitted 48, good condition avail. NOW £89,500

Neve VIII, 60 frame fitted 48, very little use, superb console £115,000

Amek Angela 28.24.2, private use only £15,500

Harrison MR4 36 frame fitted 32, inc mastermix, superb value for quick sale £18,500

Trident 80B, in excellent condition, avail. now, for quick sale £12,950

Trident TSM 40 frame fitted 32, in excellent condition, a classic console £12,950

TAC Matchless 26/24/B/2, private use, immaculate, avail. now £7,500

DDA AMR 24, 44 frame fitted 36, private use only superb condition £28,950

Otari MTR 90 MkII, private use only, very low hours avail. now £16,950

Sony PCM 3324 Digital 24 track excellent condition latest spec £38,500

Studer A80 MkIII, full autolocate and remote avail. now £11,500

Masses of mcs Neumanns, Sennheisers, AKG Beyer, stands/leads etc P.O.A.

We are also UK Distributors of the OPTIFILE 3D console automation system, the best yet the most cost effective system on the market. For more details call the number below.

All the above represents a tiny sample taken from the FREE monthly magazine BULLETIN BOARD. Do you subscribe?

Tel: 081-994 4433 Fax: 081-994 9321
Mobile 0831-319111

PD AUDIO

PROFESSIONAL SOUND EQUIPMENT

if your 'NEUMANN'S' knackered!
Your 'ROLANDS' ropy!
Or your AKAI's ad it!

Then be 'SHURE' to phone for a FULLY comprehensive list of excellent used and new equipment. Oh and by the way if your 'SSL' is going for a 'SONG' then we would like to hear from you too!

But on a serious NOTE it is impossible to advertise everything available so if you require to purchase or sell anything from £10-£100,000 we will endeavour to assist you in your SEARCH for the obvious or obscure.

PHONE OR FAX PAUL DUDDY
ON 0663 50948
FAX: 0663 51099

SOUNDCRAFT TS12 mixing console, 32 input: £9,750. Eight channel assignable Twister MIDI automation option: offers. Tel: 081-692 7171 extn. 2298 daytime.

112 Studio Sound, September 1990

PARTRIDGE ELECTRONICS REPORTER Model T26

- ◆ Two Mic. Inputs + Line Input ◆
- ◆ Auto - Manual Control ◆
- ◆ D.T.M.F. or L.D. Dialling ◆

OUTSIDE BROADCAST UNIT

EASY TO CARRY

FLIGHT CASE

BROADCAST OVER

STANDARD PHONE NETWORK



UNIT D
318 HIGH ROAD
BENFLEET
ESSEX SS7 5HB
TELEPHONE: 0268 793381

Develop a Specialist Technical Support Function c.£22K (review imminent) + Car

Our Client is a world leading manufacturer of a range of professional audio products. They maintain a technical support group to ensure the continued technical standard of the Company's products, and an excellent opportunity now exists for an experienced engineer to spearhead this small dedicated team.

The requirement is for a self-motivated individual to provide in-depth technical expertise on a wide range of analogue and digital audio products. This will involve solving product related design and application problems, field support in commissioning and customising new equipment, and setting up engineering installations at trade shows. It will also require the ability to plan and carry through proper scheduling control of tasks in hand, and to establish pro-active lines of communication with customers and group service centres throughout Europe at various levels, including liaison with factories in Japan and the U.S.

Our client is looking for someone whose technical maturity is matched by an innovative ability, and whose positive attitude will convey customer confidence. The successful applicant should possess a thorough knowledge of state-of-the-art audio equipment and have several years relevant experience with a major equipment manufacturer, or in the broadcast sector. Candidates should hold a recognised qualification in electronics and must be prepared for travel at short notice within Western Europe.

The position offers excellent career prospects and includes a competitive salary, company car and a benefits package expected of a major employer. Relocation expenses will be paid where appropriate.

Product Engineer c. £16K (review imminent)

A vacancy also exists for an experienced audio engineer who will report to the above position, and whose duties will be to provide technical support.

Candidates must be prepared to make customer visits as required throughout Europe at short notice, and be able to work on their own initiative.

The position calls for several years relevant experience working with audio equipment, and the successful applicant should be qualified to HND or degree level in electronics.

Apply in strict confidence to Mike Jones,
Broadcast Professionals, Unit 9B, Intec 2, Wade Road,
Basingstoke, Hants RG24 0NE. Tel. (0256) 470704.



FOR SALE

Rare opportunity to purchase or lease, with or without equipment, extremely large 13 bedroomed gothic mansion with 3 full-sized knights in armour, one on horse-back, medieval chandeliers, 7 acres of own grounds with very large stable block. The mansion is currently used as large recording studio which has been featured in all the leading music magazines, including *Studio Sound*. It has additional planning permission for night-club, pub and equestrian centre with full drinks license. The stables have planning permission for large house or would make very large second studio.

FOR MORE INFORMATION
TEL: 0757 638106

TANNOY MONITOR GOLDS 15" (1pr) in 'Custom' Lancaster-type cabinets £450. REVOX A700 2-track £650. TEAC AN80 Dolby-B noise reduction stereo (2 off) £50 each. Prices excl. VAT 081-462 6371.

COLLECTABLES: SX3 early BBC sound desk £450. PYE studio monitors (1 pair) £125. RADFORD MA25 valve amp (mono) £85. VORTEXION 4-channel mixer £85. Prices exclude VAT. 081-462 6371.

OTARI MTR/90 (MKII) with auto-locator, 6 years old. £17,500. AMEK ANGELA 28:24:2 with P&G faders, £12,000. WESTLAKE BB SM/12 speakers £1,800 (4 years old). KLARK-TEKNIK spectrum Analyser DN-60 (4 years old) £1,200. All items home-use only. Tel: 031-664 9953 (Contact Bob).

HILL K Series 32x24 mixer. 40 Waveframe. Very large and impressive desk, P&G faders. Full GPO patchbay, extensive EQ, very reliable. Bargain £3,500. Tel: 0757 638106.

TRIDENT TSM 32x24, immaculate as new, 3 years old. Private use only. LED meters throughout improved patchbay many more mods by Trident £27,000. Tel: 0757 638106.

BUSINESS OPPORTUNITIES

RICH AND HAPPY? Then this is not for you. Part or full-time business opportunity; call only if prepared to change to a completely new approach and DETERMINED TO MAKE MONEY. Phone Paul on 0923 853868 (011 44 923 853868 from USA).

At the
Hochschule fuer Musik Detmold
there are vacancies for the
following jobs:

To October 1, 1990:
Professorial chair C4 of the section 'Music-transmission' on the field of U-Music (Pop-Music) (a half established chair) and
Professorial chair C4 of the section 'Music-transmission' on the field of E-Music (Classical Music) (a half established chair) in extra-contractual employment.

Qualifications:

Finished Hochschul-Education of Music, relevant performances on area of Music-transmission, if possible additional activities in audio industry or broadcasting-corporations, exceptional capability of independent recording technical performances. Applicants should be well-acquainted with analogue and digital equipments.

Up to October 15, 1990 applications with autobiographical statement and usual data have to be addressed to the

**Rector of Hochschule fuer Musik
Detmold, Allee 22, D-4930 Detmold.**

FOR SALE



AUTOGRAPH SOUND RECORDING
2 Spring Place LONDON NW5 3BA
Tel: 071-485 4515

SALE OF USED PROCESSING EQUIPMENT

DIGITAL DELAYS

Lexicon T92	£ 300.00
Klark Teknik DN 700	£ 450.00
Klark Teknik DN 70	£ 200.00
Urei Model 927	£ 250.00
Deltalab DL1	£ 200.00

REVERBS

Ursa Major 8X32 with remote	£ 1,000.00
Ursa Major Space Station	£ 300.00
MasterRoom XL305	£ 50.00

EQUALISERS

Urei Model 546 parametric	£ 300.00
Klark Teknik DN22	£ 250.00
Klark Teknik DN27A	£ 350.00

MISCELLANEOUS

BSS FDS320 crossover	£ 300.00
Eventide H910 harmoniser	£ 300.00
EXR aural exciter	£ 100.00
Roland RE301 chorus echo	£ 100.00
Roland SRE555 chorus echo	£ 250.00
Boss CE300 super chorus	£ 100.00
ITC SP single cartridge machine	£ 300.00
ITC 3D 3-stack cartridge machine	£ 500.00
Klark Teknik DN36 time processor	£ 100.00

All prices subject to VAT

REGENCY HOUSE AND RECORDING STUDIO IN THREE ACRES—40 mins FROM CENTRAL LONDON

Beautifully maintained and immaculately re-furbished house; 4 reception rooms, 4 bedrooms, 3 bathrooms. Double garage and store sheds. Private parking for numerous cars. Brand new separate studio with own drive on hillside with lovely views; 2,500 sq ft with 5 recording rooms, shower, 3 cloakrooms, kitchen, etc. Equipment includes DDA desk, Otari 24-track, Lexicon, Valley, Drawmer, Sony and Akai outboards, Sanken, Shure and Neumann mics. Yamaha 6 ft Midi Grand Piano, DX7 plus M1 synths, drum kit and machine. House and Studio: £600,000. Equipment: £80,000. Willing to sell equipment separately.

Tel: 0734 402466

SERVICES

! AT LAST ! SPECIALIST FINANCE FOR PRO-AUDIO

- ★ No Deposit
- ★ No Front End V.A.T.
- ★ Low Interest Rates

£100,000 of equipment is yours
for less than £3,000 inc. V.A.T.

Contact:

Malcolm Toft and Warren Palmer
A.P.T. Financial Services Ltd.

Tel: 0344 890289

Fax: 0344 882003

STUDER-REVOX SERVICE

NEW & USED SALES

Factory condition machines
currently available

Studer A62 Stereo, Trolley	£800.00
Studer B62 Stereo, Trolley	£1,200.00
Studer C37 Stereo, Valve	£1,000.00
Studer A80 RC, VU, 7.5/15IPS	£3,000.00
Studer A80 Mkl, VU	£2,400.00
Studer A810 MkII, 15/30IPS	£4,500.00
Studer A812 4SP, VU, Trolley	£6,000.00
Studer B67 Mkl, Trolley	£2,000.00
Revox B77 MkII, HS NEW	£1,350.00
Revox PR99 MkIII, NEW	£1,900.00
Revox A77 MkIV, IV, HS	£500.00

All Calibrated and Guaranteed

We will refurbish your
old Studer or Revox
to factory condition

CALL

0246-275479

PRIVATE SALE

All items in excellent condition,
home use only with manuals —
boxed as new

Casio CZ 3000 (Synth)	£275.00
Cheetah Master Series 7P (weighted, 88 note Mother Kbd)	£0 offers
Yamaha TX81Z (expander)	£240.00
Yamaha EMT-10 (expander)	£169.00
Sennheiser headphones	£20.00
Leads (guitar & Midi)	£1.50

TEL: 081-686 2599 Ext 427 (day)
081-467 1337 (evs)

FOR SALE—complete real-time duplication system. 28×Denon cassette decks, Sony DAT, Sony F1, MCI ¼" (3 speed), amps, speakers, patchbay, racking, cabling and distribution. Details call Chris on 081-579 2748 or 081-533 0443.



CIRCULATION DETAILS

STUDIO SOUND is available without charge to key personnel actively engaged in sound recording in any part of the world. Copies must be individually requested. Non-qualifying readers will be notified in writing and invited to take out a subscription (see below for details)

NEW READER ENQUIRIES: Link House Publications plc, Link House, Dingwall Avenue, Croydon CR9 2TA, UK. Tel: 081-686 2599

EXISTING READER ENQUIRIES: Circulation Dept, Studio Sound, Link House Magazines Ltd, Central House, 27 Park Street, Croydon CR0 1YD, UK

Changes of address should be notified in writing to this address and the label containing the old address and reference number should be enclosed to ensure accuracy

SUBSCRIPTION ENQUIRIES: Subscription Dept, Studio Sound, Link House Magazines Ltd, 120-126 Lavender Avenue, Mitcham, Surrey CR4 3HP, UK

The cost of an annual subscription to Studio Sound is:
UK: £24.00

Overseas surface mail: £30.50/US\$52

Overseas air mail: £52.50/US\$89

USA airspeeded delivery \$70

The publishers reserve the right to refuse applications considered inappropriate and restrict the number of free copies sent to any one company or organisation

STUDIO CONTACT FILE

AXIS

24 Track Amek Angela.
C-Mix automation.
1,200 sq.ft. Live Room.
Lexicon 480L. Otari 2-track.

Phone Tim Strickland on
0742 750283

for further details

WANTED: DEAD OR ALIVE! Pultec EQs; Fairchild & Teletronix Limiters; Neumann, Telefunken, AKG, RCA and Schoeps microphones. Tube McIntosh or Marantz amps and preamps. Sontec, ITI and Lang EQs. Neve or API equipment. Boxes of old tubes; Urei, Orban, United Audio, dbx and other outboard gear. Ampex ATR102s or 104s. Parts for MCI JH110/114 recorders. Altec 604s/crossovers/Tannoy speakers, JBL 2231; Altec 288h drivers. Miscellaneous equipment of all types. Please contact: Dan Alexander Audio, 2944 San Pablo Avenue, Berkeley, CA 94702. Tel: (415) 644-2363. Fax: (415) 644-1848.

ADVERTISERS' INDEX

ACO Pacific Inc	103
AKG	23
Amek Ltd	64
AMP Sound	80
Ampex (UK)	28
AMS Industries plc	15, 33
ANT Bosch	109
Appoge	30
Ashby Audio	80
Audio Design	45
Audio Digital Technology	89
Audio Kinetics	41
Audio Precision	69
AXIS	34
BGW Systems Inc	92
Brueel & Kjaer	107
BSS	35
Canford Audio	195
Crown	61
D&B Electronica	68
DACS	103
Digital Audio Research Ltd	29
Dolby Laboratories Inc	100
Drawmer Distribution	77
Eardley Electronics	6&7
Eastlake Audio	63
Eventide	99
FWO Bauch Ltd	OBC, 31, 44
GLW	9
Genelec	53
H. W. International	59
Hardware House	75
Hayden Laboratories	71, 79
HJB Communications	17, 19
Hill Audio	50
Hilton Sound	14
Home Service Ltd	36, 64
JBL	56
KW Electronics	44
KGM Studio Specialists	67
Larking Studio Furniture	27
Leonardo Software	95
Lester Audio	8
Magna Tech Electronic	87
Media Products Ltd	8
Midem	110
New England Digital	25
Northern Audio	75
NTP	90
Otari	47
Palm Audio Systems	106
QSC	97
RTW	97
Radian Audio	85
Rapep & Wayman	107
RTS Telex	108
Rycote Microphone	44
Saturn Research Ltd	IBC
Sifam Ltd	91, 105
Solid State Logic	4
Sony Broadcast	54, 55
Soundcraft Electronics	1PC
Soundtraces plc	49
Sovter Ltd	15
Stevens & Billington	21
Stirling	11
Studio Spares	57
Surrey Electronics	98
Tannoy	39
Teac UK Ltd	82&83
Thatched Cottage Digital te electronics	20
Total Systems	26
Trident Audio	75
Turbosound	12
	43

Studio Sound is available without charge to qualified readers: these are key personnel actively engaged in sound recording in any part of the world. The Publisher reserves the right to refuse applications considered inappropriate and restrict the number of free copies sent to any one company or organisation. Non-qualifying readers can buy Studio Sound at an annual subscription of £24.00. Published by the proprietors Link House Magazines Limited, Link House, Dingwall Avenue, Croydon CR9 2TA and printed by Lawrence-Allen (Colour Printers) Ltd., Gloucester Street, Weston-super-Mare, Avon BS23 1TB.



SATURN FACT FILE

2.

AUTO ALIGN

*The Saturn 824
Auto-Alignment system
calibrates Bias, Record Gain,
Record HF, LF, and Phase
Compensation.*

Fully automatically.

For 24 Tracks.

In less than 10 minutes.



SATURN
RESEARCH

Saturn Research Ltd. Unit 3A, 6-24 Southgate Road, London N1 3JJ. Tel: 071 923 1892 Fax: 071 241 3644

PRIME TIME CODE

It would be true to say that the Studer A807 is already an established, well proven machine and that there is nothing new about centre track time code.

However, take the already proven A807 budget priced machine, add time code, and it will achieve with ease that which previously only much more expensive machines could do.

The reason for the A807TC's undoubted cost-effectiveness is simple. The TCIA (Time Code Reader Chip) is Studer's own development.

The A807TC features an optional integrated synchroniser if required and as expected, it is every bit as reliable, well made and state-of-the-art as all equipment designed and manufactured by Studer.

The A807TC – Prime Time Code.

STUDER REVOX

STUDER INTERNATIONAL AG Regensdorf Telephone (41 1) 8402960
STUDER REVOX AMERICA INC Nashville Telephone (615) 254-5651
STUDER FRANCE S.A.R.L. Paris Telephone (1)4533 5858
STUDER REVOX CANADA LTD Toronto Telephone (416) 423-2831

BAUCH
Solutions

RAPID RESPONSE 523

F. W. O. Bauch Limited
49 Theobald Street, Borehamwood, Herts, WD6 4RZ
Tel: 081-953 0091 Fax: 081-207 5970

