

STUDIO SOUND

AND BROADCAST ENGINEERING

JBC

LINK HOUSE PUBLICATION



AES PREVIEW MICROPHONES

More remote than digital.

And it's here now. Stand E12. AES Montreux.

STUDIO SOUND

AND BROADCAST ENGINEERING

REGULARS

- 5** Editorial: Keith Spencer-Allen makes some predictions for 1986
- 32** Diary: Winning ways?—Agencies—Address changes—SSL correction—Contracts—People—Studio Link-up—Literature received—Launch of Professional Audio—Lexicon sale of shares—Computer keyboards at the Isle of Skye
- 46** New products: Electro-Voice PL10 and PL4 microphones—Adams-Smith 2600 A/V editor—AKG D112 microphone—In brief—DDA updates—Sony ECM-44 and WRT-67 microphones—Audix Powerblocs—Alesis XT:c digital reverb—Benchmark new products—Forte Midi-Mod

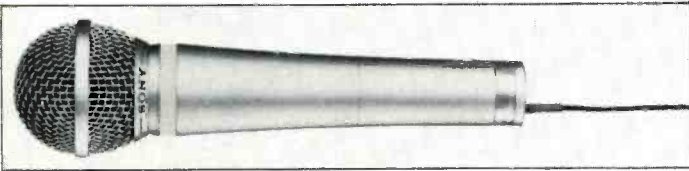

- 56** Music page: Premier snares—MIDI news—Roland Juno 1—Interactive Arts CD-ROM. By Mark Jenkins

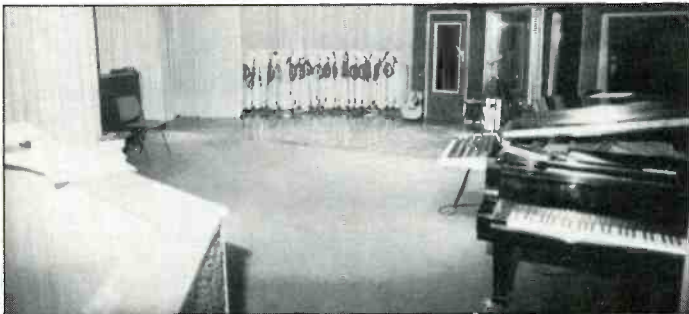

- 96** Studiofile: A Norwegian trilogy by Janet Angus: Rosenborg Studios, Oslo—Norsk Lydstudio, Trondheim—Oslo Konsert Hus
- 110** Business: Pairing up for stereo—Doc shock. By Barry Fox

REVIEW

- 114** Mitsubishi X-850: A digital multitrack reviewed by Hugh Ford

EXHIBITION

- 60** 80th AES Convention, Montreux: A guide to exhibitors and products on show

SPECIAL FEATURES

- 72** TLM 170 design: Stefan Peus and Otmar Kern of Neumann describe the TLM 170 transformerless microphone
- 76** An LF phase shuffler: Suggestions for improving directional recording of low frequencies from Tim McCormick

FEATURES

- 40** AES New York workshop programme: Terry Nelson reports from the 79th Convention held in New York. Subjects included sound reinforcement, stereo television and theatre sound
- 51** AES New York sound reinforcement: Terry Nelson reports on new PA equipment heavily featured at the show
- 82** Design: Swanyard: Carl Snape visited one of London's newest studios and reports on the background behind the project
- 88** In perspective: US correspondent Martin Polon pontificates on technology in tomorrow's computer studio
- 92** Digital information exchange: Find out what a group of prominent people from the audio industry were doing for three days at London Zoo
- 104** Controlling concert sound: Jim Griffiths of the Greater London Council spoke to Richard Vickers about the restrictions on sound systems at live concerts

EDITORIAL

Editor:
Keith Spencer-Allen
Assistant Editor:
Carl Anthony Snape
Production Editor:
Ann Horan
Production Assistant:
Beverley Hudec
Consultant:
Hugh Ford
US Commentator:
Martin Polon
Contributing Editor:
Richard Elen
Secretary:
Carrie Love

Cover: Swanyard Studio, London, and microphones from Electro-Voice and ACO Pacific

ADVERTISEMENTS

Telephone Sales:
Adrian Tippin
Secretary:
Mandy Paul
Production Manager:
Jacky Thompson
Japan and Far East Agent:
Media Sales Japan Inc, Tamuracho Bldg 3 3 14, Shimbashi Minato-Ku Tokyo, Japan
US West Coast Agent:
Herb Schiff, 1317 Fifth Street, Suite 202, Santa Monica CA 90401 USA

COMMERCIAL MANAGER
Phil Guy

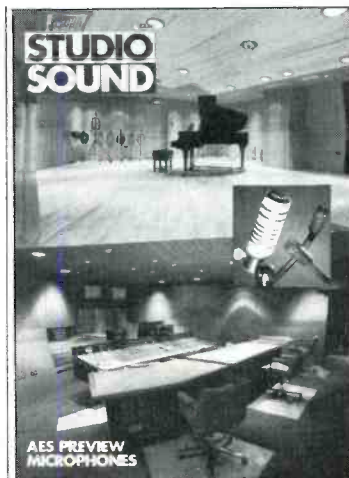

Editorial and advertising offices:
LINK HOUSE, DINGWALL AVENUE, CROYDON CR9 2TA, GREAT BRITAIN
Phone: 01-686 2599
International: +44 1 686 2599
Telex: 947709
E-mail: 78:DGS1071

© Link House Publications PLC 1986. All rights reserved.



A LINK HOUSE PUBLICATION

Publisher and consultant to APRS for Studio Sound's Producer's Guide to APRS Members 1984/85

March 1986 Number 3
Volume 28 ISSN 0133-5944

More effects from HHB.

Introducing the amazing Yamaha REV 7 digital reverb + effects processor.



At last, a professional quality, programmable digital reverb, with the sounds and features you want, at a price so low you won't believe it.

Here are a few of the REV 7's features:

- True or simulated stereo.
- 30 factory presets and up to 60 user stores.
- Hall, Plate & Room reverb programs.
- Reverb available with gating, reverse, flanging...
- Early reflection programs.
- L/R delay and stereo echo.
- Stereo phasing and flanging.
- MIDI interface.
- Remote control.
- 16 bit @ 31.25 kHz sampling giving 20-12kHz response.
- 3 band parametric EQ.

£1040



For the more demanding user, don't forget Yamaha's original REV 1 digital reverb with its full function remote control at £6595.

At £1040 the REV 7 must be the year's best buy; send now for colour brochure.

In addition to the REV 7, here are some more gadgets from HHB's effects collection:

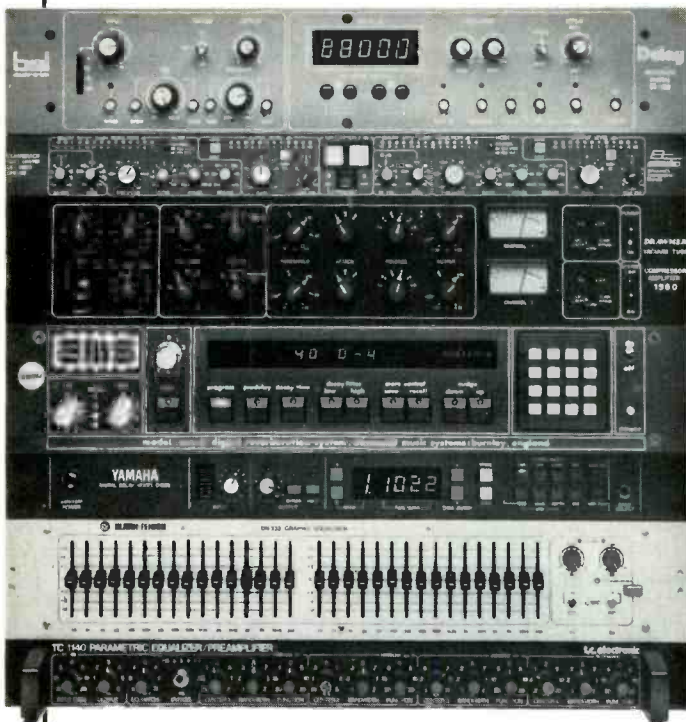

The newest from the BEL stable, the BD320 gives all the functions of the popular BD80, but with up to 32 (yes 32) seconds of delay. BD80 £695 (2 secs) + £200 per extra 2 secs. BD320 £1200 (8 secs) + £500 per extra 8 secs.

The BSS DPR402 is an all in one dynamics processor, providing compression, peak limiting, de-essing and expansion, all with frequency keying all in a lu package £615.

For that authentic 60's sound, DRAWMER's 1960 valve compressor/pre-amp is a must. "Soft knee" compression, microphone inputs, side chain operation etc £750. (Don't forget the DL221 @ £325, and DS201 @ £275)

The AMS RMX16 shown here is the state-of-the-art in programmable reverb. We also try to keep the DMX 15-80 DDL/pitch transposer, but demand is high so order now. RMX16 £4680. DMX15-80 £POA.

The YAMAHA D1500 is a low-cost, high-value programmable DDL with MIDI interface; it gives up to 1 sec delay, with 16 user memories. Our price is so low that we don't dare print it! £POA.

KLARK-TEKNIK's range of equalisers should need no introduction: they are simply the industry standard for graphics. We also stock other Klark-Teknik products, such as their excellent digital reverb and the DN60 analyser. DN332 (shown here) £525. DN360 £980. DN60 (analyser) £1650. DN780 reverb £3580.

TC ELECTRONICS TC2240/1140 are stereo/mono 4 band fully parametric equalisers offering 20dB of cut and boost. We think they are the best value and best sounding outboard EQ's around. TC2240 £330. TC1140 £195.

We also keep toys from Lexicon, Urei, ElectroSpace, dbx, Eventide and many more. Our demo room is ready for you to try before you buy, or take advantage of our mail order service for best prices and free delivery.

Access, Barclaycard/Visa, American Express. Finance arranged (All prices exclude VAT and are correct at time of going to press.)



HHB HIRE & SALES, UNIT F, NEW CRESCENT WORKS, NICOLL ROAD, LONDON NW10 9AX
TELEPHONE 01-961 3295 TELEX 923393

EDITORIAL

EDITORIAL

This month's comment from Keith Spencer-Allen

Out of time

- By the end of 1986 it will be the norm for all big budget non-classical albums to be recorded on digital multitracks of one persuasion or the other.
- By the end of 1986 almost all classical music recording will be made in a digital format.
- By the end of 1986 we will see many studios return to marketing their facilities through their acoustics design—at least as much as any other hardware facilities they might be offering.
- This year will see many new mixing console approaches come to the market—some offering facilities that you may not want and some that you may. They will all cost more than you think.
- In 1986 we will see even more reverb units come to the market all doing yet more and costing less while offering untold varieties of external interfacing. If you are smart you will have mastered the units before they become 'obsolete'.
- This year will see interesting product developments coming from areas other than just the USA, Japan and the UK.
- Hard disk-based recording systems will gradually become a real alternative for mixdown and editing and maybe even more by the end of 1986.
- Recording studios will have to adapt in some way to the fact that the profitability factors concerning studios are inversely proportional to the cost of investing in new equipment and that the client-attracting value of such equipment depreciates at a far higher rate than does their real working life. This affects 90% of all our studio equipment.
- Manufacturers of recording equipment will have to learn that it is in no-one's long term interest to undermine the recording industry by producing next year's model this year. Give the studios time to make their investment pay.
- Manufacturers might also consider that it is perhaps time to redirect their marketing to recording studios themselves rather than to the clients of the studios and so help leave the middle cost studios a chance of economic survival by allowing them to restrict their equipment purchases to gear that they can afford rather than be dictated to by opportunist clients.
- May we hope that the end of the year will see a resurgence in microphones and their technique so that a healthy mic technique will exist in the engineer's repertoire in parallel to the new techniques that we have learnt with samplers and synthesisers, etc.
- Perhaps we will have a little more time to explain the realities of the compact disc to record companies because the future of much of our industry depends on the success of this and other high quality consumer music media. Recording quality could become a marketing tool for the record companies that would be just as powerful as the average indifferent promo video—and cheaper.

In a year when there will be many uncertainties; in a year that is going to bring much change in business and hardware; in a year where there are many influences at work on an industry which is in the process of undergoing a fundamental technology change—there will only be one certainty if we are to maintain a healthy industry: *studio rates must go up all round.*

PS: this should have appeared in an issue published at the turn of the year. Instead it was *written* at the end of the year and time shifted, as magazines inevitably do. A good point, however, is worth making at any time.

**STUDIO
SOUND**
AND BROADCAST ENGINEERING

STUDIO SOUND is published on the second Friday of the preceding month. The magazine is available

on a rigidly controlled requested basis only to qualified personnel (see back page for terms) or for an annual cost of £18.00 UK, \$40 US surface mail, \$75 US airmail, £24.50 overseas surface mail or £46.50 overseas airmail to non-qualifying readers or where more than two copies are required in a studio or small organisation. New subscription enquiries should be sent to the Croydon address on page 3. All other enquiries should

be made to **Studio Sound Subscriptions, Link House Magazines Ltd, Central House, 27 Park Street, Croydon CR0 1YD. Tel: 01-760 0054.**

US mailing agents: Postmaster please send address corrections to Studio Sound, c/o Expeditors of the Printed Word Ltd, 515 Madison Avenue, New York, NY 10022.

Total average net circulation of 13,981 per issue during 1984. UK: 5,735. Overseas: 8,246. (ABC audited).

Studio Sound and Broadcast Engineering incorporates Sound International and Beat Instrumental. Printed in England.



MEMBER OF THE AUDIT BUREAU OF CIRCULATIONS

■

**A new standard
in digital recorders**

**A new standard in
pro audio rental**

■

Mitsubishi X-850

**MUSIC
LAB HIRE**
leading the way



76 EVERS HOLT STREET, LONDON, NW1 1BY. TEL: 01-387 9356. TELEX: 28159 MUSLAB G.

REVO- LUTION

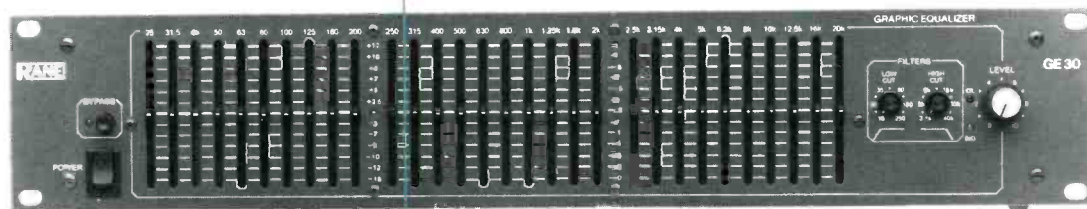

Prepare yourself. Graphic equalizers as you have known them are obsolete. Because Rane just rewrote the rules.

Introducing the GE 30, Rane's astonishing new Commercial Grade True 1/3-Octave graphic equalizer. The GE 30 is a new functional concept which allows one single model to provide all the capabilities that previously required two separate models.

It's the first graphic equalizer ever to let you switch from a +12/-15dB boost-cut mode to a 0/-20dB cut-only mode by simply pushing a button on the back. The first with 60mm sliders, for maximized resolution in a 3.5" format. And the first with a

user-switchable active direct-coupled or transformer-coupled complimentary balanced output configuration as a standard feature.

Using 2nd generation Constant-Q filters (developed by Rane), it provides all the proven advantages of constant bandwidth performance with even less overall ripple.

There's more, too, like built-in RFI filters and both 3-pin and barrier strip input/output terminations.

Check out the GE 30. After the revolution, it'll be your way of life.

Rane Corporation, 6510 216th Southwest
Mountlake Terrace, WA 98043. 206/774-7309.

**RIGHT
AS
RANE**



Toys for the boys

■ Rent or buy the latest studio processors from Music Lab ■

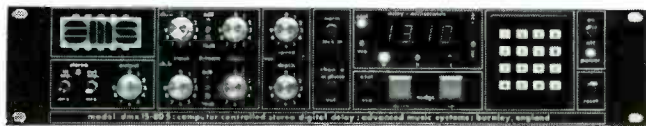

■ **AMS DMX15-80S** 2 channel digital delay available with up to 32 secs at full bandwidth, full loop editing, VCA, external trigger, 9 memory locations, optional pitch change cards/de-glitch cards, plus optional DMX-K Interface allowing sampled sounds to be played under keyboard control.



■ **BEL BD320** Now with up to 32 seconds digital sampling, full bandwidth, external trigger, loop edit facility, VCA.



■ **DRAWMER T102** Two channel trigger interface provides variable length tone bursts and can create logic pulses for triggering outboard effects. Manual or auto reset allows single or continuous sequencing, selectable delay plus invert control.



■ **DRAWMER DL221** 2 channel, stereo linkable compressor/limiter, variable threshold, ratio, attack release, separate peak limiter, VU and gain reduction display.



■ **DRAWMER DS201** 2 channel stereo linkable noise gate, frequency conscious keying with adjustable attack, hold and decay controls.



■ **RANE PE15** Five band parametric, 1.5 to 0.03 octave bandwidth, 20db cut for notch filter capability, end bands switchable to shelving mode, individual by-pass, four octave sweep.



■ **RANE HC6** six stereo headphone amplifiers in a single rack space, individual volume controls. Up to six separate mixes available.



■ **LEXICON PCM60** 2 program (room/plate) digital reverb with suitable size and decay settings, and bass/treble cut off.



■ **APHEX AURAL EXCITER TYPE B** Psychoacoustic processor, fast becoming standard studio tool.



■ **AMS RMX16** 9 program plus "soft prog." locations for previously issued programs, optional 99 memory remote control/bar code reader, optional delay memory extension (1600m/s).



■ **YAMAHA REV 7** The amazing new programmable digital reverb from Yamaha, incorporating 30 innovative factory presets, 60 user memories, 20HZ - 12KHZ bandwidth, offers an unprecedented amount of operator control of essential parameters.



■ **ROLAND SRV2000** Digital reverb with 16 Bit Linear D to A system gives smooth 30Hz to 10KHz bandwidth, up to 99 seconds decay, contemporary or non-linear sounds can be created, 32 user memories.



■ **DRAWMER VACUUM TUBE 1960** Dual compressor limiter using vacuum tubes in conjunction with semi conductors. Soft-knee compression characteristics. Classic valve guitar sound, stereo linkable.



■ **BSS DPR 402** 2 channel compressor limiter, de-esser and peak limiter. All facilities available at once, stereo linkable.



■ **ADA STD-1** Stereo tapped delay image processor, multivoice chorusing, true stereo flanging, holographic positioning, true stereo outputs, stereo outputs from mono source.



■ **LEXICON 224XL** The ultimate digital processor featuring all hyperthetical reverb programs plus many effects and split programs. LARC Remote/control, 60 stores.

MUSIC LAB SALES 01-388 5392

MUSIC LAB HIRE 01-387 9356

72-76 EVERS HOLT STREET, LONDON NW1 1BY, TELEX: 28159 MUSLAB G

Otari Rentals



THE OTARI MTR 90 24 TRACK AND MTR 12 2 TRACK

The MTR 90's track record for outstanding reliability and performance and more recently the MTR 12 master recorder have proven Otari's long term commitment to producing state of the art analogue tape machines.

Similarly, our reputation at Music Lab Hire demands we rent only the finest and most reliable recording studio products available. When it came to investing in tape machines, our commitment had to be Otari.

When you rent Otari from Music Lab, be it for 24 track, 48 track lock-up, Mastering or Video post production, our technicians arrive with the correct cable systems and a fully commissioned machine.

When synchronisation is required, a Q-lock system including all correct interfaces is available as well as the new Otari EC101 Chase Synchroniser.

At Music Lab we not only recommend Otari – Otari recommend us.

**MUSIC
LAB HIRE**

01-387 9356

24 HOUR STUDIO EQUIPMENT RENTAL

76 EVERS HOLT STREET, LONDON NW1 1BY. TELEX: 28159 MUSLAB G

Dynamic Range Control at its best.



Symetrix

SOUND TECHNOLOGY LTD
6 Letchworth Business Centre
Avenue One, Letchworth
Herts SG6 2HR
Telephone: 04626 75675

525 Dual Gated Compressor/Limiter

Simultaneous compress/limit and expand/gate.

CL150 Fast RMS™ Compressor/Limiter

A highly cost-effective single channel automatic gain controller.

501 Peak-RMS Compressor/Limiter

Simultaneous peak and RMS detection. An indispensable tool for PA.

522 Compressor/Limiter/Expander/Gate/Ducker

Versatile multi-function processing for studio, stage, or production.

511 Noise Reduction System

Removes noise from any source, pre-recorded or live, mono or stereo.

Symetrix products are sold and supported world-wide. When you specify Symetrix you specify quality, performance, and reliability.

IT'S MIDNIGHT, THE BAND'S IN A SESSION AND THE STUDIO'S DELAY LINE HAS DROPPED OUT....

MUST REACH HILTON SOUND...

AT HOME, HILTON'S DUTY ENGINEER TURNS OFF THE VIDEO AND PICKS UP THE PHONE..

'HILTON SOUND CAN I HELP YOU..'

30 MINUTES LATER A NEW UNIT IS POWERED UP IN POSITION AND WORKING. AND THE BAND PLAYS ON

WITHIN 10 SECONDS HILTON SOUND'S NEW CCF EQUIPMENT IS AUTOMATICALLY TRIGGERED.

THE URGENT CALL IS INSTANTLY REROUTED...

When you have a gear breakdown you can lose your temper, your clients and your reputation. Hilton Sound can save all these with just a 'phone call.

Anytime, anywhere – we'll be with you immediately, giving you expert service, advice, or the right replacement. There's nobody else who gives you the best in pro-audio gear.

The last thing you need is down time, so the first people you call should be us.

AT HILTON SOUND WE'RE ONE CALL AWAY NIGHT OR DAY!

01-708 0483

Hilton Sound Ltd

Our standards are even higher than yours

- DIBOX II Active direct box
 DIP Passive direct box
 PC80 Phase checker system
- SRL2 Dual compressor-limiter, de esser
 RBS2 Stereo spring reverb
 NGS2 Frequency selective noise gate
- EQ 213 Dual 13 band, 2/3 octave EQ
 EQ 128 28 band 1/3 octave graphic EQ
 EQ 228 Dual 28 band 1/3 octave graphic EQ
 RE 209 Stereo, parametric room EQ
- M 222 Stereo, 2 way crossover
 FA4-2 Stereo, 3-4 way crossover
- UB 280 series Universal buffer
- 824 series Active mic splitter

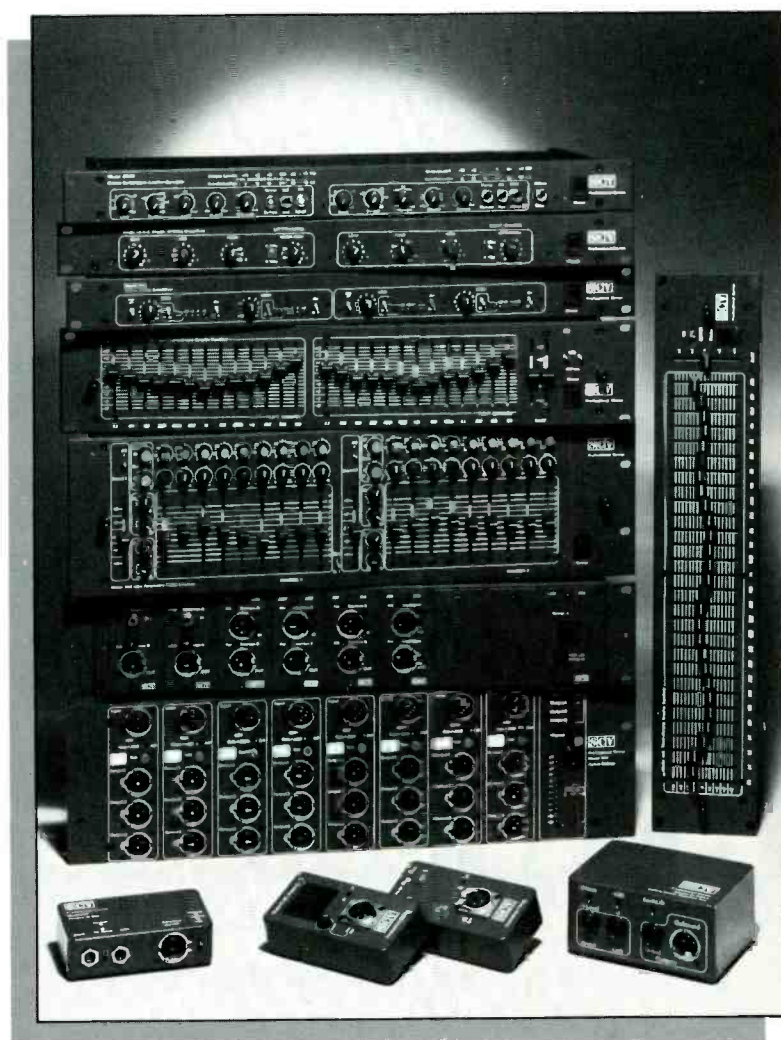

DISTRIBUTORS

AUSTRALIA

AR audio engineering
 59 Bristol rd, Hurstville 2220,
 Sydney — Australia
 Tél. : (02) 57.12.36
 Contact : Anthony Russo

BELGIUM

Inelco
 Avenue des Croix de Guerre, 94
 1120 Brussel
 Tél. : 32.02.216.0160
 Tlx : 22 090
 Contact : Luc Vandeneynde

CANADA

SF Marketing
 312 Benjamin Hudon, St-Laurent
 Québec H4N1J4
 Tél. : 514.337.6113
 Tlx : 826 765
 Contact : Sol Fleising

GERMANY

BFE
 An der ochsenwiese 6
 6500 Mainz/Gosenheim
 Tél. : 06131/463
 Tlx : 187 300
 Contact : Bodo Feldmann

ISRAEL

Sontronics electronic equipment Ltd
 103 Nordau BLVD P.O.Box
 21511 Tel Aviv
 61214 Israël
 Tél. : 03.44.22.33
 Tlx : 361 579
 Contact : Sonny Shmuelli

ITALY

Audio equipement S.R.L.
 20052 Monza Mi
 Via C.Rota, 37
 Tél. : 039.836767
 Tlx : 323668
 Contact : Giuseppe Porro

NORWAY

Nortek
 Nydalsveien 15,
 0483 Oslo 4.
 Tél. : (02) 23.15.90
 Contact : Truls Berger

SOUTH AFRICA

Tru-Fi electronics
 4 a Chadwick avenue,
 Wynberg, Sandton
 P.O. Box 84444
 Tél. : (011) 786.71778
 Tlx : 4 28708SA
 Contact : Flemming Ravn

SWEDEN

Tal & Ton Ab
 Kampegatan 16 S ; 41104
 Goteborg
 Tél. : 031803620
 Tlx : 27492
 Contact : Jan Setterberg



PROFESSIONAL SERIES

USA SCV inc.

414 North Spark St.
 91506 Burbank USA
 Tél. : 818.8437567
 Contact : Ron Fuller

FRANCE S.C.V. Audio

186 Allée des Érables
 ZI Paris Mord II BP 50056
 95947 Roissy C.D.G. Cedex
 Tél. : (1) 863.22.11 Tlx : 212802
 Contact : Richard Garrido

RTW Peak Programme Meter



PPM 1109 stereo
Analog + Digital
Audio Peakmeter

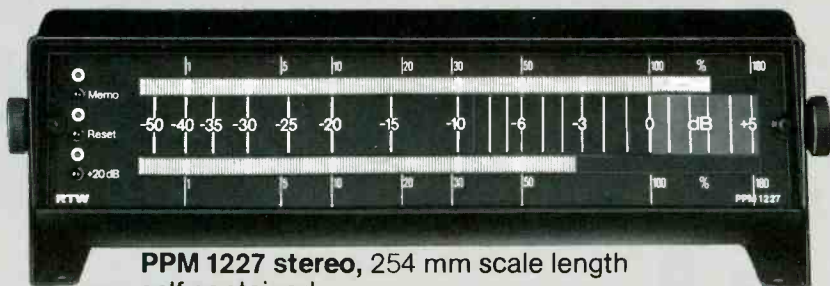

PPM 1227 stereo, 254 mm scale length
self contained

Model 1206
self contained

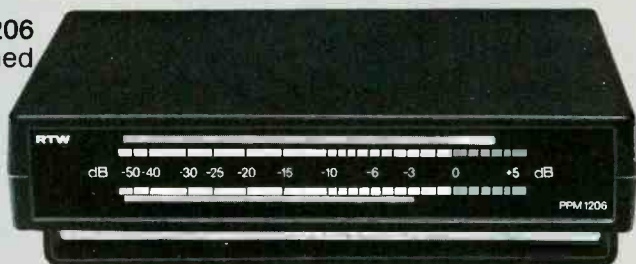

Peak programme meters
for monitoring the peak level
in analog and digital audio



PPM 1118
2-Channel
Module

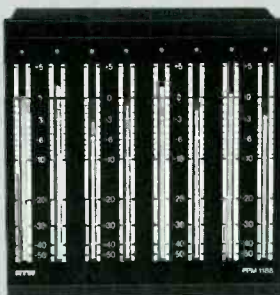

PPM 1188
8-Channel
Module

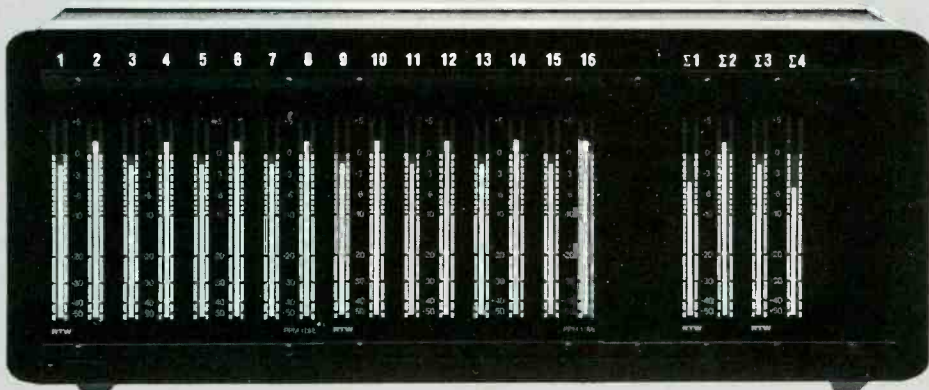

Multi-Channel Unit 16-4 and 24-4

RTW Correlator

AES Montreux
Booth No. Q 10

Compatibility meter
displays the phase correlation
of stereo recordings

Correlator Model 1170



Correlator Model 1260
self contained

Correlator Model 1160

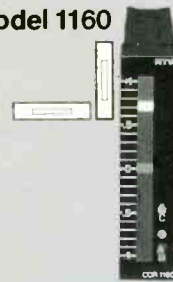

RTW

RADIO-TECHNISCHE WERKSTÄTTEN GMBH

Telefon (0221) 7 0913-0 · Tx 8 885 217

Elbeallee 19 · Post Box 7106 54 · D-5000 Köln 71 · W.-Germany

Austria: ACOUSTA ELEKTRONIK, Tel. (6 62) 84 61 64 · **Australia:** SYNTEC PTY, Tel. (2) 4 06 47 00 · **Belgium/Netherlands:** PIETER BOLLEN GELUIDSTECHNIEK BV, Tel. (Eindhoven 40) 42 44 55 · **Denmark:** S. C. SOUND SVEN SKYTTE CHRISTIANSEN, Tel. (2) 99 88 77 · **Finland:** MC MEDIA CENTER, Tel. (0) 41 32 55 · **France:** SCV-AUDIO, Tel. (1) 48 63 22 11 · **Great Britain:** AUDIO AND DESIGN LTD., Tel. (7 34) 86 10 88 · **Italy:** TTL TAPE TECHNOLOGY LABORATORY, Tel. (2) 4 69 52 13 · **Japan:** ELECTORI CO LTD., Tel. (3) 9 50-62 66 · **Norway:** SIV-ING BENUM AS, Tel. (2) 14 54 60 · **South-Africa:** ELTRON LTD., Tel. (11) 29 30 66 · **Spain/Portugal:** SINGLETON PRODUCTIONS, Tel. (Barcelona 3) 2 37 70 60 · **Sweden:** AV MEDIA AB, Tel. (7 55) 6 54 98 · **USA:** AUDITRONICS INC., Tel. (901) 362-1350

NEW PRODUCT PROFILE



QUAD 522

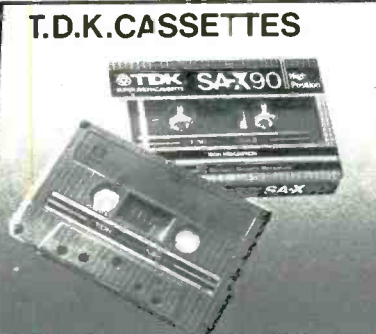

T.D.K. CASSETTES



SHURE MICS.



AKG 460



NEUMAN
TLM 170

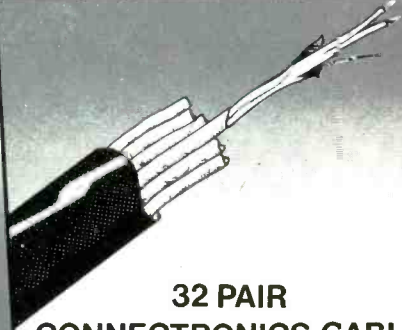

32 PAIR
CONNECTRONICS CABLE



BEYER MICROPHONES



BEL BD80

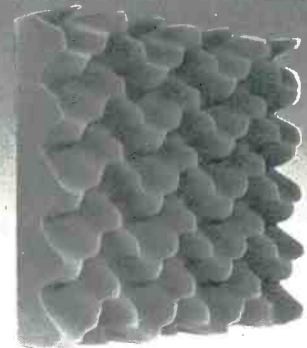

ACOUSTITILE - ADDITIONAL
ECONOMY VERSIONS

Studio Spares. Europe's No.1 supplier.
Everything is in stock and all orders
processed within the hour

TRADE COUNTER open 8am -12-30 1-30 -5-30

STUDIO SPARES

16 Stucley Place, Camden Town, London, NW1 6NS. England.

Telephone: 01-485 4908 Orders: 01-482 1692 (6 lines)

COURT ACOUSTICS

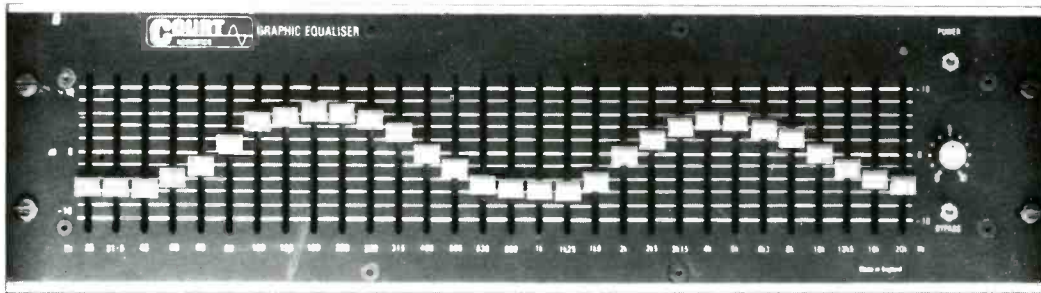

PROBABLY THE WORLD'S FINEST
GRAPHIC EQUALISERS

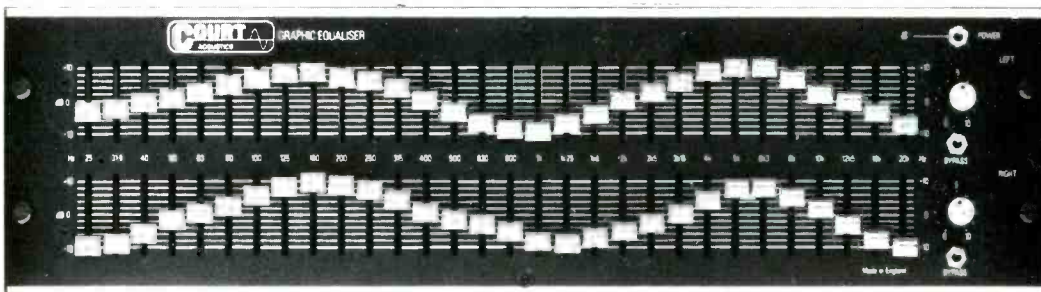

COURT ACOUSTIC SALES LTD, 29 BEETHOVEN STREET, LONDON W10 4LG ☎ 01-960 8178 Easylink No. 19018075 Telex: 946240 CWEASY G Ref. 19018075

NORTHERN AUDIO

PROFESSIONAL STUDIO EQUIPMENT SECOND HAND PRODUCTS

SECONDHAND CONSOLES

1. MCI JH400 28/24/2 with fully wired patchbay and JH50 automation, 4 yrs old
 2. Soundcraft TS24 32/24, 12 mths old
 3. MCI JH56C automated JH50 with plasma
 4. TAC Matchless with full wiring loom, in packing case
 5. Neve 8128 36/24, 2 yrs old
 6. MCI JH500, 56 in-line console with automation
 7. Amek 2500, 15/16/8/8/2 PA console, 2 yrs old
 8. Soundcraft 1600 24/16/24 with patch and stand
 9. Harrison 40/32 frame 32/32 customised, fitted with 3 extra modules (automated)
 10. Helios 28/16/24 Straight console, built 75 updated 1980, nice desk
 11. AHB Syncon 'A' 28/24/2 with fully wired patchbay, 2 yrs old
 12. Trident series 80B 32/24/2, 2 yrs old
 13. Trident series 80B 30/24/56 (new)
 14. Trident 80 32/24/2, 4 yrs old
 15. Neve 8108 56 input with Necam 2, 4 yrs old
 16. Neve 8108 56 input with Necam 1, 4 yrs old
 17. SSL 4000E Frame 40 fitted with primary computer (no recall)
 18. SSL 4000E 40/32/4/2 with recall
- SECOND HAND MACHINES**
- Soundcraft 762, 24-track with standard remote
 - Soundcraft 762, 16-track machine 30 IMPS, only
 - MCI JH110 24-track machine, 4 yrs old
 - Studer A800, Mk1A, 4 yrs old, in good con
 - Studer A800, Mk3, 2 yrs old, no remote/auto
 - Lyrec TRS 24 with ex 16-track headblock and remote, 3500 hours, 2 yrs old
 - Otari MTR 10 1/4" Master Recorder (mint)
 - Studer A810 1/4" Master Recorder
 - Lyrec TRS 24-track with remote, 6 yrs old
 - Tascam 32/5B 1/4" Master, ex demo
 - Studer A80, Mk 2, 5 yrs old approx, nice one
 - JBL 4435 Monitors, 12 mths old
 - JBL 4430 Monitors, 18 mths old
 - Tannoy little red monitors, (new)

£16,500
£24,500
£62,500
£8,450
£47,500
£65,000
£6,500
£9,500
£29,500
£7,000
£7,500
£16,500
£21,998
£13,250
£98,000
£115,500
P.O.A.

£11,500
£5,000
£10,000
£17,500
£23,000
£13,250
£3,900
£4,000
£8,950
£650.00
£14,500
£2,500
£2,000
£690.00

- Audio and Design vocal stresser
- Neumann U871 complete refurbish from Bauch
 - Neumann U871, s/h
 - AKG C451 with various capsules
 - AMS 1580 dig/del with 2 408 milli sec cards
 - AMS 1580s with 1 x 4.08 card + 2 x 1.6 cards first pitch change and deglitch, (new)
 - 1 NSF Plate stereo, 12 mths old
 - 1 Stockronics plate stereo, 2 yrs old
 - Bose 301 monitors, (new)
 - Bose 802 monitors, (new)
 - Seck 18/8/2 Ex-demo still in box
 - Quad 405/2 amp, (new)
 - 1 Pair JBL 4401, s/h
 - Drawmer DS201 (ex-Demo)
 - Ursa Major 8 x 32 (2 yrs. old mint condition)
 - EMT Gold foil plate TS stereo
 - 1 pair JBL 4425 monitors, (new)
 - 3M M79 24-track recorder with remote
 - Yamaha rev 7 reverb, (new)
 - Lexicon PCM 60, (new)
 - Tascam 38, 12 mths old
 - Trident 65, 24/16/16, with fully wired patchbay, new
 - Raindirk Concord console, 28/24, nice one
 - Drawmer 201/221/231, (new best prices telephone)

£700.00
£395.00
£350.00
£125.00
£2,650
£4,680
£650.00
£1,450
£239.00
£740.00
£1,100
£225.00
£180.00
£245.00
£1,950
£1,950
£1,323
£8,750
£1,050
£1,495
£1,250
£5,000
£6,000

NOTICE

We also act for studios as selling agents, let us handle the hassle of getting rid of unwanted items, it does not matter where you are in the world, why not drop us a line listing your equipment or ring us on the numbers below for the best rates. We assure you of our best attention and service plus the utmost confidentiality of all times.

Tony Bayley (Director)

NORTHERN AUDIO LTD

061-483 9563 and 061-483 4299

WE ARE CONSTANTLY ON THE LOOKOUT FOR USED EQUIPMENT. PLEASE GIVE US A RING.

RING TONY BAYLEY ON 061-483 9563/4299 anytime or WRITE TO US AT:

4 CHEVIOT ROAD, HAZEL GROVE, STOCKPORT, CHESHIRE SK7 5BH

TELEX 666576 HTNRGSG

Tel: 061-483 9563/4299

SAJE



RACKY

New technology makes the Racky an amazing performer.

All the features required for broadcast, OB and video sound mixing in a light and compact rack-mountable unit.

High specifications include remote control from video editor.

Modular design and a wide range of options provides great flexibility.

Contact SAJE for full details!

SAJE
3 Rue Verte 95100 Argenteuil France.
Telephone: (1) 39.61.15.62
Telex: 699672F SAJE.

ABACUS ARTA 600

Use the **ARTA 600** third-octave audio analyser adaptor and your own oscilloscope as the most cost effective solution to real-time analysis.

Verify the audio frequency responses of tape, film and VTR recorders in moments and save hours in daily maintenance.

£795 plus VAT

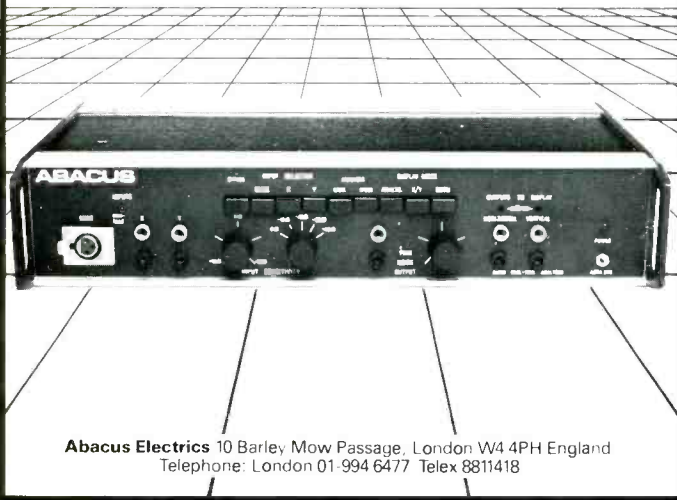

Abacus Electronics 10 Barley Mow Passage, London W4 4PH England
Telephone: London 01-994 6477 Telex 8811418

ACOUSTICAL INTERFACE™ SYSTEM

PS9200 DUAL CHANNEL POWER SUPPLY



Shown PS9200, 4012 and 7013

**Precision Acoustical Measurements
with FFT's, Scopes and Meters.**

The system includes:

- Type 1 Measurement Microphone(s), Companion Preamplifier(s) and Cables.
- Available in 1, ½ and ¼ Inch Models.

ACO Pacific, Inc.,
(415) 595-8588

2604 Read Avenue
Belmont, CA 94002

ACOustics Begins with ACO

We only change to improve

Tannoy and the Dual Concentric

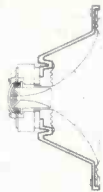

—the perfect combination.



1947
Monitor
Black



1950
Monitor
Silver



1956
Monitor
Red



1967
Monitor
Gold



1974
H.P.D.



1979
Super Red
Monitor

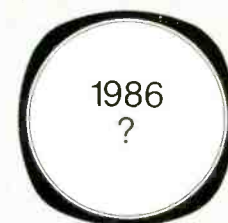

1986
?

To preview the very latest Tannoy Studio Monitors visit stand R7-5 at AES Montreux and see how Red has turned to Gold

TANNOY
The Name for Loudspeakers®

The Bilton Centre, Coronation Road, Cressex Industrial Estate,
High Wycombe, Bucks. HP12 3SB

Telephone: (0494) 450606 Telex: 83251 TANNOY 'G'

The Dolby® XP Series Professional Cost-effective

NEW



XP Series Multi-track record or playback.

The Dolby XP Series contains up to 24 channels of Dolby A-type noise reduction in 12¼" of rack space, including power supply. The XP Series utilizes an on-board, integrated noise reduction circuit instead of the interchangeable Cat. No. 22 modules used in the SP Series, providing the same A-type noise reduction at a price over 20% lower.

Each XP noise reduction channel consists of a plug-in Cat. No. 331 module which contains the Dolby A-type noise reduction circuitry, precision input and output amplifiers with low distortion, controls, and an accurate LED calibration display. The separate, regulated PS3 power supply, designed for rack mounting directly above the noise reduction unit chassis,

contains fan cooling and electronically-controlled output protection.

The XP Series includes "uncal" controls, permitting convenient resetting of Dolby level for playback of and punch-in on tapes from studios with different Dolby level standards. The user can select the option of "hard-wired" or electronically-buffered bypass of individual channels or all channels simultaneously. The XP offers discrete FET switching for reliable, noise-free routing of audio signals. For convenience of wiring and for stability, a new detachable multi-channel connector plate is used, with tie bar for the cable form.

Dolby noise reduction is a mainstay of professional multi-track recording in studios throughout the world for

music, film, broadcast, television, and videotape production. Over 90,000 channels are now in use world-wide. The benefits of Dolby A-type — improved signal-to-noise ratio, lower distortion, and reduced cross-talk and print-through — are achieved with a minimum of signal processing and with resultant high signal integrity.

Dolby®

Dolby Laboratories Inc., 731 Sansome Street,
San Francisco, CA 94111, Telephone (415) 392-0300,
Telex 34409.

346 Clapham Road, London SW9 9AP,
Telephone (01) 720-1111, Telex 919109

"Dolby" and the double-D symbol are trademarks of
Dolby Laboratories Licensing Corporation.
L85/300

The

CALREC MINIMIXER

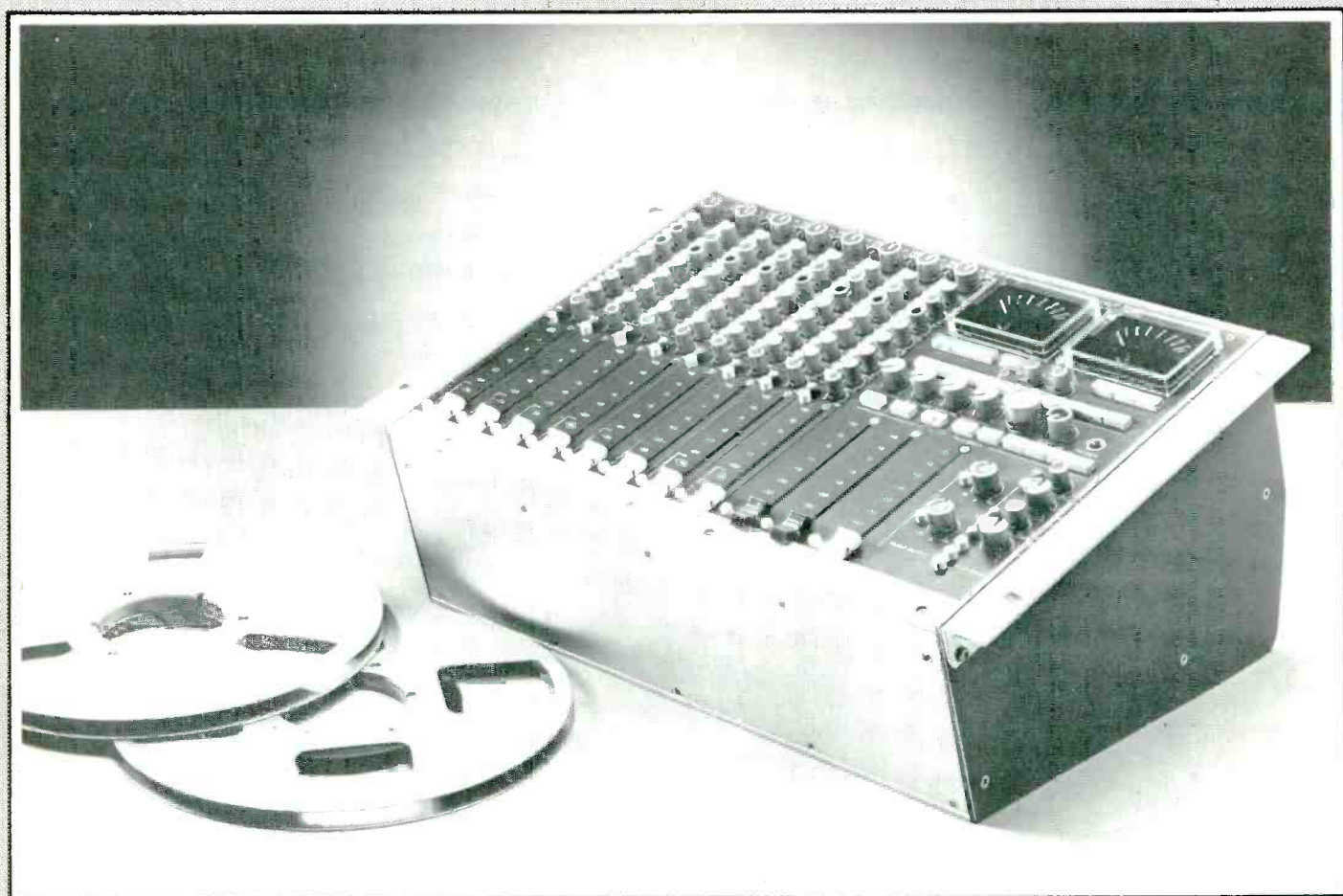

For the Professional Recording, Broadcasting and Film Industry.

- Table-top, drop-in, flight case or 19" rack-mounted styles.
- Up to 24 channels.
- Optional 1 or 2 compressor/limiters with provision for stereo linking.
- Optional channel, group and output insert system, pre or post faders.
- Low power consumption from mains or batteries.
- 2 Group or Stereo A and B faders with pre fade listen.
- 4 Auxiliary controls pre or post fader from each channel and 4 Auxiliary output controls.
- Mono master fader output with separate mix controls pre or post A and B fader.
- Full throw conductive plastic faders with pre fade and after fade listen.
- Wide range low noise input switching on each channel with optional phantom power.
- Sophisticated 3-band equaliser, HF and LF filters on each channel.
- Comprehensive stereo output monitor selection and control system.
- Channel pan controls.
- Stereo/mono high level playback or outside source inputs with pan and after-fade listen.
- Switched talk-back from internal microphone to each auxiliary, main and external outputs.
- Wide-range alignment oscillator also used for tone to line.
- Monitor headphones output.
- Choice of peak programme or VU metering.
- 2 or more units may be connected in series with no loss of channels.
- Full professional spec. on all outputs.

Audio Design
CALREC

L I M I T E D

Worldwide

Audio Design Calrec Ltd.,
P.O. Box 182, Reading, RG2 9BA
☎ (0734) 861088 Telex: 848722 ADR UK

& DISTRIBUTORS WORLDWIDE

USA

Audio Design Calrec Inc.,
P.O. Box 786, Bremerton, WA 98310.
☎ (206) 2755009 Telex: 152426 ADR USA

ECHO TIMES

AUDIOFILE UPDATE

Since the appearance of the last Echo Times AMS Audiofile has been exhibited and extremely well received at AES New York, the SMPTE show in Los Angeles and INTERBEE in Tokyo.

Probably more significantly, AMS have now accepted orders and supplied a group of existing AMS system owners with AudioFiles. The first three owners are TVS (Television South), the British Broadcasting Corporation and Trillion Video.

The AudioFile supplied to the BBC is currently being used in one of the Sypher suites in Television Centre and is being used during audio dubbing of television programmes. Trillion have incorporated their AudioFile in a radically new type of post production suite which does not include a conventional multitrack recorder.



TVS has implemented their AudioFile in a new computer based television game show as well as using the system for programme production. The following is an interview with Robert Edwards, deputy head of sound for TVS who discusses how he uses and why he chose AMS AudioFile.

Robert Edwards: The first I ever heard about AudioFile was an advert in the June '85 edition of Studio Sound which as far as I was concerned made it a talking point throughout the industry almost overnight. Because of my work commitments on Ultra Quiz '85 I was disappointed not to get to see its UK launch at APRS but was further excited by rumours as to its possibilities that filtered back to me after the exhibition.

A.M.S.: *So what convinced TVS they needed an AMS AudioFile?*

R.E.: In September I was at a meeting to discuss a new game show to be recorded by TVS called



Robert Edwards at the AUDIOFILE controls.

“Catchphrase” which was an American format conceived by Steve Radosh, who originally worked for Atari in the States. A video of the American version showed it to be both fast and entertaining and to put this across demanded shooting “as live” with no audio post production. The only problem being that there was an audio event every 5 seconds!! Much of the music on the American version was several pre-programmed domestic quality computer generated tunes, stings were generated conventionally from stacks of cartridge machines. The result was both restricted in range and quality and it was obvious even at that stage the programme would benefit from a “digital juke-box” — AudioFile.

A.M.S.: *But at this stage you hadn't even seen AudioFile.*

R.E.: At that time all we had to go on was AMS's considerable reputation. I had personally used both the AMS DMX 15-80S and the AMS RMX 16 for music production at TVS and have been so pleased with the performance of those units that I knew that whatever AudioFile did, it would do well.

A.M.S.: *So it must have been soon after that that we first met?*

R.E.: Yes and I must admit that having talked through our requirements with Mark Crabtree

and some of the R & D staff at AMS it is a tremendous credit to the enthusiasm and skill of all those involved with AudioFile that a system was configured, specialist software written, delivered and commissioned for the first pilot only 19 days later.

A.M.S.: *So how is it used on Catchphrase?*

R.E.: Each of the eight start buttons on the AudioFile control surface are addressed from our central games computer. Any contestant banging their pod results in an audio sample being triggered. A second output is used with a stack of 15 different music sections which correspond to differing Catchphrase animations, the sequence of play varying from show to show. A third output is dedicated to our “AudioFile operator” who has instant access to a stack of individual stings.

A.M.S.: *So is AMS AudioFile earning its living for TVS?*

R.E.: It has been used on all 18 Catchphrase shows so far recorded and also on the current series of “73” — both of which are fully networked. The system is extremely versatile and new possibilities are discovered for it every day. When we eventually get a chance to use it in its post-production mode we believe it could halve the time to do light entertainment dubs. ●

BOB CLEARMOUNTAIN

Echo Times has so far had no difficulty in attracting well known and respected individuals to talk about the reasons why they prefer AMS digital audio processors to others — **Bob Clearmountain** is no exception and complements perfectly other producers and artistes who have already appeared in the pages of Echo Times. Bob is one of those rare individuals that it is easier to list people whom he has not worked with at some time or other than to make a list of people he has worked with.

A.M.S.: *I have read several articles in American magazines about you but can you tell me how you first got into the recording business?*

Bob Clearmountain.: Originally I was a bass player in a bar band up in Connecticut — we weren't very successful at all. Before that I had been an avid listener to records and along with my playing I always had a feeling that I was someday going to be involved in the record business — on one side of the glass or the other!

The band finally broke up whilst doing a demo at Media Sound in New York. At that time I had nothing better to do than hang around the studio and bug them until they gave me a job.

A.M.S.: *So what advice have you got for any out of work musician who wants to be a world-class record producer?*

B.C.: Well what worked for me is I remember telling them. "I'm going to be pretty good at this someday so you really should hire me!" I liked the place and I liked the people and luckily they hired me. I was doing sessions after a couple of months and the first session I got onto, after supposedly being a runner, was a Duke Ellington session. I remember that day very well, I did two messages and was then told to get downstairs into the studio because from then on I was a recording assistant. That really blew me away!!

A.M.S.: *Did things move slowly or quickly from then on?*

B.C.: Oh pretty quickly. I spent five years there and then a couple of people there, Bob and Tony, decided to start Powerstation and I was the first person they approached on the engineering side. I jumped at the chance. When

it opened the studio did a lot of black R and B. My roots were a lot more rock and roll and so I slowly tried to make it a little more rock and roll and slowly that began to happen.



A.M.S.: *What were your rock and roll roots?*

B.C.: I was really into English music, the Beatles, the Stones, Traffic, the first couple of Jethro Tull records. Eric Clapton, Jeff Beck — and seeing as I'm getting onto guitarists I can't leave out Jimi Hendrix. By the time of the punk era Powerstation attracted Ian Hunter to work on demos of "You're never alone with a schizophrenic". He liked the warehouse feel so much that he ended up doing the whole album there.

A.M.S.: *Did that mark the start of the heavier bands working at Powerstation?*

B.C.: Yes it did because Ian Hunter hired the E Street Band who immediately went back to Bruce Springsteen and said — "you really have got to check this studio out!" From there on Springsteen came in and did The River album here and that really changed Powerstation because the word was out and more and more rock bands came in.

A.M.S.: *Who were the first band that you really got involved with and enjoyed?*

B.C.: Probably Climax Blues Band. We made a really great record

together but it was the old story — it didn't sell. Back in 1978 or 1979 I made another record that I really enjoyed with a guy called David Warner on Epic which also didn't

sell but I still figure that that was one of the best records I ever made. Brian Adams really started to open it up for me because when we first worked together we were both unknowns. Our first album was in 1980 I think and we've now done 3 together.

A.M.S.: *Speaking of Brian Adams, a few people at AMS thought his performance on Live Aid was probably one of the best performances from the American end.*

B.C.: Wow Live Aid! AMS really figured heavily there — and I know because I mixed most of the American bands, probably about 70 per cent of the acts. For instance, did you realise that most of the snare drums throughout that day were the same sample stored in a DMX 15-80S? In a situation like Live Aid you never know what you are going to get, mikes and complete set ups were constantly being changed and the one thing I could completely rely on to control was my trusty AMS 15-80S — and believe me I was triggering everything. I had one really good snare sample that I'd recorded at Townhouse with Mel Gainer of Simple Minds and that was the sample I used.

A.M.S.: *So Mel Gainer's snare sound was pretty important to Live Aid?*

TAIN

B.C.: The funny thing was that when Simple Minds got up to play he used the same snare drum that we'd originally taken the sample from — even with the same head and everything and the drum and the sample sounded exactly the same. For a while I thought the AMS had freaked out and it took me a while to realise what was happening — most unnerving. What a day that was. I'd finish mixing one band and then jump out of the way to allow set up and line checks for the next before quickly jumping back in front of the board to start mixing again. It worked fine during the afternoon when we had 20 minutes for the next set up whilst London was broadcasting, but when London went off the air it was unbelievable.

Live Aid was a fantastic event and something I am sure none of us will ever forget. Let me ask you if you think your production approach is different to that of other producers?

B.C.: Well, I do try to make a fresh approach to everything but of course you develop certain things that you know work and feel comfortable relying on. The most important thing in a session is the musicians' and artistes' performance and making sure they are as comfortable as possible usually ends up with the best results. For that reason I use things I understand and once things are rolling I will experiment in the mix. A good basic sound is important as it is incredible what can be done in the mix. For instance, I sampled a Max Weinberger snare that ended up being the snare on the Bruce Springsteen "Born in the USA" track.

A.M.S.: *And that snare sound is probably one of the most famous of all time!*

B.C.: I like AMS units a lot, the DMX 15-80S is so clean whether I use it as a DDL, pitch changer or sampler — the RMX 16 I also like and I use it alongside natural reverb or EMT plates because it is one digital device that doesn't sound too sizzly as many of the others can. The AMS Nonlin is my favourite, even with a very short amount of decay time you get a really nice room ambiance. ●

PEOPLE IN THE KNOW

Ian Jones of HHB found the show "extremely busy" and noted that particular interest was being shown in the Amek and AMS stands.

New York AES show report in Music Week.

Richard Goldblatt of Audio FX said AES 85 was the "most exciting show for four or five years". Goldblatt saw a range of items that will possibly be appearing on Audio FX inventories. Among other items, Goldblatt was particularly interested in the Lexicon PCM 70 and AMS AudioFile.

New York AES show report in Music Week.

I like working on documentary items where you may have a lot of mute library footage; that's good because you're using your memory of all the effects you have got. You can do wonderful things with the memory store on the AMS DMX 15-80S, locking sounds into it and editing the loop. We're looking into getting the one with the keyboard interface for mechanical effects. If you've got a bit of equipment with some sort of reciprocal motion you can just store one little bit of some machine in the AMS and fit it in so it's going with the picture.

Robbie Weston of Silk Sound in an interview with Tim Leigh Smith of Broadcast Systems Engineering.

A lot of the fills were doubled with timbales and the whole lot had gated reverb put on it. I used the AMS and Sony digital reverb. The great thing about the AMS are the reverse and nonlin programs.

Eddy Offord talking to Peter Buick of Sound Engineer.

I don't use a lot of effects on mixdown, although I do use a lot of AMS delay lines, the big EMT valve echo plates (140's) with tape pre-delay, and various digital reverb units like AMS and Lexicon.

Laurie Latham talking to International Musician and Recording World about the making of the Tomb of Memories track for Paul Young.

Outboard Gear: Quantec Room Simulator, 3 AMS RMX 16 Digital Reverberators, 3 AMS DMX 15-80S Digital Delay Systems.....

Following an Interview with Dave Tickle in Mix outlining the sound system for the Prince "Purple Rain" tour.

I did it at Power Station here in New York. The equipment consisted of an SSL console, three AMS digital samplers, two Emulator IIs, two AMS digital reverbs, ten reverbs of various makes, ten delay lines of various makes and miles of half inch tape. I brought in my own sampling for "Dancing in the Dark" with a kick and snare pattern. Via the AMS sampler, I combine my own pattern with that of the songs to create something new and different. You need two sampler units — one for the kick and one for the snare. [Eds Note: now with "Dual Lock-in" available on the DMX 15-80S one unit can handle both samples]. This can also be done with all other instruments. In other tunes, I've sometimes added in instruments not in the original recording if it would help in highlighting something.

Lord-Alge talking to Mix Magazine about the remix of Bruce Springsteen's "Dancing in the Dark".



Shown from left to right: Staff Engineer Bob Rosa with Producer Keith Diamond at Unique Recording, Studio B.

A.M.S.: *So how many AMS systems do you own now?*

B.N.: We have 4 RMXs and 2 DMXs and any mixing done here uses a minimum of 2 RMX 16s and 1 DMX 15-80S. Even though we have all the other reverbs a lot of them are just there — even though we bought three of the new low priced Yamaha Rev 7 units people don't run to them like they do to AMS. The RMX 16 reverb sound has become the standard for making records today. There is just something about a snare drum through an AMS reverb and you just can't get the same effect through any of the other units.

A.M.S.: *And how about the DMX 15-80S units?*

B.N.: We use them in every way possible, delay, pitch change sampling and even pitch correction of material at the wrong tempo or wrong key works fine. We used to use an Emulator for our sampling until an English client introduced us to the 80S which obviously far surpassed anything we had used before. A lot of engineers will only use the AMS in a mix as a triggering thing and go straight to 2 track, then at the end "unlock" and not let anyone else get at their samples!

A.M.S.: *So you don't think a studio should be without a 15-80S?*

B.N.: Well let's just keep talking about the 80S used as a sampler, used properly can save a group between 2 and 10,000 dollars because that's what it costs to do a set up and get the right sound. Not that they are going to take that money and put it in their pockets — we recently sampled sounds from an early Cheap Tricks album and used them on their latest album — and they weren't even aware it was possible. Anyway ask my engineer Tom Lord-Alge what he'd miss most if he walked into an empty studio.

Tom Lord-Alge.: Well I guess I'd miss the console and multitrack most (laughs). The session I'm working on now I've got the REV 7, the REV 1, Ursa Major, Sony DRE 2000, Publison, Lexicon and AMS. If there were only 2 units, no 3 units that I could have it would be 2 AMS reverbs and the AMS DMX 15-80S. I mean I use the AMS on everything because I can get all the sounds I need out of them — but if I have any other unit I can't get the AMS sounds out of that! ●

Unique Recording

Unique Recording Studios are set about one hundred feet above Times Square, New York and represent yet another successful recording venture started by musicians initially for musicians. Because of the owners' early involvement with synthesizers the facility now boasts not only one of the most comprehensive collections of keyboards, but also what appears to be at least one of every digital audio processor ever manufactured! For this reason the views of Bobby Nathen and Tom Lord-Alge seemed valuable.

B.N.: In the beginning we worked very hard to keep on top of new sounds and possibilities which meant our collection of keyboards began to grow. What we also knew was that to make a synth come alive it was much more than just the patch and because synths are dry an integral part of recording them has got to be ambiance.

A.M.S.: *You chose digital devices to do this right from the start?*

B.N.: Yes we did — even though many clients had been indoctrinated at other studios that you need cavernous rooms rather than electronic devices. The first units we owned were a Lexicon Prime Time and an Eventide Harmonizer — we believed in electronic devices from

the start right up to the present where we try and offer our clients every device available. For instance, when the Lexicon PCM 41 came out we bought 5 of them because we knew that the more DDLs in a mix the clearer the mix. Even if they weren't used for that they would be used for synching before devices like Dr. Click and the like.

A.M.S.: *What about reverbs?*

B.N.: We bought a 224 and then a Sony DRE 2000 which was one of the first 16 bit machines and therefore had a fantastically bright top end but no bottom end — and still doesn't have any bottom end but it goes very well with the 224. What came next was the gated plate sound that we had heard on Gabriel and Phil Collins albums and we experimented with what we'd got until we heard the RMX 16 and realised that was the sound we'd been working hard to get but not quite achieving.

A.M.S.: *So did you buy an RMX 16 at this stage?*

B.N.: We started by renting them but soon found out that even though Martin had something like 14 units we could never guarantee to get our hands on let alone one of them. So then we bought a couple of them and they are now definitely the standard.



• ADVANCED MUSIC SYSTEMS •

AMS Industries plc, AMS Industries Park, Billington Road, Burnley, Lancs. BB11 5ES, England.

Tel: (0282) 57011 Telex 63108 AMS-G



Australia: Syntec International PTY Limited, 53 Victoria Avenue, Chatswood, NSW 2067. Tel: 406 4700/4557/4627. CONTACT: Robert Sloss.
 Canada: Manta Electronics Group, 204 King Street East, Toronto, Ontario: M5A 1J7. Tel: (416) 868 0513. CONTACT: Marshall Freund.
 Denmark: Silt Studie & Lydteknik Aps, Skjulhoj Alle 57, DK-2720 Vanlose. Tel: (01)1-71 33 44. CONTACT: Christensen Ole Lund.
 Finland: MS-Audiotron, Laitantie 10, 00420 Helsinki 42. Tel: 566 4644. CONTACT: Jarmo Roivas.
 France: High Fidelity Services SA, 4 Rue Pierre Semard, 75009 Paris. Tel: 285 00 40. CONTACT: Jean Noel Kendrigi.
 France: Lazare Electronic, 14 Rue Condorcet, 75009 Paris. Tel: 878 35 64. CONTACT: Isabelle Yosmayan.
 West Germany: Elmus GmbH, Hohenzollerndam 58, 1000 Berlin 33. Tel: 030 823 99 61. CONTACT: Henri Keinert.
 Greece: KEM Electronics O.E., 28 Padiamadi Str., 14452 Metamorfosis, Attika. Tel: 2819151/2811626. CONTACT: Thimios Koliokotsis.
 Hong Kong: Audio Consultants Co. Ltd., 9th Floor, Kai It Building, 58 Pak Tai Street, Kowloon. Tel: 3-7125251. CONTACT: John Ho.
 India: Katonix, C-15 Greater Kailash I, New Delhi - 110048. Tel: 641-1369. CONTACT: Manjal Prabhat.
 Italy: Professional Equipment, Viale Farnagost 37, 20142 Milano. Tel: 81 78 39. CONTACT: Ermanno Parazzini.
 Italy: Audio International SRL, Via Santa Maria 100, San Maurizio AL Lambro Milan. Tel: 0039-2-25390121. CONTACT: Roberto Bep.
 Japan: Continental Far East Inc., Sa Saki Building 18-9, Roppongi 3, Chome, Minato Ku, Tokyo. Tel: 583 8451. CONTACT: Shingo Araki.
 Netherlands/Belgium: Audioscript BV, Loosdrechtse dijk 107, P.O. Box 22, Loosdrecht. Tel: 02158-5104. CONTACT: Jan Slooeter.
 Norway: Pro-Technic A/S, Lyder Sagens Gate - 19, Oslo 3. Tel: 02 460554 CONTACT: Martin Viktorin.
 New Zealand: Maser Communications Limited, 3/7 Marken Place, Glenfield, Auckland. Tel: 444 3583/4. CONTACT: Gareth Jones.
 South Africa: Tru-fi Electronics S.A. (Pty) Ltd., P.O. Box 84444, Greenside 2034, Rep. of South Africa. Tel: (011) 786-7177/8. CONTACT: Fleming Raven.
 Spain: Fading S.A. Servando Batanero 8, Madrid 17. Tel: 408 67 00/408 68 08. CONTACT: Felix Mayor.
 Sweden: Soundtrade AB, Rasundavagen 45, S 17152 Solna. Tel: 08-7300400. CONTACT: Carl Langeskiold.
 Switzerland: BVS AG, Neuhof, CH 8164 Bachs. Tel: 010 411 858 13 13. CONTACT: Rolf Jauch/Mark Ofer.
 U.S.A.: Harris Sound Inc., 6640 Sunset Blvd., Suite 110, Hollywood CA 90028. Tel: (800) 233-1580. CONTACT: Harry Harris.



TAKE THE LEAD.

Every professional wants their own sound perfectly delivered every time. A good P.A. system starts with a Beyerdynamic microphone. Why?

The Beyerdynamic range is just right in any situation. Ruggedly built for travel, and always proven reliable. Each model is designed to look great and, most important of all, each one delivers clear undistorted sound reproduction.

Take the lead, let a Beyerdynamic microphone become a natural part of your act.

M69 Vocals/Acoustic Guitar/Tom-Toms **M88** Supreme Vocals/Electric Guitar/Bass Guitar/Saxophone
M600 Vocals/Electric Guitar/Bass Guitar/Brass **M260** Vocals/Acoustic Guitar/Violin/Overhead
M201 Brass/Strings/Bongos/High-Hat

beyerdynamic

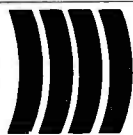

EXCELLENCE IN SOUND

*BeyerDynamic, Unit 14, Cliffe Industrial Estate,
Lewes, Sussex BN8 6JL, England. Tel: 0273 479411*

AUDIO SERVICES

4, WELLINGTON ROAD, ST. JOHNS WOOD
LONDON NW8

(Opposite The Wellington Hospital Junction with Lords Cricket Ground)

**LONDON
SHOWROOM
NOW OPEN!**

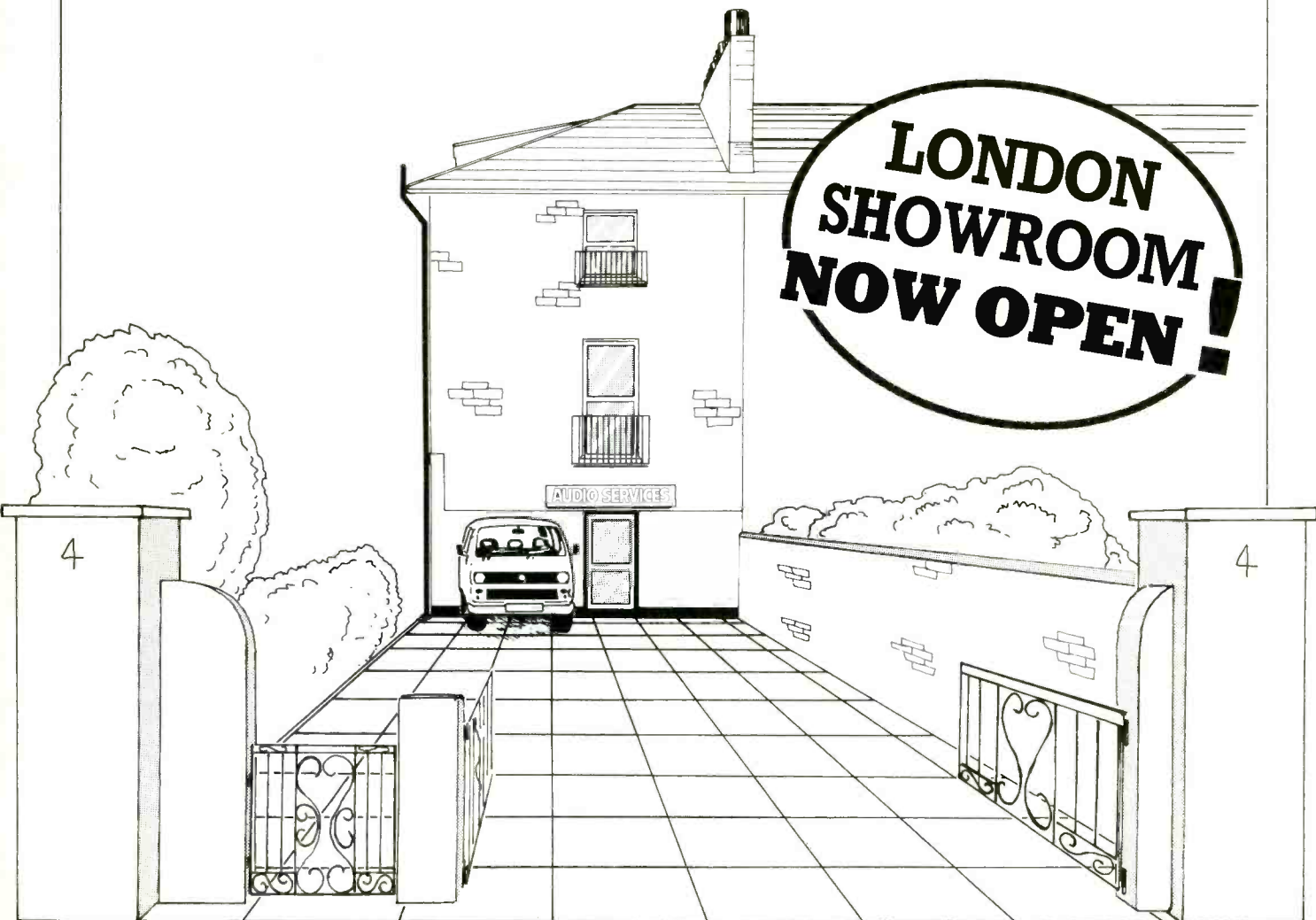

Everything a Studio
needs is here in the
centre of London

**Second Hand and
New Bargain List
Sent on Request.**

Daily Deliveries into
Central London.
Radio Phone - 0860 370079



**01-586
3167**

HEAD OFFICE: STUDIO HOUSE, HIGH LANE VILLAGE, STOCKPORT SK6 8AA. (06632) 4244

SENNHEISER

The choice of professionals



Actual size

SENNHEISER MICROPORT

- A range of five transmitters includes the miniature SK 2012 (illustrated) and the SKM 4031 vocalist model
- Five complementary receivers include the EK 2012 (same size as SK 2012) and the EM 1036 six channel diversity system
- Frequency ranges: (VHF) 25-240 MHz (UHF) 470-900 MHz
- Advanced transmitter and receiver circuitry virtually eliminates intermodulation products
- Sennheiser's integral compander system gives a dynamic range of up to 96dB

For further information on any Sennheiser product, please contact us on 0753 888447

Hayden Laboratories Ltd, Hayden House, Chiltern Hill, Chalfont St. Peter, Bucks. SL9 9UG



Drop-in, drop-out, trigger effects, remote control...

QuPlay does it all automatically!

Drop everything and listen. Whether you're a recordist who plays a bit, or a player who records alone, you'll know you can't do both jobs at once. QuPlay changes all that.

Free to play...and free to think

This brilliant new device will memorise drop-in points, trigger external devices and functions as a remote control. Leaving your hands and head free to get on with more creative things.

Save time, stop mistakes

Just program QuPlay to carry out your instructions then you can concentrate on getting the performance right. The operation is quick and efficient and you won't run the risk of wiping or clipping a perfect take.

Only a minute to master

We designed the QuPlay to help you. In operation, it's simplicity itself; after one demonstration you'll wonder why you tried to manage without it.

Rugged and reliable

Housed in a tough steel box measuring just 17 x 11 x 15cms, QuPlay is still light enough to permit one-hand use. And with its long remote cable, it'll give you mobility between instruments and tape machine, control room and studio.

Accurate even after 20 passes

If you DO need twenty takes at a drop-in (maybe you should be thinking of a new career) QuPlay will stay locked on cue.

From MTR90 to Model A80

QuPlay is designed to interface with all the latest multi-tracks: Fostex B16 and Model A80, Otari MTR90, MTR12, MTR10, and MX70, Tascam 48, 58, MS16 and 388 Portastudio. And now Studer A800.

Self-powered

Actually, strictly speaking, QuPlay draws its power from the tape machine it's plugged into. But what this means in practice is that it's never going to run out of batteries at the crucial moment.

A silent partner

Its nerves are unshakeable, performing precise drop-ins after hours of operation. It doesn't get tired, irritable or angry however long you work.

Affordable

At under £300, how much longer can you afford to be without a QuPlay? In fact, when studio time is being paid for by the hour, if it saves just one mistake it could well pay for itself.

Want one?

Post the coupon or contact any of these stockists:

America: Europatech (213) 3924985. **Canada:** Gerr Audio Inc (416) 868 0528. **France:** Regiscene (1) 374 5836. **Italy:** Audio Links (2) 302 772009.

Japan: Matsuda Trading Co. (03) 295 4731. **New**

Zealand: Maser (9) 444 3583. **Spain:** Lexonsa (320) 34804. **Switzerland:** W.A. Gunther

(391) 3939. **Denmark:** S.C.Sounds. Aps

(2) 99 88 77. **Finland:** Audiotron (0)

5664 644. **Sweden:** Intersonic A.B.

(8) 744 5850. **Norway:** Lyd/Rommet

(2) 114 085. **Australia:** Syntec (2) 406

4700. **England:** S.A.S. (01) 625 4515,

I.T.A. (01) 748 9009.

QuPlay...as versatile as you.

Works without using up valuable tracks or the risk of stretching your valuable master tape.

Does *not* need batteries or mains power.

Accepts programming by time-code driven devices.

Acts as conventional remote control.

Trigger external effects, bounce tracks, start 2-track tape machine automatically.

Allows multiple drop-in of a fixed length sound effect by shifting record window.

Control drop-ins via footswitch in recording area, or patch through on tie-lines from control room.

Provides unique pre-record rehearsal facility with arm/disarm buttons plus automatic mute is achieved with external trigger.

Program drop-in points, spot erase, track clear confidently without risk of accidental erasure.

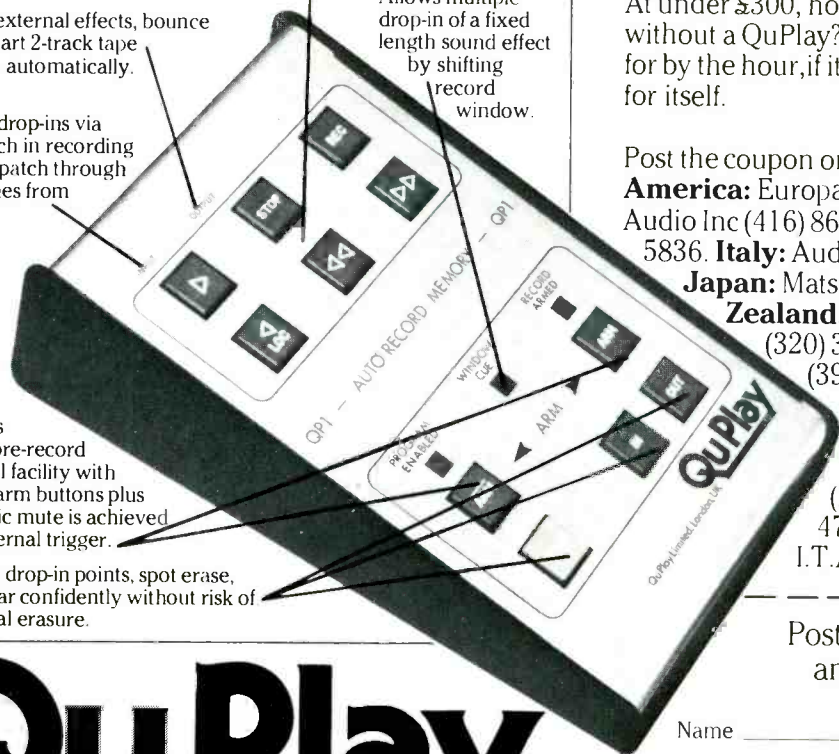

QuPlay

LTD

Tel: 01-482 4288 oor (0707) 44616, 24 hour answering service.

Telex: 8951182 GECOMSG. Attn. QuPlay.

U.K. distribution exclusively by QuPlay. Credit facilities available. Contact us for details.

Post today for free brochure
and list of local stockists

Name _____

Address _____

SS4 _____

Private Studio Commercial Studio (Please tick)

Tape Model No. _____ Your Daytime Phone _____

QuPlay Ltd., Unit 5, 43 Carol Street, London NW1

MS-MULTIMIX

TOTALLY MODULAR

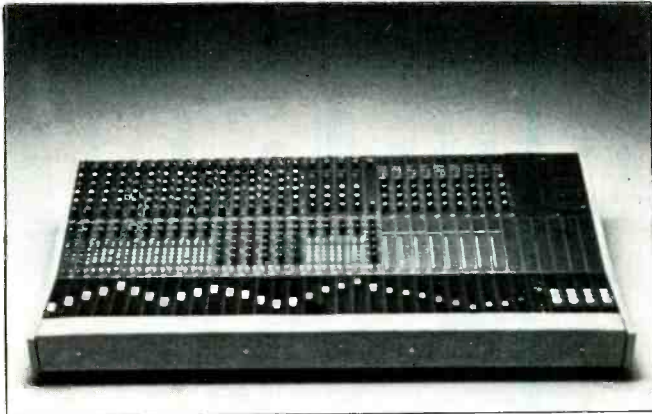

- True modularity to really meet your requirements, in theater and multipurpose hall installations.
- A family of some 20 different input, grouping, fader, metering and output modules.
- Special modules for control room and headphone monitoring, test signals, talkback, remote control etc.
- Heavy duty steel chassis.
- Transformer balanced inputs and outputs.
- Wide range meters, 60dB display.

MCA; MICROCOMPUTER CONTROLLED AUDIO SYSTEM

- Stores up to 600 cues (scenes) on floppy disk
- Controls up to four tape recorders.
- Assignable digital fader and meter to set and control output levels.
- Eight output groups.
- System operation by single cue entry push button.
- Pocket terminal for remote control and cueing.
- Optional speaker switching matrix.

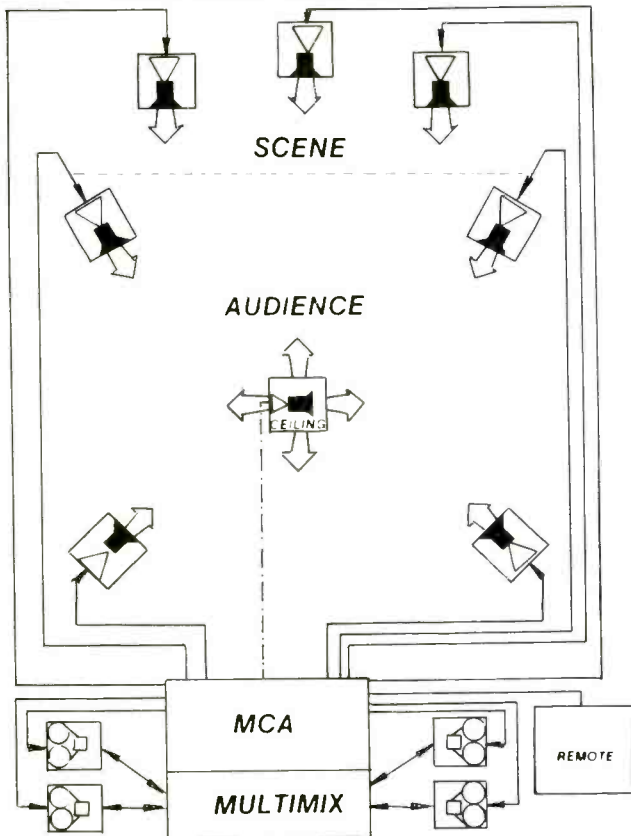

WELCOME TO OUR
DEMO ROOM R7-1
AT THE MONTREUX AES



MS-AUDIOTRON

Laitilantie 10 00420 HELSINKI 42
FINLAND ☎ 90 - 5664644
Telex: 125778 msa sf

GENELEC

THE SOUND INVESTMENT

TRIAMP 1022A



COME AND HAVE FULL DEMONSTRATION
OF ALL OUR ACTIVE MONITORS
IN ROOM R 7/7 AT THE 80TH AES
CONVENTION IN MONTREUX.

GENELEC

P.O. Box 36
SF-74101 IISALMI
FINLAND
Phone Int. + 358 77 13311
Tlx 4452 audio sf

GENELEC DISTRIBUTORS IN EUROPE

BELGIUM

HES Electronics
Vliegwezenlaan 6
1730 ZELLIK
Tel. 2-465 2917
Telex 63033 vvl b

ITALY

Audio Equipment S.R.L.
Via Carlo Rota, 37
20052 MONZA (Milano)
Tel. 03-836 767
Telex 323668 audio i

THE NETHERLANDS

Audioscript B.V.
Nieuw Loosdrechtsejdijk 107
1231 KP LOOSDRECHT
Tel. 2158-5124
Telex 43953 audio nl

NORWAY

Siv ing BENUM AS
Postboks 145 Vinderen
0319 OSLO 3
Tel. 02-145460
Telex 77681 benum n

SPAIN

Fading S.A.
Servando Batanero, 8
MADRID 17
Tel. 01-408 6700
Telex 44330

SWEDEN

Intersonic AB
Box 42133
126 12 STOCKHOLM
Tel. 08-744 5850
Telex 11136 insonic s

WEST GERMANY

FFD
Vertriebsgesellschaft
Nordenstrasse 3
8000 MUNCHEN 40
Tel. 089-278 0404
Telex 528592 giclf d

GRAFF

Today's sound buy

For the transfer of music, speech, computer software and audio visual formats.

Visit us on Stand A-6 at AES

The all British Graff series II has no peers among High Speed Cassette Duplicators.

- Fast precise cassette copying- both sides simultaneously- at 16 times normal speed
- Highest quality recordings in stereo or mono
- Advanced technology built into proven design
- Modular system to meet specific requirements
- Excellent sales and after sales service



GRAFF the sophisticated aristocrat of sound copying

Graff Electronic Machines Limited, Collingham, Newark, Notts. NG23 7NR Telephone 0636 893036 Telex 377119



TRAD

FOR SALE	£	FOR SALE	£
Studer A800 Mk.III, 24T, 2,500 hours	26,000	Trident series 80, 32-24-24	12,500
Studer A80 Mk.III, 24T, remote and autolocate 1,500 hr	19,500	Neve 8128, 32-24	47,000
Studer A80 Mk.II, 24T, remote and autolocate	16,000	Cadac 36-24-24	14,000
Studer B67 stereo console mounted	2,000	Alice 18-8 production desk	1,500
Studer J37, 4T, valve, 1/2 inch	1,500	Dolby M16H	4,500
Lyrec 532 24T, 32 memory autolocate	11,500	Dolby M24H	6,250
M.C.I. JH110B, 8T, autolocate, as new	5,000	Tannoy SRMX 15	pair 1,000
Itam 1610, 16T on 1" with noise reduction	4,500	Tannoy Devons	pair 120
Proline 1000SC, stereo, portable	each 475	Eventide 910 harmonizer	800
M.C.I. JH110 stereo	1,800	Aphex aural exciter, Type C	P.O.A.
3M M56, 16T	4,000	Electrospace time matrix	1,200
Quad Eight 32-16-24 desk	6,500	Kepex cards, 8 in rack with P.S.U.	850

The new all-valve E.A.R. Pultec Type EQ's and E.A.R. all-valve Fairchild Type Comp/Lim. are available ex stock.

Details on application

Export inquiries welcome

World Distribution: Trad Electronics Sales Limited

The above prices do not include V.A.T

TRAD

ELECTRONICS SALES LTD

149b. St. Albans Road, Watford, Herts, WD2 5BB, England

Tel: Watford (0923) 47988/9

Telex: 262741



A legend amongst legends

Shure SM58 — the world-standard professional stage microphone, with the distinctive Shure upper mid-range presence peak for an intelligible, lively sound. A tough, handsome microphone that weighs less than 11 oz, the SM58 is often imitated in appearance, but never duplicated in performance, ruggedness, or reliability. It is still the unsurpassed first choice among rock, pop, R & B, country, gospel, and jazz vocalists.

The SM58 is preferred for its punch in live vocal applications, especially where close miking is important. In addition to the slight presence rise in mid-frequencies, it has a fixed low-frequency rolloff to minimize the "boominess" usually accentuated by close pickup. A built-in spherical windscreen takes the pop out of close-up use, and minimizes breath and wind noise distortion. The uniform cardioid pickup pattern greatly reduces off-axis coloration and rejects background noise to permit higher amplifier gain before feedback.

The SM58 is world-renowned for its ability to withstand the kind of abuse that would destroy many other microphones, and is rugged enough to withstand a six-foot drop onto a hardwood floor with no adverse effects.

The distinctive shape perfectly fits the hand and the superior balance and weight distribution make the SM58 unusually comfortable in hand-held applications. The non-glare grey finish provides for exceptional on-camera appearance.

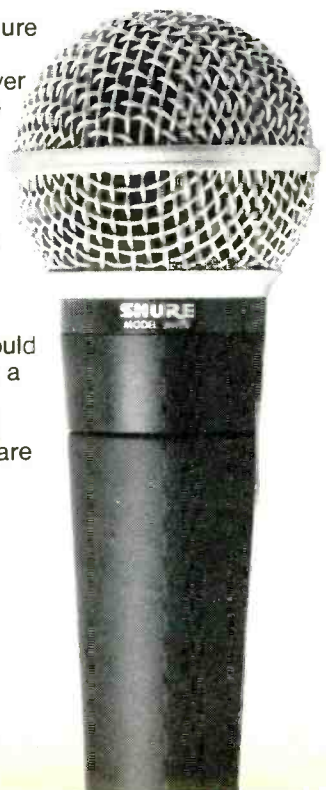

SHURE®

HW International
3-5 Eden Grove
London N7 8EQ
Tel 01-607 2717

SERIES 75

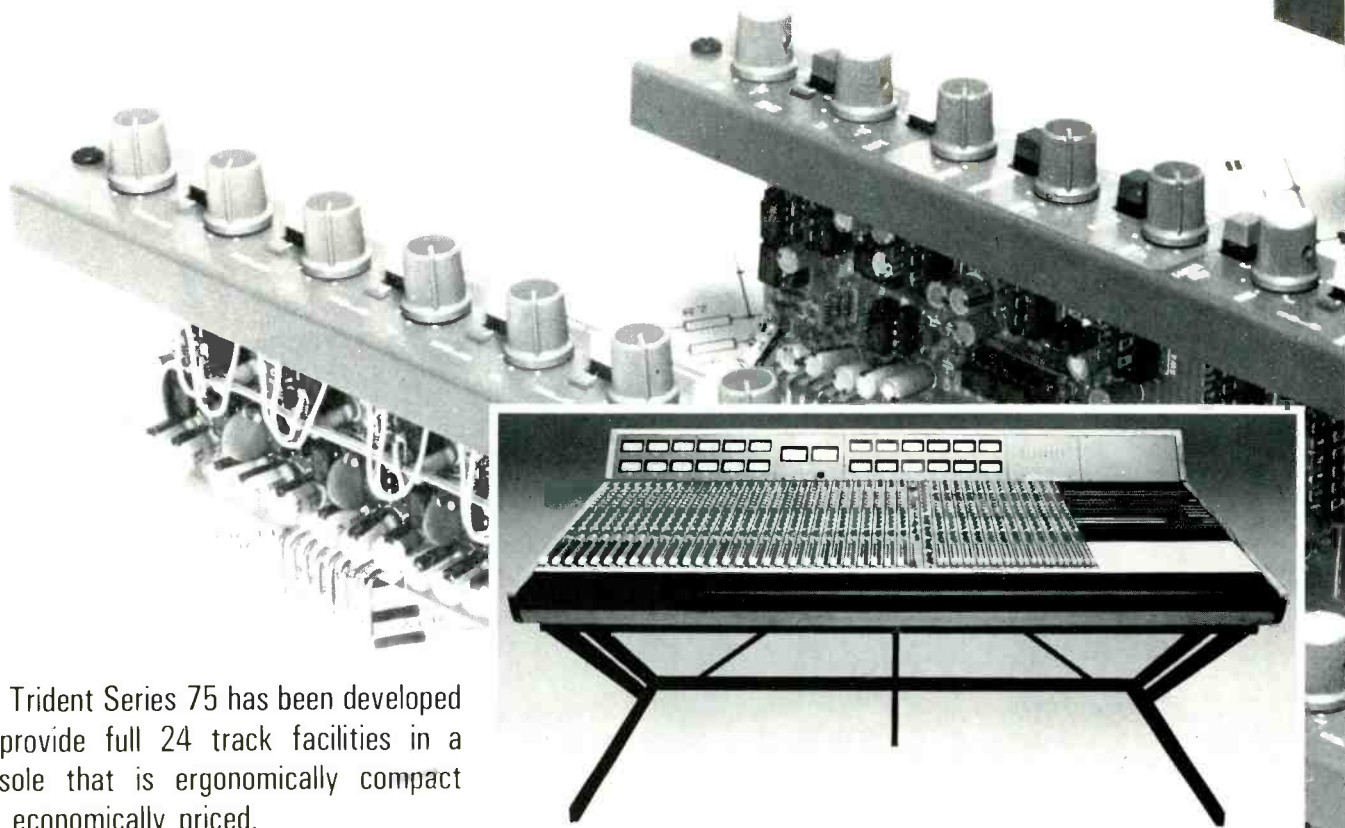

The Trident Series 75 has been developed to provide full 24 track facilities in a console that is ergonomically compact and economically priced.

Because of this, the Series 75 is equally suitable for use in a musician's home studio or a commercial multi-track facility.

The electronics design of the console allows no compromise. Trident have been manufacturing consoles that are used in world class studios for the past dozen or so years and enjoy a reputation for providing particularly warm and musical sounding equalisation. Series 75 carries on this tradition in characteristic style.

A feature of the console is its comprehensive, separate monitor section that provides monitor equalisation and the availability of up to 56 line inputs during mixdown, complete with equalisation, panning, aux sends and muting. A full 308 point bantam patchbay is also provided as standard.

Take a close look at the Series 75. We'll be surprised if you can find a console with a better reputation and more features at the same price.

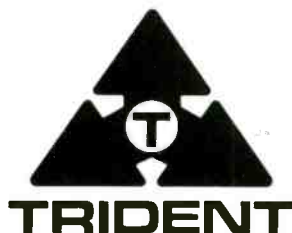

Trident Audio Developments Ltd.
Trident House, Rodd Industrial Estate,
Govett Avenue, Shepperton,
Middx, TW17 8AQ.
Telephone: (0932) 224665
Telex: 8813928 TRIMIX G

Trident U.S.A. Inc.
308 N. Stanley Avenue,
Los Angeles 90036, U.S.A.
Telephone: 213 - 933 7555
Telex: (255) 510600019 TRIDENT U.S.A.

The most intelligent move yet!

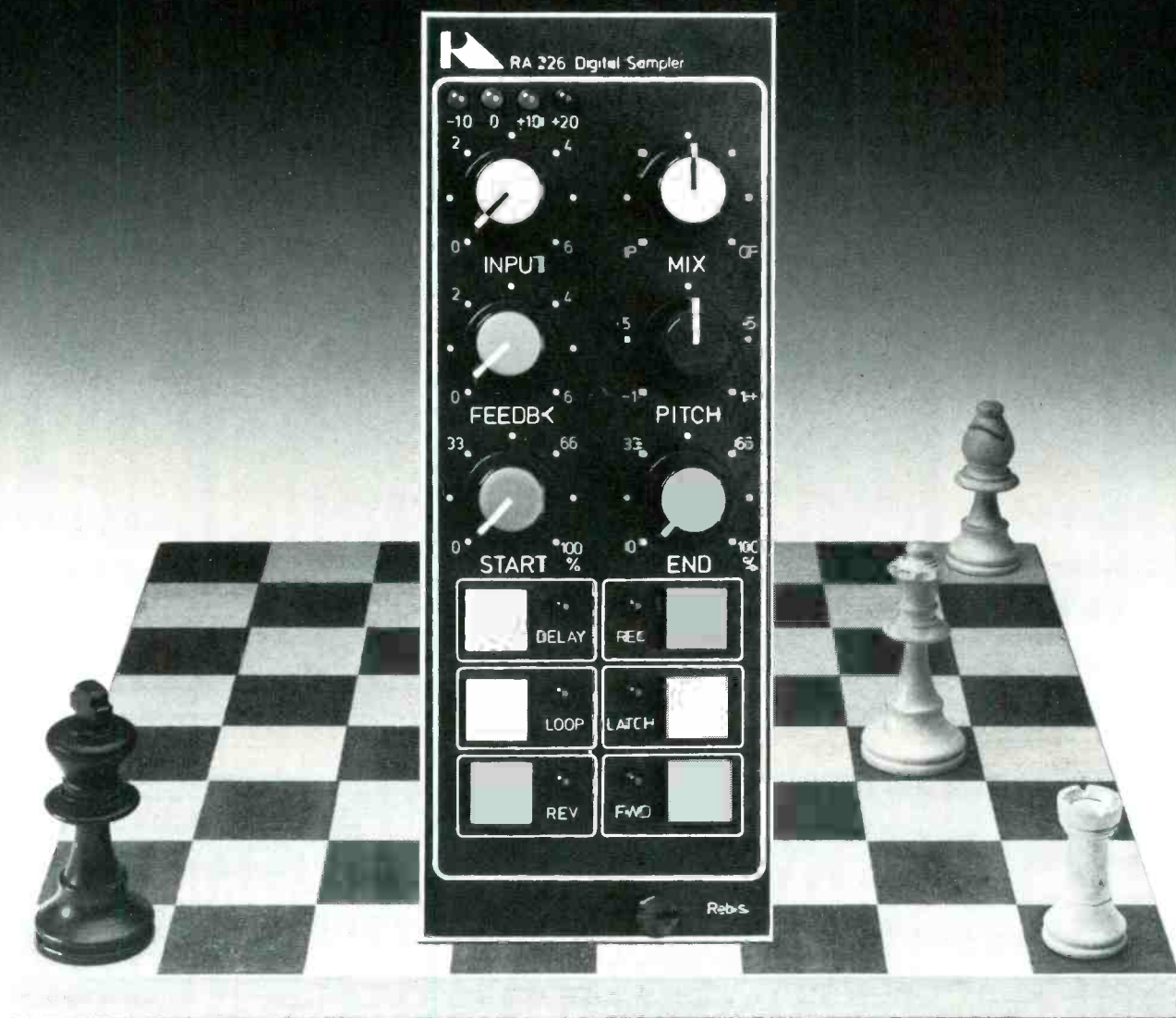

The RA226 Sampler represents a price breakthrough in digital audio technology.

Using innovative techniques in software driven processing this new Rebis module gives you 5.25 seconds record/playback expandable to 21 seconds on board, maintaining 16kHz bandwidth.

Variable two octave pitch shift also lets you take advantage of a useful range of time/bandwidth settings through to 84 seconds at 4kHz

Auto trip makes recording simple. Start and end controls define the memory zone for record and playback to enable precise

editing and splicing of single or multiple samples.

Forward and reverse playback modes plus loop, one shot and step functions with momentary or latching action ensure full creative control.

External inputs are provided for CV keyboard, DC remote and audio trigger.

Delay mode for ADT and repeat echo can be used without erasing samples from memory.

The RA226 Digital Sampler is one megabyte

of pure processing power made so instantly accessible you may never read the manual!

Give yourself the creative edge—get the full facts today!

Rebis
The Creative Edge

**Rebis Audio Ltd. Kinver Street Stourbridge West Midlands DY8 5AB. ENGLAND.
Telephone: (0384) 71865. Telex: 335494.**

Austria; Bauer Sound, Himberg 02235-89298. Belgium; S.E.D., Bruxelles 522 70 64. Canada; Heil Electronics Inc., Ontario 727-1951. Denmark; Kinovox A/S, Lyngby 02 18 76 17. Finland; Studiotec, Espoo 514 133. France; Lazare Electronics, Paris 878 62 10. High Fidelity Services, Paris 285 0040. Germany; Thum & Mahr Audio, Leverkusen 2173-7806-0. Hausmann Concert Electronic, Berlin 4336097. Hausmann Electronic, Starnberg 8151 1031. Studioteknik Jurgen Klever, Hamburg 6901044. Hong Kong & China; Audio Consultants Co. Ltd., Kowloon 3-7125251. Italy; Startek, Bologna 32 10 63. Jamaica; Audiofon Systems Ltd., Kingston 926-2569. Japan; Hibino Electro Sound Inc., Tokyo 442-4101. Netherlands; Special Audio Products B.V., Amsterdam 140035. New Zealand; Maser Broadcast Systems Ltd., Glenfield 444-3583. Saudi Arabia; Iadil Halwany & Sons, Dammam 8570848. South Africa; Tru-Fi Electronics, Johannesburg 786-7177. Spain; Singleton Productions, Barcelona 237 70 60. Sweden; Tal & Ton, Gothenburg 803620. Switzerland; E.M.M. Studio, Gempen 061 72 89 72.

A new Generation of 16/35mm Recorders-Reproducers

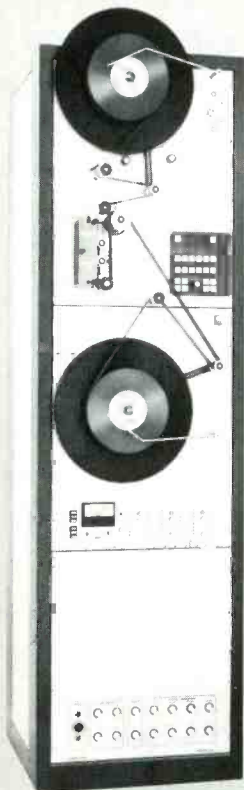

SIMPLEX

High Speed CAPERMAG PERFECTONE

Single-Capstan Drive
Digital Servo-Control
30 times speed with 16 mm
12 times speed with 35 mm
in absolute Synchronism

Perfect Master or Follower
for Television and Film
Sound Post-Productions

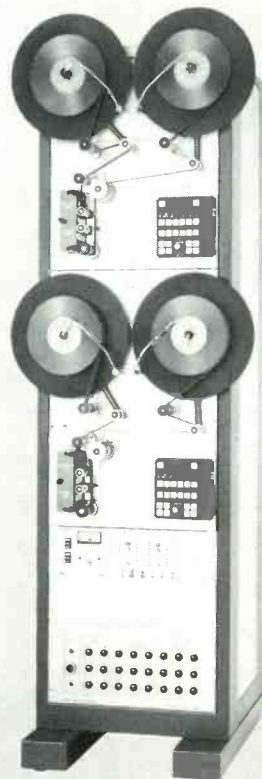

DUPLEX

PERFECTONE PRODUCTS SA 2560 NIDAU SCHWEIZ TEL. 032 51 12 12 TX 34383 Perbi CH

THE DIFFERENCE IS WELL WORTH THE DIFFERENCE

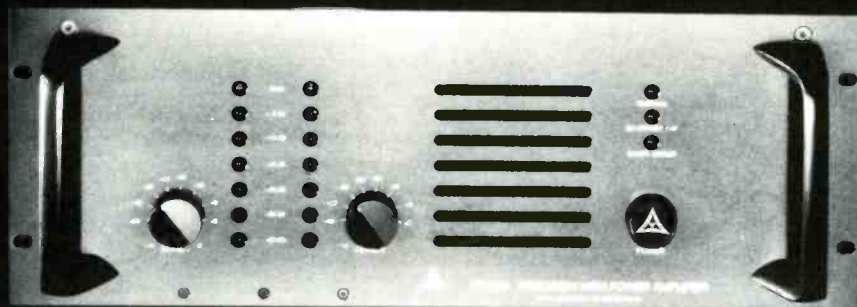

Swiss precision craftsmanship always costs a bit more but when you invest in an FM ACOUSTICS power amplifier you get more than precision craftsmanship. Thanks to proprietary technologies, unique selection procedures and circuits, FM ACOUSTICS is rewarding you with more naturalness and true fidelity.

For the ultimate in musical accuracy move up to FM ACOUSTICS.
There is no alternative.

LONDON BOROUGH OF ISLINGTON
**BRITANNIA
ROW**
N.I

01-226 3377
TELEX: 268279 BRITRO G

BRITANNIA ROW LTD
35 BRITANNIA ROW LONDON N1 8QH



FM ACOUSTICS LTD

FM ACOUSTICS LTD, Tiefenholstr. 17, CH-8820 Wädenswil/Switzerland
Telephone: 01/780 64 44, Telex: 875414 FMAC

US office: FM ACOUSTICS USA, P.O. Box 311, 956170311 Davis CA
Phone: (916) 7586300

In Canada: Perspective Audio P.A. Inc., 23 Chatel, Lorraine, P.O.
J6Z 3C4 Phone: (514) 621-4087



The Essentials.

111B Dual Spring Reverb

The most cost-effective spring reverb on the market

245F Stereo Synthesizer

Convincing pseudo-stereo from any mono source

412A/414A Compressor/Limiters

Smooth, undetectable level control. Ideal for production, PA, and fixed installations. Highly cost-effective.

412A (mono); 414A (stereo)

422A/424A Gated Compressor/Limiter/De-Esser

A complete level control system with de-esser which provides natural, transparent processing at a highly-competitive price (mono or dual-channel)

536A Dynamic Sibilance Controller

Clean, inaudible de-essing of vocals with consistent action regardless of levels

622B Parametric Equalizer

An exceptionally versatile EQ which has become the standard in studios, broadcast, and road shows

672A/674A Equalizers

A Parametric EQ with graphic controls, including variable high and low-pass filters usable as an electronic crossover (mono or stereo)

New Security Covers

Attractive acrylic security covers are available for all products in clear, transparent blue and translucent grey.

Orban Pro Audio Products are sold through a worldwide dealer network. Call or write for the name of the dealer nearest you.

orban

Belgium Trans European Music (Bruxelles) Finland Studiotec (Espoo)
 France 3M France SA, Mincom Div (Paris) Germany Estemac (Hamburg)
 Germany Hausman Electronic (Berlin) Greece Audiolab (Hellas
 (Athens) Holland Cadac Holland (Hilversum) Italy Audio Products
 International (Milano) Norway LydRommet (Oslo) Portugal Ampere!
 (Lisbon) Spain Singleton Productions (Barcelona) Sweden Tal & Ton
 (Gothenburg) Switzerland Audio Bauer (Zurich)

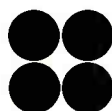

SCENIC SOUNDS EQUIPMENT LIMITED
 Unit 2, 12 William Road, London NW1 3EN.
 Tel: 01-387 1262, 01-734 2812
 Telex: 27939 SCENIC G



Audio & Video Jackfields for Recording and Broadcasting

Mosses and Mitchell are recognised as being the largest manufacturer of Jacks and Jackfields in the U.K. We are approved suppliers to the B.B.C., British Telecom, the Post Office, Pye T.V.T., Pye Telecommunications, Mercia Sound and many other major users.

We have a policy of continued design and technological innovation and are now able to offer miniature type Jacks and Jackfields which can be supplied with wire wrap terminals as an alternative to the traditional solder terminals.

At our modern factory in Farnham, Surrey we are equipped to offer a flexible manufacturing service geared to meet your individual specification and delivery requirements.



Mosses & Mitchell Limited, Weydon Lane, Farnham, Surrey GU9 8QL
Telephone: Farnham 721236 (STD 0252) Telex: 858820

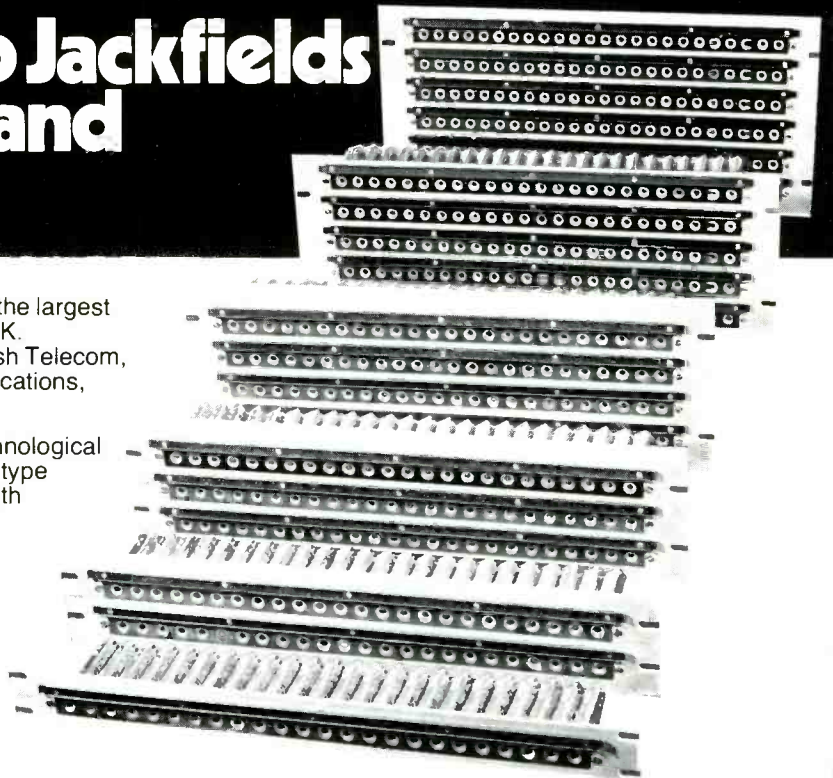

When you're in the studio you want the best.

- **Innovative products using the latest technologies**
- **Sophisticated, versatile equipment to create originality**

At Electrospace Developments Limited, we have an international reputation amongst engineers for meeting all these criteria – and more.

And, you won't need a small army of technicians to get the best from our products.

Products like our New Gate and Strate Gate, unique Audio Gates which have a level of precision and control that needs to be seen – and heard – to be believed.

Like the Spanner, the industry's first digital panning system which gives infinitesimal adjustment and variation for both mono and stereo inputs.

And like the next generation of technological engineering which we are today developing into tomorrow's products.

Distributed in the UK by Britannia Row Equipment Limited, on 01-226 3377.

Electrospace

ELECTROSPACE DEVELOPMENTS LIMITED THE SOUND OF QUALITY

**Main UK dealer, Professional Audio Limited,
Professional Audio House, 53 Corsica Street, London N5 1JT. Tel: 01-226 1226**

Authorised dealers: **Turnkey** – London, Tel: 01-202 4366/01-637 1701/0782 24257 **Don Larking Audio Sales** – Luton, Tel: 0582 450066
Carlsbro Sound Centre – Nottingham, Tel: 0602 581888

NEW POWER IN BATTERSEA

All power needs a PLUG.

And this is it!

PMD, Britain's No. 1 Magnetic Media distributors are pleased to announce the opening of their new London Sales Office.

Write or 'phone today for our CURRENT price list. You could be in for a SHOCK when you see how competitive we are.

The jokes get worse—the service gets better.

Ampex Professional Tape, Editing Sundries, Accessories, Spools, Boxes, Video Products, Floppy Disks

London Sales Office
Battersea Wharf
Queenstown Road
London SW8
Tel: 01-627 3760

Head Office
Tel: (0789) 68579
Telex: 317148 Datas G (prefix messages PMD)



**NUMBER ONE IN MAGNETIC MEDIA
PANGBOURNE MUSICAL DISTRIBUTORS LTD**

DIARY DIARY

People, events, services

Winning ways?

The Electro-Acoustic Music Association has announced the second Performing Right Society Prize of £750. Any work written in the last five years using the electro-acoustic medium is eligible (ie tape, tape+instrument or voice, live electronics) for consideration. The winning

work will be included in the EMAS concert series in London.

Further details and application forms from: Carol Butler, EMAS, 10 Stratford Place, London W1N 9AE, UK. Tel: 01-499 2576. The closing date for applications is May 30th, 1986.

Agencies

● Musimex, the London based musical instrument and pro audio marketing company, have recently been appointed exclusive worldwide sales agents for Frazer Wyatt speaker systems.

● Don Larking Audio Sales in Luton, Beds has been appointed a full range dealer for Soundcraft Electronics. Don Larking is only the second full range dealer to be appointed in the UK.

● The Hudsons-Crow Group of Companies is to market ADM Technology broadcast mixers including the *Post Pro* designed to be controlled by a computer editor such as *CMX*.

● Eastern Acoustics Works Inc in the USA, has appointed three new independent field sales representatives. Covering the south west is Pro Tech Marketing, 13031 San Antonio Drive, Suite 2, Norwalk CA

90650; representing EAW in the midwest is Fleetwood Marketing, 320 Mulberry St, Madison, IN 47250 and covering the Florida area is World Wide Electronics, 6810 Pembroke Road, Miramar, FL 33023.

● Studio Equipment Distribution (SED) has appointed MCI Intertek of Arlington, Texas as sole US distributor for all Bel products. MCI Intertek will appoint dealers throughout the USA. Contact: Jerry Spohn, MCI Intertek Inc, 245 109th Street, Arlington, TX 76011, USA. Tel: (817) 640-6447.

● Rupert Neve Inc, Neve Electronics' US subsidiary has recently opened a new office, headed by Tom Semmes, in Nashville. Rupert Neve Inc, PO Box 40108, Nashville TN 37204, USA. Tel: (615) 385-2727.

Address changes

● Lakeside Associates Inc, studio design and acoustic consultants have opened a new office at 4 Alegria, Irvine, CA 92720, USA. The new telephone number is (714) 730-1333.

● Numark Electronics has moved its West Coast office and warehouse to a new and larger facility at 4486 Runway Street, PO Box 3180, Simi Valley, CA 93063, USA. Tel: (805) 522-3550.

● Phoenix Systems' products are now being manufactured under licence by Rhoades National Corporation of Columbia. All product related

enquiries should be addressed to: Mr David Rhoades, Rhoades National Corporation, Dept R/P, PO Box 1316, Columbia, TN 38401, USA. Tel: (615) 381-9007.

● Bruel & Kjaer UK has moved to new UK headquarters at Harrow, Middlesex. The new address is Harrow Weald Lodge, 92 Uxbridge Road, Harrow, Middlesex HA3 6BZ. Tel: 01-954 2366. Telex: 934150. The premises include a fully equipped calibration department and special lecture room/demonstration theatre.

SSL correction

Two errors crept into the 'SSL digital research confirmed' piece on page 29 of January's Diary section. Firstly, SSL will be moving from Stonesfield in Oxfordshire, *not* Herts.

Secondly, the 300th sale announcement made during the AES Convention was not just for *SL4000E* consoles but for the *E* series as a whole which includes *6000* range.

Contracts

● Wessex Studio in Highbury, North London has purchased a Mitsubishi *X-850* digital multitrack. The Mitsubishi will be used in Studio One along with an SSL *4000E* and *Total Recall*.

● Rooster Studios in Shepherd's Bush, West London has recently taken delivery of a Mitsubishi *X-850*.

● Audio Engineering Ltd in conjunction with their US agents, Micron Audio Products have won a major contract to supply Micron radio microphones to Burbank Studios in Los Angeles. The order is for 60 sets of Micron *TX501* pocket transmitters and *MR510* mobile receivers.

● Toronto-based Comfort Sound now has an Otari *MTR 12-11 1/2* in tape deck which runs at 30 in/s and includes interchangeable 2- and 4-track heads. Also added to the equipment list are a Yamaha *Rev 7*, an Eventide phaser, Orban de-esser and a 3/4 in JVC video recorder.

● Universal City Studios has recently taken delivery of the largest 6-channel *PP-1* stereo post production audio console ever built by Harrison Systems. The 81-input console with 24 subgroups will be used in Universal's 'Dubbing Two' theatre.

● Evergreen Recording of Burbank has ordered a special 54-input 6-channel film scoring version of the Harrison *MR-2* automated console. The console will be installed as part of the renovation of the well known CBS/MTM Scoring Stage.

● First customer deliveries of the Harrison series *10* will be to Westlake Audio in Hollywood and to Denny Jaeger Productions in Oakland, California.

● London's Nomis Complex has created a new rehearsal studio (Studio A) which is now the largest of the 10 rehearsal studios available. Full PA is available. Studio designer Tom Hidley designed the new room.

● The Barbican Centre has recently installed a Soundcraft series *800B* 32-channel PA desk in the 2,000 seat Barbican Hall. The *800B* is an expansion and improvement on the existing house system.

● TracSystems has delivered their cassette duplicating

system to Trident Studios in London and ICC Studios in Eastbourne.

● The USA West coast's newest resort studio, Grammmies House Recording has taken delivery of an SSL 48-channel (expandable to 56) *SL6000E* with *Total Recall*. Further studio expansion is planned for early 1986 with the construction of Studio B.

● Hollywood production studio Interlock has taken delivery of a Mitsubishi *X-80* digital 2-track and a vintage Mason & Hamlin baby grand piano.

● Triple X Studio, London has installed a Soundtracs *CM4400* 28-channel desk with computer aided mixing and a Soundcraft *SCM72* multitrack machine with 16- and 24-track headblocks. Other new equipment includes the Yamaha *Rev 7* and Bel *BD80* with loop editing. The studio has also added a new drum/vocal booth for music or voice over production.

● Quad Eight/Westrex has recently completed delivery of five Quad Eight mixing consoles and 28 Westrex magnetic film transports for 35 mm and 16 mm film projectors. The equipment is for a new complex which includes four re-recording studios and a music recording stage. A new Quad Eight console for Twickenham Film Studios UK has been specified. The console will feature 72 inputs, 24 mix buses and 10 echo/effects sends and have the *Compumix IV* automation system and IDF (Intelligent Digital Fader). The console will be built in California and fully co-ordinated by the Quad Eight/Westrex team in London.

● Bell & Howell, the UK distributors of JVC pro audio and video equipment are to commission a JVC *DAS 900* digital audio system at Nimbus Records. It will be used in the control room for digital mastering.

● Trident Audio Developments has sold a 48-input *TSM* console to PSB Studios in Paris, France. The console has full cinema facilities and is the sixth film console order Trident has received. Other consoles will be supplied to Delta Studios in Shepperton and De Lane Lea, London.



To help maintain our competitive pricing policy Neutrik connectors arrive at Eardley House in consolidated shipments together with components from our various European manufacturing principals



Sole Agent UK

Eardley Electronics Ltd.

Eardley House,
182-184 Campden Hill Road, London W8 7AS

Telephone: 01-221 0606

Telex: 23894 Telefax: 01-727 9556

A Network of Distributors Nationwide



We mix with many consoles



Internationally Acclaimed Connector Technology

The 'D' Connector for printed circuit board mounting

First introduced in 1981



Sole Agent UK

Eardley Electronics Ltd.

Telephone: 01-221 0606
Telex: 23894

DIARY DIARY

People, events, services

- Music Lab Hire, London has recently concluded a deal with Mitsubishi Pro Audio Group to purchase a number of X80 and X850 digital tape machines.
- Audiosales, Austria has delivered four Turbosound TMS-4, a Klark-Teknik DN 360 and a Drawmer DL 231 for a new sound system at the Metropol. Three Klark-Teknik

Contracts

DN 780, four DN 360 and two DN 701 were delivered to ORF (Austrian Radio) and PA rental company Sound Art Service, Vienna ordered a 32/8/2 Soundtracs M series.

- Solid State Logic has sold an SL 4000E to The Castle, a new studio in Franklin,

Tennessee. The console includes *Total Recall* and is linked to a 3M digital 32-track and 4-track mastering machine. The Castle has pre- and post-production rooms and is equipped with Fairlight, Oberheim, Roland and Yamaha synthesizers plus

Simmons drums.

- New York studio Sound Ideas, has added eight more modules to their SSL 6000E console in Studio B making it possible to complete 48-track sessions. An Adams Smith synchroniser has also recently been installed along with a Roland SRV 2000 digital reverb.

Considering the vast amount of MIDI hardware and software presently available, it is surprising that only a few studios are using MIDI to its full potential. Working in the Isle of Skye, where outsiders are amazed to learn that we even have electricity, it is easy to become smug about the MIDI keyboard system which we have had running for over a year but to be honest, it was a case of choosing the right system for totally the wrong reasons.

Our first objective was to save tape tracks. Almost all our studio time is booked by our own record label and so when choosing equipment, we were not restricted by fashion in order to attract outside clients. This gave us freedom to experiment in an area which, at the time, was viewed with some suspicion by many bands.

When designing the system, we encountered our first problem—lack of available information. Even today, try asking: "Will this sequencer assign different tracks to different MIDI channels regardless of the channel used for programming?" A year ago, it was difficult to get an answer at all, even a wrong one, yet this is a pretty basic requirement for any versatile sequencer. Linking MIDI to CV/gate equipment presented further problems. Nowhere in the literature supplied with a Roland MC 202 will you find the clock rate. Three dealers quoted 96, 48 and 6 ppqn respectively and only a call to Roland confirmed our belief of 24. Questions involving several manufacturers, such as: "What effect can be expected from the pitch wheel range control on the Yamaha DX, once the data has been written into the SCI sequencer and replayed on the Korg Poly 800?" are best forgotten until an empirical result can be observed!

Computer keyboards at the Isle of Skye

After much tearing of hair, unbelievable telephone bills and a modified EPROM being air-mailed from Sequential Circuits, our system was commissioned with the following: Yamaha DX, Korg Poly 800, Roland Juno 106, two Roland MC 202s, two SH 101s, two TR 606s, a TR 808, SCI 64 sequencer with monitor and the old faithful Commodore 64, which had previously been running the accounts. One MC 202 was designated the master clock and was also connected to read and write FSK code from the multitrack. This provided mono and poly sequencing in real- or step-time, with full tape sync facility. Considering that many of the keyboards were already in residence in the studio, the system cost little more than a few rolls of 2 in tape!

It was once the system was in operation, however, that the real benefits began to show. Many people think that a 6-track sequencer needs six keyboards to work to full advantage but in practice, half this figure is about right. We often use several tracks to build up one keyboard part, particularly when the performer is none too proficient. One virtuoso, arriving at the studio with a

broken arm, hurriedly explained: "It's OK, it's not the one I play with."

The SCI sequencer has six polyphonic tracks which can be programmed by, or assigned to, any MIDI channel, including spare channels if play-back is not required during overdubs. In addition, it has eight sequence locations running through the length of the song which can be duplicated and mixed in any order. This means that it is often necessary for the programmer to play correctly for only 30 s in slowed-down real-time, in order to provide sufficient data to make up a 12 in single. Add to this the facility to correct timing errors, transpose to a different key, change patches automatically during the song, delay final decisions on patches until the mixdown and record in first generation onto the master and the system begins to look promising. The MC 202s are 2-track and can be programmed in step-time, or in real-time via SH 101 keyboards. The mono synths are used for lead and bass lines and one influence of the system on the music which we produce has been the tight sound which can be achieved by a step-time bass part with a well programmed drum

computer. It is occasionally still necessary to record keyboards on to the multi-track, when two patches are needed from the same keyboard at the same time but such is the power and speed of the computer production, that these parts are always programmed first and then run on to tape from the sequencer, rather than recording them directly.

So, did the system meet its designed objectives? As far as saving tape tracks is concerned, certainly—we can play three poly synths, four mono synths and three drum machines for the loss of one sync track on tape, but the real benefits have been in other areas. The musician's ideas can now develop beyond their musical competence, the producers use less *Grecian 2000* and we all spend more time sun-bathing on the beach, outside. As far as we're concerned, MIDI rules OK!

- For those who are about to reach for the atlas, the Isle of Skye is situated off the North West coast of Scotland. Popular belief would have it as a small rock in the middle of the Atlantic, covered with snow for most of the year and sparsely populated with kilted shepherds who fight all the time and drink vast amounts of Scotch whisky. Only one of these points is true. Skye is fifty miles long, with a population of 10,000 and at its closest point to the mainland is reached by a ten-minute roll-on roll-off ferry journey. The climate is mild, thanks to the warming influence of the Gulf Stream, and the island is generally a pleasant and relaxing environment in which to record. Oh, and yes, we do drink quite a lot of Scotch whisky!

**Roger Jackson, West Coast Music, Luib, Broadford, Isle of Skye, UK.
Tel: 04712 513.**

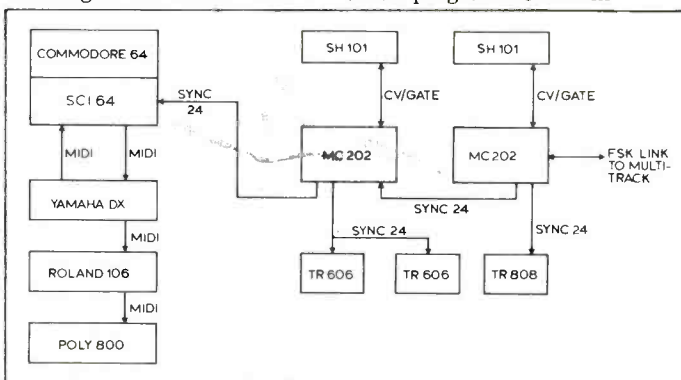

Low-cost digital audio comes of age.

The Sony PCM series has now been available for several years. In this time recording and broadcast organisations, government, educational and industrial establishments, as well as individual users have all acknowledged the unique value of these units, and made them a new standard. It is the superlative quality of Sony PCM digital, coupled with extremely low cost that has brought about this professional acceptance of the range. This is borne out by the number of new ancilliary products from other manufacturers, that have further increased the flexibility and versatility of the range. Examples of these products are the 'CLUE' logging and editing system from HHB, as well as various interfaces which allow digital communication with the PCM 1610.

Sony has acknowledged that this acceptance by professional users necessitates a change of

policy towards these products. Accordingly they have upgraded them from the domestic catalogue, and, realising the need for professional support and all that that entails, have appointed HHB as specialist dealers to represent them in the pro-audio market.

We are proud to announce this appointment, and happy to assure our customers of continued availability of the PCM range. The re-instatement of the PCM production line has been very largely due to pressure from end-users, who are after all the motivating force in the audio world. So if you are involved with audio recording and are still unfamiliar with Sony digital, then you owe it to yourself to call HHB – the No. 1 name in Digital Audio.

SONY FROM **HHB**

HHB HIRE & SALES, UNIT F, NEW CRESCENT WORKS, NICOLL ROAD, LONDON NW10 9AX. TELEPHONE: 01-961 3295. TELEX: 923393.



THE SONY PCM701 AND PCM1610 DIGITAL AUDIO PROCESSORS.

DIARY DIARY

People, events, services

People

- Aces (UK) Ltd has appointed Alan Talbot as sales manager. He has been in the hi-fi and sound industry for 10 years.
- Joe Manzella has joined New York-based Sound Ideas Recording Studios as assistant manager. He was formerly manager of A Step Above Recording.
- Simon Browne previously with the BBC has joined Audio Design Calrec as a technical representative.
- Enos Yoder has been appointed engineering group manager at Crown International. Yoder has been with Crown for 12 years.
- Murray S Kunis has been appointed vice-president of business development at Lakeside Associates Inc.

Kunis, who was formerly with Sunset Sound and Westlake studios in Los Angeles brings CD mastering and production experience to Lakeside.

● Tony Self has launched his own concert production and sound consultancy company having spent the last 10 years with Entec Sound & Light. Self, who will be acting as a consultant to Entec, can be contacted through his new company—AJS Production Services—on Ottershaw (719) 3220 or via E-Mail: DGS1378/SELF-UK.

● Francis Rumsey previously with Sony Broadcast has been appointed Lecturer in Acoustics and Recording in the Music Department of the University of Surrey.

Studio Link-up

The APRS Studio Link-Up service launched last May continues to attract new studios. The service, which is available on Prestel, has 63 studios supplying information on facilities and bookings available. Once they have accessed the system record companies are offered a choice of studio either by geographical area, by type

(residential, mobile, etc) or by availability.

Recently signed studios include Wool Hall Studios, West Side Studios, West 3 Recording Studios and Selecta Sound. For a full list of participating studios or further information contact Des Dolan on 01-379 5523 or key *5335# on Prestel.

Literature received

- AKG Acoustics has produced a simple brochure showing suggested microphone placements of various instruments for studio recording and live concerts. The brochure also indicates the recommended AKG microphone for each different instrument. *Microphone Applications* is free and can be obtained by sending a stamped addressed envelope to AKG Acoustics Ltd, Vienna Court, Catteshall Wharf, Catteshall Lane, Godalming, Surrey GU7 1JG, UK marking the envelope 'Microphone Applications'.
- The Institute of Acoustics has produced its 1985 conference handbook, entitled *Reproduced Sound*. It contains preprints of all the contributed papers presented at the 1985 Autumn Conference. The handbook contains over 380 pages, 67 of which contain profiles of affiliated companies. The price for members (IOA,

AES, APRS, EMAS and ASCE) is £20 post paid, £28 for non-members.

● The Electronic Industries Association has produced the *1985-1986 Catalogue of EIA and JEDEC Standards and Engineering Publications* the European edition of which is available from American Technical Publishers Ltd, 68a Wilbury Way, Hitchin, Herts SG4 0TP, UK. The catalogue has 30 pages and lists several hundred bulletins produced by US standard associations.

● Holden Cords, wiring harness, sub-assembly and cableform subcontractors, has released a 10 page pocket size data reference booklet containing details of their services, various formulae and a spreadsheet comparing metric and imperial wire sizes and specifications. Copies can be obtained from Len Mellon Sales Co-ordinator, Holden Cords Ltd, Bowater Road, London SE18 5TF, UK.

Launch of Professional Audio

Richard Kelley has formed a new pro audio sales company. The company, known as Professional Audio is based in Islington, North London. Simon Browne, previously with ITA, has joined Professional Audio as sales manager. Several distribution agreements—some of them UK and European exclusives—have already been agreed. Companies represented include JVC, NKA, Electrospace, Timeline, Westlake Audio, FM Acoustics, Renkus-Heinz and

Marshall Electronics.

According to Kelley the company has major plans, "These existing distributorships and dealerships demonstrate that Professional Audio has the resources, the commitment and the marketing support to enter the market and acquire an important share very rapidly." For more information contact either Browne or Kelley at Professional Audio Ltd, 53 Corsica Street, London N5 1JT, UK. Tel: 01-226 1226.

Lexicon sale of shares

In order to minimise the cost of raising capital and take advantage of the less stringent 'compliance' requirements in the UK, Massachusetts-based Lexicon Inc recently announced, through L Messel & Co, the sale of 3,505,882 shares of Common Stock of \$0.01 each. In the event the company attracted 1,969 applications for a total of 6,316,600 shares. Applications

for up to 500 shares were met in full, for 1,000 and above the allotment was approximately 53% of the amount applied for. At the Offer for Sale Lexicon is capitalised at £10.16m with 39.7% of the issued share capital being offered for sale.

Letters of Acceptance were sent out during December and dealings were expected to commence on December 19th, 1985.

Contracts

- DDA has recently supplied three consoles to the Natal Performing Arts Centre in Durban, a 28/24/2 AMR24, a 38/8/2 D series and an 8/4/2 M series. A second D series desk is on order. In addition three more AMR24s have been sold, one going to producer Steve Levine and another to new video production facility Fountain Television. Entec has taken delivery of two 28-input D series desks for Tyne-Tees Television rock show *The Tube*. DDA has also supplied a D series desk to the London Contemporary Dance Theatre and digital/CD facility, Finesplice.
- Audix Ltd has won a major order to supply audio broadcast equipment to the BBC for the 1986 Commonwealth Games. Equipment includes a 24-channel MXT1200 desk, distribution amplifiers, jackfields, control panels and equipment racks. Two further orders have also been won by Audix, these are for the supply of modified PMB 5 headphones and 250 sets have been ordered so far.
- Philippe Sarde's Paris studio

has taken delivery of a Neve 60-channel console with *Necam 96* automation.

Also in France, Studio Venus in D'Huison-Longueville has taken delivery of a 48-channel Neve console. This replaces their Neve 8128 32-channel desk bought five years ago.

● New FM Acoustics installations include: MCA-producer Jimmy Bowen and Sound Stage, Nashville; Soundscape, Atlanta; CBS, Century City and Sterling Sound, New York.

Britannia Row, FM Acoustics, UK distributor have sold units to producer Mutt Lange, and Comforts Place, Surrey. In Milan Alpha Records, Bips Studios, Cap Studios, Hole Records, Il Cortile, Il Villaggio, Moreschi, Siam Play and Celestia Records in Venice have all recently changed to FM Acoustics.

● Rainbow Bridge Recording Studio, Libertyville, Illinois has expanded its facilities to include 24-track transformerless recording and real-time cassette duplication. □

*Just when you thought the future
couldn't shock you any more.*

Introducing the Lexicon PCM 70, our extraordinary new digital effects processor with dynamic MIDI. Designed, creatively speaking, to thrust you into the future.

To begin with, the PCM 70 gives you access to the same astonishing Lexicon digital effects used by the world's top artists and studios. With complete, variable parameter control, and registers that let you create and store your own programs.

Now, about dynamic MIDI. With this pioneering Lexicon development, you can vary any PCM 70 parameter through a MIDI keyboard while you're actually playing. Just imagine being able to vary the wet-dry mix, for example, through finger pressure on the keys. Or by your choice of other controls, like the modulation wheel. Or even by a computer.

There's more. The Lexicon PCM 70 digital effects processor is also a full-fledged digital reverb, with a complete selection of Lexicon reverb programs. And the price? Shockingly reasonable.



You'll want our detailed PCM 70 brochure. At your Lexicon dealer, or contact us. Lexicon Inc., 60 Turner Street, Waltham, MA 02154, USA. (617) 891-6790. Telex: 923468. Lexicon International, P.O. Box 122, 8105 Regensdorf, Switzerland. Telex: 59222.

Come to the future.

lexicon



SCENIC SOUNDS EQUIPMENT LIMITED
Unit 2, 12 William Road, London NW1 3EN.
Tel: 01-387 1262, 01-734 2&12
Telex: 27939 SCENIC G



AUDIO EXPORT,
Badstr 14, 7100 Heilbronn,
Germany,
Tel: 07131 82275



At Stirling Audio Systems you'll find everything from an effects unit, to a complete 48 track studio system.

Across the hardware spectrum, our exclusives include the new Lynx, which synchronises up to 32 different tape machines yet can be re-interfaced simply by picking a new memory patch.

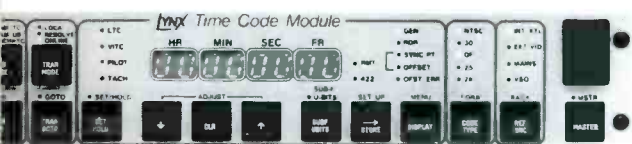

There's Westlake's complete monitor range, right up to the reference-standard BBSM-12. (With the excellent Yamaha P2002s to power them).

And Sankens' superb titanium diaphragm microphones – the ultimate in digital audio quality. (The CU-41 has a flat 20Hz-20kHz response, and zero phase distortion).

For systems, we might suggest you look at the Soundtracs CM 4400 console teamed with a Soundcraft 760 Series 3 recorder.

Or the Otari MX-70, a 16 track 1" machine that brings top quality to the smaller format – or, of course, the acclaimed MTR-90.

FROM 1

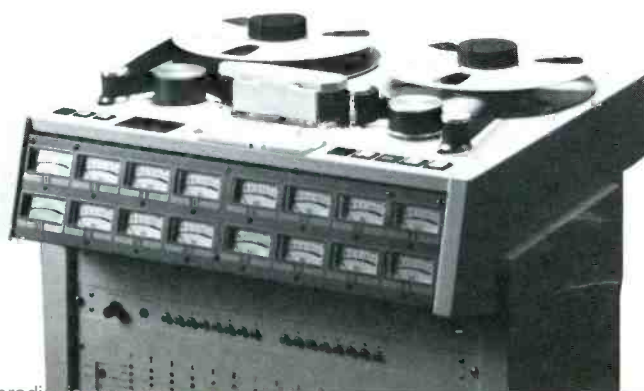

48 TRACKS 9 INCHES TO

While for broadcast use, the Otari MTR-12 includes Nagra compatibility and options such as 4 track, stereo, timecodes, and more.

Then there's the versatile Soundcraft Series 600 console, for smaller, quality-conscious facilities.

Our effects rack includes AMS, Aphex, BSS, Drawmer, Publison, Quad and Yamaha. And AKG and Neumann microphones, and...

When you add our help with financial planning and our back-up service, that's quite a range.

To keep in touch with new developments, call us and get on our mailing list. And find out more about our exclusive service.



 **Stirling**
AUDIO SYSTEMS LTD

UNIQUE SOLUTIONS FOR UNIQUE STUDIOS

1 Canfield Place London NW6 3BT Tel: 01-625 4515 Telex 946240 CWEASY G Ref No. 190 14280

AES NEW YORK WORKSHOP PROGRAMME

Terry Nelson reports on the Workshop programme at the 79th AES Convention in New York. Sound reinforcement was highlighted and other subjects were equally well covered

The AES Workshop programme kicked off with a suitably high tech approach entitled 'Smart Electronics for Sound Reinforcement'. This dealt with the use of microprocessors and permanent storage in bubble memory or EPROM for systems control in large fixed installations. 'Smart' electronics enable the use of functional building blocks to create a system that can be put under software control with manual access at any time. Another advantage is that equipment can be placed in the optimum locations and controlled via the necessary interfaces.

Requirements for 'smart' electronics were listed under four basic headings: capabilities, enhancement, functions and maintenance. Capabilities included automatic jobs such as turn on and/or reset, switchover to backup systems (eg power), self-testing routines, audio distribution, routing, etc, and control settings. These define the system's workload and capability.

Enhancement covered the possible set ups of a system and the storage capacity for different configurations, together with self-test programs in order to monitor and record system operation and diagnose faults/performance in real-time. The smart system should be able to handle all performance parameters and audio distribution as well as logging performances and giving information on operational status.

It was accepted that all functions should be programmable and facilities discussed included different configurations to suit changing needs (sport in the afternoon/concert in the evening); gain control; delay patterns; priority levels; combining of different systems within a large complex; security levels featuring access only via passwords; timed controls such as automatic turn on/off of microphones, etc; microphone assignment from various stations; control of background music including levels, distribution, ducking with announcements with control over message length and times; signal monitoring; storage. Storage media discussed was solid state memory with digital record and playback facilities for pre-recorded announcements. In the case of a system being installed in a large

complex such as an airport or shopping precinct, the computer would control emergency instructions which would override all programme material and route key microphones into all areas for safety announcements.

The smart system would run self-diagnosis routines and provide automatic fault identification procedures together with read outs. This way the system keeps a check on itself and provides the necessary information to a service engineer. Other routines may include noise level compensation where the system level with reference to the general noise floor is varied to keep pace with existing conditions. Operational status of the system can be verified at all times by computer read outs giving real-time status such as which microphones are open and where, full information on inputs, outputs and routing. Various levels of colour coding should be used to indicate different status conditions including faults.

The panel recognised that 'smart' electronics are not without their problems and the following four main points were raised. In the case of password systems, what do you do when the only person who knows it is unobtainable? How will the system respond in the case of a power failure or a bad power supply full of spikes or minute interruptions? Computer literacy has to be taken into consideration: the operators will often be people not used to abstract technology so the system has to be flexible and user friendly.

The workshop finished with a brief look at some installations using 'smart' electronics, such as the Grand Wayne Center, which has computer control of all rooms and systems (routing, delay settings, mixers, etc) and can store and automatically change from one configuration to another with all parameters. The Freedom Hall arena can have the system configured to different 'scenes' and run a systems test, either the whole installation or individual sections, while programme is running.

Another example given was the work done by Yamaha on improving the quality of the chain that links the performer to the listener. This is especially noticeable in the field of sound imaging techniques where the creation of a soundfield that is perceptible in all areas of the audience has always been fraught with problems. A system that goes a long way towards solving this problem has been installed in the multi-media presentation in the steel pavilion at EXPO'85 in Japan. Here a central computer controls multitrack tape recorders, projectors, VTRs, etc, together with a multi-screen and multi-channel sound system which uses delay panning via computer controlled digital delay lines to create 3-dimensional moving sound effects that are not limited to just one section of the audience, and are thus integral to the image being screened.

Stereo television is becoming a reality and this was dealt with in 'The Challenge of Stereo'. One of the topics discussed was the needs of television audio processing as opposed to those of FM radio. There is no loudness war in TV as there is in FM and gain jumping between stations can prove to be very annoying, also the dynamic range of the

programme material can often be as much as 45 dB. The material itself is very varied, ranging from old (and new) films, dialogue and music. One major difference is that pauses in radio tend to be distracting and cause the listener to change station, however, too much babble on television can be annoying and silence is often relied on for effect.

The discussion moved on to stereo TV production with the statement 'Stereo is not mono times two'. 'and that most VTRs are not capable of stereo. The use of VU meters for stereo was also questioned but we won't get into that.

A main problem was held to be the large differences between the average control room and living room, where the former boasts a large dynamic range and the latter a small one. This means that stereo TV will have to work with a mixture of FM and mono TV techniques—at least, to start with—by providing a mono compatible mix, a compromise between a full and a limited dynamic range and be able to have audio pauses.

Another problem was microphone positioning and whether M/S techniques or coincident pairs should be used. However, one point that everyone agreed on was that studios will have to be quiet and that a lot of the background noise that was tolerated before will have to go. It was generally felt that speech would be better in mono as in film. Stereo would require that the voices of, for example, two panellists in a game, would have to keep bouncing around when switching between cameras.

Due to the fact that the majority of viewers will still be using mono sets, the importance of keeping phase correlation and coherency throughout the audio chain was stressed, in order to avoid sound anomalies such as phase cancellation, poor reproduction, etc. The humorous aspect crept in when the audio of stereo TV was described as varying from 'fine to funny' and mono TV as 'from a rotten frequency response to a disaster!'

Terry Skelton from NBC explained that he was in charge of training programmes for stereo television and that these courses included teaching an awareness of what stereo is and how to achieve audio realism. He felt that stereo TV is more limited than 3-channel film sound and that stereo television has yet to develop its own true character: "It's very early days yet and we need to see—and hear—how the medium is going to develop and how it will be accepted."

In a discussion on microphone techniques, Ron Striker suggested that in order to have a full picture of what was going on in the audio chain, it may be desirable to use four sets of meters, viz: left channel, right channel, left+right, left-right. "These could be invaluable," was his comment.

The discussion then went on to the need for good studios from an acoustical point of view and whether this would be possible. Separate processing for mono and stereo signals was also suggested, together with 3-channel monitoring where these would be left and right for stereo and centre *only* for mono. "Mono is definitely one speaker—not two with the same signal," came a comment from the floor.

There was also a general feeling that

dbx

Stand up and be counted.

If you think you can't afford a dbx compressor/limiter, think again.

With the 166 now you can.

Total dynamics control in a brand new product from dbx, the world's number one manufacturer of professional processors.



dbx PO Box 100C, 71 Chapel Street,
Newton, Mass. 02195 USA.



Austria KAIN GBS MBH & COMPANY Salzburg, Vienna · Australia KLARION ENTERPRISES PTY LTD South Melbourne · Belgium TRANS EUROPEAN MUSIC SA Dilbeek · Denmark SLT Copenhagen · Finland STUDIOTECH KY Espoo · France S.C.V. AUDIO Paris · Great Britain SCENIC SOUNDS EQUIPMENT LTD London · Greece ANTALEX O.E. Athens · Hong Kong STÜDER REVOX LTD · Indonesia P.T. KIRANA YUDHA TEKNIK Jakarta · Italy SCIENTEL AUDIO SRL Modena · Japan BSR LIMITED Tokyo · The Netherlands SPECIAL AUDIO PRODUCTS B.V. Amsterdam · New Zealand VICOMM SYSTEMS LIMITED Auckland · Norway LYDROMMET Oslo · Singapore LINGTEC PTE LTD · South Africa PRO SOUND Johannesburg · Spain AUDIO PROFESSIONAL SA Barcelona · Sweden TAL & TON ELEKTRONIK AB Gothenburg · Switzerland AUDIO BAUER AG Zurich · Taiwan YANG'S AUDIO VISUAL LABS Taipei · Turkey OMER TRADE EXPORT AND REPRESENTATION Ankara · West Germany AUDIO VERTRIEB

NEW PRODUCTS

NEW PRODUCTS

Equipment, modifications, options, software

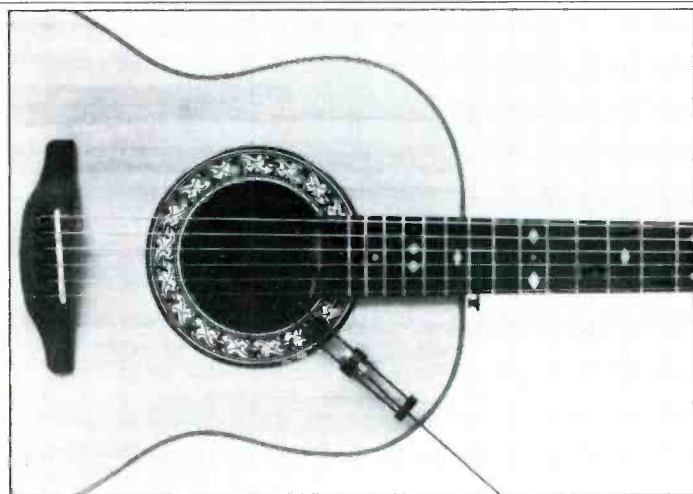

Electro-Voice PL10 and PL4 microphones

Electro-Voice has announced two new microphones the *PL10* and the *PL4*. The *PL10* is a dynamic cardioid with extended frequency response, high SPL capability and low proximity effect bass boosting. Designed to fit easily in tight situations the *PL10* is particularly recommended for tom-toms, congas, bass drums, guitar and bass cabinets, in live situations and for all round applications in the studio. The microphone has an integral nesting system and a durable, steel housing. In addition the combination of an internal shock mount/blast filter completely encases the transducer reducing rumble and subsonic vibration during close-up use.

The new *PL4* is a miniature omni condenser with a tailored frequency response designed to reproduce the natural sound of acoustic instruments. A specially designed mounting

clip made of stainless steel with soft elastomer pads is provided and this allows the microphone to be positioned directly over the bell of a horn or close to (between 1 and 3 in) the sound hole of an acoustic guitar.

The *PL4* can be battery or phantom powered and is also designed to run in 'dual' mode to reduce the problem of loss of signal. The mic is small and unobtrusive and is designed for stage, studio and on-camera use. According to E-V the *PL4* has greater sensitivity than conventional electret lavalier microphones and offers superior gain before feedback and high SPL capability without overload.

Electro-Voice Inc, 600 Cecil Street, Buchanan, MI 49107, USA. Tel: (616) 695-6831.

UK: Shuttlesound Ltd, Unit 15, Osiers Estate, Osiers Road, London SW18 1EJ. Tel: 01-871 0966.

Adams-Smith 2600 A/V editor

Adams-Smith has announced the availability of the *2600 A/V* double-system editor. Not only can the *2600 A/V* be used as a single-system editor either in playback/record or A/B Roll but it can also be used as an audio editor providing extensive list management and 1/100 frame accurate punch in and punch out. For better audio quality and improved flexibility the *2600 A/V* can be used as a double system off-line video/on-

line audio editor.

Included in the system is an ultra-high resolution colour/monochrome monitor; both 5 1/4 and 8 in disk drives; a hard disk drive; and a very fast high quality storyboard printer.

Adams-Smith, 34 Tower Street, Hudson, MA 01749, USA. Tel: (617) 562-3801.

UK: Marquee Electronics Ltd, 90 Wardour Street, London W1V 3LE. Tel: 01-439 8421. Telex: 894278.

AKG D112 microphone

Joining the *D12* in AKG's range of microphones is a new dynamic bass microphone—the *D112*. Preliminary information suggests the designers have taken a less traditional route and optimised the performance of the *D112* towards providing a 'powerful, tight and percussive' sound which, according to AKG, could only be obtained previously by heavy EQ and processing.

The *D112* incorporates a 'bass tube' and resonance cavity for better transient response. Mechanical strength and good transient response

are also claimed features of the design.

AKG Akustische u. Kino-Geräte GmbH, Brunhildengasse 1, A-1150 Vienna, Austria. Tel: (43222) 95 65 17. Telex: 131839.

UK: AKG Acoustics Ltd, Vienna Court, Catteshall Wharf, Catteshall Lane, Godalming, Surrey GU7 1JG. Tel: 04068 25702. Telex: 859013.

USA: AKG Acoustics Inc, 77 Selleck Street, Stamford, CT 06902. Tel: (203) 348-2121. Telex: 84451121.

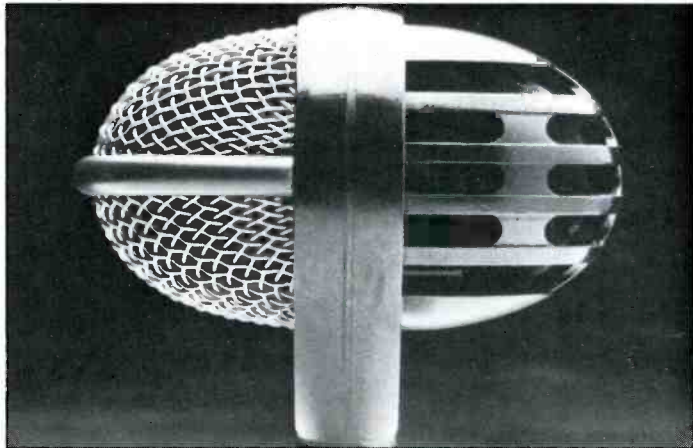

Sound Ideas

Sound Ideas has a library of 3000 stereo sound effects available on compact disc. The complete library covers 28

separate CDs. Sound Ideas, 86 McGill Street, Toronto, Ontario, Canada M5B 1H2. Tel: (416) 977-0512.

DDA updates

DDA has recently introduced the *S* series PA console and added a Theatre Input module to the *D* series. The *S* series PA is based on the *S* series frame (which is available with 16, 24 or 32 inputs) and has a removeable overbridge thus allowing a much lower profile flight case to be used. Optional PPM metering is available. Other facilities have been expanded to include a 4x4 output matrix, eight aux outputs and four aux returns all with 3-band EQ and bus inject jacks on the subgroups and auxiliaries to facilitate easy addition of a sub-mixer for additional inputs. The *S* series PA is fitted throughout with longthrow faders, full electronic balancing on all

main inputs/outputs and detented pots.

Extended flexibility is the basis of the Theatre Input module with independent mic/line level controls now available. The module also includes individual subgroup routing switches with selectable signal path either direct or via the panpot and access to all eight auxiliary buses simultaneously. In addition to long throw faders and detented controls the module is fitted with a five-segment LED input meter.

DDA Ltd, Unit 7B, Worton Hall, Worton Road, Isleworth, Middlesex TW7 6ER, UK. Tel: 01-847 0363/4000.

Some People Actually Enjoy Sitting at Their Desk for Twelve Hours a Day.



Of course, their desk is an SL 4000 E Series — a classic example of responsive technology and engineering know-how. Mixers tell us it allows them to perform their craft with extraordinary freedom and precision. Producers say it serves their work in ways no other console can.

There is something about this console that goes beyond the clarity of sound, the agility of its software, the scope of its possibilities. Something that can't be shown in pictures, diagrams or words.

When you sit behind an SSL, there is recognition. It's more than knowing that this is the best. It's a discovery that someone actually understands the procedures and the pressures of your job. And that they've developed innumerable ways to make it easier, faster and better.

We'll be happy to send you our 40 page brochure on the SL 4000 E, or to arrange an audition. But a word of warning. Once you sit down at *this* desk, you may want to stay longer than you had planned.

Solid State Logic

Oxford • New York • Los Angeles • Hong Kong

Oxford, England OX7 2PQ • (099 389) 8282
200 West 57th Street • New York, New York 10019 • (212) 315-1111
6255 Sunset Boulevard • Los Angeles, California 90028 • (213) 463-4444
22 Austin Avenue, Tsim Sha Tsui • Kowloon, Hong Kong • (03) 721-2162

NEW PRODUCTS

NEW PRODUCTS

Equipment, modifications, options, software

Sony ECM-44 and WRT-67 microphones

Sony has introduced a low cost microphone to its lavalier series. The *ECM-44* is a general applications omni microphone with an 8.5 mm capsule. The microphone is especially designed for applications where concealed or unobtrusive pickup is required and particular attention has been paid to ensuring the capsule is more resistant to external noise and weather conditions. The *ECM-44* is available either in black or satin-nickel and is powered by internal AA size batteries.

Also new is the *WRT-67* dynamic capsule UHF wireless microphone. The *WRT-67* is designed to operate on the

same frequencies as the *WRT-57* back electret condenser wireless mic and blend into any portable or fixed Sony UHF studio system. The *WRT-67* includes a three position (0, -10, -25 dB) pad and is claimed to be especially suited for undistorted recording of high level inputs. **Sony Corp, PO Box 10, Tokyo Airport, 149, Japan. Tel: 03 448-2111.**

UK: Sony Broadcast Ltd, City Wall House, Basing View, Basingstoke, Hants RG21 2LA. Tel: 0256 55011.

USA: Sony Corporation of America, Professional Audio Products Division, 9 W 57th Street, New York, NY 10019. Tel: (212) 371-5800.

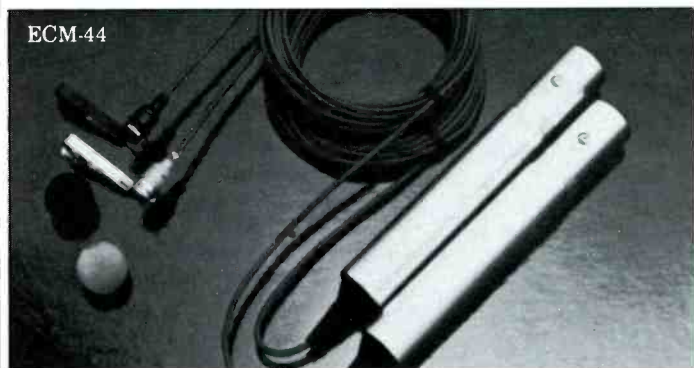

ECM-44



Audix Powerbloccs

Audix has announced a range of power amplifiers using the latest generation of MOSFET power devices. Developed by Audix the MOSFET *Powerbloccs* are new compact and efficient 60 W modules which can be connected in parallel to provide a wide range of outputs. The amplifier chassis can be fitted with either an individual unit or a combination of *Powerbloccs* to provide 100 V line outputs of 60, 120, 180, or 240 WRMS.

The Audix *MPA* amplifiers are the first in a series of new introductions. These include updated versions of the *Wenden* series of amplifiers incorporating MOSFET powerbloccs. Also a low cost integrated mixer/amplifier range—the *Newport*—will also be available shortly to complete the line-up.

Audix Ltd, Station Road, Wenden, Saffron Walden, Essex CB11 4LG, UK. Tel: 0799 40888.



Alesis XT:c digital reverb

Alesis has introduced a new digital reverb. The *XT:c* features a 16 kHz frequency response, full stereo input and output, and a decay time variable from almost 0 to 15 s set by a single rotary control. The unit offers eight separate reverberation programs each with a front panel option switch. These include small spaces, large rooms, a huge hall and gated and reverse reverb. Other selectable options include High Frequency Damping, Low Frequency Cut and Infinite Hold. Rotary controls include Predelay (0 to 200 ms), Decay Time and HF Roll (16 to 3 kHz). The front panel also includes Mix and Input and

Output connections. At the rear are ¼ in stereo inputs, outputs and Loop connections.

Developed in response to customers comments regarding the Alesis *XT* the *XT:c* can be used to fatten drum sounds, smooth strings and sustain backing vocals in addition to simulating small rooms and large halls. The use of LSIs and efficient manufacturing processes has enabled Alesis to keep the cost competitive.

Alesis, PO Box 3908, Los Angeles, CA 90078, USA. Tel: (213) 467-8000.

UK: Sound Technology Ltd, 6 Letchworth Business Centre, Avenue One, Letchworth, Herts SG6 2HR. Tel: 04626 75675.

Benchmark new products

Benchmark has announced the availability of the *DOA-1* and *DOA-2* differential output amplifiers. Primarily designed as an easy device for retrofitting to existing equipment without balanced inputs, both devices feature variable gain from off to +26 dB with clipping at +27 dBV when operated with a normal supply voltage. Other claimed features include very low noise, almost immeasurable distortion, low output impedance and a unique mounting arrangement. The *DOA-1* is designed to operate from a

dual (+ and -) power supply and the *DOA-2* from a single + supply.

Also new is the *RPM-1* Remote Program Meter card which is designed to convert a standard VU meter to VU and PPM. The device uses DIN PPM ballistics. In both modes the card provides a separately calibrated peak overload LED. Switching can be via the console or local using illuminated pushbutton switches or LEDs.

Benchmark Media Systems Inc, 3817 Brewerton Road, North Syracuse, NY 13212 USA. Tel: (315) 452-0400.

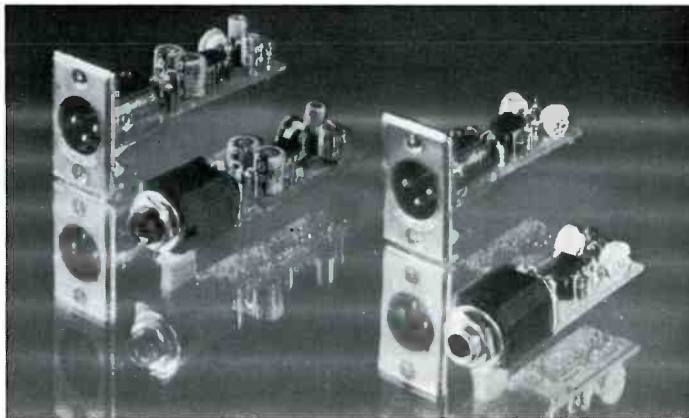



Studer 961/962 Small Wonder

It's a wonder how a console so small can do so much... and sound so good!

The Swiss have a special talent for making great things small. A case in point: the new 961/962 Series mixers from Studer. In video editing suites, EFP vans, remote recording, and radio production, these compact Studers are setting higher standards for quality audio.

Sonic performance is impeccable throughout, with noise and distortion figures well under what you'd need for state-of-the-art digital recording. By refining and miniaturising circuits developed for our 900 Series production consoles, Studer engineers have squeezed a world-class performance into suitcase size.

The 961/962 Series is fully modular, so you can mix-and-match modules to meet your requirements. The 961/962 features

stereo line level input modules with or without 3-band EQ, plus mono mic/line inputs and master module with compressor/limiter. Other choices include a variety of monitor, talkback, auxiliary, and communication functions. The 961 frame holds up to 14 modules, the 962 accepts up to 20.

Other new features in the 961/962 Series include improved extruded guide faders, balanced insert points, FET switching, electronic muting, Littlite® socket, and multi-frequency oscillator.

Thanks to its light weight, DC converter option, and sturdy transport cover, you can

put a 961/962 mixer on the job anywhere. And, with Studer ruggedness and reliability, you can be sure the job will get done when you get there.

Packed with performance and features, 961/962 consoles will surely make a big splash in audio production circles. Small wonder. Call your nearest Studer representative for more details.

With snap-on cover, mixers road ready in seconds.

STUDER
INTERNATIONAL AG
CH-8105 Regensdorf Telephone (01) 840 29 60



STUDER REVOX AMERICA INC Nashville Telephone (615) 329-9576
STUDER REVOX S A R L Paris Telephone 533 5858
STUDER REVOX CANADA LTD Toronto Telephone (416) 423-2831

F.W.O. Bauch Limited

49 Theobald Street, Boreham Wood, Hertfordshire WD6 4RZ
Telephone 01-953 0091, Telex 27502 Fax 01-2075970

NEW PRODUCTS

NEW PRODUCTS

Equipment, modifications, options, software

Most studio managers would agree that in order to be sure of providing a comprehensive service to their clients, a good piano is still an essential item of studio equipment. However with the revolution in keyboard technology, the piano has become more isolated as an 'instrument'—obviously it is still very important because its expressive qualities and unique sound are irreplaceable—but particularly in commercial music it is not the *prima* keyboard instrument it once was. If this is partly due to its inability to interface with synthesisers then it's a great pity. From a purely physical point of view the piano keyboard is the most pleasing to use. Its weighted action and dynamic response has at least 150 years' design experience behind it, and seems to suit the human physique perfectly. Proof of this lies in the number of weighted keyboards which have been designed in an attempt to simulate the action of a piano, presumably to make the player feel more comfortable.

Surprisingly this situation has, until very recently, gone unnoticed by piano makers, although several of them are now looking at the problem seriously. Yamaha have introduced MIDI versions of their highly successful *CP 70/80* electronic grands, and Bosendorfer apparently have designed a totally digitally controlled acoustic grand but the only company currently offering a tried and tested MIDI-adaptor, which can be fitted to any existing piano, are a Californian-based outfit—LA Piano Services. Their *Forte Midi-Mod* provides a MIDI-output featuring full dynamic response, sustain, transposition and range limiting, and once and for all connects the pianist with the expanding world of synthesisers.

The *Forte Midi-Mod* is actually the invention of Steve Saloni who previously worked as part of the design team on the *Prophet T8*, but it was only in collaboration with Jim Wilson, who runs LA Piano Services, that it was possible to apply the idea successfully to real pianos. Already a piano technician of some repute (he numbers among his clients

Forte Midi-Mod

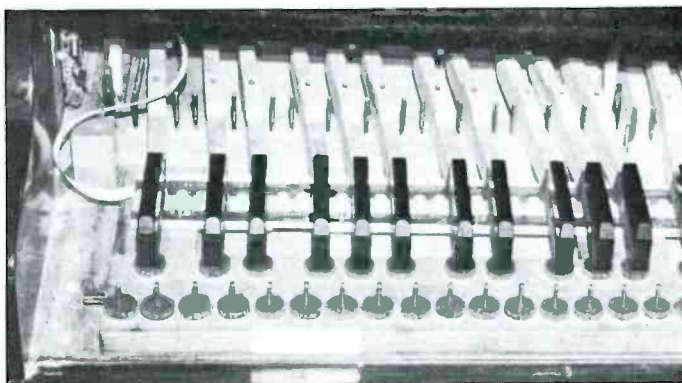

Switch rail in position with white notes removed

many famous piano names, including Chick Corea and George Duke) Jim was well qualified to advise on how a MIDI adaptor could be best suited to the instrument. His first concern was that it should not affect the appearance, sound, structure or feel of a piano in any way. In other words if the pianist should choose not to switch it on, then it may as well not be there. This in fact has not been a major problem—most people who hear the stunning effects possible when their piano is triggering a modern polyphonic synth are most reluctant to switch it off!

On meeting Jim Wilson it soon became clear that the success of the *Midi-Mod* is due largely to his belief in the piano and its potential role in modern music. He was installing the system in a piano at Power Plant studios, London, and it was impressive to note his concern for the integrity of the instrument he was adapting (in this case a Steinway). As he pointed out, many owners of beautiful and expensive grand pianos have shown some resistance to the idea that somebody might want to modify their prized possession! In fact fitting the *Forte Midi-Mod* requires a minimum of work on the piano, most of the 5 to 8 man hours being taken up in regulating the action and adjusting the device so that it triggers accurately. Externally the only evidence of the *Midi-Mod* is an output box mounted out of view under the piano (but not in contact with the sounding board) and a discreet plate fixed just inside the lid bearing the trade-mark and an

LED on/off indicator.

The output box houses the Central Processing Unit, as well as connections for the 12 V DC supply, MIDI and a footswitch. However, the main component, and the one which took the time and money to develop, is the switch rail. Mounted directly under the piano keys, by attaching it to the key frame slats, it consists of 88 special rubber 'buttons' (one for each key) each of which houses two contact switches set a small distance apart. As the CPU scans the switch rail (320 times a second) it not only can tell which switch is being activated by the piano key above it, but it also registers the time elapsed between activation of the two contacts. This information is output as a MIDI signal containing pitch and velocity data.

Because the piano is a mechanical instrument, the delay in triggering is minimised by the simple method of adjusting the height of the switch rail on its spring mountings, until the synth triggers the instant the hammer hits a string. Each individual switch is so light in operation, it is totally undetectable in the action of the piano and thus the *Forte Midi-Mod* provides an extremely sensitive and subtle MIDI-output which matches perfectly the dynamic response of the piano. However, the switch rail is also capable of taking quite a hammering, and Jim Wilson now feels confident that it will stand up to the varying approaches of pianists to their instrument!

There are several other features which add to the

versatility of the system. First a sensor on the sustain pedal of the piano enables sustain information to be transmitted via MIDI. If however the sustain pedal is pressed in conjunction with the *Midi-Mod*'s own footswitch then the next note played will transpose the synthesiser. Furthermore if the footswitch is pressed on its own, the next *two* notes played will define a limited range, outside of which data will not be transmitted.

New software available soon will enable patch selection from the piano keyboard and multiple keyboard splits, which can send on different MIDI channels. It is now Jim Wilson's aim to make it possible for a grand piano to become a control centre or 'Mother' keyboard for a complete MIDI system.

Having played a piano with a *Forte Midi-Mod* fitted it is difficult to know how any major studio can afford not to have one. Apart from the increased expressive potential in terms of complex sounds and dynamic effect, many tedious and expensive overdubs could be avoided. The fact that it does not alter the sound or action of the piano in the slightest degree has to be an asset—after all pianos have individual characters, and in this way favourite instruments can be brought right up to date.

Interestingly, only half the total *Midi-Mods* fitted to date have been for studios; it seems players have been much quicker to respond to the idea and many well-known artists now have a *Forte Mini-Mod* on their personal pianos. Elton John for example used a MIDI piano to great effect on his recent string of Wembley dates and it was easy to see how useful it could be in a live situation where control is all important. If the response in the States is anything to go by, however, it seems highly likely that it will be a facility which is requested more and more by artists and producers when choosing a studio. At under £1500 including installation it seems a reasonable price to pay to bring the Joanna into the 80s! **Forte Music, California, USA.** USA: LA Piano Services, 13257 Moorpark, Sherman Oaks, CA 91423. Tel: (818) 789 1212. **Nick Graham**

You may never know what you're missing

TWO VITAL FEATURES NEVER BEFORE SEEN ON AN AUDIO MIXER FOR A LOT LESS THAN YOU MIGHT THINK...



Visit the Sony stand at AES to find out what they are ...



Name: _____
Position: _____
Company: _____
Address: _____

Tel No.: _____

ABC



The MXP-2000

The only totally customer adaptable modular mixing console complete with assignable dynamics and video editor interface as standard for a lot less than anything you've ever seen before.

All modules are completely interchangeable and the MXP-2000 has the flexibility to be customised by the user to suit any requirement.

Plus many other exciting products...



PCM-3324 and RM-3310



PCM-1630



APR-5003



DMR-4000



C535 and C536 Microphones



PCM-3102



THIS YEAR'S PRIZE IS BIGGER IN FEATURES BUT SMALLER IN SIZE!

Here's your opportunity! Every day of the show in Montreux we are giving away a Sony Portable

Compact Disc Player – **D50 Mk II** the very smallest CD Player ever made.

To enter the draw, simply fill in the coupon and post it in the box on our Stand.

Sony Pro-Audio

AES MONTREUX, SWITZERLAND

SONY
Broadcast



Sony Broadcast Ltd.

Belgrave House
Basing View, Basingstoke
Hampshire RG21 2LA
United Kingdom

Telephone (0256) 55 0 11
International +44 256 55 0 11
Telex 85 84 24
Fax G2/G3 (0256) 474585

Designed and produced by Bell Carter Elliot Richards Limited, Basingstoke, England

Sound reinforcement has not been overlooked by the mighty micro and IED (Innovative Electronic Designs Inc) offer a flexible line of computer-controlled audio equipment that can be used in such diverse situations as stadiums, arenas, studios, convention centres, theatres, etc. The computer is able to adjust systems from initial set-up to self-testing on a periodic basis. This makes for enormous time savings in installation and maintenance, and also often makes possible configurations that previously would have been very difficult to realise.

The heart of the system is a Sony SMC 70 microcomputer which uses an IED 128 kbyte bubble memory. The computer then controls an array of rack-mount units such as the 4000 series automatic mixer, 516 switching matrix, 564 remote control system, 532 digital attenuator and 596 monitor system. The 4000 mixer can be user configured over 10 options such as mic input to compressor to programmable gain control, depending on the requirements of the situation. The 532 digital attenuator unit contains 32 isolated balanced in/out channels with a gain resolution of 3/8 dB over a range of 88 dB. The 516 matrix features a 16x16 configuration with any input being switchable to any combination of the outputs. The 564 remote control system contains 64 very high quality relays to allow remote switching of such items as speakers, small motors, power supplies, 70.7 V lines, etc. The 596 monitor unit permits the monitoring of up to 64 lines (70.7 V inputs) or DC levels such as power supplies and battery condition.

All the above modules/units are under computer control enabling working conditions to be enacted at the push of a button. Systems can be configured to suit different applications from day to day (eg: the afternoon basketball match array can be turned into the evening concert array in a few seconds) and gain conditions preprogrammed in sequence, together with matrixing and monitoring.

To round off the installation of their systems, IED also offer a fully computer-controlled announcement and communications system, with switching for the recording and playing back of messages, as well as priority override for emergency announcements, either live or pre-recorded.

Electro-Voice showed their new range of HP constant directivity horns and associated drivers, the DH1 and DH2. The horns feature better control over the high frequencies and are flat at the front, which makes installation easier. The HP horns feature a 2 in throat, making them directly compatible with other drivers (such as JBL) without the need for throat adaptors. Particularly of interest to designers of sound systems is the VAMP (Very Accurate Mapping Program). This program is designed for use with Hewlett-Packard HP-41CV/CX or HP-41 with Quad Memory Module calculators and enables the user to plot the seating boundaries of a room, select and aim appropriate horn/driver combinations, map the sound pressure level contours throughout the listening area and set the output levels for constant sound pressure level over the seating—or listening—area. The VAMP

AES NEW YORK SOUND REINFORCEMENT

The New York AES convention saw so much new activity in many areas that we are still covering many aspects of the show. Sound reinforcement was a heavily featured topic with the convention having a special programme to cover this important field of audio engineering. Here

Terry Nelson looks at some of the hardware

places the speaker array at the centre of a sphere and maps the room with the spherical radiation pattern of the array from its viewpoint or intended position. Once the parameters of the room and the listening requirements are known, the computer can calculate the expected response and enable the designer to place the array in the optimum position.

Electro-Voice also introduced several items of interest in terms of electronic hardware, these being the XEQ-3 3-way crossover and the 8108 rack-mounting mixer. The XEQ-3 provides all the normal crossover functions together with plug-in modules to provide the correct equalisation for the various EV horns and drivers while the bass section provides EQ for the different Thiele tuned low frequency cabinets. Another feature is a short delay line in each section (1 to 10 ms) which allows the driver(s) to be 'moved' around for correct phase and time alignment.

The 8108 mixer provides eight mic/line balanced inputs with a 4-way matrix, again with balanced outputs. Each channel features gain, bass and treble controls, clip indicator and phantom

power (48 V). There are also two summed auxiliary line inputs with matrix and bus-in stacking inputs. The 8108 is suitable for a wide range of uses such as providing split feeds, sub-mixing, matrixing from main mixer groups, small monitor mixer, etc.

JBL Professional/UREI introduced items of interest both in the form of drivers and electronics. For high power systems the new 2123 10 in (250 mm) speaker and 2204 12 in (300 mm) are worthy of consideration. Developed with the collaboration of touring companies such as Clair Brothers, the 2123H is designed primarily as a midrange transducer and features 250 W continuous power handling (pink noise) with an exceptionally flat frequency response from 400 Hz to 5 kHz. Usable range is 80 Hz to 6 kHz. Compact construction allows tight packing of multi-transducer arrays and new construction techniques provide greater mechanical and acoustical stability. Similar in design, the 2204H is designed for front radiator applications and has a usable range of 35 Hz to 4 kHz. Optimum performance is between 70 Hz to 2 kHz provided the correct enclosure and tuning is used. Power handling is 350 W.

JBL introduced two full range systems appropriate for fixed installations such as churches, cinemas, conference rooms and small theatres. The 46710K features an oak-grain vinyl enclosure housing a 15 in (380 mm) bass driver and a 2370A constant directivity bi-radial horn coupled to a titanium diaphragm compression driver utilising a diamond surround pattern for improved high frequency response. The 46710K claims smooth response over the 40 Hz to 16 kHz range and accurate handling of transients. Power rating is 200 W continuous pink noise. The 4660 or Defined Coverage Loudspeaker System has been designed to provide equal coverage in rectangular rooms. A unique bi-radial horn configuration provides symmetrical side to side performance with 110° front coverage as opposed to 38° back. The basis of the system is a room with an aspect ratio of 2:2.75 where the enclosure would ideally be placed 0.6 unit high and 0.35 unit beyond the front coverage area. The system is 2-way with a 15 in (380 mm) 2225H driver for the bass and a 2425J high frequency unit, with 150 W continuous power handling (pink noise).

New electronics from JBL/UREI were the 5547 and 5549 graphic equalisers and a range of power amplifiers with the

Electro-Voice DH1 2 in high frequency drive unit and 8108 rack-mountable mixer

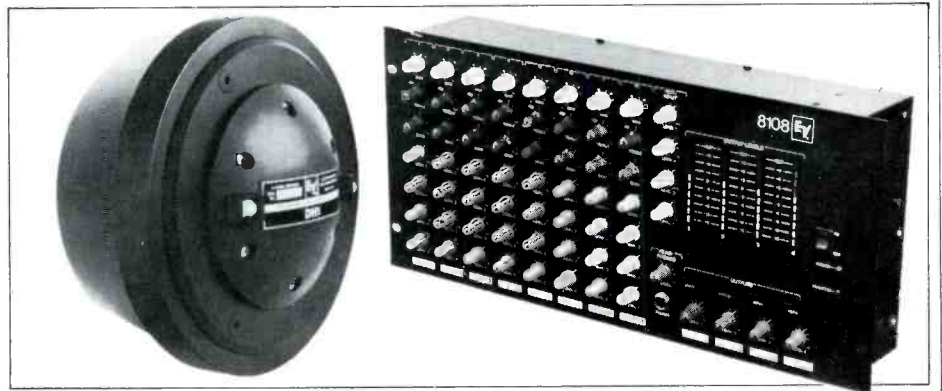

top of the line model, the 6290, capable of 1200 W total output. The two equalisers are $\frac{1}{3}$ -octave with 30 bands over ISO centre frequencies, the 5547 providing ± 12 dB of boost/cut and the 5549 providing -15 dB of cut on each band. The new active circuitry is claimed to equal or surpass classic L-C inductors and provide quiet operation linked with greater headroom for distortion-free operation. In addition to the $\frac{1}{3}$ -octave bands, there are tuneable high and low pass filters, the range of the former being 3.5 kHz to 20 kHz at 6 or 12 dB/octave and the latter 20 to 250 Hz. As well as an overall EQ in/out switch, there is a separate one for the filters. The good news for road users is that the chassis are made of steel and made for hard knocks and that the rack ears can be fixed so that the controls are either flush or recessed.

Signal processing has become an important part of sound reinforcement over the years and whereas it is always nice to have what one feels is the best in studio gear, there is a lot of equipment which performs extremely well for far less investment and well worth looking at when that last dB or two of noise floor is not really all that important. When was the last time you heard a pin drop in a concert hall?

DOD Electronics Corporation manufacture a range of processing equipment that is applicable to studios, PA and use by musicians in their racks. DOD offer single and dual channel 15-band graphic equalisers as well as single channel 31-band graphics. 1U and 2U rack dimensions are available in order to cover the different requirements in rack space. Overall specifications include high slew rate/low noise circuitry, 12 dB cut/boost, high pass filter and balanced/unbalanced inputs and outputs. The R-845 reverberation unit features separate input and output controls, mix and four band equalisation. A prelimiting and compression circuit helps to reduce 'bangs' and 'boings' from percussive signals such as drums. The R-848 is a souped-up version with six pairs of springs offering different time constants for a denser reverberation effect, variable pre-delay, 2-band sweep EQ and four preset EQ positions for rapid changes.

The effects processing line consists of the R-825 compressor/limiter, R-825 crossover, R-855 mixer and EXR SPII Exciter. The compressor is interesting in that it incorporates a separate de-essing function which can be used either separately or in conjunction with the compressor/limiter. The R-855 mixer provides four mic/line inputs with level, pan and send controls per channel mixing into a master stereo output. An auxiliary stereo input is also incorporated together with headphone monitor output with level control.

For those of you who have often wished for just one delay channel without tying up your all-singing/dancing unit, DOD now offer the RD320 programmable digital delay in a 1-in, 1-out format. The unit is brand new so final details will be forthcoming. However, the delay line is claimed to have wide frequency response and dynamic range for a natural sounding delay.

More up-market DOD products are the

AES NEW YORK SOUND REINFORCEMENT

Audio Logic and DigiTech lines. At the moment Audio Logic offer a stereo limiter/compressor and stereo 3-way (mono 4-way) crossover. The MT66 provides dual-channel or stereo gain reduction complete with a noise gate and has the following controls per channel: threshold, ratio, variable from 1:1 to ∞ :1, variable attack time from 0.5 to 100 ms (for 10 dB gain reduction), variable release time from 90 ms to 1.6 s and separate output and input level controls. Five-segment LED meters monitor gain reduction and signal level. There is also access to the side chains for the insertion of equalisers, etc. The X324 crossover has balanced inputs and outputs, together with phase inversion switches on all six outputs. An additional summed output of low frequencies from both channels allows a mono sub-woofer connection in stereo installations. Each channel features 40 Hz high pass filter in/out switch, input gain and three output level controls. The crossover points are continuously variable from 50 to 5000 Hz (in two ranges) for low/mid and 750 to 7500 Hz mid/high. For mono use there is an additional band of 2 to 20 kHz. Filters are 18 dB/octave Butterworth.

The DigiTech RDS 6400 digital reverb has 64 preset combinations and has the same functions as another well-known digital unit that has presets for room size, decay time, plate or room, clear or diffuse parameters! The 6400 uses EPROM architecture and updates will mean just plugging in the new PROMs when they become available.

SCV Audio from France carry a range of interesting sound reinforcement products but their latest offering sounds like the answer to communal prayers from sound crews all over the world. The

Turbosound TSE series enclosures



MD8 is an 8-channel active direct box enclosed in a 3U rack case, and provides an elegant solution to the problems of DI'ing multiple keyboards, drum machines, etc. Each module has ground lift and filter switches for maximum flexibility and the rugged format of the case would enable it to be used as an on-stage box feeding a snake. Another useful product from SCV is a phase checker set so that you can really see whether all your drivers are pushing and pulling at the same time.

Turbosound chose the New York show to introduce several newcomers to their range to supplement the well-known TMS series. The TSE Integrated Series uses the components from the TMS enclosures in a separated bass and mid/high cabinets format. The mid/high enclosure contains the TurboMid 'horn' with a 10 in driver and 1 in high frequency driver loaded by a proprietary flare. Frequency response is 250 Hz to 17 kHz with the crossover point at 4 kHz. The enclosure is rated at 150 W RMS into 16 Ω for a maximum SPL of 133 dB.

Turbosound offer two bass cabinets to complement the TSE-111 mid/high enclosures, the TSE-118 and TSE-218, containing either one or two 18 in driver units. Both cabinets use the TurboBass high-velocity horn loading techniques and handle 300 and 600 W RMS respectively. Frequency range of the 118 is 45 to 300 Hz with the 218 providing 40 to 300 Hz. Power outputs match with the upper section, being 130 dB and 136 dB respectively.

Various mounting options are available and these include the PA-111, a multidirectional stand that can be used to mount the 111 cabinet to the required height above either bass enclosure, and the FF-111/118 flying frame for the TSE-111/118 cabinets for use in a flown array. The dimensions and specifications of the TSE series and TMS series are fully compatible, this enabling systems to be built up from both series without matching problems.

Fresh from their triumph of having been selected by the Disney organisation were the TMW series floor monitors. The model on show was the TMW-215 housing two custom 15 in (380 mm) speakers and a new triangular horn with a JBL 2445 driver, crossover frequency being at 1.9 kHz. The enclosure is very low-profile and was chosen by the Disney people for 'it's absence of hot-spots and smooth response—coupled with very loud output!'

Also new from Turbosound was the TPC-1151 phase checker set. This consists of two units, a pulse generator with a balanced and floating output and a pulse detector with a balanced and floating input, and also a condenser measuring microphone. The TPC-1151 can be used to check the acoustic phasing and electronic polarity of the drivers in multiple loudspeaker arrays. Two LEDs in the pulse detector indicate whether the wavefront is negative or positive. The set can also be used as a test probe for verifying lines, testing for consistent electronic polarity and other such uses. On the practical side, the two units are mounted in sturdy aluminium boxes and feature extruded XLR connectors for plugging in directly, thus

Music Works Chose

AMEK

... twice.



Music Works, Music Studios, 23 Benwell Road, London N7. Tel: 01-607 9495

Music Works

AMEK

Head Office and Factory
AMEK SYSTEMS AND CONTROLS LTD
Islington Mill, James Street
Salford M3 5HW, England
tel: 061 834 6747
telex: 668127

In the USA
AMEK CONSOLES INC.
10815 Burbank Blvd.
North Hollywood, CA 91601
tel: 818 508 9788
telex: 662526



doing away with the need for patch chords.

Yamaha generated a lot of interest with the first showing of the *PM-3000* mixing console. Primarily designed for use as a sound reinforcement console, the *PM-3000* can also find applications in broadcast and recording. Based on the experience gained with the *PM-1000* and *PM-2000* mixers, the new console aims to provide enough facilities to handle concerts, general sound reinforcement and theatre/multi-media presentations. The *PM-3000* is available in three main frame sizes—24, 32, 40 input channels—with provision for slaving an extra console in order to meet situations requiring a larger number of channels. The 40-channel console also has the master output section placed in the middle for ease of operation.

Each channel features an electronically balanced input—with provision for transformer isolation—with five position pad switch and gain trim pot, variable high pass filter, sweep low and high frequency equalisation with switchable peak/shelf characteristics and fully

AES NEW YORK SOUND REINFORCEMENT

parametric low and high mid frequency bands, eight auxiliary sends switchable pre/post or off routing to eight subgroups and/or stereo buses with pan in/out switch, 48 V phantom on/off and phase reverse. Other facilities include clip LED, channel on and mute safe buttons, EQ in/out and insert in/out switches. In addition to the audio groups there are eight VCA groups and these are selected by a row of pushbuttons alongside the fader. In addition, there are eight channel mute buses, also selected by buttons beside the fader and a cue (PFL)/solo switch. All insert points in the console are fully balanced and one feature of the insert configuration is that the insert returns can be used as stand-by line inputs, tape returns, etc, the signal being selected from the channel input or insert by means of the insert in/out switch.

The *PM-3000* has two module strips housing four stereo returns, one module

also providing a home for the eight mute bus master switches. Each return features full audio routing, input level and pan, mono/stereo return mode and sweep low and high frequency EQ, PFL (cue) and channel on switches are also provided.

The group modules each contain their respective audio and VCA group master faders with the audio group section having pan, group to stereo outputs, cue and group on controls. A further switch routes the group output to the 8-way matrix at the top end of the module. The matrix features eight level controls plus the respective matrix master and a sub-in level control which inputs an external signal directly into the matrix. Cue and matrix on switches are also provided.

The remaining modules cover the eight auxiliary send masters, main stereo outputs (which can also be switched into the matrix directly) and comms/talkback. For line-up purposes there is a signal generator with pink noise, three fixed frequencies plus switchable sweep frequency ($\times 0.2$ to $\times 2$) and routing into the audio buses. The communications facility would indicate that Yamaha have been talking to live sound engineers as it is possible to connect most comms systems directly into the console and thus avoid having two sets of headphones wrapped around one's neck while one tries to PFL channels and talk to the monitor engineer at the same time! There is also a flashing light placed to catch the engineer's eye. It is possible to put the input channels into either a cue (PFL) or solo mode, the former for performance and the second for setting up at the sound check.

Construction of the console consists of a low profile extruded aluminium chassis which is said to combine ruggedness with reduced weight. Finish is with light pastel colours that you either like or you don't. Recognising that people have different ideas about channel flow, the *PM-3000* is equipped with internal switches that allow the insert points to be moved around, the matrix feeds to be pre or post fader, etc, and this should provide enough flexibility for most people.

Rising to the occasion of the show's involvement with sound reinforcement, Midas Audio Systems also showed their brand new console, the *LQ24*. The model shown was the 24-input channel version so presumably the 32-channel model would be called the *LQ32*! The console is made up from four module types, viz: input module, subgroup module, master/matrix module and communications module. Construction of the frame is to the robust Midas standards though the new pastel colour scheme is a bit startling.

Looking at the top of the channel strip and working down there is the input gain control together with switches for 48 V phantom, ground lift, phase reverse and mic/line. The input is transformer balanced with 1 k Ω for microphones and 10 k Ω for line. The equaliser section is four band with two fixed frequencies for the treble and bass controls, 6 or 12 kHz for the highs and 60 or 120 Hz for the lows. The high and low mid sections are state variable (sweep) with switchable Qs, broad or $\frac{1}{2}$ -octave narrowband. There is also a separate high pass filter at 60

HARRISON GRAPHICEQUALISERS-PLUS



Superior Sound Control

Utilising the most advanced Microchip technology HARRISON are proud to introduce the GP-SERIES. Graphic Equalisers which not only have more features than previous designs but which also outperform existing models. The GP-SERIES are precision units which incorporate extra facilities to match the requirements of today's sophisticated sound systems.

Precision Model Range

The GP215 is a 2x 15 band $\frac{1}{3}$ rd octave



Feature protective non-carrying handles.

instrument in a compact 1U high 19" rack mount unit.

The GP130 offers real precision 30 band $\frac{1}{3}$ rd octave control plus a three band Notch Filter set in one neat package. Last but not least the GP230 combines two channels each covering the full $\frac{1}{3}$ rd octave 30 band 150 centre frequencies from 20Hz to 20kHz.

Plus Extra Features.

Each model is more than a precision Graphic Equaliser — it also includes extra features that are essential to today's sophisticated sound systems. Tuneable low and high pass filters, e.g. Range Switches, On/Off Switches, Peak LEDs and Switchable Inputs and Output Levels are all provided. Electronic balanced inputs and outputs with sockets for balancing transformers are also key features, and built-in Pink Noise generators are included, as well as silent switching and a fail-safe bypass circuit and much more.



Security Cover Included

At no extra cost each model comes with a tinted Perspex Security Cover which prevents unauthorised tampering with your control settings once the GP-Series have been set up to give you the sound you want.

Notch Filters

The GP130 Model also includes a 3 band tuneable sweeping Notch Filter set which is a really cost effective means of getting up to +10dB more system gain from your sound system. This means that at last annoying feedback can be "notched out" and you can get more sound level without sacrificing quality.



Contact your nearest dealer or Harrison direct for a detailed information brochure.

HARRISON INFORMATION TECHNOLOGY LTD., UNIT 3 BUTTON END, HARSTON, CAMBRIDGE CB2 5NX. 0223 871711. TELEFAX 81667



Yamaha PM-3000

or 120 Hz with 12 dB/octave slope. The EQ section can handle wide extremes of correction with plus or minus 16 dB for each band. Alongside the controls for the sweep frequencies is a 10 LED bargraph peak indicator reading the level pre-fader. The meter sensing circuit gives priority to the greater level within the channel flow at either the pre-insert or post EQ points. The module then continues down with eight auxiliary sends, each send having its own pre/post and on/off switches, before reaching the panpot and insert in/out, PFL and mute buttons.

The fader module contains a P&G 103 mm fader with infinity cut-off and routing switches for the eight subgroups and main left and right outputs.

The subgroup module contains the respective group and auxiliary master outputs together with matrix and auxiliary routing. Each module also contains an auxiliary input section with bass and treble controls and subgroup, PFL, mute switches plus level control. The subgroup switch routes the incoming signal away from the respective module master auxiliary bus and into the subgroup bus. The subgroup can be routed into the eight auxiliary buses via four controls with pushbutton selection for aux 1 or 2, 3 or 4, etc. In addition to the auxiliaries, there are two matrix outputs and these can be selected to be pre or post group fader. The bottom of the module is as per the channels with panpot and insert, PFL and mute switches. As with all Midas consoles, the mute switches are in the form of large illuminated squares that leave no doubt that that particular channel is off! The top of the module houses a LED bargraph meter with peak response and can be switched to read level post group fader or post auxiliary master.

The master module contains the faders for the stereo and two matrix outputs, together with AFL switches for monitoring. The LED bargraph meters read either master output level or matrix master levels. There is also a solo function button which activates a solo bus to turn the channel PFLs into in-place solo signals, the solo selections being fed into the main outputs, and this is again illuminated with a large warning lamp should the operator be tempted to use it during the show.

A useful feature on the master module is a stereo record send for those times when the band ask, 'Did you record the show?' This is normally electronically

balanced but transformers are available as an option. A momentary pushbutton (check) allows the main output meters to indicate the record output level.

The communications module provides the necessary facilities for monitoring, talkback, noise generator for line-up and external intercom interface. Talkback can be routed into all of the subgroups and main outputs as well as all auxiliaries and matrix sends. Midas have also realised the wisdom of interfacing external intercom systems into the console and this can also be routed into the talkback circuits if desired. Other features include a P&G fader for solo level and a LED bargraph to indicate PFL/AFL/solo levels.

This overview has of necessity been a short one and represents what caught my eye whilst dashing around what was a very busy show. If anyone feels left out, my apologies in advance and I hope to catch you next time in Montreux. High quality sound reinforcement is definitely here to stay and it will be interesting to see what this year will have to offer us. □

The Card. Your ace in play.

telcom c4

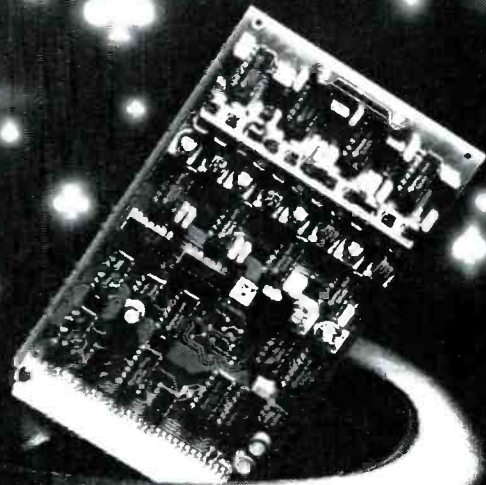

To help you survive the time of growing quality demands on audio we have redesigned one of our well known analog telcom c4 compander cards. The card wizard applied new tricks with SMDs and no less than 8 VAs for a further reduction of space requirements and even stronger performance now offering ± 115 dB dynamic range. Just take 30 of these to improve your sound.

This ace will make you a winner with audio on ATRs, VTRs and line transmission. Check it out and challenge any digital tape recorder to outperform your analog machine equipped with the telcom c4 compander ace. With these cards up your sleeve, you'll beat the parts off the competition. There are 8000 telcom c4 channels already playing worldwide. Contact us for further information.

ANT
Telecommunications

Audio & Design Calrec Ltd.
Unit 3, Ho seshoe Park, Pangbourne
Reading, RG 8 7JW England
Phone 0734 86 1088, Telex 848722 ADR UK

ANT Nachrichtentechnik GmbH
Lindener Str. 15, D-3340 Wolfenbüttel
Phone (05331) 83-C, Telex 95651 ant d

ANT WAK 6013 E

MUSIC PAGE

MUSIC PAGE

Mark Jenkins on synthesis for the studio

Premier Snares

New 6½ in and 8 in snares from Premier are intended for studio use and for live application requiring heavy miking. Apart from an external damper and snare buzz control to reduce the effect of resonant vibrations caused by other instruments, the drums feature a secondary sound chamber enabling the engineer to place a microphone 'inside'.

The snare's inner diameter is reduced and a large rubber-grommeted hole allows a microphone to be placed inside or just outside the cavity. The company claims that if allowance is made for high sound pressure levels, an unusually tight sound can easily be obtained.

Premier suggests an additional microphone on the batter head or an out-of-phase microphone on the snare head to produce some exceptional sounds without the drummer having to detune or damp the drum to an uncomfortable degree.

Premier Percussion, Blaby Road, Wigston, Leicester LE8 2DF, UK. Tel: (0533) 773121.

USA: Premier Percussion USA Ltd, 1704 Taylor's Lane, Unit 1, Cinnaminson, NJ 08077. Tel: (609) 786-1155.

MIDI news

- JL Cooper Electronics now have available an Apple *IIC* to Roland *MPU-401* interface adaptor. Easily installed, the retrofit allows Apple *IIC* owners to use the Roland *MUSE* and Laubach Software *DX-PRO* packages for MIDI synthesiser control. JL Cooper Electronics, 1931 Pontius Avenue, West Los Angeles, CA 90025, USA. Tel: (213) 473-8771.

- The Canadian MIDI Users' Group, recently formed by musician Eric Baragar, intends to promote the exchange of sound patches and system ideas, information on new products, interfacing, computer software and other information in a monthly newsletter. Exchange adverts and a members' forum are also included. Canadian MIDI Users' Group, PO Box 1043, Belleville, Ontario K8N 5B6, Canada. Tel: 613-968 9559.

- Octave-Plateau Electronics has announced *Rev 2.0* of their Sequencer Plus 64-track MIDI software for the IBM PC or compatible 256k micro. The package now features Play and Punch In Record starting and ending automatically at any bar; View Mode showing up to 72 bars in 22 tracks simultaneously; pop-up control windows which can be operated during playback; a new MIDI menu to edit pitch bend, after touch, program change and other data; individual track loading from disk; programmable tempo change; external MIDI synchronisation; a fully-featured note editor and so on. Capacity is up to 60,000 notes (with 640k RAM), quantisation is to ¼ note and an Octave-Plateau *OP-4001* or Roland

MPU-401 interface is needed for MIDI operation. A demo disk is available which lacks Record and Playback facilities (no interface needed).

Octave-Plateau Electronics Inc 51 Main Street, Yonkers, NY 10701, USA. Tel: (914) 964-0225.

Roland Juno 1

The *JU-1* is clearly a cut-down version of the successful *Juno 106*. It has four octaves of standard sized keys, six analogue voices, 64 programmable memories and 64 preset sounds.

All parameters are called up for editing with the new Alpha Dial, a continuously rotating digital access control which is to feature on several future Roland products. Parameter values are varied using the Alpha Dial or a pair of ± buttons. Most other controls are of the touch membrane type.

Each voice has one oscillator with three pulse waves combinable with five sawtooth waves, and a sub-oscillator with six pulse wave options. The envelope design has additional stages and the chorus has programmable depth and speed.

Important parameters accessible through independent controls rather than the Alpha Dial include Modulation Rate, Modulation Depth, Brilliance (Filter) and Envelope (Release) Time. Other independent controls include Parameter Select, Value, Name and Write, and a backlit LCD display shows patch names, parameter names and values as they are altered.

The *Alpha Juno 1* responds to velocity



Above: Premier Studio Snare. Below: Interactive Arts CD-ROM.



and pressure from MIDI In only, and can transmit voice data over MIDI or to tape.

Assessment

A little expensive compared to Casio *CZ* series synthesisers and Yamaha's *DX-27*, the *Alpha Juno 1* nevertheless has many applications as an expander and as an independent keyboard. Its performance controls (pitch bend and modulation, transpose, programmable chord memory, portamento, etc) can make it highly expressive but the short keyboard and MIDI-only velocity/pressure response may make control from a mother keyboard or sequencer preferable.

Nevertheless, the Roland sound continues to set a standard sharply contrasting with the cleaner sounds of FM synthesisers, and innovations in the oscillator and envelope departments do increase the possibilities afforded here.

UK: Roland UK Ltd, 983 Great West Road, Brentford, Middx TW8 9DN. Tel: 01-568 4578.

USA: Roland Corp, 7200 Dominion Circle, Los Angeles, CA 90040-3647. Tel: (213) 685-5141.

Interactive Arts CD-ROM

Interactive Arts in conjunction with E-Mu Systems Inc has announced a CD-ROM System for the *Emulator II* sampling keyboard. A new CD disc drive and interface (either direct to the *Emulator* or via an Apple *Macintosh* micro) allows the user to load sounds from pre-recorded compact disc ROMs, the first of which is entitled *The Universe of Sound, Vol 1*.

The company points out that although the disc contains hundreds of sounds, typical loading time is around 10 s as opposed to 24 s for floppy disks. The first disc includes instrumental sounds, sound effects and combinations of instrument sounds suitable for both studio and live performance applications. Each sound or sound file is stored as an *Emulator II* performance bank loading in under 10 s.

The related Optical Media Services will accept orders to convert private floppy disk libraries to CD-ROM.

Interactive Arts, PO Box 2107, Aptos, CA 95001, USA. Tel: (408) 662-1772. □

pd
PRODIGI

a few quiet words from Hilton Sound..

Some people are fighting a rearguard action to save analog recording systems. They talk about cost and convenience. About the sonic characteristics of analog. Its trouble free use. They even say that it's a good idea to record on analog and mix down on digital. They'll say anything, in fact, to avoid the inevitable conclusion that digital is the way the industry is going. The ostrich and his reaction to danger is far sighted by comparison.

We at Hilton Sound lead the field in the new era of digital recording. We were the first with the Mitsubishi X850 that has been such a revelation to the industry. If you've ever witnessed the X850's ability to decode a mangled tape and reconstruct missing passages, you'll know why the new PD format dashes the hopes of all it's rivals.

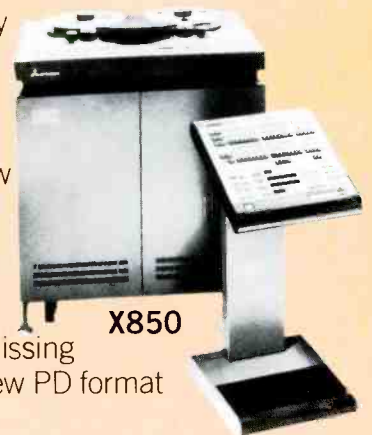

X850

Mitsubishi philosophy is to design a system not just to do this year's job, but to be capable of handling the demands of the year 2000 and beyond. Can anybody else say that? Watch this space for Mitsubishi's X86 which will do for 2-track recorders what the X850 did for multitrack.



X86

Hilton Sound, the first for Mitsubishi.

HILTON SOUND

10 Steedman Street, London SE17

EMAIL REF:

HILTON-SOUND-UK. DGS1311

01-708 0483



Syco. The madding crowd. Far from it



Gyco

20 CONDUIT PLACE, LONDON W2 TEL 01-724 2451
TELEX 222 78 SYCO G, FAX 01-262 6081

EXHIBITION PREVIEW

AES 80TH CONVENTION

The 80th Convention of the Audio Engineering Society will be held at the Centre de Congres, Montreux, Switzerland from March 4 to 7. As usual the Convention will consist of a wide range of technical papers with an associated exhibition. At the time of compiling this preview there were 179 manufacturers taking 147 booths and 10 demo rooms. In this brief preview we have concentrated on the new items on show from details available to us at the time of writing.

A

AB Systems: will be demonstrating a selection from their range of power amplifiers and crossover systems. **Adams-Smith:** will be showing their *System 2600* and the latest system additions. Other products include timecode generators, synchronisers and event controllers. **AEG-Telefunken:** will have their range of analogue tape machines, including the new *Magnetophon M20, M20TC* and *M21R* on display in addition to the *MX-850 PD* format digital multitrack recorder, *Robotechnica* cassette loaders and a new studio record player, the *TRS 9100*. **AGAP/Ateis:** will show *2010* automated theatre console, *1000* series mixer and the *Triton* portable 3/2 mixer. **Agfa Gevaert:** will be showing a range of audio, video and duplicating tape and cassette products. **Akai:** will be showing their range of signal processing devices, MIDI equipment and multi channel micro 'studio'. **AKG Acoustics:** will have on display their range of microphones, headphones, delay and reverb systems, mic stands and phono cartridges. **Altec Lansing:** Altec have supplied pro-audio equipment for 50 years although their founders, Western Electric and Electrical Research Products Inc, go back even further. The theme for the stand will be to reflect the company's history and show new mixing console, LF speaker, driver and microphone products; and to indicate the way that the company will continue to develop independently following their purchase by Gulton Industries in July 1985. **Amber:** will be displaying their range of audio test equipment. **Amcron:** will be showing the full Amcron/Crown range of amplifiers, microphones and the *TEF-12* Time Delay Spectrometry analyser. The featured product on the amplification side will be the new *MicroTech 1000* power amplifier which is a high power compact design. **Amek Systems & Controls:** will be showing a number of products including the *BC11* broadcast console and the *APC* (assignable production console). Developed from the *BC01* series 11, the *BC11* is available in either plinth or console versions. Also on display will be the *RM01* rack-mounted signal processing system. **Ampex:** full range of Ampex mastering tapes,

PREVIEW MONTREUX

A guide to exhibitors and products on show

cassettes, video cassettes and test tapes for audio and video applications including the new Ampex *467* digital audio cassette. **Ampco:** no details received. **AMS:** will be demonstrating their hard-disk digital recording and playback system, the *AudioFile*. This unit which can be configured as a mono, stereo or multitrack recording system features 16-bit sampling and a recording capacity of several hours. Other products on show will be the *RMX 16* digital reverb, *DMX 15-80S* dual channel pitch changer, A/V Sync delay compensator and A/V Sync remote, *Timeflex* and a digital keyboard interface. **ANT:** will display the full range of *telcom c4* companders for audio noise reduction including models *112* and *122* for applications in satellite, cable, microwave and line transmissions; models *232* and *233* for use with audio and video tape recorders; model *ESF* for multitrack tape machines; the *c4DM* card which is size and pin interchangeable with the *Dolby cat 22*; and a new compander card, the *c4E* which will be shown in Europe for the first time. **Apex:** no details available. **Aphex Systems:** will be showing their range of aural exciters, the *Compellor*, *Studio Dominator* 3-band limiter, and *AVM-8000* surround sound decoder. **Appel:** no details known. **ATB:** no details available. **AVS (Audio Visual Studio):** will be demonstrating a new battery powered high speed cassette duplicating system using a loop bin feed; a battery powered cassette-to-cassette copier system with the capacity to produce 15 cassettes simultaneously on all four tracks at 1:1 or 4:1; and a microprocessor-controlled receiver for measuring antennas including all TV, AM and FM radio. **Audio Design Calrec:** will be showing products from both Audio & Design and Calrec. Featured will be the *Calrec Soundfield* mic with live and tape demonstration in its re-packaged form, the *Scamp Filmex* and Multi-band Processor, the *AD-MIX* digital fader interfaced with the *PCM 701ES Professional*, the *Calrec Minimixer* and the *UA8000* music console. In addition the full range of A+D and Calrec products will be on show. **Audio Developments:** full product line with featured item being the *AD 260*. **Audio Kinetics:** will be showing several items including the *Eclipse* multi-machine audio editing system; the *Q.Lock 4.10* which will be shown in a normal 3-machine configuration; *MasterMix* computer

aiding mixing system which may be fitted to a wide variety of automation-ready consoles and to standard consoles with the Audio Kinetics VCA fader; and the *Timelink* that allows timecode interfacing problems to be solved. **Audiomatic:** will be showing the Electro Sound range of professional duplicating equipment and other products for the computer duplicating industry. **Audio Precision:** will introduce two new additions to the *System One* computer-based audio test system. The wow and flutter option measures to major industry standards and produces spot measurements or graphs against time. The new audio switcher module allows automated testing of devices such as multitrack tape machines and mixing consoles. Also on show for the first time in Europe will be the intermodulation distortion option. **Audioscope:** range of spectrum analysers. **Audio Technica:** the full range of microphones, cartridges, headsets and accessory items will be on show. New mics include the *AT814A* vocal mic and the *AT836* vocal/instrumental mic. **Audix:** will be demonstrating the *MXT1200* modular mixing systems and the *MXT500* portable mixing system. Featured new item will be the *Access* all-digital communication system for broadcast inter-studio talkback. **Auvis-Asona:** will demonstrate the second generation of Asona automated cassette winders for considerably higher output per given time. The Asona high speed audio duplicator can now be used for dubbing music onto standard, chrome and the new improved ferric tapes without any readjustment of the unit by means of remote switchover of the slaves.

B

Barth: will be showing an extensive range of equipment including the *Dynaset* compressor/limiter, *Audios* delay, and the *Musocoder* vocoder. Also on the stand will be equipment from Haase (digital interface, 4-channel mixing unit for digital mastering and a 2.32 channel mixing system); Clear Com; CEI (Australia), Cetec Ivie and Visonik. New products include the Haase Hum-killer, a professional unit for eliminating hum problems with attenuation up to 40 dB and digital interface and mixing equipment and the *CEI Auto Phase 2000* replay and record/replay cart machines. **BASF:** full range of professional audio and video tapes, cassettes, magnetic film and calibration test tapes. **Beyer:** will feature the new *M380* dynamic microphone designed for use with instruments that create a high sound pressure such as bass drum, tuba, trombone, and sousaphone. Additionally the complete range of dynamic and condenser mics will be shown with the wireless mic systems and the studio headphones including the new *990* open dynamic headphone. **BNS:** range of

EXHIBITION PREVIEW

speaker systems for low-level monitoring use. **Bruel & Kjaer:** will be showing a selection from their wide product range including the series 4000 professional mics, the new 3361 speech transmission meter which makes objective measurements of speech intelligibility according to RASTI standards; the 9573 transducer test system and the new head and torso simulator for the testing of acoustical transducers, telephones and headsets. They will also be conducting a live studio demo of the series 4000 mics.

C

Cabasse: range of loudspeaker systems for live and studio applications. **Camco:** no details received. **Canford Audio:** details of company's distributed and manufactured lines and catalogues of products including studio fittings and furnishings, and a wide range of interfacing and interconnecting products. New products to be shown include Soundtech modular mixers suited for local broadcasting, the LAD 942 and 944 direct broadcast turntable and a range of high performance distribution amplifiers. **Capitol Magnetics:** will be showing cassette duplicating tape in pancake form, cassette production sundries, and lacquer master discs. **Cetec Gauss:** will be featuring their tape duplication systems and their range of professional loudspeaker products. **Clear-Com:** wide range of intercom systems. **Connectronics:** will have on display a wide range of cables, connectors for audio, broadcast and video applications.

D

Daub: will be showing the complete range of High Technology power amplifiers from the D 120 C to the D 700 C. Featured will be the new D 400 C amplifier rated at 2-channel 380 W into 4 Ω , or mono 750 W into 8 Ω . Also on display will be a new central remote control unit which allows the central control of status and function of a large number of amplifiers using a microcomputer and a 8-bit data line. **dbx:** will feature the model 166 dual channel dynamics processor, model 202X amp module, model 2252 RMS-level detector IC, and various other audio and signal processing devices, integrated circuits and noise reduction systems. **Denon:** details of the company's digital products and their CD production capabilities. **DOD Electronics:** signal processing equipment including graphic equalisers, digital delays and reverbs, spring reverbs, compressor limiters, crossovers and interface equipment under the Digitech and Audio-Logic names. **Dolby:** will exhibit number of single and multi-channel noise reduction products including plug-in modules. Applications for audio, video, cable TV and both terrestrial and satellite broadcasting. **Drake Electronics:** will have on show broadcast standard 7000 series rack-mounting audio modular range which includes distribution amplifiers, line sending amplifiers, mic amps, 50 W power amplifiers and 8x1 audio switchers. New products will include a

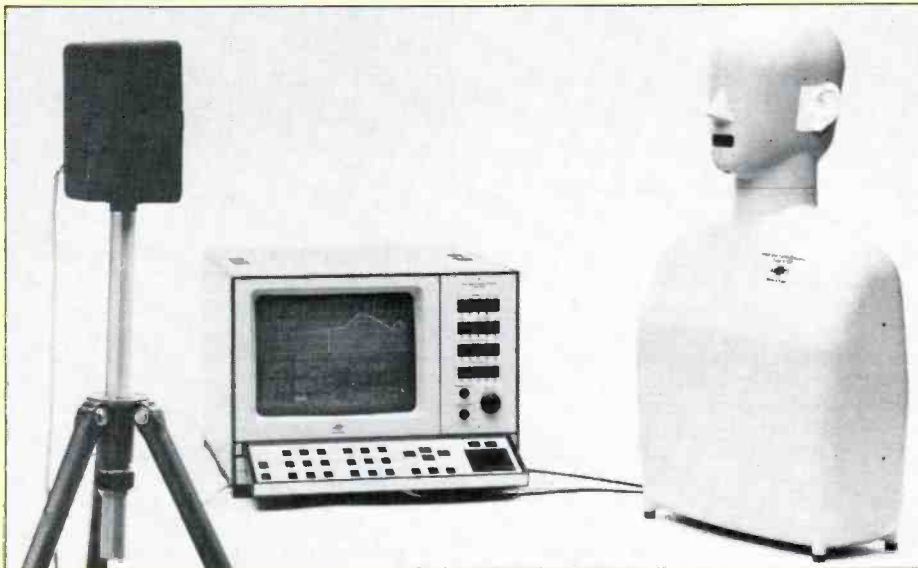

4128 head and torso simulator from Bruel & Kjaer

hard wired PD600 customised system and a PD6000 range of reconfigurable matrices for studio intercom/talkback systems. **D&R Elektronika:** will be featuring their in line recording consoles, 2000 and 4000 series, *Discom* mixer, *Score* computer remix, and fader automation ready 4000 and 8000 II consoles.

E

Eela Audio: has a range of consoles available including a portable EMG mixer and consoles for broadcast and audio use. **Electro Sound:** will display the series 8000 high speed cassette duplicator with extra larger capacity loop bin and Multimaster capability; the series 4300 automated QC system and the model 1850 cassette loader. **Electro-Voice:** will be exhibiting the new RE 98 lavalier condenser microphone and XEQ-3 3-way 24 dB/octave Linkwitz-Riley electronic crossover with built-in delay and horn EQ. Also on view will be the second generation HP Constant Directivity horns and the Thiele-Small TL series bass cabinets including the new TL 3512 subwoofer. **Elektroimpex:** will be showing items including studio tape machines of all sizes, portable studio mixing console, broadcasting studio system and studio monitoring system. **Eletraoacustica:** no details available. **EMT:** will be exhibiting the EMT 445 digital delay system with 16-bit resolution, a 48 kHz sampling frequency and a delay time variable between 1 ms and 10.9 s in stereo; the EMT 448 *Unimatic* short duration audio storage system using a Winchester disk drive; the EMT 266 X transient limiter; the EMT 252 remote-controllable digital reverb system and the line of EMT turntables. Also on show will be the EMT CD 32 Multilevel analyser and a new product, the EMT MM 40 mixing console. **Enertec:** in addition to the current range of UPS 5000 and 6000 series consoles and the F 500 series tape machines the company has a new console, the UPS 6500 which features total store and recall of routing parameters, 24-48 input channels, 8/16

group channels and 8/16 auxiliaries. Other products on display include line amplifiers, switching matrices and communication systems. **Etelac:** product range on show will include modular broadcast and PA mixers, broadcast turntables and power amplifiers. New item will be a portable ENG mixer. **Eventide:** full range of Eventide products with the featured unit being the SP2016 effects processor/reverb unit with the latest software enhancements.

F

Fabec: no details available. **Fairlight:** featured item will be the new CMI series III. This will be demonstrated together with the *Voicetracker*. Also on display will be the CVI (Computer Video Instrument). **Fane Acoustics:** will be exhibiting wide range of professional chassis loudspeakers, midrange and HF transducers designed for studio, sound reinforcement and disco applications. Latest products include MD2050 full range, 1 in compression driver with power handling of 50 W RMS. On view for first time will be expanded range of radial and constant directivity horns. **Fidelipac:** range of NAB cartridges and a newly introduced range of machines. **FM Acoustics:** will display their high power amplifiers together with the FM 236 linear phase electronic crossover and the *Forcelines* high energy transfer cable. **Fostex:** will be featuring an audio/video synchronisation demonstration using the new model E-2 ¼ in studio mastering recorder, the model 4030/4035 synchroniser/controller, model 6301B personal monitor with a power amplifier and a Sony U-matic. The E-2 is a 2-track machine running at 7½/15 in/s with a centre timecode track for SMPTE/EBU, sync pulses or cueing information. **Fougerolle** will be exhibiting two products—the *Picot N10* 2-track digital tape machine developed in co-operation with TDF; and the *DAISY* digital audio recording system—the basic system consists of four Winchester disks and the recording capacity is one hour per disc with a maximum of 16 audio

EXHIBITION PREVIEW

channels. **Future Film Developments:** comprehensive variety of cables, cords, connectors, jackfields, wiring aids and associated components plus a wide range of audio accessories.

G

Genelec: will exhibit and demonstrate a full series of active monitoring systems in an acoustically damped room. These will include the bi-amped *1019A* nearfield monitor, the tri-amp *S30* broadcast monitor; the new tri-amp *1022A* music monitor; the tri-amp *1024B* studio monitor and the *1025A* control room monitor. **Gexco:** no details available. **Ghielmetti:** no details received. **Giese:** products on display will include a demonstration of synchronisers with the *Lock-System 3*, *Lock-System 3/2*, *TAKER A/B*; timecode equipment including the SMPTE/EBU timecode generator, video display, incremental generator, reader and comparator. New products featured will be the *TAKER 1000* automatic dialogue replacement systems and a multi-slave selection unit for the synchroniser. **Goldline:** will be showing their range of real-time analysers, graphic equalisers and various DI boxes and other related accessories. **Gotham:** will be showing products handled under their export arrangements. **Graff:** will be exhibiting their existing *GEM-Diamond* range of high speed cassette duplicators and the new *GEM-Sapphire*. This is a one-to-one high speed mono copier. **gtc:** will be showing the *Edition* audio/audio and audio/video synchroniser using SMPTE/EBU timecode or CTL pulses. **Gunther:** will be showing products from Sonifex in the form of broadcast NAB cart machines including the new low cost *CQ-20R* recorder; Klark-Teknik signal processor range; complete range of Neumann microphones and accessories; Symetrix range of signal processors; Film Tech EMG mixers; and featured new items—the Brooke Siren Systems *FDS-360* 2-way, 2-channel crossover that can also be configured as a single channel 3- or 4-way; and the Barcus-Berry Electronics *202* programme-controlled signal processor that improves the sonic clarity of a processed signal.

H

Harmonia Mundi: will be showing the *BW102* digital audio processor together with a number of new additions to the system including a 4-band semi-parametric equaliser, a sampling frequency converter 44.1/48 and back, Mitsubishi and Telefunken interfaces, and a digital preview delay for album mastering. **Harrison Systems:** will be featuring a range of consoles designed for broadcast, motion picture, teleproduction live sound and audio applications. **Haufe:** no details available. **Heino Ilsemann:** cassette manufacturing machines including labelling, boxing and foil wrapping and a sorting machine for compact cassettes. **Heyna:** range of duplication systems. **HHB Hire & Sales:** will be exhibiting the Sony range of low-cost PCM digital



Fairlight Voicetracker Five

audio processors including both the *PCM F1* and *PCM 701ES* together with the new Sony *SL HF950* Betamax VCR and various new *Video 8* products. **CLUE** (Computer Logging Unit & Editor) will be demonstrated throughout the show with the various new interfaces that are now available. Munro Associates will also be on the stand to discuss their acoustic design and consultancy services. **Hidley Design:** will be exhibiting examples of recent designs and full information of services offered and the new monitoring systems.

Hiletron/Teksam: no details available.

I

ICM: wide range of C-O cassette shells and library cases. **Inovonics:** will be featuring their audio spectrum analyser and related plotter module and accessories. **ITC:** will be showing the full line of NAB cartridge machines. **Ivo Lola Ribar:** full range of products including mixing consoles, power amplifiers, and graphic equalisers.

J

JBL/UREI: JBL will be showing the new JBL/UREI *6215* power amplifier designed for applications where high power output is not required although compact size is. UREI will be showing the *813C*, newest in the *Time Align* studio monitor series featuring a new high-power low-distortion coaxial drive. **JVC:** will demonstrate a digital mastering system consisting of the *VP-900* digital audio processor, the *AE-900V* digital audio editor, the *DS-DM900* digital 4-channel equaliser/mixer, the *DS-SU900* A/V synchroniser and the *DS-FC901* digital interface unit. Also on display will be the AHD system with a capability for high definition digital still pictures.

K

King: will be showing the model 793 dual pancake audio cassette loader with the production capacity for 4400 cassettes in an 8 hr shift. Also on show will be the model 590 video cassette loader which is capable of handling both VHS and Beta formats. **Klark-Teknik:** will show the full range of audio signal processing lines including graphic equalisers, digital delay lines, realtime spectrum analysers and the *DN 780* digital reverb/processor with new software options. **Klotz:** will be exhibiting their comprehensive range of studio/broadcast cables including multicores, loudspeaker, microphone and single screen cables. New multicores are

StudioCore which is an 8-way symmetrical cable with individual PVC jackets, and *Monocore*, a cable with 16 single screen conductors. Klotz will also be showing their new modular active stagebox system of particular interest for broadcast and live applications featuring splitters, DI boxes, transformers, etc. **Kudelski Nagra:** no details available.

L

Leonhard Electronic: will be exhibiting the *System 180* modular amplifier, a multi-purpose amplifier system including balancing unit and *System 265*, a regulated 10A/24 V power supply. **Lexicon:** will be showing the new *PCM-70* digital effects processor in addition to the *PCM-41* and *42* digital delay lines, model *95 Prime Time II* and model *97 Super Prime Time* digital effects processors, the *PCM-60* digital reverb, model *200* reverb/room simulator and the *224 XL* digital effects/reverb unit with *LARC*. **Lyrec:** featured item will be a new multitrack recorder, model *TR533*, available in 16- and 24-track 2 in formats. It accepts 14 in spools and is particularly designed for audio/video synchronising. Also on display will be the complete duplication line for mastering, duplication and *QC* with 64:1 ratio with Dolby *HX Pro* capability; and the *FRED* tape deck for editing of ¼ in tapes.

M

Martin Audio: will feature various loudspeaker arrays and cabinets suitable for a variety of differing PA situations. **Meyer Sound Labs:** will exhibit their full range of established speaker products and *SIM* support technology for sound reinforcement and recording industry. On show for the first time will be the series *500* loudspeaker system—a cost engineered system using proven Meyer technology. Also on show will be the new Meyer/ATL stage monitor console. **Musicbox:** wide range of C-O cassette shells, library cases, boxes and blank cassette tapes. **Mitsubishi:** featured will be the first showing of the prototype of the *X-96* 2-channel digital recorder together with the recently launched *X-850* digital multitrack. This machine is compatible with the established *X-800*. **Mosses & Mitchell:** examples from their range of audio jacks and jackfields meeting BT and BBC specification. **MRL:** will be showing their range of test and calibration tapes. **MS-Audiron:** will show the *Simultimix* live/multitrack console for live broadcasting with simultaneous multitrack recording use. **Multimedias:** no details known. **Musik Produktiv:** first European showing of the Hitec Audio sound reinforcement system, consists of a line of special design cabinets with the heart of the system being the Hitec *Audio Processor Mk1* and *II*. The system has applications in many differing live sound applications. It is hoped to have a full live demo at a local venue. Additionally Music Produktiv will show its complete line of AAC audio cable, non-beaming horns and other



THE
CMC
RANGE



TAKE A CLOSER LOOK

Compare the advanced simplicity of the CMC range of Sound mixers with the other choices available and you will soon realise each individual CMC is more technologically advanced, economically priced, and compact in size than anything else on the market.

The CMC mixers from AHB offer built-in microprocessing, have controlled routing and muting; 32 on-board memories can be recalled instantly or stepped sequentially by footswitch. The optional interfaces CM164 and CM364 provide memory expansion; event sequencing (2048 events) and tape or drum machine synchronisation when linked to a Commodore 64 computer.

All the CMC mixers have in-line monitoring, 3-band sweep EQ, 6 auxiliary sends, solo-in-place and ultra smooth long travel faders.

8 track: CMC16, 16-8-2 format, 24 inputs at remix.

16 track: CMC24, 24-16-2 format, 40 inputs at remix.

24 track: CMC32, 32-24-2 format, 56 inputs at remix.

The main master left and right meters are switchable. The meter bridge can either have PEAK or VU characteristics.

So look into the CMC range for yourself and get into the new generation of sound mixers today.

(Commodore 64 is a registered name of Commodore Business Machines).

Please send me your fully illustrative informative brochure on the CMC range of sound mixers.

Name

Address

Tel. No. Bus. Home



69 Ship Street, Brighton, BN1 1AE • Telephone (0273) 24928 • Telex 878235 MBI AHB G
5 Cornair Road, Orange, Connecticut • Telephone (203) 795 3594



MIXING ART WITH SCIENCE

EXHIBITION PREVIEW

audio accessories including a line of cabinet and case fittings.

N

Neumann: the complete line of products including studio condenser mics, disc mastering equipment, the *AME 591* equaliser system, the *AMR 544* auto fader system, and the *AMM 576* remote controllable mic preamp system.

Neutrik: new at the AES will be six new modules for the Audiograph 3300 measuring system. They are the Synchro Module 3360 for auto measurements of record players and tape machines by generating test tones; Frequency Expanding Display Module 3335 allows extension of selected section of frequency response by factor of 1:99; Noise generator/tracking send filter 3324 1/3- and 1-octave filters with digital noise generator; tracking receive filter 3314 allows frequency selective measurements; Distortion Analyser and recorder 3337 and a compressor module 3323 containing a power amplifier, a reference mic pre-amp and a servo amplifier.

Neve: featured products will be the new *Necam 96* automation system which will be demonstrated throughout the show and incorporated in a new multitrack console that has been developed from the 51 series consoles. This desk will be available in three frame sizes up to 60 channels with full 48 bus mixing. Also there will be details of the new digital

DSP consoles. **Nexo:** on display will be various loudspeaker systems for sound reinforcement together with dedicated signal processing electronics. **NTP**

Elektronik: in addition to their range of meters, amplifiers and Audio Switching System 512 will be showing an advanced software-based automatic audio test package. The ATS enables the user to easily create test routines.

O

Optimix: will exhibit the *Optifile*, a disk-based automation computer designed to be retrofitted into non-automation ready consoles. The system offers the same basic facilities as Optimix plus the advantages of an SMPTE driven system, using only one track of the multitrack tape and eliminating cumulative time delays. **Orban:** full range of products including a new dedicated stereo synthesiser with remote control capability, polarity reversal and Dynafex. **Ortiplas:** a wide selection of audio and video cassettes and magnetic tapes.

Otari: will be showing the full range of analogue audio recorders; the *DP-80* high speed tape duplication system; the *DP-4050* cassette copiers and other products. The featured item will be the new 32-track digital PCM recorder which will be shown for the first time. This 1 in machine conforms to the PRODIGI (PD) format and is fully-compatible with the Mitsubishi X-850.

P

Penny & Giles: will be showing their full range of studio faders and servo-controlled audio faders. New products will be a servo-controlled quadrant fader and a 'T' bar quadrant fader. **Philips:** will be showing a range of CD players and disc mastering equipment.

Polyform: will show the series 100 compact disc manufacturing equipment for nickel electroforming of CD, CD-ROM video disc and optical memory disk faders. **PPG:** will exhibit latest developments in their synthesiser systems. **PRECO** (Professional Recording Equipment Co): main emphasis will be on the new compact *Micromax* NAB cart player that will allow two machines to be placed side by side in a 19 in rack. Also featured will be the Sound Technology 3000 series programmable transmission/audio test system. Additionally there will be a range of bulk erasing equipment. **Publison:** the *Infernal Machine 90* with a new multi-sampling program. It becomes a high quality bank of sounds—41 s max capacity at 20 kHz bandwidth with powerful MIDI interface. It may be remotely controlled from a new remote box which also includes a digital potentiometer. Also on show will be the *Gold Pitcher*—2-channel device with delay, echo and pitch shifting with several de-glitched programs and a

Ax[®]

Hot news on the COOLEST SOUND AROUND



Price £299 including VAT

Aphex Aural Exciter Type C

EVEN MORE EXCITING THAN THE CLASSIC TYPE B.

Ax[®] APHEX PROCESSED

EXHIBITION PREVIEW

multi-sampling MIDI interface, memory capacity is 5 s or 20 s at 16-bit, 20 kHz bandwidth. **Pyral**: range of audio tape products including sprocket punched tapes for 35 mm use and lacquer disc masters.

Q

Quad: range of products from Quad including the new 306 power amplifier. **Quad Eight/Westrex**: first European showing of the Quad Eight *Superstar* console—in 72-input form with centrally assigned mixing buses, *Intelligent Digital Fader System*, and *Compumix IV* automation. Also on display will be the *Westar* console with its plug-in interchangeable EQ, preamps, VCAs and faders. Westrex will be showing a range of film dubbing equipment. **Quantec**: both the *QRS* and the *QRS/L* room simulators will be demonstrated. The featured new product will be an external control system for the *QRS*. This is a hardware and software package to run on an IBM PC, Apple *MacIntosh* or an Atari. Connection to the *QRS* is via the remote socket and there are no further mods necessary. The unit includes an SMPTE timecode reader and this will allow full cueing against timecode of front panel functions and memories. The computer screen will show all control status information. **Quantum**: no details available.

R

Ranson: will be showing products for the broadcast and audio industry including cart machines from Broadcast Electronics; the new *Fidelipac* cart machines; Shively antennae; CRL AM and FM audio processors; and a repackaged version of the SAE scratch removal system for audio discs. British products on show include a new range of modular mixers from Soundtech; ASC's *Minx* mini mic mixer, digital profanity delay and modified *Revox PR99*. Also on display will be the *Regis* computerised automation system built by ECA 2. **Rebis**: are exhibiting their *RA200* series of modular processors and effects including the latest expanders, compressors and frequency conscious gates and revised *RA226* sampler. **RE Instruments**: no details available. **Rood**: will be showing their range of broadcast products including stereo encoders and decoders, bandwidth extension systems, MPX equipment, and drives for FM transmitters. The new product on display will be a pre-synthesised drive for FM transmitters. **RTS**: full range of products including intercom systems, preamplifiers, IFB systems, phono preamps, monitor amplifiers, distribution amplifiers and mini mixers. **RTW**: will feature their new analogue/digital interface for the Sony *PCM-701*. Other products on

display will be the *1109* peak meter for digital recording—a PPM with selectable attack time and an extended scale for headroom indication.

S

Sacher Musik: will be showing the range of products that they are Swiss distributors of including HH Electronics, C-Audio, Ram and Dynamix mixing consoles, Countryman mini condenser mics and the Hill stage products, cables and accessories. Featured new products will be the *VX* series of MOSFET power amplifiers from HH Electronics with power ratings from 2-channel 80 W to 2-channel 600 W; and the C-Audio *SR* series of MOSFET power amplifiers with power ratings from 200 W to 850 W dual channel. **SAJE**: will be featuring a variety of consoles suitable for radio, TV studios, recording, theatre and stage applications. **Saki Magnetics**: new products include 24-track 2 in replacement heads for the Otari *MTR-90* and the Ampex *MM1200*. Also on show will be the complete line of other 24-track heads for MCI, Mincom and Studer machines as well as examples of the rest of their tape head range. **Sanken**: will be exhibiting an expanded range of mics alongside the established *CU-41*. This includes the *CU-31*, *CU-32*, *CMS-2* and *CMS-6* together with a full range of *CU-41* accessories. **SATT Communications**: will show their well-

ALESIS
STUDIO ELECTRONICS

Cold facts on the HOTTEST REVERB AROUND



Alesis XT:c Digital Reverb

16 kHz bandwidth, 90dB dynamic range, 16 bit conversion, 128K bytes memory, 39 kHz sample rate, variable high frequency roll-off, 0–200 ms pre-delay, 0.1–12 secs decay time, full stereo, infinite hold, 8 programs, from plates and gated effects to massive halls and reverse reverb.

Price £720 including VAT

NOTHING COMPARES

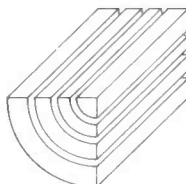

sound
technology

Telephone: 0462 675675
Telex: 826967

Sound Technology Limited,
6, Letchworth Business Park,
Avenue One,
Letchworth,
Hertfordshire SG6 2BB.

EXHIBITION PREVIEW

established **SAM 82** and **SAM 42** audio mixers. Designed for reliability, low weight and compact dimensions they are well suited to OB, ENG and EFP uses.

Schmid Fernmeldetechnik: will be showing their range of audio frequency transmission measuring equipment including the **SZ 311** programmable signal generator, the **SZ 331**

programmable measuring receiver, and the **SZ 340** stereo sound programme circuit analyser.

Schoeps: featured new product will be the **BLM 03C**, a new small boundary microphone designed to be connected to a **CMC Colette** series amplifier. In addition on display will be the **CMTS** stereo condenser mic and their three vocal mics with different directional patterns. **SCV Audio**: full range of signal processing equipment and accessories. New products include the model **MD8** active 8-channel DI box.

Seidel: cassette production equipment.

Sennheiser: full range of dynamic, electret, and condenser microphones featuring the **MKH 40P48** low noise condenser mic. Other products include headphones, test equipment and radio mics. **Shape**: no details available.

Shure: will be showing the full product range. Featured new items will include the **FP16** compact self-contained audio distribution amplifier; the **FP32** stereo microphone mixer; the **FP42** stereo studio mixer; the **SM1** one ear cue pro broadcast headphone/microphone and the two ear **SM2** version of the same model.

Siemens: no details available. **Sifam**: will be featuring a new dual peak programme meter indicator known as **type 74** which has two concentrically mounted moving coil movements. Other products on display will be single movement PPM and VU meters, low cost audio level meters, and a wide selection from the collet and push-on knobs that they produce. **Solid State Logic**: will be demonstrating their complete range of audio consoles including the **SL 6000 E** equipped with the **SSL Studio Computer**, the **SL 4000 E** Master Studio System and the **SL 5000 M** Audio Production System with the optional new Instant Reset system which holds up to 48 stores of all console switch statuses.

Sonosax: will be showing the **SX-T** compact mixer for studio and broadcast applications and the portable military spec **SX-S 6**-, **8**- and **10**-channel mixers featuring rugged aluminium cases, gold connectors and 83 mm P&G faders.

Introduced for the first time will be a small stereo mic preamplifier designed to facilitate sound recording with two microphones into any tape or video recorder. **Sony Broadcast**: will be showing a large number of products including the **DMR-2000** and **DMR-4000** digital audio recorders which interface with the **1630** processor. These machines will be shown working with the **DTA-2000** digital tape analyser in a complete CD mastering system. Two **PCM 3324** digital multitracks will be shown operating in sync under a newly developed software control. Also the digital 2-tracks **PCM-3102** and **3202** will be shown. On the analogue side **APR-5000** machines will be shown in a

number of formats. A new compact mixing console, the **MXP-2000** will be shown for broadcast applications. The new **BVR-90** chase synchroniser and two new mics—the **C-535P** and the **C-536P** will also be displayed. **Soundcraft Electronics**: will be showing the **200B** versatile mixer available in sizes up to 24 inputs; the series **600** mid range 8/16-track recording desk; the **TS24** top of the line console with the new stereo input module and the **FX** return module; the **SA** range of power amplifiers and the rest of the range. There is also going to be a major new launch but no details were available at time of writing.

Soundtracs: will be showing complete line of mixing consoles. On show for first time in Europe will be **IL24** in-line console with 24 or 32 channels with VCA grouping. Also on display will be **CM4400** with **CMS2** interface to 24-track controlling muting/routing against timecode; the **M** and **R** series for live and studio use respectively; the **8-16** series and the **T** series. **Stanton**: will be showing a wide range of phono cartridges and accessories. New items include the **681EEE Mk IIs** high performance cartridge; the **310B** stereo phono preamplifier; and the **Dynaphase 30M/SR** shoulder rest single cup

Shure's WS-41 windscreen

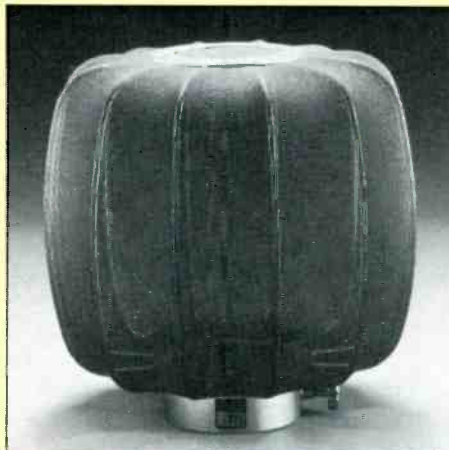

Mitsubishi X-86 digital mastering machine



headphone. **Stellavox**: are featuring their range of tape machines, mixers and related accessories. **STR**: will be showing and discussing their CCMS concept—computer-controlled matrix systems. A working model of the newly realised routing control system will be used to show some of the possibilities.

Strudwick Research: no details available. **Studer**: an all new Studer broadcast recorder, the **A807** will be introduced at the show. The **A807** features a rugged diecast chassis, three servo-controlled motors, phase compensated electronics and microprocessor audio alignment. The machine will accept up to 11.1 in reels and operates at three speeds. A wide range of available formats, including a console, portable and 19 in rack-mounted version, cover most professional requirements. Also new is the **A812** broadcast recorder designed for broadcast, video post production and general recording studio use. The **A812** is a 4-speed machine able to handle up to 12½ in reels. Most of the operating keys are user programmable from a software-based function library and the phase compensated audio electronics are all under digital control, including audio alignment. Studer is also introducing two new synchroniser control systems, the **SC 408** and the **SC 4016**. The **SC 4008** being primarily designed for audio editing and video post production and the **SC 4016** for both the simple and the most highly complex audio/video slave/master machine setups. Other products on show include two new versions of the **A820**, a ½ in version and a ¼ in stereo with centre-track SMPTE code. **Switchcraft**: full range of interconnection products. **Synton**: will be exhibiting their latest vocoder, the **Syntovox SPX 216** which features 14-channel speech analysis/synthesis with built-in VCO and noise generator.

T

TAC: will have a number of products including the **Scorpion FB**, **TX10**,

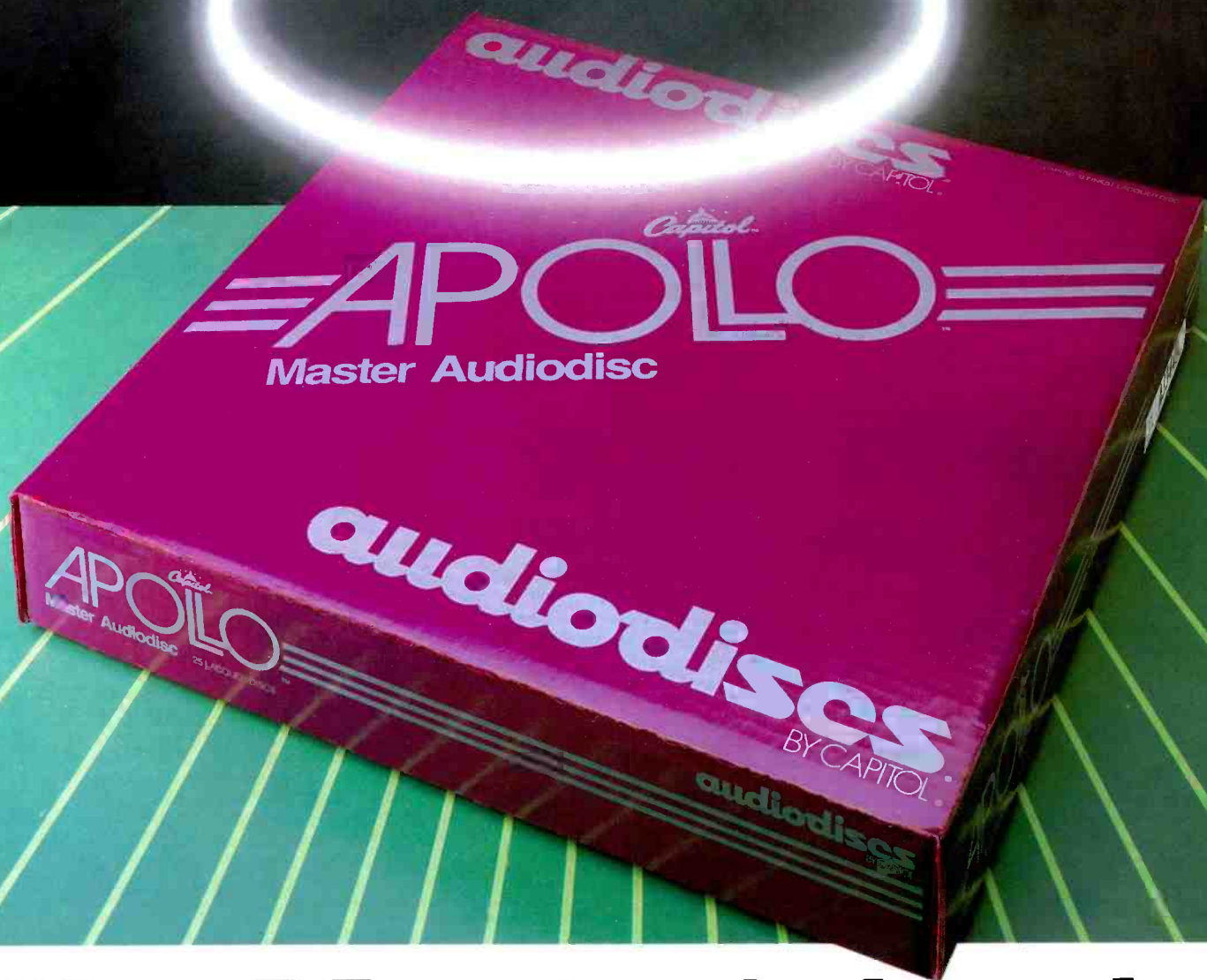

The Master is back.

We're perfectionists at Capitol Magnetic Products, so when our Apollo Master Audiodiscs no longer reached our own exacting standards we refused to supply what we regarded as an unacceptable product.

Fortunately, we had the expertise to not only identify and correct the original problem, but in doing so we have been able to further improve Apollo's overall performance, therefore we are proud to announce Apollo's return.

Capitol Magnetic Products Ltd.,
1-3 Uxbridge Rd., Hayes, Middlesex
UB4 0SY. Telephone 01-561 0922.
Telex 917029. Fax 01-573 9623.

APOLO TM
MASTER AUDIODISC

Apollo is back, now better than ever.

**SEE US AT AES
STAND E6**

EXHIBITION PREVIEW

Matchless and the latest *PBC* (Production Broadcast Console) the *PBC* is housed in a standard 27 module, all-steel chassis and is fitted in a 20/4/2/2/1 configuration which could be loaded with fewer input modules if required. In addition to recently introduced products TAC will be showing the options available with the *Scorpion*. **Tannoy**: are celebrating a 60th birthday this year. They will be showing the new improved *SRM* series dual concentric monitors, the *DTM-8* compact nearfield monitor which uses a recently designed 8 in dual concentric driver; the *FSM* studio monitor which uses a 15 in dual concentric driver with an additional 15 in bass unit and an adjustable window to acoustically match free or soffit mounting; models from the *Wildcats* live music range and the *SR840* power amplifier. **Tape Automation**: cassette duplication products. **Tapematic**: will be showing various video and audio cassette duplicating products. **Teac/Tascam**: examples from the tape machine, cassette recorder and mixing console product line. Featured new products at the AES will be the *ATR-60* series 2/4/8-track tape machines and the *388* 8-track recorder/mixer package. **Technical Projects**: will be showing a variety of equipment including test equipment, talkback systems, consoles and the *ART 421* automatic reverberation timer. **TOA**: featured items will include the *P* series professional power amplifiers in 75 W, 150 W, 300 W 2-channel versions and the 150 W and 300 W mono models; the *E* series graphic equalisers; the *ME* series monitor speakers; a range of new microphones and the *D-4/D-4E* mixers. **Tore Seem**: will be showing examples of their range of mixing consoles from large computer-controlled systems down to portable ENG types. **TracSystems**: will

be showing the *CD201* modular cassette duplication system designed to provide high quality copies at low cost. **Trident**: will be showing consoles from their series *80B*, *75* and *65*. The *65* will be shown in a 16-track form which has been newly introduced. **TTL**: no details available. **Turbosound**: will be showing the *TMS*, *TSE* and *TMW* series of sound reinforcement loudspeakers.

U

Ursa Major: will be showing the new Aurora digital reverb and effects unit model *ADR-68K*. Software-based the Aurora includes full MIDI control and sound sampling capability, a 2 in/4 out design allowing two different programs to be run at the same time. **US-Audio**: will be showing the *Gatex 904*, a single channel version of the *Gatex* 4-channel noise gate/expander designed to be housed and powered by the dbx *F-900* frame. Also on display will be the *Leveller* a sophisticated 2-channel dynamic range controller requiring minimal technical knowledge for effective operation.

V

Valley People: will be introducing the new Model *415 Dual DSP* (Dynamic Sibalance Processor) and the single channel version, model *815 DSP*. The latter including a link switch to enable two units to be used for stereo operation. Also new is the *PR-10* and *PR-2* powered rack units, designed to be cost effective and suitable for the *800* series signal processing devices they are designed to house either 10 or two units respectively

W

Wandel & Goltermann: range of audio analysing and measuring

equipment for development, production, installation and maintenance operations. **Westec**: will be showing their inline *LT 3000* Studio System console available with either 24/32/40/48 or 56 I/O modules and also featuring a comprehensive 20 Mbyte, hard disk computer system. **Westlake Audio**: European Westlake distributors. **Britannia Row**, will be showing the complete range of audio monitors and accessories. They also have a soundproof demo booth. **WH Brady**: range of splicing and sensing tapes for audio and video applications. **Woelke**: range of multitrack record, play and erase heads and cue track heads for 1/4 in use. Also a range of test equipment.

Y

Yamaha: will have a variety of signal processing devices, PA equipment, consoles and new MIDI-related products.

Z

Zonal: full range of magnetic sound recording products including audio tape available in a variety of widths for mastering and broadcast, as well as acetate and polyester magnetic sound recording film for post sync, dubbing, pre-mixing and editing.

Studio Sound: we will be exhibiting the latest issue together with copies of our sister publications, *Broadcast Systems Engineering* and *One to One*, in addition to our other reference publications. Both editorial and advertising staff will be in attendance at the stand or around the convention and we look forward to meeting anyone who wishes to drop by for a chat. □

Syntovox SPX 216



USAudio 904 expander/gate

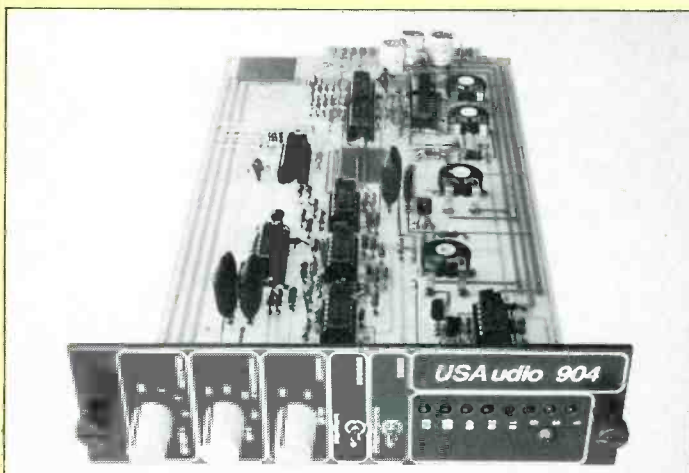

Ursa Major digital reverberation system



WHO NEEDS.....

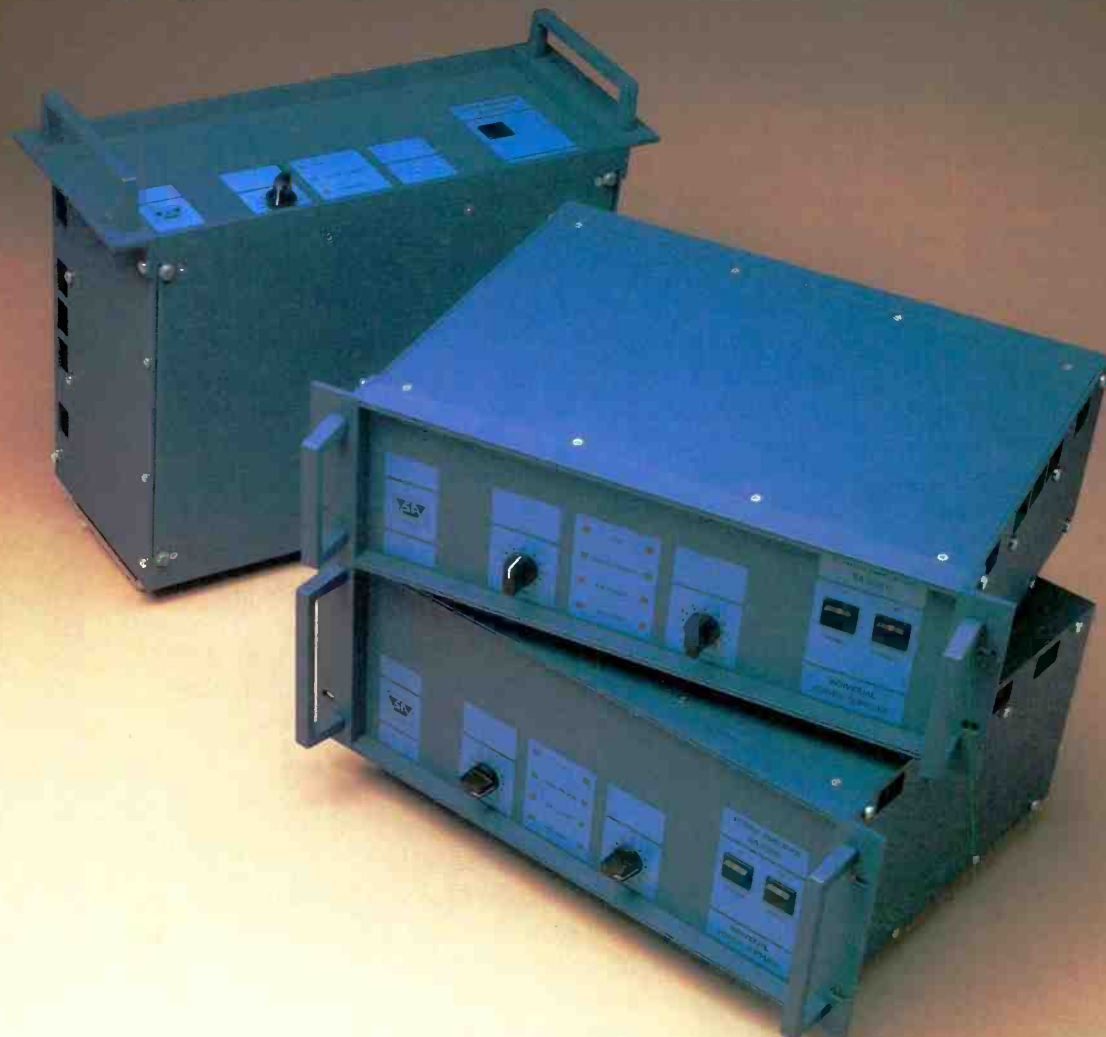

JUST ANOTHER AMPLIFIER ?

*If you want that rare combination of a superb performance, high reliability and extreme solid construction: **YOU DO !!***

The SA 900C & 500C: not "just amplifiers", they feature ultra fast, high voltage, full complementary output devices and the use of top-quality components all-over. They combine with very carefully designed circuitry to guarantee a superb performance and outstanding electronic stability.

The application of individual power-supply modules with high power, high efficiency custom designed toroidal transformers, reduces crosstalk and power-dumping to the almost immeasurable levels, necessary to accommodate the high dynamics of digital sound sources. It also creates the possibility for ideal wiring to further decrease crosstalk and harmonic distortion.

Electronically balanced inputs can be switched in and out and allow for bridged-mode operation. Long life 41-step potentiometers are

used as input level controls. To prevent earth-loops a ground-lift switch is also provided for each channel.

An opto-coupler operated protection works very efficiently against switching peaks, heavy overload, DC and short-circuit on output, whilst temperature sensors protect the amplifier against overheating. LEDs indicate clipping, signal present, overload/short circuit and overheating.

The power and driver-transistors are mounted on two heat sinks with "Sil-Pads" for superior long-life heat transmission. A two-speed, thermally controlled ultra low-noise fan is built-in for optimal cooling.

Specially designed aluminium profiles make the amplifier very solid and truly **Road** and **Roady-proof** for many years.

The SA 450C is a single channel, 100V line version of the SA 900C.



stage company

Stage Companyyou need it!

For more information contact: Holland: Stage Company, Anodeweg 4, 1627 LJ Hoorn, tel:(0)2290-12542, telex37989 Stage nl
Austria: Kühnl & Wurzer, Waldeggstraße 68, 4020 Linz, tel: (0)732-688125 Belgium: Stage Company, Hendriklei 50, 2020 Antwerpen, tel: (0)3-2160352 France: Caw Sonoss, 3 Rue Vieille, 59160 Lomme, tel: (0)20-925091 Germany: Stage Company, Marienburger Straße 29, 4460 Nordhorn, tel: (0)59211-6196 Hong Kong: Studer Revox (far east) ltd, 25th floor Arion commercial centre, 2-12 Queens Road West, Hong Kong, tel: 5-412050 Italy: Kennel snc, 324 Corso Unione Sovietica, 10135 Torino, tel: (0)11-612148 Japan: Sakata engineering co ltd, 2-6-8 Ohjima Koto-Ku, Tokyo, tel: (0)3-682-8411 Switzerland: Stage Company, Spiseeggstraße 30, 9030 St. Josefen, tel: (0)71-281696 United Kingdom: S.E.D., 27 Guildfordstreet, Luton LU1 2NQ, Beds, tel: (0)582-452495

Sycologic was formed to provide innovative new products which allow the modern musician creative freedom within the confines of today's available technologies. Three such projects are the PSP, Mi4 and M16.

The Percussion Signal Processor opens up a whole new world for the electronic percussionist. In addition to conventional pad to MIDI and MIDI to trigger conversion facilities, signal processing tasks are performed. Playing information from up to 8 drum pads and a hi-hat pedal is both digitised and regenerated, enabling the PSP to enhance a standard electronic drum kit's playability, whilst providing an advanced MIDI interface. Each pad can be assigned several performance parameters including MIDI Program, Note, Gate Time, Pitch Bend, 'Feel' and Channel. These may be adjusted independently or selected from a bank of 50 user-definable Patches. To assist live playing, Patches may be selected remotely from the drum pads allowing the drummer to select new configurations without touching a button. In addition, sound processing software has been included to allow dynamic MIDI events to be generated from sound sources connected to the pad inputs. Considering all of these advanced features the PSP must be the key component of any 'state of the art' percussion set-up.

As the number of instruments incorporating MIDI increases, the problem of interconnection becomes more of a nightmare. A solution can be found using Sycologic's MIDI Matrix switchers. These unique devices reduce the limitations encountered with MIDI 'Chain Networks' allowing instruments to be configured at the touch of a button.

The Mi4 is a 4 by 4 Matrix which allows any one of 4 MIDI Sources to talk to any combination of 4 MIDI Destinations. Connection points on the Matrix are made digitally by selecting the required Source and Destination buttons, or remotely, using the optional Mi4R infra-red transmitter. A connection is indicated by an LED at the

intersection of the lines on the Matrix. The presence of MIDI data is also indicated by LED's in the Source switches. To make the Matrix clear and simple to use, white squares have been provided opposite each button allowing the connected instruments to be labelled.

For configurations of more than 4 machines, the M16 presents an ideal solution. This new device is in the form of a 16 by 16 Matrix, but with provision for the connection of 2





Expander modules allowing the system to be enlarged to 16 by 32, or 16 by 48. Matrix connections are made via a numeric keypad on the remote control panel, the patch being displayed on a 40 character by 2 line LCD. The remote panel is connected to the rack unit via a single lead allowing all the bulky MIDI connections made to the rack to be situated out of sight. Up to 32 Matrix Patches may be stored and recalled, allowing a complete Studio to be reconfigured in seconds. Patches may be changed from the remote panel or by a MIDI Patch Change from one of the 16 Source instruments. Each Source and Destination has an 8 character label which is displayed along with its number during editing. These labels can be assigned with the name of the instrument connected, saving the need to constantly refer to what machine is connected where. Another useful feature of the Matrix is its ability to send pre-assigned Program Changes to any Destination when a new Matrix Patch is selected. This allows one MIDI Patch Change from the Master instrument to configure not only the connections of the Matrix, but also the Programs of all the instruments connected.

Sycologic — the logical solution.

20 CONDUIT PLACE, LONDON W2 TEL 724 2451
TELEX 22278 SYCO G, FAX 01-262 6081

TLM 170 DESIGN

Stefan Peus and Otmar Kern of Neumann describe the new transformerless microphone which has a very wide dynamic range

Neumann's new studio microphone differs so greatly from previous models that it's been given a completely new designation, *TLM 170* (TransformerLess Microphone). The numbers identify it as a

switchable pattern microphone with a large double-membrane capsule.

In recent years, circuit designers have focused their attention on eliminating transformers in the audio signal path. This is not an easy task and until now microphone designers have instead chosen to push transformer design to the limit in order to obtain ultra-high quality results. Still, the inherent disadvantages of transformers cannot be entirely eliminated. For example:

- the impedance of transformer windings is frequency dependent;
- transformers exhibit distortion at ultra-low frequencies and high magnetisation levels;
- transformers introduce distortion at extremely low magnetisation levels;
- transformers are susceptible to external magnetic fields;
- transformers restrict mechanical design due to their bulk.

In condenser microphone design, the transformer serves the very important purpose of matching the high internal operating impedance of the microphone circuitry to low impedance line levels.

While it is possible to use lower internal impedances, it increases the powering requirements. Current consumption of the circuitry must lie within the range permitted by the phantom powering

IEC/DIN standard. Fig 1 illustrates the normal 48 V phantom powering method utilising standard 6.8 kΩ resistors feeding positive voltage to both modulation leads. This powering method

Inside the TLM 170

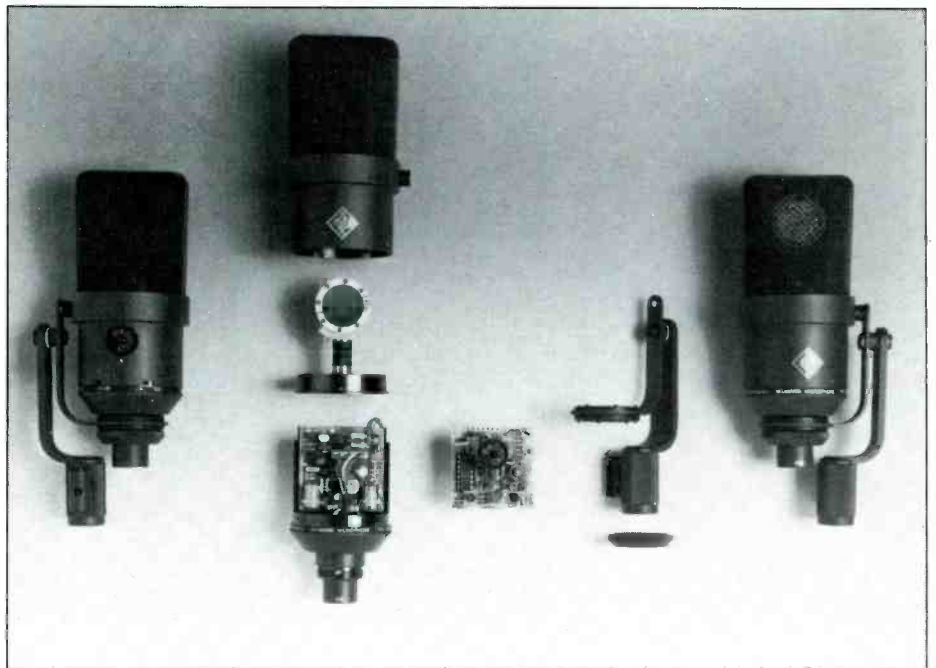
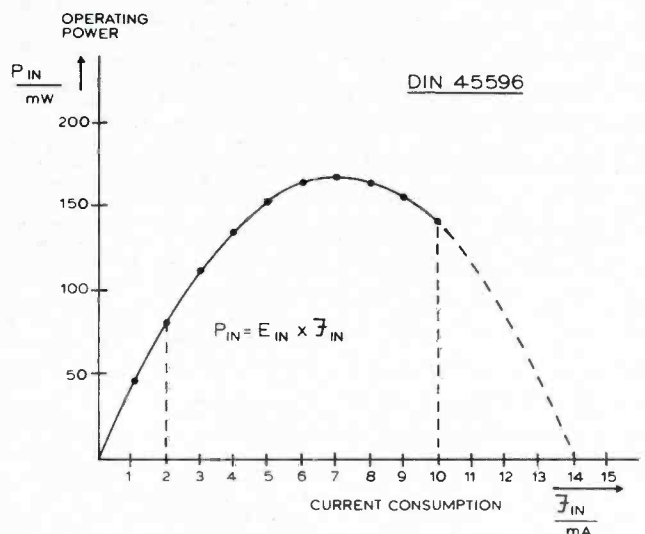
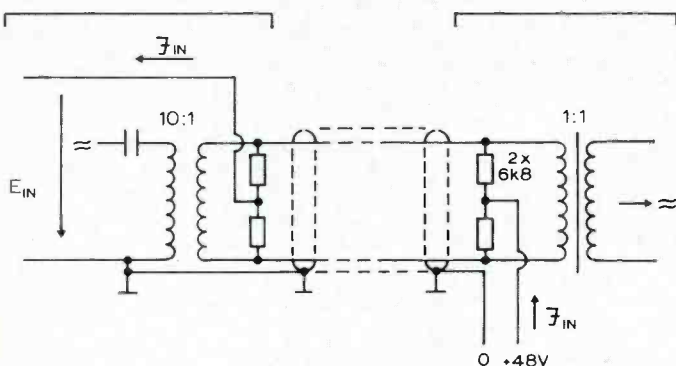

FIG 1
NORMAL 48V PHANTOM POWERING METHOD



is specified in DIN 45 596/IEC 268-15A. Formerly, only 2 mA of powering current was allowed but that was changed in 1981 to allow up to 10 mA.

Fig 2 is a block diagram of a typical condenser microphone. The 48 V from the phantom powering circuit supplies voltage to the amplifier as well as polarising voltage to the microphone capsule. The 48 V powering makes the circuitry especially simple. Other powering systems using lower voltages require the microphone to contain an internal DC voltage converter to produce the polarisation voltage for the capsule.

This is also the case where several voltages are required for pattern switching. It is important to note from the circuit diagram that the microphone output transformer is constructed with a static winding which acts as a highly effective shield against RF induction through the microphone cable.

For reasons mentioned previously, Neumann engaged in a research project to develop an electronic impedance matching network which would eliminate the microphone output transformer. The goal was to produce an amplifier circuit with low power consumption, yet have high output level capability.

The result is the *TLM 170*, a microphone with an active output stage, eliminating the usual transformer, and with an internal DC voltage converter of extremely high efficiency which allows a significant extension of the dynamic range. Until now, the highest dynamic range of a Neumann microphone was 120 dB relative to the A-weighted self-noise level attained by the *USM 69* concert hall microphone. The dynamic achieved by the *U 87* studio microphone is only 104 dB, however, the *TLM 170* achieves a dynamic range of 126 dB—22 dB greater.

Over the years self-noise level has been lowered while output capabilities have been expanded upward. The *TLM 170* microphone extends the self-noise level to 14 dBA while pushing the maximum level to 140 dB SPL without using the 10 dB overload protection switch. This dynamic range is far greater than that of the mixing console or PCM tape machine.

Development goals

The development project for the transformerless *TLM 170* microphone

had the following underlying goals:

- the self-noise level of the microphone should be significantly lower than the present day studio microphones which have a noise level of the order of 18 dBA. This would satisfy the requirements for future transmission and storage techniques with greater signal-to-noise ratios than those presently known;
- the microphone should be able to pass sound pressure levels of 140 dB SPL with less than 0.5% THD;
- the current consumption should be low for compatibility with a central powering system as well as battery powering;
- interference due to parasitic cable currents and external RF induction should equal the same high standards available today in Neumann microphones (greater than 60 dB common mode rejection);
- the microphone should maintain its technical performance without compromise from phantom powering voltages in the range of 24 to 48 V without requiring a voltage selector switch.

DC voltage converter

Because the microphone had to operate properly from 24 V phantom powering, the input voltage range was specified as 20 to 52 V but with the requirement that total powering efficiency be clearly improved relative to present microphones in order to meet the goal of extended output level capability. This objective was fulfilled completely.

Fig 3 shows a block diagram of the final circuit which is a switching power supply using pulse width modulation to regulate the voltages. When the transistor (T) is on, current flows into the transformer (Tr) which acts as a storage inductance. When the transistor switches off, energy is fed to the secondary windings thereby producing the various output voltages.

The pulse width control circuitry consists of a fixed-frequency oscillator, reference voltage, error amplifier, comparator and pulse width limiter. By using special circuit techniques in conjunction with C-MOS transistors, the power consumption of the control circuitry is kept to only 9 mW. This extremely low power consumption is made possible by utilising the self-

generated secondary voltage of the power transformer to power the circuitry. This requires start-up circuitry to deliver the initial energy to the oscillator circuit. Designing a switching supply to operate in such a low range required special attention to switching losses. These arise not from the switching transistor (T) which is a V-MOS type but rather from parasitic capacitances within the circuitry and above all from the winding capacitance of the transformer (Tr). For example, at test point (MP) potential changes of 50 V occur in less than 200 ns, thus even the smallest capacity values on the order of few picofarads cause a reduction in the efficiency.

The power transformer is a very difficult problem because it must have a step-up ratio in order to produce the polarising voltages. A rather unique circuit, based on the flyback technique used in TV receivers, made it possible to use a transformer with only a fraction of the turns normally required. This, in turn, led to a drastic reduction in the winding capacity and a comparable reduction in the losses. Referring to the circuit diagram, the choke (Dr) causes a short duration, high voltage peak to be generated when (T) is switched off. This voltage peak is limited to three times the value of the blocking voltage by the parallel zener diode (ZD). Fig 4 shows the waveforms actually generated during the switching cycle. The high voltage peak couples to the four secondary windings of the transformer and are rectified and filtered to generate the capsule polarising voltages.

There are some applications where the output capability of the *TLM 170* microphone exceeds the signal handling capability of the user's input preamplifier. This is especially true in the semi-professional field. For such cases, the output level of the *TLM 170* can be reduced by 10 dB. Rather than the usual technique of shunting the microphone capsule with a fixed capacitor to reduce its sensitivity, the capsule polarising voltages are reduced by shorting the choke with switch (S), resulting in 10 dB less output level.

Audio amplifier

The realisation of a nearly lossless DC switching supply was the most difficult step in the development. With that task completed, development effort centred on

FIG. 2
BLOCKSCHEMATIC OF A MICROPHONE

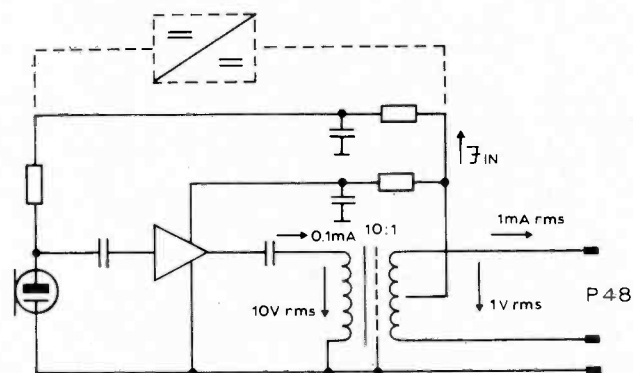
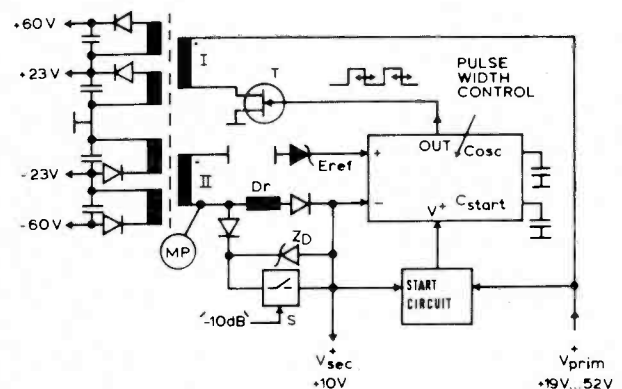

FIG. 3
BLOCKSCHEMATIC OF THE DC-CONVERTER



a linear amplifier with high output capability and the lowest self-noise level possible.

A simplified diagram of the new audio amplifier which resulted from this research is shown in Fig 5. The AC signal from the condenser capsule is fed to two field effect transistors in a series arrangement. This two-stage amplifier has an open circuit amplification of approximately 70 dB which is reduced to unity by a negative feedback connection from the output to the source of the first FET. In this circuit arrangement, the FET's source voltage directly follows the gate voltage thereby eliminating the effect of gate-to-source capacitance. The upper FET serves to eliminate the gate-to-drain capacitance of the first FET by virtue of the fact that its gate is likewise connected to the output of the amplifier and, therefore, functions as a bootstrap for the drain connection of the first FET. Both FETs are selected low-noise types with very low pinch-off voltage.

The output amplifier is also a two-stage design with negative feedback to achieve unity gain. It is followed by a push-pull output stage. The amplifier includes a two-pole Butterworth filter for suppression of mechanically induced low frequency noise switchable between 30 Hz and 100 Hz.

The output circuitry of the *TLM 170* is balanced to ground, however, the audio signal is only applied to one modulation lead. Both modulation leads were designed to have equal impedance to ground. Therefore, the common mode rejection of a balanced transmission system is maintained. The *TLM 170* offers excellent rejection of outside interference signals comparable to transformer balanced Neumann microphones.

Capsule system

The pick-up element employed in the *TLM 170* is a double membrane condenser capsule with a 28 mm diameter. It has extended frequency range and is the first such transducer produced by Neumann which is capable of reproducing the entire front half-room soundfield with no adverse colouration. This results from properly matching the low pass properties of the inner capsule elements with the transition frequency of the pressure gradient as the driving force, and the influences of pressure build-up and

TLM 170 DESIGN

sound diffraction at the transducer.

The *TLM 170* offers five direction patterns. The frequency response for all five directional characteristics is linear not only for sound from in front (0°) but for sounds impinging on the microphone from the sides. All sounds are attenuated equally in conformity to the directional characteristic of the microphone. The *TLM 170* also has a linear frequency response in the diffuse soundfield for all patterns.

These directional properties are maintained from 10 kHz down to the lowest frequency where previously all double membrane capsules had a tendency to become omnidirectional. The microphone behaves very much like a system using two separate capsules, for example, the *KM 86*. This characteristic allows much more freedom in positioning the microphone near the sound source since turning or tilting it does not introduce side colouration effects which are usual for double membrane capsule systems such as the *U 87*.

The five switchable patterns also contribute to this positioning freedom. Besides the familiar omni, cardioid and figure-of-eight, there are two additional patterns: wide cardioid and hypercardioid. The wide cardioid is a pattern between omni and cardioid which attenuates sounds from the back by approximately 12 dB while side sounds are only down 4 dB. This pattern would be preferable to the traditional cardioid for small instrumental or vocal groups. The hypercardioid pattern extracts from its surroundings the smallest amount of 'room tone' of all available patterns. This means the ratio of direct sounds (arriving at the microphone from in front) to diffuse sound (the sum of the sounds from all directions) is very high. By definition, a hypercardioid extracts one quarter of the sound power of an omni of equal sensitivity to a 0° positioned sound source. The directivity of the hypercardioid is equivalent to 6 dB

while the cardioid and figure-of-eight patterns are only 4.8 dB. The total angle over which the hypercardioid attenuates sounds is 110° which is ideal for many recording situations.

The entire surface of the capsule is metalised and at ground potential. This technique protects and shields the essential parts so that even droplets of condensing humidity or the dirt film which forms after years of operation have virtually no influence on the high impedance of the capsule and, therefore, no effect in the S/N ratio of the system.

Mounting

The *TLM 170* is mounted to its microphone stand using a swivel bracket attached to the side of the microphone. This bracket has built-in rubber elements which protect the microphone from mechanical shock. Vibrations in the mounting elements. Vibrations in the important frequency range between 50 Hz and 150 Hz are damped up to 15 dB using the swivel bracket attached to the microphone when compared with a swivel (rigid) mount connector. Only for isolation from very low frequency vibrations is the much more complex elastic suspension assembly (EA 170) recommended.

Conclusion

The *TLM 170* operates from both *P48* and *P24* phantom powering systems. Though it draws only 2 mA of current at 48 V, the highly linear amplifier achieves a maximum output voltage of 2.45 VRMS or +10 dB relative to 775 mV, while the A-weighted self-noise level is below 14 dB SPL. This is an increase of over 18 dB in headroom and a reduction of 4 dB is amplifier noise when compared to a *U 87*. The *TLM 170*'s transformerless output is particularly insensitive to capacitive loading, because there is no interaction between the conjugate complex impedances with the capacitance of the cable. There are also no energy storage elements comparable to the inductance and the stray capacitance characteristics of transformers found in other microphones. Therefore, TIM and frequency discrimination are not present even when using very long microphone cables. Amplifier pulse response is phase perfect over the entire range. □

FIG. 4
VOLTAGE AT TEST POINT 'MP'

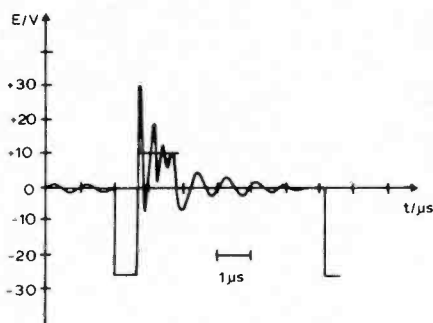
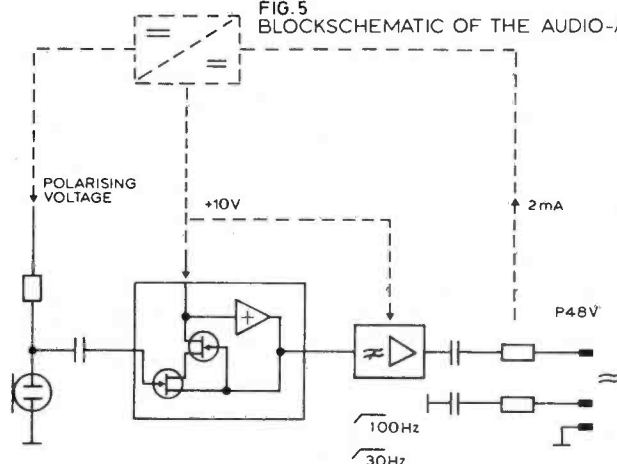

FIG. 5
BLOCKSCHEMATIC OF THE AUDIO-AMPLIFIER



► This is live sound's most far-reaching development in over a decade.

Its design carries Worldwide Principle Patents, the first of their kind in years.

Its unique, remarkable qualities are completely new to live music.

Five years after its development, with 15 years of patents still to run, Turbosound's loading devices remain the leaders.

With the companion TurboBass™ device, our system leaves speakers that depend on compression drivers and so-called 'state of the art' materials standing.

Transients, dynamics, the unique ability to keep the 'feel' of the original sound – these are Turbosound properties.

All without any active compensating electronics.

Who else can say that?

In practice, the TMS and TSE Series not only sound great, they're an economic tour-de-force too.

Because cabinets and drivers produce their acoustic results naturally, they are simple and reliable.

Super compactness adds benefits in the shape of lower touring costs. Wider installation capabilities. Fast handling.

**It's five years old.
And still 15 years ahead
of the world.**



Turbosound were the first people in sound reinforcement to see that live sound stands or falls by its midrange quality.

So we developed the TurboMid™ to cover the 250Hz – 4kHz vocal range without a crossover point.

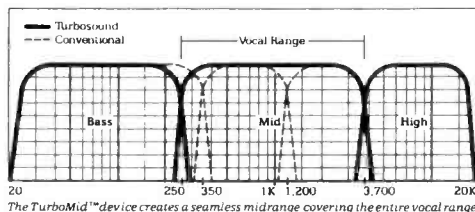

The TurboMid™ device creates a seamless midrange covering the entire vocal range.

The midrange is clear and seamless, unlike the sound of any PA system you've ever heard.

It helps us reduce distortion to hi-fi-like levels and to raise SPLs, despite our cabinets' compactness, to as much as 141dB.

Precise point-source arrays.

Add the practical to the sonic and you can see why they're increasingly regarded as the elite of sound systems.

Having created them, of course, we'll continue to listen to engineers and musicians – and stay ahead.

If you haven't heard a new Turbosound system, catch one in concert or call Tim Chapman on 01-226 0099 for a special audition at our London demo room.

You'll find out why it'll take the world years to catch up with us . . .

Turbosound
A member of the Turbosound Group of Companies London New York

Turbosound Sales Ltd. 202-208 New North Road, London N1 7BL Tel: (01) 226-0099 Telex 265612

Turbosound, Inc. 611 Broadway #841, New York, New York 10012 Tel: (212) 460-9940 Telex 230199

Worldwide distributors: Australia: Creative Audio Pty Ltd Melbourne (03) 354-3987 Austria: Audiosales Moedling (2236) 888145 Canada: Belisle Acoustique Inc Quebec (514) 691-2584 China: Wo Kee Engineering Ltd Hong Kong (5) 249073/5 Denmark: Per Meistrup Productions Karlslunde (02) 151300 France: Regiscene Paris (01) 374-5836 Greece: Alpha Sound Athens (01) 363-8317 Holland: Ampco Holland b.v. Utrecht (30) 433134 Hong Kong: Tom Lee Piano Co Ltd Hong Kong (3) 722-1098 Indonesia: Atlas Sound (Pte) Ltd Jakarta (01) 85123 Israel: Barkai Ltd Ramat-Gan (03) 735178/732044 Italy: Audio Link Parma (0521) 772009 Milan (02) 285-0334 Japan: Matsuda Trading Co Tokyo (03) 295-4731 Korea: Bando Pro-Audio Inc Seoul (02) 546-5491/5 Malaysia: Atlas Hi-Fi Sdn Bhd Kuala Lumpur (03) 432104/432077 Norway: Nordrek Equipment a/s Oslo (02) 231590 Singapore: Atlas Sound (Pte) Ltd Singapore 220-4484 Spain: Lexon s.a. Barcelona (03) 203-4804 Sweden: Inter Musica b. Skovde (500) 85260 Switzerland: Studio M + M Schonenwerd (64) 415722 Thailand: Bangkok Cine/Graphic Center Bangkok (2) 314-3570 UK: Turbosound Sales Ltd London (01) 226-0099 USA: Turbosound Inc New York (212) 460-9940 West Germany: Adam Hall GmbH Usingen (6081) 16031

AN LF PHASE SHUFFLER

Tim McCormick presents some new ideas based on an old principle to improve directional recording of low frequencies

Low frequency performance of directional microphones can often leave something to be desired, not only in their inherent LF sound quality but frequently also in their polar response because it is hard to engineer good directional properties at low frequencies. Directional mics with good LF polar responses suffer from lack of LF extension, the classic example being the ribbon figure-of-eight. It might be instructive to examine why.

A single diaphragm figure-of-eight mic operates on the pressure gradient principle. At low frequencies, wavelengths are long and therefore the magnitude of the pressure gradient between the front and rear of the diaphragm is low at these frequencies. Path difference from front to back of the diaphragm—essentially creating an amplitude difference—becomes less marked and so the bass rolls off. This path difference is necessarily limited in microphones of practical size. Improving the bass by enclosing or partially enclosing the rear of the diaphragm degrades the directional properties. All the usual directional microphones contain a figure-of-eight component (experimentally I have 'extracted' a figure-of-eight from a single diaphragm cardioid, even though there is no primary figure-of-eight component there in the first place) and so they must have a compromised performance at the bass end to a greater or lesser extent with respect to either polar or frequency response; or more commonly, a bit of both. Applying appropriate bass boost gives a directional mic more bass quantity but the quality is not always very good; also it does nothing for its LF polar response, and the LF haze of sound you sometimes get hovering around the middle of the stereo picture when using a crossed pair is only aggravated by bass boost.

What is needed is a microphone system which gives both naturally extended bass and good LF directional properties. Enter Blumlein's 1931 patent no 394325 which

describes, among other things, how to extract directional information from two slightly spaced omnis, making use of LF phase differences between the two. He envisaged this as a full range directional array, the HF directionality being achieved by amplitude difference brought about by the use of a small baffle between the mics. But why not use this system at low frequencies only, taking advantage of the good LF sound of omnis and the good LF directional properties of the Blumlein technique, leaving the mid and high frequencies to conventional directional mics which perform rather better in this area than do a pair of slightly spaced omnis each side of a baffle. The baffle can also be dispensed with as it is not required at low frequencies.

A system is proposed whereby a pair of omnis are placed 18 in apart, with a conventional directional pair in between (Fig 1). Highpass filters are used with the crossed pair. Lowpass filters are used with the

omnis, together with a Blumlein phase-shuffler circuit to give a directional LF output. The two filter outputs are combined to give a full range stereo pair, with good LF extension combined with good all-frequency directional properties. Fig 2 gives a block diagram of the layout.

Let's examine the principle of operation of the omnis. Left minus right gives a sideways-facing figure-of-eight at low frequencies: imagine a sound coming from centre-front. Both mics pick up equal sound intensity at equal phase, so reversing the phase of one, then combining the outputs, gives zero resultant output. For a sound coming from say 45° left, both mics again pick it up at equal amplitude (the mics are close enough together, and far enough away from the source, for this to be a reasonable assumption) but there is now a phase difference due to the spacing and so reversing the phase of one, then again combining the outputs produces a resultant output which gives the sideways-facing figure-of-eight. But due to the fact that phase difference decreases with decreasing frequency, the

amplitude response of the resulting figure-of-eight decreases with decreasing frequency, so appropriate linear bass boost is applied to the resulting output to correct for this. Note, however, that this is for entirely different reasons than adding a little conventional bass boost to a pair of directional mics. The output of one of the omnis is then combined with the resulting figure-of-eight in the usual M-S sum and difference manner to give conventional stereo outputs. (This is a little simpler than Blumlein's proposal; we are only going up to 100 Hz so only one of the omnis need be used for the 'sum' channel. With phase differences being small at LF one omni is nearly equal to the sum of the two omnis.) After the lowpass filter these are combined with the directional pair to give the final stereo output. The high pass and low pass filters combine in the voltage domain, not the power domain as is the case with speaker crossovers, so the high pass one is 'de-tuned' up to 130 Hz to give a flat frequency response in the overlap region.

A practical circuit is given. The spacing of 18 in is appropriate to the low pass filter turnover frequency—100 Hz—and also to the gain given by R8/R9 and C21 in the Blumlein shuffler. Eighteen inches gives a useful degree of phase shift between the mics

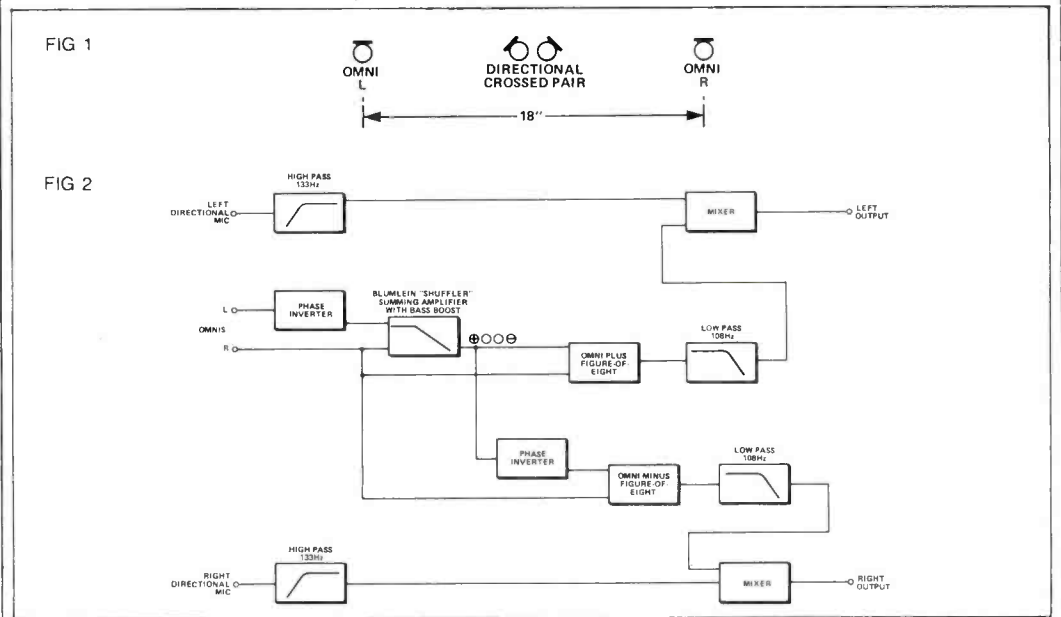

Audioscope

NO LONGER UNDER WRAPS

Now there is a range of highly sophisticated audio frequency analysers plus a technologically advanced multichannel audio level monitor . . . all is revealed in our full colour brochure

Michael Stevens & Partners

Invicta Works Elliott Road Bromley
Kent England BR2 9NT 01-460 7299

---- High Spec - Low Cost ----



At less than £1600 the remarkable Fostex Synchroniser is well worth a closer look!

Test drive or hire one now - ring (01)-267 9395



PROFESSIONAL AUDIO & VIDEO EQUIPMENT

Multitrack Hire Ltd 66 Rochester Place London NW1

AN LF PHASE SHUFFLER

and so not too much bass boost is required (about 18 dB at 20 Hz) so the system (including power supply ripple!) is not overstretched.

In these days of digital recorders with flat bass ends free of analogue 'woodles', not to mention their rather revealing qualities, I think it may well be a good idea to combine this new technology with Blumlein's 1931 ideas in the described manner to improve the LF performance of our microphone array in recording situations which can benefit from it. The technique is very simple and straightforward, and it works.

Setting up involves not only getting the right balance between the two microphone

pairs but also ensuring that the gains of the two omnis are exactly equal. Any amplitude difference as opposed to the wanted phase difference going into IC9 is subjected to conventional bass boost which is unwanted and a bad case of this will give a bass sound akin to turning up the bass tone control on a hi-fi amplifier. It is best to listen to just the omnis emerging from the circuit on their own and tweaking the left omni gain to null this effect out. Slightly too little gain produces bass boost; slightly too much

produces bass boost also, so the mid null point must be sought. A better way is to have an AC voltmeter permanently connected across the inputs of ICs 2 and 3, switched to the 100 mV range. The left omni is tweaked to give lowest meter readings—less than 100 mV in a nominal operating level of 1 V will give insignificant bass error but at this point the omnis are giving a full range output although we are only interested in the bass. It is a good idea, therefore, to contrive a simple RC treble roll-off at say

150 Hz feeding the meter, because differences of 1 or 2 dB at the bass end can easily arise due to mic tolerances and coupling capacitor tolerances which determine low bass roll-off.

After this, the omni gains should be left strictly alone, relative balance between mid/HF and LF being achieved by adjusting the gains of the directional pair. Overall level is controlled at the mixer's master output level. □

NB: TL07 series ICs are entirely suitable for the circuit. DC offsets at the outputs of ICs 9, 14 and 16 are of no consequence but should be checked to make sure that they are not too large—say less than 1 V.

References: A D Blumlein: BP 394325 December 1931
M Gerzon: 'Ultra-directional microphones', *Studio Sound*, October 1970

Editor's note

Tim McCormick designed and built this unit for his own use and it is not commercially available. The circuit is not difficult to build, however, and should there be sufficient interest, the author may be able to supply completed units.

**Tim McCormick, Central Recording Services, 17 Roy Close, Narborough, Leicester LE9 5DN, UK.
Tel: 0533 866883.**

SYSTEM CIRCUIT DIAGRAM

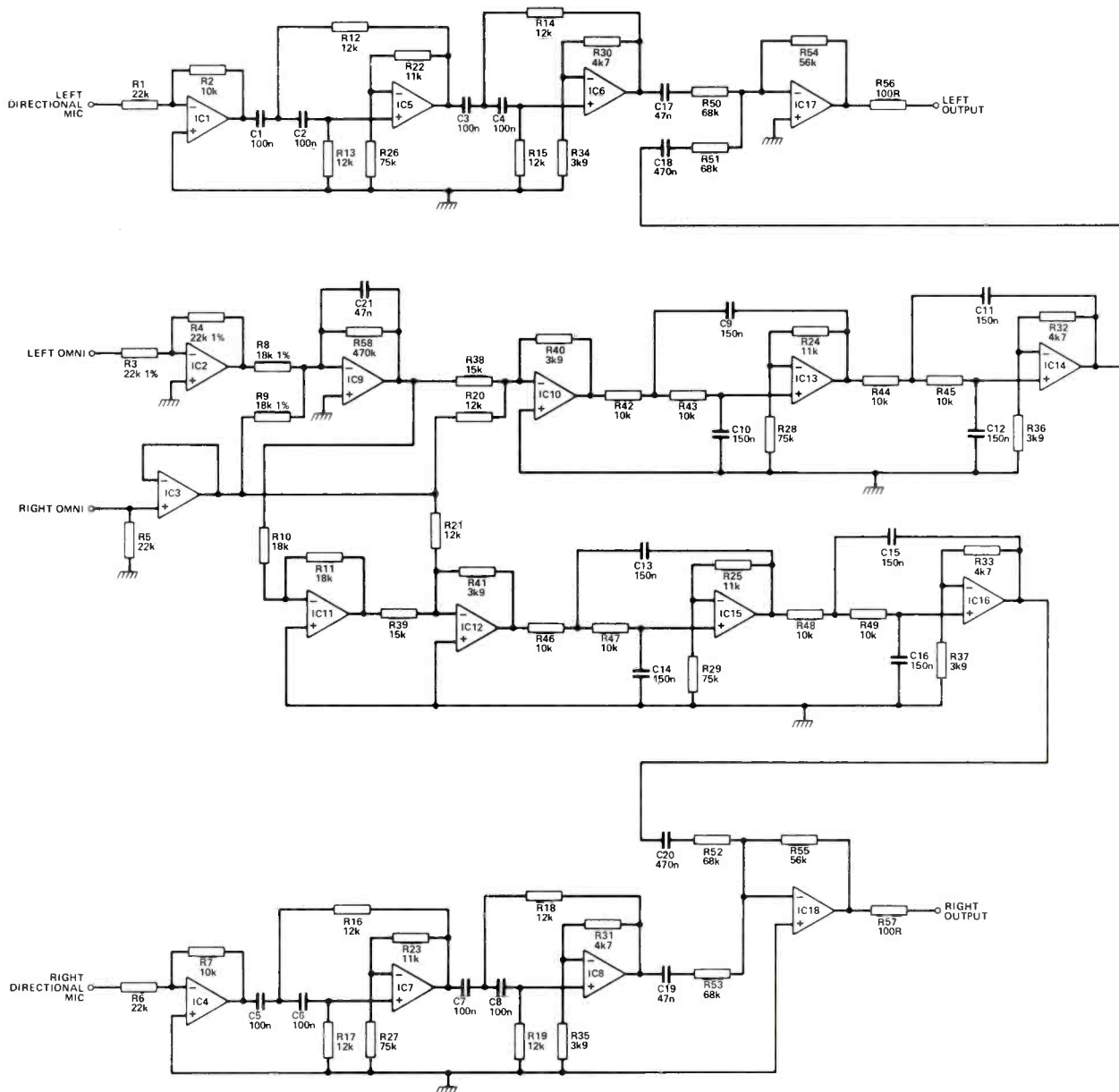

Quantec Room Simulation

Quantec heralds a new era. A revolution in acoustic versatility. Every sound environment is obtainable at the push of a button. Acoustics are no longer bound by the specific configuration of a room, but can be used to emphasize a scene, enhance or improve a sound or enrich a musical composition.



More than just a Reverberator.

Quantec GmbH, Sollnerstr. 7a
D-8000 München 71
Tel. 089/7 91 40 41, Telex 5 23 793



Syco. We are

Syco, 20 Conduit Place, London W2
Telephone 01-724 2451 for an appointment
Telex 22278 SYCO G, Fax 262 6081

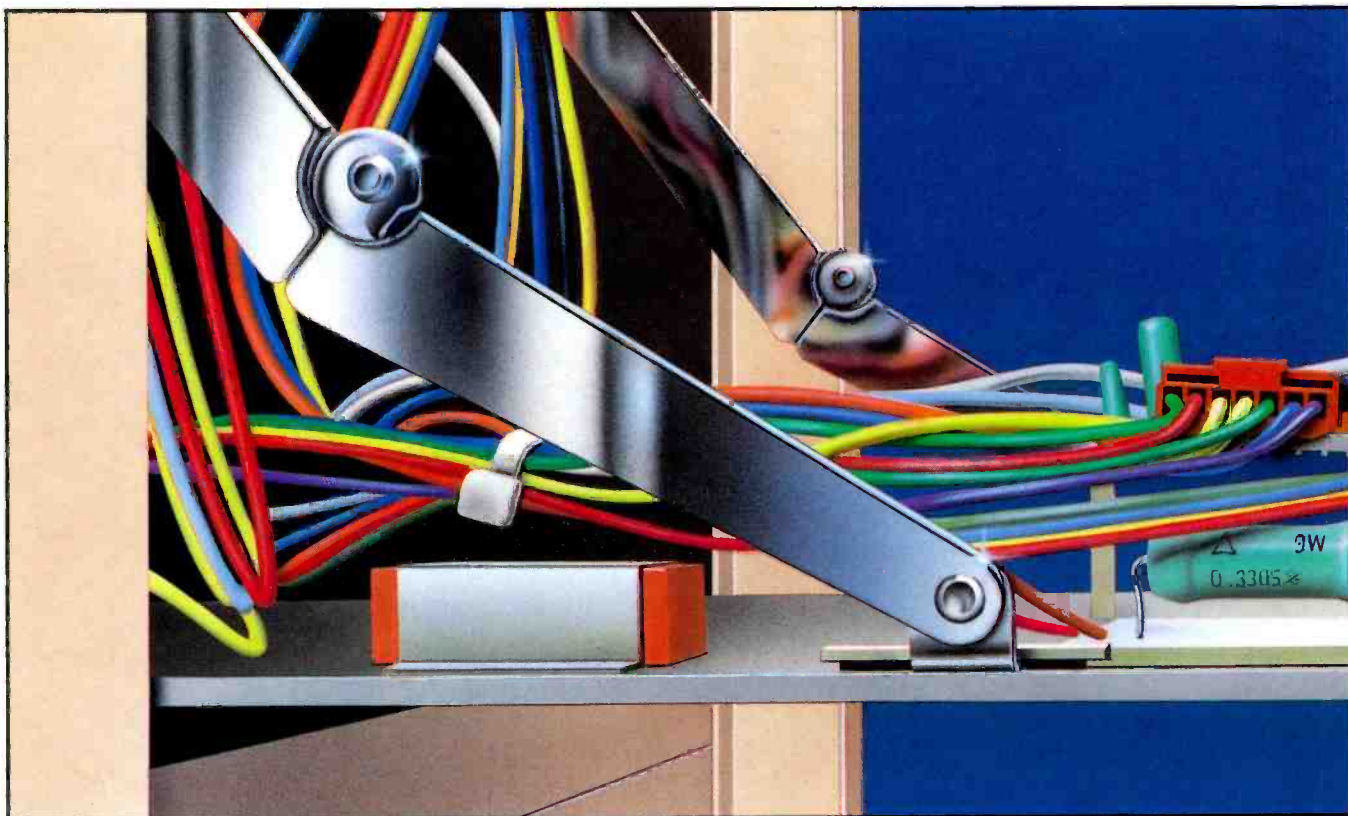

**IT MAY SEEM JUST
A DETAIL TO YOU,
BUT OUR REPUTATION
HINGES ON IT.**

Otari Corporation
2 Davis Drive,
Belmont, California 94002
Telephone: (415) 592-8311
Telefax: (415) 591-3377
Telex: 910-376-4890 OTARICORP BLMT

Otari Electric Co. Ltd.
4-29-18 Minami-Ogikubo,
Suginami-ku,
Tokyo 167
Telephone: (03) 333-9631
Telefax: (03) 331-5802
Telex: J26604 OTRDENKI

Otari Singapore Pte. Ltd.
625 Aljunied Road,
07-05 Aljunied Ind.,
Complex Singapore 1438
Telephone: 743-7711
Telefax: (743) 6430
Telex: RS36935 OTARI

Otari Electric Deutschland GmbH
Gielen Strasse 9,
4040 Nuess 1
Telephone: 02101-274011
Telefax: (02101) 222478
Telex: 8517691 OTELD

Otari Electric (UK) Ltd.
22 Church Street,
Slough,
SL1 1PT
Berkshire
Telephone: (0753) 822381
Telefax: (0753) 823707
Telex: 849453 OTARIG

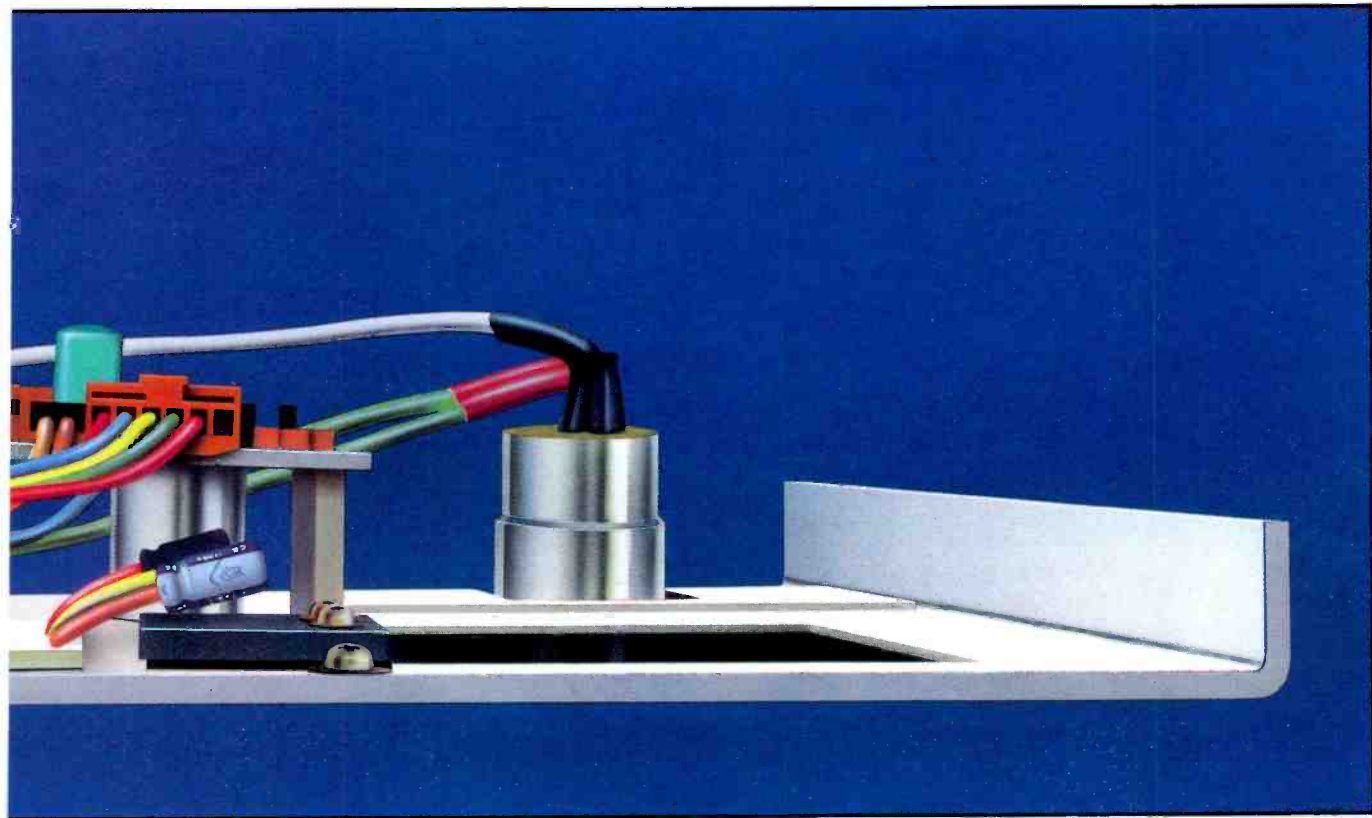

This panel protects the mother board at the heart of the Otari MTR 12. And it's hinged to allow easier access.

The MTR 12's power supply is fully modular, too, for fast diagnosis and repair.

Even the transport assembly is hinged, for total accessibility.

In fact, every area of the MTR 12 shows that Otari did more than design a recorder with superlative performance. They also made it easier for you to keep it that way.

All of which goes some way towards explaining what makes the MTR 12 the most professional of 1/4" or 1/2" two-track mastering and production recorders.

Otari's advantage can be summed up in one word.

Detail.

A passionate attention to those things that make a professional's life that little bit easier.

Naturally, because it's Otari, the technology is true state-of-the-art. It's the only recorder of its type to offer 7.5, 15 and 30 i.p.s. And the only design that lets you incorporate IEC format centre-track timecode, with the capacity to resolve mono and stereo pilotones, all in the same machine.

Other than these features, you'll find very few options on the MTR 12. For the very simple reason that the MTR 12's standard specification makes it one of the most complete professional recorders you can buy.

But Otari's attitude can best be shown by the way they build a 24-hour a day mastering recorder to the utmost standards of reliability. And then make it as accessible as they can, for maintenance.

After all, Otari reason, just because they have bent over backwards to make the MTR 12 more reliable, there's no reason why you should have to do the same to keep it that way.

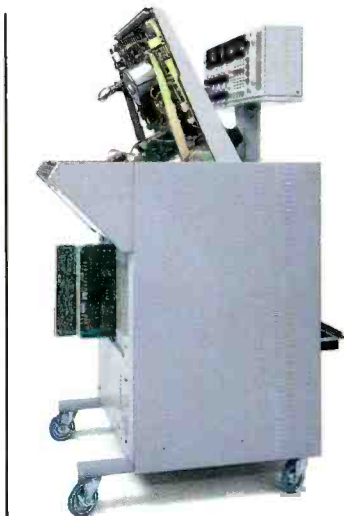

OTARI®

For more information on the MTR 12 or other Otari products, contact
 Industrial Tape Applications, 1 Felgate Mews, Studland Street, London W6 9JT. Telephone: 01-748 9009.
 Stirling Audio Systems Ltd, 1 Canfield Place, London NW6 3BT. Telephone: 01-625 4515.

DESIGN: SWANYARD



Swanyard Recording Studios is situated in the London Borough of Islington, literally a stone's throw from Highbury tube station. The studio takes its name from Swan Yard, a quiet cul-de-sac, away from the busy main road, that originally serviced a local dairy. Nowadays of course you wouldn't recognise the place.

Originally Swanyard Studios had been seen as a much smaller project. At the time Margarita Hamilton, now the co-deputy chairman of Swanyard, had been running a production company along with Roddy Macdonald, Swanyard's technical director. "I was sitting in my back garden in a deckchair one summer," Roddy explained, "thinking that the production company was spending a lot of money on studio time and that it would be a lot cheaper and much more sensible to build a facility that we could use, but which was client-based." That was three years ago and the germ of an idea that ultimately led to the current facilities.

As fate would have it both Roddy and consultant Neil Grant, of Discrete Research had been at university together and when the idea of building a studio had first been mooted they naturally discussed various ideas. Out of these informal discussions the

Every so often a new studio arrives which for a variety of reasons, seems to become something of an industry talking point. The opening of London's Swanyard Recording Studios was such an occasion. Carl A Snape reports on the aims, design and thinking behind the project

current studio began to evolve. "It was something Neil and I discussed for ages. In the end all we did was change the budget to try to make it work economically. Strangely enough, spending more guaranteed more stability in terms of returns.

"As you can see we wanted to build a large control room where lots of people could work without getting in each other's way. Seventy or eighty percent of work is done in the control room and has been for the past two or three years, if not longer. I'd seen that trend for possibly the last 10 years, so the decision to build a studio around a large control room was perfectly obvious and obvious to everyone else as well."

The basic plan for the studio had been agreed very early on. Discrete Research provided a formal feasibility study which,

apart from one major alteration, outlined the studio largely as it stands today. As architectural consultants for the project Discrete Research was responsible not only for the acoustic specification but everything from the soil pipes to the fabric in the control room. When I spoke to Neil I asked him if there had been any problems finding a suitable building.

"We looked at a whole series of places before the Swan Yard site was decided upon. It was the best available place. We had 4000 ft² that was completely open without any obstruction from pillars, structural members and we had a reasonable headroom. The headroom wasn't as much as I would have liked but it was certainly better than anything we had seen at the time. That withstanding, we removed the entire floor—it

was originally one large loading dock—and recast it at a lower level to create greater headroom."

In all it took something like five to six months to repair and renovate the derelict dairy before any of the studio structural work could begin in earnest. The control room at Swanyard is of course based on the LEDE (Live End, Dead End) principles and I asked Roddy why they had chosen that particular design.

"I had been talking to Neil about it for a long time. I don't like Eastlake rooms, they don't sound very nice—they are a bit aggressive amongst other things. Neil and I discussed various aspects of the design and we decided it would be a very good idea if I got involved in the Syn-Aud-Con design course with Neil. I can now see what I could hear—if you see what I mean!

"It allows you to have bigger rooms for a start—the larger the better—because you're getting diffuse reverberation from the back of the room. We wanted a big room and the monitors actually appear to be louder in some senses than they actually are: they are not being hammered to death. If we are talking about a Hidley type of room of the same size, we'd have problems actually getting hold of any monitoring system, from anywhere in the world, that was not going to disintegrate if you required

heavy rock and roll levels at the back of the room. The other thing was that the imaging is really good because there are no reflections early in the time domain, so everything is very much phase coherent.

"TEF analysis helps and the mathematics of it makes sense: the physics makes sense and it sounds right."

First impressions

In many ways Swanyard is full of surprises. When you first enter the building there is an immediate sense of feeling at home. The reception, general office and dining area all form a roughly open-plan area that creates an extremely relaxed and informal setting. You get a similar impression when you enter the control room. The scale is very impressive—yet the room doesn't feel cavernous. There is a sense of intimacy yet business-like professionalism. Obviously the room has been carefully designed around the needs of the people using it but there is something else about it that is hard to put your finger on. It has a soothing quality that doesn't appear to be there just by accident, as Margarita explained.

"I've always thought that studios were very depressing and tacky. People spend an awful long time working in desperately uncomfortable situations—something like 18-20 hours a day—and they spend their whole life like that. What we wanted to do was create an environment that was like in many ways a home away from home and was a more warm and sympathetic environment because I think psychologically the environment in which people work does affect the way, a) they behave and b) the way they work. If you are brain-damaged and in an really filthy, disgusting, untidy and uncomfortable studio I don't think there is much interaction between the producers or the engineers or the band. It all becomes a frantic, desperate and unhappy situation. That is what I experienced during three years in production. You would come out of the studio feeling unbelievably jaded and depressed and everybody always looked ill."

Somehow the control room at Swanyard doesn't appear that conducive to aggravation. It feels comfortable, not simply in terms of the decor but also in terms of the acoustic ambience.

The room itself is on two levels providing a subtle but useful demarcation between the recording and performing area. All the outboard equipment is housed in the centre of the room in three large wooden 'plinths', out of sight to all but the engineer and producer. There are no tape machines in the room either, these are in an adjoining machine room, again more or less out of sight. The monitors are hidden from view and apart from the SSL console there is little in the room that suggests its function.

Two shallow steps lead down to the lower 'console section' of the room. Roddy explained why, "There are two reasons really, one was to raise the height of the people at the back over the head height of the engineer and producer, etc, in order for them to be directly in the path of the monitors and the other is to keep the outboard equipment behind the engineer at a reasonable height. Now you can turn round and the bottom of the rack is accessible whereas if it was two inches off the floor it's not really accessible and you can't see what you are doing."

How does the arrangement work in practice?

"There were some tricky bits juggling the outboard equipment. It is all angled away from the monitors so the reflected sound is going up the way rather than coming back over your ears. We wanted all the stereo outboard equipment behind the engineer in the middle position so you can judge your stereo depth properly rather than being

way up on one side of the room or whatever. We also wanted to use the tops of the plinth areas for keyboards so in the end that left us only one logical option as to where to put the outboard equipment.

"We have a lot of seats behind the plinths—all the way round. Most people will not go down and interfere with the producer, they keep out of the way. That's a step down. They will sit behind the plinth, they'll lean on it, they can eat there, they can do anything they want there, it's actually very comfortable and it stops people from getting in the way. It clearly delineates the space in which people are going to do their work. The engineer and the tape operator are down there (pointing towards the console). That is their area and everyone else sits at the back and keeps out of the way, and because we use soft dome monitors we have a very wide listening area without any radical fall off."

(According to Neil, "... you can walk from one wall to the other wall and maintain the stereo image—and that's a walk of 10 meters!")

"It also seems to speed things up and generally promotes conversation about what is going on. It stops the 'us and them' and the 'goldfish' situation and makes things a little more relaxed. Everybody has the same mix and I think that produces a better end product."

Acoustic treatment

The Swanyard control room is in many ways very deceptive. To the casual observer the

fabric-covered walls may seem extremely decorative and pleasant but they hide a wealth of important structural and acoustic work as Neil explained, "At Swanyard 90%—if not more—of the acoustic treatments are hidden because the entire shell is covered in fabric. We used a nylon extrusion system which meant we could 'blind-fix' fabric wherever we wished.

"The entire back wall is one large, broadband diffuser. It is called a quadratic residue diffuser. This refers to the number theory which was used to generate the wells—well depth—and it uses mathematics in a practical design developed by Peter D'Antonio and RPG Diffusor Systems Inc. The only exposed sections are the lower frequency diffusers to the left and right of the centre section—the oak slats. These are primitive root diffusers. It is a different number theory and the concern there was to try to break down the traditional standing wave structure which is such a problem. To remove a resonant frequency or you can either diffuse it or you trap it and absorb it but conventional trapping theory is appallingly inadequate. Conventional diffusers fall into a number of well known types—the area we were concerned with was low frequency absorption.

"Low frequency absorption has been done traditionally, in rock and roll studios, by hanging baffles. These are relatively lightweight in structure and use a fibreboard with glassfibre laminated on to either side but they are not low frequency absorbers. We have taken the TEF into countless studios and demonstrated to people that they have no low frequency absorption beyond that which is caused by the diaphragmatic absorption of the acoustic shell itself.

"In order to make hanging baffles work you have to substantially increase their mass. We do use baffles, we use them to kill what would otherwise be a large resonant cavity but this form of bass absorption does not work. You can also make a very good low frequency absorber from a large membrane but in order to absorb the frequencies you require you have to have a very 'lossy', a very heavy, floppy diaphragm and a large chamber. You can then become very frequency selective and you can adjust the Q of the absorber. The problem is that these devices tend to saturate at very high sound pressure levels and we are dealing with

Studio area looking towards control room



DESIGN: SWANYARD

rooms where typical replay sound pressure levels will be considerable. There are one or two other approaches that can be taken. Mid-band and high frequency absorption is relatively straightforward but the only other option for low frequencies is to diffuse them.

"Since the conception of Swanyard we have been in discussions with RPG and we can now supply a cast concrete low frequency diffuser because at the end of the day what you are trying to achieve is a common decay time across the bandwidth. In other words we want, for example, to be able to achieve a 150 to 250 ms decay time across the entire bandwidth. We are seeing rooms which have say a 700 ms low frequency decay time and high frequencies decaying at 78 ms. Because the decay field—if you like—within the room is so skewed frequency-wise this will alter your perception of the monitoring."

Construction

The basic isolation structure at Swanyard is massive and as Neil explained now forms an intrinsic structural part of the building. "When we removed the existing floor we cut down and laid new foundations and new footings for the isolation structure. We cast floor slab footings and then built the isolation wall itself. The isolation walls are 205 mm hollow, high density concrete block which were backfilled, as they went up, with concrete.

"The roof decking was 100 mm thick, formed from a slurry of concrete and wood shavings with steel lipping, on top of which is a 50 mm concrete screed and

underneath on the soffit is a sand and cement rendering. The whole internal shell was then lined out with sand and cement render in order to make it completely airtight. Within that complex shape a completely new symmetrical timber framework was constructed. This is because your requirements are split into two areas above and below the crossover frequency. The crossover frequency is the point at which the timber shell ceases to be the boundary of the sound waves within the room. This is around 250 to 300 Hz. Below that frequency the sound energy finds its barrier outside, at the isolation shell, so you build an irregular bass boundary outside isolation shell to suit your requirements for low frequencies, within which you build a symmetrical timber frame carrying acoustic treatments.

"Isolation is the one thing that is always equated with cash: the more money, the more isolation and vice versa. There is no clever bodge which will solve the problem for you. At the end of the day mass is the most effective isolator. Now you can treat that mass in a number of clever ways. You can decouple it, you can float it, and you can float multiple masses. You can work quite hard at what is becoming an increasingly important area. There is little point in a facility investing in equipment that is capable of 96+ dynamic range if you define the scale at one end as the threshold of pain and at the other end the ambient noise floor of the room and your noise floor eliminates 30 or 40 dB of that available dynamic range!

"We are finding that clients are increasingly critical of noise intrusion. We are invariably removing machines, power supplies and so on into separate rooms. Here there is about 35 dB of isolation between the machine room and the control room. This is sufficient to push the ambient noise floor in the control room down to the levels required. We will go to the lengths of replacing fans on AMS units for example in order to push the noise floor down and this is something we will continue to refine in future rooms. The benefits of complete noise isolation continue to impress us."

Other criteria

"Every studio," according to Neil Grant, "and control room, reception, office and machine room should reflect that the clients are different. They have different budgets and they have different tastes. I see no logic in building rooms worldwide that look and feel and smell the same. Increasingly control rooms will be sold not on the type of console and tape machines that they have but on the monitoring environment and how pleasant they are to spend your time in.

"We used Jackie Ellis of the WCEC Partnership as an interior design consultant and we said what materials and what basic colours we wanted for the control room and she came back with a complete spectrum of matched finishes. I think it has been very successful. Swanyard does not look, touch, taste, smell or feel like a contemporary London studio and this I think helps considerably in the way the

studio comes over—there's no stone in the building, there is very little hardwood. What we have now built is a fabric room, or largely fabric room but we don't think we can do it again. We will have to be cleverer."

In addition to the large control room and the tremendous amount of work required in that area, Roddy had another criterion. Taking a closer look at the plinths you'll notice access to the tie lines, balanced inputs, cue returns timecode and a MIDI bus. "I don't like cables—anywhere. That is why things like Lexicon remotes are built into the desk. We have completely taken the remotes to pieces and there are extra centre sections in the console. Brian Hayward, a freelance who has his own wiring and maintenance company did that. He did the wiring at Mayfair and is doing the refit at Chipping Norton and we had similar ideas.

"Obviously Stuart Bruce our head engineer had a fair bit of input but he joined a little late in the process to effect it visually. There was myself, Neil, Brian, and Nick Ryan. Nick now works with Neil and used to be the studio manager at Sarm West and has done some work for Eddie Veale as well. Between us we decided what we required and we went through it all together."

When deciding what he wanted was this mainly because he found things wrong with other studios, or did he just try to incorporate all the good things he had seen?

"Both really, the only specific criticisms I had of other studios were to do with the sound of the control rooms. ▷

Keyboards in use in the control room



RPG diffusers at rear of control room



"I just think more people ought to know how good Soundtracs gear is . . ."



Tom Robinson

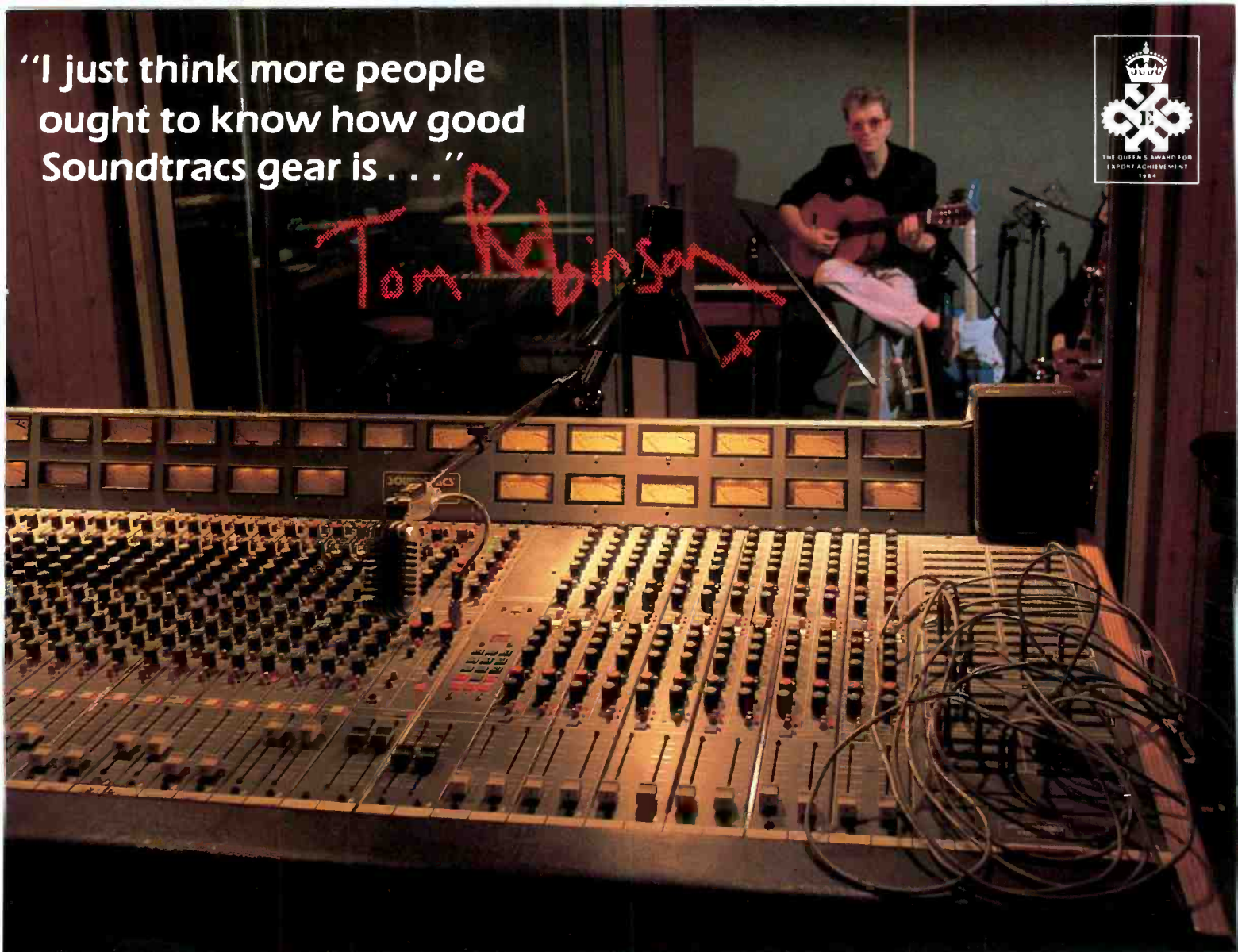

"I did a lot of research before buying a mixing console for Turbot studios. Ideally I'd have liked an SSL or a Harrison I suppose, but frankly, they were out of my price range.

Among the producers & engineers I asked, however, the general opinion was that — if it lived up to its claims — one of the new Soundtracs desks would be excellent value for the money I had.

Well it did, and it was: it's clean, versatile and easily good enough to turn out professional masters. A few minor niggles perhaps, but what the hell. I work with the engineer from a top London studio and he loves it.

Like Pete Townshend I paid the normal retail price for my desk and didn't get any backhanders for this ad. I just think more people ought to know how good Soundtracs gear is . . ."

TOM ROBINSON

THE CM4400 BY



affordable quality

Soundout Laboratories Limited
91 Ewell Road, Surbiton, Surrey KT6 6AH
Tel: 01-399 3392 Fax: 01-399 6821
Telex: 8951073/SNDOUT/G

The CM4400 features:
 Internal computer allowing 30 different mixes to be pre-programmed.
 Pre-programmed triggerable routing patches.
 RS 232 Interface for personal computer to display routing.
 Up-dateable software.
 The CM4400 is always up-to-date.

U.K. Distributor

Don Larking
audio sales

Luton: 29 Guildford Street, Luton, Beds.
 Telephone: Luton (0582) 450066
 Telex 825488 DONLAR

Stoke-on-Trent: Stafford House,
 Clough Street, Hanley, Stoke-on-Trent.
 Telephone: Stoke-on-Trent (0782) 24257

America Soundtracs Inc., 745 One Hundred and Ninth Street, Arlington, Texas 76011. Tel: (817) 460 5519 MCI Intertek Inc., 745 One Hundred and Ninth Street, Arlington, Texas, 76011. Tel: (817) 640 6447 Australia Klarion Pty Limited, 16 Suakin Street, Pymble, N.S.W. 2073. Tel: 2 449 5666. Tlx: AA71289 Austria Audiosales, Postfach 168, A-2340 Modling. Tel: 2236 88 81 45. Tlx: 79456 AUDIO A Belgium Prom Audio, Av. de Stalingradlaan 63, 1000 Brussels. Tel: 02 231 7840 Canada Omnimedia Corporation Ltd., 9653 Côte de Liesse, Dorval, Québec H9P 1A3. Tel: 514 636 9971 Denmark Kinovox AS, Industrivej 9, 3540 Lyngby. Tel: 02 187617 Dubai G&M International, PO Box 1229, Deira, Dubai U.A.E. Tel: (4) 695 794 Tlx: 45505 ETQUAD. EM Finland MS Audiotron, Box 28, SF-00421 Helsinki. Tel: 90 5664644 France Phase Acoustic, 163-165 Bd Boisson, 13004 Marseilles. Tel: 91-498728 Germany Amptown, Hamburg. Tel: 040 6460040. Session Musik, Walldorf. Tel: 06 2272876. Sound & Drumland, Berlin. Tel: 030 8827911 Musik Shop, Munich. Tel: 089 341111. Greece Sound Centre, 22 Tossitsa Street, P.O. Box 148, Athens, Greece Hong Kong Ace (International) Co., 1/F, Wing Ming Ind. Centre, 15 Cheung Yue Street, Cheungshawan, Kowloon, Hong Kong. Tel: 3-7452343. Tlx: 40442 ACECOHX Indonesia P.T. Kirana Yudha Teknik, P.O. Box 71, JNG — Jakarta. Tel: 487235. Tlx: 48120 HASKOIA Israel Barkai Ltd., P.O. Box 2263, Ramat Gan, Israel 52122. Tel: 03-735178/732044 Japan Trichord Corporation, Bunsei Building No. 3 1F18-B, 5 Chome Toranomon, Minato-Ku, Tokyo, Japan. Tel: 3 433 2941. Tlx: 2524324 CMOSL J Korea Young Nak So Ri Sa Co., 182 Jangsa-dong, Jongru-ku, Seoul. Tel: 267-9697. Tlx: K22756 YNTRADE Netherlands Pieter Bollen geluidstechniek bv/PAC, Hondsruglaan 83-A 5628 DB Eindhoven. Tel: 040-424455 Norway BE Sving Benum as, Boks 2493, Solli, 0203 Oslo. Tel: 02-442255 Portugal Amperei Electronica Industrial LDA Av. Fontes Pereira, De Melo, 47, 4°, D 1000 Lisboa. Tel: 532227/532698 Singapore Lingtec Pte. Ltd., 246 MacPherson Road 07-04, Betime Building, Singapore 1334. Tel: 07-471951/07-471952 Spain Telco Electronics SA, Gravina 27, 28004 Madrid. Tel: 231 7840-2210187 Sweden Septon Electronic A.B., Box 4048, S-42104 Vastra Frolunda. Tel: 31299400 Switzerland Studio M & M, Villa Tannheim, CH5012 Schoenenwerd. Tel: 64 4149 69 Taiwan Tai Sheng Trading Corporation, Wantai Building — 4th Floor, 24 Jilin Road, Taipei, Taiwan 104 R.O.C. Tlx: 22275 TAIHIFI United Kingdom Don Larking Audio Sales Ltd., 29 Guildford Street, Luton, Beds. Tel: 0582 450066.

DESIGN: SWANYARD

The comparison between what you think you are hearing and what you *are* hearing—if you could ever pin that down—and just the general level of comfort when listening to high levels of compression drivers and reflections. Traditional rooms reflect a lot of sound at the front end. It is harder to concentrate and very tiring. The rest was picking up ideas from absolutely everywhere. A lot of people involved in studio design have come from an engineer's background, or tend to be that way orientated. I've been playing music for a long time and working in lots of studios and therefore I have more of the artist's attitude to the thing. So I've slightly different perception."

Monitoring

Having basically got the room right, what happened when it came to the monitoring?

Neil: "Monitoring is a minefield. It is an intensely subjective area. One thing that we see clearly, however, is an increasing requirement for lower frequency response. Monitoring systems and rooms are an inextricable convolution of each other and you can't separate the two. One monitor system will sound wonderful in one room and positively appalling in another room depending on how it was installed and how it was set up and how it has been tweaked and how it has been maintained—rooms are the same and it is very difficult to deal with each of them in isolation. You have to consider the monitor system as an inextricable part of the room and work with it as an integral part of that room."

"I still, however, firmly believe that it is possible to design and install a monitor system that is all things to all people. The necessity for small and alternate monitoring, which substantially degrade your principle monitoring source because of the reflections over the console bridge, are made redundant. I would like to continue to see work and development in that direction."

Roddy explained further, "We knew we wanted soft dome monitors because we thought they sounded better. They sound more like a giant hi-fi. We've got a big room, we needed a lot of dispersion and the horns don't do that: they are narrower. We have



Control room under construction

Questeds here. We would have had Neil's monitors as he was building a new mid-dome but they were not ready in time so we ended up with the Questeds which we are very happy with."

There seems to be some growing interest in extending the frequency response of monitoring systems, what were Roddy's thoughts on this particular subject?

"Bass is a function of the size of the room as I'm sure any acoustician will tell you. The bigger the room the lower the response. In a smaller room you generate a pressure front instead of actually propagating a true wave. Whether a very low frequency response is desirable or not is a different matter. It's certainly desirable for CD because you are mastering to a medium which can actually reproduce those low frequencies and you have got to hear if there is any unwanted garbage down there. The other argument, which I think is quite real and I think has been the source of some problem—or will be with bigger rooms where the frequency response will go down—is that some people are not used to hearing such low frequencies."

"Listening to monitors is so bloody subjective and complicated. Having very low frequencies does cause problems with people's perception of the rest of the frequency spectrum. You take them out and everything seems quite normal. You put them back (and because they're not used to hearing it—people are used to hearing limited bandwidth monitoring and monitoring environments) the combination makes some people throw wobblers. Some Americans don't really want to

particularly listen to monitors in that way. Michael Breur in New York has done a lot of work over here. He does a lot of remixing, here, in New York and in Tokyo and he does not like British monitoring at all. He thinks it is too rolled off at both ends!"

Does Roddy think that musicians react adversely to a wide bandwidth?

"I don't think it is the musicians. I think it's the engineers. In fact I know it is the engineers—it's not musicians."

"There is a logical trend to think about wider bandwidth, especially with CD but I don't know that many people are actually attempting to do it. It's one of those gradual things. Mixes, for instance, have got brighter and brighter over the last 10 years and maybe by the same token we will gradually see broader bandwidth monitoring. It is happening bit by bit as people become more use to it and don't feel that they are suddenly being thrown into something where they can't work out the reference points."

The studio

One of the nice things about Swanyard is the way access to the control room has been placed at the rear of the room. Because of the large room, visitors, friends, musicians, etc, can all come and go as they please without interrupting the concentration of the producer and engineer. There is none of the congestion you find in smaller control rooms and there are no interrupted sessions caused by doors swinging in front of the monitors and people exclaiming, 'Oh sorry, I thought this was the loo!'

The view from the 56-input

SSL through to the studio area has been cleverly arranged to provide maximum visibility and minimum acoustic reflection. However, the fact that there is a studio at all appears to have been something of a tug of war situation.

The original intention had been to create an even larger control room with just enough space for basically an overdub booth. Swanyard ended up with a very large control room (with room to include eight musicians) and space for at least 15 musicians in the studio area without, as Roddy put it, "... anyone getting on each other's nerves. The studio is 'livish' at one side and more shut down at the other but not in the sense that it is very live at one end and very shut down at the other. It is more around the medium, just tilted slightly in either direction but it gives us enough separation and although it is not a huge room it really works well."

For a studio that might at first appear to just cater exclusively for the 'electronic' MIDI/SMPTE/DI musician the mic cupboard was remarkably well stocked. Beside the usual complement of microphones there were at least seven B&K 4007 mics and Roddy and Stuart had nothing but praise for the Sanken CV-41s.

Swanyard appears to have done remarkably well in the few short months it has been opened (the official opening date was July 25th 1985). Stage two, the new remix room being done by Discrete Research and incorporating a 64-channel SSL, is due to open later this summer. All in all everyone is very happy the way things have gone. And the future? Well apart from the production company and possibly plans for a record company, Margarita had quite a surprise in store.

"We will have a third studio. We are looking at buildings right now. It doesn't make sense to lose our clients if they use a big orchestra. We want to have a control room like this with an enormous studio area as well—that will be our third."

I trust their search for a suitable building doesn't take them south of Oxford Street to a certain street near to the American Embassy—Haunch of Venison Yard doesn't seem quite appropriate for the name of an undoubtedly exciting new project. □

These condenser microphones are designed expressly for digital audio recording.

They deliver an entirely natural, uncoloured sound. Their distortion figures are insignificant, and their phase response is, to all intents and purposes, perfect.

They are perhaps the finest of their kind in the world.

And in the rarefied quality of CD, they can make the vital difference.

THE SANKEN CU-41.

Developed jointly by Sanken and NHK Research, the CU-41 is the culmination of 58 years of Japanese microphone design.

Two condenser capsules are incorporated, each with a one-micron titanium diaphragm, the most stable material available.

Just as in a full range loudspeaker, one handles the high frequencies; the other, the lows.

The overall response is flat – within 1dB – from 20Hz to 20kHz, and at the maximum SPL of 134dB, T.H.D. is just 0.5%.

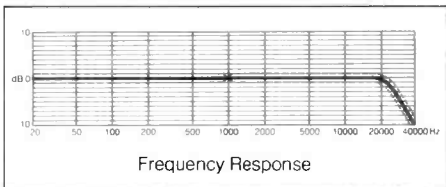

(Each microphone is accompanied by an individual frequency response trace, a unique guarantee of quality).

The Sanken CU-41's perfectly phase-complementary design exceeds the performance of any other microphone in the world.

THE SANKEN CMS-2.

Our unique MS Stereo microphone is the smallest and lightest in the world – just 180 grams of leading-edge technology.

Again, it's in an acoustic class of its own. A very flat response, inaudible self-noise (below 16dB) and a startling 129dB dynamic range add up to extremely low colouration and a near-perfect stereo image.

They are features that make it the perfect choice for broadcast/compact disc recording.



How to make a perfect microphone.

THE SANKEN CONNECTION.

As users of a world-class product, our clients receive excellent before and after-sales back-up.

Ask your distributor (see list) to arrange a demonstration for you, in your studio.

And, of course, they'll provide you with a service that's as good as the microphones themselves – perfect.



Pan Communications Inc., Azabu Heights, Suite 607,
1-5-10 Roppongi, Minato-ku, Tokyo 106, JAPAN.
Tel. 03 505 5463. Tlx. 2423934 KNMPCM J



SANKEN DEALERS WORLDWIDE

Australia: SYNTEC INTERNATIONAL PTY LTD New South Wales Tel: (02) 406-4700 Belgium: RADELCO Antwerp Tel: (03) 233-7800 Canada: GOULD MARKETING INC Montreal Quebec Tel: (514) 342-441 Denmark: SLT STUDIO AND IYDTEKNIK APS Vanlose Denmark Tlx: 22924 SLT DK England: STIRLING AUDIO SYSTEMS LTD London Tel: (01) 625-4515 France: 3M FRANCE Cergy Pontoise Cedex Tel: (03) 031-6423 Netherlands: STAGE THEATER EN STUDIO TECHNIEEL Nieuwegein Tel: 03402 65780 Norway: SIVING, BENUM A/S Oslo Tel: (02) 14 54 60 S. Africa: ELTRON Johannesburg Tel: (011) 29 3066 Sweden: TAL AND TON ELEKTRONIC AB Goteborg Tel: (031) 80 36 20 Switzerland: TEC NAD SA Lausanne Tel: (021) 35 35 01-02 U.S.A.: MARTIN AUDIO VIDEO CORP New York Tel: (212) 541 5900 STUDIO SUPPLY COMPANY INC. Nashville Tennessee.

IN PERSPECTIVE

IN PERSPECTIVE

Comment from Martin Polon, our US columnist

The sleek young man walked into the modernistic suite. Through the double glass and on video monitors the phalanx of musicians surrounding the female vocalist were visible deep in the process of contemplative rehearsal. The man sat down in front of a computer keyboard and flicked a switch. A bright orange glow appeared on a large plasma display above the viewing windows; echoing a smaller plasma display at the computer console. The displays confirmed all of the setup configurations for 24 mixing channels of audio control and equalisation, delay, modifications, shaping and filtering. Microphone, channel, amplifier, digital tape cassette recorder, and monitor patching and distribution matrixes were displayed in a different portion of the outsized overhead screen. The operator glanced at this information and then turned to a small microphone. "I'm looking over my dead dog Rover. One leg is broken and the other is bent. And in the middle is a great big dent." He smiled at his little joke "Your voice is recognised for access to system and customisation of recognition," chanted a pleasant if not mechanical female voice. "Set-up confirmation," he intoned. "Proceed," the synthesised female voice intoned. "Current configuration accepted, except," he paused, "channel 3 volume of six, EQ 3 at two, Delay 2 at eight." He turned to check the mixing software ROM inserted into a slot on the side of the computer. It was labelled 'Hot Pop DOS, Series 2, Release 4.1' The mixer looked up to greet the producer and others entering the studio. "Consoles two and three are active for Joe and Nancy with control over channels 9 through 16 and 17 through 24 respectively. I'll keep 1 through 8." The producer walked over to the console and fed sheet music into the unit's optical scanner. The display opened up a third segment showing the music along with timecode indications. They were ready to start the session.

While the above descriptive paragraph will cause some of my loyal readership to gratefully assume that the 'bloody yank' is (A) finally smoking something good and maybe he'll stop playing recording industry know-it-all, or (B) has lost what ever minimal presence of mind he once had, or (C) all of the above; the reality of the computerised recording studio seems inescapable as audio, video and computer technology merges. Many in our industry feel that the size, shape and perceptions of the role of the recording console will change as the recording medium and ancillary units complete the permutation from analogue to digital. One practitioner in the field of human engineering with a strong bent to audio felt "... the control of such a computerised recording system could fall to a console more computer than mixing board. There is no reason for tomorrow's computer studio to follow current practice in layout or ergonomics. The major advantage of the computerised recording studio is to replace space-consuming control functions with computer operating positions. Instead of a 15 to 25 foot analogue console; there would be two or three computer consoles with large displays. Digital audio electronics and tape machines

Tomorrow's computer studio

could be housed in a central equipment room, with computer control data only travelling between the studio and the audio chain. Switching and patching would be performed on computer-directed matrixes, as it is today in state-of-the-art television broadcast plants. The potential for other recording mediums alone will justify some of these changes. Still store recording into solid state memory is not a science fiction topic any longer. With one million byte RAM chips becoming a reality from in-house semiconductor facilities at IBM and ATT, the idea of digital recording into a giant RAM store will proceed apace."

Currently, providing digital or computer control of studio functions (the 'analogue inside process') seems to be enormously expensive and a complicated proposition but as more experience is gained in designing for digital audio operations, hardware can be created to perform specific tasks that will be capable of being placed under the control of a next generation PC computer system. It seems likely that such components as digital delay systems and digital equalisers are just the first of a broad range of digital devices that will not necessarily change the analogue nature of audio itself but will provide the increased utility and flexibility of computer control for the studio process.

Parallel with this, the impending digitisation of the entire analogue television/video process, inevitable under any circumstances will just as inevitably shape the digitisation and computerisation of the professional audio industry. There are very few facets of analogue video technology that are attractive in comparison to the visual and processing advantages of total digital video. Unlike audio, where the subjective qualities of the aural experience still cause purists to attack the digitisation of audio; digital video looks better, is easier to control and process and produces tangible advantages for everyone from broadcaster to home viewer. This change will inevitably colour professional audio because of the current integration of audio programming with video à la music television and stereo television — the development of new home video recording techniques that deliver digital audio tracks — and because the makers of professional video recording equipment are in or interested in being the large digital audio recording business. As one industry seer puts it: "There should be no surprise that the expected advent of the digital video cassette recorder for broadcasters will possess four AES/EBU digital audio tracks, a timecode track and audio cue track. No one is going to produce a hybrid machine — half digital video, half analogue audio. With that technology in place, the standard digital cartridge transport could soon offer audio users the option of multitrack digital audio recording at more affordable prices than currently available. More than that; the video industry is going to digitise control,

synchronisation and system management functions using standard computer components and techniques from the business arena. It's there—it works—it's proven. Perhaps the audio industry will understand that it is not really necessary to reinvent the wheel."

The history of the business of audio is full of technological changes that came from other arenas. It does not seem far fetched to suggest that computer technology pioneered in offices and television stations will play a large part in audio systems and recording studios of the future. Many of today's standards of the recording studio and audio control have come from the telephone industry. Impedance standards, matching, transformer devices, connectors and patching panels/devices all have historical roots in the telecommunications industry. Similarly, the VU (volume unit) meter and its associated standard was jointly devised by those working with audio in broadcasting and the telephone industry (Bell Tel Labs, CBS and NBC among others). Much of the research and development of the audio magnetic tape recorder took place in Germany during World War II to provide a superior recording system (Magnetophon) indistinguishable from live broadcasts for propaganda purposes. The list goes on and on but the transfer of outside technology to the audio industry has proven to be the rule rather than the exception as some of the progress in audio comes from those endeavours with deeper pockets.

In the case of computer products, the size and scope of research and development exists on a financial basis that the audio industry cannot afford. For example, IBM alone spends more on advertising than the total sum spent for research and development in the entire professional audio marketplace; and spends three times that budget for its research and development (in excess of three billion dollars yearly). The personnel employed by IBM (in excess of 400,000 employees), represent a far greater number than those employed in any way in the business or applications of professional audio. This huge staff base allows IBM to Beta test new products internally even before they hit the user market.

It does not matter how these developed technologies are incorporated into systems and reach the professional audio market place just so long as they do eventually get there. One way that computers have entered the recording studio over the last 10 years has been via audio equipment makers who have 'rolled their own' computers for studio and/or mix automation. This has been more or less successful. The use of dedicated audio computers has proven reliability at least equal to computers used in the office arena. Problem areas seem to be involved with user competency, unauthorised modifications and the presence of a computer 'boffin' at the studio 'who can make it better'. Today, it is not uncommon to stand about the refreshment area at an AES or APRS convention and hear studio owners, technicians and other users grouse about their newly 'modified console



IN THE PAST WE HAD A BIG ADVANTAGE OVER THE COMPETITION. NOW WE'VE GOT A SMALL ONE.

Until UREI's 813 Time Align® Monitor entered the studio, speaker systems had become a "smear" on the industry. A "time smear" in which high and low frequencies subtly assaulted the ear because they arrived out of sync. The results were general listener fatigue and unrealistic sound, particularly on lead instruments and vocals.

The UREI 813 solved the "time smear" problem with Time Alignment™, unifying sound into a single point source. This dramatic breakthrough, along with other major technical advances, soon established the 813 as the industry standard.

Now UREI introduces less of a good thing: the 809 Time Align® Studio Monitor. The 809 delivers all the engineering depth of its big brother, but at a compact size and price that's ideal for small control rooms and near-field applications.

UREI's 809 features a remarkable, all-new 300mm (12") coaxial driver that achieves a true one-point sound source, superior stereo imaging, and tight bass. It incorporates a unique titanium diaphragm compression driver that unleashes unequalled high frequency response.

The 809 has exceptional power handling capabilities, high sound sensitivity, and low distortion. It accomplishes precise acoustic impedance matching and smooth out-of-band response with UREI's patented high-frequency horn with diffraction buffer. And its ferrite magnet structures assure the system's high sensitivity drivers will not degrade with time and use.

UREI's Model 809 Time Align® Studio Monitor. Smaller package. Smaller price. Same impeccable "813" sound quality. See how it fits into your studio today.

JBL Professional
8500 Balboa Boulevard
Northridge, CA 91329

UREI

IN PERSPECTIVE

IN PERSPECTIVE

computer'. A recent conversation went like this. "The bloody thing has blown this or that chip when it crashed. The console was a dream with it; now it runs like a bloody sausage roll." "Can't you get somebody to fix it?" "Not right away. The only guy who really understands it has a dog with eczema and he can't travel to where we are now." "Send it to the manufacturer." "Terrific. They are angry that we played with it. We won't see it for three months like the last time while they wait for enough quantity to re-order the custom chips that have undoubtedly blown again."

It seems clear that the future will of necessity consist of more than one category of computer automation and digitisation equipment. It seems likely that dedicated units will coexist with personal computer technology as new systems enter the audio studio marketplace. Several current trends in personal computer development seem to indicate potential applications in the computerised recording studio. Central to the operation of tomorrow's computer studio will be the Super PC/Mini computer. The early 1980's trend of the limited plain vanilla PC as the design block has played out. The recent advent of Super PCs, establishes a new direction from IBM with the PC AT and the awaited PC Two. It appears that even these advances may be temporary as IBM conforms their 'standard' machine to the 32-bit Intel 80386 super processor chip. DEC has countered with a reduced size VAX desk-mounted PC-like mini. Hewlett-Packard has likewise introduced a desk top-sized Series 3000/37 mini. Such systems have the speed, computation power and memory space to house all software and data necessary to run one or several recording studios in a complex as well as handling all bookkeeping and management functions. The core unit in a studio complex could be a super PC such as the AT, but increasingly it could be a PC-sized mini as the distinction blurs between a desk-top mini and a multi-chipped super PC. Potential super processors besides the Intel 80386 include the Motorola MC 68020 or custom chips such as those produced by HP's in-house technology.

Displays will be large enough to read easily, with virtually no fatigue despite hours of usage. Plasma seems to be the most likely option for tomorrow's studio. Military experience with similar control functions has shown plasma to be reliable, non-fatiguing and capable of resolution in excess of anything available from cathode ray tubes. Plasma displays produce no radiation and are virtually indestructible, exhibiting three times the life span of CRTs. Versatility of the plasma screen would be a crucial feature of the computerised recording studio. Plasma displays typically provide 740,000 addressable display points; allowing four standard 2,000 character viewing screens to be displayed or one large image screen providing up to 70 lines with 160 characters per line or any combination in-between. Graphic displays are limited only by the dexterity of the driving software. The display would most likely use graphic indication for all volume and equalisation

settings with different display modes available for any operable function within the studio. The size of a plasma display would allow simultaneous viewing of specific parameters needed for a session; with each session's special needs programmable for viewing during the recording process.

Programming languages could well include Unix and ADA. The control of audio is little different from many other control processes being derived through these modern computer programming tongues. The business of writing software; both as recording studio architectures and as specific setup formats for particular kinds of recording is vital to the future of computers in the recording studio. One great advantage of using computers built to a known standard is that software can be written on any machine and emulated for use in a particular system architecture. That should make software production by publishers for the audio studio more likely.

The current trend towards equipping PCs with floppy and hard disk memory could well be augmented and eventually replaced

The reality of the computerised studio seems inescapable

by the use of RAM disk. In this innovation, the pricing battle for random access memory chips (RAM) amongst world semiconductor manufacturers will be exploited in creating solid-state memory systems. These RAM disks are already available and lowering chip prices, especially for 1 Mbit chips or larger, will allow memory makers to package RAM drives with the same storage as a hard disk system. These controllable arrays of chip memory are non-mechanical and more exactly match the reliability of the computer itself. Access speed, vastly improved MTBF (mean time between failures) and read/write reliability are all signal improvements over mechanical magnetic disk systems. Such systems will allow the use of 'still stores' for computer editing of specific segments of a recording. The same principles govern the ROM disk as the RAM disk; again the use of semiconductor memory to replace mechanical memory components. The ROM disk does not write; it is a read-only device that stores software in chip memory. It can be any format of ROM chip with the addition of microprocessor control so that it can be read like a mechanical disk. It can also be of the electronically alterable category allowing specific information to be upgraded or written into the chip. Such units, as plug in ROM cartridges will carry specific setup and mixing software; allowing a console to be customised for any session. The reality of the computer studio is that it is command and software driven. The studio and console configurations will be set by the ROM packs or carts as steerable memory, allowing virtual access and the ability to address specific portions of the installed console software architecture. The large-scale storage capacity of ROM will

help software and training functions to reside on the same chip with the operating software. That means help for any console function is a pushbutton away.

One of the crucial elements in the evolution of computer automation concepts, the optical scanner 'reads' printed material and enters it into computer memory for further display and/or action. In the studio, this will allow documents to be 'read' into the computer for session display line by line. It can also serve to enter software into the studio computer system.

Another of the high technology lynchpins on which the future computerised studio will depend is the companion technologies of voice recognition and voice synthesis. Aside from providing the interactive contact with the computer for setup and operation, voice technology will allow the computer to sound obvious warnings for high channel levels, out of tape, etc. An interesting aside of voice recognition is the current bugaboo of having to train the recognition system to identify a particular user's voice. This will undoubtedly be changed as technology moves forwards but it may well be retained as a perfect lock for the recording studio workstations that will respond only to the voice of the designated user.

The application of computer 'brains' to studio automation could tie the console computer and all of the studio peripherals to simple plain language user commands and careful interrogation to implement the specific use intended. In an 'AI' (artificial intelligence) environment in the studio, the computer will deduce needed functions by a series of questions and the provision of branching options for the user that will focus on the desired result. In this mode, no computer literacy or software agility is needed. It is, in effect, using the computer without ever having to say you're sorry (or making a mistake). The use of AI is another reason for needing the power of a super PC or a mini as part of the studio package.

Now comes the loaded question. When does all this happen and at what cost? The answer to the first question is whenever the audio industry wants it. The technology is in place. Aerospace systems are already using voice recognition to fly helicopters and aeroplanes. Computers have been telling pilots for several years in a sultry female voice when a hazardous condition occurs. The development of an office automation concept around optical scanners, voice synthesis and recognition, artificial intelligence and super processor equipped computers will see all these features common place in offices over the next five years. Cost is a different question, but given the push for many of the same components in the television studio, the automated office, the commercial airliner and military usage; it seems that an off the shelf computer studio could be assembled at competitive prices to a state-of-the-art analogue/digital studio in the million dollar price range. That price tag will come down as applications reduce cost. But, the most difficult part of the package is the software. It will take a major commitment to write but once done it will be a gold mine for the writer and for the studios who use it. □

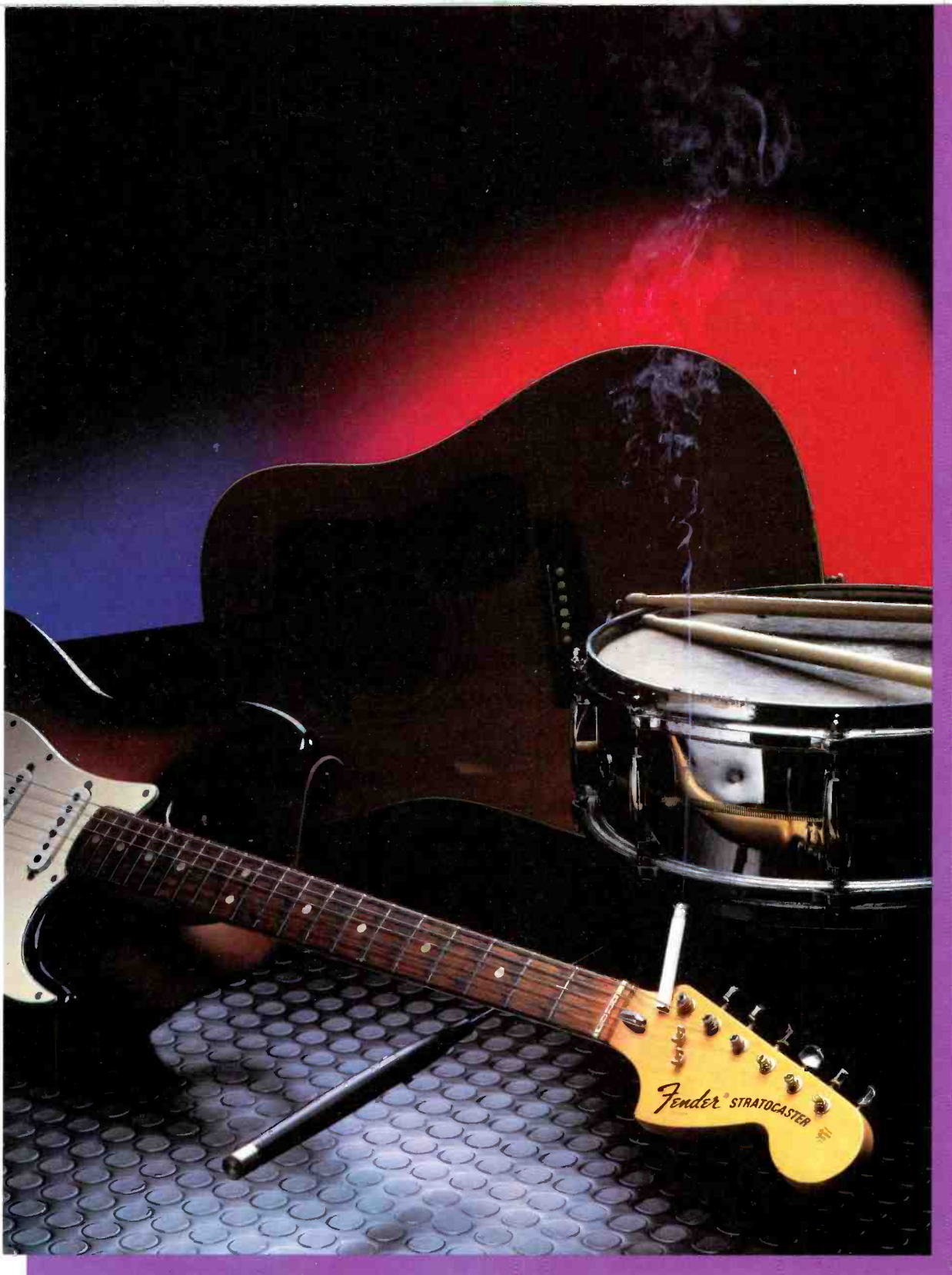

CAPTURE THE MAGIC WITH BRÜEL & KJÆR SERIES 4000 PROFESSIONAL MICROPHONES

THESE WORLD-CLASS RECORDING STUDIOS AND RECORD COMPANIES ALREADY HAVE · CBS RECORDS, NEW YORK · TREASURE ISLE RECORDING STUDIOS, NASHVILLE · SURREY SOUND, ENGLAND · MADHATTER RECORDING STUDIOS, LOS ANGELES · DIGITAL MUSIC PRODUCTS, NEW YORK · DENON RECORDS, JAPAN · UNIVERSAL RECORDING STUDIOS, CHICAGO · SIGMA SOUND STUDIOS, NEW YORK · STREETERVILLE STUDIOS, CHICAGO · CASTLE RECORDING, ENGLAND · BRÜEL & KJÆR SERIES 4000 PROFESSIONAL MICROPHONES, THE CHOICE OF PROFESSIONALS THE WORLD OVER, CONTACT THE BRÜEL & KJÆR MICROPHONE DEALER NEAREST YOU FOR FURTHER EVALUATION

SERIES 4000 PROFESSIONAL MICROPHONES

Brüel & Kjær  World headquarters: DK-2850 Nærum, Denmark · Telephone: +45 280 05 00

In early December, British-based distributor/manufacturer HHB in partnership with Sony Broadcast and *Studio Sound* held a three-day event under the collective title of the Digital Information Exchange. The venue was the Members club of London Zoo which proved an ideal central London location. Each of the days covered different aspects of digital technology and in addition to the speakers and valuable dialogue from the floor, an integral part of the exchange was a hands-on demonstration of digital audio equipment from CD, *F1* and *Video 8* up to *3324* and digital tape analyser systems.

Day 1: Planning for Growth with the Compact Disc

This day was aimed at the record industry and was opened by the day's chairman, Ian Jones managing director of HHB, who gave an introductory perspective to the role of CD in the world market. Ian was followed by Ian Duffell who is managing director of the HMV chain of record stores. He was able to present full details regarding the rapid sales growth of the CD and how they as a major retail chain saw its development in terms of turnover and the relationship of the format to album and cassette. Additionally he presented examples of the different CD packaging used in the worldwide markets. Clive Swan, managing director of UK PolyGram record operations opened his presentation by playing an extract from Dire Strait's *Brothers in Arms* CD single to return consideration to the quality benefits of the medium. This was backed up with results of a survey PolyGram recently commissioned which showed that the prime reason for CD purchase was audio quality. He then went on to deliver estimates of the relative strengths of the medium over the next six years, predicting the overtaking of the vinyl disc by 1988 and the cassette at some time into the 90s.

Record producer Rupert Hine followed giving advice to record companies planning digital recordings—the cost factors involved and how to minimise them through pre-production planning, and the benefits to be gained from taking maximum care at all stages. The last speaker of the day was Ben Turner, managing director of Finesplice who is probably the most experienced CD mastering engineer in the UK. His presentation was aimed at explaining the differences between the masters that CDs could be prepared from. The centre-piece of his talk was a detailed flow chart to guide the record company to the

DIGITAL INFORMATION EXCHANGE

correct tape for CD mastering in a whole range of real life situations. Through a number of true stories, Ben showed that this chart was very useful to avoid a number of horrific situations that he had been presented with and tapes that were just too bad to master.

Day 2: Digital Workshop

This day was aimed at the producer and engineer involved in the practical aspects of recording and post-production of digital audio. The day commenced with Keith Spencer-Allen, editor of *Studio Sound*, giving an insight into the growth of digital audio within the UK, the equipment available on a global scale and the basic principles of PCM recording. He was followed by Chris Hollebhone, pro-audio sales manager of Sony Broadcast who detailed the role of available products within the digital audio chain. Record producer Pip Williams then went into a considerable amount of detail regarding pre-production planning and the do's and don'ts of the recording aspects of digital sessions.

In the afternoon attention turned from the recording process to the mixing and mastering stage. Richard Salter, pro-audio product manager of Sony Broadcast covered the principal tools available to the engineer during the mix and mastering stages. He was followed by Pip Williams who again was able to pass on a considerable amount of his experience recording fully digital albums on most of the available systems. Ben Turner then gave a presentation that was similar to his record company talk of the previous day but went into far more technical detail, provoking a lively debate with the floor regarding the most suitable procedures in mastering and care of equipment.

Richard Kershaw of HHB then covered the role of some of the newer additions to the digital audio production process—in particular the digital tape analyser that Sony recently introduced and the way in which it can give a certain piece of mind to the mastering engineer and help ease communications between the record company, the mastering facility

and the CD pressing plant. The subject of video lay-backs and the synchronisation problems encountered was covered by Mike Bradley of Videosonics which again created a great deal of interest from the floor especially from other facilities with different procedures.

The day was interspersed with plenty of time for playing with the equipment on show and questions; communication between the attendees was a very important part of the day.

Day 3: Digital in Industry—a forum

This was a particularly interesting day because there was no common theme other than that the speakers and attendees all used or were interested in using equipment intended for digital audio applications in academic, industrial and scientific uses. The day was chaired by Peter Woodcock who had the task of tying together a very diverse day. The first speaker was Richard Salter from Sony Broadcast who covered the full range of digital equipment available to suit the particular markets in question. He was then followed by David Malham from the University of York who described the way he was using and developing digital equipment within the music department at York. Following a full question and answer session and lunch, Mike McLaughlin and Tom Fillin of Sony UK gave a full presentation of *Video 8* systems from both the video and audio aspects, whilst passing disassembled machines and cameras around the audience.

They were followed by Dave Parker from the Department of Acoustics at the University of Salford who described the way in which they have modified *F1* units for digital audio and data storage particularly regarding recording seismic data. The final presentation of the day was from Dr Trevor Lamb of the Department of Physiology at the University of Cambridge. He described modification to a *PCM 701* system to allow recording down to frequencies approaching DC. His presentation example was the use of the modified *701* to record the electrical output signals from the cone taken from a salamander retina under different light stimuli. The afternoon ended with a lengthy question and answer session.

The general impression of the three days was that the event had been well worthwhile and that with the concept of a Digital Information Exchange established, then let's start planning the next.

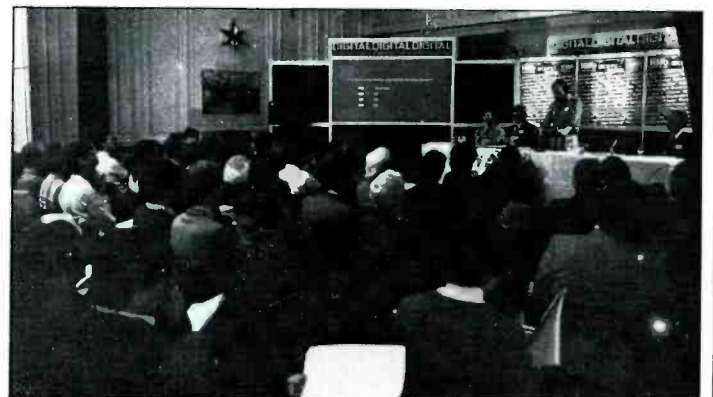

DIGITAL REVERB *IS* LEXICON



PCM 60: LOW COST, EASY TO USE PLATE AND ROOM SIMULATOR. IDEAL FOR BROADCAST, CONCERT AND STUDIO USE WHERE SPEED OF FAMILIARISATION IS IMPORTANT

200: THE DEFINITIVE MID-RANGE FULL STEREO UNIT. WIDE PARAMETER ADJUSTMENT, DUAL MONO OPERATION, SPLITS, FREEZE, INVERSE ROOM, VARIABLE ROOM SIZE AND THE LEXICON SOUND.



224XL: THE TOP OF THE LINE LEXICON, DUAL MONO/STEREO OPERATION, WIDE RANGE OF EFFECTS, LRC REMOTE, UNIQUE DYNAMICS PROGRAMS VIRTUALLY LIMITLESS PARAMETER ADJUSTMENTS, HUGE RANGE OF PRE-SETS, IN EFFECT, TWO COMPLETE REVERB PROCESSORS IN ONE PACKAGE.



lexicon

Lexicon Inc, 60 Turner Street,
Waltham, MA 02154, USA.
Lexicon International, PO Box 122,
CH-8105, Regensdorf, Switzerland.



AUDIO EXPORT,
Badstr. 14,
7100 Heilbronn,
Germany,
Tel: 07131 82275



SCENIC SOLUTIONS EQUIPMENT LTD.
Unit 2, 12 William Road,
London NW1 3EN.
Tel: 01-387 1262, 01-734 2812
Telex: 27939 SCENIC G



GRISBY MUSIC PROFESSIONAL SRL.
Via Dell'Industria 4,
60022 Castelfidardo,
Ancona, Italy.
Tel: 33-71-781494

TWO DEFINITIONS OF

A SOLAR ECLIPSE

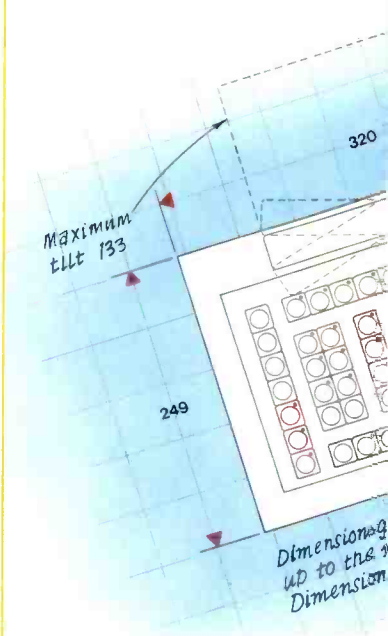
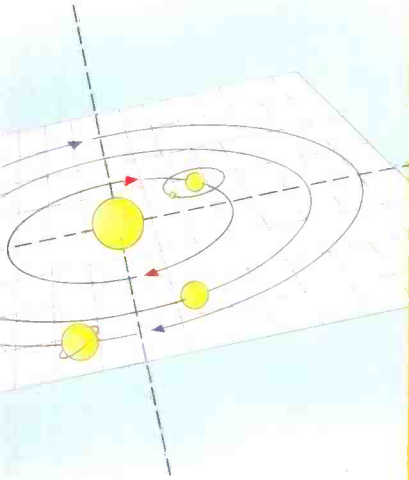

A SOLAR ECLIPSE

A natural phenomenon occurring when the moon passes between the earth and the sun, resulting in total darkness. This unique event is the result of a complex chain of events culminating in the perfect alignment of their orbital trajectories.

Its cause was for centuries beyond the comprehension of man, who's imagination and superstition associated it with the supernatural and religious ritual. Magicians and alchemists made the most of the awesome spectacle to assert control over their bewildered followers, until astronomers were able to disprove the mystical theories by offering a scientific explanation.

THE PERFECT ECLIPSE

THE ECLIPSE EDITOR

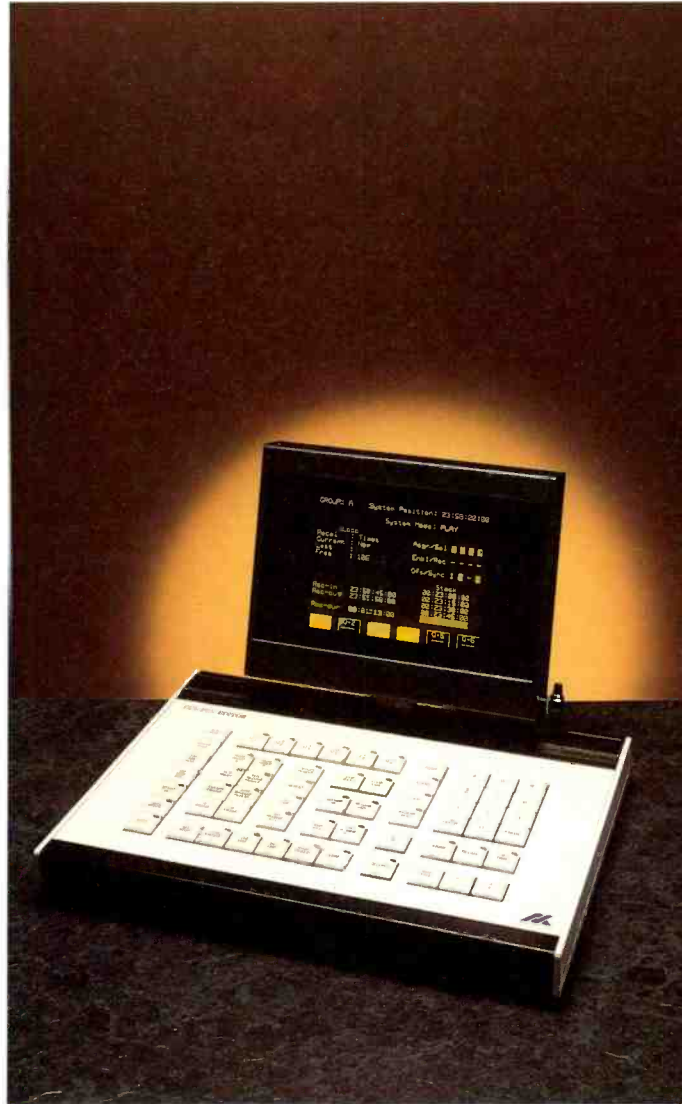
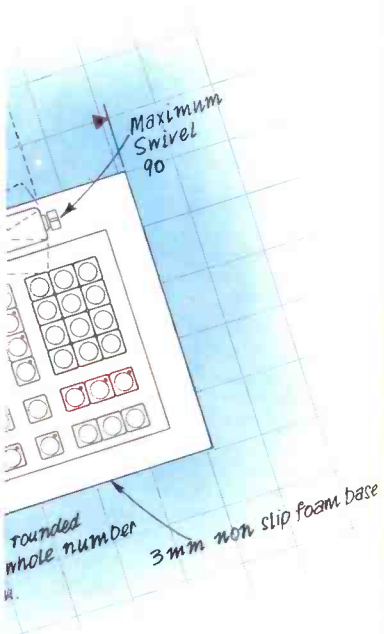

THE ECLIPSE EDITOR

A technological phenomenon in the form of an Intelligent Audio Edit Controller which puts rival products in the shade. Having a capacity to control a large number of events, firing complex user-programmable sequences in perfect alignment from a single Q-key, The Eclipse is capable of supporting 32 machines.

Many of The Eclipse's unique functions were beyond the wildest imagination of Audio engineers until Audio Kinetics applied their advanced research technology to create an electronic edit controller which will, when interfaced with Q-LOCK Synchronisers, add a little magic to modern post production facilities.



AUDIO KINETICS LIMITED
Kinetic Centre, Theobald Street,
Borehamwood, Herts. WD6 4JP,
England.
Tel: 01-953 8118 Telex: 299951
Fax: 01-953 1118

AUDIO KINETICS INC
1650 Highway 35,
Suite 5, Middletown,
New Jersey 07748, U.S.A.
201-671 8668 Fax: 201 671 6902

AUDIO KINETICS INC
4721 Laurel Canyon Blvd,
Suite 209, No. Hollywood,
Cal 91607, U.S.A.
818-980-5717 Fax: 818 761 3916



STUDIO FILE

STUDIO FILE

Oslo's Rosenberg Studios is a monument to Norway's PolyGram heritage and, although it has gone the way of all the other PolyGram studios, ie into the private sector as it were, the studios are run by ex-PolyGram man Svein Sundby and his daughter Unni. Because Svein was with the company for many years, the studio has not been altered a great deal and still maintains its 'large record company' air.

Norway is rather a special case in many ways. Difficult though the concept may be to grasp, the fact is that as a country they owe nobody a penny. Having struck oil, the standard of living has shot up and rather than debating where to make their annual cuts, the government are in the enviable position of being able to decide where to lavish their new-found wealth.

One would assume, therefore, that the average family/person has more money at his disposal for leisure activities. At the same time, however, the rest of the world competes in the same areas and applying this theory to the music industry in a country with a miniscule population of four million, who are able to purchase records made outside Norway, the industry is faced with an almost insurmountable problem. The equipment the studios must have at their disposal costs them as much, if not more, than in for instance England. The market they are recording records for is minute since most of the work will only sell at home, studio rates cannot be higher than nearby countries (Germany, England, etc) so just how do they keep their heads above water?

The problem is compounded by the fact that there is no commercial television or radio, therefore no market for pop videos, no way of promoting your artists, etc. This problem is not confined to Norway but it is intensified by the smallness of the market. As in other Scandinavian countries, there are currently experiments being conducted into allowing local radio and television stations to broadcast but they are, as yet, non-commercial. Obviously, those working in the industry are hoping that the local

Rosenberg Studios, Oslo



Musicians and engineer at the PolyGram console

experiment will succeed and eventually lead to a commercial medium. It looks, however, as though it will be a long slow haul to get there.

Rosenberg is one of some six 24-track recording studios in the city—the music *business* capital of Norway. Svein Sundby is respectfully best described as one of the 'old school' of recording engineers. His career was launched in the '50s when he started cutting records as a hobby: "Many people my age in this business came into it from a hobby." Another hobby was playing in jazz dance bands while his 'proper job' was with EMI as a cutting engineer. He later became involved in building cutting rooms and studios for other companies as the industry began to bloom. Svein's own cutting company gave up the fight when the demand for stereo cutting equipment outstripped his finances and so he went to PolyGram in 1969, as a production manager in the factory (there was no studio as yet). Svein was thus well positioned to witness the excitement of PolyGram's studio build, finished in 1971, and in which he was very much involved.

Since those early 4-track days Svein has watched the facility change and grow, keeping with changing technology and trends. "Some of the old 4-track equipment is still here—a Philips mixing console and a 4-track machine. That console was converted to 8-track with a Lyrec machine, and then 16-track with Studer.

Those old Philips things are so rugged that when it was finally sold it was refurbished and sent out to Taiwan. The PolyGram equipment has to be so rugged, you can never wear it out. The drawback is that you can't throw it away when it is still working!"

1979 brought 24-track facilities in the form of a new console and Studer A80 24-track. The desk was developed in Holland by PolyGram engineers. Svein worked at the facility as engineer until 1978 when he took over the management as well as audio sweetening in the video workshop. In April 1984 PolyGram closed down technical operations almost everywhere and many of the studios shut down. Svein decided to step in and buy Rosenberg. The facility consists of a main recording studio, edit room and video workshop. The old A&R offices are sub-let to independent record label Slagerfabrikken A/S (The Hit Factory) which makes for a good reciprocal arrangement.

"We record all kinds of music here. Classical is slowly going out—it is all sponsored by the government anyway and the record companies themselves do hardly any. For the most part it is folk and jazz, a lot of pop and some religious.

"The difficulty is that we need facilities as good as those in the UK or USA, and it is very difficult to make it pay with rates at around £50/hour (\$70)." The cost of living in Oslo it must be

pointed out is phenomenal—it is not unusual for an average hotel to set you back a cool £100 for one night! The studio's rate thus put into context is incredibly low but necessarily so if they hope to appeal to foreign musicians and record companies.

Competition in the form of small Teac and Fostex studios is beginning to hurt the professional studios. "There are five or six of them in Oslo and they are even managing to attract some of the bigger record companies as well who are only interested in getting a cheap recording." Most of the work which the professional studios attract is native bands, very seldom foreigners.

Competition sounds pretty fierce in a city whose population is no more than half a million. One of Svein's old cutting colleagues has set up business on his own and spends a lot of his time attempting to cut from "all these funny cassettes for direct cutting!" But back to the matter in hand: "Recording costs are the same here as anywhere else in the world and yet if you sell between five and 10,000 records you will get a number one."

What about video then? Any money to be had here? As far as pop videos are concerned the only outlets are television and point of sale. If a record company decides for whatever reason to gamble the money on making a pop promo they are banking on the fact that the television company will choose to broadcast it and even if it does, it is almost certain it will only be once. So all that money for a vague chance of a broadcast, it is not surprising that the record companies seldom go in for this particular medium. It is also not surprising that the people who produce the videos do not earn very much from the work.

Rosenberg's video facility is, therefore, used mostly for industrial filming—ie internal videos for companies. Another source of work is brought about by the fact that "the television people are not equipped to make the videos themselves, especially the local television studios who are helpless technically and do not have the money for producing



THE FUTURE IS... SOUND

Sound is present everywhere we go, in everything we do. And the pacesetter for audio reproduction is Altec Lansing, a company whose strength has always been found in its ability to anticipate and meet customers needs. We're committed to sound systems designed and built exclusively for fixed installations. It is this commitment that's made us the choice of professional sound contractors who demand uncompromised quality and dependability coupled with the most extensive factory support available. Altec Lansing emerged as a company single-minded in its resolve to serve a specific industry by combining a reputation for innovation based on solid engineering and our unique total system concept. Not involved in consumer, portable or patchwork multiple vendor systems, we've molded 50 years of expertise into performance. This enables us to stand alone as the premier supplier for the fixed installation market. Our total dedication to this market and to our worldwide dealer network is now backed by Gulton Industries, our new parent company, and a mandate to continue building a sound future as the preeminent force in our field.



**Altec Lansing Takes The Words,
The Emotions, The Music Of Man And
Projects Them To Mankind.**



a **gulton** company

STUDIO FILE

STUDIO FILE

videos (apart from some of the religious ones)". This is a story we heard time and time again. Among the groups granted licences to broadcast under the Norwegian local radio and television experiment are several religious-based ones who are able to lay their hands on far greater financial resources than for example a student group, and in this way they wield greater influence and power than the other groups. It's rather ironic really.

As far as video facilities go, one or two studios in Norway have *Q.Lock*, but it is hardly ever used because the medium is not that developed. Rosenberg has done a lot of music for film but "in the old way down to 1/4 in and then sent off to the film people. In our suite here we work with a cameraman who writes the storyboard, does the filming and edits it here".

It is with surprise that one learns of the lack of impact CD has made on the Norwegian market, it is difficult to imagine what native companies could afford the equipment investment required. Audio fidelity in the home market does not seem to be that important since sales are highest in cassette format. The people at Rosenberg have to take stock of which direction the industry is going.

"Musicians will often bring their own effects units in nowadays—this happens more and more often. The trend at the moment is towards electronic music the same as the UK but let's face it, it doesn't sell in Norway and is not worth that expensive investment. As a nation we do look to England most to follow trends but there you have a bigger market. If there is a big hit in Norway it is *definitely* not that kind of music; it is more likely to be a cross between country and rock with Norwegian language lyrics. Occasionally electronic music is successful but it is less of a safe bet."

Although the Norwegians are aware of the fact that compared to facilities in larger countries they have a particularly tough job to be commercially successful, they seem to accept this as just a hazard of business in general.

Rosenberg, continued

The original PolyGram studio room was completely dead, the walls being finished in foam rubber covered in electrostatically applied flocking. The room was rebuilt four years ago to a Tom Hidley-type design of their own. "It's very simple, you just shrink it all until there is nothing left and then it has to work! There are sound traps above the piano and things, and there is also the drum booth. The day after we finished the studio a drummer came in and took his drums out into the live part of the studio and it's been like that ever since. The building work was done by the boys who worked here; they made their own drawings and did the whole lot."

The room is very large (around 100 m²) with several different acoustics created with various surfaces including a granite tiled floor, angled pine slats with tuned bass absorbers underneath, a live ceiling above the live area consisting of perspex sheets, various removable carpets and curtains, and the aforementioned flocked foam rubber. Svein reported that very good isolation is achieved. Scattered around the room are all sorts of instruments and amplifiers, including a Steinway grand piano and an upright honky tonk.

Svein Sundby in his video suite



The control room is approximately 40 m² with angled ceiling, wooden clad monitor wall, stone side wall and cork at the back. The Studer tape machines are recessed out of the way and most of the space is taken up by the PolyGram 36/24 console. Features of the mixer include eight auxiliary sends (four reverb and four foldback) and 3-band equalisation on channels. "PolyGram equipment very seldom breaks down but daily maintenance of all the equipment is done by all of us who work here. The console is hand made and very rugged."

Monitoring is on Lockwoods with Tannoys powered by Electrocompaniet power amps, supplemented with JBL 4401s and Auratones, not forgetting the Philips car speakers which are built into the console. Noise reduction is catered for with Dolby A361s and a few M16s. In the reverb department there are two EMT plates, two AKG BX20s and an AMS RMX16.

Effects are kept to a minimum with Eventide H949, PolyGram limiter/compressors and Lexicon PCM41 digital delay line being the main units.

Moving on to the edit room we meet Per Sveinson—engineer and, according to Svein Sundby, 'the old goat'. (I

think it may have lost something in translation.) Anyway, on the day of the grand tour, Per was presiding over the edit suite which houses three Studer A80 stereo machines, a Studer console, three Akai cassette machines, a Dolby rack and Lockwood/Tannoy monitors. It speaks for itself really.

This only leaves the video facility, which even has its own little video studio hidden away behind a secretive black curtain. The workshop is equipped with a Philips *Studio 80* set-up comprising two Sony VO-5800PS U-matic VCRs, Revox B77, Auratones, two JVC and one Panasonic video monitors, Akai and Philips cassette decks, Sony automatic editing control unit, JVC AV-2000 video console, Gemini highband effects mixer, For.A test generator, VHS Panasonic and lowband editing—in other words a professional outfit. Here they specialise in 8 mm and 16 mm film scanning and slides. The video studio is equipped with three cameras but most filming work is done on location. In spite of all the things Svein told us about the comparative lack of demand for video work, this facility is in high demand and in fact, having quickly watched a few demonstration pop videos, the studio had to be quickly vacated to allow the patiently waiting customer to come in and finish his work.

Rosenberg is run on a base of four staff: Svein, Unni, Per Sveinson, engineer, and Geir Malmnes, tape op. These are supplemented with freelance engineers as and when necessary. Other facilities include a kitchen and relaxation room.

Svein's main criterion for running a successful studio business is to keep prices at a level where they can keep things steady. "If you over estimate you go out of business." I guess it is a maxim which applies to most businesses, it is just that with some you have to balance things more finely than in others." Meanwhile Rosenberg continues to produce hit records and win through.

Janet Angus

Rosenberg Studios,
Rosenborggt. 19, Oslo 3,
Norway. Tel: (0)2 60 68 97.



— NEW STANDARDS —
IN TAPE ENGINEERING

Teac has been the name behind many of the milestones in the development of tape transports. You will find it on the world's leading data recorders, on NASA's shuttle video recorders, on military equipment and of course on the finest musicians' sound recording machines.

Now you will find Teac's TASCAM brand on a new breed of professional-standard multitrack sound recorder/reproducers, built to satisfy the most sensitive ears and engineered to cope with the most punishing workloads, even on video lock-up.

The new ATR-60 range includes 2, 4 and 8 track machines with 1/4 inch, 1/2 inch, 15 ips and 30 ips formats, while the 1 inch 16 track MS-16 is technically without rival.

By employing more efficient construction techniques, Tascam are now setting new standards in value: from around £3,400 for a 2-track with centre track time code to around £7,000 for the 16 track MS-16.



TASCAM
TEAC Professional Division

Find out more about the new standards — contact:
Harman UK, Mill Street, Slough, Berks SL2 5DD.
Telephone: (0753) 76911

STUDIO FILE

STUDIO FILE

If you have the time to make the journey from Oslo to Trondheim (six to eight hours) by car you will be able to savour breathtaking views of mountains and lakes as well as the odd fjord and it is well worth the effort. Although Trondheim has only one 24-track facility (albeit *SSL et al*), there are several smaller studios—two or three 16-tracks and about 12 8-tracks—and it has been described as Norway's centre for young people and music. Whereas the capital city of Oslo has an international flavour, being greatly influenced by other countries such as Denmark, the UK and Germany, Trondheim is a musical centre for native artists and their arts, notably TNT who recently made waves in both the UK and USA.

The 24-track *SSL/Eastlake* studio is Norsk Lydstudio which is situated in an industrial estate on the outskirts of the town. Studio manager Roger Valstad has worked there for the last six years during which he has seen demands on the studio change, so much so that they recently re-equipped with *Q.Lock* facility to embrace what they predict to be a fast growing demand for video.

Norsk Lyd was originally set up to complement a cassette duplicating facility, and in those days was used mainly for recording cover versions of international hits. Apparently these did not make very much money, whereas the cassette factory did. The studio was therefore sold off in 1984. The new owners are musician Org Alexandersen, record company Genner Hordvik Plate Selskapet and newspaper *Adressavisen*. The Norwegian newspapers are all getting involved in this type of medium—several have shares in the trial radio stations—all waiting for the advent of commercial broadcasting from which they hope to make, no doubt, enormous profits.

Adressavisen is no different from the others—future plans include a media centre in town embracing all types of media, including television.

The original studio equipment included an early Solid State Logic *4000E*—the third or fourth console made. There was obviously no

Norsk Lydstudio, Trondheim,



Roger Valstad with engineer Christian Schreiner at the console

following of trends here, the reason for this choice was simply that they felt it was the best desk made. Multitrack machine choice was more traditionally Scandinavian—the Danish Lyrec.

The facility has been given the traditional Eastlake treatment, creating control room, studio area with drum booth and isolation room, as well as an editing room.

Apparently the Eastlake team enjoyed themselves so much in Trondheim, they stayed an extra week to build the edit room from left over materials. Since then Eastlake's David Hawkins has returned twice to adjust the monitoring as requirements changed. Two years ago he also widened the live area with marble floor, and oak wall and ceiling.

Nowadays the studio is used mostly by Norwegian customers with the occasional English, US, Danish or Swedish visitor. As already mentioned, Norsk Lyd are now looking ahead and have re-equipped for a video post production market which they foresee as a huge money maker. Whilst awaiting the predicted commercial television laws being passed, there is nevertheless a small market for in-house commercial video making, enough to justify the initial outlay of capital.

Roger expressed no desire to change the *SSL* console: "Ours is six years old and we have never had any problems with it. We are the best equipped studio in the country and although we are a bit out of the town centre, we make records which sell the most." A recently acquired Otari *MTR90* supplements the Lyrec 24-track to provide 48-track

facilities with *Q.Lock* and a Sony VTR facilitating video post production. An Otari *MTR12* was winging its way to Trondheim, and no doubt arrived as planned the following week. Stereo machines are Studer *A80* and three Studer *B67s*. They also have a Lyrec 4-track to provide cassette masters for the factory. Monitoring is by *UREI 813* and *Auratone*, with *Adyton P3000* amplifiers.

Outboard equipment includes *Lexicon 224, 200, Super Prime Time* and *Prime Time* digital delay, two *EMT* plate reverbs, *Eventide H949 Harmonizer*, *FL201 Instant Flanger*, *AMS DM220 phaser*, *Roland Dimension D* and *SDD3000*, *Quantec Room Simulator* and *Deltalab DL-1* digital delay line. There is also *Dolby* but "I don't use it except for video. We just have it for those customers who feel they want it but I personally usually work at 30 in/s without it".

Norsk Lyd's microphone collection includes *Neumann U47s, 87s* and *84s*, *AKG 414s*, *Electro-Voice RE20*, *Schoeps*, and *Sanken*. "The *Sanken* is very good. You can compare it with the *U87* or *414*; it is quite similar to the *AKG Tube*. We have got the first one in Norway and it is excellent." A very nice *Steinway* concert piano also lives in the studio.

Upstairs in the edit room there are two Studer *B67s*, a small *Audio Developments* mixer, *JBL* monitors, *Klark-Teknik* equalisers and *Dolbys*. This facility is used mainly for editing and mastering for cassette duplication.

The people at Norsk Lyd feel that they have to have "international standard equipment" if they are to attract outside work, and this

is the main reason for the Otari choice: to specifically pitch for customers abroad. "We can do exactly the same work as they do in England. We have bought the Otari 2-track ½ in machine in order to make the best possible quality masters to cater for CD. It would be absolutely ridiculous in Norway to buy 32-track digital. The machine costs as much as our *SSL* console and for a market where 70% of buyers purchase cassette and 30% record, it would be utterly pointless. The quality is really not that important."

Roger sees the studio's 'city edge' location as a positive advantage: "It is not like a city studio, it is very peaceful here. You can get on with it without people dropping in all the time. Trondheim itself—we're only 8 or 9 km from the centre—is a nice place, not too big. There are plenty of restaurants and hotels there."

Sustenance-wise, there is a cafeteria opposite the studio but "We are here to work, not to eat," explained Roger, and he meant it.

"I believe artists should stay in cheap hotels and invest the money in studio time instead. People are not hungry anymore, that's why they don't make good rock and roll records. TNT saved all their money to buy guitar amps and things like that. They had no money for food when they were working here." Well it certainly paid off for them.

"The Norwegian record industry is not spending enough money on marketing. They should spend two times on marketing what they spend on studio time. I am considering offering a fixed price for an album, regardless of how much time it takes—I can estimate roughly what it will take and then that will enable the record companies to budget for their promotion."

Presumably more marketing means more sales means more money for more artists for more studio time for a stronger music industry. Maybe he's got a point. "No one makes money in the industry. You are lucky if you break even." **Janet Angus**
Norsk Lydstudio A/S,
Nordslettveien 2, 7000
Trondheim, Norway.
Tel: (07) 9 679 66.

BASF Studio Master Series. The new Tape Generation.

NEW BASF Studio Master 911 BASF Loop Master 920

This sophisticated recording tape of high dynamic was designed especially for the high professional demands of modern multi-track technology.

The wear resistance of the magnetic layer ensures reliable operation even after hundreds of passes.

In spite of its considerable high MOL (+12 dB over reference level 320 n Wb/m), BASF Studio Master 911 has an unusually good print ratio of 57 dB and is therefore also suitable for long-term archiving. BASF Studio Master 911 excels by its low modulation noise.

The chromium dioxide master tape for high-speed duplication systems. At 64-times duplicating rate, the master is usually recorded at 9.53 cm/s. It is only the typical chromium dioxide properties featured by Loop Master 920 which offer that extra quality needed to allow exploitation of all the advantages of a high-class cassette tape (eg. BASF chromdioxid II). In spite of the mechanical stress to which it is subjected in the "loop bin", the durable magnetic layer means that the recording level remains extremely constant, particularly in the high frequencies, even after running thousands of times.

BASF Digital Master 930

This professional chromium dioxide tape is especially tailored to the requirements of digital sound recording (PCM), where the high storage density makes exceptionally high demands on the evenness of the coating. The typical chromium properties are brought out excellently in this latest form of sound storage. The antistatic magnetic layer and the black, conductive matt back protect the recording against dust-induced dropouts and ensure smooth, steady winding without damage to the tape edges.

Coupon: Please send me further information on the BASF Studio Master Series.

Name/Company _____

Address _____



BASF United Kingdom Ltd.
4 Fitzroy Square
London W1P 6ER
Tel: 01-388 4200
Telex: 28649

BASF Aktiengesellschaft
Gottlieb-Daimler-Str. 10
D-6800 Mannheim 1
Tel: 06 21/40 08-1
Telex: 4 62 621 basf d

 **BASF**

CONTROLLING CONCERT SOUND

The Greater London Council, scheduled for abolition in the next few months, funds a wide array of organisations besides its day-to-day municipal functions—including several scientific departments related to the well being of Londoners, their environment and London's entertainment facilities. One of these bodies is the Noise and Vibration Group, which is concerned with the monitoring and controlling of noise levels in everything from live concerts to airports and motor traffic.

The department has adopted a flexible approach in dealing with open air live concert situations and has become actively involved with methods of increasing audience sound levels, while decreasing complaints from surrounding residents.

As the GLC is a body for the whole of the Greater London area which licenses all entertainment throughout the boroughs, it will often give the go-ahead for an event even when the local council takes a less conciliatory attitude.

When, in the past, some boroughs have shown themselves to actively discourage outdoor gigs by restricting sound levels, the GLC's Noise and Vibration Group has, on occasion, overruled these councils by promoting sound levels based on its own Code of Practice—a code that's been proved to be fair to both audience and residents alike. Because of this, it will be unfortunate for concert-going Londoners if this forward looking department is lost in the abolition process, leaving local councils with individual control in these areas.

The following conversation is between Jim Griffiths MIOA, Senior Noise Consultant, London Scientific Services GLC, and Richard Vickers who first spoke to Jim in

Consideration for local residents may not be our prime concern when setting up a concert sound system but Jim Griffiths of the Greater London Council tells Richard Vickers how a control body could actually improve the situation for everyone

connection with one of our Live Aid articles (*Studio Sound* Nov 1985).

Jim Griffiths works for the Noise and Vibration Group which is part of the Scientific Services Group at present part of the GLC. The branch came into existence about 100 years ago when the first chemists started to analyse Thames river water. The Scientific Services Group covers around 14 different areas of work from metallurgical diagnosis with electron microscopes to paint, polymeric materials, air pollution—and noise.

Jim's enthusiasm for his work—coupled with his department's wish that all Londoners should get a fair crack of the whip—has led to this article.

RV: Can you describe the areas of noise pollution that the group looks at?

JG: There's one section that deals mainly with road traffic noise under the Land Compensation Act. We look at aircraft noise, including helicopter noise, and we monitor various sites around Heathrow airport—which we've been doing since 1979. We've built up a data bank of about a million different recordings of aircraft going over—something that no-one else has done—it allows us to look at trends, to see whether the situation's getting worse or better. Then there's industrial noise and the field of vibration—historic buildings and the effect of road traffic vibration on them.

RV: Has legislation led to your involvement, or vice-versa?

JG: Government legislation has been fairly poor, in fact. We've gone in more from the

point of view that, for example, the GLC is responsible for a large number of historic buildings and are worried about the effects of vibration. The Government hasn't been particularly active in these areas. For instance, we've introduced a lorry ban for certain sized lorries in Central London late at night to help protect buildings. We look at vibration on machinery like the Thames Barrier, which we're monitoring with about eighty units—from these we can tell whether a machine's likely to break down, before it does. We look at the ferries in the same way.

RV: When did your division first get involved with live concerts, and what led to that involvement?

JG: It was in the early '70s when open-air concerts first started, which coincided with the development of modern PA systems and increasing noise levels at concerts. As the GLC licensed these concerts, they decided a Code of Practice was needed to help people, both in London and throughout the United Kingdom, to have a unified approach. Hence the original code, which was first written in 1976, came into being.

RV: What were the parameters for measurements in producing the Code of Practice, and how were the recommended levels arrived at?

JG: The Code covers not only noise but other areas such as seating and first aid. With regard to noise, we started off producing parameters for hearing damage and for noise annoyance. Hearing damage research was based on 90 dBA for eight hours, which is the recognised standard for industrial noise. If someone's exposed to 90 dB for eight hours that's written as '90 dBA Leq' over eight hours, with Leq being equivalent to continuous sound level.

RV: I believe there was an

Concerts have recently been monitored from the mix position



See us at the
80th AES Conv.
Stand S-09



Yes – An Audio Analyzer.

The RE201 Dual Channel Audio Analyzer looks and performs like no other audio analyzer. The instrument combines analog and digital measurement technology to gain distinct advantages over the competition. This single instrument replaces an entire configuration of audio test instruments.

The RE201 can measure:

- Level: True RMS (selective bandwidth), Peak, Quasi-peak, Average, DC
- S/N: weighted and unweighted
- Harmonic distortion
- SINAD
- Difference Frequency distortion (DIN std.)
- Intermodulation distortion
- Transient Intermodulation distortion
- Frequency and Drift
- Phase and Phase Drift
- Separation and Crosstalk
- Rumble
- Wow and Flutter

Performance The RE201 delivers speed and test diversity without a compromise in performance. For example, harmonic distortion below 0.001% (-100 dB) and single harmonics down to 0.0006% are guaranteed specifications.

Speed Operation of the RE201 is designed to match the way you test audio. Manually, semi-

automated or fully automated. Performs complete audio testing without the need of an external controller. Or have the RE201 under full control using any IEEE controller. The speed table demonstrates measurement time under IEEE488 bus control.

Measurement	Time to first result (seconds)	Measurements per second	
Level Peak	0.35	Frequency >50 Hz	3.6
Level RMS	0.17		47.6
Level Selective	0.35	Bandwidth >600 Hz	5.3
THD	0.40	Frequency >500 Hz THD >0.1%	4.0
SINAD	2.50	Frequency >200 Hz SINAD >0.1%	0.4
DFIM	0.37	Diff. frequency >500 Hz	4.4
IM	0.4	Low frequency >500 Hz	4.9
TIM	0.39		4.2
Frequency	0.34	Frequency >200 Hz	5.4
Phase	1.0		9.1
Separation	0.65		1.6
Wow & Flutter	3.6	W&F >0.2%	0.8
Signal	Setup Time (seconds)		
Sinewave	0.1		
Multitone	2.6	10 Hz resolution	
	0.43	100 Hz resolution	
	0.21	1000 Hz resolution	
TIM	0.013		
1 kHz reference	0.09		
Level change	0.09		

It's easy to use. It takes only minutes to customize the RE201 to your testing requirements. Up to 100 complete test setups can be stored and recalled. And it takes just a few simple keystrokes to make the measurements you need. With the use of available options, the RE201 can meet your individual applications.



RE201 available options

The RE201 – a complete audio test system in one instrument. Does it sound too good to be true? Write or call us today. Find out why all audio analyzers should look like the RE201.

RE INSTRUMENTS Ltd.
RE INSTRUMENTS Corp.
RE INSTRUMENTS AS
RE INSTRUMENTS GmbH
saRE INSTRUMENTS

Sherwood House, High Street, Crowthorne, Berkshire RG 11 7AT
United Kingdom (0344) 77 23 69
31029 Center Ridge Road, Westlake, Ohio, 44145, USA (216) 871-7617
Emdrupvej 26, DK-2100 Copenhagen Ø, Denmark +45 118 44 22
Dürener Strasse 17, D-5170 Jülich, West Germany +49 02461/4147
140 Avenue Pablo Picasso, 92000 Nanterre, France +33 1 47 78 74 92



Licensed agents in more than 30 countries throughout the world.

CONTROLLING CONCERT SOUND

earlier standard, 'L50'?

JG: In assessing environmental annoyance, we used L50 which is the level exceeded for 50% of the time. If you have a time varying signal, say over a 15 minute period, the level of the signal being exceeded for 50% of the time would be the L50 reading. An L1 would be right at the top, and L100 at the bottom.

As more sound level meters were designed with Leq measurement facilities, which coincided with the acceptance of Leq as a good unit measurement for residential complaints, Leq was adopted into our Code of Practice in 1978.

Our guideline for hearing damage is 93 dBA Leq for 8 hours continuous music while industrial noise limits are set at 90 dBA for the same time period. The increased level for music is due to the non-stationary nature of most audiences at concerts, plus people want to go to concerts to hear loud music as opposed to some industrial machine environment where you can't escape from the noise.

The guide is based on the 'equal energy principle', so it's 96 dBA for four hours, 99 dBA for two hours, and so on—3 dBA for doubling or halving the duration of the music.

RV: So a dB meter with a print out reads the energy from a minute's duration, analyses it and produces a mean average?

JG: That's it, yes. Fairly recently we've been monitoring concerts at the mix position. We use a microphone positioned roughly 8 ft high and have found that the difference between monitoring there and at audience height is between 3 and 5 dBA.

RV: Is that for places like Wembley, to give you a mean average between the stalls and the side breachers? So the likelihood is that anybody in the audience will be receiving pressure levels a couple of dB lower than your reading?

JG: Yes, certainly—that's what we did at Wembley. Our guidelines might have seemed low but we added extra dB to take into account the attenuation from the mixer to the audience—and also the mixer was closer to the stage than our guidelines state.

RV: Do you take measurements in other areas

of the hall to check level fall off rate against that at the mix position?

JG: We use DOSE meters; that's a meter that looks at the overall energy over a longer period. 100% DOSE means 90 (dBA) for eight hours but we can correct it for whatever time period or level we want. It's a small, portable instrument which we use to monitor at four or five different places throughout the hall. All our guidelines are based on measurements for 50 m from the sound source. You can't just pick a measurement out of the blue: we did an attenuation from the mixer to 50 m out with a DOSE meter. We position these over the mixer and they show us how the levels drop from 8 ft down.

RV: Do you take a different approach for concert halls?

JG: With regard to hearing damage we apply the same rules, though in an indoor venue you're more likely to have higher sound levels, and more danger of hearing damage. Outside, the emphasis is more on the environmental aspects—annoyance to neighbours, etc.

Again we look at the Leq and allow an increase for one-

off concerts of 10 dBA over the background noise level up to 8pm, and then 6 dBA until 11pm.

RV: I must admit that most of this technology is totally alien to me.

JG: I must admit to the same thing on the PA side, though obviously I've picked up bits with the work we've done.

Nagras are used for environment recordings, which are then played through real-time analysers. We also place Environmental Noise Analysers outside to monitor noise levels every 15 min—at concerts we use them to measure ambient noise levels over the day and during the concert. It prints out the Leq every 15 min, and any other parameters we want. We use them for many types of noise; we have a number permanently installed at Heathrow airport, for instance. With a tape recorder you can get an idea of the frequency distribution, which is something that we've been looking at—particularly low frequencies and their effect on the environment.

Most people complain of this 'DUMPTH, DUMPTH' and because we measure the noise by A-weighting the sound, we

don't really pick up the low frequencies—I've been looking at that in a bit more depth.

The high frequencies, of course, get absorbed quite quickly, whereas the low frequencies, especially when someone's sitting down in their room, just produce this thump thump which annoys them more than anything.

RV: I think it may be because the lows 'won't go away', so it gets to you more easily. If the noise from the gig is in a low frequency range with sufficient volume to excite an audience, and you're sitting at home not wanting to be excited at all, its going to make you positively upset.

JG: We've found that letting the level go up 10 dBA above background tends to limit complaints to about two on a large concert, providing you take other steps, eg public relations—going round telling people that an event is going on, you know; it's a one-off and it will end at this time, etc.

RV: If they know it's going to happen, it's not so much of a shock.

JG: The 'free tickets' touch can help as well.

RV: So they paper the complainers?

JG: That's it. If it makes for an easier life, it seems to be the route to take.

RV: Do you find it surprising that very few promoters and sound companies working on open air gigs, who must know that you're coming down, contact you in advance of the gig to arrange the best compromise, ie complying to your standards while retaining the best crowd coverage possible?

JG: It does depend on the promoter; we've worked well with, for instance, Jo Chester Promotions who've always talked to the people who live on the boundaries of the gig. I think some promoters don't know where to go in the local borough, or whether they should come to us. They'd benefit from our knowledge in trying to come to a reasonable level for the people inside, whilst disturbing as few of the residents outside as possible.

RV: I understand you've taken active steps to maintain sound levels within stadia, at the same time as reducing sound levels outside?

JG: We developed this technique first at Reading, and ▶

Crystal Palace football ground in South London

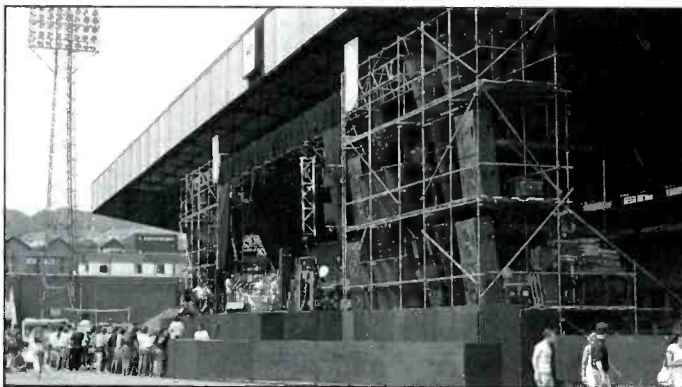

A DOSE meter in action at the Live Aid mixing position



STUDIOMASTER

12M



SPECIFICATIONS

FREQUENCY RESPONSE: 10Hz - 28kHz \pm 1 - 3dB. **TOTAL HARMONIC DISTORTION:** Typically, 0.01% @ 1kHz (Input 0dBV, Output +4dBV). **HUM & NOISE:** (20Hz - 20kHz, Input termination 150ohms) Equivalent input noise - 126dBm, Residual output noise (all faders down) - 85dBV. **MAXIMUM VOLTAGE GAIN:** 88dB. **CROSSTALK:** Input to input - 30dB. **DIMENSIONS (LxHxD):** Of flight case (incl. wheels), 1651x37x1068mm. Of 24-channel mixer, 1218x207x870mm. Of 32-channel mixer (add-on fitted), 1540x207x870mm. **WEIGHT:** 24-channel 12M in flight case (incl. PSU) 75kg. 32-channel 12M in flight case 85kg. **ACCESSORIES:** External Power Supply, DC lead, AC lead.

THE STUDIOMASTER 12M MONITOR MIXING CONSOLE

This exciting new mixing console from Studiomaster gives the smaller bands and P.A. companies the opportunities to possess monitoring facilities and sound quality previously beyond their means.

The 12M comes as standard in 24-12 format but the flight case in which it is supplied has provision for a further 8 inputs to be added - so if the time comes when you want to expand your monitoring capabilities, then your 12M can expand with you.

The 12M has too many features to list here, but they are all to achieve the same result: total sound control of a very high standard. In particular, Studiomaster's acclaimed EQ facilities have been expanded up to FOUR bands on the inputs and the output 4-band EQ has FULL-PARAMETRIC mid-bands. The flexibility of this EQ can even render outboard graphics unnecessary.

Studiomaster have positively attacked the problem of feedback with a number of features which will eliminate it at the desk: every input channel has a notch filter which, by turning an infinitely variable rotary control, will cut the feedback frequency with a very narrow "notch" in the frequency response. Also, "C" control on the output equalisation can be used to create another notch filter effect.

Input and output connections are XLR type. All inputs are electronically balanced, high impedance for minimum interaction with the front-of-house desk. The inputs also have a parallel out socket. The outputs are unbalanced, low impedance with a transformer option for complete ground isolation.

A 12 segment display on every channel, combined with the built in monitor output (for headphone or amplifier listening) allows the monitor engineer to constantly check the mixes he creates. The 12M also has a talkback system which allows him to communicate with the artists on stage, particularly useful during soundchecks.

The 12M is not only electrically superb; the chassis is built with quality materials and careful consideration of the ergonomic aspect has resulted in a logical channel layout which combined with detented rotary controls and 00mm ALPS master faders makes for confident, precise adjustments.

With all these features and versatility though, the 12M is still very affordable. State-of-the-art design has made it possible to offer no-compromise performance at a price which puts it in reach.

For more details, contact:

STUDIOMASTER

Home Farm, Northall, Dunstable, Bedfordshire, LU6 2EZ England
Telephone: (0525) 22 331 (3 Lines) Telex: 825512 Studio G Facsimile: 0525 221-894

CONTROLLING CONCERT SOUND

refined it over the last 10 years. It was devised by Duffy Wallis of Cirrus Research. We take a sound attenuation test prior to the concert when the PA system first arrives. Once the PA has been EQ'd we measure the background noise level outside the venue and allow the level to go up 10 dBA. We used to play pink noise but these days we play a shaped noise, which we've developed over the years from recordings of popular music, over the PA system—that tends to centre more on the low frequencies which normally carry further in free air. We then measure outside at the nearest residential property, allow the level to go up 10 dBA and then see what kind of level we're getting at the mixer. If this level isn't reasonable, we've had the speakers tilted in certain sections, and we've maintained levels inside with a reduction of up to 5 dBA outside, which is a significant reduction for the residents.

Although the sound companies found this rather strange to begin with, they've gone ahead with it, and at Crystal Palace we had 30,000 people enjoying themselves and only two complaints—which is quite amazing considering the housing virtually overlooks the gig itself!

The sound companies have found it much easier since the advent of flying systems; at first, they were wedging bits of wood under cabinets, which for safety aspects wasn't too good!

RV: With the Government action which is now disbanding the GLC, what fears are there for your department? The Springsteen concerts showed a local borough trying to insist on levels that were really too low—do you see a potential 'war' between promoters and local councils developing?

JG: We don't know our fate at the moment. I feel the system we have at present, with the GLC licensing pop concerts, is fair. At present our entertainments licensing dept looks both to entertaining people and at the residents' interests. If licensing goes over to the local boroughs, the councillors who will make the decision as to whether a concert goes ahead or not are likely to look after their own residents first and not think of

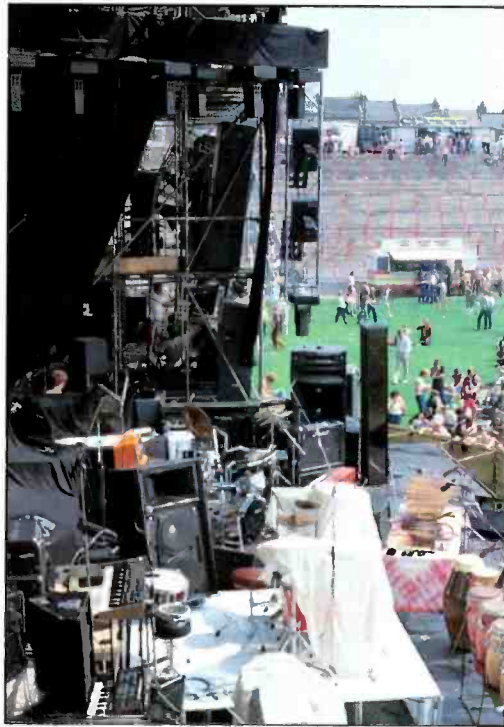

At many venues, houses are very close by. Tilting speakers is one way of reducing sound levels outside the stadium without losing impact within the grounds

the entertainment value. Certainly concerts at the Crystal Palace football ground are likely to stop. It's very likely that the council hasn't wanted the concerts there but the GLC Entertainments Licensing Board has decided it wouldn't annoy a lot of people.

Secondly, the GLC Code of Practice gives a uniform approach to the idea. We've had a lot of experience of monitoring and we're not just coming in saying 'you've got to meet this'. Our aim is to make a fair balance between the rights of people to enjoy themselves and the rights of people not to be unduly disturbed—that's the whole crux of the matter. The local

boroughs simply may not have a full understanding of the whys and wherefores of holding pop concerts.

RV: With the disbanding of the GLC, what would you see as the ideal position for your department?

JG: We hope that we'll be able to act for all the London boroughs, should they wish us to help them, just as we do already—including lending them monitoring equipment, providing guidelines and updating them. The boroughs have a lot of work under the pollution acts and they really need someone to develop and monitor guidelines for them.

RV: Presumably they don't have the database that you

have, or the experience your department has, and perhaps they had a naïve approach to the way these things need to be run?

JG: Well, within our branch we run workshops for the London boroughs giving advice and information on many topics of environmental noise and pollution, we're intending to introduce entertainment noise as a new topic this year.

RV: I called a lot of people from the main PA companies in town today to see what their worst experience was of this department, yet nobody had a bad story to tell. Their reactions all seemed to be 'whatever level was set initially a reasonable compromise was arrived at by both sides'. So would your long term aspirations be to cover the whole of the UK as a government department that would advise borough councils up and down the country?

JG: That would be very nice—whether it will ever come about I don't know. They need an overall control in most cities; it already happens in Australia and the US, within their environmental agencies. That's certainly the way we'd like it to work and I really hope something like that does evolve.

If not, entertainment in London will certainly suffer quite badly. □

Further information

Despite the very encouraging report by the House of Lords Select Committee on Science in Local Government which very strongly advocates the need to maintain a central scientific service and the various undertakings by Lord Elton during the 'abolition debate', the future of the service is still very much in doubt. If the Group is unable to secure finance from the 50 or so successor bodies which will take on the various functions of the GLC it is quite possible that the scientific support which it now has in a wide range of topics including technical support for building construction and maintenance, consumer protection, education, environmental health, highways, parks, planning, safety, waste disposal, and pollution and noise control would cease.

Anyone requiring more information on the GLC Codes of Practice or wishing to consult the department with regard to forthcoming events should contact: Room 705, Scientific Services Branch, County Hall, London SE1 7PB, Tel: 01-633 6005.

AMEK APC 1000

The next revolution
in console technology
is here.



80th AES Convention
Montreux 1986
Stand no. 01 Level 100

BUSINESS BUSINESS



Barry Fox investigates the facts behind the industry news

Pairing up for stereo

Several years ago I wrote about an idea, put forward by American recording engineer Jerry Bruck. He thought it might be possible to recreate genuine stereo from old cylinders. The theory goes like this.

It was difficult to duplicate cylinders by moulding. So at the recording sessions they used a bank of separate machines. That way they got several masters and from there made copies by acoustic dubbing. A little lateral thinking tells you that if you can match up a pair of masters which have been made at the same session on sensibly spaced machines, then you have the left and right channels of a stereo recording. Put them together and you have the real thing. So far as I know, no-one has yet found a matched pair and put them together. But in California Brad Kay has been doing the same thing with old discs.

Kay is a pianist and recording engineer who earns a little extra out of dealing in old discs. To cut a long story short, his friend Steve Lasker found an odd test pressing made by Duke Ellington and his band in February 1932. It ran for around 8 min at 33 $\frac{1}{3}$ RPM—the LP format which RCA tried to launch in the early 30s. The format failed because it was ahead of its time. The records had to be pressed from soft plastic (shellac is too noisy at the low speed) and the blunderbus pickups of the day just ate into the grooves.

Back in 1981, when Kay and Lasker first played the LP, their main interest was in discovering a rare Ellington recording. The matrix number scratched at the centre of the master didn't match the matrix number listed in collectors' catalogues. Perhaps it was an alternative take.

Three years later, in 1984, Kay and Lasker laid their hands on another copy, at a Pasadena record swapping session. Although the two discs had slightly different matrix numbers they were clearly both recordings of the same take. But Kay was sure that there was a difference in audio perspective. It showed up particularly clearly on Sonny Greer's drums. He suddenly realised what they had found; the left and right halves of a stereo pair.

By dubbing one disc on to tape, then patching the tape and disc deck outputs through a mixer Kay was able to play both at the same time. With careful cueing and speed control it was possible to get short passages running in sync. The result was stereo. Lovely genuine stereo. Subsequently Kay built up an edited version of the 8 min Ellington medley, by re-recording literally dozens of attempts at syncing the left and right channels, and then splicing the best passages from each pass. The first attempt took around 40 edits in 8 min.

With practice, and the benefit of musician's ears, he got down to a few per side.

He got the practice with another Ellington LP session recorded a few days later. He has since done the same with a 1929 section from Stravinsky's *Rite of Spring*, conducted by Stokowski. The two channels were dubbed from pairs of standard issue 78s. Kay has also made a stereo blend of Sir Edward Elgar conducting *The Cockaigne Overture* at Abbey Road in 1933. His latest finds are some more matching halves from the same *Rite of Spring* session and the Boston Symphony Orchestra hammering out Ravel's *Bolero* in 1930.

Needless to say Kay is now looking for more matched takes. There are some tantalising leads. A two part recording of *Private Lives* has Noel Coward obviously close to one microphone on one part but more distant for the second part. Gertrude Lawrence is distant on the first part and close on the second part. If the missing disc pairs can be found, the result should be very wide stereo.

Kay wants everyone with an old record collection to have a look for matching pairs. "The signpost is an 'A' after the matrix number," he explains, "that signifies that it comes from an alternate turntable. When you have found an 'A' take you can be pretty sure that somewhere there will be a plain take, with the same matrix number but without the 'A'. That came from another turntable."

Here's how Kay believes it happened. Just as modern studios will often run two tape decks, one for safety, so early recording studios ran two disc cutters. If one wax master was faulty or spoiled, there was a good chance that the other would be good. As often as not both wax masters were good. Both masters were then available for pressing. Sometimes the 'A' master would be brought out of the vaults when all the mothers and stampers for the main master had worn out. Other times the record company would send the 'A' master abroad. This seems to have happened regularly with HMV in Britain and RCA-Victor in America. "The US catalogue of HMV recordings is lousy with 'A' takes," says Kay.

He has found that putting two recordings of the same take together will not always produce the stereo effect. He deduces that in some studios, the engineers split the feed from a single mic and thus cut the same signal on both discs. This would also happen if the session was handled in radio fashion, with several mics (some close on the singers) and their outputs mixed into a single mono feed for recording. But some engineers preferred the more natural sound of a single mic. It would seem logical that they would then hedge bets and use two single mics, one for each turntable and perhaps a different

position for each to capture a choice of perspectives. If so, they were unwittingly capturing a stereo pair. It would make sense to duplicate the full recording chain, rather than just part of it.

Kay says he has tried blending plain and 'A' takes which apparently come from a single split feed rather than a double mic set up. He has also tried blending two copies of the same disc. "When they are slightly out of sync you get a phase shift and pseudo stereo. But flip to mono and you just hear terrible phasing. With plain and 'A' takes from different mics, the effect is quite different. The closer you get them in phase, the better it sounds. Then flip to mono and there is no phasing."

Kay's equipment is relatively simple. A Revox A77 $\frac{1}{2}$ in running at 15 in/s, and a 25 year old Bogen turntable. A good pair of ears is vital. And a lot of patience. When I originally started researching this story, I was convinced that it was either a hoax or that someone had got the wrong end of the stick. Now I have spoken with Kay in California and heard the results of carefully sync'd plain and 'A' takes, apparently made through different mics, I am convinced Kay is genuine. The theory is plausible. The audio effect is remarkable. He could very well be right.

Kay makes the point that if he has been able to get this far, as an amateur ("I don't make anything out of this—in fact it costs me money," he explains) just think what could be done with more wide scale searching. In fact just think what could be done... if the record companies showed an interest, and searched through their vaults for original plain and 'A' take metal work.

Devil's advocate says it is all just technical serendipity—for instance mismatch of resonances in the two cutters used to make double takes from the same mono feed. This might create a comb filtering effect, similar to that used by modern stereo synthesisers.

What do *Studio Sound* readers think about it all?

Doc shock

The Hank Wangford band played at the DEAF ball last year. It's now an open secret that under a different name Mr W is a doctor specialising in obstetrics. Anyone who saw his performance may find that hard to believe. So did one of his patients.

A few years ago Hank, under his real name of course but still looking much more like a C&W singer than a doctor, was working as a locum for a family planning clinic. One young wife checked in expecting her usual matronly doc. Finding Mr W instead she got the hell out, telling the receptionist en route that she didn't find *Candid Camera* one little bit funny. □

Precisely!

High fidelity, total reliability, consistency, simplicity, pure quality.

The new Aces MT range of 16/24 multitrack recorders for the permanent or mobile studio.

Take out what you put in: nothing more, never anything less.

Precisely!

(and priced nicely at £7700+VAT)

Write away right away to
Aces (UK) Ltd, Freepost
(no postage required)
Featherbed Lane, Shrewsbury,
Shropshire, England SY1 4NJ
Telephone: Shrewsbury (0743) 66671
Telex: 35188 ACES G



Aces
Sound
Professionals

EC 402 EC 101

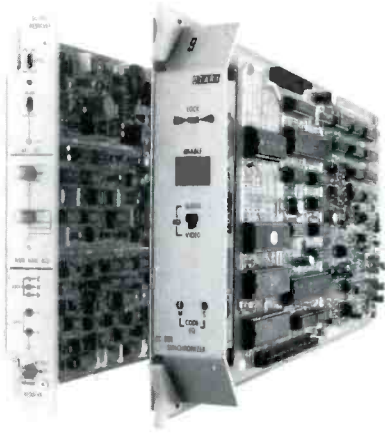

EC 401



MTR 20

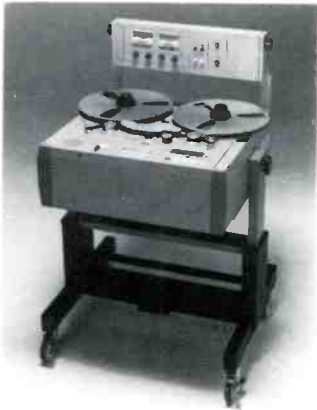

APC PROTOTYPE



BC II



HERE IS THE NEWS

Otari and Amek will be two manufacturers to watch in 1986. At ITA – the only distributor of both ranges of products – we have a unique vantage point.

Otari's SMPTE/EBU chase synchroniser module for the MTR90 is now in stock. The EC-101 will lock the MTR90 to a master machine (audio or video) in all modes.

The EC-401 & 402 resolvers permit Neopilot* or Nagrasync* pilot-tone tapes to be replayed, locked to virtually any reference. Both resolvers can record pilot-tones, and the EC-401 additionally allows frame-locking with SMPTE/EBU timecode from tape or reference, and universal capstan control.

There are two new Otari recorders – the MX70 1" 8- or 16-track, and the MTR20 Series of master recorders. The MX70 has an advanced new transport, and offers performance and facilities exceeding most 2" machines. The MTR20 is probably the world's most sophisticated master recorder, offering ultra-smooth tape handling, 14" spool capacity and fully-automatic record alignment.

From Amek/TAC come several new mixers, plus new formats of existing ones. The new Amek BCII Broadcast Mixer is a high quality, flexible small mixer system with many features and options. The TAC Scorpion and Matchless consoles have new versions; the Scorpion now has EQ on the monitors, and a larger 36-channel Matchless is available.

The most important development is the new Amek Assignable Production Console. The APC represents the next stage in recording console design. Central assignment of all console functions with on-board memory, choice of automation systems, and a unique Total Reset facility put the APC ahead of all existing or projected designs. Yet it's ergonomic approach make it possibly the easiest-to-operate multitrack console ever.

At ITA, we have a helpful, friendly approach to pro-audio, and in 1986 it makes even more sense to talk to us. Call us now.

* NagraSync and NeoPilot are trademarks of Nagra-Kudelski Ltd.

INDUSTRIAL TAPE APPLICATIONS
PROFESSIONAL PRODUCTS DIVISION

The logo for Industrial Tape Applications (ITA) Professional Products Division. It features the letters 'ITA' in a large, bold, stylized font. The 'I' and 'T' are connected at the top, and the 'A' is separate. The letters are black with a white outline.

1 Felgate Mews, Studland Street, London W6 9JT. Tel: 01-748 9009.

REVIEW REVIEW

A digital multitrack reviewed by Hugh Ford

MITSUBISHI X-850

The Mitsubishi X-850 offers 32 channels of digital audio on 1 in tape with the ability to synchronise with further machines if extra channels are needed and video machines using either a 25 Hz or 30 Hz frame rate with or without drop frame. The recording format is to the professional digital, or PRODIGI, format currently agreed between AEG Aktiengesellschaft (formerly AEG Telefunken), Mitsubishi and Otari in direct competition with the DASH format agreed between Sony, Studer and others. The two formats are 100% incompatible but I am sure that someone will manufacture a digital converter for dubbing in the digital domain between DASH and PRODIGI machines.

In addition to the 32 channels of digital audio there is an SMPTE timecode channel, two analogue audio channels and two auxiliary digital channels. Whilst this machine uses different software from the earlier model X-800 it can replay tapes which were recorded on the X-800 provided that they do not contain splices.

A further feature is that digital dubbing is possible not only between channels but also to the ¼ in digital stereo Mitsubishi model X-80 (see *Studio Sound* May 1982, 'Telefunken MX-80' review). Cut and splice editing is a feature of both machines with the model X-80 having an excellent performance in this and other respects.

The basis of this large and very heavy machine is a grey fabricated steel cabinet fitted with four sensible wheels in addition to screw jacks at each corner. At the front two doors give access to the electronics in the form of two full width card frames each having a capacity of the best part of 40 plug-in printed circuit boards plus one smaller frame at the top.

To the rear are seven cooling fans, with a further internal fan, all of which make the machine rather noisy. All interconnections are on the rear panel, the audio inputs and outputs being XLR-3 connectors. A multiway connector in parallel would be a useful addition.

Power input is at a fixed lead fitted to uninsulated terminal posts behind a rather inadequate transparent cover which also covers the transformer tap changing link with a nearby on/off circuit breaker. Two 2-pin auxiliary power output sockets are also fitted.

Three 50-way Amphenol connectors are used to connect the locator, the remote control unit and the optional meter bridge which contains digital metering. The RS232 and RS422 interface connections, details of which are not currently known, are standard 'D'

connectors with an additional 25-way 'D' plug providing a timecode output.

Digital dubbing involves the use of two 50-way and one 25-way 'D' connector for each of the inputs and the outputs with the remaining connections being via BNC sockets. Two of these in parallel form the video input with a switched 75 Ω termination. Similarly two connectors in parallel form the external clock input with the internal clock being available at a BNC output.

The tape transport, a modified Otari MTR-90, is mounted on a hinged alloy plate at the top of the machine. (This is an excellent transport see *Studio Sound*, November 1982 for review.) This arrangement provides very good access for servicing the tape transport components. The transport can cope with 14 in NAB reels which contain enough tape to run for 1 hr at the 30 in/s standard tape speed with the tape thickness of 27.5 μm. This thin tape dictates a good transport and the

pinchroller-less Otari transport is entirely suitable.

The modifications to the transport are all around the head area which contains four 45-track ferrite heads covered by a substantial cast alloy cover which is secured to the top surface of the machine by four Allen screws.

At the entrance to the head area is a perforated tape stabiliser/edge guide followed by the first replay head and the erase head then an edge guide post. This in turn is followed by the record head, the second replay head and an exit edge guide post. Tape lifter pins are located between the two pairs of heads.

All the heads and guides are firmly mounted on to a sub-casting which is bolted on to reference faces on the main transport casting giving a strong and stable assembly with the heads plugging into the electronics via 'D' connectors. These in fact connect directly into a screened head preamplifier section containing five printed circuit boards directly beneath the head area.

Within the cabinet the power supplies are at the rear bottom and are removable as a single unit to the rear complete with their three cooling fans with the input/output connections panel being above the power supplies.

At the front the bottom card frame has the five transport control boards to the right, these having the minimum of preset controls as in the Otari MTR-90. The remainder of this frame contains the A/D, D/A and analogue circuits occupying 24 indirect edge connector plug-in printed circuit boards arranged in four groups each having six boards. Each group covers eight channels involving 10 tracks on tape and contains two of each analogue amplifier boards, A/D converter boards and filter/output boards.

The preset controls are minimal with test points being readily accessible at the front of the boards although a card extender is needed for adjusting the preset potentiometers.

The PCM card frame in the middle is divided into four groups each with seven printed circuit boards and dealing with 10 tape tracks. The delay, fader and interleave boards have no controls or indicators with the codec board having a single LED to indicate uncorrected errors.

Only the read amplifier board has preset adjustments in the form of two potentiometers per tape track with the two modem boards in each group having five LED's to indicate single track errors.

The remaining boards in the PCM section deal with the auxiliary analogue and digital channels, and overall control

MANUFACTURER'S SPECIFICATION

Number of channels: PCM 32 channels, analogue (cue) two channels, timecode one channel, auxiliary digital two channels.

Tape speed: 30 in/s (762 mm/s) ±10%.

Tape width: 1 in (25.4 mm).

Recording time: 1 hr with 14 in reel.

Recommended tape: Ampex 467, Agfa PEM 297D, SONY V-16.

Power supplies: 110/117/220/240 VAC, ±10%, 50/60 Hz.

Power consumption: 2 kVA.

Line input level: +4 dBm nominal, +19 dBm maximum.

Line input impedance: 10 kΩ (electrically balanced).

Line output level: +4 dBm nominal, +24 dBm maximum.

Line output impedance: suitable for 200 Ω load (unbalanced).

Frequency response: 20 Hz to 20 kHz

+0.5 dB -1.0 dB; 40 Hz to 15 kHz ±0.5 dB.

Dynamic range: over 90 dB (unweighted RMS).

Distortion: <0.05%. 50 Hz to 20 kHz.

Crosstalk rejection: 85 dB (1 kHz) minimum.

Wow and flutter: limited only by quartz crystal oscillator accuracy.

Sampling frequency: 48/44.1 kHz.

Number of code bits: 16-bit linear.

Error correcting code: RSC.

Modulation: 4/6 M.

External clock interface: 9.6 kHz (for

synchronisation to VTR). Composite video,

48 kHz/44.1 kHz, 60 Hz/50 Hz, 59.94 Hz.

Compatibility with X-800: PCM tracks with non-spliced tape are compatible with X-800.

Weight: 275 kg.

Optional accessories: peak level meter unit.

Manufacturer: Mitsubishi Electric

Corporation, Mitsubishi Denki Building,

Marunouchi, Tokyo 100, Japan.

UK: Mitsubishi Pro Audio Group, Digital

Entertainment Corporation, 1 Fairway Drive,

Greenford, Middlesex UB6 8PW.

USA: Mitsubishi Pro Audio Group, Digital

Entertainment Corporation, 222 Parkside Drive,

San Fernando, CA 91540.



AT PROFESSIONAL AUDIO WE GIVE YOU MORE THAN JUST THE TIME OF DAY.

Professional Audio is a new company, staffed by experts with years of industry experience who are dedicated to helping you achieve the very best sounds that money can buy. The end result is a company that offers a complete service to professional audio experts – staffed and run by acknowledged experts in the industry.

Already in just a few short months, our growing reputation has enabled us to secure dealerships from leading industry names including Electrospace, Westlake Audio, FM Acoustics, Marshall Electronics, SCV, Renkus-Heinz, NKA and JVC.

Call Richard Kelley or Simon Browne and experience a very special kind of service and expertise. **01-226 1 226**

Professional Audio Ltd., Professional Audio House, 53 Corsica Street, London N5 1JT.



YOU CAN COUNT ON US

**PROFESSIONAL
AUDIO LTD**

REVIEW REVIEW

and timing of the signals, data and synchronisation, plus metering when this option is fitted. The logic control board has facilities for selecting remote control via the normal remote unit or via the RS422 interface at 38,400 baud or via the RS232 interface in steps between 1200 and 9600 baud. Additional controls select the television standard and frame rate, etc.

Another board with user facilities is the clock 1 board which has several LED status indicators which show such functions as edit found, mute and clock origin. Controls on this board select the type of synchronisation source and provide an electronics to electronics test for all channels thus testing all the analogue/digital and digital/analogue sections without going via tape.

The remaining electronics in the machine at the top left comprise four write amplifier boards each covering 10 tracks and having 10 pre-set controls. To the top right there is a single VU meter together with pushbutton switches which select its source. This is done by means of 10 'units' pushbuttons and three 'tens' pushbuttons which select channels 1 to 32 with the selection of 33 to 37 covering the auxiliary digital and analogue channels and the timecode channel.

Also included in the VU meter panel is a ¼ in headphone jack for monitoring the selected channel, together with a headphone level potentiometer. Two lights above the VU meter indicate which replay head is in use: the sync replay (read) head before the record and erase heads, or the read after write replay head after the erase and record heads. Changing between replay heads is a rather untidy operation involving removal of the head cover and turning over piggyback 'D' connectors on the head leads.

Next to the VU meter panel is what is called the 'ping pong panel' which has 2 mm sockets for the digital input and output for each channel underneath which there is a horizontal bank of three interlocked pushbutton switches. These switches select the input to all channels between analogue, digital (rear panel input) and ping pong.

Selecting the ping pong setting allows one channel to be dubbed to another in the digital domain according to the linking of the 2 mm input and output sockets for each digital channel. Four further 2 mm sockets are included for dubbing to or from a stereo digital machine such as the Mitsubishi X-80.

Four further interlocked pushbutton switches select the system clock between internal and three external possibilities including a feed from a 2-channel machine (X-80) or from another multitrack both via the dub connectors on the rear panel.

Examination of the printed circuit board showed them all to be manufactured to a very good standard,

however, many hand wired modifications are included.

All components are clearly identified with only software associated integrated circuits being socketed. Whilst the operating and maintenance manual includes full circuits and very good information about mechanical servicing, information about the digital electronics is decidedly sparse and plagued by spelling and grammatical errors.

The tape transport itself is easy to load and has the minimum of controls to the front of the unit. These include an illuminated power on pushbutton and the usual stop, play, record and fast wind buttons which are properly interlocked. In addition to these there is an unload button which is pressed to unload the tape when editing and also inhibits the tape timer during editing. The latter, which has a reset button, indicates minutes and seconds and I feel that an indication of tenths of seconds would have been useful.

A well designed splicing block is located to the centre front of the machine with an illuminated cue button to the left together with a finger operated rotary control. When the cue button is pressed in the stop mode it and a light by the rotary control become illuminated. Subsequently rotating the control in either direction moves the tape in either direction and illuminates an arrow by the rotary controls to indicate direction.

A second function of the cue button is to defeat the tape lifters in the fast wind modes whilst it is held depressed. The tape speed during this process can be varied by rotating the control but remains constant when the control is not moved. Pressing any tape movement button aborts the cue mode.

The cue arrangement is a good feature for locating edit points which have to be located using the analogue channels as digital replay is not possible beyond $\pm 10\%$ of the nominal tape speed. Finer location of edit points is done by moving the tape by means of either the large diameter tachometer roller or the similar roller at the exit from the head area.

This method works extremely well and is similar to that used on the Ampex ATR-100 which was so popular. Editing by rotating the spools is not possible but is completely unnecessary in view of the alternatives.

Alone the machine may only be used for replay: the autolocator is essential for recording. This has the controls on a panel about 400 mm square mounted on a suitably heavy pedestal with the panel being tiltable between horizontal and 45°. The tape movement controls on the recorder are duplicated at the bottom.

In common with most multitrack recorders each channel has a selector key and LEDs to indicate the status between ready, record, input and tape. The 32 audio channels are separated into groups of eight channels. A further group of five keys deal with the auxiliary analogue and digital channels and the timecode channel. Four more keys allow any combination of channels to be formed into one of four groups.

A useful feature of the input mode setting is that the signal within the recorder passes through A/D and D/A conversion such that these processes are checked when monitoring the inputs.

Setting-up the channel status is done by first selecting the desired status with record, safe, input and tape keys and then selecting the desired channels. Alternatively there is an All key which sets all channels to the currently selected status and an All Mute key.

All the keys are fitted with LEDs to indicate their status with the overall machine status being clearly shown on matrices of LEDs. Further keys in this area allow manual or automatic switching between input and tape when entering the record mode and select the internal timecode generator or an external source of timecode.

Four memory keys permit four complete setups to be stored and recalled at the press of a key, this does not, however, include the auxiliary channels and the code channel which are also excluded from any of the four groups.

Within the locator section there are four 7-segment LED displays and a

STEREO STABILIZER



- Rack mounting frequency shifter for howl reduction in public address and sound reinforcement
- Mono version and box types also available

**SURREY ELECTRONICS, The Forge, Lucks Green, Cranleigh, Surrey GU6 7BG.
Tel. 0483 275997**

Leading Edge Sampling Technology?

The laboratory standard sampling equipment illustrated on the right will not give you 21 seconds of 20 KHz sampling on each stereo channel, full editing and triggering, plus delay, pitch transposition, sound shrinking and reverberation; all in stereo.

The Publison IM 90 Infernal Machine (*not illustrated*) will do all these things and more.

Distributed in the UK By:



Scenic Sounds Equipment Limited
Unit 2, 12 William Road, London NW1 3EN
Tel: 01-387 1262, 01-734 2812
Telex: 27939 SCENIC G

Publison 18 Avenue de la Republique, 92170 Bagnoleet. France

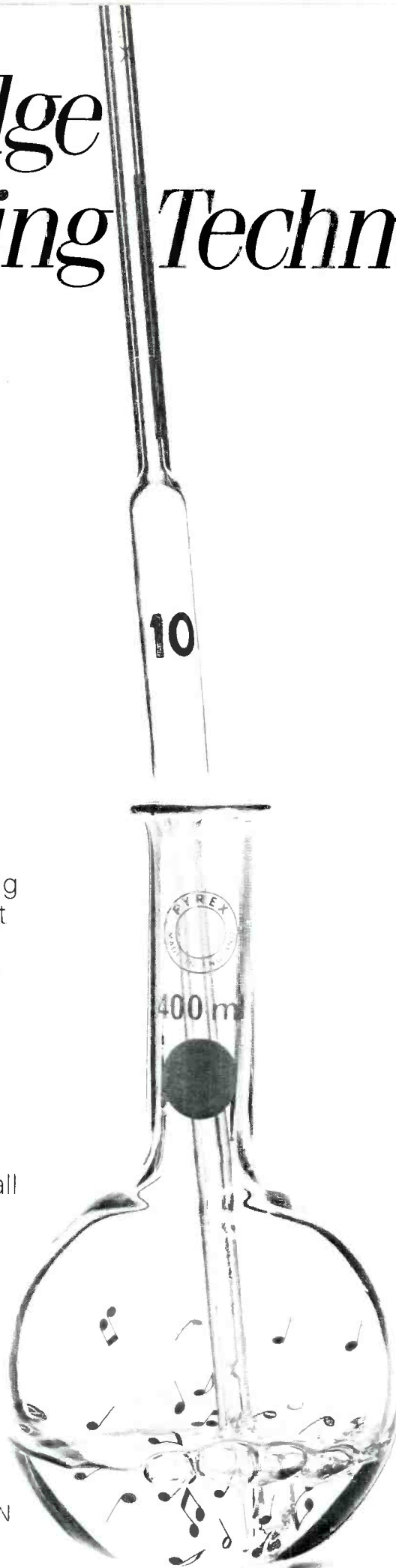

REVIEW REVIEW

variety of functions available. The lower 3-digit display indicates the percentage speed variation in the varispeed mode which has increments of 0.1% over the range $\pm 10\%$. Varispeed may be set from the decimal keyboard or may be set by using increment up and down buttons near the speed display with LEDs in the varispeed and fixed speed keys indicating the current situation.

Above the speed display are two separate time indicators which may be switched between hours, minutes and seconds from the tachometer or to display timecode where the frames indication is added. As a timecode generator is built into the system an external one is not necessary. As is not unusual one display is time and the second locate.

In addition to being able to transfer one display to the other, the locate display may be increments up/down in units of 1 s when displaying time or one frame in the code display. The contents of the locate display may be transferred to any one of 100 time stores, the fourth display being used to indicate which time store is being addressed.

Operation of the stores is very simple with up/down keys by the store number display selecting individual stores whilst indicating their contents in the locate display. Alternatively pressing Recall and keying in the store number on the decimal keypad selects stores.

There are four further keys strictly associated with the stores, one of which when pressed stores the current tape time in the currently selected store. A repeat button with an inbuilt LED allows the machine to cycle between times stored in any two stores with addresses less than 10, with the LED being illuminated during the process. The locate button has a similar LED with this button locating the time on tape currently shown in the locate display. Fourthly there is the 'RLB' or roll-back button which functions in the same manner as the locate button but then rolls back, normally 4 s. The roll-back time may be varied between 1 and 10 s but the manual didn't say how.

Other than the Event Clear key which

clears a currently set event there are five more keys fitted with inbuilt LEDs and an illuminated pushbutton associated with rehearsal and editing. The locking pushbutton allows entry into record to be rehearsed without actually writing data on to tape.

The Auto Mark button automatically enters into the current store the time when the machine is started, set in and out of record and stopped, with the store number being automatically incremented at each event. When these stores are recalled the LEDs in the Stop, Record In and Record Out buttons are appropriately illuminated to show what the event was. These three buttons are also used to label stored times as Record In, Record Out and Stop events, this being done by recalling the desired store and then pressing the desired event key.

The Auto PIPO (Punch In/Punch Out) key is then used to automatically perform these events at the preset cue points, in conjunction with the REHE (Rehearse) key if a trial punch in is required without actually recording on to tape.

The overall autolocator system is versatile but the methods of operation are not obvious and a fair amount of learning time is needed to remember all the possible functions without making mistakes.

Signal processing and format

The PRODIGI digital recording format supports 2-channel $\frac{1}{4}$ in machines, 16-channel $\frac{1}{2}$ in and 32-channel 1 in machines. All machines use 16-bit linear encoding with the sampling rate being 48 kHz. With the exception of the $\frac{1}{4}$ in format which includes $7\frac{1}{2}$ in/s and 15 in/s machines the standard tape speed is 30 in/s.

In the multitrack machines the channels are divided into sets of eight channels each of which are recorded on to 10 digital tracks with additional tracks being used for auxiliary analogue audio, auxiliary date and timecode. Thus the 32-channel machine has 40 digital

audio tracks, two each auxiliary analogue and digital tracks and a timecode track.

Each audio channel occupies one tape track in order to allow drop-in editing, so that eight channels occupy eight tracks, in addition to which there are the two parity tracks for each set of eight channels. These parity tracks in fact record the check bits of a Reed Solomon code providing protection against data errors across the width of the tape. The power of the Reed Solomon code across the tape width is such that two of the ten tracks may be lost without the introduction of errors.

In the longitudinal direction 'sub-frames' are formed out of 12 samples of 16 bits, being 192 bits to which are added a 16 bit sync word at the beginning of each 12 samples and a 16 bit Cyclic redundancy Check (CRC) at the end of the sub-frame. Thus a sub-frame contains 16×1 (sync) + 16×12 (audio) + 16×1 (CRC) = 224 bits.

In order to provide further protection the samples within the sub-frame are scrambled and two main frames (A&B) each formed from eight sub-frames to form a group of $224 \times 12 = 2688$ bits. Further rather complicated interleaving takes place.

The upshot is that eight adjacent tracks occupying 4.8 mm of tape width may be lost whilst fully correcting data or up to 12 adjacent tracks occupying 7.2 mm of tape width whilst concealing errors.

Across the tape all tracks may be lost for 2.9 mm whilst fully correcting the data or 11.6 mm whilst concealing errors. This strong error correction is enhanced as there is no clock track with the machine deriving its timing from any digital audio track such that it is virtually impossible to lose clock.

The tape tracks are arranged such that the less critical analogue audio tracks are at the tape's edge where most errors are likely to occur with the timecode and auxiliary digital tracks inside the analogue audio tracks further guarding the digital data from tape edge damage and slitting defects.

During this review some very well worn tape was used and in spite of this the individual track error LEDs were flashing quite regularly with no flashing of the interpolation lamp and no audible defects.

Inputs and outputs

The electronically balanced line inputs to the digital audio channels were very closely matched in impedance to 10 k Ω +0/-2% with the maximum permitted input level varying only 0.11 dB between channels averaging +18.97 dBm.

Low frequency common mode rejection was found to vary widely between channels. The extreme cases are shown in Fig 1 where the rejection at 50 Hz

FIG 1 COMMON MODE REJECTION

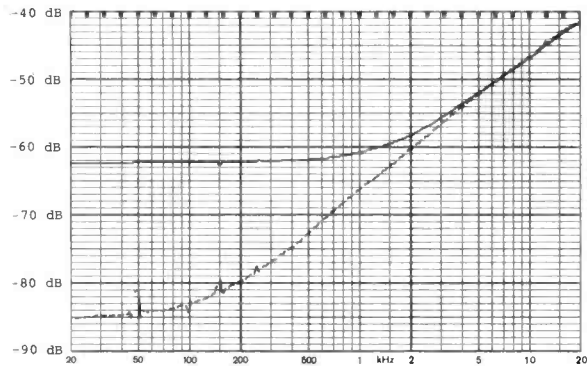

FACT! AUDIO PRECISION SYSTEM ONE:

Performs most audio tests 3 to 10 times faster than the fastest audio test and measurement equipment presently available.

Delivers industry-leading residual thd + n, noise, flatness;

tests 16-bit digital systems to manufacturers specifications.

Provides real time test results graphed on screen; paper print-out at the touch of a key.

Comes bundled with software package for all common audio tests; runs automated tests 20 minutes out of the box.

Allows expansion with future modules for additional audio tests.

System THD + N	0.001%
Noise	1.5 μ V
22k BW	(-114 dBu)
Flatness	0.05 dB

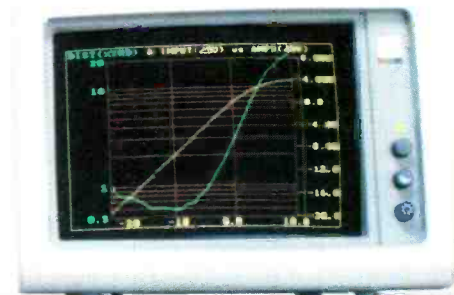
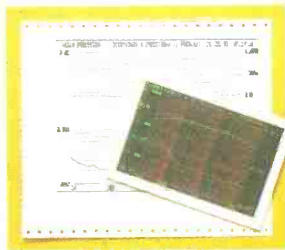
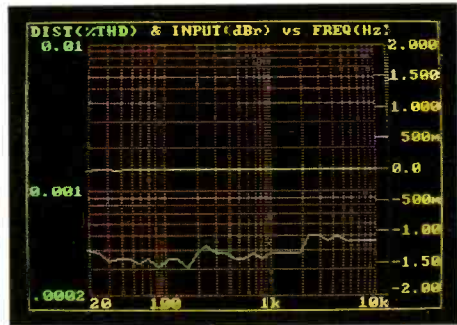

PROOF!

While we can't prove the distortion and noise specs without an actual demonstration, we can show the ease of use and flexibility of the graphics with a demo disk that can be used in any IBM® PC compatible computer.



If you would like more facts and the proof, return the coupon to:

Audio Precision
P.O. Box 2209
Beaverton, OR 97075
503/297-4837 1-800/231-7350
TELEX 283957 AUDIO UR

- I have enclosed \$10, please send demo disk and literature.
 Send literature only.

Name _____
Address _____
City _____ State/Country _____ ZIP _____
Company _____ Phone _____

IBM is a registered trademark of International Business Machines.

**Audio
precision**

Now, that's the way to test audio!

Australia: JNS Electronic Industries, PO Box 85, Rosanna, Victoria 3084 Austria: ELSINCO elektron GmbH, Rotenmühlgasse 11, A-1120 Wien France: S.C.V Audio, BP 50056, Paris Nord II, F-95947 Roissy Ch. de Gaille Cedex Germany: West: RTW GmbH, Elbeallee 19, D-5000 Köln 71 Switzerland: Technad SA, Rue Cantonale 116, CH-1025 St. Sulpice-Lausanne U.K.: Scenic Sounds Equipment Marketing Ltd., Unit 2, 10 William Road, London NW1 3EN

REVIEW REVIEW

varies between 62 dB and 84 dB. At high frequencies all channels examined were identical offering 42 dB rejection at 20 kHz with the anti-aliasing filters taking effect shortly above 20 kHz and making the common mode performance meaningless.

Matching of the input and output levels either via tape or in the electronics to electronics mode was extremely accurate with a maximum recorded error of only 0.03 dB at 1 kHz.

The unbalanced digital audio outputs could all drive +18.93 dBm from a very low source impedance less than 2 Ω with a VU meter indication of 0 VU correctly corresponding to +4 dBm.

Auxiliary analogue and digital channels had a slightly higher input impedance around 11.9 kΩ with the auxiliary analogue output having a source impedance of 30 Ω and the digital output a very low source impedance. The digital channels required a minimum input level of ±2.5 mV and delivered a fixed output level of ±1 V peak to peak as did the timecode output.

The maximum level accepted by the auxiliary audio channels was +20 dBm at the onset of distortion with the output level matching the input level to within 0.2 dB at 1 kHz.

Whilst the digital audio outputs are unbalanced, balancing transformers may be fitted as an option. The auxiliary channels and the timecode channel are all floating input and output connections.

The clock output at the BNC connector delivered a standard TTL level of

0/+5.0 V from a very low source impedance. After a 10 min warm-up time the clock frequency nominally 48 kHz was within -1 part in 10⁶ to +3 parts in 10⁶.

The video input when not terminated offered a bridging impedance of 5 kΩ or when terminated 74 Ω. The multiway timecode output delivers TTL levels for both serial and parallel timecode, the latter being formatted as two digits plus three data address lines.

In the case of the remote connector this covers the normal tape movement functions as TTL input and output levels in addition to a standard 9.6 kHz synchronisation input facility. The remaining interface connections were not investigated because the DUB connections are effectively internal signals to the Mitsubishi system and no information was available about the RS232 and RS422 interface commands.

Frequency response

As no pre-emphasis is used as standard the frequency response is the same irrespective of level and the highly consistent results for three separate channels are shown in Fig 2.

Measurement of the precise -1 dB and -3 dB points for four channels gave the good results shown in Table 1.

Pre-emphasis is understood to be an option, there being space for an emphasis board but I have no information about the available time constant(s).

The frequency response of the auxiliary

analogue channels is shown in Fig 3 to be flat at low frequencies falling to -1 dB at 7 kHz and falling very rapidly thereafter. As the purpose of these channels is for editing the frequency response is adequate per se.

So far as the auxiliary digital channels are concerned, they are intended for recording data and the frequency response is rather meaningless. The rise and fall times of the auxiliary digital data from tape was 4.5 μs and it is this that effectively limits the data rate usable with the auxiliary digital system.

Distortion

Sinewave distortion from the auxiliary channels appeared to be constant with frequency (within the pass band) and with level, with the second harmonic around 3% and the third harmonic around 1.5%. The so called analogue channels do not work in an analogue recording mode and with an automatic gain control feature, in fact produce a low grade digital type recording.

Second and third harmonic distortion versus frequency was plotted for four channels at the rated maximum level and at 20 dB increments down to -80 dB. In general the distortion did not vary much versus frequency but, as is to be expected with a digital system, it did vary with level.

At higher levels the second and third harmonics were below 0.02% with consistent results from channel to channel. At -40 dB differences between

FIG 2 DIGITAL FREQUENCY RESPONSE OF THREE CHANNELS

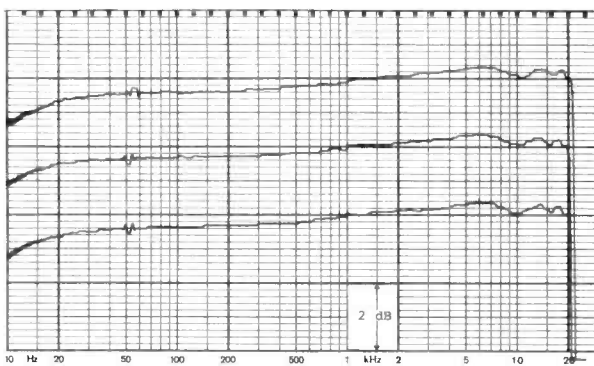

FIG 3 AUX ANALOGUE FREQUENCY RESPONSE

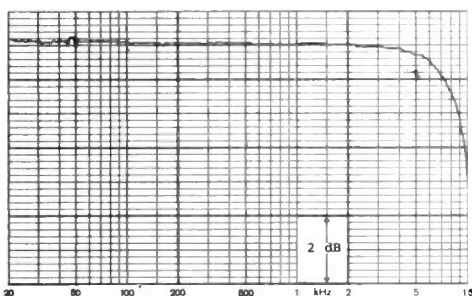
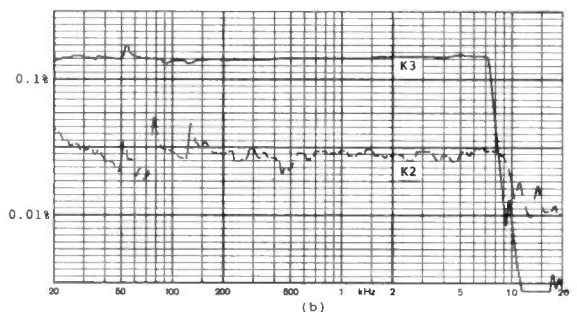
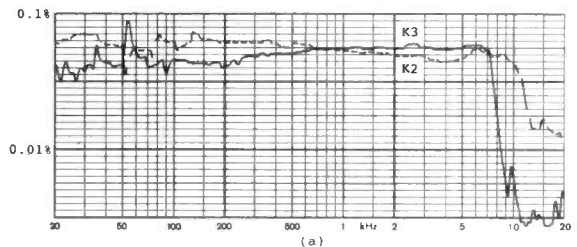

TABLE 1 Frequency response

Channel	-1 dB	-3 dB
1	12.6 Hz to 20.404 kHz	5.6 Hz to 20.587 kHz
5	12.2 Hz to 20.426 kHz	5.4 Hz to 20.609 kHz
9	10.3 Hz to 20.440 kHz	5.1 Hz to 20.600 kHz
24	12.6 Hz to 20.400 kHz	5.3 Hz to 20.580 kHz

FIG 4 HARMONIC DISTORTION
EXTREME CASES AT -40dB OF TWO DIFFERENT CHANNELS



AKG

ACOUSTICS

The world's smallest control room?

Because of the difficulties in monitoring in reverberant suites due to their varying acoustic characteristics, the Institute of Radio Technology, (IRT) of Munich, through extensive trials, has established a standard of headphone response which equates to the ideal monitoring environment.

Despite the exacting nature of this standard, AKG had made this possible, through the development of the K240 DF (Diffused Field) headphone.

The existing K240 model, long appreciated in studios for its open and natural character, proved an ideal basis for this final development of the reference headphone and AKG's stringent standards of production and test ensures that the K240 DF in production, equals that of the existing prototypes. For the first time, the mobile engineer can have reference listening conditions, almost literally in his pocket.



- Please send me details of the K240 DF
- Please send me details of the AKG professional microphones

Name

Address

.....
.....

AKG Acoustics Ltd., Vienna Court, Catteshall Wharf, Catteshall Lane, Godalming, Surrey GU7 1JG. Tel. (04868) 25702

REVIEW REVIEW

FIG 5 HARMONIC DISTORTION AT -60 dB

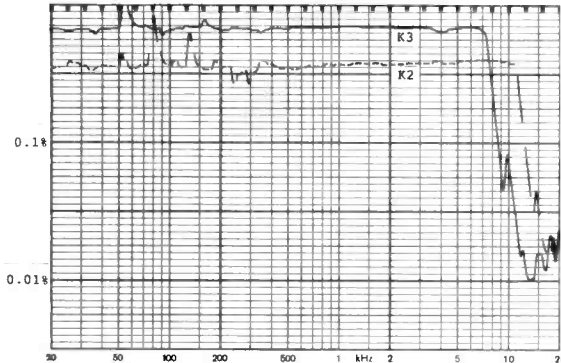

FIG 6 HARMONIC DISTORTION AT -80 dB

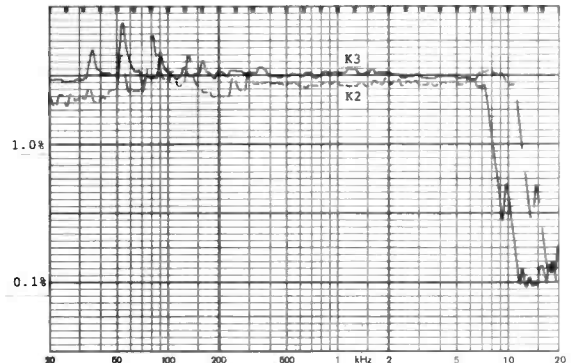

FIG 7 CCIF IM DISTORTION AT 0 dB (MULTIPLY FREQUENCY SCALE BY 10)

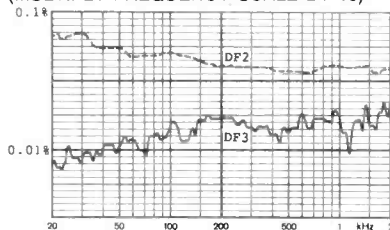

FIG 8 RINGING ON 1 kHz SQUARE WAVE

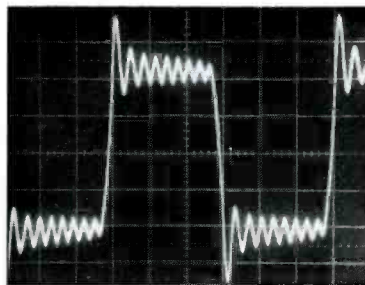

FIG 9 WAVEFORM AT A MUTE

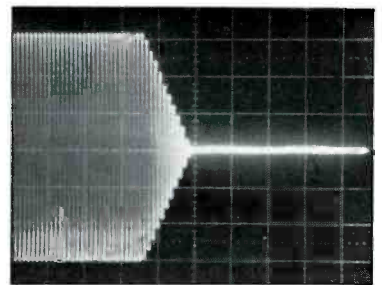

TABLE 2 Noise related to maximum signal levels

Measurement method	Signal to noise
22 Hz to 22 kHz RMS	91.8 dB
A-weighted RMS	93.5 dB
CCIR-weighted RMS	86.9 dB
CCIR-weighted quasi-peak	82.6 dB
CCIR/ARM ref 2 kHz	93.4 dB

channels appeared and continued at lower levels. Fig 4 shows the extreme cases found at -40 dB.

Figs 5 and 6 show typical results at -60 dB and at -80 dB respectively. While at first sight the distortion may appear to be objectionable at -80 dB it must not be forgotten that the distortion products are in fact about 110 dB below the maximum signals so that provided a digital machine is fully modulated distortion is extremely low.

Intermodulation distortion was measured to the CCIF twin tone method sweeping the two tones separated by 70 Hz from 200 Hz to 20 kHz. At the rated peak level the typical situation is shown to be very good in Fig 7 with a virtually identical plot being made at -20 dB. Lowering the level to -40 dB and to -60 dB gave results which were constant with frequency with the two difference tones having effectively equal distortion of 0.1% at -40 dB or 0.8% at -60 dB.

As is inevitable with digital machines there is ringing on squarewaves or other transient signals. Such an effect for a 1 kHz squarewave is shown in Fig 8 where the ringing occurs at the cut-off frequency of the anti-aliasing filters. No other form of distortion was found on tone bursts or other transients.

Noise

Noise in the output, in the absence of any input signal, was measured for a

number of channels in the electronics to electronics mode and also via tape with no significant differences being found.

The outputs are as standard unbalanced, with a balancing option, so care is needed to avoid ground loops. Table 2 relates noise to the maximum signal levels for a typical channel, there being less than 1 dB variation from one channel to another. Attempts to find signal related noise showed these effects to be at extremely low levels and only audible under the most unlikely conditions.

All outputs were effectively free from sampling rate or other unwanted signals all such spurious components being below -70 dBm, that is at least 89 dB below full output.

Noise in the analogue channels was very much signal related but remained

at a reasonable level having regard to the purpose of the analogue channels with their performance being quite acceptable for edit point location.

It has been shown with other machines that a very poor analogue performance is not acceptable for editing but I believe that this machine has been set to a reasonable compromise standard.

Editing

Before dealing with actual editing it should be mentioned that if the machine finds excessive error rates off tape the output is muted. This was found to be a smooth operation without any clicking at the mute or de-mute with the duration of the mute depending upon the extent of data loss. The waveform at a mute is shown in Fig 9 where the scale is 8 ms

Rycote windshields

new

a large windshield for stereo

a fantastic unique wind JAMMER

a twist locking end cap.

Rycote Microphone Windshields, New Mills, Slad Road, Stroud, Gloucester GL5 1RN, England.
Tel. 04536 79338

PPX AMPLIFIERS

CITRONIC

A SIGN
OF
QUALITY



Technically superior and totally dependable high quality power amplifiers.

PPX, better performance.

Citronic Ltd, Bowerhill, Melksham, Wilts, SN12 6UB, Telephone (0225) 705600, Telex 444131

GREENGATE



DS:4-8

8 VOICE, 8 CHANNEL SAMPLER/SEQUENCER

12 SECONDS SAMPLING TIME AT 44.1 kHz

16-Bit Technology with a future development progression that only a true computer-based system can offer. All the excellent features of the DS:3 plus dynamic range for the very highest studio sound quality: £1,500

GREENGATE PRODUCTIONS LTD - UNIT D - HAPPY VALLEY INDUSTRIAL PARK - PRIMROSE HILL
KINGS LANGLEY - HERTFORDSHIRE - WD4 8HZ - TEL: (09277) 69149 & 69322

REVIEW REVIEW

TABLE 3 Varispeed performance

Nominal	Actual	Nominal	Actual
+0.1%	+0.1703%	+2.0%	+2.0830%
+0.2%	+0.1703%	+2.1%	+2.0830%
+0.3%	+0.3413%	+2.2%	+2.2608%
+0.4%	+0.3413%	+2.3%	+2.2608%
+0.5%	+0.5128%	+2.4%	+2.4390%
+0.6%	+0.6849%	+2.5%	+2.4390%
+0.7%	+0.6849%	+2.6%	+2.6177%
+0.8%	+0.8576%	+2.7%	+2.6177%
+0.9%	+0.8576%	+2.8%	+2.7972%
+1.0%	+1.0309%	+2.9%	+2.9772%

FIG 10 DROPPING IN OR OUT TO AN UNRECORDED TRACK WITH 1 kHz SINE WAVE

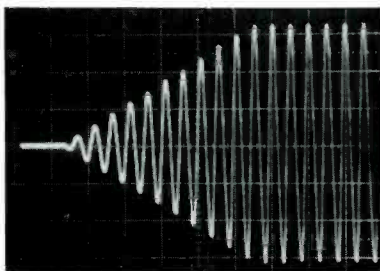
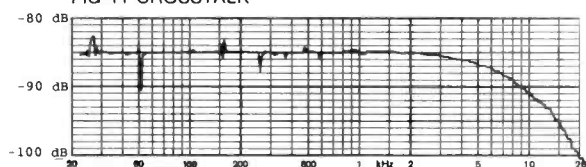

FIG 11 CROSSTALK



per horizontal division, to be a linear fade of 10 ms duration.

The recovery from mutes had a similar waveform with a steady increase in level with the 1 kHz sine wave used for Fig 9 and investigation at low frequencies also yielded click free results.

Dropping in on to a recorded track, or dropping out, were completely free from undesirable effects, even dropping in a 100 Hz sinewave 180° out of phase with the recording was not easy to detect in the replayed waveform and completely inaudible.

Dropping in or out to an unrecorded track showed a fade in or out as appropriate, the effect with a 1 kHz sinewave being shown in Fig 10 where the fade in time approximates 10 ms.

Tape splicing is not easy with this thin tape and great care is needed to achieve a good mechanically aligned splice. For some reason I found 1 in wide tape easier to handle than the 1/2 in version.

Edit points are easily found using the analogue track(s) whilst using the rollers to move the tape but in the unload mode the reel brakes are on and this is a nuisance when editing, as it is when loading the tape transport.

Plastic splicing tape tended to pick-up the edges to be joined due to static electricity and I personally preferred to use metallised video splicing tape which did not suffer from static electricity. In order to detect edits the machines like to see a small gap at the splice of about 1 mm and in order to make a satisfactory edit the splicing tape had to be trimmed to just inside the tape width.

Like the other digital multitracks I have reviewed, splice editing is far from easy or reliable and a backup copy must be available as it is almost impossible to re-make edits.

Once a satisfactory edit has been made it is completely inaudible but unsatisfactory edits lead to muting of the output for around 60 ms minimum which is not always easy to hear depending

upon the programme material.

Re-using tape with good edits did not present any problems and the error correction system was such that tape damage had to be severe before audible errors occurred. As with other available digital audio recorders the operator does not have any warning when the tape is becoming worn out and giving excessive error rates—I would like to see such a feature added because the only sign of the end of the life of a tape is catastrophic failure, rather the degraded audio quality as with analogue machines.

Other matters

Whilst the *X-850* has been criticised by competition for using time shared digital/analogue converters, each handling two channels, this criticism is completely unfounded. The time coherence between any two tracks was found to be better than 500 ns, that is about 3° at 20 kHz with no discernible jitter. Time sharing has been a problem in some domestic compact disc players where a delay between channels has upset monophonic compatibility but this is certainly not a problem in the *X-850*.

Crosstalk, as in other digital machines, was at a very low level as shown in Fig 11 which was plotted recording channels 1 and 3 and replaying channel 2. This is probably a worst case condition with the result of a maximum crosstalk of -85 dB being negligible.

The varispeed function which indicates in 0.1% steps did not in fact operate in 0.1% steps and the actual speed variation was not precise. A nominal ±10% in fact varies the speed +10.0023/-9.9540% with a nominal ±1% actually being +1.0309/-1.0100%. The step size varied between 0.1% and 0.2% with the figures in Table 3 being recorded.

The VU meter was found to be a

genuine instrument to the American Standard specification in terms of the rectifier characteristic and the ballistics.

Unfortunately the machine was not available long enough for me to complete this review to my satisfaction and time did not permit investigation into other aspects of the machine such as synchronisation and general interfacing. At first sight there would not appear to be any more problems interfacing this machine than is common with other machines due to lack of standardisation.

Summary

The Mitsubishi *X-850* offers all the expected advantages over analogue multitrack machines, one of the major advantages being the almost complete absence of crosstalk such that little thought has to be given to channel allocations.

The measured performance of the electronics was excellent in terms of conventional parameters and I was unable to fault the audio performance of this machine.

The tape transport already being well established in multitrack analogue machines, proved to be to a very high standard competitive with the very best of analogue machines.

A combination of the powerful error correction capabilities of the Mitsubishi PRODIGI digital format and this high performance tape transport makes the *X-850* a robust digital recording system. Such robustness is essential if reel-to-reel digital machines are to withstand the rigours of professional use, involving use in non-ideal environments and in some instances in mobiles.

Editing possibilities include completely click-free dropping into and out of record with an inbuilt crossfade action which was very effective together with loss free digital dubbing from track to track or to other Mitsubishi digital machines such as the stereo *X-80* which may be freely cut and splice edited.

In the case of the *X-80* (and other digital multitrack machines) I regard cut and splice editing as hazardous but a more sophisticated splicing block might make editing reliable. Splicing the thin tape requires care and it is very difficult to recover from a poor splice thus it is vital to have back-up copies if this is to be attempted.

The autolocator and remote control unit is of a sensible design with useful facilities but its operation is far from obvious and the overall instruction manual for the machine was incomplete and in part inaccurate. No doubt the manufacturer will put this to rights and incorporate facilities which are not mentioned in the instruction manual.

As time was not available I cannot comment on the inbuilt synchronisation facilities covering all television and film standards. □

NEW FROM Urei

THE 809 COMPACT TIME-ALIGN® STUDIO MONITOR

Now there is a Urei Time-Align® monitor for small studios, or near-field use in any control room.

Built on the same solid principles to the same high standards as the respected and widely used 811B and 813B, the 809 is less than half the size. Natural sound, flat power response, accurate stereo image and reduced listening fatigue at high SPLs – all these qualities are perpetuated in the 809.



**Find out more about: the 809
by writing or 'phoning:**

Urei, Harman Audio UK Ltd, Mill Street
Slough, Berks SL2 5ED. Tel: (0753) 76911

**Time-Align is a trademark of EM Long Associates, California*

ASONA for Complete Cassette Production

ASONA offers a complete program of tape duplication and winding systems.

The ASONA loop-bin, a high-speed master tape reproducer, feeds and controls up to 40 slave recorders. Long-life ferrite heads provide flat frequency response and high dynamic range.

Available for 16 : 1 and 32 : 1 duplication ratios for a variety of tape formats.

Robust construction, with a minimum of moving parts.

Low maintenance requirements, low personnel costs.

Economically priced.

ASONA High-Speed Loop-Bin

The loop-bin/slave system employs neither compressed air nor vacuum. Completely self-contained; requires only one mains connection.



**We can tailor a cassette production system to your needs.
Write or call for a proposal.**

ASONA is manufactured in West Germany by AUVIS ASONA GmbH & Co. KG, Bahnhofstraße 60, D-7634 Kippenheim
Tel.: (C)7825-1038, Telex: 754325 auvis d

HARDWARE HOUSE



As UK distributors for Nady radio systems and Countryman microphones, we brought together two products which between them can produce the high dynamic range and audio quality essential for live performance.

To find out more about these and our full range of technical and engineering services and equipment rental, phone us on:

01-986 6111

Hardware House (Sound) Limited
West Works, Chalgrove Road, Morning Lane, London E9 6PB



UK distributors for
Nady radio systems and Countryman microphones.

Dealers for:

AMEK/TAC (live performance), Amcron, Court, JBL



CARTRIDGE MACHINES FOR BROADCASTING

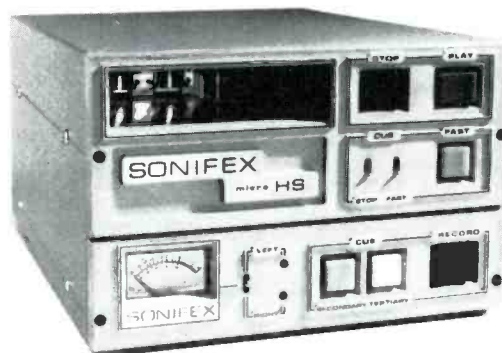

The Micro HS series, the ideal choice of cartridge machine for broadcasting and facilities work.

Impressive engineering quality, rugged and reliable with an outstanding technical performance second to none.

A combination of innovative engineering design and careful production processes; giving a balance of performance and price.



15 College Street, Irthlingborough
Northamptonshire NN9 5TU
Telephone: 0933 650 700
Telex: 8954667V BSTLX G SFX

AUTOMATED REALITY

ALBERTO CORTEZ
ALPENPOPSTUDIO
ART
ARTISTIC PALACE (2)
BAGARIA
BOB STUDIO
BURKHARD
CAROLINE
CAMPUS
CAN
CASTLE SOUND
CLOUDBORNE
CONDORCET
DAGUESSEAU
DAMIENS
DAVOUT (2)
DB
DIAN RECORDS
DICK LASKY'S
DO NOT ERASE
ESPACE NOUVEAU
E-ZEE STUDIOS

Madrid
Austria
Geneva
Paris
Napoli
Milano
W. Germany
Paris
Paris
W. Germany
Edinburgh
Chicago
Toulouse
Paris
Paris
Paris
Rennes
Jakarta
New York
London
Paris
London

FAMILY
FANTASY
FINNVOX
FRANKIE STUDIO
FR3
G7 STUDIO
GRANADA RECORDS
HOWARD CONDER
JIVE STUDIOS
KLANGWERKSTATT
LAZER
LEE SINK STUDIO
LIVINGSTONE
LOKANANTA
LOUIS CHEDID
MARCONIX
MELODIJA (2)
MINIREC
MIXER
MORIZON
PRISME
PYRAMIDE

Paris
San Francisco
Helsinki
Drassburg
Strasbourg
Torino
Jakarta
Florida
Tokyo
Dusseldorf
Lyon
Shanghai
London
Oslo
Paris
Roma
Moscow
Torino
Milano
Geneva
Lausanne
Brussels

RAMSES
REALISATIONS AUDIO
REEL PLATINUM
SANWA VIDEO
SGGMD
SOUND MILL
SRI SIAM PROD
STUDIO 150
STUDIO DE MILAN
STUDIO UNION
TALLER DE SONIDO
TIENJIN RADIO
THE RANCH
THE YARD
TITANIA (2)
TROD NOSSEL
UB 40
WEST END STUDIO
WOODHOUSE
XIAN FILM PLANT

Paris
Paris
New Jersey
Osaka
Paris
Vienna
Bangkok
Amsterdam
Paris
Limburg
Madrid
Peking
New York
London
Rome
Connecticut
Birmingham
Munich
Dortmund
Peking

+ MANY OTHERS

OPTIMIX

13 RUE LACUÉE — 75012 PARIS — TEL: (331) 43 42 41 59 — TELEX: 215622 F

36 SECONDS

Sampling time, that is.....

That works out at £55 per sampling second at 15kHz bandwidth.....

Including the computer.

Work it out for the others.....

Even without the computer!



DS:3



NOT JUST A KEYBOARD...

Please send me information on the DS:3, DS:4

Name _____

Address _____

City _____ Post Code _____

Greengate Productions
Unit "D" Happy Valley Industrial Park
Primrose Hill, Kings Langley
Hertfordshire WD4 8HZ
Tel: (09277) 69149 & 69322

WITH OVER 44 YEARS' EXPERIENCE IN THE DESIGN AND MANUFACTURE OF SEVERAL HUNDRED THOUSAND TRANSFORMERS WE CAN SUPPLY:

AUDIO FREQUENCY TRANSFORMERS OF EVERY TYPE

**YOU NAME IT! WE MAKE IT!
OUR RANGE INCLUDES**

Microphone transformers (all types), Microphone Splitter/combiner transformers. Input and Output transformers, Direct Injection transformers for Guitars, Multi-Secondary output transformers, Bridging transformers, Line transformers, Line transformers to British Telecom Standard Isolating Test Specifications. Tapped impedance matching transformers, Gramophone pickup transformers, Audio Mixing Desk transformers (all types), Miniature transformers, Microminiature transformers for PCB mounting, Experimental transformers, Ultra low frequency transformers, Ultra linear and other transformers for Valve Amplifiers up to 500 watts. Inductive Loop transformers, Smoothing Chokes, Filter inductors, Amplifier to 100 volt line transformers (from a few watts up to 1000 watts), 100 volt line transformers to speakers, Speaker matching transformers (all powers), Column Loudspeaker transformers up to 300 watts or more.

We can design for RECORDING QUALITY, STUDIO QUALITY, HI-FI QUALITY OR P.A. QUALITY. OUR PRICES ARE HIGHLY COMPETITIVE AND WE SUPPLY LARGE OR SMALL QUANTITIES AND EVEN SINGLE TRANSFORMERS. Many standard types are in stock and normal dispatch times are short and sensible.

OUR CLIENTS COVER A LARGE NUMBER OF BROADCASTING AUTHORITIES, MIXING DESK MANUFACTURERS, RECORDING STUDIOS, HI-FI ENTHUSIASTS, BAND GROUPS AND PUBLIC ADDRESS FIRMS. Export is a speciality and we have overseas clients in the COMMONWEALTH, E.E.C., U.S.A., MIDDLE EAST, etc.

Send for our questionnaire which, when completed enables us to post quotation by return.

SOWTER TRANSFORMERS

Manufacturers and Designers

E. A. SOWTER LTD. (Established 1941), Reg. No. England 303990

The Boat Yard, Cullingham Road, Ipswich IP1 2EG,
Suffolk. P.O. Box 36, Ipswich IP1 2EL, England.

Phone: 0473 52794 & 0473 219390. Telex: 987703G

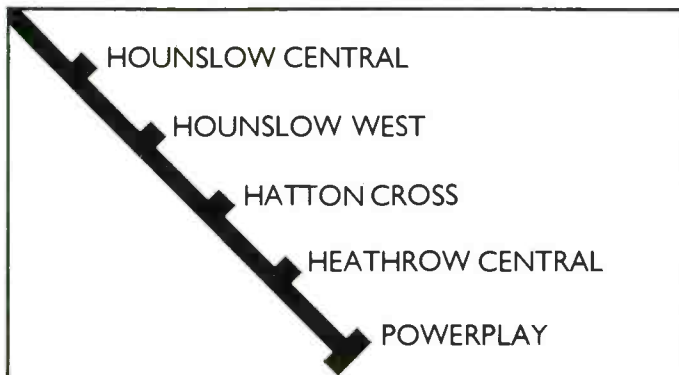

NEXT STOP ON THE PICCADILLY

At least that's the way we, and many of our English clients, think of Powerplay Studios.

15 Minutes from Zurich Airport – 90 minutes from London – you will find our two studio facility, complete with SSL 4000E and Total Recall, Studer A800, a mouth-watering choice of outboard equipment and just about everything else you would expect in a top London Studio – except the hassle.

We hardly dare mention our residential facilities, leisure area, lake views, ski-ing, and the very special advantages of working in Switzerland, irresistible? We hope so. To find out more contact Silvia Hagen at Powerplay.

POWERPLAY

RECORDING STUDIOS AG

CH 8124, MAUR ZURICH. SWITZERLAND Telephone 01-980 1521/22

LONDON BOROUGH OF ISLINGTON

**BRITANNIA
ROW** N.I

COMPLETE SERVICE AUDIO HIRE

2-24 TRACK TAPE RECORDERS

BTX SYNCHRONISERS

DIGITAL TAPE RECORDERS

NOISE REDUCTION SYSTEMS

PROFESSIONAL VIDEO EQUIPMENT



01-226 3377 TELEX: 268279 BRITRO G
BRITANNIA ROW EQUIPMENT LTD 35 BRITANNIA ROW LONDON N1 8QH

The Lyrec TR 55

From

- 1 to 4 tracks
- 1/8" to 1/2" tape width
- 1 7/8 to 30 IPS
- 3" to 14" spools
- £3,400 to £6,200

From Denmark...

a flash of ingenuity.

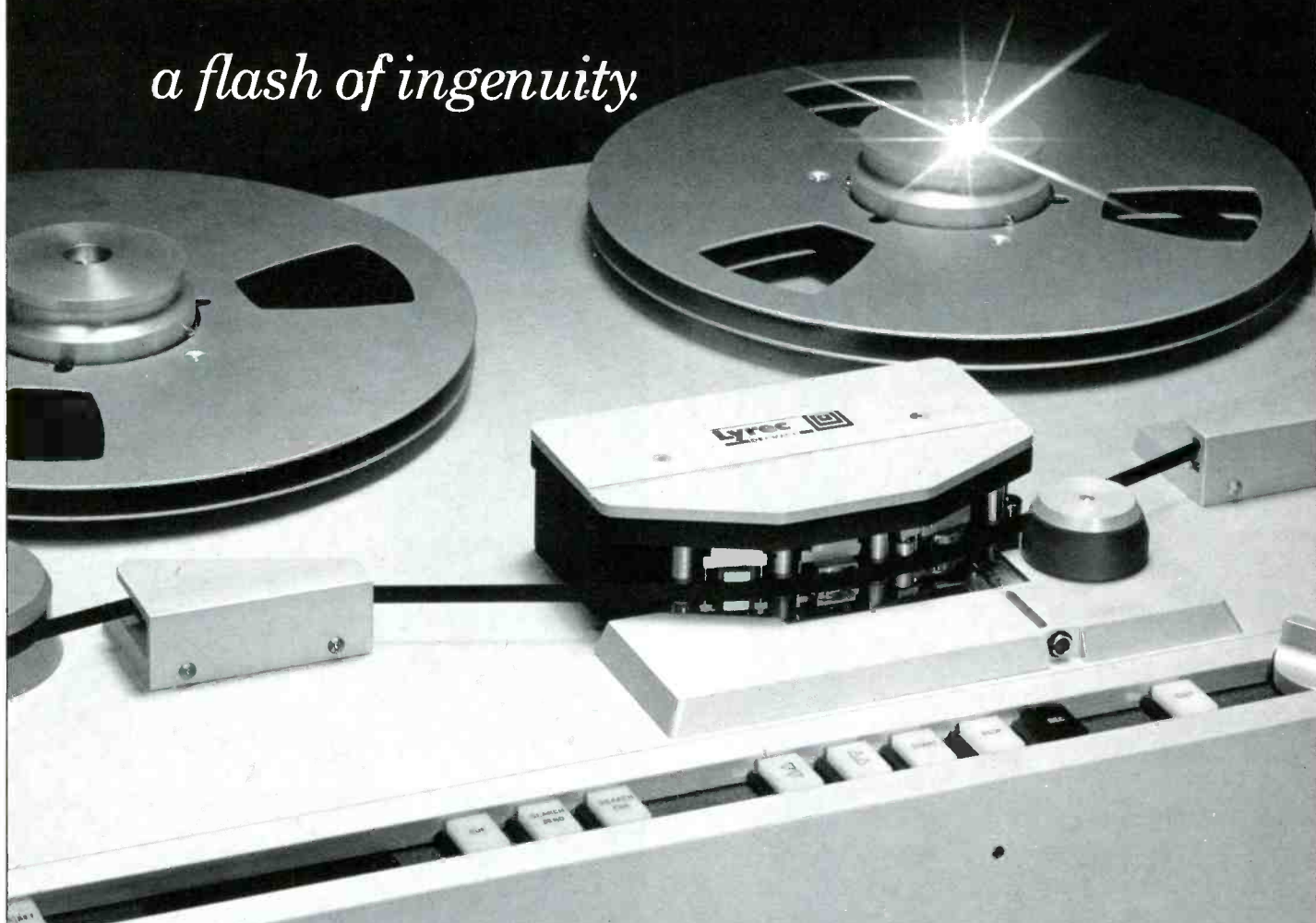

Lyrec (J.K.) Ltd
13 Harpenden Hill Beaconsfield
Buckinghamshire HP9 2BP
Tel: National (04946) 4425

Lyrec Manufacturing A/S
Hollandsvej 12
DK-2800 LYNGBY Denmark
Tel: International +45 2 87 63 22
Telex 37568 dk

Lyrec 
OF DENMARK
Technology where it counts.

AKG

ACOUSTICS

C 460 B comb-ULS/62 - The linear omni-directional condenser microphone.



AKG Proudly Presents the New Ultra Linear Series Condenser Microphones of the Future:

The New Ultra Linear Series from AKG is a generation of microphones with unprecedented, truly linear characteristics. Low self noise combined with high headroom ensures a microphone dynamic range of at least 120 dB for the entire audio range. Direct A/B comparisons with conventional designs in their class will clearly reveal the excellent characteristics of the Ultra Linear Series microphones. Write for your free copy of the C 460 B comb-ULS brochure today.



C 460 B comb-ULS/61 - The linear cardioid condenser microphone.

ADV 329/2/E



AKG Acoustics Ltd.
Catteshall Wharf
Catteshall Lane/
Godalming
Surrey GU7 1JG
TF: (04868) 25702
TX: 859013 akmic g

AKG AKUSTISCHE U. KINO-GERATE
GESELLSCHAFT M.B.H.
Brunhildengasse 1
A-1150 Wien, Austria
TF: (43222) 95 65 17-0*
TX: (47) 131839 akgac a



Essex Tape Supplies
Manufacturers of High Class
blank & pre-recorded cassettes



215 Moorfield
Hartlow, Essex
CM18 7DL
(0274) 445513

Main distributor for B.A.S.F.
professional audio tape products

AMBISONIC
SURROUND SOUND DECODERS
PRESENTER'S CLOCK
PROGRAMMABLE TIME SWITCHES
TELEVISION SOUND TUNERS

MiniM

Please send me information on: (tick items of interest)

Name

Address

Minim Electronics Limited, Lent Rise Road, Burnham
Slough SL1 7NY Tel: Burnham 63724

SS/3

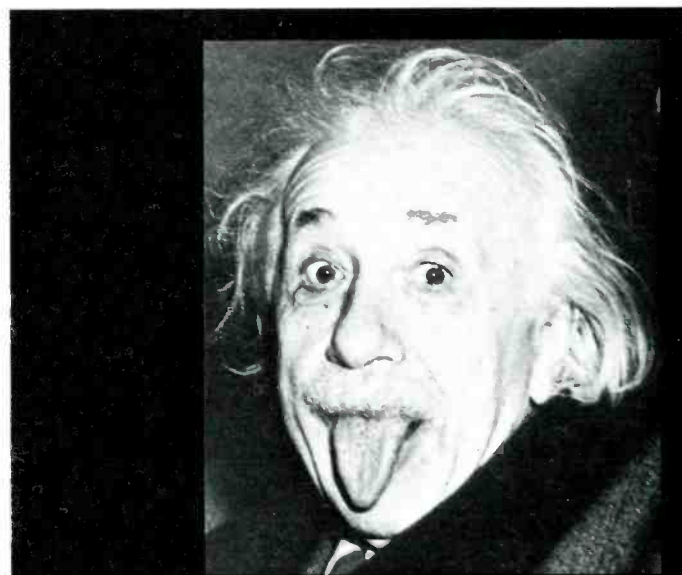

GENUINE SOLUTIONS FOR PHYSICAL PROBLEMS

HITEC AUDIO PA-Systems:

- louder
- safer
- cleaner

For more information write to
MUSIK PRODUKTIV
Gildestraße 60 - D-4530 Ibbenbüren - W.-Germany
or see us on the AES !!

**Wham goes to
CHINA,
Placido goes to
MILAN,
Frankie goes to
HOLLAND,**

**Audio FX goes
EVERYWHERE.**

At Audio FX we can rent equipment to you anywhere in the world...fast.

Backed by a team of service engineers and drivers our office can ship from Singapore to Shepherds Bush the best in Audio Processing Equipment.

From a 48 Track Digital Multitrack System to a DI Box, all our equipment has the latest software and updates and we understand that when you need it, you need it now, not four hours after the session has started!

So next time you need to process in Paris or compress in Camden...

Call Audio FX like everyone else!



· Our reputation's built on success ·

15 Elizabeth Mews, London NW3 4UH
Telephone 01-586 9592 (24 hours)

ISA

Input Signal Amplifier
one of a series

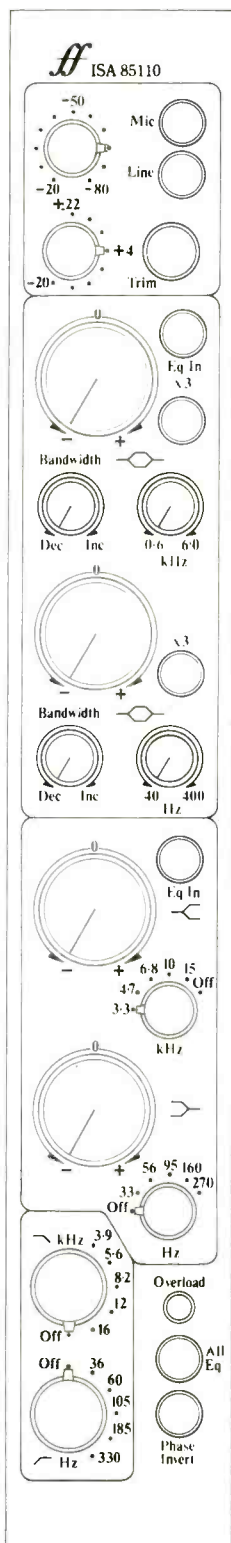

First Foundation

Electro-Acoustic design engineers
P. O. Box 38
Newmarket Suffolk CB8 7EG.
Tel: (0638) 730696

APRS

86



Olympia 2

Wednesday 25
26
27

JUNE 1986

EXHIBITION OF PROFESSIONAL
RECORDING EQUIPMENT
APPLY NOW FOR EXHIBITION SPACE

23 Chestnut Avenue
Chorleywood, Herts
England WD3 4HA
Tel: 0923 772907

PA-VS 01-540 2164

7 DAYS A WEEK 24 HOUR EXPRESS
STUDIO EQUIPMENT HIRE SERVICE

DIGITAL RECORDERS	DIGITAL DELAY
SYNCHRONISERS	DIGITAL REVERB
DRUM COMPUTERS	ANALOGUE EFFECTS
KEYBOARDS	VIDEO EQUIPMENT

SALES AND TECHNICAL SERVICES

PA-VS offers a range of new and used studio equipment for sale at competitive prices plus a comprehensive studio and studio equipment design and installation service. Repairs and modifications carried out on most makes of equipment.

Palmer A-V Systems Ltd. 67 Mostyn Road, London SW19 3LL.

SOUND CONTROL

FOR STUDIO EQUIPMENT SALES AND
MAINTENANCE IN IRELAND

Fast, efficient installation and servicing

STUDIO EQUIPMENT HIRE SERVICE

MAIN AGENTS FOR

SOUNDCRAFT, D.D.A., REBIS, BEL, SOUNDTRACS,
C-DUCER, DRAWMER, NEUMANN, AMPEX, REVOX,
YAMAHA, CONNECTRONICS

used studio equipment bought + sold

Contact John Connolly at

10 DONEGALL PARK AVENUE,

BELFAST BT15 4ET

Tel: (0232) 772491/771555

FFD CANARE products FFD



- * Star-quad 4-conductor mic cables.
- * Cable reels & cable reel systems.
- * Multi-pair cables & junction box systems.
- * Multi-channel snakes & pigtails.
- * Combined video/power/audio/intercom cables.
- * Data cables.

FFD FUTURE FILM DEVELOPMENTS

P.O. Box 3DG, 114 Wardour Street, London W1A 3DG, England.
 Telephone: 01-434 3344 & 01-437 1892. Telex: 21624 ALOFFD G.
 Cables: Allotrope-London W1.

Ernest Turner instruments

Known worldwide for high performance PPM and VU meters we offer:-

- * A wide range of case sizes
- * Internal illumination
- * Meter drive card for PPMs
- * True performance specifications
- * Analogue or gas plasma bargraph

Send now for further details



HAWKER SIDDELEY ERNEST TURNER INSTRUMENTS

TOTTERIDGE AVENUE, HIGH WYCOMBE, BUCKS HP136XG.
 ☎ 0494 30931 ☒ 83444
 EEC & Scandinavian countries-Crompton Turner Instruments BV,
 Groenendaal 219-221, 3011 ST Rotterdam, The Netherlands
 ☎ 010-140144 ☒ 26324
 INSTRUMENT SUPPLY & SERVICE CENTRE AT CHICAGO & LOS ANGELES USA,
 MONTREAL & TORONTO CANADA, SYDNEY AUSTRALIA, SINGAPORE



PROFESSIONAL SERIES LOUDSPEAKERS

	L12/544	L12CX20	L15P200	L15/864	L18/551
APPLICATION	LOW/MID FREQUENCY	CO-AXIAL COMPACT SYSTEMS	HIGH POWER LOW FREQUENCY VENTED CABINETS	HIGH EFFICIENCY GENERAL PURPOSE	HIGH POWER LOW FREQUENCY VENTED CABINETS
DIAMETER	12"	12"	15"	15"	18"
FREQUENCY RESPONSE	40Hz-6kHz	60Hz-18kHz	29Hz-3kHz	50Hz-4kHz	22Hz-2kHz
POWER HANDLING					
100 HOUR SINE	150 W	100 W	300 W	125 W	200 W
100 HOUR IEC	300 W	200 W	600 W	250 W	400 W
SENSITIVITY (1W AT 1M)	97dB	98dB	95dB	102.5dB	96dB
RESONANT FREQUENCY	40Hz	60Hz	29Hz	50Hz	22Hz

This is just a small selection from the RCF range of loudspeakers, compression drivers and studio monitors.

For further details please write or telephone.

Three leading microphones from Electro Voice that have become synonymous with the broadcast industry, all dynamic, and built to take years of hard work.

635A Dynamic Omnidirectional

The 635A is quite simply the most rugged, durable microphone Electro-Voice manufacture. A slow roll-off below 200 Hz (-8 dB at 50 Hz) with a broad rise of several dB from 2,000 - 12,000 Hz results in bright yet natural vocal quality without the low frequency noise pick-up problems that can plague microphones with flat low frequency response.

RE 20 Variable D Dynamic Cardioid

The sound of the RE 20 has made it one of the most coveted, unique microphones in the world, and it is still one of the few true multi-use studio microphones.

TOOLS OF THE TRADE

However, unlike many condenser microphones, the RE 20's dynamic element provides undistorted output at the high sound pressure levels found in up-close vocal and instrument miking (in excess of 160 dB), its Variable-D design frees it of any bass-boosting proximity effect.

RE 50 Shock-mounted Dynamic Omnidirectional

This mike was designed expressly for hand-held newsgathering work. It has the same tailored frequency response and high output level as the famous 635A. The RE 50's rubber shock-mount "mike-within-a-mike" design achieves a degree of shock isolation never before known in the industry. The construction is also highly resistant to damage from mechanical shock.



RE 50

RE 20

635 A

Many Electro-Voice professional product dealers can arrange hands-on trials at no cost to you. For further information please contact your E-V dealer or write to: Shuttlesound Ltd. Unit 15, Osiers Estate, Osiers Road, London SW18 1EJ. Telephone: 01-871 0966 Telex: 27670 Shutso G

SHUTTLESOUND

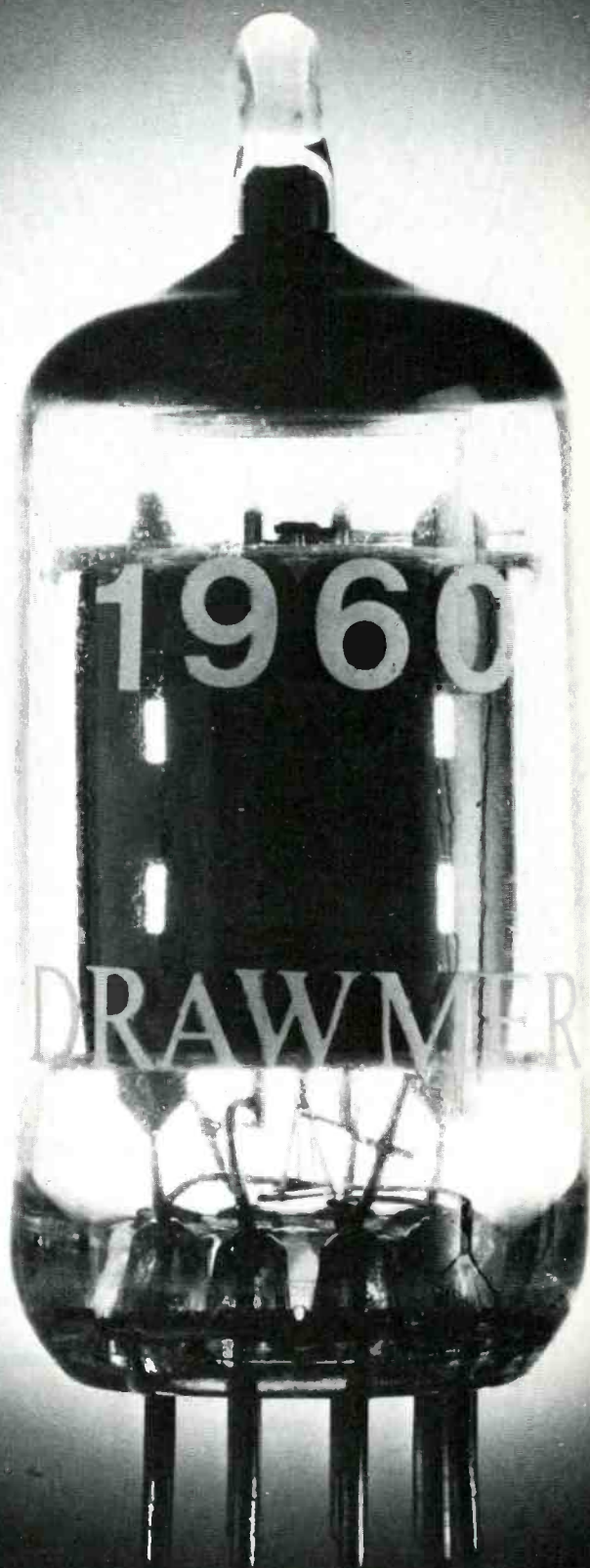

**DRAWMER · VACUUM TUBE
COMPRESSOR AMPLIFIER · 1960**

**DRAWMER MARKETING AND SALES
UNIT 4, BROOK LANE BUSINESS CENTRE
EPOOK LANE NORTH, BRENTFORD
MIDD. ESEX TW8 0PP
TEL 01-847 2890**

Why do Jensen Transformers have Clearer Midrange and Top End?

The high frequency rolloff of a *Jensen Transformer* is optimized, by computer analysis, to fit the *Bessel Low Pass Filter* response. This means *minimum overshoot and ringing* and *flat group delay* for best *time alignment* of all spectral components of the musical waveform.

In other words, the harmonics arrive at the same time as the fundamental frequency.

The result is a clear midrange and top end without the harsh, edgy sound which has been one of the most objectionable sonic complaints about transformers.

There's no "midrange smear."

Only *Jensen* has this benefit of hi-tech computer optimization.

Visitors by appointment only. Closed Fridays.

10735 BURBANK BOULEVARD • NORTH HOLLYWOOD, CA 91601 • (213) 876-0059

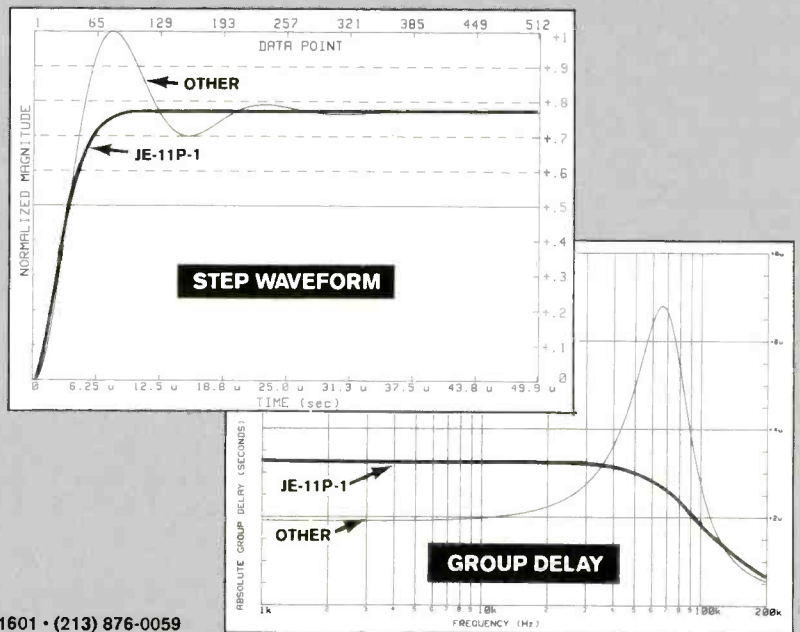

jensen transformers
INCORPORATED

3 fully equipped sound dubbing suites. Music recording to picture in our 72 sq. m. studio. ADR and Foley sound FX recording. Audio off-lining ... track laying. Computerised audio on-line conforming. The latest computerised synchronisers. Our own in-house 1" VTR. Extensive sound FX library and the best dubbing mixers in town.

Undoubtedly London's most comprehensive video sound facility.

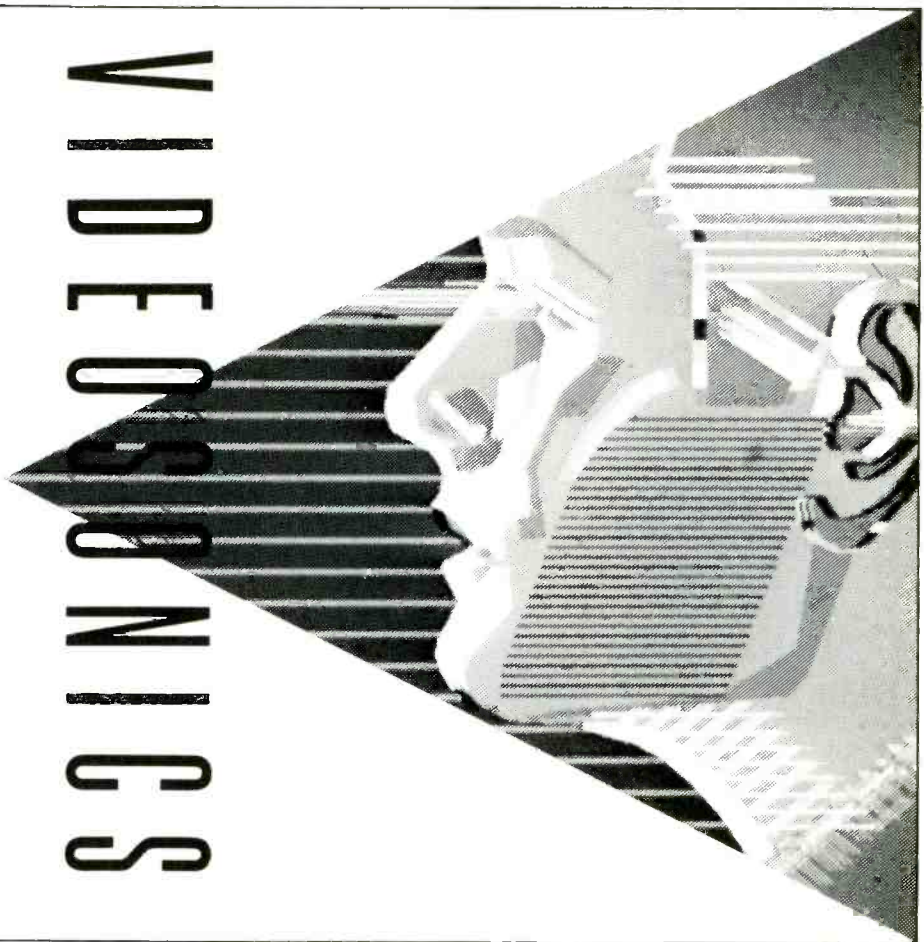

VIDEOSONICS

13 HAWLEY CRESCENT LONDON NW1 6NP TELEPHONE 01 482 2855 TELEX 26453

"I can't imagine ever recording without BBE™ again."

Steve Levine, Producer of Culture Club, The Beach Boys.

Steve Levine's got an ear for hits. He can pick a winning song out of a hundred rough demos, take it into the studio and polish it till it's Triple Platinum. That's why he's topped the charts time after time with trendsetters like the Culture Club. That's why he was named 1984 British Phonographic Institute Producer of the Year. And

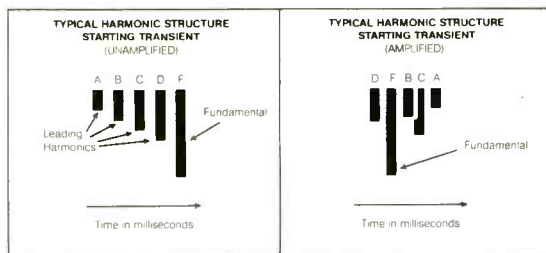

that's why Steve Levine records with the BBE 202R. When Steve produced The Beach Boys' new all-digital album, the 202R was on the team, too.

"BBE is to digital what equalizers were to analog. I'm particularly impressed with BBE's effect on synthesizers."

BBE has its own sharp ear for sound. It senses and instantly corrects problems in that all-important interface between amplifier and speaker. That's where phase and "overhang" distortion

develop, due to voice coil characteristics, reflected impedance from the environment, crossover impedance anomalies and the mechanical properties of dynamic speakers. The relationships among the fundamental frequencies, their leading harmonics and between the leading harmonics themselves become distorted in both amplitude and time. The result? Muddiness, poor imaging and pinched, colorized sound that lacks the presence and punch of the real thing.

The BBE 202R puts the clarity and sparkle back into amplified and recorded sound. We like to think of it as the "unprocessor." Rather than artificially altering the original source, BBE restores the natural harmonic balances that were present in the live performance. How? First it divides the audio spectrum into three bandwidths. Then it applies phase correction across the full spectrum and dynamic high frequency amplitude compensation as required. BBE's continual sampling of the mid/high frequency relationship allows this

correction to take place automatically. Convenient front-panel controls let you boost low frequencies and regulate the

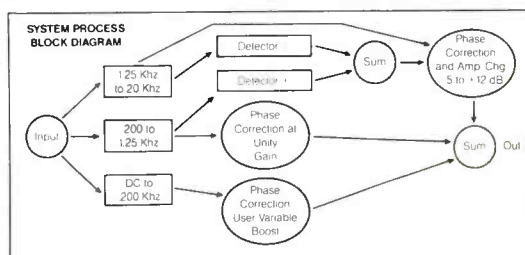

amount of high-frequency amplitude correction to suit your needs. There's no encoding or decoding involved, so BBE can be used anywhere in the recording chain—from individual tracks on a multitrack tape to a mastering lab monitoring system.

Successful producers like Steve Levine count on BBE to bring that hit potential into focus. Why not discover the hidden potential in your own recordings?

To find out what the BBE 202R can do for your sound, contact your professional sound dealer.

Or write to us at Barcus-Berry Electronics, 5500 Bolsa Avenue, Huntington Beach, CA 92649, or call 1-714-897-6766.



BBE™ All the sound you've never heard.
Barcus-Berry Electronics, Inc.

8 SECS



SED

Bel BD80 DELAY LINE/SAMPLER

4 TWO SECOND CARDS
15kHz

24 SECS



SED

Bel BD240 DELAY LINE/SAMPLER

4 x SIX SECOND CARDS 18kHz

32 SECS

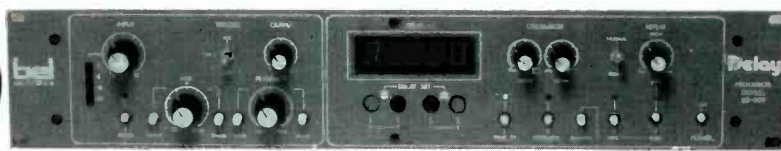

SED

Bel BD320 DELAY LINE/SAMPLER

4 EIGHT SECOND CARDS 15kHz

Audio Services • Carlsbro Sound Centre • Chromatix • Don Larking Audio Sales • ESS • Future Music • ITA • Jones & Crossland • Gig Sounds
• HHB • JSG Music • KG Music • Michael Stevens & Partners • Movement Audio Visual • Music Labs • Raper & Wayman • Sackville Sound •
Studio Spares • ShuttleSound • Sound Business • Turnkey • The Turnkey Shop •

Studio Equipment Distribution

29 Guildford Street, Luton, Beds., LU1 2NQ

Tel: Luton (0582) 452495

SOUND ENGINEER

COURSE

*"The most practical way
to learn the art of
recording"*

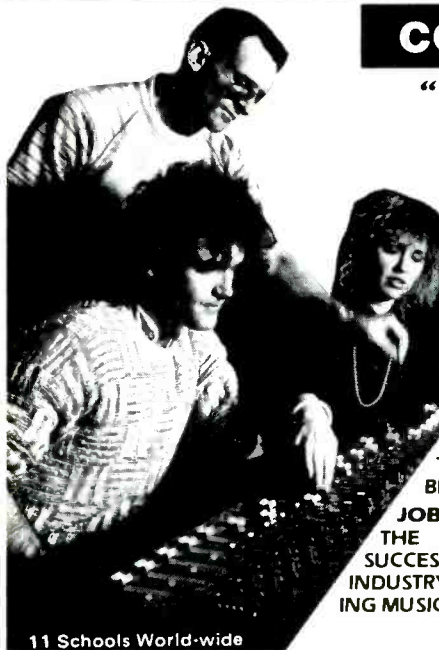

11 Schools World-wide

DIPLOMA
A RECOGNISED
ONE YEAR DIPLOMA
COURSE WITH PRACTI-
CAL & THEORY INSTRU-
CTION IN OUR OWN MULTI-
TRAK STUDIOS.

THE LARGEST SCHOOL
AS THE LARGEST, WE OFFER AN
INTERNATIONAL NETWORK OF
FORMAL TRAINING SCHOOLS IN
THE FIELD OF STUDIO, FILM,
BROADCAST, SOUND.

JOB PLACEMENT
THE SCHOOL IS ACTIVE IN ASSISTING
SUCCESSFUL STUDENTS INTO JOBS IN THE
INDUSTRY WITH THE HELP OF OUR LEAD-
ING MUSIC MAGAZINES.

☀ WE GUARANTEE
HANDS ON STUDIO TIME.

School of Audio Engineering

LONDON SYDNEY MELBOURNE MUNICH MANCHESTER

LONDON	1st Floor, 97 St. John Street, EC1. Tel: 01-608 2420
MANCHESTER	465 Chester Road, Old Trafford, Manchester M16 Tel: 061-872 1868
SYDNEY	420 Elizabeth Street, Surry Hills 2010. Tel: 02-699 7931 Telex: AA 25349 ASB
MELBOURNE	80-86 Inkerman Street, St Kilda 3182 Tel: 03-534 4403
ADELAIDE	263 North Terrace, Adelaide 5000. Tel: 08-223 3535
BRISBANE	22 Heussler Terrace, Milton 4064 Tel: 07-369 8108
COFFS HARBOUR	Unit 3a/11 Cook Drive, Coffs Harbour 2400. Tel: 066-528 934
PERTH	44 Wickham Street, East Perth 6000. Tel: 09-325 4533

Also opening in Germany, USA and New Zealand

NEW!

The Aphex Aural Exciter® Type C

The Best Way to Improve Your Sound System Just Got Better.



And more affordable!

Like the famous Type B, the new Type C restores natural brightness, presence and detail to live and recorded sound... and does it more quietly and musically! Lyrics will have more intelligibility... guitars more bite... drums more kick. The overall mix will be cleaner, more natural and exciting.

The Type C is the best way to improve any sound system. It adds that *extra edge* that is impossible to add with any other

processor. Live sounds fill the room without all the problems of high frequency EQ. Multitrack tapes made on narrow format machines will sound like they were made on expensive studio recorders. Even cassette dupes will have an unmuffled, professional sound.

Hear the difference *only* a genuine Aural Exciter can make at your dealer today. Or write us for more information and the name of your nearest dealer.

The Aphex Compellor.™

Invisible Compression in Stereo or Mono.

The Aphex Compellor is the most acclaimed compressor/leveler/peak limiter ever made. With good reason... you simply can't hear it work. It doesn't add *any* color or other sonic effects. Best of all, the Compellor is easy to use. Set it once and it goes to work automatically... inaudibly controlling your dynamics.

Ask your professional sound dealer for a demonstration of the remarkable Aphex Compellor. Available in monaural and

stereo versions. Or write us for the name of your nearest dealer and more information on the full line of innovative Aphex products.



Aphex Systems Limited
Sound Technology Ltd.
6 Letchworth Business Centre, Avenue One, Letchworth, Herts SG6 2HR

Aural Exciter and Compellor are registered trademarks of Aphex Systems Ltd., North Hollywood, CA
© 1985 Aphex Systems Ltd.

AUSTRALIA
East Coast Audio Sales,
Melbourne

AUSTRIA
AKG, Vienna

BENELUX
Trans European Music,
Dilbeek

CANADA
AKG Acoustics,
Scarborough

DENMARK
SC Sound, Taastrup

FINLAND
Nores Oy, Helsinki

FRANCE
3M France
Cergy Pontoise Cedex

GERMANY
AKG, Munich

GREECE
Omikron, Athens

HONG KONG
Audio Consultants,
Kowloon

ITALY
M. Casale Bauer, Bologna

JAPAN
Matsuda Trading, Tokyo

KOREA
Young Naksorisa, Seoul

NEW ZEALAND
Maser Comm., Auckland

SINGAPORE
Auvi Private Ltd.

SPAIN
Neotecnica, Madrid

SWEDEN
AB Betoma, Solna

SOUTH AFRICA
Tru-Fi Electronics
Wynberg, Sandton

SWITZERLAND
Audio Systems
PAS AG, Basel

TAIWAN
Linfair Engineering, Taipei

CLASSIFIEDS

Advertisements for this section must be pre-paid. The rate is 55p per word, minimum £13.75. Box Nos. £3.50 extra. Semi-display rates on application. Copy and remittance for advertisements in MAY issue must reach these offices by 10th MARCH addressed to: The Advertisement Manager, Studio Sound, Link House, Dingwall Avenue, Croydon CR9 2TA. Cheques made payable to Link House Publications (Croydon) Ltd. Note: Advertisement copy must be clearly printed in block capitals or typewritten.

Replies to Box Nos. should be addressed to the Advertisement Manager, Studio Sound, Link House, Dingwall Avenue, Croydon CR9 2TA, and the Box No. quoted on the outside of the envelope. The district after Box No. indicates its locality. **SEX DISCRIMINATION ACT 1975:** No job advertisement which indicates or can reasonably be understood as indicating an intention to discriminate on grounds of sex (e.g. by inviting applications only from males or only from females) may be accepted, unless (1) the job is for the purpose of a private householder or (2) it is in a business employing less than six persons or (3) it is otherwise excepted from the requirements of the Sex Discrimination Act. A statement must be made at the time the advertisement is placed saying which of the exceptions in the Act is considered to apply.

The attention of advertisers is drawn to "The Business Advertisements (Disclosure) Order 1977", which requires that, from 1st January 1978, all advertisements by persons who seek to sell goods in the course of business must make that fact clear. From the above date consumers therefore should know whether an advertisement relates to a sale by a trader or a private seller.

SERVICES

QUALITY HIGH-SPEED and real-time audio and video cassette copying and processing. Any quantity. While you wait. 24-hour, 7-days-a-week service. Central London W2. GWBB Audiovision. Tel: 01-723 1583/5190. (X)

WHO SAYS YOU DON'T NOTICE THESE SMALL ADS! For as little as £12.50 + VAT you too could be getting your service message across. For more details contact Adrian Tippin at STUDIO SOUND. Tel: 01-686 2599.

LOCKWOOD, TANNOY, etc., new and used equipment always available and wanted. Lockwood Audio Sales 01-866 0671. (X)

MUSIC SUITE—Low cost real time cassette duplication. Labels, blank cassettes, boxes, etc.—Fast and efficient service. Phone for price list 0239 711032 (C)

INSTALLATION: studio cabling assembled on- or off-site. Guaranteed tidy, reliable, hum-free and safe. Phone for free quotation 01-701 1390.

THE COMPLETE SERVICE. Disc cutting (masters and demos), pressings, sleeves, cassettes, labels. Fixed and mobile recording studios. Free brochure. TAM STUDIO, 13a Hamilton Way, London N3. Tel. 01-346 0033 (X)

REAL TIME CASSETTE COPYING. High quality professional service. Normal or chrome tape. Cassette, reel to reel or digital masters. Brochure and price list, call H.S.D. Basildon (0268) 413731 (24 hours). (D)

WEST 5 Tapes Ltd.

Rapid supply of high quality blank bulk cassettes C1 C120 Example C60 31p
5-screw C-Zero — no minimum or maximum order
Phone Dave West 01-502 2447
West 5 Tapes Ltd, Unit 34, Oakwood Hill Industrial Estate, Loughton, Essex



THE CASSETTE DUPLICATING SPECIALISTS
Real time & high speed duplication
Blank cassettes wound to length
TEL: 061-881 2402

REAL TIME CASSETTE DUPLICATION
Dolby B/C Standard / Chrome Tape
CUSTOM WOUND BLANK CASSETTES

Tel: Cardiff (0222) 790040
Backyard Recording Studios Ltd.
60 Orchard Park, St. Mellons Cardiff



SELF ADHESIVE CASSETTE LABELS

We are specialists in self adhesive cassette & computer labels and can supply them in a wide variety of formats. Send or phone for our full price list and size chart.
Telephone (0795) 28425 - 24 hours
INDUSTRIAL PROCESS - Self Adhesive Labels SUPERFAST
UNIT A4, SMEED-DEAN CENTRE
SITTINGBOURNE, KENT ME10 3RN, ENGLAND

100 C-60 cassettes beautifully copied in stereo from £59.50 (plus VAT)

We can copy from 100 to 5,000 high quality cassettes on our high speed loop-bin system, load them precisely into top-class shells. Price includes library case and all production work from your ¼ in edited master. Any length C-5 to C-90. Ring for price check.

STUDIO REPUBLIC

47 High Street, Pinner 01-868 5555 01-866 5555

REAL TIME CASSETTE COPYING

All work carried out on Nakamichi machines to the highest standard. Normal or chrome tape available.

We also supply blank cassettes wound to length. AGFA and BASF chrome tape available.

GATEWAY CASSETTE SERVICES
1 GAUDEN ROAD, LONDON SW4 6LR
TEL: 01-627 4758



DIRECT FROM OUR MODERN U.K. PRESSING PLANT

- CUTTING · PRESSING
- TEST PRESSING
- LABELS · SLEEVES
- CASSETTES
- ARTWORK
- COMPETITIVE PRICES



01-446 3218

CASSETTE DUPLICATING:
GAUSS Loop-Bin / TELEX In-Cassette
High Quality Blanks / Label Printing
OPEN REEL DUPLICATING
(ANY SPEED - ALSO TO BROADCAST SPEC.)
SPEECH RECORDING
(VOICE-OVERS; LANGUAGES; AUDIO-VISUALS)

SPEECH-PLUS RECORDINGS LTD.

UNIT 32, NO. 19, PAGES WALK, LONDON SE1 4SB. TEL: 01-231 0961

DON'T GO BLIND CALIBRATE with WEBBER TEST TAPES

London and South
PMD 01-627 3760
Music Lab 01-388 5392
Turnkey 01-202 4366
Stirling Audio 01-625 4515

Midlands and North
PMD 0789 68579
Carlsbro 0623 651633

ALL FORMATS AVAILABLE
—INCLUDING CASSETTE

CLASSIFIEDS

SERVICES

HIGH QUALITY CASSETTE DUPLICATION AND SPECIALISED LENGTH BLANK CASSETTES

ICM C-O's

Leeholme Audio AGFA/BASF TAPES

Leeholme Audio Services Ltd., 350-4 Leabridge Road, Leyton, London, E10 Telephone 01-556 4748

Revox & Uher Sales & Service

16mm sound 35mm slide projectors, open reel and cassette recorders, amplifiers, etc., serviced and repaired. Bell & Howell, Elf, Ferrograph, Revox, Tandberg, Uher approved service agents. Maintenance contracts available. Visit our Amateur Radio Showroom at:- 58 High Street, Newport Pagnell. Tel: 0908 610625.

Photo Acoustics Ltd

Let Saki expertise relap your tape heads in London

Factory-approved laboratory and training guarantees finish to original performance specification

ALL MAKES RELAPPED

Tapetek, 44A Brighton Road, London N16 8EG
Tel: 01-254 5203 or 0860 317260 (mobile)

Replacement Saki heads from:
Tape Marketing, 13 Elm Road
Faringdon, Oxon SN7 7EJ



SPEEDY REVOX SERVICE

Plus TEAC/TASCAM, FOSTEX, UHER, most Mixers, Amplifiers, Effects. Priority Bookings taken. Collection/Delivery arranged. A personal service by experienced engineers.

34 Danbury Street, London N1 8JU
Telephone 01-359 9342/3030

RAPER & WAYMAN

MUSIC-SPEECH-COMPUTER

REAL-TIME or (Slow) HIGH-SPEED Quality Cassette Duplication and Blanks from 1 to 1000+. Computer printed Cassette Labels, Speech and 1/4" reel-to-reel recording/editing. Fast Security Delivery service.

jbs records - a division of FILTERBOND LTD.
19 Sadlers Way, Hertford SG14 2DZ. 0992-551188.

WHY PAY LONDON RATES?

Professional Disc Mastering operation offering top quality with over 20 years experience. Contact Brian East, "Suncliffe", 43 Sandgate Hill, Folkestone, Kent.

SPECTRUM SOUND

0303 38752

SOUND BUSINESS

EAST LONDON AND ESSEX'S TOP RECORDING EQUIPMENT CENTRE
NEW AND SECONDHAND

Iowa
Tascam
Revox
Fostex
Yamaha
Lexicon
DBX
Lyrec
Neumann
Aphex



Symetrix
Allen-Heath
Studiomaster
Tannoy
Dynamix
Scundtracs
MTR
Electrovoice
Ampex
AKG

Drawmer
BEL
Alesis
Amek
Sony
Sennheiser

Best prices. Many special discounts. Full back-up service.
Open 7 days a week 9am-9pm.
(London Central Line)

SOUND BUSINESS HOUSE

SOUTH WOODFORD E18 1DG
01-989 6359

BOOMLESS BOGIE IN BUCKS!!

Best wishes to Barry (purple bits) Caws, with his "flat as a pancake" monitoring, in the new 8-track writing/demo facility the Boogie Bunker at High Wycombe.

Well you came to the right people didn't you.
Boomless pancakes & Boogie, for not a lot of Bucks.

STUDIO INNOVATIONS

740 6060 661 9380

MEASURE IT

If you can hear it we can measure it and whats more tell you what to do with the minimum of inconvenience.

MUNRO ASSOCIATES. 01-480 7121

QUALITY CASSETTE COPYING

High speed on Loop Bin System/Real time on Nakamichi Machines. Exact length blank cassettes

ACCURATE SOUND LIMITED

Melton Road, Queenborough Industrial Estate
Queenborough, Leicaster LE7 8FP
Telephone (0533) 602064

CASSETTE DUPLICATORS

SALES SERVICE MAINTENANCE

High speed cassette duplicators throughout the United Kingdom and export.

GRAFF WOLLENSAK SONY

Sound Cassette Services Ltd.

P.O. Box 2, Chard, Somerset
0460 67237

LONDON SERVICING FACILITIES

YOU NEED IT... WE SUPPLY IT

Precision wound cassettes, high speed duplication. Both using Ampex, Basf, Capital open-reel copying. Full printing facilities (side labels & inlays). Major suppliers of Ampex open-reel tape. Also razors, leader tape, splicing tape spools and boxes, etc., etc.

Rainhill Tape Specialists

31 Eccleston Street
Prescot, Merseyside L34 5QA
051-430 9001

THE COMPLETE SERVICE

includes:

BLANK CASSETTES (C1 - C100 incl. Chrome)
HIGH-SPEED LOOP-BIN CASSETTE COPYING
OPEN-REEL COPYING
CASSETTE LABELS & INLAY CARDS
EMPTY TAPE SPOOLS & TAPE BOXES
LEADER TAPE & SPLICING TAPE
AMPEX MAGNETIC TAPE

and is available from -
MEDIATAPE LIMITED

The Courtyard, 152-154 Ewell Road, Surbiton, Surrey KT6 6HE England 01-399 2476 7

THE SOUND & VISION WORKSHOP LIMITED



SOLE U.K. AGENTS

COMPETITIVE 3M HEAD PRICES EXCHANGE MOTORS AND BOARDS. ALL SPARES IN STOCK. EXPORT ENQUIRIES WELCOME

SERVICE FOR ALL MULTITRACK RECORDERS
SPARES · REBUILDS · PROFESSIONAL AUDIO
ELECTRONICS · SALES · EQUIPMENT

153A Victoria Street,
St. Albans, Herts. AL1 3TA
Tel: (0727) 58977 24hr.

SELECTA

REAL TIME AND LOOP BIN DUPLICATION
EXACT LENGTH CASSETTES
STUDIO SUPPLIES 04024-53424



SOUND WHERE THE CHOICE IS YOURS

AUDIO LEADS

ALRIGHT JACKS

No flashing lights or sexy promotion, just quiet, RELIABLE connections. Call Geoff Lowther with YOUR requirements.

TEL: SLOUGH (0753) 821812
FOR FREE CATALOG & INFO
MUSICABLE

FOR SALE—TRADE

ALTEC 604-8k/620c MONITORS. Offers for pair. Phone David Collison 01-240 5411.

STUDER A800 MkIII (24-track). Mint condition, low hours. Offers around £23,000. Telephone: 01-482 4288.

DISC CUTTING EQUIPMENT and systems bought, sold, installed and manufactured (under licence from ORTOFON). TAM/ENGLAND, 13a Hamilton Way, London N3 1AN. Telephone 01-346 0033. (X)

TEAC 244/34/38 discounts and HP and leasing. Erricks VCD, Brighouse 722121 (Bob) (X)

OTARI Duplicator recently serviced and brought up to spec by OTARI. £2,500+ VAT ono. Tel: 051 430 9001.

CLASSIFIEDS

AUDIO SERVICES

BRITAIN'S LARGEST MULTITRACK STORE
OVER SEVEN THOUSAND SQUARE FEET OF MIXERS,
TAPE MACHINES, HI-TECHNOLOGY KEYBOARDS

TAPE MACHINES	EFFECTS & P.A.	MIXING CONSOLES
MITSUBISHI X900, 850 for hire & sale	P.O.A.	AMEK 2500 series & 'Angela' To Order
STUDER A80 MK IV 24 track	£24,427	TAC Matchless & Scorpion On Demo
LYREC TRS32 24 track inc locator	£22,500	SOUNDTRACS 'M' series 24/8/2 £4,265
TASCAM MS16 sixteen track	£5,995	SOUNDTRACS 16/8/16 £1,995
TASCAM 480B (special price)	£2,495	SOUNDTRACS 24/8/16 £2,500
TASCAM 38 (new)	£1,695	ALLEN & HEATH CMC24 with Commodore computer routing £2,155
TASCAM 42NB (special price) (new)	£1,200	RAM RM10 £450
FOSTEX B16 (from stock)	P.O.A.	RAM RM16 £575
FOSTEX Model 80 (new model)	P.O.A.	FOSTEX 450 £595
FOSTEX A8 (re-con, new heads)	£895	TRIDENT 16 way input frame 10 channels loaded (10/8/2) (as new) £1,595
TEAC A3440 (showroom model)	£695	ALLEN & HEATH system 8 II 16/8/2 (as new) £1,195
TASCAM 34 (second hand)	£750	TASCAM MS20 20/8/16 £2,750
MCI JH110BC 8T 1" (as new)	£2,495	SECK 16/8/2 (very good condition) £695
TASCAM AT860 2T with CNTR time code	£2,750	DYNAMIX 12/2 (new) £225
TASCAM 52 NAB/IEC record/play	£1,595	TASCAM M-30 (mint) £495
TASCAM 38 Inc. Remote Ex Showroom	£1,450	STUDIOMASTER 6/2 with 6 chan ext (new) £395
TASCAM 52 (new in box, 1 only)	£1,295	TASCAM M35 (new) £695
TASCAM 32	£749	YAMAHA RM602 £195
TASCAM 3440 S/H (mint)	£590	STUDIOMASTER 8/4 (new) £550
REVOX B77 MK II HS NAB & IEC	£775	SECK 18/8/2 (in-line console) (new) £1,195
TEAC X2000M (new)	£750	RAM Mega 18 £1,495
TASCAM 22-2 (new)	£425	AHB SR series 2 & 4 buss (on demo) P.O.A.
UHER 4200 report monitor (new)	£550	SECK 12-2 £425
FOSTEX Model 20 (new model) SMPTE compatible	£649	SECK 6-2 £245

DIGITAL PROCESSORS (NEW)

SONY F1 P.O.A., SONY 901 £389, SONY 701 ES £725, SONY beta hi-fi P.O.A.

CASSETTE MACHINES AND PORTASTUDIOS

AKAI MC-1212 (on demonstration)	£4,345
TASCAM 388 8 track reel/reel portastudio	£2,080
TASCAM 246 (new model)	£775
TASCAM Porta-1 inc PSU & headphones	£347
TASCAM 234 (4 track)	£550
TASCAM 244 Portastudio	£600
FOSTEX 250 Portastudio	£550
TASCAM 144 Portastudio (nuce) (cash)	£350
FOSTEX X15 mini-studio	£210
FOSTEX MN15 mixer/comp for X15	£39
TASCAM 225 (synthesizer)	£195
TEAC V700 3H B & C	£295
TEAC V340 B	£75
TEAC V380C Dolby B & C	£89
TEAC V707 Auto-rew B & DBX special purchase	£185
TASCAM 122B	£510
YAMAHA MT44D Portastudio	£295
YAMAHA RM602	£295
YAMAHA PB35B	£129
MARANTZ CP430 Portable	£234

CASSETTE - CASSETTE DUPLICATORS

TASCAM T2640MS (new model on demo)	£1,495
GRAFF HMSF (master/slave/PSU)	£1,395
TEAC W440C dual speed master/slave	£180

NOISE REDUCTION

TASCAM DX40 4 chan DBX	£235
TASCAM DX20 2 chan DBX	£193
DBX 150 (new)	£250
DOLBY 360 (1 only)	£295
SYMETRIX S11 single ended stereo	£519
BEL 8 channel, S/H, 2 available	£298

COMPRESSORS, LIMITERS, EXPANDERS AND GATES

REBIS rack with 6 gates, 2 comps and 2 dist amps	£450
AUDIO & DESIGN compex limiter F760RXS	£795
BROOK SIREN SYSTEMS DPR402	£495
DBX 166 (new product)	£560
DBX 165A (new product)	£695
DBX 163X (new product)	£132
DBX 163X	£375
ACCESSIT gates and comps from stock	£49
DRAWMER 1960, DS201, DL221 & DL231	P.O.A.
SYMETRIX dual comp/lim/exp/gate/duck	£495
APHEX type 'B' (in stock, new)	£195
APHEX type 'C' (in stock, new)	£290
FOSTEX 3070	£195
YAMAHA CC2020	£199
ACCESSIT apex extier	£59
UREI 1176 LN limiter	£580

AMPLIFIERS BY YAMAHA, STUDIOMASTER, CITRONIC, JBL, UREI QUAD, TEAC, HARMAN KARDON AMP BARGAINS

HILL DX700 (new)	£395
FOSTEX 600 (300 WPC/RMS 4 ohm)	£375
TURNER B502 (180 WPC/RMS 8 ohm)	£395
AMCRON D150A (75 WPC/RMS 8 ohm) II (brand new)	£450
QUAD 405 S/H	£165
H/H D500 250 + 250 8 ohm	£295

MICROPHONES BY AKG, BEYER, C-DUCER, NEUMANN, SENNHEISER, SHURE, ELECTRO-VOICE

AKG SPECIAL S/H un-used C422 comb	£900
NEUMANN SPECIALS U47: 1 year old (mint)	£495
1 pair M269C	£900 each
SM69 valve with accessories (immaculate)	£1,100

MONITORS PAIRS BY JBL, UREI, TANNAY, VISONIC, AURATONE, BOSE

JBL 4435 £3,100, JBL 4430 £2,400, JBL 4225 £1,295, JBL 4411 £995, JBL L-1S £225, JBL TLK3 £129	
UREI 809 on demonstration at St Johns Wood	£1,595
TANNAY DX X0600	£4,140
TANNAY M2000	£1,795
TANNAY M1000 super red	£1,595
TANNAY DTM8	£295
AURATONE SC	£89

HOURS OF BUSINESS: MON - FRI 9.30 a.m. - 6.00 p.m. SAT 10.00 a.m. - 2.00 p.m. FOR SALES ONLY.

...STOP PRESS...STUDER A800 S/H 2300HRS PERFECT £25,000.....
RAINDIRK CONCORDE 24:16 (IN LINE) £1,200 o.n.o., BRENNEL 8 TRACK 1" - SUPERB COND WITH TAPE COUNTER, VARI-SPEED & REMOTE £2.2K...
QUANTEC ROOM SIMULATOR 2i/p, 4o/p, MODEL WITH LATEST SOFTWARE - OFFERS AROUND £5,000, ADC 52 HOLE PATCHBAYS (2 AVAIL) £150Ea...
PPG WAVETERM-LATEST ONE WITH 500 SOUNDS £3,500, YAMAHA CP70B ELECTRIC GRAND PIANO £1,595 o.n.o., FENDER RHODES 73 £450, ARP-ODYSSEY (OLD MODEL) £50, TANNAY SRM12B 'LITTLE REDS' £495, ...
REBIS PARAMETRIC EQ S/H £50, STUDER B67 MK1 VCC FULL SERVICE HISTORY £1,595, OTARI MTR90 AUTOLOCATOR £995, QUAD-8 DIGITAL...
REVERBERATOR CPR16 S/H £595.....

LONDON SHOWROOM NOW OPEN

4, WELLINGTON ROAD, ST. JOHNS WOOD LONDON NW8 01-586 3167
(Opposite The Wellington Hospital Junction with Lords Cricket Ground)

STUDIO HOUSE 06632 4244

HIGH LANE VILLAGE, Nr STOCKPORT SK6 8AA. Telex 665721 SOTA

FOR SALE-TRADE

MOVING BACK TO USA. ENTIRE CONTENTS OF PRIVATE, MODERN well equipped, immaculately maintained 24-track (Otari MTR9011, MTR12G, Trident 80B, AMS etc.) MASTERING recording studio for sale. No equipment more than 2 years old! Excellent opportunity for someone setting up complete studio. Highly experienced technical assistance also available. Will only consider splitting contents if necessary. Many many extras. £70,000+ VAT. 01-286 5269. (D)

HILL 'K' SERIES. Professional 24tr console 28:16:24, 30 Sifam VU's, P&G faders, 280 way GPO patchfield. Beautifully maintained and finished in light oak. £3,950 ono. Tracksid Studios (0702) 333453.

USED STUDIO EQUIPMENT FOR SALE? Advertise it now in STUDIO SOUND CLASSIFIEDS for as little as £12.50+ VAT. For more details call Adrian Tippin at STUDIO SOUND. Tel: 01-686 2599.

USED EQUIPMENT PACKAGES

Don Larking Audio Sales has masses of used equipment taken in part exchange and available at very competitive prices.

PACKAGE 1: 24-TRACK SOUNDCRAFT SCM762 24-track recorder with autocontrol RAINDIRK Concord 28-input in-line console plus set of interconnecting cables £16,500

PACKAGE 2: 24-TRACK SOUNDCRAFT SCM762 24-track recorder with remote control SOUNDCRAFT IIB 32-input console with professional patchbay, plus set of interconnecting cables £18,000.

PACKAGE 3: 16-TRACK MCI 16 track 2" recorder with remote control, AMEK 2000 20-input in-line console plus set of interconnecting cables £7,000.

PACKAGE 4: 16-TRACK FOSTEX B16 16 track 1/2" machine MCI 400 in-line mixing console plus set of interconnecting cables £6,000.

ALSO IN STOCK: 3M 16" and 24" track machines, STUDER 16" and 24" track machines, AMPEX MM1200 24-track machine. PLUS wide variety of mixing consoles and outboard equipment.

Don Larking audio sales

Luton, 29 Guildford Street, Luton, Beds Telephone: Luton (0582) 450066. Telex: 825488 DONLAR G

KGM Studio Specialists

Your Northern appointed agent for:

NEUMANN	J.B.L.	LEXICON	SOUNDCRAFT
SENNHEISER	TANNAY	DRAWMER	STUDIOMASTER
SHURE	REVEX	D.B.X.	B.E.L.
BEYER	TASCAM	YAMAHA	APHEX
UREI	QUAD	AMPEX	APPLIED
TRIDENT	ROLAND	AKG	MICROSYSTEMS

18-42 Charlotte Street, WAKEFIELD, W. Yorks WF1 1UH
Tel: (0924) 371766

FOR SALE

LOW BAND U-MATIC VIDEO STUDIO

Comprising of:
J.V.C. EDITING SUITE
2 x SONY SINGLE TUBE CAMERAS
SONY PORTABLE U-MATIC
SEVERAL B/W + COLOUR MONITORS
LIGHTS
SONY U-MATIC RECORD/PLAYBACK
SYNC PULSE GENERATOR
ELECTROCRRAFT VIDEO EFFECTS MIXER
AUDIO AMPS/SPEAKERS/MIKES

Complete with cables, distribution amps and patch bays
All in full working order - hardly used - Price £15,000
complete - PHONE (01) 440 7033 OFFICE HOURS
CONTACT IRENE HARE

ALSO T.E.M. TELEVISION TRANSMITTER - NEW E.R.P. 7 KW COMPLETE WITH ANTENNAS - CHANNEL 60 PLUS TRANSPONDER LINK - RETAIL VALUE £23,000 WILL SELL FOR £17,000 - CONTACT IRENE HARE

Neve multitrack recording console, currently controlling 40-track studio system fully maintained, includes 6 Neve compressor limiters and separate comprehensive jack bay. Great track record. All sensible offers invited.

Phone for details:
521-2040

CLASSIFIEDS

SOUNDCRAFT 24 track recorder. No ghosts in this machine – just 12 months old and in very good condition. Complete with peace of mind in the shape of our 6 month warranty. The price includes a remote control and a small audio interface cable.

MCI JH110 1/4" stereo master recorder. Something of a rarity: it's one of the few to be built into a wooden floor console (always a talking point among engineers). It's in very good condition, too.

SPENDOR BCI Not just one, but a whole pair of these fine monitors, and in excellent condition too. Offers, please.

2ND USER AUDIO.

Stirling
AUDIO SYSTEMS LTD

1 Canfield Place London NW6 3BT ☎ 01-625 4515
Telex 946240 CWEASY G RefNo. 190 14280

DBX 150 2-channel noise reduction. Shhhh... 12 of the 19" rack mounting units which add up to (where's the calculator?) a total of 24 tracks. They're all in excellent condition. £170 each (ono), or a case – one dozen – for £1,920.

ALESIS XT stereo digital reverberrrrration – justly popular; very spacey and equipped with a very low price (it's an ex-demonstration unit). A mere £499.

STUDER A800 Just passed its 2nd birthday, and in jolly good condition. The price? On application, please.

All our prices are subject to VAT, and are correct at time of going to press.



PARTRIDGE ELECTRONICS
phone 03745 3256

you are never far from a

PARTRIDGE COMMUNITY MIXER

- * the user friendly desk
 - * the heart of any quality studio
- DIAL 03745 3381**

for advance information on our NEW stereo broadcast desk

**56 Fleet Road
Benfleet, Essex
SS7 5JN, England**

3M M79 24-track tape machine,
quick sale required
£8,500 + VAT

Tel: 0272 426409 ★ 0272 693812 (evenings)

WANTED

WANTED 3M M79's. With or without heads, motors or boards. Best prices paid, buyer collects. Tel: (0727) 58977 24hr.

STUDER A.62—B.62. 7½-15. parts: REC/PLAY UNIT: 1.062.700 CCIR + stereo-heads for same. Also a wreck with above. Tel: 0243 59200. Bill.

WANTED DEAD OR ALIVE

Neumann valve mics
Types U47, U48, U67
Tel: 01-387 9356

FOR SALE—PRIVATE

NEVE 12 in to 4 with comprehensive 4-track monitoring, 19" patch panel. Producers desk — £4,500 plus VAT. Two Neve 2252 compressors—£75 ea. plus VAT. Glenthams Studios, Barnes. 01-741 9696.

AKG C414EB MICROPHONES £300. MILAB, Sennheiser, Shure mics, many headphones, VERY CHEAP. Tandy portable computer £300. Dual CS505 turntable £50. Used 2" tape £15, unused 1/4" £11 p/reel. Tel: 01-543 6585.

FULLY PROFESSIONAL 32x24 K-SERIES HILL MIXER. Extensive EQ patchbay PG-faders fortyway frame. Immaculate £5,500. Eventide, Klarktechnik, MXR, Roland 501, Urei, Hammond C3. Telephone (0757) 638812.

WESTREX 16mm RECORDER in 19" rack. Trimate electronic switchable centre and edge track. EBU £450.00 plus VAT. Glenthams Studios, Barnes. 01-741 9696.

FOR HIRE

DIGITAL AUDIO RENTALS

SONY DIGITAL

- PCM 1630 DIGITAL AUDIO PROCESSORS
- 5850D/A U-MATIC RECORDERS
- DMR 2000 U-MATIC RECORDERS
- PCM 1610 DIGITAL AUDIO PROCESSORS
- DAE 1100 DIGITAL AUDIO EDITOR
- PCM F1 DIGITAL AUDIO PROCESSORS
- SLF1 BETAMAX RECORDERS
- DTA 2000 TAPE ANALYSIS
- FULLY EQUIPPED AIR CONDITIONED DIGITAL EDITING & TRANSFER FACILITY



HHB Hire & Sales, Unit F, New Crescent Works, Nicol Road, London NW10 9AX. Telephone: 01-961 3295. Telex: 923393.

WORKING IN THE USA?



"THE AUDIO RENTAL PEOPLE"
Complete selection of pro audio equipment for hire. Outboard Equip ★ Digital Recorders ★ Walkie Talkies
A/T Scharff Rentals. 1619 Broadway, New York.
Phone (212) 582-7360/IMC(367)/MCI Mail 260-0455

THE P.A. COMPANY HIRE • SALES
INSTALLATIONS
01-607 0087
PROFESSIONAL SOUND SYSTEMS AND CONTROL EQUIPMENT (TOYS)

CLASSIFIEDS

FOR HIRE



LEXICON 224XL LARC
AMS 15-80s 6.4sec/1.6sec
PUBLISON INFERNAL MACHINE 90:
- 21 SEC. STEREO SAMPLING
01-228 0984

TECRON TEF 10

Time Energy Frequency
Measurement Service

MUNRO ASSOCIATES. 01-480 7121

EMULATOR II

PLUS FULL SOUND LIBRARY
ALSO: LINN DRUM, SIMMONS KIT, KEYBOARDS ETC.
STUDIO SUPPLY SERVICE
061 928 5037
THE MANCHESTER BASED HIRE COMPANY



HIRE AND PROGRAMMING

Please ring for details of our programming
service and comprehensive range of hire
equipment.

MOBILE PHONE: 0860 316 269

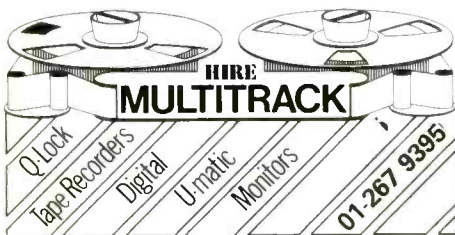

SAM THERAPY

FOR AURAL EXCITEMENT

FAIRLIGHT + . . .
32-TRACK STUDIO

Tel: 01-221 5967/960 1336

SITUATIONS VACANT

TRAINEE SERVICE

ENGINEER

A unique opportunity to join
the UK's fastest-growing professional
audio dealer.

As a trainee engineer with
Stirling Audio Systems you'll work
under our Technical Services Manager,
looking after the multitrack
recorders, mixing consoles and other
equipment of major UK studios. So
while a sound basic knowledge of
audio is a must, full training will be
provided.

For a keen young person, willing
to learn an increasingly high-
technology profession, this is a superb
opportunity with excellent long-term
prospects. Please contact Ruth Dalby
with your C.V.



1 Canfield Place London NW6 3BT ☎ 01-625 4515
Telex 946240 CWEASY G Ref No. 190 14280

THE CITY UNIVERSITY

DEPARTMENT OF MUSIC

LECTURER IN MUSIC INFORMATION TECHNOLOGY

Applications are invited for the post of Lecturer in Music Information Technology tenable from
October, 1986.

The successful candidate will be expected to contribute to the Music Department's Diploma
in Music Information Technology, its B.Sc. (Hons) in Music and its post-graduate music
technology research courses. Experience in digital applications is essential, together with degree
level qualifications in Electrical and Electronic Engineering or Computer Engineering and a
knowledge of the principles of music.

The appointment will be for an initial period of three years on the Lecturer scale, £8,817 to
£16,222 per annum inclusive of London Allowance (under review).

Application forms and further information may be obtained from The Academic Registrar's Office,
The City University, Northampton Square, London, EC1V 0HB. Telephone 01-253 4399, Ext.
3037.

Closing date: 5 March, 1986

PRIVATE RECORDING STUDIO—SURREY/SUSSEX BORDERS

ELECTRONIC MAINTENANCE ENGINEER

A second maintenance engineer is required for 24/48-track studio with SSL/Studer/Sony
Equipment. Would suit young person with good practical electronics background seeking an
introduction into this field. Replies in writing, enclosing recent CV to:

Hit & Run Music Ltd, 81-83 Walton Street, London SW3 2HP
Reference 'Engineer Ad'

CLASSIFIEDS

SITUATIONS VACANT

AMERICAN STUDIO needs talented, experienced sound engineer. Located in Texas, this studio has state-of-the-art recording equipment by Sound Workshop, supported by Korg, Dalquist, Studor, Lexicon, Neumann, Yamaha and B&W equipment. Work primarily with rock band on upcoming album. Excellent salary and full benefits. Relocation expenses paid. Send work history and sample tapes to:

Allan Smith, 73 Copthorne Road
Croxley Green, Rickmansworth, Herts

SITUATIONS WANTED

WANTED: FULL TIME WORK IN, OR ASSOCIATED WITH SOUND ENGINEERING.

Some tape operator experience. Not afraid of menial tasks in interest of furthering career. Young. Musically minded. Hard working. Really enthusiastic. Tel: Phil Walsh (04946) 5678 evenings.

EXPERIENCED ENGINEER. Many credits. Worked in many studios as freelancer. Looking to join a new or established studio. London or South West. Reply to box no. 930. (D)

SUCCESSFUL FREELANCE ENGINEER, fully experienced (SSL etc.), currently working in London, very anxious to work anywhere in Europe, Belgium especially. Even humble offers considered. Reply to box no. 931.

SITUATIONS WANTED

ATTENTION ALL STUDIOS EVERYWHERE! Young creative freelance recording engineer with several years experience of working in studios here and abroad, seeks new and aspiring work. Willing to work anywhere throughout the world. For further information tel: 0202 603532.

STUDIO DESIGNERS AND CONSULTANTS

STUDIO CONSTRUCTION

Studio environments built to the highest standards. Our services include:
Fully engineered floating floors, suspended ceilings, high density doors, sound lock lobbies, concrete and brickwork, double glazing, low frequency absorbers, attenuated ventilation systems, insulating sealants, acoustic screens, electrical and electronic installation, equipment sales and commissioning.

U.K. and international projects undertaken.

Planning, design and materials export.

Ring **RECORD CONSTRUCTION LTD**
01-985 7573 - London, England

TIME DELAY SPECTROMETRY

Discover why your studio sounds the way it does . . . or should

MUNRO ASSOCIATES. 01-480 7121

STUDIO DESIGNERS AND CONSULTANTS

KENNETH SHEARER AND ASSOCIATES

Consultants in acoustics and noise control

Over 30 years' experience in the custom design of all kinds of recording and TV studios, remix, dubbing and viewing suites - new and conversions, down to 25 Hz.

Tel: 0442 54821

STUDIO FOR SALE

FOR SALE

24 TRACK STUDIO

JACKSON MUSIC GROUP
The Studios, Rickmansworth,
Herts, England WD3 2XD

Telephone: 0923 772351 or Vodafone 0836 203557

Come and see Studio Sound at the AES Convention on Stand No. E13

STUDIO SOUND
AND BROADCAST ENGINEERING

CLASSIFIED ADVERTISEMENTS ORDER FORM

Please use this coupon for all your sales and wants. Rates: 55p per word. Min £13.75. Box Nos. £3.50 extra

PLEASE PRINT IN BLOCK CAPITALS

To: **STUDIO SOUND**, please publish the above advertisement for insertions under the heading Cheque/P.O. to be made payable to **LINK HOUSE PUBLICATIONS LTD, LINK HOUSE, DINGWALL AVENUE, CROYDON CR9 2TA.** Is a Box No. required Yes/No. If no, please include remittance to cover name and address and/or tel. no.

Name Address

CLASSIFIEDS

INDEX TO ADVERTISERS

APRS	132	JBL Professional	89
Abacus Electronics	16	Jensen Transformers	136
Aces UK Ltd	111		
ACO Pacific Inc	16	Lexicon	37, 93
AKG	121, 130	Lyrec UK Ltd	129
Allen & Heath/Brenell	63		
Alphaton	133	Michael Stevens	77
Altec Lansing	97	Minim Electronics	130
AMEK Ltd	53, 109	Mitsubishi Pro Audio	44, 45
Ampex (UK)	IBC	Mosses & Mitchell Ltd	30
Ant Nachrichtentechnik GMBH	55	MS Audiotron	23
Asona	125	Multitrack Hire Ltd	77
Audio Design Calrec Ltd	18	Music Labs Group Ltd	6, 8, 9
Audio FX	131	Musik Produktiv	130
Audio Kinetics	94, 95		
Audio Precision	119	Northern Audio	14
Audio Service Co	20		
		Optimix International	126
BASF AG	101	Orban	29
Barcus Berry	137	Otari	80, 81
Beyer Dynamics	19		
Britannia Row	31, 128	Palmer Av Systems	132
Bruel & Kjaer A/S	91	Pangbourne Musical Distributor	31
		Perfectone Products SA	28, 132
Capitol Magnetics	67	Powerplay Recording Studios	128
Citronic Ltd	123	Professional Audio	115
Clifford Manor	42	Publison	117
Connectronics Ltd	133		
Court Acoustic Sales Ltd	14, 134	Qu-Play Ltd	22
		Quantec	79
DBX	41		
Dolby Laboratories Inc	17	RE Instruments Ltd	105
Don Larking Audio	103	Rane Corporation	7
Drawmer Marketing & Sales	135	Rebis Audio	27
		RTW	12
Eardley Electronics	33	Rycote Microphone Windshields	122
Ernest Turner	134		
Essex Tape Supplies	130	SCV	11
		SED	138
FM Acoustics	28	Sanken	87
Feldon Audio	133	SAJE	15
Foundation First	132	Scenic Sounds	29, 37, 41, 93, 117
Future Film Developments Ltd	134	School of Audio Engineering	138
FWO Bauch Ltd	49, OBC	Shuttlesound	135
		Solid State Logic	47
Genelec Oy	23	Sonifex Sound Equipment	126
Graff Electronic Machines Ltd	24	Sound Control	132
Greengate Productions	123, 127	Sound Technology	64, 65
		Soundcraft Electronics Ltd	IFC
H W International (Shure)	25	Soundout Labs	85
Hardware House	126	Sowter Ltd, EA	128
Harman Audio UK	125	Stage Accompany	69
Harrison	OBC	Stirling Audio Systems	38, 39, 87
Harrison Information Technolog	54	Studer	49
Hayden Laboratories Ltd	21	Studiomaster	107
HHB Hire & Sales	4, 35	Studio Spares	13
Hill Audio Ltd	43	Surrey Electronics	116
Hilton Sound	10, 57	Syco Systems Ltd	58, 59, 70, 71
		Symetrix	10
ITA	112, 113		
		Tannoy Products	16
		Tascam	99
		Trad Sales & Services	24
		Trident Audio Developments	26
		Turbosound	75
		Urei	89, 125
		Video Sonics	136

Studio Sound is available without charge to qualified readers: these are directors, managers, executives and key personnel actively engaged in sound recording in any part of the world. The Publisher reserves the right to refuse applications considered inappropriate and restrict the number of free copies sent to any one company or organisation. Non-qualifying readers can buy *Studio Sound* at an annual subscription of £18.00. All enquiries to: Subscription Department, Link House Magazines, Central House, 27 Park Street, Croydon CR0 1YD. Tel: 01-760 0054. Published by the proprietors Link House Magazines Limited, Link House, Dingwall Avenue, Croydon CR9 2TA and printed by Lawrence-Allen Ltd., Gloucester Street, Weston-super-Mare, Avon BS23 1TB.



THE LEGEND CONTINUES

When you're in the studio, tape that's good enough is not enough. Which is why for ten years Ampex has continued pushing the potential of recorded sound. Through a decade of increased fidelity and reliability, Grand Master® 456 remains an audio tape obsessed with performance. Which is why more top albums are recorded on Ampex tape than any other tape in the world. For Grand Master 456, the beat goes on.

AMPEX

Ampex Corporation, Magnetic Tape Division, 401 Broadway, Redwood City, CA 94063, 415/367-3869

Ampex Corporation • One of The Signal Companies

AND THE BEAT GOES ON

Ampex Corporation Magnetic Tape, International Division, Acre Road, Reading, England. Tel. (0734) 875200



SPECIAL PERMISSION.

To show the new Harrison Series 10 at the AES Montreux the US Defense Department has had to grant a special export licence under the heading of Exportation of High Technology Products. The Series 10 is so advanced that it came under very close scrutiny before approval was finally granted.

Series 10 is the first *totally automated* console. All levels, pans, equalisation, dynamics processing, and all signal routing functions are *dynamically automated* with subframe accuracy.

Series 10 uses *No VCA's* (voltage controlled amplifiers). All Series 10 signal processing parameters are digitally controlled analog functions using proprietary DCA (digitally controlled attenuator) technology.

Series 10 is the first *virtual*

console. It can be instantly configured to any music recording, multitrack production, teleproduction, film post-production, or venue console signal flow architecture.

Each series 10 module contains two complete totally automated signal paths and is the first to offer the new Penny and Giles motor driven fader as standard equipment.

The Harrison Series 10 sounds good and more importantly sounds musical. The use of DCA's eliminates the remaining anomalies of VCA's—but don't take our word for it—come and listen to the Harrison Series 10 at the 80th AES convention at Montreux 4-7th March 1986.

 **Harrison**
Harrison Systems, Inc.
P.O. Box 22964, Nashville, Tennessee 37211

