

studio sound

September 1980 75p

AND BROADCAST ENGINEERING



Monitor loudspeakers

MIDAS the professionals' choice

Steven St. Croix with the 26 into 8-24 MIDAS Sound Recording Console he chose for his private studio. Steven, besides creating the Marshall Time Modulator,[™] is a respected musician and producer who has helped artists such as Stevie Wonder achieve their special sounds.

Why MIDAS? Because MIDAS experience and design philosophy provide highest quality signal processing in a compact and rugged modular frame built to withstand years of use. Steven St. Croix is a professional. MIDAS is the professionals' choice.



MIDAS AUDIO SYSTEMS LTD David Solari, 54-56 Stanhope Street, Euston, London NW1 3EX Tel: 01-388 7060 01-387 7679
MIDAS CANADA Bob Snelgrove, Gerr-Electro-Acoustics, 363 Adelaide Street, Toronto, Ontario M5A 1N3 Canada, Tel: 416-868-0528

EDITOR

ANGUS ROBERTSON

ASSISTANT EDITOR

NOEL BELL

PRODUCTION ASSISTANT

ANN HORAN

CONSULTANT

HUGH FORD

SECRETARY

WENDY MARSHALL

ADVERTISEMENT MANAGER

PHIL GUY

PUBLISHER

DOUGLAS G. SHUARD

Editorial and Advertising Offices:LINK HOUSE, DINGWALL AVENUE,
CROYDON CR9 2TA, GREAT BRITAIN

Phone: 01-686 2599

International: +44 1 686 2599

Telex: 947709

Telegrams: Aviculture Croydon

© Link House Publications Ltd 1980

All rights reserved

*STUDIO SOUND is published on the second Friday of the preceding month.***SUBSCRIPTIONS***STUDIO SOUND is available on a rigidly controlled requested basis only to qualified personnel (see back page for terms of control), or for an annual cost of £11.60 to non-qualifying readers or where more than two copies are required in a studio or small organisation.*

UK Subscription cost £11.60.

UNITED STATES Surface mail subscription \$30, airmail subscription \$58.

OVERSEAS Surface mail subscription £12.50, airmail subscription £24.

Change of address*All changes of address must be notified to our Poole address in writing, preferably including an old address label or at least the seven digit number on the address label together with the old address. We are unable to accept verbal changes of address.*

All subscription and circulation enquiries to:

Subscription Dept, Link House Publications Ltd,
Robert Rogers House, New Orchard, Poole, Dorset
BH15 1LL, Great Britain.

Phone: 02013 71171.

Telex: 417109.

US mailing agents:

Expeditors of the Printed Word Ltd, 527 Madison
Avenue, Suite 1217, New York, NY 10022.SECOND-CLASS POSTAGE PAID AT NEW YORK,
NY**BACK COPIES***A limited number of back copies are available, 75p each.***BINDERS***Loose-leaf binders for annual volumes of STUDIO SOUND are available from Modern Bookbinders, Chadwick Street, Blackburn, Lancashire. Price is £3 (UK and overseas). Please quote the volume number or date when ordering.**Total average net circulation of 13,412 per issue during 1979. UK: 6,056. Overseas: 7,356.*

Printed in England

 A LINK HOUSE
PUBLICATION

studio sound

AND BROADCAST ENGINEERING

NEWS	28
STUDIO DIARY including Arco, Munich; Sierra Pacific; 3M digital, London	32
STUDIO MONITORING—Stephen Court	38
AGONY	40
SURVEY: MONITOR LOUDSPEAKERS	42
BUSINESS	52
PROSOUND '80—A PREVIEW	54
DESIGNING A PROFESSIONAL MIXING CONSOLE Part One Steve Dove	58
LETTERS	66
APRS EXHIBITION '80, A REPORT—Noel Bell	68
REVIEWS: Hugh Ford Tresham SR402 amplifier	78
Yamaha P-2200 amplifier	84

Back in the March editorial I mentioned that the most successful series of articles *Studio Sound* had ever run was 'A Studio Quality Audio Mixer' designed by David Robinson and first published in 1964. Back in those days the design principally used germanium transistors, but an updated version was published in 1970 using silicon transistors and more up-to-date circuit design. While we are uncertain of the precise number of these mixers that were actually built, based on printed circuit board sales it must have been in the region of 750 around the world. While this series was primarily constructional, in 1971 we published another series, this time called 'Designing a Studio Mixer' by Peter Levesley which was concerned only with design of a rather more upmarket mixer that the original David Robinson design dating from the early sixties. Unfortunately, the last words in the series at the end of part eight were, "In part nine I shall give suitable circuits for a peak programme meter driver and for a small power amplifier" and those were the last words supplied by the author—part nine was never written, and therefore never printed. Thus arose the 'Phantom Part Nine' which has plagued our secretaries ever since.

While the format of *Studio Sound* has changed completely in the interceding nine years and we no longer publish constructional type articles, this issue sees the publication of the first in a new series called 'Designing a Professional Mixing Console', written by Steve Dove. *Studio Sound* is definitely not reverting to publishing constructional articles, but we felt that the technological changes since these previous designs warranted the description of a totally new design of mixing console (in practice in four different configurations) to give recording engineers some idea of what actually happens inside their current consoles. While everybody can see the knobs, few mixing engineers today have a technical background and are often thus uncertain about why circuits are designed a particular way. So the purpose of the series is to give a background to mixing console design, the easiest way being to publish the arguments behind the design of the many separate circuits that make up a complete mixing console, culminating in the publication of sufficient circuits to actually build one.

While there are many companies manufacturing very competitively priced mixing consoles today, it seems quite probable that many people will still wish to build the 'Studio Sound Mixer', so in early 1981 printed circuit boards (and possibly kits and metalwork) will be made available, together with additional information about construction—which will not be printed in *Studio Sound*, but made available to potential purchasers of printed circuit boards. At that time (and not before), the articles not then printed will also be made available (at a charge) enabling budding constructors to make a start. The complete series is expected to run to about 11 or 12 parts, depending upon how many points arise during publication of the series. Meanwhile, the author of the series will be making available his prototype 30-channel multitrack music mixing console for purchase—could interested parties please drop a line to The Editor, *Studio Sound*, etc, and we will pass the letters on. At a later stage in the articles, we will also be publishing Hugh Ford's comments on the console's performances—we promise not to bribe him!

Cover of JBL monitor drive units by
Paul Burbridge and Ray Hyden.

ISSN 0144-5944

SEPTEMBER 1980 VOLUME 22 NUMBER 9

AKG

ACOUSTICS



Studio condenser microphone C414EB

The twin-diaphragm system enables the selection of four different microphone polar patterns.

Pre-attenuation before the output stage is incorporated to permit the increase of undistorted maximum

sound pressure level by 10 or 20 dB for close-up recordings.

The incorporated bass-cut circuitry will reduce the risk of distortion at low frequencies. This feature is especially useful to combat wind noise and stage floor vibrations. The slope of the bass-cut filter is more than 12 dB/octave, the cut-off frequency may be set to 75 or 150 Hz.

The all metal housing adds to the rejection of r.f. interference when the microphone is used close to

transmitter stations or in conjunction with wireless microphones or other communication equipment. A recessed switch on the front enables the user to select any one of four different polar patterns to adjust for different recording situations. Four different types of microphones are thus combined in only one C414EB. The chosen polar patterns are almost frequency independent to guarantee the same sound character for all angles of incidence.



AKG Acoustics Ltd.
191, The Vale, London W 3 7 QS
TF: 1-749 2042,
TX: 28938 akgmic g

Send this coupon for information about AKG products

- STEREOHEADPHONES
 MAGNETIC CARTRIDGES

Name _____

Street _____

Town _____

Postcode _____ SEPT.

Response Curve

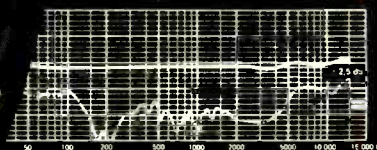

Super-cardioid

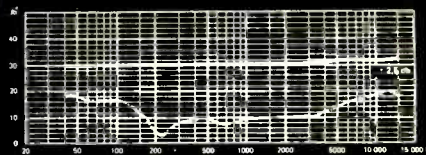
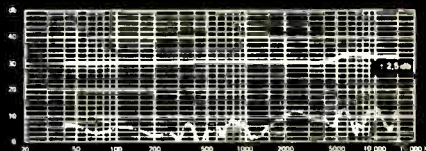
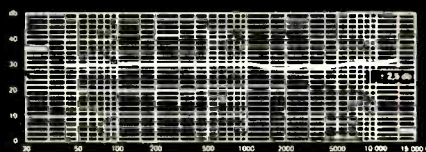

Figure-eight



Omni-directional



ADV 256/E

AEG-TELEFUNKEN

The amazing 32-track Telefunken 'magnetophon' 15A. A new dimension in studio recording technology.



Available in 8, 16, 24 and 32-track format.

AEG-TELEFUNKEN

Tape Recorder Division,
Postfach 2154,
D-7750 Konstanz, W. Germany.
Telephone: (7531) 86-2430.
Telex: 733233.



Hayden Laboratories Limited,
Hayden House, Churchfield Road,
Chalfont St. Peter,
Bucks SL9 9EW, England.

Telephone:
Gerrards Cross 88447.
Telex: 849469.

HAYDEN
Exclusive UK Agent

Gotham Audio Corporation,
741 Washington Street,
New York, NY, USA.
Telephone: (212) 741-7411.
1710 N. La Brea Avenue,
Hollywood, CA, USA.
Telephone: (213) 874-4444.

GOTHAM
AUDIO CORPORATION

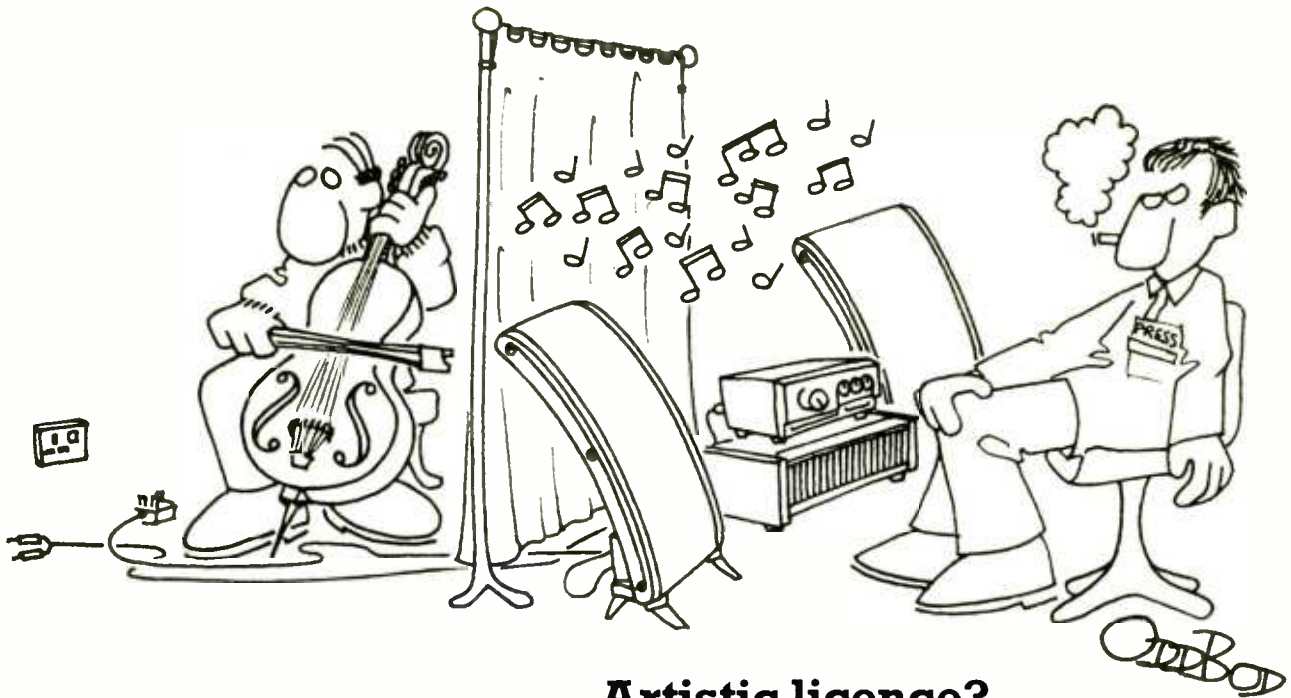

Artistic licence?

We at QUAD go to a very great deal of trouble to ensure that with a QUAD 33 in the Cancel position, the voltage delivered to your loudspeakers is a virtually exact RIAA transfer of the voltage the pickup will produce into a stated passive load. Nothing added – nothing taken away.

A visiting journalist recently suggested that we should not do this. Final adjustment should be done by ear, he said.

What an opportunity!

After all we know that if we add a little warmth with a subtle boost in the lower middle and balance this with an ever so gentle hump in the quack region (2-3kHz), we can make most programmes sound superficially more impressive. Come to that, why not change the 3180uS to 5000uS adding a little more 'heft' that most people will fall for. We could even make a special model for the boom and tizz brigade.

Been to any live concerts recently ?

For further details on the full range of QUAD products write to :
 The Acoustical Manufacturing Co. Ltd.,
 Huntingdon, Cambs. PE18 7DB
 Telephone : (0480) 52561

QUAD 

for the closest approach to the original sound
 QUAD is a Registered Trade Mark

focus on I.T.A.



panies have accounts with I.T.A. A six figure stock level ensures rapid delivery from a very wide range of products which include tape recorders (mono to 24 track), mixers, tape duplicators, signal processors and tape. Most items are on permanent display in the showroom, which is conveniently located, one minute from Marylebone Station with good parking.

In addition to supplying individual items of equipment, complete studio systems are catered for, from small 4 or 8 track demo-type applications, to the high-technology 24 track full-scale installation. 40% of turnover is exported to over 30 countries from Iceland to

India, and Norway to New Zealand. European distribution is handled through a subsidiary company based in Paris.

The list of customers includes all the top recording studios plus some rather sur-



prising names like Rolls-Royce, British Gas, National Coal Board, C.E.G.B., Ministry of Defence. On a lighter note there's The Who, Queen, The Police, Pink Floyd, to name but a few. Other areas served include Universities (UK and Overseas), Broadcasting Companies, even the Royal Courts of Justice.

For almost a decade, I.T.A. has provided the recording industry with a comprehensive facility for the supply and maintenance of a large range of equipment. Originally specialising in semi-professional products, the company now supplies everything from a 24 track recorder to a reel of tape, and the back-up facilities have expanded rapidly to cope with the demands of the largest studios.

In addition to an in-house service department, a 999 service is provided for the more sophisticated equipment which has to be maintained on site. This operates nationwide, in fact quite literally from Lands End to northern Scotland. To cope with the requirements of studios running 24 hours a day,



a massive inventory of spare parts and components (currently numbering over 250,000 individual items) is held at Harewood Avenue.

Coping with the latest advances in electronic and electro-mechanical design requires a high level of expertise. Backing up the engineering staff, many of whom have factory training behind them are the latest innovations in test equipment. An extra facility is the machine shop, which was totally re-equipped in 1979 with the most modern lathes, milling machines and drills, thus giving I.T.A. a truly total in-house capability — a unique advantage.

To maximise customer convenience, over 1,000 com-

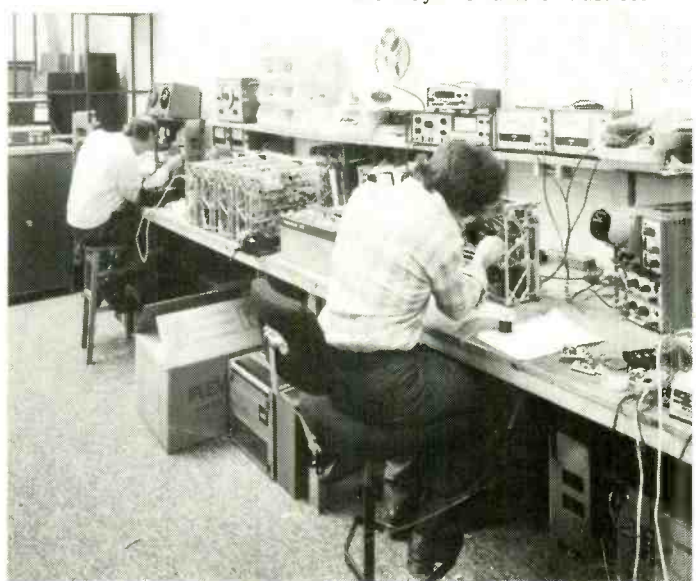
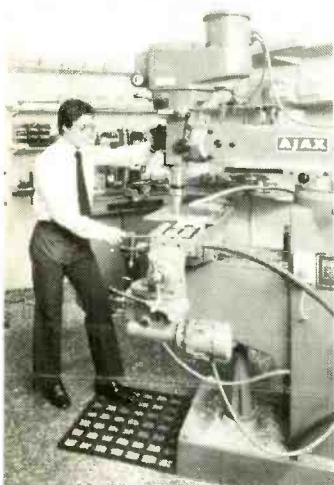

fact: this condenser microphone sets a new standard of technical excellence.

The Shure SM81 cardioid condenser is a new breed of microphone. It is a truly high-performance studio instrument exceptionally well-suited to the critical requirements of professional recording, broadcast, motion picture recording, and highest quality sound reinforcement—and, in addition, is highly reliable for field use.

Shure engineers sought—and found—ingenious new solutions to common

problems which, up to now, have restricted the use of condenser microphones. Years of operational tests were conducted in an exceptionally broad range of studio applications and under a wide variety of field conditions.

As the following specifications indicate, the new SM81 offers unprecedented performance capability—making it a new standard in high quality professional condenser microphones.



SM81 puts it all together!

- WIDE RANGE, 20 Hz to 20 kHz FLAT FREQUENCY RESPONSE.
- PRECISE CARDIOID polar pattern, uniform with frequency and symmetrical about axis, to provide maximum rejection and minimum colouration of off-axis sounds.
- EXCEPTIONALLY LOW (16 dBA) NOISE LEVEL.
- 120 dB DYNAMIC RANGE.
- ULTRA-LOW DISTORTION (right up to the clipping point!) over the entire audio spectrum for a wide range of load impedances. MAXIMUM SPL BEFORE CLIPPING: 135 dB; 145 dB with attenuator.
- WIDE RANGE SIMPLEX POWERING includes DIN 45 596 voltages of 12 and 48 Vdc.
- EXTREMELY LOW RF SUSCEPTIBILITY.
- SELECTABLE LOW FREQUENCY RESPONSE: Flat, 6 or 18 dB/octave rolloff.
- 10 dB CAPACITIVE ATTENUATOR accessible without disassembly and lockable.

Outstanding Ruggedness

Conventional condenser microphones have gained the reputation of being high quality, but often at the expense of mechanical and environmental ruggedness. This no longer need be the case. The SM81 transducer and electronics housing is of heavy-wall steel construction, and all internal components are rigidly supported. (Production line SM81's must be capable of withstanding at least six random drops from six feet onto a hardwood floor without significant performance degradation or structural damage.) It is reliable over a temperature range of -20°F to 165°F at relative humidities of 0 to 95%!

Send for a complete brochure on this remarkable new condenser microphone!

SM81 Cardioid Condenser Microphone



Shure Electronics Limited, Eccleston Road, Maidstone ME15 6AU—Telephone: Maidstone (0622) 59881

Penny-pinching Packages from ITA

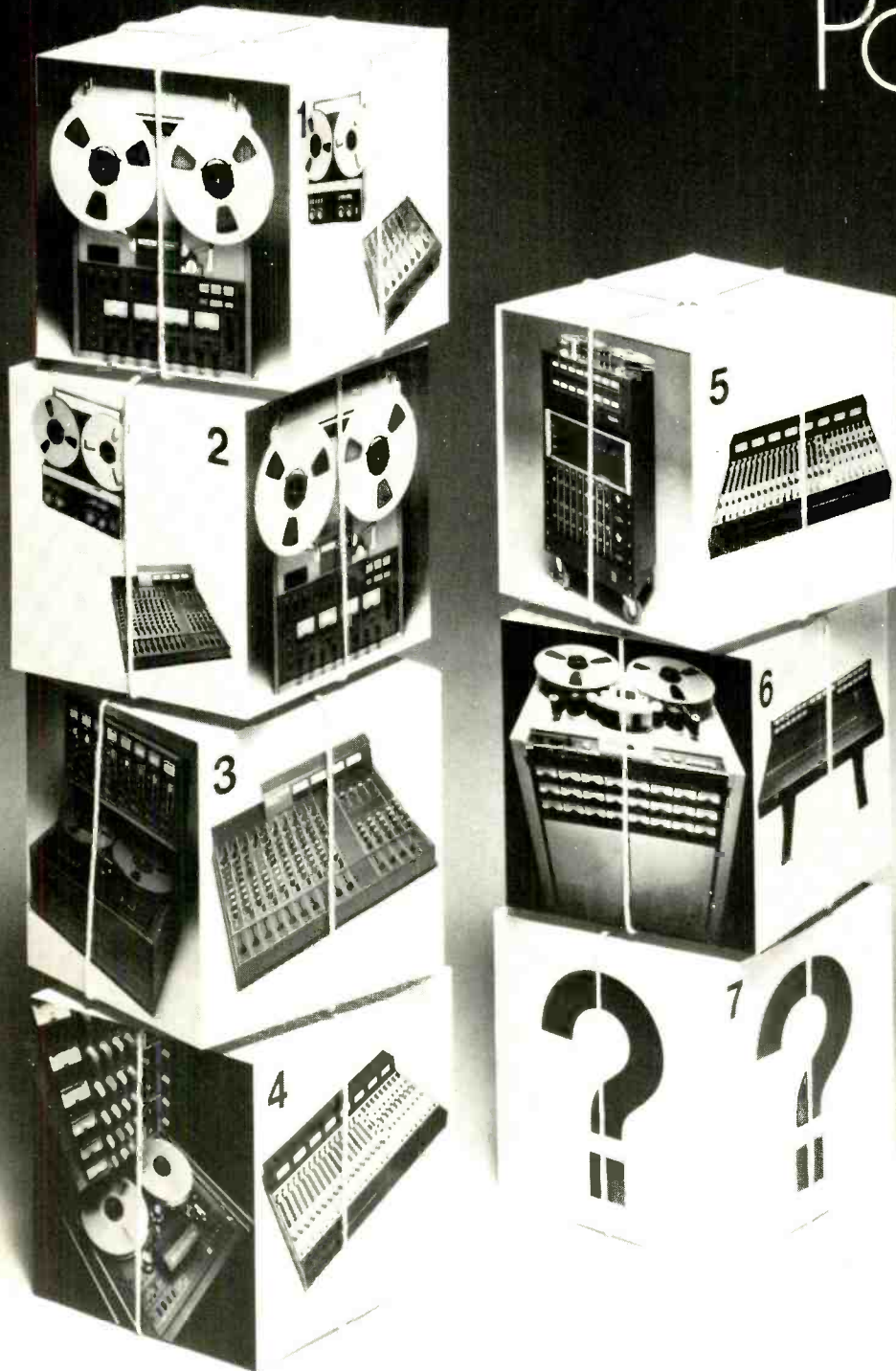

Prices exclusive of VAT

Full range of ancillary equipment available. Finance facility. Full after sales service back up.

ITA, 1-7 Harewood Ave., Marylebone Road, London NW1. Tel: 01-724 2497. Telex: 21879.

	List	Package
1. 4 track package. Teac A3440, Revox HS77, Model 2A Mixer	£1668	£1350
2. 4 track package. Teac A3440, Revox HS77, Itam 10-4 Mixer	£2535	£2090
3. 8 track 1/2 inch package. Itam 806, 10-4 Mixer, Revox HS77	£3917	£3220
4. 8 track 1 inch package. Otari MX7800, Allen & Heath 16x8 Mixer	£7185	£6395
5. 16 track 1 inch package. Itam 1610, Allen & Heath 16x8, Revox HS77	£9045	£8185
6. 16 track 2 inch packages		from £13800
24 track 2 inch packages		from £23000
7. Any other package tailored to your requirements	?	?

AC-ES multitrack mixing consoles

12-4-2 £578
 16-4-2 £825
 16-8-2 £1073
 24-8-2 £1320
 24-16-2 £3000

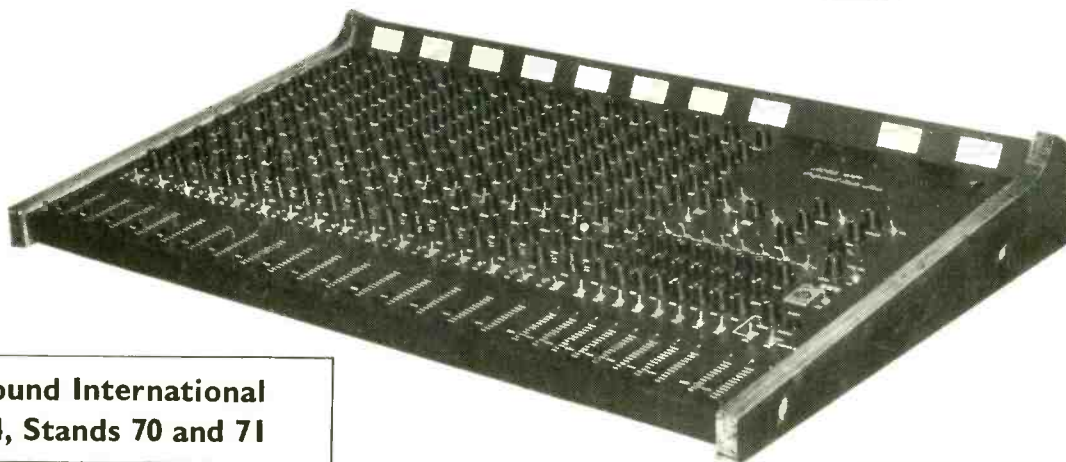

Model SM 16-8-2

See us at Prosound International
 September 2-4, Stands 70 and 71

also
 Power Amplifiers, Graphic Equalisers, Electronic Crossovers, Instrument Amplifiers

A. C. ELECTRONIC SERVICES

BROADOAK, ALBRIGHTON, near SHREWSBURY, SALOP

Tel. (0939) 290 574

BUZZ MUSIC

BUZZ MUSIC PROFESSIONAL SALES

Buzz Music Professional Sales division exists to service the needs of professional recording studios, hire companies, broadcast and production studios, management companies, and the professional in the music industry in general.

POWER AMPLIFIERS

Amcron

D75: £260.00
 D150A £390.00

DC300A £595.00
 PSA-2 £895.00

SOUND ENCLOSURES

12 unit flightcase rack £108.00

BSS—Europe's leading electronic crossover system

Modular Format

3-way with limiters Mid/High £595.00
 3-way/limiters and Led ladders ... £760.00
 4-way plus limiters £726.00
 4-way plus limiting plus Led ladders £946.00

BSS Stage/Studio Active D.I. Box £59.00
 Phantom powering module ... £15.00
 BSS Leads Tester £20.00

TANNOY

Super Red Professional Monitors (per pair)

10in. £400.00
 12in. £500.00
 12in. £620.00

15in. £1200.00
 K3808 chassis (each) £300.00

Full details and professional price list available on request. All items available ex-stock
 Prices exclude VAT but include postage and packing.

NEW—AVAILABLE FREE ON REQUEST—Multitrack Studio Catalogue No. 2

65 Widemarsh Street, Hereford. Tel. (0432) 52016/51831





OTARI

Where quality stands alone

Otari MX5050-8 8-track 1/2 inch recorder.
£2490 + VAT.

Industrial Tape Applications Ltd., 1-7 Harewood Avenue,
Marylebone Road, London NW1. Tel: 01-724 2497. Telex: 21879.

18000Hz, 0.9mv Pa \approx 60dbm, 153dbm, 200 ohms, > 10000 ohms

These are the specifications that make the Beyer Dynamic M260 NS ribbon microphone the best in its field.

A specially shaped short ribbon, 0.002 mm thick, weighing only 0.000438 grammes guarantees that the M260 NS gives absolute fidelity of reproduction.

Complete absence of non-linear distortion lends startling clarity and transparency to the whole sound spectrum.

But for professionals, the most attractive feature of the M260 NS must be its excellent anti feedback characteristics over the whole frequency range.

Small wonder it is the world's most popular microphone for vocal and instrumental recordings and public address work.

The M260 NS is only one of the range of ribbon microphones made by Beyer Dynamic.

And each one is manufactured to the same high standards, incorporating all that is best in microphone technology.

The figures speak for themselves. And as a professional you can't afford to settle for less.

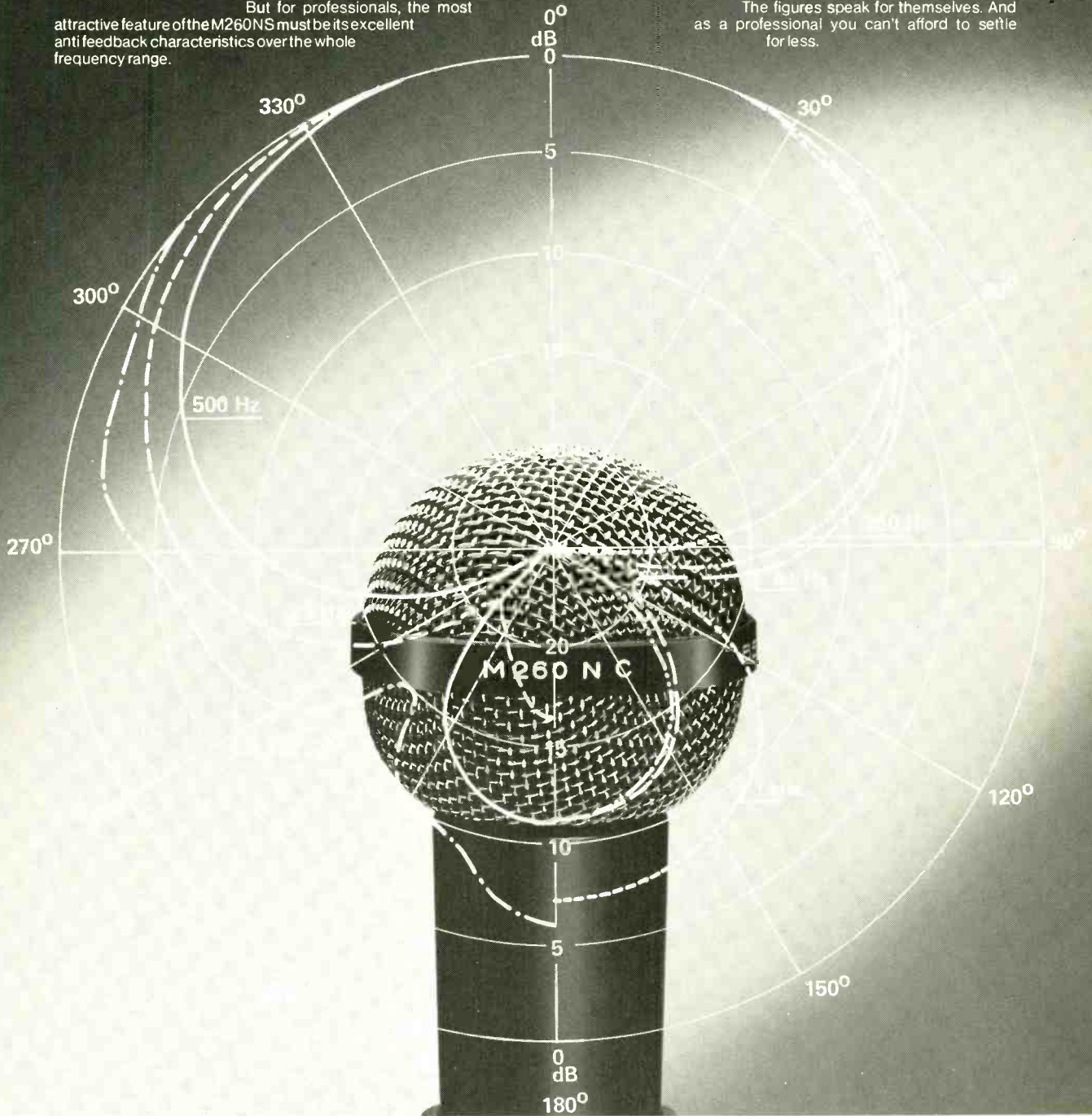

For a complete catalogue of Beyer products send to the address below

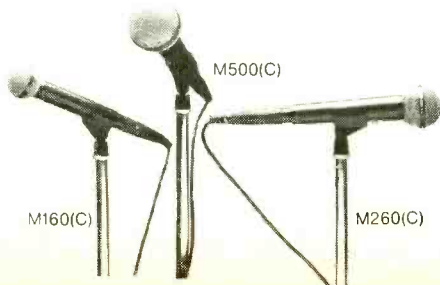

Beyer
Dynamic

Beyer Dynamic (GB) Ltd, 1 Clair Rd., Haywards Heath, Sussex RH16 3DP Tel: (0444) 51003

The No.1 Plate

Echo Plates are established as the most natural form of reverberation available. Their high resonant density and smooth exponential decay produce very high quality reverberation characteristics free from flutter, echoes and metallic 'twang and boing'. The RX4000 owes much of its natural sound to recent developments in accelerometer and true charge amplifier designs. Its plate material is a specially formulated Swedish steel for absolute consistency. When compared to its nearest rival the main difference is over £2000.

Price £1290 + VAT.



Industrial Tape Applications,
1-7 Harewood Avenue, Marylebone Road, London NW1.
Tel: 01-724 2497. Telex: 21879.

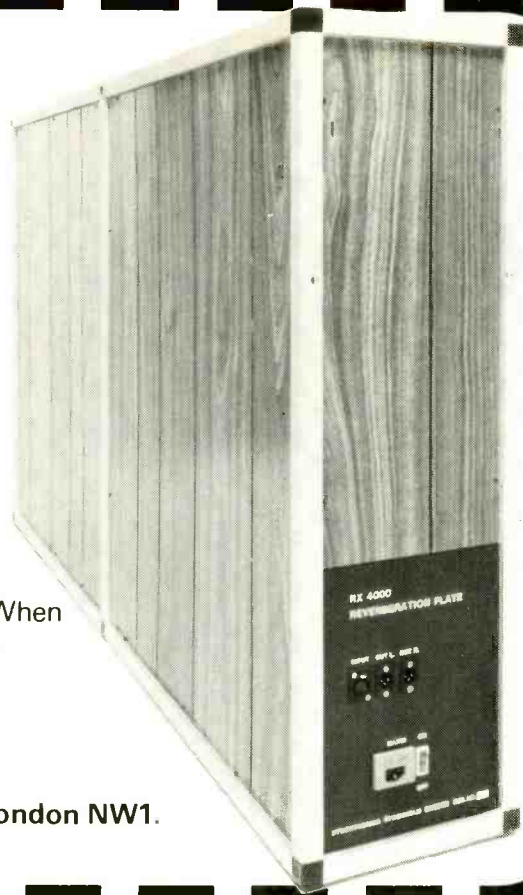

Now-highest quality copying at low cost OTARI DP4050 C2 cassette duplicator

The first low cost copier to give you reliability and performance to professional standards. No other copier can match its precision engineering, and it is the only budget copier suitable for music programmes.

- * One master, 2 slaves.
 - * Add on units available up to 11 slaves.
 - * Automatic rewind.
 - * Ferrite heads.
 - * 16:1 duplicating ratio.
 - * Modular slave decks with DC servo motors.
- Also available: Reel to cassette version with 6 slaves.



OTARI from ITA

1-7 Harewood Avenue, Marylebone Road, London NW1. Tel: 01-724 2497. Telex: 21879.

HARBETH ACOUSTICS

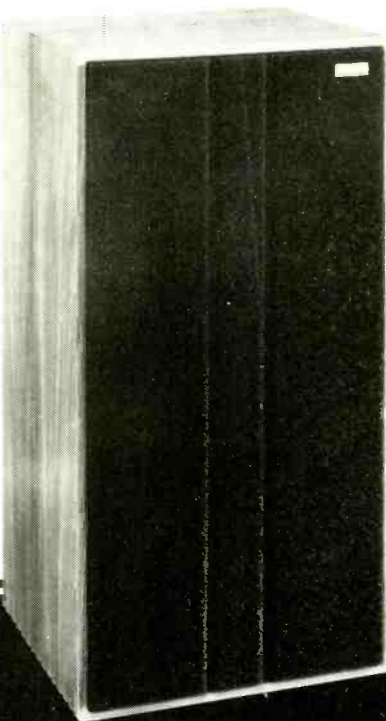

TYPE HL PROFESSIONAL MONITOR LOUDSPEAKER

with the revolutionary new patented* polypropylene copolymer bass/mid frequency cone giving a clearer less coloured sound particularly in that most sensitive middle frequency region than any other known material.

Dimensions: 63.5cm (25ins) high x 32.5cm (13ins) wide x 30cm (12ins) deep.

Axial Frequency Response: 50Hz to 25kHz \pm 3dB.

Power Handling: 100 watts programme.

Sensitivity: 87dB per watt at 1 metre.

Nominal Impedance: 8 ohms.

Units: 20cm (8ins) diameter, L.F. unit of specially vacuum-formed polypropylene copolymer and 2.5cm (1in) dome HF unit of soft impregnated fabric.

Crossover Network: Close tolerance laminated iron inductors and solid dielectric capacitors. Adjustment of relative levels of L.F. and H.F. units to \pm 1/2dB by means of tapped auto transformer.

Cabinet: Vented cabinet of heavily damped panels to satisfy BBC criterion. Vent resonance 45Hz.

Price per pair—£298—* VAT (Teak) £299 (Walnut).

Enquiries invited from the trade.

* Patents applied for in all principal countries.

HARBETH ACOUSTICS

2A NOVA ROAD
CROYDON, SURREY CRO 2TL
Tel: 01-681 7676

SEND FOR FURTHER DETAILS
NAME _____
ADDRESS _____
95580

CANFORD AUDIO

STARGATE WORKS, RYTON
TYNE and WEAR, NE40 3EX
Tel: RYTON (089422) 4515



Just two of the two thousand sound effects on our completely new high quality library. Available stereo or mono, NAB or CCIR, on 1/4 in. tape. Ring now for a demo tape.

Our other products include: Studio Acoustic Tables* Acoustic Script Lecterns* Custom studio Joinery* Automatic Cable Tester* Battery mic preamp* Microphone splitters* Neutric and Deltron XLR's* 'Musiflex' conductive plastic screen-phone splitters* Cable ed coloured mic cable* Cable drums* Cable ident custom printed sleeving* AA3 cartridges* PA loudspeakers* Full info and prices on request.

POWER AMPLIFICATION BY MUSTANG



Our SS.100 and SS.50 are economical amplifiers with outputs of up to 175 and 100 Watts RMS into 4-16 ohms, typical THD figures being 0.1%, slewing rate $> 10\text{V}/\mu\text{s}$, noise $> 90\text{dB}$ down, zero level input, and full electronic protection. Considering these points with their proven reliability and robust construction, plug-in output transistors and driver board, optional balanced input and 100V line output, and virtually ex stock despatches we reckon we take some beating! Contact us now for the full technical specifications.

Manufacturers of mixers, integrated mixer amplifiers and slave amplifiers, studio power amplifiers, transformers, lighting control equipment and cabinets for the home and export markets. Contact us for full illustrated technical brochures.

MUSTANG COMMUNICATIONS

Eastfield Industrial Estate,
Cayton Low Road, Scarborough,
North Yorkshire YO11 3UT
Telephone (0723) 582555





Studio or live- the effect's the same.

Lexicon Prime Time offers professional quality delay with special effects.

A completely self-contained unit, its features include:

- Two independently adjustable delay outputs.
- Up to 2-second delay for special effects.
- Flanging, doppler pitch shift, vibrato.

- Repeat hold functions.
- Remote control for all dynamic functions.
- Complete independent mixing for delay and reverb processing.

The Lexicon 93 Prime Time Digital Delay Processor provides unparalleled quality both live and in the studio.

It combines simplicity of use with versatility and flexibility, allowing creative innovation.

For more information on Lexicon Prime Time contact F.W.O. Bauch Limited.



lexicon

Lexicon, Inc., 60 Turner Street, Waltham, MA 02154 (617) 891-6790

F.W.O. Bauch Limited

49 Theobald Street, Boreham Wood, Hertfordshire WD6 4RZ
Telephone 01-953 0091, Telex 27502

www.americanradiohistory.com

MOSSES & MITCHELL LTD

Approved suppliers to B.B.C.,
Post Office, Pye T.V.T.,
Pye Telecommunications,
and other major users.

Mosses & Mitchell, who for
several years have supplied many
of Britain's largest users with
standard audio jacks and
jackfields, can now offer
MINIATURE-type JACKS and
JACKFIELDS.

**These miniature jacks can now
be supplied with wire wrap
terminals, an alternative to the
traditional solder terminals.**

Special arrangements of Jackfields
differing from our standard
modules can be manufactured in
our well-equipped factory.

Audio jackfields

Audio jacks

Patchcords

Plugs

Please write or call for details

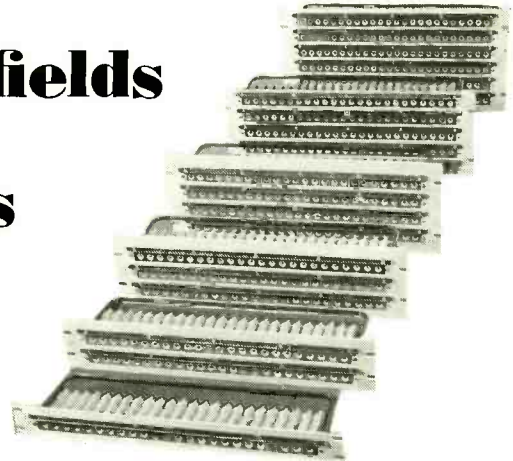

MOSSES & MITCHELL LTD

Weydon Lane, Farnham,
Surrey GU9 8QL

Tel. Farnham 721236 (STD 0252)
Telex: 858820

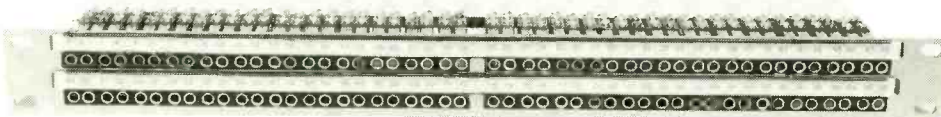

A member of Plasmec

AUDIO CONSOLES OF DISTINCTION

The M series — like the current M10/2
shown here — was first introduced eight
years ago. Through well earned recom-
mendations it has sold steadily since —
a tribute to its inherent reliability and
performance!

Supplied to Christian Broadcast organi-
sations worldwide, hospital radio, film
and T.V. production studios, B.B.C.,
theatres etc.

For example we have just supplied 10/2
and 24/8 mixers for the new sound
system at St. Pauls Cathedral.

M10/2 and M16/2
from £740 + VAT



CHILTON MAGNETIC TAPES LTD.

Chilton Works, Garden Road,
Richmond, Surrey, U.K.
Tel: 01-876-7957



THE ITC PD-II SERIES OFFERS YOU A LONG, ECONOMICAL AND RELIABLE LIFE.

Some cartridge machines are cheap. And in every sense of the word. But the ITC PD-II Series is cheap in only the value-for-money sense. No other mono machine on the market can offer so much for so little. Rugged reliability from a deck milled from 1/2"-thick aluminium and solidly-built solid-state electronic components.

Super-quiet operation, thanks to ITC's famous and much-copied, air-damped solenoid.

And simplicity of operation because the PD-II Series operates completely automatically from the insertion of the cartridge and the press of the start switch.

These are just a few of the features that make the PD-II Series the workhorse

that performs like a thoroughbred.

Find out more about the cartridge machine that gives you more quality for less from F.W.O. Bauch Limited.

International Tapetronics Corporation
Bloomington, Illinois 61701, USA.



F.W.O. Bauch Limited

49 Theobald Street, Boreham Wood, Hertfordshire WD6 4RZ
Telephone 01-953 0091, Telex 27502

THINKING OF MICROPHONES: WHAT GOES IN SHOULD COME OUT. THAT MAKES SENSE!

You may have heard in Montreux or at some of the other top line concerts what Boney M., Rod Stewart, Bob Seger, Yes or Journey sound like with ELECTRO-VOICE? Like Boney M., Rod Stewart, Bob Seger, Yes or Journey of course. ELECTRO-VOICE microphones reproduce precisely what each singer puts into his voice or each musician into his instrument. No wonder, therefore, that our microphones are so highly acclaimed.

All that sounds good, but better still put it to a test at your music dealer. Or ask for further information from Gulton Europe Ltd., Electro-Voice Division, Maple Works, Old Shoreham Road, HOVE BN3 7EY.



Telephone: Brighton (0273) 23329
Telex: 87680 Gulton G



Penny Dropped?

Switchcraft QG Connectors are money savers

Because we have introduced an attractive new quantity discount structure. Switchcraft are still the same high quality, with unique features such as captive design screws and shell ground terminals.

Two new additions to the range are —

FAS-DISCONNECT

A new non-locking feature allowing immediate disconnection that requires only a 4 lb (1.8 kg) force. Great for that fast equipment take-down in hard to reach, darkened areas. Stage hands never had it so good!

REAR MOUNTED RECEPTACLES

The new Y series QG receptacles permit a complete sub assembly to be soldered, cleaned and tested prior to chassis mounting.

Available with PC or solder terminals with lock or Fas-disconnect latching, the Y series offers real savings in production costs. Extra colour trim escutcheons provide functional panel trimming and colour coding.

Switchcraft QG Connectors are just right for audio mixers consoles, PA systems and in computer applications.

The professionals choose Switchcraft QG and save the pennies!



F.W.O. Bauch Limited

49 Theobald Street, Boreham Wood, Hertfordshire WD6 4RZ
Telephone 01-953 0091, Telex 27502

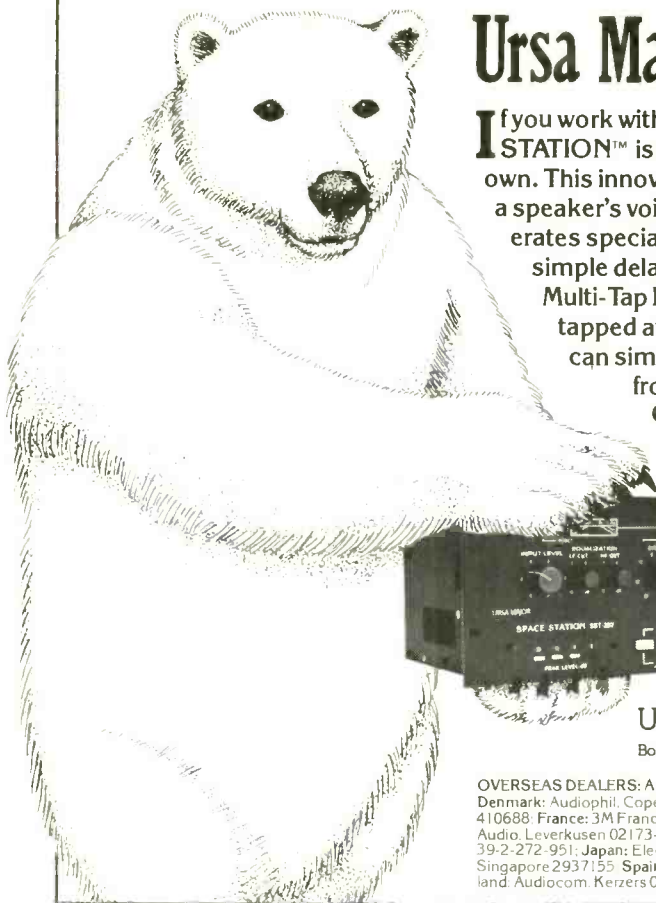

Ursa Major Is a Sound Improvement

If you work with close-miked sound sources, the Ursa Major SPACE STATION™ is one of the most creative sound processing tools you can own. This innovative new digital reverb system adds warmth and body to a speaker's voice, enhances both live and recorded music, and generates special effects that range from the subtle to the exotic. Unlike simple delay units, the SPACE STATION incorporates a proprietary Multi-Tap Digital Delay algorithm in which a digital RAM can be tapped at more than 20 locations at once. With this feature, you can simulate an almost endless variety of reverberant spaces, from tiny rooms to parking garages and concert halls. Check out the SPACE STATION soon. For reverberation quality and variety, for special effects features, and for price, the SPACE STATION is the best sound improvement you can make.

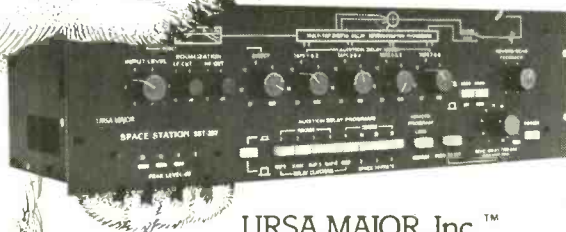

Demonstration cassettes for broadcast and recording applications are available for \$2.00 each.

URSA MAJOR, Inc.™

Box 18, Belmont, MA 02178 • Telephone (617) 489-0303 Telex: 921405 URSAMAJOR BELM

OVERSEAS DEALERS: Australia: Marion Enterprises, S. Melbourne 61-3801; Belgium: Naybies, Brussels 02-734 31 38; Denmark: Audiophil, Copenhagen 01-34 1622; England: Feldon Audio, London 01-580 4314; Finland: Audiotron, Helsinki 410688; France: 3M France, Cergy-Pontoise (1) 031 61 61; Germany: R. Barth, Hamburg (040) 2 29 88 83; Thum & Mahr Audio, Leverkusen 02173-41600; Holland: Pieter Bollen, Eindhoven 040-424455; Italy: AudioProd's International, Milan 39-2-272-951; Japan: Electri Co., Tokyo (03) 950-6266; Norway: Pro-Technic, Oslo (02) 46 05 54; Singapore: Auv Private, Singapore 2937155; Spain: Mike Llewellyn-Jones, Madrid 637 07 52; Sweden: Elfa Radio & TV, Solna 08-7300700; Switzerland: Audiocom, Kerzers 031 95 57 42; Taiwan: Linfair Eng. & Trading, Taipei 32144 54-7

British Engineers demand the world's best. We supply it.



Ursa Major SPACE STATION SST-282

URSA MAJOR'S NEW SPACE STATION is a true breakthrough in audio technology. A complete processing centre providing comprehensive REVERBERATION, MULTI TAP DELAY, REPEAT ECHO, plus a multitude of other effects.

The SPACE STATION uses the latest digital memory circuitry and is offered at a fraction of the price of many single function devices available at present. For further details contact:



UK Distributors

Feldon Audio Ltd.,

126 Great Portland Street, London W1 Tel: 01-580 4314 Telex: London 28668

bel

ELECTRONICS NOISE REDUCTION

- 30 DB Noise Reduction
- Pre/De Emphasis
- 3 Connector Options
- Modular Construction
- (Signal & Level Sense)
- 19 Rack Mounting
- No Line Up
- Spare Channel Supplied

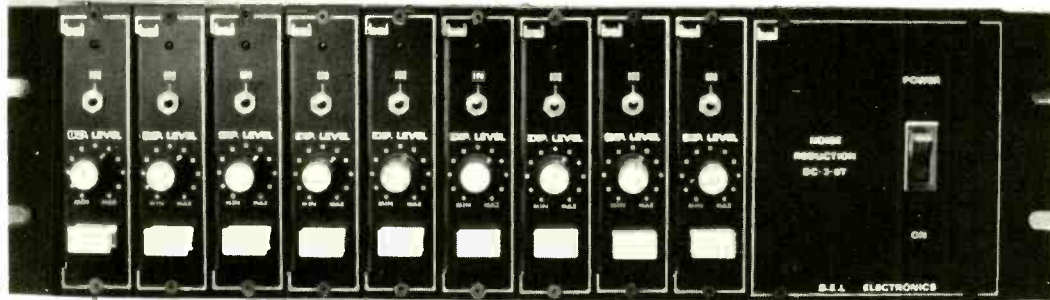

The latest in the range of B.E.L. Professional Audio Processing Equipment. The B.E.L. Noise Reduction unit gives over 30 DB of noise reduction and is capable of decoding DBX encoded tapes. The 8 channel unit is modular with an extra slot in spare module. All B.E.L. noise reduction units are simultaneous encode/decode enabling the user to monitor a decoded signal off the tape machine while it is being recorded, Immediate A/B comparisons. There is no need to line up the B.E.L. noise reduction unit to the tape recorder as the signal is processed at all levels.

There is a gain control to adjust replay signal level, once set the unit requires no further adjustment. Using B.E.L. electronics. 2 to 1 compression and expansion circuitry with pre and de emphasis. Enables the user to record low level signals without the worry of tape noise. Allows extensive track bouncing often required with 8 track recording. The B.E.L. electronics 8 track unit is available with XLR type sockets ¼" Jacks or Multipin Connector (plug supplied) from £500 + V.A.T. 19" Rack Mounting Stereo Unit at £130.00.

B.E.L. BF20 STEREO FLANGER £450

The B.E.L. BF20 Stereo Flanger is a true stereo unit with separate circuits. Which enables flanging of a stereo mix without upsetting the stereo image. There is a Mono Switch which feeds the signal of either input into both circuits, used in conjunction with the Reverse Sweep Switch an unusual image shift can be obtained giving a stereo effect from a mono instrument. There are three operating modes, Manual, Envelope and Continuously Variable Oscillator with Depth and Speed Control.

In the Envelope Mode there is a Threshold Control. Once the signal level exceeds that set by the Threshold the unit will start to sweep. The rate of recovery is set by the Decay Control. In this mode Channel 2 can be used as a Mono Flanger and keyed by a signal from an external signal source. There is also a Feedback Control for increased depth and additional pitch changing effects.

When used in the Stereo Mode the unit sweeps across its



- 3 Operative Modes
- Stereo/Mono
- Keying Facility
- Image Shift
- Random Auto Panning

left and right inputs, producing a wide variety of unusual stereo effects, not just flanging, but also completely random Auto Panning created by the HAAS effect.

B.E.L. BF20 MONO FLANGER £275 ^{New!}

Now available in Mono Form the B.F.L. BF20 Flanger is available at reduced cost to a larger market and is a must for the smaller studio, P.A. Hire Company and Musician for use on stage (fed through a pre amp).

The B.E.L. BF20 has all the features of its stereo sister apart from the Keying Facility but with the addition of C outputs (normal and reverse) and a VC input, two units can be linked to give the same see-saw panning effect as the stereo version. Both versions are 19" Rack Mounting available unbalanced (standard) or balanced (option).

- VC In/Out
- Envelope
- Negative & Positive Flanging
- Manual Switch
- Feedback Enhance

WORLD WIDE DISTRIBUTORS

50 Cheapside, Luton, Beds.

Don Larking
Audio Sales

Tel: Luton (0582) 26693 or 27195 daytime

Amphill (0525) 403528 evenings

Telex: 825488 DONLAR

BEL Foreign Agents

ITALY
Professional Equipment,
20135 MILANO,
Via Anfossi, 6,
ITALY
President: Ermanno Parazinni
Tel: 02 8353514/ 02 581650

HOLLAND
Pieter Bollen Geluidstechniek BV,
Hondsruglaan 83a,
5628, DB EINDHOVEN,
HOLLAND
Prop: Pieter Bollen
Tel: 040 424455 Telex: 59281
SWEDEN

Stage & Studio AB, S: T Olofsgatan 35, S-41 728 GOTHENBURG, SWEDEN
Dir: Ake Eldsater, Bo Hansen Tel: 031 224090 Home: 030 350348

W. GERMANY

Peter Struven GMBH,
Bargweg 45b,
2000 Norderstedt,
HAMBURG,
W. GERMANY
Prop: Peter Struven
Tel: 040 524 5151 Trade Mark: 'STRAMP'

DENMARK

Audiopower,
Smaaland 1,
2300 COPENHAGEN S,
DENMARK
Prop: Ole Mosbaek
Tel: 1 571223

OVERSEAS ENQUIRIES WELCOMED

Alice's BABY

The 828, a high-performance portable mixer from one of the U.K.'s leading manufacturers of Broadcast Audio Equipment.

- Transformer-balanced mic. inputs via XLR-type connectors
- Separate line inputs
- Direct channel outputs post-fader
- 3-Band EQ with parametric mid.
- Echo, Foldback, Pan and P.F.L.
- Limiters with Threshold and Cut
- Stereo Monitoring Output
- Illuminated V.U. Meters
- Optional PPM's to order
- Internal mains power supply
- Phantom power available
- 12-channel version to order

AGENTS

Australia

Rank Electronics Pty. Ltd., P.O. Box 632,
Chatswood, N.S.W. 2067
Tel. 406 5666 Telex. AA 24407
Contact: Bill Dougall.

Holland

Audio-Electronics Johan Mattijsen,
Rijksstraatweg 125a, 1115 AN Duivendrecht
Tel. 020 - 990480 Contact: Johan Mattijsen.

Greece

Audiolab Hellas, 8 Enianos Street, Athens 104,
Tel. 8225 222, 8226 860 Telex. (21) 5800
Contact: Christos Liliis.

New Zealand

Magnetic Products Ltd., P.O. Box 47 - 124,
Auckland 2,
Tel. 760 607 Contact: Greg Watson.

Singapore

Turnkey Services Co., Unit 516, 5th Floor,
Cuppage Centre, Cuppage Road, Singapore 0922.
Tel. 7345736 Telex. HERR RS 25959
Contact: Roland Tan.



Alice (STANCOIL LTD)

ALEXANDRA ROAD, WINDSOR, ENGLAND. Telephone WINDSOR 51056/7 Telex: AEGIS G 849323

REAL-TIME SPECTRUM ANALYZER

£340

You can now buy, for about one-sixth the price of current products, a third-octave spectrum analyzer with more features and capabilities than were previously available at any price. What's the catch? If you don't already own a Commodore PET computer, a Radio Shack TRS-80 or Apple, you'll have to get one. This will raise the price to somewhat under one-half the price of competing products, but of course you'll also have a COMPUTER!

The THS 224 REAL-TIME FREQUENCY ANALYZER comprises a single circuit board which installs inside the PET. This board contains a set of 31 analog third-octave filters (20 Hz to 20 kHz), detectors, an analog-to-digital converter, a 1K Read Only Memory containing machine language routines which allows the PET processor to interface with the Analyzer, and the peripheral circuitry necessary to transfer analog data into the PET memory. The simplest BASIC program required to turn the PET into an analyzer is only three statements long! Much longer programs can be written to allow complete user interaction with the analyzer, including many new forms of statistical signal processing, curve weighting, voice recognition etc.

• COUNTLESS EDUCATIONAL APPLICATIONS



EXPANSION MEMORY

with space for eeprom

Price
break-
through

24k
£280



32k
£325

All items can
be seen and
demonstrated at
our London showroom.
Orders accepted by
mail, phone or in person.

PETS 8k inc. cassette
from **£380**

PET IS A TRADEMARK OF
COMMODORE BUSINESS SYSTEMS

Prices exclude VAT. Send or phone
for further details and brochure

Access, Barclaycard,  
and Trustcard accepted.



UK Distributors

Feldon Audio Ltd.,

126 Great Portland Street, London W1 Tel: 01 580 4314 Telex: London 28668

Custom built studio? Call the professionals.



BRENELL MINI 8

A truly professional machine within the reach of anyone seriously considering 8 track. I.C. logic transport control, sync facilities, silent drop in/drop out record functions, and everything that makes this 1 inch machine probably the best value for money on the market.



REVOX B77

The ideal mastering machine for the small studio giving really excellent results at a reasonable price. And for those who want to go even better we also stock the Revox A700.



TEAC A3440

The new four channel machine replacing the famous A3340S. Now with even more facilities: — I.C. logic control, built-in pitch control, improved function select layout with auto sync for silent drop ins/drop outs, and a new monitor select system for easy monitoring in any mode direct from the tape machine.



TEAC 80-8

The 1/2 inch 8 track for the budget conscious studio. Giving high quality at a very reasonable price. The 80-8 has all the facilities normally associated with a machine of this calibre. And with the optional DBX unit gives excellent results.

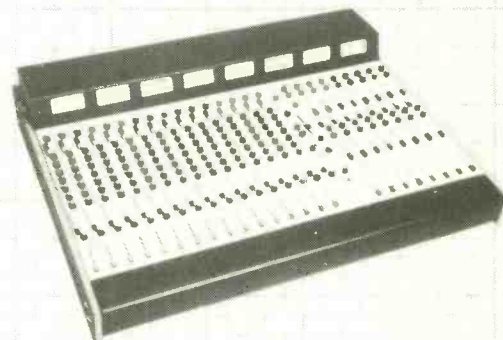

A&H MODEL III

The high quality modular mixer for the quality 4, 8 or 16 track studio. Available in virtually any configuration up to a maximum frame size of 24/8. This mixer is available together with the Brenell Mini 8 at a special package price.

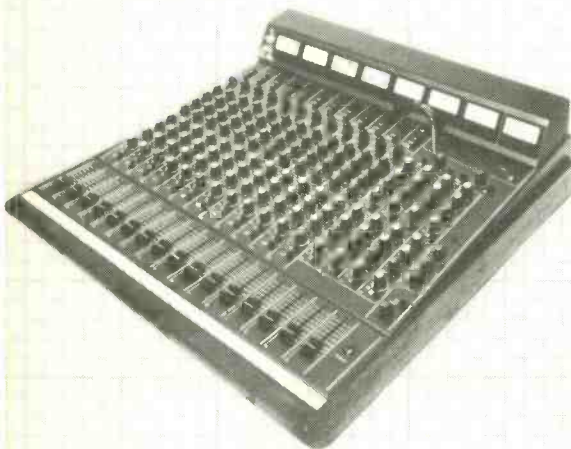

ALICE 12-48

The quality mixer for the 4 or 8 track studio. 12 inputs (16 input version also available) 4 outputs but wired for 8 track recording and monitoring. The standard model includes line up oscillator, talk-back and 48V phantom powering. Long throw conductive plastic faders available to special order. All in all a high quality mixer with all the facilities needed at a very reasonable price.



JBL MONITORS

We can supply the full range of JBL Monitor speakers from the small 4301 broadcast monitor; the 4311, popular with the smaller studio, through to the 4343 for more critical monitoring purposes.

REW

**REW Professional Audio 114/116 Charing Cross Road
London WC2. Tel:01-836 2372/7851**

REW

Introduce the first 15in x 18in. Studio

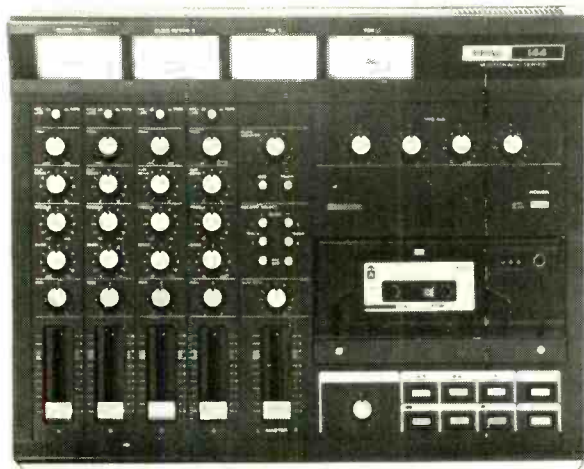

Now you can have the essential functions and flexibility of multitrack recording in one compact, self contained unit. It's called the Model 144 Porta-Studio and it lets you record basic tracks, overdub in sync and remix to stereo. On standard cassette tape.

TEAC engineers created a totally unique format for Porta-Studio. Four tracks in sync on cassette tape at 3 3/4 ips. It's fast, simple, reliable and economical. Rehearse on it. Learn on it. Create on it. Just plug in a microphone or instrument and go to work on it.

Porta-Studio's versatile 4X2 mixer section gives you mic/line/tape switching, trim control, high and low EQ, fader, pan and Aux Send for each input. The failsafe group switching matrix lets you record on up to two tracks at the same time. And there's a master fader that gives you overall level control during recording and mixdown.

The full-logic cue system in Porta-Studio lets you hear everything you're

doing all the time. Input and tape cueing, monitoring for recording or mixdown are all available. And every signal can be metered. Coming or going.

Porta-Studio's drive system is built specifically for the rugged needs of multitrack recording. Transport controls are all solenoid-operated for faster, easier switching. And you get a built-in variable speed control that lets you add special effects, fix a flat note or solve timing and cueing problems.

You can work with Porta-Studio using nothing more than headphones. Or send the output through your home audio system. You'll also find the patch points and controls that let you use Porta-Studio with equipment like echo or delay units, equalizers and additional mixers.

Come in to REW for a demonstration of the very affordable Porta-Studio. Nothing else in the world puts so much multitrack function into a small package.

REW Professional Audio 114/116 Charing Cross Road,
London WC2. Tel: 01-836 2372/7851

FUTURE FILM DEVELOPMENTS

36/38 Lexington Street, London W1R 3HR, England.
Telephone: 01-437 1892. Telex: 21624 ALOFFD G.
Cables: Allotrope-London W1.

STOCKISTS OF:

Studio Microphones • Monitoring Loudspeakers •
Intercoms & Headsets • Noise-Reduction Units •
Audio Jackfields, Patchcords, Cables & Connectors •
Splitter Boxes • Multi-Pair Cables • Video Jackfields,
Cables & Connectors • Cable Drums & Winders •
Wiring Aids • Racks & Cabinets • Switches, Faders &
Attenuators • Microphone Stands & Accessories •
Level Meters •

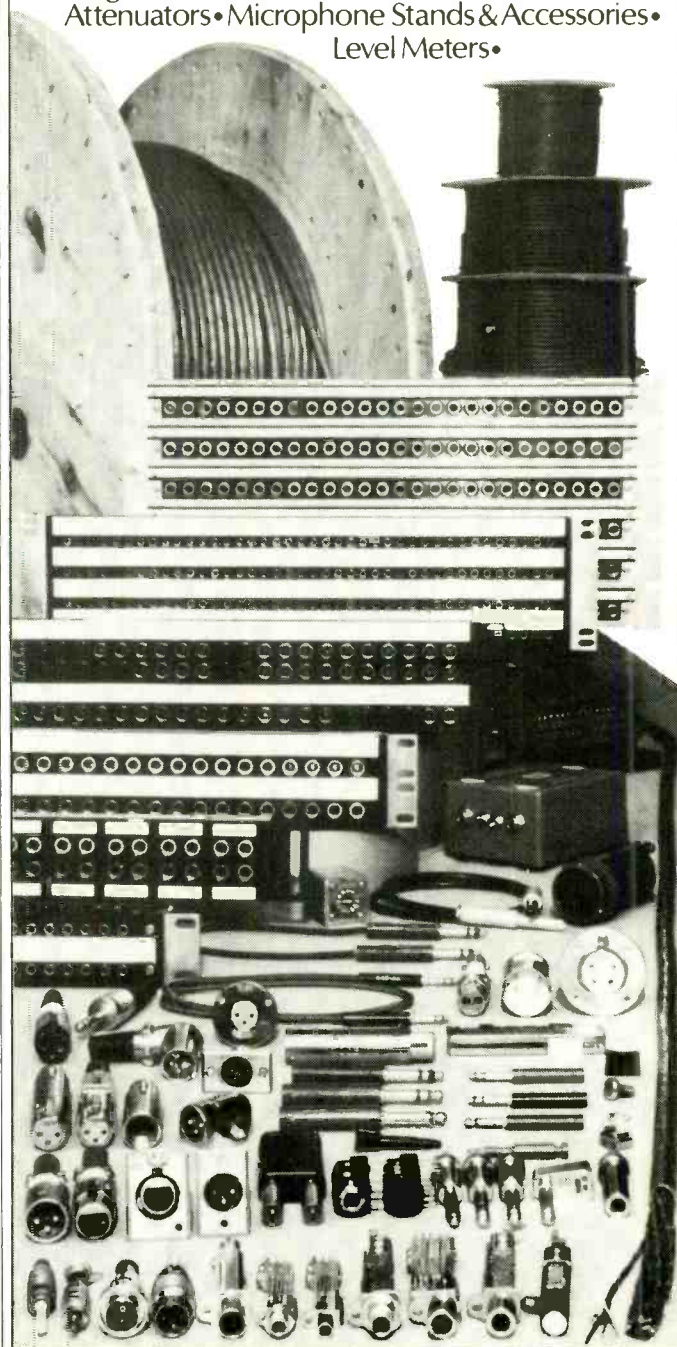

LEE ENGINEERING LIMITED

Showing at IBC Prosound 80 5th Sound Broadcast

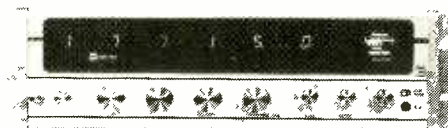
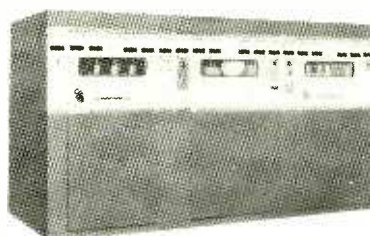

BROADCAST EQUIPMENT

STUDIO TO TRANSMITTER

LEE ENGINEERING offer a diverse range of professional equipment for all your broadcasting needs

- ★ NAB Cartridges
- ★ NAB Cartridge machines
- ★ QRK Turntables
- ★ IGM Instacart Gocart multiple cartridge and instant access machines
- ★ IGM Program automation equipment
- ★ ORBAN advanced audio processors AM and FM
- ★ CONTINENTAL communications and broadcast transmitters up to 2MW
- ★ ELECTRO IMPULSE dummy loads, color meters water and (forced) air cooled
- ★ McKAY Professional multifunction communications receivers
- ★ ALDEN WEATHERFAX

LEE ENGINEERING LIMITED

Napier House, Bridge Street, Walton-on-Thames, SURREY, ENGLAND
Tel. Walton-on-Thames 43124 Telex: Cables:

Talk is Cheap.

While others talk about performance and reliability, BGW is at work proving it, day after day after day. That's why so many pros Depend on BGW.

You already know BGW is pre-eminent in discos... recording studios... and on the road. Tough, demanding applications. But, BGW is chosen for even tougher assignments.

Consider the 1980 Winter Olympics. Future Sound, Inc. of Weston, CT was faced with providing PA, background music and network feeds for the Alpine events on Whiteface Mountain. The four amplifier sites were inaccessible by road. The only access was by snowmobile or on foot. Temperatures are, at their mildest, bitter. Naturally, Future Sound selected 20 BGW 750's because of their proven reliability.

And, when the Pope celebrated Mass on Washington's mile-long Mall, BGW 750's were there again (along with BGW 250's and 600's)... selected by Audio Technical Services, Ltd. of Vienna, VA for their reliability and because they can be operated right up to the clip point for hours with no problems.

In fact, the BGW 750 outperforms Crown's latest amplifier, the PSA-2. The 750 delivers more power at 4 and 8 ohms, has more output devices, and uses audibly superior full complementary circuitry.* One thing the Crown does have... a higher price, it's 37% higher.* And you know the BGW 750 is dependable. If you don't know from personal experience... ask the Pope.

*Based on Manufacturers' specifications.

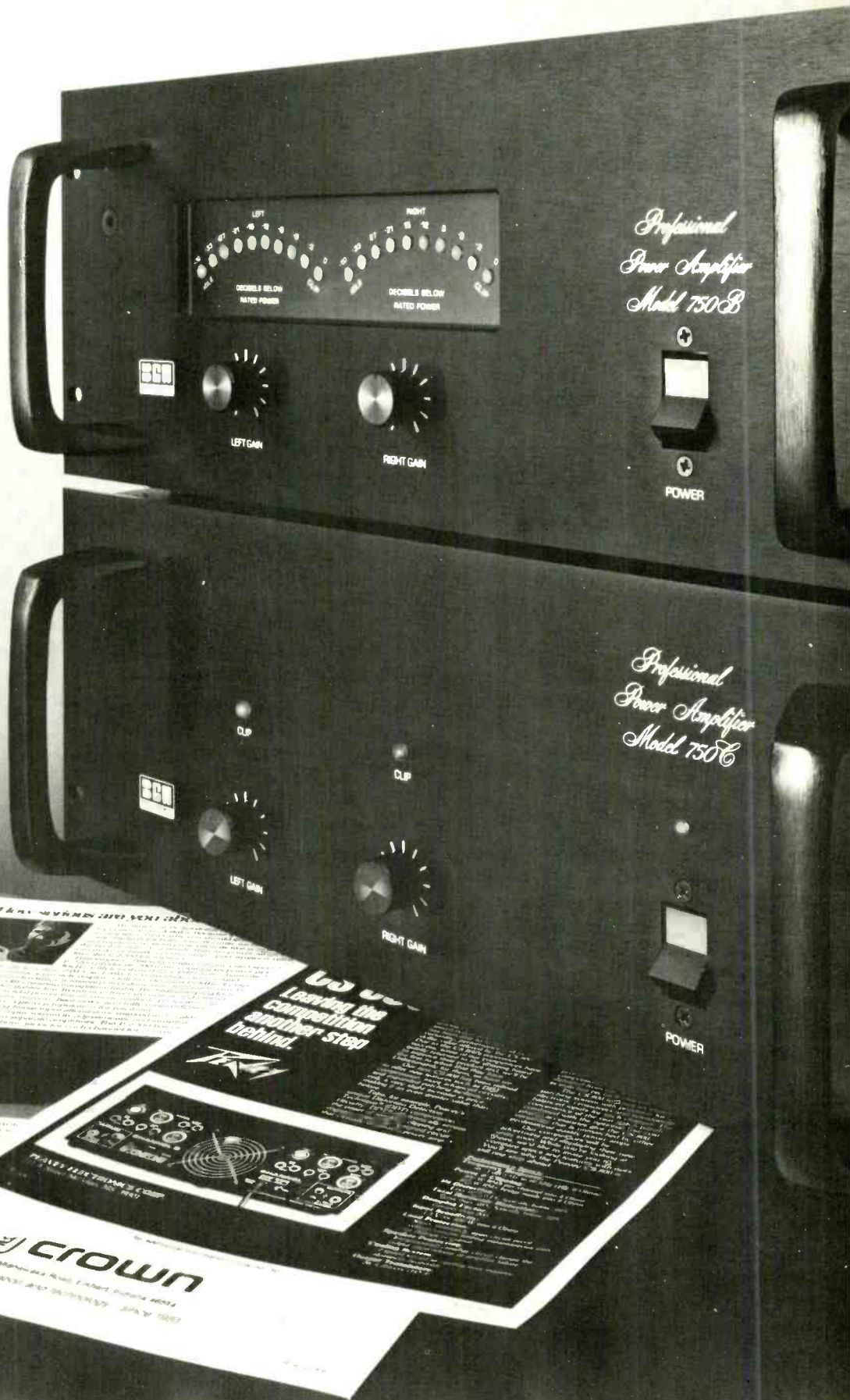

Depend On Us.

BGW Systems, Inc., 13130 S. Yukon Ave., Hawthorne, CA 90250 (213) 973-8090 In Canada: Omnimedia Corp., 9653 Cote de Liesse, Dorval, Quebec H9P 1A3

Radio Studio Projects

Radio Studio Projects -

We system design,
manufacture and install



TV studio sound
systems too!



Audix Limited, Station Road, Wenden, Saffron Walden, Essex CB11 4LG
Telephone Saffron Walden (0799) 40888 Telex 817444

THE DAWN OF AN AMPLIFIER

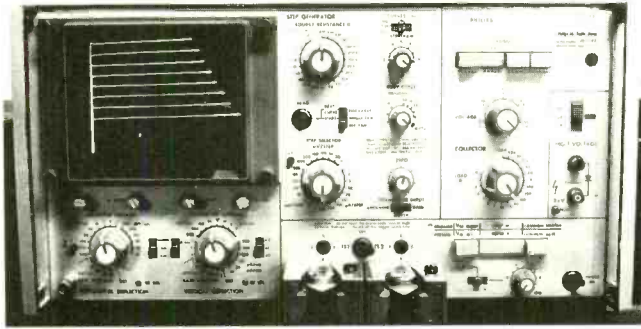

Before we start to build our amplifiers we test and select every single component from the 1% tolerance metal film resistors to the drilling of the glasepoxy PC boards. The above picture shows transfer curves of an FM 17418 transistor displayed on a high-power curve tracer, a test that is performed at different voltages, currents, loads and temperatures. One of the four different tests that each and every of the 46 transistors used in an FM ACOUSTICS power amplifier has to pass. Very time consuming, very expensive and very safe. No other manufacturer is able to make this kind of effort, an effort that pays off: superb natural sound reproduction, no unit to unit variation, extreme stability and unmatched long-term reliability under worst case conditions. Just one of the reasons why an FM ACOUSTICS is more expensive initially but in the long run is more cost effective and therefore better value than any other power amplifier. FM ACOUSTICS. There is no alternative.

Distributors:

ASEAN:	LULLA MOTION SINGAPORE, 2528030
AUSTRALIA:	DURATONE PHILLIP ACT, 821388
BELGIUM:	CD TRONICS EDEGEM, 031/402299
DENMARK:	SC SOUND TAASTRUP, 02/998877
FRANCE:	SYMPHONIE DIFFUSION PARIS, 3360434
GREECE:	LYRIC ATHENS, 01/3606787
HONG KONG:	JOLLY SOUND LTD, 5-752246
ITALY:	ROJE MILAN, 02/4154141
NETHERLANDS:	AUDICOM WADDINXVEEN, 01828/6931
NORWAY:	PRO-TECHNIC OSLO, 02/460554
SWEDEN:	LEAB STOCKHOLM, 08/506039
U.K.:	FM ACOUSTICS WEYMOUTH, 0305/784049

All other countries:

FM ACOUSTICS LTD
TIEFENHOFSTRASSE 17
CH-8820 WÄDENSWIL/SWITZERLAND
PHONE: 01/7806444
TELEX: 56058 telag/fma

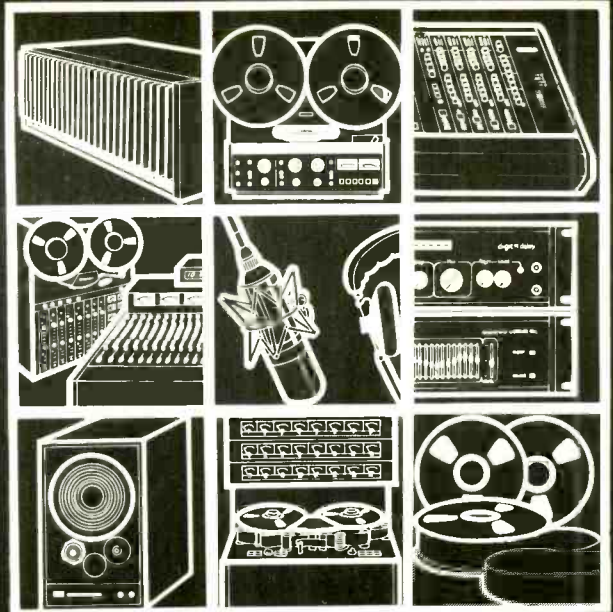

The Total Package

If you are considering a multitrack system or updating an existing studio, Lake Audio offer a comprehensive range of studio equipment. We specialise in supplying the Total Package, which can be tailored to your exact requirements. We offer studio design, consultancy, installation, service and excellent prices.

Packages

We specialise in supplying the Total Package whether your requirements are for an audio visual system, broadcast or production studio or a complete multitrack installation, no matter how small or large. Lake Audio will be able to assist you in selecting the correct components for your system.

Audio processing

The range available is vast, so we choose to stock only those products we believe are the best such as MXR, Flanger/Doubler, D.D.L., Graphics and Pitch Transposer, these are just some of the products making MXR a leader in the field. We also stock Audio and Design Recording, Scamp racks, etc.

Mixers

Our range of mixers is vast, from a modest 12 into 2 to 24 track professional consoles, the list includes Alice, Allen & Heath, Fleximix, HH, MM, RSD, Studiomastrer and Soundcraft.

Monitoring

JBL and Tannoy supply most of the world's monitor speakers but no studio is complete without a pair of Auratones. Monitor amplifiers include Quad 405, 303, HH TPA and MOS FET Turner and Amcron.

Tape machines

The Revox B77 is probably the most popular studio mastering machine and we can supply all versions of this versatile machine. Multitrack machines include Teac 3440, Tascam 80/B complete with DBX, Brenell Mini B Soundcraft SCM series and Lyrec.

Accessories

We have large stocks of many accessories, including Ampex 406/407 tape and Grand Master, all lengths of Ampex cassettes, EMI splicing blocks, leader tape, D.I. boxes, track sheets etc.

Microphones

We supply AKG, Beyer, Calrec, Neumann, shure and Pearl.

Mail Order

Our fast efficient delivery service is available to anywhere in the UK. Just phone or write for a quotation on the equipment you require.

Lake Audio

Lake Audio Consultants
 33 Church Street
 Rickmansworth
 Hertfordshire WD3 1DH

If you would like to know how Lake Audio can help you, telephone us on Rickmansworth (092 37) 70488

For your copy of the
'The Total Package'
 send S.A.E.

Telephone interface equipment

A company producing a wide range of PO approved telephone interface equipment is UK manufacturer, Partridge Electronics. Of particular interest are the company's two latest products, the *Producer* and the *Reporter*, both designed for OB usage.

The *OB200/PMW300 Producer* provides programme transmission and studio control line operational facilities on location. The unit incorporates a 3-input channel programme transmission section (two balanced transformer inputs 200-600 Ω , and a line level input) with rotary sensitivity controls, PFL switches and slider faders; feeding an auto-level PO line drive section via a key switch which may also be used to route the control line return signal into the drive circuit for test purposes. The programme channel output has a PPM meter and LED indication of limiting in the auto-level section. The talkback section features a rotary gain control, on/off switching and a VU meter. Monitor facilities comprise switchable post fade, control line, and optional off air feeds which are routed to a headphone output. The unit uses either mains or internal battery power supply with various options being available. The talkback section is

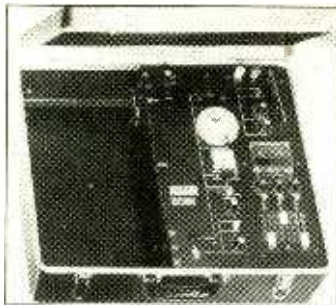

fitted with a telephone dial to enable an OB operator to call the studio if an STD line is in use, and has an LED to indicate calls from the studio. The unit can optionally be supplied with AM and FM tuners, and telephone dial and/or ringing generator export models are available. (Dial facilities are not permissible in the UK under present PO legislation, hence where a unit is used on an ordinary PO line oper-

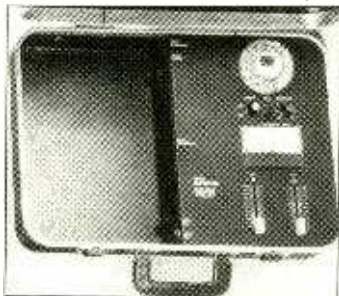

ators must use PO telephones to call the studio and only when the call is established can the unit be switched to hold the call.) Price of the basic *Producer* model is approximately £575.

Studio terminal equipment for interface with the *Producer* comprises the *PMW400* audio level receive module, the *OB200* non-hybrid termination module, and a power supply module. These are available as a complete unit either as a 19in rack mount unit or free standing. Price is approximately £325.

The *OB100 Reporter* is a battery operated, portable unit for feeding programme material to a studio. Facilities include separate mic (200-600 Ω) and line unbalanced inputs with level control; VU meter indication of drive level; a battery test facility; and a receive section with a headphone outlet. As with the *Producer* a telephone dial facility is available on export models. Price of the basic *Reporter* model is approximately £200. Studio terminal equipment for the *Reporter* comprises the *OB200* non-hybrid balancing unit which is available with various options from a starting price of approximately £100.

Partridge Electronics, 56 Fleet Road, Benfleet, Essex SS7 5JN, UK. Phone: 03745 3256.

American test instruments

An omission from our test instruments survey were the products of American manufacturer, Potomac Instruments Inc. Of particular interest is the *AT-51* audio test system comprising the *AG-51* audio generator and *AA-51* audio analyser. The system will measure total harmonic distortion (20Hz to 20kHz in three ranges); intermodulation distortion (SMPTE standard, 0.1% to 100% range); wow and flutter ($\pm 0.3\%$ fsd or $\pm 1.0\%$ fsd); frequency response (20Hz to 200kHz ± 0.1 dB); S/N ratio (20Hz to 20kHz); rms voltage level (1mV to 100V rms); stereo phasing ($\pm 54^\circ$ or $\pm 180^\circ$); and differential gain ratio in the audio frequency spectrum (20Hz to 20kHz, ± 6 dB range).

Features of the system include transformerless stereo outputs (balanced or unbalanced, switch selectable); switch selectable 150 Ω or 600 Ω source resistance; automatic nulling; automatic signal levelling (0.1V to 80V rms); 10dB, 1.0dB and 0.1dB step attenuators; RFI shielding; automatic 'set level' and 'balance' circuits; an oscilloscope output; and an output level monitor.

The *AT-51* system costs \$3,069 and the *AG-51* and *AA-51* are available as separate instruments. Optional accessories are the *DX-51* AM envelope detector and the *IX-51* input transformer. In addition to the *AT-51* system Potomac also produces units primarily for broadcast usage including field strength meters, a frequency synthesiser and coherent detector, and antenna monitors and ancillary equipment. Later this year the company will also be introducing an automatic broadcast transmission system.

Potomac Instruments Inc, 932 Philadelphia Avenue, Silver Spring, Maryland 20910, USA. Phone: (301) 589-2662.

Export: Telesco International Corp, 125 Mineola Avenue, Roslyn Heights, NY 11577, USA. Phone: (516) 484-3822.

30 ►

MiniMoog mods

Rivera Music Services has notified us of a comprehensive modification package for the *MiniMoog* synthesiser. The modifications significantly enhance the capabilities of the basic instrument and allow the user a totally new range of tonal manipulation and control signal routing. Among the numerous modifications is the provision of keyboard control voltage and gate outputs, plus oscillator and filter signal outputs, to allow external processing of the *MiniMoog's* signals.

Rivera Music Services, 48 Brighton Avenue, Suite 11, Boston, Mass 02134, USA. Phone: (617) 782-6554.

Gordon Headroom Meter

Our report on the AES 64th Convention, New York, (January 1980, page 54), included outline details of a new type of programme monitor meter, the Gordon Headroom Meter. This alternative to the VU meter and the PPM, has now been introduced by Inovonics. Characterised as the HU meter, the device integrates the UK/EBU quasi-peak reading configuration with that of the VU meter. Inovonics are producing a complete HU meter for \$122, comprising drive circuitry and an HU meter display, or alternatively a VU meter conversion option for \$69.

Inovonics Inc, 503-B Vandell Way, Campbell, Cal 95008, USA. Phone: (408) 374-8300.

AB Systems Model 1200A

American manufacturer AB Systems has introduced a totally modular power amplifier, the *Model 1200A*. The amplifier features both independent power supplies on each channel and completely interchangeable output sections. Each output module which slides into the amplifier's front panel, is independent of the other, even down to having separate cooling fans. Each output section will deliver 500W into 4 Ω , or 300W into 8 Ω , while in a bridged configuration the amplifier will deliver 1,000W into 8 Ω . Quoted THD or IM distortion specification is no more than 0.1% from 0.25W to full rated power. The *Model 1200A* is a standard 19in rack mount unit. AB Systems Design Inc, PO Box 754, Folsom, Cal 95630, USA. Phone: (916) 988-8551.

AB Systems Model 1200A

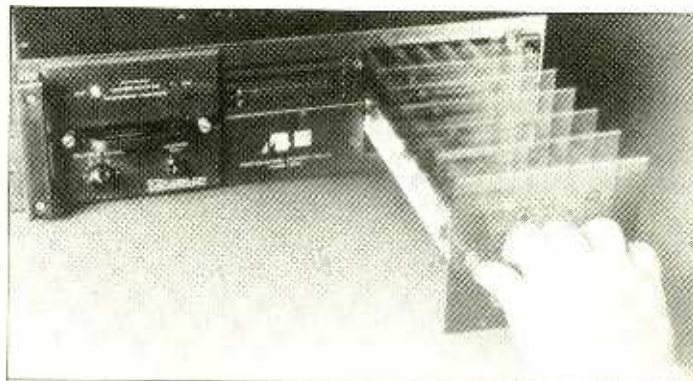

Audio standards

The AES and EIA have jointly made a proposal to the Acoustical Standards Management Board (ASMB) of the American National Standards Institute (ANSI) that the scope of the American National Standards Committee S4 on Sound Recording be enlarged to encompass the more generic audio engineering field and be renamed Committee S4 on Audio Engineering. This committee would cover all aspects of audio engineering with the exception of communications equipment, electronic components, acoustic measurements, combined

visual/aural discs, and those aspects of audio engineering which pertain to safety. The AES and EIA have also proposed that the present S4 Committee continue its work as a subcommittee on Audio Recording S4-1, with a slightly revised scope of reference. These proposals have been approved in principle by the ASMB and formal approval is expected by the beginning of June. The advantage of these proposed changes is that they would unify the development of audio engineering standardisation under the management of the ASMB, without duplication of effort by other bodies.

Designed for the 1980's, the MTR-90 is a synthesis of the most up-to-date technology and innovation currently available. The new generation tape transport incorporates a pinch-roller-free direct drive capstan with the PLL DC-servo circuitry. Other

features include gapless, noise-free punches, digitally controlled logic, $\pm 20\%$ varispeed, and SMPTE interface access. Comes with a full function remote and available in 16 and 24 track configurations. For further details, please contact us.

OTARI

Industrial Tape Applications
1-7 Harewood Avenue, Marylebone Road,
London NW1 Phone: 01-724 2497, Telex: 21879

Otari Electric Co., Ltd.
4-29-18 Minami Ogikubo, Suginami-ku,
Tokyo 167 Phone: (03) 333-9631,
Telex: OTRDENKI J26604

The most advanced 24-track available. OTARI MTR-90.



New sound level meter

Wandel & Goltermann has introduced a new sound level meter, the *PM-20*. The meter is a hand-held digital model and will measure from -50dB to +30dB over the range 15Hz to 20kHz. It has a resolution of 0.1dB, and is provided with two switchable impedances of 600Ω and 100kΩ for terminated or through measurements. Other features include measurement of dc voltages from 0V to 100V (±0.1V), auto-ranging, and a large 3-digit display which always shows whether a reading is positive or negative — allowing repetitive values to be read with ease. The meter is housed in a rugged shock-proof case and is powered by either an internal dry battery or alternatively by a rechargeable nickel-cadmium cell. A battery warning arrow indicates when the battery has two hours of operation left, and if the voltage drops further the meter switches itself off to avoid erroneous readings.



Wandel & Goltermann (UK) Ltd, 40-48 High Street, Acton, London W3. Phone: 01-992 6791.

ProTech audio distribution amplifier

A new audio distribution amplifier has been introduced by ProTech Audio. Termed the *DA1521*, the amplifier is capable of providing up to 14 simultaneous 600Ω balanced outputs from a single source at +20dBm maximum output and is a 19in rack mount model. Features of the *DA1521* include adjustable gain up to 30dB; switchable VU metering of input or output levels; balanced, bridging, transformer coupled input; built-in regulated power supply with combined power on/off switch/circuit breaker; and plug-in pcb construction with access from the front. Quoted specifications are frequency response 30Hz to 20kHz ±0.5dB, ref 1kHz; THD less than 0.25% at -20dBm output; S/N ratio 85dB at maximum gain, ref +20dBm; 70dB channel separation; and input impedance 20kΩ, balanced, bridging and transformer isolated. Price of the *DA1521* is \$375. ProTech Audio Corp, PO Box 638, Lake Ronkonkoma, NY 11779, USA. Phone: (516) 473-5979.

Get well soon!

When Impulse Sound Studios' *F600* turned up on the doorstep of Audio and Design Recording, she was accompanied by a note asking that the beloved old lady be treated kindly and sent back repaired. Her son the *Ex-press* limiter, the note continued, had gone to America to seek fame and fortune but her nephew, *F760X-RS* remained at Impulse in perfect health.

From her repair bench Auntie *F600* sent a postcard of the River Thames at Reading to her nephew, just to let him know that she was getting better. Aaah. . .

Headphone Amplifiers

American manufacturer, Eddcor, has introduced two new headphone amplifiers for studio use. The *HA100* has eight stereo channels and is a 19in rack mount unit, while the *AP10* has four stereo channels and is a free standing unit. Both units have a power on/off switch and a balance control in addition to stereo channel pots. The units can be used with any combination of headphones in the impedance range 8Ω to 2kΩ. Quoted specifications include THD less than 0.1% and an A weighted S/N ratio of -101dB. Eddcor, 16782 Hale Avenue, Irvine, Cal 92714, USA. Phone: (714) 556-2740.

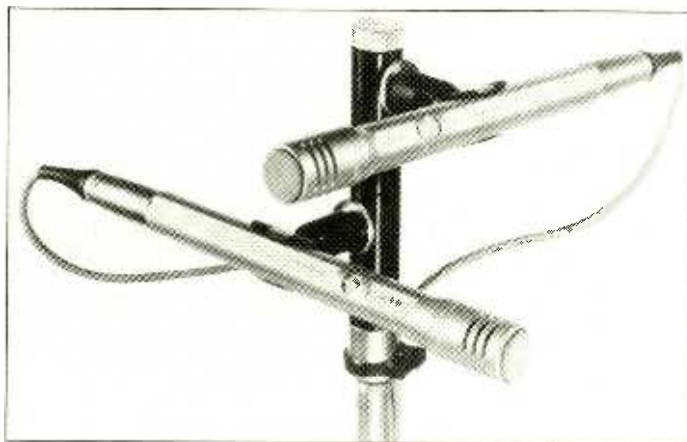

Shure stereo mic adapter

Shure has introduced a new stereo mic adapter, *Model A27M*, which permits two mics to be mounted on a single stand. Use of the *A27M* allows horizontal coincident or closely spaced mic mounting at a wide range of directional angles to be accomplished with ease. A variety of stereo pickup configurations

can be selected including X-Y or ORTF configurations, while vertical mic separation may be either 31.8mm, 66.7mm, or 102mm. The *A27M* is 168mm long with a diameter of 25.4mm and costs approximately £15. Shure Electronics Limited, Eccleston Road, Maidstone, Kent ME15 6AU, UK. Phone: 0622 59881.

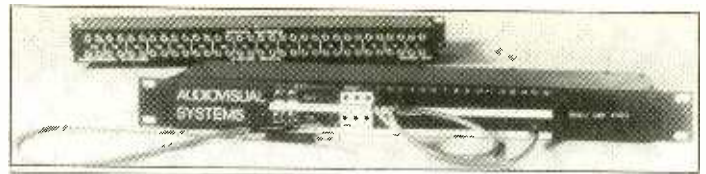

Magnasound contact condenser mic

DI Tapes Ltd has introduced the *Magnasound* contact condenser mic designed to give clean, spill-free signals from the soundboards of acoustic instruments — principally piano, guitar, harpsichord, harp, string bass and members of the violin family. The contact mic features inbuilt preamp circuitry, measures 92 x 35 x 8mm (lwd), weighs 23gm, and is in the form of a robust, sealed unit suitable for live and recording applications. The mic is supplied with a dual-powered power pack operating on either 48Vdc phantom power, or from its own twin PP3 9V batteries. The pack supplies either a balanced mic input direct to the mixer stage, or an unbalanced low impedance output to amps. Price approx. £150.

DI Tapes Ltd, 107 Park Street, London W1Y 3TA, UK. Phone: 01-629 6223.

Edinburgh International Radio Festival

Coinciding with the prestigious Edinburgh Arts Festival, an International Radio Festival covering a wide variety of topics including technical developments is being held on August 21 and 22, under the auspices of the BBC and IBA. Venue is the Royal College of Physicians, 9 Queen Street, Edinburgh. Further information from Sue Francis, c/o Broadcast, 111a Wardour Street, London W1V 3TD. Phone: 01-439 9756.

Audiovisual Systems patch bay

American manufacturer Audiovisual Systems has introduced a fully-normalled patch bay featuring 16 stereo inputs and outputs (256 2-channel crosspoints), with 64 gold-plated RCA phono connectors on the rear panel and 3-conductor Bantam jacks on the front panel. Front panel phono connectors enable connection of external equipment anywhere in the system. The patch bay uses a fully shielded printed circuit design with no discrete wiring or active circuitry, has gold plating on all contact surfaces, requires no power, and is a 1½in EIA rack unit. Price of the patch bay is \$540.

Audiovisual Systems, 725 Lorraine Boulevard, Los Angeles 90005, USA. Phone: (213) 934-3006.

AKG brochure

AKG has published a new brochure entitled *AKG in Studios*. Consisting of 47 pages, the brochure illustrates and has technical details of all AKG's products suitable for studio usage, including microphones, reverb units, time delay units and headphones. A useful additional facility is the provision of a glossary of technical terms, a description of wiring methods, and an application guide for AKG mics. Copies of the new brochure are available from AKG Acoustics Ltd, 191 The Vale, London W3 7QS. Phone: 01-749 2042.

Hard metal tape heads

Magnetic Components Ltd has become the first European manufacturer to offer magnetic recording heads with a hard metal alloy bonded to the magnetic cores at the contact surface, a technique hitherto only used by some American and Japanese producers. Heads of this type have applications in the high-speed production of pre-recorded cassettes, computer tapes, and wide band instrumentation recorders. Magnetic Components is developing heads for all these applications, the first to become available being the *AT Series* for cassette production systems operating at 120in/s. Future heads to be introduced are record heads for 60 and 30in/s cassette production and heads for master tape replay. Magnetic Components Ltd, Data Products Division, Bridge Wharf, Chertsey, Surrey KT16 8LJ, UK. Phone: 09328 64401.

advanced technology for the recording industry



Mixing consoles from AMEK
Tape Pack & Allison 65K Automation



Monitoring,
from Eastlake to Auratone



Sole distributors
of dbx noise
reduction and
dbx compressors

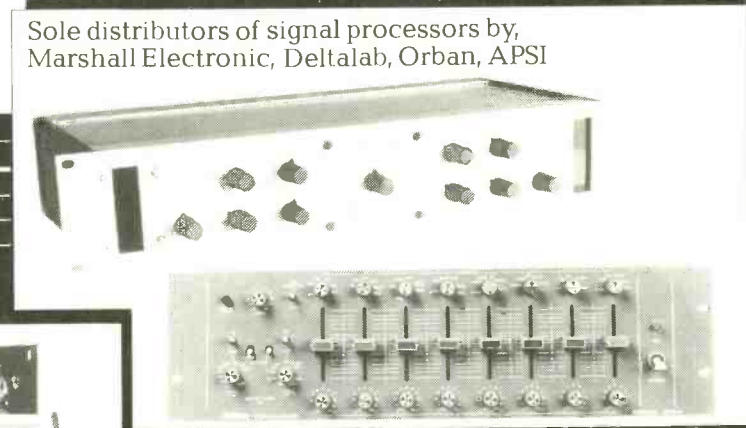

Sole distributors of signal processors by,
Marshall Electronic, Deltalab, Orban, APSI



Sole distributors of
reverberation systems by
Lexicon, MIC-MIX, Orban

Scenic Sounds **SSE** Equipment Ltd.



97-99 Dear Street, London W1V 5RA
Telephone: 01-734 2812/3/4/5
Telex: 27 939 SCENIC G

studio diary

3M Digital in London

Shortly after the AES 65th Convention in London, two studios in London — Roundhouse and The Town House — became the first European recipients of the 3M digital multitrack system. Effectively, Roundhouse has received the multitrack recording part of the system, while The Town House has received the disc cutting part of the system. Shortly after installation I visited both studios and my visits turned out to be not merely a question of the digital system as will become apparent.

Starting with The Town House, April 1st was the perhaps inauspicious day that its new cutting room was officially opened. Cutting engineer Ian Cooper certainly won't forget that it was April 1. Being an expectant father, on what day and during what function did his wife decide that birth was imminent! You guessed correctly. Although it was a false alarm and Ian has since become the proud father of a bouncing baby boy (his second), his nerves are still recovering. Prior to his hurried departure en route to hospital, though, Ian did manage to take me on a tour of the cutting room's equipment.

The 3M digital disc cutting equipment comprises a 4-track digital recorder and an associated digital delay preview unit. As the final link in the recording chain the 4-track recorder fitted with a preview facility is able to directly drive the disc cutting lathe via the drive amplifiers, without the requirement to go via the disc cutting console. The digital preview unit is a dedicated unit for use with the 3M 4-track and is a digital in/out device using 16-bit words. It features a dual channel digital delay line for previewing, with delay time measured and displayed on a 4-digit LED display having an interval timer using its own reference oscillator, and it provides preview signal for



Town House cutting room

cutting lathe pitch and depth control. The preview unit and digital recorder share outputs, with Tracks 1 and 2 becoming preview outputs left and right — Tracks 3 and 4 becoming programme outputs left and right. Any of the four tracks may be isolated via front panel switches for preview/programme on either the left or right channels. Programme signal delay is selectable in 5ms increments over the range 0 to 1.3s (optionally 0 to 1.96s with an extended memory option), while sample rate is nominally 50kHz, but is controlled by the recorder's 'Vari-speed' allowing variable rates to be used.

Ian Cooper's limited experience (to-date) of using the 3M digital system for cutting is that it is basically a much simpler system without the problems of analogue cutting. For example it allows optimisation of groove pitch and cutting amplitude without the phase and equalisation problems of analogue. Additionally he doesn't have to battle with analogue tape machine

alignment and Dolby alignment. In fact Ian's principal comment with regard to analogue versus digital cutting was that he preferred digital and wished that he was using solely one or the other, as going from one to the other involved totally different techniques which required a mental re-adjustment.

The 3M recorder is housed in an empty office adjacent to the new Town House cutting room. The reason for it not being in the cutting room being that the office provides a basically dust-free and cigarette-ash-free atmosphere which should help obviate the possibility of gunk-induced dropouts beating the recorder's error correction system. It also has the advantage of keeping the rather noisy 3M digital machine's transport out of the cutting room.

Back in the cutting room which is an Eastlake room sized 20 x 15ft, the two items of equipment which immediately catch the eye are the Neumann disc cutting console and the sparkling new Neumann VMS80

lathe. The lathe is fitted with an SX74 cutter head and operates in conjunction with a pair of SAL74 drive amplifiers. The console is a Neumann SP79 used in conjunction with U473 limiters, EMT 156 PDM compressor, Rebis RA402 parametric eq. and it has an A/B disc mastering system. Mounted in the console is the remote tape controller for the 3M, plus remotes for an Ampex ATR-102/ADD-1 disc cutting digital preview system and a standard analogue Ampex ATR-100 recorder. Both these Ampex 2-tracks have Dolby A361 noise reduction. On the wall opposite the console is a video monitor which operates in conjunction with a UREI Vidigraph bargraph display generator to display frequency spectrum and overall stereo level. Finally, for monitoring there are a pair of Auratones and a quad-configured Eastlake Gauss/JBL monitor system triamped using HH 5500D power amps with White room equalisation. The new Town House cutting room is fairly spacious and as the 3M recorder is housed outside the room, from an operator's point of view the working atmosphere is relaxed.

Shortly after my visit to The Town House, it was the turn of Roundhouse Recording Studio to come under scrutiny. In the company of a number of fellow journalists I attended a demonstration utilising the studio's 3M digital 32-track and 4-track recorders and the digital editor. The demonstration took the form of a live session which was recorded simultaneously on the 3M digital system and on an analogue Studer A800 running at 30in/s and without Dolby noise reduction. The results of A/B switching between the two, not unexpectedly were very much in favour of the digital system. The lack of tape noise and wow and flutter on the digital system in

34 ▶

Roundhouse control room



PROGRESSIVE MANUFACTURE
CONSOLES TO SUIT YOUR
REQUIREMENTS AND YOUR
POCKET!
PROGRESSIVE DELIVER ON
TIME WITH NO BROKEN PROMISES!
PROGRESSIVE HAVE SUPPLIED
STUDIOS, THEATRES, RADIO STATIONS,
RECORD COMPANIES, AND ALL WITH A
SMILE! SO WHY NOT CONTACT US
FOR COMPREHENSIVE DETAILS ON
ALL PROGRESSIVE ELECTRONIC
PRODUCTS. P.S. SEE US AT PROSOUND
SEPT. 2ND. DETAILS ON REQUEST

PROGRESSIVE ELECTRONIC PRODUCTS

83 LEONARD STREET, LONDON EC2

Tel: 01-729 5411

Price List as at 31st March, 1980

MBC	— 1	Meter Buffer Card	£3.68
MIC	— 1	Microphone Pre Amplifier	£8.50
BAX	— 1	Bass and Treble Tone Control	£7.40
MID	— 1	Mid Range Tone Control	£6.85
UGB	— 1	Unity Gain Buffer Amplifier	£4.40
VEM	— 1	Virtual Earth Amplifier	£4.95
LHD	— 1	Line Headphone Driver	£6.30
GPA	— 1	General Purpose Amplifier	£5.48
SFR	— 1	Scratch Filter	£7.55
GAP	— 1	General Purpose Amplifier	£5.48
SFR	— 1	Scratch Filter	£7.55
SUB	— 1	Subsonic Filter	£6.20
MAG	— 1	Disc Pre Amplifier (Moving Magnet)	£8.70
CM	— 1	Complete Channel Module	£70.26*
CM	— 1b	Complete Channel Module (with E.Q. defeat switch and additional facilities)	£80.24*
GM	— 1	Complete Group Module	£57.46*
GM	— 1b	Complete Group Module plus LED Display	£78.52*
LHD	— 1 +	10dB Line Headphone Driver plus 10dB Gain	£7.15
IPM	— 1M	Input Module Microphone	£27.00
IPM	— 1L	Input Module Line	£20.00
PPM	— 1	PPM Driver Card	£26.40
PPM	— 1	PPM Meter Movement	£36.00*
RIM	— 1	Ring Intercom Master Station	£56.00*
RIO	— 1	Ring Intercom Outstation	£16.50
LDM	— 1	LED Display Module	£26.23*
MC	— 1	Moving Coil Pre Amplifier	£26.00*
MT	— 1	Microphone Transformer (net)	£8.50
PSU	— 1M	Power Supply 24v DC at 1A	£18.00*
PSU	— 3	Power Supply 24v DC at 100mA	£12.00*
PAC	— 1	50 watt Power Amplifier	£34.00
	104mm	Conductive Plastic Fader	£26.00*
	60mm	Carbon Fader (no panel)	£1.10
CUSTOM-BUILT MIXERS				P.O.A.
Frame Work for Use With CM — 1 and GM — 1				P.O.A.

TERMS:

Cash with order, except approved accounts.

All Prices subject to 15% VAT.

75p Postage and Packing per order, except on items marked with *, which will be charged at £2.00 per order.

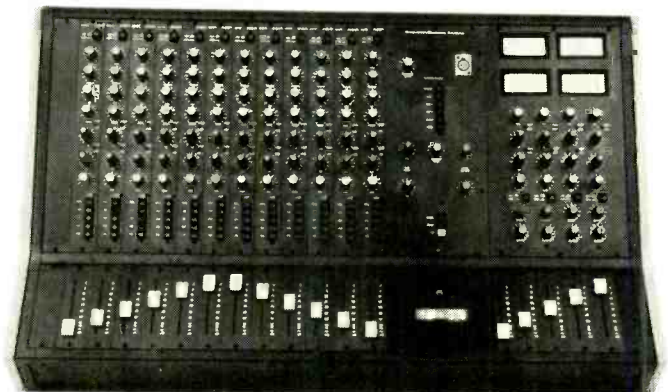

PROGRESSIVE ELECTRONIC PRODUCTS

83 Leonard Street, London EC2

Tel: 01-729 5411

Sierra Pacific Studios, California

Robert Apperson used to be a bass player with Buffalo Springfield in their latter days, he also played bass and toured worldwide with Jose Feliciano and later he worked as a staff writer/musician signed to recording labels. By hopping from one side of the control panel to the other he gained multitrack recording experience and in 1974 began to build a small studio in a motel room in Studio City in 'The Valley' that's over the hill from Hollywood. The studio gradually expanded until there was no room at the motel; it was all recording studio.

Today Sierra Pacific is a fully fledged 24-track studio doing quite nicely on a mixed diet of singles, albums, movie soundtracks and jingles. It consists basically of one rock-and-roll sized room about 700sq ft in area, a control room about 250sq ft, an isolation booth, offices and storage units. "The studio might be small but the parking lot is spacious," says JC Stone, producer and engineer at Sierra Pacific and erstwhile Canadian chart artist.

The console is a 24-track Amek 2000, with 3M 79 recorders with 24-track Dolby. Monitoring is with Century EV5 monitors, UREI Time-Aligns and Altec 604E Time-Aligns. For artists' take-home

copies there is a Scully 2-track machine, Teac and cassette-copying machines. Outboard there is a full complement of limiters and peripherals like Lexicon *Primetime* Eventide *Harmonizers* and flangers and a *Kepe* noise gate system. The studio has a 9ft Steinway grand built into its own booth in the wall, a wide range of mics including Neumann, Sennheiser, Shure, ECM, RCA, AKG and Sony, and for reverb an EMT stereo plate.

Looking back to the studio's inception Robert Apperson says, "I had a desire to build my career and although I was making a good living doing sessions and masters, my code of ethics prevented me from doing certain things. So I had to get into a position where I was in control, and I could do only the things that I wanted to do. That's what kindled the decision to build a studio. It was tough at the beginning, starting really small with demos and 4-track stuff through 1975 and 1976, and in 1977 we were in a position to upgrade to 24-track. We have a small but growing reputation. The build-up is just a gradual blending of effort, less and less music and more and more wires."

Artists who have worked at Sierra include Carole Connors, who did the theme for the two Rocky's (no, not the Two Ronnies) — soundtrack represents about 5% of their busi-



Control room

ness — Delaney Bramlett, Tom Jones and Christopher Lee. Most successful record in terms of sales being *Contact* by Edwin Starr which sold more than 200,000 copies on a 12in disco single. The same artist recorded *Happy Radio* at Sierra Pacific.

"Characteristic of the studio is that people feel comfortable here. It's an intimate room. I used to sing at other studios where the rooms absorbed you. You get lost trying to get the right sound. Here you feel gutsy without tearing out your

throat," says Robert who still works as an engineer along with Reed Stanley, Pat McDonald, Sherman O'Neil and Larry Staffin.

"We're running 24 hours a day, there is just one crazy shift," says JC Stone, "we are too small to have two crews. There is no pool table, no jacuzzi, it's strictly a work room, but it's comfortable." **Bill Third**

Sierra Pacific Studios Inc, 11739 Ventura Blvd, Suite 6, Studio City, Cal 91604, USA. Phone: (213) 769-3344.

3M Digital cont'd

particular being impressive.

Again as with The Town House, the Roundhouse has had only limited experience of using the digital system. To date they have used the system on material recorded by Uriah Heep and The Beat, and Peter Gallen the studio's manager expressed complete satisfaction with the system. Despite one or two minor teething troubles — only natural when a new system using new technology is installed — Peter's only quibble was the amount of recorder transport noise which was present during fast spooling. To overcome this Peter is toying with the idea of closing off the digital machines from the rest of the control room. However, as he intends fitting perspex dust covers over the machines anyway he hopes these might cut down the noise and solve this minor irritation.

While at Roundhouse, I noticed that since my last visit to the studio, a number of changes to the studio's control room had taken place. For a start it is now smaller than before, with the rear wall having been moved forward, and the console is at 90° to the control room window. The control room is now 24 x 18ft with the ancillary equipment behind the console, the analogue tape machines opposite the console, and with the digital tape machines

against the rear wall. On the equipment front the control room now has a Harrison 48/32 console, a Studer A800 24-track, and a pair of A80 2-tracks, plus of course the 3M digital units. The ancillary equipment remains the same as before, but with the addition of a *Scamp* rack and an AMS *DMX15-80* DDL. The other major change to the control room is the provision of Eastlake *TM3* monitors driven by HH power amps and with White room equalisation.

The limited experience of the Town House and Roundhouse with the 3M digital system has been an encouraging start to introducing digital multitrack recording to Europe. So far both studios are more than pleased with the results and they look forward to a stimulating future usage of the equipment. To sum up, their response to the system is that having decided to go digital they have no regrets and they now believe even more strongly than before in the advantages of digital recording.

Noel Bell

The Town House, 140 Goldhawk Road, London W12, UK. Phone: 01-743 9313.

Roundhouse Recording Studios, 100 Chalk Farm Road, London NW1 8EH, UK. Phone: 01-485 0131.

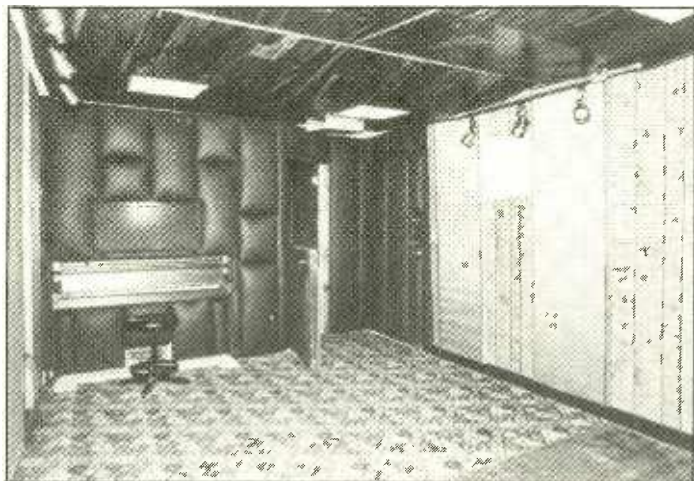

Sierra Pacific studio

Dig-it Studio, Belgium

A new 24-track studio which has recently arrived on the European recording scene is Dig-it Studio situated in Hekelgem, Belgium. Owned by Ardyns Luc, the studio is well equipped and has already attracted many overseas users including UK artists Roy Wood, Ian Hunt and Gerry Lockran. The studio is a healthy size (1,140sq ft), is fully air-conditioned, and amongst a wide selection of instruments boasts a Blüthner grand piano.

The control room is equipped with an Amek *M2000* 28/24/28 console, while tape machines include a Lyrec *TR532* 24-track with 16-memory autolocator, an Otari

MX5050 2-track and a Revox *A77*. Ancillary equipment includes Lexicon *Primetime*, AMS DDL, Eventide *Harmonizer*, Evans analogue delay, Denfish noise gates, dbx comp/limiters, Dolby and dbx noise reduction, Synton vocoder, and a variety of graphic equalisers. Monitoring is via Tannoy *Berkeley* loudspeakers driven by an Amcron *DC300A* with Neptune room equalisation, while headphones are Hosiden driven by a Technics 50W per channel amplifier. Microphones are AKG and Neumann dynamic and condenser models. Dig-it Studio, 76 Terlindenstraat, B-1790 Hekelgem, Belgium. Phone: 053 66.23.23.

New realms of expression from MXR.

The Pitch Transposer is MXR's newest addition to our professional line. It is one of our most innovative products, and possibly the most revolutionary signal processor in the music industry today. It is a unique, high-quality unit which provides a cost effective and flexible package for today's creative artists.

The Pitch Transposer extends your musical boundaries by creating live instrumental and vocal harmonies. It has 4 presets which allow the artist to predetermine the intervals to be processed. Transposed intervals can be preset anywhere from an octave below to an octave above the original pitch. The chosen interval is activated by means of touch controls or a rugged footswitch. LED indicators display which of the four presets has been selected.

A mix control is provided, enabling the unit to be used in one input of a mixing console, or with musical instrument amplifiers. A regeneration control provides for the recirculation of processed signals, creating more and more notes, depending upon the selected interval. This results in multitudes of voices or instrumental chords. An entire new range of sound effects and musical textures, unattainable with any other type of signal processor, is suddenly at your fingertips.

With many other pitch transposition devices a splicing noise, or glitch, is present. The MXR Pitch Transposer

renders these often offensive noises into a subtle vibrato which blends with the music, and is, in some cases, virtually inaudible. The result is a processed signal which is musical and usable.

We have been able to maintain a high level of sonic integrity in this most versatile signal processor. The frequency response of the processed signal is beyond 10 kHz, with a dynamic range exceeding 80 dB.

A micro computer based display option allows the user to read the created harmonic interval in terms of a pitch ratio, or as a musical interval (in half steps). This unique feature allows the pitch to be expressed in a language meaningful to both musicians and engineers.

We designed our Pitch Transposer as a practical musical tool for those actively involved in creative audio. It reflects our commitment to provide the highest quality signal processors with the features and performance that will satisfy the creative demands of today's musical artist. See your MXR dealer.

Atlantex Music, Ltd., 34 Bancroft Hitchin, Herts. SG51LA, Eng., Phone 0462 31513, Tlx 826967



**Professional
Products Group**



Arco Studios, Munich

Very much a part of the 'Munich sound', Arco Studios are situated in a former cinema fairly well within Munich though due to the original nature of the premises, parking is no problem as the car park came with them! It also means that equipment load-in is on the ground floor and directly into the main studio. Arco as such has been in existence since 1974. Before that the studios belonged to Deutsche Grammophon for 12 years and as far as the main studio is concerned, things have remained pretty much the same. After all, someone with their reputation can have been relied on to do a good job of things! Work done at Arco is roughly 40% international clientele with the remaining 60% being taken up by the German hit parade market, folk music, pop, etc.

Somewhat stemming from the freelance situation that exists with Munich engineers, Arco works quite a lot in collaboration with Music Land and other studios. Basically this comes down to 'ping-ponging' clients between the studios depending on how booked up the studios are at the same time in an effort to keep the customers within the family circle. The idea seems to work well as the engineers are usually equally at home in the different studios and it is a case of everyone pulling for the common good rather than wasting time on what can often turn out as destructive competition — there's enough cake for everyone so why try and eat a slice that's too much for you? As mentioned earlier, Arco consider themselves very much a part of the 'Munich sound', which would tend to suggest that a fair proportion of the work done is disco. In fact, it accounts for about 80%! The other 20% is principally TV music, including the transfer of film music to videotape. Arco has two studios though the bulk of the music recording is done in the main studio, the upstairs facility being mainly used for vocal overdubs, TV work, etc. It is also due for a complete rebuild, and since it was busy when I arrived, deemed not really worth looking at.

Access to the studios (apart from equipment load-in) is past the pay desk, sorry, reception desk and into the large — here we go again — bar and restaurant. Since Herr Hans Falkenberg, studio manager and chief engineer was occupied when I arrived, lunch was very kindly provided with yet another brand of Munich beer that I hadn't yet sampled! During coffee Herr Falkenberg filled me in with the background on the studio and then it was off to see the facilities. The auditorium is entered into by large double doors at the rear, leading off from the rest area.

Nothing much remains to give an indication of the building's former occupation apart from the quite considerable screen that is installed over the control room window at the far end of the studio — where in fact the old cinema screen used to be. The parquet covered floor has been levelled and mounted on springs in order to minimise ground borne vibrations from the nearby main road. Wall treatment consists of modules mounted in various configurations and patterns and though the aspect is fairly businesslike, the use of soft tone colours and intimate lighting give the studio a very relaxing atmosphere. As can be seen from the photo, the front left corner and wall have several isolation booths for drums, vocals, electric instruments, etc. Again, these booths are of a semi-permanent nature and can be modified very quickly to be completely closed or with one wall open. The studio also boasts a very nicely finished set of separation screens of differing heights and thicknesses mounted on 'easy glide' castors. Apart from some re-touching the studio is as Deutsche Grammophon left it, the only major change made by Arco being the installation of angled panel absorbers from the ceiling in order to pull the reverberation time down to 0.9s. There is enough room in the studio to put 90 musicians — ie a symphony orchestra — without their feeling cramped, though at the present time classical recordings are very much in the minority. However, due to the acoustics and availability of space some classical recording is done from time to time. It is also evident that large TV music scores present no problem. Foldback is mainly stereo though more channels can be accommodated if required and listening is by headphones and/or trolley mounted monitors. As would be expected microphones range from Neumann, AKG, Sennheiser, etc.

The control room is situated behind where the cinema screen used to be and access is via doors at the far right of the studio where there is also an engineer's entrance if he doesn't feel inclined to come in through the front door! The room is on a higher level than the studio (about 3ft) giving that little extra visibility over the studio floor. The control room is of the 90 degree variety with the window to the left of the console. The decor draws much of its inspiration from the Eastlake style, being a mixture of wood panelling, tree bark and grille cloth. However, the space being rather limited the trapping is confined to the ceiling. As can be seen from the photo, the room is none too wide and careful thought was needed to make the best use of the available space. Whereas the walls are not symmetrical — though not



(above) Control room, (below) main studio



too asymmetrical either — care has been taken to put different materials opposing each other giving a low reverb time and avoiding standing waves and flutter echo. Centrepiece of the room is an MCI 528 36/24 console which is linked to two MCI 24-track machines in adjoining room. The two machines are not linked together for 46-track though this possibility is under discussion. For the moment the main reason for the two machines is for copy and transfer purposes.

Stereo machines for mastering, copying and other duties consist of two Studer A80s and Telefunken M15 and M10 recorders. The toy department is not forgotten either with playthings from Eventide, Audio & Design, Orban, Universal Audio, etc, etc. (Yes, one of the things from Eventide is the *Harmonizer!*) Monitoring is by the 'you see them here, you see them there, you see those Auratones everywhere' plus a pair of JBL 4350 monitors to impress drummers! Dolby is also available should you want it. In the interests of space and convenience there is a small room leading off directly from the control room proper where the multitrack, video and other recorders are kept. Thus copying can be done while the

control room is taken up with a session, without any trouble. Rack mounting equipment is either installed in the soffits under the monitors or in trolleys that can be wheeled to where the engineer wants them, eg for manual operation of an effect whilst remaining at the console. Usually one mastering machine is kept in the control room under the right monitor but this can be wheeled out and plugged up in the 'tape room' should it prove necessary. Arco also have quite an impressive library of music and sound effects for TV productions enabling them to provide a comprehensive service as regards TV sound productions.

At the time of my visit all seemed to be going well for Arco and recent clients included Donna Summer, Claudia Berry and Ellen Parsons. In fact the international work was on the increase and studio policy is, as would be expected, to encourage this trend. Anyway, it was time to move on so all that remained was for me to thank Hans Falkenberg for a good lunch and for showing me around, and hop onto a tram for my next destination. Terry Nelson ARCO Studios, GmbH, Kreillerstrasse 22, D-8000 Munich 90, West Germany. Phone: 089 432287. ■

Rebis RA200 Series

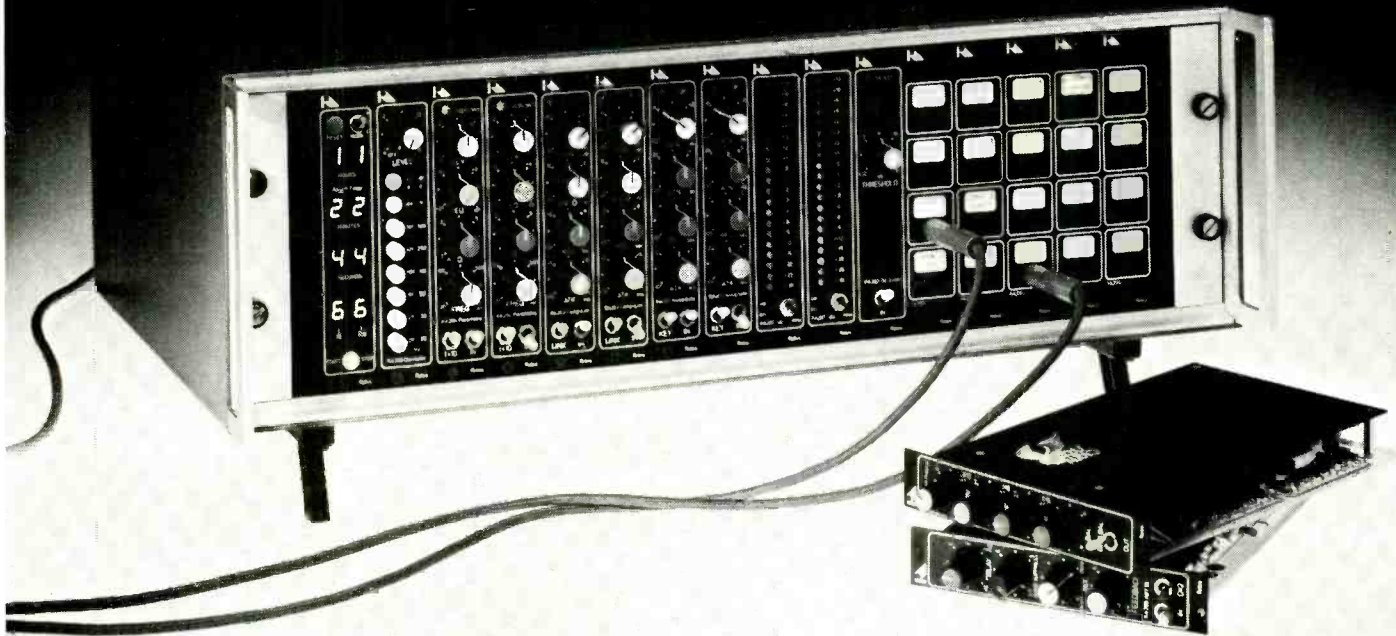

The RA200 Series has established itself as the most versatile approach to sound processing. Now there's a new connector module and rear rack mounting power supply to make it even easier to put together a package that does the job you want, wherever you want it.

If you have a problem in O.B., stage, studio or mobile recording the RA200 Series is almost certainly your answer.

Like to know more? Ring us now on 0384-71865.

Rebis Audio, Kinver Street, Stourbridge, West Midlands DY8 5AB.

Export enquiries: Scenic Sounds Equipment, 97-99 Dean Street, London W1V 5RA. Tel: 01-734 2812. Telex: 27939 Scenic G.

See us at
**PROSOUND
INTERNATIONAL**
2nd-4th September

Studio monitoring

Stephen Court

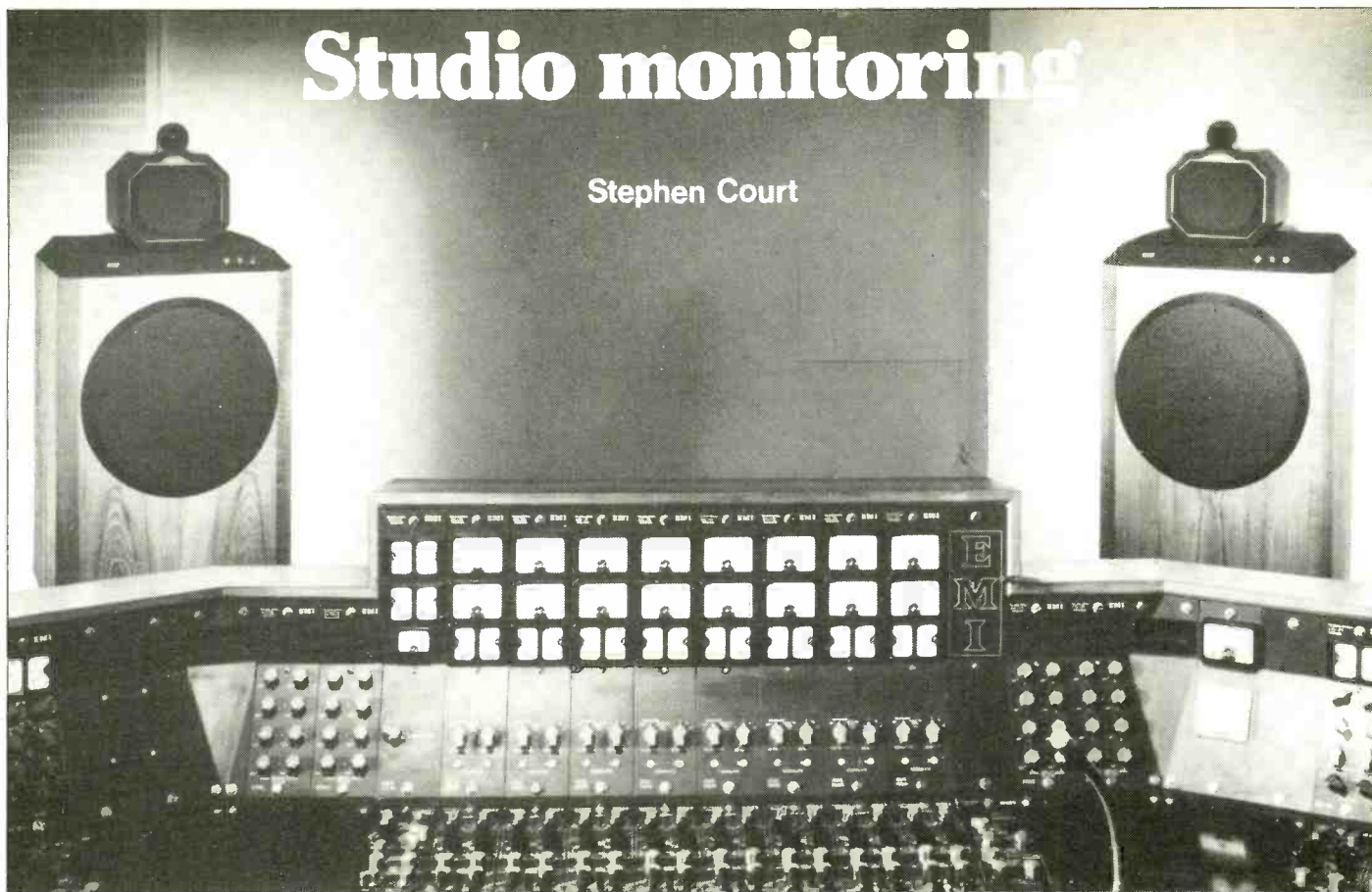

SINCE CONTROL room monitoring is not only complex in terms of its interface with room acoustics, but probably the least understood, it is primarily this department which differentiates the sound of one recording studio to the next. The tendency of tapes to be recorded in one studio and remixed in another, has been followed by 'roving' engineers and producers, especially the latter who rightly become highly confused when they achieve excellent results on one particular system and poor results on exactly the same system in another control room.

Possibly the most common problem, from an initial design point of view, is the lack of provision for monitoring systems when the studio is at the design stage, whether building from scratch or converting an existing building.

Monitor installation

In either case, the walls are inevitably parallel and the console is located centrally in the control room—both situations creating problems acoustically. There are many publications on this subject, such as the APRS book *Sound Recording Practice*, and which cost little at the design stage, yet failure to observe them usually results in substantial bills when attempting to correct them later.

It cannot be overstressed that provision for flush mounting the

Following the article on Monitoring Systems in Feb. 1977 *Studio Sound* there have been many developments in the recording studio field, although most of them are fiscal rather than technical developments. When a studio considers spending something like a hundred thousand pounds on a mixing console, the budget allotted to monitoring systems seems even further remote from the rest of the studio equipment chain.

monitors not only solves most monitoring problems, but also looks a lot more professional than a couple of speaker stands out in the control room floor. The essential difference is that monitors mounted this way have nothing to 'push' against when attempting to move large masses of air at low frequencies. This may not sound logical since the mass of the speaker itself would appear sufficient, but when using one or two 15in cone transducers and several hundred watts to create an intense low frequency pressure wave, the difference in bass 'tightness' is considerable when the monitor is absolutely rigid.

We use the term rigid, although it is advisable to mechanically decouple the speaker from the room. This can be done simply by surrounding the enclosure in 2in or so of heavy foam or wool fibre which mechanically isolates the speaker from the surrounding structure, yet satisfies the requirements of flush mounting. If it is not possible to construct recesses in the control room wall, as shown in

fig 1, then a surface structure built around the monitors will largely satisfy the requirements for flush mounting fig 2. This structure is built with 4 x 3in stock, with high density chipboard glued and screwed to simulate a wall flush with the existing control room walls, and acts as an extension between them and the loudspeaker baffle.

Acoustic theory tells us that the resulting void between the speakers when flush mounted this way should create all sorts of acoustic hazards, but in practice this rarely, if ever, occurs. In fact the space can be usefully employed to house a pair of smaller domestic type loudspeakers for commercial compatibility tests as in fig 2.

Apart from a considerable improvement in the 'tightness' of the low frequency spectrum, flush mounting means the speakers are then operating under 2π conditions, in other words radiating into a hemisphere giving a theoretical 3dB (double) increase in output than when mounted in free air. In commercial terms the monitors will offer

considerably increased output/headroom for the same capital investment. Also, since mounting in free air means the speaker is radiating low frequencies at the sides and rear, severe low frequency response deviations can result in phase cancellation and addition between the direct and reflected signals.

Equalisation

There is no reason in theory why an 'off the shelf' monitoring system should not work in any control room without equalisation since the speakers themselves were designed under carefully controlled acoustic conditions as was the control room itself. In practice, however, a perfectly linear response without correction is largely an exception rather than the rule. In any event, electro-acoustic equalisation is a very useful tool, not only ensuring a well controlled system response irrespective of the room acoustics, but also ensuring compatibility between one studio and another. There are various ways of doing this, probably the most convenient being a graphic equaliser, fig 3, which provides a quick and visual representation of the correction required. This provides correction in $\frac{1}{3}$ -octaves, considered the optimum filter width to fall within the ear's critical bandwidth. The 25Hz filter also acts as a highpass filter, to eliminate unwanted subsonics which have no musical value yet are likely to agitate room modes unnecessarily.



FIG 1

This type of equaliser can be used as a 'cut-only' type—considered preferable for control room equalisation.

The alternative to graphic equalisers is the type shown in fig 4 which doesn't have the convenience of visual representation, but offers low frequencies further divided into 1/6-octaves which require very careful setting up, but offer more control over difficult situations. Control room equalisation is a very complex procedure, and even with the aid of a spectrum analyser, simply boosting or cutting a 1/2-octave band where the analyser indicates a response deviation can cause more problems in the form of phase and image shifting than it cures.

Also, although a 'flat' response is considered ideal, it is often preferential to introduce some degree of response modification by correlating measurements with listening tests in order to produce a consistent result on the final master. One hesitates to use the expression 'tune for maximum smoke' in monitoring systems, but in practice that is what inevitably happens. In any event it is a job for the specialist, but generally considered pounds well spent.

Since a loudspeaker does 'mellow' with age, and other response changes can occur due to settlement of structural material in the speaker and control room itself, it is a good practice anyway to have the system realigned periodically. The classic case is the compression driver—present in 90% of high power monitors—where the diaphragm after all is simply a mechanical spring. With high level monitoring combined with high

FIG 3

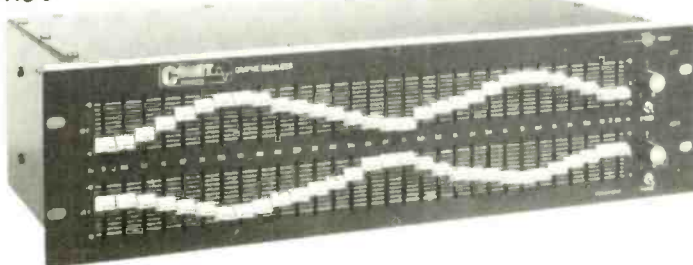

speed tape spooling and switch-on transients, the diaphragm assembly can fatigue, resulting in the slow deterioration of high frequency response and subsequent over correction of hf during the recording and mixdown process. Similarly, as discussed at the end of this article, as well as structural changes, the low frequency response can change also, emphasising the need for periodical re-assessment.

Split sub-bass monitors

With the steady increase in floor value, control room size is defining more and more the nature of equipment installed therein. Back in the 50s, Gilbert Briggs stated that there is no loudspeaker like a 'big-un', and since we are dealing with the laws of physics, that situation remains fundamentally unchanged. Ironically, nearly all the mass of a loudspeaker is for the lower octave and the rest of the sound spectrum can easily be handled by an enclosure the size of a small television receiver. Paradoxically, since low frequencies are radiated in a spherical wave pattern, there is no left-right symmetry below 100Hz, so stereo, or two large enclosures is largely academic anyway.

In situations where there is no space for large monitors, or as in fig 5 where there was insufficient room to allow the required rake for conventional monitors, the bass was split and the low frequency enclosures mounted separately. In this particular case, two sub-bass units were used since the crossover frequency was in the region of 250Hz, where



FIG 2

directional information is radiated from the LF transducers and two enclosures had to be used to preserve the stereo image.

In systems where the sub-bass is crossed over at 100Hz or less, the single bass unit can be placed between the monitors, over the control room window, or even on the floor on a small shelf. The system in fig 5 has a third high frequency system in the centre for mono film monitoring.

Split sub-bass can also be used to considerably increase the power handling of existing monitors. Most loudspeakers are rated in terms of how much power in the form of heat the voice coils can safely dissipate. Added to this is the degree of cone excursion afforded by the lf unit(s). Most of the sound spectrum energy is present at the low frequency end of the audio spectrum, so removing low frequencies from loudspeakers can

normally double their power handling and therefore acoustic output. Since we are now crossing over at around 250Hz, there is still directional information radiating from the sub-bass units, therefore it is necessary to place them next to the existing speakers to preserve the phase/stereo signal. The main criterion when installing this type of system is ensuring the separate lf and hf systems are equally placed from the engineer to preserve the time alignment of the complete system.

Time alignment

In the last year, or so, greater emphasis has been placed on the time correlation between the separate drivers. Not a particularly new idea—this was the old bugbear of horn enclosures where the bass unit had a 3ft or so longer path length to

40 ▶

FIG 4

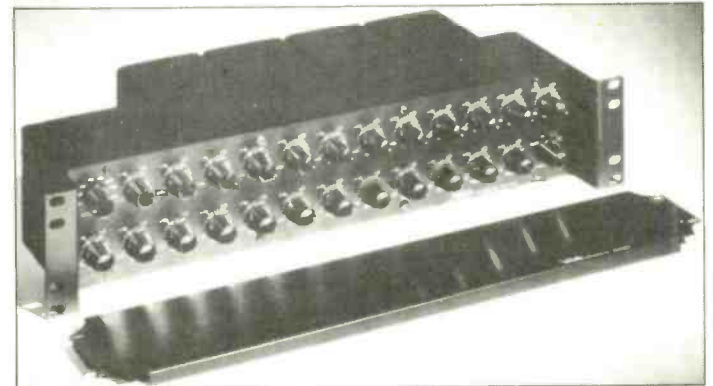

Studio monitoring

the listener, than the shorter hf horns. In modern terms, we are talking about distances of a few inches, the theory being that a plane wave emitted from each transducer should arrive at the ear at exactly the same time.

There is still considerable dispute about the advantages of time alignment—basically we are talking about how sensitive the ear/brain mechanism is to phase. Obviously it is very sensitive to phase, since speech is largely phase changes rather than amplitude or frequency changes. But this, and the perception of movement/location is a function of **relative** phase shift. Many of the neural receptors in the central nervous systems are called 'changing state receptors' for this reason. Whether the ear is as sensitive to **absolute** phase shift is a question of debate. We can certainly say that when an engineer moves back a couple of inches, the sound from the monitors has undergone several hundred degrees of phase shift, but that is absolute phase shift. The contradiction to that is when two or more transducers are emitting for example, the components of a squarewave, it will only arrive at the ear as a squarewave providing the separate transducers emit the signal simultaneously in time and space. The argument continues if you consider a conventional loudspeaker with bass unit at the bottom, hf driver at the top, and a midrange driver in the middle. A tall person will be nearer the hf unit, and a short person will have a shorter path length to the



FIG 5

bass driver—and so the argument goes on.

To say a squarewave will be more accurately reproduced when the system has been time aligned, suggests that there is a deficiency in the bandwidth or frequency response of the system. In practice, however, time alignment does not affect the axial response of the monitors, so much as improve the spatial quality of the monitoring system by providing a more coherent stereo perspective.

Monitoring electronics

Having already discussed electronic crossovers and equalisers, the final link in the monitoring chain is the power amplifier. As mentioned before, small signal electronics are very compatible with semiconductors, but not necessarily so with high current systems—power amplifiers are a good example. The difficulty in achieving good performance at high power levels was amply demon-

strated, when monitoring power amplifiers were the last items to be converted to transistor working. In fact some studios still use thermionic power amplifiers today somewhat strangely running alongside digital and voltage controlled systems.

The technical reasons are long and involved, but basically in order to achieve the same performance, a lot more rms power is required with a transistorised power amplifier. A rule of thumb is that the amplifier should be capable of delivering at least twice the monitors rated power handling. This obviously requires intelligent use, but a 50W power amplifier driven into clipping can do a lot more damage to a 50W speaker, than a 200W amplifier at the same SPL but running 'clean'.

This article is intended as a follow up to the article printed in *Studio Sound* Feb 1977, to indicate advancements in monitoring systems. Since loudspeakers are largely

governed by the laws of physics, the improvements are few. One change, however, is worth mentioning. Until now, nearly all high power speaker systems (with the exception of those used in broadcasting) used magnets based on Cobalt—*Alcomax*, *Alnico* are but a few of the trade names. Basically they had the advantage over cheaper ceramic magnets in that for a given weight they had two to three times the power and could be designed in a closed magnet circuit, giving less leakage, and more flux concentrated in the voice coil gap.

In the last couple of years, there has been a world cobalt shortage so all major loudspeaker manufacturers are now resorting to other materials—mainly ceramic. They do have to be substantially greater physically, but they also have a distinct advantage. As discussed earlier, it is a good idea to periodically realign the monitoring system, and one of the reasons is that through consistent high power use, and high cone excursions at low frequencies, Cobalt magnets tend to reduce their total flux—which in turn can considerably modify the bass drivers characteristics over a period of time. Ceramic magnets however appear not to suffer from this effect, and in some cases, the manufacturers' ceramic versions of their Cobalt drivers have the added advantage of even higher efficiency with new materials and production methods.

We are still a long way off from range electrostatic or modulate air monitors, but fortunately the greatest limitations in conventional monitoring systems are through poor installation and acoustics, and hopefully some remedies for the last two have been mentioned in this article.

agony

Silent night?

A well seasoned maintenance engineer borrowed the van of a company in the audio industry (to move a double bed!).

Due to an 'electrical problem' he was unable to get any sounds from the van's stereo. So he pushed in a cassette. Great difficulty was experienced, in fact he used so much force that the cassette was stuck half way in!

The 'electrical problem'? There was a blank cassette already in the machine.

Dolby cards unclassified

The air conditioning in the new studio on the tropical island had never worked right and the *Cat 22* cards in the Dolby mainframe were failing with astonishing regularity. Dolby had been duly notified, and the studio had quickly received a cable assuring that help was on the way, but two months had passed

and the replacements had still not appeared.

The local customs officials finally admitted that, yes, they had them, but they were waiting for a 'classification' from the studio. "They're electronic subassemblies," the studio replied and, as they were being supplied free of charge, the cards had no cash value. "Ah!" said customs. "Are they parts, or are they equipment?"

"Neither," said the studio, "They are subassemblies."

"But we have no such classification in our customs books," came the reply two weeks later.

"All right then," said the studio, "consider them parts."

"But we make all manner of electronic parts in our country, and you cannot import anything that is made here without special dispensation. Besides, you do not have a licence for importing parts."

"Well then, call them equipment," replied the studio, ad-

dressed, under its breath and in digital code, "you bloody fool."

"Ah!" said customs again, "but then the equipment must have a cash value!"

The studio pulled out \$5 in local currency and asked, "How much cash value would this cover?"

"At 17% duty, \$29.41," said the customs man.

"\$29.41 it is," said the studio, and walked out, leaving the money and taking the Dolby cards with them.

Never rely on the weather

On the Friday before Carnival in Trinidad, everyone leaves work early in preparation for the ensuing four-day-long party, and the crew repairing the tin roof on the new studio complex was no exception. On Monday morning, however, the chief engineer was roused out of a profound rum-induced sleep. "There's trouble up at the studio," the bleary-eyed owner told him, "we'd better get up there."

The trouble was 2in of water on the control room floor, courtesy of the downpour on Sunday night. Climbing up to the roof, the two men discovered a gaping hole, 5ft wide, with the plastic sheeting that was supposed to be covering it lying neatly folded in a pile beside it.

When the head of the roofing crew was finally located, he explained, "But it's Carnival!" He was politely asked what that fact had to do with leaving the roof open. The astonished gentleman replied, "Because Carnival is during the dry season!"

... and speaking of rain ...

Have you ever wondered why some American consoles have echo routing labelled wet and dry?

A West London studio found out when they installed an additional echo plate in their basement. Due to heavy rain the now 'goldy-green' plate fulfilled the former criteria!



Cherokee Studios, Hollywood, California

JBL 4313 Studio Monitor. It flattens the competition.

Introducing the 4313.

Flat frequency response. It means accuracy. Naturalness. Reality.

JBL gives it to you without the bigger box that you'd expect along with it, since the 4313 only measures about 23" x 14" x 10"!

This new, compact professional monitor produces deep, distortion-free bass. And does it with a newly developed 10" driver. Its massive magnet structure and

voice coil are equivalent to most 12" or 15" speakers. Yet it delivers heavy-duty power handling and a smoother transition to the midrange than most larger-cone speakers.

The 4313's edge-wound voice coil midrange accurately reproduces strong, natural vocals and powerful transients.

Up top, a dome radiator provides high acoustic output with extreme clarity and wide disper-

sion. A large 1" voice coil gives it the ruggedness needed in professional use.

Working together, these precision matched speakers offer superb stereo imaging, powerful sound levels and wide dynamic range.

Audition the 4313 soon.

We think you'll agree that its combination of flat response, power and moderate size flattens the competition.

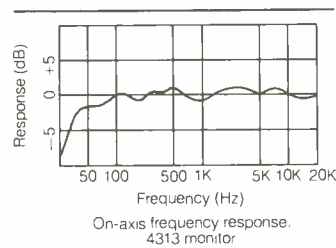

James B. Lansing Sound, Inc.,
8500 Balboa Blvd.,
Northridge, California 91329

JBL First with the pros.

Survey: Monitor Loudspeakers

Where possible, this survey includes speaker systems that are used primarily for monitoring in studios, although there is obviously an overlap with better quality hi fi speakers. We have not included separate components, stage monitors or PA speakers.

ACD/JOHN MEYER (Switzerland)

USA: Meyer Sound Laboratories Inc, 2194 Edison Avenue, San Leandro, Cal 94577.
Phone: (415) 569-2866.

Monitor Loudspeaker System

Type: monitor system, biamplified.

Impedance: 62kΩ audio input.

Max power: lf 150W, hf 75W.

SPL: max 120dB at 3.3ft.

Frequency response: 27Hz to 18kHz.

Features: 2-way system, one 12in lf unit, one hf horn/driver, integral amplifiers with electronic crossovers, phase and amplitude correction networks.

Dimensions: 17 1/2 x 19 x 7 1/2in, 58lb.

Price: on application.

ACOUSTIC RESEARCH (UK)

Teledyne Acoustic Research, High Street, Houghton Regis, Dunstable, Beds LU5 5QJ.
Phone: 0582 603151. Telex: 825467.

USA: Teledyne Acoustic Research, 10 American Drive, Norwood, Mass 02062.
Phone: (617) 769-4200.

AR90

Type: monitor speaker.

Impedance: 4Ω.

Max power input: 300W max, 100W typically.

SPL: 1W for 87dB at 3.3ft.

Frequency response: 23Hz to 30kHz.

Crossover frequencies: 200Hz, 1.2kHz, 7kHz.

Features: 4-way system with two 10in side firing woofers, one 8in high temp lower midrange, one 1 1/2in high temp dome upper midrange, one 3/4in high temp dome tweeter.

Dimensions: 43 x 14 1/2 x 15in, 81lb.

Price: on application.

ALTEC (USA)

Altec Corporation, 1515 South Manchester, Anaheim, Cal 92803, USA.
Phone: (714) 774-2900. Telex: 655415.

Europe: Altec Lansing International Limited, 17 Park Place, Stevenage, Herts SG1 1DU, UK.
Phone: 0438 3241. Telex: 825495.

UK: Theatre Projects Sound Limited, 10 Long Acre, London WC2 9LN.
Phone: 01-240 5411.

9842-8A/D

Type: monitor speaker system.

Impedance: 8Ω.

Max power input: 75W normal, 200W with auto power control.

SPL: 95dB at 4ft from 1W.

Frequency response: 35Hz to 20kHz.

Crossover frequency: 1.5kHz, variable eq.

Features: 2-way system with 12in bass driver, hf compression driver/horn assembly with Tangerine radial phase plug and Mantaray horn.

Dimensions: 28 x 24 x 14in, 70lb.

Price: on application.

9844A

Type: monitor speaker.

Impedance: operates from 8 to 16Ω.

Max power input: 30W.

SPL: 99dB at 4ft from 1W.

Frequency response: 30Hz to 20kHz.

Crossover frequency: 800Hz.

Features: two-way system with twin 12in cone type units for lf, and hf compression driver with aluminium horn.

Dimensions: 24 x 31 x 16in, 90lb.

Price: £446.

9845A

Type: monitor/playback speaker system.

Impedance: 16Ω.

Max power input: 50W.

SPL: 97dB at 4ft with 1W.

Frequency response: 25Hz to 20kHz.

Crossover frequency: 500Hz, switchable shelving.

Features: 2-way system with one 15in cone unit for lf, hf compression type driver with aluminium horn.

Dimensions: 40 x 28 x 24 1/2in, 130lb.

Price: £506.

9849-8A/D

Type: compact studio monitor speaker systems.

Impedance: 8Ω.

Max power input: 60W.

SPL: 94dB at 4ft with 1W.

Frequency response: 40Hz to 15kHz.

Crossover frequency: 1.5kHz.

Features: 2-way system with 12in lf unit, hf sectoral horn.

Dimensions: 20 1/2 x 24 x 15in, 60lb.

Price: £349.

ATC (UK)

Acoustic Transducer Co Ltd, Worton Hall Estate, Isleworth, Middx TW7 6ER.

Phone: 01-568 6633. Telex: 888941.

S50/85

Type: studio monitors.

Impedance: 6Ω.

Max power input: 300W.

SPL: S50 10W for 96dB, S85 8W for 96dB.

Frequency response: S50 40Hz, S85 30Hz to 20kHz.

Crossover frequencies: 450Hz and 5kHz.

Features: 3-way system, S50 one 9in lf unit, S85 two units, 3in dome mid, dome hf unit.

Dimensions: S50 15 1/2 x 29 x 17in, S85 18 x 34 x 19in.

Prices: on application.

AUDICON (USA)

Audio Consultants Inc, 1200 Beechwood Avenue, Nashville, Tenn 37212, USA.

Phone: (615) 256-6900. Telex: 554494.

UK: Trad Electronic Sales Ltd, 149b St Albans Road, Watford, WD2 5BB.
Phone: 0923 47988. Telex: 262741.

Alpha One Monitor System

Type: studio monitor, designed in collaboration with John Storyk, biamplified.

SPL: 70dB to 118dB at 10ft.

Frequency response: 25Hz to 20kHz.

Features: 3-way system, JBL components, twin 15in bass units, 2in compression driver with wide dispersion horn for mid, hf with slot type compression driver. System supplied as pair with BGW amplifiers, crossovers, UREI filters.

Price: \$4,950 pair.

Alpha Two Monitor System

Similar to *Alpha One*, but for smaller studios with twin 12in lf units and 1in horn and lens assembly. Supplied as pair with all components and crossovers.

Price: \$4,250.



Audicon Alpha One monitor

AUDIO MARKETING (USA)

Audio Marketing Ltd, 652 Glenbrook Road, Stamford, Conn 06906, USA.

Phone: (203) 359-2312. Telex: 996519.

UK: Edward Veale & Associates Ltd, 16 North Road, Stevenage, Herts.

Phone: 0438 50023. Telex: 825211.

Super Red

Type: studio monitor.

Impedance: 13Ω.

Max power input: 150W.

SPL: 1W for 101dB at 4ft.

Frequency response: 20Hz to 20kHz.

Features: uses Altec 604-E2 duplex speaker with additional extended range woofer, infinite baffle, shelving at 2kHz and 8kHz.

Dimensions: 47 1/2 x 30 x 17 3/4in, 125lb.

Price: \$1,350.

Big Red

Basically similar to *Super Red*, but less extended range woofer, bass reflex.

Dimensions: 23 x 30 x 17 3/4in, 65lb.

Price: \$1,050.

Little Red

Smaller version of the *Big Red*.

Impedance: 13Ω.

Max power input: 50W.

SPL: 92dB with 1W at 3ft.

Frequency response: 40Hz to 18kHz.

Features: 2-way system with 12in acoustic suspension lf unit, 1/2in dome/cone tweeter, mf and hf frequency equalisers.

Dimensions: 24 x 16 x 12in, 45lb.

Price: \$250;

Tiny Red

Type: check or squark speaker, true bass reflex.

Dimensions: 7 x 8 x 9 1/2in.

Price: on application.

AURATONE (USA)

Auratone Corp, PO Box 698, Coronado, Cal 92118, USA.

Phone: (714) 297-2820.

UK: Scenic Sounds Equipment, 97-99 Dean Street, London W1V 5RA.

Phone: 01-734 2812. Telex: 27939.

5C Super Sound Cube

Type: recording mixdown/comparative monitors, generally console mounted.

Impedance: 8Ω.

Max Power input: 30W.

SPL: 89dB with 1W at 3.3ft.

Frequency response: 50Hz to 15kHz.

Features: 5in full range driver.

Dimensions: 6 1/2 x 6 1/2 x 5 3/4in.

Price: \$75 pair.

I am extremely interested in your
new Series 400 console.

Please send me the colour brochure
which gives full details.

Name

Address



Post to:
Soundcraft Electronics Ltd., 5-8 Great Sutton St.
London EC1V 0BX, England
Telephone: 01-251 3631. Telex: 21198

or
Soundcraft Inc., PO Box 2023
Kalamazoo, Michigan 49003, USA
Telephone: (616) 382 6300. Telex: 22-4408 Soundcraft:KMZ



Survey

5PC Super Pro Cube

Similar to 5C, but with fused blow out protection, 1/4 in jack.

Price: \$90 pair.

5S

Similar to 5C but full range system for broadcast/auditioning, increased bass, smoother low mid-range.

Dimensions: 6 1/2 x 10 1/2 x 4 3/4 in.

Price: \$80 pair.



Auratone 5C

AWO/FOSTEX

AWO/Fostex, division of Interlake Audio Inc, Winnipeg, Manitoba, R2K 1G4, Canada. Phone: (204) 668-0246. Telex: 0755725.

LS/4

Type: monitor system.

Impedance: 4Ω.

Max power input: 150W.

SPL: 98dB with 2.83V at 3.3ft.

Frequency response: 19Hz to 20kHz.

Crossover frequencies: 200Hz, 800Hz and 7kHz.

Features: 4-way system, twin 15 3/4 in lf units and 12 in mf unit in a 668 litre enclosure, hf unit with radial horn milled from solid Eurasian teak, uhf unit with unique diffraction horn.

Dimensions: 60 x 40 x 38 in, 450lb.

Price: on application.

LS/3

Basically similar to LS/4, but less mf unit and only single lf unit, power input 100W, dimensions 36 x 35 1/2 x 29 1/2 in, 176lb.

LS/2

Basically similar to LS/3 but 12 in lf unit, power input 65W, dimensions 25 1/2 x 29 x 20 in, 95lb.

BARCO (Belgium)

Barco Electronic NV, Sevenslaan, B-8500 Kortrijk, Belgium.

Phone: 056 21.11.24. Telex: 85105.

USA: Rohde & Schwartz Sales Co Inc, 14 Gloria Lane, Fairfield, New Jersey 07006.

Phone: (201) 575-0750.

MLS1

Type: monitor loudspeaker system.

Impedance: 8Ω.

Max power input: 250W short term (10ms), electrically limited.

SPL: 89dB with 1W at 3.3ft.

Frequency response: 50Hz to 20kHz.

Features: 3-way system with lf, mid and hf dome units, self-powered electronic limiter operating when distortion exceeds 1%.

Dimensions: 16 x 31 x 12 in, 77lb.

Price: on application.

B&W (UK)

B&W Loudspeakers Ltd, Meadow Road, Worthing, West Sussex BN11 2RX.

Phone: 0903 205611. Telex: 87342.

USA: Anglo American Audio Co Inc, PO Box 653, Buffalo, NY 14240.

801

Type: monitor loudspeaker.

Impedance: 8Ω.

Max power input: minimum 50W, no upper limit, overload protection.

SPL: 85dB with 1W at 3.3ft.

Frequency response: 45Hz to 20kHz.

Features: 3-way system, each in effectively separate enclosures vertically in-line, 10 1/2 in ultra long throw suspension lf unit, 4 in aromatic polyamide fibre matrix cone midrange unit, 1 in multifilament polyester weave dome unit.

Dimensions: 17 x 37 x 22 in, 97lb.

Price: £934 pair.

802

Type: monitor loudspeaker.

Basically similar to 801, but more compact design with reduced 7 1/4 in bass unit.

Dimensions: 11 3/4 x 41 x 14 1/2 in, 70lb.

Price: £775 pair.

CELEF (UK)

Celef Audio Ltd, 130-132 Thirsk Road, Boreham Wood, Herts.

Phone: 01-207 1150/953 8933.

RT1

Type: monitor loudspeaker.

Impedance: 8Ω.

Max power input: 300W.

SPL: 110dB at 3.3ft, max output.

Frequency response: 25Hz to 25kHz.

Features: resistive reflex, ribbon tweeter, studio bass unit.

Dimensions: 30 x 13 1/2 x 15 in, 77lb.

Price: £850 pair.

CELESTION (UK)

Rola Celestion Ltd, Ditton Works, Foxall Road, Ipswich IP3 8JP.

Phone: 0473 73131. Telex: 98365.

Ditton 662

Type: monitor loudspeaker.

Impedance: 8Ω.

Max power input: 160W.

SPL: 90dB with 2.9W at 3.3ft.

Frequency response: 38Hz to 20kHz.

Crossover frequencies: 700Hz and 4.5kHz.

Features: 3-way bass unit 13 in fibre cone, passive radiator 13 in, midrange, treble unit.

Dimensions: 15 3/4 x 42 x 12 in, 75lb.

Price: on application.

COURT ACOUSTICS (UK)

Court Acoustics Ltd, 35/39 Britannia Row, London N1 8QH.

Phone: 01-359 0956. Telex: 268279.

JM5

Type: studio monitor.

Impedance: 4Ω and 8Ω.

Max power input: 300W to 250Hz, 200W above.

SPL: 95dB with 1W at 3.3ft.

Frequency response: 20Hz to 20kHz.

Features: 4-way using JBL drivers. Can be custom built with split sub-bass for small control rooms.

Size: 40 x 40 x 20 in.

Price: on application.

JYM3

Type: compact monitor.

Impedance: 8Ω.

Max power input: 250W.

SPL: 90dB with 1W at 3.3ft.

Frequency response: 20Hz to 20kHz.

Features: 3-way using JBL lf and hf units and a dome radiator for mf. May be triamplified with the EC3 crossover.

Size: 30 x 18 x 13 in.

Price: on application.

Note: All Court monitors can be supplied with integral amplifiers and/or line transformers.

EASTERN ACOUSTIC WORKS (USA)

Eastern Acoustic Works Inc, 59 Fountain Street, Framingham, Mass 01701, USA.

Phone: (617) 620-1478.

MS50

Type: studio reference monitor.

Impedance: 8Ω.

Max power input: 120W programme, 60W rms.

SPL: 90dB for 1W at 3.3ft.

Frequency response: 39Hz to 22kHz.

Crossover frequency: 2.5kHz.

Features: 2-way system, 8 in lf unit, 8 in aux bass radiator, 1 in dome tweeter.

Dimensions: 19 x 15 3/4 x 12 1/2 in.

Price: on application.

MS200

Type: studio reference monitor.

Impedance: 8Ω.

Max power input: 250W programme, 150W rms.

SPL: 95dB with 1W at 3.3ft.

Frequency response: 43Hz to 22kHz.

Crossover frequencies: 800Hz and 11kHz.

Features: 3-way system, 15 in bass driver, midrange driver, ultra hf driver with conical horn.

Dimensions: 23 3/4 x 30 1/2 x 16 1/2 in.

Price: on application.

MS300

Similar to MS200, but 'superior acoustic output, amplitude response, distortion and power handling'.

EASTLAKE

Eastlake Audio Ltd, 97-99 Dean Street, London W1V 5RA.

Phone: 01-734 2812. Telex: 27939.

USA: Sierra Audio, 621 South Glenwood Place, Burbank, Cal 91506.

Phone: (213) 843-8115. Telex: 691138.

TM-3 series

Type: studio monitor generally only fitted within recording facilities designed and constructed by Eastlake Audio. Drive components may be specified by the client, versions being available as 2-way with twin 15 in bass units and single mf/hf unit, or 3-way with separate mf and hf units. It employs a proprietary dense timber segmented horn for mf. Normally supplied with a pre-wired 19 in rack assembly containing the power amplifiers, White Model 4001 equaliser sets, White Model 4016-800 18dB/octave 800Hz crossovers, and input/output connector panels.

Price: on application.

TM-7

Type: smaller two-way version of the TM-3 cabinet using twin 12 in bass drive units but the same wooden horn.

Price: on application.

ELECTRO-VOICE (USA)

Electro-Voice Inc, 600 Cecil Street, Buchanan, Michigan 49107, USA.

Phone: (616) 695-6831.

UK: Electro-Voice (Gulston Europe) Ltd, Maple Works, Old Shoreham Road, Hove, Sussex BN3 7EY.

Phone: 0273 778401. Telex: 87680.

Sentry 100

Type: professional monitor system.

Impedance: 6Ω.

Max power input: 30W average, 300W peak.

SPL: 91dB with 1W at 3.3ft.

Frequency response: 45Hz to 18kHz.

Crossover frequency: 2kHz.

Features: 2-way system, 8 in direct radiator lf unit, super dome tweeter.

Dimensions: 12 x 17 1/4 x 11 in, 28lb.

Price: on application.

GENELEC (Finland)

Genelec Oy, Satamakatu 7, SF-74100 Iisalmi, Finland.

Phone: (9) 77 24942. Telex: 4404.

UK: Future Film Developments, 36/38 Lexington Street, London W1R 3HR.

Phone: 01-437 1892. Telex: 21624.

Triamp S30

Type: monitor system with integral power amplifiers.

Impedance: audio 10kΩ bridging.

Max Power: 300W.

SPL: typically 105dB at 3.3ft.

Frequency response: 43Hz to 25kHz.

Crossover frequencies: 400Hz and 4.5kHz.

Features: 3-way system, long throw 8 in lf driver, 3 in mid unit, direct radiating ribbon hf unit, separate amplifiers for unit, low level crossover, tone controls.

Dimensions: 12 1/2 x 19 1/2 x 12 in, 44lb.

Price: £710.

Triamp 1024A

Type: monitor system, similar to S30, but larger

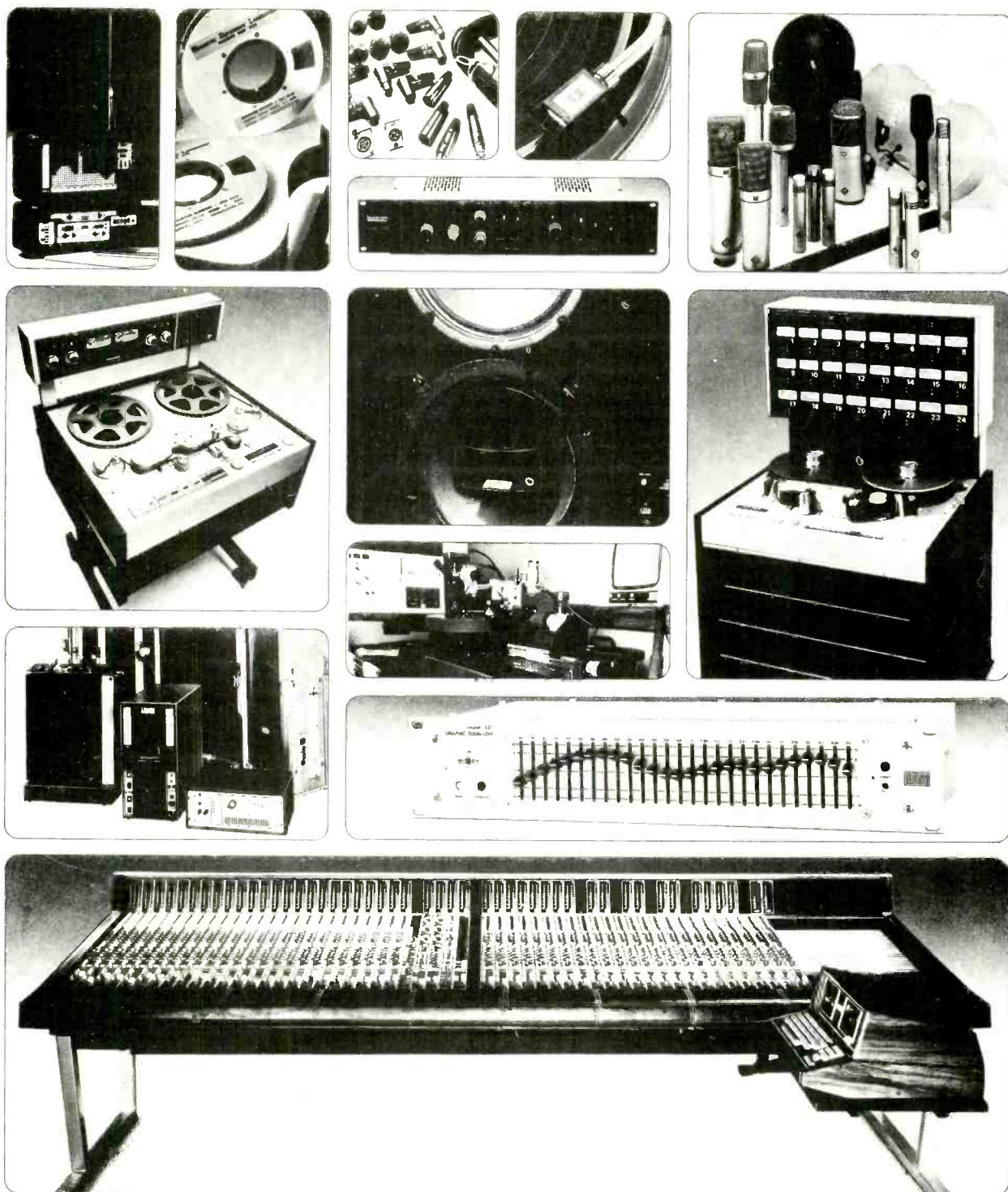

The Complete Studio.

Studer, Neumann, EMT, Albrecht, Klein+Hummel, Harrison, Urei, Lexicon, ITC,
 Allison, MRL, Transco, Switchcraft, Gotham, Europa Film and Revox.
 We represent all the major names in the audio field and can supply the best
 equipment for any studio requirement.

F.W.O. Bauch Limited

49 Theobald Street, Boreham Wood, Hertfordshire WD6 4RZ
 Telephone 01-953 0091 Telex 27502

Why buy British?

EFFICIENCY QUALITY COST

TANNOY

speakers invite comparison. Elliott Bros. stock the full range of professional Tannoy products.

Ring for a demonstration.

Elliott Bros.

01-388 1833

114-115 Tottenham Court Road
London W.1.

Our installations meet broadcast specifications
DOES YOURS?

**Elliott Bros.
Audio Systems Ltd.**

Installation to a standard not a price.

Survey

15in lf drive unit, 112dB SPL, dimensions 19 x 35 1/2 x 18in, 132lb.
Price: £1,925.

Biamp 1019A

Type: mini monitor, similar to S30 but 2-way biamped, 5in lf unit, 3/4in dome tweeter, crossover 3kHz, SPL 94dB at 10W, dimensions 9 x 12 x 9 1/2in, 15lb.
Price: £330.

HARBETH ACOUSTICS (UK)

Harbeth Acoustics, 2A Nova Road, Croydon CRO 2TL.

Phone: 01-681 7676/657 1788.

USA: William McCabe Audio Systems Inc, 916 NE 64th Street, Seattle, Washington 98115.

HL MkIII

Type: professional monitoring loudspeaker.

Impedance: 8Ω.

Max power input: 100W peak.

SPL: 87dB with 1W at 3.3ft.

Frequency response: 50Hz to 25kHz.

Crossover frequency: 2kHz.

Features: 2-way, 8in lf unit with vacuum formed plastic cone, 1in hf Son Audax unit of soft impregnated fabric.

Dimensions: 13 x 25 x 12in, 30lb.

Price: £298 pair.

ML

Type: studio monitor.

Impedance: 8Ω.

Max power input: 25W programme.

SPL: 98dB with 1W at 3.3ft.

Frequency response: 50Hz to 20kHz.

Dimensions: 8 1/2 x 13 x 7 1/2in.

Price: £220 pair.

IMF (UK)

IMF Electronics Ltd, Westbrook Street, High Wycombe, Bucks HP11 2PZ.

Phone: 0494 35576. Telex: 83545.

RSPM MkIV

Type: monitor system.

Impedance: 4-8Ω.

Max power input: 150W.

SPL: 96-98dB with 40W at 3.3ft.

Frequency response: 17Hz to 'beyond audibility'.

Crossover frequencies: 350Hz, 3kHz and 13kHz.

Features: 4-way, 11 3/4 x 8 1/4in flat polystyrene bass unit loaded by transmission line, 6in plastic cone mid unit, 1 3/4in diaphragm high gauss tweeter, 3/4in chemical dome super tweeter.

Dimensions: 19 3/4 x 39 3/4 x 16 3/4in, 100lb.

Price: on application.

JBL (USA)

James B Lansing Sound Inc, 8500 Balboa Blvd, Northridge, Cal 91329, USA.

Phone: (213) 893-8411.

UK: Harman (Audio) UK Ltd, St John's Road, Tylers Green, High Wycombe, Bucks HP10 8HR.

Phone: 049481 5331.

4301B

Type: broadcast monitor, E version has built-in 10W amplifier.

Impedance: 8Ω.

Max power input: 15W.

SPL: 88dB with 1W at 3.3ft.

Frequency response: 45Hz to 15kHz.

Crossover frequency: 2.5kHz.

Features: 2-way, 8in lf unit, 1.4in hf unit, hf level control on front baffle.

Dimensions: 12 x 19 x 11 1/4in, 28lb.

Price: 4301B £159, 4301BE £240.

4311B

Type: control monitor.

Impedance: 8Ω.

Max power input: 40W.

SPL: 91dB with 1W at 3.3ft.

Frequency response: 45Hz to 15kHz.

Crossover frequencies: 1.5kHz and 6kHz.

Features: 3-way using 12in lf, 5in mid and 1.4in hf units, front level control of mid and hf.

Dimensions: 14 1/4 x 23 1/2 x 11 3/4in, 46lb.

Price: £290.

4313B

Type: control monitor.

Impedance: 8Ω.

Max power input: 40W.

SPL: 89dB with 1W at 3.3ft.

Frequency response: 40Hz to 18kHz.

Crossover frequencies: 1kHz and 4kHz.

Features: 3-way system, 10in lf, 5in mid units, and 1in dome radiator.

Dimensions: 14 1/4 x 23 1/2 x 10in, 47lb.

Price: £339.

4315B

Type: compact studio monitor.

Impedance: 8Ω.

Max power input: 60W.

SPL: 89dB with 1W at 3.3ft.

Frequency response: 35Hz to 20kHz.

Crossover frequencies: 400Hz, 2kHz and 8kHz.

Features: 4-way, 12in lf, 8in mid, 5in hf, and a uhf transducer.

Dimensions: 20 1/2 x 33 3/4 x 13in, 105lb.

Price: £795.

4331B/4333B

Type: studio monitors.

Impedance: 8Ω.

Max power input: 75W.

SPL: 93dB with 1W at 3.3ft.

Frequency response: 35Hz to 15kHz, 4333B to 20kHz.

Crossover frequencies: 4331B 800Hz, 4333B 800Hz and 8.5kHz.

Features: 4331B 2-way, 15in lf unit, hf compression driver with horn/lens assembly; 4333B 3-way with additional uhf transducer.

Dimensions: 24 1/4 x 30 3/4 x 20 1/2in, 130lb.

Prices: 4331B £895, 4333B £1,035.

4343B

Basically similar to 4333B, but with additional 10in mid unit, 4-way, crossovers 300Hz, 1.25kHz and 9.5kHz, dimensions 25 x 41 1/2 x 17in, 185lb.

Price: £1,300.

4350B

Type: studio monitor, designed for biamplification.

Impedance: 4-8Ω.

Max power input: 200W below 250Hz, 100W above.

SPL: 95.5dB with 1W at 3.3ft.

Frequency response: 30Hz to 20kHz.

Crossover frequencies: 250Hz, 1.1kHz, 9kHz.

Features: 4-way, twin 15in lf units, 12in mid unit, hf compression driver with horn and acoustic lens, and uhf transducer. May be mirror image mounted for optimum source location.

Dimensions: 47 3/4 x 35 x 20in, 261lb.

Price: £1,850.

KEF (UK)

KEF Electronics Ltd, Tovil, Maidstone, ME15 6QP.
Phone: 0622 672261. Telex: 96140.

Model 105 Series II

Type: reference series monitor.

Impedance: 8Ω.

Max power input: 200W, switchable LED flashes at lower specific levels.

SPL: 85dB with 1W at 3.3ft.

Frequency response: 38Hz to 22kHz.

Crossover frequencies: 400Hz and 2.5kHz.

Features: 3-way, 12in lf unit in separate enclosure, mid and hf units mounted in vertically aligned enclosures above.

Dimensions: 16 1/4 x 38 x 18in, 80lb.

Price: on application.

Model 101

Type: compact reference series monitor.

Impedance: 8Ω.

Max power input: 100W, electronically overload protected.

SPL: 81dB with 1W at 3.3ft.

Frequency response: 90Hz to 30kHz ± 2dB.

Features: 2-way, 4 1/2in bass driver and 1in dome tweeter. Crossover network maintains loudspeaker impedance.

Dimensions: 13 x 7 x 7 1/2in, 12lb.

Price: on application.

KLEIN & HUMMEL (West Germany)

Klein & Hummel, Kernat, Postfach 3102, D-7302 Ostfildern 4, West Germany.
Phone: 0711 455026. Telex: 723398.

48 ►



YAMAHA P2200 PROFESSIONAL POWER AMPLIFIER



the power is with you

Reliability, power, clarity, ruggedness and outstanding performance in the field.

If this seems good, it's no accident. Yamaha set out to show the industry and professionals what a good power amplifier is all about.

For details contact

BAN electromusic

89/97 ST. JOHN STREET,
LONDON, EC1M 4AB.

TEL 01-253 9410/9079
STUDIO 1549
TELEX 25960 BANMUS.

P2200 pro user price £395 inc.VAT
P2201 as P2200 but without meters £345 inc.VAT.

} Min 400 + 400w RMS
into 4 Ω before clipping.

Survey

UK: FWO Bauch Ltd, 49 Theobald Street, Boreham Wood, Herts WD6 4RZ.
Phone: 01-953 0091. Telex: 27502.
USA: Gotham Audio Corp, 741 Washington Street, New York, NY 10014.
Phone: (212) 741-7411. Telex: 129269.

O92

Type: studio monitor system, triamplified with crossovers.

Impedance: 4.7kΩ audio input.

Power output: 1f 120W, mid and hf 60W each.

SPL: max 105dB at 6.6ft.

Frequency response: 27Hz to 17kHz.

Crossover frequencies: 500Hz and 3kHz.

Features: 3-way, twin 10in lf driver, 3.5in mid, 1in dome hf unit. Built-in amplifiers, protection circuits and processing.

Dimensions: 17 x 31 x 12in, 66lb.

Price: £1,339.

O96

Type: studio monitor system, triamplified with crossovers.

Impedance: 4.7kΩ audio input.

Power output: 60W each amplifier.

SPL: max 100dB at 6.6ft.

Frequency response: 50Hz to 20kHz.

Crossover frequencies: 600Hz and 4kHz.

Features: 3-way, 10in lf unit, 2in mid and ¾in dome units. Built-in amplifiers, protection circuits and crossovers.

Dimensions: 12½ x 20½ x 11½in, 48lb.

Price: £657.

OY

Type: studio monitor system, bi-amplified with crossovers.

Impedance: 4.7kΩ audio input.

Power output: 1f 30W, mid and hf 30W.

SPL: max 104dB at 3.3ft.

Frequency response: 40Hz to 20kHz.

Crossover frequencies: 500Hz and 3kHz.

Features: 10in lf unit, 4in mid, hf unit, lf amplifier, mid and hf separate at high level.

Dimensions: 19 x 12 x 9in, 35lb.

Price: £490.

KLH (USA)

KLH Research and Development Corp, 145 University Avenue, Westwood, Mass 02090, USA.

Phone: (617) 326-8000.

UK: Webland International Ltd, 4 Cromwell Place, London SW7 2JJ.

Phone: 01-584 7735. Telex: 25570.

327

Type: monitor speaker.

Impedance: 8Ω.

Max power input: 80W.

SPL: 90.5dB with 1W at 3.3ft.

Frequency response: 55Hz to 18kHz.

Crossover frequencies: 900Hz and 3.6kHz.

Features: 3-way system, 10in lf unit, 4in mid and 2½in cone units, acoustic suspension enclosure.

Dimensions: 14 x 23¼ x 10¾in, 42lb.

Price: £264 pair.

KLH-1

Type: monitor speaker, 'computer controlled'.

Max power input: 200W.

SPL: 87dB with 1W at 3.3ft.

Frequency response: 30Hz to 20kHz.

Crossover frequencies: 500Hz and 4kHz.

Features: 3-way, twin 8in lf units with polypropylene cones, 4in mid, 1in hf unit.

Dimensions: 11 x 30½ x 10¼in, 125lb.

Price: £521 pair.

LOCKWOOD (UK)

Lockwood & Co Ltd, Lowlands Road, Harrow HA1 3AW.

Phone: 01-422 3704/0768.

Universal Major

Type: monitor system.

Impedance: 8Ω.

Max input power: 500W 1kHz, 250W 20kHz.

SPL: with K3808 unit 94dB with 1W at 3.3ft, with K3838 92dB.

Frequency response: K3808 35Hz to 20kHz, K3838 30Hz.

Crossover frequency: 1kHz.

Features: 2-way system using single point source dual concentric Tannoy K3808 or K3838 monitor kits, 15in.

Dimensions: 30 x 41 x 18in, 176lb.

Price: £720.

Studio Academy 1/2

Type: monitor system.

Infinite baffle enclosure available as 1 with Tannoy DC386 15in 70W, or 2 with Tannoy DC316 12in 50W.

Dimensions: 20 x 30 x 14in, 70lb.

Prices: Studio Academy 1 £370, Studio Academy 2 £330.

Miniature Monitor

Similar to Studio Academy, but using Tannoy DC296 10in 40W unit.

Dimensions: 15 x 22 x 12in, 38lb.

Price: £260.

MISSION (UK)

Mission Electronics Ltd, PO Box 65, London SW7 1PP.

Phone: 01-589 0048. Telex: 8813188.

Canada: Mission North America Corp, 89 Galaxy Blvd, Unit 10, Rexdale, Ontario M9W 6A9.

Phone: (416) 675-7730.

Mission 770

Type: broadcast monitor.

Impedance: 8Ω.

Max input power: 150W.

SPL: 84dB with 1W at 3.3ft.

Frequency response: 40Hz to 20kHz.

Crossover frequency: 2.7kHz.

Features: 2-way system, lf unit 8in polypropylene cone, hf unit 1in soft plastic dome.

Dimensions: 12 x 23 x 12in, 28lb.

Price: on application.

Mission 730

Type: monitor speaker.

Impedance: 8Ω.

Max power input: 175W.

SPL: 84dB with 1W at 3.3ft.

Frequency response: 40Hz to 20kHz.

Crossover frequencies: 800Hz and 2.2kHz.

Features: 3-way system, reflex, 10in lf unit plastiflex cone 4½in mid unit plastic cone, 1in soft dome hf unit.

Dimensions: 13 x 35 x 13in, 39lb.

Price: on application.

KEITH MONKS (UK)

Keith Monks (Audio) Ltd, 26-28 Reading Road South, Fleet, Aldershot, Hants.

Phone: 02514 20568. Telex: 858606.

USA: Keith Monks (USA) Inc, 652 Glenbrook Road, Stamford, Conn 06906.

Phone: (203) 348-4969/1045. Telex: 643678.

LS1/8

Type: bookshelf speaker, self powered.

Impedance: 10kΩ audio.

Max power: 10W.

Frequency response: 40Hz to 18kHz.

Features: 6½in long throw lf unit, twin 3in hf units, internal amplifier, LS1/8 has balanced jack input and captive mains lead, LS1/8 (XLR) has XLR inputs and XLR mains chassis socket, LS1/9 may also be externally dc powered.

Prices: LS1/8 £120, LS1/9 £133.30.

PHILIPS (Netherlands)

NV Philips Gloeilampenfabrieken, Eindhoven, Netherlands.

Phone: 040 791111. Telex: 511121.

UK: Philips Audio, 420 London Road, Croydon CR9 3QR.

Phone: 01-689 2166. Telex: 946169.

RH545

Type: studio monitor, uses motional feedback, triamplified.

Impedance: 10kΩ audio input.

Max power: 1f 50W, mid 35W, hf 15W.

Frequency response: 20Hz to 20kHz.

Crossover frequencies: 500Hz and 3kHz.

Features: 3-way system, integral amplifiers with motional feedback for bass, 12in lf, 2in dome mid, 1in dome hf units.

Dimensions: 17 x 25¾ x 14½in.

Price: £1,184 pair.

QUAD (UK)

Quad Electroacoustics Ltd, Huntingdon, Cambs PE18 7DB.

Phone: 0480 52561. Telex: 32348.

50 ▶

DOUBLE PRECISION EQUALIZATION ONE-SIXTH-OCTAVE



SERIES 4301
ACTIVE EQUALIZERS

- 1/6 Octave offers TWICE as much TUNING RESOLUTION as 1/3 Octave.
- Our 1/6 Octave Equalizers are COST-EFFECTIVE HYBRIDS of 1/6 Octave and broader bandwidth filters, typically 1/3 Octave. The DOUBLE RESOLUTION is concentrated where you need it the most for your tuning application.
- Recording Studio Control Rooms and other Small Volume Rooms tend to have more acoustic problems below 1000 Hz than above. Models 4301 and 4303 offer 28, 1/6 Octave bands from 40 Hz through 900 Hz plus 13, 1/3 Octave bands from 1000 Hz through 16 kHz.
- As the volume of rooms increase to Auditorium or Gymnasium sizes, the acoustic

problems tend to rise in frequency. Models 4310 and 4311 offer 29, 1/6 Octave Bands from 180 Hz through 4.5 kHz plus 12, 1/3 Octave bands from 31.5 Hz through 160 Hz and 5000 Hz through 10 kHz.

- We have a 1/6 Octave equalizer OPTIMIZED FOR SPEECH. The Model 4240 concentrates DOUBLE RESOLUTION in the SPEECH INTELLIGIBILITY band with broader bandwidth filters to trim either side.
- Quick and efficient installation of these new equalizers is made possible by the MODEL 200 SIGNAL ANALYZER which features inexpensive, field plug-in, INTERCHANGABLE FILTER SETS
- Call or write us for all the details

ONE SIXTH OCTAVE REALTIME ANALYZERS AVAILABLE

White instruments, incorporated

P O. Box 698 AUSTIN TEXAS 78767
PHONE AREA 512/892-0752

Distribution in U.K. & Western Europe
SCENIC SOUNDS EQUIPMENT
97-99 Dean St., London W1 Tel: 734-2812

Glowing praise and flattering photos about the Ex-Press Limiter from ADR.

Stereo input/output attenuators and 1.5:1, 2:1, 5:1 and limit (20:1) ratios.

Digital logic momentary switches for complete function mode control.

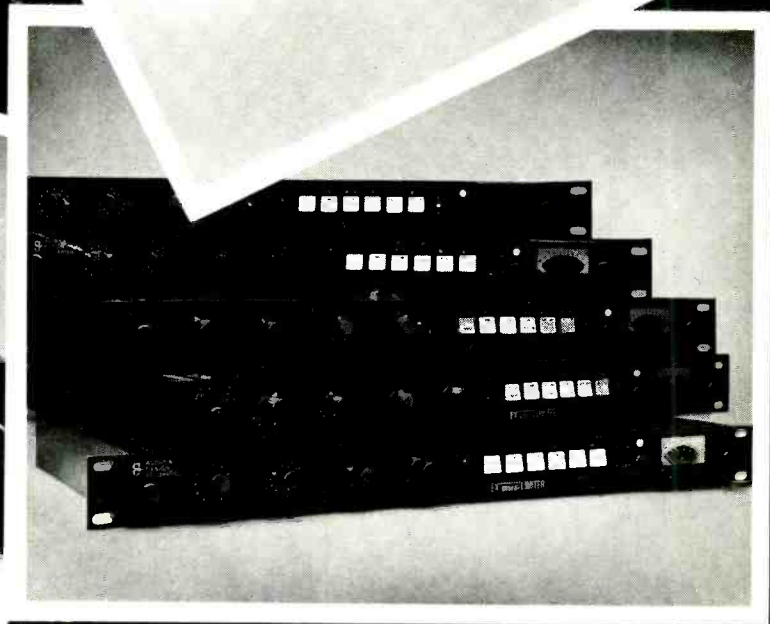
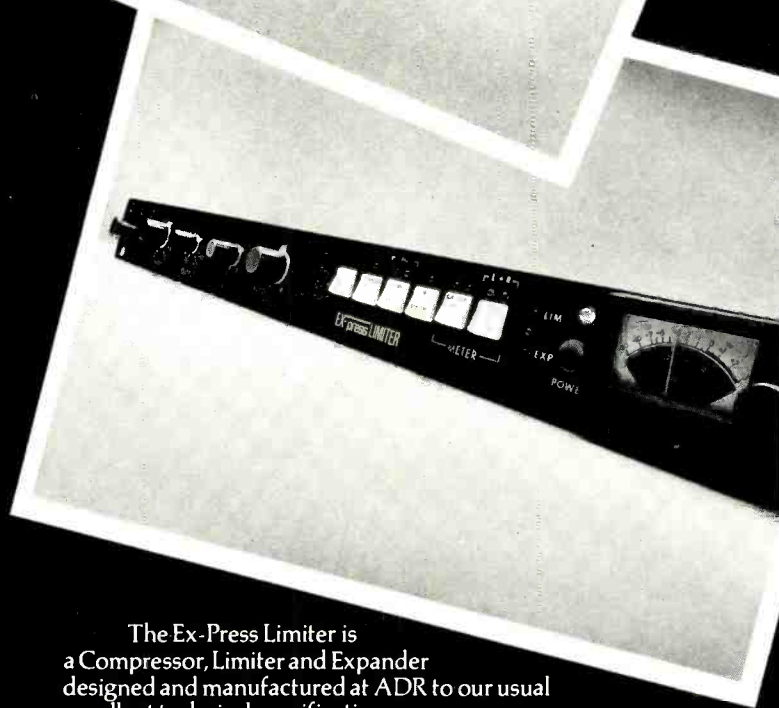
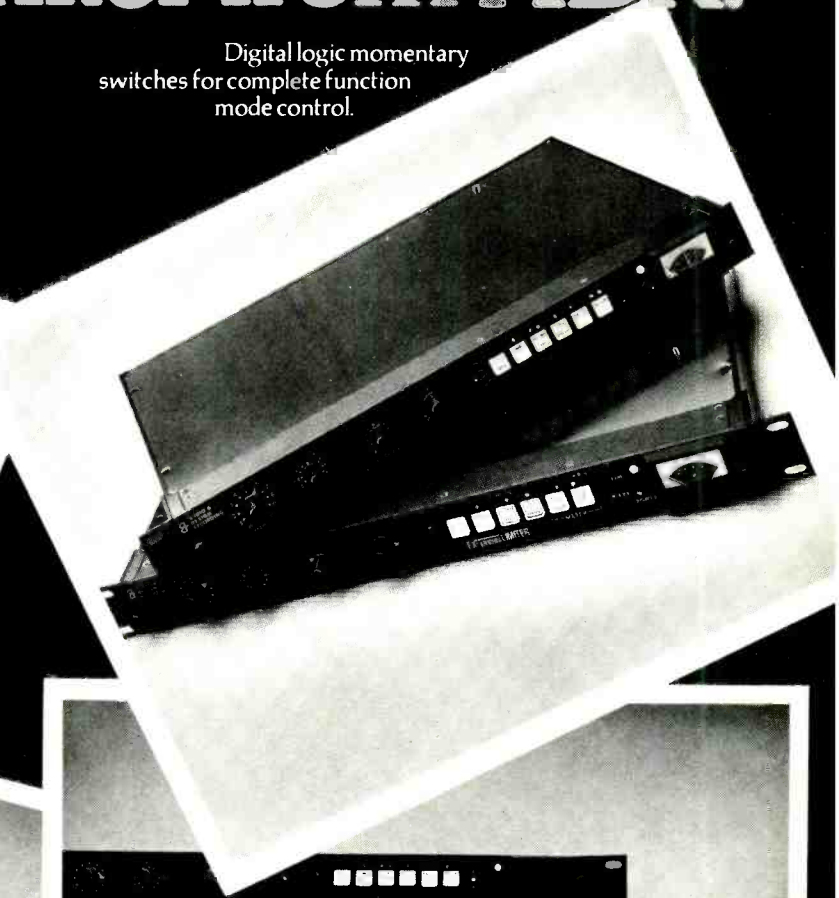
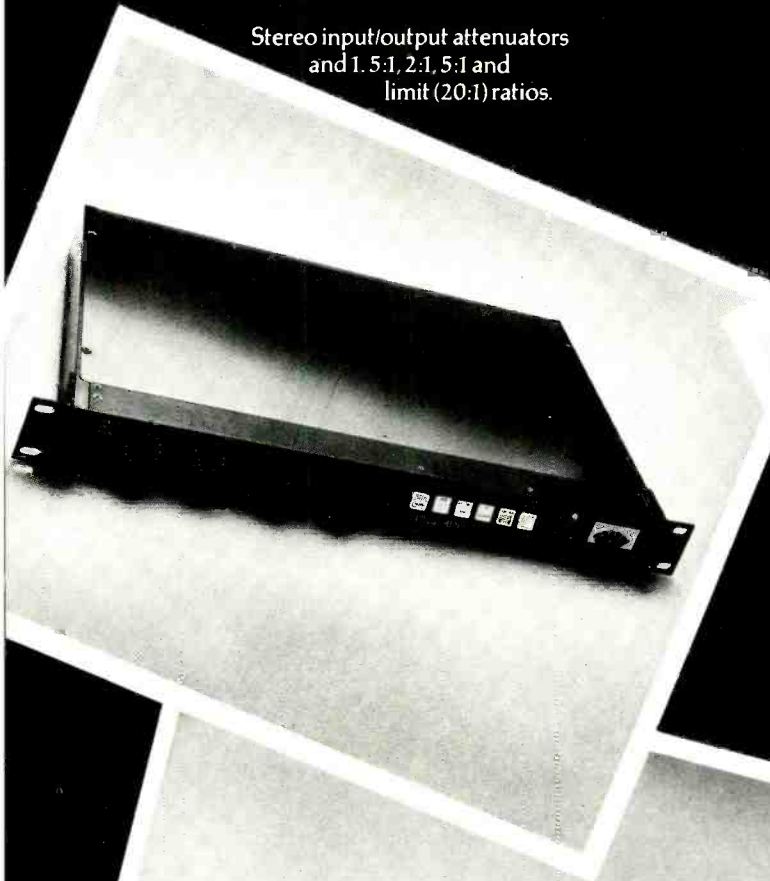

The Ex-Press Limiter is a Compressor, Limiter and Expander designed and manufactured at ADR to our usual excellent technical specification.

Function Control is by digital logic switches and Led indicators show options in use as well as remembering 'last use' settings when the power is cut.

The Ex-Press also has stereo input/output attenuators, variable attack and release times and an auto release network for maximum in-studio versatility.

All this in a 1 1/4" rack mounting makes the Ex-Press about the best signal processor on the market.

And it's in stock! Call us now, we're as near as your telephone.

Unique dual-calibrated meter with both V.U. and Gain Reduction scales.

RMS or Peak sensing compressor side-chain.



Audio & Design (Recording) Ltd.,
84, Oxford Road, Reading, Berks. RG1 7LJ.
Telephone: Reading (0734) 53411.
Telex: 847605 a/b TILLEX G.

Audio & Design Recording Inc.,
PO Box 786, Bremerton WA98310 U.S.A. Telephone: (206) 275 5009.
Telex: 152426 a/b NOTAB.

Survey

ELS Electrostatic

Type: electrostatic monitoring loudspeaker.
Impedance: 30-15Ω in range 40Hz to 8Hz, falling above 8kHz.
SPL: 93dB 50Hz to 10kHz, 100dB 70Hz to 7kHz.
Frequency response: 45Hz to 18kHz.
Features: uses electrostatic principles, mains powered.
Dimensions: 34 x 31 x 10in, 40lb.
Price: £263.

RCF (Italy)

Radio Cine Fourniture SpA, Via G notari 1/A, I-42029 S Maurizio, Italy.
Phone: 0522 91.840.
UK: Coveman Ltd, Dunchurch Trading Estate, London Road, Dunchurch, Rugby, Warwicks CV23 9LL.
Phone: 0788 815020.

BR200

Type: studio monitor.
Impedance: 8Ω.
Max power input: 200W.
SPL: 102dB with 1W at 3.3ft.
Crossover frequency: 2kHz.
Features: 2-way system, 15in lf unit, hf compression driver with horn and slant plate acoustic lens assembly.
Dimensions: 33 x 42 x 26in, 145lb.
Price: £477.98.

RED (UK)

Red Acoustics Ltd, Chelsea Wharf, 15 Lots Road, London SW10 0QH.
Phone: 01-351 1394.

Pro Monitor

Type: monitor system, biamplified.
Impedance: 68kΩ audio input.
Max power: twin 100W amps for lf, 50W for hf.
SPL: 115dB at 3.3ft, peak 120dB.
Frequency response: 40Hz to 18kHz.
Crossover frequency: 2.5kHz.
Features: 2-way system, uses twin, separately amplified and housed 8in lf units with Tristar front mounted acoustical device to increase sound dispersion, twin 1in dome hf radiators. Integral amplifiers and equalisation.
Dimensions: 19 x 13½ x 13½in, 70lb.
Price: £450, also Pro—PA double unit flight cased £1,000.

Pro Compact Stereo System

Basically similar to Pro Monitor, but using only single lf and hf radiators, providing 5dB less output, supplied as pair with electronics mounted separately.
Price: £500 pair.

REVOX

Revox ELA AG, Althardstrasse 146, CH-8105 Regensdorf, Switzerland.
Phone: 01 840.26.71. Telex: 52063.
UK: FWO Bauch Ltd, 49 Theobald Street, Boreham Wood, Herts WD6 4RZ.
Phone: 01-953 0091. Telex: 27502.
USA: Studer Revox America Inc, 1819 Broadway, Nashville, Tenn 37203.
Phone: (615) 329-9576. Telex: 554453.

Triton

Type: stereo loudspeaker system, uses combined lf unit, but separate hf units.
Impedance: 4Ω.
Max power input: 130W/channel.
Frequency response: 30Hz to 25kHz.
Crossover frequencies: 150Hz, 1.3kHz, 3.2kHz.
Features: 4-way system, uses single cabinet for twin 9½in lf units, with separate bookshelf size units for remaining low/mid 7in unit, 1¼in dome mid range unit and ¾in hf unit, crossover in cabinet.
Dimensions: cabinet 41 x 15 x 19in, bookshelf units 8¼ x 12 x 7in.
Price: system £750.

BR530

Type: monitor speaker.
Impedance: 4Ω.
Max power input: 150W.
Frequency response: 25Hz to 35kHz.
Crossover frequencies: 750Hz and 3kHz.
Features: 3-way system, 12½in lf unit, 2in dome mid, ¾in hf unit.
Dimensions: 15 x 24 x 13½in, 41lb.
Price: £336 pair.

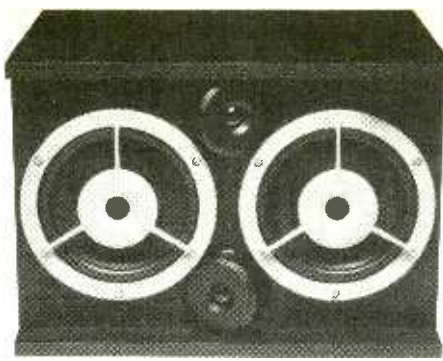

RED Pro Monitor

ROGERS (UK)

Swisstone Electronics Ltd, 4-14 Barmeston Road, London SE6 3BN.
Phone: 01-697 8511. Telex: 847777 for Swisstone.
USA: Reference Monitor International Inc, 2380 Camino Vida Roble, Carlsbad, Cal 92008.
Phone: (714) 438-1214.

LS3/5A

Type: small monitor speaker.
Impedance: 15Ω.
Max power input: 25W.
SPL: max 95dB at 5ft.
Frequency response: 70Hz to 20kHz.
Crossover frequency: 3kHz.
Features: two-way system, 4in lf driver with plastiflex doped bextrene cone, and ¾in dome hf unit.
Dimensions: 6½ x 7½ x 12in, 11½lb.
Price: on application.

LS5/8

Type: monitor system, biamplified.
Impedance: audio input.
Max power: two 100W amps.
Crossover: electronic.
Features: 2-way, 12in polypropylene coned bass/mid unit, hf dome unit.
Dimensions: 18 x 30 x 16in, 70lb.
Price: on application.

Export Monitor

Type: studio monitor, higher power version of the LS3/6.
Impedance: 8Ω.
Max power input: 100W.
Frequency response: 40Hz to 20kHz.
Features: 3-way, 8in lf unit, Celestion HF1300 hf unit, HF2000 'super tweeter'.
Dimensions: 12 x 25 x 12in, 31lb.
Price: on application.

Chartwell PM450P

Type: monitor speaker.
Impedance: 8Ω.
Max power input: 350W.
SPL: 110dB with 350W at 3.3ft.
Frequency response: 40Hz to 18kHz.
Features: 2-way, 12in low/mid unit, 1½in dome hf unit.
Dimensions: 18 x 30 x 16in, 75lb.
Price: on application.

SMC (UK)

SMC Loudspeakers, 76 Bedford Road, Kempston, Beds MK42 8BB.
Phone: 0234 854133.

AS40

Type: studio monitor.
Impedance: 8Ω.
Max input power: 70W.
SPL: 96dB with 11W at 3.3ft.
Frequency response: 45Hz to 20kHz.
Crossover frequencies: 500Hz and 3.5kHz.
Features: 3-way system, 10in dense pulp cone lf unit, 4½in doped cone mid unit, 1in fabric dome hf unit.
Dimensions: 12¾ x 25 x 14in, 40lb.
Price: £256 pair.

AL50

Type: studio monitors.
Impedance: 8Ω.
Max power input: 100W.
SPL: 96dB with 15W at 3.3ft.
Frequency response: 35Hz to 20kHz.
Crossover frequencies: 500Hz and 4kHz.
Features: 3-way, 12in plastic piston lf unit, 5in pulp cone mid, 1in fabric cone hf unit, acoustic labyrinth cabinet.
Dimensions: 15 x 29 x 17in, 75lb.
Price: £541 pair.

SPECTRA SONICS (USA)

Spectra Sonics, 3750 Airport Road, Ogden, Utah 84403, USA.
Phone: (801) 392-7531.

Model 3000

Type: monitor speaker, externally triamplified.
Impedance: 8-16Ω.
Max power input: lf 50W, mid 30W, hf 50W.
Frequency response: 20Hz to 20kHz.
Crossover frequencies: 800Hz and 4kHz (crossover not included).
Features: 3-way system.
Dimensions: 24½ x 37¾ x 17in, 118lb.
Price: \$1,271.

SPENDOR (UK)

Spendor Audio Systems Ltd, Station Road Ind Est, Hailsham, Sussex BN27 2ER.
Phone: 0323 843474.

BC1/2

Type: monitor loudspeakers.
Impedance: 8Ω.
Max power input: BC1 55W, BC2 50W.
SPL: BC1 74dB with 1V at 3.3ft, BC2 77dB.
Frequency response: 50Hz to 15kHz.
Crossover frequencies: 3kHz and 13kHz.
Features: 3-way system, Spendor 8in lf unit with bextrene cone (BC1 has 1in voice coil, BC2 1.5in voice coil), mid is Celestion HF1300, hf Coles 4001G. Optionally available as BC1A with 25W or 50W built-in amps.
Dimensions: 11¾ x 25 x 12in, 33lb.
Prices: BC1 £112.28, BC1A 25W £175.28, 50W £180.27, BC2 £117.34, BC2A 50W £185.34.

BC3

Type: monitor loudspeaker.
Impedance: 8Ω.
Max power input: 70W.
SPL: 77dB with 1V at 3.3ft.
Frequency response: 30Hz to 20kHz.
Crossover frequencies: 700Hz, 3kHz, 13kHz.
Features: 4-way system, Spendor 12in lf unit, Spendor 8in mid, Celestion HF1300 hf, Celestion HF2000 uhf. Optionally available as BC3A with 50W or 100W amps built in.
Dimensions: 15½ x 31½ x 15½in, 75lb.
Prices: BC3 £216.96, BC3A 50W £284.96, BC3A 100W £304.96.

SA1

Type: mini monitor loudspeaker.
Impedance: 8Ω.
Max power input: 40W.
Frequency response: 50Hz to 20kHz.
Crossover frequency: 3kHz.
Features: 2-way system, Spendor 4½in plastic cone lf unit, Audax hf unit.
Dimensions: 12 x 8¾ x 8½in, 15lb.
Price: £141.08 pair.

SA3

Type: monitor loudspeaker, biamplified.
Impedance: 20kΩ unbal, 10kΩ bal.
Power: lf 100W, hf 50W.
SPL: max 113dB.
Frequency response: 50Hz to 20kHz.
Crossover frequency: 2kHz (low level).
Features: 2-way system, Spendor 12in lf unit, Audax hf unit.
Dimensions: 15 x 33½ x 17in.
Price: on application.

TANDBERG (Norway)

Tandberg Radiofabrikk A/S, PO Box 9, Korsvoll, Oslo 8, Norway.
Phone: 02 23.20.80. Telex: 16441.
UK: Tandberg Ltd, 81 Kirkstall Road, Leeds LS3 1HR.
Phone: 0532 35111. Telex: 557611.
USA: Tandberg of America Inc, Labriola Court, Armonk, NY 10504.
Phone: (914) 273-9150. Telex: 137357.

TML3005

Type: monitor loudspeakers.
Impedance: 8Ω.
Max power input: 200W.
SPL: 90dB with 1W at 3.3ft.
Frequency response: 30Hz to 20kHz.
Crossover frequencies: 450Hz, 1.8kHz and 4kHz.
Features: 4-way system, 13in lf unit, 6in lower mid, 1¼in upper mid, 1in hf unit. Available as .mirror image pair.
Dimensions: 23½ x 34½ x 11½in, 88lb.
Price: £826.08 pair.

You've met our new baby...



Technical Specifications	SRM 15X	SRM 12X	LRM	SRM 10B
Maximum Input Power. Continuous (Peak)	120W (500W)	100W (350W)	100W (350W)	80W (300W)
Maximum Output SPL. Continuous (Peak) at maximum cont. input power at 1m anechoic	114dB (121dB)	111dB (116dB)	111dB (116dB)	109dB (115dB)
At a distance of 3m in a room measuring 7m x 9m x 2.3m and having a reverberation time of 0.35 ± 0.1 seconds over the band 100Hz – 10kHz, a pair of speakers each fed with half max. continuous input power pink noise band limited to 50Hz – 20kHz will produce:	110dB	107dB	107dB	104dB
Sensitivity 1W at 1m anechoic	94dB	92dB	92dB	90dB
Impedance Nominal (Minimum)	8 (5.5) ohms	8 (6) ohms	8 (6) ohms	8 (6) ohms
Frequency Response ± 4 dB measured in $\frac{1}{3}$ octave bands	52Hz – 20kHz	52Hz – 20kHz	55Hz – 20kHz	55Hz – 20kHz
Dispersion Included angle at -6dB points at 10kHz	90° conical	90° conical	90° conical	90° conical
Crossover Frequency Acoustic	1 kHz	1.4 kHz	1.4 kHz	1.2 kHz
Control Functions	Presence, Treble Energy & Roll-off	Treble Energy and Roll-off		
Enclosure Internal Volume Litres (cu. ft.)	175 (6)	68 (2.4)	46.5 (1.6)	35 (1.2)
Enclosure Dimensions Height x Width x Depth in millimetres (inches)	1020 x 650 x 390 (40 x 25.6 x 15.3)	846 x 446 x 372 (33.3 x 17.6 x 10.7)	584 x 400 x 275 (23 x 16 x 11)	524 x 350 x 265 (20.6 x 13.8 x 10.4)
Weight Kgs (lbs)	51 (112)	30 (66)	21 (46)	18 (40)
Finish	Oiled Walnut with 2 piece brown fleck grille.	Oiled Walnut with 2 piece brown fleck grille.	Oiled Walnut with short brown fleck grille. Also available with full height black grille.	Oiled Walnut with short brown fleck grille.

TANNOY®

PROFESSIONAL PRODUCTS DIVISION

Tannoy Products Ltd., St. John's Road, Tylers Green, High Wycombe, Bucks. 8P10 8HR Tel: Penn. (049481) 5221. Telex: 837116

TANNOY

Professional Products
are distributed in
the following countries.

Austria:

Karl Gangl Kg.,
1030 Wien,
Gartnergasse 8
Tel: 731289

Denmark

Per Meistrup
Artillerivej 40-3
DK - 2300 Copenhagen S
Tel. 01-57 09 10

Finland:

Audiotron,
Kiskontie 7,
00280 Helsinki 28.
Tel: 410688

France:

Malfroy,
7 Rue St. Vincent,
40103 Dax
Tel: 58 746569

Germany:

Harman Deutschland GmbH,
Hunderstrasse 1,
7100 Heilbronn,
Tel: 07 1314801

Holland:

Allwave Hi Fi,
Weteringweg 5,
Pijnacker
Tel: 01 7365961

Italy:

Gilberto Gaudi SPA,
Corso di Porta Nuova 48,
20121 Milan
Tel: (02) 664981

Spain

Mabel Sdad Anma
Epipolies 84
Barcelona 13
Tel. 235 4000

Sweden:

Tal and Ton
Kaempegatan 16
S-411 04 Gothenburg
Tel: 031 083620

Switzerland:

Musica A G
Ramistrasse 42,
8024 Zurich 1,
Tel: (01) 344952

U.S.A.:

B. G. W. Systems,
13130 South Yukon Avenue,
Hawthorne, California
Tel: (213) 9738090

Please note our new address
77/79 High St. Watford, Herts

Survey

TANNOY (UK)

Tannoy Products Ltd, St Johns Road, Tylers Green,
High Wycombe, Bucks. HP10 8HR.
Phone: 049481 5221. Telex: 837116.
USA: BGW Systems, 13130 South Yukon Avenue,
Hawthorne, Cal 90250.
Phone: (213) 973-8090. Telex: 664494.

M1000 Super Red

Type: studio monitor.
Impedance: 8Ω.
Max power input: 500W peak to 1kHz.
SPL: 94dB with 1W at 3.3ft.
Frequency response: 50Hz to 20kHz.
Crossover frequency: 1kHz.
Features: 2-way system, uses single point sound source 15in dual concentric drive unit, calibrated control network, optional electronic dividing network for biamping.
Dimensions: 28½ x 40½ x 17in, 60lb.
Price: £600.

Little Red

Type: studio monitor.
Impedance: 8Ω.
Max power input: 300W peak to 1kHz.
SPL: 90dB with 1W at 3.3ft.
Frequency response: 55Hz to 20kHz.
Crossover frequency: 1.2kHz.
Features: 2-way system, uses single point sound source 12in dual concentric drive unit, calibrated control network.
Dimensions: 15¾ x 23 x 11in.
Price: £250.

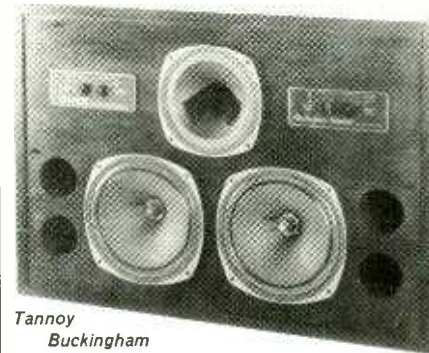

Tannoy
Buckingham

M2000 Buckingham

Type: studio monitor.
Impedance: 8Ω.
Max power input: 1000W peak to 350Hz.
SPL: 94dB with 1W at 3.3ft.
Frequency response: 35Hz to 20kHz.
Crossover frequencies: 200Hz and 3kHz.
Features: 3-way system, uses twin 12in lf drivers, and single point sound source 10in dual concentric drive unit for mid and hf.
Dimensions: 40½ x 28½ x 17in, 176lb.
Price: £935.

M3000 Classic

Type: studio monitor.
Basically similar to M1000 Super Red but extended low frequency response to 40Hz. SPL is 92dB with 1W at 3.3ft.
Price: £600.

SRM15X

Similar to Super Red, using same 15in dual concentric unit and crossovers, but more compact and free standing cabinet.
Dimensions: 25½ x 40 x 15in, 112lb.
Price: £460.

SRM12X

Similar to SRM15X, but 12in unit, 350W peak.
Dimensions: 17½ x 33 x 11in, 66lb.
Price: £275.

SRM10B

Similar to Little Red monitor, but uses 10in dual concentric unit and more compact cabinet, 300W peak.
Dimensions: 14 x 20½ x 10in, 40lb.
Price: £200.

UEP (UK)

Unique Electronic Products, 26 Woodstock Road,
London NW11 8ER.
Phone: 01-458 8118/5157. Telex: 922488 ref 67 UEP.

Dynaribbon pro reference monitor

Type: professional monitor.
Impedance: 8Ω.
Max power input: nominal 75W.
Frequency response: 40Hz to 20kHz.
Crossover frequency: 1.5kHz.
Features: 2-way, 8in bextrene cone lf unit, ribbon horn 'acoustic transformer' hf unit.
Dimensions: 12 x 30 x 16in, 65lb.
Price: £780 pair.

Compact Pro monitor

Type: professional monitor.
Impedance: 8Ω.
Max power input: nominal 50W.
Frequency response: 50Hz to 20kHz.
Features: 3-way system, uses Coles 2000 8in bextrene cone plastic chassis lf unit, Coles 3000 modified tweeter, 4001 super tweeter.
Dimensions: 12 x 24 x 12in, 44lb.
Price: £968 pair.

UREI (USA)

United Recording Electronics Industries, 8460 San Fernando Road, Sun Valley, Cal 91352, USA.
Phone: (213) 767-1000. Telex: 651389.
UK: FWO Bauch Ltd, 49 Theobald Street, Boreham Wood, Herts WD6 4RZ.
Phone: 01-953 0091. Telex: 27502.

Time Aligned Model 811

Type: studio monitor system.
Impedance: 8Ω.
Max power input: 75W.
SPL: 87dB with 1V at 3.3ft.
Frequency response: 80Hz to 15kHz.
Features: 2-way system, single woofer with coaxial hf horn, available as mirror image for stereo.
Dimensions: 26½ x 20¾ x 17½in, 110lb.
Price: £647.

Time Aligned Model 813

Type: studio monitor system.
Impedance: 8Ω.
Max power input: 75W.
SPL: 89dB with 1V at 3.3ft.
Frequency response: 40Hz to 15kHz.
Features: 3-way system, woofer with coaxial hf horn, additional 15in direct radiating driver, available as mirror image for stereo.
Dimensions: 31 x 36 x 23in, 221lb.
Price: £931.

Time Aligned Model 815

Basically similar to Model 813, but twin 15in drivers in addition to coaxial woofer with hf horn.
Dimensions: 43½ x 32 x 19½in, 225lb.
Price: £1,164.

WESTLAKE (USA)

Westlake Audio, 6311 Wiltshire Blvd, Los Angeles, Cal 90048, USA.
Phone: (213) 655-0303. Telex: 698645.

HR-1

Type: studio monitoring system, external quadamplified.
Impedance: 4-16Ω.
Max power input: 400W below 1kHz, 80W to 4kHz, 30W above 4kHz.
SPL: 96.8dB with 1V at 1m, max 130dB.
Frequency response: 34Hz to 16kHz.
Crossover: Westlake HR-1X active crossover mandatory.
Features: 4-way with twin lf units, mid, and wooden horn hf unit, external amplifiers and crossover.
Dimensions: 44 x 31 x 21in, 325lb.
Price: on application.

WHARFEDALE (UK)

Rank Hi Fi, Highfield Road, Idle, Bradford BD10 8SF.
Phone: 0274 611131.

Laser 400

Type: monitor speaker.
Impedance: 6Ω.
Max power input: 120W.
SPL: 89dB with 1W at 3.3ft.
Frequency response: 38Hz to 26kHz.
Crossover frequencies: 1kHz and 4.5kHz.
Features: 3-way system, 10in mineral filled lf driver, 4in bextrene mid unit, 1¾ x 1in flat field transducer.
Dimensions: 13½ x 26¼ x 13¾in, 44lb.
Price: on application.

PCM for all

Audio enthusiasts are discovering that the quality of digital recordings made by the BBC with their Sony 1600 PCM system is so good that an off-air tape copy, made on good analogue equipment, is virtually equivalent to a first generation master tape. So far the choice of material digitally recorded and transmitted by the BBC has been limited by the virtual impossibility of editing with the system in use. But as soon as this situation is rectified, perhaps by purchase of a Sony editing unit as shown at the London AES, there's no doubt that the Beeb will be making more and more use of their digital system. Heaven knows what this will do to record sales if the record companies don't make strenuous efforts to improve pressing quality. Can you blame a hi-fi enthusiast for not buying an expensive, warped and blemished analogue pressing when the audio equivalent of a first generation master tape is coming down the aerial free, gratis and for nothing. But can the record companies afford to spend more on pressing? One suggestion gaining strength in the record industry is that there may have to be a re-think on the price structure of disc releases. Is it reasonable, some people are asking, for a piano solo record to cost as much as a full orchestral and choral performance? After all we don't pay the same for an encyclopedia as a short novel.

Another spin off from the BBC's use of digital recording could hurt the Post Office. At the present time, BBC Radio hires Post Office analogue land lines to relay outside broadcasts back to the studio for live transmission. The BBC's digital equipment has been used to cover these OBs as a back-up and the digital recording has been transmitted a few days later. But it hasn't escaped anyone's notice that the delayed digital recordings sound better than the analogue landline originals. The landline links are not only of inferior audio quality to the digital masters, they are also expensive to hire. Why not, it's being asked in the perennially poverty stricken BBC, do away with the use of land lines altogether and simply drive the digital tape back to London in a car for transmission the next day, or even later the same day? After all it doesn't really matter a hang whether a Tuesday concert is broadcast on Tuesday or Wednesday because, unlike sporting events, few concerts end with an unpredictable surprise. There's even an advantage in putting out 'live' broadcasts the next day. Anyone lucky enough to attend the concert in person will have the chance to hear it again the next day.

Digital News

It's all systems go now for digital recording. So here is the news behind the news. It's not all good.

3M have already installed a 32-track and 4-track digital system including a digital editor at the Roundhouse Studio in Chalk Farm. Although mixdown still requires a return to analogue, via the Harrison desk, Roundhouse can make digital butt joints using the first generation 3M editor — it is in fact the actual unit shown at the London AES. Roundhouse

doesn't have a cutting room but the Virgin Townhouse in London can cut from digital tapes using the 3M preview unit, which delays the signal coming off digital tapes by up to 1.3s on each channel.

The Roundhouse still has its 'old' Studer 24-track machine and artistes can choose between analogue and digital recording. There's a premium, of course; digital basic time costs a basic £80 an hour and analogue £55. There's a premium on tape too; digital 1in multitrack tape costs £100 a reel as opposed to £60 for 2in analogue. But for that extra money groups get none of that good old analogue tape hiss, an extra eight tracks to play with and the opportunity to cook the tape to unprecedented levels. They can for instance record spikey beasts like tambourines well into the analogue red.

Although well cooked digital tape may sound wonderful on studio monitors it can't really mean too much to the average buyer. Even if discs could be cut with a dynamic range approaching the 90dB range offered by the 3M recorders, people who bought them would be more likely to complain than congratulate the producer. The ambient noise in most homes is likely to be around 40 or 50dB and most domestic hifi systems will run out of steam and clip at well under 100dB.

It is true that low level music can be distinguished from higher level ambient noise and that only a few transients will peak at the top end of the dynamic range. So with careful gain level settings, a domestic reproduction system with apparently inadequate dynamic range can be made to perform better on wide range material than might at first appear likely. But in practice domestic listeners, (familiar only with compressed recordings and broadcasts) will tend to crank up the average listening level high enough to make the quiet passages of a wide range programme more readily audible. In so doing they will push the top end of the dynamic range up and out into orbit. Even if bulldozer loudspeakers and enough amplifier watts are available to cope with the massive peaks necessary for a high average listening level of wide range material, the neighbours will very soon start to demand drastic limiting with the amplifier volume control. So any commercial disc cut with anything approaching digital dynamic range will be quite unsuitable for normal domestic listening. Digital masters will thus have to be heavily compressed and limited for domestic release. But of course they will still be noticeably free from tape hiss and distortion, even where the master or individual tracks on the master mix have been bumped and copied through several generations.

Arguments on what is, and what is not, a practical dynamic range for domestic listening are only just around the corner. As soon as digital discs are available, mastering plants will have to take value judgements on just how many dB of range to offer the listener. It's hard to see how everyone, from extreme hifi buff to casual listener, can be satisfied with the same mastered range. Probably domestic reproduction systems of the future will have to have a variable compressor and limiter built in so that the home listener, rather than the studio or mastering engineer, controls the effective dynamic range.

And all this could start to happen sooner than you think.

The US firm dbx, now owned by BSR of the UK, has for years had a dbx encoded disc system available. For a variety of reasons the idea has never yet taken off, but now the company is starting to push the idea as a variable stop gap between conventional analogue and pure digital discs. dbx is to sell encoded discs which are mastered from digital master tape. Cost in the UK is around £12 a disc, with a simple replay only decoder selling at around £70. dbx discs are claimed to offer a dynamic range of 90dB from conventional vinyl, which in theory means that 3M digital master tape could be cut straight onto analogue vinyl without any compression or limiting. Incidentally even the best friends of dbx would have to admit that the system can be prone to noise modulation, ie background hiss pumping. But mastering from digital tape solves this problem in the simplest way possible; there isn't any tape hiss to modulate.

3M has ambitious plans for selling its digital recording systems around Europe, but add the rider that the system will only be sold in countries where there are trained service engineers. The wisdom of this policy was brought home quite dramatically during the course of a demonstration to the press and trade which 3M gave earlier this year at the Roundhouse Studio. Roundhouse were playing the first digital recording to be cut and issued from their system (*Mirror in the Bathroom* by The Beat, Ska band). Suddenly the Westlake monitors started spitting those viciously loud cracking sounds, which are an evil characteristic of digital glitching and muting. Within literally seconds, a 3M engineer chatting in the corner of the room had broken off his conversation, dived inside the recorder, diagnosed the fault (a PCB had been taken from its mount and only loosely plugged back) and corrected it. If he hadn't been there, and an engineer unfamiliar with the system had been left crawling round the floor looking for the fault, the whole credibility of the 3M system could have been blown for literally dozens of trade people present.

Two-bit release

Lo and behold, another wrong press release! Grundig has proudly announced (pity it was after the event) that the company was sponsoring a digital recording session at the Guildhall, Southampton. The occasion: conductor Simon Rattle's first digital recording. The equipment: EMI 2-channel machines. The work: Mahler's 10th. The orchestra: The Bournemouth Symphony. The motive: publicity.

According to Grundig, "digital recording effectively narrows the gap between the fidelity of the source and the quality of the very best replay equipment as exemplified by products in the new Grundig hi-fi range". Under the circumstances it seems a pity they managed to get the back-up technical description wrong. According to Grundig the EMI recorders use "a 12 bit digital system".

Sorry, but no. If whoever wrote the press release had checked with EMI they would have learned that the EMI recorders use a 14 bit system, but as two bits are for ranging, the system is equivalent to 15 bits. ■



Substantially more than just a recording console, the Solid State Logic Master Studio System is the world's only thoroughly integrated control room command center. The scope of the system's features affords a degree of creative precision that is without rival; yet the "total controller" approach actually simplifies studio operations. Producers have commented that the SSL brings previously impossible accomplishments within reach, while handling procedures which were once both tedious and difficult almost effortlessly.

A unique tandem-function logic network provides simultaneous command and status indication of both console and multi-track electronics. The most sophisticated studio software yet developed brings valuable computer assistance to recording and overdubbing as well as mixing. Comprehensive in-line signal processors, coupled with innovative signal routing, provide virtually un-

limited control of your audio without patching!

Control panel layouts are both logical and legible, allowing the most complex session requirements to be handled with nearly instinctive ease. Readily accessible modular electronics simplify maintenance, as does the extensive "Tests" program of the SSL Studio Computer. To ensure impeccable performance and reliability, production-line construction standards have been raised to the level of meticulous craftsmanship.

We were not satisfied to build just another recording console. Our challenge was to create, for the true artists in our industry, a powerful, elegant instrument which would not limit their creative expression in any way. The strength of this commitment has shaped one of the most exceptional products of recording technology ever offered: The Solid State Logic E Series Master Studio System.

Solid State Logic

Master Studio Systems

UK and EUROPE
Solid State Logic
Stonesfield
Oxford, England
Colin Sanders
099 389 324
TLX 837400

THE AMERICAS
Washington Musicworks Inc.
3421 M Street N.W.
Washington, DC 20007
Doug Dickey
East Coast (202) 333-1500
West Coast (213) 464-8034
TLX 440519

Prosound 80, London-

A preview

The Prosound '80 Exhibition will be held from Tuesday 2nd to Thursday 4th September, 1980 at the West Centre Hotel, Earls Court, London. Some 50 companies will be displaying their products and services, and in conjunction with the exhibition a seminar programme is being mounted. The seminars will cover technical advances in recording; sound reinforcement; the development of recording studios; and general aspects of professional audio. Facilities will be available for visitors to mixdown tapes in recording studio conditions. Outside the exhibition will be the Rolling Stones and Mobile One mobile recording studios which visitors will be able to look over.

- **AC Electronic Services:** range of mixers, crossovers, graphic equalisers and power amplifiers, including the *ACSP1000* stereo power amp and the *ACSM 16/6* mixer. Also the new *SCM24162 24/16/2* mixer.
- **Allen & Heath Brenell:** recently introduced *Syncon Series B* in-line modular console. Also the original *Syncon 16/24/28*-track console and the *AHB 8*-track package system. The *Series B* will be available in a 24-track to 2-track fully operable mixdown room to enable visitors to gain hands-on experience.
- **ATC (Acoustic Transducer):** range of loudspeaker drive units and the company's studio monitor loudspeakers which are now available in kit form.
- **Atlantex Music:** wide range of signal processing equipment from MXR, Ashly, and Furman Sound. Also Sescom audio interface boxes and a range of cables, connectors and multiway systems from Whirlwind Music.
- **Audio Reinforcement Services:** stage wiring systems and a new range of loudspeaker enclosures. Also new *Taurus* power amplifiers, professional conversions of the *Quad 405* power amp, Eela mixers, the Brooke Siren Systems *MCS Series 200* modular crossover and limiter system, and the Formula Sound *SI9G* graphic eq.
- **Audio Technica:** new *Artist Series* of mics, plus the established mic range, pick-up cartridges and stereo headphones.
- **Avcom Systems:** Telex high speed cassette duplication equipment, NAB cart machines, and the Telex *Audiocom* intercom system.

- **Beyer:** wide range of dynamic and condenser mics plus headphones.
- **Brodr Jorgensen:** Roland *RSS Series* of rack-mount signal processing units, *RE Series* of echo units, and Roland synthesisers, etc.
- **Buzz Music:** 'Music Works' range of power amps, graphic equalisers, crossovers, and disco equipment. Also flight cases and loudspeaker enclosures from associate company Sound Enclosures.

- **Cinesound International Enterprises:** display of magnetic tape heads, plus tapes and magnetic filmstock from Pyral.
- **Covemain:** RCF *AFSA1* 1/3-octave realtime spectrum

analyser; range of professional loudspeakers and compression drivers; a new studio monitor enclosure; and a range of mics.

- **Cripple Creek Case Co:** wide range of cases for instruments, consoles, amplifiers and tape decks.

- **Don Larking:** details of the company's new and used equipment retail operation. Also BEL flangers and noise reduction units and a Trident *Series 80 24*-track modular console.

- **Electro-Voice:** full range of professional mic and loudspeaker systems, plus a range of mixers and amplifiers from sister company Tapco.
- **Eurotronic:** range of PA and sound reinforcement equipment including the new *MC60* cassette/8-track cartridge music system.

- **Future Film Developments:** comprehensive range of cables, cords, connectors, jackfields, wiring aids and associated components, plus a wide range of audio accessories.

- **Hayden Laboratories:** Nagra portable tape recorders; Sennheiser mics and headphones; Sendor film sound equipment; and Telefunken tape machines.

- **ITA:** ITAM Model 1610 16-track recorder with modular electronics and full function remote control; *Model 806* 8-track; and the *10-4* and *Model 882* mixers. Also Stocktronics stereo echoplate; dbx noise reduction; Revox and Teac units; and Otari tape machines.

- **Kemble/Yamaha:** Yamaha sound reinforcement consoles including the *PM-1000 Series*.
- **Klark-Teknik:** new *DN60* 1/3-octave realtime spectrum analyser; plus the *DN27* and *DN22* graphic equalisers; *DN70* digital delay line and *DN71* controller; and the *DN34* analogue time processor.

- **Lake Audio:** details of the company's design, consultancy, installation, service and retail operations.
- **Lectriflex:** wide range of cables and accessories for power, control and instrumentation applications.
- **Lee Engineering:** Ampro cartridge recorder/replay units; Audi-Cord 100 Series cartridge recorder/replay units; Mckay Dymek communications receivers; and the *Optimod-AM* and *Optimod-FM* units from Orban.

- **Martello Sound:** range of PA equipment, plus the *Rello* cordless desk radio mic system.

- **MBI Broadcast Systems:** *Series 24A* broadcast/production modular mixer, plus details of the company's turnkey design and installation service.

- **Mega (Acoustic Design and Manufacture):** range of loudspeaker cabinets; plus a range of instrument and flight cases from CP Cases. Also instrument/flight case and cabinet hardware from JH Sessions.
- **Music Laboratory:** recently introduced PSE 1in 8-track conversion to the *Teac 80-8*. Also *PSE Super Red* and *Standard* flight cased monitors, phantom power supplies, and reverb units.
- **Music Systems:** range of glass fibre horn loudspeakers, plus new bass bins and wedge monitors.

- **Neal-Ferroglyph:** recently introduced *Penthouse Studio 8* tape recorder; new *Neal Model 312* stereo cassette recorder with *Dolby HX*; *SP7* 1/4in tape machine with various options; plus the company's other tape and cassette machines and audio test instruments.

- **Optical & Textile:** range of products from Swintek including the *dB-S* radio mic system.

- **PA:CE:** MM Electronics *DM Series* mixers, amplifiers, comp/limiters, and equalisers, plus the Bell Electrolabs modular effects system.

- **Peter & Nicholas:** comprehensive range of stands and accessories.
- **Plan Audio:** details of the company's studio equipment retail and studio construction operations.
- **Progressive Electronic Products:** wide range of mixer modules for self-constructed mixers, plus details of the company's custom-built mixers.

- **Rank (Strand Sound):** range of modular mixing systems plus the *SS10* graphic equaliser.

- **Rebis Audio:** *RA200 Series* compact modular signal processing system including a new 4-way jack module and rear rack mounting power supply. Also the *RA402* parametric eq and *RA301* compressor/limiter.
- **Recording Studio Design:** *RSD PA* mixers, power amps and crossovers, plus *Studiomaster* mixers and power amps.
- **Roger Squire:** wide range of equipment primarily for disco applications.

- **Scenic Sounds Equipment:** Amek sound reinforcement console, plus Deltalab ancillary processing equipment and other items from the wide range of audio gear handled by this company.
- **Shure:** new *SM63*, *SM77* and *SM78* microphones; *Pro Master* sound system; *SC39 Series* phono cartridges; and the full range of sound reinforcement mixers and mics.

- **Sigma Sound Enterprises:** *SSE* range of *Turbo PA* cabinets, plus electronic crossovers.
- **Statik Acoustics:** *SA100* analogue delay line; *SA30* stereo 3-way electronic crossover; *SA20* dual channel compact multi-spring reverb; and the *SA10* dual channel single octave graphic equaliser.
- **Steve Graham Audio:** cables, connectors and stage link systems.
- **Studio Equipment Services:** details of the company's design, installation and retail operations. Also, on display the *AHB Syncon Series B*, 2/4/8-track tape machines and mixers, and the *Teac Tascam 85-16* 16-track recorder.

- **Tannoy:** *Buckingham* 3-way monitor loudspeaker system; *Classic Dual Monitor* and *Super Red* loudspeakers; recently introduced *Little Red* monitor; and the company's hybrid passive/active crossover.
- **Toa:** comprehensive range of audio equipment including: horn loudspeakers and drivers; and 6, 8 and 16-channel mixers.
- **TRAD:** details and products from this company which specialises in second-hand equipment. Also Sound Workshop consoles.
- **Tresham Audio:** range of power amplifiers and graphic equalisers.
- **Turnkey:** wide range of products from various manufacturers including the various Soundcraft mixers and tape machines. Also details of the company's retail and turnkey operations. Visitors will be able to operate a working 24-track mixdown room complete with Solid State Logic automated console and Tannoy/JBL monitors courtesy of Turnkey.

- **Westrex:** wide range of PA and sound reinforcement equipment.

- **James Yorke:** details of the company's cassette recording, production and packaging system, plus the *Digitrax* cassette duplicator.

- **Studio Sound/Sound International:** editorial staff from both magazines will be on hand at the exhibition. ■

Our business is helping you with yours

Considering or upgrading a multitrack system?
We offer a select range of studio equipment, backed with advice, demonstration and service. Turnkey sell, install, lease or hire.

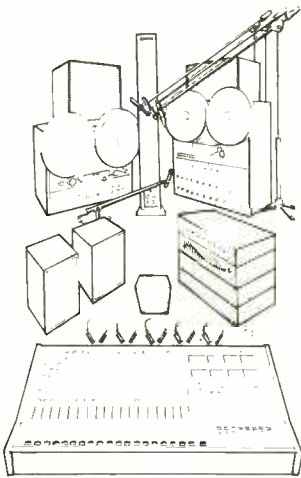

SYSTEMS

As our name implies, at **TURNKEY** we specialise in systems. From the simplest four channel setup to large eight or sixteen track installations, we can tailor a package to fit your exact needs. This can include acoustics advice, wiring, consoles, training and so on. Ask for our 'Quotation Sheet' or call Andrew Stirling now, on 01-440 9221 and discuss your requirements first hand.

MONITORING

QUAD is a remarkable company that has stayed in the forefront of monitor amplifiers for over a decade. Their current series, the 303 and 405 are available for medium and high power use.

JBL and **TANNOY** share the market for studio monitors worldwide. We demonstrate and supply matched systems for budget and big-time monitoring. The renowned **AURATONE** mini-mighty speaker cubes, are also in stock.



SIGNAL PROCESSORS

The choice is immense. We cannot sell them all so we pick and choose the best. Take **MXR** for example. This American based company has grown from making effects for guitars to studio equipment for professionals. Their digital

MICRO-PHONES

As with speaker systems, the choice of microphones is very much one of personal preference and we stock a range to satisfy most requirements. Our current favourites are the new **CSE** range by **AKG**. This is a system (in similar lines to the revolutionary **C451** range some years ago) of interchangeable bodies and capsules. As electret technology is used, the prices are correspondingly low.



delay and graphics are second to none. **Roland** of synthesiser fame, have introduced their 'Studio Series' of rack-mount units, including a phaser/flanger with extensive control facilities. We also have the budget **ACCESSIT** range.

ACCESSORIES

As well as supplying standard plugs, tapes etc., We have developed an exclusive range of 'hard to find' studio accessories.



Take for example our 'Great British Spring' - a high quality stereo reverb developed for the budget conscious studio.

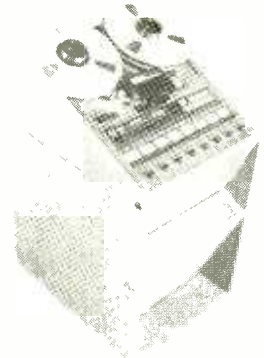

We also have . . . mike boxes . . . track sheets . . . preamplifiers . . . direct boxes . . . rolling consoles . . . and much more. Full details in our 'TURNKEY by mail' catalogue.

MIXERS

Our exclusive 1478 is a freebie with all four track recorders. Treble, bass, pan and level on four channels.

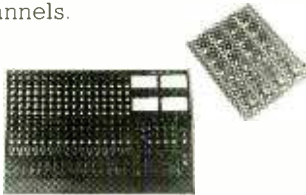

The **RSD**, 16 by 4, offers great value for money in budget multitrack mixers. Packed with features and our own mods for 8 track.

SOUNDCRAFT is well known for its' state of the art performance. We have extensive experience of the Series Two, 16 by 8.

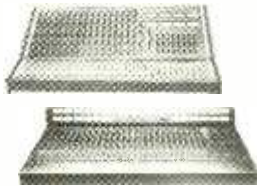

SYNCON by **A&H** is a major breakthrough in the design of big consoles for 16 and 24 track. We offer fast delivery and installation.

TAPE RECORDERS

REVOX lead in the field of 2 track mastering. The new **B77** includes all the features that were hot-rodded to the **A77**.

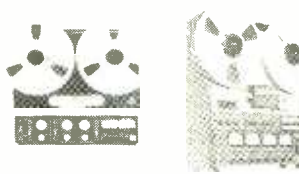

TEAC's new 3440 is the updated version of the 3440S. Now with varispeed, logic switching, monitoring and motion sensing.

The **TASCAM 80-8** is the most reliable half inch, 8 track recorder available. We also supply **dBx** and a studio console optionally.

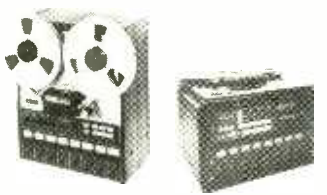

The 8 track, one inch from **SOUNDCRAFT MAGNETICS** is a sophisticated workhorse with unique remote control facilities.



Write or call for a free copy of the 'Turnkey Book', the 'Turnkey by mail' catalogue.

You are welcome to come and visit our extensive demonstration showroom at any time during normal office hours.

**8 East Barnet Road,
New Barnet,
Herts EN4 8RW**
Supply & Installation
of Recording Equipment
Telephone 01-440 9221
Telex: 25769

turnkey

Introducing a present



Once you go through a recording session with the new ATR-124 24-channel recorder by Ampex, you'll want to go through another. Because with each new session you'll discover something new you can do. Things that you can only do with a recorder that's full of features of the future.

ATR-124 gives you the unheard of: Time on your hands.

Which means you can use that time to give clients more of what they're paying for—your creative skills. With the ATR-124 microprocessor-based control system, you can pre-program what you want to do ahead of time so you won't waste studio time setting things up. When their time starts, you're ready to record by touching a single recall button.

ATR-124 also lets you duplicate a technique you may have used earlier in the session without

having to rethink what you did. Just touch the memory button and it'll all come back to you. ATR-124 lets you rehearse what you've got in mind, without recording it, to make sure what you've got in mind is right. Tape can be manipulated faster which means you'll get the sound you want sooner. And the chance to try something "a little different." All because of the speed and accuracy that ATR-124 puts at your fingertips.

ATR-124 doesn't take away your creativity, it adds to it.

The less time spent setting up, correcting, and redoing, the more time spent creating. And when you add features that help you create to the ones that help you save time, you've got one very potent piece of audio machinery. Take the control panel for instance. It's like nothing you've ever seen. Pushpads linked to a microprocessor give you a new level of creative flexibility. Program a setup, then change it. Then change it back, all with a single fingertip.

A repeatable, variable speed oscillator for pitch correction and special effects is built in. In addition

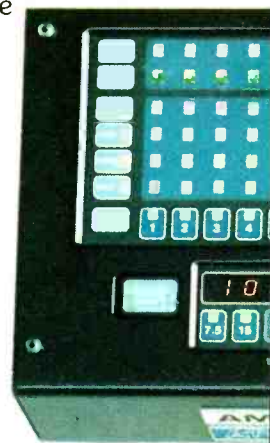

from the future: ATR-124.

to the standard output, there is an optional auxiliary output with each channel that enhances flexibility. So don't think that ATR-124 is going to

Memory, and Record Mode diagnostics. The point is this: If you like the ATR-100, you're going to love working with the ATR-124.

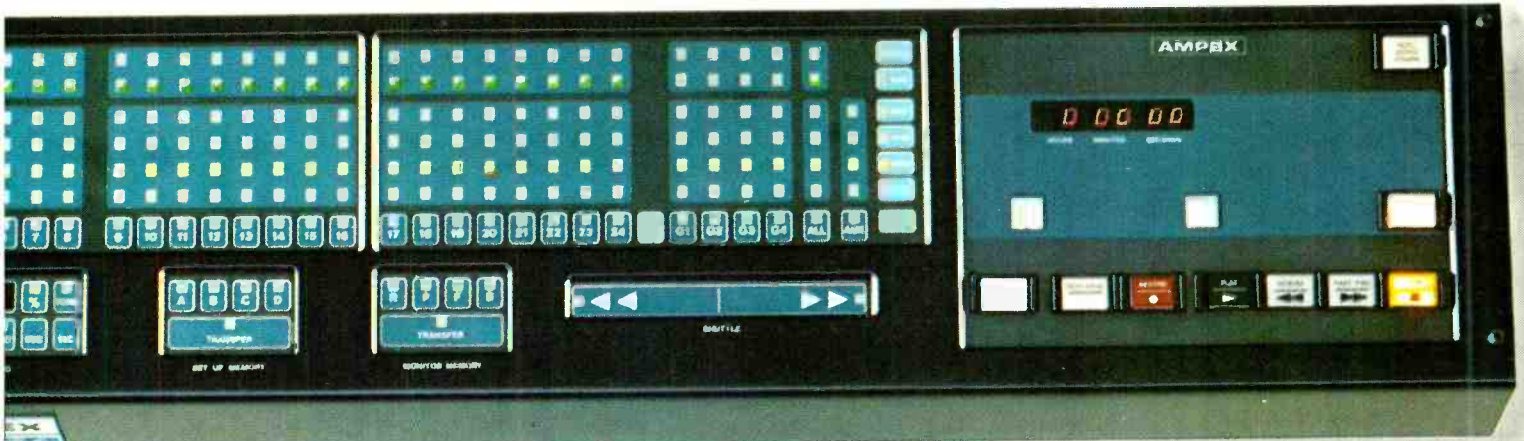

ATR-124's Control Panel. Speed and accuracy at your fingertips.

replace anything that you do. On the contrary, it's going to improve the skills you have, if not help you develop some new ones.

ATR-124 picks up where ATR-100 leaves off. It's only natural that the people who brought you the ATR-100 should be the ones to bring you something better. ATR-124 offers you 24 channels instead of 4. You also get many new and exclusive features. The kind that have set Ampex apart from the crowd for the last 30 years. Features like balanced, transformerless inputs and outputs; a patented flux gate record head; 16" reel capability; input and output signal bus for setup alignment; membrane switch setup panel; fingertip-operated shuttle speed control; and microprocessor-based synthesized Varispeed -50% to +200% in .1% steps or in 1/4 tone steps. ATR-124 also features microprocessor-based control of Channel Grouping, multiple 24-channel Setup Memory, Programmable Monitoring, Stay Alive

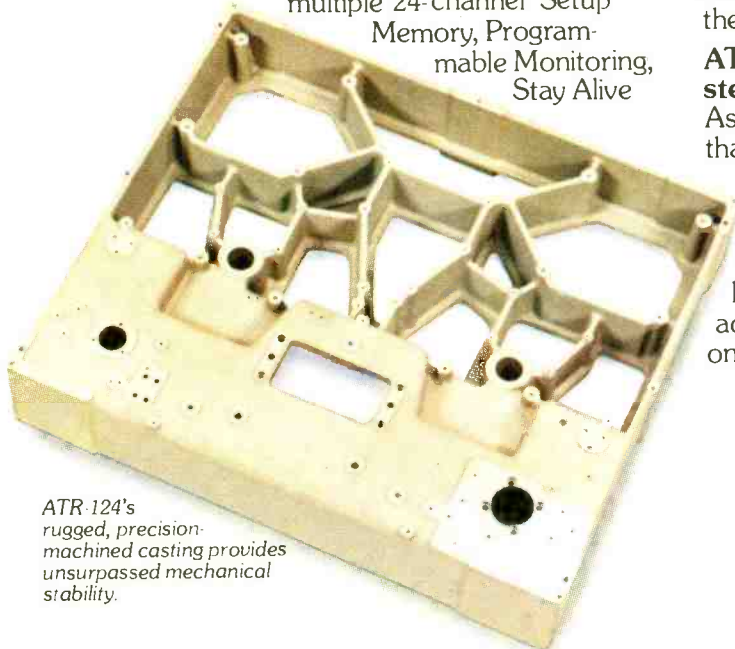

ATR-124's rugged, precision-machined casting provides unsurpassed mechanical stability.

ATR-124 options.

As impressive as the ATR-124 itself.

With the addition of a built-in Multi-Point Search-To-Cue (MPSTC), you can rehearse edits and control five tape-time actuated events and be compatible with SMPTE time code. Separately controlled auxiliary output amplifiers with each channel provide simultaneous monitoring of normal and sync playback as well as all other monitoring modes. A roll-around remote control unit can also be added to the ATR-124 which contains all control features normally found on the main unit.



ATR-124's Multi-Point Search-To-Cue (MPSTC). Provides 100 cue locations.

ATR-124. Your next step is to experience it firsthand.

As you scan the points we've covered, remember that you're scanning just a small portion of ATR-124's story. We haven't even begun to discuss the accessibility of key components for easy servicing and minimal downtime, or the features we've built in to give you greatly improved tape handling. To find out more, write to us at the address shown below. We'll send you a brochure on ATR-124, our latest audio effort.

ATR-124. Pure 24-Channel Gold From Ampex.

AMPEX

Listen to the future

Ampex Canada Limited
132 East Drive, Bramalea, Ont., Canada (416) 791-3100

Designing a professional mixing console

Steve Dove

Part One ~ Introduction and Recording/PA Console Description

AS PART of this project, a considerable amount of electronic design culminating in the construction of current professional standard modules was undertaken. Circuitry of these modules and much else is to be published in subsequent issues. In their most advanced form they exemplify the kind of circuitry found in consoles that are evolving toward complete programmability of all functions and control statii used in the mixdown process. This is primarily to give an insight into how the latest brand of 'magic' can be implemented. A discussion of how a console based around these modules can be used in conjunction with a proprietary automation system—in this case the Valley People's *Fadex* system—is dealt with in depth and that particular issue will probably be of use and interest to current owners of a *Fadex* or similar system based upon the Allison Research *65K Programmer*.

A simplified but no less well performing module based on a good, solid conventional 'buttons and knobs' format is described and this particular design (perhaps more than the 'all-singing' one) may be of interest to constructors, being that it was originally designed for a commercial mixer and hence is very cost-effective and easily producible. The card layout and terminations are such that they may be single front panel mounted or channel mounted, dependent on your willingness to play at metalworking!

Two distinct considerations interplay in determining the ability of a console to fulfil a given application. These two, the system and the electronics, have entirely differing parameters which need to be refined, but are nevertheless completely indivisible. The design approach taken in this instance was to devise an operationally workable (many aren't) multitrack recording and monitoring channel based upon the experiences of studios. Sufficient access is made to all the individual elements within the channel to enable them to be reconfigured to the extent of allowing establishment of almost

This series of articles was written in the hope of explaining in relatively straightforward and non-mathematical terms, the processes involved in the conception and design (both systems and electronic) of cost-effective consoles to today's upper-bracket commercial standard. Along the way a lot of ill-founded mystique about what goes on under the knobs will be attacked mercilessly, and a few hypotheses as to the future direction of audio control thinking will be mooted. Please see the editorial on Page 3 for further comments on the series.

any of today's conventional recording console formats.

The electronics, as much as being designed to perform the required functions, have been very carefully designed *not* to be a major influence on the 'sound' of the console—most causes of sonic disturbance can be attributed or predicted and these are mitigated in design, with *still* dubious circuit configurations avoided altogether. To the shock of some purists, commonly available integrated circuit operational amplifiers are used throughout, the reasons why (other than the obvious convenience) together with the reasons they acquired a bad reputation are treated in depth later in this series.

Operational amplifiers, known to their friends as op-amps, have in recent years revolutionised the concepts and systems capability of full performance audio consoles. Allowing system elements to be thought of, designed and implemented as building bricks, simplifies matters considerably but also entertains the valid criticism that console design can be relegated to 'do it by numbers' status. Fortunately, device idiosyncracies, subtleties and the entirely separate science of getting heaps of individual system elements to behave successfully as a total console, prevent design falling into the precincts of bureaucrat, marketing persons and other genres noted for inappropriate motives, insensitivity and general idiocy. This leaves it largely, at least for now, still in the hands of the people who know and care; intelligent user engineers and the tiny number of sympathetic electronic

engineers and manufacturers.

Manufacturers

Fortunately for the industry, a very large proportion of current console manufacturers started off in life as small bunches of studio engineers furtively constructing a mixer for their own ends in a garden shed or the managing director's loft—grass roots system design owing everything to immediate operational needs. Continuing in this vein in production, listening to and, most importantly, relating to customer requirements because they've played this game for themselves. Take now the few notable cases, no names mentioned, on both sides of the Atlantic of large prestigious manufacturers in which the system design people are career-jockeys and the electronic engineers probably haven't even set foot in a recording studio. A caricature, maybe, but not a million miles from the truth. The product, as beautifully made as it may be, probably had the maintenance people at the studios who took delivery of the first couple sweating nights to iron out the system gaffes and inadequacies.

The worst cases, though, are the 'rubber-stamp' console manufacturers who break out into a shifty-eyed sweat at the mention of anything other than a 'standard console'. Perfectly reasonable if you're selling 8 into 2s, but 40 by 32s? They, unfortunately are also the people who by the large quantity of product they place through carefully manipulating sales techniques, create a customer expectation climate facilitating ever increasing techno-

logical, hence monetary, inflation. It is a business. It has increasingly little to do with recording music.

Retaliation is partially what these articles are about—if as a result of reading them you feel more knowledgeable and better equipped to understand more fully what mixers are really about and not have to rely on sales guff, pretty pictures and hearsay as much, a worthwhile strike has been made. Even if you don't reach the extreme of constructing your own console, at least you will be more in tune with manufacturers' thinking and stand a better chance of finding one who cares as much about mixers as profiting from them.

History

Once upon a not so distant time, systems didn't exist. Mixers as such didn't exist. All the bits of electronics used in the control room sat there with all their inputs and outputs accessible, by way of a jackfield if you were prosperous, or by small screwdriver and sore knees if you weren't.

Mixing sources was accomplished by directly paralleling amplifier outputs (possible because all the old valved gear had a finite and predictable output impedance usually arranged to be a conventional balanced 600Ω) and either hoping or arranging that the destination had enough gain in hand to make up the accrued loss. Crude as that may seem today, from an engineering viewpoint it has a sheen of pure elegance. An amplifier was just that—a box that had balanced 600Ω source and termination impedances, maybe an alternative 'bridging' (>10kΩ) input term, a selectable amount of gain, and, of universal application from mic-amp through mix-amp to headphone amp. If you wanted to do more things, you got more boxes. Equalisers and limiters, a treasured few if there were any, were similarly universally applicable. Variable level control was again by true balanced 600Ω source and termination via studded rotary attenuators. The utter beauty of the systemless studio was that anything could go to anywhere

via anything else and be mixed or distributed at any point on the way.

Soon enough, amplifiers were hard-wired to attenuators and designated specifically 'microphone amplifier' or whatever—a system had been created. Some of these together with a mixing gain make-up amplifier were thrown in a box. The mixer was born.

It's been downhill all the way since, with ever-increasing numbers of system elements being tied together in increasingly circumlocuous manners in order to maintain some kind of flexibility—a system can be defined as a means of reducing the ultimate versatility of its constituent parts.

Once a 'mixer' was accepted as a system element itself, the rot set in further. There was no need to provide for connection of its internal interconnections to the outside world so (conveniently) the balancing transformers disappeared, and more economic alternatives to the stud attenuators operating at more convenient internal impedances evolved. By a more positive token, the electronics were becoming gradually optimised for specific functions to which they were designated, mic-amp, mix-amp or whatever. (The question nags whether a universal amplifier, by now all but obsolete, could be optimised for all the varying requirements.) Still, at least all the inputs and outputs of the mixer were still conventional. This held true until the slow demise of valves in professional audio.

Transistors were justifiably unpopular for a long time because of the numerous limitations they placed upon design. Headroom was severely limited because of the low rail voltages that could be applied to the early devices, they were noisy, the lower operating impedances and differing modes to valves took some getting used to and when they clipped, they actually clipped, rather than the graceful 'bending' people had known, and frequently taken advantage of, characteristic to valves. In order to realise a reasonably low stage distortion, many transistors in compound configurations using heavy amounts of negative feedback were used—a far cry from a single valve stage operating virtually open with little feedback. This gave rise to a peculiar phenomenon that sounded as if it hailed from science fiction—zero impedance.

It was possible by virtue of the mechanism of the heavy negative voltage feedback employed to render an amplifier's output insensitive (in terms of output voltage) to varying load impedances—obviously within the current handling capabilities of the output structure. Goodbye termination problems with the worry of compensating in level for differing load hook-ups. With the exception of long-line feeds, 600Ω terms were dead. High level balanced inputs were now almost exclusively 'bridge-

ing'. For better or worse, it has become the conventional studio interconnection technology.

It has taken until fairly recently for an accepted distinction and separate level specifications for the two technologies to be accepted.

The original transmission line level specification referred to a power level of 1mW at whatever the impedance was. It was a universal specification applicable to any signal of any frequency being transmitted along any bit of wire for any purpose at any rated impedance and is used extensively in radio-frequency work and other things entirely unrelated to audio—the dBm definition is sacred and can't be changed just because it doesn't suit us anymore. Zero dBm in a 600Ω load works out at about 0.775V rms this having also been adopted as the reference for use in general audio work. With zero impedance technology, although the working voltage is specified, the impedance varies so the power varies; 0.775V rms across say a 100Ω load works out at +7.78dBm, whilst across 10kΩ it would be -12.22dBm. Confusing to the point of insanity.

The reference level for zero impedance thinking is a voltage, and the one chosen is that familiar 0.775V rms that everyone was used to dealing with. That voltage is distinguished as 0dBu. Some lunatics have tried to impose a new universal reference for audio, based around a voltage level of 1V, called the dBV, which made some sums nice and easy, looked neat and proved confusing to anyone brought up on the dBm. Adding 2.2dB to everything was a dreadful bore. Or was it subtracting?

Monitoring

With the exception of disc mastering suites, most professional audio work ends up on magnetic tape, the replay of which is required often simultaneous to its recording. Source/return or A/B monitoring is as crucial a subsystem as the live recording chain itself. Until the advent of multitrack, monitoring was a fairly straightforward business consisting of, in essence, a switch that fed the monitoring chain from the desk output, the outputs of however many machines you had, the Light Programme or whatever. It was totally passive as far as the recording chain was concerned since any overdubs took place whilst the appropriate machine was being replayed through the recording chain and being mixed with the additional source(s). With little variation, this technique was used extensively in 2-track also, the final master representing only the first generation of the last overlay. (In retrospect, that is an advantage over contemporary multitracking where the master is at best the second generation of everything.)

Initially, as the number of tracks per machine increased so did the

number of mixer groups correspondingly. Each group had its own A/B switch relating to that track output and the associated machine return, with a level and pan control feeding an altogether separate stereo mixing buss from the recording chain. This independent stereo mix appeared as another source on the main monitor selector. This, alas, was insufficient. Foldback pre-fade mix feeds became no longer a luxury but a necessity, since the desk stereo output or a derivation thereof could no longer be relied upon to be roughly what the artist needed to hear—there was no proper desk stereo output at any time other than mixdown. In order not to clog up the input channels appropriate to the multitrack returns just so that pre-recorded tracks could be made accessible to the foldback busses, foldback feeds were added to the monitor system on each group. Effect sends also, just to let the monitoring sound pretty.

The monster had split itself amoeba-like into two entirely separate signal processing systems, with the curious situation that the mix used for monitoring during the original multitrack recording had to be transferred over to another system entirely some time for mixdown.

Perhaps the first major rationalisation (which occurred long after many 'X' input, 24 group, 24 monitoring consoles had been made) was a result of the realisation that you don't actually need 24 group faders sitting there full up, collecting coke and fag-ash. This instantly avoided a normally unwanted gain variable stage in the signal path which, if maladjusted, could upset noise or headroom performance.

A much smaller number of stereo mixing subgroups which could again be routed to any of the multitracks together with the individual channel outputs proved easily as flexible. But still there was duplication of monitor busses and main stereo mixing busses both with their attendant effects and foldback feeds—rarely being used simultaneously. At last the dawning of realisation that the pair, monitoring and stereo mastering busses, could be one and the same thing.

In-line monitoring recording systems had come to fitful fruition.

A potted 'action replay' of console evolution is an impossibility—well, maybe not an impossibility but it would make an excellent basis for a comedy series. We all have to be thankful for the cranks and visionaries along the way (often the same) who have manipulated or shocked the industry into grudgingly lurching back into step with technology's capability. These milestones represent significant plateaux of thinking that point the way to today's console concepts.

The designs published in this series were evolved around a full function in-line monitoring recording system, together with all its attendant frantic system juggling to make it opera-

tionally feasible. Each, or any, of the system 'modes' almost certainly is directly appropriate to other mixer formats and conventions, so little flexibility is compromised as a result of this approach.

Applications

Four distinct system requirements will be considered in order to demonstrate how the basic elements provided can be rearranged to suit the specific differing needs:—

- a full scale 32-track capable multitrack console;
- a (nominally) 12 input, 8 group system optimised for smaller scale multitracking;
- a (nominally) 32 input, 8 subgroup, stereo output mixer intended for large-scale PA;
- an on-air broadcast control console.

Broadcast technology traditionally owes little or nothing to recording, consequentially it will be regarded separately, although crossbreeding (both ways) has come up with interesting approaches to some critical applications, notably in monitoring.

The full, completely stacked, bells, whistles and foghorns (all transients faithfully reproduced) in-line monitoring and main signal path modular system is used in entirety on the 32-track capable system. As the complete module contains all the system elements that would be used in other module functions (such as stand alone groups, effect returns, or subgroups with subsidiary mixing and routing) all modules in the recording class utilise the same basic module designs with unrequired bits and controls left off or relabelled as needed. This 'bits left off' thinking as well as being superbly efficient for the scheduling and manufacture of a console, additionally is ergonomically delightful in operation—similarly acting functions on differing module types are found in just the same physical location, reducing 'knob-grovel' (searching for control functions) greatly.

The necessary trade-off between control density (ie cramming as many knobs into as small a space as possible) and ease of operation is simply resolved, if the designer has ever had to use one of his own creations!

Exceptions to this 'identical module/variable format' concept are obviously monitoring control for studio and control room, studio communications (talkback) and master foldback/effects send controls. Multi-destination routing, whether it be of control of the 32-track electronic switching matrix or of local conventional 8-group switching obviously differ and are (usually, but not necessarily always) mutually redundant, but both are allowed for within the concept of the universal modules.

Absentees from convention in-

Mixing console

clude a dedicated multi-input effects return module, since in nearly every studio with which the author has had dealings, they are disused in favour of additional full-function input channels. In fact, this is a most often quoted rationale for having an excess of channels over the size of the multitrack recorder in use. Admittedly, this absence could be a hang-up in a mobile recording situation where inevitably all the input channels get used up simultaneously on 'real' sources, the effect returns (unless it is a 'hot' to disc, 2-track or broadcast) almost always just end up as a guide in the monitoring. A way around this is to bring the effect returns back up into the 'machine return' inputs on channels not appropriate to the multitrack—those channels will in order to be recorded have to be routed elsewhere anyway, leaving their 'B' monitor chains free. Access in the monitoring module is made to the stereo buss for external extension of the monitoring capability for this, or any purpose in any case.

The channel (fig 1)

Three source input stages exist on the module intended as front ends for the main signal path and multitrack machine send and return monitor paths. The microphone amplifier which may be gain reduced and padded to act as a line-input amplifier if need arises, heads the main signal path, fixed-level electronically

balanced differential inputs acting as the machine send and return (or 'A' and 'B') inputs to the monitoring chain. No level adjustment is available to these stages as monitoring returns since the levels returning from the multitrack are (!) conventional and consistent. The microphone amplifier is gain adjustable sufficiently to enable most common microphone types to be used for most given circumstances.

Around the second stage of this amplifier is a gain-reduction element for limiting coupled from a peak-detector side chain. The detector is selectable to sense either pre-equaliser (ie post mic-amp and highpass filter) or after the post-equaliser insert point (in order to catch any extra level incurred during eq or inserts). The detector level is switchable between 'clipping' (2dB before supply rails) or an operational level, nominally +8dBu but tweakable up or down. Whether or not reaching the selected level activates the limiter is a switchable choice, but an indicating LED shows regardless — so a choice exists whether to use the limiter as protection, an operational effect or not at all, but still keeps a useful indication of channel level status or impending clipping.

The switch shown on the main module block diagram following the machine return input amplifier and mic preamp is part of the module status switchery (which will be described fully in due course). This particular switch disables the microphone preamp and selects the

machine return into the main signal path in the 'mixdown' mode—incidentally this switch and all the others concerned with status or routing may be electronic or mechanical, dependent on which design is utilised, but for the purpose of the block diagram conventional switch symbols are shown.

Following the second stage of the main path is a variable highpass filter of second-order response with an ultimate 12dB/octave roll off with the turnover frequency adjustable between 20 and 250Hz or bypassable by means of an end-stop switch on the control. The output of this is a line-amp capable of feeding any normal studio-type load in the case that the pre-equaliser insert point is selected and used, whilst the input to the equaliser section is a ground-free electronic differential input to simplify potential ground-path problems at this insert point. Similarly the return from the post-equaliser break point encounters a differential input.

Equalisation should at this point just be regarded as a 'black box' since again its specifics vary with the design used, being discussed in a subsequent article in this series.

The two basic variants of the equaliser both contain high and low frequency shelving of selectable turnover frequencies, with the lf shelf curve selectable to a 'bell' shape—otherwise meaning that the response falls back to unity below the turnover frequency selected. In addition either one or three sections of 'parametric type' curve genera-

tion are present, each with variable centre frequency, resonance sharpness (Q) and differential level with respect to unity gain. The output of the equaliser is again line-drive capable for the purpose of the post-equaliser insert point.

In the module's basic form, no provision is made for transformer balancing the break point outputs. The assumption is made that it is unlikely an insert point is likely to be required to feed anything beyond the confines of the control room and little untoward can happen to a high level, low impedance (if unbalanced) signal given that constraint.

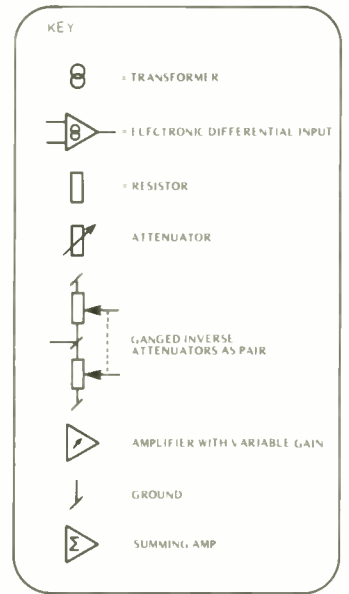
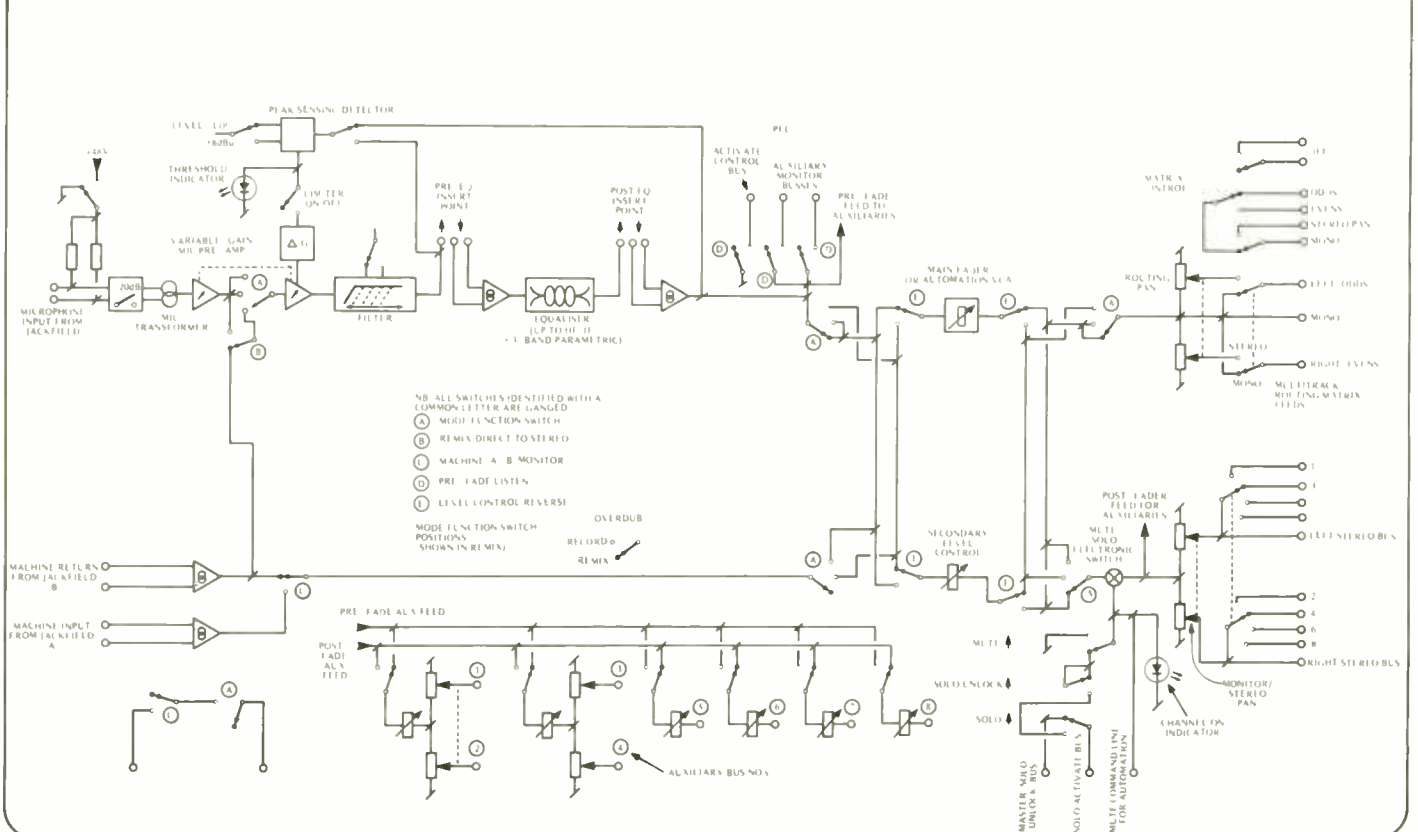

FIG1 BASIC SCHEMATIC, IN-LINE MULTITRACK RECORDING AND MONITORING CHANNEL



At TDK, we've developed a high performance video cleaning tape exclusively for VHS recorders.

Immodestly, we've called it the TCL Super 30. Super, because it can get even very dirty heads as clean as a new pin.

30, because in 30 seconds flat it restores the precise contact between heads and tape. Thus restoring the quality of both picture and sound.

One TCL Super 30 cassette will do this 200 times. (It runs in all for a total of 6,000 seconds.)

And, more to the point, after every 30 seconds (or 90 seconds if the heads are particularly dirty) you needn't rewind the tape.

As you know, the price of dirty heads is flecks on the picture, poor colour quality or flickering, unstable images. The TCL Super 30 offers the perfect solution. But this new cassette has an added significance. It provides Mary Whitehouse with a powerful ally in her campaign.

CLEANS UP TELEVISION BETTER THAN MARY WHITEHOUSE.

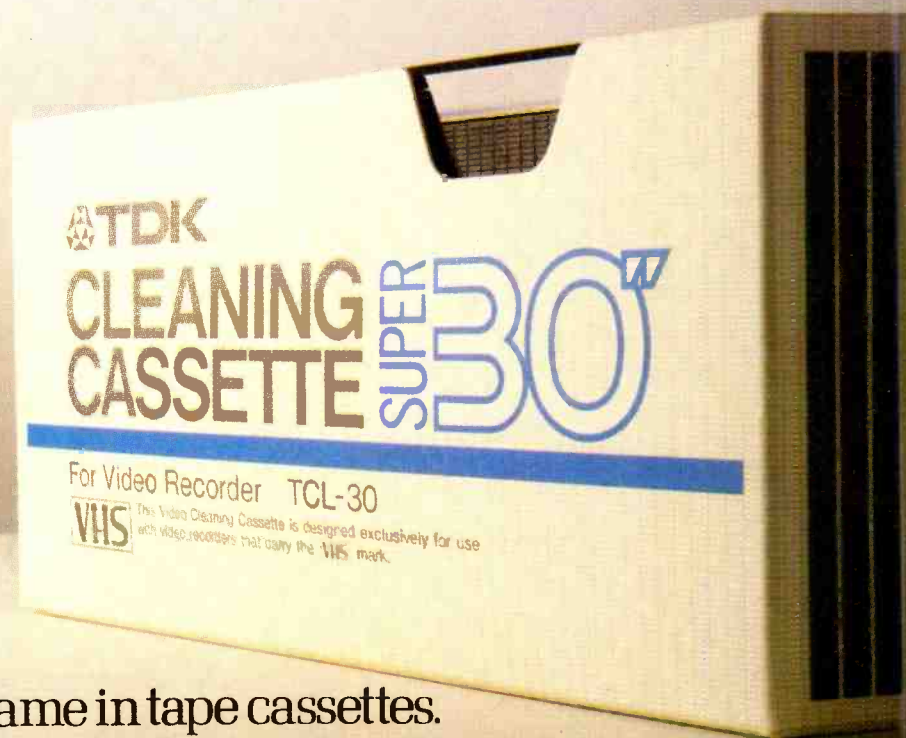

TDK. The great name in tape cassettes.

TDK Tape Distributor (UK) Ltd., Pembroke House, Wellesley Road, Croydon. CR0 9XW.
Eire: Peat Wholesale Limited, Chapel Lane, Parnell St., Dublin 1.

Mixing console

Whatever is being fed has its electronic ground referred to the mixer whilst the return, whether balanced or unbalanced, faces a ground free differential input eliminating grounding problems at least within that particular loop. There is easily sufficient common mode voltage swing capability in the differential input to cope with anything that may occur under normal operational circumstances.

Both the input and output of the equaliser section are available on the module card connector allowing, if required, full jackfield pre- and post-eq insert points. Under normal conditions only the post-eq position is necessarily available for a variety of reasons.

The greatest application for a pre-eq break point is to insert a limiter on 'untidy' sources or those with a high peak to mean level difference. There is a limiter available that can be wrapped around the mic-amp built into the channel. Should any access be required pre-eq during a tape replay mode, it already exists in the form of 'tape machine return/channel input' jackfield normalised/broken access and insert points.

The facility is present not only to fulfil this possible requirement, but to contribute to the systems' versatility as a whole.

Various modes

Unless you possess a mind warped in similar fashion to a railway enthusiast's, the status switchery following the post-equaliser break point will seem totally unfollowable. Logic diagrams are like that. To make life simpler, further sketch system drawings of the blocks arranged in the three main operating modes are shown in fig 2.

Fig 2a shows the 'record' mode used when the console's immediate function is principally recording lots of live sources simultaneously. The microphone/line input is accessible to all the response and dynamics modifying circuitry in the channel as well as being accessible externally through insert points. It passes through the main fader (or VCA if automated) and through to the multitrack routing matrix. The monitoring stereo busses are fed via their panpot from the secondary level control which is sourced from the multitrack input and return ('A' and 'B' switch) appropriate to that channel. All the usual monitoring functions (mute, solo) are available on this chain. PFL, though, is taken from the main signal path.

During 'mixdown', (fig 2b), the machine return is applied to the main signal path and is mixed onto the stereo busses via the main (or VCA) fader, whilst multitrack routing is still accessible for versatility's sake, through the secondary level control. Very useful if you run

out of effects sends! A function very closely related to mixdown is 'direct', shorthand for direct to stereo. The microphone preamp is recoupled to the main chain, everything else remaining the same as in 'mixdown', enabling direct live multisource mixes onto the stereo busses without having to access the multitrack routing.

'Overdub', fig 2c, is a half-way house between 'record' and 'mixdown'. This mode would be entered when most of the console is in 'mixdown' status, but individual tracks are still being laid or touched up. It is identical to 'record' with the exception that the main (VCA) fader is on the stereo busses feed in order to match functions with all the other channels which would be selected to mixdown (with all their main faders feeding the stereo busses). The ability to have all the main (VCA) faders on stereo mixdown whilst recording is still in progress means that the engineer can get a feel of the final mix and even start constructing sequences on the automation system during the 75th synthesiser overdub or vocal attempt. Two jobs for the price of one. If for any reason, valid or dumb, it is felt necessary to reverse the relative positions in the system of the main and secondary level controls, a button doing just that is available without otherwise upsetting the signal paths appropriate to the selected status. It is a

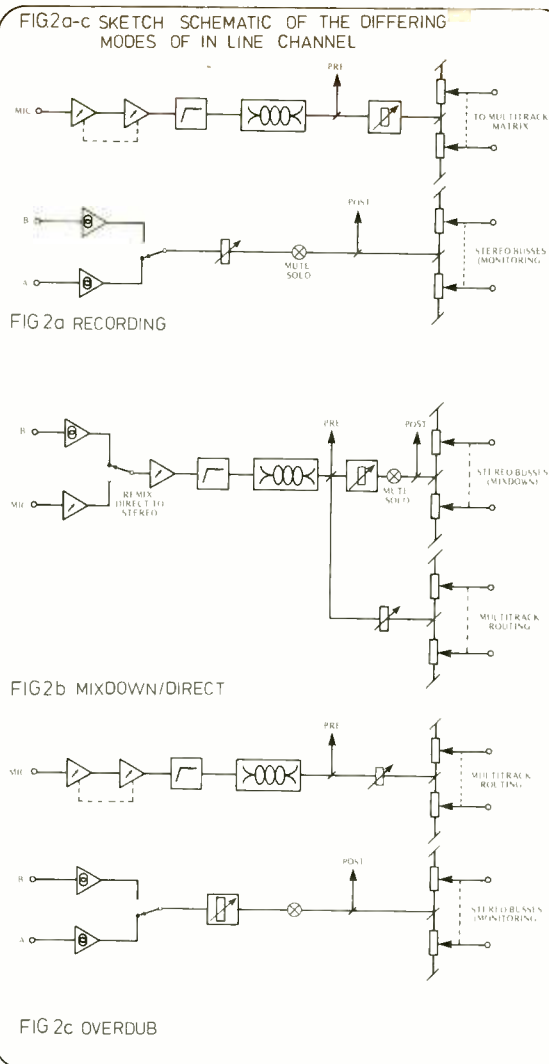

'local' reverse in that it still reverses the controls whether the channel status is defined by a console 'master' mode (in the case of the full electronic switching design) or by a channel command.

PFL and solo

Immediately following the post-eq insert diff-amp is the take off for the 'pre-fade listen' feed which, upon activation, sends the signal onto auxiliary stereo monitoring busses whilst the 'PFL activate' buss is simultaneously pulled, causing those busses to override whatever else may be selected on the main monitoring module. This does not interrupt at all any signal paths, other than the monitor speaker (or headphone) feeds—hence it is described as 'non-destructive' channel monitoring.

The 'solo' facility though, is 'destructive'. It might seem a little in the sledgehammer-to-crack-a-walnut vein, but depressing a solo button mutes every other source feeding the main stereo mixing buss, leaving just that particular channel present at whatever level and panned stereo position it originally held in the mix. A refinement to this is the 'solo-unlock' button, which keeps any channel upon which it is depressed 'open' despite the presence of an active muting control voltage on the solo buss. This is especially useful for channels utilised as effect returns since it is then possible to monitor in

'solo' any channel with any effects in use with that channel, all at their relative levels and in-place stereo. Since effect sends are generally fed from post-fader feeds, all those feeds on channels other than the one in 'solo' will be obviously muted also, thus leaving all the effect sends free of extraneous clutter.

Note: the individual channel 'mute' function uses the same electronic switch as the 'solo', but when the channel 'mute' is depressed the channel stays muted regardless of a 'solo' or any other function. A control line is taken from the 'mute' as a facility to either instruct or receive commands from an automation system, if one is in use.

A 'solo' only interrupts feeds to the main stereo busses (which are the monitor busses in 'record' and 'overdub' modes and the main console stereo mixing busses during 'mixdown') leaving the feeds to the multitrack routing matrix intact.

An interesting subtlety in this particular area of the system is that the prefader auxiliary feeds (which are usually used for studio foldback monitoring feeds) are taken from before the solo/mute switching. This prevents musicians using these cue-feeds thinking they've gone deaf suddenly, just because somebody in the control room has hit a 'solo' for their own benefit. An incongruity avoided.

A deliberate choice was made not to transfer the channel in solo onto the auxiliary monitoring busses (such as is the PFL) although it would mean the 'solo' could then become similarly non-destructive. The design problems involved in then isolating all the other effect feeds in order that the returned effects into the monitoring were solely those appropriate to the solo channel would be very, very messy indeed. Even then, unless a completely duplicate set of effects were in use solely for this facility, it would mean 'robbing' the effects from the mix that you were attempting not to interfere with in the first place! Conclusion: why bother with a separate solo buss? Essential non-destructive channel monitoring is why PFL is provided.

It is not beyond the 'ken' of most people to realise that a destructive 'solo' is potentially lethal. Other than crashing a mix half-way through because an idiot producer decided he wanted to solo something, the most heart-strain inducing possibilities are in live PA. Now, a 'solo' function is a real boon during a PA soundcheck—but trying to work out why at the beginning of a show all you can hear is a MW kick-drum—no fun in the slightest! For these reasons, two approaches are taken here. Firstly, when a 'solo' is hit all the channels that are consequently muted lose their 'channel on' LED indicators. Secondly, a console master 'solo disable' is in-

corporated, which is essentially a master of the individual channels' 'solo unlock' function, for use during those delicate moments.

Recorder control and routing

Other obscure switchery can be seen littering the periphery of the main system diagram. Adjacent to the machine 'A' and 'B' selector is a pair of switches—one ganged with that selector, and one ganged with the status switching, having continuity in 'overdub' mode. The object of this is to create a closing loop of contacts when the channel is in overdub and the monitor selector is switched to 'A' (as one has to when the actual recording part of an overdub commences). This closing loop may be interfaced with the multitrack recorder's record enable circuitry appropriate to that channel, hence allowing (provided the machine is primed) 'one-button' drop-in as soon as the 'A/B' selector is hit to 'A' and dropout (?) when it is returned to 'B'. An admitted disadvantage to this particular method is that it doesn't take into account the possible routing of the main channel path to a track other than the one to which its monitoring is related—that would require a subsidiary switching system to the routing matrix, which is another design exercise altogether.

It is a relatively unimportant consideration since as a function it is most likely to be useful once the majority of the basic tracks are recorded, defined and being used with their appropriate monitoring chains.

Ganged to the mono/stereo switch in the multitrack matrix feeds are off/stereo/odds/evens switch control lines for steering the matrix logic—the 'off' functions being the mute facility for this feed. It is kept separate from the stereo busses' mute since it would be quite a shame to stop recording something just because you didn't want to hear it in the monitors for some reason.

A variety of formats for switching matrices will be described blow-by-blow at a later juncture, but for now there are principally two arrangements for the purposes of system description.

The stereo/mono channel outputs together with the logic control lines for 16 pairs of odds/evens or stereo feeds and not least the on/off commands are intended to feed a specific matrix card constructed around two 1 of 16 analogue multiplexer ICs. Whilst it may seem like a limitation only being able to access any two tracks at a given time, the author has yet to hear any heart-rendingly convincing arguments for doing otherwise. An alternative to this card, populated with individually controllable switching elements can be

arranged to be free-access, but frankly some of the great advantages that these matrices convey—including simplified control, less panel space taken up with switches, and less money spent on same—are thrown away by doing so.

The multidevice card has an advantage that it may be populated for only as many groups as required, say 16, 20, 24 or 32. Both the multidevice and the large-multiplexer cards may be configured also into 1 into 32 switchers which, as will be discussed, is useful and advantageous in many system solutions, whilst the control functions and actual routing information on each card can be made to appear as a functional single 8-bit memory location for parallel data buss microprocessor control applications.

An overlap between differing system philosophies is apparent when the feeds to the multitrack matrix and the main stereo busses are scrutinised in fig 1. Hanging off the stereo busses' output is a pair of 4-way switches, intended as basic 8-track routing, which would not be needed if a stereo matrix routing system were in use. Similarly, the stereo matrix feeds would not be necessary in a system where the stereo 8-track routing were being employed. Taking this into account, the system PC card and metalwork are designed to house either, but not

both (at least not without an uncomfortable squeeze). An interesting crossbreed between the two may be handy for those who need matrix routing facilities (for say 24 or 32 sources) but are unlikely to be using an automation system with its inherent subgrouping capabilities. By using a 1 into 32 (say) matrix card from the 'un-panned' matrix feed (permitting channel-to-any-track grouping) and having eight subgroups driven off the stereo busses' output, each with further 1 to 32 matrix cards fed from them, a useful alternative evolves. Reduction of any number of sources (either live or during mixdown) may be made across up to four pairs of stereo tracks on the multitrack by using the re-routing on eight sub-groups. Each of the subgroups of course may be panned as another source in its own right back into any of the other subgroups and thence again across any pair on the multitrack. This system of consolidating subgroups into a defined physical area of the console is, if anything, simpler to use and more identifiable operationally than a totally stereo freegrouping system and almost certainly better suited to the more panic-fraught operational circumstances of live recording and broadcasting.

ONE SLAVE.. OR TWO?

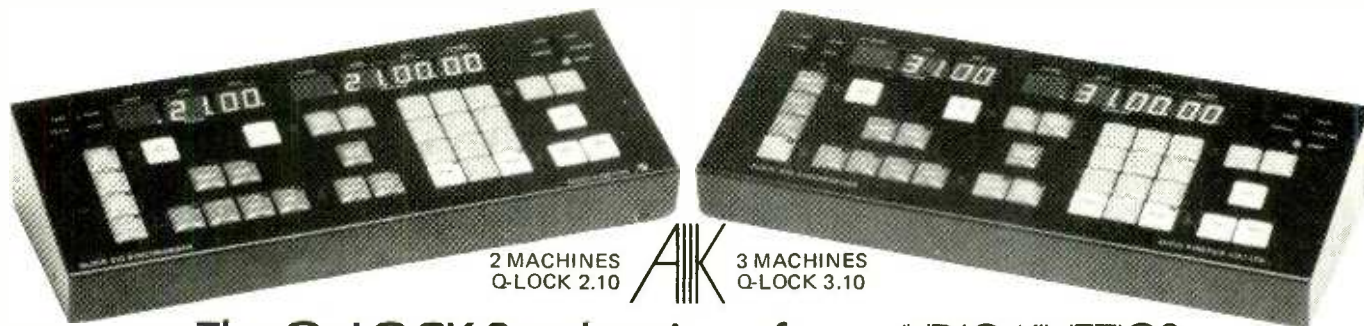

The Q-LOCK Synchronisers from AUDIO KINETICS

Before you buy an SMPTE Synchroniser, check:

That it uses tach pulses in wind, eliminating high speed tape on heads. This avoids degraded HF response and accelerated headwear.

That it transfers a minimum of wow and flutter from the Master to the Slaves. Typically a VCR with 0.2% WF causes an addition of 0.01/0.02% WF to the Slaves, when synchronised with Q-LOCK.

That it uses optimized software for uncompromised machine control.

That it can chase, read code at -30db, ride over dropouts, has an SMPTE generator, includes a 10 memory intelligent cycling autolocator, auto-record.....

Q-LOCK does.

Europe: AUDIO KINETICS (UK) LTD., Kinetic House, Verulam Road, St. Albans, Herts. AL3 4DH England Tel: 0727 32191 Telex: 299951
America: QUINTEK, 4721 Laurel Canyon Blvd., Suite 209, North Hollywood, CA 91607 Tel: (213) 980-5717 Telex: 194781

Mixing console

Auxiliary feeds

Auxiliary pre- and post-fader feeds again vary in configuration with opted design, the largest allowance being four single channel feeds (normally fed from post-fader for effects send use but selectable to pre- if required) and two separate stereo pannelable (another four feeds), normally fed from pre-fader for studio foldback or auxiliary stereo mixing but again also individually selectable to post-fade feed should need be. The pre-fader feed is derived (referring to fig 1) from directly after the post-eq break point return differential amplifier at the same point as the 'pre-fade listen' is taken. Immediately following the mute/solo electronic switch is the take-off for the post-fader feeds, so they also, in addition to the stereo busses' feed, become muted when any other channel is in 'solo' unless the 'solo-unlock' function is applied.

This total of 10 auxiliary busses (don't forget the PFL) are applied to mixing amplifiers in the console's auxiliary function (known in vernacular as the 'garbage') module.

Monitoring selection

Fair warning must be given of a fairly radical approach toward master monitor selection. One of the main bugbears of complex console system design is the practical elimination of crosstalk, the worst variety of which is differing material crosstalk. The relatively dire crosstalk between adjacent tracks on a multitrack recorder is passable because usually the interfering signal is related musically and probably up in the mix in its own right.

This isn't true of many of the alternate sources that appear on master monitor switches—tape machine returns, effect returns, radio tuner, turntable, other studio outputs (maybe); any of which is dissimilar from and immediately noticeable at any level when present as crosstalk into the main recording signal paths, multitrack or stereo. Whilst the actual crosstalk figures in a well built mixer between these high level line sources and the few inevitably vulnerable spots in the main path might seem to measure quite well, time and time again its been seen that any crosstalk at the same or higher level than the residual noise of the path is subjectively objectionable. For console manufacturers this has been a slowly developing nightmare—as signal path noise levels subside with development more and more rubbish is left visible, or should we say audible.

It is not so much crosstalk within the monitoring itself that is the concern, it is crosstalk into the real, live, signal paths that is to be avoided. The self evident answer (once, as much

has been done to clean up the mechanics of the crosstalk as the given design permits) is to remove all the dissimilar high level line sources from the console altogether, except when they are deliberately selected for monitoring purposes.

This is precisely the approach taken—the master monitor selector is in fact a remote rack mounted box containing a stereo input matrix, with the normal switching and priority functions controlled by a logic system user addressable on the console itself.

An 8-track format

The requirements for a 12 into 8 small multitrack console imply a monitoring system other than that outlined earlier. Physical size is not as crucial, with the extra eight module widths for the group modules not representing any serious problems, given the facilities present on them. Multitrack monitoring is contained entirely on the groups. The questions of what needs to be where within this format should be largely answered in the rough block system drawing in fig 3.

Instantly vanished from the channel module are the secondary gain control and pan control appropriate to multitrack routing, but a mono channel output is maintained, derived from immediately pre-pan along with all the other post-fader auxiliary feeds. This is to facilitate external routing via the jackfield of channel outputs or possibly even via an electronic matrix should the basic 12-8-8 concept get 'stretched' to sufficient input channels to deem it worthwhile. No 'A'/'B' monitoring is allowed for, but the original multitrack return differential amplifier is (in the case of the channels designated for remix) paralleled in the frame with the appropriate group monitoring multitrack return input amplifier. On those channels not so designated, it is available as a line input for effect returns etc.

Eight-group routing is achieved in odd/even pairs via the main panpot,

an extremely versatile method despite its basic simplicity, with any of the four pairs (pick a number, any number) being designated the main stereo mixing buss.

Sufficient isolation between these 'stereo pairs' to enable their use as eight single groups or subgroups is achieved largely as a result of the excellently low end-stop resistance values of the panpots specified in the design—previously with such a routing method it has been a case of crossing fingers and hoping for a good batch of pots. As the design stands, the crosstalk characteristics, reactive and resistive, are significantly better than those achievable on most multitrack recorders.

The groups are themselves re-assignable and panable onto any of the other groups (being prevented from routing back into themselves for obvious reasons by the main-frame wiring) giving an altogether quite versatile subgrouping and routing arrangement. The groups also carry the full 'A'/'B' monitoring routine of the original in-line module complete with a full complement of pre- and post-monitor gain control auxiliary feeds.

Ordinarily, the main group fader is dedicated to the group gain whilst the monitor chain takes the secondary control, but the local fader reverse facility is retained enabling these functions to swap—again allowing the engineer to juggle the mix on the 'right sort' of faders whilst other recording is still occurring.

Each of the channels is capable of having its 8-track routing disabled in favour of direct routing to the monitor busses, this being intended specifically for those channels not dedicated to the multitrack recorder but carrying effects returns. As can be seen from fig 3, the post-fader auxiliary feeds in this mode are still contained in the channel path enabling tape or DDL repeat echoes or other re-entrant effects to be created in the monitoring independent of the main recording channels.

Should all the input channels be in

use and effect returns still required (a likely course of events with the relatively small number of channels) two panable line inputs to the stereo monitoring busses are present on the monitor select module.

As regards subsidiary monitoring functions, there are two individual solo activation systems for the channels and groups, by virtue of the fact they are not being asked to perform the same function. The channel solo defeats (again with 'unlock' if needed) every other channel in order to ascertain how that particular channel's signal has fared through the console path. It would be quite daft to have a channel solo muting the groups through which it is being monitored, similarly so for a group monitor solo to mute the channels which it is intended to monitor! The solo function on the group modules is called 'monitor solo' to save confusion and, being solely in the monitoring chain, is non-destructive to the recording signal path. Pre-fade listen whether of channels or groups overrides any other monitor selection, but despite this monitoring priority is non-destructive to the main signal paths also.

And so . . .

As can be noted from the progressively less description required for alternative formats, the restructurable basic module concept is obviously quite workable, also well beyond the examples outlined here. These described formats are by no means The Only Gospel Way of approaching the various applications even within the confines of the basic modules—other system arrangements will automatically suggest themselves as the elements are detailed in subsequent articles.

There is no pleasing everyone—this design approach will undoubtedly be accused of being simplistic by a few, 'too fussy' by others. Although the perfect 'systemless studio' is nowadays impracticable, this possibly offers the closest working approach. ■

FIG 3 SKETCH SCHEMATIC OF 8-TRACK FORMAT

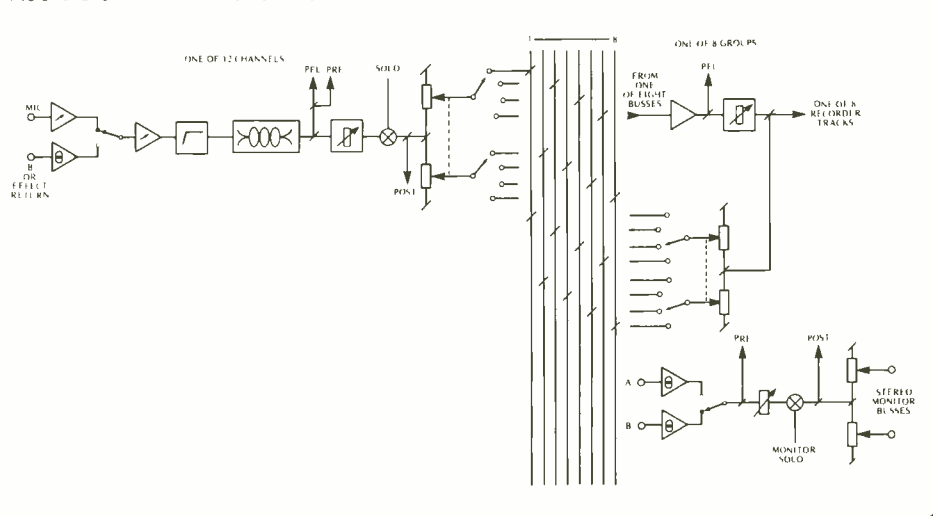

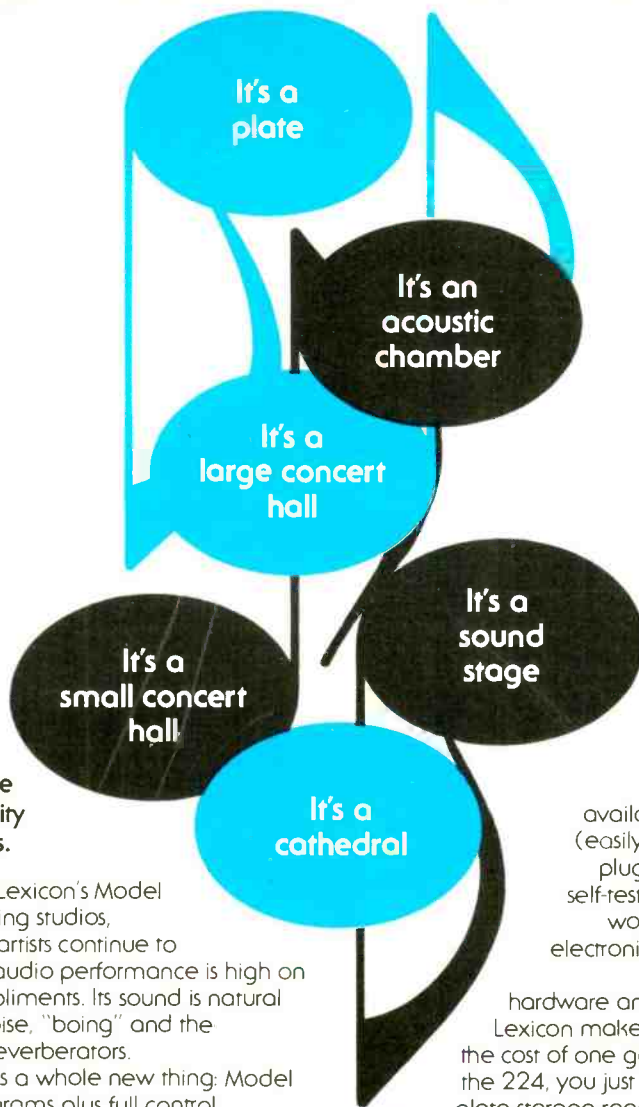

... A complete repertoire of the very highest quality reverb at your fingertips.

Rave Notices for Lexicon's Model 224 from the world's leading studios, broadcasters and musical artists continue to pour in. The 224's superb audio performance is high on the list of everyone's compliments. Its sound is natural and completely free of noise, "boing" and the problems of mechanical reverberators.

And its versatility is a whole new thing: Model 224's multiple reverb programs plus full control of all reverberation parameters allow audio engineers to create the sound that "is exactly right for the material." It's a whole stable of quality reverb capabilities in one compact package.

The model 224 Digital Reverb is available with 2, 4 or 6 basic reverb programs (easily updated in the field by simple program plug-in) and comes complete with extensive self-test diagnostic programs that take the guess work out of maintenance. Its mainframe, all electronic, requires only 7 inches of rack space.

If all this sounds expensive, it isn't. Digital hardware and software technology breakthroughs by Lexicon make the 224 surprisingly affordable ... about the cost of one good plate. And after you've experienced the 224, you just might find more productive uses for your plate storage rooms and acoustic chamber!

For full details write or call — better yet contact your leading Pro Audio dealer for a demonstration. Once you've heard it you'll never want to do another session without it.



WORLD CLASS REVERB

lexicon

Lexicon, Incorporated Waltham, MA USA TELEX 923468
In U.K.: Scenic Sounds Equipment, 97-99 Dean Street, London W1V 5RA • tel 01-734-2812



letters

More squarewaves

Dear Sir, We have for some time been aware of the inherently poor transient performance of conventional analogue tape recorders. Our investigations indicate two main causes. 1) hf ringing caused by excessive peaking in the record (and sometimes replay) amplifiers. 2) Phase-shift resulting from the need to equalise hf losses due to tape self-demagnetisation and bias. This causes the characteristic overshoot and rounded trailing edge observed on squarewaves.

The remedy for the first is obvious. Recent research indicates that a flat response to 15kHz is entirely adequate and with a suitably gentle roll-off ringing can be eliminated.

Fortunately it is not too difficult to devise a phase equaliser to deal with the second, however it should be noted that the correction required varies with tape type and speed and the chosen bias setting.

Mr Hall (March 'Letters') is quite right to draw attention to the loss of headroom resulting from these effects. Our tests confirm that the peak amplitude of a squarewave (as measured at the output of the record amplifier) is significantly reduced when appropriate equalisation is used.

We believe we are unique in offering a precision cassette-copying service employing phase equalisation.

Yours faithfully, David M Wright, Gemini Sound, 'Braeside', London Road, Binfield, Bracknell, Berks, RG12 5BS.

Studio operators unite

Dear Sir, With the advent of APRS 1980 I am seriously concerned about the technological plight facing top line studios today.

Having over the last few years re-invested in capital equipment in order to remain technically competitive and at the same time refusing to pass on the increases by raising the studio rates, we now find ourselves in a situation where we have become overpriced in relation to the reduced budgets available by the record companies to make new recordings! In order to maintain their profit margins in the face of constantly reducing record sales, these companies and producers are using the smaller, cheaper studios to record their product. This trend reduces the turnover of the larger studios and therefore restricts vital re-capitalisation. This will depress the market of the equipment manufacturers and delay technical advancement making the British recording industry less competitive with the rest of the world.

As studio operators and equipment manufacturers, the time has come to endeavour to put our house in order. We must go back to the source of income and ascertain the reason for lack of record company profits and sales of discs and tapes. These reasons are shown under five headings: 1) poor quality product; 2) high quality continuous FM stereo broadcasting of records; 3) piracy; 4) cheap imports; 5) home taping from records and radio.

It will be noticed that headings 1 to 4 can be controlled to a certain extent by the record companies themselves. Heading 5, however, is a different matter, as it appears to concern public conscience. We have little or no control over what the average person can do in his own home—rightly so. He therefore cares little for the industry purse and will continue to make illegal recordings from radio and records. Is it not time they were educated to realise the folly of their ways? The BPI have spoken a great deal but have not acted regarding this problem. They intend to procure a

levy on each cassette sold to offset record company losses and artists royalties. Unless this levy exceeds several pounds, it can do no good!

The real problem has been caused by the cassette machine and tape manufacturers. By taking a basic dictaphone machine and improving it technically, they have built up an industry totally parasitic to the record business. The more technically advanced it becomes, the more it eats into our livelihoods.

Another consideration is that the great majority of both cassettes and machines are made abroad. This means that not only are they leaching our business but adding insult to injury by damaging our balance of payments! Maybe Mrs Thatcher should be asked to slap a massive import duty on these items and use the surplus to reduce income tax of benighted studio managers!

There is one small way that studio operators can exercise a small amount of persuasion. Our suppliers of blank 2" and ¼" tape (again mostly foreign) also have divisions which produce and market blank cassettes. They are, therefore, killing the goose that lays the golden eggs. If we were to refuse to purchase tapes from any supplier who also manufactures blank cassettes, we might see some reaction.

Finally, I think that cassette machine and tape manufacturers and importers who wish to remain within this industry should take a very serious look at their actions. There is no doubt that they are destroying the record industry and should be controlled.

Yours faithfully, David J Harries, studio manager, Air Recording Studios, 214 Oxford Street, London W1

Editor's comment: there has been much talk in the press about slapping a tax on blank cassettes, to offset home pirating. Apparently, the tape producers intend to get around this by recording any old non-copyrighted rubbish on their 'blank' cassettes, so they are no longer blank, but pre-recorded, and may be sold bypassing the proposed tax! It could even become an outlet for up and coming bands, who only wanted exposure, not money.

Monitor loudspeakers

Dear Sir, I am puzzled by what Noel Bell calls "a slightly dated sound" from the monitors at Polskie Radio (February issue). I wish I knew what that really means, because monitor speakers should be noted for their accuracy and departures from this ideal should be subject to descriptions such as 'limited high range', 'bass distortion', 'poor transient response', etc. But what is 'dated sound'?

As an observer from the periphery, I am puzzled by the marked predominance of one brand of monitors (namely JBL) in the studio world, and by the relatively narrow distribution of the rest of the market among a few speaker manufacturers. Although speaker manufacture is admittedly a difficult task, I think there are many more units deserving of consideration in recording studios. After all, our recordings will not be listened to mainly on JBLs. Is it a matter of sticking to what is usual rather than risking experimenting with other brands? It is curious that this attitude has not been extended towards, say console manufacturers. Don't innovative speaker designs—although usually aimed at the hi-fi market—merit some serious consideration by recording studios?

Speaking of monitoring, Studio Sound has frequently warned of the potential ear damage resulting from excessive monitoring levels. Apart

from the health risk, there is another one, more relevant to the quality of our recordings—and that is usually disregarded. I quote from John M Woram's The Recording Studio Handbook: "The implications of the equal loudness contours should be clearly understood by every recording engineer. As the loudness level is changed, the ear's frequency response is significantly altered. Therefore, a frequency balance that is satisfactory at one listening level may not be so at another . . . Equal loudness contours do suggest that if studio monitoring levels are kept on the conservative side, there will be less disappointment later on. If the proper amount of bass is heard at low monitoring levels, any subsequent level increase will bring with it an apparent bass (and midrange) boost. Generally, this is to be preferred over the opposite condition, where the bass apparently decreases from the ideal point as the level is dropped". Our buying public may be getting worse sound balances with our present high-level practice.

Yours faithfully, Hector D Calabia, Centro Paulino de Audiovisuales, 5149 Rivera Indarte, Cordoba, Argentina.

Noel Bell replies: The Polskie Radio monitors were described as having "a slightly dated sound" because they did not exhibit the crispness or clarity of current monitors. Using rather elderly Goodmans drive units which do not have the advantages of the latest loudspeaker cone materials, the monitors exhibited a roundness of tone which because it was not plummy in character I found perfectly acceptable. Accordingly, since there was nothing fundamentally wrong with the sound I felt the above phrase adequately described their performance.

With reference to the wider points of Mr Calabia's letter, there is considerable scope for interpretation as to what constitutes a good monitor loudspeaker. The fact that some monitors such as those from Eastlake, JBL and Tannoy predominate in studios is partially due to the fact that many individual albums are recorded and mixed in different studios, hence it is preferable to monitor on 'known-quantity' loudspeakers. Another factor is that engineers like the performance qualities of particular monitors and like to have them available as 'reference monitors'. Although this approach precludes experimentation with other loudspeakers, engineers are not so bigoted as to ignore other potential monitors. The real problem is that loudspeakers are a matter of subjective preference. Hence, while certain objective tests can be carried out, their relevance to the subjective performance of a loudspeaker within a given listening environment is a totally different matter. What performs well in an anechoic chamber doesn't necessarily sound right in a control room! It is primarily for this reason that Studio Sound does not review monitor loudspeakers. As the relevance of objective testing is open to question, and likewise the difficulty of adequately describing subjective aural performance is also open to numerous pitfalls, we prefer end users to be their own judge of monitors.

Regarding the problem of excessive monitoring levels, the effect of equal loudness contours on sound balances is an aspect of sound engineering which is often overlooked. However, short of statutory monitoring levels or some form of automatic monitor level cut-out protection system, the buying public will have to rely on the experience and good sense of sound engineers and disc cutting engineers to get sound balances right. ■



It's not only in love
that the french show
great taste...

3M
FRANCE

Bld de l'Oise
95000 CERGY
Tél. : (01) 031.61.61

3M
DEUTSCHLAND GmbH

4040 Neuss 1, Postfach 643
Carl-Schurz-Strabe 1
Telefon (02101) 141

3M
ITALIA Spa

20090 Milano
S. Felice-Segrate
Tél. : 02.75451

3M
NETHERLAND bv

Rooseveltstraat 55
Postbus 193, 2300 AD Leiden
Telefoon : (071) 76.93.30

3M
ESPAÑA, S.A.

Josefa Valcarcel, 31
MADRID 27
Telf. (91) 742.00.12

PULLIS 300

37, rue des Annelets - 75019 Paris
Tél. : 202.21.02 - 202.58.69

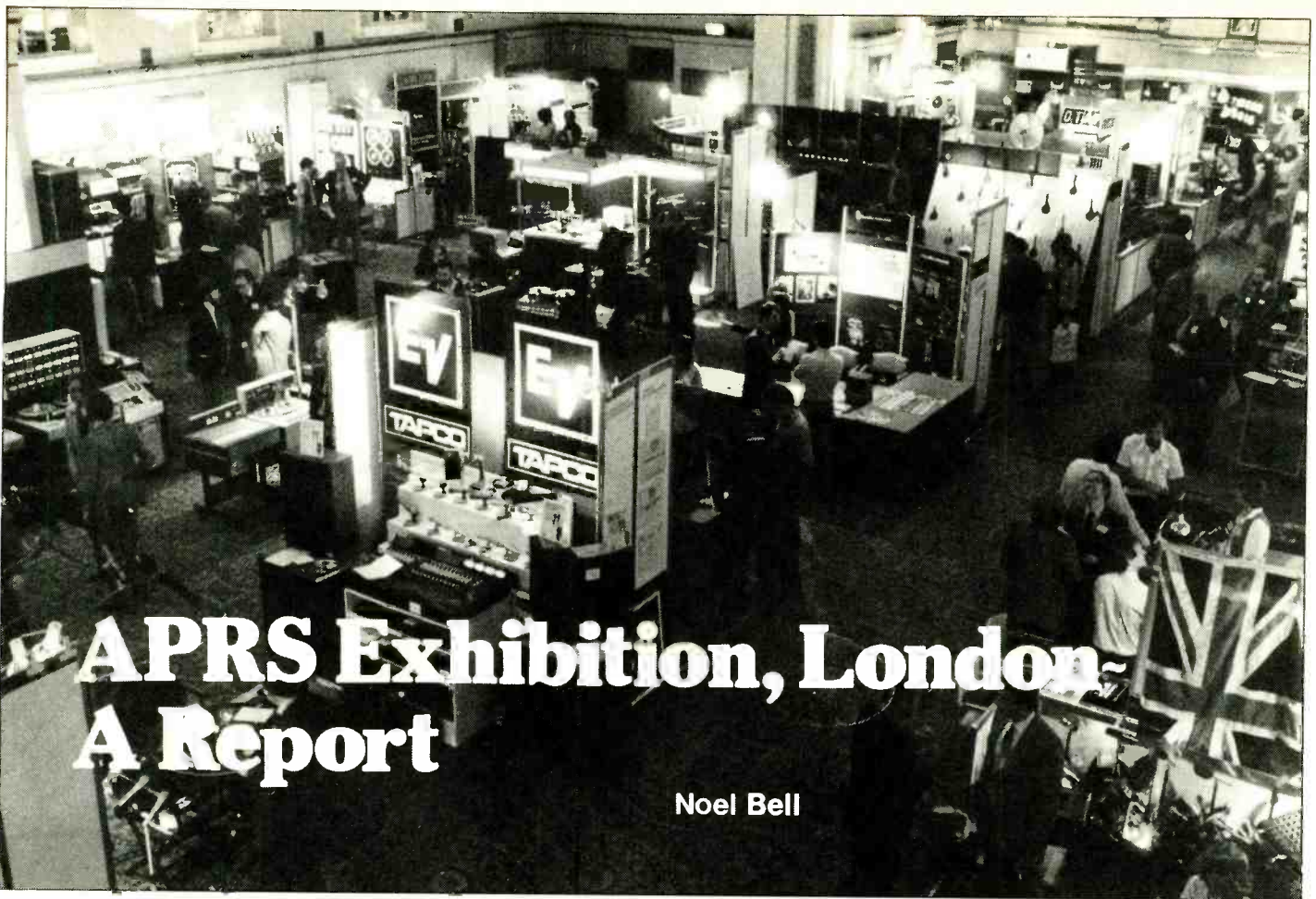

APRS Exhibition, London A Report

Noel Bell

The 13th annual APRS Exhibition took place from June 18 to 20 at its traditional London venue, the Connaught Rooms. Noel Bell reports on happenings at the exhibition.

THIS YEAR the APRS reached the milestone of its 13th exhibition. This might have been an unlucky omen, but despite the gloom and despondency over the current state of the music and recording industry emanating from some quarters (indicated by reduced numbers of visitors this year), most exhibitors put on a brave face and got on with the job in hand, namely continuing the search for orders. Although there wasn't a vast number of new products on display, (rather a retrenchment of their position by most exhibitors), several new items debuted at the exhibition or made their first UK appearances. As expected the decision at short notice to hold the European AES Convention in London earlier this year entailed many new products being launched at AES, which not unexpectedly meant that the APRS wasn't exactly brimming with new products.

Readers who recall my somewhat critical comments last year about the APRS exhibition's organisation and venue will be pleased to learn that this year matters had improved. For a start there was increased security presence, although it was still not up to the excellent standards of American exhibitions. Secondly, much better sign-posting to the various exhibition areas (and bars!) was provided, however, until a new venue for the exhibition can be found, especially with the facility for loudspeaker demos, the rabbit warren-like Connaught Rooms with all its attendant problems will have to suffice. One definite

improvement though, was that the majority of console and tape machine manufacturers were on the ground floor level, thus avoiding the problem of bulky equipment being manhandled up and down staircases. However, problem areas do remain. The most aggravating to exhibitors is the problem of delivery/set-up and take-down/departure. The London police were slightly more co-operative than usual this year and seemed less avid in their desire to whisk away exhibitor's waiting transport, but there were still one or two unfortunates who were on the wrong end of their attentions. It seems illogical to me that the delivery/set-up and take-down/departure procedure is so totally lacking in organisation. Surely it would be much better (and would avoid potential aggravation with the London police) if a schedule of staggered arrivals and departures was instituted. This way exhibitors would not be fighting each other to get their equipment in and out, and it would also soothe taut nerve ends at the end of a hectic and busy exhibition. Perhaps, the organisers might care to investigate the possibility of instituting such a schedule for future APRS exhibitions?

Recording

One of the highlights of the exhibition was the introduction by **Trident** of its new **TSR 24-track** tape machine. A compact sized, floor standing machine, the recorder has the same natural wood finish as the Trident consoles, and uses conventional 2in wide tape. Optionally available with a 16-track headblock, the new recorder will accept 14in tape spools and has tape speeds of 15 or 30in/s or 6 to 45in/s varispeed. The transport is housed in a solid cast and machined 2in aluminium deck plate, and uses a dc printed circuit servo motor with xtal lock. Capstan frequen-

cy is 9.6kHz enabling easy interface with tape synchronisers. Quoted transport specifications are wow and flutter, less than 0.035% at either 15 or 30in/s; and rewind time is a maximum of 90s for 2,400ft. The deck plate is sloping, and hinges for easy access, as does the meter panel at the front. The recorder incorporates a logic control system with full motion sensing, while all switching is electronic. The electronics which are mounted below the meter panel are modular plug in cards with transformerless inputs and solid state switching. Features include separate record and repro hf/lf equalisation settings and differential balanced inputs. Quoted specifications are: input impedance 15k Ω ; output impedance 600 Ω unbalanced (optionally balanced); crosstalk 50dB at 1kHz; distortion 0.5% at 1kHz at 250nWb/m; erase efficiency 75dB, frequency response 40Hz to 18kHz \pm 2dB at 15in/s (50Hz to 18kHz \pm 2dB at 30in/s); and s/n ratio (record/repro) 62dB ref 520nWb/m, 20Hz to 20kHz. The **TSR** is sized 44 $\frac{1}{2}$ x 30 x 25in (hwd) and comes complete with a compact remote control unit and the Audio Kinetics **XT-24** autolocate. The remote control unit provides machine controls, varispeed, status master and monitor status switching, and selection and indication for channel modes. Although marketed with the standard **XT-24** autolocate at present, I understand that this will be repackaged to match the styling of the **TSR** recorder. Price of the **TSR** multitrack including remote and autolocate is approximately £18,500.

Receiving its first UK showing in the wake of AES Los Angeles was the new **Ampex** auto-bias accessory for the **ATR-124** 24-track. This allows the degree of overbias to be preset in 1dB and $\frac{1}{4}$ dB steps using two switches, whilst depression of a single button automatically aligns all 24 chan-

70 ►

**PROLINE
PROFESSIONAL**

recorders

**In action with the professionals
everywhere –**



**Radio Clyde
Scotland**



**LBC
London**



**IRN
Parliamentary
Studio**

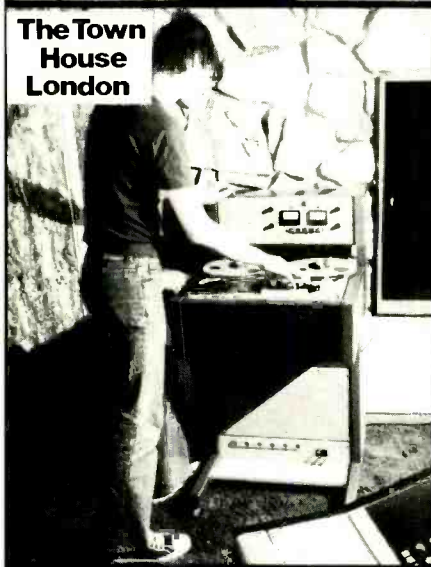

**The Town
House
London**



**Radio Trent
Nottingham**

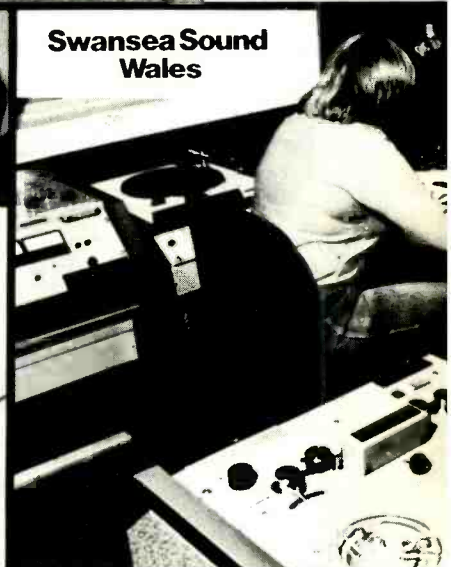

**Swansea Sound
Wales**

Speak to Tony Costello or
John Robinson about them at:

319 Trinity Road Wandsworth
London SW18 3SL

Telephone 01-874 9054
Cables Leemag London SW18
Telex 923455 Wembley

**LEEVERS-RICH
EQUIPMENT LIMITED**

APRS Report

nels. The system has the advantage that different biasing frequencies can be used for different tape speeds, while different user alignments can be easily catered for. The auto-alignment procedure takes about 10s to complete and is a useful additional feature on an already excellent machine.

Leavers-Rich showed its successful *Proline 1000SC* recorder in console and transportable versions. The *Proline 1000* has undergone a number of changes and now has a servo controlled capstan as standard, is fitted with an improved pinch roller mechanism, and features tape damping for quieter operation. Additionally fitted is a fully automatic solenoid operated headshield for improved noise performance. First introduced at AES London, the new *Proline 1000L* logging recorder was also on show. This records four tracks at 15/16in/s for full 24 hour recording capability, has an auto changeover facility, and features an electronic master clock which is programmable for changeover to a second machine or on/off functions over a seven day period. Other features include a 2:1 companding system for low noise performance, and fully modular electronics with a comprehensive monitoring system. The popular *Proline 2000TC* recorder has until now only been available with a standard return to zero remote control unit, however, a new addition at the APRS was the availability of a microprocessor based programmable autolocate. Finally, from Leavers-Rich, the company has added a tape tension gauge to its ancillary range of demagnetisers, bulk erasers, and magnetometers.

Although not a new machine, **Lyrec** was showing its new-look *TR532* 24-track which has been externally redesigned. Looking much more compact than before, the *TR532 I* understand is soon to be joined by a new 1/4 in recorder. Also on show was the fourth generation *ATC* (audio tape controller) remote which features direct access to three search positions, recycling between two positions, 32 position memory, 5s or 10s pre-roll function, tape speed (in/s) display, and 'in-place' solo-function for individual tracks or groups of tracks.

Again not totally new, but certainly worth a second look, were the recently introduced additions to the **Neal-Ferrograph** range. These comprise the *Penthouse Studio 8* for broadcast use with a three-position stand; the *SP74* four channel logging recorder; the *Edii 7* replay only editing machine; and the *Model 312* stereo cassette recorder with Dolby *HX* and metal tape capability.

Sony displayed its now well known digital audio systems utilising the *PCM-1600* (16-bit) and

PCM-100 (14-bit) processors, the *DEC-100* editing controller, and *U-matic* and *Betamax* video cassette recorders. While there was nothing new on the digital front an interesting unit tucked away somewhat, was the compact *TC-D5* portable stereo cassette recorder for professional applications. Only 9x6in and weighing less than 4lb, the recorder features XLR mic inputs, headphone output, a monitor loudspeaker, Dolby B noise reduction, facilities for ferric/CrO₂/ferrichrome cassettes, and everything you would expect to find in a portable cassette recorder. However, perhaps the most remarkable aspect of this tiny recorder is that its frequency response extends from 40Hz to 16kHz ± 3 dB (ferrichrome) while wow and flutter is less than 0.06%. Other products on display from Sony included its full range of studio mics and its comprehensive range of radio mics.

A completely new machine shown at APRS was the *TD88* from **Stellavox**. This is a universal recorder accepting either 1/4in, 1/2in or 16mm perforated formats and will handle any number of tracks from 1 to 8 tracks. This is achieved through the use of interchangeable headblocks which include all the sensing electronics and necessary electro-mechanical options. The *TD88* is microprocessor controlled; will operate at 3/4, 7/8, 15 and 30in/s and 24 or 25 frames per second; includes headphone outlets and a 5W monitor loudspeaker; and will operate from an external battery source if necessary. The recorder is fully portable and weighs only 75lb. Approximate price is £3,500 for a 2-track recorder and £4,200 for a 4-track machine.

Harman (Audio) the UK distributor for Teac had a number of interesting Teac products on display. Highlight was the *Tascam 85-16* 1in 16-track recorder with dbx noise reduction and operating at 15in/s. Used in conjunction with the *Model 15* console the recorder offers an extremely versatile system at reasonable cost. Introduced to the UK was the new *Tascam 32-2* 2-track with selectable IEC or NAB equalisation, closed loop transport, 10 1/2in spool capacity, 15 or 7 1/2in/s speeds, motion sensing, $\pm 6\%$ pitch control, and dbx and remote control unit options. Finally, Teac had on display its *Model 144 Portastudio* integrated 4/2 mixer and 4-channel multitrack cassette recorder with Simul-Sync. Full details of the latter will appear in our *News* pages in due course.

Music Laboratory under the guise of PSE (Production Studio Equipment) were showing a Teac 8-track recorder termed the *Master 8*. This is basically the Teac *Tascam 80-8* 1/2in machine converted to a 1in machine with a new headblock. The conversion is available either as the *Master 8*

recorder for £3,000, or alternatively a kit to convert the *80-8* is available for £850. Other new items from PSE include special flight-cased Tannoy *Super Red* monitors, and the *Production Spring* 6-spring reverb offering up to 3s delay at a cost of £175.

FWO Bauch were showing the new compact Studer *B67* and a new audio remote for the *A80VU*, while I understand that the new head assembly for the *A800* which debuted at AES Los Angeles will also be introduced to the *A80* this year.

Synchronisers were as usual being shown and demonstrated by a number of companies, and new additions included a synchroniser from **CB Electronics** with styling to match the autolocate, and two new units from **Maglink**. The first of the new Maglink units is an EBU timecode reader with video character insertion and regenerating capability, made under licence from the BBC. The reader has an 8-digit LED display showing timecode in hours, minutes, seconds and frames; and has controls for local/remote control, timecode/user bits, run or hold; and various controls governing the insertion, size, format and position of the video display. Price is £1,400. The second new unit is an SMPTE/EBU sprocket code generator enabling any SMPTE/EBU timecode equipment to be easily interfaced to any machine having an additional shaft encoder output related to the transport. The unit generates standard SMPTE/EBU or optionally 24 frame timecode from a bi-phase input clock frequency normally available on most sprocketed film and sep mag machinery, thus eliminating the need for a recorded timecode track. The generator has an 8-digit LED display, a bank of eight thumbwheel switches to preset timecode start, preset button, sprocket or oscillator timecode generation selector switch, SMPTE or EBU switching, and 'run' and 'hold' buttons to control an internal crystal oscillator. Price of the sprocket code generator is £1,300.

Consoles

Making its UK debut was the newly introduced *Syncon Series B* console from **Allen & Heath**. Based on the in-line format, the new console is modular in construction with the mainframe accepting 20 I/O modules with monitoring and masters, while a subframe accepts a further 12 modules. The *Series B* can be expanded up to 44/24, with retrofit automation (Allison compatible), and with a modular patchbay frame. Full details of the console are given in our AES Los Angeles report.

Audio Developments showed two new mixers.

72 ▶

Left Mike King, centre Roger Cameron of Feldon Audio



(l to r) Ken Bray, Trident TSR 24-track, Malcolm Toft



Graham Langley and Nick Franks of Anek



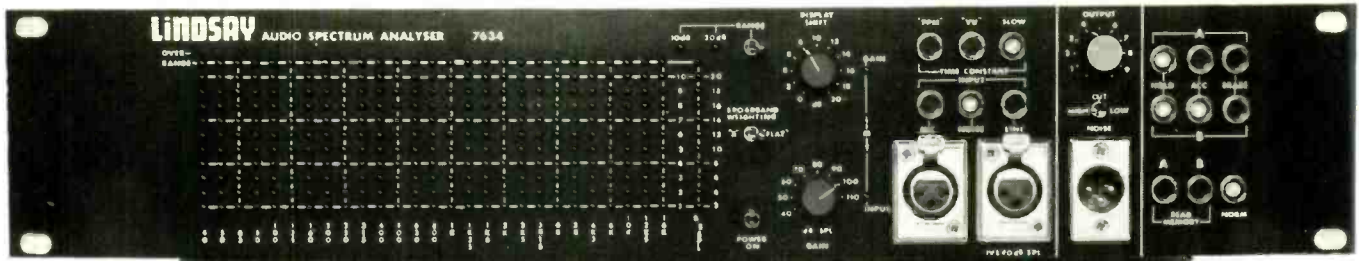

THE LINDSAY AUDIO SPECTRUM ANALYSER 7634

- 27 1/3 octave I.S.O. bands (40Hz-16KHz).
- 1/3 octave filters meet specifications of ANSI S1.11-1971 Class II and I.E.C. 225-1966.
- Flat or "A" weighted broad band channel.
- Slow, "VU" or "PPM" time constants.
- 28 x 11 L.E.D. display.
- 10dB or 20dB display ranges.
- Display shift facility increases dynamic range to 40dB.
- Over-range indication on each channel.
- Microphone and line inputs transformer coupled (balanced and floating).
- Microphone input displayed in dB SPL directly.
- Internal calibration facility.

- Gain range of 70dB.
- Overload limit indicators for input and gain.
- Internal noise generator, low impedance balanced output.
- 2 independent memories, each with hold, accumulate and erase functions.
- 19" rack mounting.
- Sync and video outputs.

LINDSAY LINDSAY ELECTRONICS LTD.,
Ifton Hill House, Portskewett, Gwent.

Sales and export enquiries to:
Scenic Sounds Equipment,
97-99 Dean Street, London W.1.
Tel: 734 2812



SSE for **H||H**
electronic

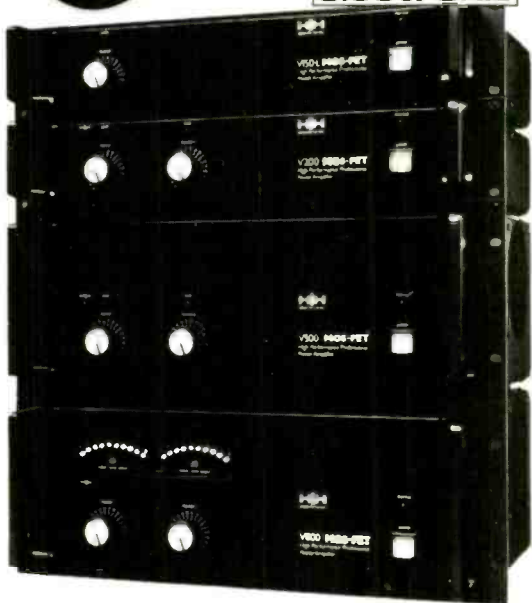

professional power amplifiers

Scenic Sounds Equipment
97-99 Dean Street, London W1V 5RA Tel: 01-734 2812/3/4/5
Telex: 27 939 SCENIC G

SSE for **JBL**



**professional
monitoring**

Scenic Sounds Equipment
97-99 Dean Street London W1V 5RA
Telephone: 01-734 2812/3/4/5
Telex: 27 939 SCENIC G

APRS Report

The first the *ADO49* portable mixer is a compact 4 into 1 unit, with either a VU or PPM meter, LED overload indicators, and headphone monitoring. Either battery or mains powered, the mixer can also be powered directly from positive and negative earth Nagra recorders without any external switching. The second new mixer, the *ADO60* is a compact 4 into 1 unit designed particularly with ENG usage in mind. Features include external 24V dc powering, XLR inputs/outputs, three input filters, headphone monitoring facility, and LED column output level indication with a PPM characteristic.

Another new small mixer being shown was the *PM-80* compact modular production mixing system from **Formula Sound**. Based on a 19in frame, the system features plug in input (mic/tape/phono) and output modules, remote tape/phono starts, PFL monitor switches, headphone monitoring, and P & G faders.

Moving up in size, the **Hill K Series** console, has been joined by the new *J Series* modular sound reinforcement console. Very similar to the *K Series* in electronics and styling (they were parallel developments), the new *J Series* is available as either 24/8/2 or 32/8/2 with the option of adding 10-channel extensions. The input and effect return module features four effect returns, comprehensive equalisation facilities, pan, mute, PFL, routing switches, 3-way LED metering, and P & G fader. The subgroup module offers all the facilities of the input module without the routing switches. Additionally there is the master/talkback module with all the usual facilities. Price of a *J Series* 24/8/2 console is £6,219, while a 32/8/2 configuration costs £7,486.

Another console making its UK debut was the new *Britannia Series* from **Raindirk**. An in-line design 40/32 console, it features master status logic control with PROM controlled signal switching; 24-track routing as standard (optionally 32-track routing); and optional VCA grouping, Allison *Fadex* automation, and *Param* equalisation. Again full details appeared in our AES Los Angeles report.

The new Sound Workshop *Series 30* modular console which was shown by UK distributor **TRAD** was also fully described in our AES Los Angeles report. Designed to complement the *Series 1600*, the new console features most of the facilities of the older console, but in a smaller console at lower cost. Mainframe sizes range from 12 to 36 inputs with the number of outputs depending on what input configuration is chosen.

Returning to small mixers, **Turnkey** showed the *Seck 62*, *Seck 104*, and *Seck 1480* mixers manufactured by Bandive Ltd. Designed with semiprofessional usage in mind the mixers are respectively 6/2, a 10/4 main section with a 4/2 line mixer, and a 4-channel mixdown unit. All the mixers are available in kit form as well as ready made which is an advantage to those diy hobby electronicists among us. While facilities differ from model to model and the mixers offer considerable scope for customisation, the *Seck 104* looks particularly interesting and should become very popular with semiprofessional and hobby recordists.

Tweed Audio introduced two new broadcast consoles at APRS, the *RP1601* and the *BC102/104*. The *RP1601* offers options of up to 16 mic, mono or stereo channels; stereo or mono outputs; two clean feeds; 2x8 remote source selector; talkback; PFL; and comprehensive monitoring facilities. Price of the basic model is £4,138. The *BC102* is a 10 input channel console



BC102 console from Tweed Audio

Ray Moore of Audix with wrap-around broadcast console



with two group outputs, while the *BC104* has four group outputs. Although more compact than the company's standard broadcast consoles, the consoles offer the same circuits and components as the larger mixers. Price of the *BC102/104* is expected to be between £3,500 and £4,000 depending upon which Tweed modules are installed.

Readers might be forgiven for thinking that this year's APRS exhibition was the year of the small mixers, so just to reassure everyone that the larger varieties of console were present it is worth noting that the usual wide selection was on show from **Alice, Amek, Audix, CA Audio, Eela, Enertec, Harrison, MCI, Midas, Neve** (including the first UK demonstration of *Neveam II*), **Solid State Logic, Soundcraft, and Trident**. Particular mention should perhaps be made of **MBI** who built its stand (combined with Allen & Heath) as a mock-up on-air broadcast studio where visitors were able to operate the *Series 24A* console as though they were handling a real on-air production.

Signal processing

One of the highlights of the APRS was the *Param* computer assisted parametric equaliser system distributed in Europe by **R Barth KG**. Once again this was fully described in our AES Los Angeles report, but a few brief details will not go amiss. Unlike conventional equalisers the *Param* uses a central control panel with a keypad and joystick to set the equalisers. Monitoring of the eq curve is via a television monitor. A number of eq settings can be stored in the system's computer memory allowing eq settings to be compared at the push of a button. Use of the system was extremely simple and I mastered the system within a couple of minutes once I had got used to the joystick control and associated control button which has to be kept depressed to enable the joystick. This was a rather fiddly operation but once mastered I encountered no further problems, and the system was a pleasure to use.

Another new item from **Barth** was the *Dynaset U311* (dual limiter/compressor/expander), a novel dynamic processing unit which provides two independent bands of operation through the use of two independent threshold settings. A

feature of the unit is that each band can independently be set to compressor through limiter as well as expander functions, while attack and decay response behaviour can be dynamically adjusted in three ranges. Other Barth processing equipment on display included the *MusiCoder* 'music optimised vocoder' and the *Audios* digital delay and pitch change processor.

Audio & Design (Recording) introduced two new units, the *Gemini Easy Rider* stereo rack mounting compressor/limiter and the *Scamp S25* de-esser module. The *Gemini* unit features digital gain metering, stereo or dual mono operation, platformed 'auto' release and dynamically controlled attack; while the *S25* is a 2-channel unit which may be used to de-ess two separate channels or alternatively it can be set to de-ess at two frequencies on one channel.

AKG showed its new *BX5E* stereo reverb unit developed on the torsional transmission line principle. The *BX5E* has two separate inputs and outputs, but utilises one common reverb system. It incorporates a parametric equaliser and delay times of 1, 2 or 3s may be selected. Features include reverb drive level VU-meter readout, switchable input sensitivity selection, and LED indication of signal peak overloads. Also on show was the *TDU7000* modular time delay unit with memory extension module. The *TDU7000* operates with 16k RAMs, employs a 12+2 bit system with floating decimal point, and provides a frequency range of 30Hz to 14kHz with a dynamic range of 90dB. Modules available include input, output, delay extension, and effects.

AMS (Advanced Music Systems) was showing its recently introduced *DMX15-80S* stereo programmable delay, based on the *DMX15-80*, together with a broadcast version the *DMX15-80SB*. Also new to APRS was the *DM-DDS* disc mastering DDL available in two versions with frequency response extending from 10Hz to either 20kHz or 24kHz. All these new units were covered in our July News pages.

UK distributor **FWO Bauch** showed the new *Lexicon Model 122 Series* digital delay system, successor to the *102 Series*. Available in mono or stereo versions, the system offers variable delay,

74 ▶

APRS Report

has a VCO module to provide a wide range of effects, and uses 14-bit floating point digital encoding. For full details, though, see our AES Los Angeles report where the system was introduced.

Although primarily designed for on-stage use, the wide range of Roland equipment distributed by **Brodr Jorgensen** includes several items of interest in the studio field. In addition to PA mixers and amplifiers, synthesisers, guitar synthesisers, vocoders, digital sequencers, etc, Roland also produce a wide variety of echo/reverb units ranging from the established *RE-501 Chorus Echo* and *RE-201 Space Echo* to items in the Roland rack mount series. The large number of items rather precludes detailed coverage here, however, units which might repay further investigation include the *SVC-350* vocoder with 'a series of 11 voice character analysis filters'; the *SBF-325* stereo flanger; the *SDD-320* spatial dimension decoder (a type of chorus effect unit); and the *SPH-323* stereo phaser with independent LFO's.

Scenic Sounds Equipment had two new items on display for the first time in the UK. First of these is the Deltalab *Memory Module*, a 19in rack mount add-on unit for the Deltalab signal processing range which extends the available delay by up to 2s per module. Unfortunately, further details were unobtainable, but we hope to cover this unit in greater detail in our *News* pages at a later date. The other new product on display was the *Model 5402 Time Modulator* from Marshall Electronic. Based on the original Marshall *Time Modulator* the new unit has an expanded delay capability of 400ms; yet retains the original unit's short delay functions; has a 72:1 sweep range; and is quoted as having a full 15kHz bandpass and 95dB dynamic range at all delay settings.

Already well known for its *SR402* MOSFET power amplifier, **Tresham Audio** also manufactures two graphic equalisers. These are respectively the *SR112* and *SR271* 19in rack mount units. The *SR112* is a stereo 11-band graphic eq offering ± 12 dB cut or boost at $\frac{1}{4}$ -octave centres and

featuring a bypass facility and peak monitoring LEDs with a variable threshold control range. The *SR271* is a $\frac{1}{3}$ -octave 27-band graphic eq at ISO standard frequencies with similar facilities to the stereo unit. Both units feature discrete preamplifier circuitry providing up to 20dB gain and a switch to reduce input sensitivity by 20dB. The power output stages will drive up to +20dBm into 600 Ω . Inputs and outputs are XLR and jack connectors.

Turnkey displayed a new American manufactured DDL which I had not come across before. This is the Advanced Audio Designs *Model D-250*. A 19in rack mount unit, this new digital delay offers full band delays of up to 250ms in 1ms steps, has a front panel digital LED display which shows the programmed delay, and facilities for remote control. As well as normal delay effects the *D-250* also offers such effects as flanging, vibrato, pitch bending, frequency modulation, and infinite repeat hold. Price of the *Model D-250* is £449.

Microphones

Two recently introduced microphones were shown by **AKG**. Pride of place must go to the *C414E1*, similar to the established *C414EB*, but featuring remote control facilities and offering cardioid, omnidirectional, figure-of-eight and six other intermediate polar response patterns. The *C414* has always been a popular mic, but I was rather surprised to discover that over 10,000 of the type have been produced. How did I discover this figure—well totally coincidentally AKG presented the 10,000th *C414* to the BBC at APRS. The *C414* obviously will be with us for some time yet as a new version of the *C414EB* (with the suffix *P48*) has been introduced designed for 48V phantom powering. Also on display was the recently introduced *C567E* which is a miniature lavalier condenser mic with an omnidirectional response.

Beyer as usual had a wide range of mics and headphones on display. A recent addition to its range is the electret-condenser *MCE5* claimed to be the smallest mic in the world, while Beyer also showed its complete *700 Series* modular studio condenser mic system with a wide range of mic capsules. In addition to these APRS also saw the introduction of two hypercardioid mics, the *M420N* and *M422N* special purpose dynamic mics for PA and sound reinforcement use. A further mic addition was the reintroduction of the *M130N* figure-of-eight dynamic model which utilises a unique double ribbon design. Turning to headsets, the Beyer *DT100* is probably the most widely used model in studio and broadcast usage. Other headsets in the Beyer range include the *DT102* single ear muff configuration; the *DT108* combination dynamic mic/headphone; and the *DT109* with boom dynamic moving coil mic and

independently wired left and right headphone channels allowing one channel to be used for studio talkback and the other for programme monitoring.

Crown/Amcron distributor **HBB** in addition to showing the current range of amplifiers, also had on display the new Crown PZM microphones. Based on the pressure zone concept these mics will accept up to 150dB spl without distortion and they are free from phase cancellation anomalies.

Shure introduced the *SM63* omnidirectional dynamic mic which is a compact hand held lightweight mic for vocal applications. Features include a shock mounted capsule to eliminate mechanical noise, an integral wind and pop filter, a hum bucking coil to reduce the effect of strong magnetic fields, and improved sensitivity (6dB more) over the *SM61*.

Walter Luther Ltd showed two ranges of microphones in addition to the Wyndcliff range of mic stands and booms, these being the Primo range of electret condenser and dynamic mics, and the Rello range of radio mics. The Rello range includes a ball-top handheld transmitter mic, a pocket pack transmitter for use with tie-clip mics, and a radio guitar system. Receivers are either free standing or built-in amplified units for PA applications. Prices of both the tie-clip and handheld mic systems are identical, costing £350.

Amplifiers and monitors

Swiss manufacturer **FM Acoustics** showed new versions of its *FM600A* and *FM800A* power amplifiers. Termed the *Series II* the new versions feature greater protection circuitry, improved power output (250W rms into 8 Ω for the *FM600A* and 400W rms into 8 Ω for the *FM800A*), and the ability to now drive 2 Ω loads. In addition to these new versions the company also introduced the *FM212* moving coil pre-preamplifier. This unit features two switchable moving coil inputs and three impedance matching push buttons allowing eight different input resistances to be selected.

Loudspeaker manufacturer **Lockwood** displayed its wide range of monitor loudspeakers incorporating Tannoy drive units. A new addition to its range was the *Director* a multi-direction angled monitor designed for either ceiling or wall mounting, or alternatively floor standing. This monitor is a small unit, incorporates the Tannoy 12in *3148* dual concentric drive unit and offers a power handling capability of 100W. As this unit was only being shown in its prototype form further details have yet to be released.

The UK MXR distributor, **Atlantex Music**, showed two interesting products, a system preamp and a linear preamp. The MXR system preamp features full signal routing flexibility, two independent input sources, two tape monitor



Nick Martin, left, and David Hawkins (standing) of Scenic Sounds

Alice stand: John Andrews and Ted Fletcher, with Ian Peltman of Mercia Sound



The Ultimate Equaliser

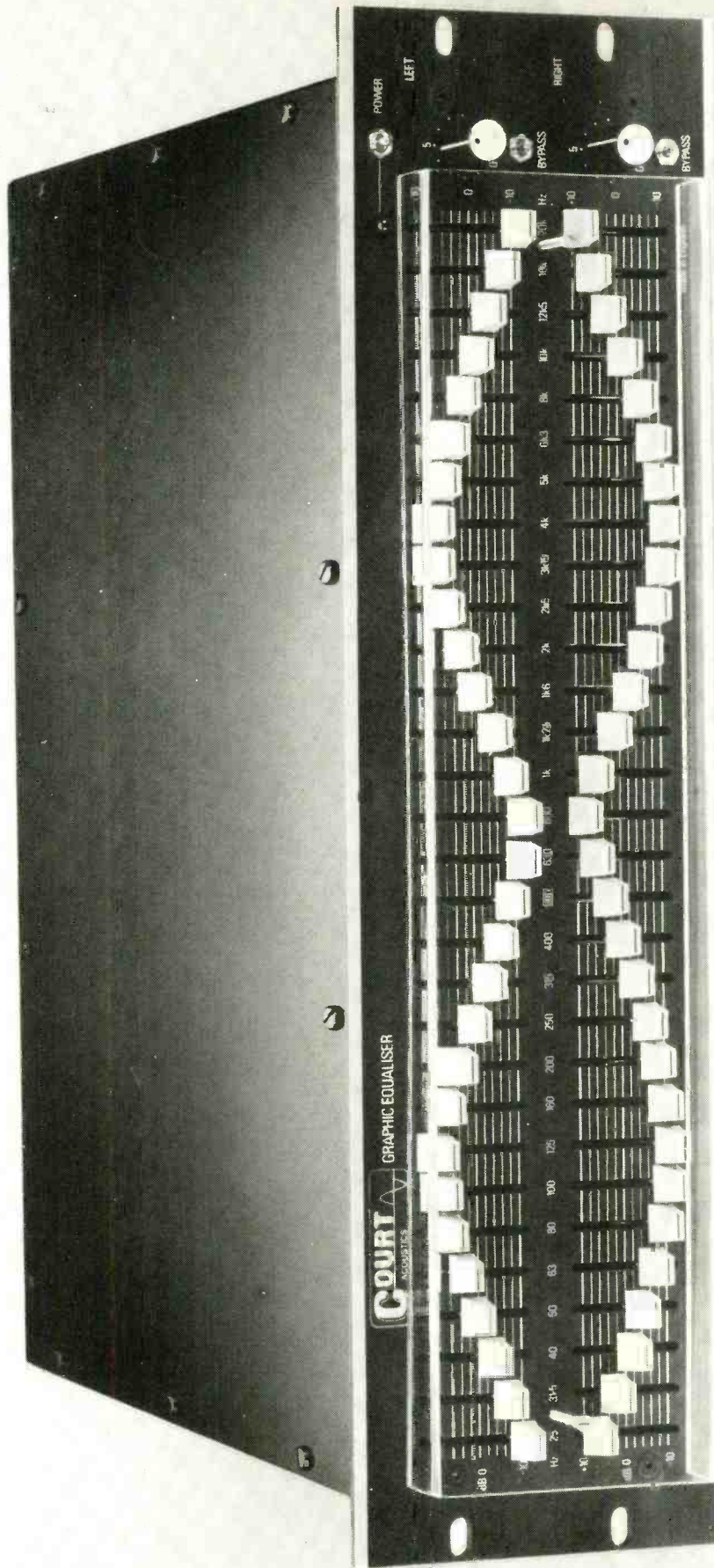

- 2 Stereo bands of 30 faders with centre click stops giving 20db of control
- Entire audio spectrum from 21hz to 21khz in 1/3 octaves
- Up to 20db of gain
- High and Low pass filter on end faders for subsonic and supersonic rejection
- \pm 10db of boost and cut, or 20db 'all cut' and 'all boost' with flat response
- Plug in balancing transformers
- 60 Precision inductors with minimally flat response for maximum curve performance
- Passive bypass for accurate pre & post eq. comparison
- Perspex 'Tamper-Proof' cover
- 100-240 volt operation in 5 1/4" rack space



COURT ACOUSTICS LTD

35 Britannia Row, London N18QH ☎ 01-359 0956 Telex 268279 Attn. BRITRO G

APRS Report



Michael Fabricant in MBI's mock broadcast on-air studio featuring Series 24A console

loops, two signal processor loops with assignable locations, tape copying facilities, separate channel monitor and mixing facilities, switchable subsonic filter, and switchable (20dB) gain. The MXR linear preamp features phono/tuner/aux inputs, two tape monitor/signal processing loops, switchable subsonic filter, switchable gain, a level compensating balance control, and a headphone monitor. Although both units form part of MXR's consumer product line, both are useful central control units.

Console manufacturer, **Raindirk** introduced a new range called Status. Comprising the *S500* MOSFET power amplifier and *S20* stereo control unit, both are 19in rack mount units. The *S500* features comprehensive protection circuitry, high speed MOSFET output stages, has a power output of 250W per channel into 8Ω both channels driven 20Hz to 20kHz, and is switchable for bridged mono operation (650W into 8Ω). Signal inputs are via XLR connectors and ¼in jacks. A version of the power amp is available fitted with LED power meters calibrated in six steps from 5 to 250W and having a PPM characteristic. The *S20* control unit features a modular disc replay amplifier which may be remotely located, adjustable gain and impedance for cartridge matching, a comprehensive 3-band equaliser section, a variety of inputs, an external power supply, and a separate 3W output headphone amp.

Although previously shown at both AES London and AES Los Angeles, **Tannoy** once again featured its new *Little Red* monitor together with its established range of monitor loudspeakers. The *Little Red* uses a 12in dual concentric drive unit in a small 46.5 litre ported enclosure, has a calibrated control network allowing adjustment of treble energy and roll-off, and has a recommended minimum power handling of 100W.

Test equipment

Bruel & Kjaer showed its usual wide selection of test equipment and one new item, the *2033* high resolution signal analyser. The *2033* is ideally suited to real time FFT analysis and comprises a combined transient recorder and Fourier analyser. The analyser has a 10k sample input memory with internal, external or free running trigger; facilities for manual or automatic stepping of a 1k sample window; and a unique zoom feature allowing measurement of high resolution spectra. Other features include constant bandwidth baseband frequency analysis in 400 frequency lines; 11 selectable baseband frequency ranges; spectrum displays over 80dB, 40dB or linear ranges with variable display gain; and an alphanumeric readout facility fed directly from the display screen using a line selector.

Wayne Kerr introduced its *AMS1* audio measurement system, a multi-purpose test set with facilities for measuring level, programme, noise, wow and flutter, rumble, distortion,

crosstalk, phase and power. A general purpose instrument the *AMS1* has a wide choice of meter indications including rms, VU or PPM, and CCIR quasi-peak; takes plug-in noise weighting filters; has a low distortion oscillator, a 4-digit frequency counter, and a built-in headphone amplifier.

Other lines

Feldon Audio showed the new *Tempo-Check Studio 120* digital multi-metronome and chromatic tuner from Pulse Designs. This unit is a rack mount compact and accurate metronome with a crystal controlled microcomputer which calculates the tempo and digitally displays the tempo in beats per minute. Control is either by a rotary control (using the readout in beats per minute) or by thumbwheel switches (in frames per beat) but with the equivalent speed in beats shown simultaneously on the display. In addition there is a 'Tempo' facility where pressing a button in time with the music instructs the computer to calculate and display the tempo. Other facilities include 12 crystal controlled tuning notes from C to B, programmable beats per bar, and separate triplet and quaver outputs which may be combined together as desired.

Blank and pre-recorded cassette manufacturer **Fraser Peacock Associates** showed the Sony high speed cassette copying system. A variety of units are available all duplicating at 8 times normal speed, and the range comprises the *ORM-10* stereo 4-track open reel master recorder, the *CCP-04A* 4 cassette slave unit, the *CCP-13A* cassette-to-cassette copier with three copy bays, the *CCP-11* cassette-to-cassette master/copy unit, and the *CCP-02* slave unit for the *CCP-11* with two copy bays. An additional unit is the *AA-10* adaptor unit for use when more than three slave units are utilised.

Kelsey Acoustics Ltd were showing the *ADI* active direct injection network which will accept a wide range of inputs. Gain is switchable from -45dB to +30dB in 15dB steps, maximum output is +6dBm, output impedance is 50Ω capable of driving 600Ω loads, and the network is powered by two 9V PP3 batteries.

Lee Engineering specialise in distributing products for the broadcast industry, and showed a wide range of broadcast orientated products. New to the UK, though, was a range of all wave receivers from American manufacturer Mckay Dymek. The receivers comprise the *DR22*, *DR33*, *DR44*, *DR55* and *DR101* which offer continuous all wave coverage from 50kHz to 29.7MHz.



At APRS this year, AKG Acoustics' managing director, Ben Woolf presented Des Browning, head of studio operations, BBC TV Centre, with the 10,000th C414EB microphone.

The C414EB is the fifth generation of its type, having descended from the C12 produced over 20 years ago. The presented model will go on display at the TV Centre in London.



John Southard Trad, Emil Handke Sound Workshop

Features include LED frequency readouts, solid state phase locked digital synthesis tuning with quartz crystal accuracy, crystal and ceramic filtering for improved selectivity and intermodulation performance, switch selectable 4 to 8kHz RF filters, 5kHz audio heterodyne notch filter, and Class D AM envelope detection.

Swiss manufactured Neutrik connectors and sockets are distributed in the UK by **Eardley Electronics** who as usual had the full range on display. In addition to the established XLR types, however, there was a new type the *D-Series*. Designed for direct pc-board mounting, the new series which are XLR compatible, are front-fixed and rear insert mounted with the same unified housing for both male and female configurations. The new series are RF-shielded by a coaxial ground-contact-element at the point of entry, feature direct internal grounding of the shell and ground lug to Pin 1, and are available for vertical or horizontal mounting with or without locking latches.

Penny & Giles introduced the *1000 Series* fader, a lower cost fader with a stroke of 90mm and with the same tracks and feelers as the standard P&G faders. Designed for back mounting the series are available as either mono or stereo units with linear or log law outputs. Also introduced was a new digital fader with a 104mm track, 0.4mm resolution, and an 8-bit parallel Gray Code digital output.

A new British engineered cartridge machine was introduced by **John A Steven**. Termed the *Cartridge Technology*, the machine uses NAB AA carts and is available either as a playback only machine or as a record/reproduce machine. Features include crystal controlled dc motor transport with ceramic shaft, a unique pinch roller mechanism, removable head assembly, front panel timer, adjustable presets for frequency response alignment, phase linear record equalisation, automatic alignment of record head azimuth, built-in test oscillator, PPM (optional VU) meters, cue track erase facility, 150Hz and 8kHz cue tones as standard, and remote record/playback control facility. Quoted specifications include wow and flutter 0.12%, frequency response 40Hz to 16kHz±2dB, and noise -54dB. Price of the playback only unit is £1,100, while the record/playback machine costs £1,700.

Finally, **Turnkey Two** the new acoustics and studio design service run by Andy Munro was launched at APRS. Turnkey Two offers a microprocessor aided analysis and design service allowing complete system performance to be assessed, and also provides a basic control room analysis service. Techniques used include time delay spectrometry and LEDE (live end dead end), plus the usual RT60, gated time mode and spectrum analysis techniques. In addition to providing the above services Turnkey Two can also supply acoustic materials such as Rockwool and Ecomax.

Why Amcron is demanding protection money.

Over the years, Amcron has earned a peerless reputation as a pioneer in professional sound.

Amcron built the first solid-state four-channel tape recorder back in 1962. Then they developed the first stereo amplifier with direct coupled input and output.

In 1977, they introduced digital logic to the pre-amplifier and achieved another first.

But Amcron's latest first is probably the most significant of all.

The PSA-2 power amplifier is self-protecting.

A Self-Analysing circuit employs an analogue computer which constantly monitors the performance of the amplifier's critical stages.

Should the power transformer begin to overheat, an output transistor fail, or a short circuit occur, then the amplifier will automatically shut down to its 'stand-by' mode without damage to itself or to external equipment.

The protection circuitry also safeguards the PSA-2 against 'chain destruction' and damage caused by mis-matched loads.

As Dr. Mark Sawicki observed in his

review of the PSA-2:

"When reading reports of systems used by The Who, McCartney and Genesis...the Amcron name appears frequently...Why?

Well, reliability and outstanding performance are the answers.

Overall, the performance of the PSA-2 amplifier...is excellent."

Now. Given that you're spending a lot of money on a power amplifier (arguably the most crucial piece of equipment in your system), doesn't it make sense to spend a little



more on a unit which is virtually disaster-proof? We think so.

Which is why we went all out to win the sole British agency for the PSA-2. And, indeed, the whole range of Amcron audio equipment.

Drop in and see us anytime. We'll be delighted to give you an earfull.

HHB
HIRE AND SALES

HHB HIRE AND SALES, UNIT F, NEW CRESCENT WORKS, NICOLL ROAD, LONDON, NW10 9AX. TEL. 01-961 3295, TELEX 923393.

Tresham SR402 amplifier

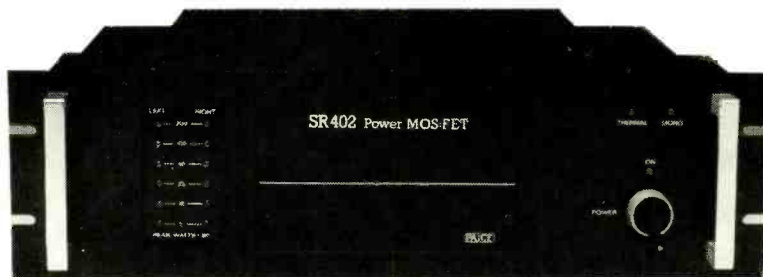

MANUFACTURER'S SPECIFICATION

Input sensitivity: 1V for rated output.
Input impedance: 50k Ω unbalanced.
Power output: (both channels driven, 20Hz to 20kHz bandwidth) 120W into 15 Ω , 200W into 8 Ω , 350W into 4 Ω , 500W into 2.5 Ω .
Bridged mono operation: 350W into 16 Ω , 650W into 8 Ω .
Distortion: 1kHz, 200W into 8 Ω less than 0.01% total harmonic distortion; 20Hz to 20kHz, 200W into 8 Ω less than 0.03% total harmonic distortion. Less than 0.02% imd (4:1 60Hz and 7kHz).
Signal to noise: ref full output - 110dB (A weighted).
Residual noise: less than 0.5mV (20Hz to 20kHz).
Crosstalk: ref full output, 1kHz less than 80dB; 10kHz less than 70dB.
Rise time: 1.5 μ s.
Slew rate: 80V/ μ s.
Meter: rise time approx 10ms, fall time 1s, accuracy \pm 5%, dc offset 20mV.
Price: £663.
Manufacturer: Tresham Audio Limited, 32 Tresham Road, Orton Southgate, Peterborough, Cambridgeshire.

THE TRESHAM SR-402 (formerly PA:CE Studio Equipment) amplifier is a twin channel power amplifier which may be switched for mono operation in the bridged mode by means of a rear panel switch. Also at the rear panel are audio inputs in the form of unbalanced connections via either XLR connectors or 1/4in jack connectors which are connected in parallel.

The outputs to the loudspeakers take the form of terminals/sockets which are not on the standard 3/4in spacing, but, it is understood that future production will be modified to this spacing. Mains power input is via an IEC connector with a properly identified mains fuse and the mains voltage selector adjacent.

Remaining rear panel features consist of a slide switch and a 110V ac output from an IEC standard socket. These features are intended for use with an optional cooling fan assembly. When the slide switch is placed in the FAN position, 110V becomes available at the IEC socket when thermostats on the heatsinks operate. In the NO FAN position, the thermostats disconnect the load by a relay. If the switch is accidentally left in the fan position without the fan accessory being fitted thermal protection is lost and for this reason it is

felt that either this should be made an internal switch, or it should require tools for operation.

To the left of the front panel are twin LED power indicators calibrated for power into 8 Ω with red LEDs becoming illuminated at 100W, 50W, 25W, 10W and 5W peak power. At the right of the front panel further red LEDs indicate power on, mono (bridged) operation and thermal tripping. After switching on by means of a large rotary switch, the power on LED initially flashes for a few seconds to indicate that the loudspeakers are not yet connected by the protection relay which is controlled by a turn-on delay before the amplifier stabilises. The same relay also provides protection against excessive dc offset at the outputs, nominally operating at 2V. If the dc offset reaches 5V crowbar protection is provided by firing an SCR across the outputs and thus blowing the mains fuse.

At the centre of the front panel the two gain controls and two HT fuses which protect the MOS:FET output stages are located behind a cover which is fixed with socket screws to discourage knob twiddlers. Maybe this would be a good place for the fan switch? Whilst the value of the fuses is quoted in the instruction manual, the fuses are not identified in value and the manufacturer should rectify this omission.

The amplifier is designed for mounting into a standard 19in rack with the front panel being an alloy plate with substantial handles and mounting slots for the rack mounting screws. Similarly the base and the rear panel are constructed from alloy plate with sheet metal sides supporting the heatsinks for the six output MOS:FETs at either side of the amplifier.

Within the case there is a central large toroidal mains transformer supplying separate rectifiers and smoothing capacitors for each channel located to the front of the base plate.

The electronics for each channel are mounted on printed circuit boards inside the heatsinks at the sides of the amplifier. Each board has two preset potentiometers and a slide switch which gives the alternative of ac or dc coupling. No component identifications were to be found on the

printed circuit boards and whilst the instruction manual gives advice on adjusting the preset controls no circuit diagrams or layout diagrams are provided.

A further printed circuit board behind the front panel (also without component identifications) supports the front panel indicators and also the protection circuitry and the level indicator circuits.

Whilst the standard of construction was generally satisfactory and the wiring reasonably tidy, it is felt that the standard of soldering could be improved.

In operation the amplifier was relatively quiet with only a slight hum from the mains transformer—the heatsinks did however become rather hot to the extent that touching them was not advisable.

Power output and distortion

Using a stabilised 240V 50Hz power input and loading the amplifier into accurate load resistors monitored by a digital voltmeter, the output power for the onset of clipping was determined at 1kHz.

With 8 Ω loads the two channels had identical performances delivering 240W with both channels driven or 255W with single channels driven. Working into 4 Ω the onset of clipping occurred at 370/375W with both channels driven or 415/420W with single channels driven—all far better than the manufacturer's specification.

Checking the peak power handling capacity using 10ms bursts of 1kHz tone every 100ms showed that a considerable reserve of power was available with the two channels beginning to clip at 290W into 8 Ω or 480/500W into 4 Ω . Similarly the amplifier was capable of giving a continuous power of 480/450W into 2 Ω so that it will be quite happy to drive any loudspeakers having a nominal impedance of 4 Ω and falling well below their nominal impedances.

Checking the half power bandwidth at 100W into 8 Ω for 0.1% total harmonic distortion showed that the two channels performed up to

80 ►

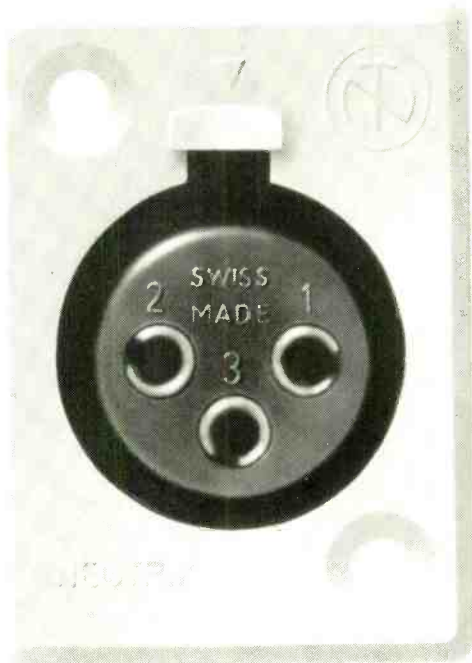

Eardley Electronics Ltd

TEL: 01-2210606 TLX: 299574



we're moving in all the right directions

to even faster service

S.E.S. has a reputation for fast and personal service in supplying the right equipment for studio installations. Now with improved premises and facilities our supply and installation functions will be even more efficient — and that goes for our 'same day' service too. We hold stock from over 25 leading manufacturers plus a full range of accessories.

Our stocks include AKG, Alice, Allen & Heath, Ashly, Auratones, Beyer, Brenell, Formula Sound, Furman, JBL, Keith Monks, MXR, Neal, Quad, Revox, Sescor, Sonifex, Spendor, Tannoy, Tascam, Teac, Technics and Uher.

We can therefore select the right 'package' for your needs, without bias.

Please telephone for our brochure and price list.

to larger premises

From July 1st 1980 our new premises become operational. We're not moving far but for the better.

We'll have more room, better facilities, larger and more comprehensive stocks. You are welcome to call at any time and test equipment in our demonstration studio.

Our new address: 100 Hamilton Road, London NW11

Telephone: 01-458 9133 Telex: 87515 WISCO G

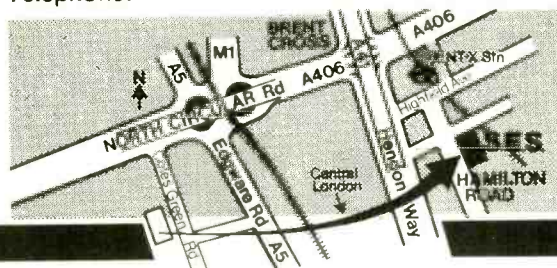

Studio Equipment Services Limited

100 Hamilton Road, London NW11
Telephone: 01-458 9133
Telex: 87515 WISCO G

FIG.1
TRESHAM SR402
INTERMODULATION
DISTORTION AT
1W OUTPUT

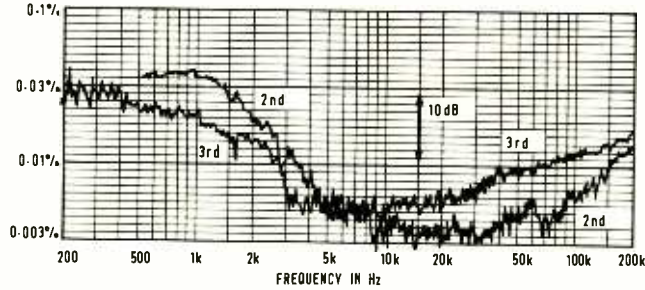

40/49kHz with the results at 175W into 4Ω being 26/30kHz.

Total harmonic distortion at 1W output at 1kHz into 8Ω was the same for both channels at 0.01% with the right channel giving the same performance into 4Ω. However the left channel exhibited a peak in harmonic distortion at 2W into 4Ω producing large crossover spikes. Working at 10kHz at 1W into 8Ω produced 0.02/0.01% total harmonic distortion largely consisting of second harmonic products and noise.

Checking the intermodulation distortion to the CCIF method using two tones separated by 70Hz provoked disastrous results from the first sample of the amplifier. As a result the manufacturer discovered a faulty batch of transistors and promptly replaced the review sample of the amplifier. Subsequently, for other reasons, this second sample was replaced with a third sample from which the review results were taken. Reference to fig 1 shows the intermodulation distortion at 1W output with excellent results for both the second and third order intermodulation products. Working at half power into 8Ω produced the intermodulation distortion performance shown in fig 2 for the third order distortion products which remained at a very low level at frequencies below 20kHz.

Plotting the fifth harmonic distortion using an asymmetrical waveform produced fig 3 which shows that the amplifier is slightly sensitive to

waveform symmetry with the distortion rising at high audio frequencies.

Frequency response and noise

The overall frequency response in the ac coupled mode is shown in fig 4 from which it can be seen that from 20Hz to 15kHz the amplifier is flat to within +0, -0.2dB with the -3dB points occurring at 2.5Hz and 100kHz.

As a result of the manufacturer having difficulty with his supply of mains transformers, the first and second samples of the amplifier suffered from high mains hum levels in their outputs. The noise performance of the third review sample is shown in Table 1 which shows that whilst

82 ►

TABLE 1

	Noise reference 200W into 8Ω	
	Left	Right
Maximum gain		
22Hz to 22kHz rms	95dB	98dB
A weighted rms	105.5dB	105.5dB
CCIR weighted rms		
ref 1kHz	105dB	105dB
CCIR weighted quasi-peak		
ref 1kHz	97.5dB	96.5dB
Minimum gain		
22Hz to 22kHz rms	110dB	113dB
A weighted rms	115dB	117dB
CCIR weighted rms		
ref 1kHz	111dB	112dB
CCIR weighted quasi-peak		
ref 1kHz	103.5dB	106dB

FIG.2
TRESHAM SR402
INTERMODULATION
DISTORTION AT HALF
POWER FOR 3rd
ORDER PRODUCTS

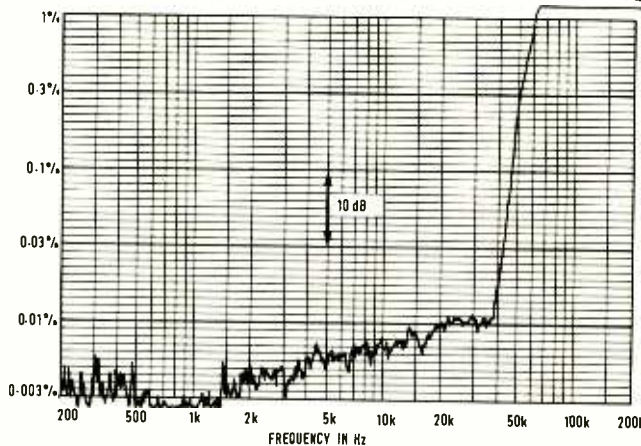
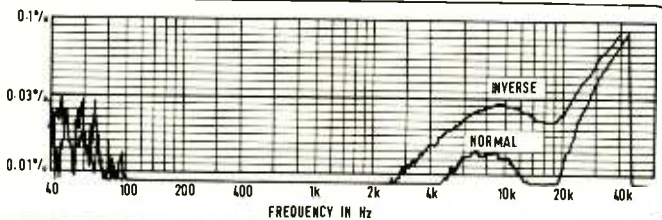
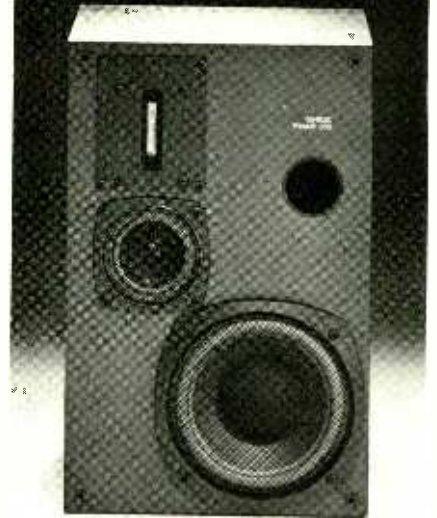

FIG.3
TRESHAM SR402
5th HARMONIC
DISTORTION



THE SOLUTION TO YOUR MONITORING PROBLEM



The TRIAMP S30 speaker system has been designed to satisfy the requirements found in broadcasting, monitoring in small and medium-sized music and speech studios and control rooms where the maximum SPL needed is roughly 100 dB. The TRIAMP S30 is a three-way system with three integrated power amplifiers and an active crossover network.

Features

- ± 3 dB from 40 Hz to 20 kHz
- symmetric input, + 6 dBm
- 105 dB SPL at 1 m
- separate power amplifiers for each driver
- level controls in each amplifier
- low level active crossover
- reliability
- solid construction with no frills or gimmicks
- compact size, 45 litres
- low cost

GENELEC OY

SATAMAKATU 7
SF-74100 IISALMI
FINLAND
Phone -35877-24 942
Tlx 4404 islmi sf

elektroimpex

BUDAPEST

THE FIRST OFFICIAL SUPPLIER TO THE MOSCOW OLYMPIC GAMES OFFERS

- AUTOMATION-READY, ALL-IC MIXING CONSOLES FOR STEREO, QUADRAPHONIC AND MULTITRACK SOUND RECORDING
- SERVO CONTROLLED TAPE RECORDERS
- DIRECT DRIVE STUDIO TURNTABLES
- SOLID STATE SWITCHING AND ROUTING SYSTEMS
- FIELD COMMENTATOR'S UNITS
- COMPLETE AUDIO SYSTEMS FOR RADIO AND TV STUDIOS, INCLUDING DESIGN, SUPPLY AND INSTALLATION

ELEKTROIMPEX-HUNGARY
H-1392 Budapest, P. O. Box 296.

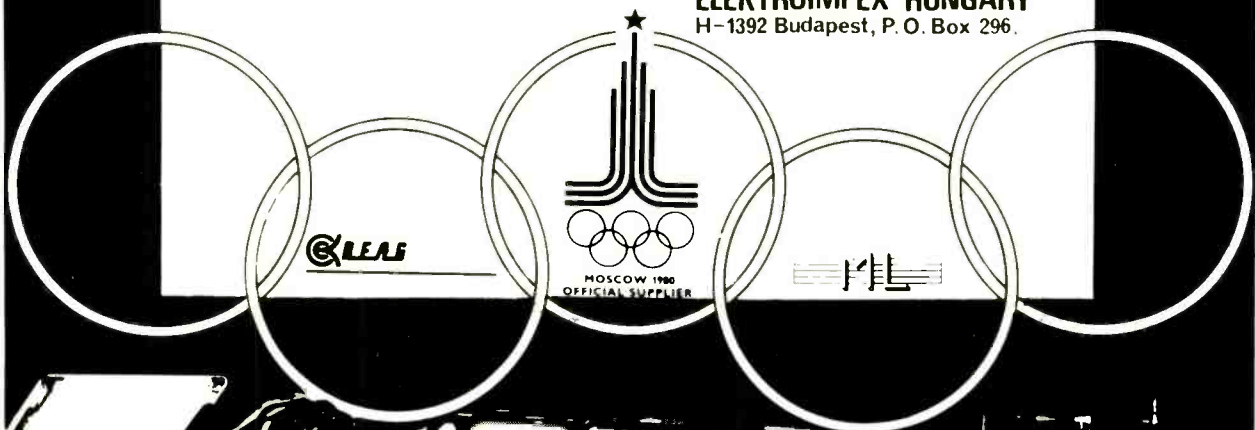
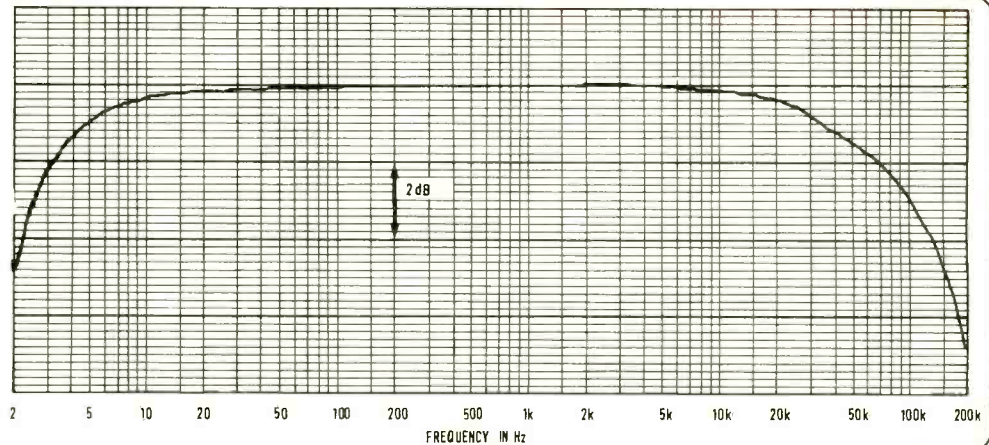

FIG. 4
TRESHAM SR402 OVERALL
FREQUENCY RESPONSE IN AC
COUPLED MODE



unweighted noise and hum vary to a large extent with the gain setting, the levels are reasonable.

Inputs and outputs

At maximum input gain the input level at 1kHz required for the rated output of 200W into 8Ω was identical for the two channels at 270mV with the gain controls having a full range, being located

across the input terminals.

Measuring the input impedance showed that this varied with the gain setting. At maximum gain the input impedance was found to be 50kΩ increasing to 100kΩ at minimum gain—all adequately high.

The damping factor at the outputs was found to be 125 at 60Hz or 130 at 1kHz with respect to 8Ω

loads with the dc offset at the outputs being negligible.

Other matters

Driving the amplifier with a 1kHz squarewave into 8Ω in parallel with 2μF produced the oscillogram fig 5 which shows significant overshoot. Working into an 8Ω resistive load both the rise time and the fall time were measured at 2μs with the maximum slew rate being recorded as 20V/μs.

The result of driving the amplifier continuously at half power with a 1kHz tone and then applying an asymmetrical toneburst at +10dB for 10ms every 100ms is shown in fig 6 which is a generally clean recovery.

The crosstalk between the two channels when driving 1W into 8Ω is shown in fig 7 which gives a respectable 85dB at 1kHz falling to 60dB at 10kHz which is more than adequate. As shown in fig 8 the overall phase shift in the ac coupled mode is small right up to 200kHz.

Investigating the power level indicators showed them to be genuine peak reading with a rise time to 0dB indication of 35ms or about 5ms to the -3dB point which is adequately fast for most requirements with the hold being such that short peaks could be seen reasonably. Generally the accuracy of the level indicators was within 2% with a worst case error of 4% at 5W in the left channel.

Summary

Clearly in some respects this MOS:FET amplifier has many good points, but, it is also clear that the manufacturer should pay attention to quality control.

Out of the three samples of this amplifier all three had faults. The first had poor im distortion, the second poor mains hum and the third had poor harmonic distortion in one channel.

As these were different faults it is fair to assume that proper quality control would produce good amplifiers.

Hugh Ford

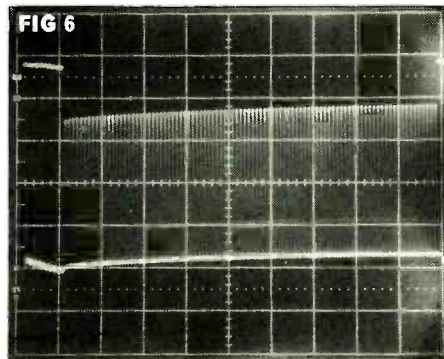
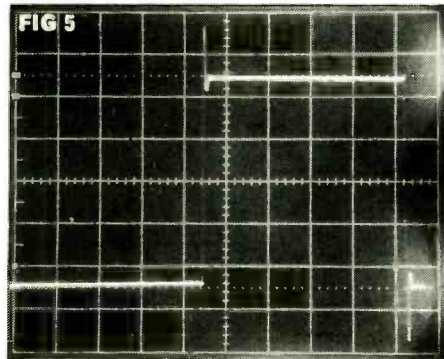

FIG. 7
TRESHAM SR402
CROSSTALK BETWEEN
CHANNELS WHEN
DRIVING 1W

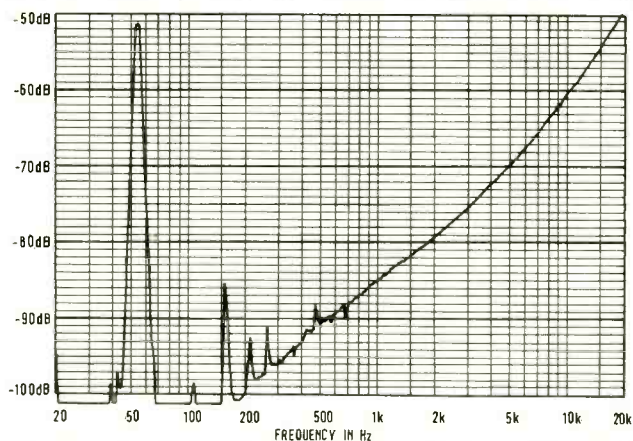
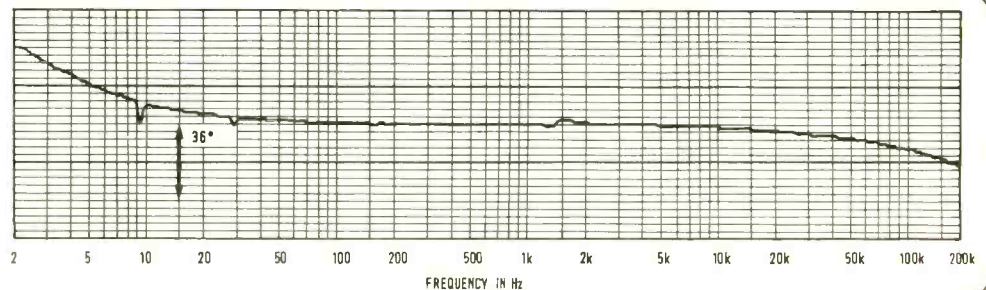
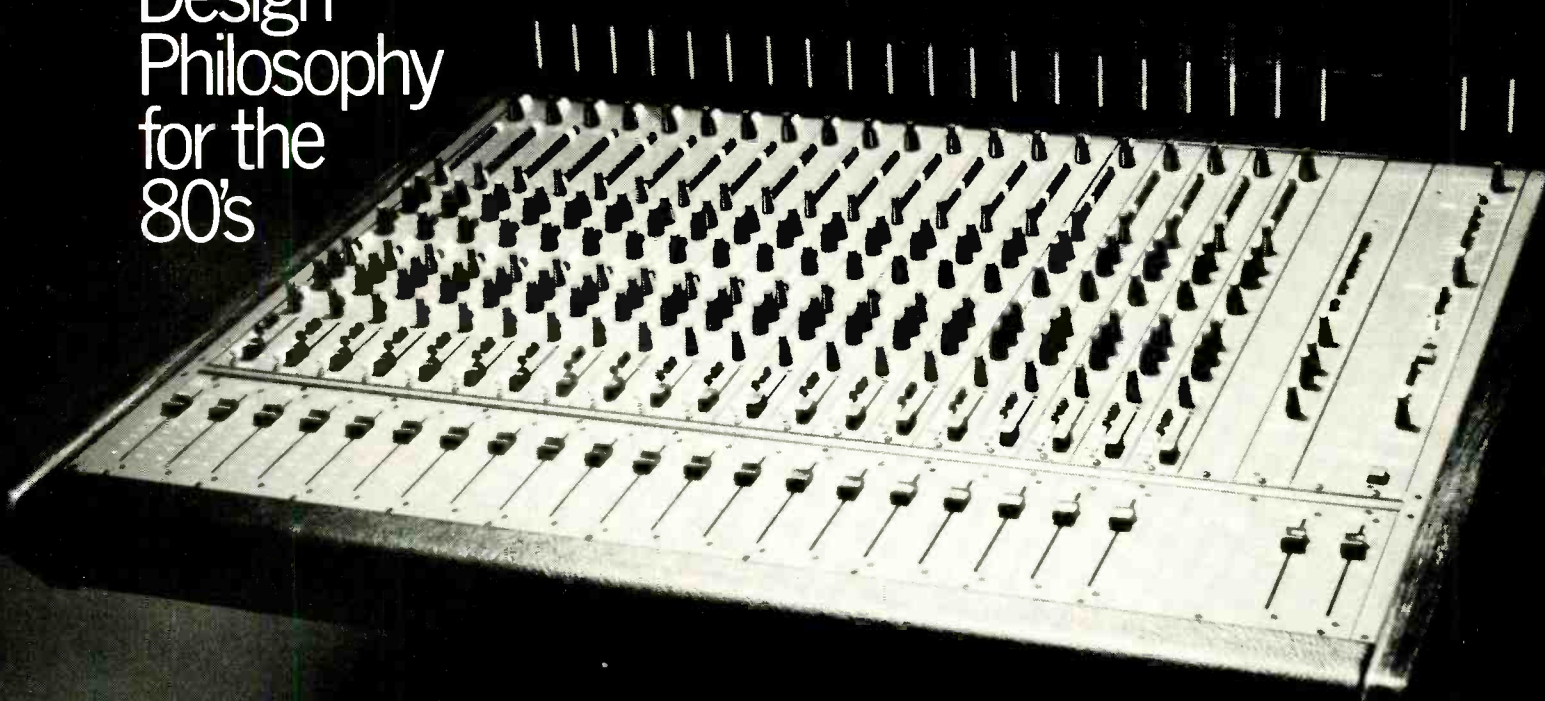

FIG. 8
TRESHAM SR402 OVERALL PHASE
SHIFT IN AC COUPLED MODE



SYNCON Series B

Design
Philosophy
for the
80's



AHB explodes the myth that 'state of the art' technology cannot be designed into a low price mixing console — the Series B proves it can. Following the incredibly successful Syncon has not been easy. It is still the best selling British made in-line console but the demand for a smaller more flexible system has guided AHB to design a mixer which in its most basic format is ideal for small 8 and 16 track studios and yet with no factory modification can be expanded to a 44/24 fully automated console with full function patchbay.

The Series B utilizes many of the chips and mechanical parts found in the world's most expensive audio equipment. Cost saving has been made in streamlined production design and volume purchasing — not in quality control.

The Series B is the most important new audio product to emerge in 1980. Check it out!

- 24 track and 2 mix busses
- 20 input/output mainframe
- 12 input/output expander frame
- Modular patchbay frame
- Innovative auxiliary mix system
- Sweep frequency equalisation
- Free routing and subgrouping
- Light column metering
- Auto PFL audio & metering
- In-place solo
- Fully automatable (Allison compatible)
- Solid hardwood trim
- 3 channel fader options
- LED channel functions
- New mic. input design
- Monitor channel effects mixing
- High slew rate
- Full function monitoring

Made in England by ALLEN AND HEATH LTD.
Pembroke House
Campsbourne Road
London N.8.
Tel: 01-340 3291

AHB
ALLEN AND HEATH BRENNELL LTD.

audiomarketing ltd
Glenbrook Industrial Park
Stamford, Connecticut 06906
U.S.A.
Tel: (203) 359 2312

Yamaha P-2200 power amplifier

MANUFACTURER'S SPECIFICATION

Power output per channel: 200W continuous average sinewave power into 8Ω with less than 0.05% total harmonic distortion, over a bandwidth of 20Hz to 20kHz, both channels driven. 230W continuous average sinewave power into 8Ω with less than 0.05% total harmonic distortion, at 1kHz, both channels driven.

Frequency response: +0dB, -0.5dB, 20Hz to 50kHz.

Total harmonic distortion: less than 0.005% at 50W, 8Ω, 1kHz, less than 0.01% at 150W, 8Ω, 20Hz to 20kHz.

Intermodulation distortion: less than 0.01% using frequencies of 70Hz and 7kHz, mixed in a ratio of 4:1, single channel power output of 150W into 8Ω.

Input sensitivity: an input of +4dBm (1.23V) ±0.5dB, produces an output of 230W into 8Ω (maximum output power), input attenuator set for maximum level.

Input impedance: 25kΩ, minimum (unbalanced).

Damping factor: (8Ω) greater than 300 at any frequency from 20Hz to 1kHz; greater than 70 at any frequency from 20Hz to 20kHz.

Actual output impedance: less than 0.04Ω, from 20Hz to 10kHz.

Hum and noise: at least 110dB S/N ratio (IHF/ASA No Z24.3-1944).

Rise time: 3.8μs or better (10%—90% of 1V at 1kHz squarewave output).

Slew rate: 45V per μs or better (at 175W into 8Ω, 200Hz, squarewave input).

Channel separation: at least 82dB at 1kHz, at least 75dB at 20kHz.

Phase shift: 20Hz to 200kHz, ±10°.

Offset voltage: less than ±10mV dc.

Thermal specifications: massive black anodised heat sinks are thermally joined with the chassis, thereby utilising the entire amplifier as a heat sink.

Protection circuits: thermal warning light turns on when heat sink temperature reaches 100°C; a self-resetting thermal switch shuts down the ac power if the power transformer winding temperature reaches 130°C.

Turn on/off specifications: there is no turn off transient; the turn on transient is minimal. Warm up time is less than 0.2s.

Power requirements: (except USA and Canada) 1,300W, 220V or 240V ac nominal, 50 to 60Hz. USA and Canadian models: ac, 120V nominal, 50 to 60Hz (105V min, 135V max) 8A maximum at 120V ac; 960VA maximum at 120V; approximately 57VA at idle.

Efficiency: as high as 63%.

NOTE: all performance specifications are made on US and Canadian models at an ac line voltage of 120V±1%, using a ±1% nonreactive load resistor at an ambient room temperature of 25°C. Also effective for other territories' models.

Input connectors: one male and one female XLR connector in parallel, pin 2 'hot', pin 3 connected to pin 1 (shield); switchable for pin 3 'hot'. XLRs are unbalanced and in parallel with two tip-sleeve (standard) phone jacks.

Output connectors: standard 3/4in spacing, '5-way' binding posts.

Meters and indicators: two peak reading meters (one per channel) indicate the instantaneous power output, over a 5-decade (50dB) range. '0dB' represents 100W into 8Ω. One 'power on' indicator LED; one 'thermal overload' indicator LED.

Meter rise time: less than 10ms (-40dB to 0dB on the scale).

Meter release time: less than 0.8s (0dB to -20dB on the meter scale).

Controls: 22-position, log-linear, detented, and dB-calibrated input attenuators (one per channel) attenuate input signal in 2dB steps from 0dB attenuation to -34dB, then steps of -37dB, -42dB, -50dB, infinity; power (on/off) switch; input polarity switches.

Fuses: AGC (3AG) type, 7A x 2 parallel fuses for the ac line input (US and Canadian models). 4A x 2 parallel fuses for the ac line input (other territories' models).

Dimensions: mounts in a standard 19in (480mm) rack, 7in high (176mm); maximum depth behind front panel is 13in (330mm); maximum depth including front handles 14.5in (379mm).

Weight: 44lb (20kg).

Colour: semigloss black.

MONAURAL MODE SPECIFICATIONS

Power output: 400W continuous average sinewave power into 16Ω with less than 0.05% total harmonic

distortion, 20Hz to 20kHz.

Frequency response: +0dB, -1dB, 20Hz to 50kHz.

Total harmonic distortion: less than 0.01% at 300W into 16Ω at 1kHz.

Intermodulation distortion: less than 0.05% using frequencies of 70Hz and 7kHz, mixed in a ratio of 4:1, at a power output of 200W into 16Ω.

Input sensitivity: an input of 0dBm (0.775V), ±0.5dB, produces an output of 200W into 16Ω (input attenuator set for minimum attenuation, max level).

Input impedance: 25kΩ min (unbalanced).

Damping factor: (at 16Ω) greater than 220 at any frequency from 20Hz to 1kHz; greater than 100 at any frequency from 20Hz to 20kHz.

Hum and noise: at least 110dB S/N ratio (IHF/ASA No A24.3-1944).

Slew rate: 35V per μs or better, at 100W into 16Ω, 200kHz squarewave input.

Price: £395.

Manufacturer: Nippon Gakki Company Limited, Hamamatsu, Japan.

UK: BAN Electromusic, 89/97 St. John Street, London EC1.

THE YAMAHA models P-2200, as reviewed here, and P-2201 are identical except that the P-2201 does not have any metering.

As will be seen the manufacturer's output power rating of 200W into 8Ω is very conservative and whilst the specification does not suggest the use of 4Ω loads, considerable power is available into 4Ω or less.

The amplifier is designed for mounting into a standard 19in rack and has two illuminated peak power meters clearly scaled in W and dB reference 100W symmetrically placed about the centre of the front panel. Scaled from 10mW up to 300W, the meters serve the dual purpose of indicating the presence of even low level programme and indicating the onset of distortion.

To the right of the meters are two recessed gain controls which step in 2dB increments from 0dB to -34dB and thence to -37dB, -42dB, -50dB and infinite attenuation. Switched attenuators like this are to be far preferred to potentiometers as it is simple to preserve the balance between the two channels.

To the left of the front panel, which has two substantial carrying handles, is an unusual power on/off switch above which is the power on-in-

dicator light and a second light to indicate thermal overload.

At each side of the rear of the amplifier there is a bracket around which the fixed power lead may be wound in transit. These brackets also protect the other rear panel features from accidental damage. These include the two amplifier outputs in the form of terminals and the inputs in the form of unbalanced input via paralleled male XLR, female XLR and twin 1/4in jack sockets. In addition to these practical features, there is a slide switch which selects either pin 2 or pin 3 of the XLR connectors as the 'hot' input.

All that remains at the rear are twin paralleled imperial size power fuses with their values and all other rear panel features clearly identified. Within the amplifier there are further fuses which are also properly identified and the 220/240V mains voltage selector.

At the centre of the amplifier is a massive toroidal mains transformer enclosed in a screening can and the bridge rectifier together with smoothing capacitors with the amplifier channels mounted either side with an intervening screen. Each outer side of the amplifier consists of finned heat sinks onto each of which the six output transistors are mounted.

The drive electronics for each channel are mounted onto a glassfibre printed circuit board screwed to the inside of the heat sinks with the components being well identified for servicing. An excellent service manual was provided with clear (but in Japanese English) alignment instructions, a full parts list and complete circuit diagrams—why can't other manufacturers give users proper information?

Another printed circuit board behind the front panel supports the level meters and their associated electronics plus the lamps to illuminate the meters.

The overall standard of construction was excellent with the finish being beyond reproach. Within the amplifier everything was compact with the minimum of wiring. The general design was such that amplifiers may be rack mounted on top

86 ►

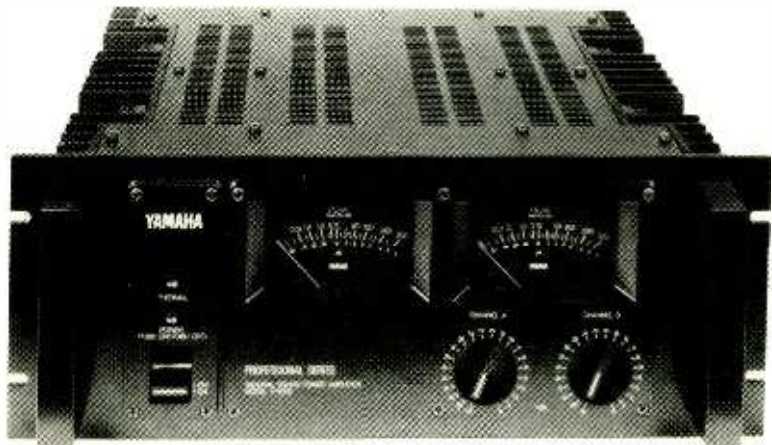

The Strong, Silent, Types.

Atlantex products are built for a tough, professional life. They are well-designed and made with the finest components for clean, noise-free circuitry.

Ashly audio processing units represent the technology of the future. The well-designed, easy-to-use layout allows precision control over the audible spectrum. Shown is the SC-50 peak limiter compressor. Other 19" Ashly units are parametric equalisers, electronic crossovers, pre-amp/processors.

Sescom, the world's finest audio interfacing units, are renowned for high quality products, combined with ruggedness and reliability. The wide range of models includes D.I. boxes, audio transformers, cable testers, and many more useful studio accessories.



The Furman range includes mono and stereo parametric equalisers with pre-amps, tunable crossover/bandpass filter, and (shown here) the neat reverb system with limiter and equaliser. The simple layout and wide range of control gives full scope for creative engineering at a price which gives great value for money.

Built to the highest standard, Whirlwind leads are made with top quality Belden cable, with Switchcraft and ADC connectors. Available from 1' patch cords to 24-input multicores, they are sturdily constructed to give years of trouble-free service.

Atlantex

Write or phone for illustrated catalogues.

Atlantex Music Ltd., 34 Bancroft, Hitchin, Herts SG5 1LA.
Telephone 0462 31511 Telex 826967

of each other; an outstanding feature was that at all power levels it ran amazingly cool without any forced air cooling, which is so commonly too noisy.

Power output and distortion

An uncommon feature is the provision of both 240V and 220V power transformer taps; something that should be welcomed in continental Europe. Taking the usual precaution of using an accurately stabilised mains supply together with precision load resistors and accurate digital meters, the power output at the onset of severe distortion at 1kHz was measured for 8Ω and 4Ω loads with both channels driven, giving 280W into 8Ω and 425W into 4Ω for both channels. Driving single channels gave significantly more power at 315W into 8Ω or 510W into 4Ω.

Under practical audio conditions, considerably more power is available with the onset of clipping of a 10ms burst of 1kHz tone every 100ms giving (for single channels driven) 360W into 8Ω or 650W into 4Ω.

From the above it is clear that the amplifier can safely drive any 8Ω loudspeakers even if their actual impedance falls to 4Ω and whilst the manufacturer does not mention the use of nominal 4Ω loudspeakers, the impedance of which can fall well below 4Ω, the amplifier can deliver 260W/230W into 2Ω for the left and right channels.

At half the rated power of 200W into 8Ω, the bandwidth for less than 0.1% total harmonic distortion was quite exceptional, extending from less than 10Hz up to 110kHz for both channels. Checking the total harmonic distortion and noise at 1W output into 8Ω showed this to be less than 0.009%/0.0075% at 1kHz, or less than 0.085%/0.075% at 10kHz for the two channels, or less than 0.01% at 1W into 4Ω. In all cases the residual was noise with no indication whatsoever of crossover artifacts. It was noted that the total harmonic distortion and noise was consistently low at all power levels below clipping.

FIG. 1
YAMAHA P2200
INTERMODULATION
CCIF DISTORTION
AT 1W OUTPUT

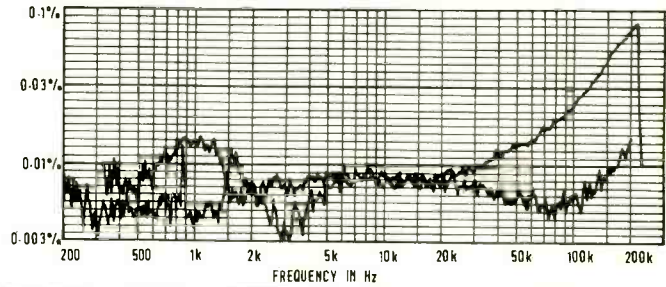
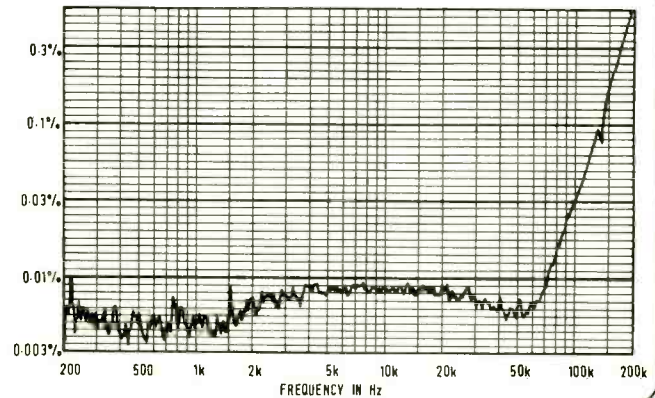

FIG. 2
YAMAHA P2200
INTERMODULATION CCIF
DISTORTION AT
HALF POWER (100W)



Measuring the intermodulation distortion to the CCIF method using two tones separated by 70Hz produced **fig 1** at 1W rms output showing that intermodulation distortion within the audio band was close to the residual of the instrumentation. This was also true of the intermodulation distortion at half power (100W) into 8Ω as shown in **fig 2**. However, at this power the intermodulation distortion showed a rapid increase above 80kHz. Checking the fifth harmonic distortion at 1W output using an asymmetrical test signal produced **fig 3** which shows some change in

distortion when the waveform is inverted but with the overall level being low.

Frequency response and noise

The overall frequency response from the input to the output is shown in **fig 4** which shows the amplifier to be flat to within +0, -0.5dB from 3Hz to 30kHz, falling to -3dB at 120kHz. As the amplifier is capable of delivering full power at very low frequencies, some care is required to protect the loudspeakers as the amplifier does not have any low frequency protection with minimal roll off in the frequency response at low frequencies.

Measuring the amplifier noise related to the specified power output of 200W into 8Ω gave excellent results as shown in **Table 1**.

FIG. 3
YAMAHA P2200 5th
HARMONIC DISTORTION
AT 1W

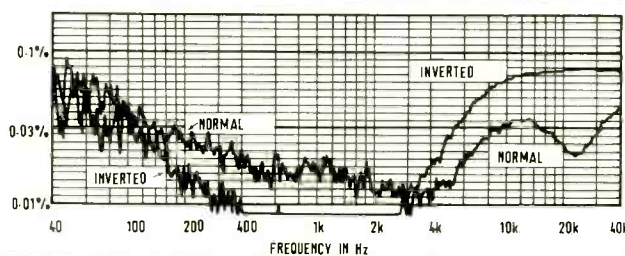

FIG. 4 YAMAHA P2200 OVERALL FREQUENCY RESPONSE

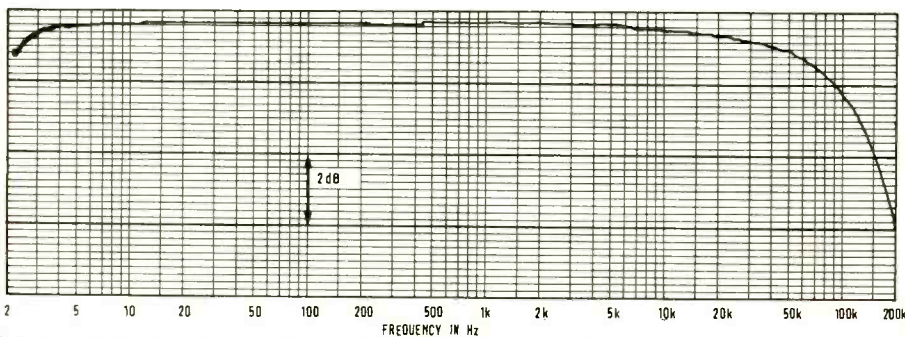

TABLE 1

	Left	Right
22Hz to 22kHz rms	116dB	112dB
A weighted rms	119dB	118dB
CCIR weighted rms	111dB	111dB
CCIR weighted quasi-peak ref 1kHz	107dB	107dB

As can be seen the unweighted noise was similar in both channels and close to the A weighted noise showing that mains hum was at a very low level.

Inputs and outputs

Checking the maximum input sensitivity for an output of 200W into 8Ω at 1kHz showed that the two channels had a very similar performance requiring 0.250V/0.252V. The accuracy of the two attenuators was excellent with less than ±0.04dB error present over the full range of the attenuators. The input impedance only varied slightly with the attenuator settings, being 33kΩ in

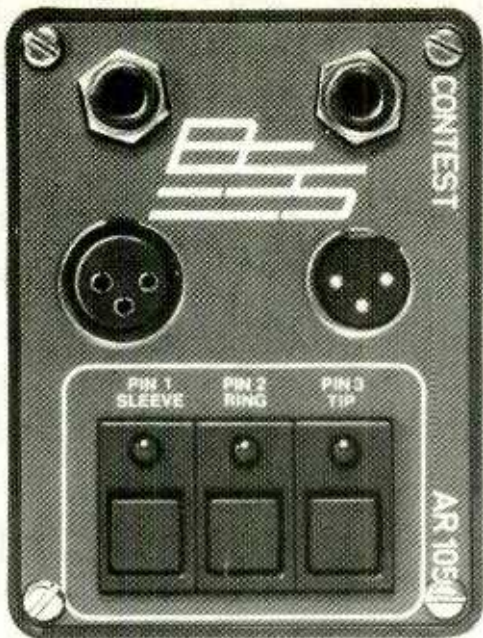

The Problem Solvers.

Two innovative accessories at realistic prices, from the same company as the MCS200 crossover. A high performance active direct injection box, battery or earth isolated phantom powered, for all direct injection techniques and a useful leads tester with top mounted connectors which allow leads to be supported during repair.

Call or write for your spec sheet, to see how your problems can be solved.

Also available in the UK through: Turnkey, Buzz Music and Audio Reinforcement Services.



Brooke Siren Systems, 92 Colney Hatch Lane, London N10. Tel: 01-444 7892. Telex: 912881 BSSAUDIO

Available, ex-stock, from: Turnkey 01-444 9221; Buzz Music, Hereford 55961
Audio Reinforcement Services, 01-341 1506

Spendor Audio Systems Limited

Station Rd, Industrial Estate, Hailsham, Sussex BN27 2ER Tel. Hailsham 843474

spendor

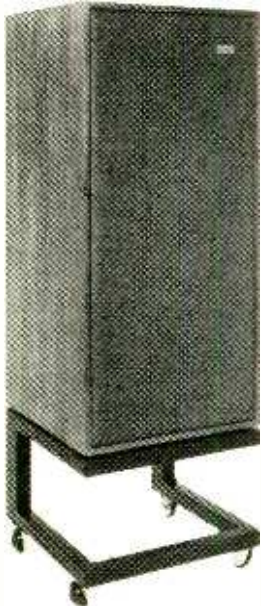

All Spendor loudspeakers are of studio quality and are generally regarded as one of the most accurate monitoring systems available.

Spendor loudspeakers and amplifiers are used extensively by professional organisations such as the BBC, IBA, RTE (Ireland), WDR (Germany) and many other broadcasting and recording studios.



parallel with 360pF over most of the range and going to 25.2kΩ in parallel with 540pF at maximum gain.

Measurement of the damping factor related to 8Ω gave figures of 120 at 1kHz or 127 at 60Hz which is perfectly adequate, but less than the manufacturer's specification. Similarly the dc offset at the outputs of 19mV/9.3mV was out of specification. However it should be simple to rectify this error.

Other matters

Investigating the performance of the meters showed that they were peak reading instruments with a fast rise time of 3ms to 3dB below the equivalent steady state reading, but taking 100ms to the equivalent steady state reading. A hold circuit increased the fall time such that it required 1.5s to fall back, making meter reading easy.

Checking the accuracy of the meter calibration showed that an indicated 200W corresponded to 175/166W such that the meters were too sensitive—an easily corrected error on the right side.

Applying a fast 1kHz squarewave to the amplifier driving 1W into 8Ω in parallel with 2μF produced the oscillogram fig 5 which shows about 20% overshoot with some ringing. Working into 8Ω the rise and fall times were identical at 3μs with a maximum slew rate of 45V/μs.

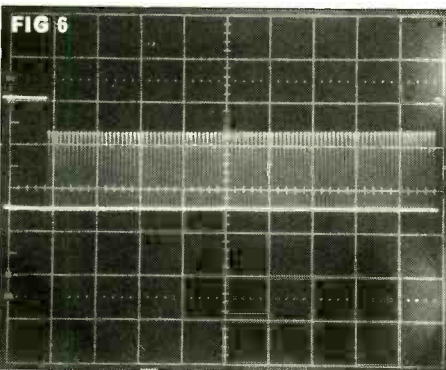
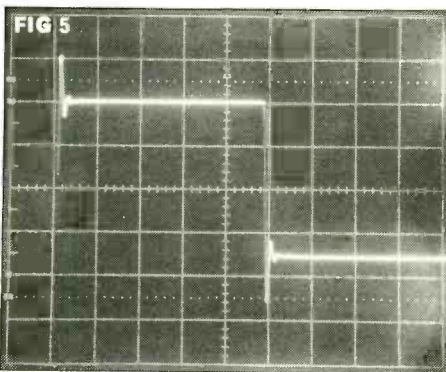

As a check of the overload recovery characteristic the amplifier was run at half power into an 8Ω load and a 10ms asymmetrical toneburst applied 10dB above the half power level every 100ms. The recovery from this overload is shown in fig 6 which displays a complete lack of any dc shifting of the operating point and a perfect recovery.

The overall phase shift of the amplifier, which is minimal within the audio frequency band, is shown in fig 7 with the exceptionally good interchannel crosstalk shown in fig 8 which also demonstrates the very low hum level in the output.

FIG 7 YAMAHA P2200 OVERALL PHASE SHIFT

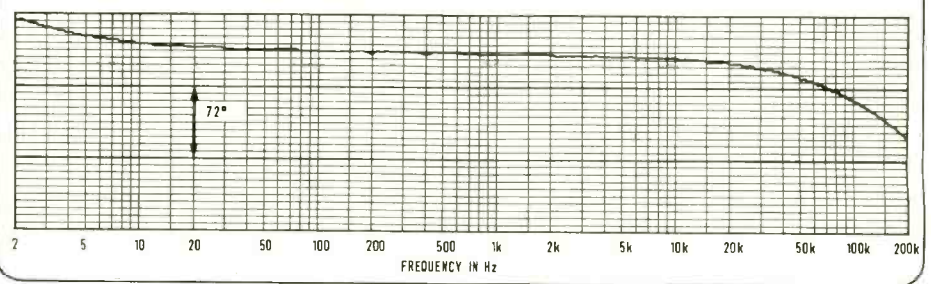

Summary

The Yamaha P-2200 is a well built amplifier which offers an unusually good performance in terms of noise, distortion and interchannel crosstalk. The meters are a sensible design and serve a useful purpose having a wide dynamic range and a fast peak reading characteristic.

At all times the amplifier ran unusually cool without any forced air cooling and this amplifier would appear to be an excellent choice for high quality monitoring as well as PA work when the versatile input connectors come into their own. However, bridged mono operation requires an external transformer.

Hugh Ford

FIG 8 YAMAHA P2200 INTERCHANNEL CROSSTALK

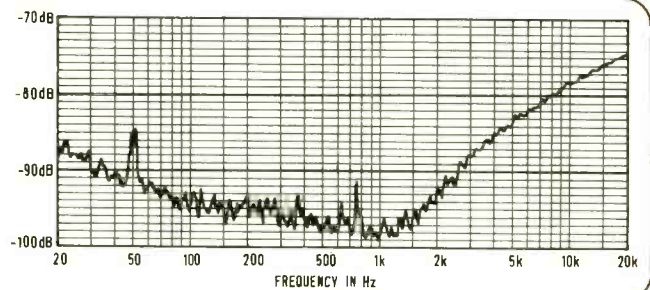



DISC PLAYBACK

Optimum performance from any cartridge

STEREO DISC AMPLIFIER 3
Line level RIAA equalised outputs from moving magnet cartridge inputs.

MOVING COIL PREAMPLIFIER
A preamplifier for all low impedance cartridges

Please ring or write for extensive specification leaflets.

Dominus P.O. Box 1, Cranleigh, Surrey GU6 7JF. Tel. 04866 6477

Exhibiting at International Broadcasting Convention, Brighton, September 20-23

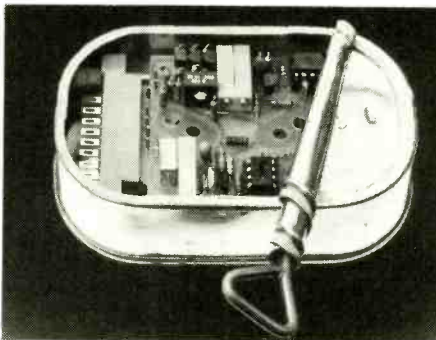

PPM3
drive circuit to IEC268-10A, BS4297, draft BS5428-9. Unbalanced input. May be used in equipment which will be required to pass IBA Code of Practice inspection.

PPM2 drive circuit under licence from the BBC. Balanced inputs. Approved for critical programme monitoring by IBA, EBU and BPO.

SUM AND DIFFERENCE changeover board to suit PPM2 or BBC ME12/9.

ERNEST TURNER high quality movements 640, 642, 643 and TWIN with flush-mounting adaptors and illumination kits from stock.

Peak Deviation Meter * Programme and Deviation Chart Recorders * Stereo Disc Amplifier 2 and 3 * Moving Coil Preamplifier * 10 Outlet Distribution Amplifier * Stabilizer * Fixed Shift Circuit Boards.

SURREY ELECTRONICS, The Forge, Lucks Green, Cranleigh, Surrey GU6 7BG. Tel. 04866 5997

BROADCASTING VERSATILITY

The fully modular, expandable Series 24A stereo mixing console

The Series 24A with its wide choice of modules and variable frame size permits the console to be used in a range of functions including 'on-air', production, outside broadcast, drama, network switching, audio visual production etc.

mbi studio construction

A cost-effective turnkey service incorporating:

- Architectural and Interior Design
(with RIBA supervision of builders)
- Acoustic Design and Construction
- Studio Equipment Selection and Installation

Consultancy, construction, installation and commissioning—an effective, integrated facility.

- Wide selection of input modules
- Self-operation or engineer driven capability
- EQ available (if required) on mono and stereo inputs
- Sophisticated metering and monitoring
- Equipment remote starts
- Comprehensive talkback and intercom
- Logic controlled telephone-in and o.b. modules
- All inputs and outputs fully balanced

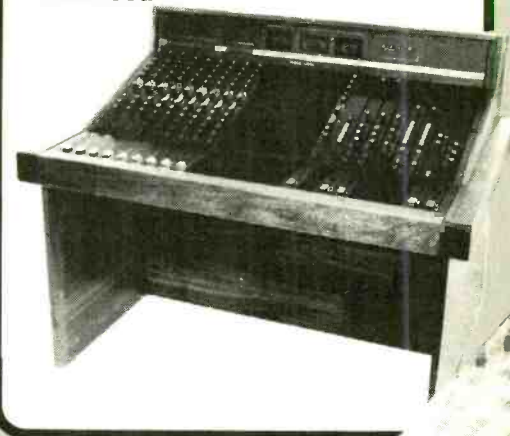

Economically priced,
ergonomically built

*Meets or exceeds
broadcast authority
specifications . . .*

mbi
broadcast
systems ltd

PO Box 112, Brighton,
BN2 2RS, England.

Telephone (0273) 607384.

broadcast imagination

www.americanradiohistory.com

The Quality Microphone That Isn't Made In Deutschland.

DC-96



DC-63



VM40/41



Before you assume you must go for the standard condensers from Germany, we think you owe it to your ears (and wallet) to consider The Swedish Alternative: PML. Since 1941, PML has maintained a tradition of handcrafted quality that is immediately apparent in the sound and design of each painstakingly crafted microphone. The essence of superb Swedish attention to detail and quality is exemplified in the DC-63 and DC-96 condensers. Each employ a unique rectangular dual membrane capsule together with a dual FET preamplifier that features low noise, high output level, and very smooth on and off-axis frequency response.

The VM40 (omni) or 41 (cardioid) are extremely rugged and compact mics that are particularly impressive for close range miking.

The '63, '96 and 40/41 are only 3 of a full line that includes electret lavaliers, advanced design XY-axis stereo mics, and complete accessories.

Please write us for full technical information and ask your pro-dealer for a demonstration.

We'll bet you dollars to marks you'll be surprised how much more you'll get with the Swedish Steal. Dealer inquiries invited.

Sverige Är Bäst.

PML PROFESSIONAL MICROPHONES

Worldwide Marketing: **Creative Trade, CTAB AB**, Knutsgatan 6, S-26500, Astorp, Sweden, Tel: 4642/515 21
 U.S. Distributor: **Cara International, Ltd.**, P.O. Box 9339, Marina del Rey, Ca. 90291, (213) 821-7898
 Australia: **Werner Electronics Ind. Pty. Ltd.**, P.O. Box 98, Kilkenny S.A. 5009, Tel: (08) 268-2766
 U.K.: **Allotrope Ltd.**, P.O. Box 4BS, London W1R 4BS, Tel: (01) 437-1892/3



We Sell Everything in the World that Switchcraft® Makes

As the U.K. stocking representative for Switchcraft, we at Canadian Instruments & Electronics Ltd., can deliver any one of Switchcraft's 6,000 quality electronic components directly to you from our Ilkeston warehouses. Anything from connectors and switches to jacks and plugs. To help you out we've included a coupon. Just check the product categories you are interested in. We'll send you literature and follow up to see how we can be of further help.

I'd like to learn more about the following Switchcraft products

- Connectors, telecommunications components, AC Receptacles, Phone Jacks and Plugs, CB Connectors, Adapters.
- Switches (Pushbutton, Multiple Station, Thumbwheel, Double Wipe.
- Tini DW Double Wipe, Lever, Slide, Rocker and Miniature Slide).
- Audio Accessories (Adapters and Kits, Molded Coil Cords, Audio Cable Testers, Hi-Fi Switches & Controls).

Name _____ Position _____
 Company _____
 Address _____
 Telephone _____
 Telex _____

CE CANADIAN INSTRUMENTS & ELECTRONICS LTD.,
 Harris-Bass House, Station Road,
 Ilkeston, Derbyshire DE7 5TX.
 Tel: 0602-302331. Telex: 377755.

SWITCHCRAFT



KONFERENZSAAL BUNDESKANZLERAMT BONN

conference
systems
simultaneous
interpretation
systems

We take care of the comfort
of delegates and interpreters.

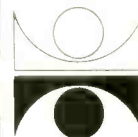

televic

Panoramastraat 36
B 1810 Wemmel
(Brussels)
Tel. 02/479 99 70
Telex 24 120

Award yourself the P.P.M!

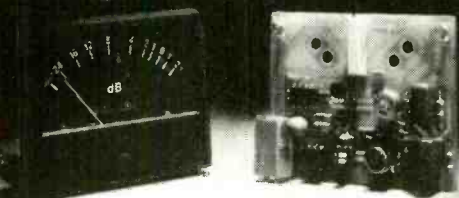

Soundex

Bulgin Electronics Park Lane, Broxbourne, Herts.
Telephone: Hoddesdon 84455

Our business is getting you into business—

MICKS ELECTRONIC WORKSHOP

PROTOTYPE WIRING SERVICE
PRODUCTION WIRING
INSTALLATIONS UK, OVERSEAS

Phone **MICK ENEVER** on
Reading 473 042 or Telex 87515 WISCO. G.

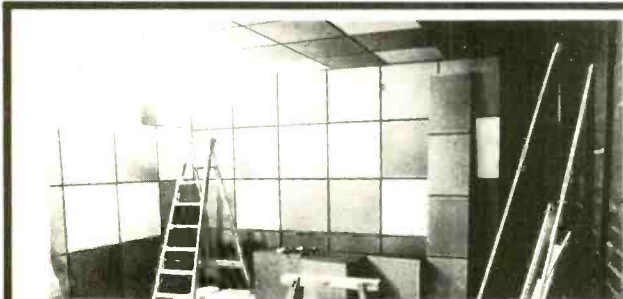

Installation of Sound Absorbers, Scripture Union, London

**SOUND ADVICE
FROM PROFESSIONALS TO PROFESSIONALS**

BTS specialise in Acoustic Design, specification, measurement and treatment for studios of all types to full Broadcast Standards.

Also Special Purpose, Educational and Budget Studios,
Music and Conference Rooms.

Acoustic problems associated with reverberant buildings, traffic, air conditioning or other noise sources, measured and dealt with.

For further details write to Alan Foster

2 Hills Road, Cambridge CB2 1JP, England
Telephone Cambridge (0223) 62392
Telegrams Broadcast Cambridge
Telex 817976 (BCAST G)



Broadcast Training and Services Limited

Yes!
Please send me
a copy of your 28-
page catalogue*

My address _____

First fold

▲
Tuck in

Do not affix Postage Stamps if posted in
Gt. Britain, Channel Islands or N. Ireland

▲
Postage
will be
paid by
licensee

11

BUSINESS REPLY SERVICE
Licence No. BBT92

turnkey

8 East Barnet Road
BARNET
Hertfordshire
EN4 8BR

Second Fold

Fourth Fold

*P.S. include your list of pro-audio specials.

Third Fold

AUTOMATIC AUTOMATION

NOW A DISC BASED SYSTEM THAT WORKS WITH YOU.

- * No labels, no files, no button pushing
- * Real professional disc reliability
- * SMPTE/EBU timecode
- * Double SMPTE/EBU scanrate
- * Unique digital filter front end
- * Real time error 10 mS average, 20mS worst case
- * Zero cumulative timing error
- * Six previous mixes plus current mix and scratch store
- * Automated mutes which do not overwrite previous data
- * Very simple installation using single screened data links
- * Complete retrofits or computer only for auto ready consoles
- * Proven software with several thousand hours mixing music to its credit
- * Available now (if you're quick) or on short leadtime
- * Very quiet ultra high precision European disc drives for in-studio installation
- * Automated data handling leaves the engineer to concentrate on music

Melkuist

DRIVE 0

DRIVE 1



Mc Melkuist

LABEL console automation ← LABEL

millbrook house 12 millfield lane london N6 6JD

tel: 0582 416328

Studio Compressor-Limiter

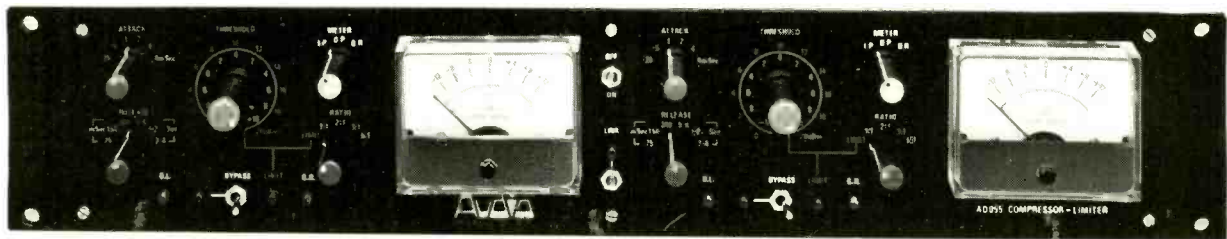

A new product designed and developed with care by Audio Developments – The quality and performance you expect.

The ADO55 is for rack mounting. The controls on the attractive front panel are clearly laid out and colour-coded for greater simplicity. All the input and output connectors have XLR, DIN and PO Jacks fitted as standard.

The ADO55 Compressor is a dual channel compressor/limiter with a comprehensive range of useful facilities. The two identical systems may be linked for stereo operation.

Specification

RATIOS 2 1.3 1.5 1 Limit (20:1)
 RELEASE TIME Adjustable – 75mS 150mS 300mS 600mS 1.2sec 2.4sec
 ATTACK TIME Adjustable – 0.25mS 0.5mS 1mS 2mS 4mS 8mS
 FREQUENCY RESPONSE 1dB 20 Hz to 30 kHz NO COMPRESSION
 DISTORTION 0.1% at 1kHz to 10kHz NO COMPRESSION +8dB input
 MAX. COMPRESSION 25dB
 MAX. OUTPUT +19dB at 1kHz +12dB at 20Hz
 MAX. INPUT Dependent on the MAX. OUTPUT and MAX. COMPRESSION
 NOISE Wideband –68dB Band Limited –71dB

Audio



Developments

Hall Lane, Walsall Wood
 WALSALL, W. Midlands, WS9 9AU
 Telephone: Brownhills 5351/2/3 (STD Code 05433)
 Telex: 338212 Audio

SYNTOVOX

202 VOCODER

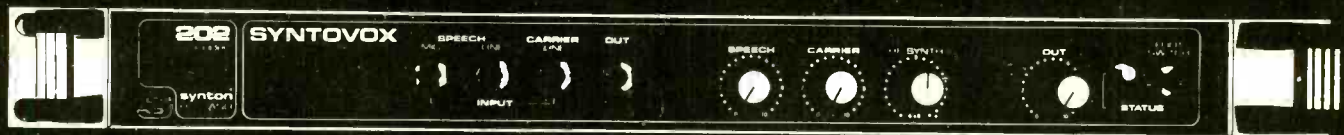

Syntovox 202 is the latest development in vocoders by Synton. It was designed primarily to make a match between a polyphonic keyboard, a boosted bass or a fuzzed guitar and its player.

Syntovox 202 introduces the elegant way of moulding musical sounds into the shape of vocal articulation, enabling the user to impose his timbre upon cliché sounds - instantly!

We could have called Syntovox 202 'The Little Imposer'. We didn't. We called it 'The Incredible Machine'. You'll find out why.

■ Syntovox 202 - a thrilling effect at rock bottom price.

vocoders by synton[®]
 HOLLAND

BELGIUM: Naybies/Brussels ☎ 7343138 • FRANCE: Lazare/Paris ☎ 8786210 • NORWAY: Pro-Technic/Oslo ☎ 460554 • SWEDEN: Elfa AB/Solna ☎ 7300700 • SWITZERLAND: Audiovideo/Lugano ☎ 523827 Audiocom/Kerzers ☎ 955742 • FINLAND: Ertama Musiikki Oy/Helsinki ☎ 639050 • UK: Feldon Audio London ☎ 5804314 • USA: Parasound Inc/San Francisco ☎ (415)6734544 • NETHERLANDS & EUROPEAN MARKETING & SALES: SYNTON ELECTRONICS BV/POB 83-3620 AB BREUKELEN ☎ 03462 - 3499 TLX 40541

"The definitive studio monitor"

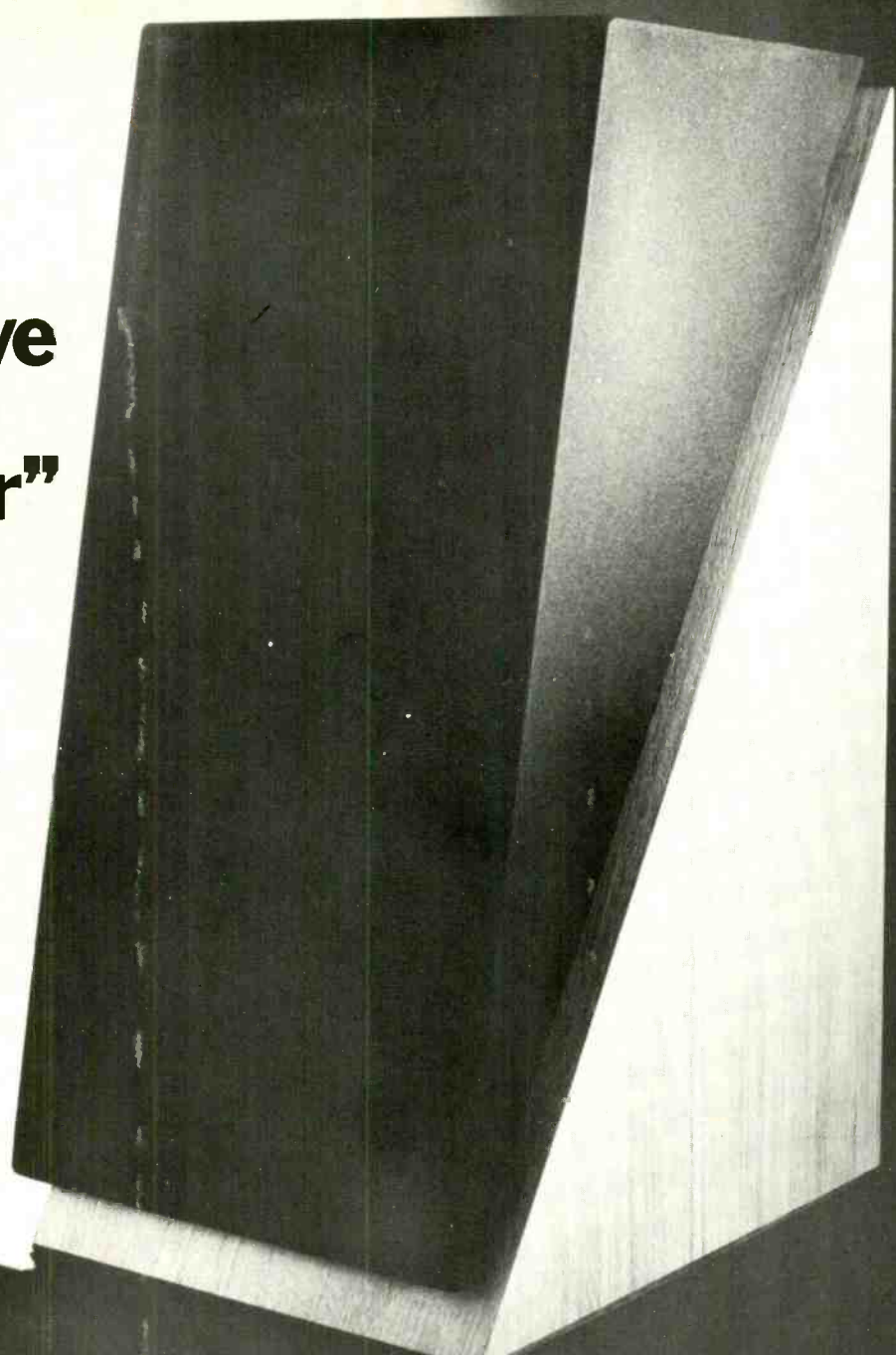

Conceived for the engineer who appreciates both exacting performance and distinctive style, the ATC S50 and S85 studio monitors provide a state-of-the-art solution to a tough problem — that of providing the *best* studio sound reproduction there is.

On the basis of its performance specification, the S85 simply has no competition. It has a bandwidth of 40Hz to 20kHz, sensitivity of 1Watt @ 90dB @ 1m, maximum power input of 300Watts, a usable radiation angle of ± 60 deg horizontal and ± 10 deg vertical, plus harmonic distortion of better than 0.3percent at 1W and below 1.0percent at 25W. The S50 offers performance within a whisker of this, but in a smaller package and at a lower price.

The key to the ATC monitors' world-beating performance is their SM75-150 soft-dome mid-

range drive unit which combines unequalled definition and transparency with high power handling ability — from 350Hz to 3kHz.

If your criteria is ultimate performance — and the kind of style that matches it — you should telephone ATC now for more information or to arrange a demonstration.



ATC (Acoustic engineers)
Acoustic Transducer Co Ltd
Worton Hall Estate, Isleworth
Middlesex TW7 6ER
Great Britain
Telephone 01-568 6633
Telex 893148

DON'T MISS PROSOUND '80 Exhibition

Visitors will be able to see a fully equipped recording studio in operation which will include a 24 track console mixer, tape machines and a full range of ancillary equipment,

SEE THE ROLLING STONES & MOBILE ONE (TAPE ONE STUDIOS) FULLY EQUIPPED MOBILE RECORDING STUDIOS

3 Day Conference covering 14 papers presented by specialists in the professional audio industry

2-4 September 1980 West Centre Hotel London

SEASON TICKETS AND CONFERENCE BROCHURES NOW AVAILABLE FROM

BATISTE EXHIBITIONS & PROMOTIONS, PEMBROKE HOUSE CAMPSBOURNE RD HORNSEY N8 (TEL: 01 340-3291)

THE ACOUSTIC SCREENS from AK

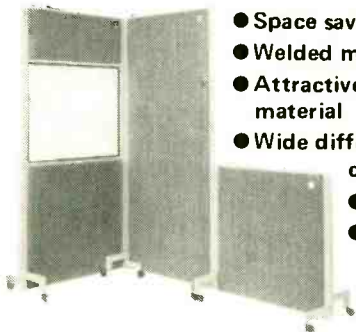

- Space saving corner interlock system
- Welded metal frames
- Attractive 'cigarette proof' covering material
- Wide differential non crushing castors
 - Custom size option
 - Roof sections to match

SONAPANEL ACOUSTIC SYSTEM

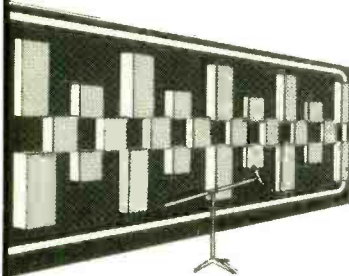

- Economic and flexible
- Individual layout scope
- Fast delivery
- Detachable fixture allows relocation or resale



AUDIO KINETICS (UK) LIMITED
Verulam Road, St Albans, Herts, AL3 4DH. Tel: 32191. Telex: 299951

LOCKWOOD

ACADEMY RANGE

THE SMALLER STUDIO MONITOR

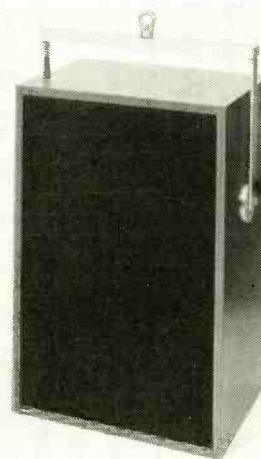

ACADEMY I 85w
15" DRIVE UNIT
ACADEMY II 60w
12" DRIVE UNIT
ACADEMY III 60w
10" DRIVE UNIT
INCORPORATING
TANNOY DRIVE
UNITS
CEILING MOUNTED
VERSION
ILLUSTRATED
(OPTIONAL EXTRA)

LOWLANDS ROAD, HARROW, MIDDX.
HA1 3AW ENGLAND
Telephone: 01-422 3704 and 01-422 0768

THE GREAT BRITISH SPRING

Spring Reverbs are notorious for the odd sounds that they tend to produce. Many manufacturers have tried to remedy this with limiters, equalisers and the like. In the design of 'The Great British Spring' we took a different approach. We started out with a custom spring unit that sounds good without any fancy electronics. The unit simply has a variable line input and a stereo output.

The six spring paths produce a natural sounding reverberation that is full at the low end and sparkling on the highs. But don't take our word for it. Fifty pence brings you our demo cassette, or drop in and hear it live.

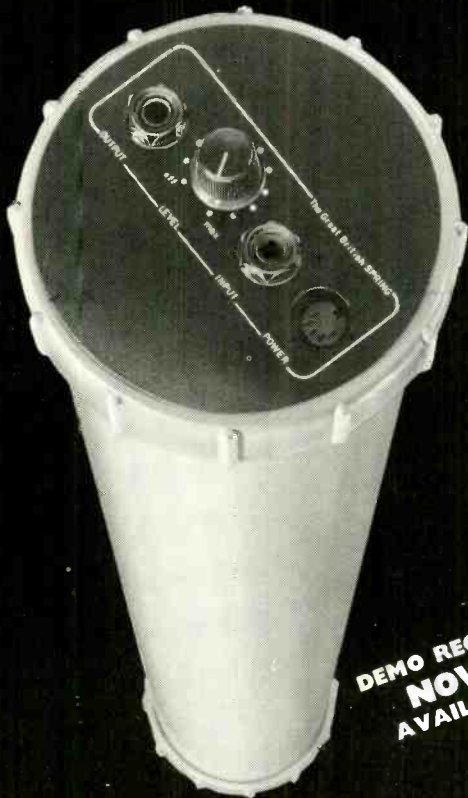

**DEMO RECORD
NOW
AVAILABLE**

Exclusively from;
**TURNKEY, 8 East Barnet Rd.
New Barnet, Herts. 01 440 9221.**

**REW, 114 Charing Cross Rd.
London WC2. 01 836 2372.**

**Studio Equipment Services,
The Studio Shop, Oxgate Farm,
Coles Green Rd. London NW2. 01 452 1980.**

RED

PROFESSIONAL

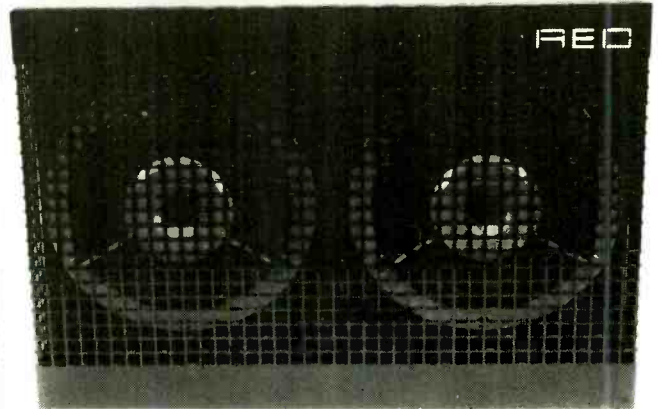

◀ 19" ~ ACTIVE ~ 120db ▶

RED PROFESSIONAL is a 2-way selfpowered loudspeaker system incorporating four drive units and a modular electronic assembly, housed in a 19in cabinet. The unit is mains powered with active electronic overload-proof input signal processing and filtering circuits, two independent 150W power supplies, and separate output amplifiers (two 100W for 1f units and one 50W for the hf units) directly driving two independently baffled 8in 1f drivers and two specially positioned 1in hf radiators. Typical frequency response is 40-18,000Hz +3dB (in-situ 1/3 pink noise front sound-pulse measured) and the maximum undistorted peak programme level is 120dB SPL/1m (in-situ measured). Input facilities include sockets for all internationally used audio plugs and adjustable sensitivity for input signal range 300mV-30V from balanced or unbalanced sources.

Size of unit is 345x480x335mm (hwd). Overall volume 32ltr. Weight 32kg.



RED ACOUSTICS LTD CHELSEA WHARF
15 LOTS ROAD LONDON SW 10 0QH ENGLAND

Cassette Duplicating Supplies

Blaylynn Ltd.

INTRODUCE



Loop-bin & In-cassette duplicating systems

For quality production at low cost designed and built for maintenance free operation 24 hrs a day; configuration to suit customer needs. Demonstration by arrangement

Automatic cassette winder

A fast proven production machine; can be run unattended for max output; one operator to 4 or 5 machines. Demonstration by arrangement

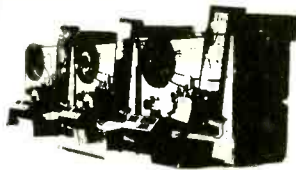

For full details contact

FRANK WHIPP

Tel: 01-478 7965 Telex: 826715 AERO G

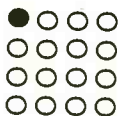

Crowmay Ltd.
757 Romford Road.
Manor Park
London E12 5AW
Tel: 01-478 7965



ADC Sound Connectors

M.W.M. OFFERS YOU A CHOICE

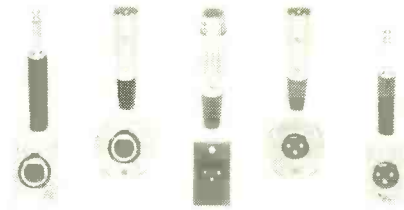

ADC LOW IMPEDANCE AND CHASSIS CONNECTORS FEATURE:

Die cast zinc housing

Nickel or Black finish

Inserts of crack resistant high impact thermoplastic

Compatibility with most other connectors in both mating and fixing

Reliability up to 5,000 insertions

ALSO — SOLID BRASS JACK PLUGS IN PLASTIC OR METAL SHELL

For further information on surprisingly low prices, delivery and service please contact UK distributors,

M.W.M. — COMPANY

159, Park Road,

Kingston, Surrey KT2 6BX.

Telephone: 01-549 9130

ABACUS ARTA 600

Use the ARTA 600 third-octave audio analyser adaptor and an oscilloscope to display the real-time intensity and spectral distribution of sounds.

The internal pink noise generator enables the electrical or electro-acoustic frequency response of systems to be accurately and rapidly determined.

£495 plus VAT

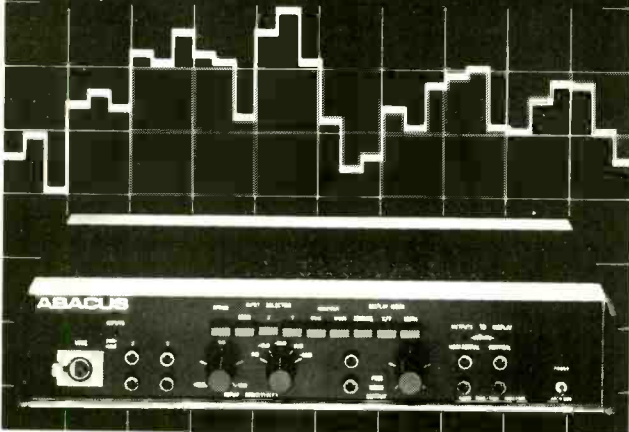

Abacus Electronics 10 Barley Mow Passage, London W4 4PH England
Telephone: London 01-994 6477 Telex 8811418

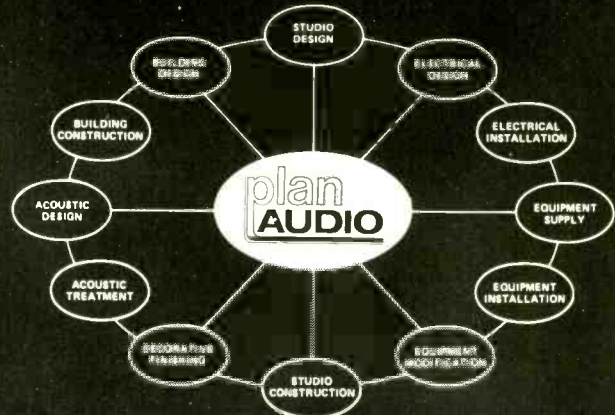

A COMPLETE SERVICE TO THE MUSIC INDUSTRY

PLAN AUDIO —

9 SOUTH STREET, EPSOM, SURREY, ENGLAND EPSOM 41822

Classified Advertisements

Advertisements for this section must be pre-paid. The rate is 25p per word, minimum £5.00. Box Nos. 75p extra. Semi-display rates on application. Copy and remittance for advertisements in **NOVEMBER 1980** issue must reach these offices by 4th **SEPTEMBER 1980** addressed to: The Advertisement Manager, **Studio Sound**, Link House, Dingwall Avenue, Croydon CR9 2TA.

Note: Advertisement copy must be clearly printed in block capitals or typewritten.

Replies to Box Nos. should be addressed to the Advertisement Manager, Studio Sound, Link House, Dingwall Avenue, Croydon CR9 2TA, and the Box No. quoted on the outside of the envelope. The district after Box No. indicates its locality. **SEX DISCRIMINATION ACT 1975:** No job advertisement which indicates or can reasonably be understood as indicating an intention to discriminate on grounds of sex (e.g. by inviting applications only from males or only from females) may be accepted, unless (1) the job is for the purpose of a private householder or (2) it is in a business employing less than six persons or (3) it is otherwise excepted from the requirements of the Sex Discrimination Act. A statement must be made at the time the advertisement is placed saying which of the exceptions in the Act is considered to apply.

The attention of advertisers is drawn to "The Business Advertisements (Disclosure) Order 1977", which requires that, from 1st January 1978, all advertisements by persons who seek to sell goods in the course of business must make that fact clear. From the above date, consumers therefore should know whether an advertisement relates to a sale by a trader or a private seller.

SERVICES

★Pressings of classical quality (colour also), promptly manufactured from your master tapes. Sleeve printing, mailing service. Studio or mobile units for master recording. Specify requirements to Mike Bull, Sound News Studios, 18 Blenheim Road, London W.4 1ES. Tel. 01-995 1661. L

IF YOU NEED . . .

Cassette Duplication	Empty Tape Spools
Blank Cassettes	White Tape Boxes
$\frac{1}{4}$ " Tape	8T Cartridge Bodies
Leader Tape	Lubricated Tape
Splicing Tape	Head Cleaner Tape

Why not ring us on 01-399 2476/7 and let us quote you for your next requirements.

MEDIATAPE LIMITED, 29a Tolworth Park Road, Surbiton, Surrey.
01-399 2476/7

HIGH SPEED CASSETTE COPYING IN MONO OR STEREO AT COMPETITIVE PRICES

Long or short runs.
Blank cassettes supplied in bulk.
A growing reputation for reliability.

MORARD SOUND PRODUCTIONS
THORNTON HEATH, SURREY
Telephone 01-689 7424

Our Business is Sound

Cassette and open reel copying in large and small runs.

Blank cassettes supplied between C-3 and C120.

Dolby A and B facilities available.

Studio facilities available for voice-overs.

Design, artwork and print service.

Established suppliers to most of the major publishing houses and Examining Bodies.

SOUND COMMUNICATION

Field House, Wellington Road, Dewsbury, West Yorkshire
WF13 1HF. Telephone 0924 451717

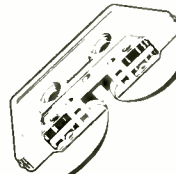

**HIGH QUALITY
CASSETTE DUPLICATION
AND SPECIALISED LENGTH
BLANK CASSETTES**

Leeholme Audio

LEE HOLME AUDIO SERVICES LTD. 350-4 LEABRIDGE ROAD LEYTON LONDON E10 7LD TEL: 01-556 4748

TAPE COPYING SERVICES

We specialise in short run cassette duplication.

NO JOB TOO SMALL

Fast turnaround, reliable service

LOW COST

STEREO—MONO—PULSED

01-723 6301 (Baker Street)

★Tannoy speaker hire and repair: repairs by ex-Tannoy engineer. Rapid turnaround Monitors for hire at competitive rates. Berkhamsted 74653. J

★Cassette copying. Superb quality one to one copying service. Ring or write for full details: Gemini Sound, Braeside, London Road, Binfield, Bracknell, Berks. (0344) 54935. X

BETA SOUND SERVICES

HIGH SPEED CASSETTE
DUPLICATING MONO/
STEREO. SHORT OR LONG
RUN MASTERING SERVICE

Good quality cassettes supplied.
A prompt and reliable service

Croydon 01-684 8363 01-654 8903

SPR

SPEECH RECORDING
CASSETTE DUPLICATING
OPEN-REEL DUPLICATING
LANGUAGES/AUDIO-VISUAL

SPEECH-PLUS RECORDINGS LTD

32, PAGES WALK, SOUTHWARK, LONDON SE1 4SB.

01-231 0961/2

Quantity	CASSETTE DUPLICATING inc L/case.											Label and inlay card printing.												
	C1-10	C11-20	C21-30	C31-40	C41-50	C51-60	C61-70	C71-80	C81-90	C91-100	C101-110	C111-120	C1-10	C11-20	C21-30	C31-40	C41-50	C51-60	C61-70	C71-80	C81-90	C91-100	C101-110	C111-120
10-49	51p	53p	55p	59p	63p	67p	72p	80p	87p	97p	107p	117p	68p	76p	84p	94p	104p	114p	68p	76p	84p	94p	104p	114p
50-99	48p	50p	52p	55p	58p	61p	68p	76p	84p	94p	104p	114p	68p	76p	84p	94p	104p	114p	68p	76p	84p	94p	104p	114p
100-149	47p	49p	51p	52p	54p	56p	63p	72p	79p	89p	99p	109p	60p	69p	74p	84p	94p	104p	60p	69p	74p	84p	94p	104p
150-249	43p	45p	47p	48p	50p	52p	60p	69p	74p	84p	94p	104p	56p	64p	70p	80p	90p	100p	56p	64p	70p	80p	90p	100p
250-499	41p	43p	45p	46p	47p	48p	56p	64p	70p	80p	90p	100p	51p	59p	67p	77p	87p	97p	51p	59p	67p	77p	87p	97p
500-999	39p	40p	41p	42p	43p	44p	51p	59p	67p	77p	87p	97p	48p	54p	64p	74p	84p	94p	48p	54p	64p	74p	84p	94p
1000+	33p	35p	37p	38p	40p	42p	48p	54p	64p	74p	84p	94p	47p	53p	63p	73p	83p	93p	47p	53p	63p	73p	83p	93p
10,000+	32p	34p	36p	37p	39p	41p	47p	53p	63p	73p	83p	93p												

R.F.W. RECORDING SUPPLIES 50 Bedford Lane, Feltham, Middlesex. Tel: 01-890-6460

COUNTY RECORDING SERVICE

For super quality Master Discs, Demo Discs and Pressings. Scully lathe with our latest MKW 80 Stereo Cutting System.

Also half speed cutting for that very special disc. Dolby 'A', Dolby 'B' and DBX noise reduction.

London Rd., Binfield, Bracknell, Berks RG12 5BS

Tel. BRACKNELL (0344) 54935

CASSETTE COPYING IN THE MIDLANDS

Specialists in short run productions. Prices from 1p per minute, inc. cassette and library case. Label and Inlay card printing, plus services and supplies for film, disc and AV productions.

Write or phone for rate card to:

AUDICORD RECORDS

10 The Chapel, Shilton Road, Barwell, Leics LE9 8HB. Tel. 0455-47298 (24 hr. answering service)

★A quality pressing and duplication service provided to studios, etc. Complete with cutting, processing, labels, sleeves, art work, inlays, etc. Minimum order for LPS—250, singles—500, cassettes—250. Example price for complete 46 minutes cassette to include mastering, printed label and library case, on Agfa tape—80p each plus VAT. For further details: SRT Record and Tapes Ltd., 01-446 3218. X

Main 3M WOLLENSAK Dealers

Meticulous alignment of all machines before sale. Excellent servicing facilities. Suppliers of quality virgin cassettes in bulk. Fast-copying service. Prompt personal attention.

SOUND CASSETTE SERVICES Ltd.

P.O. Box 2, Chard, Somerset TA20 1LR
Tel. 04606 5393

FOR SALE—TRADE

★Bose 802 speakers with equalisation, £499 per pair or £473 without equalisation. Amcron DC 300 £530 and D150A at £335. All prices plus VAT. Contact Geoff Yates, C.A.V.S. Ltd. 01-363 6125. X

CASSETTE DUPLICATING

Hi-speed or I-I.

From 33p

Write or phone for rate card to:

SIMON STABLE PROMOTIONS

Inglenook, West End, Launton, Oxon

Tel. 08692-2831 (Bicester) 10 a.m.-7 p.m.

STUDIO ACOUSTIC DESIGN

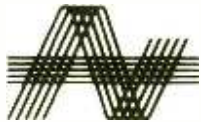

Acoustic Technology Limited

58 The Avenue
Southampton
SO1 2TA
Tel. 0703 37811

320 Dresser Tower
601 Jefferson
Houston Texas 77002
Tel. 713/759-9768

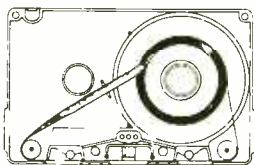

ENDLESS CASSETTES
From 10 secs to 20 mins.

TELEX COPIERS FROM £365.00

AMPEX GRAND MASTER Cassette Tape wound to special lengths—also BASF, Memorex, Agfa and Pyral.

Full details of endless Cassettes and Tape

SELECTA SOUND

FREEPOST, Romford RM2 1BR.
Tel. 040-24 53424.

CODEC is the ONLY

noise reduction system which **GUARANTEES** that you will not hear any audible side effects such as—noise breathing, drop-out exaggeration, frequency response errors due to incorrect level setting.

CODEC

offers 17 dB of noise reduction plus 8 dB of extra headroom.

4-track switchable free standing unit £175 inclusive.

For free trial or demonstration contact:

D.B. ELECTRONICS

2 Ash St., Buxton, Derbyshire SK17 6LL

Tel: 0298 3756

Have you seen the superb new Uher portables with monitoring head?

They are actually in stock and at competitive prices at:

SIMMON
SOUND AND VISION

28a Manor Row, Bradford I, W. Yorks.

Telephone: 0274 307763

BROADCAST CARTRIDGES

Large selection available ex stock. Competitive prices. Standard lengths.



Custom winding. Lubricated tape. Also full range of tape cartridge storage systems.

JOHN A. STEVEN

Professional Recording Equipment

Brentwood (0277) 215485

SOWTER TRANSFORMERS

WITH 37 YEARS' EXPERIENCE

we have the expertise to design and manufacture ANY TYPE OF AUDIO TRANSFORMER AT THE RIGHT PRICE

WE SUPPLY ALL TYPES OF MICROPHONE, TRANSFORMERS, BRIDGING TRANSFORMERS, INPUT TRANSFORMERS FOR RECORDING, BROADCASTING AND PUBLIC ADDRESS APPLICATION.

We call your attention to our very successful MICROPHONE SPLITTER/COMBINER TRANSFORMER type 4079

with a high impedance 200ohm primary and two 200ohm secondaries. It will handle up to 2.3 volts rms at 30Hz and has a frequency response of plus/minus ±dB from 20Hz to 20kHz. It is contained in a Mumental Can 33mm diam x 37mm high and **WORKING DETAILS OF THE CONSTRUCTION OF A SPLITTER ARE AVAILABLE ON REQUEST.**

WE HAVE AVAILABLE STANDARD DESIGNS OF OUTPUT TRANSFORMERS WITH EXCEPTIONAL PERFORMANCE FOR ALL TYPES OF VALVE AMPLIFIERS.

E. A. SOWTER LTD.

Manufacturers and Designers

P.O. Box 36 Ipswich IPI 2EG England
Tel. Ipswich (0473) 52794 and 219390

TANDBERG UHER REVOX NEAL-FERROGRAPH

For the best prices and Service

PHOTO ACOUSTICS LTD.,
255a St. Albans Road,
WATFORD. Tel: 32006

or at

The Studio, Perry Lane, Sherington,
Newport Pagnell. Tel: 610625

FOR SALE—TRADE

(Continued)

★Yorkshire Erricks of Bradford. Tascam, JBL, Bose, AKG, Beyer, Calrec, Revox, Ferrograph, Spondor. Sales, servicing, exchanges, leasing. Bradford (0274) 22972 (Paul). X

★Stereo plate echo. Brand new, £600 plus VAT. Trade enquiries welcome. Smile Studio Sales. Steve Foley, 061 226 5369. L

M & B Radio

10½" empty NAB Alloy Spools. £1.25 ea. or 10 for £10
 Jack-fields 20-way 10½" x 3½" x ½". New. Per strip £12
 Sennheiser Mikes, MKH110, new ... £50
 Ferrograph Tape Recorders from ... £35
 Ferrograph Tape Recorder Test Set, R.T.S., as new ... £310
 Uher 4000L Tape Recorder, as seen ... £70
 T.V. Cameras, 625-line Video out, complete with lense. As new ... £85
 EMI BTR2 Tape Recorders, fully refurbished, solid state electronics, new motors, stereo and mono. A constant running machine. Beautiful condition ... £300
 EMI BTR2 Decks only, with head-blocks ... £55
 Twin 301 Record Decks, instant start mech., groove and speed indication, pre-amp and fader, in oak cabinet ... £100
 Single Deck Unit as above ... £65
 Carriage and VAT extra. Wanted: used equipment.
 86 Bishopgate Street, Leeds LS1 4BB. 0532-35649.

SINGLE-EDGE BLADES

£4.50 (inc VAT) per box of 100. Cheque with order please. Agents wanted in most areas. Very Special Prices are available for Wholesalers.

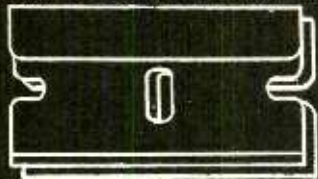

ODD-JOB BLADES LTD

62 Kenilworth Road, Edgware, Middlesex HA8 8XD
 Phone: 01-958 5476

FOR SALE—PRIVATE

★Stellavox Model SP7 portable stereo recorder. With accessories including case, power supply and ABR large reels adaptor. In immaculate condition, £1,200. Godstone (0883) 843221. J

★Mixer, 18 into 4, in flight case with full eq, foldback etc. Complete with 100 metres multi-core and stagebox. One owner, low mileage. £2,250 ono. Brighton (0273) 607384. J

★Soundcraft series two Desk, 26 x 16, 16 ppm's, 4 auxillary sends, 4-band dual concentric EQ, 240 patchway with leads, Penny & Giles faders in excellent maintained condition. 250 new pots and switches fitted recently. 4 years old, has produced 3 U.K. number ones. £4,500. Ampex MM 1000 16-track with 8-track head block, vari speed and remote, new 16-track heads 9 months, £5,200. Ampex 700 2-track, 1 year old, £1,000. Pair Lockwood majors, unused, reconditioned Tannoy H.P.D's, £500; unused spare H.P.D. £150. Astronic graphic equaliser, mono, £30. Gooseberry, London 01-671 3731. J

★Pair Tannoy Lancaster loudspeaker enclosures, fitted with excellent Tannoy red 15in drive units. Best offers to Mr. J. Thomas, 01-437 3161. J

★Hill "K" Series Mixing Consul, 20 x 16, as new, P. & G. faders, £3,450+ VAT. Tel. 01-552 0555 (Barry). J

★Dolby A301 (Stereo, remote controlled), just Dolby overhauled + manual, £300. KEF R103 compact 100w. "Classical" monitor loudspeaker. £100 pair. 01-794 2839. J

★8-track Studio for sale (mint condition), 16/8 professional custom-built mixer, Tascam and DBX mikes inc. Neumanns/Stennheiser/Limiters/Quad amps. JBL monitors. Ring for details 01-223 9015. J

★Tandberg Eleven P ¼-inch Recorder. Good condition, very little used. £350 or near offer. Phone Uxbridge 55775. J

★24-8/8 Alice Mixer. PPM metering, P. & G. faders, in all wood console, £4,000. Brenell mini 8, lin. 8-track, two years old, £2,700. Raindirk 10-4/4 mixing console, PPM metering, £1,250. Various acoustic screens, offers. Tel. Chief Engineer, 01-734 5572. X

★AMPEX MM1100 24-track tape recorder with autolocate and varispeed. Excellent condition. Price £14,250. 2 Ampex AG440 stereo mastering machines in consoles. 3 Scully stereo mastering machines in consoles. Offers. Contact Studio Manager on 580 9956. X

SITUATIONS WANTED

★Hardworking young man (22) with 4 years experience in a small 8-track Studio, seeks a position in a 24/16-track Studio. Any position, any location considered. 0533 836717. J

★Balance engineer, experienced in most kinds of music, with name acts and a wide range of equipment, seeks permanent position or freelance work. Box 837 c/o Studio Sound. J

FOR HIRE

★Teac Portastudio Hire. £50 per week plus VAT, including headphones and microphone. Delivery and collection in London area. The Playback Studio, 01-969 8216. J

★Revox hire. From £35 per week, including delivery and collection Central London. The Playback Studio, 01-969 8216. J

SITUATIONS VACANT

VCR Bench Engineer

Selfridges, one of the world's biggest and most successful stores, requires a VCR Bench Engineer to work on our increasing volume of video service and repair work. Experience in audio, television and VCR work is essential. A competitive salary is offered for a 40 hour, 5 day week, together with benefits such as valuable shopping discounts (after 6 months), subsidised meals, and 4 weeks holiday. If you are interested in this opportunity, which is based at our W2 depot just off the Edgware Road, please phone Bruce Lawson on 01-629 1234 ext 3414 for an early interview, or call in to the Personnel Department, Selfridges, Oxford Street, London W1.



Selfridges

there's no place like it

STUDIO FACILITIES

★Fanfare Records. Tape-disc pressings, demo's masters, any quantity. Studio/mobile Neumann disc cutter. S.A.E. brochure. 1 Broomfield Close, Rydes Hill, Guildford. Tel. 0483 61684. X

ZIPPER MOBILE RECORDING STUDIO
 Get Taped Where You Play
 16 TRACK Acoustically Designed



Control Room £9.50 per hr
 JBL Monitors/Phasing/Flanging
 Comp/Lim's/Noise Gates/A.D.T.
 Dolby A's For Mastering.
 Contact Jeffrey on
 01-435 3076 or
 01-637 9977

★Disc Cutting master and demos, pressings, cassettes, mobile recording studio. Free brochure. TAM Studio, 13a Hamilton Way, London N.3. Tel. 01-346 0033. X

★New Wollensak cassette copiers directly imported by C.A.V.S. Ltd., cost less and have full service/spares back up. E.g. Wollensak 2770 still costs £999 plus V.A.T. Also available Telex Copuette at £299 plus V.A.T. and all other Wollensak, Telex, Pentagon similar units. Contact Yates, C.A.V.S. Ltd., 01-363 6125. X

★Accurate level control starts with a Cathedral LA3 comp/limiter module, from £30 per channel. Telephone Halsall (0704) 840328. B

WANTED

★Used 16 or 35mm Magnetic recording and reproducing equipment, and associated electronics. Tecnocine, P.O. Box 503, Madrid (Spain). K

WANTED

Tannoy Speakers, Tannoy Autograph, GRF, York, Lancaster, Monitor Gold, Red, Silver, etc., and Vitavox Klipschorn.

Day 01-947 9938, Evening 01-549 7187

CLASSIFIED ADVERTISEMENTS ORDER FORM

Please use this coupon for your private sales and wants. Rates 25p per word. Minimum £5.00. Box Nos. 75p extra. To: *Studio Sound*, Classified Advertisements Dept., Link House, Dingwall Avenue, Croydon CR9 2TA. Please publish the advertisement indicated below for insertion/s under the heading

Name

Cheque/P.O. enclosed £

Address

Is a Box No. required Yes/No. If no, please include remittance to cover name and address and/or Tel. No.

Please write in block capitals.

INDEX TO DISPLAY ADVERTISERS

<p>A AC Electronic Services .. 10 AKG Acoustics .. 4 Abacus Electronics .. 98 Acoustic Transducer Co. .. 95 Acoustical Manufacturing Co. .. 6 Alice (Stancoil) Ltd. .. 21 Allen & Heath/Brenell .. 83 Ampex .. 56, 57 Atlantex Music .. 85 Audio & Design (Recording) Ltd. .. 49 Audio Developments .. 94 Audio Kinetics .. 63, 96 Auxid Ltd. .. 26</p> <p>B B.G.W. Systems .. 25 Ban Electro Music .. 47 Batiste Publications .. 96 Bauch, F. W. O., Ltd. .. 15, 17, 18, 45 Beyer Dynamics .. 12 Broadcast Training & Services .. 91 Brooke Siren Systems .. 87 Bulgin Electronics Soundex Ltd. .. 91 Buzz Music .. 10</p> <p>C Canadian Instruments & Elect. .. 90 Canford Audio .. 14 Cara International .. 90 Court Acoustics Ltd. .. 75 C.D.S. .. 98</p> <p>D Dominus .. 88</p> <p>E Eardley Electronics .. 79 Electro-Voice .. 18 Elektroimpex .. 81 Elliot Brothers .. 46</p>	<p>F FM Acoustics Ltd. .. 27 Feldon Audio .. 19, 21 Future Film Developments Ltd. .. 23</p> <p>G Genelec .. 80</p> <p>H Harrison .. IBC Harbeth Loudspeakers .. 14 Hayden Laboratories Ltd. .. 5 HHB Hire and Sales .. 77</p> <p>I I.T.A. .. 7, 9, 11, 13</p> <p>J JBL .. 41</p> <p>L Lake Audio Components Ltd. .. 27 Larking, Don, Audio .. 20 Lee Engineering .. 24 Leavers Rich Ltd. .. 69 Lexicon .. 65 Lockwood & Co. .. 96</p> <p>M MBI Ltd. .. 89 MCI Ltd. .. 73 Magnetic Tapes Ltd. .. 16 Melkuist Ltd. .. 93 Mick's Electronic Workshop .. 91 Midas .. IFC Mosses & Mitchell .. 16 Music World Merchandising Co. .. 98 Mustang Communications .. 14 MXR Innovations .. 35</p>	<p>O Otari Electric Co. Ltd. .. 29</p> <p>P Plan Audio .. 98 Plus 30 .. 67 Progressive Electronic Products .. 33</p> <p>R Rebis Audio .. 37 Red Acoustics .. 97 REW .. 22, 23</p> <p>T Tannoy + Insert .. 51 TDK Tape Distributor .. 61 Televic .. 91 Trident Audio Developments Ltd. .. OBC Turnkey .. 55, 99</p> <p>S Scenic Sounds .. 31, 71 Shure Electronics .. 8 Solid State Logic .. 53 Soundcraft Electronics .. 43 Spendor Audio Systems Ltd. .. 87 Studio Equipment Services .. 79 Surrey Electronics .. 88 Synton Electronics .. 94</p> <p>U Ursa Major .. 19</p> <p>W White Instruments Ltd. .. 48</p>
---	--	---

STUDIO SOUND is available without charge to qualified readers: these are directors, managers, executives and key personnel actively engaged in sound recording, broadcasting and cinematograph industries in any part of the world. The Publisher reserves the right to refuse applications considered inappropriate and restrict the number of free copies sent to any one company or organisation. Non-qualifying readers can buy STUDIO SOUND at an annual subscription of £11.60. All enquiries to: Subscription Department, Link House Publications Ltd., Robert Rogers House, New Orchard, Poole, Dorset BH15 1LU. Tel. Poole (02013) 71171. Published by Link House Magazines (Croydon) Limited on behalf of the proprietors Link House Publications Limited, Robert Rogers House, New Orchard, Poole, Dorset BH15 1LU and printed by Arthurs Press Ltd., Woodchester, Stroud, Glos. GL5 5PB.



Evergreen Recording Studios, Burbank
Studio B. 4032C Master Recording Console

“...MAKING MUSIC SOUND LIKE MUSIC”

Two worlds exist side by side at Evergreen Recording Studios — the somewhat specialized world of film scoring and the, perhaps, more conventional world of contemporary studio recording. When Artie Butler and Charles Fox planned the Evergreen recording complex, they designed the studios to combine the latest and best efforts of both worlds. As composers, arrangers, and producers, they had a special insight into the needs of a studio. In selecting their two recording consoles, they chose Harrison.



Studio A. 4832C Master Recording Console

“The Harrison console is very ‘musical’ and very easy to work with.” — Charles Fox
 “It’s probably the only console that actually performs as a mechanical device but sounds more like a musical instrument.” — Bill Lazarus, General Manager
 “And that’s what this business is all about — making music sound like music.” — Artie Butler

F.W.O. Bauch Limited

49 Theobald Street, Boreham Wood, Hertfordshire WD6 4RZ
Telephone 01-953 0091 Telex 27502

HARRISON SYSTEMS, INC.

P.O. Box 22964, Nashville, Tennessee 37202 · (615) 834-1184, Telex 555133

NO COMPROMISE





TSM- Mixing with Style

Trident Audio Developments Limited
 Post No 38, Studios Road, Shepperton, Middlesex, England.
 Telephone: Chertsey (09328) 60241 Telex: 8813982



Agents Worldwide
America Studio Maintenance Services, California Tel 213 877 3311 Empirical Audio, New York Tel 914 762 3083 Phil Reddish Stereo Inc., Ohio Tel 216 886 1222 Wilson Audio Sales, Tennessee Tel 615 794 0155 Harris Audio Systems Inc. Florida Tel 305 944 4445
Australia John Barry Group Sydney Tel 61 2 439 6955
France Lazare Electronics, Paris Tel 33 1 878 62 10
Canada Radio Services Inc. Tel 90 742 133
Finland Into Oy, Helsinki
Japan Nissho
New Zealand Electronics International, Tokyo Tel 392 27 29 51
Spain Neotechnica SAE Madrid Tel 34 1 242 09 00
Norway Protectronic AS, Oslo Tel 02 46 05 54
South Africa Leepny (Pty) Ltd, Johannesburg Tel 27 11 48 3821
Sweden Stage & Studio KB, Kungälv Tel 0303 503 48
Taiwan Lintair Eng. Ltd, Taipei Tel 321 4454 17