

studio sound

January 1979 60p

AND BROADCAST ENGINEERING



**TRAINING IN STUDIOS
MULTI-TRACK MIXING
CONSOLES**

LAKERS

PROGRESS WITH MIDAS

The versatile PR System caters for many live media and recorded sound situations where performance and reliability compromises are not affordable.

Perhaps the most unique aspect of the PR System is the system concept. Thorough understanding and analysis of our clients varied requirements has produced a range of 20 standard modules augmented by additional sub-module options.

Situations requiring operational simplicity

are catered for as effectively as situations requiring comprehensive facilities.

With such a system every detail matters. Every control function is designed to provide optimum response. Every component is selected to assure consistent high quality performance for many years. The rugged main frame is modular and offers expansion at any future time.

The Midas PR System provides the reliable link between you and the perfect sound.



MIDAS AUDIO SYSTEMS LTD. DAVID SCHWEL, 34-36 STATION STREET, LONDON N1 3JX. TEL: 01-388-7000 (9:30-7:30)
MIDAS AUDIO CORPORATION, BOB SINKOVIC, 750 MAIN STREET, MIDDLETOWN, N.Y. 10941 U.S.A. TEL: 716-282-4100
MIDAS CHINA, FRANK PRITSCHKE, ORR ELECTROACOUSTICS, 365 SPADINA ST. EAST, TORONTO M5S 4R9, ONTARIO, CANADA. TEL: 416-868-0328
For complete list of Midas agents please contact Midas U.K.

EDITOR
ANGUS ROBERTSON

ASSISTANT EDITOR
NOEL BELL

PRODUCTION EDITOR
DRUSILLA DALRYMPLE

CONSULTANT
HUGH FORD

**EDITOR'S
PERSONAL ASSISTANT**
WENDY SMEETH

ADVERTISEMENT MANAGER
MIKE STORMER

PUBLISHER
DOUGLAS G. SHUARD

Editorial and Advertising Offices:
LINK HOUSE, DINGWALL AVENUE,
CROYDON CR9 2TA, ENGLAND
Telephone: 01-686 2599
Telex: 947709
Telegrams: Aviculture Croydon
© Link House Holdings Ltd 1978
All rights reserved.

*STUDIO SOUND is published on the second Friday
of the preceding month.*

SUBSCRIPTIONS

*STUDIO SOUND is available at an annual subscrip-
tion of £9.50. All enquiries to: Subscription Dept,
Link House, 25 West Street, Poole, Dorset BH15 1LL.
Poole (02013) 71171. STUDIO SOUND is also available
on a rigidly controlled requested basis ONLY to qualified
personnel. For terms of control please see back page.*

OVERSEAS READERS

For overseas readers, outside Europe, who require
STUDIO SOUND within days of publication instead
of weeks, we have the facility to send the magazine by
Accelerated Surface Post (USA only) or Airmail.
The Accelerated Surface Post charge is \$10 per annum.
The Airmail charge is £12 (sterling) per annum.
These charges are either in addition to the ordinary
subscription rate of £9.50, or stand alone if a qualified
reader.
If you would like your copies of STUDIO SOUND
sent by either of these methods, please write to the
Editorial Office at Croydon.
On receipt of your remittance all subsequent issues of
STUDIO SOUND will be sent to you by ASP/Airmail.
All copies to Europe are sent Airmail.

BINDERS

*Loose-leaf binders for annual volumes of STUDIO
SOUND are available from Modern Bookbinders,
Chadwick Street, Blackburn, Lancashire. Price is £2
(UK and overseas). Please quote the volume number
or date when ordering.*



*Total average net circulation of 12111 per issue during
1977. UK: 6175, Overseas: 5936.*

studio sound

AND BROADCAST ENGINEERING

NEWS	22
STUDIO DIARY_____ including Utopia, Town House & Studio Seven	28
LETTERS	30
TONMEISTER DEGREE COURSE—A GRADUATE'S VIEWPOINT_____ Tony Spath	32
INSIGHT INTO TRAINING_____ Noel Bell	36
BUSINESS	42
ETEAP REPORT FROM PARIS_____ Jean Marandet	44
RUMBLINGS ON MIXERS_____ Nick Franks and Graham Langley	46
SURVEY: MULTITRACK MIXING CONSOLES	50
REVIEWS: Hugh Ford	
_____ LEEVERS-RICH PROLINE 1000	62
_____ DELTA LAB DIGITAL DELAY DL-1	70
_____ AVAB VISU-LIZER	76
_____ UHER CR240	80

Standardisation on formats has never really been a serious problem in the audio field, unlike the video industry which is forever stumbling over new types of video tape recorder. The $\frac{1}{4}$ " (6.25mm to continental readers) tape format has been around since the year dot and is basically interchangeable on a worldwide basis with only minor compensations for different equalisations that might be in use. As more tracks were required, tape became wider until the present 2" tape (which had been used for video since the early Fifties) was reached about 10 years ago, first with 16 tracks, then 24. A couple of companies have made bold attempts to market 32 or more tracks on 2", but these have not yet found wide acceptance in recording studios. Tape speeds have until now remained multiples or submultiples of 15in/s (38cm/s to those who have forgotten about inches). Until now, manufacturers have adhered to these self imposed standards and have produced designs bounded by these criteria. At AES in New York, MCI introduced its long awaited JH-32 32-track tape recorder using 3" wide tape (now also available from most major audio tape manufacturers) which can also be used in more conventional 2" 16 and 24-track configurations. One of the current trends in studios is towards recording at 30in/s without noise reduction, but this sometimes creates equalisation problems caused by the head extinction frequency which begins to creep into the audio band. Having been the first to introduce a new tape width to the industry, MCI has also chosen 20in/s as the optimum tape speed to compromise between frequency response and signal-to-noise. A considerable number of JH-32s have already been ordered, so it must only be time before other manufacturers follow and update their transports to 3" 32-track capability.

While discussing new recording formats, the digital side is becoming even more complicated. The first 3M digital 32-track tape recorders should shortly be delivered, but meanwhile Sony has been showing a prototype digital recorder claimed to be available with four to 48 channels, although only a 24-channel (but 48-track using two digital tracks per analogue channel) unit was demonstrated. Although not actually publicly demonstrated, Ampex claims to have produced its first digital recorder a couple of years ago, and presented a paper describing a 2" tape 48-channel digital tape recorder, but until some standardisation becomes prevalent, this is unlikely to be marketed. With this in mind, the AES formed a 'Digital Standards Committee' some while ago. During October a Justice Department complaint was filed and the committee had to stop all actions. After consultations with lawyers, a new 'Committee on Digital Audio Engineering' has been formed and will now hopefully make some progress towards standardisation.



THE LINK HOUSE GROUP

JANUARY 1979 VOLUME 21 NUMBER 1



AMEK M3000

favourably comparable to any console available today — standard frame 36 in, offering simultaneous quad, stereo and mono mix from 32 tracks with DC subgrouping of VCA-assisted channel faders and echo returns; complete with parametric equalization on all i/o modules; overall status control of main modes of operation; automation ready with floppy disk memory system under design, and compatibility with other programmers.

Contact Nick Franks and Graham Langley

AMEK SYSTEMS AND CONTROLS Ltd., ISLINGTON MILL, JAMES ST.,
SALFORD M3 5HW. Tel: 061-834 6747. Telex: 668127

Or—Australia:
Con Psorakis,
AUDIO CONTROLS,
22 Finnis Street,
North Adelaide.
Tel. 08-267 2049
Telex: 88729

Belgium:
Luc Ardyns,
JUST BORN STUDIOS,
Terlindenstraat 76,
1790 Hekelegem,
Belgium.
Tel: 053-70 50 03

France:
Francis Linon,
SOCIÉTÉ CYBORG,
72 Ave. Lenine,
Gentilly 94250.
Tel: 161-657 0812
161-366 1772
161-845 9448

Germany:
Manfred Brunwey,
RECORD STAR STUDIO,
Berstorffstrasse 123,
D-2000 Hamburg 50.
Tel: 40-439 7245

USA:
Brian Cornfield,
EVERYTHING AUDIO,
16055 Ventura Boulevard,
Suite 1001,
Encino, Los Angeles, CA 91436
Tel: (213) 995 4175
Telex: 651485
East Coast Distributor:
Martin Audio, New York City

AKG

ACOUSTICS



ADV 244/E

A short time ago we celebrated our 30 year anniversary as a specialist in the development and production of high grade studio equipment, microphones and headphones. Many international events are broadcast using AKG microphones. Many patents are the insurance of our technical lead. Use an AKG product together you will make an unbeatable team. Whenever you have a question about our product contact a serious music or Hi-Fi shop or write to us for further details.



AKG Acoustics Ltd. 191 The Vale, London W3 7QS, Telephone 01-749 2042 (5 lines), Telex 289 38 (akgmig)

www.americanradiohistory.com

REW Professional

We Will Beat Any Genuine Advertised Price

Europe's Largest Suppliers of Studio



EQUALIZERS

SOUNDCRAFTSMEN
Graphic EQ's.

SAE Parametric EQ's.
JVC SEA 10 (2 x 5 Band),
SEA20 (2 x 7 Band)
TECHNICS SH9010 (2 x 5
Band), SH9090 (1 x 10 Band)
MXR (1 x 5 Band), (1 x 10
Band), (2 x 10 Band)
MM-Pace (2 x Band), SR271
(1 x 27 Band)

WOLLENSAK

WOLLENSAK/West
End Distributors

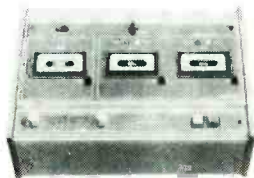

High Speed Duplicators.
£1498.90 + VAT. New 2772A/V
gives 2 stereo musicassettes in
under 4 minutes. Call in for a
demonstration.

UHER PORTABLE RECORDERS

As used by most
Broadcasting Companies.
All models in stock plus every
accessory available.



Very low
prices, e.g.
4000IC £225
+ VAT.
+ SONY +
NAKAMICHI
+ JVC +
TECHNICS +
TEAC.
Portables all
Off the Shelf.

REVOX

Incredible stocks at
ridiculous prices!



A77, B77, A700 Off the Shelf.
High speed, low speed, vari-
pitch + all accessories!
Ring us now for the lowest price.

TAPE AT TRADE PRICES

Any quantity—
same price $\frac{1}{2}$ "
tape, 10 $\frac{1}{2}$ " reels.

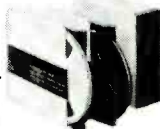

AGFA PEM368 Metal £10.06
AGFA PEM368 Plastic £7.79
SCOTCH 207 Metal £9.81
SCOTCH 207 Plastic £8.03
MAXELL UD180 Metal £8.89
TDK AUDUA LB3600 Met £11.40
TDK AUDUA L3600M Met £9.50
SONY SLH-11-1100BL Met £10.00
SONY SLH-740B Metal £6.89
REVOX 601 Metal £11.80
REVOX 601 Plastic £10.00
All above prices exclusive of VAT.
Also large stocks of 7" & 5" reels.

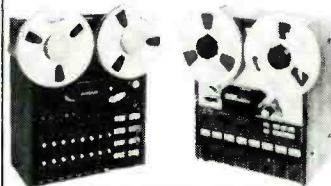

8 TRACKS $\frac{1}{2}$ " or 1"
Both Tascam and Brenell
Recorders in stock for immediate
delivery.
Plus complete range of 8 Track
ancillaries.

MICS-OVER 500 ALWAYS IN STOCK!

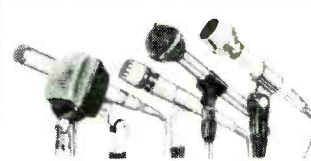

AKG We carry every model
inc. capacitors
BEYER Most dynamic + ribbons.
CALREC 600 Range.
SENNHEISER Large stocks.
SONY All models.
NAKAMICHI All models.
E.V. Selected range.
SHURE Very large range.
NEUMANN All popular
models.
+ Cables, Transformers, Stands,
Connectors & Clips, Windshields,
etc.

CANNON XLR'S

ANY QUANTITY—SAME PRICE

XLR-3-110 £1.39 + VAT
 XLR-3-120 £1.06 + VAT
 XLR-3-310 £1.85 + VAT
 XLR-3-320 £1.06 + VAT

AMPLIFIERS

HH S500D, TPA, All stage
amplifiers.
SAE From 2 x 50 watts to
2 x 400 watts RMS.
QUAD 405, 303, 50E usually
in stock.
JPS A fantastic range of budget
studio amps.
AMCRON DC 300A, D150A,
D60. Trade prices.

SPECIAL OFFER

AMCRON D150A
£311 + VAT FEW ONLY

TEAC A3340S

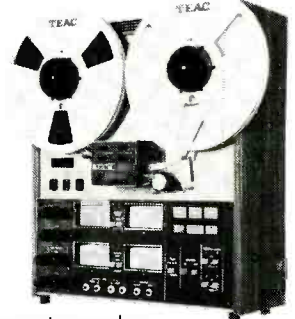

4-channel recorder.
Symul-sinc. 10 $\frac{1}{2}$ " reels,
7 $\frac{1}{2}$ + 15 ips.
NOW BACK IN STOCK
Price on application.

MIXERS

The widest range under one
roof!

From £35-£2500.
Mixers in stock:
SOUNDCRAFT 16/2, 12/2,
12/4 Series II.
HH 16/2, 12/2.
MM All models.

TEAC-TASCAM Models
1, 2, 3, 5 + Accessories.

CANARY 10/2, 10/4.
HILL 16/2, 10/2.
SONY MX8, MX510, MX650.
Plus **ALLEN & HEATH**,
JVC, **UHER**, **EAGLE**, etc.



Plus Echoe's, Phasers, Flangers,
Limiters, Noise Reducers,
Expanders, Mix-Downs, Mic
Stands, Cable Drums, Disco
Gear, Chassis Speakers, Studio
Monitors, Headphones, Demags,
Splicers, etc.

REW

PRO-AUDIO & DISCO: 114-116 Charing Cross Road, WC2 01-836 2372 7851
Also separate floor of Hi-Fi and Video Phone 01-240 3386/7
TAX-FREE EXPORT & EXPRESS MAIL ORDER: REW House, 10-12 High Street,
Colliers Wood, SW19. 01-540 9684 ● Also at 230 Tottenham Court Road, W.1.

The Professional Everything Store

Audio Established 1948

Largest Stocks Lowest Prices!!

& Stage Equipment

EXCLUSIVE FROM REW

SAE A superb range of studio electronics from the U.S.A.

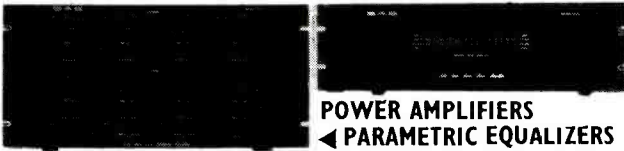

**POWER AMPLIFIERS
PARAMETRIC EQUALIZERS**

Prices exclude VAT

2800 Parametric equalizer 2 x 4 Bands	£408.00
1800 Parametric equalizer 2 x 2 Bands	£239.00
4000 Electronic crossover, stereo, variable frequency	£155.00
4100 Digital time delay, stereo	£354.00
2200 Power amplifier 2 x 100 watts	£346.00
2400L Power amplifier 2 x 200 watts	£578.00
2500 Power amplifier 2 x 300 watts	£755.00
2600 Power amplifier 2 x 400 watts	£887.00
5000 Impulse noise reduction unit	£176.00

SOUNDCRAFTSMEN

America's Largest Manufacturer of Graphic Equalizers



GRAPHIC EQUALIZERS

2204 2 x 10 Bands	£199.00
2205 2 x 10 Bands, rack mount	£226.00
2209 2 x 10 Bands, rack mount, 600 ohm balanced in/out XLR	£319.00

NEW CLASS H POWER AMPLIFIER

MA5002 2 x 250
watts, meters

Prices exclude VAT

HH DIGITAL MULTI ECHO

Studio quality at an economic price. Facilities include A.D.T., echo and reverb. Fully electronic (no tapes or discs) giving exceptionally low noise.



**Open 9.30 am — 6 pm — 6 days a week
just walk in — 95% of advertised
gear available off the shelf**

Payment by: Cash,
Barclaycard, Access,
American Express, Diners,
HP (Instant credit possible)

**THE LOW PRICE HOT
LINE 01-836 2372**

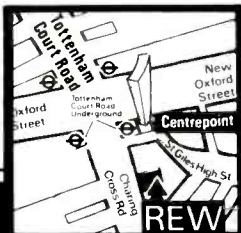

**NEAREST TUBE STATION
TOTTENHAM COURT ROAD UNDERGROUND**

two more Penny & Giles audio products

the 1100 fader

our new 1100 series linear motion conductive plastics faders provide the opportunity to build in performance at a budget price because we've designed them to have all the smooth performance advantages of Penny & Giles audio products - but limited the options to keep manufacturing costs down. Examine the specification - the 1100 fader sounds good.

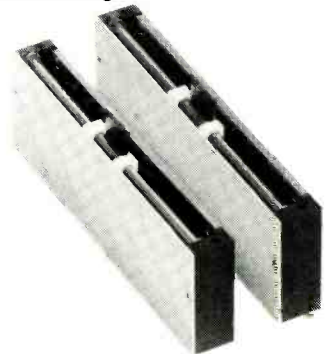

Write for full details or ring
our sales office

and the QCP-1

Penny & Giles QCP-1 quad pot takes a single input and produces four correctly attenuated channels of output with only 0.5dB insertion loss. The feel is positive. Direct coupling to the infinite resolution conductive plastics tracks means very fine settings can be made. Six special law tracks produce a truly balanced sound effect and enable sensitive control in the central position. Our quad pot is impressive, but you need to use one to know how much better it is.

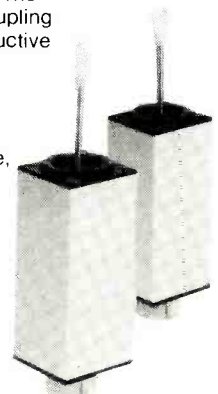

Write for full details or ring
our sales office

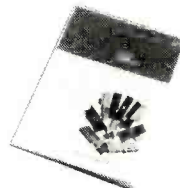

Why not have full details of Penny & Giles complete range of audio products. Send for our brochure.



Penny & Giles Conductive Plastics Ltd.

Newbridge Road Industrial Estate Pontllanfraith Blackwood Gwent
South Wales Telephone Blackwood (0495) 223771

1640 5th Street Santa Monica California 90401
Telephone 213 393-0014

We made the man with the triangle in the Boston Pops extremely happy.

He wasn't cut off this time.

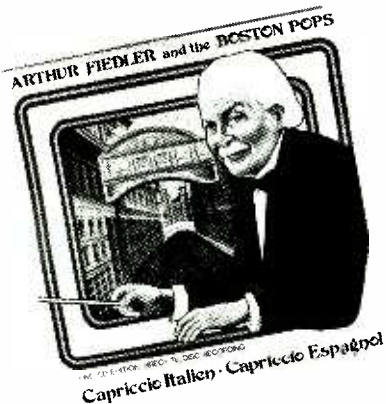

Arthur Fiedler's Boston Pops and Crystal Clear production made this new direct-cut record.

To be sure, they used three different combinations of cutting equipment. And the result, the Scully cutting machine with Ortofon cutterhead, was chosen by Arthur Fiedler and the sound experts. Not only to please the triangle player in the famous orchestra - but the depth in the music responded to the name "Crystal Clear".

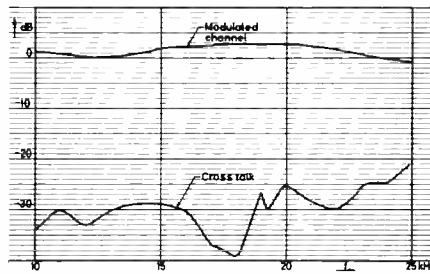

Channel separation measured on cut lacquer disc by interferometric methods. DSS 731/GO 741.

**The explanation:
The special construction
of the Ortofon cutterhead**

Every cutting engineer knows the difficulty of cutting frequencies in the supersonic area because of problems with the resonances in the cutterhead. These problems can be solved in several ways. The high frequencies can be cut off. Or an equalizer can be used to compensate for the resonances. Excellent when producing "middle-of-the-road". But for more sophisticated music you'll need the Ortofon equipment because we have solved these resonance problems. The Ortofon cutterheads DSS 731 and DSS 732 have the lowest secondary resonance above 30 kHz and 24 kHz respectively. This ensures a flat frequency response and high channel separation in the lacquer.

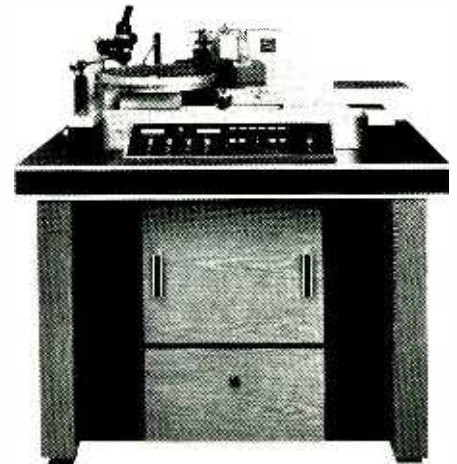

**"The Lathe" by L.J. Scully.
The Perfect Partner.**

We looked for a cutting machine designed to meet the most stringent requirements of the master record industry. And found it.

Which means that Ortofon now represents this unique mastering unit in Europe. Just as L.J. Scully Manufacturing Corporation represents Ortofon in America.

We believe Ortofon and Scully to be a perfect combination. And so do others. Just ask Arthur Fiedler . . .

Please send brochures covering the Ortofon cutting equipment and The Lathe from L. J. Scully.

Studio: _____

Address: _____

Zipcode, town and country: _____

**Let's make you happy.
Cut us out. Now.**

ortofon

accuracy in sound

Send this coupon to:

Ortofon Manufacturing A/S
Mosedalvej 11 B,
DK-2500 Valby,
Denmark

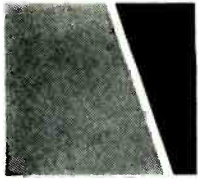

fact: the 10 most common nuisances in PA can be cured. permanently. instantly.

These 10 problem solvers in your toolbox are like 10 new tricks up your sleeve. Or 10 hours of saved time. Or money in the bank. They tailor the sound, match the lines, smooth out the peaks, fill in the valleys, make molehills out of troubleshooting mountains. Snap one in. Out go the hassles. Without soldering, or splicing, or internal equipment modifications:

Problem:	Solution:	
Input Overload	A15A	Microphone Attenuator prevents input overload. Ideal where very strong signals are applied to a microphone input.
Phasing	A15PR	Phase Reverser reverses the phase of a balanced line without modification of equipment.
Low-Frequency Noise	A15HP	High Pass Filter provides a low-frequency microphone cutoff to reduce unwanted low-frequency noises and proximity effect.
High-Frequency Noise	A15LP	Low Pass Filter provides high-frequency cutoff to reduce objectionable high-frequency noises.
Lack of Presence	A15PA	Presence Adapter adds voice-range intelligibility and extra brilliance.
Sibilance	A15RS	Response Shaper provides excellent sibilance filtering; flattens microphone response.
Line Level to Mic Input	A15LA	Line Input Adapter converts balanced low-impedance microphone input to line level input.
Matching/ Bridging/Isolating	A15BT	Bridging Transformer, a balanced unit, matches balanced or unbalanced devices of different impedances.
Troubleshooting	A15TG	Tone Generator produces a continuous 700 Hz low-impedance microphone level signal — extremely useful in setting-up and troubleshooting lines. Helps check levels, connections, mixer inputs, and cables. Allows one man to do the work of two!
Microphone Impedance Matching	A95 and A97	Series Line Transformers make it possible to connect low-impedance lines to mid- and high-impedance inputs (or vice-versa). Completely reversible. Solves problems of excessive high-frequency loss and objectionable hum.

Shown Actual Size: 114mm (4½ in.) long x 19mm (¾ in.) diameter.



Send for the free Shure brochure, SEL3025



Shure Electronics Limited, Eccleston Road, Maidstone ME15 6AU—Telephone: Maidstone (0622) 59881

EVERYBODY'S GETTING BEHIND BGW

Even Crown and Yamaha

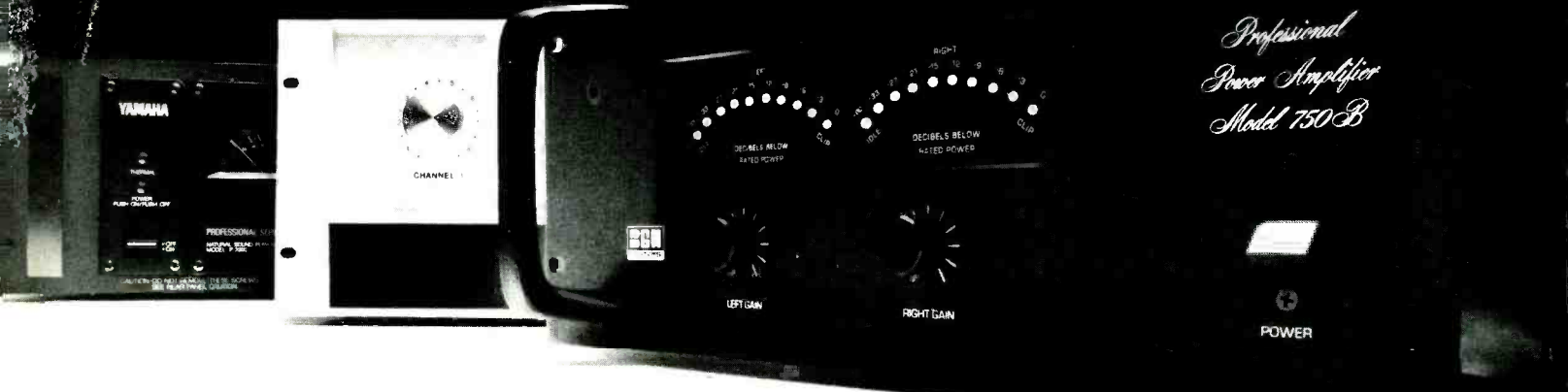

	POWER* @ 8 OHMS	HEATSINKS/COOLING SYSTEM: TOTAL # OF OUTPUT TRANSISTORS @ 4 OHMS	SPEAKER PROTECTION	MAINS (AC) PROTECTION	CONSTRUCTION DESIGN	TURN-ON DELAY	CIRCUITRY	T.I.M.	PRICE*	YEAR INTRODUCED	
BGW 750 B/C	225 Watts/ch.	360 Watts/ch 20	Forced air cooling for 2 massive removable modules	Active arc-interrupting circuitry	Front panel magnetic circuit breaker	Modular all Teflon wiring	Relay operated transient delay circuitry	Full complimentary	\$ 999 — Model 750C \$1099 — Model 750B	1978	
CROWN DC300A	155 Watts/ch	NO FTC RATING 16	Passive airflow only	None provided	Rear panel fuse only	Hard-wired, non-modular	None	Quasi-complimentary	Not specified*	\$ 919 ***	1974
YAMAHA P2200	200 Watts/ch	NO FTC RATING 12	Passive airflow only	None provided	Rear panel fuse only	Hard-wired, non-modular	None	Full complimentary	Not specified*	\$1095	1976

Here they are — The big guns of professional amplification: The respected Crown DC300A, The cosmetically impressive Yamaha P2200, And BGW's new, no-nonsense 750B/C.

Top-of-the-line professional power amplifiers from the industry's most respected manufacturers. All boasting impressive reputations. All costing about \$1,000.

The table reveals the specifications.* You decide which one is best.

THE RELIABILITY FACTOR

Above all else, professional musicians and audio engineers want to know two things about their power amplifiers: How dependably they function under extreme conditions, and how well they interface with other components.

BGW's new 750 Series amplifiers have taken the lead in both areas. Twenty (20) output transistors as opposed to Crown's 16 and Yamaha's 12 provide a Safe Operating Area unmatched by either the DC300A or the P2200. While both Crown and Yamaha rely on passive "convection" cooling, the extensive heat sinks on BGW's pro amps are cooled by forced air for reliable, continuous performance even on the hottest outdoor concert stages. Unique new arc-interrupting circuitry protects speakers — not just the

amplifiers themselves — from catastrophic DC offset.

Like all BGW amplifiers, the 750B and C feature modular construction and front-panel circuit-breakers rather than hard wiring and cumbersome rear-panel fuses. The result: Maintenance is easier both onstage and in the studio — when time and tempers can be very short.

CLARITY AND PRESENCE

Now that audible Harmonic and Intermodulation Distortion have been all but eliminated from professional power amplifiers, Transient Intermodulation Distortion (TIM) has become important. Neither Crown nor Yamaha specifies TIM levels whereas TIM specs for BGW's 750's Series are published with the greatest of pride. The 750B and C consequently produce clearer, warmer, and more open sound.

Pros will also appreciate another BGW exclusive: A delay circuit that eliminates all transient "thumps" when the 750B and C are activated. Neither Crown nor Yamaha has anything like it.

POWER

This is where BGW really leaves the competition behind. While the Crown DC300A and the Yamaha P2200 are rated at

155 and 200 watts, respectively, BGW's 750B/C delivers a full 225 watts per channel into 8 ohms,** leaving the competition behind entirely at 4 ohms, with a whopping 360 watts. Only BGW has FTC rated 4 ohm power specifications.

Both the DC300A and the P2200 are good power amplifiers by conventional standards. But real recording pros don't deal with convention.

They get behind BGW.
Because the competition already is.

*Based on manufacturers' published specifications and prices available 7/1/78.

**BGW 750B/C FTC Specification: 225 watts minimum sine wave continuous average power output per channel with both channels driving 8 ohm loads over a power band from 20Hz to 20kHz. The maximum Total Harmonic Distortion at any power level from 250 milliwatts to 225 watts shall be no more than 0.1%.

*** Includes optional HMB-7 Handles (\$20.00, not shown)



Get Behind Us!!

BGW Systems, INC.
13130 S. Yukon Avenue
Hawthorne, California 90250
In Canada: Omnimedia Corp., 9653 Cote de Liesse
Dorval, Quebec H9P 1A3

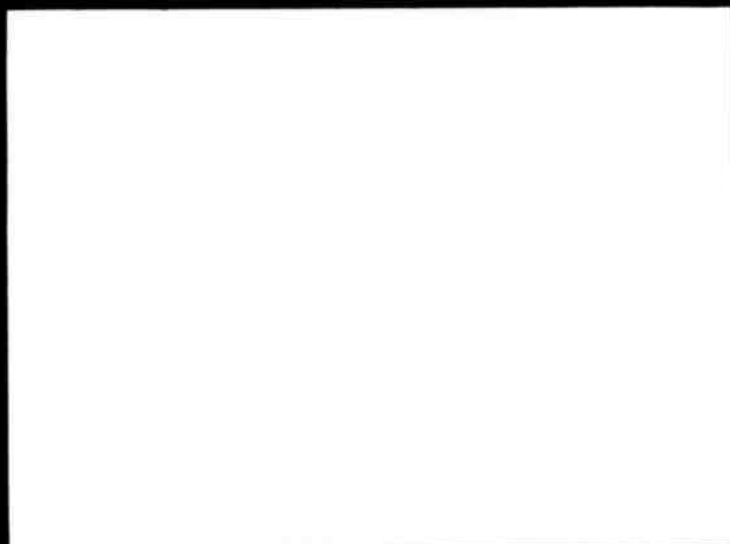
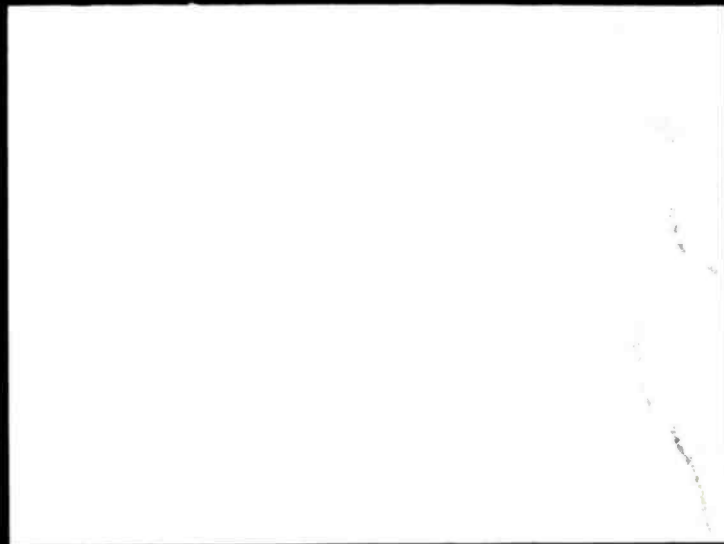
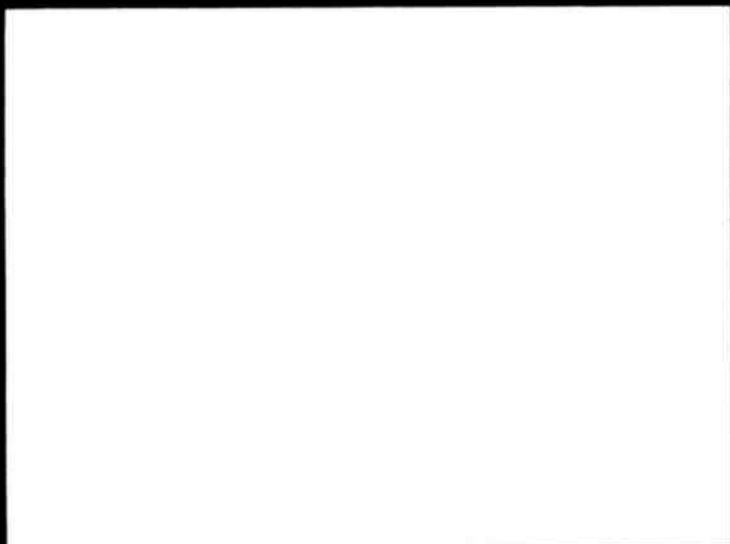

NO COMPETITION

The superb 3.77 is the only choice in compact professional recorders.

Who says?

Hundreds of satisfied professional users—Broadcast authorities, studios, record companies, universities etc etc.

What makes it the best?

The 3.77 provides more performance and features for your £ than any other model. Like 3 speeds, flat metal facia with excellent editing facilities, 100% variable speed control, logic control with motion sensing, line-up oscillator.

An **ITA** Product.

1-7 Harewood Avenue, Marylebone Road, London NW1. Tel: 01-724 2497. Telex: 21879

APRS

ASSOCIATION OF PROFESSIONAL RECORDING STUDIOS

PROGRAMME FOR 1979

**JANUARY
19.25**

MIDEM. Cannes

APRS Stand will distribute members' trade literature and 50 page Catalogue of member studios in the UK.

**MARCH
13.16**

**BRUSSELS. AES CONVENTION/
EXHIBITION.**

27 British manufacturers will exhibit under joint venture organised by APRS.

MARCH

Course in basic electronic engineering for studio staff.

APRIL

Course in digital techniques for sound recording and automation.

**JUNE
20-21-22**

12th annual APRS Exhibition of Professional Recording Equipment.
Connaught Rooms, London.

SEPTEMBER

6th engineers' course.

Lectures and demonstrations for studio engineers to exchange views on techniques and problems of common interest.

For further details write :

**Secretary APRS
23 Chestnut Avenue,
Chorleywood, Herts
WD3 4HA
United Kingdom.**

The unique TEAC range from ITA

Only ITA offer such a wide range of models—always in stock.

TASCAM 80-8

This 8 track recorder is available with or without DBX noise reduction.

Immediate delivery.



A2340 SXH

All the advantages of 15 ips operation now available on this model. Outstanding value among 4 channel recorders.

Exclusive to ITA.



A3340S Industrial

This upgraded version of the A3340S standard model features 63dB signal to noise ratio.

Exclusive to ITA.



We hold the largest stock of TEAC in the UK for immediate delivery. Visit our new showrooms for a demonstration.



MIXERS

The Tascam Series Model 3 and Model 5. In stock, and available for demonstration.

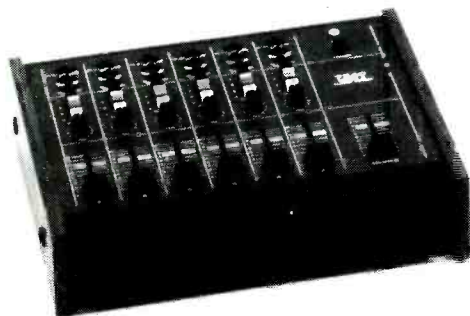

ITA

1-7 Harewood Avenue,
Marylebone Road, London NW1.

Tel: 01-724 2497

Telex: 21879

NEW LEADERS IN FRANCE

Publison Audio Professional Manufacturing

COMPRESSOR-LIMITER PUBLISON CL 20 B



Stereo-compressor-limiter with fast photocel—very low noise : - 102dB and low distortion when compression operates : > 0.1%—use fat opa bandwidth 100 kHz even for + 20 dB—insertions in side-chains—stereo-coupling—display of compression ratio by 11 led—special circuitry to suppress distortion on low frequencies.

HARMONIZER-DELAY LINE DHM 83 with MEMORY MODE



STEREO VOLTAGE CONTROLLED DELAY up to 360 mS for 5 kHz - bandwidth (180 mS for 10 kHz - 120 mS for 15 kHz).
HARMONIZER: from - 20 to + 1 octave—micro-computer operates phase coincidence of successive sequences and suppresses **ARTIFACTS** precedently usual in such systems.
MEMORY MODE with keyboard remote control, one can play with any memorised sound.
TRUE DYNAMIC RANGE: 100 dB by the mean of a 13 bits flying comma D/A converter.

Publison Audio Professional Distributor

ANALOG DELAY LINE/FLANGER—LOFT 440



At last an analog delay system that gives you the best of two worlds. It has the long delays, greater bandwidth and higher S/N of the better digital units, without digital step error or quantizing noise. Delays are continuously variable from 5 mS right up to 160 mS. The bandwidth is still 18 kHz at 40 mS and a very respectable 6 kHz at 120 mS. A sophisticated noise reduction system preserves dynamic range while lowering noise and avoiding input limitations common to most delay units. The voltage controlled time-sweepable function combined with the clock mix and regenerate controls provide the potential for an unlimited variety of new and exciting effects. True doubling, stereo synthesizing, slap-back, short echoes, vibrato, resonant pitches, and of course a wide range of flanging, to name a few, can all be derived from the unit.

For further information, contact **PETER DEAN**—Publison Audio Professional
5-7-9-11, Rue CRESPIN DU GAST—75011 PARIS

Tel : (010-33-1) 357 64 08

NEW PRODUCTS BULLETIN

ITA



ORBAN from USA

Dual channel multispring reverb unit. Each channel features four springs — far smoother than single spring systems. "Twang" and "boing" are virtually eliminated by incorporating a floating threshold limiter. Bass, mid-range EQ and bandwidth controls. The best compact reverb unit available.

ITAM 882

New Stereo Mixer, built to a specification not a price! Ultra low noise, -128dB. 8 inputs+8 direct outputs, 2 outputs with VU meters. 2 limiters. XLR mic inputs (balanced). 3 band EQ + mid sweep. £395 + VAT



AURATONE



The amazing 5C Super Sound Cube. Only 6" x 6" — but it sounds enormous!
Only £38 per pair.

NEW! Cassette copiers from PENTAGON

Simple operation—fully automatic 16 times speed. Choice of one or three copies. C32/34—outproduces all other makes—75 C60 per hour. Budget price from £587 + VAT.

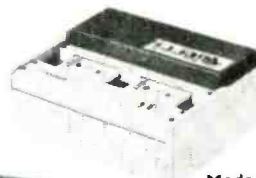

Model C-1 — Mono
Model C-4 — Stereo



Model C32S — Mono
Model C34S — Stereo

AMPEX ATR-700

Now every studio can afford legendary Ampex performance and reliability. Fully professional specification including balanced inputs/outputs, Cannon connectors, variable tape speed, sel sync. The price will fit this year's budget, not next year's! Sole distribution by ITA.



QUAD

The new 405 power amplifier is now in stock. 100 watts per channel — simply the best, for £££'s less! Immediate Delivery!

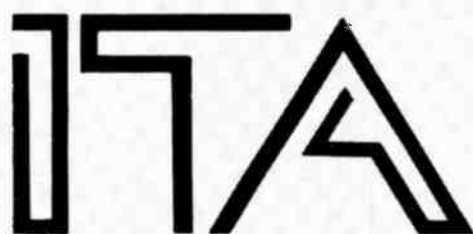

1-7 Harewood Avenue, Marylebone Road, London NW1.
Tel: 01-724 2497 Telex: 21879

FRANCE: Son Professionnel, 2 Rue des Tennerolles
92210 Saint Cloud (Paris). Tel. 602 6815

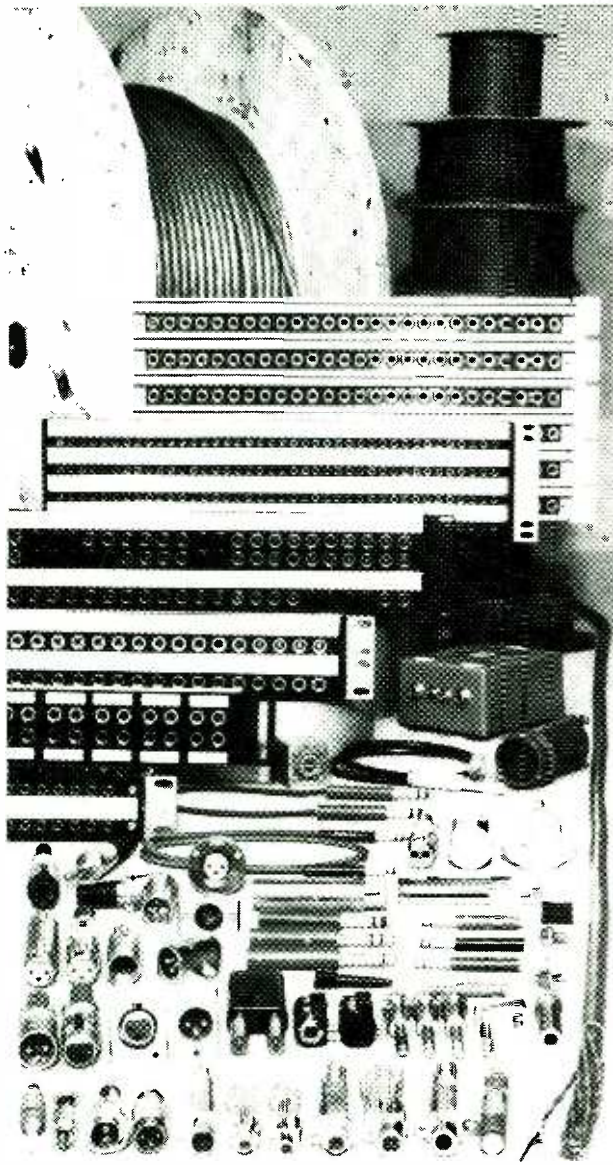

Cable, Connectors, and
Accessories for the
Broadcasting & Recording
Industries from

**FUTURE FILM
DEVELOPMENTS**

36/38 Lexington Street, London W1R 3HR
Telephone 01-437 1892/3 • Telex 21624 ALOFFD G

R. D. G. PRODUCTION COMPANY

12 HILL VIEW NEWPORT PAGNELL

Tel. 0908 613009

Telex: 826419 Answerback R.D.G. G.B.

MIXING CONSOLES

Cadac Serie E 28 x 16 x 24 less than two years old	£22000
Cadac Serie E 18 x 16 x 16 pre-wired for 28 x 16 x 16, one year old	£20000
Cadac Serie E 32 x 24 x 24, as new	£30000
Trident B 16 x 8 x 16	£11500
Studer Model 189 18 x 8 x 8	£9000
Allen & Heath Modular 2 16 x 8 x 16	£2200
Allen & Heath Modular 2 10 x 8 x 16 with Brennel 8 tracks 1" recorder, two items	£3100
Allen & Heath Modular 2 10 x 8 x 16	£1600
AMEK 2000 20 x 16 x 16	£9000

MULTI TRACK MACHINES

3M M79 24 track, 8 months old	£18000
Studer 16 track Mk I	£9500
MCI JH 10 24 tracks	£9500
Ampex MM 1100 16 tracks	£9250
3M M56 16 track	£9000
Studer A80 Mk I 8 track	£6750
Scully 280 8 track	£3200
Scully 280 8 track	£3000
3M M79 Stereo with auto locate, as new	£4800
3M M79 4 tracks with stereo head block	£4500
Ampex AG 440 4 track	£1800
Ampex AG 440 stereo	£1200

MISCELLANEOUS

DOLBY A301 Stereo	£400
JBL 4311 Speakers, new, each	£255
Eventide Phaser	£150
Neumann U87, used	£275
Neumann U67	P.O.A.
Neumann M49	P.O.A.
Neumann M50	P.O.A.
Neumann KM56	P.O.A.
Neumann KM54	P.O.A.
AKG D202	£45
AKG D224	£80
AKG DI90	£22

R.D.G. in France. Agent: Magnetic France, 11 Place De La Nation, Paris.

Wanted: all studio equipment. For a realistic quote RING NOW.

VAT not included

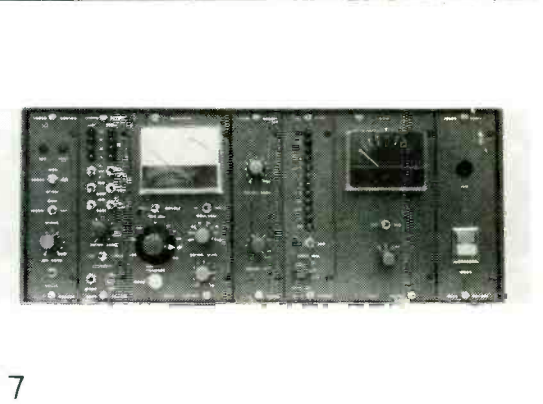
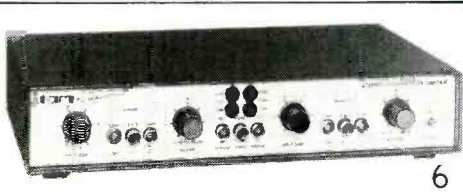
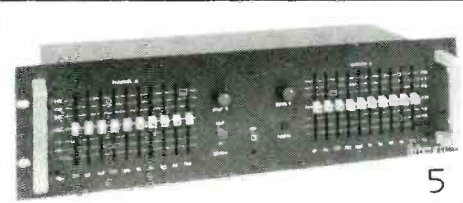
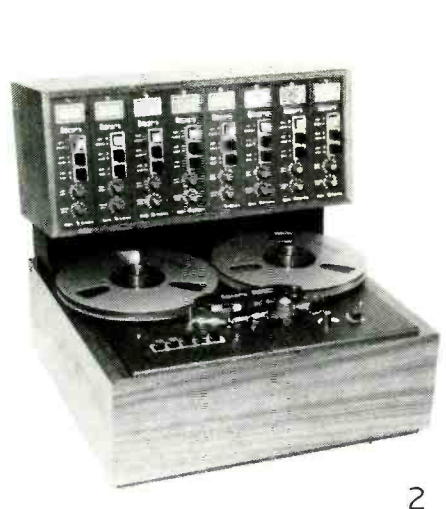
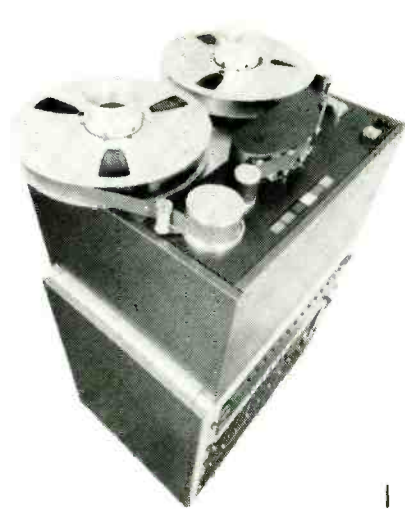

This is ITAM '79

1. ITAM 1610. 16 track 1" recorder

2. ITAM 806. 8 track 1/2" recorder

3. ITAM 10-4. 10 input 4 output mixer

4. ITAM 882. 8 input 2 output mixer

5. ITAM Graphic Equalizer. Stereo, 10 bands per channel

6. ITAM Compliment. Stereo compressor limiter

7. ITAM Modular Ancillary System

ITAM
from Britain

1-7 Harewood Avenue, Marylebone Road, London NW1. Tel: 01-724 2497 Telex: 21879
FRANCE: Son Professionnel, 2 Rue des Tennerolles, 92210 Saint Cloud (Paris). Tel: 602 6815

IVIE

IS A NATURAL

A state-of-the-art
real-time analyzer

The IE-30A RTA from IVIE is
the most advanced audio analysis
system in the world, yet it weighs a mere 3 pounds.
It's so small that you can place your complete acoustics
laboratory under an airline seat.

To assure the ultimate in measurement accuracy, IVIE uses
6-pole (Class III) 1/3-octave filters, and built in a low noise, precision (Type 1)
sound level meter. These features combine to provide unmatched measurement capabilities for
sound system equalization and evaluation. Having a calibrated voltage input range of 180 dB
(0.5 mV - 500 V_{RMS}) allows for accurate measurements from the noise floors of preamplifiers to line
level voltages (selectable true rms, average or peak detectors).

A new microprocessor accessory. With the new IE-17A accessory, the
IE-30A has microprocessor calculating power, and an X-Y recorder
interface for data output. Now you can automatically analyze RT₆₀,
time delay events, reflections, articulation losses,
tone burst and absorption characteristics - all under
computer control. Don't settle for bulky test gear
that does only half the job. Get the IE-30A System.



The IE-30A is shipped fully calibrated in
a rugged flight case with a precision
Type 1 microphone, RTA test probe
and rechargeable batteries.

**For the professional, it's a
natural.
Call or write for a brochure
and a demonstration.**



IVIE ELECTRONICS INC.
50C West 1200 South
Orem, Utah 84057 U.S.A.
(801) 224-1800
TELEX or TVX: 910-971-5894

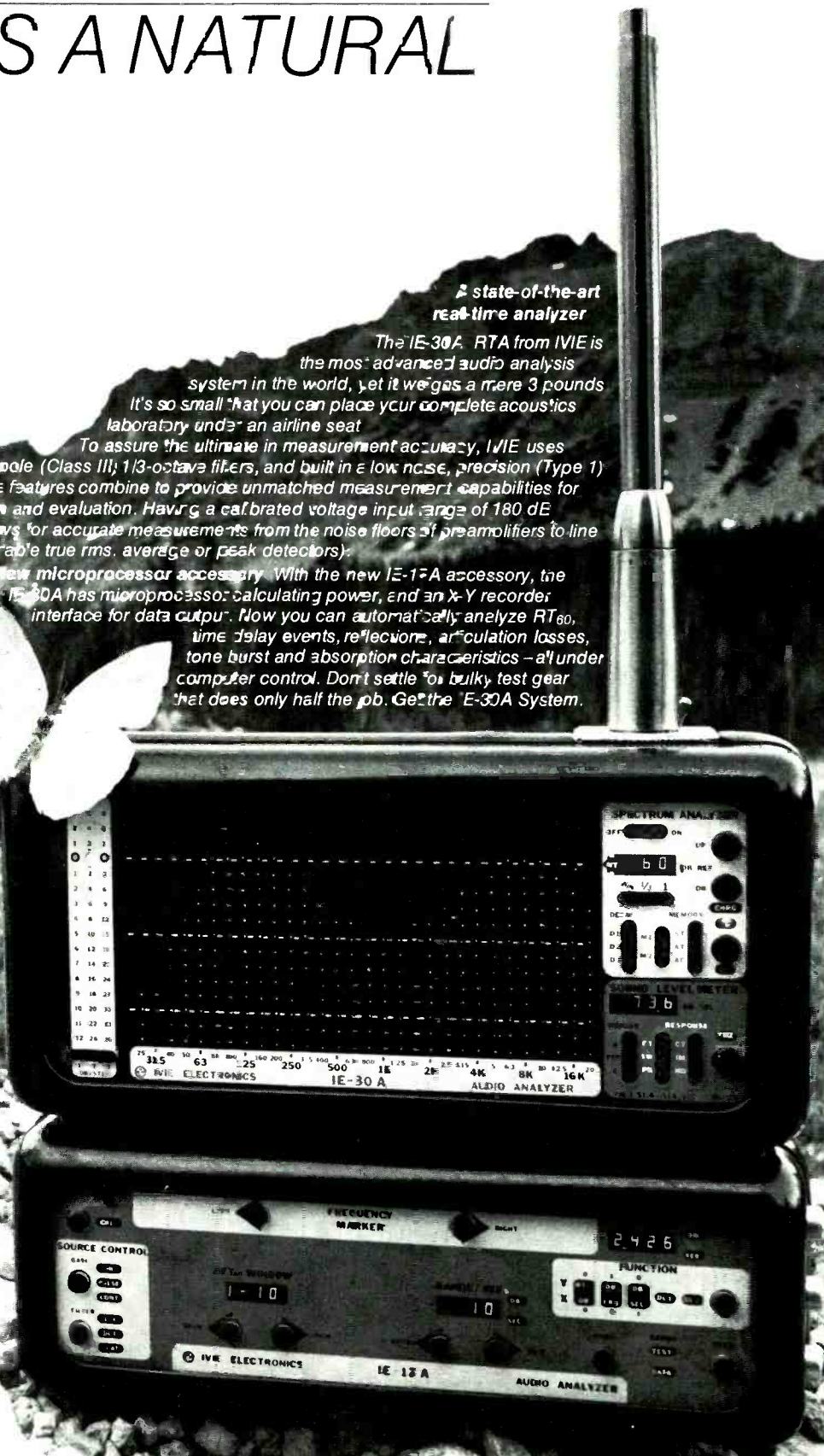

REVOX

The Music Laboratory is England's main Revox Centre serving the recording industry. We hold large stocks of equipment and accessories for rapid delivery. We are the official Revox Service Centre London, holding vast stocks of spares for fastest service turnaround; 24 hour collection service. If you are out of the area, we will send you a flight case for safe transportation.



Revox B77

Revox
hire service.



72-74 Eversholt Street, London N.W.1. Telephone 01-388 5392/3/4/5.

Teac/Tascam Centre

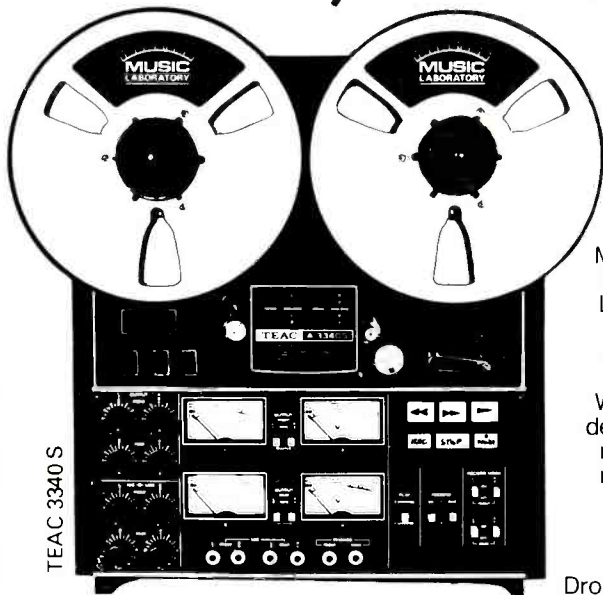

TEAC 3340 S

Once again the Music Laboratory have been appointed main London Centre for the entire Teac/Tascam professional range of studio products. We have on permanent demonstration the whole range of 4 and 8 track recorders and mixers; also we hire out complete systems.

Drop in for a demonstration.

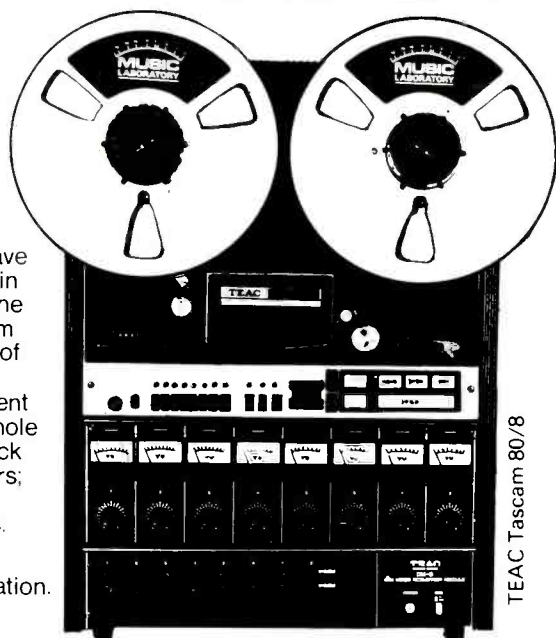

TEAC Tascam 80/8



72-74 Eversholt Street, London NW1. Telephone 01-388 5392.

Cherokee
Los Angeles

Jydsk Grammofon
Nibe, Denmark

Location Recording Service
Los Angeles

Radio Band of America
New York

Rock City
Shepperton, England

Sarm
London

Sound 80
Minneapolis

Soundtrack
Copenhagen

Tony Visconti
London

You can tell a console by the company it keeps

... and these TSM consoles are in pretty good company - worldwide - like this studio of Sarm's in London.

Join this recording elite! See a TSM in action by contacting Trident. You won't be disappointed.

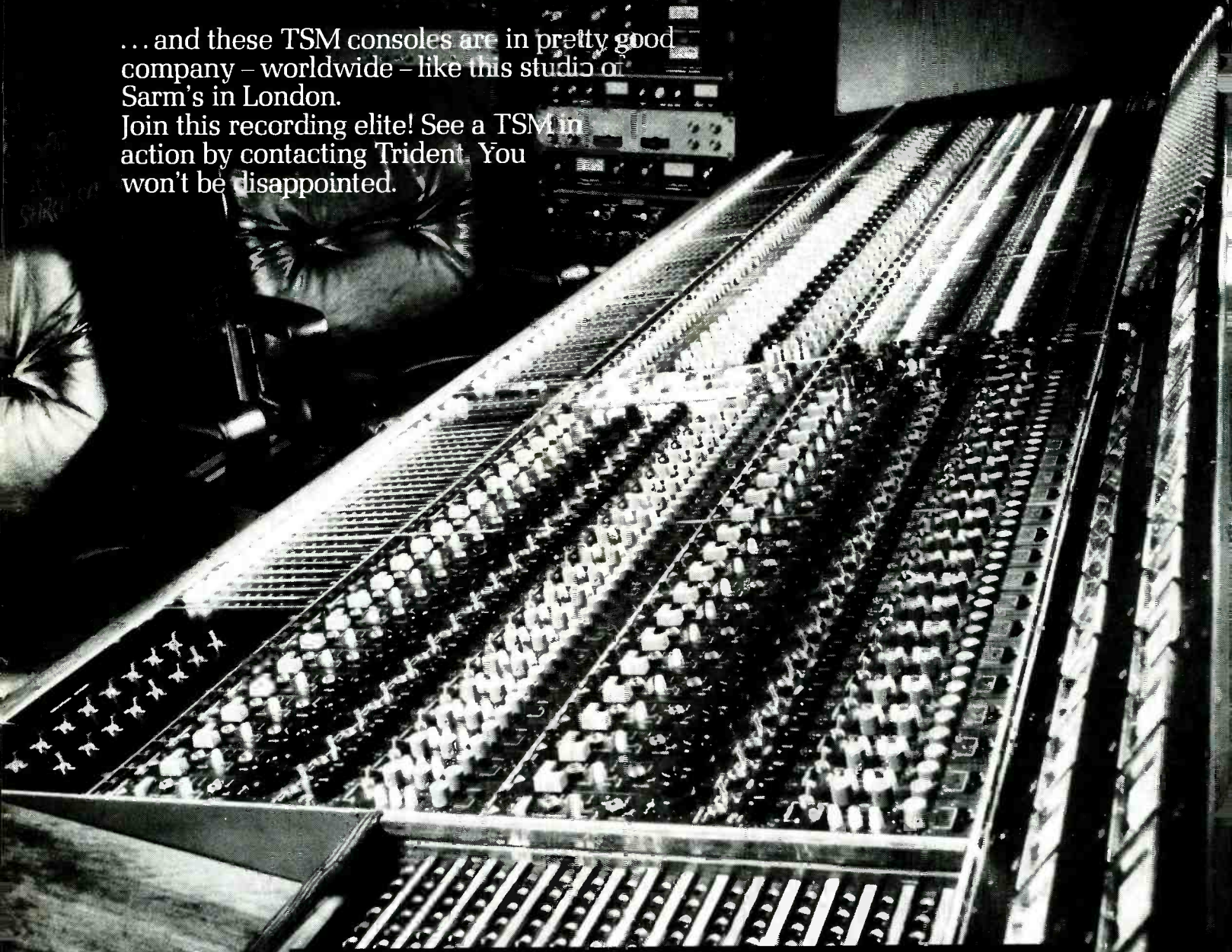

Trident Audio Developments Limited
Shepperton Studios, Squires Bridge Road, Shepperton, Middlesex, England.
Telephone: Chertsey (09328) 60241

SYNCON MIXING BUSINESS WITH PLEASURE

Recording is a personal experience made better or worse by the ergonomics of the mixing console. Syncon has more creative facilities than any other unit in its price range, not that you will find many 24 track consoles at any price to compare with the following standard features. A 22 page information package will reveal even more. Write today.

- 28 input-output module capacity.
- 24 track monitoring and metering.
- Quad and Stereo echo returns.
- Quad monitor and mixdown.
- Free grouping and subgrouping.
- Single master Record-Remix switch.
- Sweep frequency eq. with switchable Q.
- Noise and distortion insignificant.
- P & G Faders as standard.
- +26 dB output on groups and inserts.
- Producers desk with full patchbay options.

Rod Houston
with 28/28 Syncon
at DeCibel Studios, London.



A.H.B.
ALLEN AND HEATH/BRENELL LTD.

Agents

Audiomarketing
Stamford U.S.A.

Son Professional
Paris

Intersonic
Stockholm

Fading
Madrid

Studio Sound
Frankfurt

S.E.D.
Brussels

Sun Music
Denmark

Audiolab Hellas
Greece

Peter Bollen
Eindhoven

Italy

Lastron
South Africa

ALLEN AND HEATH/BRENELL LTD., PEMBROKE HOUSE, CAMPSBOURNE ROAD, LONDON N.8. 01-340 3291

JVC technical seminar

A number of selected audio journalists were recently invited by JVC to a technical seminar to demonstrate and discuss some of the company's latest technical developments. Of particular interest to those who use cassettes was a demonstration of the new 3M *Metafine* 'metal tape' cassettes. With a coercivity of 1,000Oe and bias current of 690 μ A, and with playback equalisation of 3180/70 μ s (the same as that for chrome tape) the metal tape has twice the coercivity and residual magnetic flux of other tapes. Improvements offered by the new tape include about 4dB improved output level at 1kHz rising to 8dB at 10kHz and 11dB at 15kHz allowing improved distortion levels and S/N on high input signal level recording. A demonstration of the tape was quite remarkable when played against a conventional cassette tape. The clarity and dynamic range being particularly impressive. This development certainly takes cassettes into a new realm.

JVC treated us to a demonstration of its research on Pulse Code Modulation (PCM) digital audio. This used the wide band VHS helical scan video recorder as the storage device with a prototype PCM encoder. The encoder was operating on a 13-bit system using 12 linear bits with one bit for correction purposes. The scanning rate being four megabits per second. JVC explained that the standards for PCM audio recording were still under discussion within the industry, but that it appeared that Europe was likely to adopt a 16-bit system. If this should be so, JVC will of course produce suitable hardware. The system demonstrated used *VHS* cassettes which accommodate three hours of recording. Pre-recorded cassettes, when marketed, are likely to retail at about £18.

Trident Fleximix going well

Trident Audio Developments report that production of the *Fleximix* modular sound mixing system has been increased to meet home and overseas demand. The system has become increasingly popular in the theatre and to date several UK productions are using the system including *Oliver* at the Albery Theatre; *Elvis* at the Astoria Theatre; *Evita* at the Prince Edward Theatre; *Annie* at the Victoria Palace Theatre; and *Chorus Line* at the Drury Lane Theatre. In addition, the Sadlers Wells Royal Ballet are currently

using the system on tour, and outside London the Haymarket Theatre, Leicester and the Thorndyke Theatre, Leatherhead are using *Fleximix*. Trident's MD Malcolm Toft comments, "having sold *Fleximix* mainly to studios in the past it is particularly gratifying to see the merits of its flexibility being appreciated in the theatre. The system seems ideally suited to theatre applications and we have many more theatre orders in the pipeline."

Trident Audio Developments Ltd, Shepperton Studios, Squires Bridge Road, Shepperton, Middx, U.K. Phone: 09328 60241.

Professional Marketing Services

Professional Marketing Services are to market a new range of sinewave inverters manufactured by LBK Electronics. These feature a completely stable sinewave output on all loads, with high efficiency performance and a variety of optional refinements such as remote control and synchronised 3-phase operation. Full self-resetting protection is provided and the units will operate over a temperature range 0-60°C. Claimed distortion and regulation are both better than 2% and the

units offer a frequency stability of 0.2% with negligible overshoot. The first two models to be marketed will be the *Model 200VA* and *Model 500VA*, both of which may be either rack mounted or free standing and provide 200VA and 500VA out respectively with an operating voltage of 48V DC with 230V AC output, other voltages and output powers being available to special order.

In addition to the LBK range Professional Marketing Services already market the Hill range of professional power amplifiers. Professional Marketing Services, 15 Greenfield Close, Stapleford, Cambridge CB2 5BT, UK. Phone 02204 2060.

New ribbon loudspeaker

Pyramid Loudspeaker Corp have introduced a new ribbon loudspeaker *Model T-1*. The unit is finished in brushed black anodised aluminium, is sized 121x124x197mm and uses a 19x95mm ribbon with a surface area of 71mm². Frequency response is quoted as ± 3 dB from 3kHz to 40kHz, sensitivity 93dB SPL at 1m (1W pink noise), input impedance 12 Ω at 20kHz, and maximum peak power input 200W (pink noise). The

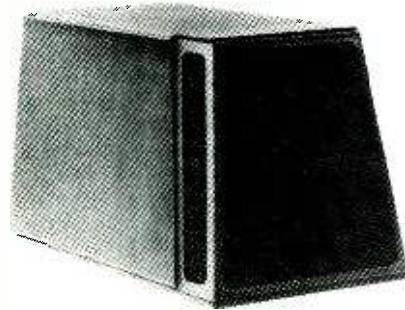

loudspeaker has a five position step attenuator operating at approximately 2dB per step and has a built-in 12dB per octave crossover (-3dB at 3kHz). A pair of *Model T-1* loudspeakers will retail at \$990. Pyramid Loudspeaker Corp, 131-15 Fowler Avenue, Flushing, NY 11355. Phone: (212) 762 1300.

Home Office announces 18 new UK local radio stations

Contrary to expectations, the Home Office announced the intended locations of nine new BBC local and nine commercial radio stations during October. Wavelengths have not yet been announced and are subject to future discussions. The BBC will be initially opening local radio stations in Barrow, Lincoln, Norwich and Taunton, and when funds are available in Cambridge, Northampton, Shrewsbury, Truro and York. All stations are expected on-air by 1982. Meanwhile the BBC is also opening fifth networks in Scotland, Northern Ireland and Wales (with both English and Welsh language services). Independent local radio stations (commercial) named by the Home Office are Aberdeen/Inverness, Bournemouth, Cardiff, Chelmsford/Southend, Coventry, Dundee/Perth, Exeter/Torbay, Gloucester and Peterborough. The IBA should be advertising these contracts during 1979 with first stations potentially coming on-air during 1980. All stations should be available on both MF and VHF, with the commercial stations all being stereo (but not BBC Local Radio).

Kerr audio analyser

Kerr Research has introduced an *Audio Analyser* suitable for a wide range of testing applications. The unit offers sinewave (2Hz-200kHz), triangular wave (2Hz-30kHz); and squarewave (2Hz-30kHz) signal outputs which may be swept over the whole or part of the ranges 2Hz-2kHz, 20Hz-20kHz, and 200Hz-200kHz by an internal or external sweep ramp. The internal sweep ramp is converted to a logarithmic form to give an approximately logarithmic frequency display; internal sweep rate is variable from 0.1s to 2.5s, maximum output volt-

age is 20V p-p and output impedance 100 Ω for all waveforms. Other signal outputs are white noise and pink noise, the latter having an accuracy of ± 0.75 dB over the range 50Hz to 20kHz. Additional outputs available are ramp output for driving an oscilloscope X amp or for connection to an external ramp to sweep the oscillator, sync for oscilloscope synchronisation, and log amplifier monitor. The analyser also has a calibrated output meter with a 26dB range.

Kerr Research, 31 Lionel Avenue, Wendover, Bucks HP22 6LL, UK. Phone: 0296 623506.

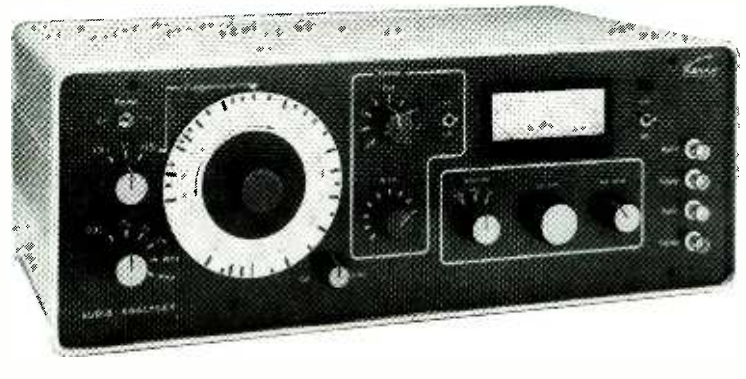

Quadrant digital clock

The rather unusual digital clock shown at APRS with a clock-face circle of LEDs showing rotating seconds, is now being manufactured by Leavers Rich for £150. Leavers Rich Ltd, 319 Trinity Road, London SW18 3SL.

Deltalab Research DL-1 Digital Delay Unit

**Better Performance ...
Better Dynamic Range ...
Better Operational Flexibility ...
Best Value
in Digital Delay Devices Today!**



Fully professional 'no performance compromise' Digital Delay has at last become available at a reasonable cost with Deltalab Research's DL-1 Delay Unit. Equally suitable for high quality

recording or PA use, the DL-1 is flexible (3 outputs each with selectable delays) easy to install (balanced input outputs) and small in size (19" x 1 3/4").



U.K. Distributors
Scenic Sounds Equipment,
97-99 Dean Street,
London W1V 5RA
Tel: 01-734 2812

Spain
Mike Llewelyn-Jones
AP Postal A 8.178
Madrid
Tel: Madrid 637 0752

Denmark
Lake Audio APS,
Artillerivej 40,
DK-2300 Copenhagen S
Tel: Copenhagen 570 600

France
3M France SA, Mincom Div.,
Boulevard de l'Oise,
95000 Cergy
Tel: Paris 749 0275

Holland
Pieter Boilen Geluidstechnik,
Hastelweg 6,
Eindhoven
Tel: Eindhoven 512 777

Norway
Kvam Audio,
Tollbugt 7,
Oslo 1
Tel: Oslo 412 996

Sweden
Tal & Ton Musik & Elektronik AB,
Kungsgatan 5,
411-19 Gothenburg
Tel: Gothenburg 130 216

**Scenic Sounds Equipment, 97/99 Dean Street, London W1V 5RA.
Tel. 01-734 2812. Telex 27939.**

Association of Professional Audio & Radio Consultants

Standards of equipment reviewing in technical publications has come under much fire in recent years, and have no fear that more flames are imminent. Concerned about the harm done by 'rogue' reviewers, a group of engineers met during the summer and unanimously agreed to form the Association of Professional Audio & Radio Consultants. The objectives of the association are (a) to maintain and where possible improve the standards of professional conduct and competence of Consultants concerned with audio and radio engineering, (b) to represent and make known the views of its members upon matters relating to, or effecting the profession, (c) to promote further education and knowledge in audio, radio and acoustic engineering. Founder members of the association are Hugh Ford, Denys Killick, Angus McKenzie and James Moir. Other consultants of suitable standing will shortly be invited to join the association. Further details from the acting secretary James Moir, at 16 Wayside, Chipperfield, Herts WD4 9JJ.

Arak Polycontroller

Arak Sound Ltd has introduced a polyphonic keyboard controller for use with any standard synthesiser (or synthesisers). The *Polycontroller* has control voltage and gate (trigger) outputs as in a normal keyboard controller; however, this unit differs from usual controllers in multiplying these by ten, therefore allowing polyphonic playing of up to ten voices. In addition, the unit has a bank of ten transient generators (envelope shapers) controlled by five functions (attack, decay, sustain level, release, and release level), plus switching for infinite sustain. The unit has a 61-note keyboard and also has controls for vibrato, portamento, control voltage tuning, a rocker-bar pitch bender which electronically zeros on release, a 'phonics' switch allowing choice of one to ten VCO's, and a volts per octave control to allow playing of polyphonic micro or macro tones. The *Polycontroller* may be interfaced with a computer and a number of functions are pedal switchable. Although the unit is intended for use with large synthesisers it may also be used for live performance with several small synthesisers, acting as a master control which may be switched in or out—when switched out only the pitch bender, vibrato and tune control remain active allowing normal usage of synthesisers coupled to



The *Polycontroller* from Arak

the unit, when switched in it gives polyphonic control of all the synthesisers at once. Price of the *Polycontroller* is £850 approx. Arak Sound Ltd, Preston House, High Street, Crowthorne, Berks RG11 7EP, UK. Phone 03446 2550.

Neve takes North America by storm

Neve informs us that business is booming in North America for its mixing consoles and *NECAM* computer controlled mixing system, with orders worth in excess of \$1M having recently been acquired. In New York City, A & R Studios, Electric Lady Studios, Mediasound, Power Station and the Phil Ramone Studio have all invested in Neve mixing consoles, several including the *NECAM* system. Electric Lady is equipping its studio with three consoles valued at over \$400,000, Mediasound is buying equipment valued at \$250,000, whilst the Phil Ramone Studio has spent \$150,000 on a *NECAM* computer assisted mixing console. In Nashville, Woodland Sound Studios has placed an order for a model 8078 console with VCA sub-mastering worth \$130,000. On the west coast Los Angeles based Studio 55 and Village Recorder have just installed *NECAM* computer consoles, whilst Motown Studios took delivery of Neve equipment in November. In Canada three consoles have been installed with Eastern Sound, Toronto, whilst further consoles have been delivered to Manta Sound in Toronto, Century 21 in Winnipeg, Experience in Montreal and Marc Productions in Ottawa. In addition numerous consoles have been supplied to various broadcast networks including the Canadian Broadcasting Corporation.

Rebis Audio move

Rebis Audio, the Midlands based designer and manufacturer of studio equipment, has moved to Kinver Street, Stourbridge, West Midlands DY8 5AB. Phone: 0384 71865.

Contracts

● The Harris Corporation has received a \$3.7M contract to supply seven AM transmitters, studio equipment and a UHF link system to the Ondo State Broadcasting Corporation of Nigeria. Other recent Harris contracts include a *BC-20H*, 20kW medium wave transmitter and a 1kW *FM-1K*, FM transmitter for Radio Nacional, Portugal; and a *MW-50A*, 50kW AM transmitter for WGAR, Cleveland, Ohio.

● Ampex has received an order for six 24-track *MM-1200* audio recorder/reproducers from Record Plant, New York. Two of the units will be used in a newly purchased mobile unit, whilst the others will be used to upgrade the studio.

● Neve has won an order from Kinetex Studios of Singapore for a 40/32 model 8078 multitrack console.

● Helios has received an order from Capital Radio for a further three custom-built programme production consoles.

● Produits Perfectone of Switzerland have been awarded a contract by the organising committee of the 1980 Moscow Olympic Games to supply all the sound recording, dubbing and mixing units for the film production centre of the Olympic television and broadcasting complex.

● Enertec of France has received orders from the French broadcasting company FR3 for *UPS 2000* series consoles, superimposition systems, *F 200* series tape recorders and *TD 200* series turntables to equip studios at Montpellier, Besancon, Clermont Ferrand, Rennes, Dijon and Reims. Additional equipment will also be supplied to studios at Strasbourg, Nice and Ajaccio, Corsica.

Radio Monte Carlo has ordered a switching matrix and two custom-built *UPS 4000* series sound mixing consoles from Enertec for the master control room of its Paris studio.

Enertec is to equip the 'La Voix du Zaire' Kinshasa broadcasting complex with equipment for 18 radio studios, a master control centre, four TV studios and several film studios including an overdub and post-synch studio.

ADC audio connectors

A new range of low impedance audio connectors for broadcast and professional use has been released by ADC Products, a division of Magnetic Controls Company. The range consists of eight low impedance input and output 3-pin/contact connectors, electrically and mechanically designed to meet the EIA RS297 standard. The connectors offer high reliability, total interchangeability and complete compatibility with other audio connectors.

ADC Products, 4900 West 78th Street, Minneapolis, MN 55435, USA. Phone: (612) 835-6800. ▼

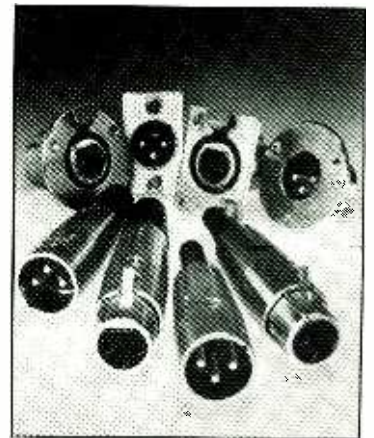

Nagra Servicing

Samuelson Film Service Ltd informs us that it is now offering servicing facilities on all types of Nagra tape recorders.

Samuelson Film Service Ltd, Samcine House, 303-315 Cricklewood Broadway, Edgware Road, London NW2 6PQ. Phone: 01-452 8090.

Music Laboratory

Music Laboratory, the well-known supplier of professional and semi-pro studio equipment, has just opened new premises at 72-74 Eversholt Street, London NW1 (Phone: 01-388 5392). The new premises have fully equipped demonstration showrooms and include service and hire departments. 26 ►

Four of the Best from Orban



Model 245E Stereo Synthesiser

Uses a unique and patented process to create a realistic and mono compatible synthesised stereo from a mono source.

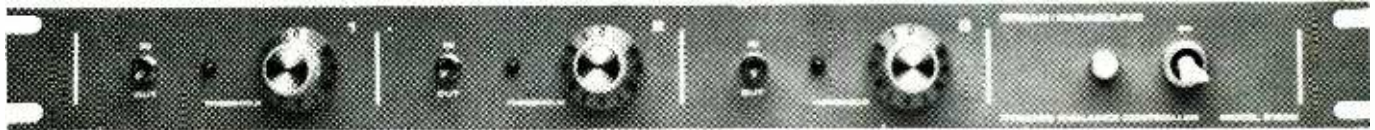

Model 516EC Dynamic Sibilance Controller

Three independent channels of easily adjusted and effective de-essing. Tracking automatically over a wide range of input signals.



NEW Model 622B Parametric Equaliser

Two channels of overlapping four band parametric equalisation with continuously variable tuning, equalisation level and bandwidth. 'Constant Q' rather than reciprocal equalisation curves for musically useful extremes of EQ.



NEW Model 418A Stereo Compressor/Limiter

Variable time-constant H.F. limiter section. Accurately ganged stereo controls. 'Programme controlled' attack and release times. Simple and sensible front-panel controls.

For full information or a demonstration of any of the Orban products, contact:

Scenic Sounds Equipment

97-99 Dean Street, London W1V 5RA. Telephone: 01-734 2812/3/4/5

Sweden: Tal & Ton Musik & Elektronik AB,
Kungsgatan 5, 411-19 Gothenburg Tel: 130 216

Chromatec TVD 100 series

Chromatec Video Products Pty has introduced a multichannel video monitoring system for recording industry use. Designed to accept up to 32 inputs and displaying the level of each channel in the form of a vertical bar graph, the units may be used as an alternative to PPM's in studio applications. The *TVD 100* instruments accept up to 32 channels at a sensitivity of +5V DC for full deflection of the vertical bar, with linear or logarithmic response being available (the latter being chosen for audio applications). Outputs from the basic instrument are R, G, B and Sync, for coupling to a suitable TV monitor. A standard PAL colour encoder can be supplied as an option to provide a composite video signal at 1V into 75Ω. Various additional modules are available for audio applications including peak program detectors to realise multichannel PPM, and a set of 1/3-octave filters to realise a realtime spectrum analyser. Other features, supplied as standard, are alphanumeric characters for labelling vertical and horizontal axes, an electronically generated graticule, two adjustable threshold levels where each bar changes colour to indicate under- or overload (red for overload, blue for underload) and a customer selectable pattern of colours for groups of bars to facilitate visual distinction of bars. Options currently available are input bridging transformers on each channel, pink noise generator and mic preamplifier for use in conjunction with the spectrum analyser, on-screen clock, and colour encoder.

World Procurement Service Pty Ltd, 10 Barley Mow Passage, Chiswick, London W4 4PH, UK. Phone: 01-994 6477.

Chromatec TVD 100

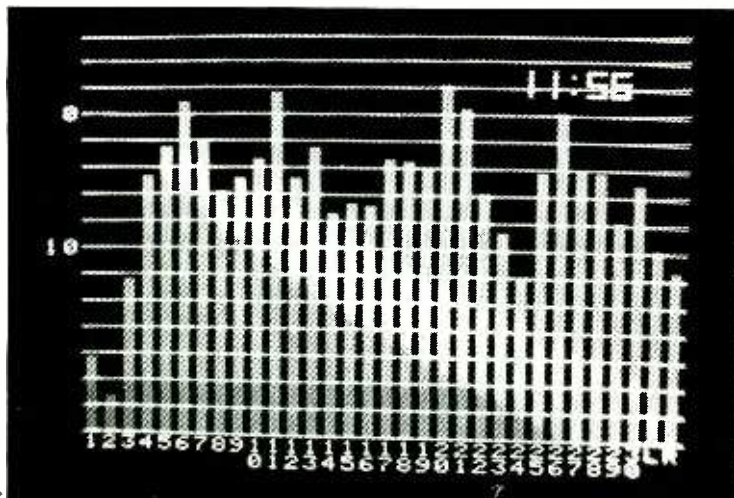

Klark Teknik analogue time processor

Klark Teknik has introduced the *DN34* analogue time processor, a versatile signal processing and special effects unit. The device features two independently controllable delay sections which are switchable to either parallel or serial configuration, allowing a variety of effects including true through zero tape flanging to be created. The two delay sections can be swept in either the same or opposite directions by a choice of three different sweep waveforms. Comprehensive 'on board' mixing and phase

reversal controls allow all effects to be created without wasting console facilities. A limiter prevents delay overload and regeneration 'take-off', and together with input and output level controls plus LED headroom indicator ensures optimum level match into almost any system. Quoted specifications include a dynamic range of better than 90dB, a time sweep range of 70:1, THD of less than 0.3%, and 0.4 to 52μs delay at 16kHz bandwidth.

Klark Teknik Research Ltd, Summerfield, Kidderminster, Worcs DY11 7RE, UK. Phone: 0562 64027.

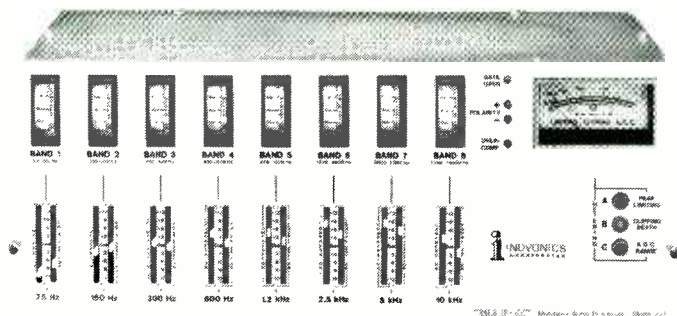

Inovonics multiband processor

Inovonics has introduced a new multiband audio processor, the *MAP-II*, designed to assure optimum transmitter modulation in AM and AM-stereo broadcast service. The

unit features a gated, gain-riding AGC amplifier to provide constant programme level and to erase long-term programme level variations; an eight-band open loop compressor section equipped with calibrated input and output controls, selectable high and low pass filters; an integrated peak controller with a low distortion peak limiter and a variable clipping circuit; a phase rotation circuit to provide positive modulation; and an optional accessory chassis permitting remote operation of the peak controller card for split studio/transmitter installations. Price of the *MAP-II* is \$1670.

Inovonics Inc, 503-B Vandell Way, Campbell, CA 95008, USA. Phone: (408) 374-8300.

New ITC cart machine

The high penetration of International Tapetronics cartridge machines in broadcasting studios has provided much feedback, and now ITC has introduced a new generation machine incorporating many novel features. Microprocessor control handles all logic, functions, digital cue tone

generation and detection, and also built-in frequency shift tone facilities for data purposes. A new cartridge positioning system assures rigid alignment of tape and head, mechanically latched solenoid with heat reduced from 24W to 6W and providing quicker release, less phase jitter, DC brushless motors generating only 24W of heat, ceramic shaft with polyurethane pressure roller, removable head assembly, solid aluminium tool deck plate, +26dBm output before clipping, meets new NAB equalisation, new playback head design with improved hum shielding, and numerous other improvements. An optional cartridge preparation system is available with automatic motorised azimuthing and erase. As before, the recording amplifier is separate with initially only a single transport available with a triple stack following in late 1979.

International Tapetronics Corp, 2425 South Main Street, Bloomington, Illinois 61701, USA.
UK: FWO Bauch Ltd, 49 Theobald Street, Boreham Wood, Herts WD6 4RZ. Phone: 01-953 0091.

Aphex improves Aural Exciter

Aphex has announced an improvement to its *Aural Exciter* with new electronics to increase the even-order harmonics and almost totally eliminate odd-order harmonics. Aphex also claims to have given the device greater headroom and greater dynamic range.

Aphex Systems Ltd, 7801 Melrose Avenue, Los Angeles, Cal 90046, USA. Phone: (213) 655-1411.

UK: Aphex Audio Systems UK Ltd, 35 Britannia Row, London N1 8QH. Phone: 01-359 0955.

Medium sized KLH

KLH has introduced a new medium-sized acoustic suspension loudspeaker model *CL-1*. The loudspeaker has a 203mm woofer and 63mm tweeter with a choice of veneer finishes and grille cover. Cabinet size is 533 x 305 x 222mm. Frequency range is quoted as 64Hz to 18kHz with a frequency response within ±2dB; sensitivity 90.5dB at 1m (1W pink noise); nominal impedance 8Ω (minimum 7Ω); crossover frequency 3kHz; and maximum power handling capacity 50W (minimum 8W). Suggested retail price is \$115.

KLH Research and Development Corp, 145 University Avenue, Westwood, Mass 02090, USA. Phone: (617) 326-8000.

**40 Channel Remix Console supplied recently
to Olympic Sound Studios, London.**

**The Series III De Luxe range of mixing console
represents a high quality versatile system. A fully
detailed colour brochure, including price lists, is
available direct from the factory or agents.**

AGENTS:

Canada
C.O.R.A. Inc.
131-18ème Rue, 1046 Quebec P.Q.,
Canada Tel. 418-522-1397

Denmark

Audiophil
Howitzei, 49-1, 2000 Copenhagen,
Denmark Tel. 134 1622

**Netherlands
& Belgium**

Pieter Bollen, Geluidstechniek bv,
Hastelweg 6, Eindhoven,
Holland. Tel. 40 512777/520662

South Africa

Prosound,
Elkam, Upper Level/Pretoria Street,
Hillbrow, Johannesburg 2001,
South Africa. Tel. 642-8721/1209

Spain

Telco Sociedad Limitada, Gravina 27
Madrid, Spain. Tel. 1 2317840

France

Reditec,
62-66 Rue Louis Ampère,
93330 Neuilly/Marne, France
Tel. 30 96 30

W. Germany

Elmus GmbH,
D1 Berlin 12,
Herderstrabe 16,
W. Germany. Tel. 030 312 20 12

U.S.A.

Chulista Service, Inc.
Kettering, Ohio (USA)
652 Glenbrook Road,
Glenbrook, Ohio 46906
Tel. (203) 348-9909

RAINDIRK LTD. - Downham Market Norfolk Tel. 03663-2165 Telex No. 817737

studio diary

Looking for Utopia - Try Regents Park!

Interested in zoo animals and canal barges, well try Regents Park! However, if you're looking for Utopia you probably wouldn't expect to find it in London NW1. But then you'd be wrong. Search out Chalcot Road and leading off it Spencer Court, a secluded village-like mews complex, and Utopia is yours.

Brainchild of Phil Wainman, producer, songwriter and owner of Utopia Records, Utopia Studios has been used by many top artists including Heatwave, Elton John, Queen, David Bowie, Justin Hayward and Ian Hunter.

A visit to the studios to meet Phil and look around soon convinced us why such well known artists liked Utopia. We were immediately impressed by the standard of construction and decor and were pleased to enter a friendly but businesslike atmosphere. Phil has a long history of successful involvement in the music business, starting as a professional drummer at the tender age of 15. He played with a number of bands including the Paramounts (with Robin Trower and Gary Brooker in the line-up) and has been a well respected session musician for many years. In association with Nicky Chinn, Mike Chapman and John Goodison, he has penned several top 20 hits and as a producer has been responsible for the chart success of bands such as The Sweet, the Bay City Rollers and Mud. With a track record like that and with an office wall covered with gold, silver and platinum discs (not ostentatiously done you understand, but there just to show that you're dealing with people who know what they're doing), it isn't surprising that Utopia exudes a quiet confidence.

We asked Phil how he came to set up Utopia. He explained that he had always hankered after being able to do things his own way. In early 1976 when he eventually, after years of thought, decided to put into action his pet project of designing and building Utopia Studios he decided to look for the best premises possible and then to work with architects to build a studio complex to the highest specification.

With these thoughts in mind he set to work on his present premises, in conjunction with the Eastlake design team, to produce a studio complex which he felt met his requirements. Tailoring his working experience with that of the Eastlake team he worked towards one aim—to produce one of the best studios available in the UK. As he says himself, "When I decided to set up



Utopia Studio

Utopia I decided that only the best would do. I wasn't prepared to compromise. After all if a thing is worth doing it's worth doing well. I set myself high standards deliberately because otherwise Utopia would be just another studio, that's not what I want. I want Utopia to be one of the best and that will always be my aim."

Utopia at present comprises a cutting room, Studio One (24-track) and Studio Two (16-track). In addition building work has just commenced on Phil's ex-office which will soon be a mixdown suite to relieve studio congestion, some of the equipment having already been purchased, and completion scheduled for February 1979.

Equipment in use by Utopia is of an excellent standard comprising a Neve 40/32 mixing desk with Studer A80 24-track recorder with Studer 2 and 4-track recorders in Studio One; an Amek 20/16 console with Studer A80 16-track (24-track head block) recorder with 2-track Studer B62 in Studio Two; and a Neumann console and VMS 70 lathe in the cutting room. The new mixdown room will have a 52 input Neve console with Necam automation and Studer A80 24-track.

As to ancillary equipment, this includes the usual selection of AKG, Neumann, Sennheiser and Shure microphones, Beyer DT100 headphones, Crown and Quad amplifiers, EMT reverberation plates, Ampex tape, Eastlake designed Gauss and Emilar loudspeakers together with Tannoy HPD's, and a variety of equalisers and comp/limiters. Musical instruments include Hammond, Hohner, Fender, Polymoog, Steinway and Yamaha models.

Before we took our leave, we sat in on a session with one of Phil's

record company signings, the UK Upstarts, a young Scottish group with an abundance of talent. Phil was having problems catching the snare drum sound he wanted. A change of snare later and Phil launched himself into a succession of drum solos whilst engineer Andy Jackson did the balancing. Drum rhythms filled the control room and Phil had caught that elusive sound he required.

We departed with a sobering thought in the back of our minds, Phil has recently acquired the lease of the remainder of Spencer Court, soon to be renamed Utopia Village! He has a number of plans for future expansion and among them is the possibility that he will enter the video field with plans for a superb video facility of the same high standard as the sound studios. If this happens, does this mean that Utopia becomes more utopian? We daren't speculate!

Noel Bell

The Town House Studios

Anyone passing by the erstwhile Goldhawk Studios on the corner of Godolphin Road and Goldhawk Road, can't fail to notice that much of the block, of which the former cutting rooms were a part, has recently been extravagantly redecorated and emblazoned 'The Town House Studios'—owned by Virgin Records. The transformation inside the building is even more impressive, but what attractions can yet another top-rate recording studio offer in an already highly saturated London market?

Technical boss Phil Newell immediately drew attention to the 32-track recorder in Studio 1 (a Telefunken *Magnetophon 15A*, which is a first in the UK. He also displayed an array of Ampex *ATR100s*, which, apart from fulfilling conventional stereo mastering functions, have alternative headblocks to provide an optional 4-track mastering and surroundsound crossfading capability. Studio 1 has a 40/32 Helios desk, while Studio 2 at present equipped with a 24-track Ampex *MM1200*, has a Solid State Logic console, also capable of 32-track operation. Both consoles provide automated mixing facilities, but whereas the Helios desk sports a traditional central monitor - mix section, the Solid State Logic offers the alternative of American style in-line ergonomics. The Eastlake monitors and an impressive array of auxiliary electronic gadgetry, complete the picture in the control rooms, while the studio areas offer a comprehensive selection of variable acoustics. A spectrum of materials from carpets and fabrics through wood, stone, mirrors and glass have been imaginatively employed in a flexible arrangement of separable studio

Helics custom-built console at Town House Studios



environments. There is even a subterranean ceramically tiled echo room.

Tape copying, editing and disc cutting facilities are also scheduled, but studio manager Barbara Cragges emphasised that the technical complex is only a part of the total concept, 'to provide a Manor Studios atmosphere in London,' hence the name (and Virgin's first London studio). The location was carefully chosen to avoid the aggro endemic in the prestigious, overcrowded and inaccessible West End. A TV lounge, a games room, and comfortable sleeping accommodation is available, not only for the artistes, but also for the inevitable retinue of roadies and wives, whilst an inhouse restaurant is currently under construction.

All in all Town House Studios seems to be a very cosy prospect.

Bill Aitken



Control room of Studio Seven

Studio Seven

In contrast to the 'big money—music only' status of recording studios scattered throughout the States, it is worthwhile to check in with something else . . . variety being the spice of life. So off I set determined to find the newest studio facility in Colorado—Studio Seven.

This is a modest 16-track room designed to specifications found in older, more established Reiddiger textbooks. The room is quite large, with many differing angles and an extremely high ceiling. As I moved about, I could readily detect a change in characteristics, in even the smallest of movements. When I brought these details to the attention of Soren Bredsdorff, resident designer and engineer, I was reminded that the room is used mostly for the production of soundtracks for radio commercial productions, and for film. And it was also called to my critical attention that Soren is a rather fastidious person when it comes to mic placement. Work done in the

studio was proof of that fact, though somewhat bottomy for the TV and NAB specs used throughout.

Reliable Ampex 440 series is used in the 16-track format and likewise for mastering in stereo and mono. 30 in/s is used at all times in lieu of any noise reduction. I did see much in the ancillary department with dbx compression, Eventide Harmonizer and so on—all in overhead mounting. JBL 4350's sat on floor mounts and thus added to the heavy bottom feel to the room. Tapes of my own production, done in London, were bass heavy and highs were all but lost—again, with their own tapes this effect was not so apparent. The console is of Soren's design, using much in the way of API components and design for logistics.

The attitude expressed by Soren is one of being careful in the selection of the work that they are prepared to perform. Hence, the room is great for multimedia presentations, radio and film—although I feel that Ivan Berg and his facility in Hampstead is more to the point. Don't get me wrong, this is not a bad room . . . it

is more specialised than others and you will find that Soren is a most talented and creative individual, certainly compensating for any deficiencies in the room that may have been caused by design, lack of funds, or both. David Clamage

His Master's Wheels

Forthcoming articles from the West Coast will be looking at new studios, the expansion of existing studios and studios of note, but this month I want to depart from the norm and mention briefly a studio which no longer exists . . . a salute to the passing of one of the West Coast's oldest and most well known studios—'His Master's Wheels' in San Francisco. Owned and operated by 'His Master' Elliot Mazer for the last five years, the studio finally closed its doors for good on September 30.

Located in a fairly ethnic quarter of San Francisco not far from the city centre, His Master's Wheels began life 12 to 15 years ago as 'Pacific High'. In those days it was a 4-track affair and although very basic by today's standards, produced some classics in rock history including Sly Stone's *Dance to the Music*, a couple of Santana albums and a Van Morrison radio show for KSAN (San Francisco's original FM progressive rock station).

Alembic took over the premises from Pacific High during the late Sixties and were responsible for the basic studio design which remained until last month. The 50ft x 48ft x 16ft studio was rendered acoustically non-symmetrical—a high arched ceiling was built (with a skylight—very rare to see daylight in a studio these days) with curved walls employing a lot of wood and glass. In fact the ceiling in the studio was probably one of the first-ever active ceilings—the forerunner of what so many studio designers are offering today.

The fully trapped and floating control room resulted in an overall

sound from His Master's Wheels that has been likened to studios such as Rampart and Abbey Road 2 in London—a big sound and ideal for rock 'n' roll. When Elliot Mazer took over, he brought with him the bulk of his previous mobile facility and to the last day much of the equipment was still on wheels. On its last working day, His Master's Wheels' arsenal of equipment included an Ampex MM1000 16-track, Ampex 351 2-track, Ampex MR70 2-track and 4-track, Studer B62, a 34/16 Neve console, Phase Linear amps, JBL and Altec monitors, MXR digital delay, stereo EMT plates, live Quad Chambers, ADR Vocal Stresser, ADR Scamp system, and UREI limiters—many housed permanently in flight cases ready for the road.

From there, His Master's Wheels proceeded to record some historic album projects, with Elliot producing in many cases. Such names as Barclay James Harvest, Frankie Miller, Gerry Garcia, the Grateful Dead, Juice Newton, The Dingoes, The Tubes, Buffe St Marie, Yesterday and Today, and Journey. Some of these projects were completed using a remote truck—a case in point being *The Last Waltz* (a very successful film of The Band's last concert) in which a large proportion of His Master's Wheels was carted off to a film sound stage for the concert recording.

It was during one of the final projects at His Master's Wheels (Journey's most recent album) that an inebriated producer let go with a fire extinguisher in the control room (so well was the session going). To cut a long story short—the chemical in the extinguisher apart from quelling flames also rots aluminium and it was five long months before His Master's Wheels wheels were rolling again; the Journey album of necessity being completed elsewhere.

It was after an experience like this together with his increasing involvement with the Stanford University Centre for Computer Research in Music and Acoustics (digital recording in other words) that Elliot Mazer decided to sell His Master's Wheels. Unfortunately, at the time of writing, it does not look as if the new owner will be continuing in the tradition of recording but possibly antiques? So San Francisco has lost one of its original studios—one that helped shape the 'San Francisco Sound' of the Sixties and early Seventies.

Elliot Mazer continues in his capacity as a producer using other independent studios and also with his research into digital recording—for both these he saved a flight case full of signal processing equipment from the sale of His Master's Wheels. His MXR Digital Delay Lines, ADR Vocal Stresser and Scamp system: with these he has all the signal processing he's ever likely to need all in one box. Enbee

Effective wood finish to walls of Studio Seven

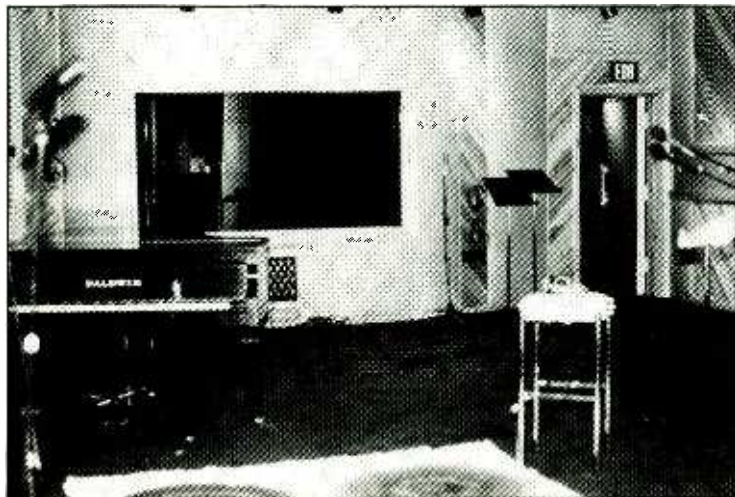

IF YOU NEED JACKFIELDS WHY NOT TALK TO THE SPECIALISTS?

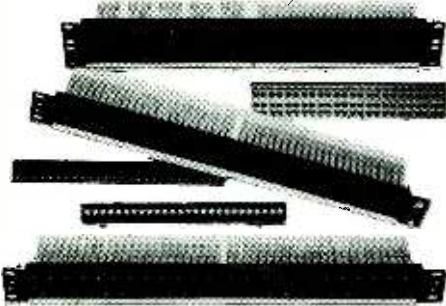

PANELS AND ASSEMBLIES

No supplier offers a wider range of panels, inserts and accessories for just about any configuration. And you can get them in any stage of assembly... individual components, sub-assemblies, or complete pre-wired and connectorised assemblies ready to install. Our Bantam range gives a space saving of up to 50 per cent.

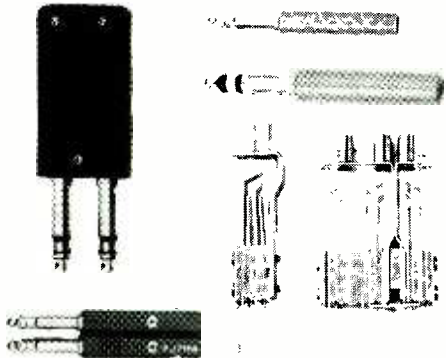

JACKS AND PLUGS

Singles, twins, back-to-back, 2+1, patch and switchboard cords, in long frame and Bantam, and our new Printed Circuit Board Jacks. Most standard types are available for immediate off-the-shelf delivery.

For further information on these and our range of B.P.O. type components, telephone or send the attached below to:

C.A.E. LIMITED

70/82 Akeman Street, Tring, Herts.
HP23 6AJ
Tel. (044 282) 4011 Telex: 82362 BATECO G

Please send us copy of current catalogue
NAME
COMPANY
POSITION..... Tel.....
ADDRESS

Commercial radio

Dear Sir, We have read with interest Tony Attwood's article on Commercial Radio in Britain.

In his second article (November 1978) he highlights the wide diversity to be found in Independent Local Radio stations and comments "that ways in which the studios and control rooms have been put together vary enormously...". He is, however, wrong in saying that this is in spite of the IBA issuing an exact specification for the equipment.

The IBA is charged under the Act of Parliament with ensuring that high technical standards are maintained and it performs this duty partly by laying down in its Code of Practice minimum performance standards for studio systems. We are careful, however, not to specify particular types of equipment. This choice is left entirely to individual stations.

Yours faithfully, Alan James, Independent Broadcasting Authority, Crawley Court, Winchester, Hants SO21 2QA.

Amplifier reviews

Dear Sir, It has been brought to my notice over recent months that there is considerable variation in the objectivity of equipment reviews in professional magazines such as *Studio Sound*. In a letter to *Wireless World* published in the August issue, Gordon King makes reference to the fact in the following way: "... even if it were possible to be subjectively sure that one amplifier produces a different sound from another there are no universally proclaimed adjectives suitable for describing the differences. Consequently, and as so clearly demonstrated by Reg Williamson (in his letter October 77) a whole range of often highly ambiguous adjectives is brought into play. Real damage can then result to a manufacturer, designer or company which is so totally out of scale with the real performance of the equipment. A small firm could easily end up in *Queer Street* from a solitary, opinionated judgement.

It is true that the nature of a review and the positive or negative bias applied to it can significantly influence the subsequent magnitude of sales. Conversely, a rave review given to a piece of equipment which is relatively poor in design and engineering could have just as grave consequences on competing manufacturers of similar type and price equipment but of superior design and engineering."

He ends his letter: "... little wonder, then, that manufacturers and distributors are beginning to look in detail at the reviewers who will be handling their equipment before submitting it to the magazines".

In *Studio Sound* editions of March 1977, August 1978 and September 1978, a total of nine amplifiers have been reviewed. In these reviews the question of overshoot has been dealt with by photographs of oscillograms. In the textual description various words have been used to describe the overshoot. Taking the degree of overshoot as a percentage of the overall waveform we find that whilst 35% is described as 'excessive', 34% is 'fairly substantial' or 'significant', 38% is 'fairly large' and 30% is only described as 'a certain amount' or 'some'.

May I make a plea for reviewers to evaluate all parameters by means of percentages or other mathematical means which cannot be misinterpreted rather than by adjectives which may appear to be subjective.

May I also ask if it is possible for all reproduced charts to use the same mathematical scale relationships, even if for reasons of layout of the printed page, the same physical size cannot be used. If it

is easy for the professional to be misled from a casual comparison of one chart with another in a different issue, how much more would the non-professional be influenced?

Yours faithfully, Peter J. Moody, Professional Marketing Services, 15 Greenfield Close, Stapleford, Cambridge.

Hugh Ford replies. It has recently become fashionable to attack reviewers of audio equipment and no doubt readers have read some of the correspondence in other publications; rest assured there is more to come! It may come as a surprise to Mr Moody that I am in complete agreement with Gordon King's comments and amongst others, Gordon King and myself are Members of the Association of Professional Audio & Radio Consultants, the aim of which is to promote professional engineering standards to reviewing and other matters.

So far as the comments about overshoot are concerned, it would appear that Mr Moody has been using a travelling microscope to come to his 34%, 35% etc. The difference between these in the reproduced photographs is only a fraction of a millimetre. The whole point in reproducing the photographs is for readers to make their own judgements of overshoot and ringing; a matter which Mr Moody carefully ignores.

Taking two examples of overshoot, fig 1 was described by me as 'mild overshoot with minimal ringing' and fig 2 as 'severe ringing'—just how can these be reasonably described in terms of 'percentages or other mathematical means'? How do you describe the quality of winding of a tape machine in these terms? How do you describe quality of engineering? You then go on to ask for 'all reproduced charts to use the same mathematical scale relationships'. Just how do you show fractional decibel errors in frequency response on the same scale as harmonic distortion which may be 80dB down rising with frequency to 40dB down?

Perhaps Mr Moody might put his own camp in order. I have in front of me a specification bearing his name with abbreviations kHz and KHz, v and V, w and W on the same page. In addition there is w instead of W and v/us instead of V/us. Come on Mr Moody, if you really want to help the cause, *Studio Sound* would like to print a glossary of audio terminology which you might prepare.

Frank Zappa live

Dear Sir, Your article on Frank Zappa and his equipment (September 78) mentioned the many special effects used in the Zappa show—however, you mentioned his wireless guitar as being "much the same as many wireless mics". Please note that the wireless system with which Zappa experiences "no loss or degradation of signal, even at extreme ranges" is the Schaffer-Vega Diversity System, used by over 130 major stage acts. While there are indeed many wireless systems, often similar to one another, only the SVDS guarantees 100m of range with no dropouts or interference whatever. Only the SVDS is in use by any touring band (including the Rolling Stones, ELO, America, Fleetwood Mac, Aerosmith, Yes, and Black Sabbath).

Your article was complimentary to our wireless system in the extreme, and we felt it only fair that we be represented among the many manufacturers who supply performance equipment for Frank Zappa. Yours faithfully, Michael Stone, The Ken Schaffer Group, Inc, 10 East 49th Street, New York, NY 10017, USA.

 **Neve** supreme in sound

superior in multi-track music recording consoles

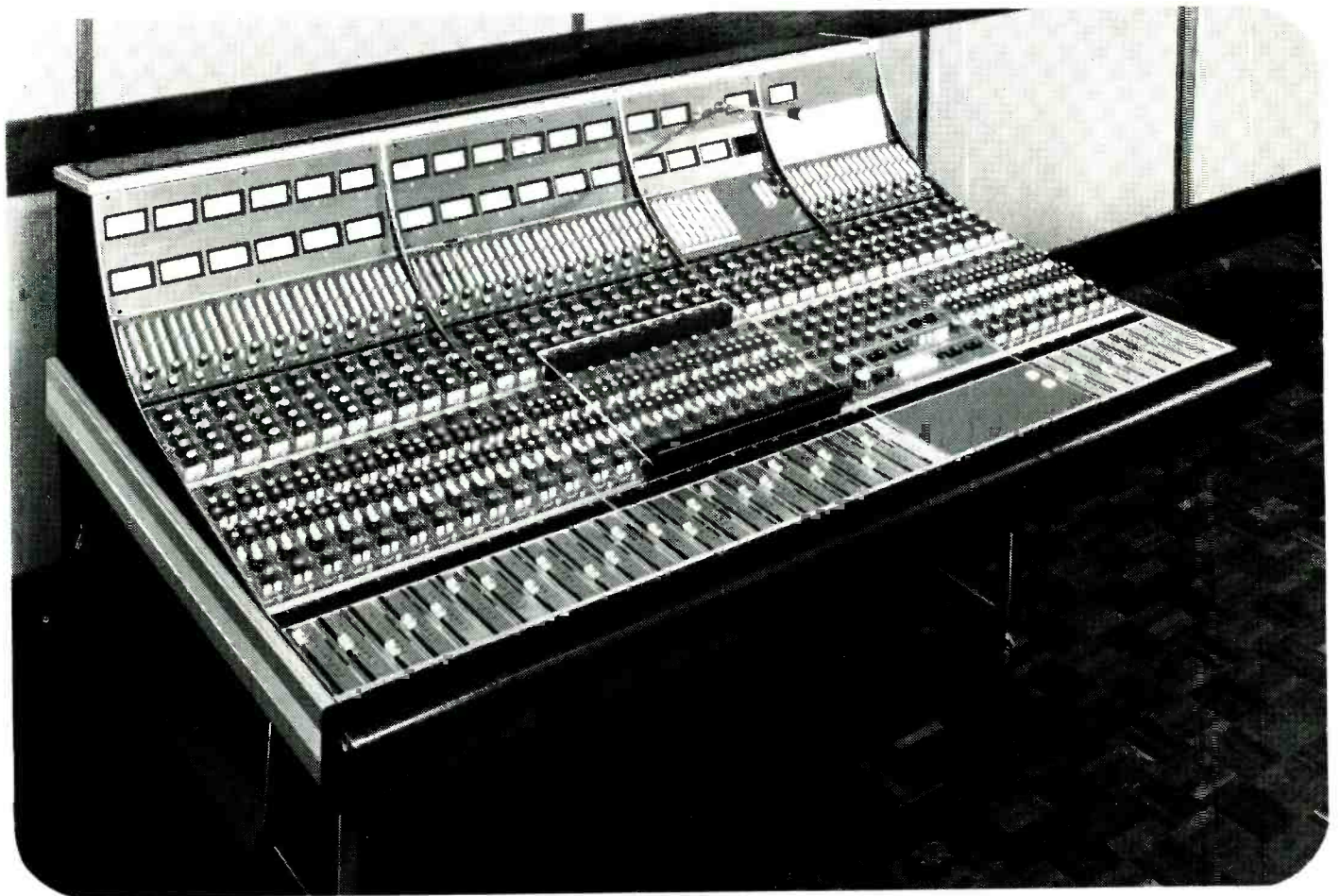

Neve multi-track recording consoles enjoy a worldwide reputation for their high standard of performance, reliability and operator convenience. Realistic price tags make them a good long term investment too.

MODELS INCLUDE:

The 8078 with 40 inputs and 32 tracks — probably the world's most sophisticated music recording console available as a standard item.

The 8068/8058 — 24 track consoles featuring a compact in-line layout.

The 8066 — an 8 or 16 track full facility console for the modest budget.

The 5315 with a versatile 4 track or stereo capability ideal for broadcast production and film use.

Neve Electronics Int. Ltd.,
Cambridge House, Melbourn, Royston, Herts SG8 6AU, England
Tel. Royston (0763) 60776 Telex 81381
Cables NEVE Cambridge.

Rupert Neve Inc.,
Berkshire Industrial Park, Bethel, Ct 06801 USA
Tel. (203) 744 6230. Telex 969638

Rupert Neve of Canada Ltd.,
2721 Rena Road, Malton, Ontario
Tel. 416 6776611. Telex 21 06 983502

Rupert Neve GmbH,
D-6100 Darmstadt, Bismarckstrasse 114, W. Germany
Tel 6151 87038 Telex 419581

Neve

Tonmeister degree course— a graduate's viewpoint

Tony Spath

Twenty-eight students have now graduated from the Tonmeister Degree Course offered by the University of Surrey. But has the course met its expectations and how do potential employers view it? Tony Spath, who graduated in 1977 and is now studio manager of Strawberry Recording Studios South, looks back.

UNLIKE MANY industries, sound recording has never made stipulations regarding academic qualifications for its employees short of 'a reasonable level of general education' as would be indicated by a number of GCE passes at 'O' level. Until recently a good pair of ears, a likeable personality and bags of enthusiasm were quite sufficient qualification for people who have since emerged as the very best of recording engineers. Nowadays, with autolocates and remote controls for just about everything, the trainee is no longer a tape operator but an assistant engineer and the responsibility particularly of recording a pop album becomes more and more that of the engineer. The main criterion of 'if it sounds good that's fine' still holds and obtaining the 'good sound' still requires a reasonable understanding and feel for the equipment being used. But with the recent and continuing increase in control room technology there is, to put it simply, a lot more to understand—increasingly an engineer is required to contribute musically as well, even if he is not officially concerned with the musical production. Consequently, with this increased responsibility and advancing control room technology, a higher standard of education and intelligence is now required from a trainee engineer, particularly musical ability and an interest in electronics in addition to his charismatic personality and wonderful ears. This as I see it is an important part of the background concept of the University of Surrey's course in Music and Recording for the Tonmeister degree. On paper the ideas make sense—the student is taught about recording through music, and by the technical 'how it works' approach. He also gains practical experience in recording, both in the University and in a commercial studio, and after four years receives the qualification

Bachelor of Music (Tonmeister). Obviously this does not mean he is immediately entitled to a job as an ace recording engineer, or even that he will ever make a success of that particular career, but it does emphasise his field of knowledge and intelligence.

To qualify for the Tonmeister course the student requires respectable 'A' level passes in music, physics and maths, a competent keyboard technique with the ability to sight-read a four-part score (say a simple string quartet), with a reasonable standard of performance on a solo instrument and an accurate musical ear. The subjects studied on the course are similarly diverse. Music is examined in a historical context as well as through detailed analysis of works, composers and their respective styles—there are also lectures in orchestration and score reading technique. This area of the course aims at a musical understanding with the accent on how and why a composer writes, and in particular the way he writes for, and uses, instruments—for example an engineer recording Schumann's *Fourth Symphony* needs to know how the sound must differ if the previous day he has been recording Brahms's *First Symphony*.

The scientific side consists of lectures in mathematics, electronics, acoustics, electro-acoustics and recording techniques—here the idea is that mathematics leads to an understanding of the hows and whys of such subjects as room acoustics, psycho-acoustics and musical acoustics, basic operational electronics, microphone theory and magnetic tape recording. Further to this, special lectures are given on particular areas within the industry by people who are themselves specialists. The principles on the face of it are indeed good—there is a small but professionally equipped studio including a 16/4 Neve console, two

stereo Studers, a 4-track Scully and a wide variety of other equipment where students learn for themselves the basics of recording through trial, experiment and, not too surprisingly, error. For the third year of the 4-year course, the students are normally expected to work in a professional studio or elsewhere in the industry. Studio time at the college and the requirement for industrial year places limit the annual intake of Tonmeisters to a maximum of eight.

Musically, I found the course excellent in its content as a forward-thinking music degree with interesting applications to classical recording. For example we would discuss and compare as a group the production, performance and recording techniques of several commercially available records of a single work, with continual reference to the musical score, to try to decide for ourselves how the producer and engineer had attempted to translate the conductor's interpretation onto disc, or indeed where they might have failed. On the other hand, Tonmeisters are encouraged to create new sounds themselves in the direction of electronic and synthesised music. However, I feel that the science area of the course needs some serious thought as to the subjects treated, and to the detail in which they are studied.

Before discussing this, it is worth considering just where the course is aiming. Among the newer universities in this country, there is a move towards degree courses that provide a practical training in specific vocational subjects as opposed to giving someone a degree which, for the purposes of any industry, puts an 'I can think' label on graduates. The Tonmeister course belongs certainly to the former, but must be viewed in perspective.

'It is not a kind of super engineers course, nor does it seek to replace any of the traditional modes of entry to studio employment,' to quote John Borwick (*Studio Sound*, March 1973). Unfortunately, due possibly to attitudes early on in the course, this is the opposite of the recording industries initial impression of 'the Tonmeister, which, true to the lasting qualities usually associated with first

impressions, is taking a long time to eradicate.

John Borwick, formerly senior lecturer on the course, puts the basis of the Tonmeister idea down to a suggestion from composer Arnold Schoenberg that a new music department at Chicago University should have classes for soundmen to be 'trained in music, acoustics, physics, mechanics and related fields to a degree enabling them to control and improve the sonority of recordings, radio broadcasts and sound films'. The implication is clearly that soundmen should be aided by a general education in the field of recording and the neighbouring areas of music technology. Again a sense of perspective is necessary in considering what is and what is not useful knowledge. For example, being able to derive the reverberation time in a live room, T , in terms of its volume V , wall area S and various absorption coefficients and constants (α , m & k) as

$$T = \frac{kV}{\text{slog}_e \left(\frac{1}{1-\alpha} \right) + 4mV}$$

is of no practical use. Anyone wanting to use it merely looks it up and anyone making a location recording in a place new to him will learn all he wants to know about the acoustics by clapping his hands and listening to the sound decay at various points around the room. One of the most successful studio designers to date, Tom Hidley, works on past experience coupled with innovative ideas and experiments—common sense acoustics, not high level acoustic theory and mathematical derivations.

I would only envisage the unearthing of these equations (and there are many, many more) with reference to concert hall and lecture theatre construction—certainly not for creative sound engineering. Even so, a basic working knowledge of acoustics can be very helpful, particularly on location work—it is also very useful if you are involved with modifying an existing studio or the design of a new one as an engineer ultimately to work in the facility,

since you can at least talk to the designers on their own terms. Similarly electro-acoustics is heavily burdened with detailed theory, but here at least, the ideas and equations that emerge have some bearing on sound recording.

Understanding the mysterious concept of the decibel dB(V), dB(m), dBm or whatever, is very useful and an understanding of bias and how and why it relates to magnetic recording is also interesting although as I said heavy maths is not really necessary. Integrated with these subjects are laboratory sessions where accurate B & K test equipment may be used in a variety of practical applications such as control room frequency spectrum measurement and alignment, reverb time measurement, microphone calibration and so on. As in the use of the college control room, this equipment is used with minimal supervision enabling the student to experiment for himself and understand from first-hand experience and results.

Having stated my opinions as to the heavy mathematical approach to a lot of the technology in the course, I would like to suggest areas of study to replace subjects which I feel could be dropped, such as musical acoustics and vector analysis, both of which are relevant to the 'Physics with Musical Acoustics' course that has recently opened up at the university, but of little use to someone heading for the recording industry. Obviously it is very useful if an engineer knows the rudiments of maintenance and fault finding—if there is a fault somewhere, or part of the signal chain electronics goes down mid-session, considerable time can be saved if he knows where to look and is able to pinpoint the fault. Fixing it is not so immediately important as this can be done by a maintenance guy in studio down time or on the work bench but what is important is that the engineer can find a way round the problem, permanent or temporary, so that the momentum of the session is not lost.

Another area lacking in the Tonmeister course, is to do with psychology—how to approach the session. A few lectures in this sort of psychology would not go amiss and could easily be incorporated into the course before the industrial stage, thus removing some of the burden from the studios concerned. As an alternative to these, a more detailed electronics option should be open to students of technical inclination, giving tuition in new studio technologies such as computers, micro-processors and digital techniques in general. There is a real shortage of true maintenance engineers sympathetic with the sound recordist's job (as can be seen from the number of studios advertising for just this type of person), and the Surrey course could help alleviate this shortage.

Ideas like these would not be difficult to incorporate in the course, but it is really down to the students themselves—there are only eight per year and if the guys are single minded in what they want from the lectures, the system is flexible enough (with a little persuasion!) to accommodate changes. For example, my year altered the industrial stage from six to 12 months, and rearranged the lectures and course structure accordingly.

Tonmeister graduates from Surrey first appeared in the summer of 1974 although the industry's initial impression came in 1973 with the first industrial stage. With the graduation of six students this summer, the number of Tonmeister graduates will



be 28; so what sort of impression has the industry gathered from the Tonmeisters presently at large? This is rightly the only way anyone is going to judge the merits or otherwise of the course, which puts the onus very much on the individual and the impression he creates of himself—a bad impression will not only close doors for him but could possibly make things difficult for future Tonmeisters (in fact one or two guys have found it advantageous to keep quiet about their degree). Graduates at present in industry are employed in a wide range of fields; in the studio as full-time engineers, freelance producers, engineers, musicians and arrangers, as well as in

broadcasting, marketing of associated products (mics etc) and design electronics—oh yes, and one farmer!

From my year of five students (graduated 1977) we have a freelance producer, a freelance arranger/publisher, a studio manager/engineer, another studio engineer and a designer in computers, with each of us working in fields first opened up in our industrial stage. Clearly this is a very important part of the course and indeed provides an important starting point in one's career and making useful contacts on a personal level with people in the industry. Criticism is due here on the system of industrial year placement and how it is organised. Its importance should not be understressed, and no one

three sugars, all about not verbally treading on clients' toes, six months or so as an assistant engineer and the remainder as a useful engineer—and then he leaves. This is always going to be a problem with the course and to my mind there are few ways around it—possibly the course could move its industrial stage to year four, swopping with the present final year of lectures. Degrees would be awarded after the student has submitted an extended industrial year report along with the project/dissertation and portfolio of his best recordings that he currently submits during the existing final year. The advantage to the studio is that here is an assistant engineer with above average technical and musical groundings, and who could usefully stay on as an engineer on completion of his degree. The disadvantage to the course is that after an initiation period, industrial year places could become thin on the ground as studios fill their vacancies with a Tonmeister undergraduate and then employ the same guy fulltime on graduation and thus close a potential industrial stage place; yet I'm sure that if the scheme were successful, other studios would be keen to try it out.

The only alternative system seems to be one along the lines of that employed at present—a studio employs consecutive third-year Tonmeisters such that as one completes his year there, the vacancy is filled with an incoming student. The success of the latter depends very much on the studio accepting that it is taking part (for the initial weeks at any rate) in the student's educational training, as well as on the student fitting in, and getting on, thus preserving the job for future Tonmeisters. Again the fate of the course is in the hands of today's undergraduates; however, it is good to see Tonmeister industrial stages being pursued in hitherto virgin studios—if you'll pardon the expression.

As part of my final year project as a Tonmeister, I chose to visit some of the industry's more prominent people to ask them their opinions of, amongst other things, the Tonmeister course at Surrey, and the qualities they considered important in today's recording engineer and how, or indeed if, the one touched upon the other. I spoke to engineers, producers, studio managers and musicians in pop, classical and broadcasting applications, and general impressions of the course seemed favourable yet with specific reservations in every case. Some people were concerned that an intelligent graduate would possibly object to leaving university at 22 to start at the bottom making the inevitable tea for engineers younger than himself. Others levelled the criticism that as the course contains

should consider missing it out to take what becomes a 3-year academic course as I believe is now possible—those who bypass it are missing both the valuable studio experience and the chance to correlate their knowledge with today's recording practices.

Placing a 20-year-old with a good musical ear and experience, familiarity with the technicalities of recording and an albeit basic first-hand knowledge of recording techniques would not be difficult were the studio not being asked to commit itself to the temporary employment and education of a student—an unknown quantity. From the studio's point of view, the guy spends the first weeks learning the ropes, who has

Tonmeister degree course—a graduate's viewpoint

a high proportion of recording technology and associated science theory, the graduates would be inclined to put the production of a technically correct recording before anything else. Naturally in any recording the technical side is secondary to the musical content and sound quality—the end result is what matters, knowledge of technicalities being no more than an aid to achieving it.

Tonmeisters seem to polarise into two groups, one of which is musical with varying degrees of 'acquaintance' with the technical side, the other being the exact opposite; it is significant that the much larger 'musical' group have found their way into engineering and production, whilst the latter are working in electronic design and computing. A similar criticism was that the course is a classically based music degree, whereas the bread and butter of the music industry lies in pop music and its recording—perhaps more attention could be paid to this before a student begins his year's work in a studio. As well as being of practical use, this may also dispel any outward signs of disdain a classically inclined student may have for the pop world.

This touches on the strongest criticism of Tonmeisters; the question of psychology. Admittedly psychology is one of those things that anyone going into a new job must learn about before too many disasters happen, especially as I mentioned earlier with someone from a closed academic environment such as a university. But how much easier it would be, both for students and employees, if the Tonmeister training studio at Guildford was used to examine the recording session further than getting a good sound onto tape. Talking to performers is an art in itself, especially via a talkback system to a possibly unsighted studio. A classical engineer made a more specific point when talking about score reading. An engineer needs to be able to use a score like a map to follow 'musical landmarks' and of course as a reference for editing—he does not need to hear it in his head in the same way a conductor or musician would. However, he does need to be able to ascertain information about the scoring, internal balance and sonority required for his recording; and if he is not familiar with the piece he must be able to tie it in with a similar piece that he

does know just by glancing through the score. I am talking here about the difference required in approach to balancing say the Schumann symphony as opposed to the Brahms, as I mentioned earlier. Certainly any Tonmeister would be well aware of this.

These points bring me to what must be the biggest misjudgement of the Tonmeister degree course and its organisation. It is academically and practically aimed at producing a musician who is to be musically and technically responsible for a classical recording (ie a producer/engineer), making decisions as to sound quality, performance, final balance and takes to be edited. This is the German idea of the Tonmeister and in practice it does not work. The unanimous opinion of the industry in this country is that on a classical recording session with even the most conservative multitrack technique, there is simply too much for one person to think about to effect as good a recording as two or more people working together could under the same circumstances. The engineer's area of responsibility must be the sound quality and balance as well as coping with the technical restrictions of tape recording, leaving the producer to listen closely to the music and able to continually refer to the score. With pop music, however, things can be very different—in a creative over-

dub situation where a song is recorded layer by layer and where the sound and often the music is created and evolved within the studio, a producer/engineer can have a close and constructive relationship with the musicians obviating the need for a third party. There is still a lot to make decisions on technically and musically, yet it is far more suited to the scope of one operator than the recording of classical music. Paradoxically only two out of the 28 Tonmeisters have worked on commercial classical sessions.

Overall my feelings about the course, though mixed, are that for someone aiming for the sound recording industry it can provide a good background knowledge and an understanding of the related technical and musical fields that would otherwise be hard to accrue. As I have said there are new areas the course should look into, and others which it rather tends to go too far on—in defence of such Sebastian Forbes (music lecturer at Guildford) maintains that on the face of it, it is still an academic qualification and that learning something for its own sake and for furthering personal knowledge is not a bad thing. Fair enough, but sooner or later someone has to decide as to whether or not the Tonmeister course is to become a white elephant on precisely this point. ■

ITC -the first name in cartridge machines

ITC's engineers are acutely aware that broadcasters need cartridge machines which are both simple to use and ruggedly made. That's why the baseplate of every deck is hewn from a half-inch thick slab of toughened aluminium. All sub-assemblies are plugable (not hard wired), thus dismantling and service is rapid and simple.

The 3D reproducer contains three independent decks, driven by a common direct-drive thick-shaft motor. The pressure roller assembly utilises ITC's innovative air-damped solenoid via a chain and sprocket linkage for fast, reliable and above all, quiet operation.

You can order the 3D as a mono or stereo machine, with single or additional secondary and tertiary cue tones. By adding the WRA Series Recording Amplifier, the bottom deck of the 3D can also function as a complete recorder/reproducer.

Discover for yourself why ITC have won the respect of numerous broadcasting studios on both sides of the Atlantic.

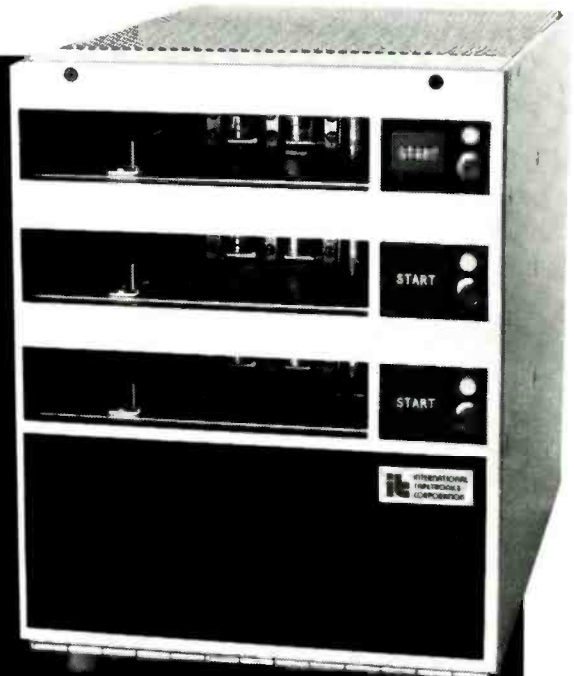

F.W.O. Bauch Limited,

49 Theobald Street, Boreham Wood,
Herts WD6 4RZ
Telephone: 01-953 0091

You always perform better with the right equipment

With Neal Ferrograph you get the right equipment for the job, and the best in its class. A good formula for success, of which you can be assured every time you choose from the fully - integrated range of specialist recording and ancillary equipment in the NEAL FERROGRAPH range.

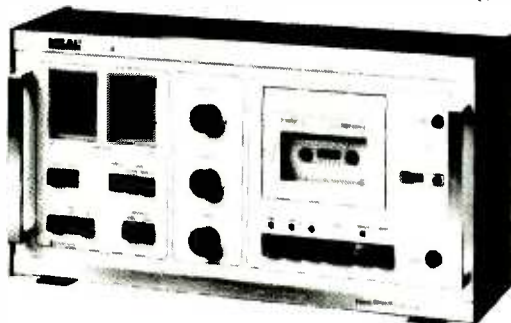

The NEAL 302.

Incorporating a 3-motor mechanism, controlled by a full solid state logic system actuated by ultra light touch buttons, this is the machine used by top recording studios and broadcasting stations, for quality cassette copies and for in - cassette duplication masters.

Studio 8

A professional studio tape recorder logic controlled for superb tape handling characteristics, offering a choice of stereo, twin track and full or half track mono heads, PPM or VU meters, IEC (CCIR) or NAB equalisation, console or transportable models.

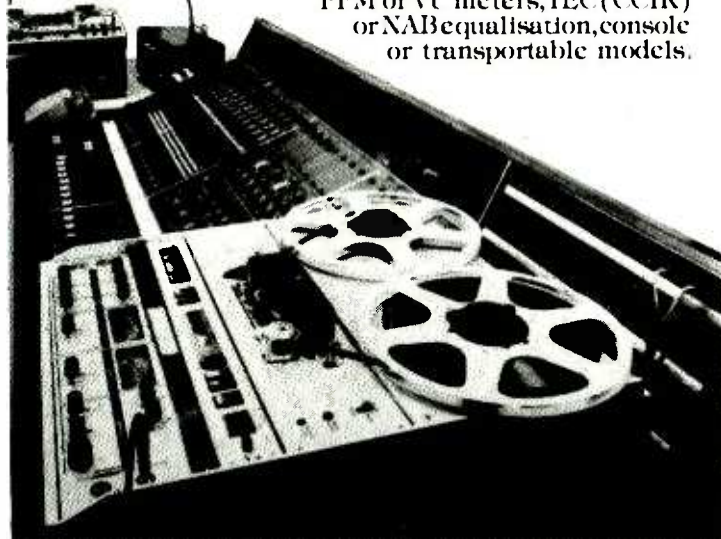

The Ferrograph Logic 7.

A transportable tape recorder of unrivalled facilities; taking all spool sizes up to 27 cm, and providing three speeds, plus positive action push buttons in association with logic circuits ... for fast, safe tape handling under all conditions.



The RTS 2.

Combines in one easy to use compact instrument the measurement of gain, noise, frequency response, input sensitivity, output power, distortion and the parameters relating to recording equipment, such as wow and flutter, crosstalk, drift and erasure. Its range of application can be extended even further by the addition of the Auxiliary Test Unit ATU 1.

NEAL FERROGRAPH
TOTAL TAPE TECHNOLOGY

SIMONSIDE WORKS · SOUTH SHIELDS · TYNE & WEAR NE34 9NX Telephone: SOUTH SHIELDS (0632) 566321 Telex: 537227

Insight into training

Noel Bell

An examination of what types of training courses are available, and the views of educationalists and the recording industry on training for studio engineers.

TRADITIONALLY, when the subject of training for recording engineers is brought up in conversation it arouses varying responses and passions from educationalists and people working within the recording industry. As I discovered whilst talking to both those who run the available courses and those who make use of them or employ students who have completed the training courses, the fact that we now have available a number of courses to aid training has made little difference to the general concepts both sides hold. To a large extent these concepts, whilst differing considerably in outlook at times, do have a great deal of common ground. Everyone concerned wishes to produce competent and experienced engineers with flexible, open minds and with good technical and operational training. Where they differ is over the means to achieve this aim and the value of the various areas covered in the courses.

Until the present decade, there were no courses as such designed to assist training; however in recent years a number have started becoming available. Whilst many engineers were, and still are, self-taught so to speak, rising from the tea boy/tape op stage to the handling of odd recording sessions before becoming fully fledged engineers, there are now a variety of opportunities and options available to gain acoustic and audio engineering knowledge outside the confines of the recording studio. Although these courses will not and cannot replace operational experience in the studio, as a foil to this experience the available courses can supplement and provide additional knowledge to that likely to be learnt in the studio. Whether this additional knowledge is considered to be relevant to the recording industry's needs is another matter which I will discuss later.

Before going into the semantics of the structure of courses, it would be as well to detail the types of courses

available. Tony Spath's article elsewhere in this issue gives an in-depth appreciation of the Tonmeister degree course at the University of Surrey. The Tonmeister course is an example of the comprehensive approach which the university academic structure creates. Encompassing both music (performance, sightreading and orchestration) and science (electronics, acoustics, electro-acoustics and recording techniques), the course if anything suffers from a degree of overkill. As an academic course it is excellent, but while many of its graduates have become full-time engineers, or freelance engineers and producers, its comprehensiveness and academic structure can lead to overqualification which creates problems when the graduate is faced with the prospect of making his way in the recording industry. Unfortunately due to the nature of the course, the prospect of Tonmeister graduates having to start from scratch with a studio when they should at least be considered to be assistant engineers is a prospect which neither recognises the training they have undertaken nor utilises them to the full. Although this situation generally does not arise, the creation of Tonmeisters has created an anachronism in the present training and employment system. This occurs because Tonmeisters, despite their 'industrial year', often spent in a recording studio, are outsiders—they are not employed full time by a studio learning the ropes, nor are they employed by studios with the facility of day release to follow a training course. Accordingly, they are as it were interlopers who having spent a year in a studio must return to university to complete their course prior to re-entering the recording industry.

The four-year Tonmeister course at the University of Surrey which is structured in the format of three years of academic study and practical work in the Tonmeister's 4-track studio with one year's practical

experience in the recording industry (the 'industrial year') in the third year has its counterparts overseas. In fact the concept of 'the Tonmeister' originated in Germany, building on a suggestion from composer Arnold Schoenberg for a new type of syllabus for a new music department course at Chicago University. The German Tonmeister courses, which are run in three places (Berlin, Detmold and Dusseldorf), last five years and are designed to train producer/engineers, in other words someone with overall control of a recording session. This objective, although usual in Europe, is in the eyes of the UK recording industry total heresy—the recording of sessions by a hybrid expert in both record engineering and record production is not the way we like to record. Whereas in Europe the producer/engineer tends to be the norm, we usually separate the functions of producer and engineer using two people instead of one. Hence, while this does not preclude the training of our producers and engineers in aspects of both fields, we tend to have our trainees specialise in one or the other. In view of this, the UK Tonmeister course tends to produce a wide spectrum of graduates, who find employment either in the electronics industry, or become arrangers, producers and engineers. By comparison the European Tonmeister is regarded as being too academic and hidebound, steeped in theory, and intent on producing technically correct recordings even though these recordings might be produced at the expense of the musical content. Flexibility and experienced initiative are the watchwords as far as the UK is concerned. No doubt the European retort to this view would be to state that by recording under the control of one person, the producer/engineer, they retain the overall concept of a recording throughout; but this is a complex question of recording attitudes which does not really concern us here.

In addition to the Tonmeister course in Germany, similar courses are run in Poland (Warsaw) and

Sweden. The comments which apply to the German courses in general also apply to these. With regard to overseas courses outside Europe, considerably foreshortened formats tend to be adopted. For example the Recording Arts and Sciences Institute of Canada in conjunction with Dawson College, one of Canada's largest colleges, have just introduced a course termed *Recording Arts* which in two years aims to train a student in the art, science and technology of recording. A third of the time is spent in a multitrack recording studio giving valuable practical experience, but perhaps the most interesting aspect of the course is that in line with the aforementioned UK industry view, the course is structured toward different career prospects within the recording industry—these being record producing, sound engineering, or record industry management. In view of this, it could be argued that since the world's recording industry tends to revolve around the output of North American and British studios (some would say is dominated by these studios to the detriment of others!) then perhaps we have got the career structure right. This is a questionable point which this article cannot answer as such since it owes more to product availability and record buying prejudices than anything else.

The structure of the Canadian course, laid out on the 'unit system', precludes any real overlap of expertise between the various recording industry careers, since the second year of the course aims students at specific careers. A glance at fig 1 which shows the course layout at Dawson College, illustrates this point. To a large extent this structured format represents a laudable aim since it appears to be fulfilling the requirements of the recording industry for specialists in particular fields; however it can be argued that the format is too structured by precluding any indepth cross-reference between the different fields. By comparison, for example, the UK Tonmeister course allows its students to specialise in the particular field which interests them most, but at the same

time ensures that the student is taught about, and receives experience if possible, in all aspects of the recording industry. This indepth approach which results from the fact that the student's degree qualification entails examination and assessment in all facets of the course, including assessment of practical work and a report on the 'industrial year', ensures a greater all-round knowledge which can open up a larger vista of career possibilities as well as giving valuable parallel career knowledge.

To return to overseas courses North America, apart from university and college music and acoustics based science degree courses, appears to thrive on the 'how to make a quick buck' approach. This perhaps explains why whilst there are a wide variety of courses available, almost all of them are short-term courses (the average length being about six weeks) which confidently inform the potential student that they will be able to do 'hands off' studio recording by the time they complete the course. This is not an approach which finds much credence elsewhere, but since there are several of these courses they must fulfil a need. Other than this approach, the best way of training is undoubtedly the 'foot in the door' technique of being taken on by a studio as tea boy/tape op and working your way up. However, for anyone who wants to train on a successful and reputable course, they need look no further than Al

Grundy's training course which is run in New York.

Away from the Tonmeister concept of training, there are a number of avenues which can be explored. Naturally there are other university degree courses which, whilst not directly aiming the student at the recording industry, can aid anyone wishing to make a career in the industry. In this country, as elsewhere, music degree courses can be of use; however, perhaps of greater interest are science courses which cover the fields of acoustics, electro-acoustics, and electronics. For example, The City University (London) and Southampton University both run science degree courses which include the study of relevant areas, in particular the study of acoustics. Yet another course of interest is the BSc course in *Electronic and Communications Engineering* run at The Polytechnic of North London. This is a three-year course mainly designed to train engineers for the electronics and communications industries; however, a number of the course's graduates have gone into the recording industry. This degree course has a one year part-time counterpart entitled *Sound Studios and Recording* which I will discuss later. The degree course at The Polytechnic of North London allows scientists to gain a wider view of sound and communications technology than is possible on the short course and aims to provide training which will be of use in advanced

development electronic engineering, teaching, research and broadcasting. As I have mentioned, a number of graduates from this course have gone into studios; however, it must be admitted that the course is more applicable to the studio maintenance engineer than the recording engineer.

Staying with The Polytechnic of North London, they also run several interesting short courses two of which (*Digital Techniques for Audio Engineering* and *PCM and Digital Transmission*) may well be of interest for future training needs in view of the recent moves toward digital studio recording. However, the course which interests us most is that on *Sound Studios and Recording*. This course, which is organised by Roger Driscoll (a name well known to many British sound buffs), is a part-time course of two hours a week which runs for three terms. It provides teaching on the fundamental principles of sound production, microphones, loudspeakers, acoustics, sound studios and OB equipment, disc and tape equipment, sound and noise limiting systems, simple principles of studio electronics, and acoustic standards and references. The course is aimed specifically at the young studio, broadcast or audio engineer who has no basic acoustics knowledge. No formal knowledge of any of the principles discussed is required although it is usually expected that students will be of A-level physics standard—however, exceptions are made to this

general prequalification depending upon the quality of the applicant. The course is usually oversubscribed and many of the students joining it are referred to it by the APRS and the AES. The basic aim is to fill the gap between the Tonmeister degree course and that of basic electronics courses such as those run at some technical colleges.

Mention of the APRS and AES brings in another avenue of training which can be explored. The APRS as well as referring potential students to relevant courses, also runs short courses itself. The most notable course being the technical course for studio engineers, managers and directors which is held each September at the University of Surrey. This course, now in its fifth year, lasts a week and covers all aspects of recording, including cassette duplication and disc cutting, and also includes a multitrack mixing session in a London recording studio. The course features lectures from approximately 20 visiting lecturers all of whom are experts in their field. The advantage of holding the course at the University of Surrey (in the university vacation period) is that accommodation, catering and instruction facilities including the Tonmeister studio are all available in one location, hence simplifying the course organisation.

In addition, the APRS run two courses held in March and April on basic instruction. These courses are extremely popular in the recording industry, this year's courses having had three times as many applications as there were places to be filled. Unfortunately, though the same cannot be said of the APRS weekend studio management course. This year's course due to take place in November had places for 20 people; however there was little response from the industry and the course had to be cancelled. Whether this represents a lack of interest in the industry, or whether it is a reflection on the content of the course, is difficult to say, but it does seem unfortunate to say the least to see an important aspect of training at the top level seemingly being ignored.

Beyond the accredited courses run specifically for the recording industry, there are a number of other ways of receiving the necessary training. For example the City and Guilds courses in technical electronics can prove of great use. However, undoubtedly one of the best methods of receiving training is by being employed by the BBC. Although the BBC trains engineers specifically for its own purposes, many of its trainees having left the BBC move across into the recording industry. It is therefore of interest to examine the type of training which the BBC gives its recording engineers. To get the view of the BBC on training I

FIG.1 STRUCTURE OF DAWSON COLLEGE 'RECORDING ARTS' COURSE

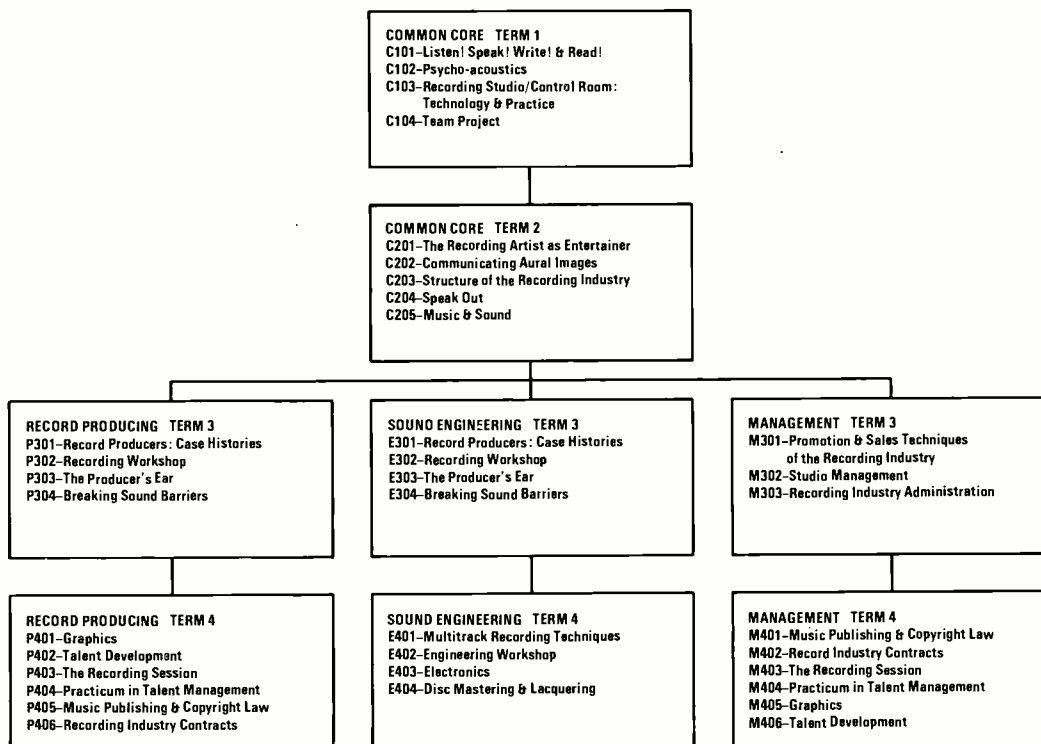

Insight into training

spoke to John Brooks of the BBC's engineering training section at Wood Norton. John explained that the BBC consider that it takes roughly three years to train a recording engineer, this time being taken up by two residential courses lasting some 20 weeks plus the acquisition of experience whilst in the job. With regard to the actual courses these were, he said, 'not an exercise in physics', the BBC like to take a broad view—anyone who was being trained as a control room operator, he considered, had to be given an overall view of all aspects involved and not only those pertaining solely to his or her own function. Essentially the BBC break training down into three areas—source origination and equipment (disc, tape, and microphone), including the use of editing; the principles and operation of control desks; and finally continuity, the bringing together of everything required to achieve the smooth running of a programme.

Obviously, broadcasting has its own format which the BBC training programme must cater for, but the general principles are of interest. In particular the need to take a broad view and John's view that what he looks for in a potential engineer is programme sense, a wide range of interests, and an ability to deal with people, is a view which finds much support, especially from the educationalists. It is a stimulating point as to whether specialisation and training for just one job function should be encouraged, but before I come to this there are two other forms of training which must be mentioned.

In addition to training its own personnel the BBC also train overseas students, usually students from the developing or 'third world' countries. This is accomplished either through sponsorship by the Ministry of Overseas Development, through the British Council, or at the expense of the particular student's government or broadcasting organisation. Normally the main criteria observed for accepting an overseas student being that he or she is proficient in the English language and that the equipment they use in their home country is compatible with BBC equipment. The latter is necessary since there would be little point in training a student on equipment which he or she will probably never use or see again. An adjunct to the training of overseas students by the BBC in this country is the sending of BBC training personnel to other countries to advise on training or to help set up training centres in those countries.

One of the most usual methods of training to be a recording engineer, and perhaps the most important as

far as the number of people involved is concerned (which is why I have left it until last), is to be trained 'in-house' in a recording studio. To find out whether there was any particular structure to this 'in-house' training as a rule I spoke to Denny Bridges, operations manager at Air Recording Studios, London. The first question I asked was whether Air trained their personnel in the strictest sense of the word, ie whether they had a firm policy or format through which a new employee wishing to become a recording engineer was taken. The answer frankly and quite simply was 'No'. Denny explained: 'What we do when taking on a young chap who wants to be a recording engineer is to employ him as a tape op; we then breed our own engineers by slowly making them up to engineers. When we employ a tape op, what we look for is a potential engineer. Like all studios we get inundated with letters from youngsters or their parents, teachers, or whoever, who ask if we

have any vacancies, and that Joe Bloggs wants to be a recording engineer. Of course usually there's nothing we can do to help, in fact we've got letters going back nearly two years, all of which we keep and have answered, but generally there's little we can do that can be of any real help. When we do need someone then we look at quite a few people, try to assess their personalities, try to gauge their likely development, and look for potential. Whoever we choose we always take on three months probation. During this time what we look for is interest and curiosity, and at the end of the three months then we reassess the position. After this we have a problem between real and prospective time as to how long it takes to become a fully fledged recording engineer. I reckon it takes a tape op about two years in prospective time, but in real time it probably takes between four and six years to get to be a full engineer. For example, at Air we've got six full engineers and four tape operators, of which say two are quite capable of handling sessions. Also each year we have a Tonmeister

student as a second engineer. Really what it comes down to is a question of teamwork; if you all pull together then the youngsters learn and get experience.' I wondered if, since Air had no formal training structure, they utilised any part-time courses. The answer again was no, but Denny did add that Air's young technical engineers did go on ONC courses on day release. Speaking to Denny it did seem slightly unusual to me that Air didn't take advantage of any of the training courses which are available, but Air are perfectly happy with this arrangement.†

On my travels in recent months to recording studios (both large and small) while researching this article, I have made a point of asking how the recording industry regards the question of training. Everyone concerned recognised the importance of training, but no consensus as to how it should be carried out emerged. It would seem that an attitude of 'each to his own' operates. When I visited Morgan Recording Studios recently, I discussed the question of training with Jack Davies, the chief engineer. Jack has been in the industry for many years and is well respected, therefore I felt I could ask him how he had seen training develop in his time in the industry. I asked him firstly what types of training he felt were most useful. Jack replied that the BBC's training gave a good grounding, the part-time course at the Polytechnic of North London was good, and that the Tonmeister course was very good.

I then asked Jack what he looks for in a potential recording engineer. This he felt really fell into three areas—past history, experience, and temperament. Like all the people in the industry I talked to, he felt that it was difficult to find the right sort of person. What he looked for was somebody with natural talent, someone who combines an electronic and mechanical background, in fact someone who is a bit of a rare bird. If a young person, he wanted to know what they had been doing at school and whether they had any hobbies which had leanings toward their intended career. This early period he felt was very important since in his experience natural talent for the job usually manifests itself whilst still at school. If someone comes to him who as a schoolboy built his own amplifier, for example, or modifies his own equipment, or plays around with domestic tape equipment, even if any of these things weren't done successfully, then Jack is interested because then he knows he has found someone with an enquiring mind who has the necessary interest. With regard to experience, this he felt really comes with the job, even if the trainee is only a tape op, and is the only way to learn about professional recording

Tonmeister student learns the ropes



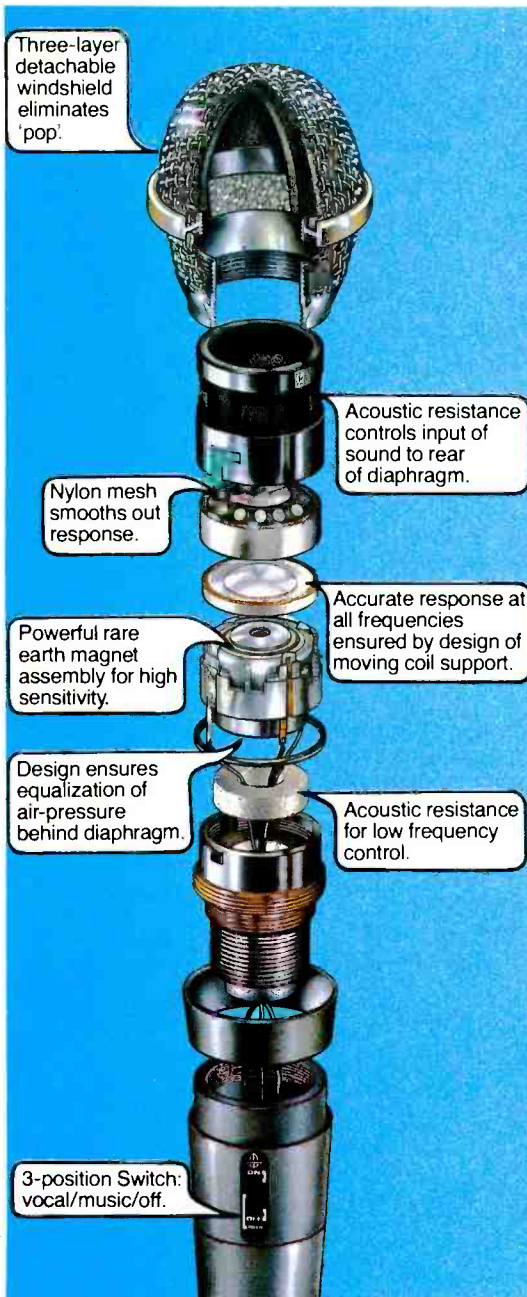

NINE REASONS WHY THE EAGLE PRO M90 MIKE COSTS A LITTLE MORE THAN ITS NEAREST COMPETITOR

A tough cardioid mike for stage use. Voice or music. Indoors or out. Really good feedback control and an amazing 40 to 16000 Hz frequency response. A mike that will never let you down.

That's why real professionals use it.

Fifty available for a month's free trial. Tell us who you are and where you're playing. First come, first served.

Microphones: **EAGLE**



- Please send me full details of all Eagle Microphones
- Please send me a PRO M90 on a month's free trial

Name: _____

Address: _____

Name of Band/group etc where appropriate: _____

Next performance at: _____ Date: _____

EAGLE INTERNATIONAL Precision Centre, Heather Park Drive, Wembley, Middlesex HA0 1SU Phone: 01-902 8832

SS2

Insight into training

machines and studio equipment and its limitations. In addition he also believed that it was the only way to learn studio working methods—such as overdubbing, or how to get different effects using different equipment for certain instruments. Temperament was usually evident in the personality of a trainee and he looks for the ability to work under pressure without getting flustered, tact in approaching the client if for example there was a breakdown of equipment, technical knowledge to either repair or bypass the breakdown, in fact a man of many parts. In addition Jack wanted trainees with enquiring minds, a love of the unexpected, flexibility since nothing is sacred or cut and dried when it comes to recording, an involvement in the work and perhaps above all dedication. Dedication he felt was very important since without it he could see no trainee succeeding. An attitude of 'work comes first' he felt was a necessary evil even if it meant working unsocial hours. An unfortunate side effect of this though was, he felt, the number of marriage break-ups which this dedication tended to cause.

With regard to the types of courses available, Jack commented that he felt there were insufficient courses available catering for the kind of electronics knowledge of use to recording studios. Technical colleges he felt generally provided nothing more than the basics; in fact the same he felt could be said of university science courses. The part-time North London Polytechnic course he felt filled a gap, but it was really only of use if the student were working in a studio. As to the APRS courses he felt these could only be considered as being a reinforcement to existing knowledge. Accordingly, Jack thought that the Tonmeister course was the best course the UK had for training. However, Jack did wonder if the UK recording industry warranted a large number of courses since the industry is still rather small and they are already deluged with people who want to become recording engineers.

Having ascertained the views of the recording industry on training, I spoke to Roger Driscoll of The North London Polytechnic and John Borwick of the University of Surrey (who conceived the Tonmeister course) to see if there were any differences in attitude toward training from the educationalists point of view. Roger Driscoll in particular was very forthright in his views on this subject; however, before reaching that point, I asked Roger what the aim of his part-time course was. Essentially Roger felt the aim was to cater for people who wished to add further specialised principles in sound

and audio engineering to their experience. This required, he felt, involvement and commitment from the student as well as the lecturer. For studios who were very conscious of 'in-house' training he thought it was better to leave the training to them, but he was pleased to see that many studios made use of his course, sending students to him on day release.

With regard to training, Roger felt he had a responsibility to students from the industry to make them more aware and accordingly he wondered if the industry itself was not too intent on pointing students towards particular job roles. Roger's view on this was that since recording engineers had to be in command of the recording situation, it was important that the management and development of trainees was geared toward making them confident and self-sufficient. What the trainee needed to feel was a sense of achievement and curiosity. As an example of what he feels tends to happen, Roger said he had recently been talking to a 24-year-old engineer who was the top recording engineer at a small studio. He had progressed well, was earning well, had good qualifications and plenty of experience, but he could see no rewarding future for himself. What he wanted to do was to develop his career and to do this he needed greater technical knowledge. To achieve this he was prepared to move to a larger studio and if necessary start at the bottom of the ladder again, rather than stay at the top in the small studio. This for Roger was a sad comment on the recording industry since through not training properly in the first place, this person would have to virtually start from scratch again. Roger lays the blame for this type of situation squarely at the feet of studio management and very forthrightly described the majority of them as being 'a motley lot, interested only in slave labour, with no interest in training, and with no knowledge of how to train!'

Roger's view of the role of studios in training was very critical. He felt that they did not encourage curiosity and initiative, that they did not offer enough encouragement anyway, and that they should allow the trainee more time to reveal his abilities. In fact Roger felt that studios should expect less specifically from a trainee, unless they are prepared to give them the attention they deserve. In addition he feels that the majority of studios fail to acknowledge their responsibilities in training and therefore had to broaden their horizons, as otherwise they would not receive the loyalty and support of their employees. On the specific point of training for a job role, he felt

educationalists had to take a wider view than studio management. Studios must understand this and hopefully agree, since it was not possible to provide in detail a course which any given studio might require. Educationalists, he felt, had to take a broad view encouraging initiative, liberality and progress, both socially and technically. It was not just a matter of providing a trainee with the tools for the job.

I asked Roger what his ideal course for training would be. His view was that it would be similar to the Tonmeister course, but that it would be more open ended with less teaching of formal classical music knowledge and less emphasis on pure physics. Instead of these facets of the Tonmeister course, he would include more training in music appreciation, and would include greater opportunities for gaining recording experience at a practical level. Above all, he felt any course would have to have as one of its main aims the encouragement of initiative with more liberalised qualifications than the present Tonmeister requirements.

Turning to the views of John Borwick, I found a striking similarity in his general views on training to those of Roger Driscoll. Whilst John was not as forthright or critical as Roger, he did feel that the only way the recording industry would be able to improve the status of the recording engineer was through education. The most unfortunate aspect of training for the industry was, he stated, the complete lack of any effort on the part of the industry to get together to produce a syllabus for recording engineers which was similar to that operated through the City and Guilds courses for technical engineers. Training was accordingly very much a hit or miss affair as far as studios were concerned.

An interesting point which John raised was that many equipment manufacturers found problems regarding training when installing new equipment in studios. If they delivered, for example, a new console they might often be asked to train the studio personnel in the operation of the new desk. Unfortunately very few have the facilities to do this, in which case who trains the personnel? For some companies, with every desk they sell they really need to sell the services of a training manager for say two months with it, but this doesn't happen. In view of this, John feels that without the training courses which exist, the recording industry would find it difficult to operate efficiently as there would be a lack of knowledge to get round problems of this sort.

John felt there was 'a touch of sour grapes from those in the industry who didn't have the present training opportunities'. Because of this there was to some extent an in-built aversion to giving training its due

place in the industry. With regard to his own Tonmeister course, attitudes were changing and the industry was becoming more appreciative; however, he still came across negative viewpoints. In answer to these John only replies: 'Why shouldn't the no man's land between music and electronics have a successful course, since as long as you ensure the training is good and relevant, then we are fulfilling a need'.

Throughout my conversations with people within the recording industry, it has become clear that the industry collectively has no clear idea of exactly what it wants in the way of training. Different companies tend to do their own thing and the educationalists tend to do their own thing. Although there is a partial meeting of the ways between the two, there does not appear to be any move toward rationalising training. Everyone I have spoken to feels that as techniques and equipment become more complex, something needs to be done. The problem is the means by which technical, electronic, acoustic and music knowledge is related to the need for practical experience. Perhaps the answer would be to promote an equivalent to the City and Guilds courses in technical electronics aimed at a studio based day release orientated format. Alternatively perhaps an elongated version of the Canadian 'Recording Arts' course might be the answer.

Despite the interest and concern which came across in my conversations, no single body seemed to possess the initiative or willpower to collectively promote, discuss and produce a course either full-time or day release which will fill the needs of the industry. Perhaps everyone is perfectly happy with the way things are now; however, I think not. Maybe *Studio Sound* should play a bigger part in training. After all, much of the material we print, especially the technical articles, is of educational use in training (and used as handouts on the APRS courses!). However, without practical experience and the opportunity to experiment, these articles can only be of limited use. I can't help feeling that if the recording industry were to alter its outlook toward training by investing not only in equipment but also training (after all what is the use of new equipment if it is being inefficiently used), there would be dividends for the industry. Whilst I agree that the recording industry is to a large extent an ad hoc meeting of minds, concepts and techniques, surely it would not be too difficult to produce a rationalised and agreed training structure. If this were to take place then not only would the industry be bettering its facilities, but also it would have the personnel to make the best possible use of the increasingly complex equipment now on the market. ■

It takes Nakamichi to release the true exuberance of your music.

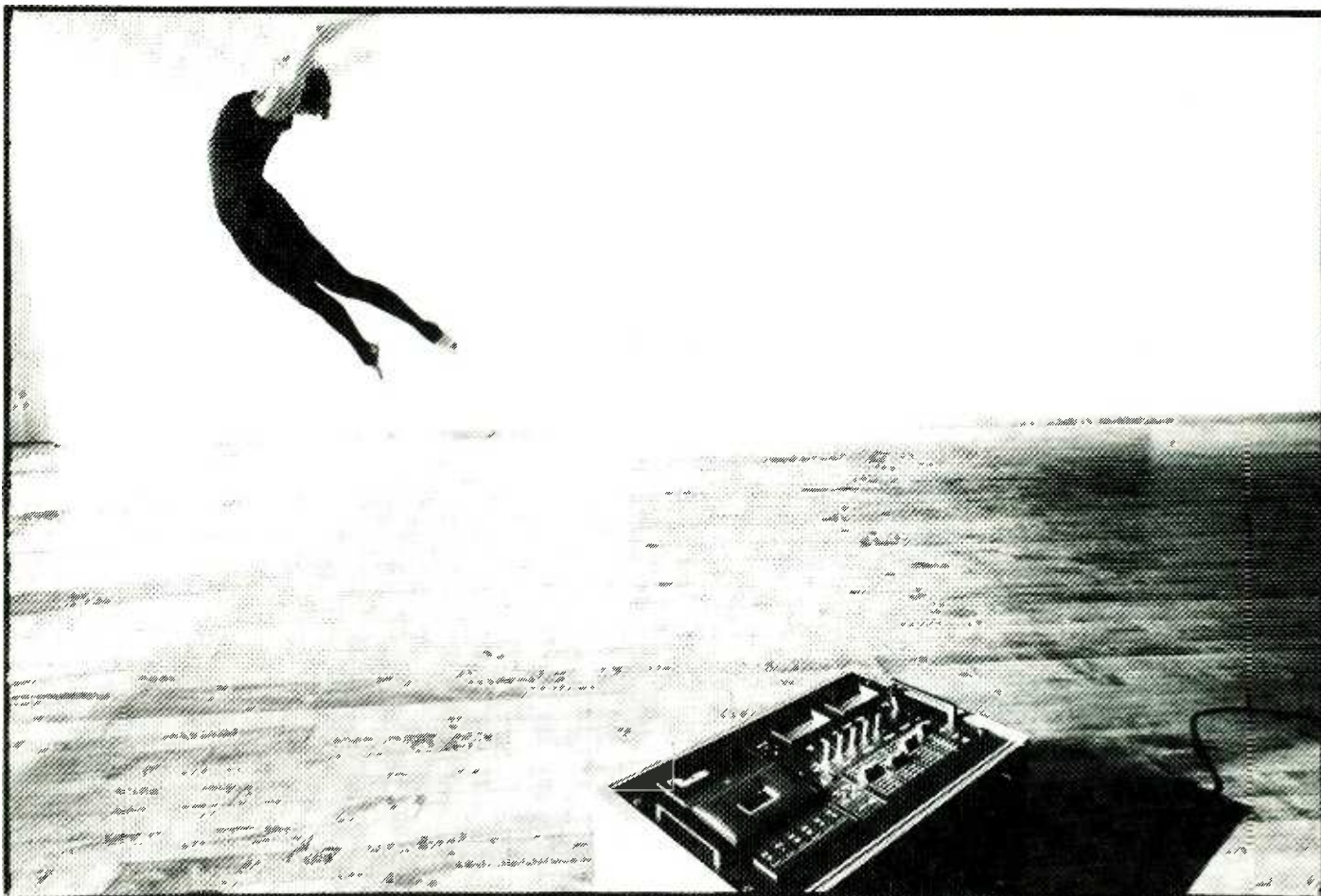

Each piece of music you play is a stream of emotion

It takes much more than an impressive array of features and numbers to realise their depth and power

The technology that can is unique to Nakamichi.

Technology of the kind that produced the most advanced and accurate cassette deck in existence.

The 1000 11.

And it takes courage and vision to risk doing the unconventional. To aim to release those subtleties and passions

Nakamichi risk it

And succeed.

Write for more information to
Natural Sound Systems Ltd, 10 Byron Road,
Wealdstone, Harrow, Middlesex HA3 7TL.

 **Nakamichi**

Products of unusual creativity and competence.

Cinemas and film sound

CINEMAS ARE now discovering sound for the third time round—and twisting their knickers in the process. Discovery number one was in the late Twenties. Between 1900 and 1927 there were around 60 experimental sound film shorts or sequences made with a variety of film sound systems. So the *Jazz Singer* was by no means the first sound film but it was the first sound film to capture the public's imagination. In 1927, there were over 300, mainly features. Discovery number two was in 1952/3 when *Cinerama* and magnetic stripe sound tracks unleashed surround-sound stereo on cinema audiences. Now with *A Star is Born*, *Star Wars* and *Close Encounters*, the cinema has discovered Dolby stereo as a practical way of laying two optical sound tracks down the side of a film in the width normally occupied by one.

Blumlein not only first suggested the double track idea, but actually made optical stereo test films at EMI Hayes way back in the mid 1930s. But Blumlein didn't have the benefits of noise reduction and suffered from the perennial inventors' problem—he was working and thinking several decades ahead of his time. Dolby Labs are in many respects taking over where Blumlein left off. Noise reduction encoding cuts down the hiss which is present on all optical tracks and is inevitably increased by splitting the mono track into two discrete halves with a land inbetween. Dolby has also tackled the problem of deriving a stable mono centre image for all dialogue while music and effects spread wide across the screen and even out around the cinema in surround fashion. All this is from the basic stereo optical pair and I note that patents are now being issued on these developments. Film makers have now increased scope for using sound to dramatic effect and the overall improvement in audio quality available from encoding and reducing equalisation has encouraged anyone making a musical film to go Dolby. This is where some knickers have developed a twist.

Up until recently cinema sound systems were designed along guide lines laid down in the late Thirties, and never radically rethought. When a cinema is equipped with Dolby encoding equipment in the box, the whole sound chain is ideally (but not in practice always) equalised to flatten out the overall characteristic. This improves the quality of reproduction but not the quantity. The sad truth is that most cinema sound systems are grossly underpowered. More accurately they are underpowered for what is now expected of them. The kind of sound levels for which films like *Star Wars*, *Close Encounters*, *A Star is Born* and more recently *The Last Waltz* and *Grease* are intended, are higher than anyone would ever have dreamed of just a few years ago. Some copies of *The Last Waltz* are even marked 'play this film loud'. To project a film like *Grease* at low level would be to invite a riot from the audience. But to play these films as loud as the producers and the audience want is just too much for many sound systems. Even after Dolby conversion, some of the very large and major West End first run theatres still rely on power amps rated at 40W per channel and dating back at least ten years. The bass drivers behind the screen may well have a 25W rating! When the wick is turned up two things happen, as sure as night follows day. The amps clip horribly and speaker cones blow out. I went to two press screenings for *Star Wars* and on each occasion heard the characteristically nasty buzzing

sound of a blown cone before the end of the film. The same thing happened recently at a press show for *Grease* and when the National Film Theatre showed *The Last Waltz*, the first ten minutes or so were shown at screamingly unpleasant level. The sound then dropped by around 10dB and fluctuated like a yo-yo for the rest of the screening to the accompaniment of a tell-tale cone buzz. Wouldn't it be cheaper for cinemas to uprate their sound systems than go round after every high level screening replacing blown cones? And are cinema managers a peculiar breed unable to hear the sound of an amplifier clipping?

Fortunately there are a few cinemas presumably run by non-deaf managers who have grown tired of replacing blown cones, and who have made a move in the right direction. For instance several London Odeons now have Altec bass bins rated at 150W to replace the 25W originals. The London Pavilion in Piccadilly Circus, for many years a cinema that I actively avoided for its terrible sound, saw the light and re-equipped before showing *The Last Waltz* in Dolby stereo.

Incidentally an interesting anomaly has arisen over films like *The Last Waltz* and *Grease*. Because the original picture *negative* contains the Dolby logo as a credit, it appears on every print that is ever screened. But by no means every print screened is a Dolby print and by no means every cinema is Dolby equipped. So don't take too much notice of the Dolby logo. Trust your ears not your eyes. That NFT screening of *The Last Waltz* was for instance mono, non-Dolby. The print of *Grease* screened at the press show was a 70mm non-Dolby copy even though both the screen credits and the printed hand-out referred to 'Sound by Dolby system'!

Radio Trent

IT IS NO secret in the broadcasting business that progress for Radio Trent, the Nottingham ILR station, has not been smooth. Trent launched in 1975 with the slogan 'sounds like you want to hear' but when the station contract became due for its first roll in 1976, the IBA deferred a decision. In July 1977, after keeping Trent under 'especially close review' for a year, the Authority extended the contract for a further period up until the end of July 1979. Trent now has high hopes of further rolls without special review. The station can point to market research which shows them to be number one in the area, have the ear sometime during the week of one out of every two members of the local population, and also to have been responsible for half the total national increase in ILR listeners over the last year.

The IBA's concern over Trent stemmed from very poor industrial relations inside the station and the national publicity that they received. Suffice it to say that the station is now into its third programme controller and fourth news editor! As a result of the most recent shuffles the programme format is changing, especially in the 4pm to 8pm period, with a move towards a more magazine approach. The avowed aim is to mix music with coverage of lighter local news in depth. Like what? Like stories that may or may not reach the local paper. Local lad keeps poisonous snakes in his bedroom, and that kind of thing. Phone-ins will be cut down even further with Nottingham locals now having even

less chance than before to ride boring hobby horses on the air. 'Provincial not parochial' and 'Nottingham based but not Nottingham biased' is the way the station sees itself.

Certainly Trent is enterprising. The station recently joined with a local hifi dealer to stage an audio exhibition at the Albany Hotel. Despite initial problems with lost Post Office land lines and missing musicians, they did a creditable job with live broadcasts and concert recordings for instance of a local college chamber orchestra, for later transmission. Less lovely was the disco system Trent booked for the exhibition party. Arguments raged in the bar on whether THD was 45% or 50%.

The Trent DJs and engineers are clearly an enthusiastic team but will need more backup from their bureaucracy if the station is to survive. Before visiting Nottingham I phoned Trent twice and wrote to them twice to set up a studio visit on behalf of *Studio Sound*. In neutral terms it was not a rewarding experience. 'We have no press officer or publicity officer' I was told and shunted around in ever decreasing circles to nowhere. 'What's IRN?' and 'How do you spell Studio Sound?' were a couple of nice quotes picked up en route. Calls weren't returned, letters weren't replied to and promised publicity bumph never arrived. Being a persistent sort I persevered, and turned up uninvited in Nottingham and finally made personal contact with the helpful grass roots staff running the exhibition OB operation. If the Trent management is interested in a smooth roll next time round they would do well to check out their input links from the outside world. Who knows, next time it might be an IBA rep, not just a hack journalist, showing an interest in the station.

To Litz, or not to Litz?

CURRENTLY SOME sectors of the audio fraternity are excited about special connecting cables for loudspeakers. These are of the Litz type with the coils wound in braid fashion to offer low inductance as well as low resistance. For as yet unspecified and unproven reasons, these cables are supposed to improve on a loudspeaker sound. Because they are even more expensive than the heavy copper, cooker-capable mains cable of low resistance that many people use to connect loudspeakers, a few points are worth bearing in mind. First, audio frequency signal wavelengths are literally many miles long. So it's worth stopping to think just how significant or insignificant induction effects may be at these wavelengths.

It's also worth noting that at least one amplifier manufacturer is now warning users not to use low inductance cables and disclaiming all guarantees if they do. The amplifier in question has no inductive components in the output stage, has a very wide bandwidth output and goes madly unstable and self-destructs in a puff of expensive smoke when confronted with low inductance cables. But, for me, by far the most significant pointer is a purely commercial one. One large British firm both makes and sells loudspeakers and imports and sells special loudspeaker connecting cables. At the recent Harrogate Audio Festival, the firm was demonstrating its full range of loudspeakers to the trade, press and public with connections made by guess what?—ordinary twisted flex!

ETEAP report from Paris

Jean Marandet

During October, L'Exposition des Techniques Electro-Acoustiques Professionnelles (ETEAP) took place in Paris. Jean Marandet attended.

FOR THE FIRST time in France (if we discount the ineffective AES show in 1977) a professional recording equipment exhibition was presented in the Sofitel Hotel on 3, 4 and 5 October, with 30 exhibitors on the ground floor and ten demo rooms on the mezzanine. Lectures also took place during the whole period.

Zéro VU, a new French language magazine dedicated to recording, and Soracitel, the French importer of Lyrec and Neve, were the main organisers with the help of several studio managers. It was a good opportunity for the few French manufacturers to present various, often complex, pieces of equipment.

Audio Help showed two types of mixing consoles, including an impressive *CS 3600* offering 24 to 40-inputs and 16 busses. Inputs have 4-band parametric eq, eight echo sends, and two auxiliary sends. Automation is optional, and the price is around £45,000. The other model was the *CS 2405* with 8 to 32-inputs, 16 busses, two echo sends, two aux sends and monitoring facilities up to 24-tracks.

Plus 30 presented a console offering 28 inputs and 24 busses for an attractive price (£16,000), and the *LC7600* level controller that claims an attack time below 50µs, a signal-to-noise ratio

greater than 80dB and distortion below 0.4%.

Freevox exhibited their excellent *2000 Series* consoles mainly intended for PA use (8 to 32 inputs and direct outputs, four main outputs). Prices came from £2,000 to £7,000. Also on show: 2 and 3-way active crossovers, power amplifiers and the ATC speaker range.

Girardin presented their small portable mixers for broadcast use.

Sonetec showed their *CM1243* (12 inputs, four outputs, three auxiliary sends) and *CM2044* consoles in strong flight cases. They are used by Radio-France.

Pyral, in addition to their well-known tapes, exhibited the *ASA3* $\frac{1}{3}$ -octave analyser with 28 filters, two independent memories and optional generators, at a price around £5,500.

Techniques Contemporaines, the importers of Racial Zonal, showed the *PE6* stereo parametric equaliser with 4 bands, balanced inputs and outputs. They also had a small console.

Puhllison displayed the *DHM83* harmoniser and stereo digital delay that claims to suppress artifacts, and the *CL20B* compressor/limiter.

Cabasse presented the *Cyclone* loudspeaker for PA use. It claims 106dB for 1W at 1m.

Fougerolle showed the *Picot 2000* magnetic per-

forated-tape recorder with monocapstan drive, without pinch roller, designed to be used as a master machine in automated systems with time-code editing (SMPTE/EBU) as well as in traditional film dubbing or postproduction theatres (price around £11,000).

A lot of other high quality gear was presented at the show for the first time in France, but they're no doubt well-known in other parts of the world.

In the demo rooms you could see, in operation, a **Neve 8068** console with *NECAM* system, a **Lyrec 5324** tape recorder, a **Studer A800**, a **Harrison 2824** with *Autoset*, the **Ampex** professional range (*MM1200*, *ATR100* and video recorder), a **Raindirk Series III** console, and a **Frident Fleximix**. The **Altec** and **JB**L ranges were also on display (an overpowering demonstration).

On the ground floor **Simplex** showed the enormous **Telefunken M15A** 32-track tape recorder.

3M exhibited the **Eventide** range, *dbx 150* series, and their tape recorders.

Ampex presented the new *ATR700* at a price around £1,200 (exc tax).

You could also see the **Schoeps**, **Neumann**, **UREI** and **EMT** ranges. By the last day, all the exhibitors were happy, mostly amazed at the success of the show. Foreign visitors were numerous (including **Studio Sound**) and we even saw people from Canada.

Those who didn't believe in this show will presumably pop up for the next—ETEAP 1979. ●

Below: Sonetec CM 1243 mixer.
Bottom: Audio Help CS 3600.

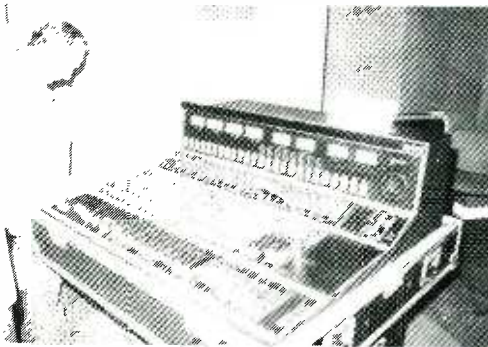

Techniques Contemporaines showing Racial Zonal tape and a range of small mixers.





The days of amplifiers with one distinctive sound are gone. It is no longer enough just to amplify; today's musicians need amplification systems which are versatile enough to adapt to any instrument, any musical environment.

Similarly the perfect mixing system is one which extends the performer's capabilities without being obtrusive.

In a field where quality and reliability are often sacrificed in the race for more advanced specifications,

Yamaha stand alone in offering a comprehensive range of amplification and mixing units which combine advanced technology and traditional craftsmanship.

When you choose Yamaha, you can be sure that the only sounds you hear are the ones you want.

 **YAMAHA**
Craftsmen to the world's
musicians since 1887.

Kemble/Yamaha, Mount Avenue, Bletchley, Milton Keynes Telephone 0908 717771

Birth of the two-track masterpiece. Otari MX5050-B

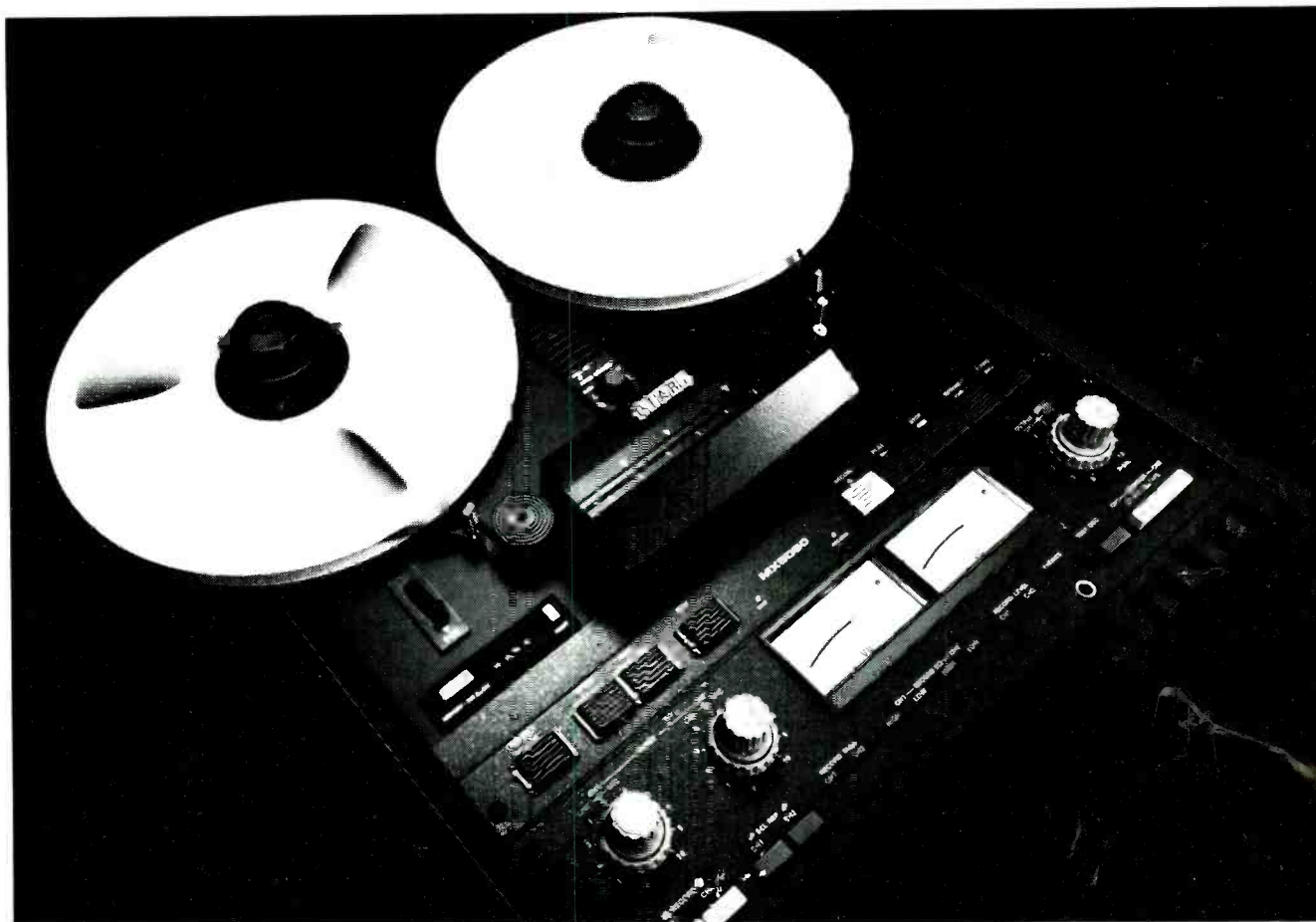

The new Otari two-track machine is designed for discriminating recordists. Built with inside-out improvements over our long succession of compact professional recorders. With built-in operation ease and better serviceability. With fidelity, reliability and professional functions indispensable for every critical application you have in mind.

DC-servo direct-drive for minimum wow/flutter and speed deviation. With $\pm 7\%$ pitch control for variable speed record and playback. Foolproof motion-sensing control logic. Optional remote control for all transport operating functions. Minimum -15dBm input and three calibrated switchable record levels of 185/250/320 nWb/m. 600 ohm $+4\text{dBm}$ or -10dBm switch-over output with XLR connectors. Front-panel edit and cue, test oscillator, stepless bias and IEC or NAB

equalization. Full professional four heads with four-track playback. And it's designed for both vertical and horizontal operation.

Resultant performance: click-free punch-in/punch-out mastering at 63dB S/N, 55



dB crosstalk and 70dB erase with 30Hz — 20kHz ($\pm 2\text{dB}$) response. It's the latest and wisest choice for your 15/7 $\frac{1}{2}$ ips masters. For the full story about the new generation recorder/reproducer, contact your nearest Otari distributor and see why we call it the masterpiece.

OTARI

U.K.: Industrial Tape Applications, London
Phone 724 2497

France: Redilec, Paris, Phone 300-9630

West Germany: Peter Struven GmbH, Hamburg
Phone 801028/29

Belgium: Trans European Music S.A., Brussels
Phone 569 1823

Italy: Exhito Italiana S.R.L., Monza
Phone 10391360021

Switzerland: Audio Bauer AG, Zurich
Phone 643230

Australia: Klarion Enterprises Proprietary Ltd.
South Melbourne, Phone 613801

Japan: Otari Electric Co., Ltd., 4-29-18 Minami Ogikubo,
Suginami-ku, Tokyo 167

Rumblings on mixers

Nick Franks and Graham Langley

Nick and Graham of Amek, a very small British mixing console manufacturer, describe below the reasoning behind the development of their latest automation capable console and make a few controversial observations of the mixer industry.

AMEK HAS just introduced a large VCA-assisted console, the M3000 which is our response to the demands of an expanding industry for consoles which can cope with the increasingly complex techniques of multitrack recording and the wider ambitions of musicians, engineers and producers. Our two basic ideas took into account that:

a) if the functions are more complex then actual operation should be simplified as far as possible in order not to detract from the engineer's attention to the sound and/or the producer;

b) circuitry performance be optimised so that deterioration of the signal quality should be prevented. The signal may have to be passed through the console several times before mix-down—in short, music must come first.

Of course no manufacturer producing such a console would claim other than the above, even minimally speaking, and we are not the first company to produce a desk in this automated generation. However by carefully assessing the state of existing desks, as we had done during the development of the existing M2000, we concluded as before that we had something to offer. At the end of 1976 when the M3000 was first projected, AMEK was virtually unknown and we had little reason to believe we could sell such a console.

The point of departure was the realisation that our initial attempt at building a viable multitrack system (the MS series) had failed in terms of appeal to studio owners and people making purchasing decisions—evidently it was necessary to have a drastic rethink. We decided to concentrate almost exclusively on the studio console market and noted that some British manufacturers were beginning to pay serious attention to the success of certain American console companies. We also observed the trend towards the need for more inputs and outputs, since the number of tracks in use was increasing.

One of the problems with the MS

series was that we had adopted the standard 'British' approach using a separate input and output/monitor section leading to prospects of problematic size. This of course is not to say that Messrs Neve and other famous British *marques* whom we respect were wrong, but that this was evidently not the correct approach for us to take. So on January 1, 1977, we decided to build an in-line, 16-buss console (the M2000) and show it at AES Paris at the beginning of March—in the interim period we made our first sale to Village Way Sounds in Harrow, who had great confidence in our abilities. We delivered the first desk on May 16.

The benefits of the in-line approach rapidly became obvious—the system is easier to produce, the console becomes more compact and much more cost effective in that there are fewer mechanical and electro-mechanical components involved. Our decision to produce the M2000 console was justified by sales success and the enthusiastic response of customers such as ABC Records in Los Angeles, particularly regarding, the acoustic transparency of the electronics and the musical sound of the equalisation.

This type of encouragement showed that we could compete with established *marques* with a product that offered significant ergonomic and performance advantages. So if it could be done at this level, then it were also possible upmarket.

During 1977 we supplied some small desks to Amazon Studios in Liverpool and suggested the M3000 for their projected 24-track facility. They accepted the proposal and in January 1978, we began designing in earnest.

Whatever the general approach adopted, it is always necessary to obtain as much user feedback as possible. A manufacturer might design a console from a point of view well suited to his construction ideals, but this may well not coincide with what is easiest to operate or service. So the designer must listen, not only to the sound of his electron-

ics, but also to the comments of the users and purchasers. Much energy was expended on design, discussion, redesign, further discussion, and asking the opinions of all and sundry who might have useful comments (and in as many countries as possible)—to get the broadest possible sample of ideas. In practical terms, a relatively small company cannot afford to invest in such a complex project and get it wrong—so we didn't.

The standard M3000 console is configured to 36-inputs offering simultaneous quad, stereo and mono mixes from 32 tracks, with DC subgrouping of VCA-assisted channel faders and echo returns. The main operational features include separate mic and two line amps; completely parametric, reciprocal curve 4-band equalisation with swept high and low pass filters; four mono and one stereo send each addressable to eight busses; quad monitoring; extensive monitoring and solo systems including in-place check (positional solo with positional echo); groupable and programmable muting; groupable in-place check; VCA faders with LED indications for VCA status, fader position in 'Read' mode, and nulling; 24-buss select switches with panning odd/even. The eight echo returns all feature VCA faders with attendant subgrouping advantages, quad panning and shelving equalisation; four returns also have buss selection.

Eight separate submaster faders allow control over subgroups being addressed by thumbwheel from the individual fader and submaster commands may be programmed along with other VCA information. Comprehensive studio and control room monitoring systems are provided along with oscillator and talkback facilities. Two independent stereo cue systems allow foldback from a selection of sources. A full jackfield is fitted, with 32-track reading VU meters, four reading quad mix, and two reading from a selection of sources. Later, we will introduce an optional LED ramp display.

Having described the general features of the console, there are some typical questions which must be dealt with before producing a 'standard' console of this type.

a) Quad mixdown or not? The utter failure of quadrphony is notable to say the least. Unlikely ever to be used and costly to install, the quad

buss and its attendant electronics must be provided. With the introduction of new technology, a third or fourth track may be required sometime in the future, but for the moment it is still a costly headache. But would you dare omit it on a console of this type?

b) Module construction. Some manufacturers are producing an all-embracing in/out module strip (we do in the M2000) but we chose to split the channel into three sections—routing module, centre module (in/out), fader block. Using this approach, if a desk is sold for a mix-down suite only, the studio doesn't have to pay for routing it will not use—a bank of compressors, for example, could conveniently fit in the same space. Likewise with the fader—suppose we developed a digital fader, a retrofit would be a simple matter.

c) How much equalisation? We assessed that engineers in general prefer to have the choice of having a facility and not using it rather than not having a choice at all so instead of providing adequate facilities needing outboard equalisers, we built a complete parametric equaliser, assuming that this would cover almost all requirements.

d) Number of busses—we decided on 24 busses guessing that 24-track users would be the largest contingent but we added eight direct assigns with the possibility of patching a mix buss into a tape track at the jackfield. When this is done, the monitoring on for example channel 29, will have the illusion that it is listening to mix buss 29 in the normal way. Having 32 buss selectors may be useful but begins to take up a large amount of space and if the desk is supplied for 46-track operation, another routing system altogether might have to be devised (digital?).

e) What size mainframe? Speed of delivery is helped by holding frames in stock since lead times on metal-work tend to be long. So we chose a 36-input standard frame with larger or smaller sizes to order. With eight returns, this should create no problem when used for 32-track mixdown. We further decided to locate auxiliary and monitor modules in the frame centre, making it easier for one man to operate the desk—a 36-frame is not unmanageable.

More Than Great Specs, Great Ideas.

For the past three years we've been telling you about the benefits of using graphic equalizers; now we've made it even easier to appreciate them. Introducing the MXR Dual Fifteen and Thirty-One Band Equalizers. Two equalizers designed with the imagination and understanding to solve your toughest equalization problems. Designed for use in either studios or sound reinforcement situations, our new eqs offer features not previously available at any price.

The Dual Fifteen Band Eq features two channels of equalization with the bands set two-thirds of an octave apart. By breaking the frequencies down further than conventional octave equalizers, you now have the flexibility to contour your music with much greater selectivity. As most musical information occurs in the midrange, this is where you need even more definition, and the Dual Fifteen Band Eq gives you six bands of contour in this area rather than the usual four. In addition, each channel has its own level control.

The Thirty-One Band Eq divides the frequency spectrum even further. A single channel unit, the Thirty-One Band features frequency bands set one-third of an octave apart, generally regarded to be the optimum amount of resolution.

When used in conjunction with any PA system, our equalizers can make a bad environment sound good, and a good performance sound great. Unlike parametric equalizers, the frequency response change is immediate and easily visible, so that when you shape a response curve you know what it's going to sound like.

Both units feature a range of -12 to +12 decibels on each band, standard 19" rack mount, and the rugged construction you always get with an MXR product. Both units also feature phone plug input/output connections, (the Thirty-One Band also features Cannon type XLRs), high slew rate (7V/microsecond), and incredibly low noise (better than -90 dBm). But not only do we offer great specifications, we produce great ideas... you wouldn't expect any less from us.

Atlantex Music Ltd., 16 High Street,
Graveley, Herts., England. (0438) 50113

MXR Professional
Products Group

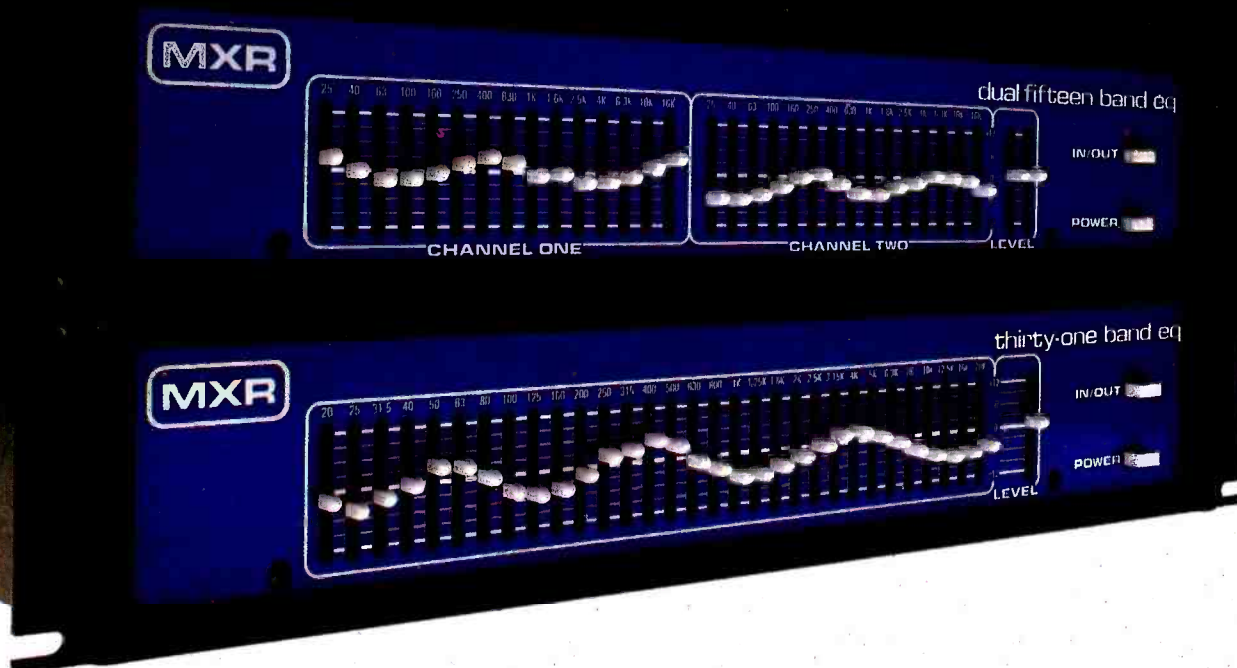

Rumblings on mixers

f) Reference level was also a matter for some discussion. American manufacturers in some cases work with a reference of -6dBV , which allows colossal headroom figures. We chose to refer to 0dBV (0.775V RMS) and offer a nominal headroom of $+24\text{dBV}$ over zero. The main disadvantage with referring to -6 is that signal-to-noise ratio will tend to be worse and, as we pointed out initially, if the signal must pass through the desk more than several times, optimum performance is a must. Most outboard equipment is referenced to 0dB and there could be interface problems if the jackfield, or part of the jackfield, is working at -6dBV .

g) Automation. The advantages of DC subgrouping are obvious and whether or not a computer is ever used, the grouping feature would make the extra cost of VCA faders worth the money. On the *M2000* we included an audio subgrouping system but in view of the obvious possibilities of computer assistance, we felt that a VCA system was a *sine qua non* for the *M3000*—in fact the automation is compatible with Allison or similar programmers. For those looking for more computer

power, we decided to have developed (by Advanced Music Systems) a more comprehensive system involving a floppy disc memory and synchronisation with tape via SMPTE code. This would only involve one audio track with the possibility of accessing and merging from up to, for example, six mixes—the price should not be particularly prohibitive. However, the best automation technique is a problem unresolved—there is talk in some quarters of storing the information between the audio tracks on the multitrack machine, whilst Necam is an altogether different approach. So we shall see what the future brings: from our point of view, we want to leave desk compatibility as wide as possible.

One of the central problems with quadruphony was the inability of giant corporations to agree on a standard system whereas the general upgrading of domestic equipment sales shows that the idea was acceptable to the consumers who were being conditioned to spending more money on hi-fi. Thus a rising climate of expectations was created in which the marketing possibilities were not seized; and it is in the interests of

all studio operators and hardware manufacturers that the sales of music be in a continual state of stimulation and increase—so that we remain in business. It is definitely not the province of this article to argue about the virtues of competition, but some facts are emerging.

Plainly, sales in the international studio market place are being dominated by some non-British firms who are taking the bigger slice by virtue of marketing technique, scale of production, standardisation, and delivery—and we're not only talking about consoles. It is a fact that there is not so far a British multitrack machine of internationally recognised quality and if British manufacturers are not careful we will also get squeezed out of the console market.

The point is that if uniform approaches are generated, this may be by dint of the clout of one or two large manufacturers acting in tandem and imposing their ideas on the rest—rather than by mutually acceptable technological advance. Should this happen and the research and development cost be too high for smaller manufacturers, then the British might virtually drop out some time in the future.

Even the largest manufacturers in studio equipment are quite small compared with the giants of electronics. But the headlong technological rush is in full bore and Britain is

already losing out. So those who have the capability to master the rapid advances of electronic and particularly digital technology, may be those who have the biggest financial resources available for development (one wonders who did what between the BBC and 3M?); the worry is that by the time a definitive digital technology emerges, British firms may not have sufficient sales revenue and profitability to catch up, and so be eclipsed. This is definitely not inconceivable within say five years.

So it is very important for British manufacturers to take a very good look at what they are trying to do, at the economic context in which they work, both nationally and internationally, and to assess the digital revolution—the future may look a little black unless there is some smart thinking and possibly mutual co-operation in vital areas of development.

This is a controversial closing note in an introductory article to a new desk from a small company. But in the final analysis, when you assess the best direction to take, you inevitably pay attention to who has been the most successful and why, and how that success can be emulated or bettered. To not do so at this moment may lead to more gloomy news announcements in these pages . . .

Studio Compressor-Limiter

AS REVIEWED IN NOVEMBER STUDIO SOUND

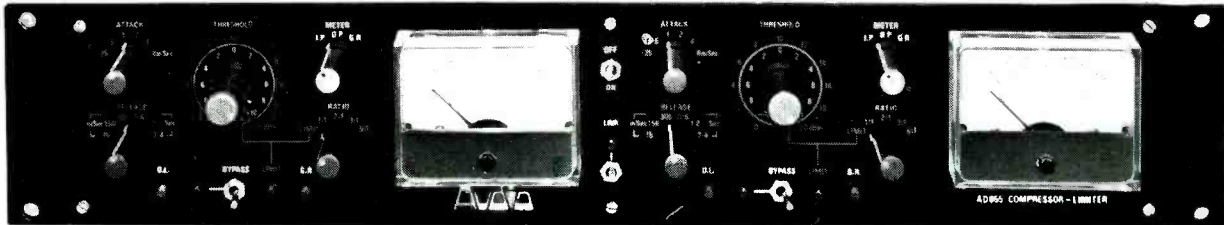

A new product designed and developed with care by Audio Developments – The quality and performance you expect.

The ADO55 is for rack mounting. The controls on the attractive front panel are clearly laid out and colour-coded for greater simplicity. All the input and output connectors have XLR, DIN and PO Jacks fitted as standard.

The ADO55 Compressor is a dual channel compressor/limiter with a comprehensive range of useful facilities. The two identical systems may be linked for stereo operation.

Specification

RATIOS 2:1 3:1 5:1 Limit (20:1)
 RELEASE TIME Adjustable — 75ms 150ms 300ms 600ms 1.2sec 2.4sec
 ATTACK TIME Adjustable — 0.25ms 0.5ms 1ms 2ms 4ms 8ms
 FREQUENCY RESPONSE 1dB 20Hz to 30kHz NO COMPRESSION
 DISTORTION 0.1% at 1kHz to 10kHz NO COMPRESSION +8dB input
 MAX COMPRESSION 25dB
 MAX OUTPUT +19dB at 1kHz +12dB at 20Hz
 MAX INPUT Dependent on the MAX OUTPUT and MAX COMPRESSION
 NOISE Wideband 68dB Band Limited 71dB

Audio



Developments

Hall Lane, Walsall Wood
 WALSALL, W. Midlands, WS9 9AU
 Telephone: Brownhills 5351/2/3 (STD Code 05433)
 Telex: 338212 Audio

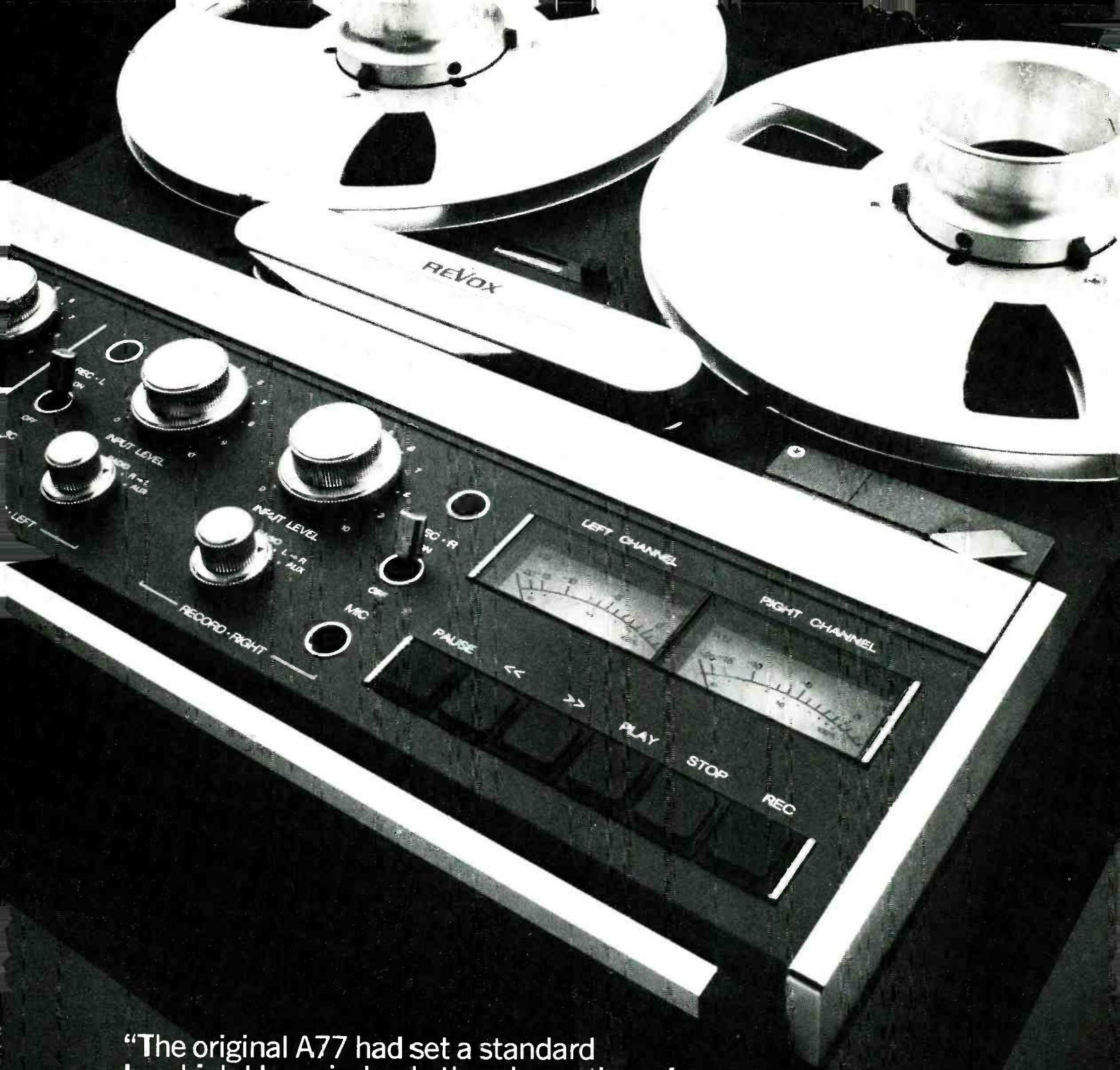

"The original A77 had set a standard by which I have judged other domestic and semi-professional recorders for many years. It is now clear that the new B77 sets a new standard not easily surpassed at its price"

Argus McKenzie (March 1978)

REVOX

For the full story contact F.W.O. Bauch Ltd., 49 Theobald St., Boreham Wood, Herts. WD6 4RZ

Survey: multitrack mixing consoles

Last month we covered Broadcast and PA consoles, and in this issue we are covering multitrack consoles. Defining such a console is difficult since many now have direct outputs from channels and do not necessarily require separate groups for each output. Generally, however, all consoles covered are suitable for 8-track recording and up.

ALICE (UK)

Alice (Stancoil Ltd), 38 Alexandra Road, Windsor, UK.

Phone: 07535 51056. Telex: 849323.

Australia: Rank Industries Australia Pty Ltd, PO Box 632, Chatswood, NSW 2067.

New Zealand: Magnetic Products Ltd, PO Box 47-124, Auckland 2.

Singapore: Lulla-Motion (S) PTE Ltd, 8E-9E Block 3, 1004 Toa Payoh North, Singapore 12.

ACM series

Modular mixing system with four or eight subgroups and matrix routing of direct channel outputs (post fader) and group outputs for multitrack. Full A/B monitoring for up to 24-tracks with monitor pan, echo and sync foldback.

Prices: 12/4 £2,850, 16/8 £4,650, 16/8/16 £6,000.

ALLEN & HEATH (UK)

Allen & Heath Brenell Ltd, Pembroke House, Campsbourne Road, London N8, UK.

Phone: 01-340 3291. Telex: 287727.

USA: Audiotechniques Inc, 142 Hamilton Ave, Stamford, Connecticut. Agents in Canada, Belgium, France, Germany, Austria, Greece, Italy, Portugal.

Syncom

Modular mixing system capable of accepting up to 28 input/output modules per frame with 16 busses (24 with split buss configuration), four master busses, six auxiliary busses. Modules combine input, output and monitoring sections with a master multitrack/remix selector and comprehensive solo system with monitor priority. Typical of the simplified and cost effective design philosophy are the channel insertion points mounted directly on each module but normally hidden

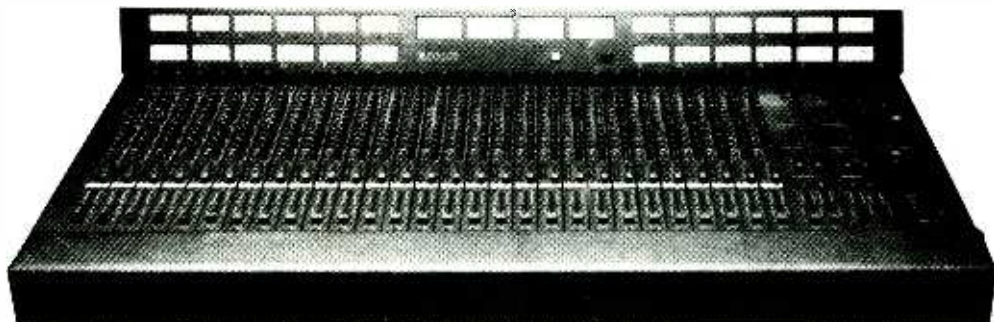

Allen & Heath Syncom

by the armrest. Other modules include stereo output channel and monitor/communications types.

Prices: 28/28/4 £9,800, 24/24/4 £8,760, 20/20/4 £7,720, 16/16/4 £6,680.

Modular series III

Compact range of consoles for smaller studios with maximum of 24 input modules and eight output groups with 16-track monitoring standard. Parametric eq standard, three pre/post aux sends, line level input and output insertion point.

Prices: 24/6/16 £2,950, 16/8/16 £2,300, 12/4/8 £1,692.

ALLINGTON

Allington Audio Developments, 14 Lenton Blvd, Nottingham, UK.

Phone: 0602 44943.

EMM range

Modular multitrack consoles using input/monitoring/output module, master status, monitoring, echo send/return modules. Only three modules are required in addition to the input/output modules, and the master status module enables channels to be switched to record, remix and overdub. The input/output modules have mic, line and remix inputs, four-band eq, two foldback and two echo sends.

Prices: EMM 16/16 £3,950, EMM 24/24 £4,950.

AMEK (UK)

Amek Systems and Controls Ltd, Islington Mill, James Street, Salford M3 5HW.

Phone: 061-834 8747. Telex: 668127.

USA: Everything Audio, Los Angeles.

Phone: (213) 982-6200. Telex: 651485.

Australia: Audio Controls, 22 Finniss Street, North Adelaide.

France: Cyborg, 13 rue Pi Bisson, Paris 19.

West Germany: Record Star Audio, Bernstorffstrasse 123, D-2000 Hamburg 50.

M2000

In-line format configured console, 24/16/24 with Integral patchbay, extensive facilities, subgrouping system.

M3000

Similar to M2000 but 36/24/32 with VCA fader automation, full parametric eq, quad mixdown, DC subgrouping, and many other features. A dual drive floppy disc memory system is available together with SMPTE interlock to tape by Advanced Music Systems.

Price: around £50,000 including computer.

AUDIO DESIGNS (USA)

Audio Designs and Manufacturing Inc, 16005 Sturgeon, Roseville, Michigan 48066, USA.

Phone: (313) 778-8400.

NRC series

8/16/24 track recording consoles, in identical design but format as appropriate. Pcb mother board inter-connection reduces cost of hand wiring; simultaneous quad, stereo and mono mix-down, 'total' op-amp circuitry; Vue Scan metering; full talkback and slate; four cue, two solo systems; four quad joysticks; sync interface.

1641

Remix console for simultaneous four, two and one channel mix from 8/16 source. Sixteen dual concentric quad pots, four joysticks, with full group routing; four remote tape controls; solo on all inputs; quad matrix break points; four es.

RMX 921/1721

Remix consoles with 16 or eight line inputs plus single mic channel.

AUDIO HELP (France)

Audio Help, 5 Rue de Solferina, F-92100 Boulogne,



Alice ACM series

helios



hands on

The most comprehensive desk ever built

Think of any control room, think of the controls, think of the controls sited off the desk. Now imagine the new Town House recording studios in London, all the controls are within fingertip reach, built into the most comprehensive music desk ever produced. For instant control just reach out, no need to break concentration to cross the room, it's all there directly to the engineer's hand.

Just some of the features to hand on the desk are: fader automation on 44 channels, monitoring for 32 tracks centrally located and including 4 echo return channels, and a total of 108 inputs all quad-pannable to 4 re-mix busses (thus two 32 track tape machines may be ganged for 60 track recording with 48 spare line inputs available for other purposes). There is a 1,024 way jackfield for the entire control room, tape remotes, digital delay lines, noise gates, compressor/limiters and all the other facilities you could require, all built into the Helios desk.

If you would like to talk about your new console, whether you are thinking of standard models or custom models, small or large, contact Neil Adams or Peter Moody at the address below.

P.S. If on the other hand you would like to work in an environment committed to constant development, contact Alan Kiddle, Production Director.

Helios Electronics Limited

Browells Lane Feltham Middlesex TW13 7ER Telephone: 01 890-0087 Telex: 8814265

International Sales and Service Representatives

SCANDINAVIA - Siv. Ing Benum A/S. Boks 2493. Solli. Oslo 2. Norway.
Telephone: (02) 565753

CANADA - Radio Service Inc., 2500 Bates Road. Montreal. Canada H3S 1A6
Telephone: (514) 342-4503 Telex: 055-60070

SURVEY: MULTITRACK MIXING CONSOLES

Audio Help cont'd
France.
Phone: 609 0311.

CS2405

Modular console mixer available with 16, 24 or 32 inputs, separate monitoring for eight to 24-track, 16 submasters (in stereo pairs), stereo and four masters, patch bay with cable trough, VU metering, usual eq or parametrics, four echo sends, numerous other facilities.

CSM6

Modular console/portable mixer with input modules in multiples of 6, 12, 18, 24 etc, and eight subgroups, two echo sends, two foldback sends. Two different input modules, one with parametric eq and peak LEDs.

AUDITRONICS (USA)

Auditronics Inc, 207 Summit Street, Memphis, Tennessee 38104, USA.
Phone: (901) 276-6338.

Model 532

Automated console designed around the Allison Research 65k programmer. Uses automated faders designated *Model AFG* which have read, write and update modes. A grouping function is incorporated working with nine busses selected by thumbwheel which includes automated group mute, group master channel automatically becomes member of group. Installed on desks of varying complexity, the 532 automation system includes two separate modules: automation master fader and automation track select which allows interfacing with three tracks on the tape recorder for recording the automation information.

AUTOMATED PROCESSES (USA)

Automated Processes Inc, 789 Park Avenue, Huntington, New York 11743, USA.

Phone: (516) 427-6024. Telex: 950-247.

UK: 3M UK Ltd, Witley Works, Witley Gardens, Southall, Middx.

Phone: 01-574 5929.

France: 3M France, 135 Bd Serurier, 75 940 Cedex 19e, Paris.

Phone: 202 8080.

Canada: Audio Acoustic Labs, 2 Thorne Cliffe Park Drive, Unit 22, Toronto, Ontario.

Phone: (416) 425-7655.

Chromacord Corp, 2343 43rd Ave Lachine, Quebec H8T 2K1.

Germany: 3M Deutschland GmbH, Carl-Schurz-Str 1, D-4040 Neuss 1.

Phone: 2101 141.

Switzerland: 3M (East) AG, PO Box Baarerstrasse 8, 6301 Zug.

Phone: 355 050.

Modular systems for any requirement, based on sections including the following: 312 preamp, balanced in for 150/600Ω, 15-65dB gain, reverse polarity and overload protected; 544 input assign module; 840 slate/tone; 544 echo send/return; 846 foldback; 325 line booster; 330 eq preamp; 440 fader, plastic track, illuminated scale, multigang within 0.5dB; 475 fader with precision metal wiper; 480 joystick quadpot; 525 complimiter with threshold, output two range frequency dependent release and stereo link; 550 equaliser, hf 5, 7, 10, 12.5, 15kHz, mid 0.4, 0.8, 1.5, 3, 5kHz, lf 50, 100, 200, 300, 400Hz, audio band pass filter switchable, eq in/out; 553 equaliser, hf, mid, lf fixed frequency; 559 nine band graphic equaliser, approx octaves 35 to 16kHz; 575 sine wave osc, 20 to 20kHz in 13 steps, low distortion and output meter; 701 10W power amp for small speaker or can systems; 705 50W power amp; 730 2 x 200W power amp; 940 automated fader, with plastic track and LED cursor indication, write/safe/update switching; 954 programmable parametric equaliser hf 800, 1.8k, 3.5k, 7k, 16kHz, mid 200, 500, 1k, 2k, 5kHz, lf 30, 60, 130, 260, 600Hz, bell and notch options, with write and in switching, compatible Allison/Automated programmer.

Automix

For typical channel arrangement on Automix fully automated console mixdown system. Console available in 24 or 32 channel options as standard, in conjunction with Allison/Automated programmer. All functions automated, including eq, subgroups and pan. Multiple LED indications of status and related functions.

1604

Supplied standard as up to 16/4 console using various standard modules. Includes standard echo foldback, monitor and metering options.

2483

Supplied standard as up to 24/16/24 console with extra capacity for particular requirements as necessary.

2824

Up to 28 inputs each with direct output and quad or stereo panning, 16 mixing busses, up to 24 VU meters, four echo busses comprehensive monitoring, two *model 525* compressor limiters, wired for four.

3224

Up to 32 inputs with 16 groups, eight echo busses.

D & R (Holland)

D & R Electronica, Keizersgracht 284, Amsterdam, Holland.

Phone: 020 250130.

MR122 series

PA mixer with 6, 12 or 18 inputs, two master outputs, one monitor output, one aux input/output and one stereo phones. Channels accept line or mic level inputs, hi, mid and lo eq, VU meters.

Prices: Dutch guilders 6/2 1,035, 12/2 1,575, 18/2 2,135.

800 series

Console mixers available in multitrack or PA configurations, with 8, 16, 24 or multiples of 8 input channels, internal jackfield, parametric sweep equalisers, active filtering and stereo width control. *MT840* series feature multitrack outputs after the master faders of each channel and provide comprehensive tape monitoring facilities, while the *PA820* series has normal stereo masters.

Prices: Dutch guilders *MT840* 16 channel 4,140, - 8 extension 1,425; *PA820* 16 channel 3,395, 8 1,230.

ST1600 series

Master recording consoles using input/output channels featuring two overlapping parametric equalisers, overload indicators, six cue sends, simplified construction by using modules of eight channels. Master modes include record, replay/sync and remix, and subgrouping is also available.

Price: Dutch guilders 16/16 13,500, 24/24 15,850, 32/32 18,500.

ELEKTROIMPEX/BEAG (Hungary)

Elektroimpex, PO Box 296, H-1392 Budapest, Hungary.

Telex: 225771.

FIT-IC

European style multitrack recording console available with up to 30 input channels with hi, mid and lo eq with lo and hi pass filters, two aux sends, four main groups, eight full and eight extensive multitrack output groups, 16-channel monitoring, internal patchbay, PPMs, numerous other modules and facilities. Console is based upon 25mm channel width.

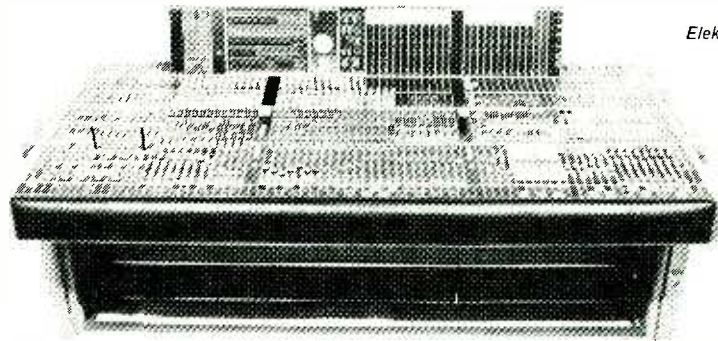

Elektroimpex FIT-IC

Prices: on application. Official supplier to Moscow Olympics.

FAIRCHILD (USA)

Fairchild Sound Equipment Corp, 75 Austin Blvd, Commack, Long Island, New York 11725, USA.

Phone: (516) 543-5200.

UK: Jacques Levy Professional Recording Services, 6 Carlisle Mansions, Carlisle Place, London SW1.

Phone: 01-834 9248.

FPC

Portable, flat console available in formats between 8/2 and 16/8. Balanced mic input with gain, lf, hf boost/cut, peak selectable. VU metering on groups, balanced out; 25 hours operation on one set 'C' batteries; solid aluminium construction. 72 x 62 x 5cm, weight 12 to 19kg depending on format.

54 ▶



D & R Electronica console

Part of every great performance

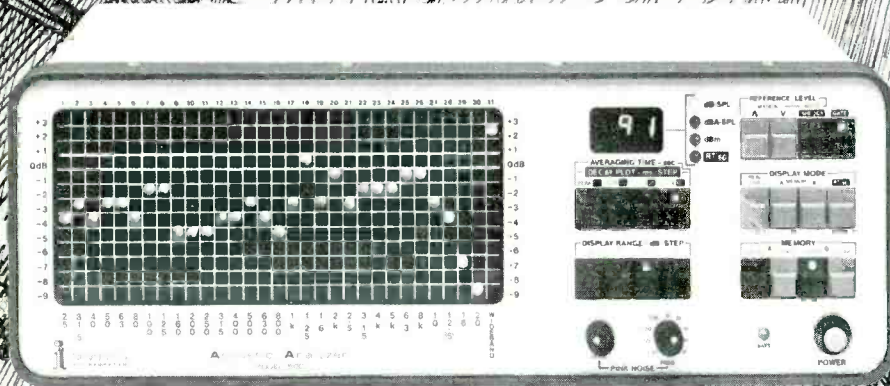

Inovonics Model 500 Acoustic Analyzer

Here's everything you need for one-third-octave sound-level and reverberation-time analysis in one easy-to-use package... Inovonics' Model 500 Acoustic Analyzer.

In the real-time mode, Model 500 shows you wideband or weighted SPL readings in each one-third-octave band from 25 Hz to 20 kHz. You set the reference level you

want, or Model 500 will seek the proper level automatically over a 100 dB range in 1 dB steps. The built-in pink-noise generator supplies you with wideband or octave-band test signals.

Then, touch a button for the RT₆₀ mode. The digital display shows reverberation time up to 10 seconds with 10 ms resolution, while the LED matrix plots the decay characteristic.

Rear-panel connectors provide an external oscilloscope output, an auxiliary test signal input, and digital I/O interface. The Inovonics 500 is ready for peripherals.

This rugged, lightweight, precision instrument goes wherever you go. From the freeway interchange to the auditorium, concert hall,

and laboratory. The Model 500 is completely self-contained, and comes to you with an internally charged battery.

For accurate, dependable level response and reverberation analysis, the sound choice is Inovonics' Model 500 Acoustic Analyzer. It's part of every sound design. Call or write us today for all the details. Model 500 - \$2750.

Inovonics Inc.

503-B Vandell Way
Campbell, CA 95008

Telephone
(408) 374-8300



Exclusive export distribution through
Gotham Export Corporation
New York
Telephone (212) 741-7411
Telex 12-9269

SURVEY: MULTITRACK MIXING CONSOLES

Fairchild cont'd

FIC

Flexible modular system for recording. Input module includes level, select and pad switches, input fader, eq and gain pre/post, compressor, hi and lo eq, foldback, VU. Output module includes slider, echo return, compressor, eq, VU meter. Monitor modules include 10 x 10 select matrix, slate, talkback.

HARRISON (USA)

Harrison Systems Inc, PO Box 22964, Nashville, Tennessee 37202, USA.

Phone: (615) 834-1184. Telex: 555133.

UK: Scenic Sounds Equipment, 97/99 Dean Street, London W1.

Phone: 01-734 2812. Telex: 27939.

Austria/Switzerland/Eastern Europe: Studer International AG, Althardstrasse 150, CH-8105 Regensdorf, Switzerland.

Benelux: Heijnen BV, Steendalerstraat 56, NL-6940 Genneep, Netherlands.

France: Studer France, 12-14 Rue Desnouettes, F-75015 Paris.

West Germany: EMT, Postfach 1520, D-763 Lahr 1.

Agents also in Brazil, Canada, Central America, Denmark, Far East, Finland, Greece, Italy, Japan, Mexico, Spain, Sweden.

3624 and 2824

In-line multitrack consoles using input/output modules where all internal stages have their inputs and outputs brought out onto an electronic switching card using FETs which allows the 'organisation' to be freely changed to accommodate different operating modes. Each channel features 24 independent assignment busses, assignment pad, mic gain and pad, full parametric eq and hp filter, multitrack monitor, stereo cue, echo sends, quad pan, mute/solo, automated fader with nine grouping busses. An internal channel patchpoint can be selected to different areas of the module. Operational status includes source monitor for recording, return monitor for overdubbing, return mix for mixdown, and source mix allowing a monitor mix on the main VCA faders. Metering is 12 segment electronic VUs, and automation is available. 36 and 28 input versions with 24 outputs.

Prices: 3624 \$75,562, 2824 \$63,566.

4832, 4432, 4032 and 3232

Basically similar to above but with 48, 44, 40 and 32 inputs with 32 outputs. Input/output modules have further facilities such as two patchpoints, two echo sends etc. 36 segment electronic VU/PPM meters are fitted as standard. Transformer less microphone amplifiers also available.

Prices: 4832 \$129,717, 3232 \$106,261.

Auto-Set

Microcomputer based programme primarily for automation of Harrison consoles but which can be used for many other applications. Uses full ASCII keyboard with visual display unit (32 x 16 characters) and provides numerous facilities. Full details on application.

Price: \$19,900.

HELIOS

Helios Electronics Ltd, Browells Lane, Feltham, Middx TW13 7ER.

Phone: 01-890 0087. Telex: 8814265.

Scandinavia: Siv. Ing. Benum A/S, Boks 2493, Solli, Oslo 2, Norway.

Canada: Radio Service Inc, 2500 Bates Road, Montreal H3S 1A6.

Custom

From special purpose units of any size for broadcasting up to 40+ inputs 32-track recording/mixdown consoles with automation, memorised routing etc. Special modules are designed for clients when required. Console shapes can be individually designed for control room dimensions, with emphasis on operator ergonomics.

54 STUDIO SOUND, JANUARY 1979

Mobiles

Complete acoustically treated, wired and equipped vehicles for multitrack recording and sound broadcast, or custom sound consoles to fit dimensions of clients vehicles.

Nordic

Broadcast (and small to medium music recording) consoles. From 12/4 to 32 - /8, with multitrack monitoring. VCA fader vers on. Flexible format using standard module family. Meet European broadcast technical specs.

Series Seven

Common denominator music recording consoles. 32 channel frame fitted 20 channels upwards. 16 or 24 out, with group faders. Separate track monitor. Input modules choice of simple or very sophisticated parametric eq (interchangeable). 40+ channel version also available.

Auto Seven

As above but with eight VCA fader control busses, separate DC grouping faders instead of audio output group faders. Read, write, update etc. Ready for direct connection of Allison 65K or similar programmer.

MCI (USA)

MCI Inc, 4007 NE 6th Avenue, Fort Lauderdale, Florida 33334, USA.

Phone: (305) 566-2853. Telex: 514362.

UK: MCI (Professional Studio Equipment) Ltd, MCI House, 54-56 Stanhope Street, London NW1 3EX.

Phone: 01-388 7867. Telex: 261116.

500 series

Available in 28/36/42 frame sizes (48 to special order), these are top of the MCI range and with optional automation. All modules are input/output with a package of group modules including eight group faders, four echo returns with VCA, 32-track assignment, and four 3-point equalisers. Either VU or plasma display meters are available, the latter reading VU or peak and optionally the VCA DC status and/or an peak accumulative for both display modes. I/O modules are standard equipped with VCA, odd/even panning, hi, two mids and lo eq switched to either mic or line inputs, hi pass filter, four mono and one stereo aux sends, mute and solo, separate sliders for mic and line inputs (monitor channel). Price: 24 I/O with plasma display \$59,760, 36 I/O with plasma display \$82,075, 42 I/O with plasma display \$101,450.

600 series

Available in 18 or 36 frame sizes, the 600 series provides a cost effective automation ready console. It is microprocessor controlled for level, mute, solo and grouping functions and equipped with VU meters for 16 or 24 output busses, left, right and mono outputs, and six sends, one phasemeter (optional). Additional VU meters for 32 busses available on larger frame. Uses I/O modules to provide complete mic channel and complete remix channel in one module. Provides differential line inputs, differential mic inputs (optional), hi and lo pass filters, six sends, momentary short travel mute switches, balanced push-pull outputs, multiway connectors for all rear panel connections, true parametric eq with three separate controls for frequency amount of boost and Q (sharpness) that are not interactive (optional).

Prices: 18 I/O \$28,000, 24 I/O \$34,900, 36 I/O \$44,200.

MIDAS (UK)

Midas Audio Systems Ltd, 54-56 Stanhope Street, London NW1 3EX.

Phone: 01-388 7060.

USA: Midas Audio Corporation, 730 Main Street, Niagara Falls, NY 14301.

Phone: (716) 282-4100.

Canada: Gerr Electro-Acoustics, 365 Adelaide Street East, Toronto, Ontario M5B 4R9.

Belgium: S.E.D., 146 Rue Bara, 1070 Brussels, Belgium.

Japan: International Equipment Hire, Rosa Bianca Building 201, 42-12, Jinguamae 3-chome, Tokyo, Japan.

PR System

Various modules providing studio functions are available for the PR system described last month.

NEVE (UK)

Neve Electronics International Ltd, Cambri House, Melbourn, Royston, Herts SG8 6AU.

Phone: 0763 60776. Telex: 81381.

USA: Rupert Neve Inc, Berkshire Industrial Park, Bethel, Conn 06801, USA.

Phone: (203) 744-6230. Telex: 969638.

Hollywood: Suite 609, 6255 Sunset Blvd, Hollywood, Ca 90028, USA.

Phone: (213) 463-4822.

Canada: Rupert Neve of Canada Ltd, 2721 Rena Road, Malton, Ontario, Canada.

Phone: (416) 677-6611. Telex: 06968753.

Germany: Rupert Neve GmbH, D-6100 Darmstadt, Bismarckstrasse 114, West Germany.

Phone: 06151 81764. Telex: 0419581.

France: Soracitel, 161 Bd Lefebure, F-75015 Paris.

Necam

A minicomputer based automated mixing system which may be used with existing or new consoles and provides operation of faders and associated mute circuits in its basic form. Full remote control and locate facilities are provided for the multitrack tape recorder and the console uses servo controlled faders with plastic tracks which enable manual override to be performed. The audio tape has SMPTE timecode recorded on one track with a special wide bandwidth head amplifier to enable this to be read at high winding speeds. Up to 999 points of the tape may be 'labelled' for use in automated runs. A small control unit with 16 instruction keys, a numeric keypad and a 32 character alphanumeric display provides full instruction for the computer. Two floppy discs are used to store data.

8068/8058

Compact range of multitrack consoles with the following facilities: 28/32 channel, 16 buss, 30 track monitor—24 channel, 16 buss, 24 track monitor—18 channel, eight buss, 18 track monitor respectively. Eight auxiliary busses. Neve will repair or replace free of charge any part found to be defective within one year of taking delivery of the console, unless such defect is caused by neglect, abuse or act of God.

8066

20/16 recording and mixdown console fitted with 16 type 31099 amp/eq modules, wired to accept additional four channels. Line inputs 1 to 16 assigned to 16-track playback, inputs 17 to 20 assigned to 4-track playback. Separate 16-track mixdown section, six aux outputs, four reverb returns, numerous options.

8078

40/24/32 recording and mixdown console, separate 32-track monitoring section, eight aux sends. Options include phase meter, digital clock, up to six additional correction units, up to four quad panpots, tape remotes, P&G monitor faders, phantom power supplies. Automation ready.

PLUS 30 (France)

Plus 30, 42 Rue Pierre Nicole, F-75005 Paris, France.

Phone: 834 0136.

Modular mixer

Modular mixing console with combined input/output modules offering hi, mid and lo eq, hi-pass filter, mic/line inputs, cue and echo sends, complex monitoring including panning. P&G faders, echo return modules, general module with communication and oscillator, remote tape starts etc.

PROGRESSIVE (UK)

Progressive Electronic Products, 593 High Road, Leyton, London E10.

Phone: 01-558 0678.

Modules

A range of low cost modules that may be assembled into an inexpensive mixing desk. Comprise CM-1

56 ►

NOV. 77

BESTOP

- | | | | | | |
|--------|---|---------|---|---------|---|
| 1(-)* | LOVE YOU LIVE
Rolling Stones - Rolling Stones | 17(33)* | EVEN IN THE QUIETEST MOMENTS
Supertramp - A & M | 35(40)* | DERRINGER LIVE
Rick Derringer - Bluesky |
| 2(1) | ON STAGE
Rainbow - Oyster | | BOSTON
Boston | 36(47)* | OVERNIGHT |
| 3(3) | LIVE
Status Quo - Vertigo | 18(37)* | | | |
| 4(12)* | MADE IN EUROPE
Deep Purple - Purple | 19(10) | | | |
| 5(5) | HOTEL | | | | |

Bragging is not our business, but which other mobile studio records the top 4 albums in the European charts?

We feel we have the best... with our 2x3m 24 track machines, Helios 32/24 desk, Maglink, Dolbys, Altec monitors, Lexicon Digital & 58 mike lines with Actively Isolated Splits....



Taken outside RIGA BALLET USSR

THE FIRST MOBILE STUDIO INTO RUSSIA

The Rolling Stones Mobile Studio :-

2 Munro Terrace, London SW10 0DL

Try calling Ian Stewart or Ellen on 01-352 0005

STELLAVOX

TD88

1/4 in tape

1/2 in tape

16mm perf.

17.5mm perf.

1 to 8 tracks

24 Volts or mains

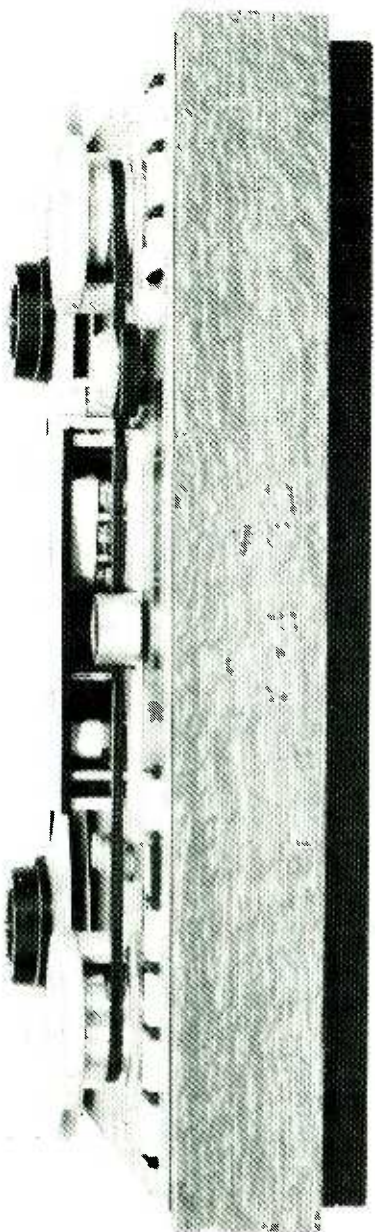

JOHN PAGE LIMITED
 WESLEY HOUSE, 75, WESLEY AVENUE, LONDON, NW10 7DA
 ☎ 01-961 4181 TELEX 24224 REF 568

SURVEY: MULTITRACK MIXING CONSOLES

Progressive cont'd

channel module with mic and line inputs, 3-band eq, four aux sends, PFL, eight groups, overload indicator, external fader. *GM-1* group module provide two echo returns, external fader, AB monitor switching, external VU meter, and monitoring facilities. *VEM-1* is a virtual earth mixing module while *LHD-1* is a headphone driver. (Further details in review in December 1978 *Studio Sound*.)

Prices: *CM-1* £40.50, *GM-1* £34, *VEM-1* £4.50, *LHD-1* £5.50. Power supplies, metering faders, cabinet extra.

QUAD/EIGHT (USA)

Quad/Eight Electronics, 11929 Vose Street, North Hollywood, California 91605, USA.

Phone: (213) 764-1516. Telex: 662446.

UK: Audio Kinetics (UK) Ltd, Verulam Road, St Albans AL3 4DH.

Phone: 0727 32191.

Pacifica

Modular mixer using combined input/output modules configured with 16, 24, 36 inputs, eight mixing busses and stereo mixdown and monitoring capability. Two independent cue mixing circuits are provided together with four separate aux sends. Console is transformerless except for mic input, programme, foldback and echo outputs. Modules include input/output, input/master mix, echo send/return control room monitor, studio monitor, communications modules.

Brentwood/Coronado

VCA designed multitrack recording mixdown console with six subgroup masters assignable independently from each input. The consoles accommodate 24 or 36 inputs and have 24 mixing busses with quad down and monitoring capability (in-line). Otherwise similar to *Pacifica*.

Compumix III

Automation system that can be updated from conventional data storage on multitrack tape or the more versatile floppy disc memory.

QUANTUM (USA)

Quantum Audio Labs Inc, 1909 Riverside Drive, Glendale, California 91201, USA.

Phone: (213) 841-0970.

QM-8B and QM-12B

Compact consoles with 8/4 and 12/4 configurations and separate 8 or 16 track monitor section. It includes two aux sends and returns, solo, VU metering etc.

QM-128 and QM-168

Compact consoles with 12/8 and 16/8 configurations, four aux sends, solo, mute, panning, separate 8 or 16-track monitor section.

QA-1010

Professional recording console with up to 24 inputs and 8 or 16 main busses with separate stereo busses. Channel outputs may be taken direct to recorder for 24-track operation. Each channel features three band parametric with boost/cut, frequency and Q on front panel. Full VU metering for up to 24 channels, five independent mixes, complete input/output modules.

RAINDIRK (UK)

Raindirk Ltd, 33A Bridge Street, Downham Market, Norfolk.

Phone: 03663 2155/3617.

Canada: Le Centre d'Orientation de Recherche Acoustique CORA Inc, 131-18eme Rue, 1046 Quebec PQ.

France: Reditec, 62-66 Rue Louis Ampere, F-93330 Neuilly/Matne.

Benelux: Geluidstechniek BV, Hastelweg 6, Eindhoven,



Quad/Eight console

Holland.

West Germany: Elmus, D1 Berlin 12, Herderstrasse 16. Agents also in Denmark, South Africa and Spain.

Mini 4 Group

Low cost mixer of basic 10/4 format or custom design, portable, desk or floor mounting, maximum 24/4 with 8-track monitoring.

Series III

Manufactured in console format in either a standard or deluxe format offering 18 to 40 input channels, 8, 16, 24 or 32-track monitoring with eight main output groups and a further master remix stereo group output. The master remix groups are accessible from both input channels and normal main group outputs for sub-mixing. A routing module enables the eight main groups to be switched to any tape input 9 to 16, 24 or 32 as applicable.

Quantum range

Available in main frame sizes 24, 32 and 40 input/output channels. The in/out channel module contains the mic and line input stages, facilities to record on to multitrack or remix tape machines, and the monitor circuits. Penny & Giles faders throughout, fitted with MCI *JH-50* automation system or automation ready as desired. A 36 push button assembly provides the 32-track group assign facility, phase change, mic pad, pan and route pre-fader signal to insert points on patch bay. Separate mic and line input amps/controls. Three-section full parametric bell response eq with bandwidth (Q) frequency and boost/cut controls—ranges 40-4000Hz, 200-10kHz and 1.6k-16kHz. Additionally the bass and treble section may be switched to shelving response. Also a high pass filter range 30-300Hz at -12dB/oct. Output section comprises the group mix amp, insert point, group trim (fader) control and output line amplifier. Quad monitoring of multitrack and remix tape machines with linear fader controls. Mixer states record, overdub, remix and track jump.

REBIS (UK)

Rebis Audio, Kinver Street, Stourbridge, West Midlands DY8 6AB.

Phone: 0384 71865.

Custom-built mixing consoles but also offer a standard mainframe accepting up to 28 input modules, with 16 output groups and up to 24-track monitoring, metering with 17 VUs. Input module accepts line and mic inputs with switched attenuator, aux pre/post, two fully parametric sections, two or four aux sends, 16 routing switches, P&G faders. Group module has three aux sends. Master module includes osc, monitoring facilities, talkback etc. Ancillary module duplicates monitor and talkback function switches. Options include channel overload LEDs, group peak LEDs, comp/limiters, graphics etc in existing mixer rack space.

Price: for basic 24/16/16 £8,000.

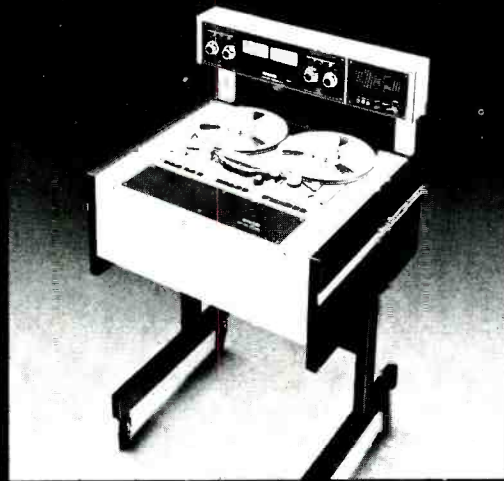

STUDER B67
Professional Tape Recorder
Respected STUDER quality at attractive prices.

Performance — we guarantee it...

tomorrow's generation with features you requested,
available today

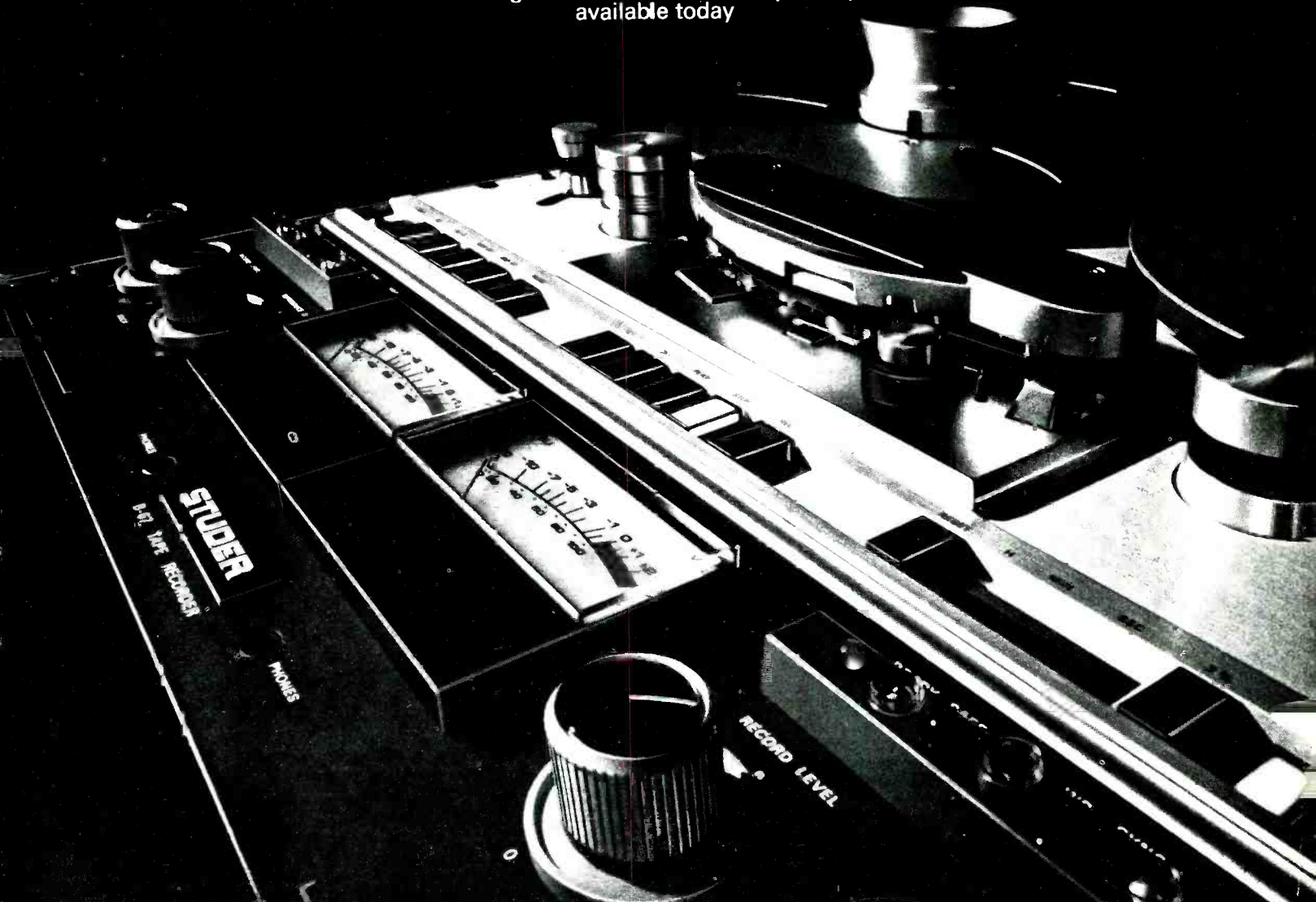

STUDER INTERNATIONAL AG

CH-8105 Regensdorf, Phone (01) 840 29 60, Telex 58489

STUDER REVOX AMERICA INC., Nashville, Phone (615) 329-9576, Telex 55-4453

STUDER REVOX CANADA LTD., Toronto, Phone (416) 423-2831, Telex 06-23310

STUDER FRANCE S. à. l., Paris, Phone 533 58 58, Telex 24-744

F.W.O. BAUCH LTD., Boreham Wood, U.K., Phone (01) 953-0091, Telex 27502

SURVEY: MULTITRACK MIXING CONSOLES

SOLID STATE LOGIC (UK)

Solid State Logic Ltd, Stonesfield, Oxford, UK.
Phone: 099389 324/444. Telex: 837400.
USA: Sierra Audio Corp, 621 SO Glenwood Place, Burbank, Cal 91506.
Phone: (213) 843-8115. Telex: 691138.

SL4000 series

Automated, computer controlled recording console claimed to be one of the most expensive in the world. Includes full distributed logic control of major console states, comp/limiter/expander/noise gate on each channel, in addition to master quad compressor on the output bus, on each channel 14-control parametric eq with 4-bands, two fully parametric filters, overload indicators on each module monitoring at three separate points, two independent subgrouping systems, eight VCA subgroups using separate faders, one-button drop-in system, pretimed automatic fader adjustable from 1-60s, multiway connectors. Options for computer system providing level memory, timing autolocation, editing and record keeping, 100-step plasma display meters with peak hold facility, additional patch rows, extra producers table, precision phasemeter. The console uses combined input/output modules with six aux sends and the console is available in 32, 40 and 48 module mainframes with options for VU, PPM and plasma metering.

Prices: 32 channel plasma metering £61,805/\$133,408, 40 channels £73,275/\$157,600, 48 channels £86,605/\$185,700. SSSL computer £13,500/\$30,000.

SOUNDCRAFT (UK)

Soundcraft Electronics Ltd, 5 Great Sutton Street, London EC1V 0BX.
Phone: 01-251 3631. Telex: 21198.
USA: Soundcraft North America, PO Box 2023, Kalamazoo, Michigan 49003.
Phone: (616) 382-6300. Telex: 224408.

Series 3B

Fully modular studio console for 16, 24 or 32 track applications. Features include a proprietary transformerless mic amp with almost theoretically low noise level, sweepable 4-band eq, hi and lo pass filters, eight aux busses, mono and stereo solo. Metering is by a 24-segment VU/PPM LED ladder display with two column display.

Price: 24/24 £11,950/\$33,810.

SOUND WORKSHOP (USA)

Sound Workshop Professional Audio Products Inc, 1324 Motor Parkway, Hauppauge, NY 11787, USA.
Phone: (516) 582-6210.
UK: Industrial Tape Applications, 1-7 Harwood Avenue, London NW1.
Phone: 01-724 2497.

Series 1600

Available in 20, 28 and 36 input mainframes ready for automation. Series 1600 includes either transformer or *Trans-Amp* transformerless mic amps, standard 3-band eq or optional 3-band parametric, lo pass filter, P&G faders, balanced mic/line inputs, transformer balanced track outputs, independent control room and studio sections, four send busses with exclusive input source matrix and master assign matrix, optional VCA grouping package, optional ARMS automation (compatible with MCI JH50).

Prices: 20/16 \$18,250, 28/24 \$24,650, 36/32 \$30,700. ARMS 32 channel \$8,750.

SPECK (USA)

Speck Electronics, 11408 Collins Street, North Hollywood, California 91601, USA.
Phone: (213) 980-9919.

SP800C

Mixing console configured 16/16 with stereo out and can be expanded to 24-track with an option. Input module includes conductive plastic fader, 3-band para-

metric eq, 8/16 track assignment buttons, post echo send, monitor send, two cue sends, solo button, mic/line switch, programme/sync switch.
Price: \$6,500.

SPHERE (USA)

Sphere Electronics, 20201A Prairie Street, Chatsworth, California 91311, USA.
Phone: (213) 349-4747.

Eclipse C

Automated consoles using Allison 65k programmer. Facilities include nine selectable VCA groups, three programmable programme mutes, echo send and return mutes, switchable insert point, three pannable stereo sends, and four mono sends available for echo, cue, effects or whatever, quad pan and track odd/even pan. Modular construction offers five interchangeable equalisers, including two 3-knob, two graphics and a 4-knob parametric.



Soundcraft Series 3B

SPECTRA SONICS

Spectra Sonics, 770 Wall Avenue, Ogden, Utah 844041, USA.
Phone: (801) 392-7531.
UK (modules and components): Sun Recording Services, 34-36 Crown Street, Reading, Berkshire.
Phone: 0734 595647.

Custom and standard consoles for recording and broadcast purposes. Various configurations available based on modules including the following: osc with qe select frequencies, gain; hi/lo pass filter 40/70/100Hz and 10/12.5/15kHz; electronic filter with various standard frequencies; power amp; simple mic program eq at 100Hz and 7kHz; mic/program eq ± 12 dB at 50/100/200Hz and 2.5/5/10kHz; rotary and joystick quad pan; rack mounting and console face complimitters variable 1.1:1 to 100:1, attack 0.1 μ s to 1.2ms, release limiter 0.09 μ s, compressor 50ms to greater than 10s.

1024-24

Available with 12, 16 and 24 group outputs, based on input module including line/mic switch, input attenuate, PFL, monitor submix route, two foldback, eq at lo/mid/hi, 4/5 frequencies in each band, shelf curves at 50Hz and 10kHz switchable. Usual program assign and monitor select facilities.

STRAITA HEAD

Straita Head Sound, 7578 El Cajon Blvd, San Diego, California 92041, USA.
Phone: (714) 465-9997.

Custom consoles based on standard modules for music balancing and recording. Any configuration supplied. Typical facilities extend to multiple stereo reinsert, LED peak reading VU meters, built-in crossover for multiamp operation, three band eq switchable three frequencies in each, two aux subgroups pre-post; pad, phase, hi pass filter.

INTERNATIONAL DEALERS

United Kingdom

Audio Kinetics (UK) Ltd., Verulam Road, St. Albans AL3 4DH Tel: (0727) 32191

Austria

Acousta Elektronik, Hofhaymerallee 15, A-5020 Salzburg Tel: 06222/46164

Germany

Estemac Electronic GmbH, Alter Teichweg 67, 2000 Hamburg 70 Tel: (0 40) 61 06 60

Norway

Siv. Ing. Benum & Co., Boks 2493, Solli, Oslo 2 Tel: (02) 56 57 53

France

Recording. Electronic. Design., 3 Rue Du Telegraphe, 75020, Paris Tel: 636 73 10

South America

Electronica Gramco, Av. Sanz - Edificio Escar, Local B - Apt. 75442, El Marques, Caracas, Venezuela Tel: 35 43 78

Hong Kong

Fee Lun Radio Service, Wai Shun Bldg., 11th Floor, 5 Yuk Yat Street, Tokwawan, Kowloon Tel: 3-656611

Republic of China

Linfair Engineering & Trading, 7/F 7, Jen Ai Road, Sec. 2, Taipei, Taiwan Tel: 3214454-7.

Canada

Commercial Electronics Ltd., 1305 Burrard Street, Vancouver 1 B.C. Tel: (604) 685-0301.

New Zealand

Magnetic Products Ltd., 108-110 Jervois Road, Herne Bay, Auckland 2 Tel: 760-607.

Australia

Rank Industries Australia (Pty), Ltd., 12 Barcoo Street, East Roseville, N.S.W. 2069 Tel: 406 5666.

Indonesia

P. T. Kirana Yudha Teknik, P.O. Box 71, Jatinegara, Jakarta Tel: 883823.

Japan

Electori Co. Ltd., Mondo Bldg., 1-19-3 Kamiochiai, Shinjuku-Ku, Tokyo Tel: (03) 950-6266.

Singapore

Electronics & Engineering Pte. Ltd., 271 Outram Road, Singapore 3 Tel: 75873.

Philippines

Electro-Systems, Corinthian Plaza, Garden Floor, 121 Paseo de Roxas, Legaspi Village, Makati, Metro Manila Tel: 85-99-96

India

Magna-Tech Electronic, 273/4 "Rama Baug", Deohar Road, Matunga, Bombay Tel: 400 019.

Quad/Eight International Quad/Eight Electronics

11929 Vose St., No. Hollywood CA91605
(213) 764-1516 Telex: 662-446

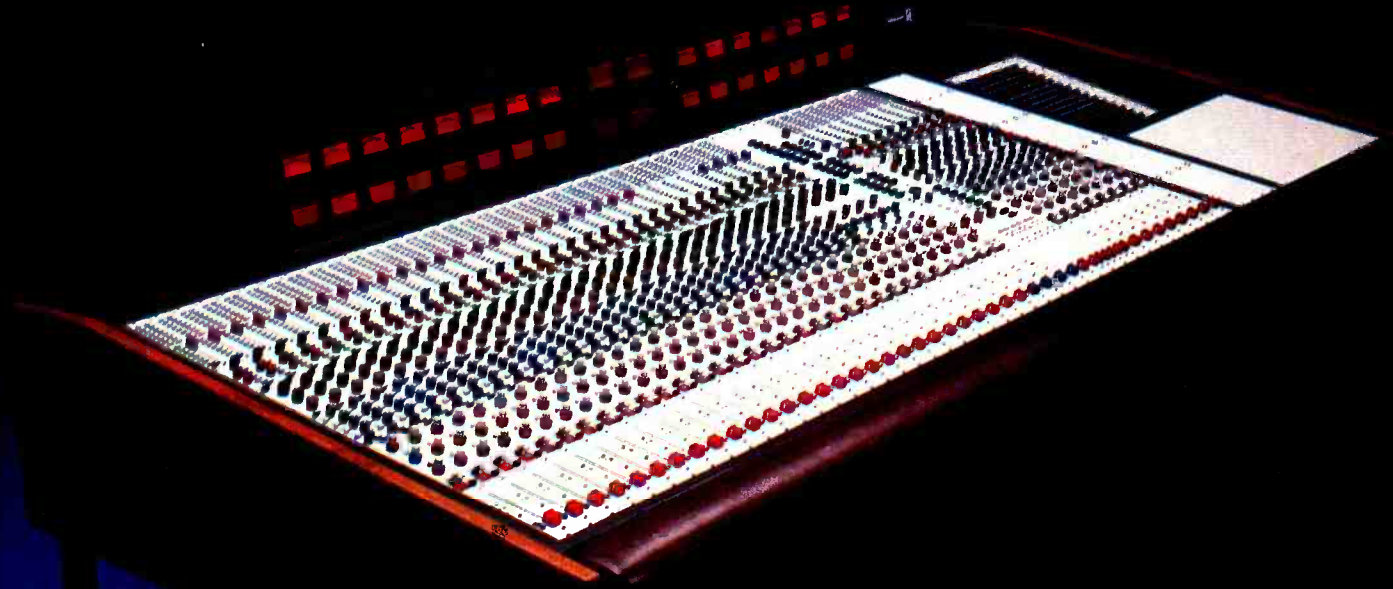

*Introducing the Coronado:
40 input, 24 Mixing Buss Console
with Compumix III Automation*

For the Artist in Every Engineer



**Quad/Eight Electronics
Quad/Eight International**

11929 Vose Street, North Hollywood, California 91605 (213) 764-1516 Telex: 662-446

www.americanradiohistory.com

Cuemaster CARTRIDGE MACHINES

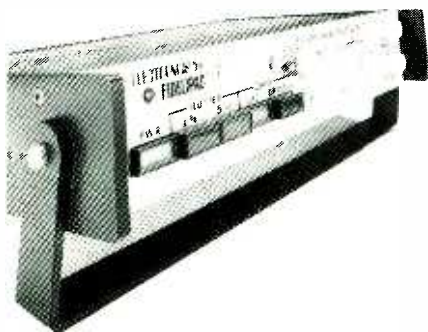

C
Cetec Broadcast Group
schafer **SPARTA**



Granet
Communications Ltd.

39 BEECHCROFT MANOR, OATLANDS
DRIVE, WEYBRIDGE, SURREY KT13 9NZ
Weybridge (0932) 47785

SURVEY: MULTITRACK MIXING CONSOLES

STUDER (Switzerland)

Studer International AG, CH-5430 Wettingen, Switzerland.

Phone: 056 2687 35. Telex: 53682.

UK: FWO Bauch Ltd, 49 Theobald Street, Boreham Wood, Herts WD6 4RZ.

Phone: 01-953 0091. Telex: 27502.

USA: Willi Studer America Inc, 3916 Broadway, Buffalo, New York 14227.

Phone: (716) 681-5450. Telex: 91-9138.

Canada: Willi Studer Canada Ltd, 14 Banigan Drive, Toronto, Ontario M4H 1E9.

Phone: (416) 423-2831. Telex: 06-23310.

France: 12-14 Rue Desnoquettes, F-75015 Paris.

Phone: 533 58 58/9. Telex: 24744.

389

Modular console providing 32 input channels, four echo sends, four echo outputs per input unit, four to 16 masters, four foldback outputs, up to 20 peak indicators, monitor mix channels, remix switching, remote control and additional equipment available.

TANGENT (USA)

Tangent Musical Engineering, 2810 South 24th Street, Phoenix, Arizona 85034, USA.

Phone: (602) 267-0653.

UK: Industrial Tape Applications, 1-7 Harwood Avenue, London NW1.

Phone: 01-724 2497.

Model 3216

Professional recording console in either 24 or 32 channel mainframes with 16 output busses plus direct from input modules. FET switching electronically restructures input/output module function blocks. Parametric eq on each channel, two echo and two aux busses, full monitoring capabilities, LED metering arrays.

TEAC/TASCAM

Teac Corp of America, 7733 Telegraph Road, Montebello, California 90640, USA.

Phone: (213) 726-0303.

UK: Harman UK, St John's Road, Tylers Green, High Wycombe, Bucks HP10 8HR.

Phone: 049481 5331.

Model 1

Basic 8/2 line level mixer for monitor mixing etc.

Model 2A

Basic 6/4 mixer with mic/line inputs, hi and lo eq, pan and four busses with single master fader, jack and phono sockets.

Model 3

Basic 8/4 mixer with mic, phono, line inputs, 2-band eq with switchable frequencies, pan and four busses with single master fader with stereo 8-channel submixer with pan on each channel, XLR balanced inputs on six inputs, eight direct outputs.

Model 5

Basically similar to Model 3 but with cue and echo sends, solo, overload indicator, four separate submasters, master module, optional talkback module, direct outputs for multitrack, eight XLR mic inputs.

Model 15

24/8 mixer with 16-track monitoring and direct outputs on each input. Includes 4-band equaliser, two 8x2 submixes, modular construction, comprehensive monitoring.

TRIDENT (UK)

Trident Audio Developments Ltd, Shepperton Studio Centre, Squires Bridge Road, Shepperton, Middx.

Phone: 09328 60241. Telex: 27782.

USA: Studio Maintenance Services, 12438 Magnolia

Blvd, North Hollywood, Cal 91607.

Phone: (213) 877-3311. Telex: 85127782.

TSM series

Modular console series using separate monitoring available in various configurations, 32/24 and 40/32 versions having been recently delivered. A new generation of integrated circuit is used throughout with solid state relays and Jensen transformers throughout. Input modules include four bands of graphic parametric eq with swept hi and lo pass filters, six aux sends, sends one and two being controlled by faders for echo send. Separate quad and stereo output busses with full monitoring allow instantaneous remixing leaving all multitrack routing and monitoring intact—in this mode the separate multitrack monitor mixer can be used as extra line inputs providing 60 and 76 remixing capability (including four echo returns). All monitoring channels include eq, aux send and panning, and feature a fader reverse button which interchanges the functions of track monitor fader with main plastic output group faders.

TWEED (UK)

Tweed Audio, Pinnaclehill Industrial Estate, Kelso, Roxburghshire, Scotland.

Phone: 05732 2983. Telex: 727633.

USA: Tweed Audio USA Inc, 1640 Fifth Street, Santa Monica, California 90401.

Phone: (213) 451-0688. Telex: 652337.

Offer a custom build service with modules suitable for multitrack recording, broadcasting and film dubbing. Make extensive use of CMOS electronic switching and electronic balancing.

P104

Portable 10/4 mixer with comprehensive facilities.

Standard

12/2 and 13/4 no compromise mixers with mic/line inputs, hi and lo pass filters, hi, mid and low eq, four output groups, echo and foldback sends, PFL, cut, complex metering (VU) facilities and monitoring.

16/16 and 24/24 multitrack consoles available in numerous permutations, modular construction.

WESTREX

Westrex, PO Box 989, Beverley Hills, California 90213, USA.

Phone: (213) 274-9303.

UK: Westrex Co Ltd, 152 Coles Green Road, London NW2 7HE.

Phone: 01-452 5401. Telex: 923003. Cables: Westelco London NW2.

Italy: Westrex Co Italy, 65 Via Costantino Maes, 00162 Rome.

Spain: Westrex Co Iberica, Avenida Jose Antonio 636, Barcelona 7.

Japan: Westrex Co Orient, CPO Box 760, Tokyo.

Hong Kong: Westrex Co Asia, Room 1302, Luk Hoi Tong Building, 31 Queen's Road Central.

ST3000

Various input/output combinations according to customer requirements. Modular construction. Typical channel includes: ST3009 combining panel, with p/b bussing selection; ST3003 channel control panel with pre/post eq/fb selector, send gain cue push button and overload indicator; ST3001 input amplifier, mic/line indicator, gain, 120Hz hi pass in/out, phase, fine gain; ST3002 eq unit, three boost/cut zones at 50Hz, 0.7/1.0/1.4/2.8/3.5/4.2/5.6kHz and 15kHz; ST3010 fader with slider and bottom of travel micro switch. ST3001 input amp takes mic between -70 and -20 dB and line between -10 and +20dB in 10dB steps.

ST3050

Compact mixer for small studio or location work. Available with up to eight input channels and 1/2 groups out. Modules similar or identical ST3000; illuminated ppm or vu metering; all components 'fully tropicalised'.

Wollensak Duplicator copies music expertly and fast



The Wollensak 2772AV Stereo High Speed Desktop Duplicator (£1498.70 + 8% VAT)

Quality The 3M Wollensak 2772AV Duplicator is a high speed cassette to cassette duplicator for fast stereo (or mono) copies - two stereo copies in under four minutes.

If you need to be technical: Crosstalk 45dB, frequency response 50-10,000 Hz \pm 3dB, wow and flutter 0-15% rms max., speed accuracy \pm 1%, s/n ratio within 3dB of master.

Versatility Because these copies have such professional quality, leading recording Studios like **Dick James Music** use them.

They've a rapidly growing place in university or college music departments, local radio stations, and advertising agencies, too.

Simplicity This duplicator sits happily on any desk or table.

Its colour-coded illuminated push buttons interlock to prevent accidental damage. Old programme material on copies is automatically erased. Automatic rewind, manual rewind switch, visual and aural monitoring facilities.

From Fraser Peacock Associates - the audio visual specialists

Use the coupon for more about this machine's ruggedly reliable quality. And remember the Fraser Peacock name for advice on conference presentations, film strips, recording sessions and a complete range of audio visual equipment for sale or hire.

Please tell me more about the Wollensak 2772AV Duplicator.

Name

Address

fpa To Fraser Peacock Associates Ltd.
94 High Street, Wimbledon Village, London SW19
Telephone: 01-947-7551
3M and Wollensak are trademarks

Don Larking Audio Sales

50 Cheapside, Luton, Beds.

Tel: 0582 26693/27195 Daytime

Amphill 0525 403258 Evenings

List of new and used studio equipment.

All prices ex-VAT.

MULTITRACKS

MCI JH100 24 TRACK WITH 16 TRACK H/B 1YO	£17500
3M M79 24 TRACK	£15000
3M M56 16 TRACK HEADS AS NEW	£8000
AMPEX MM1000 16 TRACK WITH 8 TRACK H/B	£6500
AMITY SCHROEDER 16 TRACK AS NEW	£6000
STUDER A80 MK. 1	£11000
AMPEX AG 440 8 TRACK	£3500
AMPEX MM 1000 8 TRACK	£4000
TASCAM 8 TRACK 1/2 INCH	£2300
AMPEX AG 440 4 TRACK	£1500
STUDER 4 TRACK 1/2 INCH & 1 INCH	
INTERCHANGEABLE HEADS	£1750

CONSOLES

NEVE 16 CHANNEL 8 GROUP	£14000
TRIDENT B 24 CHANNEL 16 GROUP	£15000
TRIDENT FLEXIMIX 10 INTO 4	£2300
CADAC 24 CHANNEL 16 GROUP	£12000
AUDIO DEVELOPMENTS 16 INTO 4 INCLUDING 3 STEREO	
COMPRESSORS 120 WAY JACK BAY	£2500
SOUND TECHNIQUES 24 CHANNEL 16 GROUP	£6000
SOUND TECHNIQUES 20 CHANNEL 10 GROUP	£1750
R.S.D. 16 INTO 4 BRAND NEW	P.O.A.

STEREOS

SCULLY 280 IN CONSOLE V.G.C	£1200
AMPEX AG 440 IN CONSOLE	£1400
STUDER B67 IN CONSOLE AS NEW	£2500
3M M79 IN CONSOLE AS NEW	£4000
REVOX A700	£750

VARIOUS

NEUMANN VALVE MIKES, COMPLETE WITH POWER SUPPLIES & LEADS, SM69, SM23, KM53, KM54, KM56, KM64, M49, M50, U67, TM253.	
MASTER ROOM MR3	£850
EVENTIDE FLANGERS	£250
JBL 4320 WALNUT 2 WAY	£450
JBL 4311 BRAND NEW 3 WAY	£500
CADAC MONITORS WITH AMPS	£1000
B.E.L. STEREO FLANGERS, BRAND NEW	£450
HAMMOND A100 WITH LESLIE CABINET	£1500
BECHSTEIN 7' 6" GRAND PIANO RESTRUNG	£2000
CROWN D 150	£275
Sound Techniques Poweramps ideal for monitor or foldback	£50.00 each

STUDIO COMPLEX IN WEST END, 2 STUDIOS 16 TRACK & 8 TRACK AVAILABLE AS GOING CONCERN.



Leever-Rich Proline 1000 recorder

MANUFACTURER'S SPECIFICATION

Power requirements: 200/240V 50Hz direct drive version, 110/240V, 50/60Hz servo version.

Speeds: 9.5cm/s and 19cm/s, or 19cm/s and 38cm/s.

Speed stability: servo capstan better than 0.01%.

Tape slip: $\leq 0.1\%$.

Peak weighted wow and flutter: 38cm/s 0.05%, 19cm/s 0.08%, 9.5cm/s 0.15%.

Spool capacity: max 29cm, will accept European NAB and cine centres.

Rewind time: at max speed 730m in less than 100s.

Start time: to rated speed at 38cm/s less than 0.1s, to 0.1% wow and flutter at 38cm/s 1s.

Tape tension: electronic servo tape tension system controlled by a sensing arm and damped by an air dashpot. Tension maintained to 80g \pm 10g throughout a NAB spool.

Tape counter: reads in minutes and decimals of a minute driven by the tape. Correct at 38cm/s, multiply by a factor of two for 19cm/s.

Overall frequency response: at 38cm/s ± 2 dB 30Hz to 18kHz, ± 1 dB 100Hz to 10kHz. At 19cm/s ± 2 dB 30Hz to 16kHz, ± 1 dB 100Hz to 10kHz. At 9.5cm/s ± 2 dB 30Hz to 12kHz.

Equalisation: switchable to either NAB or DIN.

Crosstalk: stereo better than -40 dB, twin track better than -55 dB.

Overall unweighted noise (below 320nWb/m): at 38cm/s mono -62 dB, stereo -58 dB, twin-track -56 dB. At 19cm/s mono -60 dB, stereo -56 dB, twin-track -54 dB. At 9.5cm/s mono -56 dB, stereo -54 dB, twin-track -52 dB with DIN equalisation.

Distortion at 1kHz: less than 1% at 320nWb/m at 38cm/s or 19cm/s.

Bias frequency: 100kHz nominal.

Erasure: at 1kHz at 320nWb/m better than 70dB.

Line input: symmetrical free from earth, nominal input level $+8$ dBm, minimum input level for 320nWb/m tape flux -14 dBm.

Line output: symmetrical free from earth. Output impedance approx 50 Ω , nominal load impedance 600 Ω , min 200 Ω . Nominal output level $+8$ dBm, max output level into 600 Ω $+20$ dBm.

Track widths: mono full track 6.25mm, stereo two 2.75mm, twin-track two 2.20mm.

Price: stereo version in console £2250. Monitor amplifier £60. Tape store £58.

Manufacturer: Leever-Rich Equipment Ltd, 319 Trinity Road, Wandsworth, London SW18.

THIS PROFESSIONAL RECORDER is a 2-speed machine with a choice of either 38cm/s and 19cm/s, or 19cm/s and 9.5cm/s, and full-track, stereo and twin-track versions are available. Whilst the review model was a console version fitted with the optional loudspeaker monitoring, VU meters and a tape rack below the machine in the console, portable models are available with or without control panels and there is also a trolley mounted version. All tape transport functions can be remotely controlled and a variable speed unit plugged into the servo capstan version.

The tape transport is based on a solid alloy casting used to mount the three motors and tape guidance components including the plug-in head-

block which is fabricated out of alloy plate. The mains transformer and tape transport logic are mounted onto this main casting—however it does remain cool in operation.

Outer rotor motors with solenoid operated band brakes are used to drive the spools directly, the hubs being of the cine type with knurled threaded retainers to secure either cine spools or NAB adaptors. The tape path from the pay-off spool follows a fixed guide, a sprung post guide and then to a large diameter roller, the post guide being associated with a photoelectric sensor with servo controls for tape tension. In the fast wind modes, the tape bypasses the headblock and passes directly to a large diameter rotating guide

which drives the tape counter, this being a mechanical counter calibrated in minutes and decimals of a minute at 38cm/s only; and finally to the take-up spool via a sprung post guide.

In the play and record modes, the tape is brought into contact with the heads by the pinch roller at the exit from the headblock and by a large diameter roller guide at the entrance to the headblock with the headblock itself having a fixed guide at the entrance and exit. The stereo review machine was fitted with a full-track ferrite erase head, metal record head, flutter roller and a metal replay head—all were very solidly mounted by four threaded bolts.

Behind the headblock is located a 3-position switch which acts as a mains on/off switch and selects high or low speed operation. A pair of concentric rotary switches to the left of the machine select local or remote operation and high or low tape tension for respectively NAB or cine type spools. Tape motion is controlled by interlocked pushbuttons for stop, play, record and spool, the latter being controlled in speed and direction by a potentiometer to the right of the tape transport. The final transport control is an edit button which when depressed brings the tape into contact with the heads without engaging the capstan in either the spool mode or the stop mode. Access to the heads for editing was excellent and the console version of the machine is equipped with an editing block with three cutting angles.

With the exception of tape runoff, when the spool took a long time to come to a halt, the tape handling qualities of the machine were excellent with the tape running very clean on the heads and guides and cleanliness of spooling being very good. Most sensibly the manufacturer has not only provided a variable speed spooling control, but also limited the maximum spooling speed which is a downfall of so many tape transports.

Mechanical construction standard was good but obviously not up to that of machines with twice the price tag, and the tape transport gave an impression of sound mechanical engineering and careful assembly.

Turning now to the electronic parts of the machine, the console version reviewed had a sloping panel in front of the tape transport incorporating monitoring facilities and two 'record select' buttons; the small elliptical monitoring loudspeaker being beneath the sloping panel. In addition to loudspeaker monitoring, jack sockets are provided for both high and low impedance headphones. The main feature of the monitoring panel was two good sized VU meters (with the option of PPM's) underneath which are red 'record' lights and a paddle switch which switches the VU meters to line in, line out or to follow the monitor switching.

The latter is switched by two further paddle switches one of which selects channel 1, channel 2 or the combination of the two channels to the monitor loudspeaker and the second switch selects line in, line out or monitor off. Monitoring level for the headphone outputs and for the loudspeaker is controlled by a potentiometer below the selector switches.

The card frame contains record and replay electronics and the monitoring amplifier, and is located below the monitor loudspeaker, the frame comprising a printed circuit mother board into which the individual circuit boards plug by means of printed circuit connectors, these connectors

It all adds up to the world's most versatile sound system.

Millbank produce well engineered, well styled sound equipment backed by a 2-year guarantee. At Millbank, we are proud of our flexibility.

With PAC-SYSTEM, we offer you the widest available range of plug-in system variables. Millbank is the only company in the world with plug-in ambient noise sensor, graphic equaliser, monitor amplifier, AM and FM tuners - and total system status monitoring. In fact, you can get from us any-

thing you need for a reliable installation - simply and economically - because everything plugs in: no costly specials.

When you start with a Millbank system, expansion is virtually limitless. Our sound systems are used in every type of public building from airports to supermarkets, cafes to concert halls. Every major product is researched, designed and manufactured in the United Kingdom.

“Mind the doors, please...”

(Public address system, Metro Underground, Brussels.)

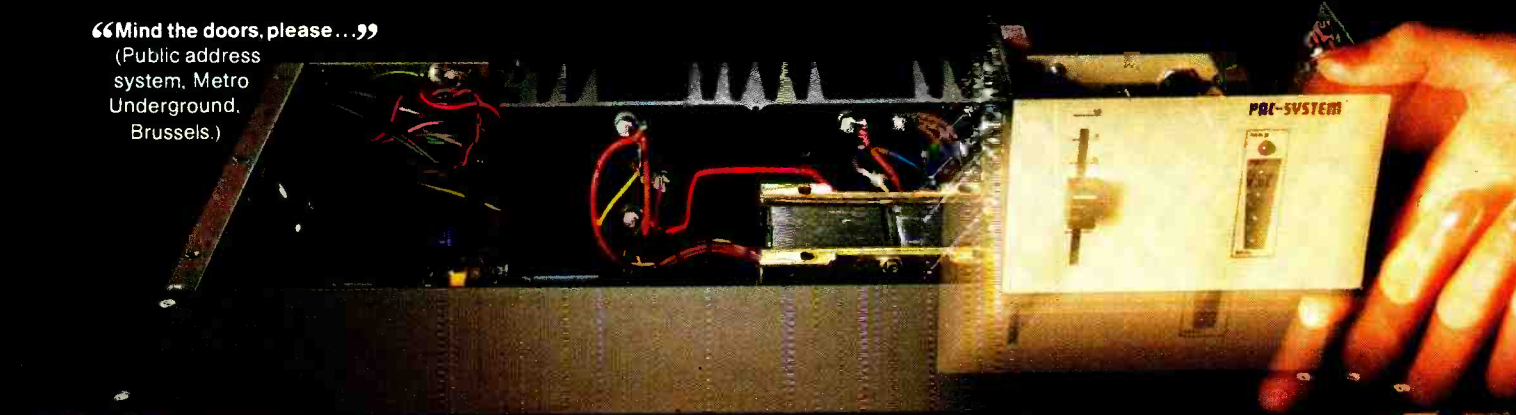

“Mr. Lee to the Personnel Office, please...”

(Factory call system, Selko Watch Service Centre, Kuala Lumpur.)



“Half-time score at Anfield is one-all...”

(Public address system, Arsenal Football Ground, Highbury.)

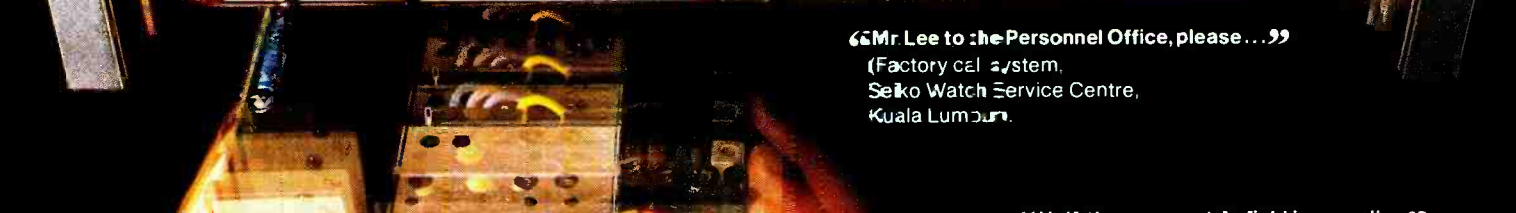

“Stand by to receive helicopter...”

(Operational instructions, Frigg oil rig, North Sea.)

“The round-London coach tour leaves in 5 minutes...”

(Public announcements, Hilton Hotel, London)



THE NAME THAT SAYS IT ALL

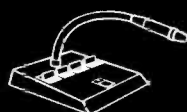

Millbank Electronics Group Limited, Uckfield, Sussex TN22 1PS. Telephone: Uckfield (0825)4166

International: 825 4166 Telex: 95505 MILLBANK G. Cable: Eurand Uckfield Sussex

being keyed so that boards cannot be inserted in incorrect positions.

The replay amplifiers have four screwdriver-operated front panel controls which provide gain and high frequency equalisation adjustment for the two tape speeds. Equalisation time constants are altered by a plug-in piggyback board on the main replay amplifier board, the plug-in board having a switch for changing between NAB and CCIR equalisation, there being an onboard potentiometer for adjusting the correct relationship between the two equalisations. Two further potentiometers on the main board allow adjustment of the low frequency equalisation.

Like the replay amplifiers, the record amplifiers have screwdriver-operated controls for high frequency equalisation and record gain at the two tape speeds, but other than the NAB/CCIR switch on the board and the bias trap, there are no further adjustments. Bias is adjusted by four front panel potentiometers on the oscillator board which is provided with solder links for driving full-track or twin-track erase heads.

The remaining electronics comprise voltage stabiliser and monitor amplifier boards. All the boards are uncrowded in layout but lack component identifications for servicing. However, the instruction manual includes excellent layout diagrams and instructions for both electrical and mechanical alignment. In addition there are exploded diagrams of the tape transport and full parts lists.

Within the console, the monitor panel, card frame and tape transport are connected by multi-way cables such that it is easy to gain access to individual assemblies by hinging the machine upwards—a tilt lock being fitted.

Signal inputs and outputs are by means of XLR connectors at the rear of the console with input and output transformers being fitted to the card frame mother board. Mains powering is via an IEC connector on the tape transport with an adjacent properly identified mains fuse; also on the rear of the tape transport are the multiway connectors for a remote control unit and a connector space for a varispeed unit.

In operation the machine was extremely quick and easy to lace and always ran without significant noise from the tape transport. Whilst the tape transport controls were rather basic types of push-buttons, the electronic interlocking could not be fooled and mains power failure did not spill tape even in the fast wind modes. While you can drop the machine into the record mode, it is not possible to drop out of record and all other changes of mode necessitated first entering the stop condition and then selecting the desired mode (with the exception of the edit mode when fast winding).

Replay performance

Checking the replay frequency response using CCIR 35:25 equalisation at 38cm/s and a Basf DIN38 calibration tape showed that both channels were within $\pm 1.5\text{dB}$ -0.5dB as the machine was received, but re-alignment reduced these errors to $\pm 0.4\text{dB}$ from 31.5Hz up to the limit of the calibration tape at 18kHz. Similarly, the performance at 19cm/s was improved by careful alignment until it was within $\pm 0.5\text{dB}$ from 31.5Hz up to 18kHz—however, at both speeds the equalisation potentiometers were found to be rather coarse in action. Fig 1 shows the available range of replay equalisation which is more than adequate at about $\pm 5\text{dB}$ at 18kHz at 38cm/s tape speed and

FIG. 1
PROLINE 1000
REPLAY
EQUALISATION
RANGE

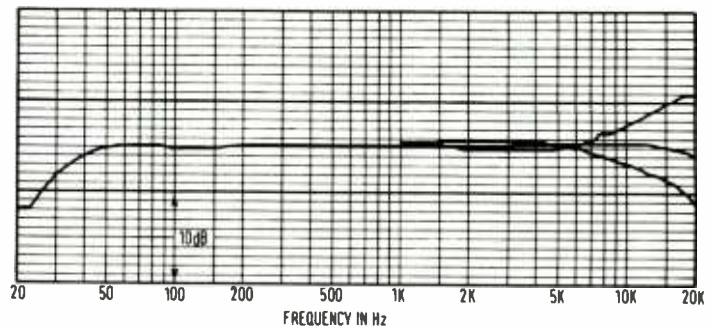

FIG. 2
PROLINE 1000
RECORD/REPLAY
EQUALISATION

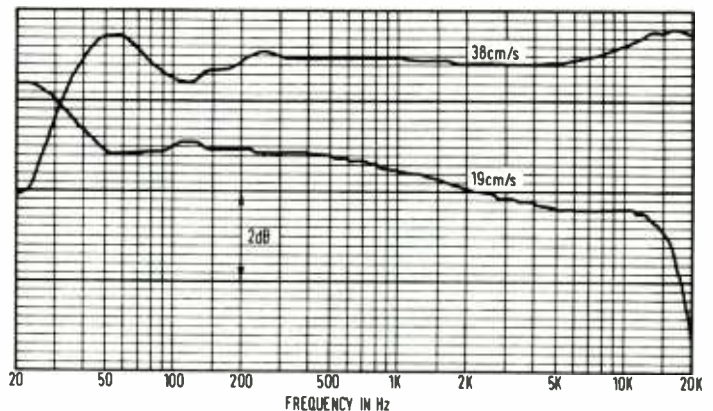
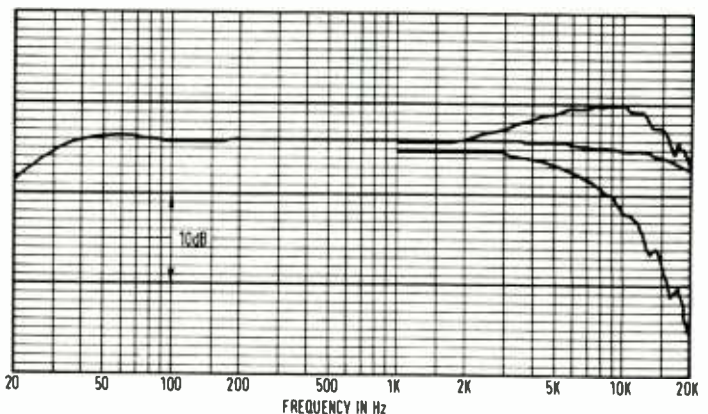

FIG. 3
PROLINE 1000
RECORD
EQUALISATION
RANGE



it is felt that either this range could be usefully reduced or multi-turn potentiometers used in lieu of the existing 270 devices.

A recorded fluxivity of 320nWb/m was found to give an output of $\pm 7\text{dBm}$ with the replay gain control providing a range from effectively zero output up to $\pm 20\text{dBm}$ —here again the control setting is too coarse in action. An indication of zero VU when monitoring the output corresponded to -3dB with respect to a recorded fluxivity of 320nWb/m and an output level of $\pm 4\text{dBm}$ —these settings being sensible.

The replay amplifier was found to be capable of handling levels in excess of -20dB with respect to a recorded fluxivity of 320nWb/m and therefore capable of handling any current or foreseeable tape with ease. Measurement of the machine noise without tape and also the noise from machine erased EMI 816 tape for which the machine was aligned gave the results in Table 1 which were effectively identical for the two channels using CCIR equalisation.

CS-800 STEREO POWER AMPLIFIER



Distributed in the U.K. and Ireland by
**COMMERCIAL DIVISION,
PEAVEY ELECTRONICS (UK) LTD,
UNIT 8, NEW ROAD, RIDGEWOOD,
UCKFIELD, SUSSEX TN22 5SX**



TABLE 1 REFERENCE LEVEL (320nWb/m) TO NOISE RATIO

Machine only (no tape)	38cm/s	19cm/s
Band limited 22Hz to 22kHz RMS	62dB	62dB
'A' weighted RMS	76dB	72dB
CCIR weighted RMS ref 1kHz	69.5dB	65.5dB
CCIR weighted quasi-peak ref 1kHz	65dB	61dB
With EMI 816 tape		
Band limited 22Hz to 22kHz	58dB	58dB
'A' weighted RMS	66dB	63dB
CCIR weighted RMS ref 1kHz	57dB	53.5dB
CCIR weighted quasi-peak ref 1kHz	52.5dB	49.5dB

The figures demonstrate a satisfactory performance with good noise margin between machine and low noise tapes. No extraneous tones were found in the noise and mains hum was at a low level.

Record/replay performance

Because the machine was delivered ready aligned for EMI 8/6 tape, this was used in all the tests of the record/replay performance, other tape types having been used for assessing the mechanical performance of the tape transport. Fig 2 shows the overall record/replay frequency response at both tape speeds, it being seen that low frequency head contour effects are minimal and that the response at 38cm/s is within 1dB deviation from 35Hz to above 20kHz. Whilst the 19cm/s performance shows some droop, it is well within specification and could be improved by adjustment of the record equaliser.

The available range of record equalisation at 38cm/s is shown in fig 3, which demonstrates that there is a sensible amount of available boost and cut at 10kHz—however I will complain again about the coarseness of the control—this complaint extends to all preset controls except bias.

Using EMI 8/6 tape, the maximum output level for 3% third harmonic distortion at 1kHz at 38cm/s was found to be identical for both channels at -8dB relative to a tape fluxivity of 320nWb/m with the record amplifier being capable of giving a further 4dB of drive—I would have liked to have seen a higher drive capability here.

The harmonic distortion at the reference level of 320nWb/m is shown in fig 4 which shows results consistent with the tape type in use. Twin tone intermodulation distortion to the CCIF method measured in fig 5 shows a higher level of distortion than I would like to see, as was the intermodulation distortion to the SMPTE method which was just under 3% with the recorded level at the previous 320nWb/m. However, I suspect that the relatively low output capability of EMI 8/6 tape, in comparison with the tapes that I normally use, can account for this.

Fig 6 shows the crosstalk performance of the stereo machine when simultaneously recording on one track and replaying the other track, the low frequency and extreme high frequency crosstalk being at a low level with the midfrequency crosstalk being far better than suggested by the manufacturer's specification. Likewise the erasing capability of the machine was such that a 1kHz tone at a tape speed of 38cm/s was erased at at least 80dB, which is some 10dB better than specification.

The final test of the record/replay performance was to record and replay a 1kHz squarewave at 38cm/s, the resulting waveform being shown in fig 7 which, whilst it exhibits slight ringing, is a good performance by tape standards.

FIG. 4 PROLINE 1000 THIRD HARMONIC DISTORTION AT 38cm/s

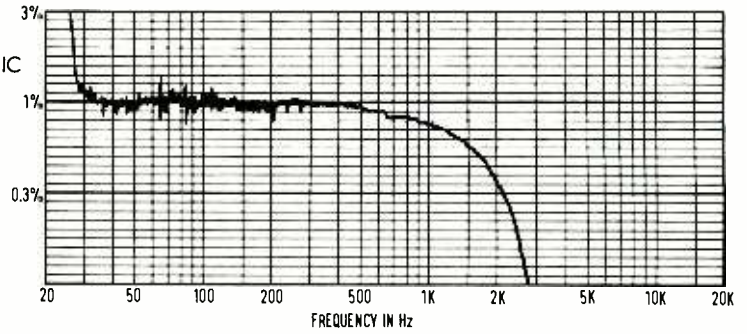

FIG. 5 PROLINE 1000 INTERMODULATION DISTORTION AT 38cm/s

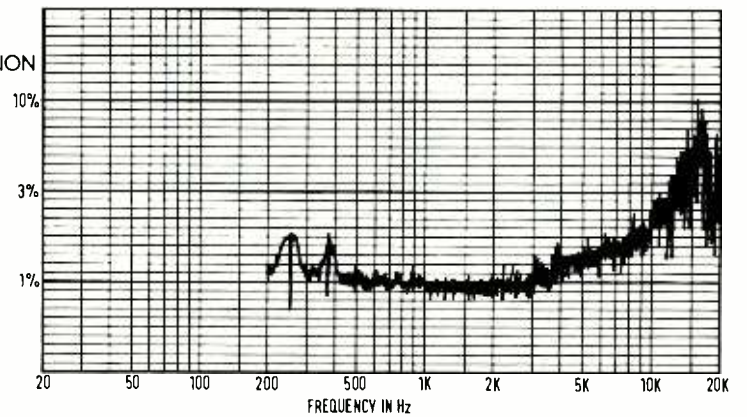
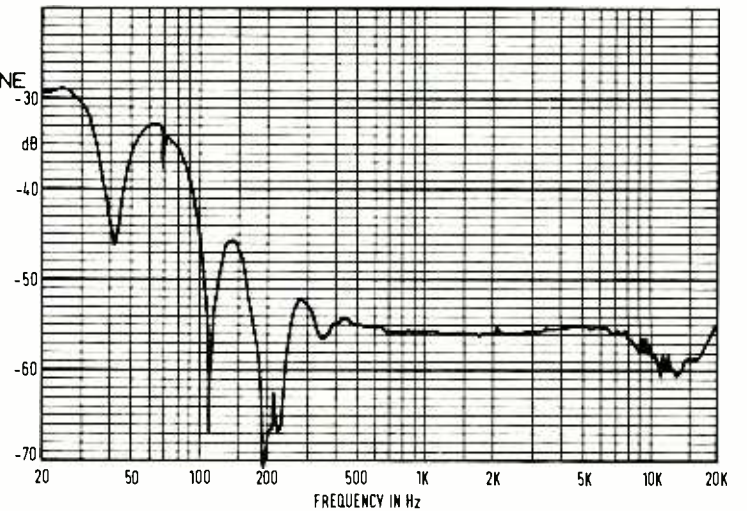

FIG. 6 PROLINE 1000 CROSSTALK ON STEREO MACHINE



Other measurements

Measurement of the wow and flutter to the IEC quasi-peak weighted method showed that at 38cm/s the wow and flutter varied to a very small extent with the amount of tape on a NAB reel, the performance at 38cm/s giving 0.025% wow and flutter and at 19cm/s 0.045%, both being respectable results but not in the very highest class.

Investigations into the scrape flutter perform-

ance by doing a narrow band spectrum analysis of a 10kHz recorded and replayed tone eventually produced fig 8 which demonstrates a very good performance.

The phase jitter between tracks using a 10kHz tone at the tape speed of 38cm/s and as seen by a Bruel & Kjaer phasemeter is shown in fig 9 which demonstrates a very high standard of performance with only ± 5 jitter.

turnkey

Our business is helping you with yours...

Considering or upgrading a multitrack system?
We offer a select range of studio equipment, backed with advice, demonstration and service. Turnkey sell, install, lease or hire.



For many years QUAD amplifiers have been a standard in UK Studios for quality monitoring. Their latest model, the 405 current dumping design is now available from TURNKEY.

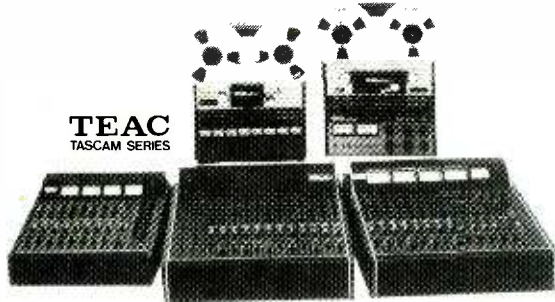

We supply and install the TEAC TASCAM multitrack system. Mixers Models 2, 3 and 5, and tape recorders 3300S, 3340S and 80-8 are suitable for both multichannel and audio production applications.

VARISPEED

By popular demand we have produced a compact vari-speed unit that can be easily connected to any fixed speed recorder. The power oscillator is housed in a free standing case and connection is via two wires to the capstan motor.

The hand held remote switches between fixed speed operation and a plus or minus 15 percent pitch control

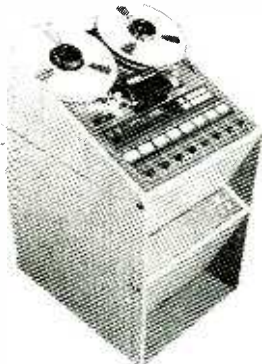

Custom rolling consoles for all TEAC recorders. A unique design permits tape storage or mounting noise reduction. Sold as a flat-pack kit.

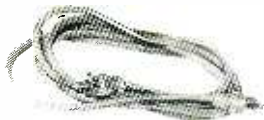

Low capacitance cables prevent high frequency loss. Now available in standard Tube-Paks.
8 Pack 18 ins, patch
4 Pack 6 ft, interconnect
2 Pack 12 ft, interconnect

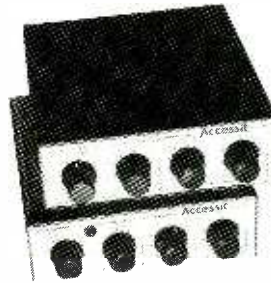

A new range of signal processing equipment designed specifically for budget installations. A versatile, expanding system that features quality and low cost.

Limiter/compressor - input, output, attack and release controls.

Parametric Equaliser - Two band boost cut control with peak frequency tuning.

Reverb Unit - For mic or line application with equalisation and mix controls.

Dual Notch - Twin tunable low frequency notches for programme filtering.



With every four track that we sell, we supply, free of charge, the remarkable 1478 mixdown mixer. Tone pan and fader on each channel, and no noise, distortion or overload.

Stop Press - Just announced, the budget stereo ten band graphic from Statik Acoustik. Phone now for details.

Monitoring Systems



Microphones and Accessories



Signal Processing



Are you ready for Multitrack ?



The Turnkey book includes comprehensive information about our products and accessories.

Please write or call for your free copy.

Teac's 16 page booklet "Are you ready for multitrack?" is also available on request.

Call Andrew Stirling at:

turnkey



So far as the absolute tape speed is concerned it was found that the machine ran slightly fast, but it is a very difficult matter to determine tape speed and although the manufacturer agrees that the machine should be 0.2% fast, I am of the opinion that it is nearer 0.4% depending upon the thickness of the tape in use.

Inputs and outputs

The XLR input connectors provide a floating input with an adequately high input impedance of 11kΩ and input sensitivity of +7dBm for recording 320nWb/m on EMI 816 tape as the machine was delivered. This sensitivity could be adjusted from -10dBm to infinity by means of the record amplifier gain control.

On the output end the XLR connectors are floating like the inputs with a satisfactorily low output impedance in the order of 55Ω. When reproducing a fluxivity of 320nWb/m the output level could be varied from -46dBm up to +20dBm by means of the replay amplifier gain controls, with the maximum drive capability being +25.5dBm (loaded into 600Ω).

Two headphone outputs are provided on jack sockets with the first low impedance output being a direct output from the internal loudspeaker drive amplifier and thus being capable of driving either low impedance headphones or an external

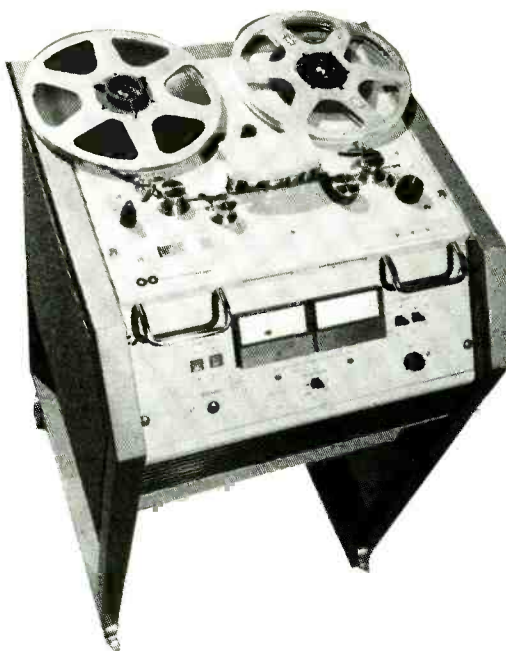

Console version of Proline 1000

loudspeaker while the second is a stereo output before the loudspeaker amplifier which mutes the loudspeaker and the low impedance headphone output. All these outputs had sensible levels available and impedances, however, all outputs suffered from high hum levels which were not particularly noticeable when using the internal loudspeaker, but objectionable with headphones.

Other matters

It was pleasing to find that genuine standard VU meters were fitted and that the overall monitoring arrangement was unusually versatile. The general finish of the machine and its console was to a high standard. The machine did not take exception to mains voltages down to 220V when the monitor amplifier hummed, but the record/replay function remained stable.

Summary

This is a well made machine with a respectable performance and it is nice to see a British recorder which I would consider highly competitive in price and performance.

Tape handling characteristics were excellent and it was a very straightforward machine to operate, the only irritation in this respect being that one had to perform the stop function when changing modes of operation. Electrical alignment was however rather tiresome due to the high sensitivity of adjustments and I would suggest that the manufacturer used multi-turn potentiometers instead of the 270° devices.

Overall this is a machine well worth looking at as a serious workhorse for general studio use and in particular for editing.

Hugh Ford

FIG. 7

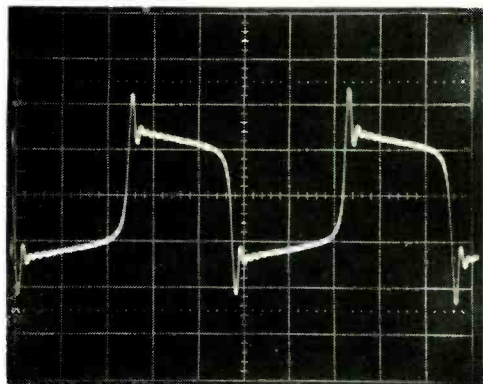

FIG. 9

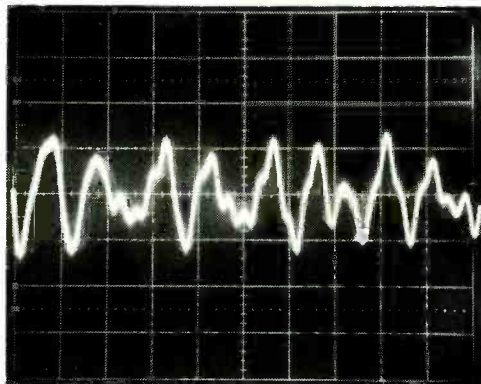
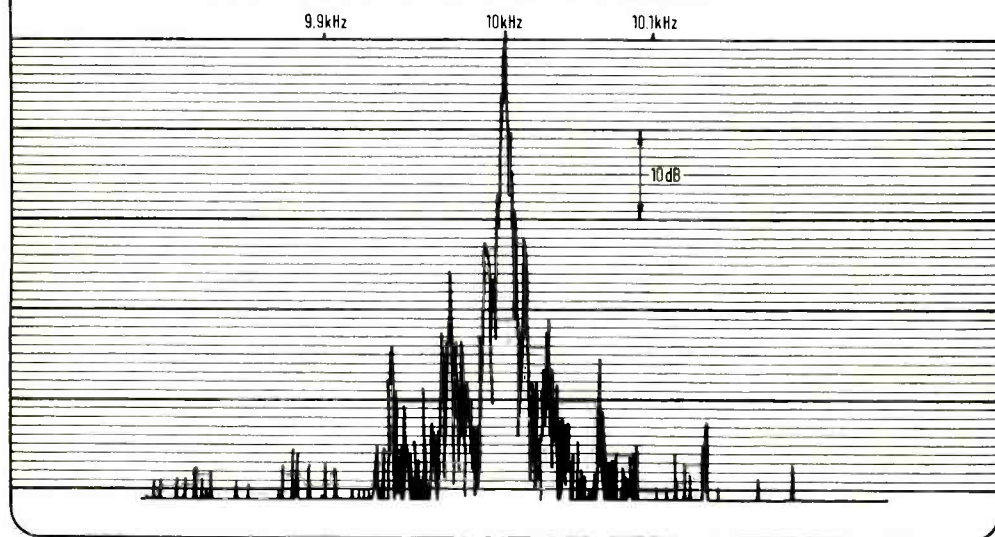

FIG. 8 PROLINE 1000 SCRAPE FLUTTER SPECTRUM ANALYSIS



agony

Kids! * ? — I spent hours setting up that patch



SR20 and SR28

MIXING BUSINESS WITH PLEASURE



The New Allen and Heath SR Series has an impressive pedigree with its origins in custom mixers for Pink Floyd and King Crimson. The SR mixer is equally at home in theatres, clubs or studios and features a unique routing system enabling the engineer to assign channels to any one of eleven outputs! At under £2000 for a 20 into 4 or 6 group model the SR Series enables any professional Sound Company or Theatre to provide studio quality performance with no sacrifice of reliability or ruggedness.

AHB
ALLEN AND HEATH BRENNELL LTD

Agents

Audiomarketing
Stamford U.S.A.
Son Professional
Paris

Intersonic
Stockholm

Fading
Madrid

Studio Sound
Frankfurt

S.E.D.
Brussels

Sun Music
Denmark

Audiolab Hellas
Greece

Peter Bollen
Eindhoven

Texim
Italy

Lastron
South Africa

- Fully modular construction allows any format up to 28 inputs per frame.
- 8 routing busses to groups and masters.
- 3 auxiliary busses for foldback and effects.
- 10 echo returns for multiple effects mixing.
- Integral stage communications system.
- Built-in oscillator with frequency sweeping.
- Sweep frequency equalization as standard.
- Phantom power as standard.
- Heavy Duty external power supply.
- XLR transformer balanced microphone inputs with low noise preamplifier.
- LED Peak reading meters with stereo monitoring.
- Comprehensive headphone monitoring system.
- Military spec multipin connector as standard.
- + 18 dBm output head room.
- P & G fader option.
- Solo (PFL) of all desk functions.
- Special dual frame option for 40 or 48 inputs.
- Heavy duty flight case (as shown).

ALLEN AND HEATH BRENNELL LTD. PEMBROKE HOUSE, CAMPSBOURNE ROAD, LONDON, N.8



Delta-Lab digital delay module DL-1

MANUFACTURER'S SPECIFICATION

Delay range: short range 0 to 100ms. Long range 0 to 160ms.

Delay accuracy: 1%.

Frequency response (at +14dB): 20Hz to 15kHz +1, -3dB.

Dynamic range: short range 'A' weighted 90dB, 'C' weighted 85dB; long range 'A' weighted 85dB, 'C' weighted 80dB.

Headroom above 0dB: 3dB.

Equivalent pre-emphasis: 50µs.

Total harmonic distortion (distortion plus noise 'C' weighted): short range 0dB 0.2%, -10dB 0.2%, -20dB 0.3%, -30dB 0.5%, -40dB 0.8%. Long range 0dB 0.4%, -10dB 0.4%, -20dB 0.3%, -30dB 0.5%, -40dB 1.0%.

Number of inputs: one.

Input level: 0 to +24dBm.

Input impedance: 10kΩ.

Number of outputs: three.

Output level: variable, front balanced up to +20dBm, front unbalanced up to +14dBm, rear balanced up to +24dBm, rear unbalanced up to +18dBm.

Output impedance: 600Ω.

Dimensions: hwd 44.5 x 483 x 254mm.

Shipping weight: 4.1kg.

Price: £726.

Manufacturer: Delta Lab Research Inc, 25 Drum Hill Road, Chelmsford, Massachusetts 01824, USA.
UK Agent: Scenic Sounds Equipment, 97-99 Dean Street, London W1.

THE DELTA LAB DL-1 is a monophonic delay line having three separate outputs which may all have different delay times, such that the unit is ideal in this respect for sound reinforcement installations. As can be seen from the manufacturer's specification, there are 'long range' and 'short range' delay facilities which offer a degradation in dynamic range and distortion in the 'long range' mode which extends the maximum delay to 160ms instead of the 'short range' capability of 100ms. Clearly these delay ranges are suitable for smaller halls, churches and so on, but there is no reason why delay units cannot be used in series for larger areas.

In the 'short range' the delay times may be selected in increments of 5ms up to 50ms beyond which the steps become 10ms up to the maximum capability of 100ms. Similarly in the 'long range' the steps are 8ms up to 80ms beyond which the steps are 16ms up to the 160ms capability.

The delay time for two of the output channels can either be selected by means of two front panel switches or by means of internal switches which inhibit the front panel controls (a very useful feature for permanent installations), whilst the

third output always has its delay time set by the internal switches.

In the case of the two delay outputs controlled from the front panel, the delay time in use is indicated by a series of LED indicators which are clearly marked with the delay time in use, but in the case of the third internally selected delay, it is necessary to examine the internal switch settings to find out what delay time is selected.

The front panel delay time settings are controlled by single 3-position toggle switches for each of the two channels. Flicking a switch to the left decreases delay time one step per flick, but flicking the switch to the right similarly increases delay time—a very nice and simple arrangement. To the left of these switches there is the input level potentiometer which has calibrations from 0 to 10 and to the left of this are two vertical rows of four LED indicators each. These are the input level overload indicators, one row for input level and the other row for input slew rate limit with the rows being identified 0, -10, -20 and -40dB.

Remaining front panel features include a long/short 'range' toggle switch, two 3-pole jack sockets,

one of which provides a balanced input which is added to the rear panel input and the other providing an output which according to a front panel toggle switch, may be either a balanced output from 'channel A' or channel 'A' and channel 'B', both unbalanced, the level being controlled by a potentiometer calibrated 0 to 10.

As with the front panel, all the rear panel functions are very clearly identified and functionally laid out. At the rear of the unit a 12-way barrier strip is provided for the balanced input and the three balanced outputs, each having +, - and ground connections. The only other feature is the fixed mains power lead which is colour coded contrary to the UK standard—why not use an IEC connector, it makes life much simpler? Unfortunately there are no components identified including the value of the two imperial size fuses (nearest hairpin please!) and no servicing information was provided.

The block diagram of the unit (fig 1) shows the overall method of operation, the balanced front and rear inputs being combined before the input level control and then being passed to an anti-aliasing filter and pre-emphasis, the overload indicators and analog to digital converter. The output of this converter, which is not a straightforward A/D converter but some unspecified form of delta modulator, is fed to the tapped digital delay line or shift register, the delay time or shifting rate of which is controlled by the clock which can be set to run fast or slow by internal or front panel controls so as to provide the 'short range' or the 'long range' delays respectively.

The three outputs can be connected to one of 16 delay line taps which in the case of outputs 'A' and 'B' are selected by an up/down counter when controlled by the front panel switches, each output being fed to a digital/analog converter followed by de-emphasis to compensate for the input pre-emphasis, and low pass filtering to remove clock rate components. From these filters the rear panel balanced outputs are controlled by preset gain controls which can be accessed through holes in the top cover. As can be seen, the front panel outputs are completely separate with the

72 ▶

FIG.1 DELTA LAB DL-1

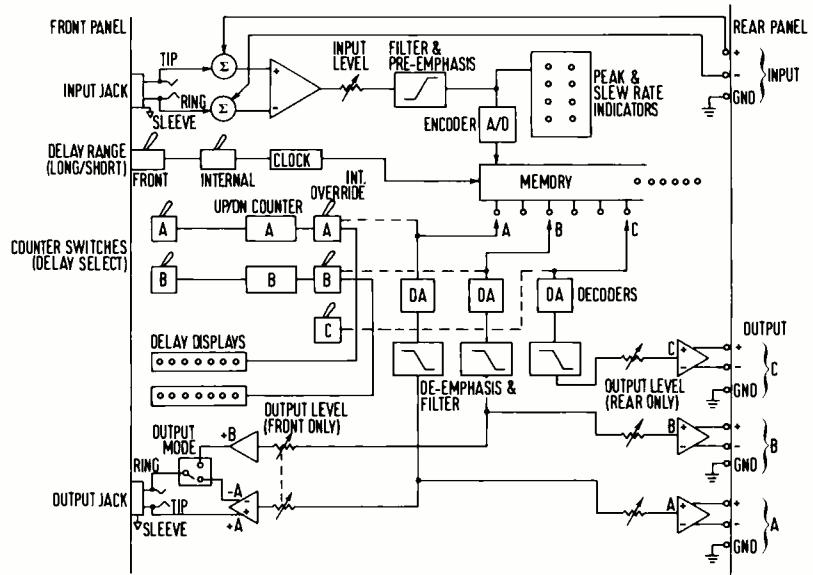

If you aren't thinking about this you shouldn't be buying a console.

Solid State Logic Ltd. Church Rd. Stonesfield Oxford England. Telephone (099 389) 324. Telex 837400

U.S.A. — Australasia: Sierra Audio Corp. 621 S.O. Glenwood Place Burbank California 91506 U.S.A.
Telephone 213 8438115. Telex 691138



32-32 Console at
Country Lane Studio
Munich Germany.

single ganged potentiometer gain control for channels 'A' and 'B' which are fed to the 3-pole front panel jack socket in accordance with the output mode switch setting.

Frequency response

The overall frequency response of the delay unit was independent of the delay time settings so far as the chosen tape is concerned and virtually independent of the long/short 'range' setting. However, reference to **fig 2** shows that the frequency response is sensitive to input level, the three plots in **fig 2** corresponding to 0dB, -10dB and -20dB input level indications at 1kHz. Something which comes as a surprise is the flatness of the frequency response up to 20kHz at low input levels and this appears to indicate poor anti-aliasing filters, a matter which is also suggested by audible beat notes even at moderate frequencies.

Noise

The noise in the output depends upon the long/short delay range setting as suggested in the manufacturer's specification, **Table 1** showing noise related to the output clipping point at 1kHz in the absence of any input signal.

	Delay range	
	Long	Short
'A' weighted rms noise	86.5dB	93.5dB
Unweighted 22Hz to 22kHz rms	81.5dB	87.5dB
CCIR weighted rms noise ref 1kHz	78.5dB	85.5dB
CCIR weighted quasi-peak noise ref 1kHz	74.0dB	80.5dB

Whilst there were little spurious clock frequency components in the output and the above performance appears to be good, this does not paint a true picture of the unit's practical performance as a result of severe noise breathing, such that the noise is in excess of 30dB in the presence of an input signal. This effect is shown in **fig 3** which is a 100Hz bandwidth spectrum analysis of the output signal in the absence of an input in the lower trace and in the presence of a 100Hz 0dB (indicated) signal in the upper trace.

These noise breathing effects would suggest that some form of compander is used in the Delta Lab delay unit and such an arrangement is typical of many digital delays and charged coupled device delays, all too many of which exhibit serious noise breathing and apparent modulation noise.

Distortion

The distortion in terms of the second and the third harmonic products is shown in **figs 4** and **5** for 0dB and -20dB indicated level respectively in the short delay range setting. As is to be expected with the use of pre-emphasis in the order of 50µs, the distortion rises rapidly at high frequencies and whilst the performance is to specification it is to be noted that the distortion minimum coincides with the 1kHz where the unit is specified. However the distortion performance at low levels is quite acceptable for many applications.

The CCIF difference frequency distortion at 20dB below the 0dB level indication is shown in **fig 6** which demonstrates a good performance up to 5kHz above which the distortion rises rather rapidly to reach 3% at 15kHz, which is considered to be rather excessive for high quality applications.

Delay time

Allowing for the basic propagation time of approximately 200µs, the delay time was very close to the nominal setting and always better

FIG. 2
DELTA LAB DL-1
FREQUENCY
RESPONSE
AT DIFFERENT
INPUT LEVELS

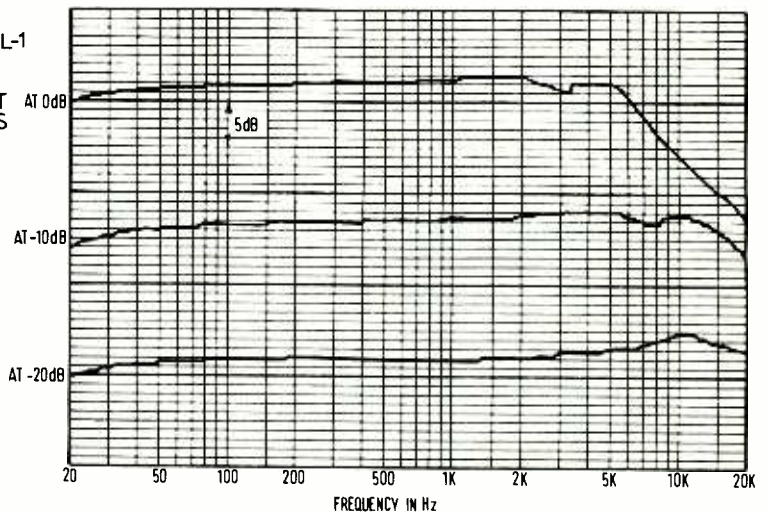

FIG. 3
DELTA LAB DL-1
100HZ BANDWIDTH
SPECTRUM
ANALYSIS

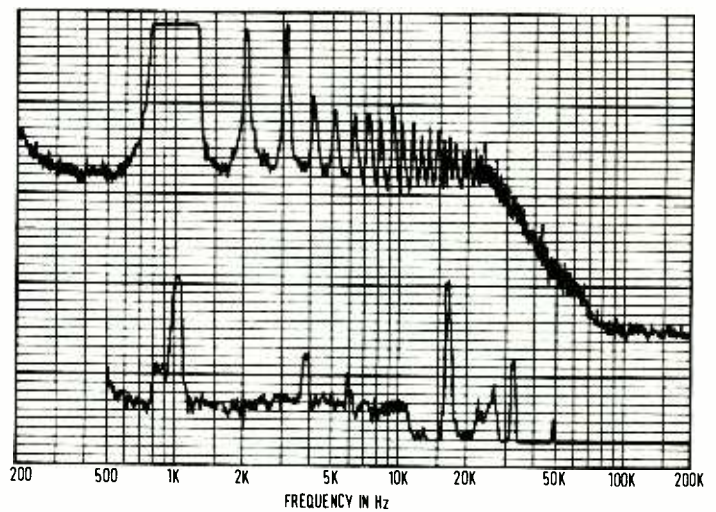
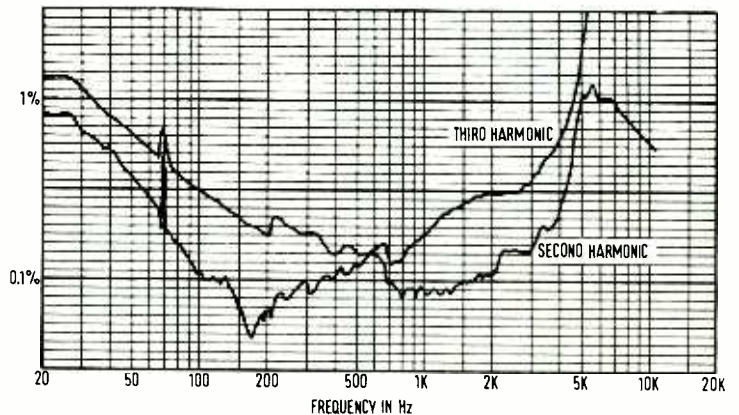

FIG. 4
DELTA LAB DL-1
SHORT RANGE
HARMONIC
DISTORTION
AT 0dB



than within 1% in both delay time ranges with all three outputs giving identical results.

Passing tone bursts through the system gave no visible degradation of the waveform irrespective of the delay time, provided that overload conditions were not approached.

Overload indications

As received, the overload level indicator showed 0dB with +2.5dBm input at maximum front panel gain setting with the gain control range allowing any higher input levels. With respect to the 0dB



ELECTRONICS SALES LTD.

Telephone : Watford 47988

FOR SALE

NEW & SECONDHAND STUDIO EQUIPMENT

M.C.I. JH 100 24T WITH 16T HEAD/BLOCK + A/LOCATE.....	£18,500
STUDER A80 16T	£11,500
STUDER A80 16T WIDE VERSION	£12,500
STUDER A80 16T WITH 8T BLOCK	£12,200
3M M56 16T WITH V/SPEED.....	£8,250
AMPEX MM 1100 WITH A/LOCATE.....	£10,000
AMPEX MM 1000 WITH V/SPEED	£6,500
SCULLY 280 8T.....	£3,000
STUDER J37 8T (VALVE).....	£2,400
STUDER C37 STEREO.....	£750
KLARK TEKNIK 8M2 STEREO	£2,000
AUDIO DEVELOPMENTS PICO MIX.....	£750
AMEK 20-16	£7,000
AUDIO & DESIGN F769 x R.....	£550
AUDIO & DESIGN E500 RS.....	£550
AUDIO & DESIGN SCAMP 524.....	£400
AUDIO & DESIGN SCAMP 504.....	£200
DOLBY M16	£4,750
ALICE 622 MIXER.....	£200
ORBAN S16EC 3CH UNIT.....	£300
AUDIO DEVELOPMENTS 007 MIXER.....	£1,100
KLARK TEKNIK DN22	£400
WHITE SPECTRUM ANALYSER.....	£950
EMT WOW & FLUTTER MIXER	£500
FERROGRAPH TEST SET	£300
2 CADAC MOTORS & AMPS.....	£500
MXR 31 BAND GRAPHIC.....	£320
MXR COMPANDER	£150
OTARI ½" 4T AS NEW.....	£1,500
TRIDENT 24-16-16	£11,500

ALL PRICES PLUS VAT

The TRADEQ Spring Reverb

- 19" RACK MOUNTING
- XLR TYPE CONNECTORS
- INPUT LEVER + BASS LIFT CONTROLS
- LIMITER ON INPUT
- PEAK READING
- VERY LOW NOISE
- THREE SPRING SYSTEM
- 12 MONTHS PARTS + LABOUR WARRANTY

PRICE £175.00 MONO

£275.00 STEREO

OVERSEAS AGENTS REQUIRED

Webber TEST TAPES

¼" NAB OR CC1R	£18.00	7½" OR 15 IPS
½" NAB OR CC1R	£28.00	7½" OR 15 IPS
1" NAB OR CC1R	£92.00	7½" OR 15 IPS
2" NAB OR CC1R	£170.00	7½" OR 15 IPS
2" A.E.S.	£180.00	7½" OR 15 IPS

ALL EX STOCK

ALL PRICES PLUS 8% VAT HOME MARKET AGENTS REQUIRED IN ALL COUNTRIES

WE PAY CASH FOR STUDIO EQUIPMENT PART X WELCOME

149B ST. ALBANS ROAD, WATFORD, HERTS.

Tel. WATFORD 47988

Telex 262741

indicator, the other indicators became illuminated at the levels in Table 2.

TABLE 2	Indicator	Input level
	0dB	0dB
	-10dB	-9dB
	-20dB	-16.3dB
	-40dB	-27.5dB

From Table 2 it is clear that the indicator calibration is somewhat arbitrary and because the slew rate indicator's function was not described in the available literature, I am unable to comment upon its accuracy. However all indicators had a fast attack time with a fast release time which made the visibility poor on transient overloads—a hold on the release time would be useful.

Inputs and outputs

The front and rear panel inputs exhibited practically identical sensitivities and both were balanced inputs with impedances constant with the setting of the input level control. The rear input showed an input impedance satisfactorily high at 9900Ω with the front panel input having an impedance on the low side at 7600Ω. Both inputs could accept levels in excess of +24dBm without input overload, the 0dB overload indicator having a 3dB margin before the onset of clipping.

On the output end, all outputs had a nominal

600Ω impedance for each leg of the electronically balanced arrangement, the measured impedance being slightly on the high side between 615Ω and 625Ω. The output drive capability was excellent at +23.5dBm (loaded into 600Ω) with the output level controls having a full range.

Summary

In many ways the facilities of this delay device are excellent, particularly for sound reinforcement applications where the delay times can be internally preset, being therefore tamper proof. Certainly the performance is very good for speech work, but I have reservations about the noise breathing and also the characteristics of the anti-aliasing filter for music applications, particularly where large energy is to be found in the high frequency bands.

This feeling was confirmed by passing a 38cm/s recording of a rattling bunch of keys through the delay unit. The direct replay was clean and had presence, but the delayed replay was decidedly 'mushy', completely lacking presence and suffering from severe modulation noise effects.

In conclusion I feel that this delay unit (in common with many) has undesirable characteristics for high quality audio work, but will be entirely satisfactory for lower quality applications such as pre-reverberation delay and many effects applications.

Hugh Ford

FIG. 5
DELTA LAB DL-1
SHORT RANGE
HARMONIC
DISTORTION
AT -20dB

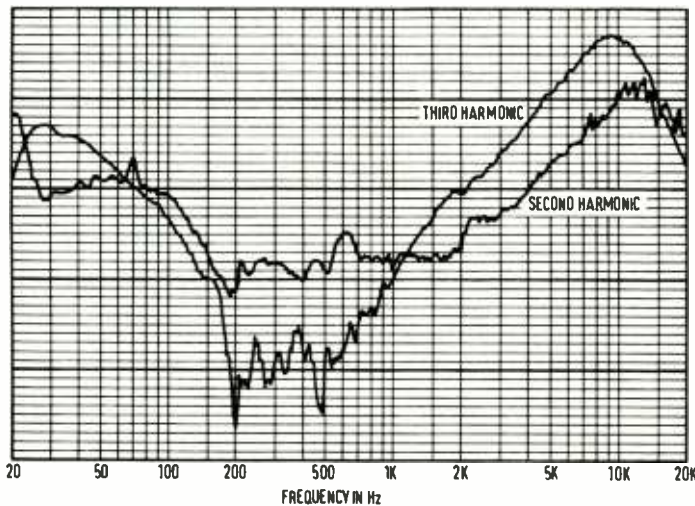
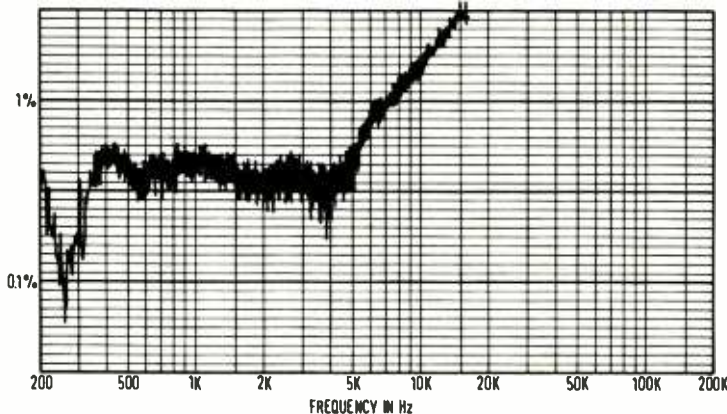

FIG. 6
DELTA LAB DL-1
DIFFERENCE
FREQUENCY
DISTORTION
AT -20dB



JBL PROFESSIONAL DEALERS
IN THE U.K.

REW

REW Audio Visual
146 Charing Cross Road
London WC2
Telephone 01-836 2372/7851



FORMULA SOUND LIMITED
FORMULA SOUND LIMITED
3 Waterloo Road
Stockport, Cheshire
Telephone 061-480 3781



Kirkham Electronics
Mill Hall, Mill Lane,
Pulham Market, Norfolk IP21 4XL
Telephone (037 976) 639

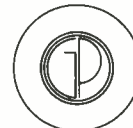

GRAHAMS PROFESSIONAL

Grahams Electrical
86-88 Pentonville Road
London N1
Telephone 01-837 4412



PROFESSIONAL AUDIO SYSTEMS
35 Britannia Row
London N1 8QH
Telephone 01-359 0956



P. A. Hire & Sales
Unit F New Crescent Works
Nicoll Road
London NW10 9AX
Telephone 01-961 3295

For further information contact
Harman (Audio) U.K. Ltd.

St. John's Road
Tylers Green
High Wycombe
Bucks HP10 8HR
Telephone
0494-815221



GET IT ALL

HEAR FROM US BEFORE YOU HEAR FROM THEM.

Today's broadcasting equipment and standards let you transmit things you never could before.

Like tape hiss, cue tone leakage and turntable rumble, to name a few.

And that's precisely why you need the JBL 4301 Broadcast Monitor.

It lets you hear everything you're transmitting. All the good stuff. And, all the bad. So you can detect the flaws before your listeners do.

The 4301 is super-compact, so it fits all EIA Standard racks. 19" h x 11½" d x 12¼" w.

And it's made by JBL. The recognized leader in professional sound equipment.

Just give us your name and address and we'll send you all the 4301's very impressive specs.

Along with the name of your nearest JBL Professional Products Dealer.

He'll tell you everything you need to hear.



GET IT ALL.



James B. Lansing Sound, Inc. / Professional Division, 8500 Balboa Boulevard, Northridge, California, U.S.A.

REVIEWS

AVAB visu-lizer



MANUFACTURER'S SPECIFICATION

Input: 3-pole DIN self-locking type, input impedance 1.5k Ω , balanced input stage.
Range: 49dB to 130dB SPL in three calibrated ranges, 3-position range switch 49-85dB, 64-100dB, 94-130dB.
Filter centre frequencies: according to the ISO

Standard, 31.5, 63, 125, 250, 500, 1k, 2k, 4k, 8k and 16kHz.
Filter slope: 12dB/octave.
Centre frequency accuracy: $\pm 5\%$ max.
Amplitude accuracy: ± 0.1 dB/division, ± 1 dB full scale.
Dynamic range: 36dB SPL with 3dB per division.
Rectifiers: each channel is rectified and filtered individually. The time constants are chosen with respect to pink noise characteristics.
Filters: 10 4-pole Chebychev octave bandpass filters to IEC 225.
Roll-off filter: roll-off position gives a frequency characteristic which falls from 1kHz at 3dB/octave.
Power supply: 15V DC battery eliminator.
Display: TV receiver (B & W or colour) switched to UHF channel 35 CCIR scanning.
Connection: coaxial type L604/S, plug L1956.
Noise generator: pink noise 20Hz to 20kHz ± 1 dB, digital pseudo-random noise.
Output impedance: 100 Ω .
Output level: 500mV maximum in position 0dB, 5mV maximum in position -40dB.
Power supply: 2 9V batteries type PP3 or 15V DC battery eliminator, centre pole negative.
Microphone: Beyer type M101N dynamic omnidirectional.
Impedance: 200 Ω .
Sensitivity: -57dBm 103 mV/Pa.
Dimensions: Visu-Lizer 294 x 94 x 40mm.
Weight: 0.8kg noise generator 110 x 60 x 32mm, including batteries 0.3kg. Complete system 3kg.
Price: 5,000 Swedish Krone (£590).
European Distributor: Tommy Jenving AB, Karl Johansgate 98, 41451 Göteborg, Sweden.

THE AVAB *Visu-Lizer* is an octave band spectrum analyser which uses an ordinary domestic television set for the display of octave band levels. The analyser comes in a small plastic briefcase complete with separate pink noise generator, microphone, microphone stand, battery charger/power supply and connecting leads.

The *Visu-Lizer* itself comprises a long flat metal box with three controls and three connectors: Controls consist of paddle-type toggle switches for power on/off, a filter with 'flat' and 'rolloff' characteristics and a 3-position range switch providing full scale deflections on the television screen of 85dB, 100dB and 130dB SPL. Power is supplied from the separate power supply at 15V DC via a socket, the remaining connections being a 3-pin locking DIN socket for the microphone and a normal Belling Lee type aerial connector for feeding the radio frequency output on UHF channel 35 to the television receiver.

On the top of the *Visu-Lizer* a silk screened diagram of the television display is provided showing the calibrations for the three ranges, the display being in the form of a vertical bar for each of the 10 octave bands from 31Hz to 16kHz inclusive, there being black horizontal lines at 3dB intervals with a total displayed range of 36dB.

A Beyer Dynamic M101N(C) microphone is provided together with a folding desk-top stand and an adequately long connecting lead, but the supplied frequency response plot for the microphone showed that its frequency response fell-off substantially in the bass and shelved substantially in the treble above 5kHz. Although a note was provided on the microphone to this effect, it would appear that the writer of the note misinterpreted the frequency response plot and thus had

supplied insufficient corrections (which were a nuisance in use anyway).

Whilst power to the *Visu-Lizer* is always from the external power supply, the pink noise generator has an internal rechargeable battery as well as being able to be powered from the external power supply. However both pink noise generator and the *Visu-Lizer* cannot be simultaneously powered from the external power supply which is in the

TABLE 2

Frequency	32	64	125	250	500	1k	2k	4k	8k	16kHz
Without rolloff	+0.8	+0.6	+0.6	+0.2	+0.3	0	+0.2	+0.8	+0.4	-0.1dB
With rolloff	+0.8	+0.6	+0.6	+0.2	+0.5	+1.0	+3.4	+6.7	+9.0	+11.0dB

FIG. 1
AVAB VISU-LIZER
PLOTTED
FREQUENCY
RESPONSE

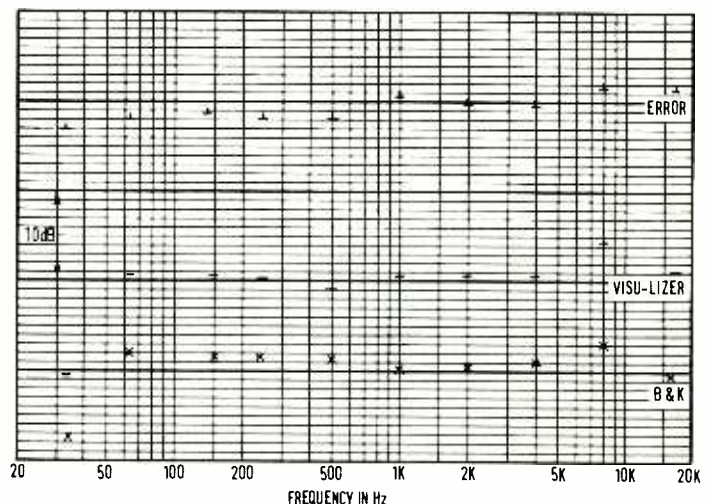

form of a box with two mains powering pins on the Continental centering, thus requiring the use of a shaver adaptor or similar in the United Kingdom, the DC output being fed by a sensibly long lead.

Turning to the pink noise generator, this is housed in a hand-held size diecast alloy box with a black finish and clear identifications of the controls and connectors in white. Three controls are fitted, a power on/off toggle switch with an adjacent red LED power indicator, a potentiometer type output level control and a further toggle switch for an additional 40dB attenuation of the output level.

Performance

Initial attention was directed at the characteristics of the octave filters and their centre frequencies, Table 1 showing that the filters are reasonably close to octave filters.

TABLE 1

Nominal centre frequency	Measured centre frequency	-3dB points		Band-width
31.5Hz	32.3Hz	23Hz	42Hz	19Hz
63Hz	62Hz	47Hz	84.7Hz	37.7Hz
125Hz	126Hz	92.5Hz	170Hz	77.5Hz
250Hz	251Hz	186Hz	340Hz	154Hz
500Hz	493Hz	374Hz	684Hz	310Hz
1kHz	980Hz	739Hz	1.33kHz	591Hz
2kHz	1.9kHz	1.46kHz	2.68kHz	1.22kHz
4kHz	4.07kHz	3.02kHz	5.39kHz	2.37kHz
8kHz	7.97kHz	6.14kHz	10.71kHz	4.57kHz
16kHz	15.9kHz	11.66kHz	21.5kHz	9.84kHz

The sinewave frequency response of the *Visu-Lizer*, without the microphone in use, is detailed in Table 2 with or without the internal 'rolloff' filter in circuit, the latter providing a 3dB per octave boost such that the response of the system being examined with the *Visu-Lizer* would roll off at 3dB per octave—I consider the naming of this filter confusing.

When using the microphone in conjunction with pink noise in a real reproducing system and comparing the frequency response with a standard

78 ▶

PROFESSIONAL QUALITY AUDIO MODULES

C.M.1.

Transformer balance mic input
Full foldback/echo facilities
Routing for 8 groups
Overload indicator
3 band EQ.
Pan

G.M.1.

Full group/tape monitoring
600Ω output driver facilities
Monitor pan and gain
All class "A" module
VU meter output
2 echo returns

For further details
of our comprehensive
range of high-quality,
cost-effective, audio modules.
Call 01-558 0678

Progressive Electronic Products

593 High Road, Leyton, London E10 6PY.

Manufacturers of high-quality custom built sound equipment.

APRS

79

Wednesday 20
Thursday 21
Friday 22
JUNE 1979

EXHIBITION OF
PROFESSIONAL
RECORDING EQUIPMENT

Apply now for *Exhibition Space*

23 Chestnut Avenue,
Chorleywood, Herts,
England WD3 4HA

Probably the best cassette sound you've ever heard

Large runs for record companies and smaller runs for studios all given the same precise attention with regard to quality and speedy turnaround. **Blanks wound any length.**

Collection and delivery service door to door for both cassette and master tape copying.

SOUND
RECORDING
PLANT



Contact
Dave Rees
at
061-795 7666 to
discuss your
requirements.

25.4mm Bruel & Kjaer measuring microphone, the measured octave band sound pressure level was as shown in fig 1 which also shows the *Visu-Lizer's* error. Whilst the actual frequency response error is not enormous and does reflect the incorrect interpretation of the microphone manufacturer's frequency response data, there was a consistent over reading of 10dB on the assumption that the *Visu-Lizer* is calibrated in octave band sound pressure level—this is not however stated by the manufacturer!

The form of the bar display which is illustrated in fig 2 was found to be difficult to interpret for absolute values of level or frequency (which is essential if microphone corrections have to be added to the displayed values), one having to count horizontally to determine the octave band, and to not only count the horizontal bars, but also to do awkward mental arithmetic to find the level to which any bar ascended because of the 3dB interval between level calibration bars.

Anyhow, the accuracy of the level calibration bars was examined and found to be within ± 0.2 dB down to 27dB below full scale with an error of 0.3dB at 30dB down, 0.7dB at 33dB down and 1.5dB at the bottom of the display corresponding to 36dB below full scale.

The input sensitivity for 130dB displayed SPL was found to be -29.5dBm into an input impedance of 16.5k Ω with the accuracy of the range switch

being within ± 0.1 dB for the three ranges.

Turning now to the pink noise generator unit the noise spectrum is shown in fig 3 together with a -3dB per octave line which is the theoretical rate of attenuation for pink noise using a constant percentage bandwidth analysis, it being seen that the unit under test is close to this theoretical requirement. The output impedance was satisfactorily low at $\approx 99\Omega$ with the available noise voltage output being 0.6V rms over a measurement bandwidth from 22Hz to 22kHz, or precisely 40dB lower when the -40dB attenuator was put in circuit thus providing a low level for using microphone and similar low level inputs.

Summary

At first sight the *Visu-Lizer* is a useful device using a domestic television as a display (with consequent diminishing cost), but it was not found to be a very easy instrument to use, particularly in view of the necessity to make corrections for the supplied microphone's response errors.

Should a better microphone be supplied, it would be a quick instrument to use for producing the flattest frequency response, but reading the errors would remain a tiresome task.

Having regard to its intended use, the pink noise generator provided a satisfactory performance and the standard of construction of both parts of the instruments were to a good standard.

Hugh Ford

FIG. 2
AVAB VISU-LIZER
DISPLAY

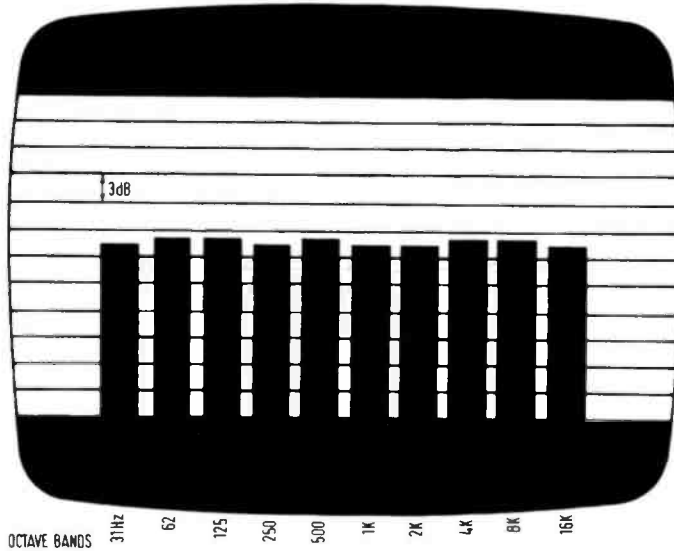
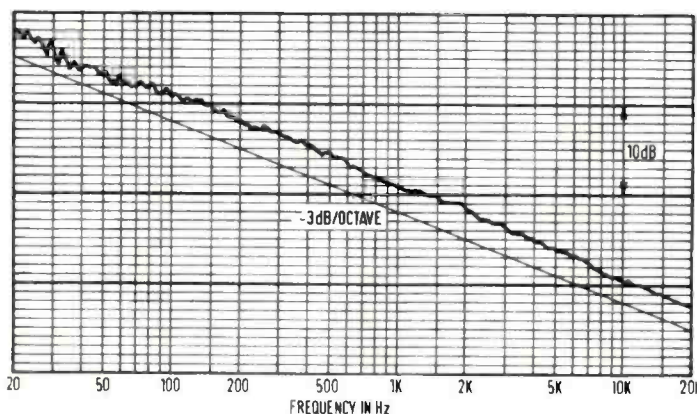

FIG. 3
AVAB VISU-LIZER
PINK NOISE
SPECTRUM



Aphex Dealers

APHEX SYSTEMS LTD.

7801 Melrose Avenue,
Los Angeles,
California 90046
Tel: (213) 655-1411
TWX: 910-321-5762

APHEX AUDIO SYSTEMS

AUSTRALIA, PTY. LTD.
(Sydney) Tel: 261381
TLX: (790) AA24035

APHEX BENELUX

(Brussels) Tel: (02) 345.44.44
TLX: (846) 26409 (TEMBEL B)

APHEX BRAZIL

(Rio de Janeiro) Tel: 205.35.66
TLX: (391) 1121008 (XPSPC BR)

APHEX AUDIO SYSTEMS

CANADA, LTD.
(Toronto) Tel: (416) 363-8138
TLX: 06225500 (OCTO TOR)

APHEX CHICAGO LTD.

Tel: (312) 642-8910

APHEX DENMARK

Tel: (01) 59 1200

APHEX COLORADO, LTD.

(Golden) Tel: (303) 278-2551

APHEX FRANCE S.A.R.L.

(Paris) Tel: (1) 500.57.87
TLX: (842) 290846 (IPARIS)

APHEX GERMANY, GmbH

(Frankfurt) Tel: (0 64 42) 53.03
TLX: (841) 184174 (INTRO D)

APHEX HAWAII, LTD.

(Honolulu) Tel: (808) 521-6793
TLX: 7430148 (SOUND)

APHEX ISRAEL

(Tel Aviv) Tel: 232-143

APHEX JAPAN, LTD.

(Tokyo) TLX: (781) 224244 (NNR)

APHEX MIDLANTIC

(Washington D.C.)
Tel: (202) 363-1223

APHEX NEW ENGLAND

(Boston) Tel: (617) 232-0404

APHEX NEW YORK, LTD.

(West Orange, New Jersey)
Tel: (201) 736-3422/(212) 964-7444
TWX: 710.994.5806 (APHEX LTD. WOGÉ)

APHEX SCANDIA

(Stockholm) Tel: 08-67.80.69

APHEX SOUTH, INC.

(Nashville) Tel: (615) 327-3075

APHEX SYSTEMS (SUISSE) SA

(Le Mont-Sur Lausanne)
Tel: 021/33.33.55
TLX: (845) 24107 (VOGUE CH)

APHEX TEXAS, LTD.

(Dallas) Tel: (214) 351-6772
TLX: 732715 (APHEX DAL)

APHEX AUDIO SYSTEMS UK, LTD.

(London) Tel: 01-359 5275
TLX: (851) 21879/25247
(TELEX G) ATTN: APHEX

APHEX WEST

(Los Angeles) Tel: (213) 655-1411
TWX: 910.321.5762 (APHEX WEST I.S.A)



Mono. Stereo. And now: Aphex.



The [®]Aphex Aural Exciter is an astonishing signal processing instrument, which brings sound to life and makes it louder without any actual level change.

This is the principle behind it.

Sound waves enter our ears with subtle phase information relating to the location of the sound source — left or right, up or down, front or back, direct or reflected. By using a sum and differencing technique, the brain provides us with our critical aural perception.

But collecting sound, mixing it and then recording it often destroys or masks much of the subtle information resulting in a “flatter sound” than the original.

However, the Aphex introduces phase information in the form of a series of minute delays, whose magnitude depends on frequency.

The formula by which Aphex selectively processes the audio signal is not random; it has been designed after considerable re-

search into the mechanisms of the ear, in particular the reflections and minute time delays caused by its shape.

Aphex is best used on selected channels, normally in the remix stage of production, fed from the echo or foldback send. The output from Aphex is then mixed back into the main signal at about -15 to -30dB.

Aphex is already famous for what it does to vocals. But any instruments with natural sound (ie not electronically produced) like snare drums, cymbals, acoustic guitars, strings and brass sound amazing when Aphexed.

Call it what you will, this effect causes no changes in level, confirming that it is truly a psychological effect.

Because the Aphex principal is young, we expect to replace it continually with new and even more exciting versions, so you can't buy it; you must lease it.

Contact us for more details, or to arrange for a demonstration.



APHEX AUDIO SYSTEMS UK LTD., 35 BRITANNIA ROW, LONDON N18QH, ENGLAND. TEL: 01-359 5275/0955.

APHEX IS A REGISTERED TRADEMARK OF APHEX SYSTEMS LTD OF LOS ANGELES, CALIFORNIA, USA.

www.americanradiohistory.com



Uher CR240

MANUFACTURER'S SPECIFICATION

Format: Compact Cassette, max 60mins recording.

Noise reduction: Dolby-B.

Tracks: 4-track stereo.

Tape speed: 4.7cm/s, $\pm 1.5\%$.

Wow and flutter: 0.20% DIN, 0.15% RMS.

Frequency response: 30Hz to 16kHz.

S/N: 59dB less Dolby, 67dB with Dolby.

Erase: better than 70dB.

Crosstalk: 68dB mono, 45dB stereo.

Inputs: mic 200 μ V at 500 Ω , tuner/rec and car radio 1.5mV-150mV, aux 150mV-10V.

Outputs: tuner/rec and car radio 775mV/1k Ω , headphones 2 x 2V/4 Ω , speaker 2 x 1W (battery).

Power supply: 6 x HP11 dry cells, nicad rechargeable, external mains power supply, 12V car battery.

Dimensions: w/d 235x59x185mm.

Weight: 2.7kg without power supply.

Prices: CR240 £344 including case, Z131 power supply £20.20, Z217 nicad for 10 hour operation £46.75, stereo microphone £32.73.

Distributor: Uher Ltd, 24 Market Place, Falloden Way, London NW11.

Editor's note: the following operational assessment details the Uher CR240's use for radio reporting by professional journalists, and is not appropriate to less demanding situations.

Independent Local Radio Stations have no automatic level control. But despite its critics, an enormously successful machine.

It was with this background that I approached the Uher cassette recorder, the CR240. This is not Uher's first move into the cassette recorder market, but this latest model comes equipped with Dolby B noise reduction and is worth a closer look.

Three different reporters at Independent Radio News and London Broadcasting took the machine on lengthy road tests. LBC's Jim Keltz who presents a country music programme was anxious to try out the CR240 at the country music festival at Wembley. Although initially impressed, Keltz discovered several niggling features about the new Uher—here's his report:

"The first time I took the CR240 out on a job I was more than a little worried about the machine's recording system. I'm sure that any company that can design a stereo set in such a neat package could have installed a 'one button' push-record system. But I must say the new Uher attracted attention. I was interviewing Don Everly of Everly Brothers fame. Just as I asked my first question he caught

sight of the CR240. 'So that's the new Uher. Wow, they really made it little didn't they and it's stereo too.' He was obviously more interested in the machine than doing the interview. A good thing too, I thought, because I was already facing problems with the new machine: little niggling ones, I grant you, but in our line of work you don't want, or need, little irritations.

"First I found that the batteries tended to fall out unless you taped down the cover. And this is a machine that costs £344. Also the case was not attached to the machine, so recording during a demonstration or riot would be foolhardy. The system for 'eating' (or loading) the cassette just didn't make any sense and it was easy to bump the lever and fire it back out at you during mid-recording.

"My worst complaint however must be with the microphone. A stereo mic on a portable tape recorder seems a great idea but surely it must be made less sensitive. You simply cannot interview outside with it because it picks up every little background noise. And if you don't stay as still as the dead when you are recording, it picks up movement noise and cable rattle. A nonsense when you are interviewing and even worse when you are in a crowd of reporters trying to talk to one man. But I must admit the CR240 never let me down in rough circumstances but it kept me thinking about it while I worked . . . a useless exercise."

Therese Birch presents LBC's highly successful children's programme *Jellybone*. She found the CR240 unnecessarily complicated.

"The first thing I look for in a cassette recorder or indeed anything that involves buttons and dials, from an alarm clock to a television set, is simplicity. My immediate reaction to the impressive array of twiddles on the Uher was to cry for help. I had decided to bypass the instruction booklet and tackle the machine on my own, but as a natural defeatist I soon sought assistance from someone 'in the know'. I did however succeed in finding out for myself how to insert the cassette (which is a nifty 'letter box' device), how to eject it with the lever below, and I managed to deduce that the button that produced a red light when depressed, must be the record button.

"But as for the many other switches like tape selection, Dolby and level knobs, I was beaten. What really foxed me was how to operate 'record'. It turned out to be a further flick of the eject switch downwards and sideways movement of another lever, marked with an arrow. But an unnecessarily complicated manoeuvre. Traditionalist

82 ►

IT IS THE WORK horse of radio broadcasting. It's been lugged on the aching shoulders of reporters round the world and dubbed by most 'the machine you love to hate'. The tape recorder is of course the Uher . . . the reel-to-reel machine that's seen more service than virtually any other portable tape recorder and of which reporters either swear by or sometimes at! But even its most ardent fans admit the 'good old Uher' has drawbacks.

First of all it is heavy—pick it up and throw it over your shoulder for the first time and its weight doesn't really seem a drawback. But carry it on your shoulders all day, following a running story and you will end up with one shoulder slightly higher than the other. The machine also has its other failings—it is difficult to 'lace up' in a hurry and it eats batteries—five at a time. Some stereo versions now in use with the BBC and most

10 OUTLET DISTRIBUTION AMPLIFIER 2



One floating input, 10 floating outputs at 600 ohms for general studio work or feeding multiple slave pa amplifiers. Electronic input circuit which withstands mains or static voltages on the signal lines.

THD, all outputs loaded 600 Ω , at ± 12 dBV.7
1KHz —86dB, 0.005%
30Hz-20KHz —66dB, 0.05%
STATIC IMD, 50Hz \pm 7KHz, 4:1
Output ± 12 dBV.7 —86dB, 0.005%
DYNAMIC IMD (DIM 100)
Output ± 14 dBV.7 sine equiv. —66dB, 0.05%

The unit meets the IBA 'signal path' specifications and is available as a complete unit or as a set of all parts excluding the case and XLR connectors.
Stereo Disc Amplifier 2 * Peak Programme Meters
Stabilizer * Peak Deviation Meter * Chart recorders
 ± 5 Hz Frequency Shift Circuit Boards and Kits

SURREY ELECTRONICS

The Forge, Lucks Green, Cranleigh, Surrey GU6 7BG
Telephone STD 04866 5997

Design,
manufacture &
installation

Audix Limited
Station Road, Wenden
Saffron Walden
Essex CB11 4LG

Tel: Saffron Walden
(0799) 40888
Telex: 817444

audix

Sound Broadcast systems

Please send details

- | | |
|--|--|
| <input type="checkbox"/> Audio mixing consoles | <input type="checkbox"/> Sound O.B. vehicles |
| <input type="checkbox"/> Self-op desks | <input type="checkbox"/> Intercom systems |
| <input type="checkbox"/> Sound reinforcement systems | <input type="checkbox"/> Switching matrices |

Name _____

Address _____

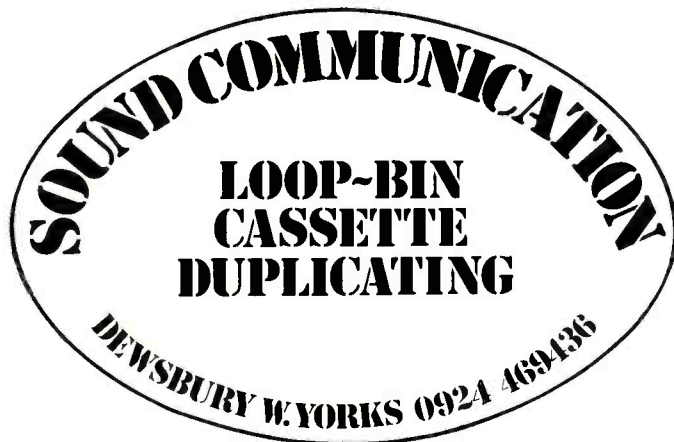

REVOX REVIVAL

WE CAN MAKE YOUR REVOX FEEL YOUNG AGAIN
SERVICING TO ORIGINAL SPECIFICATIONS OR
MODIFICATIONS

15/16 TO 30 IPS VARI-SPEED, SEL-SYNC,
FULL-TRACK, PAUSE, ETC.

SAME DAY SERVICE IF REQUIRED

COLLECTION & DELIVERY BY ARRANGEMENT

GIBSON-BRITAIN ASSOCIATES LTD.,
38 STORE ST., LONDON WC1

01 580 5352

QM2 Series

24 Inputs

8 Out 16 Track Monitor



Input noise 200ohm source-128·5dBu (1·2dB NF)
*Mixing noise 16 Ch. routed at unity gain -85dBu
Output noise -98dBu All at 20kHz bandwidth
A very quiet mixer for the small studio or Self-Op
Musician 24/8 size 176 x 70 x 30cm
*Measured at 0dBm input: Distortion 0·01% 1kHz

Very comprehensive facilities
Also 12/4 and 16/8 versions
available

CHILTON MAGNETIC TAPES LTD.

Chilton Works, Garden Road,
Richmond, Surrey, U.K.
Tel: 01-876-7957

that I am, I like to be able to see if the cassette is moving round and this just isn't possible through the frosted plastic cover positioned above the cassette slot.

"Before extolling the undoubted virtues of the machine's recording quality and other practical points, just a word about the CR240's weight. As one of the legion of radio reporters cursed with one shoulder 15cm lower than the other due to supporting the heavy weight reel-to-reel Uher, it came as no surprise to find the CR240 is also a weighty machine, although very compact. And that's good news for any reporter who, like me, has the compulsion to take three volumes of notes, clipboard, year's supply of batteries and cassettes and a spare mic on every assignment. The tough black leather case and strap look reassuring to a person who has had the salutary experience of arriving at a press conference with a cassette recorder hanging by a single thread of its plastic shoulder strap and wincing as it broke loose and crashed to the floor.

"So after the practical points, what about the CR240's recording performance. I did find it difficult to establish a good recording level—I seemed to be 'peaking' at the lowest level so I used the automatic level control which in contrast hardly seemed to register my voice at all unless I almost swallowed the mic. However at a press conference with voices at various levels and distances, the machine picked up and adjusted the voices very clearly and evenly. I had never used Dolby before and was impressed by its control of extraneous noises and also my over-sibilant S's.

"However, I did run into problems in dubbing off from the cassette recorder on to reel-to-reel tape. No fault of the CR240 but the standard jacks were not suitable at LBC so our engineering staff came to the rescue and supplied the correct jack. Then all I had to do was decide on the correct socket—a choice of about five along the side of the recorder. My first interviewee on the other end of the Uher was poet Pam Ayres. After setting the machine up for recording, everything went smoothly to my relief. Nothing is quite so embarrassing as jumping a queue to interview someone and then struggling with unhelpful recording equipment. Dubbing off was also easy and the final transmission quality was good. Pam's verdict on the new Uher? Very impressed.

"My assessment was not so enthusiastic. It's too complicated for my purposes and I never really did come to terms with the correct adjustment of the recording level. But I am quite aware that the more knowledgeable recording enthusiasts may not find this a problem. I'm going to stick to a simpler and lighter cassette recorder . . . my shoulder is still aching."

IRN's Vince McGarry used the CR240 on a series of rock interviews.

"I have the idea that, as in most other areas of life, hi-fi and stereo technology has in some ways outstripped demand. The range of equipment available, and in some cases the rather specialist applications they have, can cause bewilderment when it comes to actually laying cash out to buy the stuff.

"When I got my hands on the Uher, I marvelled at its size and toyed with it for a while, was pleased that the fine quality could come from such compact machinery—and wondered what on earth to do with it. I think there are very few people who could buy a machine like this, at its price, without thinking of including it in their normal stereo setup at home. Trouble is, it's run by batteries.

"I had a tragic and upsetting experience recently

with another machine in a similar price range. I'd put in fresh batteries, and the thing had been on for only half an hour or so, before it started sounding as if it had swallowed a crate of Valium. It ruined something I'd specially wanted. And now, no matter how much it promised not to do it again, I'd have no faith in this other cassette recorder and wouldn't use it to tape anything I absolutely desperately had to have. I've been assured that it was probably the fault of a rogue battery, rather than the machine itself, but as it happened on two occasions involving a total of 12 batteries, it's put me in a frame of mind to distrust everything.

"So it's nice to have the carry-it-anywhere quality of the Uher and similar machines but if I were going to use the equipment mainly in the home, I'd choose to spend my money in other ways. Earlier I mentioned the idea of runaway technological change, and this particular Uher seems to give a good example of it, as far as I can see. I really can't think of the need for the way the machine 'swallows' the cassette, rather like a bank card is inserted in a slot. I found while using it that it sometimes took a bit of fiddling to make sure the cassette was properly in place and working. And that brings up another point. With conventionally loaded cassette machines, you can easily see that the wheels are turning and that the machine hasn't died on you mid-flight. With this method of loading, I found it much harder. The problem is made even more difficult by the form of plastic used to protect the hole—you can barely see the cassette, let alone if the wheels are turning."

So in summary, the complaints centred mainly around the machine's cosmetic details: its weight, its appearance, its loading mechanism. Technically this latest Uher cassette recorder performed brilliantly. The quality was perfect.

But at £344 it's an expensive machine, and for radio reporters still lacks the specialised modifications that can be found on other far, far less expensive mono models.

Peter Sharp

agony

An engineer at a well known audio-visual recording studio required to use 20s or so of Handel's *Music For The Royal Fireworks* as part of a presentation for a pyrotechnics manufacturer.

In keeping with Queen's Regulations, so to speak, he obtained permission from the relevant record company and publishing house to use the work and duly approached the appropriate copyright society—not a million miles from Elgar House—to negotiate a price for the use.

To complete the picture, the recording in question was made by The London Symphony Orchestra, conducted by Charles Mackerras.

Some ten days after the engineer had telephoned all the usual information to an official at the society, the same official phoned him back with a problem, and here the plot thickens . . .

Official: "Sorry to be so long getting you a price on this one, but I'm afraid the composer has gone to Australia."

Engineer: (prompting)
"The composer . . . eh, who is the composer?"

Official: (wait for it)
"Makarios . . ."

Engineer: (wickedly)
"Archbishop Makarios?"

Official: "Well, possibly . . . um, I'm not quite sure."

Engineer: "Shall we go back and drop-in from the top?"

Somebody, somewhere, deserves a rocket (sic).

Worldwide agents for audio & design recording.

Australia

Audio & Recording, Holden Hill, S.A.
Tel: 261 1383

Austria

Soundmill Vienna, Peter J. Müller.
Tel: 222 9 444 233.

Brazil

Seris Ltd, Sao Paulo. Tel: 34 8725.

Canada

Noresco (Mfg) Co. Ltd., Ontario.
Tel: (416) 661 0541.

Caribbean

Dynamic Sounds Recording
Jamaica
Tel: 933 9138 & 9168 Tlx.: 2296

Denmark

Ole Christensen, Audiophil,
Copenhagen. Tel: (01) 341 622.

Eastern Europe

Senis Tyler Ltd., West Drayton, UK.
Tel: (089 54) 43681. Tlx 23977.

Finland

Harold Burgen, Helsinki. Tel: 692 5308.

France

3M France, Paris.
Tel: (1) 031 61 61. Telex: 695185

West Germany

Elmus GmbH, Berlin.
Tel: (030) 312 2012.

Greece

Audiolab Hellas, Athens.
Tel: 822 5222. Tlx 5800.

Holland

Pieter Bollen, Eindhoven.
Tel: (040) 512 777 Tlx 59281

Italy

Roje Telcomunicazioni, Milan.
Tel: 415 4141. Tlx 39202.

Japan

Nissho-Iwai Co. Ltd., Tokyo.
Tel: (03) 544 8311.

New Zealand

General Video Co. Ltd., Wellington.
Tel: 872 574. Telex: 31255.

Norway

Siv. Ing. Benum & Co., Oslo, 2.
Tel: (02) 56 57 53.

South Africa

Eltron (Pty) Ltd., Johannesburg.
Tel: 23 0018.

South East Asia

Brunei, Indonesia, East Malaysia,
West Malaysia, Singapore — c/o
O'Connor's (Pty) Ltd., Singapore 5,
Tel: 637 944. Tlx Oconsin RS 21023

Sweden

KMH Ijud Ab, Stockholm.
Tel: (08) 72 56 877 Telex: 13366.

United States of America

Audio & Design Recording Inc.,
Honolulu. Tel: (808) 845 7226.

UK and All Other Territories

audio & design (recording) ltd.,
Reading, UK. Tel: (0734) 53411.
Telex: 847605 a/b Tillex G.

EFFECT A CHANGE

**TWO NEW MODULES FROM ADR
TO BRING A NEW CONCEPT OF
EFFECT PROCESSING TO
THE SCAMP RANGE**

S 23 PAN EFFECTS MODULE

- ★ Automatic Panning
- ★ Patterned Sweep Control
- ★ External or Manual Trigger
- ★ Trigger, Rate & Speed Controls
- ★ Stereo Unit
- ★ Stereo/ Vibrato effect from mono
- ★ Criss-Cross or Revolving action

S24 TIME SHAPE MODULE

- ★ Automatic Double Tracking
- ★ Flanging, pos or neg
- ★ Spin, pos or neg
- ★ Limited Spin
- ★ Hall effect
- ★ Hollowing
- ★ and many, many more.....



NOW OFFICIAL!



audio & design (recording) ltd.
84 OXFORD ROAD, READING RG1 7LJ, BERKS., ENGLAND
Telephone: Reading (0734) 53411 Telex: 847 605 a/b Tillex G



PICO mixer PLUS

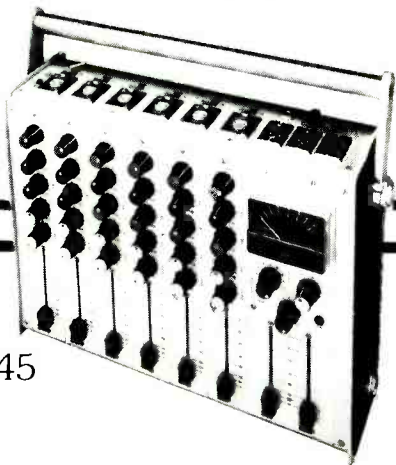

AD 045

Specially developed at the request of Thames Television and other T.V. and film production companies with Extra facilities not available on standard model.

- E Q Bypass switch.
- Phase-change switch.
- Tone Generator.
- Nickel Cadmium batteries to treble times between charges.
- Novel idea of priority p.p.m. (Two peak programme meters in space of one — reads higher of two outputs all the time with indication of left or right.)

Audio

Developments

Hall Lane, Walsall Wood
WALSALL, W. Midlands, WS9 9AU
Telephone: Brownhills 5351/2/3 (STD Code 05433)
Telex: 338212 Audio

CROWMAY

757 ROMFORD ROAD, E12 01-478 7965/6

Crowmay's New 05 Series High-Speed Duplicating Slave.

Features

- 19" Rack Mounting
- 32:1 Dupe Ratio
- Full E.Q. and Bias Adjustments on all Channels
- Compatible with any of the Crowmay Range of Master Playback Machines.

Current Price

£2,760.00 plus V.A.T.

Picture Shows:—
Two Slaves Mounted in a 19" Rack. (Rack supplied F.O.C.)

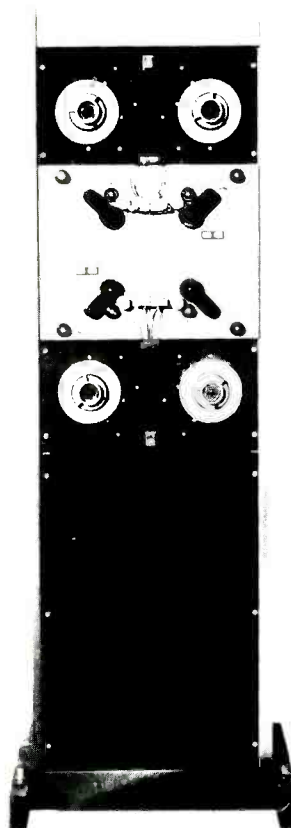

CROWMAY MASTER TRANSPORTS

- 1" 4 Channel 240 i.p.s. £5,900.00 plus V.A.T.
- ½" 4 Channel 240 i.p.s. £5,100.00 plus V.A.T.
- ¼" 4 Channel 120 i.p.s. £3,400.00 plus V.A.T.

(For 3¾ i.p.s. Masters)

ALL PRICES INCLUDE LOOP BIN.

COMING SOON:—

CROWMAY'S "IN CASSETTE"

MOBILE DUPLICATOR.

Stressing Quality

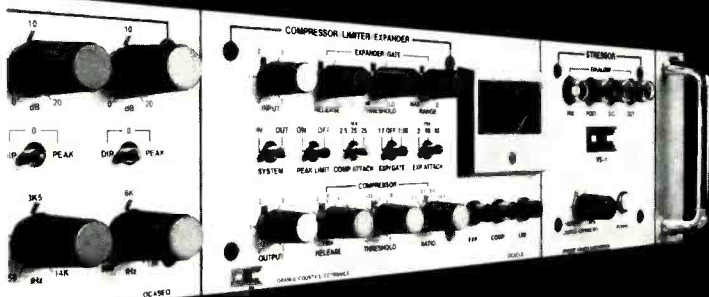

The **Orange County VS-1 Stressor** combines several necessary signal processing functions to give you the power to handle problems such as level control, noise, and equalization all in one 3½" package:

- Compressor with adjustable ratio, threshold, attack and release times, for loudness enhancement
- Fast peak limiter with 250:1 slope for overload protection
- Highly effective expander/noise-gate for noise reduction
- Full parametric equalizer with extraordinary tuning capabilities
- Overall performance specs and construction to the highest industry standard

The VS-1 Stressor belongs in your studio as a versatile and powerful production tool. It offers the creative producer/engineer the most control in any single package on the market.

Also investigate the VS-2 Stressor, which offers internally pre-set functions for the budget-conscious user looking for great sound.



ORANGE COUNTY ELECTRONICS
INTERNATIONAL INC.

Exclusive Sales & Marketing:

Parasound

Dealer Inquiries Invited

680 Beach Street, San Francisco, Ca. 94109 (415) 673-4544

Trust James not to hear the difference

And neither will you with our duplicated cassettes. You're a professional and so are we. Prove it? Certainly.

Send us a 1" master (1, 3, 5 & 7) and you'll have our copy by return - free of charge. We can't promise the same delivery with your bulk runs but we won't be far off.

For details of all our professional services ask for our leaflet.



James Yorke Ltd

Oak House, Northleach, Gloucestershire
telephone Northleach (04516) 509

We have a lot to live up to ... and we do.

SAVE OVER £800 AN 8-TRACK STUDIO PACKAGE YOU CAN'T AFFORD TO MISS...

**ALLEN & HEATH BRENELL MINI 8
STUDIO PACKAGE, COMPRISING:**

MOD II CONSOLE 16 X 8
HEAVY DUTY POWER SUPPLY
BRENELL MINI 8 1 INCH COMPATIBLE
STUDIO RECORDER
DIGITAL TAPE COUNTER
ELECTRONIC VARISPEED UNIT
PRO-LIMITER
PLUS—FREE OF CHARGE, CATHEDRAL CL4
QUAD COMP/LIMITER
FINANCE AVAILABLE

WRITE OR TELEPHONE FOR DETAILS TODAY



**CATHEDRAL SOUND LTD.,
FOURWAYS, MORRIS LANE,
HALSALL, ORMSKIRK,
LANCS. L39 8SX
TEL. HALSALL (0704) 840328**

May we introduce ourselves...

We have been well established as an important domestic Hi Fi and Video supplier for some years and we have now finalised a formidable professional audio section designed to cater for studios and professional users like yourselves.

To give you some idea of the standard we set, look at the company we keep.

We are main agents for:

- JBL (we are the only place to have 4343, 4315, 4301, 4380 monitors on dem and available, and a full stock of drive units).
- KEITH MONKS, complete range in stock:
- TEAC & TASCAM • AKG • QUAD • ALICE • REVOX • ALLEN & HEATH • NEAL • BRENNELL.

We also supply:

- Beyer • DBX • Amcron • Studer • Rusco
- Master Room • SIS • EMI • EMT • Dolby • MCI • Shure • 3M • Sennheiser • BGW • Orban/Parasound • A&R • Klark • Teknik • Agfa to name but a few.

Pricing:

very, very competitive with (proper) professional discount structure.

Stock:

big and getting bigger for fast delivery times.

Delivery service, demonstration facilities, consultancy service, and account facilities.

As you can see, a large percentage of your equipment requirements (splicing tape to 24tk masters) can be obtained from one source at your normal pricing. We do the running around and paperwork, you just 'phone.

...give us a try, you have nothing to lose, - you could gain a lot!

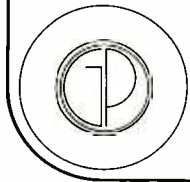

GRAHAMS

PROFESSIONAL

86-88 Pentonville Road, London N1.
Tel: 01-837 4412 Ext. 66 Telex: 299446

Direct Injection.

The Music Laboratory makes two professionally finished D.I.Boxes, the Standard and the DeLuxe.

Both boxes are currently being used by some of the World's best Studios.

They are highly recommended for use with Guitars, Keyboards and Bass.

Our D.I.Boxes are available on Worldwide distribution.

For further details contact the Music Laboratory on 01-349 1975.

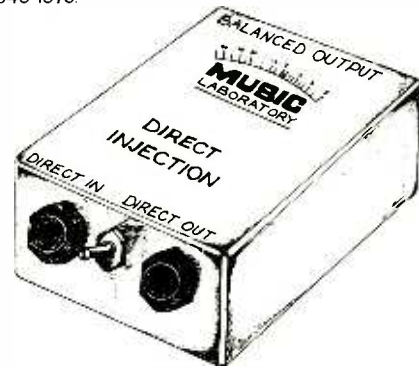

SPECIFICATION DATA FOR D.I.BOXES

Standard

Maximum Input Level +15dB
Frequency Response 20Hz to 40kHz \pm 5dB
Input Z 25k Ω
Output Z 600 Ω
Voltage Ratio -15dB
Ground Lift

DeLuxe

Maximum Input Level +20dB
Frequency Response 17Hz to 50kHz \pm 1dB
Input Z 25k Ω
Output Z 600 Ω
Voltage Ratio -13.5dB
Distortion 0.01 above 40Hz
Ground Lift



72-74 Eversholt Street, London, N.W.1 Telephone 01-388 5392

supplying studios, schools, the broadcasting industry and governmental departments - carrying a full range of products Beyer Revox Neal Quad JBL Phase Linear Tannoy Teac DBX AKG Allen and Heath and Brenell Turner Ferrograph Uher.

Accessories:

XLR Mics Stands spools De Magnetisers
Splicers Signal Processors Mixers.

PRO-WORKSHOP AND MOBILE SERVICE FACILITIES EXPORT

now at new premises

THE STUDIO SHOP
Oxgate Farm
Coles Green Rd
London NW2 7EY
Ring 01-452 1979



Buy and sell second hand Studio Equipment, collections/delivery

studio equipment services

LIMITED

To hire the very latest
NAGRA & SENNHEISER
sound equipment, contact

HAYDEN HIRE

For further details, telephone

01-723 4441/2

Hayden Laboratories Limited
6 Bendall Mews, Bell Street, London NW1

Get binding!

Keep your copies of STUDIO SOUND in smart black binders (each holds 12 copies) with title in golden block letters on the spine. Price: £2.00 each which includes inland and overseas postage. Send your order with cheque or postal order to: Modern Book Binders Ltd, Chadwick Street, Blackburn, Lancs. (state clearly your name and address and the relevant magazine title).

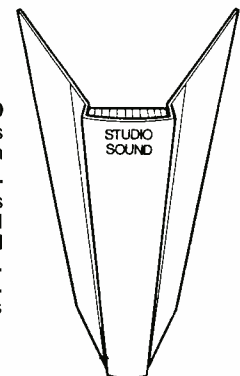

LINK HOUSE GROUP

Alice

*Our small mixers
aren't cheap....*



Alice (Stancoil Ltd.)

*...but then our big mixers
aren't expensive.*

38 Alexandra Road, Windsor, England

Tel: Windsor (075 35)51056/7 Telex: 849323 a/b Aegis G

POWER AMPLIFICATION BY MUSTANG



Our SS.100 and SS.50 are economical amplifiers with outputs of up to 175 and 100 Watts RMS into 4-16 ohms, typical THD figures being 0.1%, slewing rate $> 10\text{v}/\mu\text{s}$, noise $> 90\text{dB}$ down, zero level input, and full electronic protection. Considering these points with their proven reliability and robust construction, plug in output transistors and driver board, optional balanced input and 100V line output, and virtually ex stock despatches we reckon we take some beating! Contact us now for the full technical specifications.

Manufacturers of mixers, integrated mixer amplifiers and slave amplifiers, studio power amplifiers, transformers, lighting control equipment and cabinets for the home and export markets. Contact us for full illustrated technical brochures.

MUSTANG COMMUNICATIONS

Nelson Street, Scarborough,
North Yorkshire YO12 7SZ
England
Telephone 0723-63298



Illustrated above are the two latest additions to the well-known range of WOELKE Wow and Flutter Meters, the ME 201 Flutter Classification Unit, and the ME 401 Automatic Distortion Meter. Fuller details on application.

LENNARD DEVELOPMENTS LIMITED

206 Chase Side, Enfield, EN2 0QX
Tel. (01) 363-8238/9

Classified Advertisements

Advertisements for this section must be pre-paid. The rate is **20p** per word, minimum **£4.00**. Box Nos. **55p** extra. Semi-display rates on application. Copy and remittance for advertisements in **MARCH 1979** issue must reach these offices by **10th JANUARY 1979** addressed to: The Advertisement Manager, **Studio Sound**, Link House, Dingwall Avenue, Croydon CR9 2TA.

Note: Advertisement copy must be clearly printed in block capitals or typewritten.

Replies to Box Nos. should be addressed to the Advertisement Manager, Studio Sound, Link House, Dingwall Avenue, Croydon CR9 2TA, and the Box No. quoted on the outside of the envelope. The district after Box No. indicates its locality. **SEX DISCRIMINATION ACT 1975:** No job advertisement which indicates or can reasonably be understood as indicating an intention to discriminate on grounds of sex (e.g. by inviting applications only from males or only from females) may be accepted, unless (1) the job is for the purpose of a private householder or (2) it is in a business employing less than six persons or (3) it is otherwise excepted from the requirements of the Sex Discrimination Act. A statement must be made at the time the advertisement is placed saying which of the exceptions in the Act is considered to apply.

STUDIO FACILITIES

★Your tapes to disc. Vinyl pressings, sleeves, labels. In our own pressing plant. Top quality. S.a.e. for photo leaflet. Deroy Records, Cove, Dunbartonshire G84. X

IF YOU NEED . . .

Cassette Duplication	Empty Tape Spools
Blank Cassettes	White Tape Boxes
½" Tape	8T Cartridge Bodies
Leader Tape	Lubricated Tape
Splicing Tape	Head Cleaner Tape

Why not ring us on 01-399 2476/7 and let us quote you for your next requirements.

MEDIATAPE LIMITED, 29a Tolworth Park Road, Surbiton, Surrey.
01-399 2476/7

★Disc cutting. Masters and Demos, Pressings, Cassettes, Mobile Recording Studio. Free brochure. TAM Studio, 13a Hamilton Way, London, N.3. Tel. 01-346 0033. F

★Fanfare Records. Tape-disc pressings, demo's, masters, any quantity. Studio/mobile Neumann disc cutter. S.A.E. brochure. 1 Broomfield Close, Rydes Hill, Guildford. Tel. 0483 61684. X

TRAD

WATFORD 47988

All Studio Equipment bought and sold.
See our advertisement on page 73.

149B St. Albans Road, Watford,
Herts.
Tel. Watford 47988

SPR

SPEECH RECORDING
CASSETTE DUPLICATING
OPEN-REEL DUPLICATING
LANGUAGES/AUDIO-VISUAL

SPEECH-PLUS RECORDINGS LTD

37, PAGES WALK, SOUTHWARK, LONDON SE14 5B. 01-231 0961/2

SHORT RUN CASSETTE DUPLICATING

Min. 10. 24 hour service. Cost of cassette inc.

C10 in batches of 10 **48p** each
C45 in batches of 10 **55p** each
C60 in batches of 10 **58p** each
C90 in batches of 10 **68p** each

SIMON STABLE PROMOTIONS
Phone: 08692 (Bicester) 2831

SERVICES

★Pressings of classical quality (colour also) promptly manufactured from your Master-tapes. Sleeve printing, mailing service. Studio or mobile units for Master recording. Specify requirements to Mike Bull, Sound News Studios, 18 Blenheim Road, London W4 1ES. Tel. 01-995 1661. C

TAPE COPYING SERVICES

We specialise in short run
cassette duplication

NO JOB TOO SMALL

Fast turnaround, reliable service

LOW COST

STEREO — MONO — PULSED

01-723 6301
(Baker Street)

★Tape copying service. Open reel and cassette available. The Music Laboratory, 01-388 5392. X

★Studio equipment insurance. Full "All Risks" cover. Most competitive rates and terms. Also "Pop Group" equipment. Ring (0682) 386022/384374. F

WOLLENSAKS
CASSETTE FAST COPIERS

2770 mono & 2772 stereo, meticulously aligned by Experts. HEAVY DUTY RECORDERS: 2551 Visual Sync & 2520 9 watt.

SOUND CASSETTE SERVICES Ltd.
P.O. Box 2, Gerrards Cross, Bucks. SL9 7PH
Tel. 02813 84409

SOWTER TRANSFORMERS

WITH 37 YEARS' EXPERIENCE

we have the expertise to design and manufacture
ANY TYPE OF AUDIO TRANSFORMER
AT THE RIGHT PRICE

Whilst we specialise in every kind of transformer for audio control desks and mixers demands are increasing for **LOUDSPEAKER TRANSFORMERS** and **100 VOLT LINE AUDIO OUTPUT TRANSFORMERS** FOR MOST KINDS OF **AMPLIFIERS FROM 30 WATTS TO 500 WATTS OR MORE**. We can also supply multi-output transformers for **COLUMN LOUDSPEAKERS**. A recent tendency is the demand for **OUTPUT TRANSFORMERS FOR ULTRA LINEAR AMPLIFIERS** using **KT88** and **KT66 BEAM TETRODES** and for these we have standard designs with exceptional performance.

We call your attention to our very successful **MICROPHONE SPLITTER TRANSFORMER** type 4079 with a high impedance 200ohm primary and two 200 ohm secondaries. It will handle up to 2.3 volts rms at 30Hz and has a frequency response of plus/minus 4dB from 20Hz to 20kHz. It is contained in a Mumetal Can 33mm dia x 37mm high and **WORKING DETAILS OF THE CONSTRUCTION OF A SPLITTER ARE AVAILABLE ON REQUEST.**

We will supply single transformers, or any quantity, with short delivery times and, without obligation on your part, will quote price and exact dispatch on receipt of your requirements.

E. A. SOWTER LTD.
Manufacturers and Designers
P.O. Box 36 Ipswich IPI 2EG England
Tel. Ipswich (0473) 52794 and 219390

CASSETTE FAST-COPYING

Stereo or Mono. High Quality. Prompt Personal Service. Also bulk supplies of excellent virgin cassettes.

SOUND CASSETTE SERVICES Ltd.
P.O. BOX 2, GERRARDS CROSS, BUCKS.
Tel. 02813 84409

HIGH SPEED CASSETTE COPYING IN MONO OR STEREO AT COMPETITIVE PRICES

Long or short runs.
Blank cassettes supplied in bulk.
A growing reputation for reliability.

MORARD SOUND PRODUCTIONS
THORNTON HEATH, SURREY
Telephone 01-689 7424

The attention of advertisers is drawn to "The Business Advertisements (Disclosure) Order 1977", which requires that, from 1st January 1978, all advertisements by persons who seek to sell goods in the course of business must make that fact clear. From the above date, consumers therefore should know whether an advertisement relates to a sale by a trader or a private seller.

REVOX
SERVICE CENTRE

Service and overhaul.
High speed conversions.
Head changes.
Sel-sync.
Automatic double tracking.
Varispeed/varipitch.

 **MUSIC**
LABORATORY

01-388 5392

COUNTY RECORDING SERVICE

From your tapes we cut master discs, demo discs, using our Scully lathe fitted with the latest ME/76 UK stereo disc-cutting system.

Dolby 'A', Dolby 'B' and DBX Noise Reduction.

Telephone Bracknell (0344) 54935.

London Road, Binfield, Bracknell, Berks, England

FOR SALE—TRADE

★Cathedral Sound manufacture a professional standard compressor/limiter module for under £25, mixer modules, and complete mixer channels. Professional discounts available on Revox, N.E.A.L., Sennheiser, also MM mixers. S.A.E. details. Cathedral Sound, Fourways, Morris Lane, Halsall, Lancs L39 8SX. Tel. Halsall (0704) 840328. X

★Neumann lathe. Gear-Train Changeover model with Lyrec 33.3/45/78 motor to be sold with or without Grampian RA7 amplifier and limiter and 2 Grampian feedback heads. What offers? Write: Manley, Private Bag 3, Westhoven 2142, Johannesburg, South Africa. A

★Complete 35mm mixing/dubbing theatre rig. Bauer B11 double-band projector+Xenon lamphouse, rectifier and theatre monitor rack, 40 watt RMS magnasynch 35mm recorder with MWA Albrecht solid state electronics and 3 x magnasynch 35mm playbacks with Westrex Solid State electronics. All 25/24 frame interlock by Selsyn. Also 6 channel Mixer with EQ, 2 Garrard 30 l's in console and re-built EMI TR 90 Playoff, all in matching consoles. Also Acmade 6 plate 35mm table. Piecemeal or package. What offers please? Write: Manley, Private Bag 3, Westhoven 2142, Johannesburg, South Africa. A

★MCI JH10 16 track + 8 track headblock, used only occasionally, £7,500. Sound Techniques 20/8/16 mixing console. 4 F/B, 4 Echo send, 8-way monitor select function, 180 way-patch bay. Internal loudspeakers, PPM+VU metering, includes 21in of 19in rackspace. Excellent condition. £5,600 o.n.o. Ring for a photograph 061-228 2022.

★7in spools in strong white boxes packed 50 per carton. Only 22p each plus £1.82 p. & p. Free U.K. delivery on orders of 200+. Also 10½in. metal precision spools used once only at 85p each incl p & p. Send C.W.O. to J Vincent, 329 Hunslet Road, Leeds LS10 1NJ. A

★New high speed cassette copiers available at substantial discounts. Wollensak/Alpha/Recordex, etc. Also available cassette loading machines and similar equipment. Typical saving is £250 plus on Wollensak 2770. Contact Geoffrey Yates, 01-363 6125. F

★3M's M79 16+24 H/blocks, 4 x JBL 4311 WX's and an Otari MX 7300 series 8T recorder. Offers—tel. 0203-21000. X

★Wow and flutter meter, Rank Kalee type 1740, similar to latest model, calibrated and in good working order. £150 plus VAT. Burgess Lane & Co. Ltd., Thornton Works, Thornton Avenue, London, W4. 01-994 5752 and 5953. X

★Broadcast Cartridges. Large selection available ex-stock—competitive prices—standard lengths—custom winding service—lubricated tape. Also full range of tape cartridge storage systems. John A. Steven, Professional Recording Equipment, Brentwood 215485. A

★Revox, Teac, Otari, Brenell, Tascam, Nakamichi, Tannoy sales and service. The Music Laboratory. 01-349 1975. X

FOR SALE—PRIVATE

★Ampex MM1000 8-track £3,850 or near offer. Varispeed, full set of manuals, very well maintained. 01-993 2401 ext 31 (day), 01-889-6166 (evening/weekend). A

★Mixer components sale: Professional Modular Mic-Amps £4, Transformers to suit £3, Slimline Quadrant faders £5, Precision Stud presets and panpots £2. Beardsley, 9 Tranfield Avenue, Guiseley, Nr Leeds. Tel. 72592 after 7 p.m. A

SITUATIONS VACANT

★Pathway Studio seeks balance engineer. Some maintenance ability would help. 8-track, small and busy. 2A Grosvenor Avenue, London N5. 01-359 0970. A

★A sound trainee required by a TV Production/Facility Company. Interested? Contact Frank Jeffs, 01-874 0131. A

★As one of Europe's most advanced 24-track complexes we require an experienced and innovative recording engineer. He should be in his early 20's with relevant technical qualifications (i.e. university degree or equivalent) willing and able to undertake maintenance and associated operations. Box No. 799, c/o Studio Sound. A

★Two JBL L 100's, perfect, unmarked condition. Little used rear pair of abandoned quadraphonic project. £300. Tel. (0602) 582286 after 6 p.m. weekdays. A

★Brenell Mini 8, as new, full remote control, electronic tape counter, only few hours use. £3,250 o.n.o. Box No. 798 c/o Studio Sound. A

WANTED

★Tannoy GRF corner horns, good price offered for one pair in good condition, damaged ones considered. Tel. Mike 0473 49541. X

★Pair of JBL 4350's or Lockwood Majors. 3M's M79 stereo machine and 3M's M79 P.C. boards. Tel. 0203-21000. X

★Wanted. Revox and Teac Tape Recorders. Best prices paid. R.E.W. Professional Audio. 01-836 2372. X

★Teac 3340 (S) urgently wanted. The Music Laboratory. 01-388 5392. X

★Tannoy Speakers Wanted. The Music Laboratory. 01-388 5392. X

★Revox's urgently wanted. The Music Laboratory. 01-388 5392. X

★Wanted: Grampian ambiophonic reverb unit type 666. Contact Tony at 0202-743394. A

For Further
INFORMATION

for
**STUDIO
SOUND**

contact
MIKE STORMER
on 01-686 2599

Are you the man from Atlantex?

Applications are invited to fill a position in one of the fastest expanding companies in the field of sound processing equipment.

Atlantex Music Ltd., sole distributors of MXR Studio Products are looking for a sales person to develop and extend sales to recording studios, radio and TV stations etc.

The successful applicant will demonstrate all MXR studio products nationwide. A company car, salary, generous commission and all expenses will be provided to the successful candidate.



Please write giving full details to
Robert Wilson, Managing Director,
Atlantex Music Ltd., 16 High Street,
Graveley, Herts.

All applications received will be treated in strictest confidence.

TELEVISION AND FILM

Would you like to work for a fast growing Company providing a technical service to the television broadcast industry? Young enthusiasts with a knowledge of basic electronics and operational aptitude are invited to join KAY LABORATORIES VIDEO DIVISION. Some knowledge of basic television of film technology would be an advantage, but is not essential.

Salary scales range from £4,239 to £6,531.

Telephone or write to: **Ron Venis,**
KAY LABORATORIES VIDEO DIVISION
9-11 Windmill Street,
London W1P 1HF 01-580 0301

INDEX TO DISPLAY ADVERTISERS

A	I	P
A.K.G. 5	Inovonics 53	Page, John 56
Alice 87	ITA 11, 13, 15, 17	Parasound 85
Allen & Heath 21, 69	ITC 34	Peavey 65
Amek 4	Ivie 18	Penny & Giles 7
Aphex 78, 79		Progressive Electronics 77
APRS 12, 77		Publison 14
Audio Design 83	J	
Audio Developments 48, 77	J.B.L. 74, 75	Q
Audix 81		Quad 8 58, 59
B	K	R
Bauch, F. W. O. 57	Kemble/Yamaha 43	Raindirk Ltd. 27
B.G.W. 10	Klark Teknik <i>OBC</i>	RDG 16
C	L	Revox 63
C.A.E. 30	Larking, Don 61	REW 6, 7
Cathedral Sounds 85	Lennard Developments 87	Rolling Stones 55
Crowmay 84		
E	M	S
Eagle 39	Magnetic Tapes 81	Scenic Sounds 23, 25
F	Midas <i>IFC</i>	S.E.S. 86
Fraser Peacock 61	Millbank 49	Shure 9
Future Film Developments 16	Music Labs 19, 86	Solid State Logic 71
	Mustang 87	Sound Communication 81
	MXR 47	Sound Recording Plant 77
		Surrey Electronics 80
G	N	T
Gibson-Brittain 81	Nakamichi 41	Trad 73
Grahams Professional 86	Neal Ferrograph 35	Trident Audio 20
Granet Communications 60	Neve Electronics Int. Ltd. 31	Turnkey 67
H	O	Y
Harrison <i>IBC</i>	Ortofon 8	Yorke, James 85
Hayden Laboratories Ltd. 86	Otari 45	
Helios 51		

STUDIO SOUND is available without charge to qualified readers: these are directors, managers, executives and key personnel actively engaged in sound recording, broadcasting and cinematograph industries in any part of the world. The Publisher reserves the right to refuse applications considered inappropriate and restrict the number of free copies sent to any one company or organisation. Non-qualifying readers can buy STUDIO SOUND at an annual subscription of £8.20. All enquiries to: Subscription Department, Link House, 25 West Street, Poole, Dorset BH15 1LL. Tel. Poole (02013) 71171. Published by Link House Magazines (Croydon) Limited on behalf of the proprietors Link House Holdings Limited, Robert Rogers House, New Orchard, Poole, Dorset BH15 1LU and printed by Arthurs Press Ltd., Woodchester, Stroud, Glos. GL5 5PB.

SOME COMPANIES GIVE YOU A PRICE THAT SOUNDS GOOD. HARRISON GIVES YOU A CONSOLE THAT SOUNDS GOOD!

And "good sound" is what our business is all about. That's why we build consoles with *you*, the engineer and studio owner, in mind. We use the highest quality components and circuit designs in our consoles. These give you maximum reliability and the cleanest and quietest possible sound. The almost unlimited flexibility of a Harrison console gives the recording and balance engineers the opportunity to be truly creative. Quality, reliability and flexibility. Others talk about these features... Harrison delivers them in every console. Harrison consoles, a sound investment.

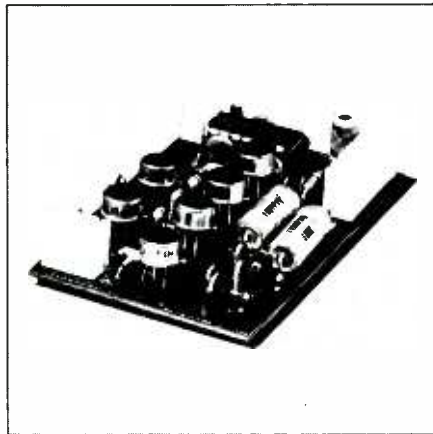
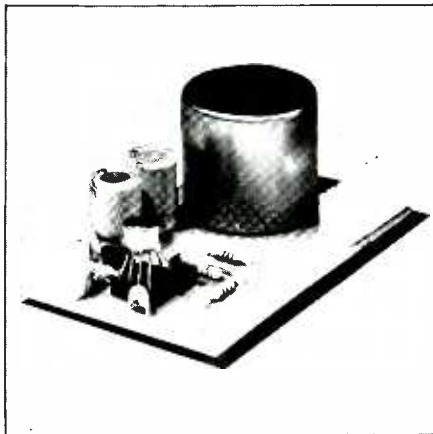
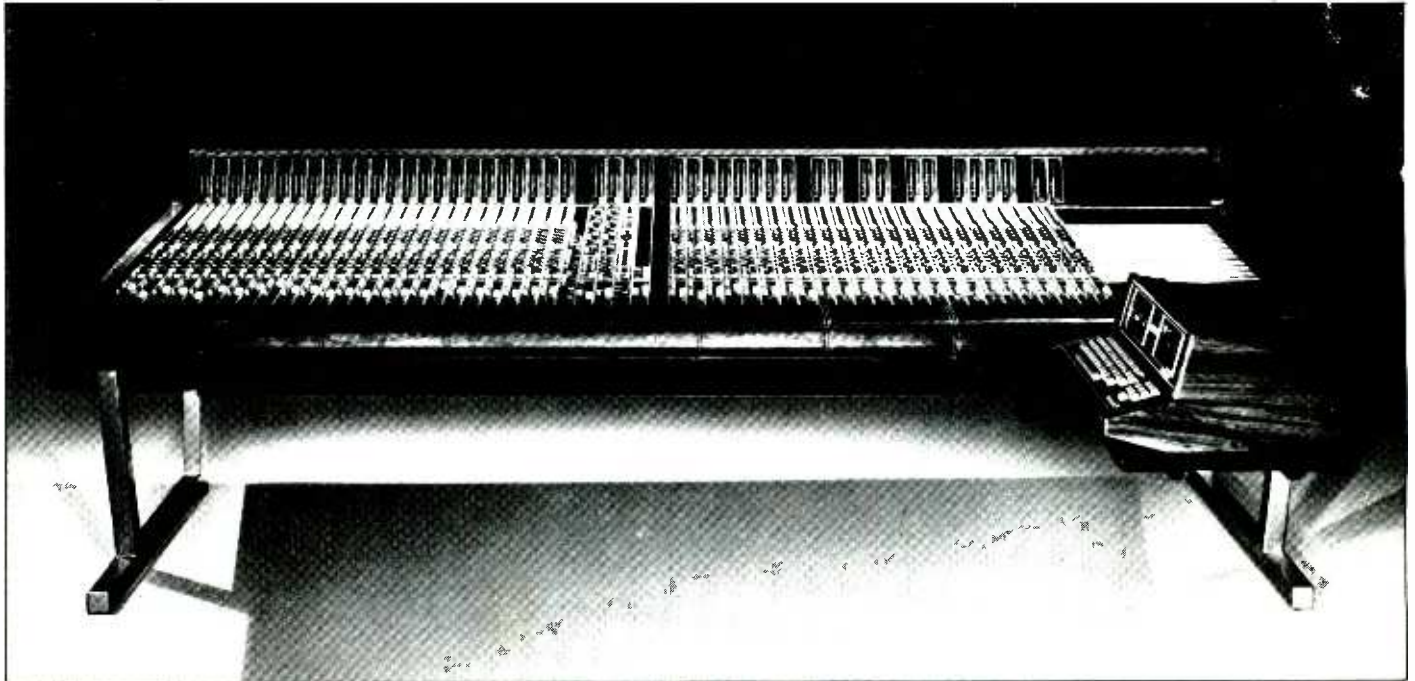

HARRISON Model 4832, 48 input channels, 32 output channels, with Harrison AUTOSSET automation programmer.

Now, Harrison also gives you a choice. Console Models 4832, 4432, 4032 and 3232 are available with your choice of microphone preamplifiers: with or without input transformers.

For further information regarding the complete line of Harrison consoles and automation systems, please contact the Harrison professional audio dealer in your area:

AUSTRALIA: SONTRON INSTRUMENTS, MELBOURNE • **AUSTRIA:** STUDER-REVOX, WIEN • **BELGIUM:** SAIT ELECTRONICS, BRUXELLES • **BRAZIL:** LAREX ELECTRONICA, RIO DE JANEIRO • **CANADA:** J-MAR ELECTRONICS, TORONTO • **DENMARK:** QUALI-FI, KLAMPENBORG • **EASTERN EUROPE:** STUDER INTERNATIONAL, REGENSDORF, SWITZERLAND • **FAR EAST:** STUDER-REVOX, HONG KONG • **FINLAND:** INTO, HELSINKI • **FRANCE:** STUDER FRANCE, PARIS • **GERMANY:** EMT FRANZ, KIPPENHEIM • **GREECE:** ELECTRONICA, ATHENS • **ITALY:** AUDIO PRODUCTS INTERNATIONAL, MILANO • **JAPAN:** SHINDENSHI MANUFACTURING, TOKYO • **MEXICO:** ACCURATE SOUND, REDWOOD CITY, CALIFORNIA • **NETHERLANDS:** HEIJNEN, GENNEP • **NORWAY:** AUDIOTRON, OSLO • **SPAIN:** NEOTECNICA, MADRID • **SWEDEN:** ELFA RADIO & TELEVISION, SOLNA • **SWITZERLAND:** STUDER INTERNATIONAL, REGENSDORF • **UNITED KINGDOM:** SCENIC SOUNDS EQUIPMENT, LONDON

EXPORT AGENT:

Audio Systems International
128 North Highland Avenue
Los Angeles, California 90036
Tel: (213) 933-2210 • Telex: 686101

FACTORY:

Harrison International Corp.
Post Office Box 22964
Nashville, Tennessee 37202
Tel: (615) 834-1184 • Telex: 555133

The new DN70 digital time processor.

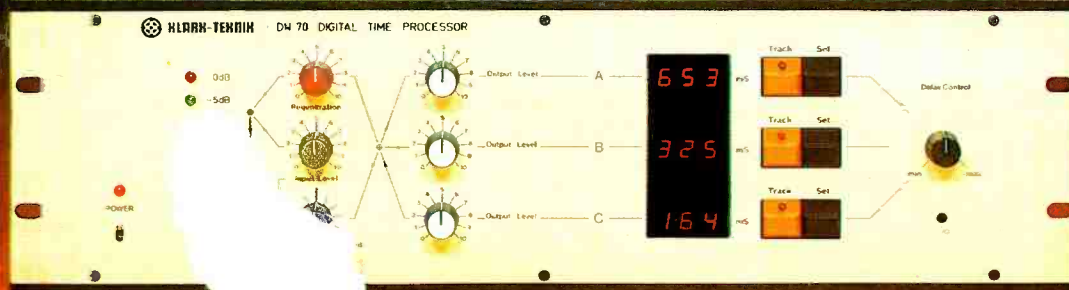

What a performance.

The DN70 is the first of a new generation of digital products from Klark-Teknik, designed for the discerning professional user.

It's years ahead of its time.

Miles ahead of all its competitors.

And offers a performance which cannot be beaten.

The secret lies in the A-D convertor, the heart of any digital system.

The DN70 is the ultimate in today's technology, the result of years of research and development.

- Digital readout in milliseconds of time delay of each output.
- Three maximum delay options. 163mS, 326mS and 652mS.
- In-house designed analogue-to-digital convertor, giving superior distortion and noise performance.
- High clocking speed of 50KHz, enabling frequency response to 15KHz on all delay options.
- High value digital word - quasi 15-bit using a 12-bit linear plus 2-bit instantaneous flying comma system, allowing the quantizing noise to be virtually eliminated.
- Mains fail-safe. The three main outputs are strapped directly to input in the event of power failure.

- Mixing and regeneration controls on the front panel are provided.
- Perpetual memory of delay settings for permanent or semi-permanent installations.
- Lockout switch - to stop tampering or accidental re-setting of delay times.
- Full control of digital processing available at remote socket.
- Any output can be momentarily set to zero delay time without affecting the actual delay settings.
- High technology semiconductor memory. The 652 option uses 28 x 16K bit Random Access Memories.
- Input level indication, allowing full use of dynamic range.



KLARK-TEKNIK

You know it's the best.

For further information about the DN70, our new DN34 analogue time processor and also our DN27 & DN22 graphic equalisers:

Klark-Teknik Research Limited, Summerfield,
Kidderminster DY11 7RE, England.
Telephone: Kidderminster (0562) 64027 Telex: 339821.

Worldwide Distributors: AUSTRALIA: Klarion Enterprises, S. Melbourne. BELGIUM: A.R.C. Sprl., Bruxelles. CANADA: Hammond Industries, Toronto. DENMARK: Teamsound, Helsingør. FRANCE: R.E.D. Studio Centre, Paris. GERMANY: Hausman Concert Electronics, Berlin. HOLLAND: Pieter Bollen, Eindhoven. ITALY: Laboacustica Srl., Roma. JAPAN: Continental Far East Inc., Tokyo. NORWAY: Siv. Ing. Benum, Oslo. NEW ZEALAND: General Video, Wellington. SINGAPORE: Ultralinear International. SOUTH AFRICA: Colosseum Acoustics, Johannesburg. SPAIN: Mabel Sdad., Barcelona. SWEDEN: SATT Elektronik, Stockholm. SWITZERLAND: Dr. W. A. Gunter, Zürich. TAIWAN: Yang's Audio Visual, Taipei. USA: Hammond Industries, Syosset, N.Y.