

July 1973 25p

studio sound

AND BROADCAST ENGINEERING

APRS '73 AND FILM '73 PREVIEWS

DESIGNING AN AUTOMATED
MIXING CONSOLE

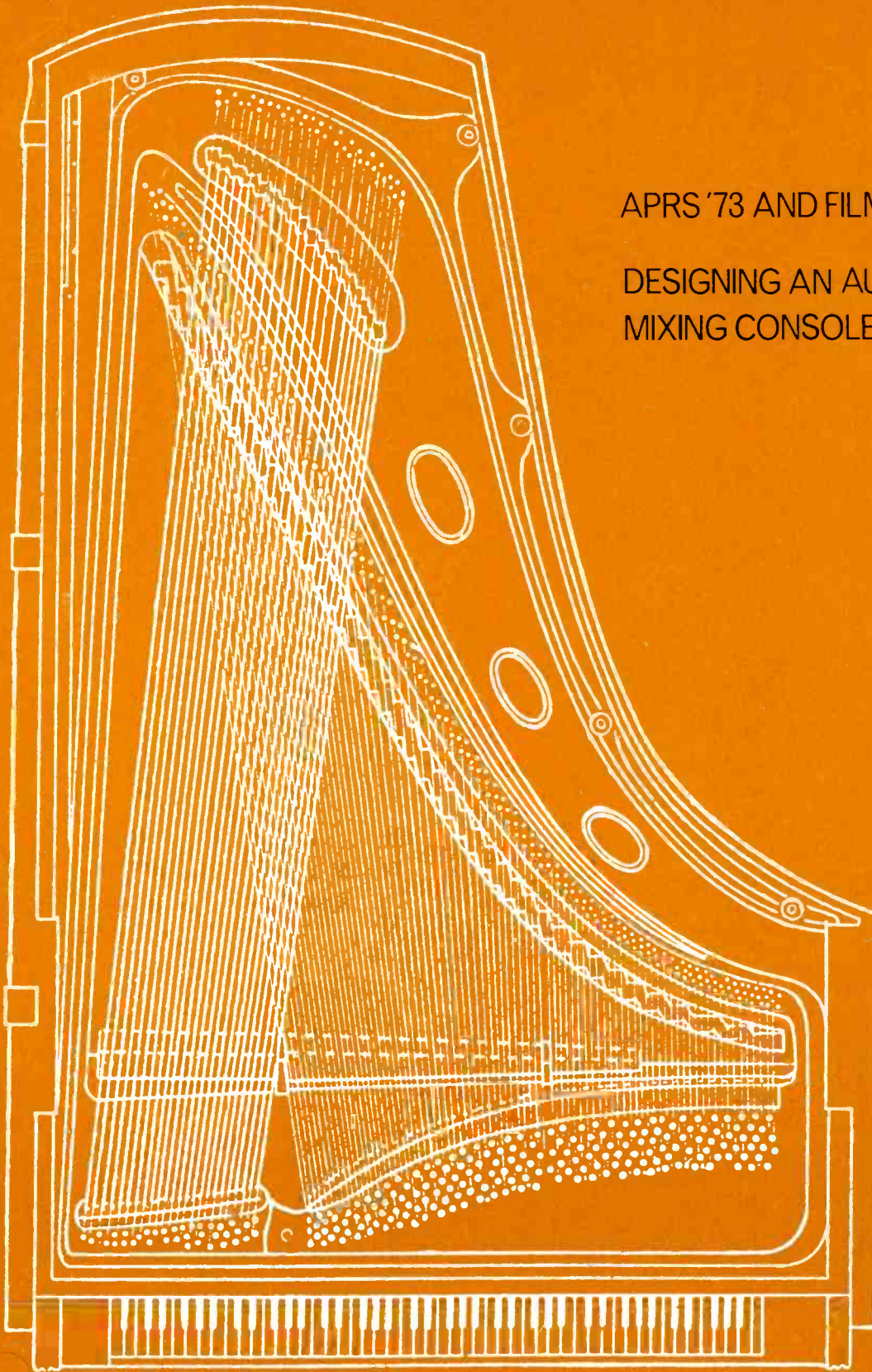

STUDIO MICROPHONE TECHNIQUE

Creative Consoles = Creative Success

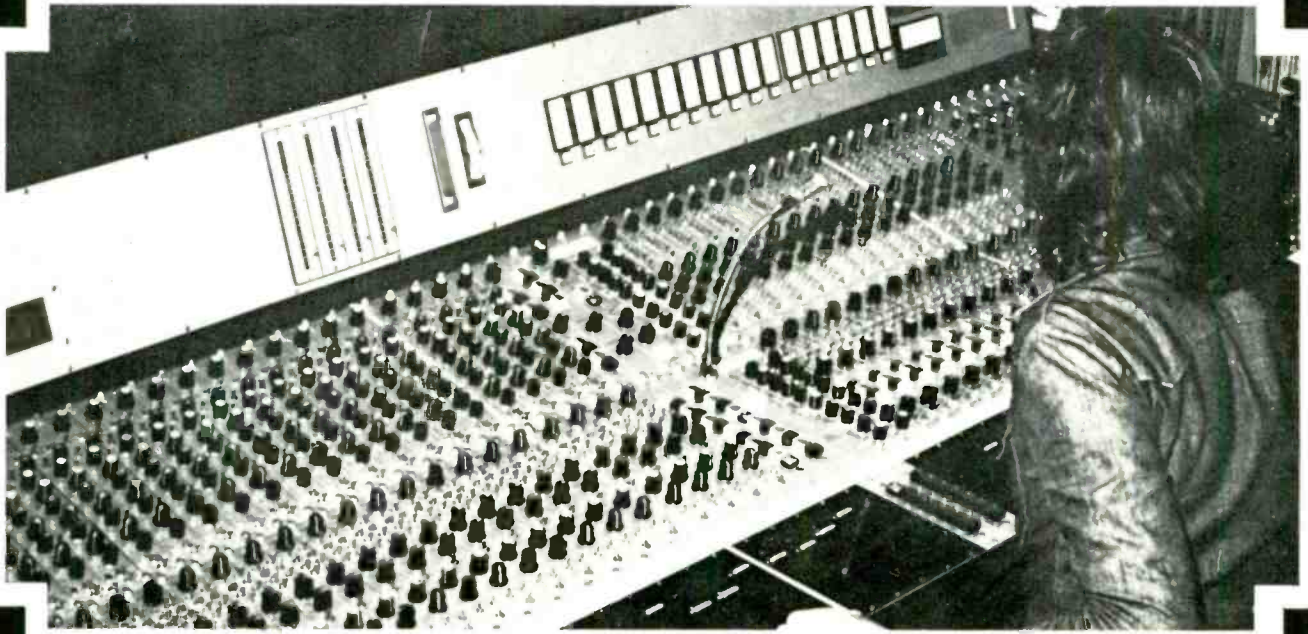

Whatever the recording

Whenever or wherever, a need for sound control console systems, stereo or quadrophonic, to the highest performance specifications in all modes of operation, the first choice of Europeans is Cadac.

Automatic D.C. logic function selection by push-button control of the audio systems, including complete sync facilities eliminating the need for multi-switching in order to change over from normal recording into overdub or re-mix.

Cadac are at Stand No. 55 APRS Exhibition
Connaught Rooms Great Queen Street
London. 22 - 23 June, 1973.

Console designed and built for Union Studios,
Munich.

Manufacturers of audio control equipment
for the sound recording industry.

Cadac (London) Limited
Stansted Essex England
Tel: Stansted 3437 & 3132

cadac

EDITOR DAVID KIRK
ASSISTANT EDITOR JOHN DWYER
ADVERTISEMENT MANAGER TONY NEWMAN
AMERICAN REPRESENTATIVE STEPHEN H. LAMPEN

Editorial and Advertising Offices: LINK HOUSE, DINGWALL AVENUE, CROYDON CR9 2TA. Telephone: 01-686 2599

American Office: P.O. Box 99569, San Francisco, California, 94109, U.S.A.

©Link House Publications Ltd 1973. All rights reserved.

CONTENTS

FEATURES

CONSTRUCTING A QUADRAPHONIC MICROPHONE Part Three By John Fisher	30
DESIGNING AN AUTOMATED MIXING CONSOLE Part One By M. S. Curtis	36
A QUADRAPHONIC CONTROL DESK By R. Birthwright	40
APRS '73 PREVIEW By David Kirk	48
STUDIO MICROPHONE TECHNIQUE By Michael Thorne	64
SURVEY: STUDIO MICROPHONES	72
FILM '73 PREVIEW By John Dwyer	78

COLUMNS

NEWS	24
VIDEO: TELEVISION SOUND By Roderick Snell	26
PATENTS	28
DIARY By John Dwyer	32
FIELD TRIALS: ALLEN & HEATH MINI MIXER By John Shuttleworth	46

REVIEWS

PHILIPS PRO72 EIGHT TRACK By Angus McKenzie	82
--	----

CORRESPONDENCE AND ARTICLES

All STUDIO SOUND correspondence should be sent to the address printed on this page. Technical queries should be concise and must include a stamped addressed envelope. Matters relating to more than one department should occupy separate sheets of paper or delay will occur in replying.

Articles or suggestions for features on all aspects of communications and musical engineering will be received sympathetically. Manuscripts should be typed or clearly handwritten and submitted with rough drawings when appropriate. We are happy to advise potential authors on matters of style.

BINDERS

Loose-leaf binders for annual volumes of STUDIO SOUND are available from Modern Bookbinders, Chadwick Street, Blackburn, Lancashire. Please quote the volume number or date when ordering.

THE DAILY press is traditionally at least a year behind the news when it comes to covering modern technology. Surprising, therefore, to find a daily making passing reference to a communications concept which at present remains highly futuristic.

It will probably be the turn of the century before the study of bio-electronics has advanced far enough to permit direct injection of the human senses. Research has already been carried out in the realm of aural and visual injection, by-passing the normal mechanisms of ear and eye. Experiments of this nature have until recently been confined to extracting signals from the brain rather than feeding data in, though considerable success in the former must in due course permit the latter.

Aldous Huxley introduced the concept of a 'feelies' cinema back in 1950 with *Brave New World*. In those days, the notion could have done little more than entertain. Today, however, there is clearly no technical impossibility in communicating touch, taste and smell data with direct or indirect sight and sound. So when can we expect the bottom to fall out of the communications hardware market?

The questions raised by the prospects of bio-electronic communication are wider than even Huxley may have realised. Firstly, the progressive devolution of Pop music shows clearly that the public as a whole prefer relatively unsubtle easily-digested art above what everyone is pained to call 'serious' creativity. Secondly, the human urge for light entertainment is bounded primarily by considerations of finance and physical fatigue. Artificial sense injection is likely to remove both these obstacles. And what, one wonders for a microsecond, will be the adult public's preferred taste in feelyfilms? No idea? Then fish out an *Evening Standard* and see the dominant subject covered by today's nonfeelies.

We repeat our certainty that this awesome prospect faces mankind though we can only guess at the effects it will have on the nation's balance-of-payments, not to mention family life. If the subject did not seem so damned amusing, it might already have been given the careful public debate it deserves. On the one hand it could be the long-awaited alternative to cigarette smoking; on the other, a threat to civilisation equally great as that presented by nuclear weapons. With a breathing space of 30 years.

SUBSCRIPTIONS

STUDIO SOUND, published monthly, enables engineers and studio management to keep abreast of new technical and commercial developments in electronic communication. The journal is available without charge to all persons actively engaged in the sound recording, broadcasting and cinematographic industries. It is also circulated by paid subscription to manufacturing companies and individuals interested in these industries. Annual subscription rates are £3 (UK) or £3.30 (\$8 or equivalent) overseas.

STUDIO SOUND is published on the 14th of the preceding month unless that date falls on a Sunday, when it appears on the Saturday.

PAST ISSUES

A small number of certain past issues may still be purchased from Link House, price 31p each including postage. Photostat copies of any STUDIO SOUND article are available at 25p including postage.

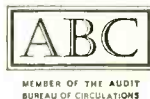

Total average net circulation of 7,374 per issue during 1972.

Celestion Loudspeaker Engineering
advances the state of the art to a
new plateau

Ditton 66 Studio Monitor

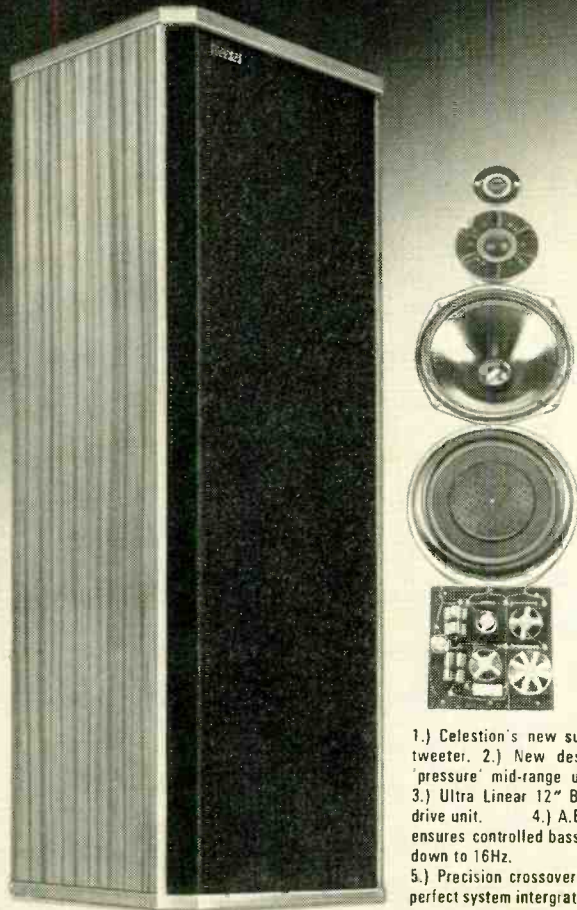

- 1.) Celestion's new super tweeter.
- 2.) New design 'pressure' mid-range unit.
- 3.) Ultra Linear 12" Bass drive unit.
- 4.) A.B.R. ensures controlled bass down to 16Hz.
- 5.) Precision crossover for perfect system intergration.

A new Loudspeaker of advanced design suitable for studio use and for home installations of the highest quality.
UNITS: HF 2000 (dome 'pressure' type) MF 500 (Mid-range Dome 'pressure' type) Ultra linear 12" bass driver and 12" ABR. The crossover has resulted from considerable research and crossover points are at 500 Hz and 5000 Hz 80 Watts Maximum, 4-8 ohm. This monitor loudspeaker system has an exceptionally wide and flat frequency response. Very low order harmonic and inter-modulation distortion. Precise response to transients. Beautifully maintained polar response ensures absence of unwanted directional effects and provides a highly satisfactory stereo image throughout the listening area. Matched pairs.

SIZE 40 x 15 x 11 1/2 Natural Teak or Walnut Cabinet

Celestion



Loudspeakers for the Perfectionist

ROLA CELESTION LTD.
DITTON WORKS, FOXHALL ROAD, IPSWICH, SUFFOLK IP3 8JP

PEAK PROGRAM METERS

to all B.B.C.
specifications



AND VU METERS

TO THE BELL
SPECIFICATION

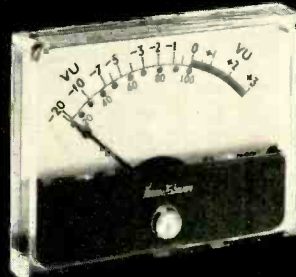

OVERSEAS AGENCIES

R. Schmidt	Copenhagen	Denmark
Oy Chester	Helsinki	Finland
Theal N.V.	Amsterdam	Holland
Vianello	Milan	Italy
Rieck	Bergen	Norway
Eltec	Lisbon	Portugal
Nordstrand	Stockholm	Sweden

Ernest Turner
ELECTRICAL INSTRUMENTS LTD

CHILTERN WORKS
HIGH WYCOMBE
BUCKS
ENGLAND

Countries shown in black have Dolby equipped recording centres.
Dots show location of authorised distributors of professional Dolby Noise Reduction equipment.

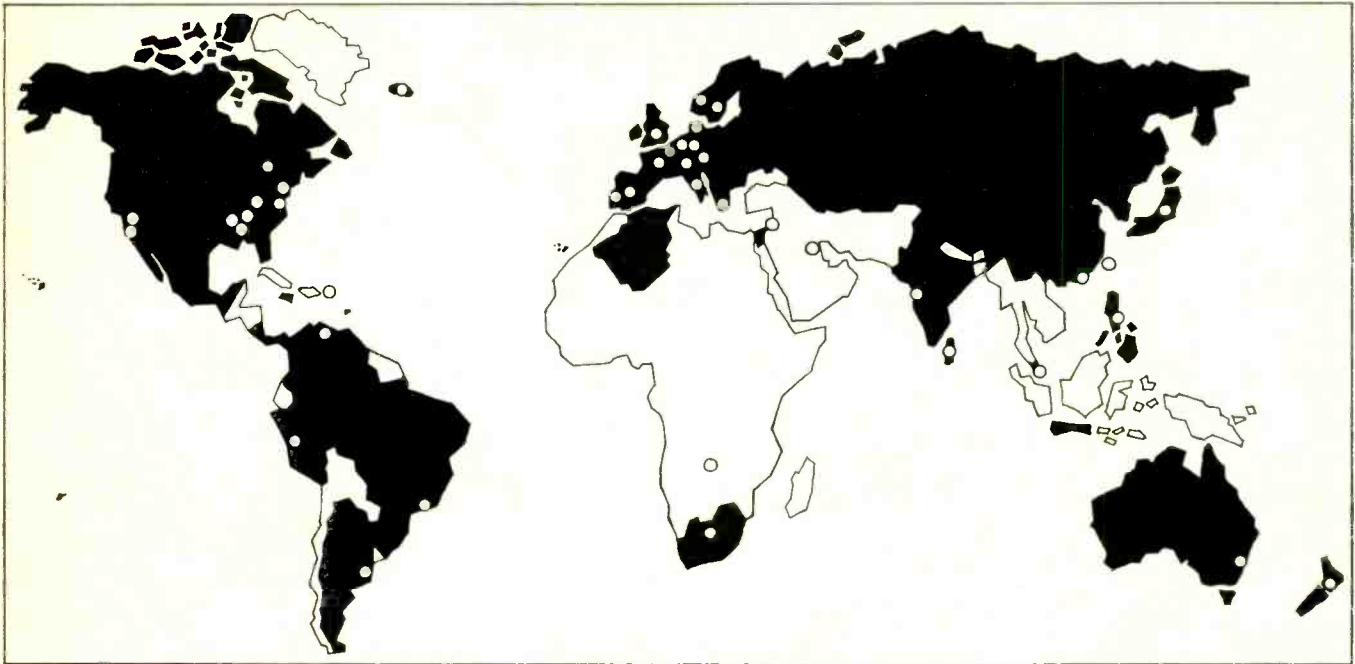

The geography of silence.

One good reason to record in London is that every major studio here is fully Dolby-equipped. In addition to aiding engineers to achieve the highest possible quality on an original recording, the Dolby system reduces any low-level noise introduced when further work is done with a tape at another studio, often in another part of the world.

Because so many studios now have Dolby equipment installed, the system is widely used to protect the substantial investments of time, money, and creative effort made in London. Whether an original tape is sent to Nashville or Peking for reduction, or a copy master is sent to a licensee in Tahiti or Heidelberg, professional Dolby installations are there to guard against noise build-up.

Be sure that your studio sends and receives Dolby-encoded tapes.
People everywhere will hear the difference.

DD Dolby[®]
Dolby and the double-D symbol are trade marks
Dolby Laboratories Inc

1133 Avenue of the Americas
New York NY 10036
Telephone (212) 489-6652
Telex 125797

346 Clapham Road
London SW9
Telephone 01-720 1111
Telex 919109

midas modular mixer system

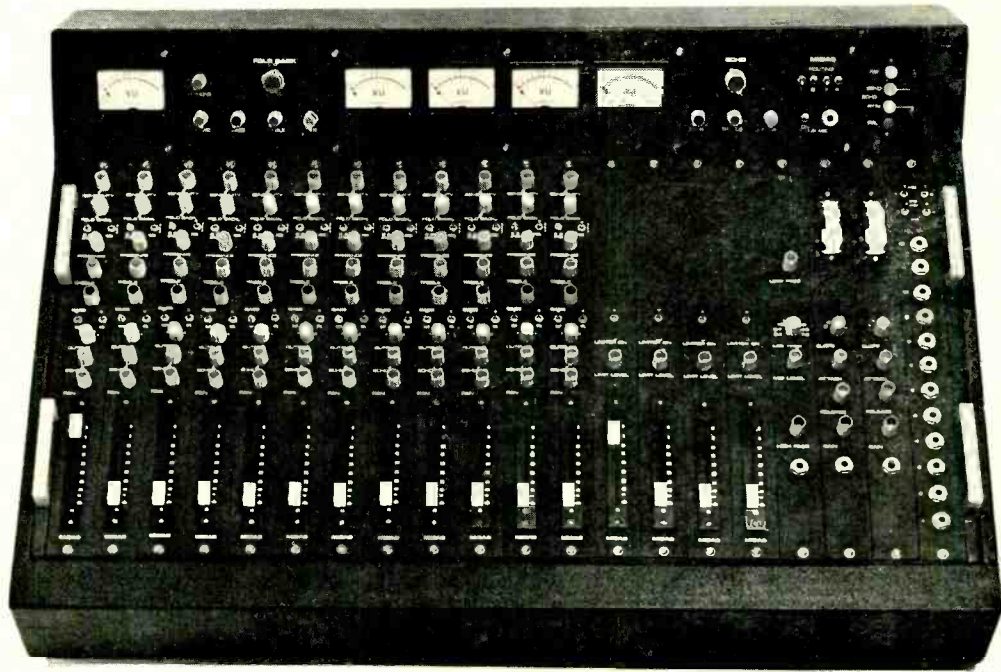

87 NORTH GROVE LONDON N15 5QS tel. 01-800-6341

Grampian

Series 7 Modular Sound Systems



Manufacturers also of the most comprehensive range of Mains/Battery Amplifiers, Microphones and ancillary items, Ambiophonic and Reverberation Units and all types of loudspeakers for sound systems.

GRAMPIAN REPRODUCERS LTD

HANWORTH TRADING ESTATE,
FELTHAM, MIDDLESEX.
TELEPHONE: 01-894 9141.
GRAMS: REAMP FELTHAM

JACW/2/182



Multi-Channel Studio Recorders
Cassette Duplicating Systems
Reel-to-Reel Duplicating Systems
Sound Quality Monitors

OTARI[®]

105 High Street, Eton, Windsor, Berks.

Telephone: (95) 52663

Everything for the professional under one roof

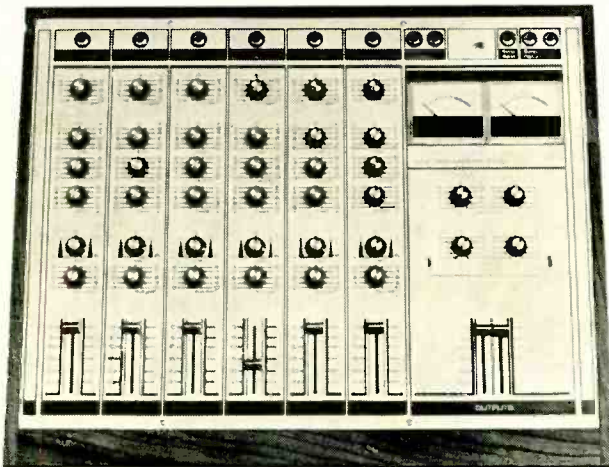

**R.E.W. AD62
Mk II MIXER (Made by Alice)**

Improved version of the very popular Alice Mixer. Features 6 input channels into 2 output channels with input sensitivity, mic line switching, treble, mid range, bass, pan pot and echo send on each input channel. The AD62 includes 2 high quality limiters. This mixer is equally suitable for studio use or P.A. applications.

R.E.W. price **£269** + VAT



TEAC A3340 (Professional Model)

R.E.W. are main suppliers to professional users of this new 4 channel tape recorder. Main features include full sel-sync on all 4 channels, 15 and 7½ i.p.s., solenoid mechanics and 10½" reels. Other recorders available with similar facilities would cost over £1000.

R.E.W. price **£445** + VAT



TEAC A7030 GSL

Transportable professional 2 channel tape unit based on Teac Studio Machines. All solenoid operated deck with accident proof controls. Bias, equalisation and meter switching for low noise/high output tapes.

Recommended Price **£500** + VAT
Nett professional price on application.



TEAC A3300-II 15 & 7½ I.P.S.

Two channel version of the ubiquitous four channel A3340. 3 motor solenoid operated. Very rugged construction.

Recommended Price **£265** + VAT
Nett professional price on application.

AMCRON

(Formerly Crown International)

R.E.W. are the central and South London suppliers of AMCRON amplifiers.—

**New DC300A 500 + 500 Watts RMS D150
140 + 140 Watts RMS D60 60 + 60 Watts RMS NETT
PROFESSIONAL PRICES ON APPLICATION — THE SAME THAT IS OBTAINABLE FROM MACINNES LABORATORIES.**



PROFESSIONAL SHOWROOMS:
146 Charing Cross Road, London WC2. Telephone: 01-836 3365

INDUSTRIAL, VIDEO and MAIL ORDER:
R.E.W. House, 10-12 High Street, Colliers Wood, London S.W.19 2BE. Telephone: 01-540 9684/5/6

WE ARE OFFICIAL LONDON DISTRIBUTORS FOR THE KEITH MONK MIC. STANDS

I.T.A. STUDIO STANDARD RECORDERS

TEAC HS2340 7½-15 I.P.S.



Frequency response 20 Hz-25 kHz. Signal/noise ratio 55 dB. Particularly suitable for use in Mini Studios and for replay of quadraphonic tapes.

£399.00*

Sole U.K. Supplier

TEAC A3340 7½-15 I.P.S.

As for HS2340 but with 10½" spool capacity.



£445.00*

TEAC INDUSTRIAL RECORDER 7½-15 I.P.S.

Special high performance version of domestic A3340. Response 20 Hz-30 kHz. Signal/noise ratio 63 dB. Currently being used in many recording studios.

Sole U.K. Supplier

£492.00*

REVOX HS77 7½-15 I.P.S.



Firmly established as the standard recorder by broadcast companies, theatres and recording studios. Suitable for master tapes to broadcast standard.

£237.00* *Immediate delivery*

DOLBY HS77 £310

SELSYNC +£20 VHS 15/30 I.P.S. £298



SPECIAL PRICES TO PROFESSIONAL USERS

ITA 10 input/4 output mixer specially designed for use with TEAC range now available.

Details on request.

SPECIAL LOW PRICES ON SCOTCH 207, 3600 ft. TAPE

INDUSTRIAL TAPE APPLICATIONS

105 High Street, Eton, Windsor, Berks.

Tel: (95) 52663

Credit facilities available

★ Prices exclude VAT



DUAL CONCENTRICS

Versions of the Tannoy Dual Concentric loudspeaker have formed the basis of many of the best studio monitors for more than 25 years. The unit is incorporated in a variety of enclosures made by leading manufacturers both in the U.K. and abroad, as well as being incorporated in "package studios" produced by foremost U.K., European, U.S. and Japanese manufacturers. The unit not only has the advantages of high power handling capacity and long term consistency, but the level frequency response, good polar distribution and exceptionally low intermodulation products make it ideal for the highest quality studio monitor systems. Apart from the current range of Monitor Gold units specified below the Monitor "Red" 15 is still in production and can be supplied upon request in its original 15Ω version.

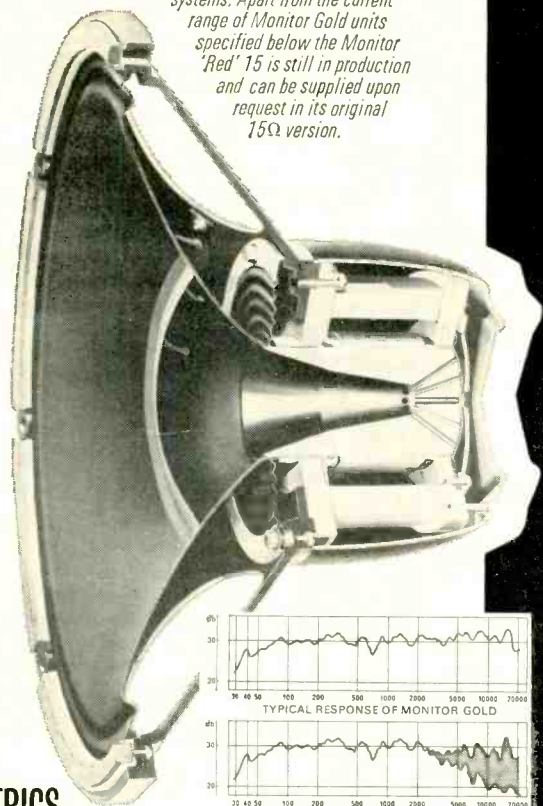

**SPECIFY
TANNOY
DUAL
CONCENTRICS
FOR YOUR
STUDIO MONITOR**

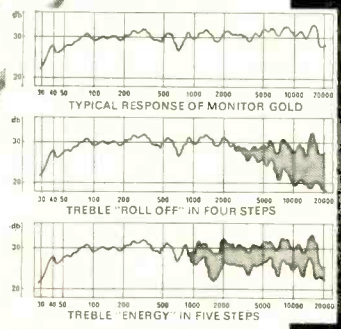

TECHNICAL SPECIFICATIONS			
	FIFTEEN	TWELVE	III LZ
Frequency Response	23-20,000 Hz	25-20,000 Hz	27-20,000 Hz
Polar Distribution for 60° inc. Angle	-4dB at 10,000 Hz	-3dB at 10,000 Hz	-2dB at 10,000 Hz
Power Handling Capacity	50 watts *	35 watts *	25 watts *
Impedance Via Crossover Network	8 ohms (5 ohms min.)	8 ohms (5 ohms min.)	8 ohms (5 ohms min.)
Intermodulation Products	less than 2%	less than 2%	less than 2%
Bass Resonance	26 Hz	28 Hz	30 Hz
Crossover Frequency	1,000 Hz	1,000 Hz	1,200 Hz

* Depending on type of enclosure.



WEST NORWOOD LONDON SE 27 9AB
TEL: 01-670 1131



NAGRA IV-s

**NAGRA III's
ALWAYS
WANTED FOR
CASH**

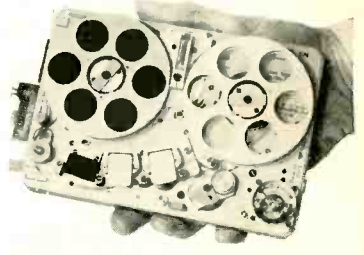

**NAGRA SN MODEL
AVAILABLE**

**50 Hz CRYSTAL £59.75 + 10% VAT
PULSE GENERATOR**

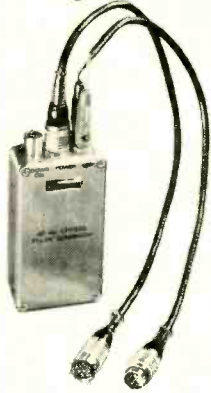

PANAMIC BOOM
A must for sound recordists

Detachable end mount for 1/8" and 3/8" thread. Anodised alloy tubes for maximum strength and minimum whip. Black finish for non-reflection. Velvetex non-slip grip. Length closed 5ft., extended 13ft. 4in. Weight 2lb. 4oz. £65.00 + 10% VAT.

Sole distributors:
J. J. FRANCIS (WOOD GREEN) LTD
MANWOOD HOUSE, MATCHING GREEN,
HARLOW, ESSEX CM17 0RS Telephone: Matching 476

A BRAND NEW RANGE OF EQUIPMENT FOR THE PROFESSIONALS!

It includes high reliability low distortion power amplifiers for studio or public address work, and some very interesting professional lighting control units, audio transformers, and rack equipment cabinets. They're all described in detail in our smart new catalogue which is yours for the asking.

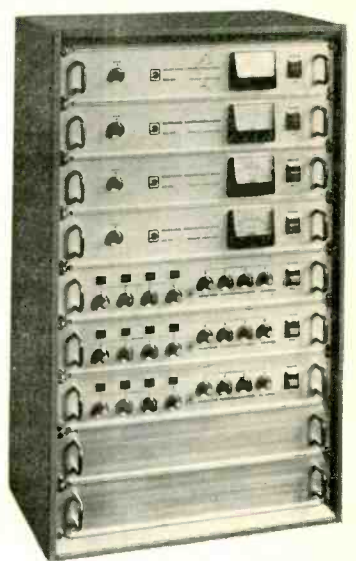

MUSTANG COMMUNICATIONS
NELSON STREET
SCARBOROUGH
Yorkshire
YO12 7SZ
Telephone (0723) 63298

SARM HAVE JUST CONSOLED THEMSELVES.

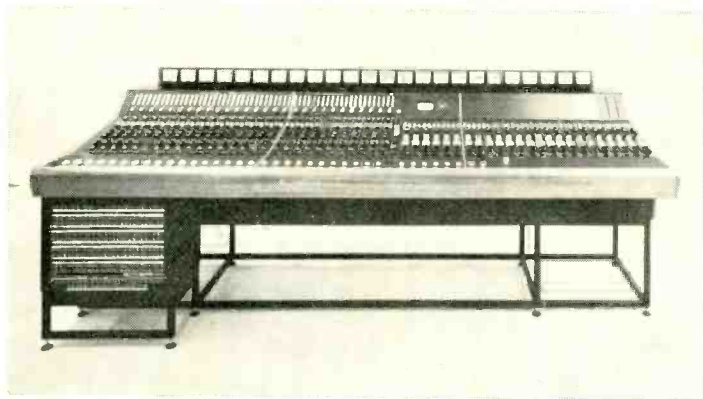

With one of ours. They had many to choose from.
Like the wise people they are, they chose the Triad 'B' Series. Thanks.



Trident Audio Developments Limited 4-10 North Road, London N7 9HG Telephone: 01-609 0087 Telex: 27782

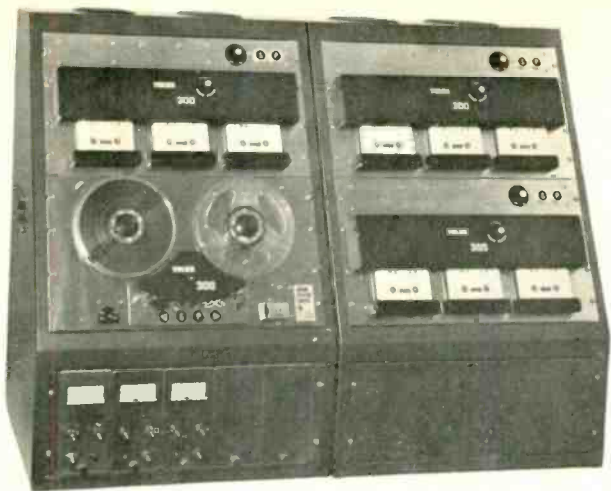

THE 300 SERIES DUPLICATOR IS ALSO AVAILABLE FOR REEL TO REEL, CASSETTE TO CASSETTE OR MIXED SYSTEM DUPLICATION, WITHOUT THE NEED FOR ADDITIONAL ELECTRONICS.

FOR PRICE SCHEDULES, FULL TECHNICAL SPECIFICATIONS AND DEMONSTRATIONS, PLEASE CONTACT SOLE U.K. DISTRIBUTORS:

AVCOM SYSTEMS LTD

NEWTON WORKS, STANLAKE MEWS, LONDON W12 7HA 01 749 2201

INTRODUCING— THE TELEX 300

TELEX IN-CASSETTE HIGH SPEED DUPLICATORS ARE NOW AVAILABLE FOR 8 TO 1 DUPLICATING RATIO IN HALF TRACK 2 CHANNEL AND QUARTER TRACK 2 OR 4 CHANNEL CONFIGURATIONS.

THE TRADITIONAL TELEX QUALITIES OF RELIABILITY RAPID SERVICING, OPERATING CONVENIENCE AND EXPANSION FLEXIBILITY HAVE BEEN MAINTAINED IN THE NEW 300 SERIES, WITH THESE EXTRA FEATURES:

- TRACK SELECTOR SWITCHING
- CALIBRATED RECORD LEVEL CONTROLS
- WIDER FREQUENCY RESPONSE
- AVAILABILITY OF CASSETTE SLAVES IN 2 DIFFERENT SPEED COMBINATIONS, 38/19 CM/SEC. OR 19/9.5 CM/SEC.

A GOOD ALL ROUNDER

HM80 Hybrid Module

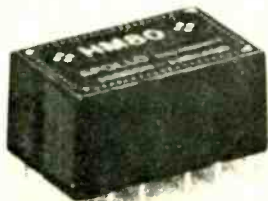

approx.
actual size

This is a general purpose Hybrid AC control module. It provides a dynamic control range of 80 db and it is capable of performing any function that lies between the frequencies of 3 Hz and 200 KHz.

Furthermore it will operate with single supply voltage ranging from 4.5 to 24 Volts with negligible variation of all other characteristics except of course the maximum input and output voltage swing which is mainly determined by the supply voltage.

This miniature encapsulated 24 pin Dual-In-Line module contains also all the necessary coupling and decoupling capacitors and therefore the external components are limited to those necessary to perform the individual function required.

The internal pin connections have been specially arranged to make the design of printed circuit boards very easy and the module will plug into a standard 24 pin D.I.L socket for maximum flexibility.

The outstanding quality and reliability of this module makes it ideal for use in the professional field and along with the specification sheet comes a very comprehensive application report dealing with all aspects of sound recording equipment.

Furthermore we undertake to design free of charge any application required but not listed in the application report.

For further details write or phone:

APOLLO ELECTRONICS
96 MILL LANE, LONDON NW6 1NQ

Telephone: 01-794-8326

KLARKTEKNIK

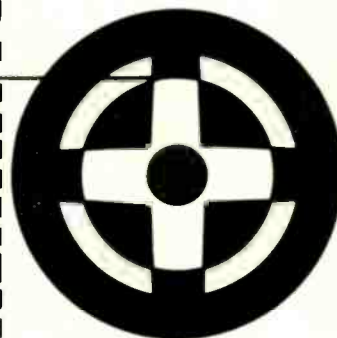

**Custom built
professional electronic
recording equipment**

Klark - Teknik Limited
M.O.S. Industrial Site Kidderminster
Worcestershire England
Telephone Kidderminster 64027

Audio Test Set RTS 2

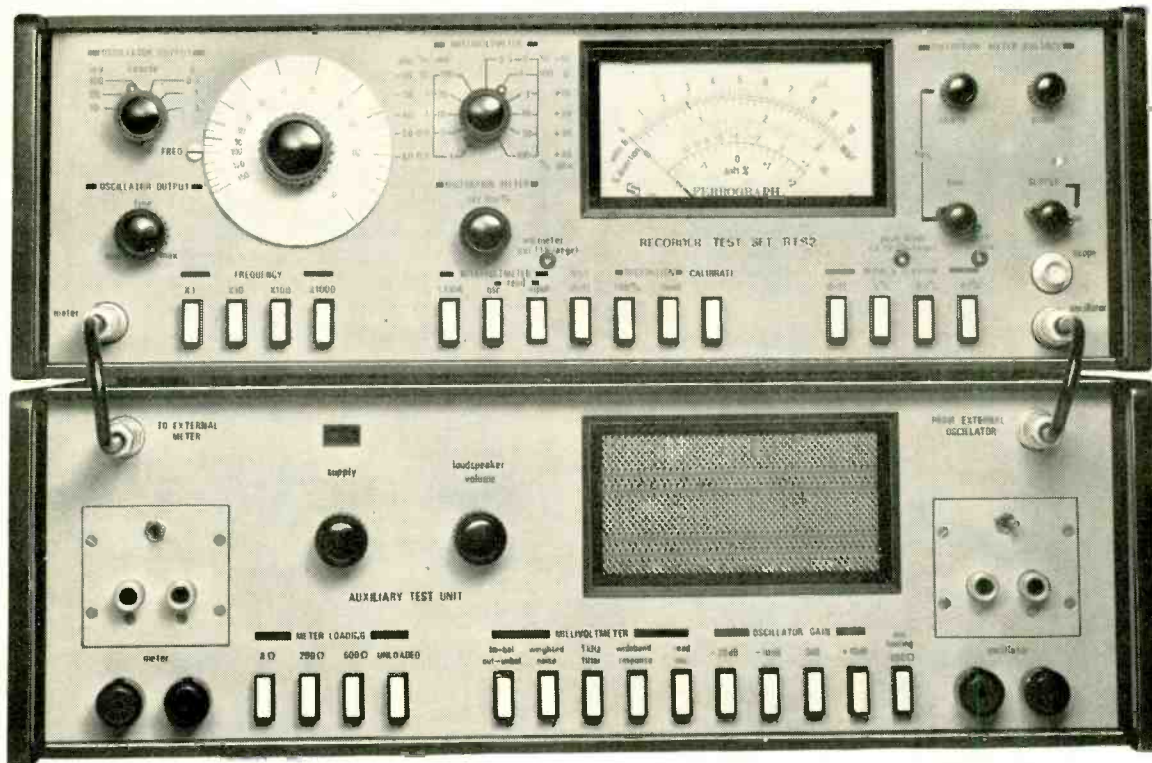

and Auxiliary Test Unit ATU1 for professional users

RTS2 Checks Amplifiers,
mixers, tape-recorders

For Frequency Response ·
Signal/noise ratio ·
Distortion · Cross-talk ·
Wow & flutter · Drift ·
Erasure · Sensitivity ·
Output power · Gain

ATU1 Extends output level and
measurement sensitivity.
Provides balanced
input/output facilities.
Incorporates weighting
filters, loading circuits.
Has built-in speaker
for monitoring purposes.

Send for leaflets RTS2 & ATU1

FERROGRAPH

A member of the Wilmot Breeden group

Ferroglyph Company Limited Auriema House 442 Bath Road Cippenham Slough Bucks SL1 6BB Tel: Burnham 62511

Telex 847297

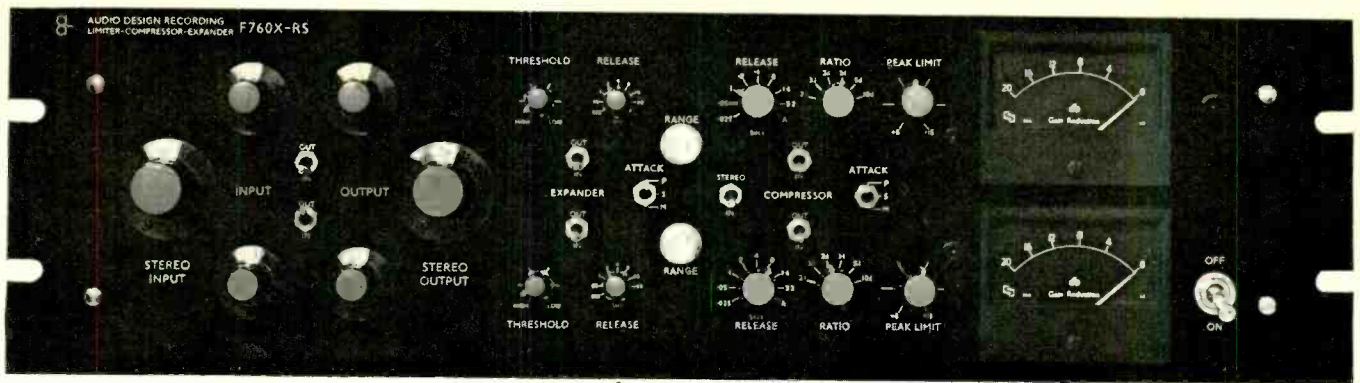

F760X—RS STEREO LIMITER—COMPRESSOR—EXPANDER

The F760X-RS level control rack-mounting unit provides extremely versatile facilities: Any function can be used independently, or simultaneous combination of all three functions can be selected. The unit can be used as two separate mono devices or to process a stereo signal. Current units now provide optional 'Gate' or 'Expand' slopes. Eliminate noise due to compression; reduce channel noise; studio cross-talk and unwanted ambience. The most comprehensive unit in the world brings you TOTAL CONTROL at a price you'll afford!



AUDIO DESIGN RECORDING

TEL: READING (0734) 84487

STAND 41—APRS '73

**ST MICHAELS
SHINFIELD ROAD
SHINFIELD GREEN
READING BERKS UK**

SONIFEX

Telephone Wellingborough 77142

A WIDE RANGE OF ORIGINAL CIRCUIT
FUNCTIONS AVAILABLE AS HIGH GRADE
FIBREGLASS CIRCUIT CARDS,
OR COMPLETED EQUIPMENT

- ★ Microphone Amplifier
- ★ Virtual Earth Mixer
- ★ Line Amplifier
- ★ Equaliser L.F. and H.F.
- ★ Presence Amplifier
- ★ Line Up Oscillator
- ★ Peak Program Meter Assembly
- ★ Headphone Amplifier
- ★ Noise Gate

B1000 6 CHANNEL MONOPHONIC MIXER.
MPI00 NAB CARTRIDGE PLAYER.
JACKFIELD ASSEMBLIES, 19" PANEL
35 and 16MM RECORDING EQUIPMENT.

**93 STANWELL WAY, WELLINGBOROUGH,
NORTHANTS NN8 3DD.**

WOW and FLUTTER METERS

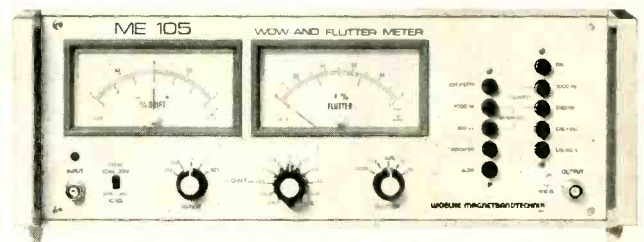

Illustrated is the ME 105, the very latest type of Wow and Flutter Meters manufactured by Woelke Magnetbandtechnik, Munich, Germany, and distributed exclusively by us in the U.K. Anyone concerned with the most accurate measurement of drift (down to plus/minus 0.1%) and wow and flutter (down to plus/minus 0.03%) will be interested in the ME 105. Fuller, final details on application.

LENNARD DEVELOPMENTS LTD.

**206 CHASE SIDE, ENFIELD, EN2 0QX
MIDDX.**

Tel. 01-363 8238

AMCRON

THE NICE ONES!

Amplifiers



DC.300A

Power at clip point (per channel) 200 watts into 8 ohms: 350 watts into 4 ohms: 500 watts into 2.5 ohms. Used mono—greater than 650 watts into 8 or 4 ohms. This new unit will operate into loads as low as 1 ohm and no longer requires protection fuses as did its predecessor the DC 300. Power response ± 1 dB from zero to 20,000 Hz at 150 watts per channel into 8 ohms. Total harmonic distortion 0.02% at 300 watts per channel into 4 ohms. Hum and noise below 110 dB at 150 watts per channel into 8 ohms. IM distortion 0.05% from 0.01 watt to 150 watts per channel into 8 ohms. Input sensitivity 1.75V for 150 watts out per channel into 8 ohms. Size, with front panel, 19in x 7in x 9 $\frac{1}{2}$ in (suitable for standard rack mounting).

Others in the range include the D150 100 watts rms into 8 Ω per channel, and the D60 which will deliver 42 watts into 8 Ω per channel or 100 watts as a mono amp.

Test Equipment



IMA Intermodulation Distortion Analyser.

Ranges: 0.1, 0.3, 1, 3, 10 and 100% fsd.

Accuracy: 5% of full scale

Residual IM is less than 0.005%

Integral High and Low frequency generators

The IMA is a rugged, versatile instrument capable of fast, accurate measurement of IM reading over a wide range of levels.

Loudspeakers

Amcron produce 4 electrostatic loudspeaker systems, and two cone systems. The magnificent ES-224 electrostatic speakers will be shown at the APRS Exhibition.

Speaker Complement	ES-224
Usable Frequency Response in Recommended Max. Room	2—10", 24-HF-150
Crossover Frequencies	22 Hz—30 kHz
Recommended Max. Room Size	350 Hz
Recommended Max. Amp Power	6000 Cu. Ft.
Dimensions: Tweeter	150 watt
Woofer	26 x 39 x 12 Deep
	26 x 21 x 16 Deep

Greater Sound Pressure levels are obtainable than were before possible in an electrostatic. Measurements done in a 12' x 25' living room show levels of 116-122dB with the amplifier below clipping. Yet, this speaker is capable of enduring huge sustained power levels over long periods. (Typically, the ES 224 has sustained the full output of the DC-300, with a music source, for several hours. Needless to say, we left the room during this period). The speaker showed no signs of stress, and only practical time limitation and the neighbours prevented us from continuing the test.



MACINNES LABORATORIES LTD. STONHAM, STOWMARKET. IP14 5LB.
Telephone Stonham (044 971) 486.

COMMUNICATION ACCESSORIES & EQUIPMENT LIMITED

77 AKEMAN STREET, TRING, HERTS, U.K.

G.P.O. Type components on short delivery

JACK PLUGS—201, 310, 316, 309, 404

JACK STRIPS—310, 320, 510, 520, 810

JACK SOCKETS—300, 500, 800, B3 and B6 mountings

PATCH PANELS—made to specifications

LAMPS & LAMP STRIPS—SWITCHBOARD No. 2 LAMP CAPS 10 way PO 17 20 way PO 19 BALLAST PO No.11 HOLDER No. 12

CORDS, PATCHING & SWITCHBOARD—made to specifications

TERMINAL BLOCKS DISTRIBUTION—20 way up to 250 way

LOW PASS FILTERS—type 4B and PANELS, TELEGRAPH 71 (15 x 4B)

UNISELECTORS—various types and manufacturers both PO and miniature

LINE TRANSFORMERS/RETARDATION COILS—type 48A, 48H, 149H, 3/16, 3/216, 3/48A, 3/43A, 48J, etc

FUSE & PROTECTOR MOUNTINGS—8064 A/B 4028, H15B, H40 and individual 1¹/₂

COILS—39A, 40A and 40E, etc

PO TYPE KEYS—1000 and PLUNGER TYPES 228, 279, etc

19" RACKS—VARIOUS SIZES

Telephone: Tring 3476/8 STD: 0442-82

Telex: 82362

Answerback: Batelcom UK Tring

AUDIO CONNECTORS

BROADCAST PATTERN JACKFIELDS, JACKCORDS PLUGS & JACKS. QUICK-DISCONNECT MICROPHONE CONNECTORS. AMPHENOL (TUCHEL) MINIATURE CONNECTORS WITH COUPLING NUT. HIRSCHMANN BANANA PLUGS & TEST PROBES. XLR COMPATIBLE IN-LINE ATTENUATORS. LOW COST SLIDER FADERS BY RUF.

FUTURE FILM DEVELOPMENTS LTD.

90 Wardour Street W1V 3LE

01-437 1892/3

* Dolby A361 and Revox High Speed A77 for hire.

* Revox A77 MK III Recorders from stock.

* All leading makes supplied including A.K.G., Beyer, Ferrograph, Teac, Quad, Tannoy, Spondor, Uher 4000/4200/4400, Report IC Recorders.

BAILEYS

131 The Parade, High Street, Watford WD1 1NA
Tel. Watford 34644

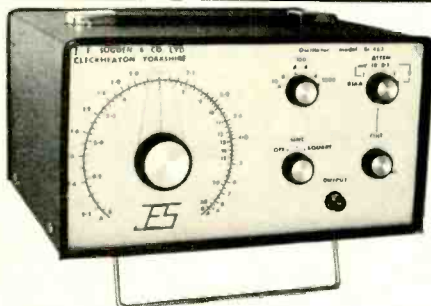

Si451 Millivoltmeter

★ 20 ranges also with variable control permitting easy reading of relative frequency response exc. vat £35.00

JES AUDIO INSTRUMENTATION

Illustrated the Si453 Audio Oscillator

SPECIAL FEATURES:

- ★ very low distortion content—less than .03%
- ★ an output conforming to RIAA recording characteristic
- ★ battery operation for no ripple or hum loop
- ★ square wave output of fast rise time
- ★ overlapping scales to prevent end cramping

also available

£40.00 exc. vat

Si452 Distortion Measuring Unit

★ low cost distortion measurement down to .01% with comprehensive facilities including L.F. cut switch etc. exc. vat £30.00

J. E. SUGDEN & CO. LTD., CARR STREET, CLECKHEATON, YORKS, BD19 5LA.

Tel: 09762-2501

richardson



Mixer installed in the studios of Molinare Sound Services—10 Stratford Place, London, 01-529 0761

Richardson Electronics at A.P.R.S. 73

We announce a new economical range of tape electronics using chassis modules 19in (482.5mm) wide x 1.75in (44.5mm) high. The system uses our already well known plug-in amplifier cards with a mother board to provide interconnections within each chassis module. Each module comprises single channel playback, sel-sync, record circuits with 2 equalisations and using external power supply. Level, equalisation, and bias controls are accessible through the anodised aluminium front panel and Vu metering is provided on each module. A number of modules can be electronically coupled such that multi-track machines can be catered for in multiples of one. External connections are via Cannon XLR compatible and interconnections are via multi-way connectors.

Our well proven modular tape electronics system constructed on Vero series 1 rack frames each 19in (482.5mm) wide x 7in (177.8mm) high will be displayed. In standard form each rack comprises 4 replay, sel-sync, record, buffer oscillator units, thus the building of multitrack electronics is achieved in multiples of 4 together with external power supply and master sync oscillator. The complete system facilitates the electronic automation and remoting of many functions including muted drop-in and drop-out of record, meter monitoring on each channel for line in, line out, and bias, and switching between 4 equalisations.

Having built a number of modular mixers during the past 5 years for the entertainment and broadcast industries we are able to offer a compact system which provides flexibility, portability and serviceability within an economical price but without relatively non-essential 'features'.

An input module has been developed from customers' requirements and is now offered as a standard version together with custom built output, routing and monitoring facilities. Normal routing is for 2 or 4 channel out although up to 8 could be accommodated.

REMEMBER—

Richardson Electronics also offer a comprehensive range of plug-in amplifier modules to meet YOUR individual requirements. The range is being continually revised but, for example, comprises microphone (lo or hi level), gram (magnetic RIAA), hi-impedance, null point mixer, tone control, line out, 15W monitor, 30W and 100W driver, power supply, record and replay (DIN or NAB), tape oscillator, tone source, PPM driver. In addition a universal mother board to allow customers the freedom of building to their own system diagram but obviating connections directly to edge connectors and the running of bus-bars. Our own successful small mixer range including the 'DISCO' and '8 x 2 TRANSPORTABLE' uses the above system to great advantage.

To all those concerned with sound, come and have a chat with us about YOUR requirements.



J. RICHARDSON ELECTRONICS LIMITED

57 JAMESTOWN ROAD, LONDON N.W.1

01-267 0723/4874

Be Ready for Holidays & Europe!

On EMI cassettes & reels direct from manufacturer learn

FRENCH SPANISH GERMAN ITALIAN

... its so simple, just slip cassette into machine, or reel onto recorder. Each pre-recorded language course comes complete with manual. Ideal for beginners or as a brush up course!

Why pay £5 per course!	ONE COMPLETE COURSE OF 24-26 LESSONS	OR ALL FOUR LANGUAGES
	£1.49	£5.50 p&p 20p per order

**GIGANTIC
OFFER** Most at
less than
HALF PRICE

**MANUFACTURED
UNDER CONTRACT
BY EMI
LOW NOISE
5 SCREW TYPE
CASSETTES**

with index cards at less than half list branded prices all in plastic presentation cases.

C60 32p, 10 for £3; C90 45p, 10 for £4.20

HEAD CLEANERS 30p; C120 58p,
10 for £5.50; EMPTY PLASTIC
CASES 10p. P/P 20p

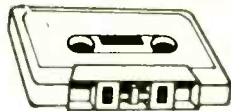

CHEAPER GRADES OF CASSETTES BY AUDIO CERTRON & OTHERS

5 SCREW TYPE INDEX CARDS AND CASES.

C60 25p, 10 for £2.35; C90 35p, 10 for £3.25; C120 45p, 10 for £4.25. P/P 20p

INDEX CARDS 3p PER DOZEN

RECORDING TAPES

SUPERB QUALITY WITH
LEADERS & BOXED · POLY-
ESTER · PVC · & MYLAR BASED.
MANUFACTURED BY LEADING
ELECTRONICS FIRMS

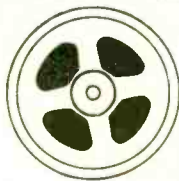

Why not try one and cut your recording costs?

	Standard Play		Long Play		Double Play	
5"	600'	35p	900'	42p	1200'	60p
5½"	900'	40p	1200'	55p	1800'	80p
7"	1200'	48p	1800'	70p	2400'	98p

EMPTY SPOOLS 5" 10p, 5½" 11p, 7" 12p. P/P 20p

WALKERS (S) 16 Woodthorpe Road, Ashford, Mdx. 52136

PLUGS & LEADS

PLUGS

Pack 107 5 pin Din	22p
Pack 108 3 pin Din	20p
Pack 135 ¼" Jack	27p
Pack 130 4" Jack Stereo	50p
Pack 103 Loudspeaker Plug	17p
Pack 100 Phono Plug	7p
Pack 230 3 pin Socket	25p
Pack 236 5 pin Socket	33p
Pack 234 Loudspeaker Socket	33p

READY MADE LEADS

3 pin to 3 pin Din	70p
3 pin to open end	55p
5 pin to 5 pin Din	90p
5 pin to open end	70p
5 pin to 4 phono plugs	100p
Speaker lead Din to spade 12ft	40p
Extension lead Din plug to socket 12ft.	70p

All leads approx. 6ft. in length

DIAMOND STYLI

(Send S.A.E. for Complete List)
8TA; 9TA; 9TAHC; GP91; ST4; ST9;
EV26, GC8. All at 80p each.
Double Diamond ... £1.25
Diamond suitable for Orbit NM22;
G800; M3D £2.25 each.

CARTRIDGES

Goldring G800	£6.00
Orbit NM22	£4.00
Shure 75/6	£6.00
Sonotone 9TAHC (Dia)	£2.00
Sonotone 8T4A (Dia)	£1.50
Ronnette 105 (Dia)	£1.25

All prices include VAT and postage

J. J. Francis (WOOD GREEN) Ltd
MANWOOD HOUSE, MATCHING GREEN, HARLOW,
ESSEX CM17 0RS Telephone: Matching 476

RECORD CARE

Cecil Watts Dust Bug	£1.20
Parastatic Disc Preener	45p
Antistatic Fluid	20p
Dust Bug Spares (Brush and Roller)	15p

CASSETTE TAPES

Audio-Magnetics C60
Qty. 3 6 10 20
Price £1.00 £1.90 £3.20 £6.30
Cassette Caddy ... £1.20
Cassette Head Cleaner ... 35p

Zonal Ilford Tape

5" Standard 600ft.	25p
5½" Standard 900ft.	50p
7" (Plain boxed) 1200ft.	60p
7" (Westminster Boxed) 1800ft.	£1.25
7" Reel of Leader Tape (Blue or green)	75p

HEADPHONES

Sennheiser HD414	£10.60
AKG K50	£6.50
Beyer DT485	£35.00

MICROPHONES

AKG D109	£11.50
AKG D202E1	£39.50
AKG D190C	£17.00
AKG D190E	£18.20
AKG D224	£50.00
Sennheiser MD211N	£45.00
Sennheiser MD413N	£27.00
Sennheiser MD421N	£35.00
Audio RM57F Radio Mike	£210.00

SPEAKERS

E.M.I. 350 Kit 8 ohms...	£8.20
E.M.I. 450 Kit 8 ohms...	£4.50

QUALITY COLUMNS



JB12 Input: 12w. RMS. 100v. line
Tapped: 3, 6 and 12 watts.
Response: ± 6dB. 110Hz. - 15kHz.
Size: 635mm x 280 x 165 depth.
25" x 11" x 6½"

JB18 Input: 18w. RMS. 100v. line
Tapped: 6, 12 and 18 watts.
Response: ± 6dB. 110Hz. - 15kHz.
Size: 952mm x 280 x 165 depth.
37½" x 11" x 6½"

JB24 Input: 24w. RMS. 100v. line
Tapped: 6, 12, 18 and 24 watts.
Response: ± 6dB. 100Hz. - 15kHz.
Size: 1270mm x 280 x 165 depth.
50" x 11" x 6½"

JOHNSON BRODY MARKETING Co.

394 NORTHOLT ROAD, SOUTH HARROW, MX.

TEL: 01-422 1863/4825.

CHYMES AUDIO ELECTRONIC

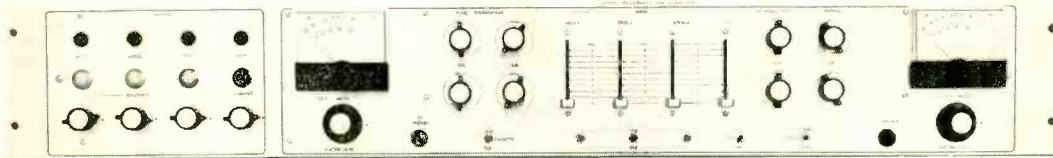

MIXERS
£96.00
NET TRADE

Mixer Inputs; 2 x stereo mag. phono, 1 x stereo tape, 1 x mono cassette 1 x mono mic with ducking and overload limiting. Variations on standard spec. available. Mixer also available with lighting unit as illustrated £117.00 (NET TRADE)

**200/400 WATT STEREO
 SLAVE AMPLIFIERS**
£79.00/£147.00
 (NET TRADE)



ENSURE THAT YOUR PROFESSIONAL SOUND SOUNDS PROFESSIONAL

SEND FOR DETAILS OF OUR STUDIO/DISCOTHEQUE MIXERS AND AMPLIFIERS

320 BARKHAM ROAD, WOKINGHAM, BERKS. Tel. Wokingham 781970

**NEW equipment for the
 professional sound-recording
 studio from *brenell***

DESIGNED AND MADE IN THE U.K.

MULTI-CHANNEL EQUIPMENT

We have set a new price/performance standard with our 4, 8 and 16 channel studio recorders offering full facilities for the production of master recordings. PPM or VU meters on each channel. Equalisation to CCIR, NAB and IEC characteristics. Remote control for tape transport and record functions. The equipment is in full production and studio use in both U.K. and overseas.

STUDIO RECORDERS

for 2-channel reducing, field recording and full-track mastering.

TAPE TRANSPORTS

We offer a widened range of 2 speed and 4 speed models from 15/16 to 60 IPS, $\frac{1}{2}$ " to 1" tape width, with heavy duty solenoid operation and remote control facilities.

brenell

BRENELL ENGINEERING CO LTD

231-5 Liverpool Road, London N1 1LY Tel. 01-607 8271 (5 lines)



**THE TPA 100D IS THE MOST ADVANCED
200W POWER AMPLIFIER MADE IN EUROPE**
Most professional recording and broadcasting
studios in the U.K. use TPA series amplifiers.



CLIENTS USING TPA SERIES AMPLIFIERS INCLUDE:

BBC Radio & T.V. ■ ATV Network Ltd ■ Thames T.V. Ltd ■ I.T.N. Ltd ■ RCA Ltd ■
De Lane Lea Processes Ltd ■ Electricity Research Council ■ Ministry of Technology ■
Cavendish Laboratory ■ British Scientific Instrument Research Centre.

HH ELECTRONIC MILTON CAMBRIDGE TEL 0223 65945



**A SIX WAY MINIATURE
STEREO MIXER OFFERING
ON EACH CHANNEL**

Continuously variable input
sensitivity
Treble, mid and bass
equalisation
Foldback Monitor output
Echo send
Stereo panning
Slider fader

**TWIN OUTPUTS,
EACH WITH**

Echo return equalisation
Vu metering
Slider fader

trade enquiries welcome

ALLEN & HEATH LTD
PEMBROKE HOUSE CAMPSBOURNE ROAD
HORNSEY LONDON N 8 tel:01-340 3291

**MIXERS CAN BE LINKED
TO INCREASE
AVAILABLE CHANNELS**

Introducing the SYNTHI AKS

which remembers up to 256 notes as they are played

Ten green apples on the tree; Good for you, good for me
Good for everybody round the tree

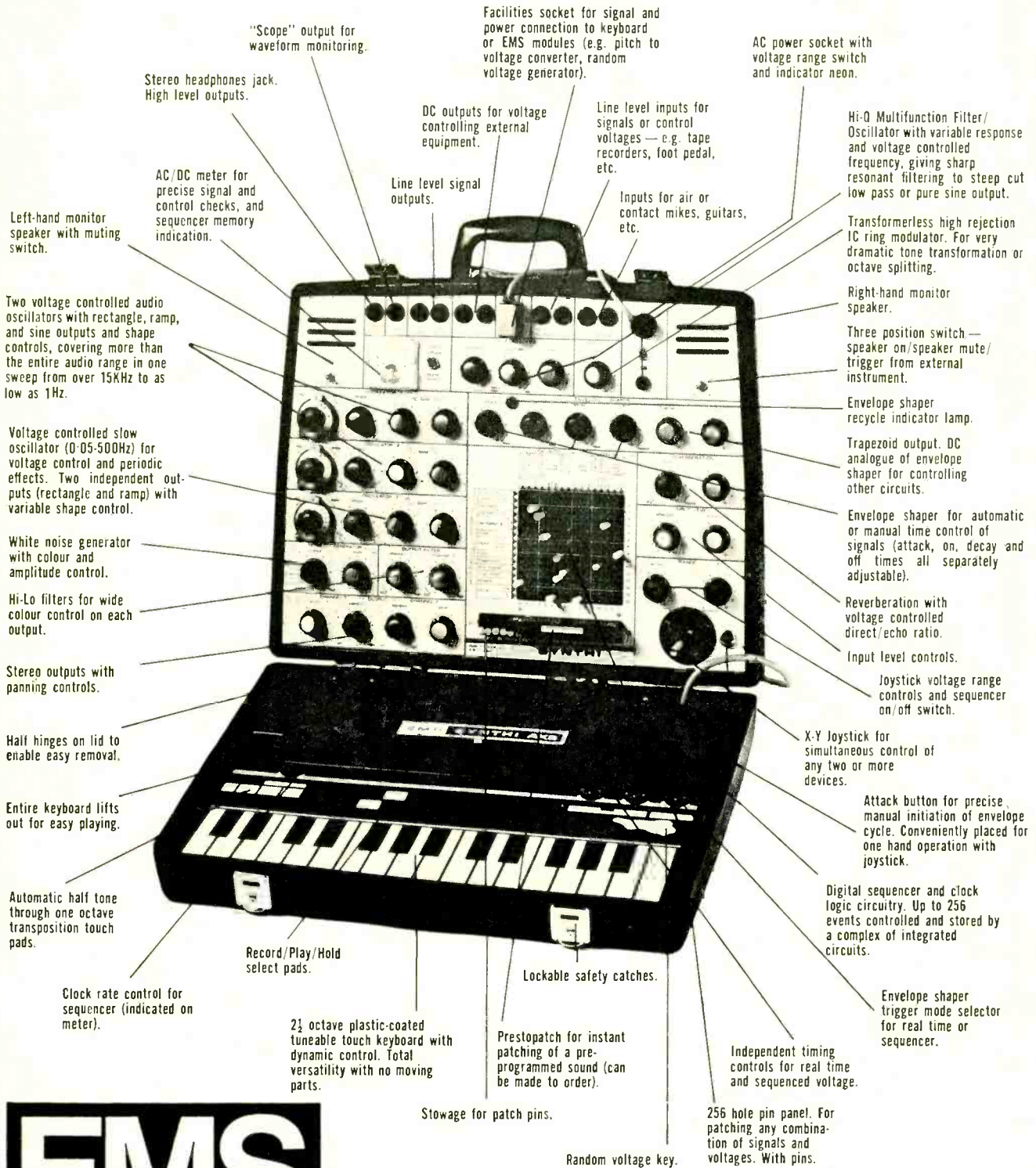

EMS

EMS Ltd. 277 Putney Bridge Road London SW15, ENGLAND TEL: (01) 788 3491
EMS Inc. 408 East 78th Street N.Y. 10021, U.S.A. TEL: (212) 628 5200

Now available in the U.K. — the world renowned ALTEC LANSING range.

Built a little better



For further details write to sole U.K. Distributors: ACOUSTICO ENTERPRISES LTD., 6-8 Union Street, Kingston-upon-Thames Surrey. Tel. 01-549 3471/3 (3 lines).

Altec speakers systems and stereo components are designed to offer you finer specifications for better listening and the latest features for better control of what you hear and the newest innovations for professional recording studios. And that's why we say they're built a little better.

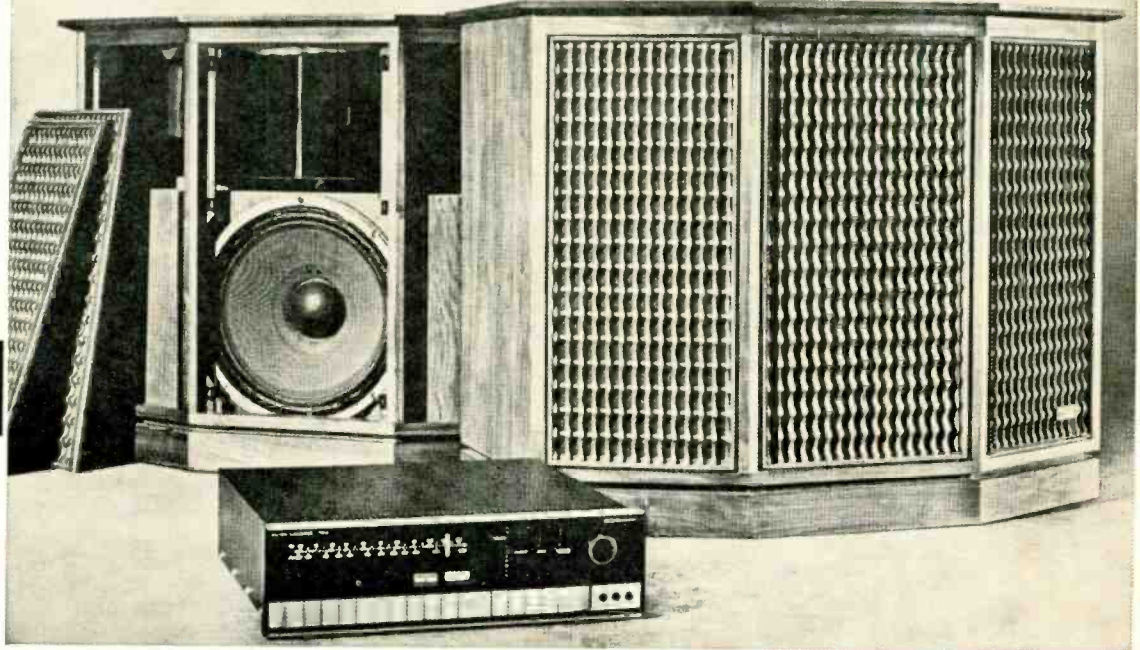

High-speed Tape Copying Equipment



Reel to cassette

Reel to reel

**HIGH-SPEED
TAPE &
CASSETTE
COPYING**
large and small runs

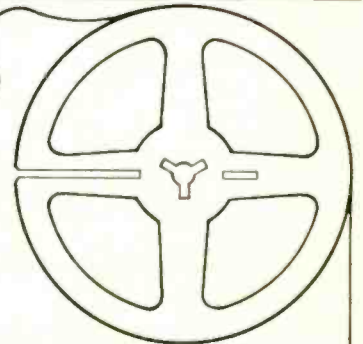

fpa

Fraser-Peacock Associates Limited
94 High Street Wimbledon Village London SW19
01-947 2233

sole UK distributors of Infonics

Fraser-Peacock Associates Limited
94 High Street Wimbledon Village
London SW19 01-947 2233

CHILTON 10/2 MARK 2

STAND 70 APRS

BASIC FACILITIES:

Prefade listen and Pre/post auxiliary send on all 10 input channels. Break jacks on all inputs and output groups. HF and LF equalisers, mtd control at two frequencies (optional) talkback and switchable (line or monitor) ppms. Line-up oscillator: 40 Hz, 100 Hz, 1 kHz, 10 kHz and 15 kHz ± 0.5 dB. Illuminated red/green cue pushbuttons. External stabilised 24V supply with auto over load cutout. **Low noise:** -122 dBm ref 600 ohm source over 20 kHz bandwidth. **Low distortion:** 0.05% at +10 dBm out, 1 kHz. **Low crosstalk:** -55 dB, 1 kHz. **Bandwidth:** 30 Hz to 18 kHz ± 1 dB. **Dimensions:** 570 x 466 x 233 mm. **Weight:** 9 kg. **PRICE:** From £275 + VAT. Also 12 in/4 out from £500.

MANUFACTURER: MAGNETIC TAPES LTD., CHILTON WORKS, GARDEN ROAD, RICHMOND, SURREY, ENGLAND. (Tel: 01-876 7957)



audix

SOUND SYSTEMS AND ELECTRONICS

MONITOR

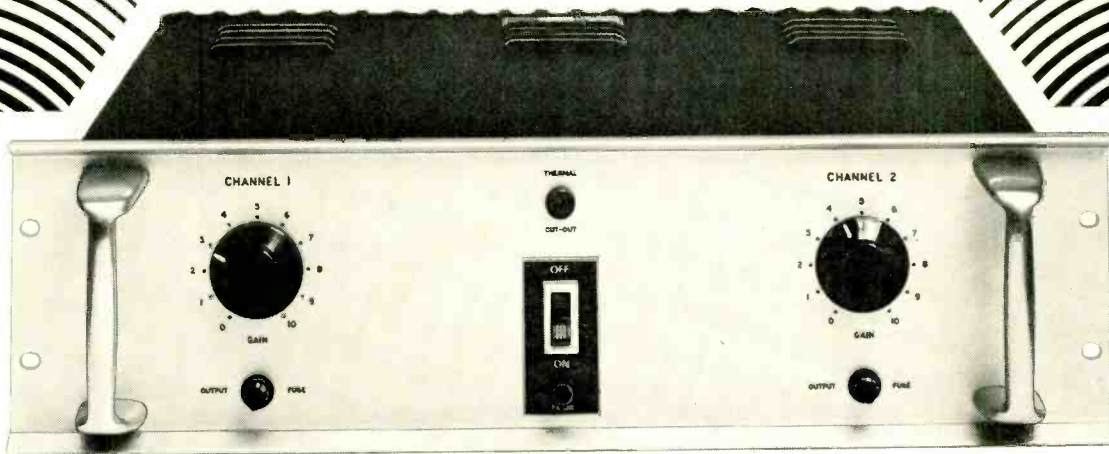

AMPLIFIERS

Three new amplifiers at 15, 30 and 80 watts (r.m.s.) suitable for rack mounting or free standing are now available for broadcast and recording studio monitoring. These units now supersede the well tried Studio 80 and represent a further improvement in the latest techniques of semi-conductor circuit designs. Stringent quality control and exhaustive test procedures combined with protection circuitry ensure continuous trouble free operation.

Typical Performance:-

- Power Bandwidth:-** 5Hz to 40KHz at rated output.
- Frequency Response:-** ± 0.5 dB 20Hz to 20KHz at rated output.
- Total Distortion:-** 0.05% at 1KHz; 200mW to rated output.
- Noise:-** -100dB.

audix

MANUFACTURERS OF
SOUND SYSTEMS AND
ELECTRONICS

AUDIX BB LIMITED
STANSTED · ESSEX
TELEPHONE: STANSTED 3132/3437 (STD 027-971)

Capital Radio to automate

NEGOTIATIONS WITH EMI are being finalised by Capital Radio's technical consultants (David Whittle Associates, Salisbury) for the installation of equipment from the Schafer range of radio automation systems. The latter are widely used in the USA where unattended 24-hour broadcasting is becoming increasingly common. The London station plan to use a 903 system; using a keyboard, an operator can program a complete day's programmes or alternatively work on a minute-by-minute basis if required. Programme storage is on open reel tapes and on carousel-stored cartridges, the number of decks and carousels depending on the proportion of manned to unmanned operation required by any station.

BKSTS award

AN ANNUAL award for the most outstanding technical contribution to UK television production is to be introduced by the British Kinematograph Sound and Television Society. Full details of the award have not been released yet; it will be named in memory of Philip Berkeley, the BKSTS council member who died in January.

Appointments

EMI's £9,000,000 subsidiary, EMI Sound & Vision, have appointed Mr Roy Blythen to the board. Mr Blythen was previously divisional general manager and retains overall responsibility for the company's telecommunications

division manufacturing transmitting aeriels and broadcasting systems. Mr Blythen joined EMI in 1934 and was appointed general manager of the communications division in 1968.

At Thames Television, Brian Scott has become head of engineering and A. J. Rickards has become deputy head of engineering. Mr Scott joined ABC TV in 1961 and became deputy head of engineering at Thames in 1968. Two years later he became head of engineering projects. Mr Rickards came to ABC from EMI in 1960. In 1968 he became head of engineering planning and installation at Thames.

Far East orders for Neve

NINE ORDERS totalling over £44,500 have been secured for Neve audio control equipment following a Far Eastern tour by sales director Alan Foster. Six are from Japan, two from Hong Kong, and one from Singapore.

Digital mixing console

A NEW GENERATION of mixing consoles was displayed by Schlumberger at the Montreux symposium in May. Two basic elements, MOS static switching matrices and digital controlled analogue attenuators, govern the switching and level control of inputs, groups, outputs, fold-back and reverberation. The experimental console has six inputs and four groups. Each channel can be controlled by programmed punched tape, magnetic tape, a computer, or human operator. Further details are available from J. L. Moranville, Schlumberger Instruments and Systems, 296 Avenue Napoleon Bonaparte, 92500 Rueil Malmaison, France.

Headphones

APOLOGIES TO Eagle for omitting them from our May issue headphone survey. The company handle 12 headsets comprising the £3.50 SE5, £2 FF8, £3.90 FF9, £5.60 SE1, £4.20 FF16, £10.10 HMA309 with boom, £7 SE40, £8 SE30, £10 SE60, £11.60 FF6, £16 SE100, and £16 FF29 four channel. Further details from Eagle International, Heather Park Drive, Wembley HAO ISU.

Irish jam

TEST BROADCASTS by the new London commercial radio station have been interfering with Irish expatriates' reception of Radio Telefis Eireann. At the time of writing, no response has been made by the IBA to an RTE request for a change in the 539m test frequency. A Ministry of Posts and Telecommunications spokesman commented that he thought the interference 'only' happened after dark. RTE broadcast on 530m.

Link to build BBC mobile

A FULL COLOUR television outside broadcast unit is to be built by Link Electronics, Andover, for the BBC. Worth some £100,000 to Link, the unit will be built on a Seddon chassis as a single diesel-engined vehicle. The van will be 9.6m long and 11 tonnes weight. Custom-built by Dell Coachbuilders, it will incorporate three control rooms handling production, sound and vision. Equipment will include an eight channel Prowest video mixer and 20 channel Neve audio desk, 17 video monitors, off-air receiver, comprehensive talkback, a telephone exchange, and a range of test units. Accommodation for eight people will be provided and Link hope to complete delivery by the end of July.

Cambridge folk choose Macinnes

A CONTRACT to supply the complete sound system for this July's Cambridge Folk Festival has been awarded to Macinnes Laboratories. Centre of the installation will be a 2 x 500W Amcron DC300A feeding Maclab and Vitavox speakers in Macinnes cabinets. Mixing will be accomplished on an Alice desk.

Sait mixer for Aberdeen University

A 16 INPUT four group Sait Electronics mixing desk has been supplied by Allotrope to the University of Aberdeen Television Service. Features include eight equalisers selectable between channels and groups, two Audio & Design group compressors, two Audio Engineering ppms and a 200-way Future Film Developments jackfield.

Marriott producing RCA video heads

MAGNETIC HEADS 'similar to those used in eight track car and home stereo recorders' are being supplied by Marriott Magnetics Ltd (Cornwall) to RCA for use in a low-cost vtr system. The television recorder is reported to be in its final stages of development.

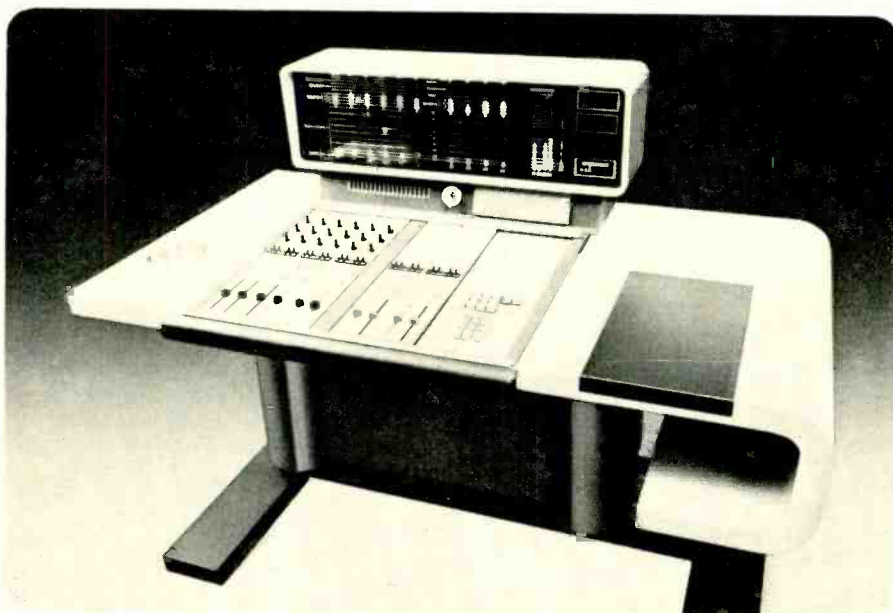

one good name deserves another

Hampstead High Fidelity/STC

We are main distributors for all STC high quality professional microphones. The complete range is available from stock and can be seen in our Hampstead Showrooms. Professional terms available.



4038
BIDIRECTIONAL
Ribbon
30 Hz - 15 kHz
Impedance: 30Ω or 300Ω
Output: -80 dB ref 1V at 30Ω



4104
BROADCAST QUALITY
COMMENTATOR'S NOISE
CANCELLING LIP
MICROPHONE
Sensitivity -84 dB ref 1V
Impedance 30 or 300Ω



4021
OMNIDIRECTIONAL
Moving coil
40 Hz - 12 kHz
Impedance: 30Ω
Output: -80 dB ref 1V/dyne/cm²



4037 A & C
OMNIDIRECTIONAL
Moving coil
Frequency response:
30 Hz - 12 kHz
Sensitivity: -84 dB ref 1V
Suitable for interviewing



4105
CARDIOID
MICROPHONE
Small, lightweight and
robust, suitable for
high quality sound
reinforcement
Impedance 30Ω

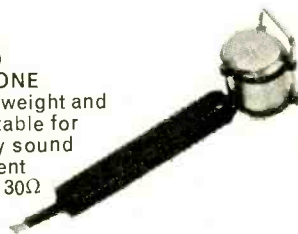

4115
LIGHTWEIGHT
BROADCAST QUALITY
NOISE CANCELLING
RIBBON MICROPHONE
Impedance 30Ω
Sensitivity 85 dB ref 1V



4001G
HIGH FREQUENCY
PRESSURE UNIT
as used by leading
loudspeaker
manufacturers

h
HI
FI

HAMPSTEAD HIGH FIDELITY
91 Heath Street, Hampstead, London NW3 6SS
Telephones: 01-435 0999 and 01-435 6377

Also at **DESIGN AUDIO**
36 Marylebone High Street,
London, W.1
Telephone: 01-935 4058

TELEVISION SOUND

DISCUSSING BROADCAST television, Glyn Allyn has several reasons for television sound being treated as a poor relation to vision (*Sound and Vision*, reviewed next month):

'Although there has been a continual and steady development in sound techniques and equipment to make possible the very high standards that are now attainable, the intangible nature of the sound medium has made its progress less spectacular and less easily appreciated by the layman than that of the picture.

'Secondly, in a combined operation, the resources required to produce the vision and the sound elements are extremely unbalanced. The sheer size of the operation required to produce a picture, in terms of human effort and expenditure, is so much greater than for sound alone that it is almost impossible for those engaged in the business to consider the relative importance of the two media only in terms of programme value—and that is surely the real criterion.'

Thirdly, Allyn finds that sound problems are evaded because of the mistaken belief that the picture carries most of the information (that this is not true can be confirmed by watching a few tv broadcasts in vision only; apart from a few of the snappiest commercials, most of the information is still borne by the sound).

Experience with closed circuit tv bears out all three of the above points. In educational tv, the vision is often used as a mere aid to concentration on the sound. Also, cctv installations (unlike their broadcast counterparts) generally lack decent sound monitoring systems and in both cases the programme is often received on the sideways-facing baffle-mounted speakers common to tv receivers and monitors. Much cctv sound is so poor that not even crisp pictures can reduce the discomfort of viewers.

Some techniques for improving cctv sound will be known to **STUDIO SOUND** readers. Others, such as the dynamic levelling requirements, the poor performance of vtr sound agc circuits, and the very low dynamic range of vtr sound tracks, may be less well known. For completeness, all the links in the cctv sound chain will be described in order together with their common weaknesses.

Microphone positions in television are chosen for minimal visual obstruction and, in the absence of boom operators, this usually means placing them a long way from the subject. As the noise level in a tv studio is high because of the extra machinery, highly directional microphones are essential. Cardioid or hypercardioid are worth the extra cost and, in a large studio or outdoors, a gun microphone

such as the AKG *C9* or Sennheiser *MKH415T* is effective. The presence boost of some low-cost electret mics (for example the Sony *ECM21*) and of the *CK1/S* 'sharp cardioid' capsule in the AKG *C451* capacitor range is a worthwhile insurance against poor playback conditions. The adjustable presence peak of the AKG *D109* lavalier microphone is useful for similar reasons.

In the case of battery portable vtrs (e.g. the Nivico, Sony, National and Shibaden), microphones are built into the camera. Although convenient for the one-man recording team, it is too far from the subject in most shots, as well as picking up handling noises. While the built-in microphones can be bypassed in all the above-mentioned recorders, doing this leads us to the next problem peculiar to non-broadcast vtrs—their sound agc circuits.

In many vtrs, the sound agc is the crudest possible kind of the sort found in the cheapest sound cassette recorders and not known to respectable engineers. In a typical circuit, the zero level output is half-wave rectified, smoothed by a single capacitor, and the signal-dependent dc voltage used to turn on a transistor which simply shunts the collector load of an earlier amplifying stage. Where additional gain is used in this side chain, the agc action is effective. Otherwise the system is nearer to a limiter. There is often no level meter and the gain control, any pre-set gain adjustment being deep in the electronics.

The best solution is to regulate the input levels by a more elaborate agc amplifier such as the Shure *Level-Loc* or the cheaper equivalent made by Japanese TTC. Alternatively use a portable miniature sound mixer. The electrical specifications being less stringent than for pure sound recording, low cost mixers like the Sony *MX12M* or the Unimixer *4S* are quite satisfactory. Where tone controls are needed, the tiny

Allen & Heath (see page 44) still costs under £120. Where such an ancillary level control system is used, it is worthwhile opening up the vtr and raising the agc threshold level so that it now acts like a peak limiter.

Not all vtr agc systems are inadequate; the Philips vcr is not only switchable but has a fairly complex side chain with three time constants and works very well over a wide range of input levels.

Finally, those using vtrs mainly for recording broadcasts have very little trouble with sound levels, however poor their agc systems are. This is because very careful control of dynamic levels will already have been carried out on the programme at source.

Even off-air recordings may still be troubled with vtr tape noise, however, and here the problem is fundamental. Firstly the track width can be less than that for a Philips sound cassette. Here are a few examples:

EIA/J1 12.5 mm:	1 mm
Philips vcr:	0.7 mm
Akai 6.25 mm:	0.35 mm
Sony U matic 19 mm:	0.8 mm
Philips 25 mm:	1 mm

Furthermore, the oxide coating for optimum video performance is very much thinner than that for audio so for a given track width the tape saturates at a lower level at the longer wavelengths used on the audio track. Taking a sample of video tape that was available in 6.25 mm widths, it was found to saturate at about 5 dB above 320 nWb/m which is about 10 dB lower than a good low noise audio tape; the A weighted background noise was about 3 dB worse. Thus the figure of 40 dB often given for the signal-to-noise ratio of vtrs is not directly comparable with that from audio tapes, there being much less 'headroom'.

Soundtrack noise reduction. Given that the dynamic range is nearly always well below that of a non-Dolby B Philips cassette recorder, the cctv user with sufficient interest is recommended to investigate noise reduction systems. Both the low level expanders, or noise gates of the type used to reduce multitrack crosstalk, reduce the gain of the system on playback during the times when the programme falls below a certain level. The dynamic spectral filters (exemplified by the Philips *DNL* and the Teac unit) attenuate the high frequency noise, again during times of low programme level. While both the above systems are partially successful, their action can be obtrusive on the noisier vtrs, particularly when low frequency noise is also present.

Vtr sound tracks are a clear case for those noise reduction systems which compress the signal on record and expand it on playback. The Dolby *A* and *B* compander systems are too well known to need describing here; the *B* system is economical and gives a worthwhile reduction in hiss and the more expensive *A*

Myall compander module,
115 mm true width

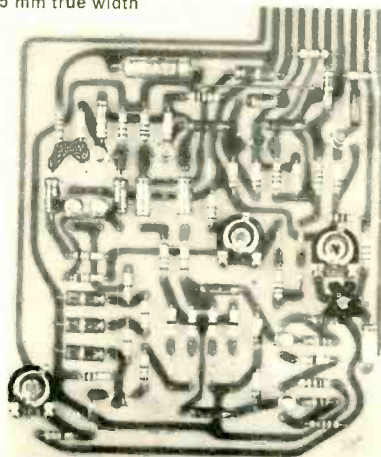

The Other Half Of The Story.

BY now you probably know that Action Video sell video equipment—anything from a portable outfit to a complete broadcast quality studio set up. But we're not just a shop, nor did we start by selling hi-fi equipment or cameras—we started in video. So here's the other side of our story.

Since we understand a video company to be a company that understands video, we offer a comprehensive range of services which have been built up in tandem with the sales section.

In this way all sections of AV's operations benefit from new developments in any one area—experience is shared so you receive an economical, professional service, based on a thorough technical understanding, from a company which is developing as the video field itself develops.

Under one roof, for continuity and speed, Action Video offer the following facilities

Studios



A large studio fully equipped for six channel operation with complete mixing, editing and effects capabilities. Comprehensive lighting and set building facilities are available. A smaller studio is also available for interviews, casting sessions or for use as a viewing room. Studio facilities are available from £25 per hour.



Film/Tape Transfer



Designed to enable the full potential of both film and video tape to be combined economically, Action Video maintain comprehensive facilities for professional telecine and tape to film transfer in monochrome and colour using 16 mm or 35 mm film. Monochrome transfer rates start at £12.50 for the first 15 minutes and reduce thereafter. Colour rates start at £17.50.

Outside Broadcast Unit



For location shooting and playbacks, as well as conference or exhibition work, AV have an outside broadcast unit which is fully compatible with the studio equipment so simplifying video tape production. The O/B unit is available from £150 per day.

Hire and Lease

A very wide range of CCTV equipment is available from AV on economical hire and lease terms.

Service



An integral part of all Action Video's operations is the service section, fully equipped to ensure reliability in all areas.

Coupling a professional, unbiased approach with an appreciation of the user's viewpoint of video means that AV can help you, whatever your requirement. Call 01-734 7465 today for the full Action Video story.



ACTION VIDEO LTD

45 Great Marlborough St., London W.1.
Telephone: 01-734 7465/6/7

PATENTS

THE FOLLOWING list of Complete Specifications Accepted is quoted from the weekly *Official Journal (Patents)*. Copies of specifications may be purchased from The Patent Office Orpington, Kent BR5 3RD.

April 4

- 1316771** Yando, S.
Sound reproducing system.
- 1316791** Western Electric Co Inc
Apparatus for and methods of testing echo suppressors.
- 1316805** Matsushita Electric Industrial Co Ltd
Magnetic video recording and reproducing apparatus.
- 1316811** Matsushita Electric Industrial Co Ltd
Microphone.
- 1316917** International Business Machines Corporation
Magneto-optic transducers.
- 1317004** Baldwin Co, D. H.
Music laboratory.
- 1317112** Brown Ltd, S. G., and Ibbotson, T. D.
Microphone assemblies.
- 1317192** Browning, I., and Johnson, P. R.
Laser impinged recording apparatus.
- 1317244** Communications Patents Ltd
Wired broadcasting systems.
- 1317297** British Broadcasting Corp
Recording media.
- 1317428** International Business Machines Corporation
Parametric acoustic surface wave mixer transducer.
- 1317481** Philips Electronic & Associated Industries Ltd

Time division multiplex system for the transmission of signals by means of pulse code modulation.

1318142 Crosfield Electronic Ltd

Half-tone image reproduction.

1318251 General Electric Co

Voltage controlled oscillator.

April 11

- 1317530** Motorola Inc
Volume and balance control for four channel sound system.
- 1317541** Standard Telephones & Cables Ltd
Speech transmission system.
- 1317542** Tektronix Inc
System for providing a copy of electronically received information.
- 1317634** Philips Electronic & Associated Industries Ltd
Method of manufacturing magnetic heads.
- 1317655** Eastman Kodak Co
Film cartridges.
- 1317794** Sued-Atlas-Werke GmbH
Cassette tape recorder.
- 1317820** Thomas Organ Co
Electrical musical instruments.
- 1317878** International Standard Electric Corp
Frame synchronisation system.
- 1317924** Marconi Co Ltd
Capacitive transducers.
- 1318011/2** Daini Seikosha, KK and Hattori Gokeiten, KK
Nematic liquid crystal materials.
- 1318037** Image Analysing Computers Ltd
Television picture production.
- 1318041** British Broadcasting Corp
Television camera registration.

1318061 Wurlitzer Co

Electrical simulation of the sound of rhythm instrument.

1318095 Sperry Rand Corp

Magnetic recording.

April 18

- 1318392** Hoff, S.
Low tension endless tape cartridge.
- 1318502** Corbett, G. D.
Electromagnetic valves for wind-pipe organs.
- 1318621** Licentia Patent-Ver-Waltungs-GmbH
Monopole radiators and antennae incorporating the same.
- 1318663** Hasler AG
Apparatus for recording storing and reproducing information.
- 1318665** Grado, J. F.
Electromagnetic pickup cartridge.
- 1318734** Pioneer Electronic Corp
Electrostatic electro-acoustic transducer.
- 1318823** Audio Services Ltd
Electrostatic speakers.
- 1318990** Licentia Patent-Ver-Waltungs-GmbH
Record medium for recorded signals.
- 1319001** Sony Corp
Audio signal delay systems.
- 1319088** Matsushita Electric Industrial Co Ltd
Method of manufacturing multi-element magnetic head.

April 25

Publication delayed by Easter holidays. Extraction next month.

VIDEO

system is needed if hum and other low frequency noises are also a problem. Since the pre-1940 days of compandor development for telephony, several noise reduction systems have been produced for high quality speech and music. One wide-band compandor which was developed at roughly the same time as the Dolby system, but which is less well known, is that by W. H. Myall. His compandor uses the very techniques that Dolby rejected, namely compression of all high level signals on record with corresponding expansion on playback. Dolby divide the frequency spectrum into two bands for the B system and four for the A system, for the good reason that changes in one band will fail to mask changes in hiss that result from a single band compandor.

The cost of the Myall is low (being under £20 without power unit and switching) and, although not designed specifically for vtrs, its characteristics seemed well suited for their sound tracks. Their low output on playback

and proximity with head/drum electromechanics result in both hum and field-frequency noise.

Two Myall modules were loaned for trial and connected to a common power supply with two record/play relays, four preset pots and a level setting meter. Each module needed four pole two-way switching between record and play modes so wiring up was quite a task. It would be a good idea to make a version available with switching and level pots built in. When two modules were used 'back to back', weighted noise level was 82 dBA below zero reference level. However, when set up as instructed, the units clipped at only 9 dB above this in the record mode. While this seemed low for sound tapes, the fact that video tapes saturate well below this meant it was not a problem. Distortion at 1 kHz was below 0.12 per cent at all levels up to 0 dB but the hf turnover (-3 dB point) dropped from 18 kHz at high and low levels to 15 kHz at the reference level.

The two main weaknesses of this type of

system are noisy action (breathing) and transient overloading. To be absolutely sure of any system for sound broadcasting or recording needs very lengthy tests on every possible kind of sound. These tests should be done to every type of noise reducer but are out of place in this report. In a series of live versus recorded tests by David Rees last autumn, using professional musicians and studio recorders playing into electrostatic loudspeakers, the Myall system gave a very good account of itself. Used with a vtr on live speech and off-air speech/music, it gave a genuine 14 dB reduction in noise at all frequencies and was not obtrusive in action. The release time is carefully *chosen* to be unobtrusive but observations with tone bursts and a storage oscilloscope suggested that the attack time was longer than need be. But this is theory, not practice, and with cctv sound the question is not whether the Myall system can be detected but rather whether the reduction in hum, field frequency spikes and tape hiss is worthwhile. On this basis the Myall system certainly is a success.

STANCOIL LIMITED

Alexandra Road,
Windsor, ENGLAND.

Tel: Windsor 61308
51056

ALICE would like to thank everybody who visited our stand at this year's A.P.R.S. Exhibition and we are sure you liked the gear.

If we can be of further help, either by supplying additional information, or arranging a visit to us, please write or telephone.

Sincerely,

TED FLETCHER

BYRON DAVIS

ERIC KEENE

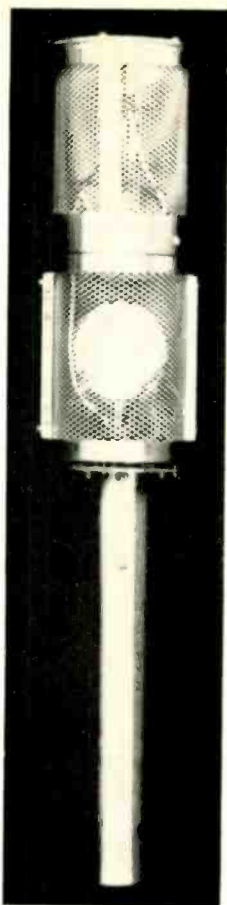

Constructing a quadraphonic capacitor microphone

PART THREE
JOHN FISHER

30 STUDIO SOUND, JULY 1973

I FOUND IT necessary on practical grounds to use a simpler amplifier in the quadraphonic microphone than in the stereo units. It consisted of an n-channel fet followed by a pnp bipolar transistor, direct coupled, to give a voltage gain of 10, a high input impedance (defined by the gate leak resistor), and a low output impedance.

Since the dc conditions of the circuit will depend on the fet characteristics and any variation in them will be reflected (magnified) in the collector voltage of the bipolar, it may be necessary to pick the fets for pinch-off as well as for low noise and gate leakage if the available voltage swing is to be maximised. Ideally the voltage at the collector should be just below half supply volts to give the maximum swing while allowing for some drop in supply voltage as the battery ages. In practice 7 to 10V above earth at the collector is quite acceptable. As an alternative to picking fets, since the required pinch-off voltage is on the low side, it is possible to trim the dc conditions by adding a small resistor (selected on test) in series with the source of the fet.

Two channels on my prototype used Semitron C96E fets as in the earlier stereo microphones and the dc conditions proved very close to optimum without trimming. The other two channels used 2N3819 fets, one of which resulted in +7V (acceptable) on the collector. The other (with a higher pinch-off voltage) resulted in saturation of the bipolar and required a trimming resistor. While it is slightly tedious to have to trim the dc conditions, it is certainly cheaper and simpler than picking for dc conditions as well as for noise. From my samples, it seems that the Semitron C96E fets give more consistent results than the more readily available 2N3819.

The amplifiers in the prototype were constructed between busbars and tags, with the components self-supporting in the wiring. This minimises leakage problems and makes for a compact assembly. At the capsule end, the busbars (two earth, two positive) are connected to the plastic capsule support through a series of fine holes drilled in it at one end and to three of the Cannon plug pins at the other. The fourth anchorage at the plug end is provided for one of the +ve busbars by drilling and tapping 10 BA in the 'missing pin' position of the eight-pin insert and inserting a piece of 10 BA brass studding. At the capsule end, additional tags are provided by inserting Vero pins or wire stubs in the plastic mounting. Connections are made directly to the remaining five pins at the plug end. Shorting links are provided between the two earth busbars and between the two +ve busbars towards the centre of the amplifier assembly, which adds to the mechanical rigidity.

The ht tag, at the centre of the amplifier assembly, is formed simply by the end of the decoupling resistor supported by the two polystyrene decoupling capacitors connected to the two earth lines. The +ve supply decoupling is by tantalum bead capacitors whose leads are too light to contribute much rigidity; on the other hand they save space. The links between the +ve supply busbars and between the earth busbars are wrapped round pipe insulators threaded on the ht decoupling resistor leads.

To the Cannon female plugs used on the connecting cable, it was found necessary to add a subminiature tag under the lock retaining

bolt to provide a reliable earth connection between the casing of the plug and the earth lines. The earth line was duplicated in the connecting cable to keep resistance down, as was the +ve supply line, and links between the earth pins were soldered into the free plugs in order to switch in the decoupling capacitor in the battery pack automatically when the plug is inserted.

The amplifiers were assembled between one pair of busbars for each channel, adjacent channels being mirror image layout. The fets and glass-encapsulated high value resistors were arranged at the capsule end of the amplifiers so as to have the minimum lead length from the capsules to the amplifier inputs. The junction of fet gate, resistor and capsule lead floats free but in fact, due to the tight packing and the shortness of the fet leads, it cannot move enough to touch the casing. Not using a tag minimises the risk of a leakage path between the gate and an adjacent tag. It is very important to wipe the high-value resistor and fet body clean before wiring them in, preferably using a cloth moistened with alcohol or petrol to remove dirt traces from earlier handling, and they should not be handled once in position without being cleaned scrupulously afterwards. Otherwise there is a risk of moisture or dirt providing a noisy leakage path across the body of the fet or resistor, particularly in the area of the plastic body around the leads of the fet.

Great care must also be used in handling the capsule when it is being fitted (and indeed in assembling the components of the capsule) to avoid finger marks (and consequent noise) being left on the capsule. One has to balance this against the risk of dropping the capsule, of course, but disposable surgical gloves can come in handy. *Not* household gloves which have been used for washing up! It is not a bad idea to clean between pins of the F & E plug though there is less risk of trouble here.

A few small pieces of plastic sleeving threaded on the busbars will prevent their touching the casing when it is slid over the amplifier assembly. Pieces of plastic sleeving can also be slipped over component leads and bodies for the same purpose but in practice there should be little difficulty in assembling the circuits well clear of the casing. Removing the six bolts at the capsule end of the case and the two recessed bolts at the F & E plug end enables the casing to be slid on and off easily for tests to the circuit.

There is a slight risk of rf instability if the microphone is operated into a virtual open-circuit from the full output windings of the transformers. This can easily be cured by loading the windings with 10k or 20k ohms. Alternatively the rf gain of the amplifier can be reduced as in the earlier stereo microphones. The instability was found to occur only in the cardioid mode, all other settings being completely stable.

I hope the foregoing description has provided enough detail for anyone interested to construct their own variable polar diagram microphone, whether they intend using the four available channels for quadraphony or only two for stereophony; indeed a single capsule version could be built, with only two transformers, providing a variable polar response mono or back-to-back-cardioid stereo mic in the same unit.

To be concluded

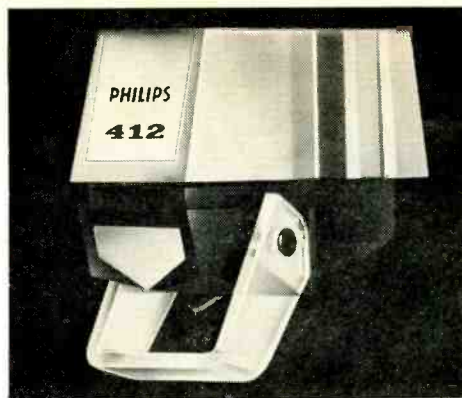

The experts put Philips magneto-dynamic cartridges in the top class.

Read what they say about the Philips GP412 Super M.

From the technical point of view, Philips may be cordially congratulated on this magnificent element, which certainly belongs to the top-five. The sound character proved beautifully transparent; sufficiently well balanced at very low frequencies, brisk in the middle, brilliant in the high notes and not too pronounced in the extremely high range.

*Sinus
DISK*

The Philips GP412 has an excellent frequency response, good crosstalk attenuation throughout the entire frequency range and combines excellent tracking with a pleasingly high sensitivity. Also when judged on tone it is to be placed among the best in the world.

*BR.
Hi-Fi Stereophonic*

The overall sound quality was immediately impressive with plenty of bite and attack in the highs and extraordinarily clean, firm and extended bass. The first few hours of use were spent in listening to a wide variety of fairly serious, well recorded music. The very best of my records sounded first rate—as good as, if not better than I had ever heard them before.

*John Wright
Hi-Fi Sound*

The only fault I found with this cartridge was a loose stylus guard (which I would remove anyway!). Its performance is excellent and if you are seeking the best, hear this one for yourself before making a final choice.

*Norman J. Clayton
S. A. World of Sound*

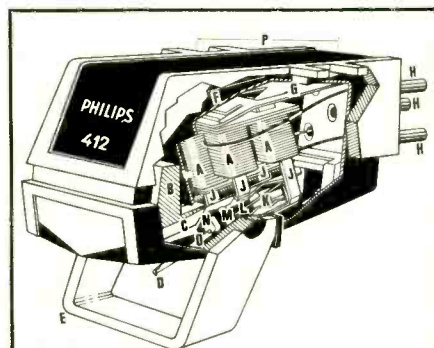

KEY:

- A Pickup coils, 2,500 turns each, wire half as thick as human hair.
- B High precision moulding for accurate mounting of coils and stylus assembly.
- C Stylus assembly enclosed in precision-fitting square brass tube for exact positioning and easy replacement.
- D Accurately ground diamond stylus tip.
- E Stylus guard.
- F MU-metal casing prevents hum pickup.
- G Fixing jig and earth bar.
- H Five contacts.
- J Right and left channel MU-metal pole shoes.
- K Rubber damping block, precision moulded to 0.05 mm.
- L Guide wire of 0.08 mm CrNiFe for controlled compliance.
- M Suspension block.
- N Super M ticonal XX magnet, a high-energy magnet generating a strong field, so that only 7 mg need be used.
- O Stylus bar of thin-walled (0.05 mm) aluminium alloy tube.
- P $\frac{1}{2}$ " distance between mounting centres.

Technical measurements of the system produced on the whole good figures, among which the excellent crosstalk suppression (even at high audio frequencies) is particularly worthy of note. The tracking performance of the cartridge is also very good. Both in combination with the pick-up arm SME 3012 and with the Sony PUA 286 the stylus force did not have to be raised above 1 g. The sound produced by the GP412 was balanced and clear with strong low notes and brilliant high ones.

*Stratos Tschanglou
Fono forum*

The sound quality was extremely pleasing, and the little extra brightness of tone in the upper-register compared with some other high quality moving magnets proved attractive to some listeners. The nature of the sound which it produces is slightly, subtly, different from that of other members of the same family and this cartridge is worth serious consideration and a careful listening test if the purchase of a new high quality pick-up is contemplated.

*B. J. Webb
Hi-Fi News*

There are three Philips Super M magneto-dynamic cartridges. The GP400, GP401 and GP412. Write now for a Super M Brochure to Philips Electrical Limited, Dept SP, Century House, Shaftesbury Avenue, London WC2H 8AS.

**We want you
to have the best.**

PHILIPS



AT THE TIME of writing, Command have almost completed the sale of their studios to as yet unknown buyers. I understand that the price was around £145,000. Whatever it was, it was well above what bidder Monty Babson (who came second) said he thought reasonable considering that the lease had only another three and a half years to run: it expires on Christmas Day, 1976.

Command's story goes back to 1970. They had just formed and were looking for premises when the BBC decided to close all their outside studios for economic reasons, a process which continues. So Piccadilly One went up for grabs and Command grabbed.

I asked the BBC how much they got for Piccadilly One but they wouldn't say, which seems a little high-handed since they are a public corporation accountable to each of us as taxpayers. Therefore you're entitled to know that the building stands on property owned by Joe Lyons and that the BBC has sublet it for £12,000 a year.

The studios were financed by 10,000 £1 shares, offered at £5 each, and a loan of £200,000 from Wm Brandt's Sons and Company, secured by the assets which Command owned. Brandt's, merchant bankers, owned 2,998 of the 10,000 shares, Ashmor Nominees owned 3,000 and the rest were distributed among other directors of Command: Denis Comper; John Mosely; Jacques Levy; Tim Miller and Michael Gampell.

It may seem strange that £1 shares could be offered at £5. In large or very profitable companies it is quite usual to offer shares 'at a premium', that is to say at the nominal value of the shares plus an extra amount which the shareholder stands to lose if the company goes to the dogs. If, as in this case, the company are issuing their first batch of shares, it is not common at all.

Command's chairman at that time, Tim Miller, is married to Margaret Pitman. She is the daughter of Sir James Pitman, once a director of the Bank of England. He is the grandson of the man who invented Pitman shorthand and when he retired in 1966 he had been chairman of Pitman's for over 30 years. He is now a director of Boots and of the Equity & Law Life Assurance Society. Brandt's representative on the Command board was Peter Nutting.

Gampell, a director of Ashmor, had something like 50 other directorships, including those of Abercorn Properties, City and West End Properties and Trafalgar House Investments. Trafalgar House, whose current assets are reckoned to be around £230 million, include such firms as Commercial Union Assurance Ltd, Trollope and Colls, the builders and demolishers, and the Cunard Steamship company, won a year or two back after a fierce takeover battle.

Some people have referred rather unkindly

to Trafalgar House as one of the city's most aggressive property developers: their schemes include their own headquarters in St James's Square-Cleveland House—as well as the Bristol Hotel Piccadilly and Scotland Yard. They are hoping to develop two sites on the north side of Piccadilly, across the road from Command, at the moment but, although planning permission has been agreed, pressures within Westminster City Council may cause it to be revoked. Mr Gampell was also a director of the Heritage Collection of Historic Documents Ltd, an outfit dedicated to preserving at least some of our historic past, not least from property developers.

Jacques Levy resigned from Command in February 1971. Around then Command put in quadrasonic equipment: four pan pots on each of the three control desks as well as extra speakers in the control rooms. Each control room was then equipped with a 24/24 Automated Processes desk, an 8/16 track Scully tape machine convertible to 24 tracks, and two Scullys to provide one to four track facilities.

In July 1971, Command secured an overdraft of £10,000 from Barclays Bank, again by mortgaging their assets. This brought their capital to £260,000.

In November, Command opened their Rock Box in the old Studio Three. The idea was that each instrument of a rock group would have virtually infinite separation, yet the musicians could play together in the middle of the studio floor. John Mosely had seen the idea in the United States and had persuaded the other directors that it would be a good idea to convert their rehearsal studio. After using the Rock Box, rock musician John Jones described it to STUDIO SOUND as a 'great step forward'.

Evidently someone disagreed. According to the necessary papers at Companies House, when Jacques Levy left, the word 'resigned' was used. When, in May of the following year, John Mosely left, the notification to the Department of Trade and Industry said tersely that he ceased to be a director on May 31, 1972. The same applied to Denis Comper, though I understand he left Command by mutual agreement after a period of illness.

At the same time as they left, Command increased their share capital from £10,000 to £13,000, giving them an extra £15,000. That John Mosely and Denis Comper were not replaced indicates that some economies seemed necessary. Only £1,000 was paid out in golden handshakes (compensation for loss of office to directors) during 1972, compared with £2,580 in 1971.

Unfortunately for Command the period they were given to recover the loan was too short: unaudited figures for the trading year to September 30 last year show that the trading loss was £54,876 on a turnover of £131,110. The debenture from Brandt's stood at £190,000, meaning that they had paid off one-twentieth

of it. In their first 18 months of operation they had made a loss of £77,342, which meant that in spite of increased turnover in the second year they were now £132,218 under. Those first 18 months, when they were setting up, were almost bound to cause a loss. But business was not as good in the second year as it should have been: because of technical problems such as control room peculiarities and frequent equipment breakdowns according to some sources; a wrong attitude to the recording business on the part of the management according to others.

When Command found themselves unable to repay the loan, there were a number of things that Brandt's could have done: they could have sued; they could have entered and taken possession, though this is not usually done because the mortgagees, in this case Brandt's, have to account for every penny of income and expenditure; they could have foreclosed, which means that they ask the court to order payment within a specified time with a view to obtaining permanent ownership; they could have sold the property, subject to the type of mortgage and to the conditions written into it; or, as they chose to do, they could appoint a receiver.

That they appointed a receiver does not mean that Command were bankrupt. The receiver, in this case Ian Watt of Thomson McLintock and Partners, acts as agent for the mortgagor, Command, though he is appointed to manage the firm by the mortgagee, Brandt's. He pays charges on the property, interest on loans and so forth, as well as using income to reduce the loan.

Note that Brandt's had made the loan repayable 'at any time up to 1974, but not before October 1, 1972'. Brandt's receiver was appointed only 88 days later. I understand that business has improved since the receiver went in, but he denies reports that charges for studio One have been cut from £32 to £8.5 an hour. At any rate the new buyers should be able to make a go of Command since they don't have to worry about that disastrously high mortgage—unless they've mortgaged themselves to get the place. Anyway I wish them the best of luck.

Capital Radio, the London general entertainment commercial station, have made a number of new appointments: John Witney, once Chairman of the Local Radio Association, will be managing director; Ruth Leon, now deputy director of the Washington public service station, was to be programme controller but changed her mind; Tony Salisbury, of Southern TV, will be general manager; Tony Vickers of ATV will be sales director, and Gerald O'Reilly of the EVR partnership will be chief engineer.

The IBA have been making test transmissions since January on 539m on the medium wave-

The Quad/Eight Gate

NS-120

The fast, accurate,
flexible
noise gate.



**quad/eight
electronics**

11923 Vose Street, North Hollywood, California 91605
Telephone: 213/764-1516

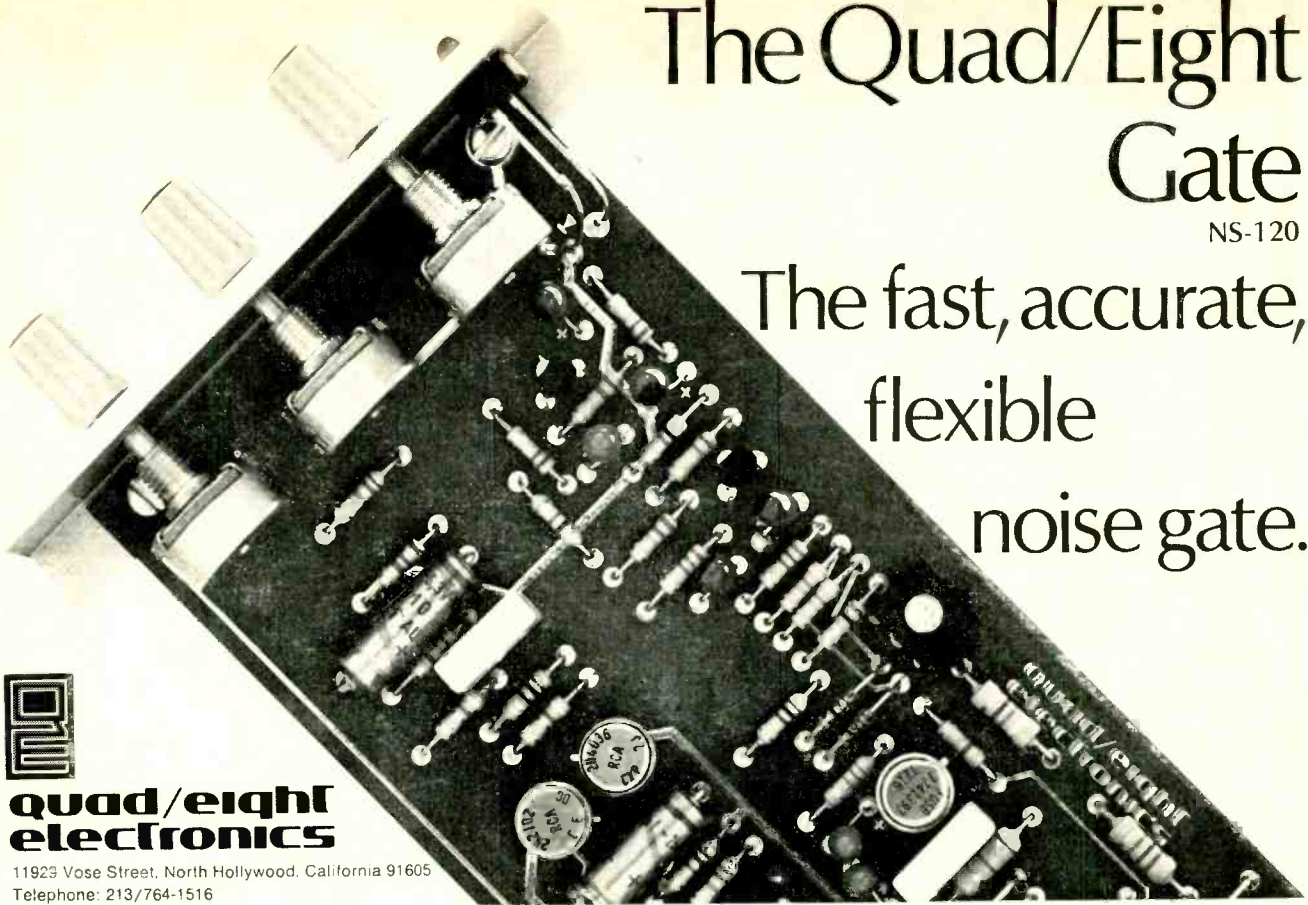

Quietly

ZEL-VA

RECORDING STUDIOS

Have gone 8-track

Please write for new studio brochure or
telephone 021-455 0645 (24 hour answerphone)

ZELLA RECORDS (BIRMINGHAM) LTD.

"Walker Hall," Ampton Road, Edgbaston, Birmingham B15 2UJ

HIGH SPEED COMPACT CASSETTE COPYING SERVICES

- ★ Central London
- ★ Cassette copies in minutes
- ★ 10 to 10,000
- ★ Write today for rate card

MAGNEGRAPH-EUROTEL

1 Hanway Place, London W1 (Junct Oxford St/
Tott Ct Rd) Telephone 01-580 2156

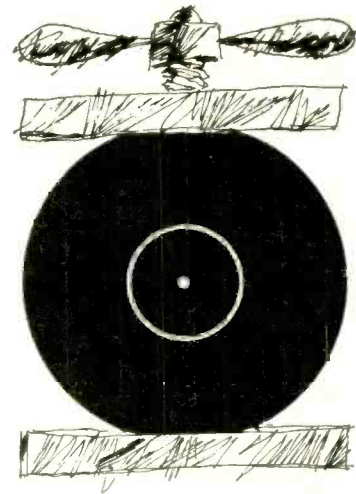

**for all Professional,
Custom, & Trade Pressings**

C. H. Rumble Ltd., Benedict Wharf, Benedict Road,
Mitcham, Surrey. Telephone: 01-648 5106

band. This frequency will probably be taken up by the IBA when the stations start broadcasting in the autumn. The frequency was selected by the Ministry of Posts and Telecommunications after informal talks with the BBC and the IBA.

The Minister, Sir John Eden, was unlikely to have allowed himself to be hampered by any knowledge of broadcasting. (According to one report it was he who, when taken round Thames TV last year, was heard to ask, 'What is ATV? Could you explain that to me?') It is much more likely that he would have taken account of more familiar, political, considerations.

That is why the frequency allocated to test and subsequent transmissions is such that it completely masks broadcasts from Radio Telefis Eireann's transmitter at Athlone, which are on 530m on the medium wave. The reason why the British government should do this is not all that hard to surmise. Because of an oversight on the part of the Irish broadcasting authorities they are not so inclined to give out the kind of P.R. man's prose about 'The British Army doing a great job in Ulster' that the BBC and the IBA are.

According to one report, RTE have already asked that the frequency be changed because there are about a quarter of a million Irish in London who are being deprived of RTE's programmes. The IBA say that the interference is only temporary, but that is by no means certain. The Ministry of Posts and Telecommunications say that the interference only occurs after dark, a statement for which I can find no basis whatever.

Strawberry, Manchester. Peter Tattersall of Strawberry tells me that the studio is now re-equipped with a 16 track MCI tape machine and 24 channel Helios desk. The studio was completely stripped during its six week closure and redesigned by Sandy Brown, designer of the Manor. It reopened on March 28 and the first session was to record a single by the Sunderland football team, who recently won something called the FA Cup. Just before they had closed the studio, Strawberry had recorded a single by the Leeds football team who, by coincidence, recently lost something called the FA Cup.

Neil Sedaka has been working on an album and a single at Strawberry and Barclay James Harvest, currently on tour, have just done a single called *Rock'n' Woman*.

Strawberry have also worked on Muriel Young's *Lift off* series for Granada; Strawberry do the orchestral pieces, I understand, and Indigo do the overdubs and group work for the series. Strawberry have also done Granada's theme music for their tv station; the music was composed by Derek Hylton. John Schroeder came in to produce a single by Mike Rhodes, and John Goodison came in to produce tracks by Blackwater Junction, sessions which Peter Tattersall says he enjoyed very much. 'It's a great pleasure to work with professionals,' he says.

Roger Squire, London. Squire have been working on a number of programmes for fm radio stations, among them Radio Zurich in Switzerland and stations in the United States. Consequently they have re-equipped with Shure

M55E cartridges in their disc replay machines and suitable electronics.

Bill Foster, who has been with Squire for over a year now, has decided to leave and take up a post with Data Communications in Paris as their head of sound. Data are not open yet—they anticipate opening in the autumn—but Bill will be taking up his appointment in June. Data are a video studio who will provide independent video services to PAL standards. They are equipped with RCA video equipment. When they're ready we'll give a full report.

Ray Moore, who recently left Neve, has taken up an appointment with Audix Sound Systems as systems manager. He will investigate any enquiries that Audix receive to see if they are feasible and to cost them.

AIR, London. Geoff Emerick spent most of April in the US recording a Mark Wirtz album and returned at the beginning of May to mix it down at Air. Studio owner George Martin booked the studio for much of May to record the music for *Live and Let Die*, an Eon production; during the last week of April, a voodoo drum sequence was recorded for this.

Rupert Hine is recording his own album and is also involved in an album of newly recorded World War Two sound effects called *The Colditz Story*. 'The effects will be linked with *The Colditz Story*', says Air's Bill Barringer, 'and will contain certain music recorded during the early war years'. Other May artists include Blackfaith, T Rex, Congregation, ELO, ex Procol Harum organist Matthew Fisher, and the Graham Collier sextet, who scored a film by the Shell film unit.

Advision, London. Over 200 films dubbed in 93 sessions in the last month. Jeff Wayne booked time to do films for Dulux, Pepsi, SR Toothpaste, Worthington E, McDougalls flour and Typhoo Tea. A Polo Mints commercial for Film Troupe involved Jackie Richardson's shooting 10km of film in one day (86.4 ks). This resulted in 12 films of varying lengths. Sierra Films dubbed a film about the rent rebate scheme for the Central Office of Information. Other clients in the dubbing theatre this month have included BBD & O, Young & Rubican, Lintas, United Artists, Trick Films, Pearl & Dean, Quartet Films, Ray Elton and Partners, Gillie Potter, London Post Productions and McCann Erickson, whose Barry Day was responsible for the Hertz 'We Say Yes' rent-a-car ads and also for Edward Heath's 'We Say Yes' speech at the last Conservative Party Conference.

Question: who said 'You are Roger Cameron and I claim my £5'?

Pye, London. At the end of April I gate-crashed a stag party for Gordon Vicary, one of Pye's cutting engineers. Champagne was drunk to toast the bride, Paula Clayton, in her absence. Then another toast was drunk to Paula in case the first one didn't work and then another to be trebly sure and altogether what with the corks going off and the metal foil being taken off the next bottle it is doubtful whether a group of engineers have heard such pop and crackle since the days of 78s.

Marquee, London. Marquee report 'there's no truth in the rumour that Moyshe Dayan has just recorded a single titled *Please Don't Talk About Me One Eye's Gone*'. Well it's a bad 'un lads but Israeli not a patch on last month's. Engineer Phil Dunne fell down some

stairs last Friday 13, but I understand he's fully recovered now. The last I heard he was attempting to talk the hind leg off an MCI.

To business: a new band called Batti Mammelle put down single tracks with producer Tony Atkins: Bruno Kretzchmar self-produced a single and an album for Gaff; a Stapley Markstein album and a Moon Williams single were produced by old Marquee customer Kaplan Kaye and engineered by Phil 'It only hurts when I laugh' Dunne.

The Sarstedt Brothers single that Phil was working on when he had his misfortune was finished for him by Will Roper. The producer was Tony Visconti.

Earlier in the month Marquee recorded a single by Jackson Heights organist Brian Chatton produced by Tony Visconti and engineered by Will Roper. Will also mixed a new album by Morgan, who had recorded it in Rome. A new album was started by the Graham Field Rock Orchestra, Phil engineering. Bruce Baxter, who produces the *Top of the Pops* series, came in with Geoff Calver to record an album by McBains Scottish Country Dance Band.

Jack Clements, Nashville, USA. Jack McFadden and Bob Morris have produced Freddie Hart tracks for Buck Owens Enterprises; Al Martino and Shirl Milete were produced separately by Joe Allison for Capitol; Jim Fogelson worked with Roy Clark and Brian Collins and Donna Fargo was recorded by Stan Silver, all for Dot Records; Four Star Music brought producer Joe Johnson in three times, once each with Jimmy Ellis, George Morgan and Jo Anna Neal; Bob Mackenzie produced the Downings and the Singing Rambos for Heartwarming Records; Don Williams produced Frank Myers; Bob McDill and Bob Webster produced Jackie Burns; McDill came back to work with Caspar Peters; Allen Reynolds produced Don Williams; and Chuck Neese produced Tennessee Pulleybone sessions, the last five all for JMI; Polydor brought John Richbour into work with Joe Simon; Poppy Records had Kevin Eggers produce Rocky Hill.

Alpha, Richmond Va. Alpha claim that they are Virginia's first 16 track recording studio and I for one will not quarrel with that, although someone else might. Anyway they have been good enough to send me their monthly newsletter, from which I learn the following: At the beginning of this year Alpha were formed by the merger of Alpha Audio, Candyapple, and Quigg Lawrence Associates. Alpha were a recording studio, Candyapple a production company for music for commercial and films and Quigg Lawrence dealt in tv, radio and audio-visuals.

Alpha have just finished building a second recording studio. The desk in there has 12 input groups, four output groups, six channel equalisation and six echo sends and two returns. Because of construction work Alpha say they had to use their echo room to store materials but it is now back in operation. They have now installed a Leslie speaker in the echo room, so that echo can be added 'to any track via echo send, any time in the recording or mixdown process'. Alpha also have on hand a variety of EMT plates, spring units and tape delay units.

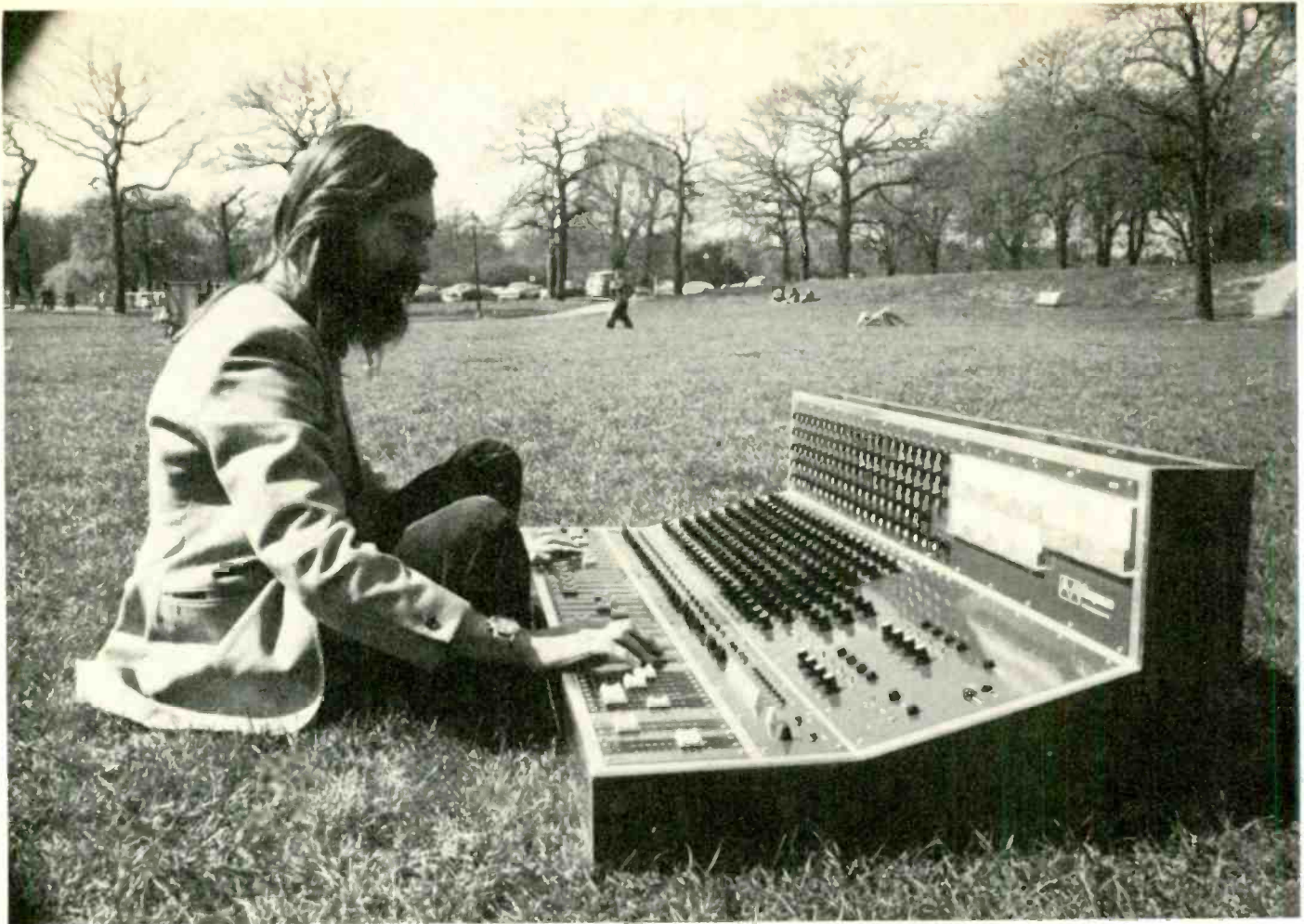

We at Audio Applications believe that, not only should a mixer perform to a high standard electronically, but that meticulous attention must be given to the functional aspects of its design. Only then will it be so logical to use that an engineer can concentrate on the business of sound-mixing and not have to spend time struggling to master his equipment.

SEE US ON STAND 29 AT APRS 1973

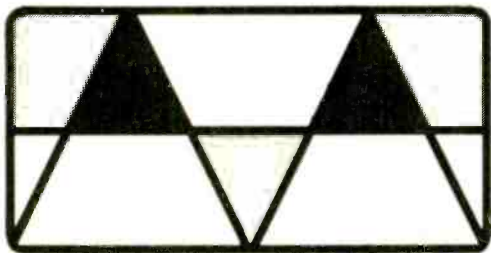

Response

by Audio Applications Limited

**AUDIO APPLICATIONS LIMITED, Kensington Barracks, Kensington Church Street, London, W8 4EP
01-937-6615**

Designing an automated mixing console

PART ONE
M. S. CURTIS

The basic requirements of an automatic audio reduction chain having already been outlined by Clive Green (November issue), M. S. Curtis progresses to the various methods of executing a practical system.

STUDIO SOUND, JULY 1973

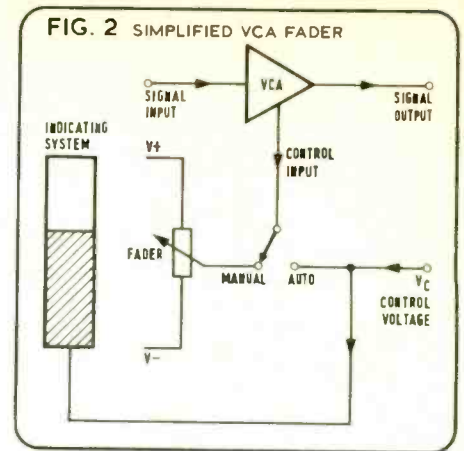
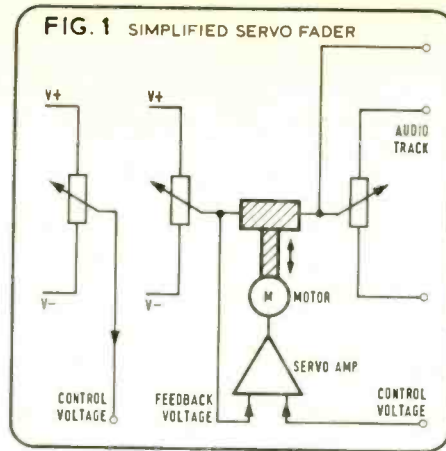

THE INTENTION of this article is to assist small studios and experimenters in producing automated mixing desks for themselves. No complete circuits or constructional details are given but the techniques and systems are based upon experimental work done by the author while evaluating the feasibility of such equipment.

The requirements for automated re-mixing, and one particular approach to it, were well covered by Clive Green's recent article 'Multitrack Remixing: A Fresh Approach'. This visualised the simultaneous recording on spare tracks of control data coincident with the audio content. Thus upon replay the control data would re-calibrate the desk levels to produce the previously achieved audio mix. Such a system could be updated at will and equally several possible mixes could be recorded consecutively, thereby making for a more relaxed and economic approach to record production.

Such a system can be described as a real time system in computer terms. Any control data change has an immediate effect upon the sound being controlled.

To achieve automated mixing two essential items are required:

- (1) a remotely controlled (or automated) fader; (2) a 'black-box' control unit.

Automated faders

There are two approaches to the automated fader. The first is Mr Green's servo controlled fader, driven by a servo motor system. Practically, this would consist of a conventional fader whose manual control could equally be positioned by a gear-train driven by a motor. The motor would be powered by a small servo-amplifier, one of whose inputs would be a control voltage. Another input would be the slider of a parallel linear track providing a feedback control voltage to stabilise the servo system. A further parallel linear track would duplicate the control voltage for updating (or this could be included as the servo feedback track).

The obvious advantages are: low noise, since the attenuating element is passive and is identical to conventional present day faders; clear and obvious operation, the fader knob moving up and down in sympathy with the attenuation as if by an invisible hand; smooth operation free from the inherent inertia of the servo system. The disadvantages are: com-

plexity of mechanical construction; the need for a power amplifier (albeit small) with its heat output and high current requirement (consider a 24 channel desk with 500 mA for each fader!), the tendency of all but expensive servo systems to drift with temperature and time with the danger that a fader might eventually go out of control. (Consider 40 faders drunkenly sliding in and out while a frantic engineer tears his hair out and a stoned producer books more time!)

The second approach is the voltage controlled amplifier (vca). These devices have been available for many years but the demands of synthesiser manufacturers have stimulated the availability of amplifiers having low inherent noise, high gain and consequently low distortion, and large output voltage swing. In its crudest form the amplifier would be set up with its maximum gain equal to unity. However, more use can be made of the vca's capabilities if it becomes an inherent part of the channel's amplification chain. In order to become a practical fader, an indicating strip (usually leds) must be added to indicate the control voltage magnitude and hence the effective fader position.

The vca's advantages are: comparatively low cost (in fact very low if the mixer is designed from scratch with vcas incorporated); low current requirements; a high degree of stability; and a low level of complexity. The obvious disadvantages are: the need for a complementary indicating system, which still leaves something to be desired insofar as clarity is concerned; and the degradation (although small) of the signal that an active circuit must cause.

Thus the tendency is to choose a desk incorporating vca faders in its original design.

The control unit

The control unit has to multiplex the fader control voltages, convert them into a digital signal for recording on spare tracks, decode replayed signals, convert them back into analogue voltages, demultiplex them back to sample and hold circuits for each fader, and provide adequate timing and control facilities. These requirements call for some very elaborate electronics, compared with manual mixing desks. Two techniques are described. The first is a very flexible system which requires some

REIGN Equipment Hire

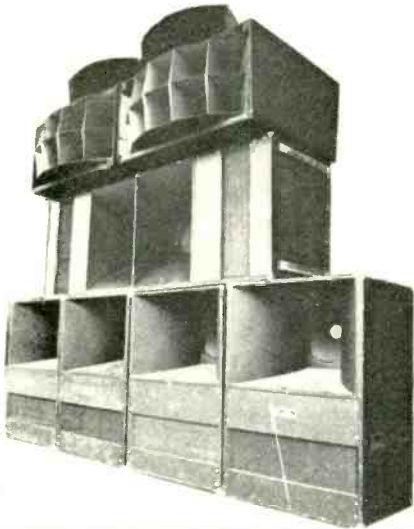

EQUIPMENT AVAILABLE FOR HIRE:

1600 Watt P.A.

800 Watt P.A.

ALTEC Bins and Horns

400 Watt Monitor System

H/H and AMCRON Amplifiers

AKG and SHURE Microphones

20 Channel Studio Desk

Talk-Back between Stage and Mixer

Engineers and Truck Supplied

Light Show available



Write or Phone :- 67 Eardley Crescent, London SW5. 01-373 2077

A good mix.
Our boards.
Your talent.

Our boards are made so that creative engineers and producers can get behind them and work behind them. We feel we're an important part of your artistry. Good sounds, flexibility, reliability and human engineering are what you expect from a professional recording system.

We make some of the best (and most sophisticated) systems and signal-processing devices one would find in any good studio. Like our 2082 mixing console. (it can be automated) Next session, get behind us.

**quad/eight
electronics**



U.K. Distributor

Feldon Audio Ltd London
126 Great Portland Street 01-580 4314

AUTOMATED MIXING

experimentation and research initially but yields very good results. The second is a much more modest system which I believe is unique in parts. It is easy to set up and gives good results on small desks. Obviously at this stage my company are not going to publish full circuit information, but these systems should stimulate and guide any interested experimenter.

The basic system

The system must be considered in two halves. The recording (write) half, and the replaying (read) half. Two approaches are possible at

the write stage. We may convert each analogue control voltage (i.e. fader setting) into its digital equivalent and then multiplex the digital coding (fig. 3). Or we may multiplex the analogue voltages and then digitally encode the result (fig. 4). The latter system has the advantage that only one a/d converter is required and thus an expensive fast-operating converter may be used. Having made this decision, we can outline the write system. The many analogue control voltages are multiplexed or strobed so that each voltage is sampled for a definite time in a fixed cyclic order. During this time, an a/d converter operates on the voltage to generate, say, an

eight-bit digital equivalent which is parallel shifted to a register before the next voltage is sampled. The register can then be unloaded serially to produce a stream of 'data bits' to the recorder.

Protection

When digital data is stored on tape there is inevitably some dropout of data due to dirt on the head, or to faulty or damaged oxide on the tape. Means are thus required either to reconstitute dropped data bits or at least to indicate that the data is incomplete or has been corrupted. Audio recorders are (a) not set up to optimum for data recording and (b) use tape of

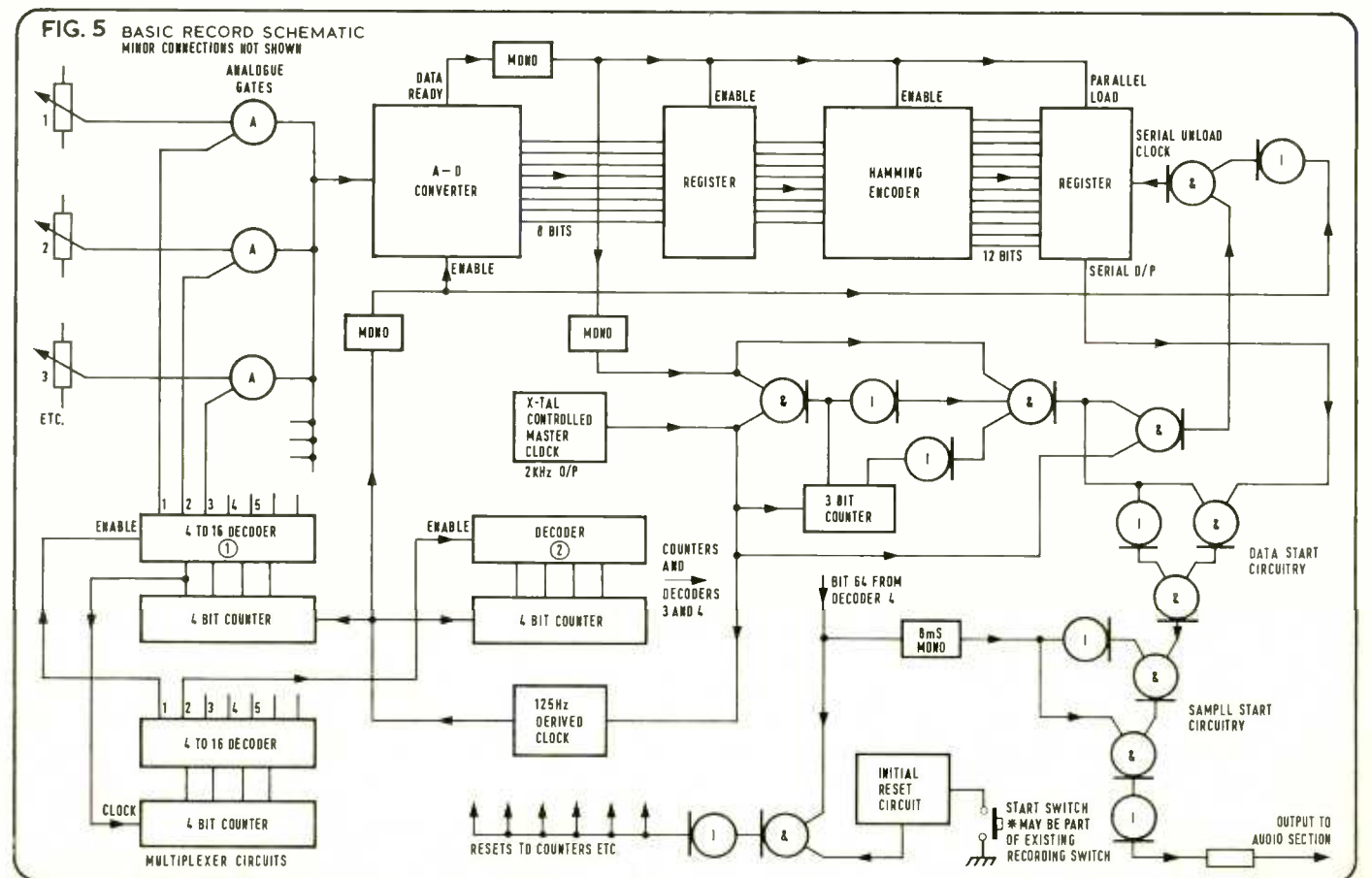
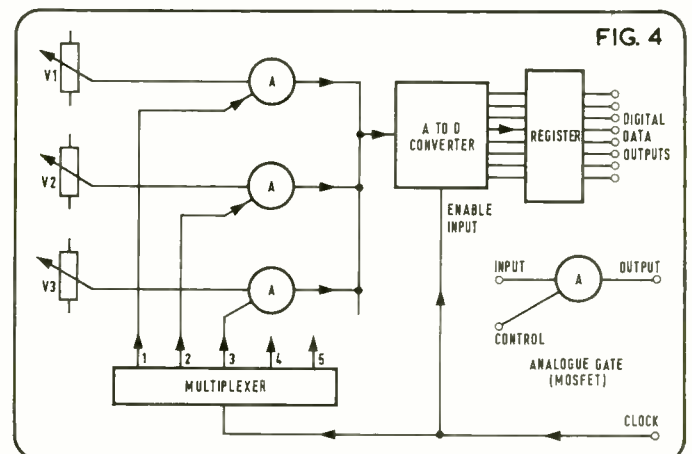
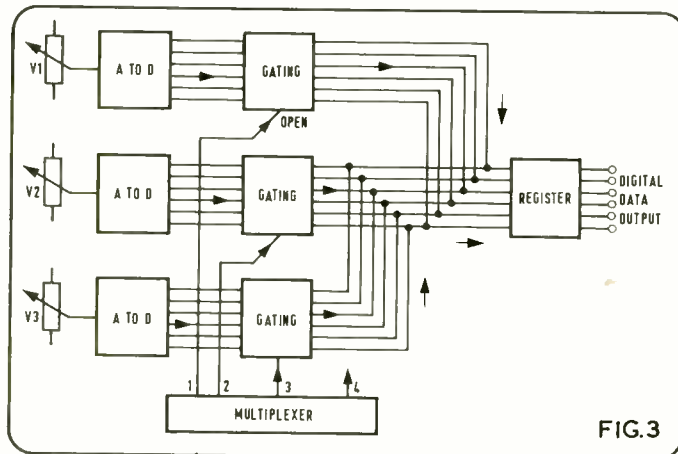

inferior quality compared to 'certified' computer tape, in that a much higher level of dropout can normally be tolerated. In addition, tapes are effectively mutilated by splicing (admittedly comparatively infrequently on multitrack machines). Thus it is obvious that we need some data protection. The obvious answer to someone with a knowledge of logic is to use 'parity bits'. This is the addition of an extra bit whose polarity is determined by whether the sum of the preceding bits was odd or even. Unfortunately these bits only indicate an error but neither specify the error bit nor correct it. Even worse, two errors will cancel out to leave us with apparently no error at all. A very simple protection can be afforded by the use of the Hamming Code. Readers can find the theory of this elsewhere but broadly Hamming showed that, by interspersing suitably calculated bits into a data block, a high level of protection could be afforded. When decoded the Hamming bits will automatically correct one error bit in the block and will highlight any additional errors. Obviously this is a suitable system for us.

So before writing an eight bit code, it must be gated into a Hamming encoder to generate the extra Hamming bits. Upon reading back the data, the block must be gated into a Hamming decoder. This decoder will remove the extra bits, check the validity of the remaining bits, correct any one bit error, and give a signal output if two or more bits are in error. (Suitable circuits are readily available in logic handbooks and ic manufacturers' application notes.) If a large dropout is experienced, then this error signal must be used to freeze all data (and therefore all fader settings) until the next sampling—i.e. the next scanning of the multiplexer.

SYSTEM ONE

Recording (writing)

The complete system diagram is shown in fig. 5. To understand its workings it is neces-

sary first to decide upon some typical performance figures and consider the resulting timing required. Let us start with a simple system. We have 63 channels and up-date each channel twice every second. Rounding up our figures, that allows some 8 ms for each channel. We can see from the resulting timing diagrams (fig. 6) that our data bits will have a period of 0.5 ms, i.e. a frequency of 2 kHz. The Mosfet analogue gates are opened for 8 ms when their count (or number) is decoded from a clock driven counter. Nothing fancy here, just a conventional signal multiplexer. At the beginning of each 8 ms sample period, the a/d converter is enabled for 0.5 ms to do the conversion. This is a very generous time; 0.05 ms is adequate for most converters. A nominal 0.5 ms is allowed for the converter to parallel load an eight-bit register that drives through a Hamming encoder to a 12-bit register. The data block for a particular sample is now available for clocking out. It is, however, necessary to introduce a couple of timing signals, or 'flags', to synchronise the system. Firstly we need a means of recognising the start of the sampling scan so that, upon replay, the correct faders are operated. The method adopted is to have a 'sample start' pulse of, say, 8 ms length before the first data block. The decoding circuitry can tie into this pulse. Secondly it is necessary to synchronise the decoding of the data bits with the stream of bits coming off tape. The simplest method is to record also a synchronising clock. This, however, would require the use of a second track and is to be avoided if possible. Another technique, which looks risky in theory, but works well if some care is taken, is to have a 'data start' pulse before each data block (i.e. each sample) and to synchronise to this. Thus our overall timing is as fig. 7 and the resulting data blocks for each sample are as fig. 8.

The 'sample start' pulse is generated from count 64 from decoder 4. This is the next count 81 ▶

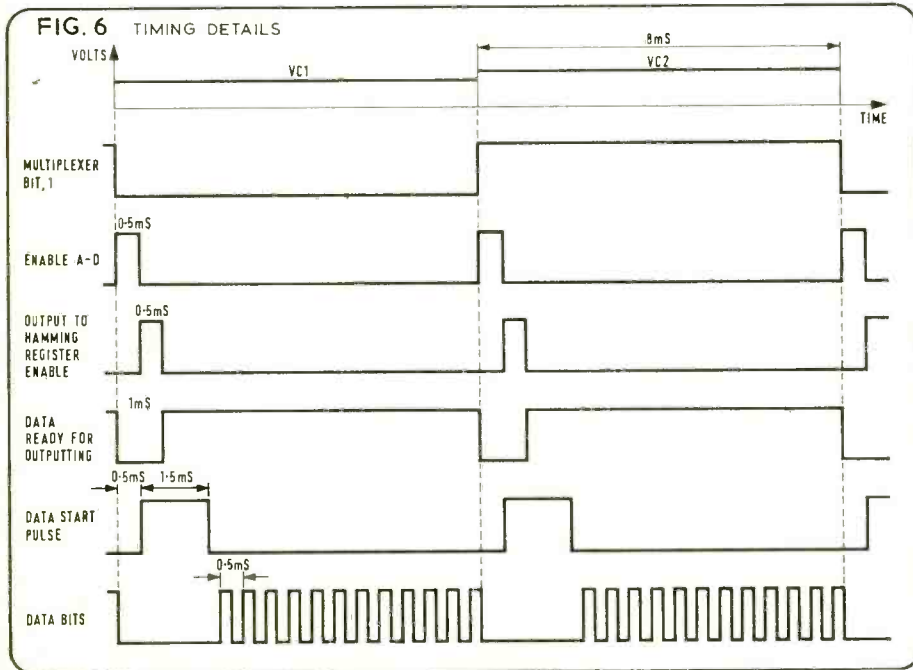

FELDON AUDIO DELIVERS a total recording system—not just the equipment but the know-how and the experience necessary to take the world's finest recording equipment and mould it to your own special needs. We thoroughly understand the very special requirements of a modern, up to date recording studio and the need to shape them to your own individual recording habits in order that you create a product that is uniquely yours. And it doesn't matter where you are in the world . . . Feldon will take care of you, whether you are in the USA or in Europe or Africa. Through our associated companies outside of the UK we can deliver any and all major components and all peripherals and give you unbiased assistance in their selection.

Perhaps the most important single thing Feldon delivers is years of experience in recording studio design and construction. Our systems designs are generated after careful consultations with you as to the types of recording you anticipate and your budget requirements. Knowledgeable guidance can be given for acoustic and interior design, with consideration of floor planning and space utilisation to achieve the best and most efficient use of either a pre-existing structure or a planned new facility.

THE CREATION OF THE PERFECT RECORDING CLIMATE FOR YOU AND YOUR CLIENTS IS OUR GOAL.

It can be done easily with our experience and our knowledge of the special techniques demanded in today's recording studio.

FELDON has access to many credit facilities and leasing plans both in the UK and Europe.



SEE US
AT APRS
STAND
43/44

126 Great Portland Street,
London W1N 5PH

Telephone 01-580 4314 Telex 28668

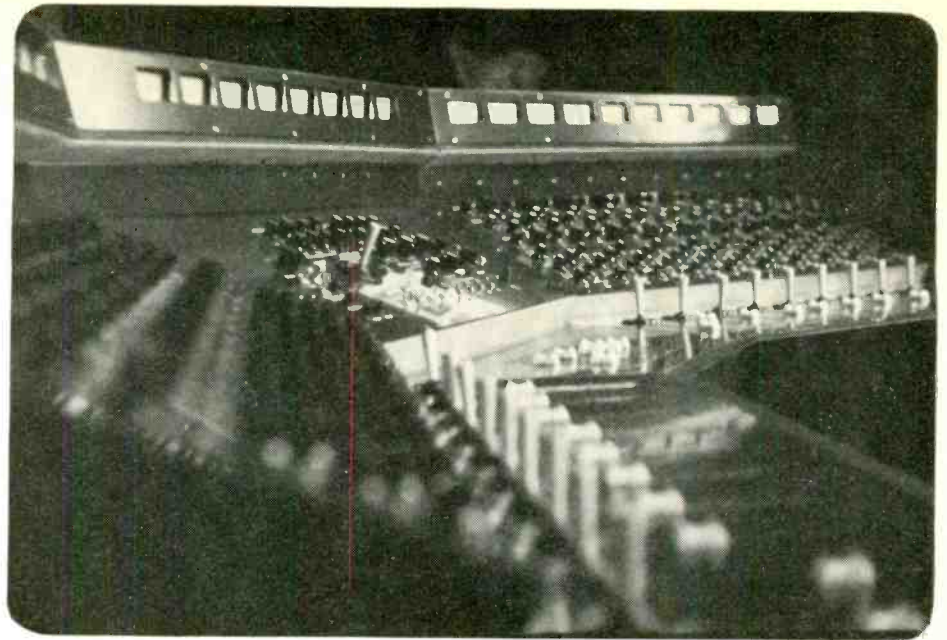

A quadraphonic control desk

R. BIRTHWRIGHT*

describes some of the problems faced in developing and selecting components for a quadraphonic mixing console.

*Canary Mixing Desks, 61 Normanton Avenue, Wimbledon, London SW19

THIS STORY begins in April 1972. While I was visiting a hire company in Kingston, a manager for an American singer walked in and said that he wanted to put the best pa on the road. Could it be 20 channel quadraphonic? Somewhat taken aback I said that I could build such a control desk and when did he want it? 'As soon as possible,' was the obvious reply.

Another 12 channel stereo mixer I had built was supplied with nearly 1 kW of amplifiers and speakers while the quadraphonic desk was being built. Having ordered all the components, I agreed to go on the road with the group as a balance engineer. In the space of four months, the specification of the desk grew almost by the week.

The first necessities were four independent foldbacks with a switch on each channel to cancel all four foldbacks from that channel. With mono foldback I found that the ego of musicians is such that, if I had what I considered to be a fair balance in my headphones, they would all say *their* instrument wasn't loud enough. Subjective faults like this are just incurable so, with four foldbacks, at least I had a chance of giving four positions on stage more or less what they wanted. With main faders and off switches above them, and a master foldback off switch, I could achieve maximum gain on stage without feedback.

The next must was a sensible intercom system. Hand signals, semaphore or runners were useless and to try and run that 50m or so myself through wriggling bodies was impossible. Dual headsets with mics was the order of the day. My mic was switchable through to any one of the foldbacks so that I could talk to the musicians on stage. This was especially useful at practices when, for instance, special echo effects were needed.

Echo was a problem. Its value is always underestimated, always appreciated by the musicians who use it, and it is the easiest thing on a desk to abuse. It had to be quadraphonic but should I use pots or switches? As mono echo seems evasive to the ear when everything else is stereo, I considered a switch with l, r, lb, rb and mono (all) sufficient. As a quadpot

is £15 and a switch 25p, all my fears were quashed.

In the event of only one echo unit being used, I felt that it would be advantageous to put a 'mono echo bypass' on four switches so that, if all the send switches are left on 'all' and the echo unit is plugged into the rb send and return, it is possible to bring the echo back to any of the four channels, so giving quite an acceptable quadraphonic echo effect with one echo unit.

Equalisation is always a problem on the road as you do not have a bank of different equalisers ready to plug into any channel. Although it is possible to plug equalisers, compressors and limiters into the desk, the less paraphernalia the better. Apart from bass and treble I decided to include a presence control which lifts everything above 1 kHz by about 10 dB and a filter that lifts 2, 4, 6, 8, 10 and 12 kHz by 15 dB (variable). With this array it is possible to lift say 10 kHz over 40 dB (ref 1 kHz) with treble, presence and filter (10 kHz) all at maximum. Although the likelihood of this being used is rare, it is worth having.

When these mixers are used on the road, they are invariably placed at the far end of the hall in the centre and linked with the stage by a multicore cable. Mains for the desk is found at the back of the hall. I am sure you know how easy it is for some bright spark at the back to show his pal how clever he is by pulling the plug out. During those 5s when the reservoir capacitors in the stabilised supplies expire, all hell breaks loose as the irate engineer races to keep the show going. Therefore on this desk there are three PP9 batteries with a switch and a lamp built in to save at least one premature coronary.

The desk is of course fully illuminated, even the jackfields at the rear. In case those 28 VU meters dazzle you so much that you cannot see the stage, there is a three position dimmer taking them down to just a glow.

The technical difficulties I had to overcome were really quite minor. The first was the quadraphonic pan pot. I purchased one to

42 ▶

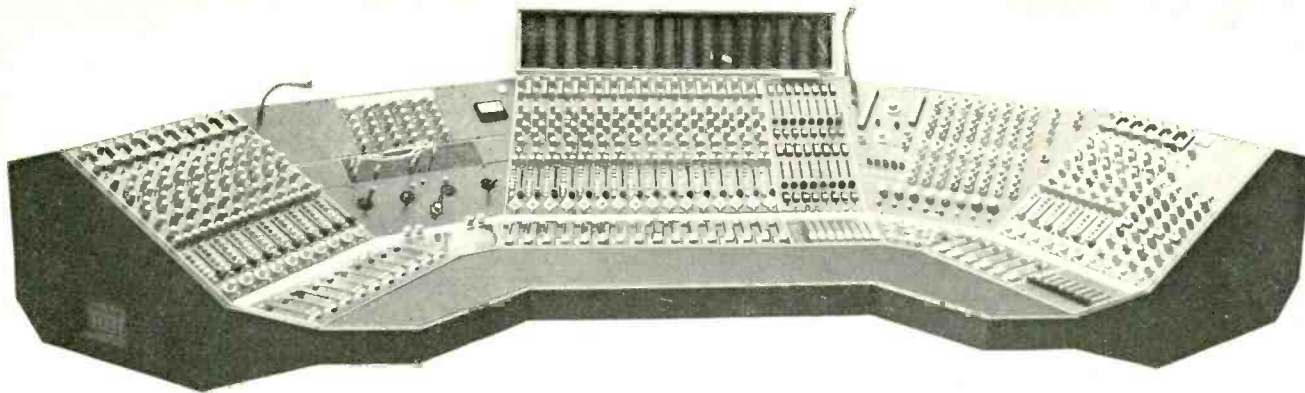

Helios mixing desks —a TOTAL capability

Helios Electronics Ltd., 161 High Street, Teddington, Middlesex, England TW11 8HT 01-977 7841 & 7877

Second-hand nose . . .
it's my second-hand nose . . .



For the best recording studio equipment
bargains ring :

Malcolm Jackson,
The Studios,
Rickmansworth,
Herts.
Tel. Rickmansworth 72351.

BIAS ELECTRONICS

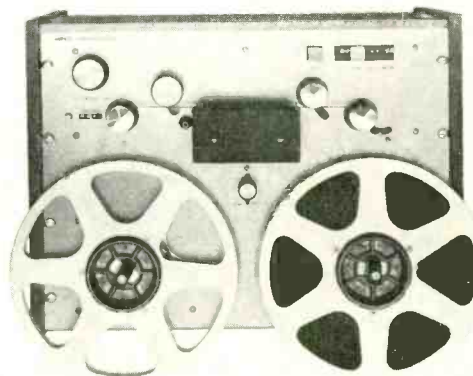

BE 1000 PROFESSIONAL RECORDER

Which ever way you look at it the BE1000 represents extremely good value for money and can be yours for as little as 47p per day. Don't take our word for it, ask for a demonstration and see for yourself.

BIAS ELECTRONICS LTD. 01-947 3121
Unit 8, Coombe Trading Estate,
112-120 Coombe Lane,
LONDON SW20 0BA.

FIG. 4 FULL SCHEMATIC OF 20 CHANNEL QUADRAPHONIC DESK

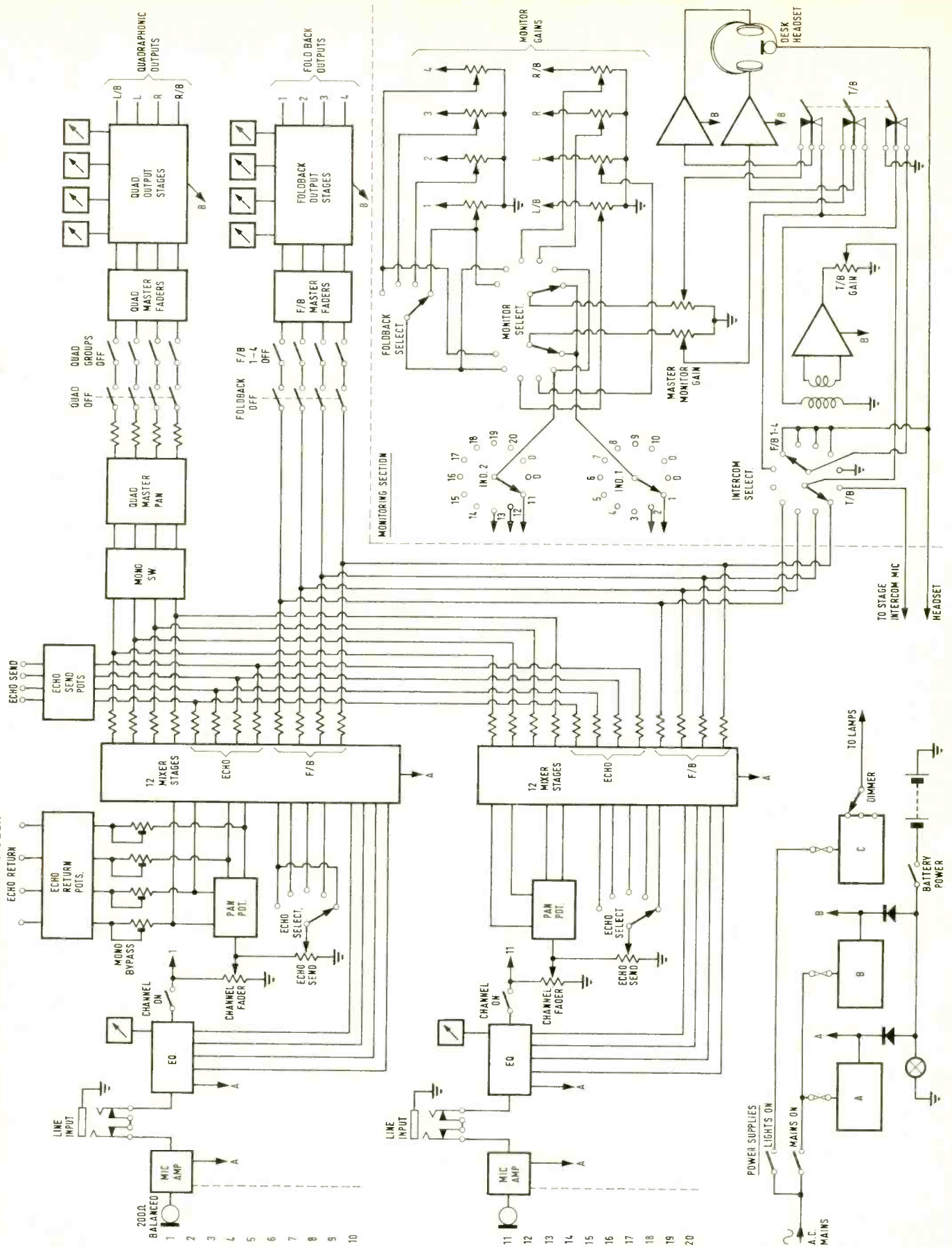

■ QUADRAPHONIC MIXER

play with and found that it comprised four 3.9k ohms linear quarter-turn pots (the only value obtainable at the time) controlled by a joystick above. Wiring it as a conventional stereo pan pot, though somewhat enlarged, I found that I could not cancel three leaving one output. So, retiring to the bathroom, I gave it some deep thought. Ten minutes later the problem was solved. I would discard one pot, ground the three remaining sliders, and feed the input signal through two stopper resistors to the first pot, which would give me front and back. From both ends of this pot I then fed the other two pots with two more stoppers each. The four outputs are taken from the ends of these four resistors (fig. 1).

By choosing suitable values it was possible to get free movement with 1 dB variation in output level for any position. If I had tried for higher tolerances, the output of each channel would have had to deliver something like 8V rms into 150 ohms. I was not prepared to commit each channel to these levels and so settled for a slightly higher output impedance. If the voltage seems high, there is a drop of 20 dB across the pot from input to output before the stopper to the mixer stages.

Another problem with the quadpots was the 'master pan' control. This had to have four separate inputs and four separate outputs, cancelling the other three when pushed into one corner. For this I used my prototype pot and again grounded all the sliders and put the signal across each corner of two pots, enclosing the signal by two grounded sliders (fig. 2).

It was obvious that the sound had to be switched to mono before the master pan was used. Because of this, four more stoppers had to be included so that, when the mono switch was used, the minute the pot moved it would not short all four circuits.

The echo switch had to have outputs to four groups individually, or all four on a six position two pole switch. I decided to use the first four for the quadraphonic channels and the fifth for the mono (all four). The only way to do this was to put stoppers straight from the echo mixer bus bars to the first four positions on the switch. Then a second set linked and taken to ground on the switch when any other position than 'all' was used. This stopped interaction between channels (no matter how small) and stopped any one echo channel mixer input being left above ground (fig. 3).

All other problems were purely of a circuit electronics nature—lowering the output impedance of each channel for the quadraphonic pan pot, bolstering up the power supplies to cope with the considerable loads involved, curing rf problems in the line output stages, raising the gain of the mixer stages and so on.

By now I expect you will be saying 'Why didn't he make it modular?'. Well, besides the time and cost factors, it has been my experience that every plug and socket is a possible fault; therefore the fewer you have the better. I also find in modular systems that, unless the whole system is modular, you might as well not bother. You are committing yourself to more plugs, more sockets, and so making the system that much less reliable. I think the precautions I have taken in this desk, and the backup

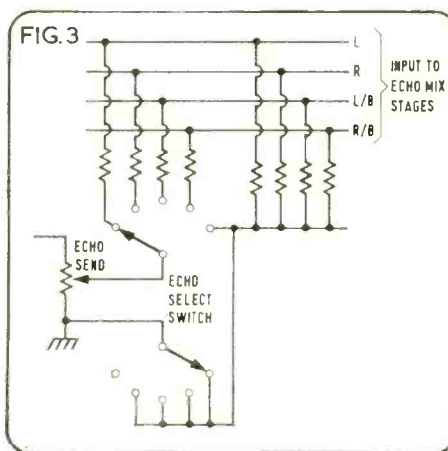
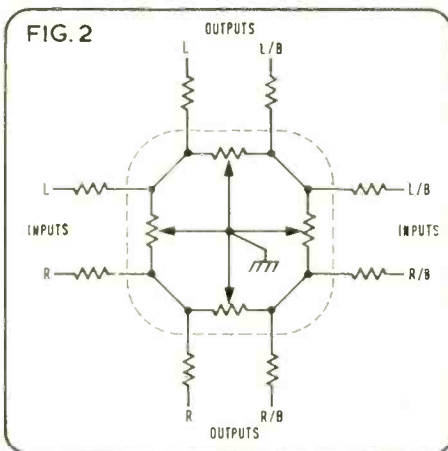
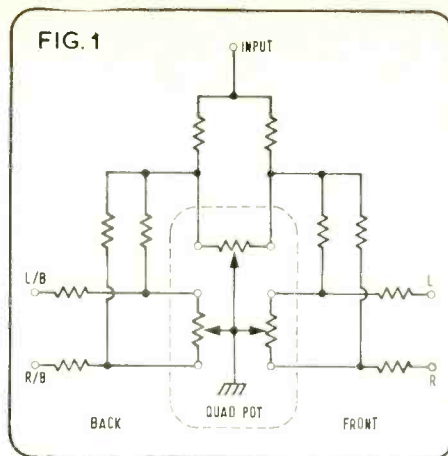

systems inherent in nearly all mixing desks, are sufficient to get any operator out of trouble.

The internal design of the desk was limited from the outset by the width of the quadraphonic pan pots (76 mm). If I could align five pots and link them together with one pc board, have take-off leads to the pan pot and fader at one end, and slots at the other to accommodate 16 gauge bus bars, I thought I could make my job much easier. This I did and the board came out at 250 x 125 mm with 37 external connections, not including bus bars. By putting 12 mixing stages on a board the same size with

81 ▶

WE HAVE IT—
IT WORKS

COMPUMIX

The first automated mixing system that makes sense. It's designed to augment your present mixing console . . . large or small. Even if you're not ready to address a memory with your mix information, our controller will give you the flexibility of an extra pair of helpful hands; to make those exasperating mixing gymnastics more comfortable.

COMPUMIX makes sense because you can utilise your existing equipment to add the benefits of automated mixing. It's ready for all the progressive thinkers to become doers.

COMPUMIX is noiseless voltage-controlled sub-mixing grouping and switching control. Think about that, when you decide . . . simply interface our digital processor for that memory feature.

COMPUMIX won't let you forget the good mixes. Little things make a big difference, however, big things make a bigger difference.

THE COMPUMIX CONTROLLER.
24 inputs (expandable) to 32.6 sub-mix groupings, master fade, 54 programme auxiliary switch functions, complete read, write, update control with our exclusive digital VCA-800.

quad/eight electronics

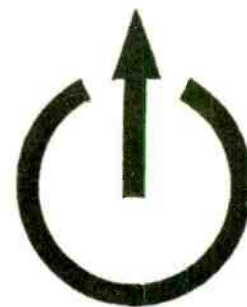

SEE US
AT APRS
STAND
43/44

126 Great Portland Street,
London W1N 5PH

Telephone 01-580 4314 Telex 28668

PRO M25



PRO M5

Eagle's new professional microphones.

We haven't rushed them.
We couldn't afford to.
We talked endlessly to professionals
like yourself about what professionals
needed.

In an omni-directional mike. A uni-
directional mike. A tie-clip, a boom-arm.

Whenever we hit a snag we came
back and talked to you some more.

It's taken two years to get them right.

We've called them Eagle Professional
Microphones.

It seemed only fair.

PRO M10 Omni-Directional Capacitor Microphone

Impedance: 600 ohms (floating)

Response: 30-17,000 Hz.

Sensitivity: -70dB

Generating Element: Electret Capacitor

Cable: 6 metres two conductor shielded

Connector: XLR 3-11C

List Price: £29.40 (excl. VAT)

PRO M20 Uni-Directional Capacitor Microphone

Impedance: 600 ohms (floating)

Response: 30-17,000 Hz.

Sensitivity: -60dB

Generating Element: Electret Capacitor

Cable: 6 metres two conductor shielded



PRO M20

PRO M10

We've been working on them for a long time.

Connector: XLR 3-11C

List Price: £29.40 (excl. VAT)

PRO M5 Lavalier Capacitor Microphone

Impedance: 600 ohms

Response: 50-13,000 Hz.

Sensitivity: -65dBV

List Price: £14.70 (excl. VAT)

PRO M25 Capacitor Boom-Arm Microphone

Impedance: 600 ohms (floating)

Response: 20-18,000 Hz.

Sensitivity: -70dBV

Cable: 6 metres two conductor shielded

Connector: XLR 3-11C

List Price: £29.40 (excl. VAT)

Please send me your catalogue containing details of the new Eagle Professional Microphones and other PA equipment.

Name _____

Address _____

Eagle International

Eagle International Precision Centre Heather Park Drive
Wembley HA0 1SU Telephone 01-903 0144

SS

ALLEN & HEATH MINI MIXER

By John Shuttleworth

MANUFACTURERS' SPECIFICATION

Input channels: Six; continuously variable attenuation from 50 dBm at 100k ohms to (with in-line microphone transformer) -70 dBm at 200 ohms.

Distortion: 0.2 per cent at 0 dBm with +13 dB overload headroom under normal operating conditions.

Noise: -120 dBm input noise from 200 ohms; -65 dBm output noise.

Equalisers: ±14 dB at 100 Hz, 5 dB lift at 700 Hz, ±14 dB at 12 kHz.

Fader: 70 mm travel, linear.

Pan, echo and foldback: continuously variable.

Line return: left and right line inputs, continuously variable from -10 dBm at 8k ohms. Lf and hf equalisations as main channels.

Meters: miniature arc-scaled VU.

Output levels: 0 dBm, 600 ohms

Construction: double-sided fibreglass pc board. Moulded track potentiometers.

Case dimensions: 236 x 299 x 30 mm.

Price: £116+VAT. Optional 21V 150 mA power supply (£10.50+VAT) and XLR-input balanced microphone transformers (£3.50+VAT).

Manufacturers: Allen & Heath Ltd, Pembroke House, Campsbourne Road, London N8.

'PROFESSIONAL QUALITY and professional facilities in a small box and at a reasonable cost.' These are the design criteria for the Allen & Heath *Mini Mixer*.

The mixer is mini indeed, occupying a small box just deep enough to accommodate the phono plug inputs and outputs. These are located at the rear of the unit and handle inputs One to Six, power, foldback, output, echo send, echo return left, echo return right, main output right and main output left.

The controls are all on the top of the mixer, one row to each channel, going from top to bottom: sensitivity control, treble, mid range, bass, foldback, echo pan and fader.

On the top right of the mixer is the left channel VU meter. Under this are the right channel VU meter and the output group controls. Reading from top to bottom on each of the two output channels, these are: echo return treble, echo return bass, echo group master, and main output faders.

The transformers supplied for use with microphones had balanced Cannon *XLR* inputs and phono outputs, making the mixer compatible with other high quality equipment. Owing to its small size there is little room on the mixer for explanatory labels and the controls are marked with more or less self-evident symbols. A brief operating procedure leaflet is supplied which gives all the information required to use the mixer.

Most dynamic and many capacitor microphones with their own power supply will connect directly to the line transformers, supplied as an optional extra, and the sensitivity controls on the inputs enable an exact match to be made with the mixer. It is essential, as with any mixer, that each channel should be properly lined up and the procedure is as follows:

The input fader is set with the centre of its slider opposite the break in the black line at its side. The main output faders are set to maximum. All the bass and treble controls are set in their central position and the mid range controls fully anticlockwise. The input sensitivity controls are then set so that the meters just move into the red on peaks. When the outputs of the mixer are fed to other items of equipment having meters, the sensitivity controls on these devices should be adjusted so that corresponding meters follow each other as closely as possible. For optimum performance the mixer should be operated with its meters just entering the red on signal peaks and, if this gives too high an output for subsequent items of equipment, an attenuator or volume control should be fitted between the two.

Ceramic pickup cartridges can be connected directly to the mixer; magnetic cartridges need frequency correction which can be applied in the mixer.

Once the mixer has been lined up, frequency correction can be applied to the individual channels and the signal returning from an echo

unit if used. The output at the echo send socket is controlled by the echo gain on each channel so it is possible to add reverberation to a singer without affecting the backing.

The echo return signals on the left and right channels can be adjusted and equalised by the controls below the VU meters. It should be noted that the signal from the echo send socket is a mono mix of the controlled amounts of signal from each channel. The signal to the echo return sockets is therefore mono even though the left and right channels can be controlled independently. It follows that a single channel reverberation unit would be adequate for use with this mixer but, if one is used, the inputs on the mixer should be paralleled.

Each channel has a pan pot with which individual inputs can be placed anywhere between the stereo outputs. Left is fully anticlockwise and right fully clockwise.

The mixer can be operated from two 9V batteries connected in series or from the external power supply provided as an optional extra. The latter has a phono plug output but, since plugging it into the wrong socket does no harm, this is not a disadvantage.

The Allen & Heath *Mini Mixer* is designed to link to further units should more than six channels be required, the output from the first mixer being fed to the echo return sockets of the next.

If echo facilities are needed, the echo send

70 ▶

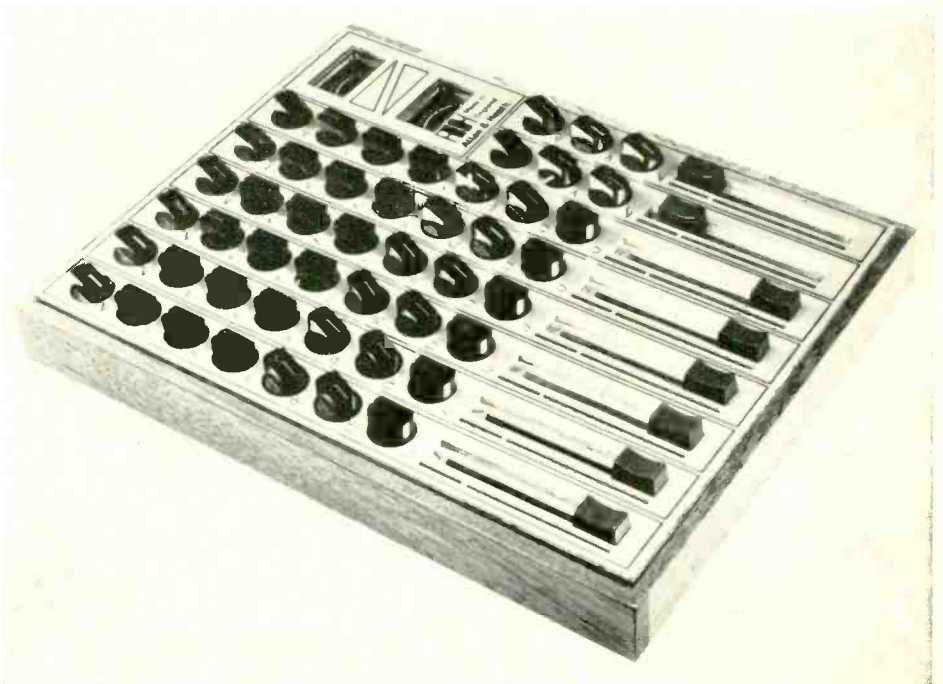

Like you~ we are specialists



Like you we can only deal in the best, that's why we are exclusive distributors to the music industry for Moog synthesizers, Fender electric pianos, R.M.I. Electra pianos and harpsichords, Sound City electronic pianos and Hayman organs.

All enquiries to:

Dallas Arbiter Ltd,
10-18 Clifton Street,
London EC2P 2JR
Tel: 01-247 9981

Please send details of
Moog synthesizers
Electronic pianos etc.....
To
.....
.....

THIS YEAR'S Association of Professional Recording Studios Exhibition promises to be the largest and most successful to date. Like APRS '72, APRS '73 will be held in the pleasant surroundings of the Connaught Rooms, Great Queen Street, London WC2. This is located off Kingsway and best approached by Underground via Holborn. Car parking in the neighbouring Covent Garden area is very slightly easier than elsewhere in Central London but visitors with the option would spare themselves a white hair by parking in the suburbs and completing their journey by rail. The other alternatives—buses and taxis—present an increasing assault on the lungs, ears and stomach, besides being less dependable.

APRS '73 is open Friday June 22 (10.00 to 21.00) and Saturday June 23 (10.00 to 18.00). Entry is by ticket only, available to all members of the film and electronic communications industry from the secretary: E. L. Masek, 22 Chestnut Avenue, Chorleywood, Hertfordshire.

On the Agfa-Gevaert stand (57), Ted Bowden and colleagues will display and discuss the merits of their audio recording tapes, compact cassettes and accessories.

Allotrope are UK agents for Sait, Pearl, Triadex and HES—respectively Belgian,

Swedish, American and Belgian. Sait Electronics produce audio mixer modules while the Pearl speciality is microphones. Two new pearls are to be shown, one being the CL3 lavalier capacitor doubling as a tin pin and measuring 36 x 8 x 7 mm. M68 is a noise cancelling microphone built to a Swedish military specification for use under adverse weather and noise conditions. Triadex contribute the Muse, a unique breed of music synthesiser generating more or less complex melodies from an externally preset binary program. If it sounds complicated, it isn't. Finally HES Electronics. The principle of their TSV broadcasting differential telephone repeater system was described by its designer in January STUDIO SOUND. CMP9 is described as an automatic potentiometer and may be used as a long-term programme attenuator with squelched gain control. Applications include automated broadcasting, tape duplicating, original recording and public address.

Amity Tape Developments will again be showing multitrack recording equipment of which their largest system is 32 tracks on 50 mm at £13,500. Next size down is a 24 track 50 mm unit at £9,500 followed by a 16 track 50 mm at £6,500. Prices have yet to be announced for their 16 track 25 mm and eight track 12.5 mm models, though an eight track 25 mm is being offered at £4,100. Remote control facilities are available for all Amity machines, costing £1,640 (32 track), £1,214 (24), £776 (16) and £432 (eight track). A remote unit covering deck functions only is offered at £42. Other items in the Amity range now include a vfo unit, varispeeding all their recorders, at £185; a 100W monitor amplifier at £165, monitor loudspeaker at £110 and trolley for same at £22. The Amity organisation is perhaps best known in this industry for its connections with Orange.

An AG-440B incorporating Dolby A will be seen on the Ampex stand alongside the compact MM-1100 multitrack audio recorder. AG-440B is available in 6.25, 12.5 and 25 mm forms covering single track, two track, four track and

50 ▶

APRS '73 preview

DAVID KIRK

Amity-Orange 50 mm transport



APRS '73 Exhibitors

Agfa Gevaert, Great West Road, Brentford, Middlesex.

Phone: 01 560 2131
Stand No: 57

Allen & Heath Ltd, Pembroke House, Campsbourne Road, Hornsey, London N8.

Phone: 340 3291
Stand No: 63

Alice (Stancoil) Ltd, 38 Alexandra Road, Windsor, Berkshire.

Phone 96 51056/61308
Stand No: 30/31

Allotrope Ltd, 90 Wardour Street, London W1V 3LE.

Phone: 437 1892/3
Stand No: 20

Amity Tape Developments Ltd, 3/4 New Compton Street, London WC2.

Phone: 836 7811
Stand No: 61

Ampex (GB) Ltd, 72 Berkeley Avenue, Reading, Berkshire.

Phone: 0734 55341
Stand No: 78

Audio Applications Ltd, Kensington Barracks, Kensington, London W8.

Phone: 937 6615
Stand No: 29

Audio & Design Ltd, St Michaels, Shinfield Road, Shinfield Green, Reading, Berks.

Phone: 0734 84487
Stand No: 41

Audio Developments Ltd, Hall Lane, Walsall Wood, Staffs.

Phone: 054 33 4605
Stand No: 6

Audix Sound Systems, Bentfield End, Stanstead, Essex.

Phone: 027 971 3132/3437
Stand No: 56

Ampex AG-440B with Dolby A



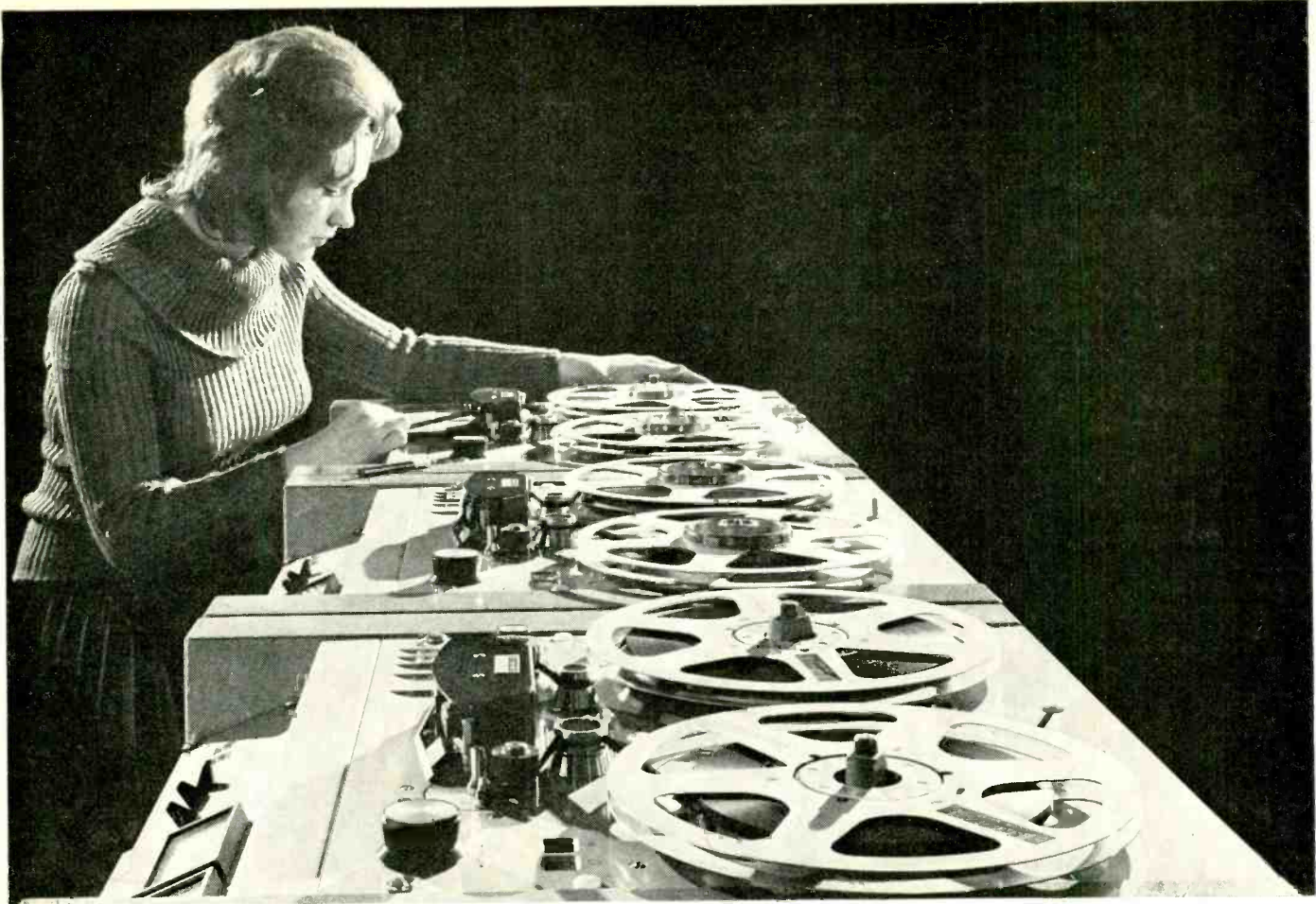

for the professional

contact **Derek Owen** at 01-874 9054 or
Telex 923455

LEEVERS-RICH

EQUIPMENT LIMITED

Agents in Scandinavia, Eastern and Western
Europe, Middle East, Africa, Australasia and
the Far East.

LEEVERS-RICH EQUIPMENT LIMITED
319 TRINITY ROAD · LONDON SW18 3SL
Telephone 01 874 9054 · Telex 923455
Cables LEEMAG LONDON



A MEMBER OF
THE MCP GROUP

APRS '73 PREVIEW

eight track standards. *MM-1100* is designed for the eight, 16 and 24 track market and features detachable controls for local or remote operation. Other Ampex exhibits: *406* and *407* backcoated low noise high output audio mastering tape. These are available in 6.25, 12.5, 25 and 50 mm standard widths.

Automation Facilities produce four basic cleaning products for recording equipment maintenance: AF-Spray, Ultraclene, Statiklene and Permagard. These are supplied in aerosol form and may be seen, discussed and sniffed on stand 71.

A 55 dB print factor, eliminating the need for Dolby noise reduction treatment, is claimed by BASF for their latest studio tape *SP50LH*. This will be demonstrated on booth ten. The tape is a low noise high output variety with a matt black back and is expected to be introduced later in the year. Other studio tapes on show will be *LGR30*, *SP50M*, *LR56*, *SP52* and *LPR35LH*. BASF also plan to display items from their range of calibration tapes available in various formats across 3.8 to 50 mm widths. In addition, two cassette recorders designed for chrome tape are to be exhibited. Dealing with BASF enquiries: Bob Hine, Keith Laird and Brian Kurd.

On the F. W. O. Bauch stand, recorders from the Studer *A80* and *B62* range, studio mixing consoles and an automatic tape position locator. From Neumann, an *SP272* disc-cutting control console and a range of capacitor microphones with accessories. EMT contribute their *240* reverberation foil, *440* digital delay line, *928* gram turntable, *DDM* compressors and a selection of audio frequency connecting cables. Lexicon's *Varispeech* is a cassette recorder with constant pitch time compression and expansion while ITI's *ME230* is a parametric equaliser. The Universal Audio *UA1186LN* limiter may be seen alongside the *UE963* electronic metronome, *UA527-A* graphic equaliser, *UA565* 'Little Dipper' filter unit, and *UA920-16* digital delay lines. From Teletronix the *LA-3A* limiter amplifier; from Klein & Hummel the *UE1000* universal equaliser and *OY/OZ* loudspeakers.

The Allison Research Kepex programme expander, *Gain Brain* limiter and *VCA-1* voltage controlled amplifier will be shown along with faders from Danner and Seydel and audio connectors in the Switchcraft *QG* series.

A 36/24 full quadraphonic music recording console is to be shown by Cadac on stand 55. The system incorporates Cadac's latest range of 40 mm modules and features a new *Quadrapot* in addition to the more conventional 360° joystick. Other features include a new automated sync-to-monitor/sync-to-foldback system which can be matched to any make of tape machine.

Peter Lindsley, Tony Costello, J. A. Richardson and L. Turner will represent Bias Electronics on stand 25. On view for the first time, a console version of the *BE1000* two track 6.25 mm tape machine. This will be exhibited along-

Automation Facilities Ltd, Oxford Avenue, Slough, Bucks.

Phone: 75 25571
Stand No: 71

AV Distributors (London) Ltd, 26 Park Road, Baker Street, London NW1 4SH.

Phone: 935 8161
Stand No: 45/46

BASF (UK) Ltd, Knightsbridge House, 197 Knightsbridge, London SW7.

Phone: 584 5080
Stand No: 10

FWO Bauch Ltd, 49 Theobald Street, Boreham Wood, Herts.

Phone: 953 0091
Stand No: 1/2

Beat Instrumental, 58 Parker Street, London WC2B 5QB.

Phone: 242 1961
Stand No: 47

Beyer Dynamic (GB) Ltd, 1 Clair Road, Haywards Heath, Sussex.

Phone: 0444 51004
Stand No: 73

Bias Electronics, Unit 8, Coombe Trading Estate, 112/120 Coombe Lane, London SW20.

Phone: 947 3121
Stand No: 25

Brenell Engineering, 231/5 Liverpool Road, London N1.

Phone: 607 8271
Stand No: 52

Cadac, Bentfield End, Stanstead, Essex.

Phone: 727 0041
Stand No: 55

Calrec Audio Ltd, Regent Street, Hebden Bridge, Yorks.

Phone: 042 284 2159
Stand No: 48/49

Cetec (UK) Inc, Shaftesbury Street, High Wycombe, Bucks.

Stand No: 23/24

Bias *BE1000* tape console and Cadec 24/16 control desk, the latter recently supplied to RCA Madrid.

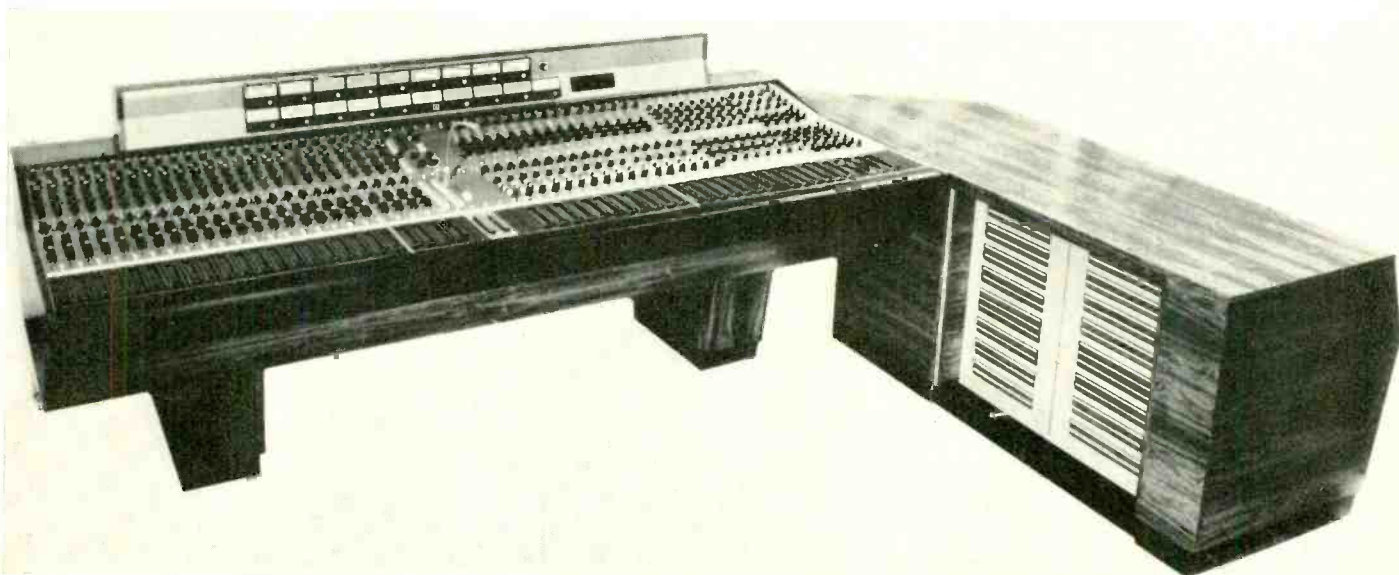

AMITY SHROEDER

WHEN IT COMES DOWN TO BASICS,
ALL TAPE RECORDERS SHOULD SOUND THE SAME



Here are five main basic factors involved in buying a multi-track recorder:

1. RELIABILITY
2. FACILITIES AND EASE OF OPERATION
3. GIMMICKS
4. PRICE
5. SERVICE

- 1) **RELIABILITY.** As a relatively new firm that's a tough one for us; but suffice it to say that our two-inch transport sixteen track machines have been working in our own Studios for a long time almost continuously with only one or two minor problems (now resolved).
- 2) **FACILITIES AND EASE OF OPERATION.** The machine was designed and built in constant liaison with our Studio Staff—it therefore does what is required easily and efficiently.
- 3) **GIMMICKS.** We don't believe in gimmicks. The transport has all the basic features needed to produce a specification comparable with any of the best (and most expensive) machines available, and nothing more.
- 4) **PRICE.** This speaks for itself.
- 5) **SERVICE.** Nulli Secundus.

8 TRACK
£?

16 TRACK
£?

24 TRACK
£?

See our new models at
the APRS Exhibition,
Stand No. 61.

Surprise announce-
ment on prices to be
unveiled at the APRS
Exhibition.

3 & 4 New Compton Street, London, WC2H 8DD

Telephone: 01-836 7811-2-3 Telex: 23197

APRS '73 PREVIEW

side a 12.5 mm *BE2000* four track console with full record, selsync and play facilities. Price is £1,498 plus VAT. A transportable version minus the track selection, sync and VU frills, is available for quadraphonic mastering and copying at £998 plus VAT. In the mixing line, *BE300* is designed to bridge a gap between studio and pa mixers. It is being aimed at mobile recording units, local radio stations and language laboratories. Smallest Bias mixer is the four or six channel *BE104/6*. All inputs are fitted with 600 ohm transformers and high/low sensitivity switches. Outputs are 600 ohms floating, giving up to +12 dB before clipping. *BE104* costs £68.25 plus VAT; *BE106* is £89.25 plus VAT.

Centrepiece of the Brenell display on stand 52 will be their four and eight track master recorders, respectively *Series D* and *E*. Both employ 25 mm tape and feature pushbutton select metering of erase and bias volts, front panel bias setting, electronic ppm limiting to safeguard the meter movement, ppm or VU option, and switchable NAB/DIN equalisation. Tape speeds are 76 and 38 or 38 and 19 cm/s obtained through two-speed hysteresis synchronous motors. The entire *A* to *E* range incorporate selsync, remote control facilities being optional. *Series A, B* and *C* formats are

respectively full track 6.25 mm, two track 6.25 and four track 12.5 mm. Spool capacity is NAB or cine, up to 29 cm. Terminations are XLR and, for lining up, jack. Oscillator frequency is 100 kHz though other frequencies are available to specification. Similar customer option applies to tape speeds, head gaps and equipment mounts. Typical prices (excluding VAT) for 76 and 38 cm recorders are £625 (*Series A*), £750 (*B*), £1,325 (*C*), £1,485 (*D*) and £2,235 (*E*). Other designs on the Brenell stand will be the *Type 19* heavy duty tape transport and the new *IC2000*, a low price recorder described as suitable for audio reduction.

Cetec have lately opened a European branch at High Wycombe and are attending their first APRS exhibition. Gauss, Electrodyn and Langevin are all members of the Cetec group. Gauss are perhaps best known for high speed duplicators and are currently producing the *1200* system. The *1200* transport is a closed loop dual capstan drive with separate supply and take-up tension servos. Tape drive itself is from two independent synchronous motors. Level indication is by peak reading VU meter. Gauss stress the advantages of their *Focussed Gap* head 'capable of sharply focussing the radio frequency bias field'.

With a 608 cm/s copying speed, bias frequency must necessarily be high and Gauss eliminate intermodulation problems by operating at 10 MHz. The basic *1200* copying system illustrated comprises master reproducer, loop bin and slave. Other Gauss products likely to be displayed will be speakers of the *2100*, *5100* and *8100* series. Largest of these are the 450 mm diameter *8100*, available in three forms for bass reflex, horn or infinite baffle mounting. Also illustrated is a 12/4 audio mixer from the

54 ▶

Brenell *Series E* eight track recorder and Cetec-Gauss *1200* copying system

CTH Electronics, Industrial Estate, Somersham Road, St Ives, Huntingdonshire.
Phone: 0480 64388
Stand No: 42

Dolby Laboratories Ltd, 346 Clapham Road, London SW9.
Phone: 720 1111
Stand No: 3/4

Electro Voice, The Hyde, Brighton, Sussex, BN2 4JU.
Phone: 0273 66271
Stand No: 65

EMI Tape Ltd, Blyth Road, Hayes, Middlesex.
Phone: 573 3888
Stand No: 39

Evershed Power Optics, 214 Harlequin Avenue, Brentford, Middlesex.
Phone: 560 6151
Stand No: 75

Feldon Audio Ltd, 126 Great Portland Street, London WIN 5PH.
Phone: 580 4314
Stand No: 43/44

Fraser-Peacock Associates Ltd, 94 High Street, Wimbledon Village, London SW19.
Phone: 947 2233
Stand No: 27

Future Film Developments Ltd, 90 Wardour Street, London W1V 3LE.
Phone: 437 1892/3
Stand No: 19

Grampian Reproducers, Hanworth Trading Estate, Feltham, Middlesex.
Phone: 894 9141
Stand No: 40

Hayden Laboratories, Hayden House, 17 Chesham Road, Amersham, Bucks.
Phone: 024 03 5511
Stand No: 53

Helios Electronics, 161 High Street, Teddington, Middlesex.
Phone: 977 7841
Stand No: 41

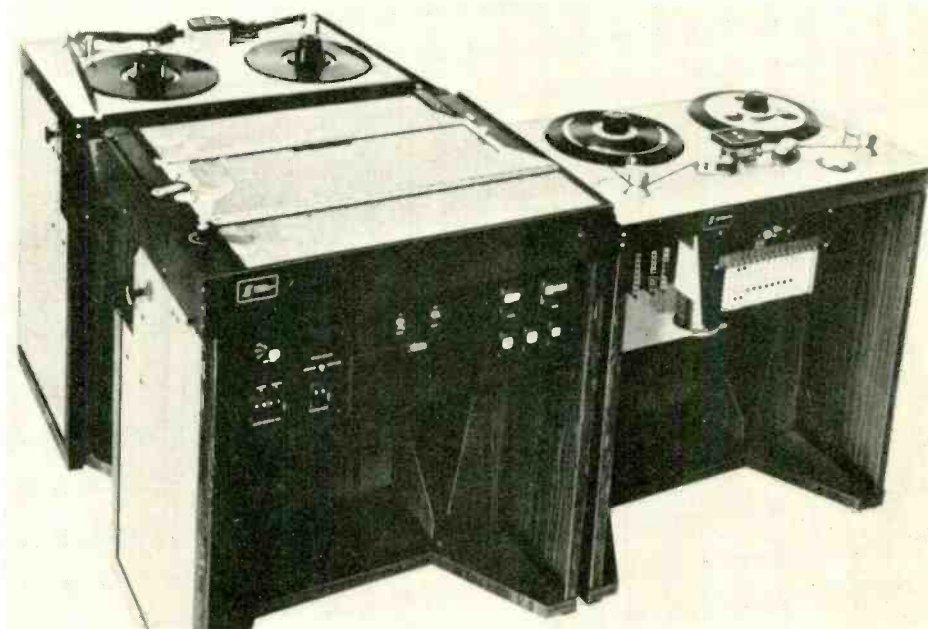
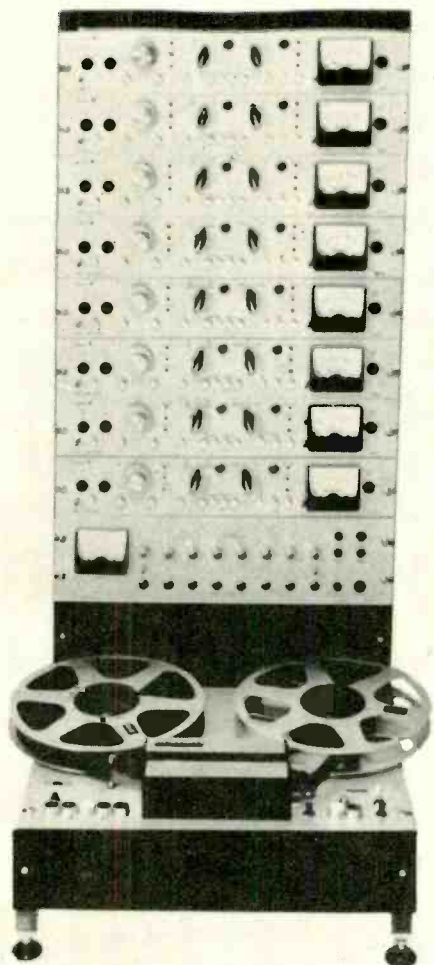



THE
CAMBRIDGE
SOUND
SM8
SOUND MIXING
SYSTEM

Professional Quality for the Smaller Studio 8 channels-mono/stereo

Pye TVT's latest sound mixing system, the SM8, brings full professional quality to the smaller broadcasting or recording studio. More than just a mixing desk, SM8 covers a whole series of modular-based units built to individual requirements. Basic features:

- 3-input Microphone/Line modules with pan-pots, equalized.
- 1-input stereo Gram modules.
- 3-input stereo Line modules, equalized.
- Mono/stereo output switch.
- Prefade listen.
- Post fader echo and PA/FB.
- Comprehensive talkback.

Pye TVT—world-renowned for professional television and sound systems.

APRS 73
visit us at the
Pye TVT stands
Nos. 11 & 18
Howell Jones · David Bott
Trevor Foxon



Pye TVT Ltd

Pye TVT Ltd., Coldhams Lane, Cambridge CB13JU
Tel: Cambridge (0223) 45115. Telex: 81103

A member of the Pye of Cambridge Group

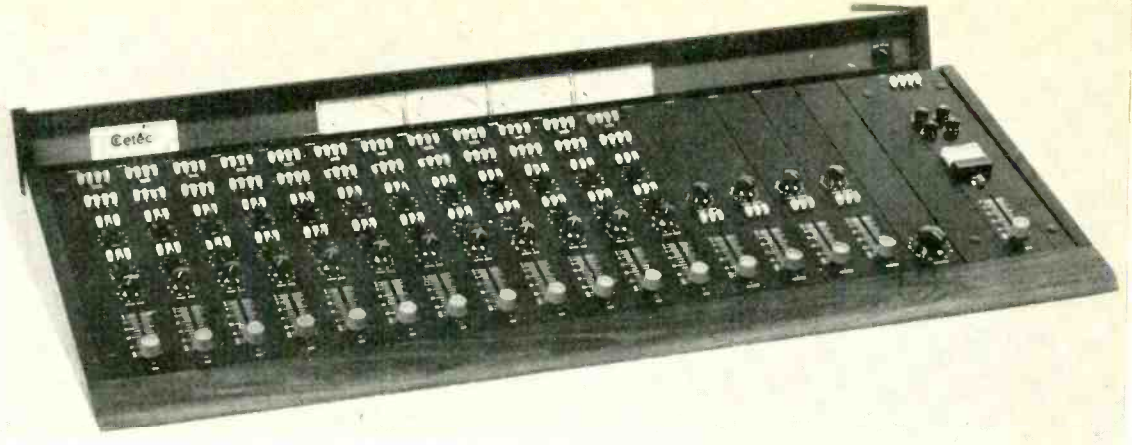

Cetec control desk, Dolby 324 broadcast noise reducer and Cetec-Electrodyne broadcast control centre of the type supplied to Station WCKT.

Langevin line, produced for recording and broadcasting applications. Basic model is the *AM4A*.

Lastly, Electrodyne mixers are available independently or as part of a complete audio system such as the installation recently supplied to Station WCKT, Miami. This was compiled from tape machines by Ampex, a Gauss turntable, RCL routing equipment, and Conrac video monitor.

Ten years ago, CTH produced their first portable battery-powered mixer. In its latest form, the *TM61*, it will be exhibited as a mains/12V battery unit or as a rechargeable field portable mixer in carrying case. Mixers from the *TM50 Mark 2* will also be displayed together with cable drums, distribution amplifiers, ppms and a variety of studio accessories.

Noise reduction units for tape, broadcast

and film applications will be seen on the Dolby Laboratories stand. Being exhibited in England for the first time are the multitrack *M16* and *M24* systems and a *324* broadcasting unit for *B*-coding fm stereo transmissions. The total number of recording tracks equipped with

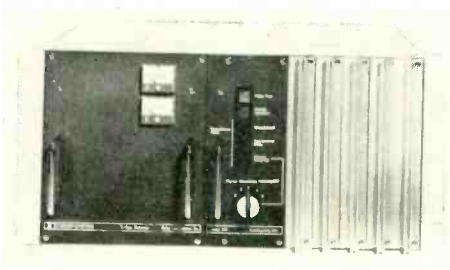

Dolby *A* is now understood to be over 11,000.

EMI, hot-foot from the Montreux Television Exhibition, will bring with them reels of *817*—described as a new high performance audio tape. This is being produced in the four standard widths from 6.25 to 50 mm and is available in lengths up to 1 km. Inherent dynamic range is 76.5 dB at 38 cm/s full track, 72.5 dB per stereo track. Signal-to-print ratio is 56.5 dB.

Evershed Power Optics handle the Perfectone range of film sound equipment and intend to exhibit a new fully automated electronic looping system for dubbing and post sync. A new broadcast quality six channel portable mixer will share the stand with electronic counter systems for Super 8, 16 and 35 mm. As well as rack-mounted magnetic film recorders, a series

56 ▶



אזרחות

for SUPERB MIXERS – MONO TO 24 TRACK

contact RON PENDER or CYRIL JONES for details
33A Bridge Street, Downham Market, Norfolk. (03663) 2165

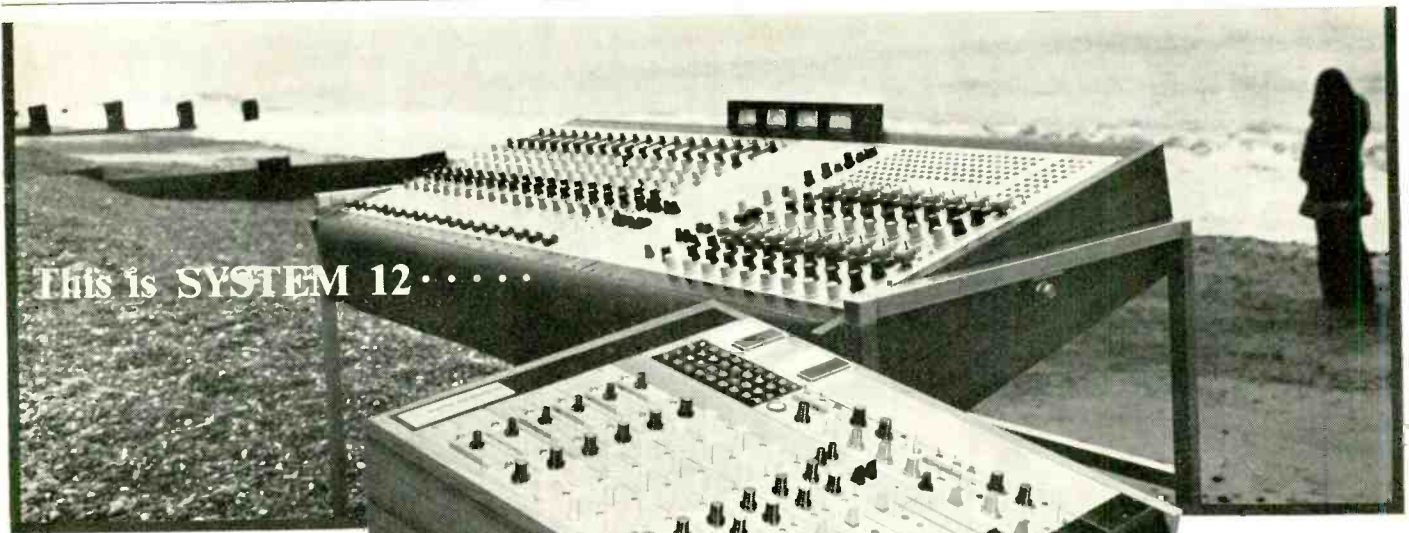

This is SYSTEM 12.....

..... and so is this

SYSTEM 12 Sound Mixers come in all shapes and sizes. But they all have one thing in common—quality, flexibility and unmatched value. There are no installation problems with SYSTEM 12. It starts earning its keep from the moment you plug it in.

Whatever your need—Big or small—there's a SYSTEM 12 to fit it.

Talk to the top people

Sound Techniques Ltd.

HAMPSTEAD AVENUE •
MILDENHALL • SUFFOLK •
Tel.(0638)713631.

APRS '73 PREVIEW

of crystal controlled camera motors will be displayed. Overshed are also agents for Bauer cine projectors.

A brief description of **Feldon Audio** activities runs rather long this year, but here goes. The company hope to display noise filters and eliminators by Burwen, the latter units described as ideal for resolving 78 rpm discs and other noisy originals. Cuemaster cartridge machines will also be exhibited. These offer mono or stereo record and/or playback facilities and are claimed to have an exceptionally fast start time. Made for Feldon to power JBL bi-amplified loudspeakers, the *EA* range deliver 50 to 200W continuous into 8 ohms and are available in mono and stereo forms. Eventide Clockworks contribute their strictly non-clockwork digital delay line and another digital device: the *Instant Phaser* equipped for manual, automatic and variable-threshold operation. Examples of JBL loudspeakers may be shown alongside audio mixing desks and multitrack recorders by MCI. New to the MCI range is the *2001* differential amplifier suitable either for summing or bridging and capable of driving several 600 ohm loads. The complete range of Moog electronic music synthesisers will not be shown though room should be found for one or two systems from the largest down to the *Mini*. Rather smaller, the Nortronics series of studio, digital, cassette and general purpose heads tape. Feldon were recently appointed agents for Schoeps capacitor microphones, taking over from AV Distributors. Highly regarded on the European mainland, Schoeps have hitherto made remarkably little headway in Britain. Their *CMT50* is a 48V phantom powered series at a basic £108 (omni or cardioid) rising to £306 for a stereo version switchable through omni, cardioid and figure-of-eight. Further details of these microphones and the *CMT30/40* series are given in the survey on page 72. Other Feldon agencies cover NTP ppms and audio processors, Quad-Eight automated mixers, Kongsberg manual mixers, STL test tapes (50 to 3.81 mm) and Wahl cordless soldering irons.

Future Film Developments interests in a nutshell: audio interseries adaptors, audio attenuators, banana plugs, cable markers, microphone cable, Colclene cleaning spray, audio connectors, faders, Hellermann cable accessories and tools, jackfields and accessories, microphone

stands and mounts, soldering irons and switches. The audio adapters, attenuators and connectors are Switchcraft *QG*, interchangeable with Cannon *XLR*. Also on offer, Amphenol *Quick* connectors with gold-plated contacts, otherwise similar to *QG*. Faders from the Ruwido range will be displayed. These are available in single or double track form, travelling 66 mm and fading 1k, 5k, 10k, 25k, 50k or 100k log or lin. And the soldering irons: Wahl cordless (familiar), reaching 370°C working temperature in 5 to 10s. FFD representative will be Tim Blackham.

H/H Electronic are this year exhibiting a new audio distribution amplifier, the *DMI2*. This is based on the *TPA25D-M* modular power amplifier with an output padding network and matching output transformer housed in a 475 mm ISEP subframe. Twelve balanced outputs are provided (optional floating or centre-tap earth) at 75 or 600 ohms impedance. Alternatively, 36 outputs can be delivered from the same subframe size. Specified thd is 0.05 per cent at 1 kHz, 600 ohm output isolation being 60 dB. Other units on show will be the *TPA D* range of hybrid ic power amplifiers and the *AM8/12* designed for monitoring in local radio studios. H/H also specialise in musical instrument amplifiers, an example being the *MA100* six channel mixer/amplifier.

Industrial Tape Applications hope to have a 12.5 mm version of the four track Teac *A3340* tape machine in time for APRS '73. Also on display will be a new version of the smaller domestic four track designated *HS2340*. Like the *A3340*, this operates at 38 and 19 cm/s but

HH Electronics, Industrial Site, Cambridge Road, Milton, Cambridge.
Phone: 0223 63070
Stand No: 28

Industrial Tape Applications Ltd, 105 High Street, Eton, Windsor, Berkshire.
Phone: 95 52663
Stand No: 76

Jackson Recording Co Ltd, The Studios, Rickmansworth, Hertfordshire.
Phone: 87 72351
Stand No: 35

KEF Electronics Ltd, Tovil, Maidstone, Kent.
Phone: 0622 57258
Stand No: 58

Klark Equipment, MOS Industrial Site, Summerfield, Kidderminster, Worcestershire.
Phone: 0562 64027
Stand No: 64

Lamb Laboratories, Lamb House, Church Street, London W4.
Phone: 995 4551
Stand No: 77

Leavers-Rich Equipment Ltd, 319B Trinity Road, Wandsworth, London SW18
Phone: 874 9054
Stand No: 54

Lennard Developments Ltd, 206 Chase Side, Enfield, Middlesex.
Phone: 363 8238
Stand No: 17

Jacques Levy Professional Recording Services, 6a Carlisle Mansions, Victoria SW1.
Phone: 834 9248
Stand No: 37

Lighting Technology, 8 Albert Gate Court, 124 Knightsbridge, London SW1.
Phone: 589 6293
Stand No: 66

Macinnes Laboratories Ltd, Stonham, Stowmarket, Suffolk.
Phone: 044 971 486
Stand No: 67

Magnetic Tapes Ltd, Chilton Works, Garden Road, Richmond, Surrey.
Phone: 876 7957
Stand No: 70

Midas Amplification, 87 North Grove, London N15.
Phone: 800 6341
Stand No: 59

3M, 3M House, Wigmore Street, London W1.
Phone: 486 5522
Stand No: 21/22

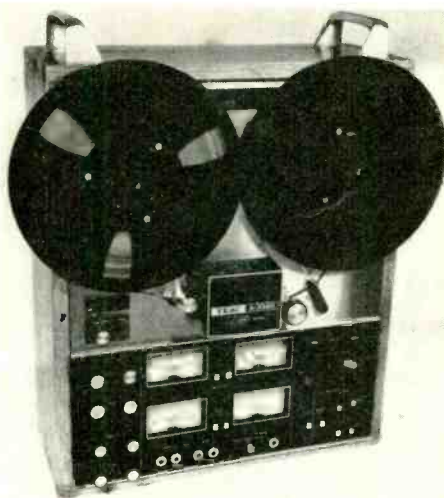

Teac *A3346* four channel and front/back views of the H/H Electronic audio distribution amplifier

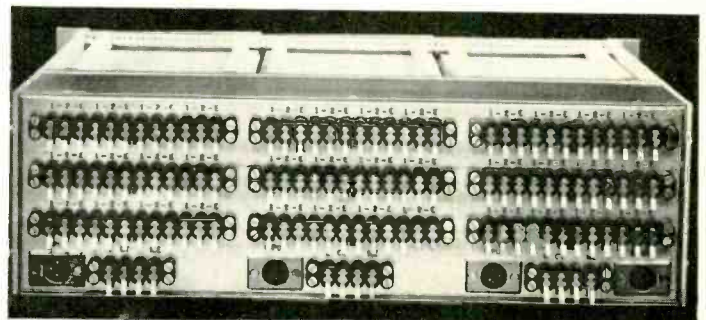
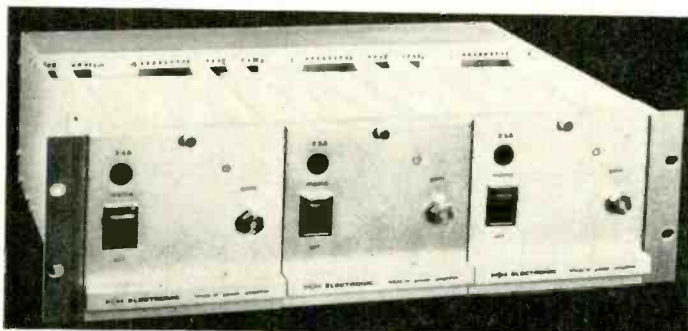

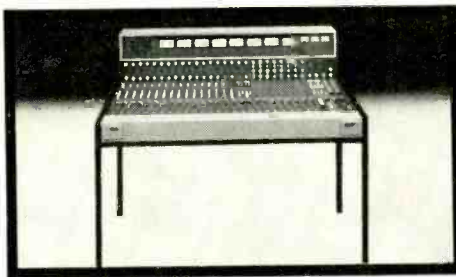
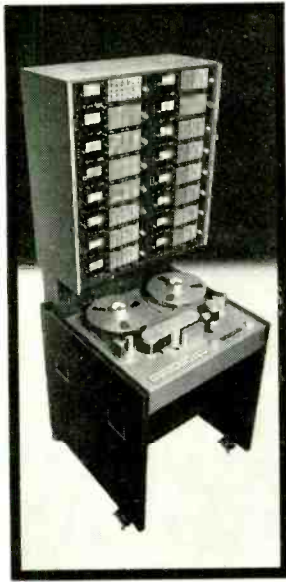

STUDER

*F.W.O. Bauch Limited
49 Theobald Street
Boreham Wood Herts
Tel: 01-953 0091*

STUDER A80 | STUDER B62
STUDER 189

APRS '73 Stand No.1

APRS '73 PREVIEW

has a smaller (18 cm) spool capacity tempered by a lower price. ITA will be offering a new 10/4 mixer designed for use with the Teacs and incorporating all normal studio facilities, including equalisation, echo, foldback, compression and pan. Price is £562 plus VAT. Other exhibits will include 76/38 and 38/19 cm/s versions of the Revox 77 and complete 'mini studios' for stereo and four track working. Representatives: Barry Lambden and M. E. Parmitter.

Three tape recorders will be shown by Klark-Teknik, a Worcestershire company based at Kidderminster. Model 2000S is intended for cartridge quality control and operates at 9.5 cm/s on 6.25 mm. The standard unit contains four replay heads though up to six can be accommodated. Claimed wow and flutter is 0.1 per cent (DIN 45509) and bandwidth is 40 Hz to 14 kHz ± 0.5 dB. A similar unit is available for cassette quality control, featuring two heads and a bidirectional drive. Considerable interest seems likely to be shown in the 2000N, a 25 mm eight track studio recorder with variable speed ic motors, fail-safe logic, ic electronics, full remote facilities and compact easily-serviced design. Claimed wow and flutter is 0.05 per cent (DIN 45509), bandwidth being 30 Hz to 18 kHz ± 1 dB with 64 dB signal-to-noise ratio. This is the basis of an entire range of studio machines available from stereo 6.25 mm to 24 track 50 mm, the latter described as one of the smallest 50 mm machines available. Representatives: Philip and Terence Clarke.

Lamb Laboratories offer a complete 'mini studio' based on a 38 and 19 cm/s Revox 77 and PML420 4/2 mixer. The recorder is available with or without selsync and varispeed (£798 plus VAT or £848 plus VAT respectively). Beyer microphones and headphones are included in the studio deal which is organised on a rental or purchase basis. The system is complete, requiring nothing more than a mains plug and 240V ac. Lamb have recently been appointed agents for Raab (West German) audio cables. These are available in a wide range of formats though perhaps Raab's main attraction is their ability to produce large or small quantities of cable to virtually any special requirement. Prices are described as keen and deliveries prompt. Representing Lamb: R. Sharpe, B. Staples and D. F. Quillen.

Evershed film sync counter and Gauss
450 mm 8100 driver



Theme of the Leavers-Rich display will be the continued success of their E200 6.25 mm recorders. These will be displayed in full and twin track versions and in several cabinet formats. A stereo/mono compatible machine of the kind being supplied to the BBC will be seen alongside a rack-mounted high speed tape duplication system and a new version of the Leavers-Rich graphic equaliser, model LR720.

Macinnes Laboratories plan to exhibit items from the Amcron range of power amplifiers, tape recorders and electrostatic loudspeakers. Among the latter, the ES224 is claimed to be capable of handling the full output of the DC300A amplifier and therefore seems particularly worth investigation. Other items on the Macinnes stand will include the SRT1 variable tape speed unit and a range of Maclab high power loudspeakers. Representative: Ian Marshall.

Naim Audio, a new naim at that, are introducing a stereo amplifier and loudspeaker on stand 70—shared with Magnetic Tapes Ltd. Naim claim: the amplifier will deliver more than 100W per channel into 4 ohms and 70W into 8 ohms. Typical thd is 0.002 per cent at all frequencies up to 10W power, rising to .004 per cent at 50W 1 kHz. The amplifier is unconditionally stable and, designated NAP200,

Keith Monks (Audio) Ltd, 5 Fleet Road, Fleet, Nr Aldershot, Hampshire.
Phone: 025 14 7316
Stand No: 68

MSR Electronics Ltd, 57 Albert Street, Rugby, Warwickshire.
Phone: 0788 71419
Stand No: 26

Music Week, 7 Carnaby Street, London W1.
Phone: 437 8090
Stand No: 10a

Rupert Neve & Co Ltd, Cambridge House, Melbourne Royston, Hertfordshire.
Phone: 0763 60776
Stand No: 50/51

Pye TVT Ltd, PO Box 41, Coldhams Lane, Cambridge, CB1 3JU.
Phone: 0223 45115
Stand No: 11/18

Racal-Zonal Ltd, Holmethorpe Avenue, Redhill, Surrey.
Phone: 71 67171
Stand No: 36

Radford Audio Ltd, Ashton Vale Road, Bristol 3.
Phone: 0272 662301
Stand No: 15/16

J. Richardson Electronics, 57 Jamestown Road, London NW1.
Phone: 267 0723
Stand No: 5

Rola Celestion, Ditton Works, Foxhall Road, Ipswich Suffolk.
Phone: 0473 73131
Stand No: 62

Rugby Automation Consultants, 220 Alwyn Road, Rugby, Warwickshire.
Phone: 0788 810367
Stand No: 32

Sansui Audio Europe SA, Brush Clevite Co Ltd, Thornhill, Southampton, Hampshire, SOP 1QX.
Phone: 0703 44811
Stand No: 69

Shure Electronics Ltd, 84 Blackfriars Road, London SE1 8HA.
Phone: 928 3424
Stand No: 33/34

Studio Republic, Church Farm, High Street, Pinner, Middlesex.
Phone: 868 5555
Stand No: 8

Studio Sound, Link House, Dingwall Avenue, Croydon, CR9 2TA.
Phone: 686 2599
Stand No: 60

Tape Recorder Developments, Hall Lane, Walsall Wood, Staffs.
Phone: 054 33 4605
Stand No: 7

Trident Audio Developments Ltd, 4/10 North Road, London N7.
Phone: 734 9901/4
Stand No: 14

Vitavox Ltd, Westmoreland Road, London NW9.
Phone: 205 8671
Stand No: 12/13

APRS: Stand No: 38



60 ▶

Just to give you the basic idea we call it the ...

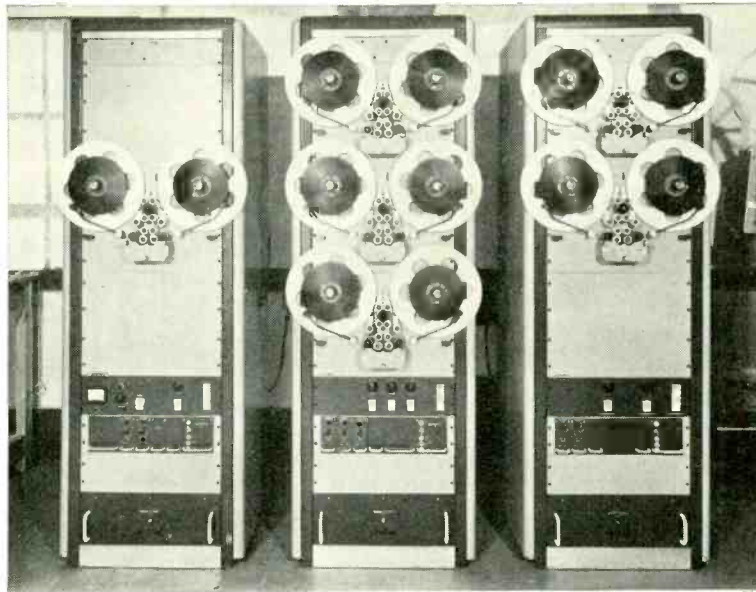

Perfectone Rack-Mounted Simplex/Duplex/Triplex Trans-Ultra Studio Recorder for 16 or 35 mm Film with Rythm-O-Start Drive System.

Perfectone is quite a name in itself especially for the highly sophisticated 'OR-Multi' recorders that have set the standard throughout the industry. The new, compact, adaptable and most reliable rack-mounted equipment is fully worthy of the name offering undoubted broadcast quality and a load of useful facilities at considerably lower cost.

Trans-Ultra film transport mechanisms — proved very successful in portable recorders — are mounted in standard 19 in. racks for recording and transfer work. All recording units incorporate a separate reproducing channel and either 16 or 35 mm mechanisms can be fitted to the racks in any Simplex, Duplex or Triplex combination. The most popular system is made up of three machines. In this, two replay units and one recording unit can be locked in perfect synchronisation with, say, a film projector by the Rythm-O-Start electronic interlock system.

A big advantage of the new rack recording/replay package compared with standard racks is the

Perfectone

EVERSHED POWER-OPTICS LTD,

Bridge Wharf, Bridge Road, Chertsey, Surrey KT16 8LJ.
Tel: Chertsey 61181 Telex: 929945 Lenservo Chrtsy.

reduction in size and weight and the combination of all facilities for synchronising, mixing and transfer work in the studio.

Unique to Perfectone is the outstandingly convenient Duplex version with integrated CCTV picture projection system.

With this or any arrangement of the facilities to match your requirements (and no more), the new Perfectone equipment adds up to superb value for money.

Ask us to send you the literature — or if nothing less than the absolute quality of the best in the world is good enough, we'll be pleased to give you information about Perfectone 'OR-16' or 'OR-Multi' models.

Visit us at these exhibitions
A.P.R.S. Stand 75
Film '73 Stand C3
INTER-NAVEX Stand 59

APRS '73 PREVIEW

will sell for £140 plus VAT. Price of the Naim loudspeaker, several of which have already been supplied to small studios, is £36 plus VAT. Naim's Julian Vereker emphasises that the low price does not imply low quality.

A new 24/16 audio console with a 16 track monitor system, type 2254A complimitters and 16 VUs is to be displayed by Neve. One of the latest additions to the S range, the desk will be despatched after APRS '73 to a Canadian recording studio. Working demonstrations will therefore be possible.

Howell Jones, Peter Johnson, David Bott, Trevor Foxon and Debby Pagan will man (Debby?) the Pye TVT stand where the emphasis is to be on a new eight channel mono/stereo mixing system—the SM8. This is based on five modules: microphone channel, stereo gram channel, high level unit, output unit and ancillary unit. Each mic channel accepts two microphones plus one high level and incorporates bass, presence and treble equalisers, echo send, foldback and prefade listen. The fader is a Penny & Giles 1500 with backstop switch. Module output can be panned between either output group. Among gram module features is a fader-start plus echo, foldback and pfl. Any one of three high level stereo inputs can be selected in the high level module, essentially a version of the microphone module with simpler equalisation (bass and treble) and a 3 dB balance control in place of the wider pan. Two or three ppms may be mounted in the metering hood, running the full width of the desk and carrying power switching, transmit/rehearse switch and reverse cue light. An eight track Philips Pro 72 (reviewed on page 82) will feed the SM8, demonstrating reduction to a stereo Pro 36. Of particular interest to local radio broadcasters, the new XMN4 station logger is capable of recording up to eight channels simultaneously over 12, 24 or 48 hours. Speed of its 6.25 mm triple play tape is 2.375 cm/s, a servo controlled capstan motor holding wow and flutter to 0.5 per cent peak (EMT 420). Bandwidth is 300 Hz to 3 kHz \pm 3 dB for 36 dB signal-to-noise and five per cent harmonic distortion at full modulation. The unit is compact (485 x 425 x 352 mm whd), weighs 35 kg and costs £1,500.

System 2 magnetic film and Spectrum 1 audio tape are to be exhibited by Racal-Zonal. Technical details and price structures will be available from Tony Pitter on stand 36.



In addition to producing low-cost audio modules, Rugby Automation Consultants manufacture portable five and six channel mixers and discotheque control units. RAC hope to exhibit a new 12 channel studio mixer with comprehensive equalisation and monitoring facilities. New modules in the basic RAC range include virtual earth mixing and output amplifiers, oscillator and compressor units. The stand will be attended by Martin Bennet and Jim Butterworth.

A litre in a pint pot, the Stellavox SP7 needs little introduction. It will be seen on the AV Distributors stand accompanied by the improved SM7 intended for high quality stereo mastering. Claimed 38 cm/s bandwidth is 25 Hz to 28 kHz \pm 2 dB with 70 dBA weighted signal-to-noise ratio. Total distortion at 800 pW/m is 1.5 per cent; wow and flutter 0.05 per cent DIN peak weighted. A four track version, again powered from batteries, will be seen in the shape of the SQ7 which incorporates full selsync 6 kg. An ABR attachment allows all

58 ▶

Stellavox SP7 battery portable stereo recorder with 4/2 mixer (top) and speed 'variator' (high right). RAC five channel mixer (mid right), Dolby 16 channel A noise reducer (bottom right) and Woelke ME105 wow and flutter meter.

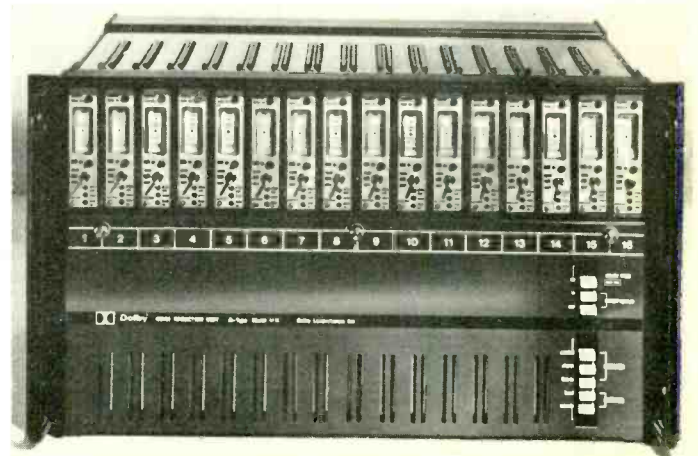
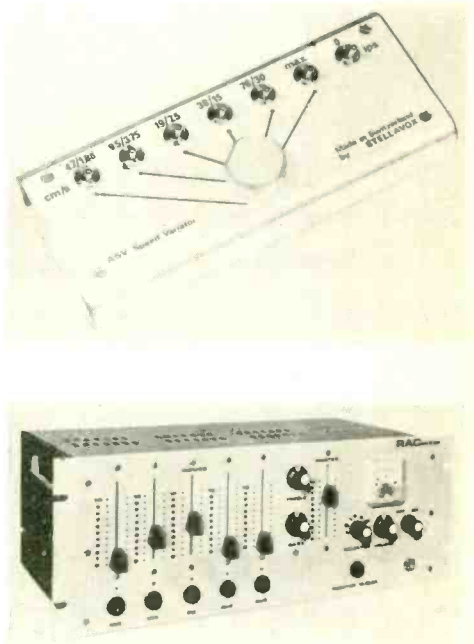

Now, another step forward
by the leader.

Ampex MM-1100

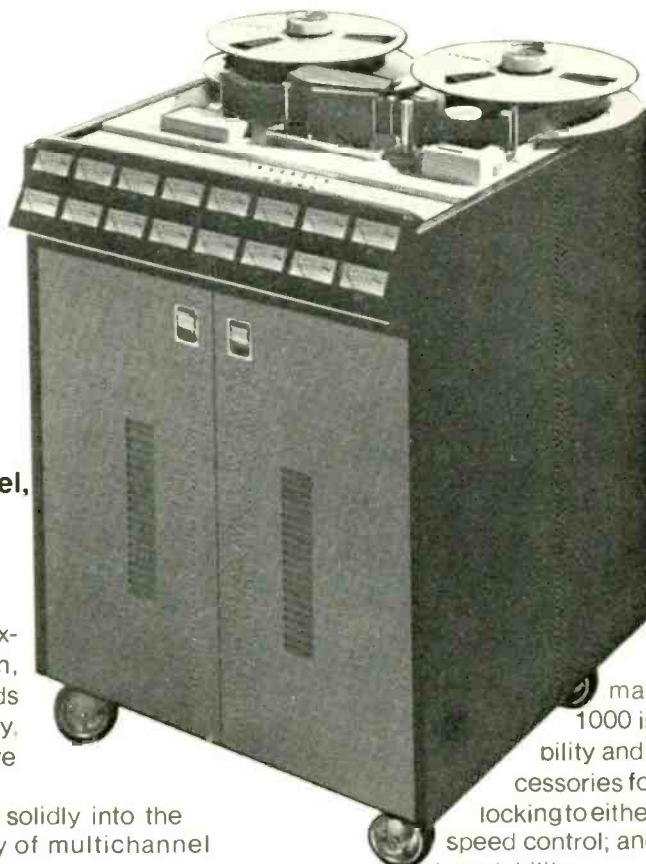

An economical, compact, multichannel, high performance audio recorder/reproducer.

As the leader in today's exciting sound revolution, Ampex has set the standards for fidelity, dependability, and flexibility in imaginative recording.

Now the MM-1100 fits solidly into the matchless Ampex family of multichannel recorders and reproducers.

For the budget-minded user there is the reliable AG-440-8, the lowest priced truly professional 8-channel recorder available.

The new MM-1100 fits the need in more demanding 8-channel applications, and also offers an entry into 16 or 24-channel recording at a cost much lower than for recorders of similar capability. Outstanding features include:

- Stable tape motion in 0.5 sec. from precision capstan servo.
- Tape tension servo for smooth handling of 10½" and 14" reels.
- Identical playback performance in both sel-sync and normal reproduce.
- Compact packaging for convenient mobility;

functionally grouped transport and electronics controls; tilt-up meters.

In performance, the MM-1100 is a no-compromise companion to the MM-1000.

Where very sophisticated mastering is the rule, the MM-1000 is also unchallenged for flexibility and versatility. Capstan servo accessories for the MM-1000 allow precise locking to either film or video; permit variable speed control; and offer tape lock for absolute pitch stability.

Also from Ampex: all-new 400 Series mastering tape—a professional tape combining low noise level with high output. For more information on Ampex recorders or tape, send the coupon to C. W. Scullion, Sales Manager, Ampex Video/Audio Products, Ampex Great Britain Limited, Acre Road, Reading, Berkshire.

Tel: 0734 84411.



MM-1000 The ultimate audio recorder/reproducer. Available in 8 or 16-channel models.

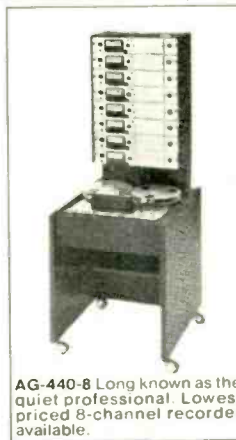

AG-440-8 Long known as the quiet professional. Lowest priced 8-channel recorder available.

Please send me full details and descriptive brochure on

- MM-1100
- MM-1000
- AG-440-8
- 400 Series Tape

Name _____

Address _____

BD1

AMPEX

■ APRS '73 PREVIEW

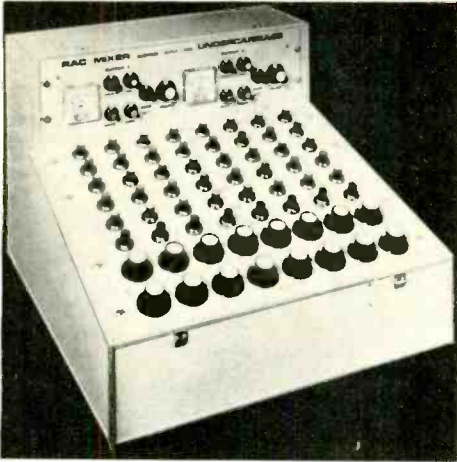

three machines to carry up to 30 cm spools. *ASV* provides smooth variation of tape speed from 76 down to 4 cm/s and *ARU* permits synchronisation with film or videotape. Also on show will be two versions of the *AMI 5/2* mixer available with optional 48V capacitor microphone powering, input limiting, prefade listen and individual channel outputs. Lastly, *APS7* is a new fully stabilised power/charger unit compatible with the entire Stellavox range.

Having campaigned for years in favour of the peak programme meter, **STUDIO SOUND** on stand 60 will display working examples of the following indicators: ppm to British Standard, ppm without logarithmic compression, VU to Bell specification, and a variety of slow ballistics meters. Visitors will be able to compare these units across a range of sources from sine waves through square waves, pulsed tones and music, to speech. Surrey Electronics (24 The High Street, Merstham, Redhill, Surrey) are producing the display which will incorporate commercially available modules based on Hugh Walker's article 'Constructing a Peak Programme Meter' published in our January 1973 issue. Our thanks to SE's Trevor Brook for making the demonstration possible.

The long-awaited **Woelke ME105** wow and flutter meter finally makes it debut this year on **Lennard Developments'** stand 17. Bearing little stylistic resemblance to the earlier *ME* models, the unit has a larger number of measuring ranges and separate drift and flutter ranges. Two crystal-controlled test tones are selectable: 3 kHz and the standard 3.15 kHz. The *ME105* is claimed to be insensitive to tape hiss, a factor which has hitherto prevented even the mythical perfect tape transport from reading zero wow and flutter. Amplitude modulations and variations in signal waveform, temperature and mains voltage are similarly claimed not to affect the measured result. Weighting, when required, is to DIN/IEC/ANSI standard. Representative: Ernest Lennard.

A few latecomers as we go to press.

Audio Applications will show a 20/8 *Response* mixer which they have built for Reign Equipment Hire.

A frequency-selective audio complimiter is to be introduced by **Audio Design Recording**, one proposed application being to solve the sibilant problem.

APRS executive committee chairman Jacques

Levy, representing **Jacques Levy Professional Recording Services**, will display Audio-disc and Emidisc blanks, Audiopak cassettes, Pultec equalisers, and the new Audiopak *A2* broadcast cartridge.

The **Studio Republic** mobile recording unit will appear at APRS for the first time, presumably parked outside. The mobile can be worked on four, eight or 16 tracks in various groupings and incorporates two Tannoy *Monitor Golds*, Neve desk and limiters, Dolby *A* and a range of accessories. Studio Republic will also show examples of their recording service, which extends from the original recording to cassette copying on high speed duplicating equipment.

The **Audix** range of mixing modules, equalisers and power amplifiers designed for theatre, sound control systems, recording and broadcast studios, will be on show on stand 56. Among these will be a range of monitor power amps rated at 15, 30, 80 and 200W, graphic equalisers, studio intercom equipment, distribution amplifiers, and mixing modules.

Prototypes of a new microphone range will be seen on the **Calrec** stand. The *700* series is based on a newly developed inverter and works from one *HP7* dry cell, alkaline Manganese or mercury cell.

Lastly, **MSR** will show the *2000* stereo disc cutting lathe. New technical sales manager Neil Raybould will offer advice.

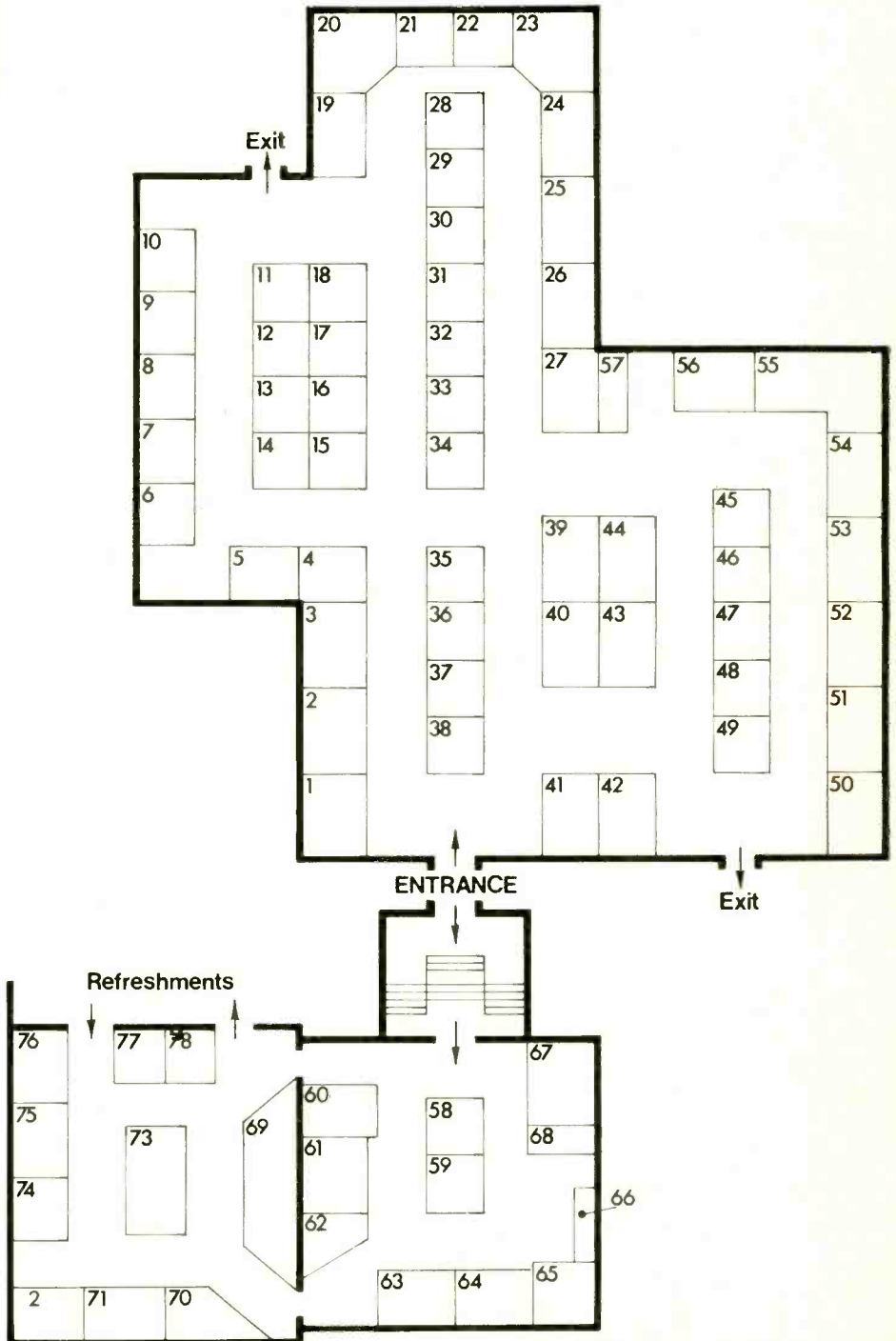

Ain't nobody else can give you an S/N ratio up to 72 dB. Nobody.

We call it the Scully 280-B Professional Recorder/Reproducer. Not a very fancy name. But it's so new, we haven't had time for anything else but a number.

Briefly, here are the high points, new electronics for up to 72 dB S/N ratio on full track .25" tapes. And a greater dynamic range than you've ever been used to.

Two-track quarter-inch and four track half-inch 280-B lays on a crisp, clean 69 dB on an NAB weighted basis.

We've built in some other choice features, too. Like an OPTAC™ optical motion sensing system that gets rid of deck plate sensor mechanisms. Plus a new mother-daughter board architecture for super easy maintenance.

The spec sheet has all the details.

*For more
information
contact your
Scully Distributor
or write direct to
Scully/Metrotech*



▶ **Scully/Metrotech**

Divisions of Dictaphone
14 Broadway
London SW1, England
Tele: 01-799-1572
Telex: (851) 27806 (Dictaphone, London)

Studio microphone technique

MICHAEL THORNE

tackles the subject of close microphone placement, one on which few exponents are prepared to commit themselves in print. The techniques discussed clearly involve the sound balancer in more direct control of timbre than is ever achieved (or desired) with Blumlein techniques. The following is not intended to lay down rules; rather to explain the influence on tone of some of the more obvious placements.

IDEAS ON microphone placement usually divide conveniently into the rather hoary categories of 'close' and 'traditional'. Carefully avoiding provocation of further controversy, it seems necessary to redefine these fields of reference, while acknowledging that most practical recording is done using an amalgam of these two extremes of technique.

The distinction directly relevant here is the broad interrelation of room, music and microphones. With traditional techniques, the instrument and microphones might be seen as matching to the room and room acoustics are therefore of paramount importance; the instrumental sound-field as a whole is captured. With close techniques, the microphone is matched to the instrument and it is often necessary to pay attention solely to those parts of the instruments which will give an approximation to the 'free air' sound when miked. Instead of moving microphones and instruments within a room for best results, the microphone is adjusted to the instrument; while ambient acoustic is acknowledged, it is not always used directly.

Close miking can imply a virtual denial of room acoustics. A dead studio adopts a defensive attitude in *avoiding* large reflections and resonances, in contrast with the constructive and often idiosyncratic behaviour of a recital room. The tremendous 'live' drum sounds emanating for years from many parquet-floored American studios is testament to the constructivists—but a small Soho room will not always permit elbow space. Nevertheless, the fact that the deadest studio can possess a recognisable sound re-emphasises the non-existence of a totally neutral acoustic.

Discussion of mic technique is often characterised by coyness and secretive evasions; unlike nuclear secrets, these are often common knowledge. A certain studio once intimated that it had a marvellous new way of miking a piano; unfortunately, someone let on that they did it *inside*. Wow.

The doubtful should by now be convinced that basic techniques are just that, and no more. No great recording ever came from diagrams and slide rules, just as great music doesn't automatically spring from the pages of music textbooks. Something more is needed, fortunately, so it seems healthier if many engineers could be a little more extrovert in order to clear more easily the basic hurdles outlined below. A musician would not progress far if denied basic technique to build on—there's no airy mystique about his operations. Likewise, the engineer starts from basics and builds according to his own inclination. Books called *Instant Sounds* belong on the same shelf as *How To Make A Million*. Conversely, it's still possible to be knocked down after looking to right and to left.

The article is concerned with close techniques almost exclusively, because they are the most amenable to careful generalisation. The complementary article would discuss room characteristics and their relevance to instruments and music taking place. In a typical situation, an engineer might choose a blend of both approaches, and he would be limiting himself unduly if he did not. Seen in this light, any polarised controversy disappears into the futile realms of academia.

Unless mentioned otherwise, the mic characteristics are all cardioid. Many of the results

can be improved by judicious use of coincident pairs in the same position as given for one mic, pan-potted to provide a spread line image as broad or narrow as required rather than a point. Given sufficient tracks, width decisions can profitably be postponed until reduction. A common fallacy is that the best place for listening is always the best place for mic positioning. This isn't helped by those curious conceptualised diagrams with mics leading to a dividing wall covered with speakers in corresponding positions, one for each. This overlooks the fact that, in the imperfect world of sound recording and reproduction, there are two sound transfers in place of one: from original sound to microphones, and from playback speakers to listener. Two sets of acoustics, two modifications of information. While a Blumlein pair can be conceived as the mirror-image of the stereo playback, no such symmetry exists for close techniques and balancing has to compensate for each stage. Entropy is not something which only happens to other people.

Although much of the following centres on reproducing a natural 'realistic' sound, the advantage of close working is that the sound is split into its elements and can be processed at will to produce the most interest within the context of the medium. There is no pretence at suggesting special treatments here but merely to indicate their basis. The engineer's activities by now directly parallel some of the composer's, in changing and creating sound textures instead of simply relaying them as before. Some instruments, notably electricians and drums, are more likely to be heard off record, which gives the listener a distorted acceptable view of the correct sound ('correct' and 'acceptable' are interchangeable, as always). Thus, feedback arises producing a change in techniques, and a change in the expected sound—and usually an improvement in the process. Old-style drum recording was with two mics only, one on top-kit, the other on bass drum, and it produced a sound which everyone recognised. Now, with the advent of multimiking, a particular recorded drum sound is imitated on stage via a stereo pa system, giving a total reversal of former hierarchies.

Piano

The piano is the classic demonstration of the principle that sound comes from many parts of an instrument. Classic old-wives' tale is that the noise comes evenly off the soundboard; this accounts for the pudgy wooden bass in many commercial recordings, assuming it is there in the first place. It's not for nothing that people build them 2m long. In achieving a faithful piano recording, you seem completely at the mercy of the room. The traditional compromise between realism and separation (one which almost works, given a bit of allied care, compression and suspension of disbelief) is to poke a microphone at the soundboard through the holes in the frame about the treble strings. If it's too toppy from one (it always is, but we overlook that) things can be improved by moving it down the soundboard (away from the player). And all this is with the lid raised just sufficiently to let the mic stand in, possibly using swathes of cloth to improve separation.

Separation is always a problem, especially when the piano is associated with raucous neighbours, and it is not helped by the need



Microphone Stands and Accessories

Curved Boom Low Level Microphone Stand with Screw Leg Base (Ref. GM. 119S) Each £13.62

With folding leg base (Ref. GM. 119F) Each £14.11

The most versatile microphone stand on the market, complete with movable adjuster for a second microphone.

Total Weight: 5kg. (11 lb. 2 oz.)

Maximum vertical extension: 151.5cm (59.5in.)

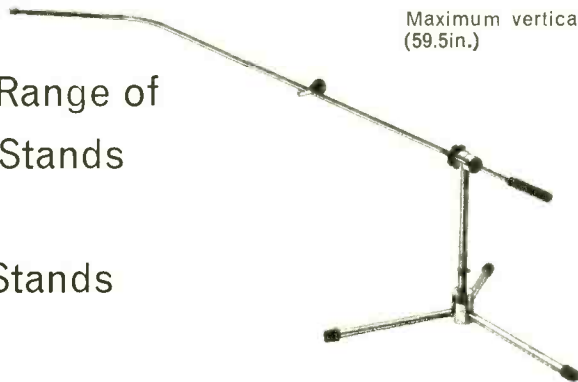

A Complete Range of
Microphone Stands
Boom Arms
Banqueting Stands
Table Tops
by

GENERAL MUSIC STRINGS, TREForest, PONTYPRIDD, GT. BRITAIN

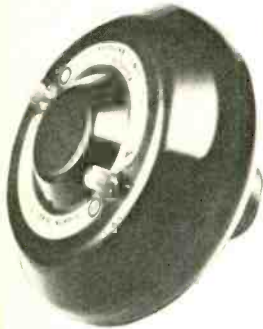

The New Loudspeaker Range...

Please send me further information on your product range

Name _____

Company _____

Address _____

V5

The sound of music, from the lowest frequency to the highest is now brought to the connoisseur of quality in sound reproduction with the new, Vitavox Power Loudspeaker Range.

The Range blends four superb units into one matchless composite, or each element as a separate unit available for use with other systems. The range gives exceptional quality of sound reproduction and handles up to 100 watts of musical power. The four units are: a High Power, High Frequency Pressure Unit and a High Power Bass Loudspeaker, each designed to give increased power handling capacity without sacrificing either efficiency or frequency response; a High Frequency Dispersive Horn, designed for use with the Pressure Unit — matching accurately the Unit's output characteristics and giving superb sound dispersion; a High Power Dividing Network for use in both high and low power systems and which ensures correct allocation of the frequency spectrum between high and low frequency units.

Carrying the Vitavox stamp of quality, this is the Range which brings you ...

the great sound of Vitavox

Westmoreland Road, London NW9 9RJ Telephone: 01-204 4234

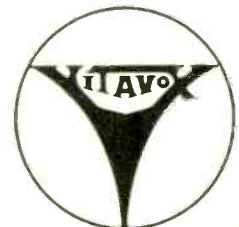

STUDIO MICROPHONE TECHNIQUE

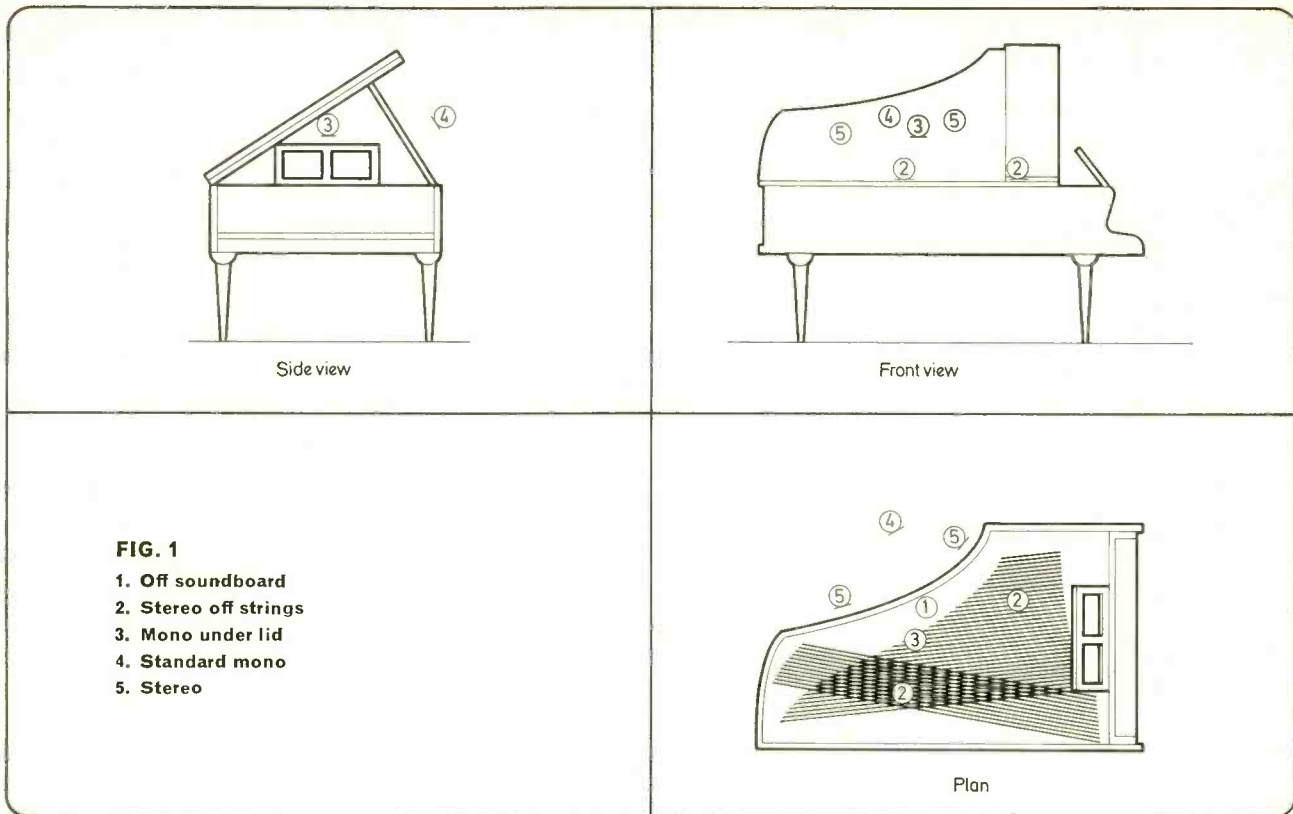

for compression on most 'non-classical' recordings. However, given an overdubbing or solo situation, the reflector can be fully raised. Then a position midway down the curved position can be used, about halfway between lid and case, and about 60 cm back. Again, adjust lateral position for optimum balance between notes.

For stereo effects, there are two approaches. The previous method can be used, with two mics positioned slightly closer in and about 1 m apart. There are no formulae for this as a decent balance is achieved only by fiddling about. A stereo pair in the 'mono' situation gives the same effect. Alternatively, use two downward facing mics as shown in **fig. 1** at about the centre of 'bass' and 'treble'. The latter are intuitive rather than mathematical points due to the folding over of the piano strings. The result is a brighter and obviously stringier sound but incurs some hammer noise.

Another position for a bright high-presence sound is about 10 cm below the open reflector, using a figure-of-eight characteristic. This makes more positive use of the lid (parallel with acoustic guitar and brass treatments) and can be surprisingly effective. It is also amenable to fiddling around with the lid down, although for separation purposes the cardioid off the soundboard is most controllable.

Harpsichord

There are many approaches to miking a harpsichord, many of them considered heretic by exponents of others. Its similarities with the piano automatically imbue it with the same difficulties but additional complications stem

from its quietness. The relatively high action noise consists not just of the obvious plucking peripherals but of deep rumbling and clonkings, obscured in the louder piano, and which make their appearance on many commercial recordings. Perhaps the harpsichord is the most defiant in submitting to close techniques, but try one must . . .

One method is to treat it like a piano, with mics in the corresponding position, although any close to the strings will give an unacceptable plucking emphasis. One way to avoid this is to mic underneath the soundboard but here the rumblings intrude and must be filtered sharply. The ideal is probably to employ a laid-back crossed pair, although this will capture distant number 73 buses as well so a *very* quiet surrounding is essential.

Acoustic guitar

Because of its popularity and richness of tone, the acoustic guitar is called upon to perform more antics than are always good for it. The result has often been unmitigated disaster. As with the drum kit and harpsichord, many people are accustomed to a larger-than-life sound by now.

The Spanish guitar does not submit to much character-building as readily as its steel-stringed counterpart. Since the Spanish is usually performed by itself, a more distant technique can be used with a single mic or crossed pair about 1 m in front of the sound hole. Coming in any closer often seems to lose resonance and result in an unnaturally jangly and fairly uninteresting stringy sound.

Steel-string guitars, with their brighter and

more competitive sound, often have loud neighbours, so it's as well they're more amenable to close techniques. Obvious place for mono recording is directly opposite the sound hole but not so close that a boomy muddy sound lacking any sort of presence will result. The further back the mic is taken, the more wooden and natural the sound. For a broad even sound, about 30 cm is reasonable. If it is necessary to come closer, miking the side of the soundhole towards the neck (chosen to keep out of his way) will reduce boominess.

Other positions are necessary if stereo effects are to be indulged, although economy pays as always. ('We used four or five on separate tracks and mixed them down . . . didn't we?') A stereo pair will give a broad sound but devoid of much localised interest. An alternative suggestion would be to use three microphones: one behind, facing the bottom of the back of the soundbox; one in front, about midway between top sound-hole edge and soundbox edge about 12 cm back (this picks up interesting action noise); and another on the other side of the soundhole—hopefully the player's position will permit this. A few centimetres error can be crucial so the unfortunate guitarist must be settled down each time he returns from control room or loo. And these positions are again just starting points; guitars differ as much as people and deserve correspondingly individual attention. Front mics to each side of the stereo stage, and the back in the centre, can produce startling results when carefully balanced and equalised.

Rycote for Sennheiser 805, 415, 405
Windgags and AKG 451, CK9

are light weight **POLYTHENE**
 almost indestructible

Write to **RYCOTE**, POOLHEAD LANE
 TANWORTH-IN-ARDEN, SOLIHULL, WARKS.

or leave your name and address on our recorder on Earlswood 2339



LOOKS LIKE LOCKWOOD BY THE SOUND OF IT

LOCKWOOD

HARROW · MIDDLESEX
 Tel. 01-422 3704 and 01-422 0768

STUDIO INSTALLATIONS

T. B. Technical, Audio Systems Consultants, can provide engineers for planning, installation, and maintenance of all professional audio equipment.

Also
 Audio Test Equipment Hire

T. B. TECHNICAL LTD.
 90 Wardour Street, W1V 3LE
 01-437 1892/3

**Audio
 Connectors**

Speaking of Audio Connectors, we have them in stock

These connectors are the XLR and EP ranges. They're famous for their reliability, and are standard equipment throughout the world for TV, Radio, the Cinema, etc., being used by such organisations as the BBC.

In addition, we can supply multi-way connectors of varying types, including Rack & Panel and Circular in standard and miniature configurations.

If the component you need is not in our stock, we can identify it and supply it quickly.

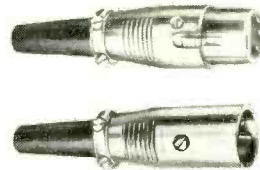

Why not telephone us now?

We'd like to demonstrate just what PSP Service and technical know-how can do for you.

ALSO

		per 100 metres
MICROPHONE CABLES	TWISTED	14/0076 £4.82
IN GREY OR BLACK	TWIN	7/0076 £4.06

— AND OTHER TYPES, ALL TO EUROPEAN AND USA STANDARDS — RING FOR DETAILS

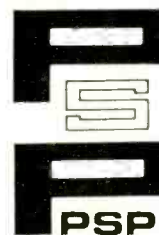

ITT Cannon Authorised Distributors

228 PRESTON ROAD,
 WEMBLEY, MIDDLESEX HA9 8PB

Telephone: 01-904 9521 (five lines)
 Cables: PSPEL Wembley

PSP ELECTRONICS LTD

STUDIO MICROPHONE TECHNIQUE

Harp

Fortunately, the number of harpists with heavy friends is not legion. For this instrument poses problems similar to those of the piano in that its rich but delicate sounds cannot be truly approximated by close miking. It is exceedingly difficult to separate successfully. Whereas an acoustic guitar can under pressure be treated very close to the hole in the sound-box, no such convenience exists here. For the more even sound, it is best to mic at a short distance from its centre, bearing in mind that sound does come off the strings. About 40 cm away is adequate; this instrument really makes a mockery of close (i.e. separate) techniques. Ideally, to pick up a reasonable spread from the instrument, a distance of 1 to 1.5m is necessary.

Percussion

The only common characteristic of percussion instruments is their constructive masochism, which rules out any convenient generalisations or common themes. Often the difficulty is not so much getting a sound out but preventing its cutting through on mics round the rest of the studio. For Latin-American percussion, and other odd bits, one might thrill an impressionable producer by miking a guiro to within 2 cm but he won't last long anyway.

Timpani are conveniently approached from about 1.5m above. The position should be biased towards the deepest since these carry less well; the balance point is best judged by eye and subsequent ear. Often a dead studio

can kill their resonance, and convenient corridors and junk-rooms can be utilised. Bongos and congas are best miked closer because of the attractive finger and skin sounds which don't carry in a normal room situation. Congas can also be miked from underneath, which gives a clearer bass, but the subtler aspects disappear.

Position for glockenspiel, vibes and xylophone directly above and towards the lf end. Height above should be around two-thirds the usable width of the board; there won't be much difficulty with other noise intrusion—again, more likely the other way round.

Drums

The standard drum kit is capable of a more inherently pleasing recorded sound than any other instrument, certainly on the basis of current recordings. But just as its classical counterpart, the tympani, demands much attention, so large amounts of effort are expended on various ways of achieving the larger-than-life sound which has gradually evolved to a stage where it is expected; anything less is considered the inferior article, even though no audience ever hear drums *live* the way one does on record.

The most elaborate set-up can involve seven mics or more, depending on time and patience available and on the studio itself. That shown in **fig. 2** makes no pretence at being a certain success, for much depends on the drums themselves. The drummer has to fiddle around, taking dampers off (the opposite of a stage situation) and using wet cloths, blankets, bits of camera tape—anything to get the sound in the first place to enable it to be registered or to

subdue rattles which aren't usually noticed. Resonances which aren't noticed on stage, or are even advantageous in cutting through, can honk alarmingly through a microphone.

The bass drum mic needs to be capable of handling high pressure and transient levels without break-up; this test is one of the most severe and recourse is generally to an old faithful dynamic like the AKG D12 or to a sturdy U87 whose capsule attenuation is often useful. Position is slightly below centre in front. A thicker sound results from removal of the front skin and weighting with blankets but this isn't always appropriate. Judicious compression can also help.

With snare and tom-toms, compromise is needed between ideal positions and the drummer's own preambulations. With a single kit, each is treated separately with a mic at the rim, about 6 cm above it and aimed at the struck part of the skin. The direction should be arranged for best separation from other drums in the circumstances. For a double kit, try one mic positioned at the centre of each pair of tom-toms, preferably on a line connecting their mid-points. Balance demands slight biasing towards the lower-pitched. Miking them separately might give extra interest in a stereo recording but, with a complete double kit and stereo top-kit, ten mics and a *lot* of getting together would be needed; the principle of diminishing returns operates.

The top-kit mics add interest to snare and tom-toms, as well as picking up cymbals, hi-hat, and any other metalwork. Height depends on the kit arrangement but a rough rule for mono recording is to position directly over the snare at a height such that the extremes

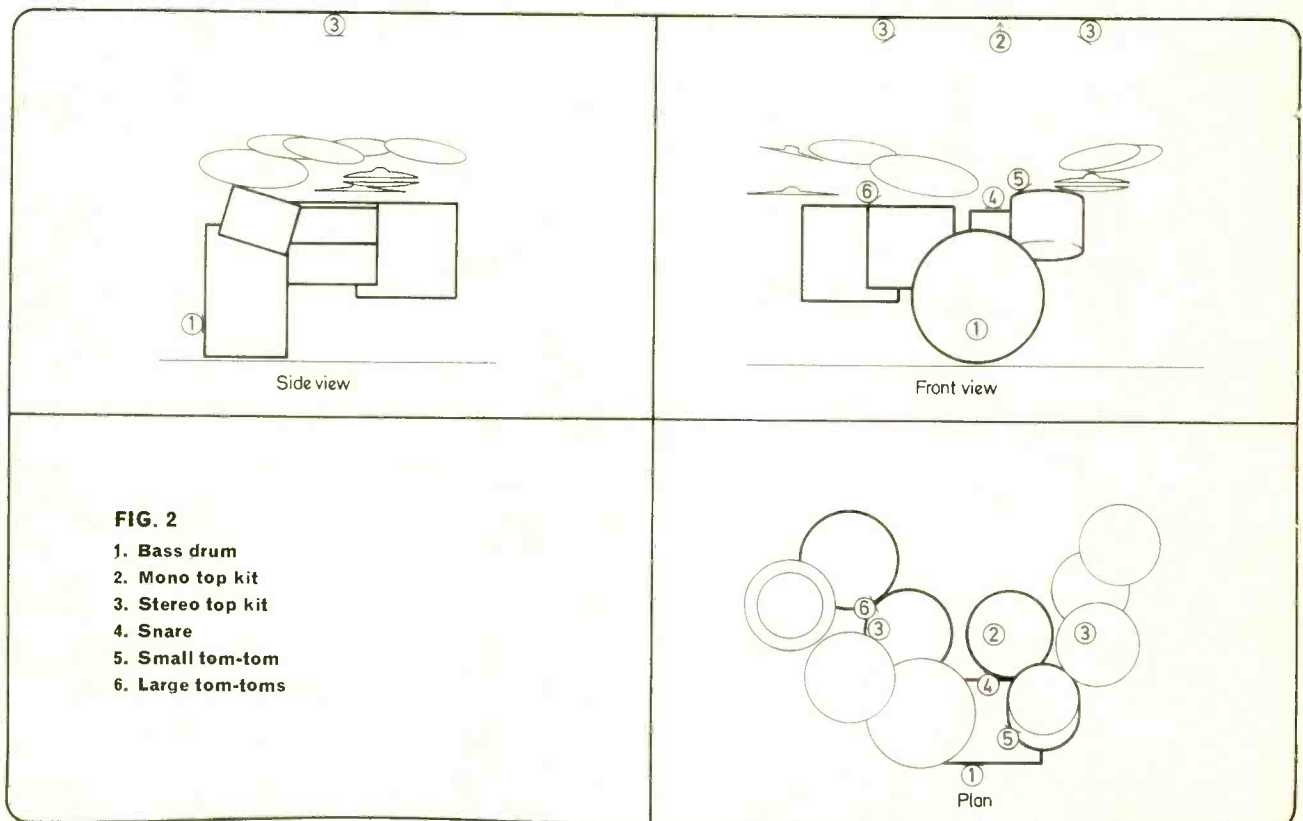

of the top kit are covered by a 60° solid angle from the mic (i.e. comfortably within the cardioid field). Stereo top kit can be achieved by separate mics at the extremes, aimed at the sides of the snare (for symmetry's sake only—it's best to fiddle around until it *looks* right). An alternative is a stereo pair slightly below the mono position. Check that they are connected to the correct stereo channels. In reducing to two stereo tracks of a multitrack master, it is often as well to undermix cymbals if a disc is the end product. Many good taped drum sounds seem just to splash around when arriving on disc, due to cutter limiting or playback mistracking of the large hf components.

In less demanding situations, the old faithful top-kit and bass drum mic arrangement will suffice, the former being lowered to about the drummer's forehead in order to pick out toms better. The snare cuts through strongly and to mic it in addition seems an unnecessary frill.

Electrics

Miking speaker cabinets might seem like just another English custom to a passing musical Martian until he tried to get a realistic sound by direct injection. The cabinet contributes positively by its various devious resonances and colorations, but getting a satisfactory sound out of it must take more studio hours than are devoted to any other instrument.

With electric instruments, it is less a case of mic positioning than fiddling with the various volume and tone controls between guitar and microphone amplifier. Positioning 10 cm in front on the centre axis of one of the speakers is adequate; not the most difficult of places to find. It is also worth enquiring whether any of the speakers are less than perfect. However, capacitor preamps can overload and, although moving the mic back cures it, presence is reduced in the meantime so it's best to utilise the guitar volume control if capsule attenuators aren't available. Unfortunately, this changes the sound too, so a versatile microphone is really needed.

Direct injection

Since a bass cabinet will rarely do full justice to the player's bottom string, direct injection is always useful, usually mixed with the mic input. However, given sufficient tracks, putting one to each side of the stereo stage gives a broad spacious effect; but check the phasing! Hum loops can also give trouble, alternative paths being via the microphone cable screen and the guitar amplifier earth return. For safety's sake, isolation must be effected at the direct injection take-off box which is usually inserted between guitar and guitar amp input.

One day, someone will invent the electronic equivalent of the Leslie cabinet. Until they do, it will be necessary to mic up its unreliable seaside whirrings. A separate mic close to each of the two speaker vents is the rule, being careful to mic the horn and not the amplifier which is at the side of it. Don't worry about the break-up. 'It's all part of the sound, guv. It was always like that.'

Vocals

Assuming that the sound of a vocalist comes completely from the mouth is as simplistic as pretending that piano tone all comes off the

soundboard. Many little sounds come from all over the body, particularly when under strain. In singing, the chest, throat and nose all make their contributions. Close-miking a vocalist is thus more complicated than at first sight. A reasonable rule is to aim for the lower lip, remembering that everybody stands up straighter when singing. Suspending the mic from a boom makes a stance more predictable—no one to square up to then. Variations can be made from this position, depending on the individual voice. A distance of at least 10 cm avoids extraneous sibilance, popping and breathing noises which will be accentuated by the compression likely to be applied before tape and which are made more awkward by any disinclination to use pop shields suspected of hf attenuation. This also reduces the likelihood of feedback from headphones, aggravated by some musicians' habit of wearing them with only one ear on. Similarly reduced are occasional unwanted phasing effects between guide tracks and final mix which occur during passages when the vocalist is silent.

These comments assume that the interest is to reproduce a super-presence voice, devoid of most surrounding acoustics. No one's voice can stand *that*. Inevitably a spraying of echo is received, with seasonings of delays, adt, Leslies and so on, often in inverse proportion to the musicianship of singer and producer. (And is there any reason why vocals should take *longer* to get together than the backing track anyway?) For uncoloured sound, it is senseless to overdub in a typically boxy and resonant vocal booth ('We always do it there . . .') if the main studio is standing empty. It is also easier for the singer to open up, physically as well as psychologically, in more expansive surroundings.

If a helpful room acoustic is conveniently available, a distance of 1m is feasible. This incidentally stops the singer accustomed to stage techniques from closing into the microphone and removes the need for leaning back on the loud parts. If he's yelling excessively, it could be that his foldback is too low—and vice versa. Some aspects *can* be compensated for at the microphone but singing is such a personal activity that more care is necessary in setting up, even paying attention to the singer's view of the studio. Such often overlooked aspects of creature comfort are important anyway but can become paramount if you are your own frail instrument and it's 3.30 in the morning.

A large choir presents few problems in a favourable hall, but that is rather remote from the daily studio situation. Here, a typical problem is anything up to 20 or 30 random souls trying vainly to come to some sort of internal balance; as well as putting up with a grotty little foldback speaker which can't be too loud anyway, they compete with an unhelpfully dead acoustic. Some external assistance is needed.

Up to three people can be conveniently grouped in front of a cardioid mic, thus facing the foldback speaker if headphones are not used. Two or more people with headphones can be balanced face-to-face, with conveniently back-to-back mics. Ideally each line would be compressed individually to give a smoother balance, but sorting out banks of machinery during one run-through of competent session singers demands agility if knobs are not in arm-shot; convenience often comes out

favourite.

With larger groups, it is often easiest to divide into vocal ranges and arrange in a circle with symmetrically placed cardioid mics facing outwards. The speakers can even go in the middle. It is generally the fastest combination of fader fiddling and person-pushing that wins.

Strings

Since the violin is a small instrument concerning itself only with notes higher than the G below middle C, one might think about positioning a mic 60 cm or so above it (i.e. about its soundbox size away). Given a predilection for dentistry, the resulting sound can be enjoyable. However smooth and silky a violin may sound in a room, a close microphone highlights all manner of unpleasant squawks and scrapings. These reduce with distance. The secret is to get far enough above the instrument to retain the sharpness and penetration but lose the extraneous bow sounds. Optimum distance begins to depend more on the room acoustic but, in a typical session situation, about 1.5m above and slightly to front and side of the player will suffice (on a line perpendicular to the plane of the instrument). Where separation demands a closer position, equalisation can reduce, but not eliminate, the scratching.

Approaching a violin section is simply an extension of the solo situation. Given one or two high microphones, all may be covered comfortably. However, this is often not so practical. With an adequate number of channels, it is simplest to divide into pairs or fours and position at the mean of the points that would be defined for solo instruments. These mics can then be balanced independently and brought up on a separate sub-group if further string integration is necessary.

The multimic arrangement gives better separation but studio set-up is obviously crucial. Given the usual central music director, and facing strings, the mics can be angled slightly away from vertical, say about 20°, but brought correspondingly forward so that they are still looking at the same area. A problem to be anticipated is the interaction of many boom stands and twice or four times the number of typically miserable, bad-tempered fiddle players; such discussion doesn't really come within the scope of the article but it does have an influence on the outcome of the session.

For viola, substitute for violin in the foregoing, though there seems to be less trouble with rasping strings so that close positions sound more natural. Also, possibly because of their comparative rarity and less exposed position in the orchestra, viola players are rather more sweet-tempered.

Whereas the tendency with violins/violas is to get well above, with cellos/basses the aim is to get low down. The low scraping which proves so objectionable is often a positive asset here, giving a sharp edge to what can in real life be a rather woollen ill-defined sound. Thus it is not so necessary to get far away. A position about 30 cm in front of and slightly below the bridge is fine for a bowed solo cello, with the mic angled towards the bridge. Don't believe the stories about all the sounds coming out of the f-holes; listen for yourself. The balance between scrape and sound is achieved in the

■ STUDIO MICROPHONE TECHNIQUE

same way as for violins, by careful distancing, but is less critical. A hard, uncarpeted floor brings out a much richer sound. Standing them on varnished sheets of plywood is a good alternative and enables you to get closer since it is largely the mid and low frequencies which are reflected.

There is no scrape problem when plucked and about 15 cm or less in front of the bridge is ideal. Due to the general athleticism of such instrumental pursuits, it is not easy to get a boom in from the side so it's as well to have the music stand at a sufficient height to facilitate coming in underneath. (If this is set up before the session, it will be better for the player to arrange himself round it since the microphone stand is the last thing he understands how to deal with). This, again, presupposes bad-tempered cellists at 09.55. Most people are human but it is best to be on the defensive.

For sections, keep well down and equidistant but at sufficient distance for a cardioid characteristic to cover them all. This works for anything up to three; above that it's necessary to use more mics or to go above, in which case the bottom end fades a little.

Woodwind

There are four basic types of flute: the piccolo, the 'concert' flute in C, the alto in G, and the so-called bass flute which is doubled round on itself and is unfortunately treated as little more than a curiosity. The immediate difficulty is one of dynamics; especially in the upper register, the level will fluctuate wildly for little subjective change in loudness. These are not the spiky transients of a piano, which can be smoothed out with little effect on the sound, but rather unruly resonances whose whims just have to be pandered to. The variation is reduced by miking well above a soloist (1m or more above his instrument). But again, this is useless in situations where separation is important. Moving closer starts to pick up his general blowing and asthmatic heaving sounds, and also the clattering of the keys. No amount of swathing in echo will convince that such a sound is related to anything Pan was responsible for.

The particular solution lies with the player and with his particular sound's balance between these troubles. Generally a compromise is reached by positioning about a 25 cm above the centre of his instrument although, since he'll move around anyway, there's no need for great precision.

Resonances tend to be less pronounced with wooden as opposed to metal flutes. Fortunately they are only especially pronounced for the higher notes which means that the antics of the piccolo are not so apparent in the alto flute—and, since this instrument is often only utilised for its beautiful low register, it's easier to cope with.

The problems of the clarinet are similar to, but rather easier than, those posed by the flute. Although the level shoots up drastically when using the upper register, the characteristic is relatively smooth. Also, action and wind noise are lower, the latter because the reed is a more efficient method of excitation. For Bb and Eb

clarinets, the usual compromise position is around halfway down the tube and about 25 cm in front although again he'll move around a bit. Although sound comes from the bells of these types, miking here doesn't seem to give a particularly interesting or characteristic sound (which owes a lot to its 'woodiness') and increases wind noise. By the time the clarinet has grown into its bass form, there's a tenor-saxophone-like bell on the end of a long body, and mic position makes a compromise between sound coming from the two points.

With flute and clarinet, the instruments' radiation of sound from many parts of their body doesn't give much trouble, because of their small size. For their larger brothers, the logical extension would be to move out in proportion to the size but this again will lose separation so that, in their way, these instruments pose the same dilemma as that of the piano. Fortunately the dimensions do not increase linearly; to be confronted by a contrabassoon grunting from all over its expanse of tube is not a happy experience. The compromise is to centre on the left-hand key section, about 25 cm away at the closest, but further if ambience permits. The bigger the instrument, the more the action noise. In a studio orchestra, bassoons aren't permitted many solos even if the largest extends itself down to the lowest note in the orchestra. The oboe is musically more fortunate but is of more manageable size and to all intents can be treated as a clarinet.

Horns

The French horn is a deceptively nasty instrument to record. It contains extremely strong harmonics which cheerfully overload monitors or preamps without much difficulty. The marvellous rich rasping sound of which a fortissimo horn is capable disappears completely on miking its bell—compare the direct sound with that happening in the Festival Hall when the section is sitting close to the polished wood surround. The best compromise is to stand a mic about 50 cm away in line with the bell; further, if situation and separation permit. However, a big improvement happens if, following the concert hall situation, polished wood reflectors are placed behind horn and figure-of-eight microphone; this seems to emphasise the harmonics responsible for its particular edginess.

The cor anglais, or angled horn, can be similarly treated, with mike 40 cm or so in front of the bell (i.e. almost on the floor). Since we hear the sound mostly directly, as opposed to off walls, a reflector isn't so useful but it will give an extra richness to the sound.

Saxophones

Saxophones can be handled in similar fashion to the brass. However, since their music tends to be less declamatory, a wind-catching position closer to the bell seems more appropriate. This is better for emphasising the relative coarseness associated with them because of their characteristically small-scale settings. It's a completely subjective assessment of its capability; a tenor sax exposed in a concert hall and receiving the benefit of a generous acoustic has a totally different, almost lugubrious, quality. We're more used to it coming at us through speakers or pas, or being miked in this particular way; conditioning thus indicates the

'natural' sound.

The precocious soprano sax can have its out-of-tune squeals miked from the bell or from the body. Choice depends on how smooth or how penetrating a sound is required.

Brass

With trumpet, flugel horn, trombone or tuba, a cardioid 30 to 50 cm directly in line with the bell is sufficient. A reflector can be used with all except tuba, as with the French horn, and this can be conveniently slung from the screen which is likely to be in front anyway. The closer to the bell, the less broad and dramatic the sound; the microphone can even end up inside the bell to give the spittlesounds favoured by Miles Davis on the 'Prestige' recordings, and by his imitators ever since. If echo is going to be added on reduction for distancing or dramatic effect, such crackling might easily sound incongruous. In general cases, best results are probably with the mic set back, unless there is a particular need for such intimate low-key tone; even though such subtle thoughts may not have been the original intention of this extrovert instrument, left dry it gives the familiar 'present' effect.

■ A & H MINI FIELD TRIAL

lines from all the mixers are paralleled into a single plug on the input of the reverberation unit and the unit's output fed to the echo return on the first mixer.

If echo facilities are not required, then the unused echo return sockets can be used as line inputs with treble and bass equalisation.

The mixer sent for field trial was extremely well made and the components seemed to be of high quality. The unit is very robust and should stand up to the sort of handling it might get on location without difficulty.

The most impressive thing about this mixer is its low noise. Even quite large and expensive mixers have been found in the past to generate higher than acceptable noise levels and no portable mixer I have tried before has been at all satisfactory.

Programme material was recorded simultaneously in straight mono (a single microphone going straight to tape), and at the same time in stereo using the six channels on the *Mini* mixed down to the two stereo outputs. The upper and lower tracks from the mixed recording were then fed into two channels of the mixer and reduced to a single mono output which was recorded on the lower track beside the original mono recording. The two tracks were arranged to be roughly in synchronisation. Comparisons were then made of the two recordings using high quality monitor equipment at high though not ear-shattering levels.

The differences in the signals were almost entirely due to the different microphone placings and the additional noise was not significantly greater than one would expect from a master copy. This test is one that few mixers in my experience can pass and the result says a lot for the design and manufacture of the *Mini*.

The mixer has been used extensively on location, no problems of any sort being experienced, and can be recommended without reservation.

The great condenser mike myth.



For a long while, condenser mikes have been at the top end of the microphone market.

They still are—in performance.

But since Unisound introduced their range of Electret condenser mikes exclusively for us the price has plummeted to an incredible £13.00, including VAT.*

And Unisound have another big plus.

Gone is the bulky power pack that made this type of mike function.

Replacing it is a tiny UM-3 battery which has all the power required to turn in the necessary sensitivity and response.

In fact, a breakthrough.

Find out more about Unisound's condenser mike.

All in all, it's quite a surprise package.

The Electret range from Unisound.

Condor 

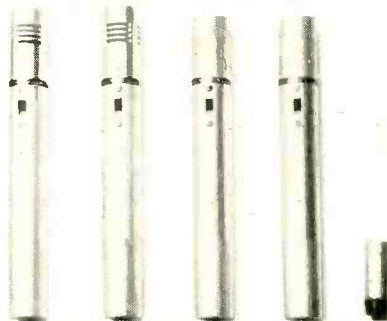

**Recommended retail price*

Condor Electronics Limited, 100 Coombe Lane, London SW20 0AY. Telephone: 01-946 0033 (4 lines).
Distributors of cartridges, styli, condenser microphones and headsets. Guaranteed 24 hour delivery.

CAPACITOR AND ELECTRET MICROPHONES

MODEL	TYPE	PICK-UP PATTERN	FRONT/BACK RATIO (dB)	IMPEDANCE (ohms)	SENSITIVITY (mV/N/m ²)	PRICE
C24	Stereo	Variable	20	50,200	0.4	£399
C414	Stand	Variable	—	—	—	£123
C451	Stand	Variable	20	200	.95	£50.50
C451/CK9	Gun	Uni	—	200	—	£89.50

AKG Equipment Ltd, Eardley House, 182/4 Campden Hill Road, Kensington, W8 7AS.

600	—	Omni	—	—	—	£29.70
652	—	Cardioid	—	—	—	£35
654	Vocal	Bass roll-off, Cardioid	—	—	—	£35
700	Details to be announced					
1001	Hand vocal	Omni, cardioid	—	—	—	£52.80
1050	—	Cardioid	20	30,200	0.3	£52.80
1051	Vocal	Bass roll-off, Cardioid	20	30,200	0.3	£52.80
CB1000	Detachable capsule base	—	—	—	—	£31.50
CC1000	Capsule	Omni	—	—	—	£32.20
CC1050	Capsule	Cardioid	—	—	—	£32.20
CC1051	Capsule	Bass roll-off, cardioid	—	—	—	£32.20

Calrec (Calder Recordings Ltd, Regent Street, Hebden Bridge, Yorkshire).

EM82	Hand	Omni	—	600	—	£13
EM82H	Hand	Omni	—	50k	—	£13
EM83	Hand	Uni	—	1k	—	£15
EM83H	Hand	Uni	—	50k	—	£15
EM84	Tie	—	—	600	—	£13

Condor Electronics Ltd, 100 Coombe Lane, London SW20 0AY.

M10	Hand	Omni	—	600	—	£28
M20	Hand	Uni	—	600	—	£28
M5	Neck	—	—	600	—	£14
M25	Boom	—	—	600	—	£28

Eagle International, Heather Park Drive, Wembley, HA1 1SU.

QM69	Stand	Quad cardioid	—	180	—	£372.45
KM88	H/S	Various	20 (max)	50 or 200	0.7	£126.10
KM83	Studio	Omni	—	50,200	5	£79.30
KM84/85	Studio	Cardioid	25	50,200	5	£85.70
KM86	Studio	Omni, cardioid figure-of-eight	—	50,200	0.7	£126.75
U87	Studio	Omni, cardioid figure-of-eight	—	50,200	8	£127.55
U47	Studio	—	—	50,200	—	£112.75
KMA	Neck	Cardioid	—	50,200	0.5	£74.40
SM69 FET	Studio stereo	Omni, cardioid figure-of-eight	22	50,200	2	£281.45
KMS 85	Hand	Cardioid	—	—	—	£117.55

Neumann (FWO) Bauch Ltd, 49 Theobald Street, Boreham Wood, Hertfordshire, WD6 4RZ.

CMT 540u	Stand	Cardioid 1f filter	—	—	—	£98.74
-----------------	-------	--------------------	---	---	---	--------

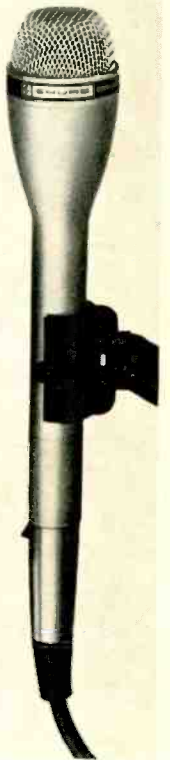
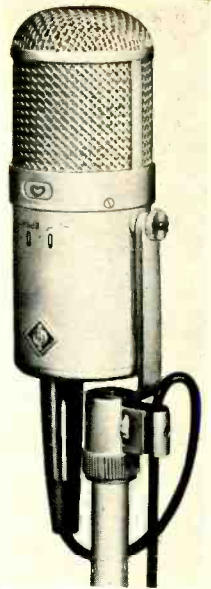

**Top: Neumann U47 fet i
Centre: Shure SM67
Bottom: Eagle Pro M5**



Studio microphones surveyed

All prices in the following tables are excluding VAT

Audio Limited radio microphones at the Royal Opera House Covent Garden

Where it is advantageous to use radio microphones, Covent Garden rely on Audio Ltd systems. These are available basically in two forms—one where a microphone is worn and fed to a tiny transmitter secreted about the person of the user and one where the transmitter is contained within the handle of a conventionally styled hand-held microphone. Audio Ltd radio microphones are also extensively used in theatres, TV, film studios and wherever it is required to use microphones free from the encumbrance of connecting cables and without loss of quality.

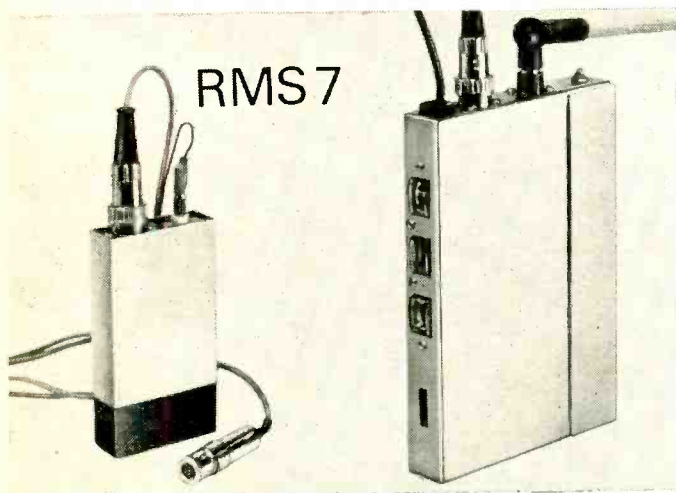

Developed out of our original Audio Ltd Radio Microphone System, we now offer for prompt delivery an improved RMS 7 system in which the newest electret capacitor microphone is used. By slightly enlarging the receiver, we have incorporated a block aerial filter to greatly reduce cross modulation interference and facilitate multi-channel operation. The receiver has battery, signal level and tuning meters, also plug-in whip aerial and output plug and lead. The transmitter is easily concealed in the pocket or about the user, and the microphone supplied is smaller than the plug used to connect it. We shall be pleased to forward full technical information on request.

Complete systems as above from £184. Others available from £115.
Literature and other information on request.

UHF OR HIGH POWER VERSIONS FOR OVERSEAS USE

Audio Ltd Radio Microphone Systems as supplied to users in the U.K. conform precisely to Post Office regulations. More powerful systems and UHF systems can be supplied for overseas in compliance with locally stipulated operating conditions. Transmitters operating up to 500 MHz and with outputs up to 500 mW at 175 MHz can be supplied.

AUDIO LIMITED
26 WENDELL ROAD
LONDON W12 9RT

Telephone 01-743 1518



CALREC

**YOU REALLY MUST SEE
OUR THREE NEW RANGES
OF CONDENSER MIKES
AT APRS '73. JUST
COMPARE YOUR EXISTING
MODELS WITH THIS LIST**

1. Professional Specification and Performance	1	—
2. Internally Powered by one 1.5v Cell (HP7 etc.)	1	—
3. Battery Life in Excess of 1000 hours*	1	—
4. Interchangeable capsules	1	—
5. Less than 8" (192 mm.) long and 7/8" (22 mm.) diam.	1	—
6. Extension Tubes available	1	—
7. Switches on when plugged in	1	—
8. Balanced output—DIN or CANNON	1	—
9. Compatible with existing capsules	1	—
10. Made in England	1	0
TOTAL	10	

*With Mercury Cell

**IF YOU SCORED 10 OUT OF 10 YOU ARE
VERY LUCKY. YOU HAVE A NEW
CALREC CONDENSER MICROPHONE
BEFORE ANYONE ELSE!**

STANDS 48-49 APRS '73



CALREC AUDIO LIMITED

HANGING ROYD LANE · HEBDEN BRIDGE
YORKSHIRE · HX7 7DD · PHONE 0422 84 2159

MODEL	TYPE	PICK-UP PATTERN	FRONT/BACK RATIO (dB)	IMPEDANCE (ohms)	SENSITIVITY (mV/N/m ²)	PRICE	
CMT 541u	Stand	Hyper cardioid	—	—	—	on application	
CMT 55u	Stand	Switchable, omni-cardioid	—	—	—		
CMT 56u	Stand	Switchable, omni-cardioid figure-of-eight	—	—	—		
CMTS 501u	Stand	Stereo version of above	—	—	—		
CMT 32u	Stand	CMT 56u Omni	—	—	—		
CMT 34u	Stand	Cardioid	—	—	—		
CMT 340u	Stand	Cardioid, If filter	—	—	—		
CMT 341u	Stand	Hyper cardioid	—	—	—		
CMT 35u	Stand	Switchable, omni-cardioid	—	—	—		
CMT 36u	Stand	Switchable, omni-cardioid figure-of-eight	—	—	—		
CMTS 301u	Stand	Stereo version of above	—	—	—		
CMT 42	Stand	CMT 36u Omni	—	—	—		£112
CMT 44	Stand	Cardioid	—	—	—		£112
CMT 440	Stand	Cardioid, If filter	—	—	—		£114
CMT 441	Stand	Hyper cardioid	—	—	—		£115
CMT 45	Stand	Switchable, omni-cardioid	—	—	—	£128	
CMT 46	Stand	Switchable, omni-cardioid, figure-of-eight	—	—	—	£150	
CMT 52u	Stand	Omni	—	—	—		
CMT 54u	Stand	Cardioid	—	—	—		

Schoeps (Feldon Audio Ltd, 126 Great Portland Street, London W1N 5PH).

DC20	Neck	Omni	—	200	—	£43.50
DC21	Neck	Cardioid	10	200	—	£43.50
DC63	Stand	Variable	30	200	—	£147
DC73	Hand	Cardioid	15	200	—	£57
DC96	Stand	Cardioid	18	200	—	£86.50
TC4V	Stand	Variable	20	50/200	—	£100
FP92C	Hand	Cardioid	10	200	—	£63
FP92K	Hand	Omni	—	200	—	£63
ST8	Stand	Variable	18	200	—	£176

Pearl (Allotrope Ltd, 90 Wardour Street, London W1V 3LE).

MODEL	TYPE	PICK-UP PATTERN	FRONT/BACK RATIO (dB)	IMPEDANCE (ohms)	SENSITIVITY (mV/N/m ²)	PRICE
MKE201	Electret	Omni	—	—	—	£32.05
MKE401	Electret	Cardioid	—	—	—	£37.40
MKH105	Studio	Omni	—	200	2	£108
MKH124	Neck	Omni	—	150	—	£144
MKH125	Neck	Omni	—	10	—	£153
MKH405	Studio	Cardioid	—	20	—	£126
MKH415T	Studio	Cardioid	—	20	—	£130
MKH815T	Gun	Uni	—	20	—	£172
MK12	Neck	—	—	—	—	£75

Sennheiser (Hayden Laboratories Ltd, Hayden House, 17 Amersham Road, Bucks).

Range of electret capacitor microphones.

Sony (UK) Ltd, Pyrene House, Sunbury Cross, Sunbury on Thames, Middlesex.

M816	Hand	Cardioid	—	low	—	£165.55
M817	Capsule (for 816)	Omni	—	—	—	£55.88
M818	Gun	Uni	—	low	—	£101.97

Uher (Bosch Ltd, Rhodes Way, Radlett Road, Watford, Hertfordshire).

RIBBON MICROPHONES

M160	Stand	Uni	20 (120°)	200	0.1	£70
M260	Stand	Uni	20 (120°)	200	0.09	£28
M130	Hand	Fig 8	—	200	0.9	£81.40
M320	Stand	Uni	20	200	1.4	£33.45
M360	Stand	Uni	25	200	0.14	£91.45
M562N	Stand	Uni	20 (120°)	500	0.13	£37.75

Beyer Dynamic (GB) Ltd, 1 Clair Road, Haywards Heath, Sussex.

RM6/L	Studio	figure-of-eight	—	50	—	£52.25
RM/M	Studio	figure-of-eight	—	200	—	£52.25

Melodium (Keith Monks Audio Ltd, 26-28 Reading Road South, Fleet, Nr Aldershot, Hampshire).

76 ▶

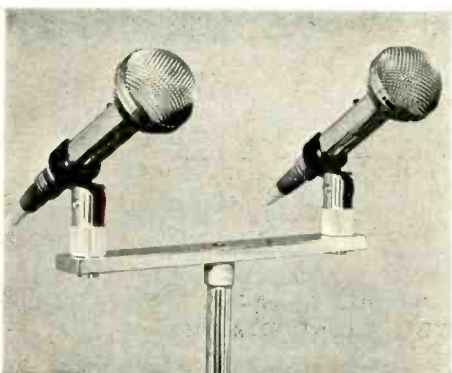

Above: Sennheiser MKH815 gun
Left: Two Melodium C133
Centre: Sennheiser MD214N
Right: AKG C414



MODEL	TYPE	PICK-UP PATTERN	FRONT/BACK RATIO (dB)	IMPEDANCE (ohms)	SENSITIVITY (mV/N/m ²)	PRICE
-------	------	-----------------	-----------------------	------------------	------------------------------------	-------

NCRB	Hand	Antinoise	—	30, 50	—	£28
MR1	Hand	Semi-cardioid	10	30 to hi	—	£28

Reslosound Ltd, Spring Gardens, London Road, Romford RM7 9LJ.

33	Stand	Cottage loaf	—	50 x 150	—	£84
-----------	-------	--------------	---	----------	---	-----

Shure (Shure Electronics Ltd, 84 Blackfriars Road, London SE1 8HA)

MOVING COIL MICROPHONES

DS111	Desk	Cardioid	17	200	0.14	£23
D12	Stand	Cardioid	18	200	0.22	£39
D14S	Stand	Cardioid	19	200, 40k	0.22, 2.8	£14
D58	Goose	Noise cancelling	—	200	0.08	£15
D160	Stand	Omni	—	240	0.13	£28
D190	Stand	Cardioid	18	280	0.23	£22.70
D200	H/S	Cardioid	18	250	0.14	£33
D202	H/S	Cardioid	20	300	0.16	£42
D224	H/S	Cardioid	20	250	0.13	£60
D707	H/S	Cardioid	15	200	0.16	£17.50
D900	H/S	Gun	28	200	0.3	£50.50
D110	Neck	Omni	—	—	—	£31
D590	Goose	Cardioid	—	—	—	£21.80
D510	Goose	Omni	—	—	—	£16
D1200	Hand	Cardioid	—	—	—	£37
D109	Neck	Omni	—	—	—	£15

AKG Equipment Ltd, 182/4 Campden Hill Road, Kensington, London W8.

M88N	Stand	Uni	22 (120°)	200	0.25	£63.95
M67N	Stand	Cardioid	18	500 or 200	0.25	£32.65
M69	Stand	Cardioid	16	200	0.24	£26.35
M101N	Stand	Omni	—	200	0.13	£31.65
X1	Stand	Cardioid	20	200	0.2	£22.80
M411N	Stand	Cardioid	20	200	0.14	£22.60
M410	Stand	Cardioid	20	200	0.25	£20.95
M111N	Neck	Omni	—	200	0.08	£41.15

Beyer Dynamic (GB) Ltd, 1 Clair Road, Haywards Heath, Sussex.

DP4	Hand	Omni	—	25 to 50k	—	£10.77
DP6	Neck	Omni	—	25 to 50k	—	£10.77
DP8	Hand	Omni	—	25 to 50k	—	£12.76
GC2	Hand	Cardioid	—	25 to 50k	—	£19.43
GC3	Desk	Cardioid	—	25 to 50k	—	£18.54

Grampian Reproducers Ltd, Hanworth Trading Estate, Feltham, Middlesex.

77A	Hand	Omni	—	200	—	£39.05
88A/L	Hand	Omni	—	30/200	—	£36.14
79A/10	Neck	Omni	—	30/200	—	£12.21
79A/Hi	Neck	Omni	—	50k	—	£16.17
76A/L	—	Cardioid	—	30/200	—	£16.17
78A/L	—	Cardioid	—	30/200	—	£18.26
C121A	Close	Cardioid	—	30	—	£14.74
C133	—	Cardioid	—	30/200/50k	—	£20.08
C133F	—	Cardioid	—	30/200/50k	—	£21.89 (basic)

Melodium (Keith Monks (Audio) Ltd, 26-28 Reading Road South, Fleet, Nr. Aldershot, Hampshire).

D44	Hand	Cardioid	—	200/High	—	£8.25
LD19	Stand	Omni	—	200/High	—	£18.40
RD16	Neck	Cardioid	—	200/High	—	£16
HM47	Neck	Omni	—	200	—	£23.50
HM49	Stand	Omni	—	200	—	£44.60
F67	Stand	Cardioid	—	200	—	£19.60
F69	Stand	Cardioid	—	£00	—	£42

Pearl (Allotrope Ltd, Audio Equipment, 90 Wardour Street, London W1V 3LE).

76 STUDIO SOUND, JULY 1973

MODEL	TYPE	PICK-UP PATTERN	FRONT/BACK RATIO (dB)	IMPEDANCE (ohms)	SENSITIVITY (mV/N/m ²)	PRICE
-------	------	-----------------	-----------------------	------------------	------------------------------------	-------

S80	Hand	Cardioid	4	30 to hi	—	£34
UD1	Hand	Cardioid	14	30 to hi	—	£24
UD3	Head	Cardioid	14	30 to hi	—	£15
PD3	Hand	Omni	—	30 to hi	—	£12
MPD	Head	Omni	—	30, 50	—	£9
MPD/D	Goose	Omni	—	30, 50	—	£17
MMD2	Neck	Omni	—	30, 50	—	£13
SL2	Stand	Antinoise	14	30, 600	—	£29
GLO	Stand	Cardioid	14	30 to hi	—	£40

Range of microphones. Details on request.

Reslosound Ltd, Spring Gardens, London Road, Romford RM7 9LJ.

MD4-2	Hand	Noise cancelling	—	—	—	£33.10
MD21	Hand	Omni	—	200	—	£29.80
MD211	Hand	Omni	—	200	—	£53.80
MD214	Neck	Omni	—	200	—	£50.85
MD402	Hand	Cardioid	20	755	—	£11.80
MD408	Goose	Cardioid	15	200	—	£28
MD409	—	—	—	—	—	£36
MD413	Hand	Cardioid	17	200	—	£32.65
MD415	Hand	Cottage loaf	—	200	—	£38.25
MD411	Stand	Cardioid	20	800	—	£18.55
MD420	Hand	Anti-feedback	—	—	—	£22.90
MD420-9	Goose	Anti-feedback	—	—	—	£22.90
MD421	Studio	Cardioid	18	200	—	£45
MD441	Studio	Cottage loaf	20	200	—	£69

Sennheiser (Hayden Laboratories Ltd, Hayden House, 17 Chesham Road, Amersham, Bucks.).

5B	Boom	Cardioid	—	150	—	£144
5C	Boom	Cardioid	—	50	—	£144
53	Stick	Cardioid	—	250	—	£84
56	Stand	Cardioid	—	50 X 250	—	£54
57	Hand	Cardioid	—	50 X 250	—	£42
58	Stick	Cardioid	—	50 X 250	—	£54
51	Neck	Omni	—	250	—	£40.80
60	Stick	Omni	—	250	—	£27.60
76	Stick	Omni	—	150	—	£67.80
50	Stick	Omni	—	50 X 150	—	£45
61	Stick	Omni	—	150	—	£37.60

Shure Electronics Ltd, 84 Blackfriars Road, London SE1 8HA.

2203	—	Cardioid	—	200	—	£41.69
2255	—	Cardioid	—	200	—	£30.75
700	—	Cardioid	—	40k	—	£43.87
2302	—	Omni	—	200	—	£37.38

Turner (Millbank Electronics Ltd, Bellbrook Estate, Uckfield, Sussex).

M136	Stand	Omni	—	low	—	£7.43
M517	Hand	Cardioid	—	low	—	£19.80
M534	Stand	Cardioid	—	low	—	£17.93
M536	Miniature	Cardioid	—	low	—	£36.19
M537	Stand	Cardioid	—	low	—	£41.47
M538	Stand	Cardioid	—	low	—	£64.02
M539	Stand	Omni	—	low	—	£41.47
M634	Pair	Cardioid	—	low	—	£33.55
M640	Pair	Omni	—	low	—	£19.58
M815	Gun	Uni	—	low	—	£102.74

Uher (Bosch Ltd, Rhodes Way, Radlett Road, Watford, Hertfordshire).

BEYER DYNAMIC

MEET THE NEW FAMILY...



M.201.



M.111.



M.101.

this doesn't mean we've got rid of the old one.

The latest mikes to join the Beyer Dynamic range are the . . . **101.111.201**, products of high quality to satisfy those who demand 'living' sound from their mikes.

Send coupon for details :

To: Beyer Dynamic (GB) Ltd., 1 Clair Road,
 Haywards Heath, Sussex.
 Telephone Haywards Heath 51003.
 Please send me full particulars and illustrated brochure of the Beyer Dynamic range.
 Name.....
 Address.....

A SELECTION FROM OUR WIDE RANGE OF MICROPHONE STANDS, SEE THESE AND OTHERS ON STAND 68 AT THE 1973 A.P.R.S. EXHIBITION.

BS1/B Banqueting Stand. 4½lb base. Matt black finish. 20in max height. Stem may be fixed upright or angled.

BS2/B Banqueting Stand. 7lb base. Matt black finish. 29in max height. Stem may be fixed upright or angled.

MSPA/B Angle Floor Stand. Matt black finish. 80in max height.



BS1/B



BS2/B



MSPA/B

SB/I Stereo Bar. Matt black finish. 10in long. ⅜in locking screws provided.

SC/I Side Clamp. Matt black finish. Adjustable for different tube diameters. ⅜in locking screw provided.



SB/I

SC/I

For further details write or phone to:

KEITH MONKS (AUDIO) LTD

26-30 READING ROAD SOUTH · FLEET · HANTS

Telephone: Fleet (02514) 7316 and 3566

Right: Perfectone TTU16 film recorder.
Below: Bauer P6 16mm double band projector

THE FILM '73 international film and tape technology conference will be held at the Royal Lancaster Hotel in Lancaster Terrace, London W2, from June 25 to June 29. The British Kinematograph, Sound and Television Society, who are organising the exhibition, say that all the exhibition space had been booked by mid-April. The last convention was held in London two years ago.

The theme of the conference will be the technology of motion picture and sound reproduction from film and tape. Papers will discuss the latest advances and the current research into the integration of film and videotape, as well as sound and picture synchronisation and videocassette systems.

The organisers say that they expect visitors from all the European countries and America as well as from China and Russia. Mr Robert Pulman, the conference chairman, has said that for these visitors one of the main attractions would obviously be the exhibition, since those from Russia and China 'would not otherwise have the opportunity to see the latest technological developments in the industry all at one time'.

AKG will be showing their C451 microphones, the CK8 and CK9 gun tubes, the D224 and C114 microphones and a number of other new products.

AV Distributors will be showing some 16 mm cameras as well as items from the Stellavox range and some projectors.

Ballancroft Film & TV Equipment say they will use Film '73 to launch their new Northlight Vallantine 2 kW lighting unit. 'By swivelling the lighting bar,' say Ballancroft, 'the unit may be used as a hard light and there is provision for the fitting of gel and silk frames'. The light uses separately switched 800W or 1 kW tungsten halogen lamps and costs £30. At £22, Ballancroft produce a 1.25 kW Northlight, which will also be on show, as well as a 1 kW pup lamp and their range of Par-36 Mini-Brutes. On the stand, A11, will be May and Des Chalcraft, Frank Gathergood and Brian Stanford.

Berkey Technical will show a new range of spotlights ranging in power from 1 to 5 kW, as well as a new motorised monopole system range similar to those they have installed at LWT.

New lighting equipment, information about Advent cassette sound recorders, Sela Swedish sound mixers and speakers, and Spectra light meters will be some of the things visitors will see on the Cintron stand. The lighting equipment will be Cintron and Ballancroft. They will also show Ronford tripods.

Colour Film Services, who offer film processing facilities, will be giving information about their services and distributing leaflets.

Debbie Lawley intend to show a black and white and colour compact continuous film printer and the ME4 colour compact processor.

Eddic Films tell us they will be exhibiting their Magnaflex 16 double band projector. This is available in any of three playback track configurations for around £1,000.

Elf Audio Visual, part of Clewer Audio Visual, will have the latest version of the Elf Automatic cine projector. This equipment operates the whole of a cinema, from pre-show background music and light dimming, through reel changing to playing the national anthem for a two and a quarter hour show. The Elf Lite EX5000, with a 1 kW Xenon lamp, will be

Film '73 preview

JOHN DWYER

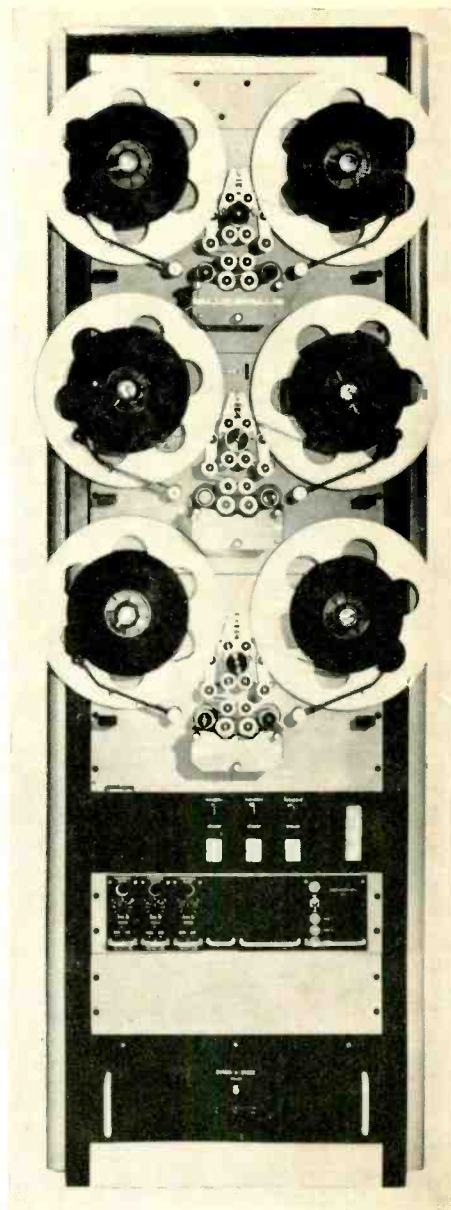
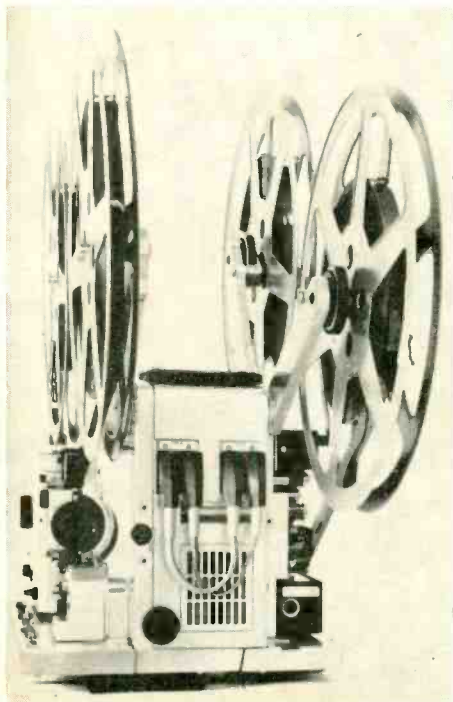

on show. This is claimed to be the world's first fully portable Xenon arc projector. The Elf Lite EX2000 will also be on show; this has a transistorised power pack built into it instead of the usual separate unit. The light output is about 2,000 lumens. Other items on display will be new projector screens and an American slide projector, the Slide King, with a 1 kW quartz iodine lamp.

EMI's stand will be the same as their stand at the APRS exhibition: namely, they will introduce a new tape, 817, which they say will complement their existing range. The tape is matt-backed and has a dynamic range of 76.5 dB. It can be used, say EMI, on sideless tape hubs or single-sided spools. They will show 817 with 815, 816 and 825.

Engineering System Developments say they are not exhibiting any hardware but are displaying their range of equipment and services on panels. They will announce at the exhibition that they are developing a new automatic additive colour lamphouse for film printing. 'This unit really does advance the technology

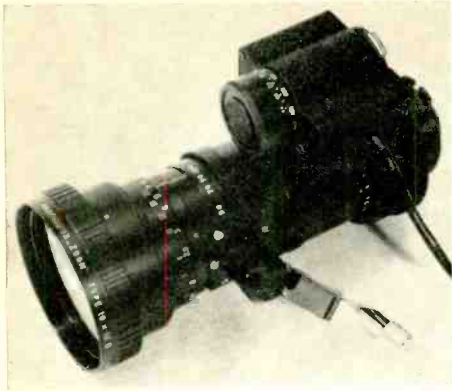

Above: Angenieux Type 10X12B 10 to 1 zoom lens with automatic iris control system.

Below: Photomec 16/35 mm continuous processor

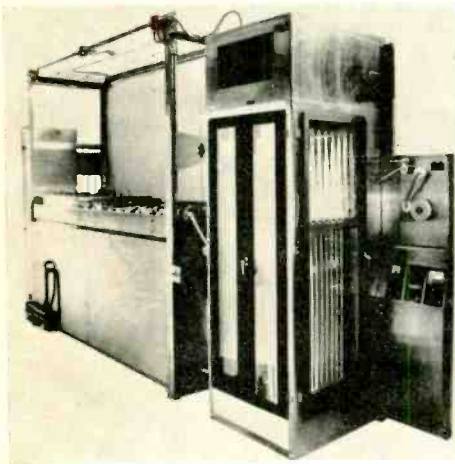

in this field by ten years at least,' say ESD. They add that, apart from making the announcement, they are not giving out any details, though they do say that it uses integrated circuits and has no moving parts. Other ESD products include an rf cuer, a cue patch counter, a frame counting cue system, a light value incrementer, a quartz halogen lamp power supply and a film break alarm.

Evershed Power Optics will exhibit new Angenieux cinematography lenses. One of these will be a 12 to 120 mm lens with a new automatic iris system which uses the camera electrical supply to power it. Visitors will be able to learn of a new high transmission lens coating which Evershed say gives light transmission of 95 per cent compared with 78 per cent for the standard 12 to 120 mm. They will also show a new version of the Bauer *P6* studio double band projector, three models from the Intercine Universal range of editing tables, and some of the Perfectone range of sound equipment. They also hope they will have a new automatic electronic looping system for dubbing and post sync use on display.

Film Facilities will have Stand C7 at Film 73, and on it they will illustrate the laboratory and treatment services they offer to the industry and to amateur users of film. The display will include a photographic guide to the company's laboratories in west London, including their facilities for striping 16, 9.5, super and standard 8 mm film, ultrasonic film cleaning, Vedette editors, which test the sound and optical condition and quality of the film, Permanew scratch removal equipment and Permafilm film toughening equipment. They will also show seven standard formats for magnetic striping of positive or negative film.

John Hadland (Photographic Instrumentation) Ltd stress the small size of *ME4* colour processor which they will show. This, they say, has an output of about 9m/minute.

General Screen Enterprises intend to distribute literature on their products and to show reels of film on cassette.

A new super 8 mm high speed camera which uses Kodak cartridges and operates between 10 and 250 frames per second will be shown by **Gordon Audio Visual**. The camera can have a pulse facility for time lapse and synchronised flash. They will also show a projector in the same format which allows single framing or projection rates between one and 24 frames per second. The projector is made by LW, as is a control unit for 16 mm to video transfer. This allows uniplex, multiplex and direct service projection and can be used as an animation printer to make 16 mm special effects through a film chain with videotape. Other products on show will include equipment by Fairchild, and literature will be available on the stand about Vacuumate and No-en film processing.

Harkness Screens make, as their name suggests, projection screens, tubular steel screen frames, portable screens, motorised screens, and so on. They also make stage structures and cinema curtains and curtain tracks. Harkness also make what they call the Harkness Power Ray Reflector screen. 'This material has such a powerful reflection on axis of projection that the smallest type of slide or film projector with a 250W light source can be used to provide a brilliant background over a very wide area, allowing the person or object to be in the composite picture to be adequately flooded with light to produce a perfect "on location" shot.' Harkness say their stand will be manned by staff who will be able to offer advice to visitors about the Harkness products.

Heyden and Sons say they want everyone at Film 73 to expose themselves—to Prevost editing tables, that is, and to HKS titling and editing systems. They will expose the Prevost *SPPE16* six plate 16 mm editing table. It has a film capacity of 360m; speeds of 24 or 25 f/s and triple speed; a sound head each for comopt, comag-sept and centre track; a 220 by 300 mm back projected picture and a choice of counters. Other Prevost models on show will include the two plate 16/35 mm table and the portable four plate *Minimovi*. They will also show the complete HKS titling unit.

Humphries Holdings subsidiaries include Humphries Film Labs, Photomec, three Mole Richardson companies, DeLane Lea, Opsec and Filmatic. All of these will be represented on the stand. The centrepiece will be one of Photomec's modular film processing machines.

SCHOEPS MICROPHONES

Their quality and reliability of Schoeps Microphones is the product of decades of experience in designing and manufacturing condenser microphones. Special technical advances and development through research guarantee the excellence of these transducers.

Schoeps have a complete range of condenser microphones which cover the requirements of all recording and broadcast studios. For example:

FET—Condenser Microphones with Phantom feeding (9V-12V-48V)

FET—Condenser Microphones with parallel feeding (9V-12V)

FET—Condenser Microphones with separate cable conductors for the modulation and D.C. voltages.

Tubular Condenser Microphones

Transducers with unidirectional pattern

Transducers with several switchable directional patterns

The alteration of the directional pattern is effected by their mechanical-acoustical elements of the transducer. By this means the phase shift effects of multi-diaphragm elements are avoided even at the highest frequencies which results in a more accurate electrical signal. Schoeps microphones have a very wide dynamic range and produces very low harmonic distortion even at extremely high sound pressure levels.

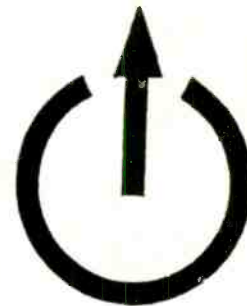

SEE US
AT APRS
STAND
43/44

126 Great Portland Street,
London W1N 5PH

Telephone 01-580 4314 Telex 28668

80 ▶

FILM '73 PREVIEW

Photomec make machinery to process motion picture, tv and stills film. Opsec rely mainly on their printed circuit boards for business, although they also make optical products and do specialist photography. They will show work intended for radio, tv and telecommunications customers.

Mole-Richardson will have an engineering team on the stand to give advice to visitors about different types of studio engineering and will distribute literature. Mole-Richardson's lighting subsidiary will also be represented, as will Humphries Film Processing, Filmatic and DeLane Lea.

The Independent Broadcasting Authority will have a stand which will show 'the continued expansion and development of Independent Television and the significance for television advertisers of Britain's entry into the European Economic Community. Information on current engineering developments of the IBA will be available, including the successful development of the first-ever digital field rate standards converter . . . and the Oracle data system for broadcasting the written word.'

The Photographic Products division of 3M make T150 and T120 motion picture film, 650 colour positive film, sound recording film, and magnetic stripe motion picture film in 16 and 35 mm formats. They will have a reception stand on which they will invite some visitors to their hospitality suite.

Kay Laboratories, who will be on stands B16 and B17, deal in film processing for 16

and 35 mm film in colour or black and white, as well as film sound recording and dubbing, titling and film strip production. They will be giving full details of their services on the stands, and a special section will show Kay's use of the Bell & Howell Seiki optical step printer, which Kay describe as 'possibly the most advanced 35 and 16 mm film processing equipment in use in the world'.

Film sprockets, gearing, machining and fitting of complete equipment are some of the products and facilities offered by Ernest F. Moy, who will be on stand E3. They will design, develop and manufacture prototypes, small batches or production quantities of their products. Recently the company modernised some sound recording equipment for use in the Kay West End Laboratories, and were involved in developing the intermittent units and sprockets for the new Marconi B3404 telecine equipment. They make spares for Worral heads and will overhaul and service these parts. On the stand they will show a second version of the Moy 400 mm geared camera head. Other products include film numbering machines and film slitters.

Neilson Hordell say they will be concentrating their main exhibits on animation equipment and special effects 'which can be created with the zoom underneath aerial image projector'. The latest computerised model 212 animation stand will be shown. This has a new 88 35/16 mm animation camera and (deep breath) a 'special effects electronic auto-focus zoom underneath aerial image projector'. A smaller animation stand, called the Junior, will be on show. It has an 86 16 mm animation

camera which has fixed pin registration type gate, built-in 180 frame per minute stop motion motor, manual fade and dissolve shutter, reflex viewfinder and daylight spool loading with provision for receiving a 120m magazine.

The latest company to make a background noise suppressor are Neve, who will be exhibiting in the foyer of the exhibition. The suppressor is 'silent in operation', say Neve, 'and can be used to suppress the background noise from a track which does not for the moment require modulation'. They will show a BCM 10 console like the one they are lending the organisers of Film 73 for use in the delegate sessions. Neve staff will answer any questions.

Neve also intend to show a notch filter which will give a notch a third of an octave wide and 50 dB in depth.

Stands D4 and D5 will be occupied by PAG Film Ltd. Their range of 16 mm modular recorders will be on show. There are three models in the range: the Mini-Rack, which can contain up to four magnetic channels and have a 16 mm or super 8 projector mounted on top of it; the Studio Rack, which is twice as tall as the Mini-Rack and can have four channels on each side of the rack; and a new model, the portable single channel recorder, which is driven by an electric pulse motor and can be

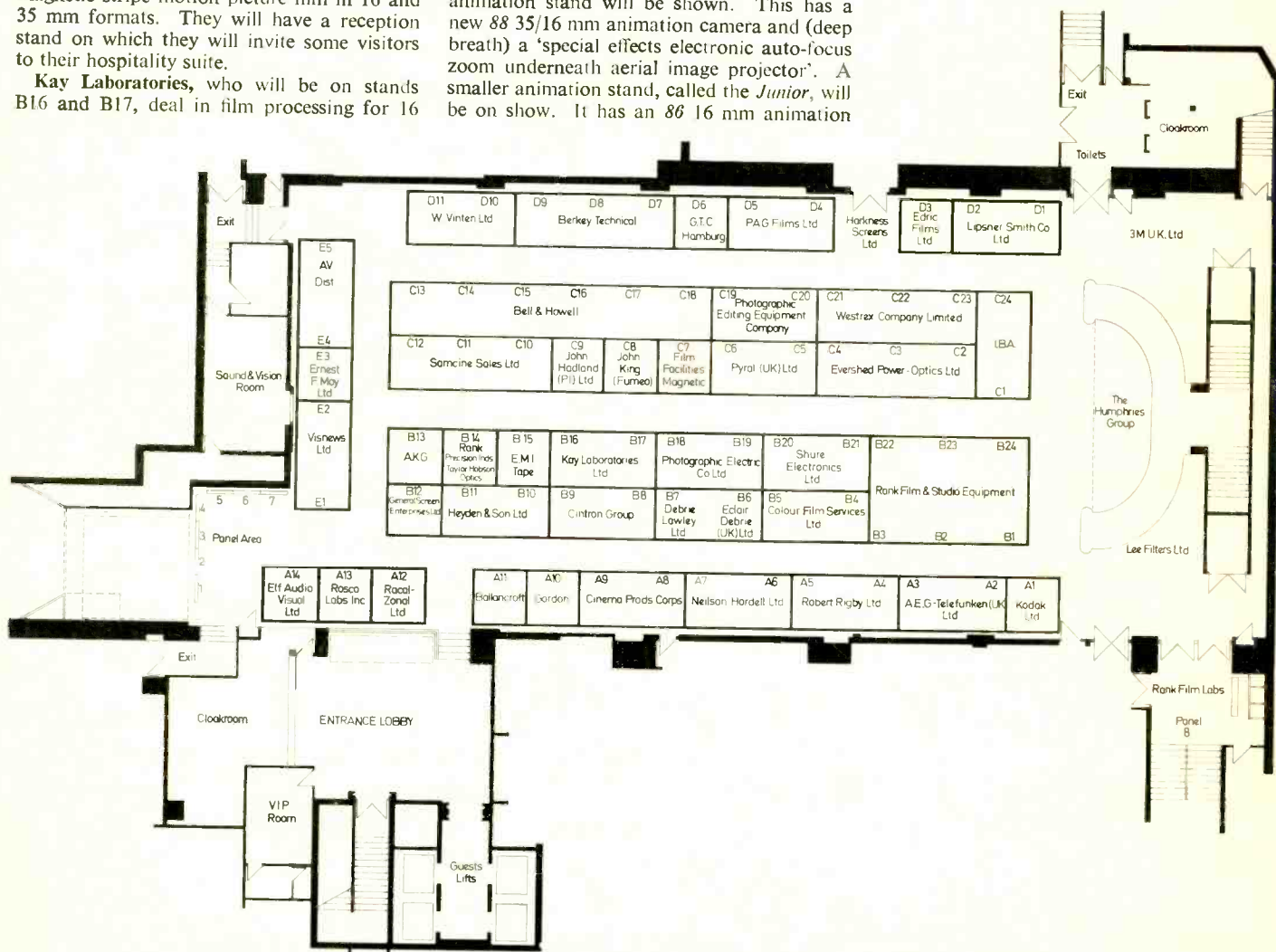

slaved off other racks and projectors fitted with a PAG encoder. Other items on the stand will include some of PAG's range of studio ancillary equipment: a footage counter, a PAG mixer desk and a studio monitor power amplifier, battery equipment, and a six plate, 16 mm version of a Dutch flatbed editing machine, the Cinemonta.

Photographic Electrical will have a double stand with Studio Film Laboratories. Visitors will be able to see Moviola film editing machines, and Magnasync 16 mm magnetic film sound recording equipment, as well as a new film identification and handling system which was first shown at Photokina last year.

John King (distributors) Ltd are agents for the Fumeo range of projectors, made in Italy. The range includes industrial projectors as well as smaller models up to 16 mm. King also supply a range of lenses from the Iscomorphot 16/2X anamorphic lens at £133 down to the

87 ▶

■ QUADRAPHONIC MIXER

inputs to line up with the bus bars, I could build two sets of ten channels with four quadraphonic mixer stages, four foldback mixer stages, and four echo mixer stages on one front panel. With 80 mm between each pcb everything was accessible and, by making two aluminium panels on the bottom of the unit, detachable servicing was easy. As you may have realised, if channels One to Ten 'blow out' (although each channel and each mixing stage has its own ht protection) at least 11 to 20 remain fully operational. The line output stages for foldback and quadraphonic are on separate pcbs so, if one of these for some reason broke down, the other could be used by repatching on the distribution panel jackfields. If both gave up, enough output could be obtained from the echo sends to run the system. If the echo channels fail it might be possible to get one microphone back down the line from its own line output. If the power supplies fail there are batteries and if the separate power supplies for the lights fail—it gets dark! So, as you can see, the backup systems in this unit provide quite a high factor of reliability.

Although I have been talking throughout about quadraphonic mixing, I quite frankly think that large speaker columns delivering over 1 kW of sound from the back of a hall is out as far as musicians are concerned. The effect of their own echo hitting them a fraction



of a second late at fantastic volume would be so disconcerting that it would make reasonable music impossible. Perhaps the speakers at far left and far right, instead of left back and right back, would produce such definition and clarity as to make the system unsurpassable in public address terms. For an act that could use this quadraphonic system to its full capability in a completely quadraphonic mode, the effects achieved could I think leave a landmark that would be talked about for years to come. As everyone will agree, the potential of a very large public address system has not so far been realised. Perhaps we shall see the beginnings of sound mixing as an art form in its own right.

■ AUTOMATED MIXING

after the last channel sample (63) and the last one before the next cycle of sampling. Whilst this pulse is outputted the invalid data block is inhibited.

Replaying (reading)

When square wave pulses are replayed on an audio recorder, the results are far from

square. However, all that is required is a pulse of some form. The 'audio' output from the control track is, therefore, fed first to a threshold detector (noise immunity) and a pulse shaper. The former being an operational amplifier and the latter a Schmitt Trigger. The resulting output is fed first to a pulse length (8 ms) detector (usually a couple of monostables) to detect the 'sample start' pulse.

To be concluded

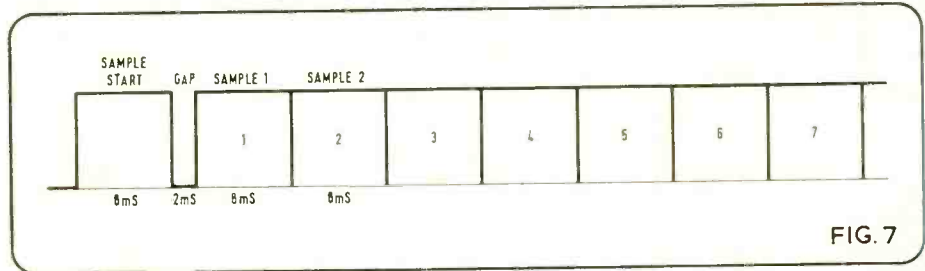
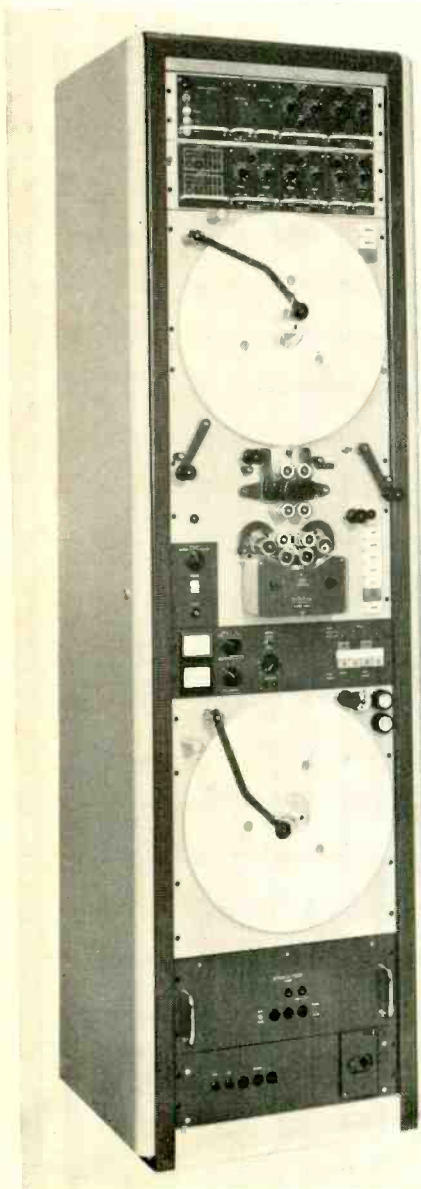

FIG. 7

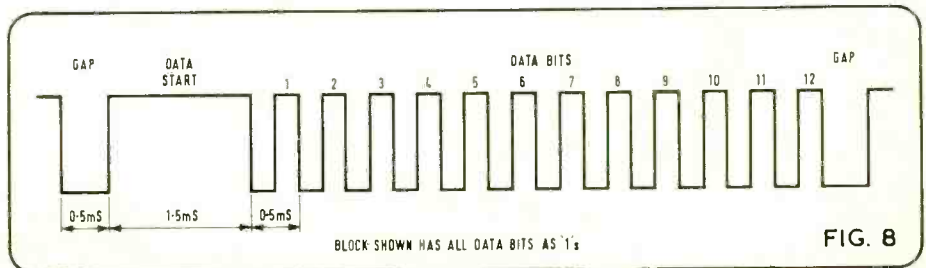

FIG. 8

PHILIPS PRO 72 EIGHT TRACK



MANUFACTURERS' SPECIFICATION

(38 cm/s)

Tape speeds: 38 and 19 cm/s.

Tape width: 25 mm.

Tape length: 732m maximum.

Spool capacity: CCIR 100 mm hub and NAB 27 cm.

38 cm/s playtime: 31 minutes.

Tape tension: 200 gm approx.

Fast winding: 2 minutes per 732m.

Starting time: 1.6s nominal.

Wow and flutter: 0.05% (EMT 420, peak weighted).

Input voltage: 700 mV minimum (balanced for 600 and 200 ohm lines).

Input impedance: 10k ohms (30 Hz to 15 kHz).

Output: 0 dBm nominal, +18 dBm maximum, balanced.

Overall distortion: 2%.

Overall noise (main and sync channel): -64 dB.

Overall frequency response: 30 Hz to 18 kHz +1

-3 dB (main); +3 -4 dB (sync).

Crosstalk: -47 dB (main/main); -40 dB (main/sync).

Power supply: 110, 220 and 240V $\pm 10\%$, 50 or 60 Hz, at 400 VA.

Price: £8,000.

MANUFACTURERS: Philips Nederland NV, Boschdijk, Gebouw, Eindhoven, Holland.

AGENTS: Pye TVT Ltd, Coldhams Lane, Cambridge.

THE PHILIPS PRO 72 is an industrial audio recorder incorporating a 25 mm tape transport capable of recording and replaying either four or eight tracks—depending upon the type of headblocks and electronics supplied. For review purposes, Philips submitted the eight track version equipped with normal record/playback functions and independent selsync on all channels. The selsync was available on independent output sockets. The machine therefore included eight record amplifiers, with equalisation and level setting for both 19 and 38 cm/s and a NAB/DIN switch to apply the necessary bass boost for NAB curves.

Output from a master oscillator supplies eight bias and erase amplifiers and provides independent bias controls for the two speeds as well as an erase current control.

There are 16 replay amplifiers provided, eight of which are for normal replay and the other eight for selsync playback. The latter are independently muted when a track is on record. Each replay amplifier offers independent equalisation and gain adjustment at both tape speeds. They are also provided with NAB/DIN switches to set the appropriate replay time constants.

The tape deck has a synchronous capstan motor and two separate spooling motors. Back tension is kept to a constant 200 gm from beginning to end of a reel and the head block is supplied with second generation Philips ferrite heads. The heads not only have a very long life but also give very low recorded tape distortion. An antiflutter roller is provided between the record and playback heads to minimise the effects of scrape flutter and certain types of modulation noise. There is also a very accurate elapsed time clock which has a reliable and easy to operate resetting control.

The deck plate includes both the normal transport functions, record and selsync controls, and there are coloured lights to indicate the operating mode of each track. Mechanical switches not only allow for cueing but can also bring the tape either immediately or gradually into contact with the heads when the record or replay mode is selected.

Access is provided for inspecting and/or cleaning the heads, and all external tape guides have roller bearings which cut friction to a minimum, cause less wear on the tape, and improve contact.

There are eight VU meters mounted end to end in a penthouse group above the deck. These are switched to read the record signal,

selsync output, or main playback output for each channel. A simple pushbutton increases by 10 dB the sensitivity of each meter and gain presets are provided.

The machine comes in a 740 x 610 x 1,130 mm console with the deck at a convenient height of 900 mm. There are separate power supplies for the deck and the record/replay and hf modules. All the electronics are of modular construction making again for ease of inspection and service.

The master oscillator and power supply sit behind a panel between two rows of modules and the tape deck. The input and output XLR sockets are mounted on the back of the machine and are wired to the conventional Continental XLR standard. This is of course contrary to the American and British convention in which the input sockets are female and the output sockets male. The machine is designed for use in a fixed installation but can be broken down and used for location work—provided one can sort out the maze of inter-connecting leads, plugs and sockets.

Each record amplifier module is fitted with a floating balanced line input transformer having an impedance of just under 20k ohms. Although this impedance falls slightly at high frequencies, it is substantially resistive over the audio range and always well above the minimum of 10k ohms as specified by the manufacturer. The distortion of the recording amplifier was found to be extremely low and was, under all conditions, considerably lower than any tape distortion that was measured. Bass boost correction for the NAB recording curve has to be switched from inside the module and, for reasons of access, it became apparent that to change the record equalisation standard on anything other than a long-term or experimental basis was impracticable.

Upon reflection, however, this very impracticability could well be an advantage in that it prevents busy engineers from absentmindedly setting the wrong recording standard or forgetting to change it back again to the norm.

Record equalisers and level adjustments for both speeds on each module had more than enough adjustments to cope with the varying sensitivities of all normal types of tape. The maximum input sensitivity was approximately 0 dBm giving 320 nWb/m on a tape at 1 kHz. With the record gain control set in the appropriate position, the full output of a Radford low distortion oscillator of +26 dBm failed to create any distortion at the input section. It was possible to get the record equalisation to give a very flat overall response at both speeds on Scotch 202 and EMI 815 tapes with all normal bias settings. No difficulties were encountered in the adjustment of any preset controls.

Each record module contains its own speed change relay, energised by the speed control switch on the tape deck. They change over



BX20

AKG studio reverberation unit

- Highly natural reverberation quality
- Decay time from 2 to 4.5 seconds
- Remote control over 500m. distance
- Dynamic adaption to the score
- Genuine sterophony
- No danger of feedback
- Full insulation against vibration and structure-borne sound
- Excellently suited for use in O.B. vehicles
- No locking or re-adjustment for transportation necessary
- Immediately ready for operation anywhere
- Readily available
- Free evaluation

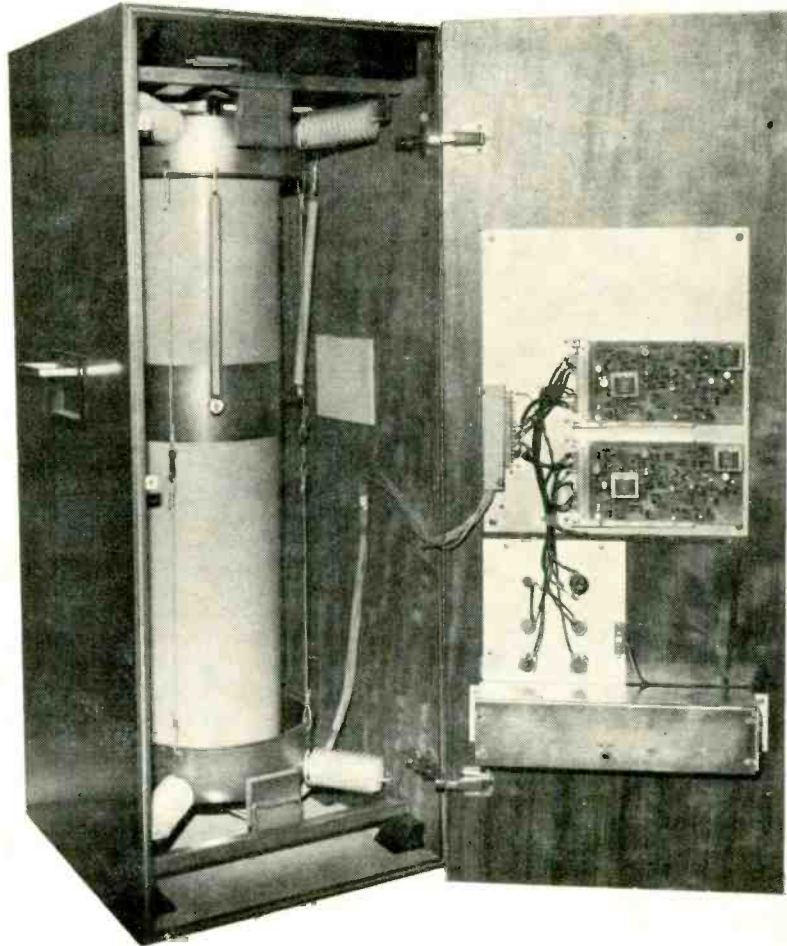

THIS IS AN ORIGINAL AKG DEVELOPMENT

MANY SATISFIED USERS (list on request)

PHOTO BY PERMISSION OF JOHN KONGOS SOUND STUDIO

For full details write to:
AKG EQUIPMENT LTD.,
Eardley House,
182/4 Campden Hill Road,
Kensington, London W8 7AS

Name _____
Address _____

SSBX

PRO 72 REVIEW

both the equalisation presets and the record gain presets.

The master oscillator, which runs at a measured frequency of 94.5 kHz, was found to be very stable and outputs from it feed the eight separate bias/erase modules for the different channels. Each of these modules contain separate bias controls for the two speeds selected by a relay. Erase peaking and current presets are provided, which were found to be simple to adjust over a very wide range of settings.

Ease of adjustment was the keynote of the replay amps too. They have the same facilities as the record amps but the NAB/DIN switches are brought out front, allowing for immediate selection of replay curve. The line output section of the replay module is floating balanced and capable of giving a level of +21.5 dBm into 600 ohms before clipping, and +22.5 dBm into open circuit. Although the output impedance was specified as 50 ohms it was found to measure 75 ohms, while the replay amplifiers had an average of 14 dB in hand.

The NAB/DIN switch was found to have insufficient bass cut in the NAB position as compared with the DIN flat position. The fall-offs were 0.75 dB at 100 Hz, 2 dB at 50 Hz and only 5 dB at 25 Hz. The figures for a 3,180 μ S bass roll-off should have been 1 dB at 100 Hz, 3 dB at 50 Hz, and 7 dB at 25 Hz. However the replay response at 38 cm/s was found to be well within the manufacturers' claims when checked with a BASF 25 mm test tape. With the exception of a fair degree of bass lift at 31 and 40 Hz, the worst results were at +3 dB at 31 Hz on track One, and at 40 Hz on tracks Two, Three, Six and Seven. This bass boost at long wavelengths could be partly due to fringing, caused by out of track modulation on the test tape, since it was a full track recording. It is more probable, however, that the boost was caused by the replay head tape wraparound. All the track measurements from 60 Hz to 18 kHz were within ± 1 dB of the response at 1 kHz. (The accompanying table shows the replay response from tracks Two, Five, Six and Eight.)

The response was also measured at 19 cm/s and found to be well within ± 1 dB on all tracks from 60 Hz to 9 kHz. These figures were computed from playing the 38 cm/s test tape at half speed. A degree of cut which varied from -1.25 to 3.25 dB was noticed at 31 Hz on all replay tracks. The NAB/DIN switch had the same effect in the bass end at 19 cm/s as it had

REPLAY FREQUENCY RESPONSE (dB)
(BASF 25 mm 38 cm/s test tape)

	TRACKS			
	2	5	6	8
31 Hz	1½	2	2½	1½
40	3	2½	3	2
63	½	½	½	½
125	0	½	½	½
250	½	½	½	½
500	½	½	½	½
1k	0	0	0	0
2k	½	½	½	½
4k	½	½	½	½
6.3k	½	½	½	½
8k	½	½	½	½
10k	½	½	½	½
12.5k	½	½	0	½
14k	½	½	0	½
16k	½	½	½	½
18k	½	½	0	½

at 38 cm/s but, at high frequencies, the relevant changes were held to very precise limits. Where appropriate there was a shelf boost or cut of 3 dB between the two positions, maintained up to 18 kHz. An interesting theoretical point here is that a playback level change of 0.5 dB at 1 kHz was noted at the lower speed when the NAB/DIN switch was operated. In practice this is of no real importance. In theory, however, it should be possible to avoid.

The reliability of the relays was called into question after four of them failed to operate; three upon initial delivery and another at a later date when the machine was used on location. It was necessary to take the modules to pieces in order to correct the first three faults and a thump in the right place soon cured the fourth! Afterwards no further trouble was encountered in this area.

Another problem at the time of delivery was replay hum, which did not come up to spec. It took prolonged experimentation with the Mu-metal shield to improve the figures so that all tracks were just within the specification. Considerable difficulty was also encountered when mixing down from eight tracks to stereo as the replay hum became obtrusive. At one stage this could only be corrected by propping up the hinged head cover by about 2 cm.

A telephone call to Philips brought two engineers from Eindhoven at this point and they managed to reduce the hum level dramatically by taking the shield out of the head cover. I did not try to do this myself as it meant breaking the Mu-metal off. I found it altogether curious that the screen was focussing hum on the replay gap rather than screening it and it is

surprising that the machine was allowed to leave the factory in that state.

Let us consider this hum problem in greater depth as it must obviously occur with many other multitrack machines. It is very important for the hum components of the replay noise to be held down to very low levels in a multitrack recorder since any hum induced will almost always be in phase on all channels. In mixing channels, the hum will add by 6 dB each time the number of tracks is doubled. For example, two tracks will have 6 dB more hum than one, and eight tracks will have 6 dB more hum than four, after addition. Random noise generated by the electrical circuitry will only add 3 dB under the same conditions.

Combining programme material when all eight tracks are recording sensibly different signals, the peak level achieved at any one moment may only be 2 dB extra per doubling. It can therefore be seen that, on reducing four tracks to one, the hum level relative to peak signal level will deteriorate by 8 dB, this figure being (2 x 6 dB) - (2 x 2 dB). The same effect will be noted for the other four tracks reduced to one or any combination of eight tracks panned into two.

The replay noise figures following removal of the Mu-metal screen became an average of 64 dB below the output obtained from the test tape reference level of 320 nWb/m. Even more exceptional, the 50 Hz component had been lowered by an average of 13 dB to a figure at worst 71 dB, at best 78 dB, below reference level. The best figures were obtained from the four centre tracks. The 100 Hz component of hum was almost immeasurable after the hum shield modification. Our original hum problem was especially bad in view of the fact that all eight tracks were Dolby A processed, giving 10 dB improvement. With the machine in its original state, normal mixing down from a non-Dolby master tape would have been quite out of the question. A multitrack machine with a replay noise figure worse than 62 dB below DIN reference level per track may well benefit from treatment of the kind outlined.

Incidentally, the average unweighted noise figure on the Pro 72 was -56 dB before modification. The average dBA weighted replay noise figure was 73 dB below reference level. At 19 cm/s the average unweighted replay figure referred to the same reference level was -59 dB or -68 dBA weighted. A filter was inserted in the B & K measuring equipment with a tight pass band from 20 Hz to 20 kHz. An improvement of 1.5 dB was noted in all the

86 ►

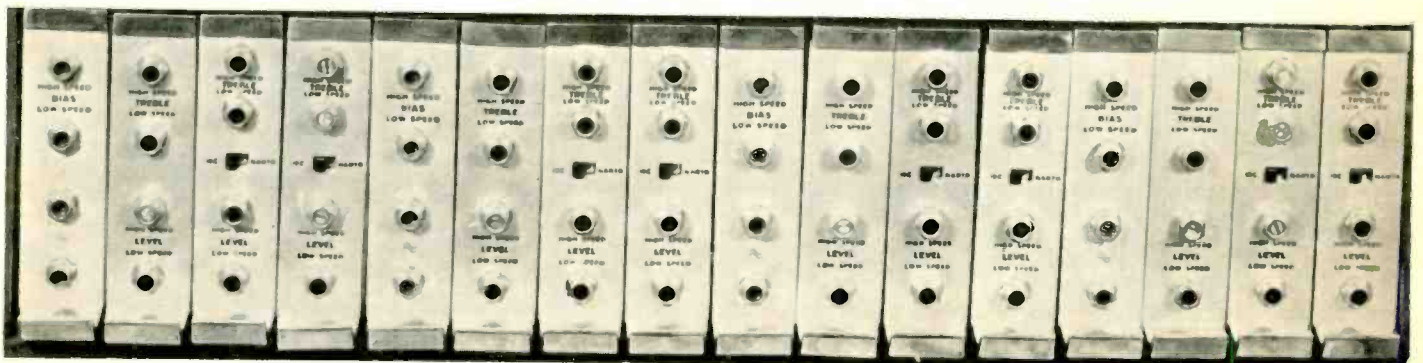

CTH TM 50 MK2 SERIES AUDIO MIXERS

Single or multi-output mixers with up to 100 input channels made to professional standards and incorporating the following features:

- | | |
|--|---|
| <input type="checkbox"/> 'XLR' input connectors | <input type="checkbox"/> +12 dBm floating output |
| <input type="checkbox"/> Prefade listening | <input type="checkbox"/> 0-30-60 dB input attenuators |
| <input type="checkbox"/> 180° self-evident dials | <input type="checkbox"/> 0-30 dB preset channel gain |
| <input type="checkbox"/> Back contacts | <input type="checkbox"/> 30Hz-20kHz +2 dB |
| <input type="checkbox"/> 'Channel on' lamps | |
| <input type="checkbox"/> Peak programme meter | |

OPTIONAL FEATURES INCLUDE:

- | | |
|---|---|
| <input type="checkbox"/> Tone controls | <input type="checkbox"/> Limiter/compressors |
| <input type="checkbox"/> Extra PPMs | <input type="checkbox"/> Battery operation |
| <input type="checkbox"/> VU meters | <input type="checkbox"/> Portable field units |
| <input type="checkbox"/> Disc and tape inputs | <input type="checkbox"/> Rack mounting units |

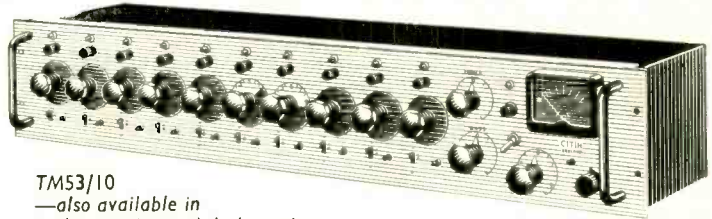

TM53/10
—also available in
rack mounting and desk versions

CTH also manufacture a range of modular mixing units, consoles, distribution amplifiers, studio disc player units, speaker amplifiers, cable drums and many other items of studio equipment.

CTH ELECTRONICS

Industrial Estate, Somersham Road, St. Ives, Huntingdonshire, PE17 4LS Telephone: St. Ives 64388 (0480 64388)

0.002% THD 100 watt per channel power amplifier

Demonstration at APRS 73 stand 70

0.002% THD at all levels up to 10 watts and all audio frequencies. Less than 0.02% THD at all frequencies and all levels up to 50 watts, typically 0.004% at 1kHz and 50 watts. Intermodulation distortion is less than 0.03%.

The amplifier is unconditionally stable and does not ring even into a 2µF capacitor.

The two channels are power limited at 120 watts rms and a tracking short-circuit cut-off protects each of the four power supplies. There is also a thermal cut-out.

Both channels will deliver continuously more than 100 watts into a 4 ohm load or 70 watts into an 8 ohm load.

The frequency response is within 1dB from 10Hz to 20kHz and the noise is more than 100dB below 70 watts into an 8 ohm load.

The case size is 430mm x 300mm x 76mm.



naim audio

15 CHURCHFIELDS RD · SALISBURY · WILTS · SP2 7NH · Tel: 3746

The price of the NAP200 Amplifier is £140 + VAT.

ALTEC

**MANUFACTURERS OF
THE WORLD FAMOUS
PROFESSIONAL
SOUND SYSTEMS
ANNOUNCE THE
OPENING OF THEIR
EUROPEAN OFFICE**

ALTEC INTERNATIONAL (UK) LTD

**17 PARK PLACE, STEVENAGE
HERTFORDSHIRE, ENGLAND**

Phone: 0438-3241

Telex: 825495

PRO 72 REVIEW

unweighted noise figures for 38 cm/s and 2.5 dB for the 19 cm/s unweighted figures.

The selsync replay amps were checked and, considering that the record head is used for replay in this condition, the replay responses were extremely good. They showed a minimal difference from the normal replay head at 38 cm/s with a top roll-off above 10 kHz at 19 cm/s. This is only to be expected from the wider gap and approximately 8 dB of replay gain was in hand.

After the replay hum induction problem had been corrected, the selsync replay noise was measured on tracks Two, Five, Six and Eight. The worst figure at 38 cm/s was 59 dB below reference level or -69 dBA weighted.

The overall record/replay response was checked on all the channels at both 19 and 38 cm/s and was most satisfactory. Typical curves at the two speeds for channel Five are shown in fig. 1.

Distortion measurements were made on channel Five in particular, although all other channels were checked. On EMI 815 tape, the distortion at 320 nWb/m was extraordinarily low, being only 0.55 per cent third harmonic of 1 kHz. The 3 per cent distortion point was reached at 6 dB above this level, exactly as per EMI specification. These figures speak volumes for the low distortion given by ferrite heads. The Philips heads also last longer than conventional iron heads and, generally speaking, all recordings made on the *Pro 72* were of as fine a quality as those heard on any other machine.

A good crosstalk figure is not normally necessary on a multitrack machine but it does become of importance if the machine is used for making mass tape duplication copy masters. Under such circumstances, recordings may be made on as few as two channels at once, recording in stereo pairs; copy masters for eight track cartridges for example.

When using the *Pro 72* to record on one track, almost all the crosstalk appeared to come from the replay head. Recording on track Six with other tracks on selsync, the crosstalk on to replay channels Five and Seven was -53 dB at 1 kHz, -46.5 dB at 20 Hz and 10 kHz, and only -40 dB at 15 kHz.

The crosstalk, with bias on all record tracks under the same circumstances, modulation on channel Six and monitoring channel Five, was -49 dB at 1 kHz, -43.5 dB at 10 kHz, -35.5 dB at 16 kHz, -44 dB at 100 Hz and -46 dB at 40 Hz. These figures are reasonably good in view of the fact that bias was on all tracks. Nevertheless, I think they could be better.

Selsync channels would normally be used simply for monitoring purposes when recording extra tracks but it is possible to use their

outputs to mix down and transfer to another track. Readings were therefore taken of the crosstalk from one recorded channel to the adjacent selsync output channel. One would expect the crosstalk to be very much poorer under such circumstances, and indeed this turned out to be the case.

Adjacent channel crosstalk was -36 dB at 1 kHz. Two channels away, the crosstalk was -56 dB. At 10 kHz the adjacent crosstalk was -15 dB and, two channels away, -37 dB. At 75 Hz the figures were -33 dB and -49 dB respectively. In practice, however, these rather poor crosstalk figures at high frequencies should not be too serious for most applications.

Integrated wow and flutter was measured at the beginning, middle and end of a NAB spool. The worst figure at the higher speed was 0.03 per cent at the beginning and end of the spool. In the middle, the reading was below 0.02 per cent. At the lower speed, the figures varied from a remarkably low 0.025 per cent to 0.05 per cent (all figures being DIN peak-to-peak weighted).

Speed accuracy was checked at various diameters of tape on the takeup and payout spools and was found to be correct to an accuracy of 0.05 ± 0.03 per cent (depending upon the position of the tape on the machine). At 19 cm/s, the machine ran 0.25 per cent ± 0.03 per cent slow. One can see from these figures that the speed accuracy is exceptionally good at the higher speed and quite reasonable at the lower. However, I was not happy with the spooling performance.

The specified spooling time for a complete NAB reel was two minutes. In fact it was approximately three minutes left to right and nearly four minutes right to left. Even when the mains was raised from 220 to 250V, the spooling time still averaged 2.5 minutes. Such a long spooling time could obviously be very annoying during a session. The problem could easily be overcome too. A special end-pressure switch could be fitted on the variable spooling control to allow full voltage on the appropriate motor for very fast spooling. This would not necessarily be recommended for spooling masters recorded on shiny backed tape but it would almost certainly be satisfactory for matt backed tape.

The elapsed time meter ran very smoothly and was accurate to within 1s over ten minutes of tape running at 38 cm/s. When the tape was rewound, the clock returned to zero at the beginning of the leader where the test had commenced.

While the *Pro 72* was in operation, the most irritating noise came from the tape riding against the top or bottom of some of the rotating guides. This in no way affected the performance, however, and the tape path was checked for accuracy with particular reference

to tape weave. This was done by recording a 15 kHz signal at 19 cm/s simultaneously on tracks One and Eight and examining the outputs of the relevant replay channels. The individual output varied by only 0.5 dB or so and the sum of the two channels never varied by more than 2.5 dB. In practice this figure should be regarded as excellent since it is the worst possible that can be measured when recording along the two edge tracks of the tape. The errors become almost negligible when closer tracks are compared.

The VU meters were particularly useful when setting up. I normally bias at 20 dB below DIN reference level but found it quite practical to use the 10 dB sensitivity button on the meters and thus bias and equalise at an output level corresponding to -6 dBm (14 dB below reference level).

The bias was normally set for an overdrip of 2.5 dB at 10 kHz. The manufacturers recommend the somewhat curious figure of 1.5 dB at 1 kHz. Surely this is too high? Only basic operating instructions were received from Philips because there was no operating manual available at the time for the *Pro 72*.

The machine performed satisfactorily at mains voltage, varying from 190 to 250V. Under standby conditions at 220V ac the machine drew 500 mA. On replay, the consumption was 1.3A. Rewinding in either direction, a current of 1.5A was drawn and, while recording on all tracks, the maximum consumption was 1.6A.

The machine was simple to use. When changing from record to replay, or vice versa, there were no audible switch clicks on any given track. Recorded tape noise was always very low and steady and, despite continual changes of function, it did not appear possible to magnetise the record head permanently.

A remote control is available for most desk functions. When the record or replay buttons are depressed, the tape starts almost instantaneously and achieves full wow and flutter specifications within 1s or so. This rapid starting is achieved by means of a constant running capstan and by applying a surge voltage to the winding motors that is restored to normal immediately the correct tape speed is reached. A light-sensitive switching device ensures that the tape transport is stopped when the end of the tape is reached.

One point I did find annoying was the fact that it was not possible to switch the selsync line out through to the main playback line output channels. It would be very simple to incorporate a switching device on the deck or on the modules which would allow the main line output channels to be connected, either to the selsync output or to the input. At present one has to replug at the back of the machine.

However, the *Pro 72* can be highly recommended as a fixed-installation machine that will continue to function well with only routine maintenance. If the price asked seems a little high, the cost of the ferrite heads should be considered in view of the substantial savings gained in terms of long life. The timing clock is quite accurate enough to be used as an automatic position finder and, one other personal comment, I would like to have seen some form of editing block fitted. The machine has no unnecessary frills or gimmicks and has an impressive, albeit functional, appearance.

Angus McKenzie

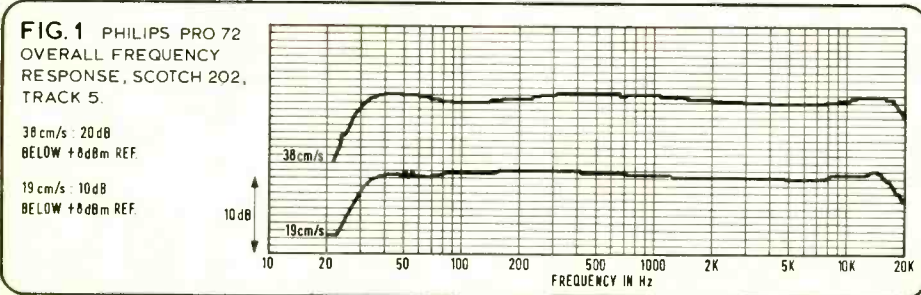

■ FILM '73 PREVIEW

Fumeo 50 mm lens at £20. Sizes vary from 30 mm to 75 mm lenses. They also supply lamps, spools and other sundry items of ancillary equipment.

Kodak do not actually have a stand at Film 73 but some visitors will be invited to the Kodak Hospitality suite where they will be told about Kodak's new negative film.

Lee Filters will exhibit their non-photographic filters and effect colours, as well as a new diffuser to replace the old spun glass. Swatch books and technical information will be available on the stand, to the right of the horseshoe staircase.

Lipsner Smith will demonstrate a new static cleaning machine, the Vedette viewing machine, and a laminar air work bench which filters contamination away from the work surface. This will be demonstrated, say Lipsner Smith, with a particle counter. A version which has an overhead laminar air filter will also be demonstrated, as will a silver recovery unit.

A new Pyral (UK) colour and monochrome helical scan video tape will be demonstrated on the Pyral stand, for the first time in the UK. The tape is available in 6.25, 12.5 and 25 mm widths in all the standard lengths and on a variety of spools. Also shown will be perforated magnetic tape in all the gauges between 8 and 35 mm with either polyester or tri-acetate base, as well as examples of a new 16 mm leader in yellow, blue and clear. Pyral will also show their range of magnetic recording tapes, as well as C60 and C90 cassettes and acetate discs.

Rank Audio Visual say their stand will feature some of Rank's range of motion picture cameras and projectors and that they will use 'a practical studio setting to demonstrate the range of television lighting systems available to the film and television industries'. The setting will incorporate a cyclorama to demonstrate Laniro television lighting systems and Arriflex motion picture cameras in 16 and 35 mm versions. Other sections of the stand will show a new Rank Strand lighting control system, new lighting effects projectors, and some of the Cinemeccanica projector range linked to Essoldomatic automation controls. Rank also intend to show a new Rank cine-wind device, which they say extends the film capacity of the

projector and allows longer programmes, and to demonstrate the Dolby cinema sound system which Rank market.

Rank Precision Industries will show a cinematography zoom lens, the Cooke Varotal high definition 35 mm motion picture lens, and other lenses and equipment in 35 and 16 mm formats. The Cooke Varotal has a three-member optical system and allows focussing from 700 mm in front of the film plane, or 330 mm from the front of the lens, up to infinity. Rank say that definition is 100 line pairs per mm on axis and 75 line pairs per mm in the corners. These figures apply throughout the zoom range. Rank say that a whole picture can be shot on this one lens.

Reeds Colour Film Laboratories will be distributing literature and advice and information about their film processing service. Visitors will learn of the recent installation of their new Eastman Equipment.

The list of gear on stands A3 and A4, those of Robert Rigby Ltd, runs to 62 items, so we can't list them all. Some of them include slide projectors, editing and splicing equipment, tape, spools, counters, rewinders, 35 mm synchronisers, mag pickups, mixer boxes, film cleaners, waxers, benches, videotape spools... and one waste paper basket. How they are going to get that lot on to two stands remains to be seen.

Visnews will show a new telerecording system which operates with 525 and 625 colour systems. They may also show some Eastman equipment.

W. Vinten intend to show a number of the American motion picture products for which they are agents. They will have Jamieson processors, Silver recovery units, Acme printers, a range of Canon lenses and a range of crystal controlled motors and oscillators.

Westrex say that their 5035 long runner unit will give 2.5 hours of uninterrupted projection in 35 or 70 mm programmes. They will show a new modular projector which the buyer can buy in whatever form suits him, and to which he can add or subtract modules later. Westrex will also show their sound reproduction equipment which is available to record magnetically or optically, and their orcon xenon projection lamps in a variety of power ranges.

Other companies who are exhibiting and who, because of postal difficulties, could not

be included in the main preview, are Kollmorgen Cinema Products Development of California; GTC Hamburg; Gudgeon Gear and Instrument Co; Rosco Laboratories of New York; Samcine Sales; and Telford Products Ltd.

Registration fees are as follows:

Weekly (for the five days): £11 for UK and overseas members, £16.50 for UK and overseas non-members.

Daily registration: £5.50 UK and overseas, members and non-members.

Those who wish to visit only the exhibition can do so for £1.50, which includes a copy of the June journal of the Society containing an exhibition guide and a precis of each of the papers delivered at the conference.

Perfectone Or-Multi 35/17.5/16 mm film recorder.

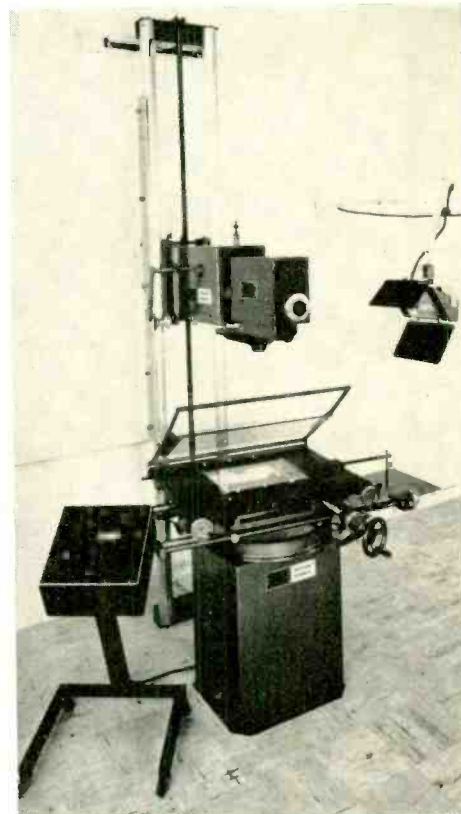

Dewtron (Regd. Trademark) modules have been going for many years now. There is a module for practically any sound effect you can think of. More especially, there is a whole range of synthesiser circuit modules identical to those used in the professional equipment, like the "Gipsy" synthesiser, distributed



by John Hornby Skewes & Co. Ltd., of Leeds, and also as used in the illustrated model "A.1". Note the revolutionary "Modumatrix" system which replaces outdated patching... no plugs or sockets; instant reset facility (pat. app. for). Write now for full Dewtron catalogue of accessories and voltage-controlled LOG-LAW modules, etc. Forget the rest... get the BEST. Dewtron craftsman precision with professional results.

Catalogue 15p

D.E.W. Ltd., 254 Ringwood Road, Ferndown, Dorset, BH22 9AR, England.

DIARY

Eleventh Hour records have finished a second album by Polyphony, a group from New Jersey. Their previous album, *Without Introduction*, was recorded at Alpha last summer. Eleventh Hour have just released their first single in some time, *Rock and Roll Man* by Powerplant, also recorded at Alpha.

Alpha have just negotiated a licensing agreement with De Wolfe Ltd in London. You'll remember I mentioned a couple of months ago that Indigo Studios had also signed a deal with De Wolfe. In Indigo's case any groups coming into Indigo who wanted songs published would 'have an ear', as Dave Kent-Watson put it, at De Wolfe. Alpha's deal is to make the contents of De Wolfe's catalogue, which Alpha describe as the best they've heard, available to clients of Alpha for a fee.

Candyapple Jingles

During the year since Candyapple opened in March 1972 they have taped about 90 commercial jingles and two film tracks. Recent clients include Borden Inc; Golden Skillet Chicken; Sunshine Biscuits; Luray Caverns; Mary Brown Chicken (Canada); Reynolds Metals and L'Image, a new low-fat milk product.

Film animator Steve R. Segal recently joined Quigg Lawrence. Steve's *A Walk in the Black Forest* and *Pandora's Box* films have won awards which include a silver medal at Cannes. The Alpha release on this intrigued me by saying 'The addition of Segal and animation

equipment will make quality cell animation, pixilation and special effects available at costs considerably below those currently prevailing in the industry'. Could someone please write and tell me what 'pixilation' means? You wouldn't believe what it says in the dictionary; my old man used to use the word to describe someone who was drunk.

Finally, the release of those disgracefully pricey Beatles albums prompts the thought that you cannot beat a record company for turning misfortune to advantage. The last time I looked there were four Billie Holiday albums in the American jazz charts and I suspect there will soon be more. There aren't any recording fees to pay since, as some of you know, the lady took exception to the treatment she received from many of the people who knew her, including white record company executives, and went off and died. These same record company executives managed to overcome their disappointment by issuing 15 volumes of the Billie Holiday story with seven tracks on each lp for 30 bob an album, which was expensive in those times.

Instant custard

Similarly, no sooner had Noel Coward's corpse cooled than RCA were bunging out a two album set of songs from the Mermaid Theatre's production of *Cowardly Custard*. Can I remember the last time a stage show like that warranted a double album issue? No, I don't think I can.

If it worries you that the record companies should be rolling in the clover growing on the

estate of the deceased ponder this: at least Eddie Cochran, Buddy Holly, Jim Reeves, Louis Armstrong . . . (amazing how many you can think of that the same thing has happened to) . . . were old enough to smoke when the call came, and the long black record-plastic fingers grabbed their lucre.

The chances are that the likes of Neil Reid (remember Neil Reid?), Jimmy Osmond, Ricky Wilde and the rest will have burnt themselves out long before they've had the chance to enjoy the debilitating pleasures that earning large amounts of potatoes can bring.

Not so the record producer. He is above the age of consent and can go into pubs. Likewise the record company executive. He is old enough to drive cars and see X films. Indeed, it is surprising how many people there are to push these kids onwards and ever up the spout. Think of the publicity machine it must have taken to get *The Times* to report that Donny Osmond had broken his voice (Dontcha wish it'd been his neck?).

We all know that the kids in question love it all. A hundred years ago, too, there were lots of little laddies running around London crying because they could no longer go up rich people's chimneys for a fee.

It had to be explained to them that there were better things for little kids to be doing than exploring chimneys. But they still didn't understand, for they had not yet lived long enough to know of anything better to do.

Now, in the twentieth century, we are enlightened. We know what a wicked thing it was to send kids up chimneys. Such a thing could never happen now.

INDEX TO ADVERTISERS

Acoustico Enterprises Ltd.	22	D.E.W. Ltd.	87	Musrang Communications	10
Action Video Ltd.	27	Dolby Laboratories Inc.	5	Naim Audio	85
A.K.G. Equipment Ltd.	83	Eagle International	44,45	Neve, Rupert, & Co. Ltd.	92
Allen & Heath Ltd.	20	E.M.S. Ltd.	21	Philips Electrical Ltd.	31
Altec International (UK) Ltd.	85	Evershed Power-Optics Ltd.	59	PSP Electronics Ltd.	67
Amity Shroeder	51	Feldon Audio Ltd.	39,43,79	Pye TVT Ltd.	53
Ampex	61	Ferrograph Co. Ltd.	13	Quad/Eight Electronics	33,37
Apollo Electronics	12	Francis, J. J. (Wood Green) Ltd.	10,18	Raindirk	55
Audio Applications Ltd.	35	Fraser-Peacock Associates Ltd.	22	Reign Equipment Hire	37
Audio Design Recording	14	Future Film Developments Ltd.	16	R.E.W. Audio Visual Ltd.	8
Audio Ltd.	73	General Music Strings	65	Richardson, J., Electronics Ltd.	17
Audix, B.B., Ltd.	23	Grampian Reproducers Ltd.	6	Rola Celestion Ltd.	4
Auto-Mix, Inc.	91	Hampstead Hi Fi	25	Rumble, C. H., Ltd.	33
Avcom Systems Ltd.	12	Hayden Laboratories	75	Rycote	67
Baileys	16	Helios Electronics Ltd.	41	Scully/Metrotech	63
Bauch, F. W. O., Ltd.	57	H.H. Electronic	20	Sonifex	14
Beyer Dynamic (GB) Ltd.	77	Industrial Tape Applications	7,9	Sound Techniques Ltd.	55
Bias Electronics Ltd.	41	Jackson, Malcolm	41	Stancoil Ltd.	29
Brenell Engineering Co. Ltd.	19	Klark-Teknik Ltd.	12	Starman Tapes	90
Brody Marketing Co., Johnson	18	Leever-Rich Equipment Ltd.	49	Sugden, J. E., & Co. Ltd.	16
Cadac (London) Ltd.	2	Lennard Developments Ltd.	14	Tannoy	10
Calrec Audio Ltd.	73	Lockwood	67	T.B. Technical Ltd.	67
Chymes Audio Electronic	19	Macinnes Labs Ltd.	15	Trident Audio Developments Ltd.	11
Communication Access. & Equipment Ltd.	16	Magnagraph-Eurotel	33	Turner, Ernest, Electrical Instruments Ltd.	4
Condor Electronics Ltd.	71	Magnetic Tapes Ltd.	22	Vitavox	65
C.T.H. Electronics	85	Midas Amplification	6	Walkers, N.	18
Dallas Arbiter Ltd.	47	Monks, Keith, Audio Ltd.	77	Zella Records (Birmingham) Ltd.	33

Classified Advertisements

Advertisements for this section must be pre-paid. The rate is 7p per word, minimum 70p. Box Nos. 20p extra. Semi-display rates on application. Copy and remittance for advertisements in **AUGUST 1973** issue must reach these offices by **16th JUNE 1973** addressed to: The Advertisement Manager, **Studio Sound**, Link House, Dingwall Avenue, Croydon CR9 2TA.

NOTE: Advertisement copy must be clearly printed in block capitals or typewritten.

Replies to Box Nos. should be addressed to the Advertisement Manager, Studio Sound, Link House, Dingwall Avenue, Croydon CR9 2TA, and the Box No. quoted on the outside of the envelope. The district after Box No. indicates its locality.

APPOINTMENTS VACANT

The NEVE GROUP OF COMPANIES specialise in the design, manufacture and sale of sound control equipment for the recording, broadcasting, television and film industries. The product has an international reputation and is an acknowledged leader for quality, reliability and flexibility.

In order to meet the needs of our full and steadily growing order book we need additional personnel in the following categories:

SALES ENGINEERS
SERVICE/INSTALLATION ENGINEERS
PROJECT ENGINEERS
TEST ENGINEERS

Applicants for the above vacancies should be suitably qualified in electronics and preference will be given to those who have had experience in the audio industry, or who are knowledgeable and keenly interested in the audio field.

Working conditions are excellent and the modern factory has a pleasant rural setting in the village of Melbourn, on the A10 between Cambridge and Royston.

Apply to: **Mrs. J. P. Wythe**, Personnel Manager, The Neve Group of Companies, Melbourn, ROYSTON, Herts. Tel. Royston 60776.

★International discotheque requires responsible young electronics engineer for installation work. Formal qualifications not necessary, but must enjoy hard work and lots of foreign travel. Tel. David Payne on 01-937 1555 for interview.

TECHNICIAN TRAINEE

Intelligent young man 16-18 years old offered opportunity to train ultimately as a public address and sound recording engineer. Must be of smart appearance and live with parents in Central London area.

Write for interview to:

MANAGING DIRECTOR
Griffiths Hansen (Recordings) Ltd., 12 Balderton Street, London W1Y 1TF

ELECTROSONIC

Our Presentation Studios which are concerned with the preparation of Audio Visual Productions on a large and complex scale require an

ASSISTANT ENGINEER

Applicants should be familiar with professional studio equipment and recording techniques.

Salary is negotiable and takes into consideration flexible working hours demanded.

Please write to: **Nigel Boswall**, **ELECTROSONIC LTD.**, 815 Woolwich Road, London SE7 8LT.

PROJECT & COMMISSIONING ENGINEER

SHOULD HAVE GOOD THEORETICAL TRAINING IN ELECTRONICS PLUS ACTUAL EXPERIENCE OF PROFESSIONAL AUDIO EQUIPMENT IN BROADCASTING, RECORDING, OR WITH A SPECIALIST MANUFACTURER.

Apply in writing to

MR. R. SWETTENHAM
HELIOS ELECTRONICS LTD.
161 HIGH STREET, TEDDINGTON
MIDDX. TW11 8HT

Audio Engineers required to help assemble and test mixing consoles, P.A. systems and other associated audio equipment.

CHADACRE ELECTRONICS LTD., Audio Division, 63 Stratford Broadway, London E.15. Tel: 01-534 1207.

SOUND ENGINEER

Experienced man with high standards required in the public address and sound recording field, capable of organising and operating temporary P.A. systems covering conferences etc.—knowledge of electronics, tape editing and recording desirable. Smart appearance essential—reliable driver—salary negotiable.

Full written details to: **Managing Director**, **Griffiths Hansen (Recordings) Ltd.**, 12 Balderton Street, London W1Y 1TF

HAMPSTEAD HIGH FIDELITY have vacancies for the following experienced staff:
AUDIO SERVICE ENGINEER for bench and field work.
AUDIO INSTALLATION ENGINEER for field and workshop.

Both these posts are vacant to experienced and versatile people who can work on their own initiative to the high standards of the company. Applications preferred in writing to the Managing Director, **HAMPSTEAD HIGH FIDELITY**, 91 Heath Street, Hampstead, London NW3 6SS

STUDIO FACILITIES

★County Recording Service. Stereo and Mono masters, 12" vinyl pressings.

YOUR TAPES TO DISC

Records made to order—7" from £1.50 12" from £4.00. 4-day postal service. Vinyl pressings, sleeves, labels. Tax-free for schools, etc. We cut records for many Recording Studios, etc. and use the same equipment for you: **NEUMANN** Disc Cutting Lathes—Mono and Stereo systems. Professional tape machines with Ferrite playback heads, Dolby A and B systems, 200W Amplifiers, Lockwood monitors, Teletronix/Ortofon Limiters. Send SAE for photo leaflet.

DEROY STUDIOS (1948)
Hawk Street, CARNFORTH, Lancs. Tel. 2273

Roger Squire

DJ Studios

The best facilities in town for making Audition Tapes, Jingles, Programmes and Sound Commercials. For further information telephone

01-722 8111

★County Recording Service. 7" vinyl discs pressed on our own plant.

★Fanfare Records. Tape - disc pressings, demo's, masters, any quantity. Studio/mobile. Neumann disc cutter. S.A.E. brochure. 1 Broomfield Close, Rydes Hill, Guildford. Telephone 0483 61684.

EDEN STUDIOS LTD

QUALITY recording tape to disc and pressing services, all at very sensible rates. Please write or phone for leaflet.

11 EDEN STREET, KINGSTON, SURREY
01-546 5577

Member Assoc. of Professional Recording Studios

★County Recording Service. Stereo and Mono discs from your tape.

mjb recording and transcription service

Vinyl pressings and acetate demodiscs. Limiting, compression and equalisation facilities; high undistorted cutting levels with feedback cutter heads. Booklet available.

ST. MICHAEL'S, SHINFIELD ROAD, SHINFIELD GREEN, READING, BERKS.
Reading (0734) 84487 Member A.P.R.S.

★J & B Recordings. Tape to disc—latest high level disc cutting, all speeds. Mastering pressings, studio, mobile. 14 Willows Avenue, Morden, Surrey. MITcham 9952.

HI-FI "RUMBLECURE"

(Patent 28949/69)

These Patents expose the inability of the trade, and its advisors, to solve the complicated phenomena of vibration. WE DEAL DIRECT ONLY.

Tel. 061-330 2836 (anytime)

Black Knight, Ashton-u-Lyne, Lancs. OL6 6TA

★County Recording Service. Top quality, reasonable price, quick delivery. Tel. Bracknell 4935. London Road, Binfield, Bracknell, Berks. RG12 5BS.

COMPACT CASSETTES PROFESSIONAL HIGH-SPEED DUPLICATION

Dolby B—compression and equalisation available—competitive prices on small runs—full productions undertaken—music and language specialists.

Contact Chris Sands

AUDIO EDUCATION COMPANY
01-723 6635

FOR SALE—TRADE

★Professional tape only 45p. 1200ft Agfa on hubs, no joins (p. and p. one box 25p, each additional box 10p). We handle 99% of all s/h professional recording equipment. Send for list. Jackson Studios, Rickmansworth, Herts.

PPM...VU

COMPARISON EXHIBIT

APRS 73—June 22-23

Come play with sine waves, square waves, pulsed tones, music and speech feeding both types of meter.

PEAK PROGRAM METERS TO BS 4297

The most sensible way of metering audio and avoiding distortion

Drive circuit for 1mA L.H. zero meters
C.W.O. further 5% less 2 off 4 off 10 off
Complete kit £8.00 £7.60 £7.20 £6.80
Built and aligned £12.00 £11.40 £10.80 £10.20
Ernest Turner PPM meters, scaled —22 to +4 OR 1 to 7. Type 642, 71 x 56mm £9.90; Type 643, 102 x 79mm £11.77.

SURREY ELECTRONICS

24 High Street, Merstham, Surrey

★Tame those dB's... Plug in professional quality FET compressor module £15.50. For the 'slick operator'... 'Voice over' module £15.50. S.A.E. details. Cathedral Sound SS, "Fourways", Morris Lane, Halsall, Lancs. L39 8SX.

RAC MIXERS

See us at APRS 73, Stand 32

Custom built mixers for groups, P.A. hospital broadcasting, recording, discos, etc.

RAC plug—audio modules for building your own mixers.

Shure, AKG, Calrec, Sony, mikes and stands in stock.

Sony, Tandberg, Nikko and Lux dealers.

'Rugby Automation Consultants'
19 Freemantle Road, Bilton, Rugby Warwickshire. Tel. 810877 Rugby

★Lancashire. Tandberg, Ferrograph, Tape Recorders, etc. Plus over 10,000 high fidelity systems. After-sales service. Holdings, Photo-Audio Centre, 39-41 Mincing Lane, Blackburn BBA 2AF. Tel. 59595/6.

SOWTER TRANSFORMERS

for all purposes in
SOUND RECORDING AND REPRODUCING EQUIPMENT
We are suppliers to many well-known companies, studios and broadcasting authorities and were established in 1941. Early deliveries. Competitive prices. Large or small quantities. Let us quote.

E. A. SOWTER LTD.

Transformer Manufacturers and Designers
7 Dedham Place, Fore Street, Ipswich IP4 1JP
Telephone 0473 52794

★20 inputs with full equalisation, 8 outputs, 4 echo send return, 2 foldback, 16 track monitoring, 4 monitor master, 9 p.p.m.'s, Jackfield, space for compressors, etc., 7.5K. Interested? Ring Hollick & Taylor 021-356 4246.

Neumann Condenser mics KM54A and KM56 in fitted case, Batt pack, charger, windshields, leads. Complete £132.00. Wolec TTR6 Radio mic. Complete £55. Schall Technik condenser mic and power pack £104.50. STC Condenser mic 28LYA-1A £33.00. Philips Condenser mic EL6051 £27.50. Sennheiser 804 gun mic complete, metal case, windshield, power pack, pistol grip lead, £187.00. Sennheiser 404 Condenser Mic £71.50. Sennheiser 805 Kit complete £231.00. STC 4115 mic £16.50. STC 4021 mic £11.00. AKG DI1000 mic £19.80. RCA mics BK6 £22.00 each. Nagra 1/2" deck, no amps or heads £110.00. Sennheiser Microport 2 channel receiver £27.50. Nagra SQ Crystal XTAL 50Hz £71.50. Another made up £44.00. Ryder Crystal XTAL for SN £88.00. Recovery unit £77.00. Perfectone EP6A Recorder £82.50. Arriflex Tripod (new) £143.00. Shoulder pod for Arriflex Camera £44.00. Four Arriflex 35mm magazines 400ft. in fitted case £165.00. Beyer M110 Lavalier (no clips) £9.90.

★All items include VAT. Please add 2p in the pound for carriage.

J. J. FRANCIS (WOOD GREEN) LTD.

Manwood House, Matching Green, Harlow Essex CM17 0RS. Tel. Matching 476

★If quality matters consult first our 105-page illustrated Hi-fi catalogue with technical specifications (60p). Members enjoy unbiased advisory service, preferential terms. Membership (40p) p.a. Our associates also manufacture records from your own tapes or record the Master at our studios (Steinway Grand). Bulk terms for choirs, fund-raising, slim discs. Please specify requirements. Audio Supply Association, 18 Blenheim Road, London, W.4. Tel. 01-995 1661.

UNIMIXER STUDIO 4 and 6 MIXERS

Each channel can be switched to accept 5 different inputs, choice of DIN, Cannon, jack-sockets, slider faders, tone controls, PPM. Overall noise is better than —127 dBv with a 200 ohm source (using 20 kHz band with filter). Mains or battery powered. Prices from £87 (as with the successful 4S range, supplied directly to users) only from:

SOUNDEX LTD

18 Blenheim Road, London W4 IES 01-995 1661

FOR SALE—PRIVATE

★Ideal opportunity for the smaller studio contemplating going 4 track. Leever-Rich 4 track 1/2 in. console machine, sel sync, 15/30, 1968. £900 o.n.o. Many lease masters to credit. Also E.M.I. BTR4 1/2 in. full track console 15/7 1/2. £300 o.n.o. Studio closing. Domino Records, Al Brighton, Nr. Wolverhampton. Tel. Al Brighton 2384.

★AKD C451 capacitor microphones. Pair c/w power unit (cost approx. £120), as new, £85. Four STC capsule capacitor microphones (similar 4136), professionally built, with power units, any reasonable trial, £160 pair or £300 four. Details 01-894 9917.

★Amplex 100A instrumentation recorder (dismantled), 1/2 in. audio tape deck, amplifiers, 19in. case on wheels. £75. Profile Records, St. Albans 58027.

WANTED

★Lee Electronics. The Tape Recorder and Hi-Fi Specialists wish to purchase good quality Tape and Hi-Fi equipment for cash. 400 Edgware Road, W.2. Phone PAD 5521.

★New or D.S.H. copy 'Swinging on the Golden Gate', Bob Scobey's Frisco Band. R.C.A. RD27031. Moiney, 234 New Cheveley Road, Newmarket, Suffolk CB8 8BZ.

★All types of Nagra equipment for cash. J. J. Francis (Wood Green) Ltd., Manwood House, Matching Green, Harlow, Essex CM17 0RS. Telephone Matching 476.

MISCELLANEOUS

★Tape and Cassette Recorder Repairs by Specialists. The Tape Recorder Centre, 82 High Holborn, London W.C.1

KEEP IN TOUCH WITH STUDIO SOUND 25p

Place a regular order with your Newsagent or take advantage of a POST FREE Annual Subscription.

WE SPECIALISE IN BRAND NEW

TOP QUALITY BRITISH P.V.C. MYLAR & POLYESTER RECORDING TAPES WITH FITTED LEADERS, Etc., EX 3"

Thanks to bulk purchase we can offer tensilised HI-FI tapes, manufactured by a British firm of world repute. All boxed individually (sealed if required) in polythene. Our tapes are not to be confused with imported sub-standard or used tapes. Full money refund if not delighted.

This month— "DRY SPLICE" (19p) given FREE with every order.

Std.		L.P.		D.P.		Boxed	
Length ea.	3 for	Length ea.	3 for	Length ea.	3 for	empty spls	
3" 150'	10p 29p	3" 220'	12 1/2p 35p	3" 400'	22 1/2p 65p	3" 3p	
4" 300'	20p 50p	4" 450'	25p 70p	4" 600'	34p 97 1/2p	4" 8p	
5" 600'	30p 87 1/2p	5" 900'	40p £1.17 1/2	5" 1200'	62 1/2p £1.85	5" 9p	
5 1/2" 900'	35p £1.02 1/2	5 1/2" 1200'	52 1/2p £1.52 1/2	5 1/2" 1800'	85p £2.50	5 1/2" 9p	
7" 1200'	45p £1.27 1/2	7" 1800'	65p £1.92 1/2	7" 2400'	£1.05 £3.05	7" 10p	

All orders despatched by return.

Postage and Packing 9p per order

STARMAN TAPES, 421 Staines Road, Bedfont, Middlesex

Studio Sound

ANNUAL SUBSCRIPTION RATES

Australia	7 Dollars	Italy	5,000 Lire
Austria	200 Schillings	Japan	2,850 Yen
Belgium	400 Francs	Norway	57 Krone
Brazil	42 Cruzeiro	Portugal	330 Escudos
Canada	8 Dollars	South Africa	575 Rand
Denmark	60 Krone	Spain	560 Pesetas
France	44 Francs	Sweden	41 Kronor
Germany	28 Marks	Switzerland	33 Francs
Greece	240 Drachma	United Kingdom	£3.00
Holland	28 Guilders	United States	8 Dollars

Ensure regular delivery of your monthly copy through a direct subscription from

STUDIO SOUND
LINK HOUSE, DINGWALL AVE., CROYDON
CR9 2TA, ENGLAND

AUTO-MIX

2nd Generation Total Automation

SLIDERS

EQUALIZERS

QUAD PANS

REVERB

SWITCHING

AND EVERYTHING ELSE.

REAL TIME OPERATION & PUNCH-IN MEMORY

Call

Daniel Flickinger

216-656-2000

AUTO-MIX, Inc.

42 SO. OVIATT STREET, HUDSON, OHIO 44236

Neve Storyboard

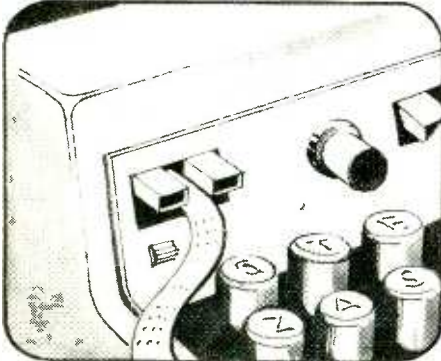

SFX: Telex machine.
Customer wishes to order
24 channel music recording
console to be in Montreal
by Monday.
Message received by Neve
previous Tuesday

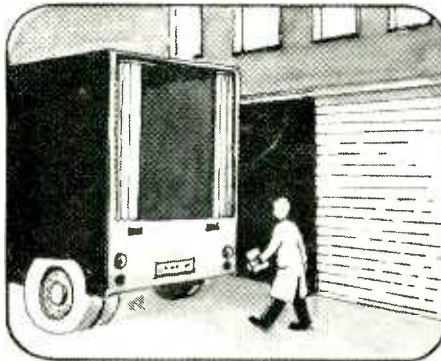

Neve S24/8/16 console
delivered to U.K.
packers Thursday.....

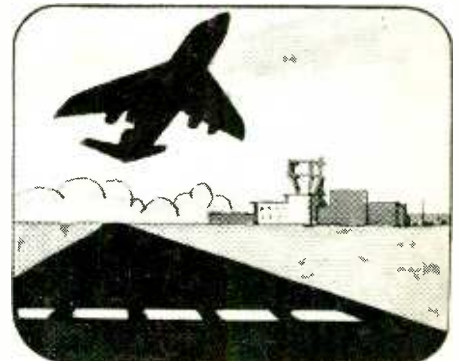

Delivered to
London Airport Friday.

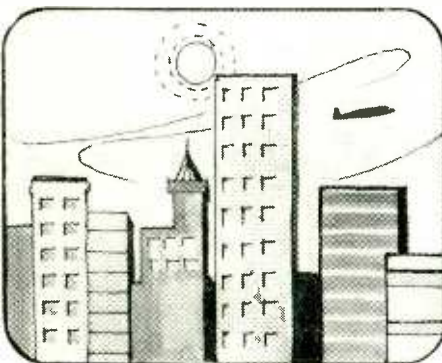

Arrives Montreal
1pm Saturday.



Powered up in studio
fully tested 6 pm same
afternoon



In use for live
F/M broadcast 10.30pm
Saturday (same evening).
MVO: 'Who said Monday?'



Rupert Neve & Company Ltd.,
Cambridge House,
Melbourn, Royston,
Hertfordshire SG8 6AU,
England.
Tel: Royston (0763) 60776
telex 81381
cables Neve Cambridge

Rupert Neve of Canada Ltd.,
7528 Bath Road,
Malton,
Toronto,
Ontario,
Canada.
Tel: 416 677 6611
telex 0621 7652

Rupert Neve Incorporated,
Berkshire Industrial Park,
Bethel,
Connecticut 06801,
U.S.A.
Tel: (203) 744 6230 telex 969638,
Hollywood Office,
Tel: (213) 465 4822