

March 1991

Recording ■ Engineering ■ Production

\$4.00

REP™

The Pro Audio Applications Magazine



**DESKTOP PRODUCTION:
Right Here,
Right Now!**

MACRO REFERENCE. FOR INCOMPARABLE SOUND.

The sound is incredibly transparent, unbelievably true. It's as if you were experiencing a live performance. Yet, the sound is a result of Crown's newest technological achievement. Macro Reference. A 20 bit amplification system with the essence of 20 bit digital sound.

Reference is the ultimately damped, high excursion amplifier. A dual velocity feedback system enables Reference to take its low frequency damping range to in excess of 20,000. This makes low-end response tight, well-defined and

incredibly natural. Crown has also enhanced ODEP™ (Output Device Emulator Protection) circuitry for Reference, creating precise transfer function (monitored by IOC®) and thereby accurate control of the music signal within the amplifier.

To assure that Reference can function under exacting requirements, its power supply was designed around an advanced toroid which nearly eliminates electromagnetic interference. And its revolutionary convection cooling system with computerized, proportional fan assist prevents thermal overload in high-demand situations. This makes Reference quiet enough to use in even the most discriminating environment.

Digitally ready with a dynamic range that approaches the environment in which we live, Macro Reference will be the industry Reference for years to come. But you must experience Macro Reference to truly appreciate it. Visit your Crown dealer today. Comparing apples to apples, there *is* no comparison.

Crown. Guaranteed Excellence.

Crown® International, Inc.
P.O. Box 1000
Elkhart, Indiana 46515-1000 U.S.A.
Telephone: 219/294-8000
Toll-Free: 800/535-6289

Circle (1) on Rapid Facts Card



MACRO
REFERENCE

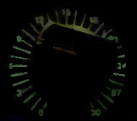

CROWN

AND WE QUOTE:

"We also tested this monitor for each of its EQ settings. The EQUALIZED mode for the PRM 308S was very strong in the rock and dance music categories, proving the **highest scores in the gestalt, clarity, and depth areas of the dance music categories**. On top of these honors, the 308S monitors were felt to have some of the **best bass extension of any monitors tested**. In the EQUALIZED mode, they were smooth and provide a very deep stereo image that must be heard to be appreciated.

In REFERENCE mode, the PRM 308S took **first place as the best-liked speaker of any tested**. In this mode they were thought to possess the **clearest and most musical sound** for all three types of music. The main difference between the two EQ settings lies in the frequency balance characteristic where the REFERENCE mode is much more even sounding than the EQUALIZED mode. Many of the near-field monitors tested had a light midrange feel to them, so it's nice to be able to flip a switch to get an idea of how your music sounds in an alternate environment. **The PRM 308S system is truly wonderful and must be heard to be believed!**"

Rolf Hartley • Audio Consultant/Journalist • EQ Magazine*

"I read with interest: The Electric Near Field Monitor Test in your premier issue. I spend most hours of my rapidly dwindling life in front of the little beasties and don't have the time or the money to buy every speaker you reviewed. On the basis of your admittedly subjective evaluation I acquired, against my better judgement, a pair of Peavey PRM 308S's. I mean, just the logo, you know?"

Boy, was I wrong. As you say, **the speakers have to be heard to be believed**. So far I've mixed two albums through them (Steve Earle and Colin James, both to be released in June) and **neither I nor the artist could be happier with the results**. Thanks for the tip and, if you're in the market for several pairs of NS-10s, please give me a call."

Joe Hardy • Ardent Recordings • Memphis, TN



Peavey Audio Media Research™ 308S™ Phase Reference Monitors

From the 14 models of near field studio monitors tested by GPI Publications in *EQ Magazine*, the Peavey Audio Media Research™ PRM™ 308S ranked number 1 in Reference Mode*. In categories such as stereo imaging, spectral balance, transient handling, clarity, and gestalt, the 308S was picked as the best-liked of those tested. . . If that isn't enough, it also placed third in the Equalized Mode.

The PRM 308S features a unique foam blanket surrounding the high frequency and midrange components to provide more accurate "imaging" and "transparency." A highly desirable reference/equalization response mode switch is provided, simulating different listening environments . . . tracking or mixdown.

Experience what the test panelists of pro engineers and producers discovered. Call us at the factory for the name of your nearest Peavey AMR dealer to arrange a "test listen" of a pair of 308S reference monitors for yourself, and perhaps your *frame of reference will change, too*.

**GPI Publications, EQ Magazine MAR/APR 1990 "The Electric Near-Field Acid Test"*

PEAVEY™
AUDIO MEDIA RESEARCH



PEAVEY ELECTRONICS CORPORATION / 711 A Street • Meridian, MS 39302-2898 • Phone (601)483-5372 • Telex 504115 • Fax 484-4278 • ©1990

Circle (3) on Rapid Facts Card

We'd been working
hard in the studio
for 14 years.
It was time we got
out for a night.





Spending years on end cooped up in small, dark rooms with a bunch of engineers takes certain special qualities. Durability, for one. We've always been known for that. Of course, incredibly clear, uncolored sound quality doesn't hurt, either. Or hand-assembled components, with gap precision to plus or minus one-millionth of an inch.

These features got TAD speakers into studios like Record Plant, NOMIS and Masterfonics. And the same features are now getting us out of them.

See, we had this funny idea that if TAD could make music sound terrific in a small room, we could make music sound terrific in a huge arena. And every outing we've had with Maryland Sound has proved us right.

Not that we won't still work our woofers off in studios from London to L.A. all day. But, at night, we'd like to get out and jam more often.

TAD Technical Audio Devices®

Pioneer Professional Products Division

Circle (4) on Rapid Facts Card

Contents

Features



16



18

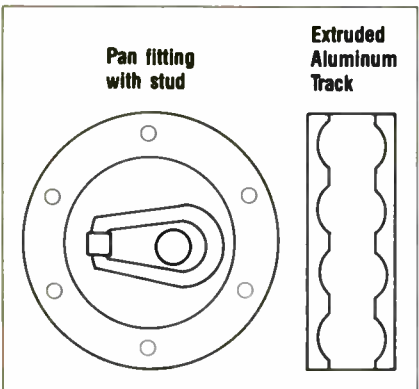

60

Taking it Tapeless	26
Digital audio production: Changing the way you work. <i>By: Rick Schwartz</i>	
Tapeless Technology	28
Sampling the universe. <i>By: Linda Jacobson and Brent Hurtig</i>	
Re: Sources	38
How to contact the various tapeless audio manufacturers. <i>By: Linda Jacobson</i>	
Reality Check	42
Hoops and ladders: Putting the systems through their paces. <i>By: Rick Schwartz and Mike Joseph</i>	
Digital Storage Technology	52
Understanding the spinning disks. <i>By: Doug White</i>	
Hands On: Roland SN-550	64
<i>By: Mack Clark</i>	

Sound Reinforcement

Live & Direct	56
Hearing Aids for the Stars. <i>By: David Scheirman</i>	
All Access	59
A monthly department spotlighting sound companies and a recent touring equipment lineup. This month: Clair Bros. Audio (Paul Simon) and Roadworx/Woodworx. <i>By: Mark Herman</i>	
Hangin' High	60
Loudspeaker rigging comes of age. <i>By: Andrew T. Martin</i>	

Departments

From The Top	7
Letters	8
Random Access	10
Fresh Tracks	16
Sound Business	22
Digital Domain	24
First Look	68
The Cutting Edge	69
Classified	73
Advertisers Index	80
Rapid Facts Cards	81
Subscriber Cards	83

On the Cover: Control Room A at Soundwave, Washington, DC, featuring a New England Digital PostPro SD and Neve 8232 with MasterMix automation.

R•E•P: Recording•Engineering•Production (ISSN 0034-1673) is published monthly by Intertec Publishing Corporation, 9221 Quivira, Overland Park, KS 66215. Subscriptions rates are \$26 to qualified readers, \$30 to non-qualified readers per year in the United States, \$50 for qualified and \$60 for non-qualified per year outside the United States. Optional airmail for non-qualified readers outside the United States is also available for an additional \$55 per year. Foreign subscriptions are payable in U.S. funds only by bank check or money order. Adjustments necessitated by subscription termination at single copy rate. POSTMASTER: Send address changes to **R•E•P: Recording•Engineering•Production** P.O. Box 12960, Overland Park, KS 66212. Second-class postage paid at Shawnee Mission, KS 66202 and additional mailing offices.

Photocopy rights: Permission to photocopy for internal or personal use is granted by Intertec Publishing Corporation for libraries and others registered with Copyright Clearance Center (CCC), provided the base fee of \$2.00 per copy of article is paid directly to CCC, 21 Congress St., Salem, MA 01970. Special requests should be addressed to Cameron Bishop, group vice president, Intertec Publishing Corporation.

DISCOVER THE LEXICON SOUND



Excellence in digital audio technology through a unique blend of scientific precision and artistic interpretation.

To perfect the Lexicon Sound, we must exploit the power of the latest digital hardware, harness that power with superb software, and expertly integrate the two. It requires a depth of



understanding that only experience can provide, and an expert fusion of the art and the science of sound.

The results can be found in every Lexicon product. We have devoted nearly two decades to perfecting clean, natural digital audio sound without the quirks that digital technology is often accused of. It's called the **Lexicon Sound**, and you'll find it in every product we make.



When Lexicon introduced the world's first digital audio product in 1971, it was heralded as a major technological achievement, a breakthrough.

We've built on that reputation with other achievements, like reverb-er-ation and time compression/expansion, that have earned us more than a dozen awards, including an Emmy.

Today Lexicon products serve more digital audio applications than ever before. There is OPUS, the world's only fully integrated random access digital audio production system. OPUS replaces a room full of equipment with a comfortable console and single equipment rack. Digital editing and mixing has never been smoother, more accurate, and more natural.

And everyone has a LARC. The Lexicon Alphanumeric Remote Console harnesses the power of the 480L Digital Effects System. The 480L produces a broad variety of superb effects from a growing library of software. It's no wonder you'll find a LARC and the 480L in virtually every major recording studio throughout the world.

Lexicon's LXP-1, LXP-5, and LXP-15 effects processors provide a compact, economical way to include the Lexicon Sound in your productions. Each processor provides significant effects capability all by

itself. But combined, the number and breadth of their effects is astonishing.

The CP-1 Digital Audio Environment Processor extends the Lexicon Sound into the living rooms of the world. It's been lauded as one of the truly



great digital audio products of all time, and *Stereophile* ranked it as "one of a handful of genuine advances in sound reproduction".

These are just a few samples of Lexicon's digital expertise. Our full range of products serves the needs of recording engineers, musicians, film and video producers, radio and television broadcasters, as well as discerning audiophiles. In each



product we've merged technical excellence with artistic elegance. The result is the Lexicon Sound.

For more information about Lexicon products or a demonstration of their capabilities, contact us at (617) 736-0300, FAX (617) 891-0340, or write Lexicon, Inc., 100 Beaver St., Waltham, MA 02154.

Lexicon
The Art and Science of Sound

EX SERIES

From the beginning we wanted it all: massive power, high efficiency and performance combined with unmatched flexibility and reliability. Together they represented the ultimate statement — amplifiers far more sophisticated than any available today. Our engineers accepted the challenge. **The result is the EX Series.**

MASSIVE OUTPUT POWER. The EX 4000 supplies 1,100 watts per channel at 4 ohms, enough power to drive today's most demanding speaker systems. No duty cycle lightweights, each model will deliver massive output power under high duty cycle conditions.

HIGH EFFICIENCY. QSC engineers developed an advanced high efficiency stepped linear output circuit to dramatically lower waste heat and AC current consumption. As a result, the EX 4000 can operate on a normal 15 amp AC plug. It's the only amplifier in its power class to do so!

CLOSED LOOP PROTECTION. A sophisticated closed loop thermal management and protection system measures actual operation and smoothly and progressively intervenes

only to the degree necessary. This eliminates harsh clipping, false triggering chatter, shut down, and other forms of protection distortion.

OPEN INPUT ARCHITECTURE.™

Open Input Architecture provides the ability to interface with computers, digital audio, and

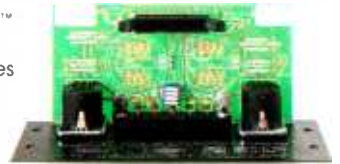

fiber optic systems. It also allows you to incorporate signal processing capabilities within the amp. No matter what your needs will be, an EX Series amp has the flexibility to meet your requirements.

YOU CAN HAVE IT ALL. At QSC, our high standards of quality and value have remained the same for over two decades. We have also earned a legendary reputation for reliability. And we've done it the hard way, by performing flawlessly in the world's most demanding sound systems. Now, with the EX Series, we have raised the standard for engineering sophistication. It will change what you think a power amplifier should be.

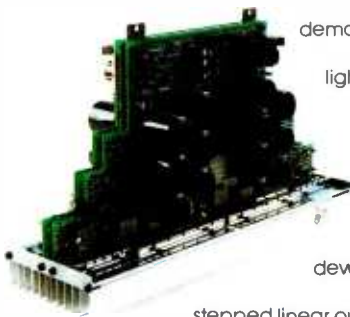

To learn more about the EX Series, contact an authorized QSC dealer for the EX Series White Paper.

Circle (6) on Rapid Facts Card

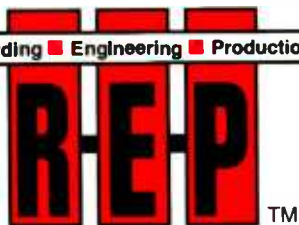

EDITOR

Mike Joseph

MANAGING EDITOR

Dan Torchia

ASSOCIATE EDITOR

Sue Edwards

GRAPHIC DESIGNER

Liz Veternick

EDITORIAL ASSISTANT

Renee Anderson

DIRECTORY EDITOR

Pat Blanton

GROUP MANAGING EDITOR

Tom Cook

CONSULTING EDITORS

John Monforte, Technical Consultant
David Scheirman, Live Performance
Laurel Cash-Jones, Editorial Consultant
Sarah Coleman, Washington Correspondent
Dan Levitin, Contributing Editor
Rick Schwartz, Contributing Editor

GROUP VICE PRESIDENT

Cameron Bishop

PUBLISHER

Dennis Milan

PROMOTIONS MANAGER

Evelyn Hornaday

MARKETING COORDINATOR

Darren Sextro

ADVERTISING BUSINESS MANAGER

Dee Unger

ADVERTISING PRODUCTION SUPERVISOR

Mary Birnbaum

ADVERTISING COORDINATOR

Pat Eisenman

CLASSIFIED ADVERTISING COORDINATOR

Mia Fountain

PRESIDENT

R.J. Hancock

CORPORATE CIRCULATION DIRECTOR

Chuck Rash

CIRCULATION DIRECTOR

Sandra Stewart

CIRCULATION MANAGER

Doug Wilding

CUSTOMER SERVICE

913-541-6633

CREATIVE DIRECTOR

Kevin Callahan

R•E•P is an applications-based publication targeted at professional individuals and companies active in the commercial business of studio and field recording, audio for video, live sound production and related fields. Editorial content includes descriptions and demonstrations of audio production techniques, new products, equipment application, maintenance and audio environment design.

Member, Business Publications

Audit of Circulation

Sustaining member, Audio

Engineering Society

Sustaining member of Acoustical Society of America

Member, International Communications Industries

Association

Associate member of Society of Professional Audio

Recording Services

©1991 by Intertec Publishing. All rights reserved.

From the Top

Welcome To Your Future

Much has changed in the audio production world during the last decade. Ten years ago in the studio environment, if you had a 32-input board, a twenty-four against the wall, a decent mic locker, a digital verb and a Harmonizer, you were in business. State-of-the-art production for commercial work was a combo facility with two cart machines, a TT and a Lux-o'd mic swung out over the rotary-knobbed board. That was recording, jingle production and video support work circa 1981.

In the past decade, however, a Toffleresque/Future Shock reality has hit us where we live. The price of processing has hit the basement, thanks to intense competition in the land of digital devices. Companies like Fostex, Tascam and Otari reduced the buy-in for multiple tape tracks to a quasi-reasonable figure. What you got for what you spent on consoles ever improved. Not to mention the plethora of higher-quality basic boards that hit the used market as our entire industry matured and upgraded.

But one thing stayed the same. Until the mid 1980s, it all went to analog tape. In the production process, whether assembling, copying or generating safeties, you burned a lot of it on the chopping block. Although linear tape may be an ideal storage and creative medium for a 5-minute AOR cut, it's ultimately not the best medium to navigate around in for a 15-second teaser consisting of two stings, four bars of music from twice as many tunes, several layered sound effects, and a multitalent voice-over. And how about tagging or slug-ging a spot 97 different ways over the out?

By the late 1980s, disk-based production promised to carry us into a new territory: instant access to any program location virtually instantly, flexibility once undreamed of, and longevity and fidelity through infinite copies, transfers and edits. All of the techniques that video editors and computer desktop publishing people had been developing for years. Possibly coining a term, I call it Desktop Production, an area that someday promises to allow video, audio, graphics and text to work off of the same machine in the same room, when memo-

ry gets cheap enough, chips become fast enough and storage becomes fat enough.

WHAT MADE IT WORK

Several disparate elements historically lead to the subject we're addressing in this issue — Desktop Production, or as a working shorthand, Tapeless Production. The elements?

- MIDI keyboard control, which allows multiple musical synthesizers, and later samplers (very important!) to intercommunicate using a common control protocol.

- Analog-to-digital conversion into common, generally shared formats and sample rates, enabling us to manipulate and store audio signals in the digital domain, avoiding noise, signal degradation and the corruption of fidelity over multiple copies.

- Magnetic disk storage, creating true random-access, non-linear retrievability in milliseconds, instead of minutes.

- The proliferation of relatively affordable computer platforms, whether in a large sense, the off-the-shelf units such as an Apple Macintosh, IBM PC, Atari or Commodore, or in a smaller sense, the Motorola and Intel CPUs, easily configured in proprietary controllers for units such as AMS, Lexicon and New England Digital systems.

- Ever-dropping prices on RAM, allowing affordably large-sized storage reservoirs where we can manipulate the instantly accessible audio samples in the virtually infinite ways that workstation production software currently provides and will truly fulfill when this new subset industry gets rolling.

WHAT THEY DO

Although it is possible today to buy an entire digital system, turnkey, for less than the price of a professional 8-track deck, this doesn't get you the universe. Signal resolution, number of functions supported simultaneously, flexibility, memory/storage size and control interface vary greatly by price. However, virtually every package has provisions to convert analog signal to digital information at CD-quality or better, in stereo pairs. Some systems allow true multitrack (that is, multiple inputs and outputs simultaneously) recording and playback. Some stay in the digital domain entirely, at selectable sample rates and with different import/export protocols.

Most systems allow you to manipulate and edit material down to sample-sized

Continued on page 67

Mics: the B&K view

From: Adrian Weidmann, international product manager, Bruel & Kjaer Pro Audio Group, Marlborough, MA.

Thank you for the opportunity to respond to Jerry Graham's letter, which addressed Dan Levitin's article, "Master of the Microphone" [November issue].

I agree with Mr. Graham's comment that "microphone self-noise is an objective measurement assessed by international standards." [CCIR 468-1 (1976)/DIN 45405 (1983) and DIN/IEC 651 (1981).] It must also be stressed, however, that in order for those measurements to be used comparatively, the measurements must also be conducted according to calibrated standards.

The design, development and manufacture of a microphone is a continuous bout with compromises. The physics of sound and microphone technology defines microphone self-noise. The larger the microphone diaphragm, the quieter the microphone capsule. There are, however, compromises made in frequency and phase response (both on- and off-axis) and impulse response when using a larger diaphragm.

I question Mr. Graham's "test results" in the column marked dynamic range. Historically, Neumann has separated the microphone capsule and pre-amplifier in its printed specifications. Although we are currently measuring a Neumann TLM 170 in order to verify Mr. Graham's claims, it is our professional opinion that the number 126 (assuming that it is referenced to the decibel scale) is the dynamic range of the pre-amplifier and not a complete microphone (i.e. the capsule and pre-amplifier as one entity).

If this is the case, the numbers Mr. Graham references for the dynamic range of Bruel & Kjaer microphones should be 10dB-15dB greater than stated. All Bruel & Kjaer specifications are for a complete microphone — an acoustic source to an electrical output — and not for select components that make the specifications apparently "better."

There isn't a professional recording engineer or producer who will select or purchase a microphone based solely on manufacturer specifications. Microphone manufacturers known to Bruel & Kjaer measure and list their microphone specifications in a fashion that portrays their microphones to the customer in the most favorable and complimentary light,

regardless of the accuracy and the customer's ability to transpose specifications into meaningful information as to the comparison, use and application of a specific microphone to another.

Bruel & Kjaer has advocated a standardized list of measurements and specifications that all microphone manufacturers would implement and list. This would make the choice and selection of a microphone accessible to the recording engineer or producer, as well as making comparisons easier and objective, and not lost in a haze of subjective adjectives. Are any manufacturers interested?

Finally, so as not to lose sight of why we're in this business, let me steal a line from Bruce Swedien. When asked about his thoughts on digital vs. analog, Bruce replied, "A groove is still a groove. Nobody dances to tape noise!" Bruel & Kjaer has always maintained that sentiment with one twist: Capture that groove as accurately and as artfully as possible. ■

No Convention Coverage

From: Carmine Jergo, Medford, NY.

Borrowing a popular joke format, the bad news is: Your September issue covering the AES Convention is a great waste of a month's space. I realize that a few people who can't attend might be interested, but in all fairness, your advertising space and new products column could function well enough to keep us informed. Please, no more issues dedicated to a stupid convention that you yourselves think a guideline on alcoholic consumption need be included. ■

Engineering Grammys

From: Timothy Powell, Chicago.

The Grammy nominations have just been announced, and the results are not earth-shattering. Well-known artists like Phil Collins and Quincy Jones are expectedly well-represented. New artists like Wilson Phillips and Mariah Carey cleaned up in their respective categories. New categories have been added or modified to appease forgotten or misrepresented genres.

For example, there are now categories for Best Hard Rock and Best Heavy Metal performances. For all you college radio dudes out there, the Best Alternative Music Performance category covers your music. Rap music has two categories. Even New Age has a category of its own. There

are two for music video, six for gospel, three for Latin and categories for reggae, polka, children's, comedy and spoken word.

NARAS has obviously made a great effort to please everyone and also to make the TV broadcast of the awards more appealing to a mass audience. The critics of the past have been answered: Why should New Age records be lumped with jazz? How could Jethro Tull win the Hard Rock award? Latin artists shouldn't have to compete with blues and folk artists in just one category. What about the new art-form of video?

It seems that, besides the pedestrian nomination habits of the academy, everyone should now be happy. Well, I'm not. The Grammy Awards are a total sham! The whole process stinks. Why? Because there are only two categories for recording engineers!

The name of our organization is the National Academy of Recording Arts and Sciences. There are 79 categories this year with only *two* for engineering: Best Engineered Recording (Non-Classical) and Best Engineered Recording (Classical).

Why should engineering for all non-classical be lumped together? The audio requirements and accepted sounds for different types of music differ dramatically. Great drum sounds for a metal record may make a jazz or dance engineer barf. With all of the advances in recording technology, the engineer plays a crucial, and sometimes dominant, role in the success of a modern record. We don't usually get points or a proportionally fair amount of money for our efforts.

So when it comes time for some recognition, why should our hard work be lumped together when the Academy tries to please everyone else?

The Chicago chapter of NARAS is going to pursue this matter until the Academy gives the sciences part of the organization an equal share. Stay tuned.

(Editor's note: Powell is the editor of The Eardrum, the newsletter of the Chicago chapter of NARAS; the above first appeared in The Eardrum, and is reprinted with permission. For more information on the Chicago chapter's activities concerning the Grammy issue, contact The Eardrum at 2097 John's Court, Glenview, IL 60025; 708-998-6421.) ■



EVEN WALTER BECKER IS TALKING ABOUT SOUNDTRACS.

Soundtracs IL Series

“ You have to be careful about what you spend for a console in a home studio. You want as clean a signal path and as versatile a board as you can get. The Soundtracs IL 4832 is logically laid out, easy to get around on, has great sounding EQs and prints a very clean signal to tape.

We use a 32-track digital recorder — the IL 4832 made the most sense. It provides a 32 buss design in an extremely affordable package. It looks great in the room, too. ”

As a founding member of Steely Dan, Walter Becker is known for his uncompromising point of view. So choosing a console for his personal studio in Maui was a carefully considered decision.

Soundtracs IL 4832 features an inline design that produces a pure, transparent sound. Its 32 Busses allow total flexibility for maximum ease of use in a variety of recording situations.

The IL 4832 comes standard with patchbay and delivers up to 104 inputs with EQ and Aux on mixdown. The board is also available in a 36 mainframe format.

Sonic purity, versatility, maximum inputs and operational flexibility. These are the reasons why even Walter Becker has so many good things to say about recording with the IL 4832.

SOUNDTRACS INC

Soundtracs distributed exclusively in the United States by:
Samson Technologies Corp., P.O. Box 9068, Hicksville, NY 11802-9068
TEL (516) 932-3810 FAX (516) 932-3815

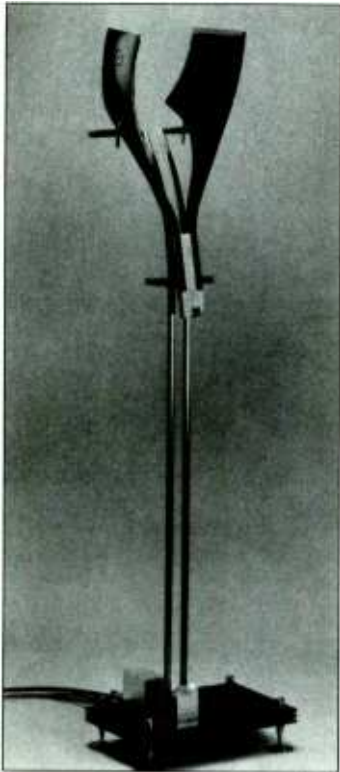

Elegant Sound:

Sennheiser's challenge was to create a non-traditional headphone design, and entrants certainly rose to the occasion. The entry shown here, by Till Kobes and Jan-Michael von Lewinski, bested more than 45 submitted from industrial design and art students at universities from across Germany. Design criteria included excellent sound reproduction quality and a high level of comfort.

Correction:

In the October interview with Gary Lux, the diagram showing the room and mic layout for the "L.A. Law" sessions was the layout for "Hunter." The layout for "L.A. Law" appears at right; R•E•P apologizes for the mixup.

DAWs: Mastering The Curve

If you doubt that Desktop Production — also known as disk-based recording, DAWs and a host of other names and acronyms — isn't the hottest trend hitting our biz, you only have to look at the issue you're holding in your hands. Our coverage this month focuses on the systems of 18 companies; there's another 30 or so in various stages of development out in the world.

Given the proliferation of systems, what's the best way to learn the merits of one system compared to another? Aside from reading this issue, there's an important opportunity to get your hands on competing systems in the same room.

The Society of Professional Audio Recording Services is again sponsoring a weekend technical conference on DAWs May 18-19 in Orlando, FL.

Following past successful events in Chicago and Nashville, the Orlando conference promises to follow the same format — manufacturers give presentations detailing design philosophy and system features, with time scheduled for hands-on operation by the attendees.

Companies scheduled to appear include AMS, Digital Audio Research, Studer Editech, Lexicon, New England Digital, Otari, Sony, Solid State Logic, Symetrix and WaveFrame.

For more information, contact SPARS at 4300 10th Ave. N., Suite 2, Lake Worth, FL 33461; 407-641-6648; fax 407-642-8263. ■

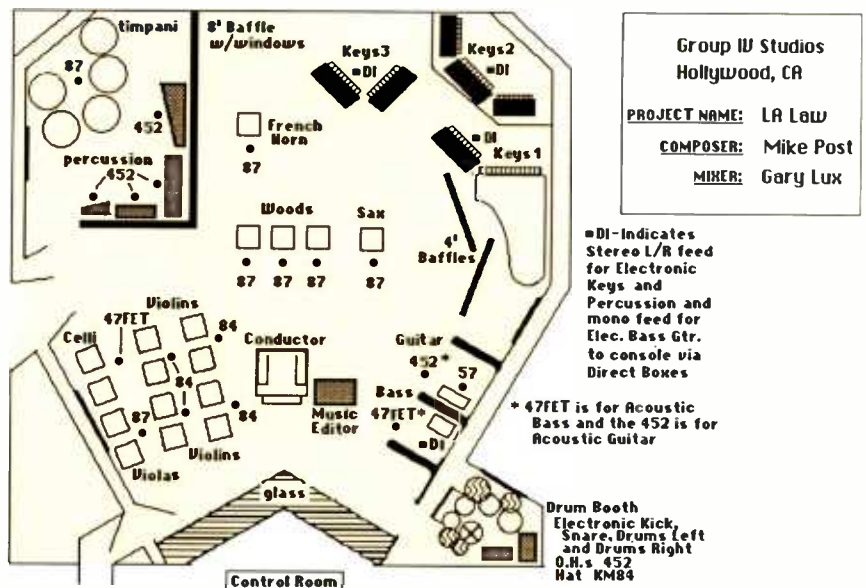

People

T R E N D W R A T I C D H

H. Shinohara has been named president of Fostex Corporation of America. He is also president of the Japanese parent company, Fostex Corporation ... **Jason Dunaway** has been promoted from director of engineering to vice president of product development and marketing at Valley International. **Jay Nelson** was promoted from operations manager to vice president of sales and operations ... Mark IV Audio has named **Roger Gains** vice president, responsible for the manufacturing of all companies in the group ... **Will Lewis** has joined Loppnow & Associates, a manufacturers representative based in the Northwest ... **Colen Earls** has been named branch manager of Communications Equipment Company's Charlotte, NC, office ... **Christen M. Armbrust** has been named the director of Meridian Data's new customer service group ... Basic Measuring Instruments has appointed **Bob Hoffman** to the newly created position of manager of customer service/repair ... **Gillian Blackburn** has been added to Digital Audio Research's pro audio sales team ... **Tracy Cranton** has joined Dynacord's marketing department as a technical services representative. **Mark Bird** has been named marketing manager for Dynacord's sound reinforcement products. ■

Trade Shows: The upcoming Summer NAMM show is history. This year's event, scheduled for August in New York's Javits Center, was canceled after the association found little support from either manufacturers or association members. Will we see similar consolidation from other associations?

Computers: Could we one day see a Macintosh clone? According to *Macweek*, a small start-up company has claimed to have developed technologies that will allow OEMs to create Mac-compatible computers without violating Apple's patents. Components could be available by the end of the fourth quarter, with OEMs shipping the product by mid-1992, at the earliest. Expect a court battle on this one.

HDTV: The U.S.'s delay in developing HDTV, usually thought of as a liability, may ultimately pay off. Industry observers say that Japan's analog HDTV transmission system is outdated, and that the United States has an opportunity to develop a better digital transmission system. This could lead to a U.S. system being adopted by other countries, giving a much-needed boost to domestic electronics and semiconductor manufacturers. The FCC is scheduled to start testing six proposed systems in April; a decision on a U.S. standard is not scheduled until 1993. ■

"Record Plant has been one of Los Angeles' finest recording studios for more than 20 years, with very solid recent studio bookings, including Guns 'N' Roses, Bruce Springsteen, Bonnie Raitt and Neil Diamond. However, studio operations no longer represent an integral part of our group strategy in the U.S. market."

— Joe Kiener, vice chairman of Chrysalis USA, owner of the Record Plant, in announcing its closing.

STUDIO UPDATE

Facility/Location	Details
NORTHEAST	
Clinton Recording Studios/New York	Co-owner Bruce M. Merley has left to pursue other interests; Ed Rak, co-founder and co-owner, will assume the role of president.
National Video Center/New York	Formed National Sound, an audio division with extensive digital and analog audio services, headed by Peter and Jennifer Fish. The upgrade of Audio Studio 4 includes a New England Digital PostPro SD workstation with a Direct-to-Disk recording system, a Sony 3324-A 24-track digital recorder, an SSL-4000 console with 48 inputs and a fully automated G Series computer. Senior audio engineer Doug Di Franco has joined the staff.
Lavskymusic/New York	Expanded New England Digital Synclavier audio system with NED's Direct-to-Disk recording system.
SOUTHERN CALIFORNIA	
Intersound/Hollywood	Gerard Shadrack named production manager.
NRG Recording Services/North Hollywood	Completed expansion at its new location, 7222 Hinds Ave., to include a pre-production/rehearsal sound stage. Its Neve-equipped room has been upgraded with an Otari 100A recorder, two Avalon E5 equalizers, a pair of Tannoy System DMT monitors and Klaus Hein-modified U67s, M49s and C12s.
NORTHERN CALIFORNIA	
Music Annex/Menlo Park	Engineer/producer Ted Brooks has joined the staff.
MANUFACTURERS	
Amek/TAC	Amek Classic console sales: Turner Broadcasting System (Atlanta); BCII sales: IBM (Miami), WAGT-TV (Augusta, GA) and WSOC-TV (Charlotte, VA); Bullet sales: South Central Bell (Birmingham, AL), Nord Communications (Greenville, SC), Postmasters (Nashville) and Cinetel Productions (Knoxville, TN); Magnum sales: Catspaw Productions (Atlanta); and Mozart sales: Cinetel Productions (Knoxville, TN).
Bryston	CBS (New York) purchased 39 2B-LP amplifiers for use during the 1992 Winter Olympics. The sale marks the use of the 2B-LP at all three major networks.
Digital Audio Research	The Swiss Film Army Service (AFD) purchased a SoundStation II System for its post-production facility in Bern.
Focusrite	Studio Jive (Tokyo) has purchased a Focusrite Studio Console.
Harrison by GLW	Pro-image (Victoria, Australia) has purchased a Harrison Series 11n B console. The South African Broadcast Corporation has purchased three Harrison TV-3 stereo teleproduction consoles.
Lexicon	NHK, the Japan Broadcasting Corporation (Tokyo), has replaced its reverberators with the 480L Digital Effects System.

NEWS NOTES

As we go to press, the parent company of the **Record Plant**, a fixture in the Los Angeles recording community, announced that it was closing the studio, effective Feb. 28; all business assets and the real estate were to be sold. Record Plant is the second major L.A. facility to close in recent months. Additional information will appear in the April issue.

In film sound production: is digital technology faster than traditional methods? John Foster, a film sound editor in the U.K., performed the same film editing tasks on an 11-minute film reel using traditional methods and the **Digital Audio Research** SoundStation II. According to Foster, the digital process improved productivity by more than 50%. A copy of the report is available from DAR.

Ampex is now making available the tape labeling system approved by the Association of Professional Recording Services and widely used in Europe. The system uses eight color-coded labels that identify tapes as to content and application. Ampex's kit includes 20 of each type and is available free of charge.

Digidesign was ranked 315th on *Inc.* magazine's 1990 list of the 500 fastest-growing privately held companies in the United States. The list appeared in the magazine's December 1990 issue.

International Music Company and its holding company have been acquired by an investor group headed by Tommy Moore, one of the company's founders. No changes are planned for any of the product divisions, including Akai. IMC has also acquired the North and South American distribution rights for the Hill Audio product line.

Sennheiser's acquisition of Neumann was finalized on Jan. 1. Terms of the sale were not disclosed.

Avid Technology has scheduled product seminars for its Avid/1 Media Composer. Staged in various cities across the country, the seminars are scheduled through the beginning of August. For more information, contact the company at 3 Burlington Woods, Burlington, MA 01803; 617-221-6789; fax 617-221-6799. ■



Listen to your heart.

From the moment you begin to play a Kurzweil K1200, you'll hear heartwarming authentic acoustic instrument samples as only Kurzweil can create them. Plus a sizzling selection of brand new synth timbres. There are 162 great sounds, each with four layers and a powerful effects processor. The K1200 delivers all the features you'd expect of a fully professional synth for the 90s, including 16-channel multitimbral operation and dynamic voice allocation. But the one thing it won't give you is programming heartaches. The K1200 features the easiest programming ever. If you've got your heart set on the ultimate keyboard controller, look no further than the 88- or 76-note K1200 keyboards. Or, if you're adding to your existing setup, you'll want the Pro I module. Visit your Kurzweil dealer and hear the astounding K1200. If you listen to your heart, there's only one choice - Kurzweil.



KURZWEIL
Music Systems
Kurzweil is a product line of Young Chang America, Inc.

Kurzweil Music Systems, Inc. 13336 Alondra Blvd., Cerritos, CA 90701, 213/926-3200

Circle (8) on Rapid Facts Card

Roadwork

By Mark Herman

On the Leading Edge: Frank Mayes & Associates (Atlanta) recently purchased TOA's Saori digital crossover and time alignment unit to go along with its top-end ATI Paragon console and Crown's computer-based IQ 2000 amplifier control system. Integrating these three high-tech gadgets with its proprietary FM-3 loudspeaker cabinets, Ramsa WR-S840 stage console and Crown amplifiers has propelled FMA into the limelight of Southeastern sound companies. Owner Chip Mayes says that his company has stayed busy throughout the winter with a steady diet of national one-offs and is on tour with the London musical "Black Heroes In the Hall of Fame." The musical runs through June, hitting the East Coast, Canada, Jamaica and New York.

BEST Audio (North Hollywood) was responsible for the pre-game, halftime and post-game audio at Super Bowl XXV in Tampa, FL. BEST has done the Super Bowl 11 times. Other recent work includes the Bob Hope show that traveled to Saudi Arabia to entertain American troops just before the onset of the war with Iraq. A small, combination Bose/Meyer/Anchor Liberty PA system was left in Saudi Arabia for later use by the troops. Hope's USO tours have been a regular account since the late 1960s. Last year, BEST traveled with Hope to Berlin and Moscow.

Soundcraft Delta Monitor: Soundcraft is now shipping the new Delta Monitor 12-bus stage console. It incorporates the smooth chassis of the 200 Delta and Venue line of consoles and is offered with up to 40 input channels. Input features include 4-band EQ with two mid-sweep, a high-pass filter, phase reverse and balanced mic and line inputs. Each output channel has two sweepable notch filters, 6dB feedback dim control and balanced outs. This might be just the item for those needing an efficient, cost-effective stage console.

Mark Herman is president of Hi-Tech Audio Systems, a sound reinforcement equipment rental company based in South San Francisco.

STUDIO UPDATE

Facility/Location	Details
Lexicon	The Family Channel (Virginia Beach, VA) has purchased CP-2 and CP-1 Digital Audio Environment Processors.
Neve	Music Grinder Studios has relocated to a Hollywood Boulevard facility with an 8108-48 console. Westlake Studios (Los Angeles) has upgraded its consoles with a VR60 with Flying Faders in Studio A and a VR72 with Flying Faders in Studio D.
Solid State Logic	NBC Studios (New York) has installed an SL 4000 G Series console.
Soundcraft	Sales: Timberline Productions (Phoenix), a 16-channel 200 B/VE console; TAM Productions (San Jose, CA), an 8-channel 200 B/VE console; and Main Street Productions (Richmond, VA), a 16-channel 200 Delta console.
Trident Audio	Gnome Productions (Hollywood) has taken delivery of a 44-input Trident Series 24 console.
DESIGNERS	
Pilchner Associates/Toronto	Construction completed at Winfield Sound recording studios (Toronto).
Walters-Storyk Design Group/New York	Completed renovation of the Manhattan School of Music's recording facility, lobbies and various student/teacher dining and lounge areas.

What's DAT? Anyone considering buying a DAT machine should check out the new Panasonic/Ramsa SV-3700. The 3700 was heavily back ordered after its release late last year. It is now readily available and offered at a surprisingly good price. The SV-3700 offers more features and improved performance at a lower cost than its popular predecessor, the SV-3500.

Studio Instrument Rentals (Hollywood) — commonly known as SIR — has expanded its main PA and electronics rental inventory and moved the pro audio production division into a separate building. Recent purchases include Crest 8001 and 7001 power amplifiers, Drawmer noise gates, dbx 160XTs and more Meyer speakers, to bring SIR's existing Meyer main PA system to 16 MSL-3s and eight 650 subs.

Crest Audio recently reported a 50% sales growth in 1990. Crest's Craig Hanbury says, "The mainstay of our business — the professional concert sound industry — just continues to grow steadily with both consoles and amplifiers. The bulk of our expansion is coming from re-entering the retail and contracting markets. We now have dedicated lines of amps specifically for both of these markets — the CC/CV Series for contracting and the

MI oriented FA & LA Series for retail. Our export business also grew considerably. Asia is one of the hotspots." The increased business has made life more cramped; Crest plans to move into a larger facility sometime this spring. The first of Crest's new NexSys amplifier control system units are scheduled to be shipped in April.

Odds and Ends: Burns Audio provided sound reinforcement for the Grammy Awards at Radio City Music Hall in New York. Burns' recently opened Washington D.C. facility handled the February 20th televised event. Burns also has locations in Los Angeles and Las Vegas ... JBL's Concert Series rigging hardware is now available for general distribution through Sound Manufacturing Inc. (North Hollywood) ... Console manufacturer ATI recently sold two Paragon consoles to Sorter S.A. (Madrid, Spain). Sorter is the first European sound company to take delivery of a Paragon ... Schubert Systems Group (North Hollywood) reported steady one-offs and short tours in the Midwest and on the West Coast with David Sanborn. Al Jarreau played sporadic dates in Las Vegas and limited rehearsals in February. Bruce Hornsby had eight arena shows in February. ■

AMS AUDIOFILE..

THE PLUS POINT



During the 1980's, one hard disc recorder both established and dominated the market - AMS AudioFile™.

AMS now announce AudioFile PLUS™ as part of a continuing policy of upgrades that take AudioFile into the 90's and beyond.

With a transfer of operating software to the latest technology 32 bit, 4 Megabyte transputer platform, AudioFile PLUS™ offers yet faster operation and the ability to accommodate a range of major new features - further distancing AudioFile from other disc based recorders.

Extended System Architecture also provides for 8 simultaneous inputs/outputs, in analogue and/or several digital formats.

Whether you have yet to make up your mind about hard disc recording or you already own an AudioFile, you'll find it comforting to learn that this system upgrade is once again available for all existing AudioFiles.



ams
A Siemens Company



Setting the pace for hard disc recording

AMS Industries plc
Billington Road, Burnley,
Lancs, BB11 5ES, UK
Tel: (0282) 57011 Fax: (0282) 39542

AMS London: (01) 722 3925 AMS USA: (203) 792-4997

New York: (212) 586 7376 Chicago: (312) 527 4569
LA: (818) 845 0199 Seattle: (206) 842 7182

Circle (9) on Rapid Facts Card

Fresh Tracks

The Phil Woods Quintet + One: "Flash"

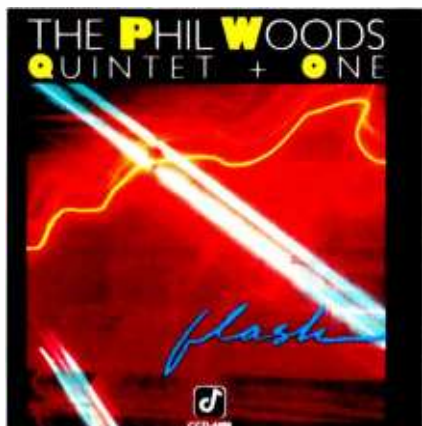

Label: Concord Jazz
Executive producer: Carl E. Jefferson
Produced by: Bill Goodwin
Recording and remix engineer: Jim Anderson
Assistant engineer: Stan Wallace
Recorded and remixed at: A&R Recording Studios, New York
Mastered by: George Horn
SPARS Code: N/A

Comments: What can Dolby SR do for jazz? In the hands of a capable engineer, the answer can be astonishing. The "warmth" and "full-bodied" nature of analog recordings can, and does, shine through without the anomalies of harsh digital artifacts.

Of special interest: With Mr. Anderson's understanding of the dynamic range of his new SR cards, you can appreciate the increased dynamic range of these sessions without the fear of distortion or clipping. Analog is not yet dead; have a listen and learn from a master. ■

The Lew Tabackin Quartet: "Desert Lady"

Label: Concord Jazz
Executive producer: Carl E. Jefferson
Produced by: Lew Tabackin and Allen Farnham
Recording and remix engineer: Jim Anderson
Assistant engineer: Blaise Sires
Recorded and remixed at: A&R Recording Studios, New York
Mastered by: George Horn
SPARS Code: N/A

Comments: This is quite possibly the quintessential jazz standard album. Manufactured by one of the craftiest rhythm sections around, this recording emphasizes how performance and production can equally render greatness. Each performance is reinforced by superb, thoughtful recording techniques. What's often missing in modern jazz recordings is revealed here in a natural live recording environment, replete with superb spatial placement and wide frequency response.



Of special interest: You'll find little in the way of rapid-fire FX processing or grandiloquent MIDI protocol; the stylistic medium won't support it. However, you will unearth tried and tested microphone placement and mixing skills that subtly augment the emotional nature of this recording session. ■

Guarneri Quartet: "Beethoven: The Early String Quartets"



Label: RCA Gold Seal
Produced by: Max Wilcox
Engineered by: Richard Gardner (recorded in 1969)
Digital remastering by: Nathaniel Johnson (supervisor), Marian Conaty (engineer), Max Wilcox (consultant)
SPARS Code: ADD

Comments: The Guarneri's cycle of Beethoven String Quartets has been re-released on three sets of three compact discs each, originally recorded between 1966 and 1969. The other two sets cover "The Middle Quartets" and "The Late Quartets." All three recordings are stunning for their clarity and sensitivity. It doesn't get any better than this.

Of special interest: The performances are superb — in our unanimous opinion, these are the definitive versions. This would be a good place to start a collection of Beethoven Quartets, and those who already have Beethoven Quartets might want to replace other versions with these. The performances are so transcendent that it is difficult to concentrate on the recording, yet the interplay and spatial placement of the strings are masterful. ■

THE MOST IMPORTANT DIGITAL EQUIPMENT ISN'T WHAT YOU THINK IT IS.



It's the tape.
And it's why Sony is so totally in-sync with every aspect of digital recording.
Because we pioneered virtually every major digital tape format: 1630. FI. DASH. DAT.
And since we also developed the digital hardware they perform on, we didn't merely
learn each tape's parameters through trial and error.

Moreover, each Sony tape is designed to capture the ultimate in digital sound.
Which is precisely why we're as committed to digital audio tape as we are to digital
recording itself.
So if you're committed to the quality of what people hear, just think Sony.
The Leader In Digital Audio.™

SONY
PROFESSIONAL TAPE

Circle (10) on Rapid Facts Card

World Entertainment War



Label: Popular Metaphysics/MCA
Produced by: Marc Senasac
Engineered by: Marc Senasac
Mixed by: Marc Senasac
Recorded at: Alpha and Omega Studios, San Francisco
Mastered By: Stephen Marcussen, Precision Lacquer, Los Angeles
SPARS Code: AAD

Comments: Not since "The Wall" has an album been released with such expansive vision, with so much pure ambition — yet WEW and Senasac pull it off. The songs span the range of funk, alternative rock and progressive. The engineering is an integral component of the vision, and it excels. Senasac has been steadily gaining respect among engineers for the last few years. He may be one of the brightest young stars on the engineering horizon.

Of special interest: There is so much music packed into the mixes, they invite multiple listenings, yet the rhythm section remains clear and up front. The guitar tones are great. ■

FOCUS:

MARC SENASAC, Producer and Engineer, World Entertainment War

R•E•P: The record sounds very different from their live show ...

MS: Not anymore. Their live show now sounds like the record, because I worked with them for two months after the record was done.

R•E•P: So they've brought all of the sampling out to the live show?

MS: Yeah. When we first started, they said, "Let's do some sampling that's new." And I said, "Well, I'm not going to go sample somebody else's record," so everything that's sampled on that record is from their record.

R•E•P: Recursive sampling!

MS: Right. In "Snake Dance," there's parts of three other songs in it, so I had to do all these pre-mixes before so I could put samples of songs in songs.

R•E•P: What box did you use for the flange effects on the vocals on "In A Crisis"?

MS: No box. That's real tape flange.

R•E•P: You couldn't have used your [Ampex] ATRs — they mess up if you lean on the reels ...

MS: Well, on an ATR you would just put your hand on that little capstain part. But I used two Otari MX5050s for this. Everyone knows tape flange sounds better than black-box flange, but usually people don't want to put the time into it. That was a big luxury for me on this record. Sandy [Pearlman, label head] encourages experimenting — he never talks about how long it's taking, he just says "make it good." He really stresses that. He's used to spending a lot of time on his *own* albums, but for me, this was a long time — five months.

R•E•P: Alpha and Omega has an API console with Diskmix and Moving Faders ...

MS: Right.

R•E•P: Doesn't it drive you crazy that at the beginning of every mix, the computer moves all the faders down to zero before bringing them up to your marks?

MS: I used to hate this system, for that and other reasons, but it doesn't do that anymore. We got a software update, version 1.3, and they've just added a new card and a 16-bit processor; the resolution on the faders is three times what it was.

R•E•P: Your studio has two APIs of about the same vintage. Are they comparable?

MS: No, they're quite different. The one upstairs has these EQs that were designed to be automated — API 954Cs. The automation never worked that well, but they're completely sweepable — there are no steps or detents. I love the sound of that equalizer; whatever they did to it to automate it made it sound great. And there are only three boards like this in the world.

R•E•P: What did you mix down to?

MS: Half-inch analog, on the ATR 102, with Agfa 468. I tracked with 468, too. I like Ampex, but it seems to get some kind of low-end buildup after awhile. And you can print really hard on 468 and there's no print-through. The mixes were pretty intricate and the album is long — Marcussen and I spent three days in mastering, just attending to little tiny details.

— By Dan Levitin

TANNOY
MONITOR
SERIES

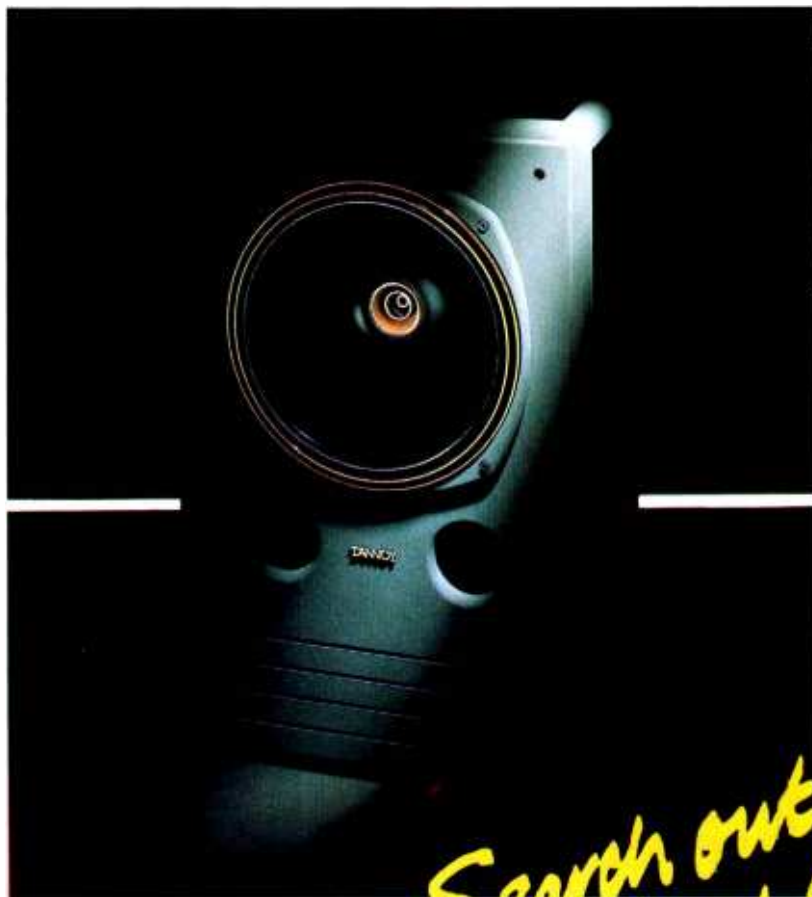

*Search out the
Gray and Gold*



TGI/TANNOY, 300 GAGE AVENUE, KITCHENER, ONTARIO, CANADA N2M 2G8.
TEL: (519) 745 1158. FAX: (519) 745 2364.

Circle (11) on Rapid Facts Card

TANNOY LTD., ROSEHALL INDUSTRIAL ESTATE, COATBRIDGE, STRATHCLYDE ML5 4LE, SCOTLAND
TEL: (0236) 20199. TeX: 778621 TANMEGG. FAX: (0236) 28230.

Our new professional DAT recorder you'll have to look at DAT in a

Time Code. It's about time someone perfected time code for DAT. And Sony's new PCM-7000 DAT recorders have done just that. They make time code based editing easier than you ever thought possible. They allow you to read and generate SMPTE, EBU or film rates which can be prestriped, poststriped or recorded simultaneously with your audio. They even let you translate from one time code rate to another during playback. All of which means if you're not using a Sony professional time code DAT recorder, you may want to take a closer look at what you're missing.

Speed and Size. When speed counts the PCM-7000 recorders are the tools you want. They have a shuttle speed 175 times play speed, which lets you locate cues or lock to other equipment faster than with open-reel systems. They also come with helpful menus and self-diagnostics for fast set-up and easier maintenance. But speed isn't the only issue. Size is also important. Unlike reel-to-reel recorders, you can fit any of our new DAT recorders into just 5 1/4" of rack space. In addition, each DAT tape can fit two hours of stereo digital audio into a package smaller than a standard audio cassette, saving you plenty of storage space. And since DAT tape costs about one-third of analog open-reel tape, most facilities could save enough in the first year to pay for the recorder.

Instant Start. If you need "On-the-Air" or "On-the-Fly" cueing, you can equip our new DAT recorders with Instant Start. It's simple to use. Just mark and trim the starting point, then press PLAY. You'll get instantaneous audio output with absolutely no start-up "wow." To make it even more convenient, you can initiate Instant Start with a fader-start or GPI.

Chase Synchronization. With the internal Chase Synchronization option of the PCM-7050 and 7030, you can press a single button to lock to any time code based equipment—whether it's a VTR, ATR or a second Sony PCM-7000. You can also enter or capture an offset instantly and maintain synchronization with the time code data or from an external reference.

The System. The PCM-7050, 7030 and 7010 time code DAT recorders are all designed and constructed for professional use. They each offer clear advantages in sound quality and operating economy over conventional analog recorders. They're smaller and faster than analog recorders. And when you add the RM-D7300 edit controller to the PCM-7050 and 7030, they create a powerful electronic editing system. No other DAT manufacturer offers you this kind of system approach because no other manufacturer looks at DAT quite the same way as Sony. For more information, call the Sony Professional Audio Group at 1-800-335-SONY.

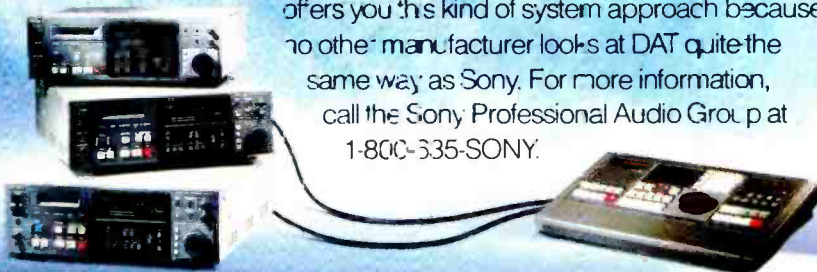

Professional Inputs and Outputs. It goes without saying that you can connect these DAT recorders with a variety of I/O's—like balanced XLR analog I/O's or optional digital I/O's, including AES/EBU. This enables you to transfer audio to digital VTR's and just about any other professional audio equipment you desire.

Recorders have so many features, a whole new way.

External Control. Our new DAT recorders offer you several external control options—an RS-232C port for computers, parallel connectors for external synchronizers and a 9-pin serial port on the PCM-7050 and 7030 for compatible video editors. So you can control our DAT recorders from just about any source you choose.

Off-Tape Monitoring. A sophisticated four head design lets you monitor off-tape as you record. So you'll always be confident of the quality of the recorded signal.

Electronic Editing. Plug the PCM-7050 and 7030 into the RM-D7300 edit controller and you'll be able to capture edit points in RAM memory, trim with the jog wheel and preview edit points before committing them to tape. You'll also be able to set the crossfade time from 0 to 999 ms and digitally adjust the audio level for the smoothest transition possible. It's definitely the best way to edit DAT.

Audio Quality. We've minimized phase distortion in our new DAT recorders by giving them 18-bit D-to-A converters with 8 times oversampling—and A-to-D converters with 64 times oversampling. And because they're digital, frequency response is extremely flat from 20Hz-20kHz, dynamic range exceeds 90dB and "wow and flutter" levels are so low they can't be measured. Which sounds pretty good here, but sounds even better on DAT.

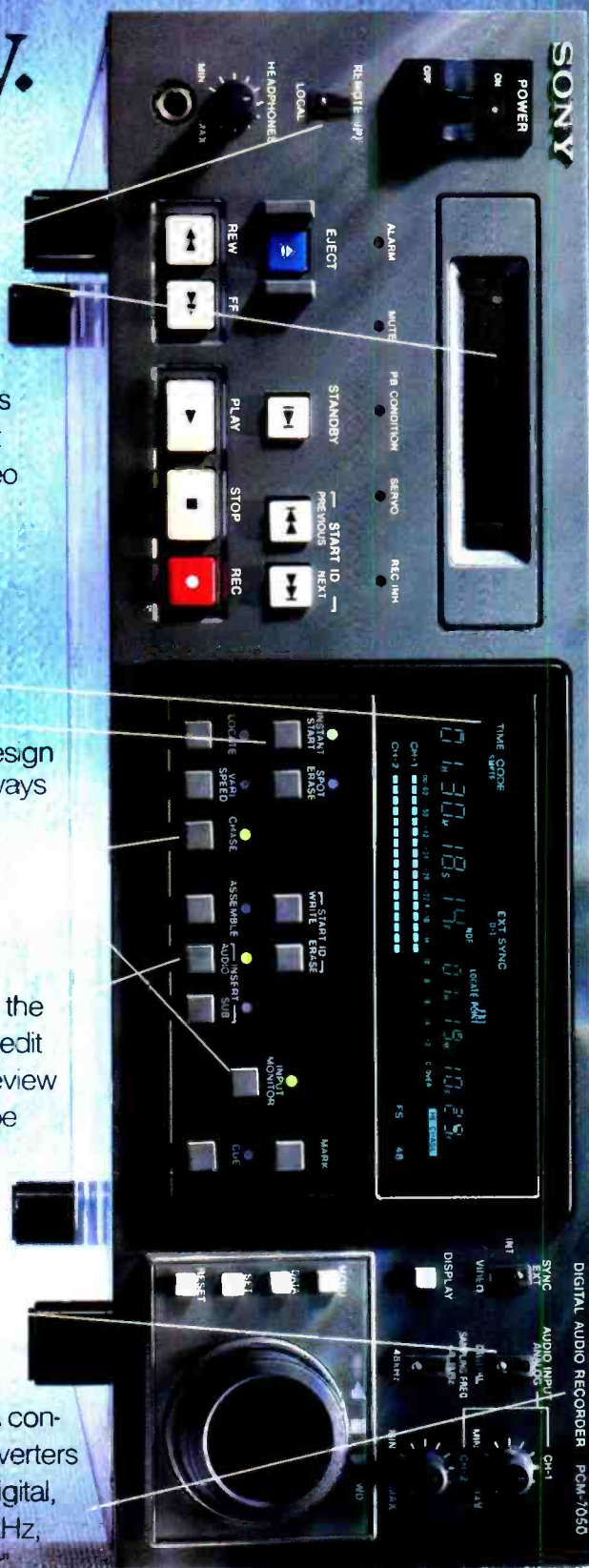

SONY

BUSINESS AND PROFESSIONAL GROUP

© 1990 Sony Corporation of America. Sony Business and Professional Group, 3 Paragon Drive, Montvale, NJ 07645-1735. Sony is a registered trademark of Sony.

Future Prospects

By Ralph E. Cousino

With the year still relatively new, it is an appropriate time to view where we are and where we are going in the audio field.

The most significant technology to impact our business has been the continuing acceptance of digital technology. Some industry observers argued against this technology in the early days of its introduction, claiming listening stress fatigue and unnatural reproduction of music. This debate has virtually disappeared with the overwhelming success of the disc. The introduction of the CD, and substantial upgrade in recorded quality of music cassettes have displaced the vinyl album product as a music carrier.

The next significant development in digital technology will be the emergence of a viable replacement for the music cassette, the most pervasive carrier of music. As you are well aware, two digital tape formats are now vying as the future replacement for analog music cassettes.

DAT has finally been introduced as a consumer product in the United States. Essentially a miniature VCR, as it uses rotary-head video recording technology, DAT's introduction was delayed because of a dispute over the machine's capability to make identical clone copies through digital recording.

The software side of the industry saw this as a major threat to the sale of pre-recorded product. This issue was settled with the hardware and software industries' negotiated settlement, resulting in the Serial Copy Management System (SCMS).

DAT provides the advantages offered by the CD, such as a linear 16-bit recording format, providing a dynamic range of 96dB, sub-channel data for both location of material and capability for graphics and other sub-channel applications. In addition, it provides a record capability, plus a longer record play time of up to two hours, compared to a CD's 74-minute play time.

Ralph E. Cousino is a newly elected member of the SPARS board of directors and vice president of technology development for EMI Music Worldwide, Los Angeles.

The disadvantage is that the present duplicating method is restricted to real time. High-speed duplication has been promised using magnetic printing technology similar to the Sony Sprinter used in video duplication. The apparent problem is the availability of barium ferrite recording tape needed for this form of duplicating.

At the recent Consumer Electronics Show, Philips announced the development of the Digital Compact Cassette (DCC). It is understood that the technology is based on multitrack digital fixed-head record/playback at the same 1 $\frac{7}{8}$ ips tape speed as the present analog cassette. This means that the format provides a record/play time of 90 minutes. Hardware will be designed to reproduce standard analog music cassettes, in addition to recording and playing back of a digital compact cassette. The duplicating technology will be similar to the current practice of linear recording at high speeds.

DCC's greatest advantage will be its backward mechanical compatibility with standard analog cassettes, while offering the advantages of new digital recording at up to 90 minutes. Its greatest drawback is the unavailability (compared to the R-DAT), with introduction reported to be mid-1992. It remains to be seen which format will succeed.

STUDIO REVOLUTION

The studio recording, editing, mix down and mastering operations have also benefited from the digital revolution. Some of the current debates center on multitrack tape vs. hard disk for multitrack original recording. There are sure to be other options to consider in the future that could include optical tape and/or disk as the recording medium. One fact is certain: The number of bits stored per unit area of recording medium continues to increase, providing the recording industry with the potential to develop new recording formats.

Another technology that continues to impact the recording industry is the low-cost DSP chip. Recording consoles have applied digital technology exceptionally well to automating the console controls. However, there has been limited application of this in the signal path. With the growing availability of powerful and cost-effective DSP chips, recording consoles will be digitized, providing many new capabilities and features.

The most exciting development with DSP technology has been its application

in audio workstations. This issue's articles on desktop production outline some of the extensive capabilities these systems have, as well as reducing noise in old tape masters, cleaning up impulse noise in historic recordings (with masters available only on disc format) and precision edits that are sonically transparent. Future software developments will greatly enhance the power of DSP technology in applications that were previously economically or technically unfeasible.

The pervasive use of digital technology has provided the industry with its benefits and new challenges. Digital quality equivalent to CD can now be delivered via cable, satellite, and in the future, by terrestrial digital broadcast. We must begin to prepare for the future control of product delivery by non-physical means. At the present time, our music product is sold as a packaged item, whereas in the future, it could well be an electronic delivery to the end consumer. The challenge is to retain commercial control over the business, which will change from packaged to electronic delivery.

Developments in data compression, in both audio and video, will provide for the growth in multimedia product. Development work to date on such systems as Compact Disc Interactive (CD-I), Digital Video Interactive (DVI) and Compact Disc-Read Only Memory (CD-ROM) will all benefit from improved compression techniques. This would provide the capability to offer a full-motion video with accompanying CD-equivalent digital audio in the compact disc format with one hour's playing time. Creative artists will no doubt exploit the capability of a cost-effective audio/video medium to create new market opportunities.

SPARS provides a good forum for a continuing dialogue with the hardware producers to assure that new studio equipment developments meet the recording community's needs. Such communications are a benefit to both parties in the never-ending quest to harness the new and evolving technologies. We can be well assured of an exciting 1991 in the recording business. There is nothing like music to keep one from becoming totally depressed with the world's day-to-day problems. ■

The Society of Professional Audio Recording Services is the industry's best source of business information. For details on activities and membership, contact SPARS at 4300 10th Ave. N., Suite 2, Lake Worth, FL 33461; 407-641-6648; fax 407-642-8263.

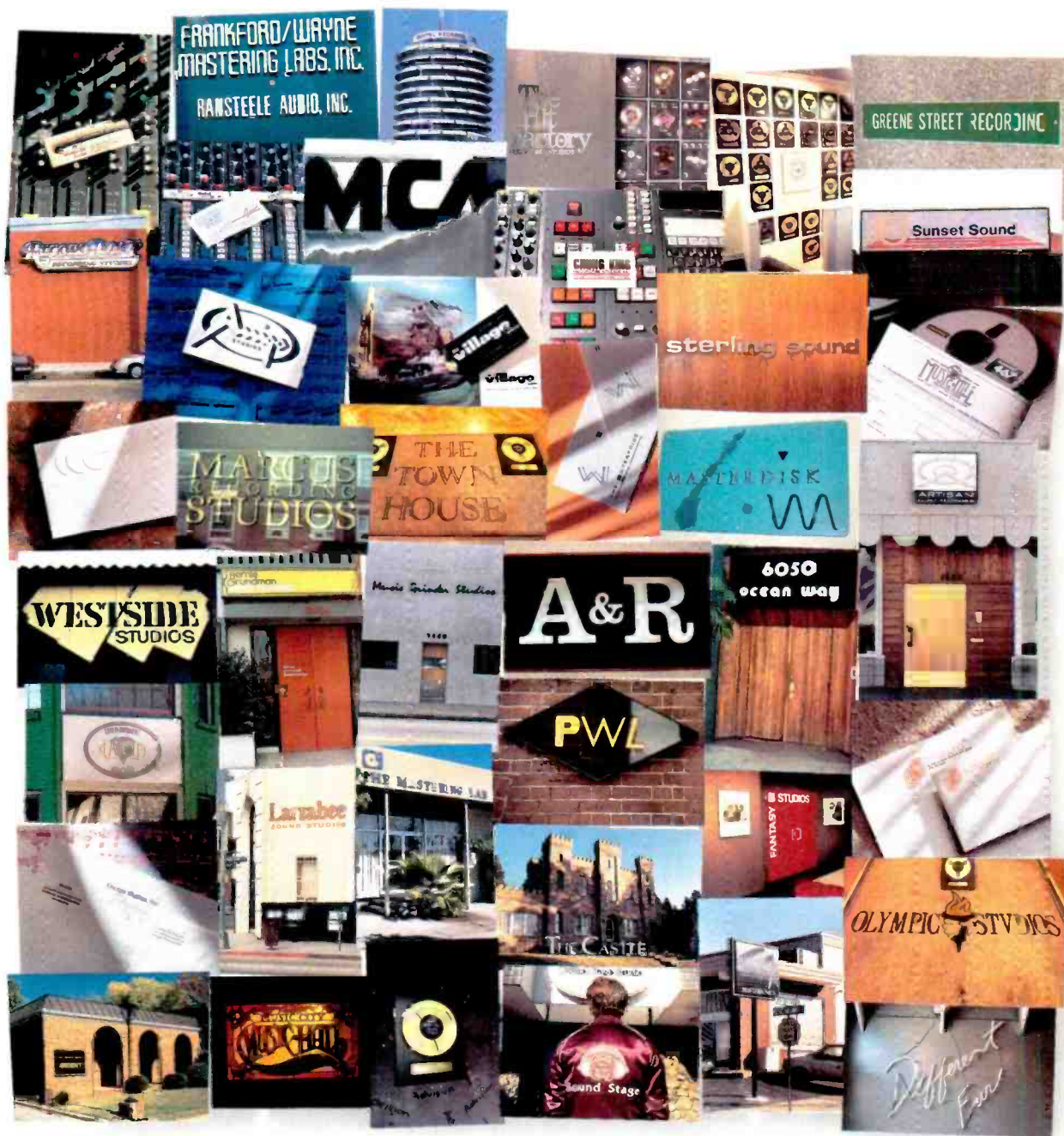

MORE STUDIOS GO GOLD ON AMPEX THAN ON ALL OTHER TAPES PUT TOGETHER.



Every studio pictured here has earned the prestigious Ampex Golden Reel Award for creating a gold album exclusively on Ampex audio tape. Find out what makes Ampex tape right for your sound. Just call or write for a copy of our new 456 Technical Brochure, and see why Grand Master® 456 is engineered like no other tape in the world.

AMPEX

A MASTER OF ENGINEERING

Ampex Recording Media Corporation • 401 Broadway, M.S. 22-0251 • Redwood City, California 94603 • (415) 367-3809

Circle (13) on Rapid Facts Card

The Audio WAN

By Rick Schwartz

Someday you will be able to record world-class musicians in your home, no matter where you live. Scheduling and cartage won't be a problem, because the musicians will never have to leave their home studios. Talkback and cue feeds will be possible, and you'll be able to watch them play via a slow-scan video feed. All you'll need is a special digital transmission line from the phone company.

By now, some of you are probably thinking, "Wake this guy up and remind him what year it is." I know, it's 1991; once again, the future is now. Many companies are already experimenting with multichannel remote links. At LucasArts, Skywalker Sound has connected its facilities in Northern and Southern California. This gives the term "remote patch bay" a whole new meaning. Now audio will be capable of the same wide area network (WAN) technology that computers already use.

THE LUCASARTS LINK

According to Tom Scott of LucasArts, "We're in the process of evaluating how to best use this remote link. Right now, we're sending audio down to Los Angeles and then looping it back so we can do A/B comparisons. Eventually, we'll have a couple of boxes down there as well, so we can send and receive audio.

"Currently we are sending only two channels (of audio), but it's clear that four to six channels would be very desirable for film applications. In the past, if there was a screening in Los Angeles, we would need to put someone on a plane with a bunch of reels of film. We're now looking at the possibility of setting up a review theater at Skywalker South and transmitting screening copies to them digitally over the phone."

T1 FOR TWO

The remote link that LucasArts is using has been made possible by special T1 transmission lines and data compression.

T1 is a digital transmission standard that uses either optical fiber or a special type of coax to achieve a 1.54Mbyte/s bandwidth. A single T1 line is capable of 24 voice-grade telephone lines or four 15kHz audio lines. But data compression allows you to put 10 to 12 channels of high-quality audio on a single cable.

T1 lines are capable of simultaneous voice and data, which makes them especially valuable. LucasArts has three different systems that use its T1 digital highway — its accounting system, a Macintosh network and a network of UNIX workstations.

"We've tied our two phone systems together as well — now Los Angeles is a local call, even though it's 400 miles away. I can even forward a call to L.A. It's ironic that our phone system (Pacific Bell) would be funding such an esoteric experiment in audio," Scott says.

T1 lines are capable of simultaneous voice and data, which makes them especially valuable.

REMOTE MIXING

In the next year, LucasArts is hoping to do multilocation post-production. According to Scott, "By early 1992, you'll be able to call the phone company and say, 'I'm going to need a T1 between San Francisco and Los Angeles between 4 p.m. and 7 p.m.' If you need to do a large transfer, you can 'dial-up' a few more T1 lines and send all 24 channels down at once.

"Of course, there are still many questions that need to be answered. Do you send SMPTE time code with the audio or do you multiplex the remote of the tape machine? Our ultimate goal is to be able to lock one machine to another (remote) machine. In other words, you could be sitting in L.A. and press play on the film projector, which would tell the tape recorder up north to synchronize to the projector and send the digital audio 'down-the-hose.'"

Other possible applications are things like remote recording. For example, if you wanted to send 10 to 12 channels from a

remote site back to the recording studio, without taking out a remote recording truck, all you would have to do is call in an order for the lines.

AUDIO DATA REDUCTION

I spoke with William Mead of Dolby Labs; he informed me that the company has two different types of data compression technologies—the first being Dolby AC-1, which has been around for about five years.

"AC-1 uses a scheme that provides about a 2:1 compression ratio over 16-bit PCM. Right now, it's being used primarily on satellite applications. The system has its own internal error-correction which can sustain the type of errors common to transmission links. AC-1 uses a technique called adaptive delta modulation, while AC-2 uses transform coding, both of which should produce no audible loss in sound quality. The encoder takes in an analog signal on an XLR connector and produces a digital bitstream from it. With AC-1, the encoder is complex, but the decoder is so simple that it can be implemented using a low cost IC. With AC-2, the costs are equally divided between the encoding and decoding technologies.

"AC-2, which LucasArts uses on the T1 transmission lines, is our latest technology. It was introduced about a year ago at AES. We see this technology as the one that will ultimately be used in hard-disk editing systems and off-line audio storage. AC-2 provides approximately a 6:1 ratio over 16-bit PCM.

"There are tradeoffs with any type of data rate reduction — one is quality, another is time delay (around 20ms) and the third is cost. Right now the technology is fairly expensive and decoders sell for about \$3,000 each. In the future, prices will drop as more manufacturers implement it into their products on a licensing basis."

BUT HOW DOES IT SOUND?

In the past, data compression had a less than perfect reputation for audio applications. I asked LucasArts' Tom Scott about the results of the remote listening tests. He replied, "When you're listening to the sound off of a Dolby SR dubber and then switch to the same sound that has been digitized, sent to L.A. and looped back to the speakers up here, they're virtually indistinguishable. We haven't discovered any limitations to the technology yet." ■

Rick Schwartz is a contributing editor to R•E•P and director of post-production at Music Animals, Los Angeles.

SAMPLE RATE SHIFTING MADE EASY.



**Introducing the NV4448 Digital Audio Sample Rate Converter
with the power to shift smoothly between rates from
32 kHz to 50 kHz.**

The NV4448 gives you 24 bit processing power to meet any professional audio application. All digital format and rate conversion between AES/EBU, SDIF and SPDIF machines in a compact 1 RU package.

Let our technology leadership give you the highest performance you can buy at a price you can afford. See our extensive line of digital audio products at NAB.

NVISION™
PAVING THE WAY IN
HIGH DEFINITION TELEVISION

NVision, Inc. P.O. Box 1658 Nevada City, CA 95959 (916) 265-1000 FAX: (916) 265-1010

Circle (14) on Rapid Facts Card

Digital audio production: Changing the way you work.

TAKING IT TAPELESS

By Rick Schwartz

Tapeless desktop production was around long before someone coined the term digital audio workstation (borrowing the workstation part from the computer industry). The first commercially available tapeless production tool was the digital sampler, which appeared as early as 1982 from companies such as New England Digital and Fairlight. These samplers were not inexpensive, and were designed specifically for musical applications.

That same year, James Moorer published several technical papers about a new device called the Lucasfilm Audio Signal Processor (ASP). The Lucasfilm ASP was the only editing system capable of processing audio entirely in the digital domain.

Three years later, New England Digital introduced the first commercially available multitrack hard-disk recorder. By then, the Lucas division of DroidWorks was working on a digital audio processing station, later known as the SoundDroid. This multiuser, disk-based system included an Ethernet network, console automation and digital signal processing.

Although the SoundDroid didn't get far in the marketplace, DroidWorks was clearly ahead of its time. Almost 10 years later, manufacturers are just now introducing systems with features found on the SoundDroid.

WHAT'S IN A SYSTEM?

There are two basic types of digital recording systems: Linear tape-based systems and non-linear, random-access systems. The latter are either magnetic or magneto-optical disk-drive-based. This is the group that we will address.

Before we get into the many advantages of tapeless production, let's talk about the basic building blocks of a digital audio workstation (DAW).

All DAWs contain four main parts:

- A computer (or CPU).
- Operating software.
- A user interface.
- Input and output converters (I/O).
- A storage device.

Manufacturers take one of two approaches to incorporating a central processing unit: design modular systems that use off-the-shelf computers, or design proprietary, stand-alone systems. Stand-alones, such as the AMS AudioFile, use their own built-in computer. One advantage of a custom computer is that the manufacturer can optimize its operating system (OS) for digital audio applications. A custom OS can reduce the system's need for memory overhead, resulting in noticeable speed improvement.

In addition, designing a custom computer means the manufacturer can truly optimize the user interface for audio production. Some manufacturers replace the standard QWERTY keyboard with a custom interface designed specifically for audio work, using controllers that are conventional in appearance and function. For example, the Lexicon Opus offers a scrub wheel, soft keys and audio faders in a standard-appearing console. Concealing the computer from the user can minimize learning time and make the system less complicated to use.

However, using an off-the-shelf system, instead of a custom job, is often more financially expedient. Major computer manufacturers spend millions each year improving their products. As a result, off-the-shelf computers are periodically better, faster and cheaper. Audio system manufacturers needn't worry as much about the computer and can concentrate on enhancing audio-specific hardware and software.

Continued on page 72

Rick Schwartz is a contributing editor to R•E•P and director of post-production at Music Animals, Los Angeles.

A ROOM EQUALIZED TO PERFECTION
MULTITRACK TO MIXDOWN
STUDIO MONITORS REVEAL
THE ENTIRE SOUND SPECTRUM

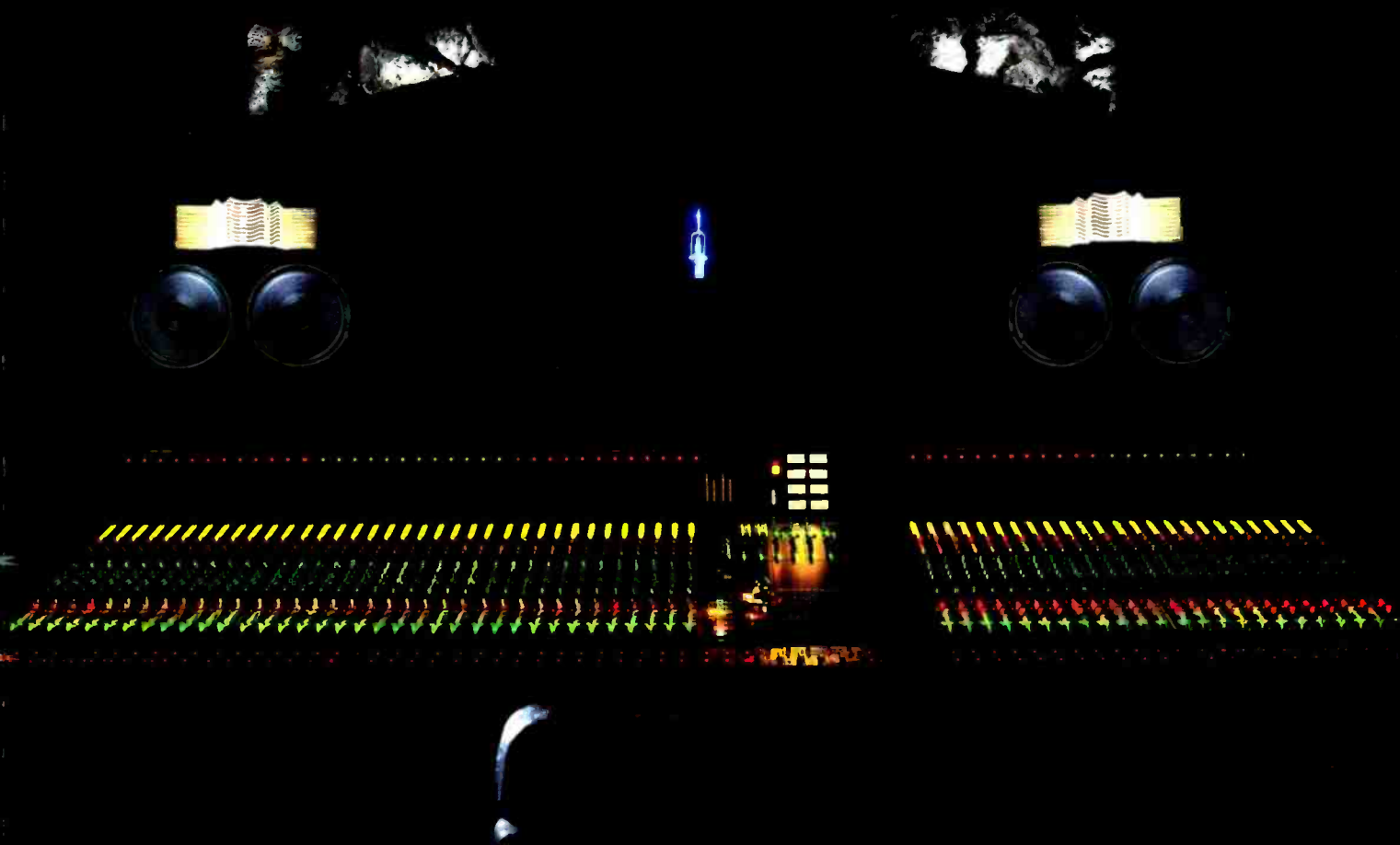

Now the excellence of sound experienced by engineers and producers
can be duplicated on Sunkyong Pure Chrome Tape.

What the producer hears, chrome remembers.

UCR Pure Chrome Professional Duplicating Tape from Sunkyong.

Because the time has come for the world to share the excitement of studio sound.

SUNKYONG
Professional Products

Sunkyong Magnetic/America, Inc., 4041 Via Oro Avenue, Long Beach, CA 90810 1-800-331-5729 Outside CA 1-800-237-8372

Circle (15) on Rapid Facts Card

TAPELESS TECHNOLOGY

Sampling the universe.

By Linda Jacobson and Brent Hurtig

As the saying goes, the journey is as important as reaching the destination. To frame that in tapeless audio production terms: There are many systems that record and edit audio, but the way we go about using a system's functions is what makes the difference.

The following is a comparative description of most of the major tapeless editing systems available on the American market as of January. Other systems may exist, but the landscape changes rapidly.

Comparisons are relatively easy when discussing tape recorders, but no standards exist for comparing tapeless systems.

For example, one company's idea of an on-screen mixer may consist of a few simple "faders;" another may offer a full-blown virtual console, complete with EQ and DSP effects. We hope that this alphabetical listing serves as a guide to help direct you toward systems that meet your performance requirements. Remember, prices, specs and features change often. Although every effort has been made to ensure accuracy, check with the manufacturers for details on the exact configuration you are interested in. Also, it is critical to spend time actually using a system before you buy. Only then can you ensure that you'll be satisfied at the journey's end.

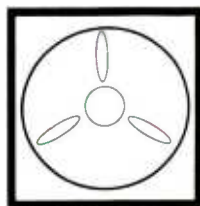

A

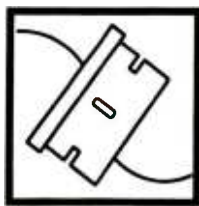

B



C

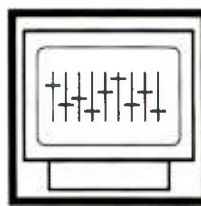

D



E

KEY TO ICONS

A "Virtual" tape deck: A disk-based recording system that provides all of the capabilities of a multitrack recorder. Number = tracks.

B Editing workstation: Allows for nondestructive cut-and-paste editing, typically down to the waveform (subframe-resolution).

C System features console hardware interface, which provides actual faders. Number indicates fader channels available.

D System features an on-screen (virtual) mixing console.

E System has facilities for digital signal processing (equalization, time compression/expansion, etc.).

Linda Jacobson is a former staffer at *Mix* and *EQ* magazines and is the owner of Wordwork, a technical writing and publishing company based in San Francisco. Brent Hurtig was the original editor of *EQ* and is a free-lance writer based in San Francisco.

Akai DD1000

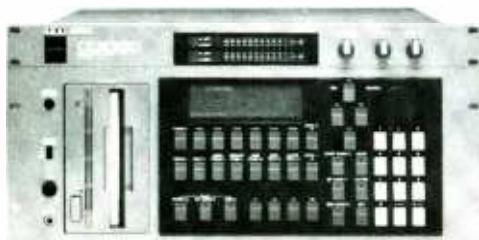

In theory, erasable optical disks represent a near-ideal storage format. Like hard disks, they allow rapid data retrieval. Unlike hard disks, they are much less susceptible to the ravages of dust, power surges and time. Until recently, most optical disks were WORM (Write Once, Read Many), making them useful for archiving, but not for daily work in which tracks are overdubbed and edits made repeatedly.

The first mass-market audio recorder that records directly to a removable optical disk is Akai's DD1000, a stand-alone, rack-mount recorder.

The DD1000 records up to two stereo pairs of tracks to disk, one pair at a time. Using MOD (magneto-optical disk) technology, the device records just over 29 minutes of stereo audio

(at 44.1kHz sampling), with additional disk drives addable for extended time. It has two discrete balanced XLR inputs and four discrete outputs, as well as AES/EBU digital I/Os. The deck can be locked to external SMPTE/EBU time code, LTC or VITC.

Although the DD1000 can function as a regular, easy-to-use 2-track, it can also handle sophisticated editing and signal processing. The current version features nondestructive cut-and-paste editing; version 2.0 will offer digital EQ and time compression/expansion. The optional DL500 trigger interface lets the DD1000 cue and play cuts much like a standard cart machine. System prices start at \$13,500.

AKG DSE7000



AKG's DSE7000 is the only tapeless system currently marketed for radio production. From a distance it resembles a small on-air board, although a color video monitor and jog wheel betray its digital soul. The console includes an onboard 10-channel digital mixer, a pair of internal speakers, and — completely transparent to the user — a 386-type PC-compatible computer.

No computer knowledge is needed to operate the DSE7000. The only time a user touches the computer keyboard (stored on a tray under the console) is to type project titles; it has no mouse to manipulate, no computer functions to learn, no on-screen faders to tweak. The DSE7000 offers dedicated buttons (Help, Undo, Record Ready) and familiar transport

controls (Record, Rewind, Cue). Program directors, engineers and DJs comfortable with analog production may adapt to the DSE7000 more quickly than some more software-interactive systems.

The DSE7000 is RAM-based, not disk-based; recording, editing, and playback happen in near-instantaneous random access memory. (Hard-disk options are available for making safety copies and data backup.) The eight digital audio tracks can be mixed internally to stereo.

Recording times are limited (4.4 track-minutes at 32kHz sampling, 15kHz upper bandwidth; expandable to 17.6 track-minutes with optional RAM cards). System price range (includes computer): \$37,500 to \$53,600.



Alpha Audio DR-2



Alpha Audio, which created the Boss audio editing system, also offers the DR-2 digital 2-track hard-disk recorder. The DR-2 is designed to replace a standard 2-track open-reel deck. Thanks to familiar transport controls, it does so with minimal operator training.

There's more to this rack-mount machine than simple 2-track recording. The "Cuestacking" function lets the DR-2 function as a digital cart machine, with instant locate and play of up to 256 start and stop points. Nondestructive cut-and-paste editing is available, although at this time there are no DSP options such as EQ or time compression/expansion. Balanced XLR analog I/Os are standard; a digital I/O option is nearing production.

There are two ways to control the DR-2. The

DR-2 Edit Controller is a small, sleek, remote that sports a jog/shuttle wheel, 10-key pad, dedicated buttons, LED meters and a small LCD. For a graphic display of the DR-2's functions, the DR-2 can be controlled optionally by a PC-compatible computer (AT-type), although the DR-2 Edit Controller can control all functions without the help of an external computer.

Depending upon hard drive size, storage capacities at 44.1kHz sampling are 15, 30 or 60 minutes stereo (30, 60 or 120 minutes mono). Archiving is on 8mm tape. The DR-2 generates and reads SMPTE/EBU time code (LTC) and can emulate a Sony BVU deck. It's also compatible with CMX and Grass Valley video editors for external control. System prices start at \$10,000.



AMS AudioFile Plus



Advanced Music Systems' original AudioFile was one of the first hard-disk recording systems. The latest version, the AudioFile Plus, isn't inexpensive, but it is among the most comprehensive and powerful of all digital audio workstations. The system consists of a "controller surface" and two outboard racks, one for the hard disks, and one for processor cards and analog and digital I/Os (balanced XLR analog; AES/EBU, SPDIF, SDF2, ProDigi and MADI digital I/Os). The AudioFile Plus can interface digitally with the company's Logic One or Logic Two digital mixing console for hands-on digital mixing.

Although the AudioFile Plus handles simple 2-track production, the base unit can function as an 8-track digital recording system with eight

discrete inputs and outputs. An expanded version offers 16-track recording (eight inputs, 16 outputs). The base unit offers up to two hours of mono recording (at 44.1kHz), equivalent to one hour stereo or 15 minutes of 8-track recording. Total recording time is expandable to eight hours mono. Archiving is to DAT or optical disk.

DSP functions include time compression/expansion, simulated reel-rocking, varispeed and crossfades; also, cut-and-paste is supported. One clever software feature, "Jukebox" mode, simulates eight cart machines, with as many carts stacked up as the total recording time allows, each controlled by trigger keys. System prices start at \$95,000.



Digidesign Sound Tools



Although Sound Tools is one of the most affordable digital systems, it handles serious production work. There are probably more Sound Tools systems installed worldwide than any other hard disk 2-track system. The system is based on the Apple Macintosh computer, and components are either installed in the computer as cards or are separate freestanding or rack-mount pieces.

The basic Sound Tools consists of Digidesign's Sound Accelerator DSP card (fitting internally in the computer), Sound Designer II Audio Editing software and an analog or digital I/O interface. A simpler card than the Sound Accelerator is available in the Audio Media, although limited in features. An unbalanced analog interface is available, but most production

facilities will want the rack-mountable Pro I/O (balanced +4dBm XLR I/Os, high-grade digital A/D and D/A converters). An all-digital DAT I/O is also available.

Recording time depends upon the hard disk: every 10Mbytes of disk space records about one minute of stereo (at 44.1kHz sampling). DAT-storage software comes with the Digital Interface.

Because Sound Tools can play back a single stereo event at any given moment (or stereo pair, using Digi's DECK), some may find it less suited for complex sound effects assembly than systems that allow simultaneous playback of multiple files. System prices (excluding computer and hard disk) start at \$3,285.

Digital Audio Research SoundStation II



In package design alone, SoundStation II is a winner. The desktop-sized Control Console is a striking blend of jog/shuttle wheel, dedicated controls and touch-screen display. DAR has created software that lets you select various audio events and manipulate them by touching the screen with your fingertip.

The SoundStation II — a disk-based system — is available in 4-, 8-, or 16-track models, with up to 16 channels of XLR balanced I/Os. AES/EBU, SDIF2 and SPDIF digital I/Os are standard. A separate processor and disk rack holds hard disks, CPU and I/Os. Depending upon hard disk size, recording (44.1kHz sampling) is between two and eight hours of track-minutes. For instance, an 8-track system, with the largest drive, records up to an hour of 8-

track audio. Archiving is to DAT or a magneto-optical drive. The system can lock to external SMPTE/EBU time code (LTC); it also follows the Sony P2 external control format.

Familiar DSP functions, such as time compression/expansion and EQ, are available (real-time EQ processing is an option). The unique "Wordfit" option is ideal for performing automatic dialogue replacement for video or film. Wordfit compares the original location-recorded track with the new replacement track recorded in the studio; the typical replacement track is slightly "out of sync" with the original. The replacement track is then processed to start and end in the same time as the original. System prices start at £41,000 (approximately \$82,000).

Digital Dynamics ProDisk-464



Think hard-disk recording is fine for editing but not multitrack production? Consider Digital Dynamics' ProDisk-464: With a Macintosh as front end, the system expands to 64 discrete digital tracks, each track with its own XLR I/O — and with total recording time (44.1kHz sampling) of up to three hours per track! The standard ProDisk-464 starts with four discrete tracks and more than 30 minutes per track.

Unlike some other Mac-based systems, which use the computer to help process audio, the ProDisk-464 uses the Mac as the graphic interface to its own system controller, housed with the hard disks and I/Os in a separate rack. Any recent Mac works with it. The

ProDisk-464 expands four tracks at a time; each 4-track upgrade includes I/Os and a disk drive. Aside from the standard balanced XLR I/Os, optional digital I/Os are available in AES/EBU, SPDIF, SDIF-2, Yamaha, and ProDigi formats. Archiving is to 8mm tape.

The current ProDisk-464 has scrubbing, cut-and-paste and edit decision list capabilities. It can read or generate SMPTE/EBU time code (LTC) and MIDI Time Code. Digital Dynamics is scheduled to offer extensive DSP, including EQ, track mixing and time compression/expansion. System price range (excluding computer, beginning with 30 minutes per track recording time): \$28,495 to \$279,995.



ROGER MASTERED DIGITAL TEN YEARS AGO, AND THE DD1000 OVERNIGHT.

Roger Nichols has been a premier proponent of digital recording since engineering his first digital master in 1981. Today, Roger's blessing on new digital technology is considered by many as the ultimate approval. That's why he extends his blessing sparingly.

It only took an evening for Roger to embrace the power and potential of the DD1000 magneto-optical digital mastering recorder. He discovered how quickly and easily the DD1000 constructs songs, combines sound effects with music, edits dialogue with total precision and syncs cues to video as easily as manipulating text in a word processor.

According to Roger, "The DD1000 combines all of the benefits of tape with the operational advantages of a hard drive. Its removable 5¼" optical disk holds an incredible 650Mb of digital audio information. You get instant random access to as much as 90 minutes of stereo audio with 3 sampling

rates, a noise-free dynamic range of 96dB and immeasurable wow and flutter."

Roger's word to the wise? "From music composition and recording to audio post, from film scoring to broadcast, the unmatched capabilities of Akai's DD1000 will play an important role in my digital future. And if you're as serious about the business as I am, you will audition it for yourself."

The DD1000 is available for your personal inspection at all authorized Akai Digital dealers. So, what are you doing tonight?

AKAI
DIGITAL

P.O. Box 2344 • Fort Worth, TX 76113
(817) 336-5114

Circle (16) on Rapid Facts Card

Doremi Labs Digital Audio Workstation Nucleus (DAWN)

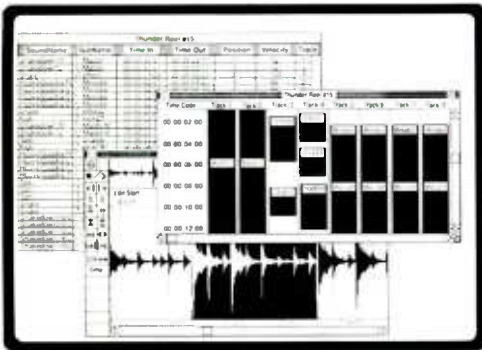

Like several systems on the market, DAWN is both disk-based and RAM-based. This allows for longer file storage (to disk) and quick access (from RAM) for editing. DAWN consists of cards and racks that can work with any recent Macintosh.

The basic system (DAWN 4+4) records four tracks to hard disk and four tracks to RAM. The advanced system, Digital-DAWN, expands this to 8-track disk recording while retaining the 4-track RAM recording feature.

Full cut-and-paste assembly is standard; DSP functions supported include gain control and waveform envelope shaping. Even the basic system sports eight discrete XLR balanced analog outputs, which means you can take full advantage of 4+4 recording. Two, four or eight

discrete analog inputs are available. DAWN 4+4 comes standard with two channels of AES/EBU or SPDIF digital I/Os; Digital-DAWN boosts this to eight discrete channels of digital I/Os.

Total recording time is limited to disk size; 10Mbytes of disk size delivers a bit more than a minute of audio (44.1kHz sampling). As for RAM time, 16Mbytes of RAM, the maximum option, records three minutes of audio (at 44.1kHz). Recommended archiving is 8mm, although DAT or optical-disk storage is possible. Sync options include reading of LTC- or VITC-format SMPTE/EBU time code (no generator at this time). Digital-DAWN has an external port available for a digital mixer, such as Yamaha's DMP-7D. System prices (excluding computer) start at \$11,000.

Hybrid Arts ADAP II



Hybrid Arts has shipped the ADAP II 2-track hard-disk recording system for more than two years. ADAP II is a stand-alone, turnkey system: a QWERTY keyboard, mouse and color monitor accompany a small rack that holds a computer, hard disk and analog (XLR) and optional digital (AES/EBU and SPDIF) I/Os.

Although the digital recorder/editor section is 2-track, an EDL/cue list mode offers simultaneous playback of up to four tracks (two stereo pairs), and a MIDI sampler mode will play up to eight tracks. Disk-based recording time (44.1kHz sampling rate) ranges from 24 track-minutes (12 minutes stereo) to 100 track-minutes (50 minutes stereo), depending upon disk size. Archiving is to DAT or removable Syquest 42Mbyte cartridges. Currently, ADAP II

has two inputs and two discrete outputs, through a 4-channel I/O option.

Editing for 2-track production is comprehensive, featuring scrubbing, cut-and-paste and crossfade functions. Time compression/expansion is a DSP option. ADAP II reads and generates SMPTE/EBU time code (LTC) and reads VITC. Aside from code, cues can be triggered by MIDI, audio click track or the computer keyboard, allowing ADAP II to function effectively as a digital cart machine for IDs, bumpers, spots, etc.

ADAP II's cost-efficiency as a 2-track production tool is appealing. And a portable ADAP II system is now available, with most of the features of the original ADAP II. System prices start at \$9,995.

Lexicon Opus and Opus/e



The original Opus, developed by one of the digital audio pioneers, is a combination tapeless recorder/editor/digital mixer. In short, it's a total stand-alone production package, complete with a traditional-appearing console top. Opus/e is similar, but lacks the 12-fader digital mixer found on the Opus. Opus/e has an on-screen 8x2x2 virtual mixer.

Like several other tapeless systems, the Opus systems can record a large number of internal digital audio tracks — up to 99 tracks. At any given time, though, up to eight discrete digital tracks may be run simultaneously through a system's outputs. Balanced analog I/Os appear on the back panel of the rack as Elco-style multipin connectors; digital I/Os are AES/EBU and SDIF-2.

Total disk recording time (at 44.1kHz) runs three to 14 hours (a 3-hour system records more than 22 minutes of audio on eight tracks). Twenty seconds of mono RAM recording (10 seconds stereo) is available. Archiving is to 8mm tape.

Opus and Opus/e will soon include Lexicon's CPEX time compression/expansion, among other DSP functions. Both read and generate SMPTE/EBU time code (LTC only); both can be controlled by a Sony BVE video editor. Cut-and-paste is supported, as is 8-track crossfading. Lexicon has done a good job of making it easy for an experienced production person to adapt to the Opus environment. System prices start at \$90,000 (Opus/e) and \$170,000 (Opus).

Digital workstation, duplication workhorse

Introducing the KABA-DYAXIS 2 + 2 system

KABA and Studer have teamed up to offer the latest in audiocassette duplication technology. With the KABA-DYAXIS 2 + 2 SYSTEM, you can master entirely in the digital domain and double the productivity of your duplication process. This means professional results are finally affordable.

- Offers significantly greater capability at substantially lower cost than available from 2 track equipment
- Direct from digital 4-track real time recording
- Records both sides in one pass—cuts duplication time in half
- Modular design allows system capabilities to grow as you do
- 10,000+ hours transport life reduces maintenance costs, increases cost effectiveness

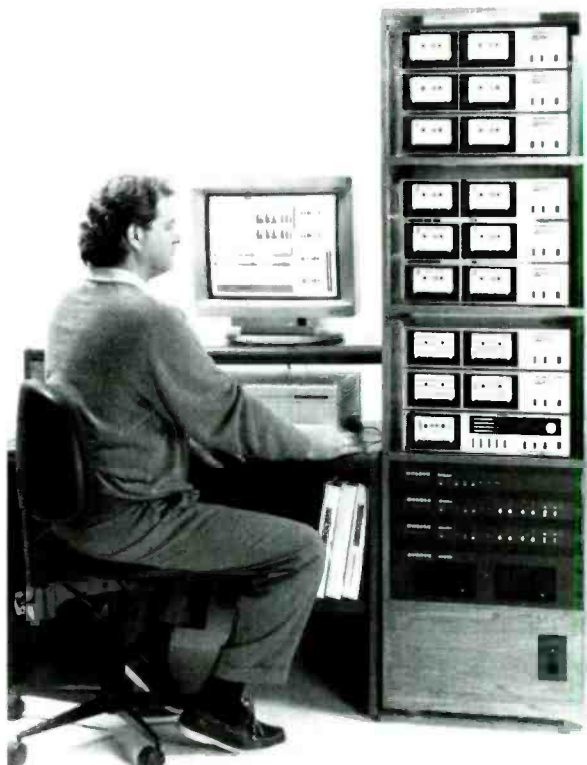

Tom Anderson, KABA-DYAXIS sales representative with 20 years recording experience in U.S. and European studios.

For all of the recording, editing and processing benefits of working in the digital domain AND the cost and quality benefits of 4 track real time duplication, get the KABA-DYAXIS 2 + 2 system. It's the super digital duper.



KABA Research & Development

24 Commercial Blvd., Novato, CA 94949 (415) 883-5041
1-800 231-TAPE FAX (415) 883-5222

Micro Technology Unlimited Microsound-AT



Enter Micro Technology Unlimited's disk-based Microsound-AT: a discrete 4-channel, 4-track version, which costs about \$1,300 per channel (excluding computer and hard drive). Configured as a 2-track, 2-channel recorder, MicroSound-AT also compares favorably with Digidesign's Sound Tools and Turtle Beach's 56K systems.

The Microsound-AT is based on an IBM PC-type platform (AT-type through 486), and supports Windows 3.0. Unbalanced or balanced analog I/Os are available; AES/EBU and SPDIF digital I/Os are options. A virtually unlimited number of internal tracks can be compiled before internally mixed as soundfiles, to be output as two or four discrete tracks. The rough guide of 10Mbytes per stereo-minute of record-

ing time (44.1kHz) applies to the Microsound-AT. Recommended archiving is to DAT or magneto-optical disk.

Time compression/expansion is available; other DSP functions (including EQ and reverb) are due for release in early 1991. For cue assembly, multiple internal stereo tracks can be triggered simultaneously. For on-air and production work, a playlist lets Microsound-AT emulate a cart machine, with manual cuing (from the keyboard) of the next spot, with prior and post spots visible. An LTC-type SMPTE/EBU reader/generator is an option; a VITC reader is under development. The Microsound-AT doesn't yet offer many interface options. System prices (excluding computer and hard drive) start at \$3,495.

New England Digital PostPro SD



Many consider NED's PostPro SD the quintessential digital audio workstation — capable of multitrack hard-disk recording, RAM-based recording, sophisticated EDL-type cue triggering, MIDI interface, disk-based editing and assembly, and more.

The PostPro SD comes with the Macintosh IIx and 16-inch color monitor, housed in a custom roll-around console. A data link cable connects the computer to a rack that houses processors, hard disks and I/Os. There are two multitrack options: 8- or 16-track. The former offers two XLR balanced analog inputs and eight discrete outputs; the latter has four inputs and 16 outputs. Digital I/Os are available in AES/EBU, SDIF and ProDigi formats.

The standard system records up to 30

minutes per track (44.1kHz sampling rate); 60- and 120-minute systems are optional. Up to 64Mbytes of RAM storage is on hand for near-instant processing. That translates to about 12 minutes of recording at 44.1kHz, with four to 32 sampling voices, assignable to eight outputs. Archiving is to DAT or WORM optical disk. Time compression and an on-screen virtual mixer with parametric EQ and six aux sends are among the available DSP functions. PostPro SD reads and generates all forms of SMPTE/EBU time code and also responds to Sony BVE and Ampex VPR-3 editor control. Future systems will accommodate multiusers on NED's MultiArc network. System prices start at \$109,000.

Otari DDR-10



With its strong history of dependable open-reel tape recorders, it's understandable why Otari wanted customers to enjoy a painless transition from tape to disk with its first hard-disk recording system. You can't use razor blades on the DDR-10, but most audio professionals will feel comfortable on this system with minimal training.

The Otari DDR-10 is a stand-alone 2-track system with built-in monitor speakers. The system is built around a Macintosh IIci, sporting a 19-inch monochrome monitor (color is optional). The operating software is a licensed offshoot of Digidesign's Sound Designer (which runs Digidesign Sound Tools). The Mac hides inside the console, and the system is controlled via dedicated and "soft" function controls, jog/shuttle wheel and a tablet-like surface

named "Unmouse" — which lets you point with a finger, intuitively, instead of with a mouse.

The DDR-10 offers all of the advanced cut-and-paste, cuing and DSP functions of Digidesign's Sound Tools. The substantial difference lies in the hardware package. With Sound Tools, the user must supply all hardware. The DDR-10 includes the computer; analog (+4dBm balanced XLR) and digital (AES/EBU XLR, SPDIF RCA) I/Os, time code generator/reader, options for 325Mbytes to 4Gbytes of hard drive storage (more than 400 minutes stereo) and 650Mbytes of magneto-optical disk — all in a self-contained console. System prices start at \$19,990.

While some transformer makers have been standing still...

We've Been Setting *NEW* Standards

- Computer-controlled Swiss winding machines for previously unattainable uniformity
- Proprietary, custom core alloys for lowest distortion
- Improved wire bonding techniques for long-term reliability in the field
- All materials are 100% inspected to our stringent specifications prior to assembly
- Higher quality, consistency and performance without a higher price
- Efficiencies and improved yields in manufacturing allow more competitive prices in high quantities.

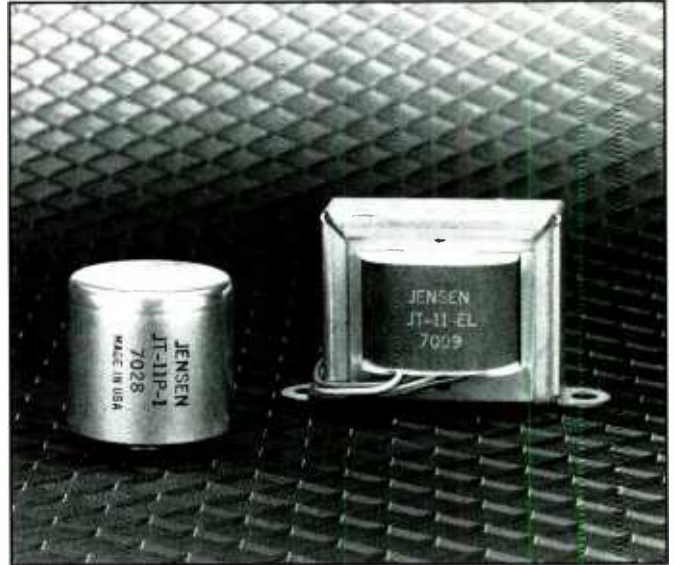

Over the years, superb specifications, outstanding performance, and unsurpassed reliability have earned Jensen a solid reputation as the world's preeminent manufacturer of audio transformers. We recently made major changes in the manufacturing process, with significant improvements in both absolute performance and transformer-to-transformer consistency.

We control every facet of design and construction, from core alloy selection to computerized electronic modeling. Because Jensen transformers are designed to function as an integral part of "real-world" circuits, not as an afterthought, all parameters are optimized. The result is a clearly audible improvement in performance.

Discerning engineers specify our field proven transformers, by the hundreds of thousands, for the most demanding environments – professional recording studios, fixed and mobile broadcast facilities, and touring sound systems. It's no accident that returns and failures are rare; we place strong emphasis on quality control. Transformer performance is verified in our modern, highly automated test lab using Audio Precision and Hewlett-Packard equipment.

We take this extra care because we are dedicated to excellence. We have an experienced technical staff who offer you free transformer applications consultation with the help of our powerful COMTRAN software. This AC circuit analysis and optimization program is one of the engineering tools we use to model and design our high performance transformers. COMTRAN is available for HP computers and 386™ PCs.

Call or write for information or to receive our free newsletters. The next time you need a transformer, remember... insist on the best – insist on a Jensen.

Choose From a Wide Variety of Transformer Types and Packages

- Microphone Input
- Microphone Splitting
- Line Input
- Direct box
- Line Output
- Electret Mic Output
- Interface of +4 dB to -10 dB circuits
- Repeat Coil
- Special Types

10735 Burbank Boulevard
North Hollywood, CA 91601
FAX (818) 763-4574
Phone (213) 876-0059

Visitors by appointment only. Closed Fridays.



UK Distribution by: SSE Marketing Ltd. • Unit 2, 10 William Rd., London NW1 3EN • Telex: 27939 SCENIC G • Phone: (071) 387-1262 FAX (071) 388-0339
Australia Distribution by: Syntec International Pty. Ltd. • 60 Gibbes Street • Chatswood, N.S.W. 2067 • Telex: SYNTEC AA 70570 • Phone (02) 406-4700 FAX (02) 406-6136
Far East Distribution by: Towa International Corp. • 2nd Azuma Bldg. • 1-14 Sakuma-cho, Kanda • Chiyoda-ku, Tokyo 101 • Phone (03) 253-3537 FAX (03) 257-0824
New Zealand Distribution by: Barton Sound Systems, Ltd. • 18 Norwich Street • Auckland 1 • Phone/FAX (09) 732-416

COMTRAN is a registered trademark of Jensen Transformers, Inc. 386 is a trademark of Intel Corporation.

Circle (18) on Rapid Facts Card

Solid State Logic ScreenSound



SSL's ScreenSound is a self-contained system with a unique user interface. The operator sits at a tablet and uses a cordless pen to select functions and move data while watching a video display.

ScreenSound records up to 16 discrete tracks of information on disk, though only eight discrete tracks can play back simultaneously. At the 48kHz sampling rate, the basic system records up to 180 track-minutes of audio (more than 10 minutes for each track, with all 16 filled). For both the analog (XLR balanced) and digital (AES/EBU) I/Os, ScreenSound has two discrete inputs and eight discrete outputs. Archiving is to 8mm tape.

At this time, ScreenSound doesn't offer DSP, although it does have full cut-and-paste func-

tions and on-screen 8-channel virtual mixing. Time code is read serially through the system's RS232/422 serial data ports. ScreenSound has been tailored for film and TV post-production; because no high-end posting system would be complete without external editor control, ScreenSound offers Sony BVU, Ampex VPR3 and other serial control options.

Unique to SSL's ScreenSound is SoundNet — a comprehensive digital audio network that lets up to seven ScreenSounds share and copy work from up to 16 hard disks (each with three hours of digital audio). Other SoundNet features include central mass storage, control of multiple ScreenSounds from one tablet (for 56-channel playback) and off-line backup and restore. System prices start at \$112,000.

Sonic Solutions Sonic System



Sonic Solutions is best known for its NoNoise system, now in version 2. NoNoise can digitally identify and remove unwanted background noise from a recording, including hiss, pops, clicks and other sonic rubbish. NoNoise is just one of many options available for Sonic Solutions' Sonic System — one of the most comprehensive hard-disk recording systems available at any price. Any of the Macintosh II computers can serve as the system's front-end, although the faster the better. All interaction is via mouse, keyboard and the computer's video display.

Sonic Systems start with a 2-track "Sonic Mini Editor" and go up to 24-track capability. Recording time runs about 10Mbytes per stereo-minute (44.1kHz sampling). Background

archiving in real time can be run to tape or optical disk. The company doesn't offer analog I/Os; multiformat digital I/Os are standard. Sync options include an LTC-format SMPTE/EBU time-code reader and generator; external Ampex VPR-3 and Sony P2 control is available.

Cut-and-paste waveform editing and cross-fading are standard. DSP options include real-time EQ, 31-band FIR EQ, vari-speed, compression/expansion, "designer" reverb and other effects and, of course, NoNoise. An onscreen virtual mixer is available with up to 24-channel control. System prices (excluding computer and hard drive) start at \$8,750.

Studer Editech Dyaxis



When Studer acquired Integrated Media Systems in 1989, the Swiss-based giant became the first major tape recorder company in the tapeless market. IMS is now Studer Editech.

Dyaxis is a Macintosh II-based system that records two tracks (one stereo pair) at once. Dyaxis 2+2, plays back four discrete channels (two stereo pairs) simultaneously. Recording time is limited by disk space; systems range (44.1kHz sampling rate) from about 15 minutes of stereo audio to more than six hours! Recommended archiving is to DAT. Dyaxis can be configured with up to four channels of balanced XLR analog I/Os; its multiformat digital I/O is one of the most comprehensive digital I/Os available. Supported formats include AES/EBU, SPDIF, ProDigi and Yamaha stereo.

Once recorded, a virtually unlimited num-

ber of internal tracks can be cut-and-pasted, waveform-edited, level-adjusted (via an onscreen virtual mixer), triggered as an EDL and finally, "mixed" to the 2- or 4-channel output of the system. An optional DSP card brings EQ, time compression/expansion and other power to Dyaxis.

A low-cost, optional MIDI Time Code interface locks the system to SMPTE/EBU time code and generates MTC data for triggering edit decision lists. The Dyaxis System Synchronizer, boasts full SMPTE/EBU code reading and generation (LTC and VITC), can lock to film tach and can generate MIDI Time Code. System prices (including hard disk, not including computer) start at \$9,950.

Get Every Bit Into Your Audio

New Aphex Dominator™ II Precision Multiband Peak Limiter

When audio is converted to digital, it had better be hot or you're going to lose resolution (1 bit for every 6dB). Too hot and you will crash! Which is why you need the new Aphex Dominator II Precision Multiband Peak Limiter *before* your A-to-D conversion.

The Dominator has become the standard peak limiter because of its superb audio quality and *absolute brick wall limiting*. It lets you run hotter with absolutely no overshoot. And now, it offers a dynamic range of 104dB, five times better than digital!

The Dominator limits the audio in three bands and recombines it in a

patented intelligent circuit. This means that signals in one band won't affect another band, eliminating spectral gain intermodulation, dulling and hole punching. The result is hotter audio with transient feel and absolutely no overshoot!

There's a Dominator designed to maximize your recording or transfer medium ... analog or digital ... tape, vinyl, disc, sampler, hard disk or film ... broadcast, land line, microwave or satellite link. Contact your Aphex dealer for a demonstration of the world's finest peak limiter, the Aphex Dominator II, today.

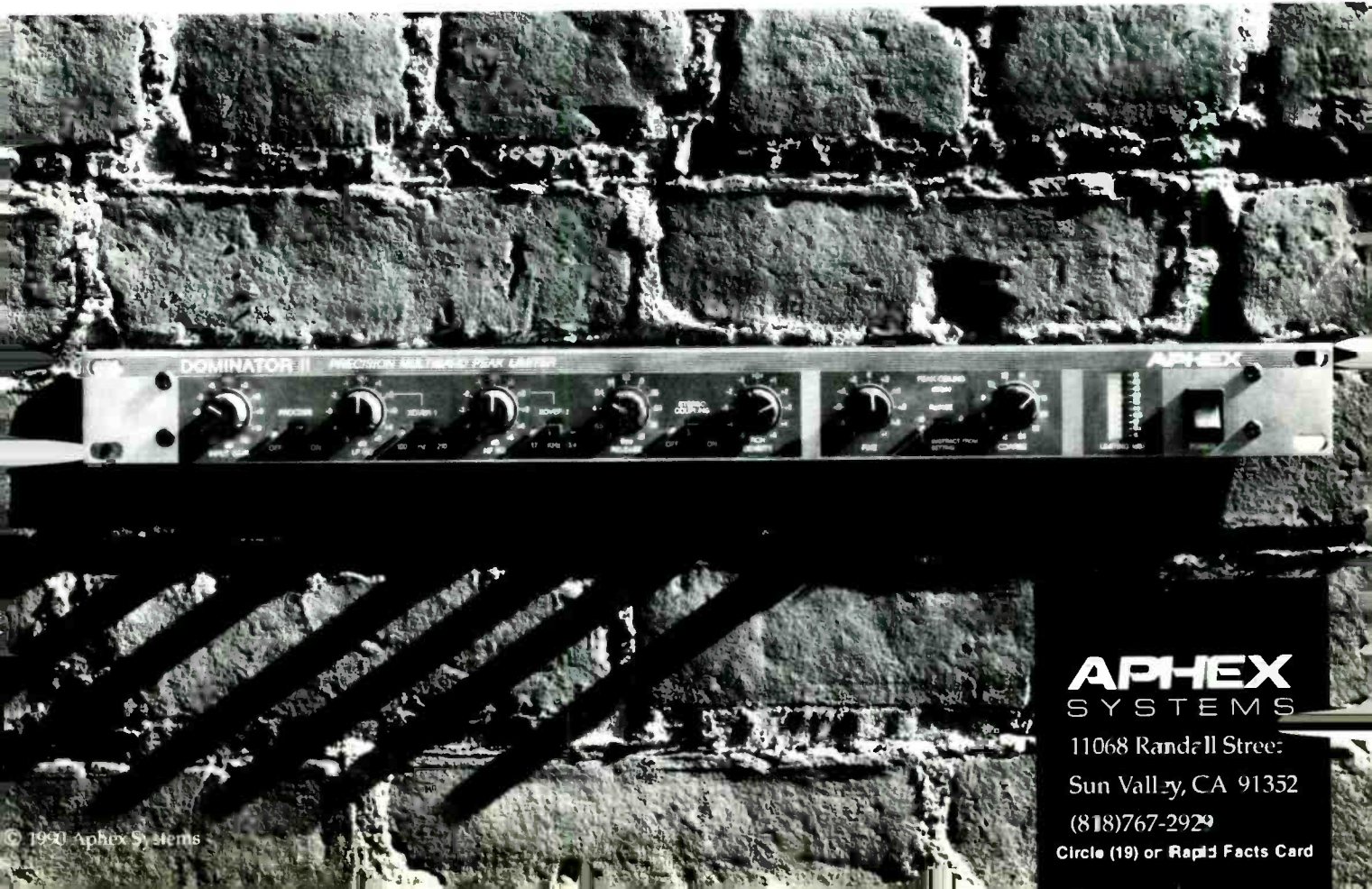

APHEX
SYSTEMS

11068 Randall Street
Sun Valley, CA 91352
(818)767-2929

Circle (19) or Rapid Facts Card

Turtle Beach 56K

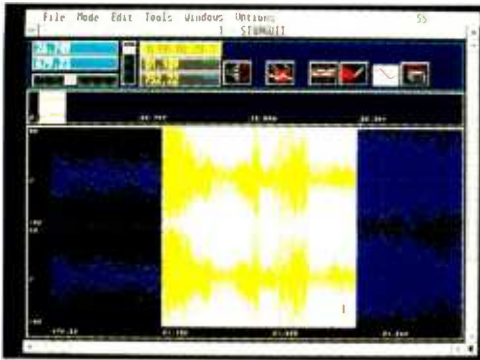

Take one 286- or 386-type PC, add Turtle Beach's DSP card, Digital Interface box, and SoundStage editing software, and you get an affordable, easy-to-use, 2-track digital editing system.

You'll probably also need to add outboard A/D and D/A converters. By asking the user to supply these components, Turtle Beach can keep the total price down, and the user can choose a high-end converter, or use the analog and digital I/Os found on most DAT machines. (Simply connect the DAT machine to Turtle Beach's Digital Interface box, and you're ready to roll. The interface box supports AES/EBU, SPDIF and other formats.)

EQ, varispeed, mixing and crossfading are among the standard DSP functions; cut-and-

paste is supported. Stereo recordings, or "soundfiles," consist of "zones," which can be stacked for random access playback, triggered by incoming MIDI data or at a user-defined time.

For cart player simulation, zones can be triggered by a mouse click. Simultaneous playback of multiple zones makes this system suitable for complex effects assembly. LTC-type time code can be read and generated. Recording time is limited by disk space; figure about 11Mbytes of disk space per minute of stereo recording. System prices (excluding computer and hard disk) start at \$2,689.

WaveFrame AudioFrame



The AudioFrame is based on a mouse-controlled IBM 386-type computer and outboard rack of processing cards, disks and I/Os. AudioFrame's five "building blocks" are: SoundProcessor (RAM-based recorder, 16 to 48 tracks); EventProcessor (triggerable EDL); StudioCAD (16x2 on-screen virtual mixer with EQ, reverb and other DSP functions); DRM (disk-based recording/editing, with three to eight discrete tracks depending on disk size and use of 16- or 24-bit storage); and Texture (sophisticated MIDI sequencer).

The AudioFrame comes with two to 32 channels of analog XLR inputs, and eight to 32 discrete channels of outputs. Digital I/O options range from two to 64 channels, in many formats, including AES/EBU and ProDigi. LTC- and

VITC-style time code can be read; LTC can be generated. An external hardware mixer is available to control AudioFrame's DSP mixing/processing. External moving fader automation is also an option. Total RAM recording time is from 20 seconds to 18 minutes; total disk recording time (at 44.1kHz) ranges from one to 40 hours! Recommended archiving is to 8mm tape.

The CyberFrame-E system builds upon the CyberFrame-M by adding a full sound editing package. Features include spotting sheets (for ADR, Foley and EDL), automatic CMX conforming. System prices start at \$50,000 (AudioFrame), \$39,950 (CyberFrame-M) and \$64,650 (CyberFrame-E).

How to contact the various tapeless audio manufacturers.

This issue's articles on digital audio workstations provide you with fundamental manufacturer information. For more detailed intelligence (and to find out how you can get your hands on the systems), circle the appropriate Rapid Facts Number on this issue's Rapid Facts Card, or contact the manufacturers directly.

Re: Sources
Compiled by Linda Jacobson

Linda Jacobson is the owner of Wordwork, a technical writing and publishing company based in San Francisco.



ANNOUNCING A BREAKTHROUGH THAT WILL STAND THE RECORDING INDUSTRY ON ITS



INTRODUCING THE MX-2D™ DIGITAL AUDIO SERIES MAGNETO OPTICAL DRIVE

The revolutionary MX-2D™ Magneto Optical Disk Drive represents the latest achievement in removable disk drive technology from the "Masters of Mass Storage", Eltekon Technologies.

Ruggedly designed for continuous studio use, the MX-2D™ incorporates state of the art innovations which enable it to record Digital Audio at 48kHz stereo directly to Magneto Optical disk. One cartridge is capable of storing a total of 650 mbytes (27 minutes per side) and is completely reusable. Repeated rewriting to the disk will not degrade its performance as is the case with conventional magnetic storage media. Furthermore, the laser optical technology of the MX-2D™ Magneto Optical Drive completely eliminates any possibility of data loss from a catastrophic "head crash".

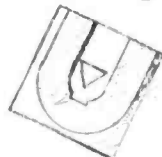
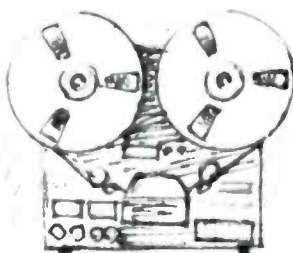

Step into the future of hard disk recording today with the Eltekon Technologies MX-2D™ Digital Audio Series Magneto Optical Drive!

*Ask about our new
CD Mastering service.*

Eltekon Technologies
37491 Schoolcraft Rd.
Livonia, Mich. 48150
Phone: 313-462-3155
Fax: 313-462-5922



Circle (20) on Rapid Facts Card

"THE MASTERS OF MASS STORAGE™"

ELTEKON



Re:Sources

Akai/IMC: DD1000

1316 E. Lancaster
Fort Worth, TX 76102
817-336-5114
Fax: 817-870-1271

Circle (101) on Rapid Facts Card

AKG: DSE7000

1525 Alvarado St.
San Leandro, CA 95477
415-351-3500
Fax: 415-351-0500

Circle (102) on Rapid Facts Card

Alpha Audio: DR-2

2049 W. Broad St.
Richmond, VA 23220
804-358-3852
Fax: 804-358-9496

Circle (103) on Rapid Facts Card

AMS: AudioFile

7 Parklawn Drive
Bethel, CT 06801
203-792-4997
Fax: 203-792-7863

Circle (104) on Rapid Facts Card

Digidesign: Sound Tools

1360 Willow Road, Suite 101
Menlo Park, CA 94025
415-688-0600
Fax: 415-327-0777

Circle (105) on Rapid Facts Card

**Digital Audio Research:
SoundStation II**

2 Silverglade Business Park
Chessington, Surrey KT9 2QJ
United Kingdom
44-37-274-2848
Fax: 44-37-272-3532

Circle (106) on Rapid Facts Card

Digital Dynamics: Pro Disk-464

270-02 E. Pulaski Road
Greenlaw, NY 11740
516-271-5600
Fax: 516-271-5607

Circle (107) on Rapid Facts Card

Doremi Labs: DAWN

4927 Glen Arden Ave.
Covina, CA 91724
818-966-2454
Fax: 213-622-1225

Circle (108) on Rapid Facts Card

Hybrid Arts: ADAP II

8522 National Blvd.
Culver City, CA 90232
213-841-0340
Fax: 213-841-0346

Circle (109) on Rapid Facts Card

THE FIRST CHOICE OF RECORDING STUDIOS IS THEIR SECOND CHOICE, TOO.

There's been an interesting phenomenon developing since the release of the ATR 60/16.

Seems when it comes time to expand, major studios already owning a 60/16 always buy a second.

100% of the time.

The studios sometimes look at other models. But what they discover, is that feature for feature, dollar for dollar, no other 16 can compete.

That's because of, among other things, the 60/16's superior head technology. It's so accurate that final EQ'ing decisions can be made right in the sync mode, without rewind or repro verification.

And our special circuitry provides transparent punch-ins for gapless edits.

There's also incredibly fast lock-ups, at speeds limited only by the quality of your other equipment.

So, get into your Tascam dealer and see the machine that has them coming back for seconds. The ATR 60/16. It's the industry's first and second choice, because it's second to none.

TASCAM®

© 1989 TEAC America Inc., 7733 Telegraph Road, Montebello, CA 90640, 213/726-0303

Circle (21) on Rapid Facts Card



Lexicon: Opus, Opus/e
100 Beaver St.
Waltham, MA 02154
617-891-6790
Fax: 617-891-0340
Circle (110) on Rapid Facts Card

**Micro Technology
Unlimited: Microsound-AT**
156 Windchime Court
Raleigh, NC 27615
919-870-0344
Fax: 919-870-7163
Circle (111) on Rapid Facts Card

**New England Digital: PostPro,
PostPro SD**
Rivermill Commercial Center
Lebanon, NH 03766
802-295-5800
Fax: 603-448-3684
Circle (112) on Rapid Facts Card

Otari: DDR-10
378 Vintage Park Drive
Foster City, CA 94404
415-341-5900
Fax: 415-341-7200
Circle (113) on Rapid Facts Card

Solid State Logic: ScreenSound
320 W. 46th St., 2nd Floor
New York, NY 10036
212-315-1111
Fax: 212-315-0251
Circle (114) on Rapid Facts Card

Sonic Solutions: Sonic System
1902 Van Ness Ave., Suite 300
San Francisco, CA 94109
415-394-8100
Fax 415-394-8099
Circle (115) on Rapid Facts Card

Studer Editech: Dyaxis, Dyaxis 2+2
1370 Willow Road
Menlo Park, CA 94025
415-326-7030
Fax: 415-326-7039
Circle (116) on Rapid Facts Card

**Turtle Beach: 56K Digital Recording
System**
1600 Pennsylvania Ave., Unit 33
York, PA 17405
717-843-6916
Fax: 717-854-8319
Circle (117) on Rapid Facts Card

**WaveFrame: AudioFrame,
CyberFrame**
2511 55th St.
Boulder, CO 80301
303-447-1572
Fax: 303-447-2351
Circle (118) on Rapid Facts Card



By Rick Schwarz and Mike Joseph

REALITY CHECK

Hoops and ladders: Putting the systems through their paces.

All cars have four tires and an engine. But what makes a Ferrari 308 GT better than a Ford T-Bird? Does the added performance really justify the cost difference? The answer depends on whether you're racing at Monaco or driving to work. Until now, most "tapeless" product coverage has concentrated only on things like the number of channels and disk recording time, things included in the article "Tapeless Technology." While it's certainly useful, it tells the user nothing about how the device will actually perform under fire, in a real-life production environment,

with billable hours slipping quickly away.

We concluded that the systems needed to be compared, and that the tests had to be accomplished in an audio production environment. And while we were at it, why not test performance on real-world projects, with real live users, as if it were really real? The kind of work that clients bring in every day to a studio like yours. We did. What better way could there be to accurately report differences than to have everyone work on the same material? We did. And to make things more interesting, we decided to do something which had never been done before — use traditional analog methods as a benchmark. Are newer digital techniques really faster than tried-and-true analog methods? We found out.

It is interesting to note that although there are a lot of bit-bashers out there, they all seemed to crawl into the woodwork when asked to participate in our test. At first we thought: what did they have to lose? The an-

swer? A lot. We applaud the brave souls who ventured under our magnifying glass, and thank them deeply for taking time out of their production day (or night, as sometimes it went well into the morning). The names of the unsung heroes and their facilities are listed in the sidebar "The Operators."

COVERAGE

This article will focus on the kind of information you can't get from a tearsheet or a glossy brochure. Instead of taking conventional measurements like signal-to-noise ratio and harmonic distortion (essentially meaningless and difficult to gauge in a digital world), we thought it would be more useful to consider other types of indicators. Things like efficiency. The length of time it takes to get a job done. How easy a system is to navigate around in. Back-up times and techniques. We also had to look at cost: Do users automatically get what they pay for? Is it worth it?

Rick Schwartz is a contributing editor to R•E•P and director of post-production at Music Animals, Los Angeles. Mike Joseph is editor of R•E•P.

To narrow the crowded field, we limited participation to products that are on the market, with an active base of professional users. This cut the quantity of entrants down from more than 40 to a more manageable number. Did we miss any? Yes. These companies either didn't have a system sophisticated enough to allow for the scope of the project we had planned (we needed more than simple stereo editing and crossfades), or they didn't have an installed system in a place we could get to. Or it may have been that we couldn't get them to join the party, period, no matter how much we tried. They know who they are.

TWEAKS AND GEEKS

Anyone who has gone to a recent industry convention knows that every computer geek in audio is offering a black box that records stereo audio onto a hard disk. Some do that and also tweak the signal. However, to build a system with all of the features required by professional users is a far more serious undertaking. Ask companies like NED, AMS or Lexicon how many man-years they have into their products and you may be very surprised. It's a multi-digit number. Mature products do not crawl out of the woodwork; they evolve over long periods.

To find enthusiastic contestants, we requested the assistance of the willing manufacturers themselves. Why? For one, there weren't enough systems out there to spin the phone book, even in Los Angeles, where these tests were made (all except for the Lexicon Opus). We figured: Who but the sellers would know where their systems were, what they're used for, and how long they'd been installed (ergo: how much experience the operators might have)? Virtually all of the individuals who took part in the tests were people who make a living using these products. We made an exception in the case of the Akai DD1000 because we were curious to see how an optical-based system would compare. Also, it had tested well in our Hands-On review last fall (see the October 1990 issue). The only knowledgeable operator available in L.A. at the time was Ron Franklin, who recently became an employee of Akai. Before that, Ron had been a long-time music editor and production engineer using other digital systems, as well as more traditional technologies. For the date, he wore his "independent engineer" hat.

CAVEATS

Let it be crystal clear: We had no axes to grind. Every effort was made to create a level playing field. Each operator, manufacturer and studio owner we dealt with had a raging curiosity about these tests, whether conducted on their own system or the one they didn't buy, how they compared, how stable they were and what you got for the money. It was virtually impossible to balance out every manufacturer, apples to apples (no pun intended). Each system had some handicap: one had a beta

software version of an update that crashed too often (the older software version with less feature-laden code was rock stable). Another didn't have the latest version of an update and therefore lacked currently advertised features. Several had important options scheduled to be installed "any day now." Others weren't fully outfitted, or available options weren't implemented. And these were the flagship installations!

Almost all systems could have been expanded with now-available factory DSP options or more disk drives. In another six months, it is almost a certainty that currently non-universal features like time compression, full resolve code chase-ability and all-digital inputs will be common as dust, thanks to ever-decreasing DSP chip prices.

Although we used electronic stopwatches to time the various steps in the production process, it was clear that most systems had multiple options, pathwise, for completing the different tasks. Accomplishment speed was reliant on the operator's choice of these paths. For our test results, we assumed all of the operators chose the best and fastest way. We're sure the manufacturers will express their opinions on that subject later.

In defense of the operators (engineers, technicians, mixers, editors?), we discovered that it was hard for a person who does a lot of dialogue editing to compete effectively in a music editing test with a person who is mainly a music editor. The differences between voice-over or effects post-production editing and music editing can be large. With one exception, our tests occurred in the rarified atmosphere of L.A. production, where specialization reigns supreme. Along with so many other things, we tried to fairly weigh these factors into our results.

On commenting on system speed, it is important to note that many of the process functions themselves, such as sound file loading or backup, happened in real-time. Getting there, or "massaging the system" on some workstations, seemed to take forever. Measured times were therefore highly relative, something we again took into account. Some operators were clearly faster than others, whether due to system familiarity or a pocketful of invaluable work-arounds. One leveraged the correct results out of the system, albeit with a large crowbar. Others were crunching on systems that flat-out didn't do what we wanted, no matter how good the operators were or how much they tried. This latter situation interested us more. Were the basic tools there? Did they work? Whose worked better?

Someone suggested that we test new users on the various systems. Our response was, "You've got to be kidding — all would fail miserably." Assuming you knew the basic computer platform already, there would still be a fairly steep learning curve. It is not difficult to record, play back and do simple edits. But taking it to the next level is much more involved.

For our tests, we tried to ensure that the things we did included material *not* covered in the instruction manual. In other words, that there were typical situations an audio production engineer might run into every day. The results showed.

No doubt many manufacturers will vehemently disagree with our conclusions. Even the operators were surprised at how many new, unpredictable things we discovered *about their own systems!* One operator was reduced to red-faced embarrassment after his system crashed three times in a row while trying to resolve. *Of course* he said it had never done that before. Wouldn't you, in front of the press?

So be it. We have a clear conscience. If anyone has doubts, let them try to do what we did and compare the results!

ONWARD: THE GAMES

Test material was selected by R+E=P editor Mike Joseph from a number of possible choices. No one knew in advance which material was to be used until the first day of testing, last December. The tests would measure performance in two different areas — music editing and audio sweetening. For music editing, we selected an upbeat contemporary track that was produced for Diet Coke. For the audio post tests, we selected a 2-minute trailer from the feature film "Air America," which had originally been edited on magnetic film (see the sidebar "The Test Procedure").

Everything we did was benchmarked against traditional analog production, in effect framing the question: How long (if possible at all) would this given process take to complete in an analog world. To accomplish this, we allowed the analog engineer the use of a mixing console, a multi-track tape recorder and synchronizers. No samplers or other computer-based devices would be allowed, save a Harmonizer. Our goal was to find the truth behind the myth that analog was faster than disk-based. To be honest, digital linear tape would virtually be analog's production equivalent in the eyes of this test, save fidelity.

We found that analog tape gets the job done, but not without taking the material down an additional generation or two, adding noise and distortion. In addition, there were some things that simply could not be done using analog tape alone. For example, time compression without pitch shift on a multitrack was not possible. Tweaking the Coke spot to exactly 29.5 seconds (without fading it) required two channels of Harmonizer for pitch shift correction. Very messy. Some math.

Overall project completion times weren't possible because many of the workstations couldn't perform all of the tasks. Since loading sounds did not vary tremendously from system to system, we focused on measurements like editing time, backup time, etc. Under the heading "Charting System Performance" (page 48), Figures 1 through 12 document the key performance measurements.

All times are in decimal minutes, unless otherwise stated.

AUDIO EDITING

How long does it take to record a 1:20 music cue? It's not a trick question. The answer depends on how much information the system needs to know before it can record (see Figure 1). With an analog recorder, you just set the levels, press the record button and roll. Digital disk-based systems need more info. How long will you be recording? Where will you put it? What do you want to call it? How do you want to view it? The Dyaxis system did well, taking only slightly longer than analog because it gives each file a default name and sets the recording time to the maximum available (imagine telling someone who has just given the performance of their life that you didn't allocate enough disk space). The NED also sped.

Recording from a digital input is even more involved because of the additional information the system needs to know: sample rates, clock source, protocol, input port, emphasis? The AudioFrame took the longest time due to the 30 seconds worth of digital filters it must first load, as well as the additional information the built-in database requires.

All the workstations really shined in the music editing tests, finishing in less than half the time required for an analog tape-based system (see Figure 2). The top prize went to the AMS AudioFile, followed by the Akai DD1000. Does this prove that a dedicated menu-driven system is faster than a Macintosh-style graphic interface? Possibly. But the skill and familiarity of the operator is a major factor. Creativity, or the ability to "hear" the edit before you move your fingers, is a crucial consideration to speed.

A side note: one of the reasons it took so long to cut the spot using analog tape was the difficulty in determining exactly how a given edit would affect the total elapsed time, before actually making the cut. Determining that with a stopwatch was a real-time process. In contrast, most of the digital systems displayed a total running time, or the time code could be used as a gauge, to multiple digit accuracy. The razor blade was no match for the computer.

SQUEEZING TIME

Time compression is a wonderful feature — just tell the computer how long you want the spot to be and it does the rest. Our tests showed that time compression on the various platforms was approximately a 1:1 process, plus configuration time (see Figure 3). Of the products that *could* time-compress, the Dyaxis was the fastest by a nose (using its fast time scale), followed by the Akai. Three of the four highest priced workstations could not do any type of time compression (at the date of testing). Clearly, a certain truth exists in this thought: latest designed, greatest features. Note that our analog operator took two tries to find an exact VSO/Harmonizer setting, with

real-time play-through for stopwatching.

Backup time has improved considerably in the past year or two. Tape streamers were the fastest means of archiving, followed by removable hard disks and, finally, removable optical disks. Sonic Solutions and Lexicon edged out other units in the backup test (see Figure 4). The Sonic System backed up data and playlist info to DAT. It will also archive in the background to a professional video recorder. The AudioFile used a similar process. The Lexicon streamed to 8mm video tape, with gigabytes of storage capability. Elapsed time was double speed per track, or stereo (two tracks) in real time. ScreenSound took the longest to backup primarily because you are forced to backup the entire working disk — it doesn't allow single file backup. We aborted after 15 or so minutes. Akai claims to backup to a second optical drive, although there wasn't one present at the tests, ergo the N/A.

AUDIO SWEETENING

Before we began the second part of the test, we asked each operator to boot their workstations from a cold start. As you can see, the systems varied tremendously (see Figure 5). The reason for this was the extensive diagnostics that some of the systems ran as part of their start-up procedure. Although the analog system powered-up in seconds, we asked the operator to thread the tape and prep it for recording. Noteworthy among the digital systems was the Akai (almost plug-and-play) and the Lexicon Opus, which had multiple levels of power-up and extensive diagnostics, guaranteeing the longest total cold-start (they recommend it never gets completely powered down). But it also guaranteed that any potential software or program related glitch (crash is such an ugly word) would only effect the top level of software/hardware, requiring merely a simple and quick soft-reset. This is a good thing.

There were tremendous differences in the costs of the systems tested (see Figure 6). At the low end of the scale is the Akai DD1000, followed by the Dyaxis. Although the latter's price does not include in the cost of a Macintosh, it is still in second place even if the price of a Mac IIcx and monitor is added on. Both could be considered bargains, in light of the fact that the next closest system costs many times as much. Although an analog 2-track is reasonably priced (quasi-pro models start at about \$2,000), the cost of equipment needed to perform time compression, or the analog multi-track tests, was quite expensive. We're talking pitch shifters, a 24-track, quality console, automation, synchronizers, etc.

Audio load times did not vary greatly, save two exceptions (see Figure 7). We spent quite a bit of time trying to get the ScreenSound to time-stamp an incoming file, but ended up failing because of its master-only status. The AMS AudioFile had a difficult time loading in the two sound effects because of digital clocking problems (see Figure 8). The Lexicon made short work of getting files labeled and on-board.

SYNC POPS

To sync up the voice-over, the operators had to line up the sync pop on the 3/4-inch machine with the sync pop on the VO itself (see Figure 9). The NED PostPro beat all others by a hair, with analog tape synchronization a close second. To sync up the VO using analog tape, the operator parked both machines on the sync pop and then stored the offset into the synchronizer. This offset was then trimmed to make it frame accurate. In cleaning up the track, it became clear that digital workstations excel at removing pieces of sound without affecting sync (see Figure 10). Analog took almost twice as long to remove noise and SMPTE bleed in front of the VO. The analog edits were done using the mutes on a console automation system — mutes which needed to be trimmed for frame accuracy. Lexicon, AMS and NED came in first on this one.

The last tests involved track combining (see Figures 11 and 12). Only the Akai, the AudioFrame, the Opus and the Dyaxis were capable of track bouncing entirely in the digital domain. The Opus, with its digital console top, did it all in real time, on demand. The NED PostPro could not bounce at all without the use of an external mixer, going through D/A/D converters each time (the system tested did not have the DSP option or digital inputs). Concerning Akai's performance, one possible reason for the poor bounce time could be the slow write times in its optical disk. The Sonic System did extremely well in these tests, thanks to the simple and straightforward on-screen mixer. And surprise! Analog tape took longer to mix than expected.

UP CLOSE AND PERSONAL

The following section is condensed from the considerable amount of information we collected. Easily, we could have spent five pages on each system and still have only scratched the surface. With this in mind, we hope the brief test synopses and data shown in Figures 1-12 ("Tracking System Performance," page 48) fit the bill. For the following, our rating system uses a 1 to 5 scale, with 1 being poor, 3 average and 5 superior. N/A is not applicable. And yes, more qualifiers went into this rating process than a gigavolt, small-particle nuclear accelerator has errant, unascertainable Quark traces.

ANALOG TAPE-BASED PRODUCTION

Ease of use:	5
Processing speed:	N/A
Configuration/data entry time:	N/A
Inclusion of features:	2
Cost/performance:	3
Flexibility (multiple solutions):	3
Applicability to multi-track recording:	5
Applicability to music editing:	3
Applicability to post-production:	3
Current software version stability:	N/A
Fidelity (conversion/input/output):	4
Backup capabilities:	N/A
Total rating:	3

Strengths: Warm sounding, handles signal overload well. Easy-to-use universal interface with media interchangeability. Good ergonomic design. Supports removable media that is widely available at a reasonable cost. Has an almost infinite sample rate. Things like sample rate conversion are not an issue. Supports real-time VSO and gain change. User serviceable to a component level. A self-contained system, so no computer required. Damaged tapes will play without muting. Noise reduction can greatly reduce noise floor.

Weaknesses: Linear, non-random access storage. Editing is destructive. Tape cloning is not possible, because generation loss adds noise and distortion to the program material. Does not have the ability to perform long cross-fades. Requires an external synchronizer to lock-up with picture. Has no visual waveform display. Scrubbing is not sample accurate. Requires daily cleaning, alignment and periodic demagnetization. Magnetic tape has a limited shelf-life. Time compression is not possible without changing pitch. Complex enveloping of sound (i.e., ducking and complex fading) is not possible without outboard "smart" equipment.

AKAI DD1000

Ease of use:	3
Processing speed:	3
Configuration/data entry time:	2
Inclusion of features:	4
Cost/performance:	5
Flexibility (multiple solutions):	3
Applicability to multi-track recording:	2
Applicability to music editing:	5
Applicability to post-production:	3
Current software version stability:	4
Fidelity (conversion/input/output):	5
Backup capabilities:	3
Total rating:	4

Strengths: Affordable. Comes standard with built-in removable optical media. Will simultaneously play back two stereo tracks from a single optical disk in real-time. Most operations, such as level and pan, etc., are real-time. Optional Macintosh software allows user to edit on a larger display. Uses high quality 1-bit Delta-Sigma technology with 64x oversampling. Optional remote controller can command up to seven units. Digital bus port is provided on the back of the unit. System is modular and expandable. Interface is true to Akai samplers. Has real time sample rate conversion. System is self-contained, so no extras are needed other than an amp and speakers. System is competitively priced compared to an analog 2-track with center-channel time code. Playlist can be built on-the-fly by manually triggering sound files. Includes built-in jog wheel, which works well for scrubbing. Can be used as a digital cart machine because samples can be primed into memory, eliminating the delay most hard-disk systems have.

Bob Ludwig

RECOMMENDS

DOLBY SR



Randall Wallace

**“With Dolby SR,
I can master CD’s that
are second to none.”**

Award-winning mastering engineer Bob Ludwig knows what it takes to turn original recordings into best-selling albums. That’s why he likes to work from analog masters that are recorded with Dolby SR.

“Dolby SR masters are transparent, free of hiss, hum, and print-through. That’s just what I need to master state-of-the art CD’s.

“In fact, Dolby SR’s high resolution can actually reveal the limitations of the compact disc. With Dolby SR, ‘AAD’ on the label is an asset, not a drawback.”

Bob Ludwig, Vice President and Chief Engineer of Masterdisk Corporation, has mastered hundreds of gold and platinum albums. Bob and Masterdisk have earned numerous honors, including seven MixTEC Awards.



For more information on Dolby SR, contact your Dolby professional products dealer.

Dolby SR: now 50,000 tracks worldwide.

Circle (22) on Rapid Facts Card

Dolby Laboratories, Inc. • 100 Potrero Avenue, San Francisco, CA 94103 4813 • Telephone 415 558 0200 • Telex 96409 • Facsimile 415 863 1373
346 Clapham Road, London SW9 9AP • Telephone 071 720 1111 • Telex 919109 • Facsimile 071 720 4118
Dolby and the double D symbol are trademarks of Dolby Laboratories Licensing Corporation. © 1992 Dolby Laboratories S90 910

Dolby

Weaknesses: Interface was designed for music editing, although a post-production interface is planned in the future. Time compression is not possible. Many keystrokes were needed to perform some simple operations. If you want to play more than two stereo sound files at once you have to do a sub-mix or use multiple systems. Small screen is a limitation, but is less of a concern because of optional Mac interface. Fan noise could require remote mounting in quiet control rooms. Only one stereo element can be recorded at one time.

AMS AUDIOFILE PLUS

Ease of use:	2
Processing speed:	4
Configuration/data entry time:	3
Inclusion of features:	4
Cost/performance:	3
Flexibility (multiple solutions):	3
Applicability to multi-track recording:	5
Applicability to music editing:	5
Applicability to post-production:	4
Current software version stability:	1
Fidelity (conversion/input/output):	3
Backup capabilities:	3
Total rating:	3.5

Strengths: Multitrack 8-channel system. Supports near real-time time compression. Real-time backup which saves the event list to floppy and the sound files to DAT (D/D). On-screen mixer has peak-hold metering. VTR machine control is supported. System is fast, as everything is real-time. Large user-base. Includes built-in jog wheel, which works very well for scrubbing.

Weaknesses: System is more keystroke-intensive than other systems. Screen is too small for clients to see from a distance. System is relatively expensive. Digital inputs support S/PDIF 44.1kHz only, whereas most DAT players default to 48kHz. System has no internal digital bus, so tracks must be bounced through analog circuitry. To read VITC requires toggling of an internal switch. Limited graphic waveform display, so user must mark edit points by scrubbing. Unit locked-up several times during tests and needed to be rebooted. Consecutive elements on the same track must be separated by 18 or more frames. Uses proprietary computer system.

LEXICON OPUS

Ease of use:	4
Processing speed:	4
Configuration/data entry time:	4
Inclusion of features:	4
Cost/performance:	3
Flexibility (multiple solutions):	3
Applicability to multi-track recording:	5
Applicability to music editing:	4
Applicability to post-production:	5
Current software version stability:	4
Fidelity (conversion/input/output):	5
Backup capabilities:	4
Total rating:	4.5

Strengths: Well-designed user-interface that includes real digital faders, scrub wheel, tape transport controls, etc. Full multi-track performance, with 99 tracks. All functions are real-time. Will source or chase time code, with Resolve, Follow or Master options. Two-times real-time tape backup. Saves decision list and segment info along with data. Automatic non-drop to drop-frame conversion, maintaining EDL locations. Has DSP EQ, 480 XL controllable on-board. Has 16 analog I/Os, eight AES/EBU digital ports and four S/DIF 2 digital ports, all software-assignable. Up to 4.8Gbytes (approximately 960 track-minutes) of storage space. Remote modem diagnostics (factory dial-in).

Weaknesses: System is expensive. Can only mix eight tracks at once, so must submix 99 tracks. Current software doesn't allow time compression or automation (update due in May). Cold start is long. No waveform display available. Proprietary computer system.

NED POSTPRO

Ease of use:	2
Processing Time:	4
Configuration/data entry time:	3
Inclusion of features:	5
Cost/performance:	3
Flexibility (multiple solutions):	3
Applicability to multi-track recording:	4
Applicability to music editing:	4
Applicability to post-production:	5
Current software version stability:	4
Fidelity (conversion/input/output):	4
Backup capabilities:	4
Total rating:	4

Strengths: Large installed customer user-base. PostPro SD incorporates a RAM-based sampler with a hard-disk recorder. Supports sampling rates up to 100kHz. Numerous music and sound effects libraries are available on 2Gbyte optical platters. MIDI option will control up to 128 different devices. Optional SoundDroid software is specially designed for film/audio-post applications: includes spotting notes, cue sheet printing and a sound effects database. System supports traditional EDL or graphic based play lists using EditView software. Has three different types of time compression algorithms. Has variable-speed playback ability. Screens are linked with the ability to mark times on-the-fly and play before or after markers. Option reads CMX-format EDLs. With Synclavier, provides a powerful music production and compositional tool. Comes standard with 19-inch color display and ergonomically designed stand. Macintosh-based front-end navigation. Multi-station networking capabilities.

Weaknesses: Multi-user and some DSP options are still under development. Complex and involved to learn. Sample rate conversion and digital EQ were not possible. Waveform editing window is too small to accurately mark edit points, as a result user has to rely on scrubbing. Screen is somewhat cluttered and hard

to read. No on-screen metering, but an external meter bridge is available. Disk space-allocation problems arose during test, resulting in a lost sound file. Too many features are optional, considering base cost of system.

SONIC SOLUTIONS SONIC SYSTEM

Ease of use:	2
Processing speed:	4
Configuration/data entry time:	3
Inclusion of features:	4
Cost/performance:	4
Flexibility (multiple solutions):	3
Applicability to multi-track recording:	3
Applicability to music editing:	5
Applicability to post-production:	3
Current software version stability:	4
Fidelity (conversion/input/output):	5
Backup capabilities:	4
Total rating:	4

Strengths: Has the most comprehensive interface for CD mastering applications. Internal data path is 24 bits wide. Supports real-time sample rate conversion and varispeed control. Well-designed color mixing screen, with on-screen metering and extensive DSP, including: digital compression and expansion, real-time level change, panning, digital effects sends and EQ. Many types of EQ filters, including variable-slope EQ. All EQ and level settings can be automated. Allows user-definable crossfade types and dithering on fades. Supports external machine control for automated runs. Supports background uploading/downloading of sound data. The only system to offer optional audio restoration algorithms (NoNoise), and direct compact disc recording. Supports background fills. Macintosh-based, so numerous third party monitors and utilities are available.

Weaknesses: Interface is not optimized for audio post-production. System is relatively expensive considering no A/D or D/A is provided by Sonic Solutions. Digital I/O is fixed at 44.1kHz; 48kHz signals require sample rate conversion. Time compression is not possible. Requires more typing than other systems, due to disk hierarchy. Four-track operation requires reconfiguration and restarting of machine. Log scaling on faders would be preferred over linear. Stores data in a non-Macintosh file format, although files can be converted if desired. System doesn't support MIDI. Has one of the longest boot times.

SSL SCREENSOUND

Ease of use:	5
Processing speed:	4
Configuration/data entry time:	4
Inclusion of features:	3
Cost/performance:	3
Flexibility (multiple solutions):	4
Applicability to multi-track recording:	4
Applicability to music editing:	4
Applicability to post-production:	5

Current software version stability:	4
Fidelity (conversion/input/output):	4
Backup capabilities:	1
Total rating:	3.5

Strengths: User-interface is intuitive, easy to learn and pleasing to the eye. Graphics pad is fast and easy-to-use. Built-in database supports multiple keyword searches. Multi-user networking option available, which supports up to 16 SCSI devices. SoundNet allows up to seven operators to share a central mass storage device. Multiple units can be slaved to one master, providing up to 56 channels of playback. Optical disk-capable. Interfaces with Quantel's Harry and Paintbox system. Has built-in machine control. Virtual fader automation and muting. Slipping tracks is remarkably easy.

Weaknesses: Sampling frequency is fixed at 48kHz. System is relatively expensive. Tape streamer is slow and will not perform single file backup. No internal digital bus, so tracks are bounced through analog circuitry. VCA automation is not digital. It is not possible to crossfade within a track. Time compression is not possible. Slewing and time code stamping is not possible because of master-only designation, so unit cannot operate as a slave.

STUDER EDITECH DYAXIS

Ease of use:	4
Processing speed:	4
Configuration/data entry time:	4
Inclusion of features:	4
Cost/performance:	5
Flexibility (multiple solutions):	4
Applicability to multi-track recording:	2
Applicability to music editing:	4
Applicability to post-production:	4
Current software version stability:	4
Fidelity (conversion/input/output):	5
Backup capabilities:	3
Total rating:	4

Strengths: Very affordable. Multifunction digital I/O supports almost any digital source and includes digital effects loop. System synchronizer includes LTC and VITC reader/generators, MIDI time code output, tach and video sync reference. Entire signal path is digital. Non-real time track bouncing is possible. Unit has unlimited (non-real time) internal tracks. Optical disk ready. Unit outputs time code and can be used to chase. Real-time digital EQ, level change and sample rate conversion. Ability to mark on-the-fly and play before and after a sound. Can paste sound files to a time code number or the left cursor. Modular and expandable to four tracks with overdubbing capability. Four-channel system has graphic or EDL playlist capability. Has large user-base. Includes built-in digital test tone and noise generators. Macintosh-based, so numerous third party displays and utilities are available. Well-designed graphic screen display.

Weaknesses: DSP card does not currently accelerate mixing or crossfades. Gain changes

in a mix window are slow. Current digital EQ is playback only. Has only two outputs, although a 4-channel system is available. Elements do not "ripple" in a playlist. One change in a mix window causes the whole selection to be reprocessed. Can't currently punch-in and -out while overdubbing. Poor scrubbing arrangement using mouse.

WAVEFRAME AUDIOFRAME

Ease of use:	3
Processing speed:	4
Configuration/data entry time:	2

Inclusion of features:	5
Cost/performance:	3
Flexibility (multiple solutions):	4
Applicability to multi-track recording:	5
Applicability to music editing:	4
Applicability to post-production:	5
Current software version stability:	4
Fidelity (conversion/input/output):	5
Backup capabilities:	4
Total rating:	4

Strengths: One of the only systems tested which supports true multi-tasking; 24-bit in-

The shape of pure sound...

Community's design philosophy has always been a little unconventional.

When everyone else was insisting on metal, we promoted the precise shapes achievable through fiberglass. When others built walls of direct radiators, we built efficiency. When most of professional sound was divided at 800 Hz, we concentrated on midrange.

For those prepared to listen, the rewards of good design are clear.

In the RS220 Wavfront Coherent™ Loudspeaker system we have created the true culmination of Community design—precise fiberglass curves flowing into matched components—a system designed for effortless performance with maximum efficiency, power and clarity.

Community's RS220
The shape of pure sound...

Community
PROFESSIONAL SOUND SYSTEMS

333 East Fifth Street
Chester, PA 19013
(215) 876-3400
FAX (215) 874-0190

Charting System Performance

(ALL TIMES INDICATED IN MINUTES)

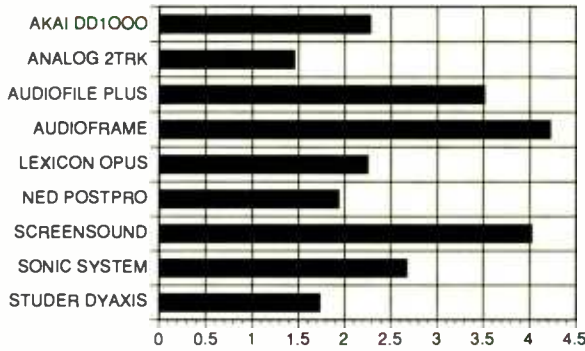

Figure 1. Loading MX.

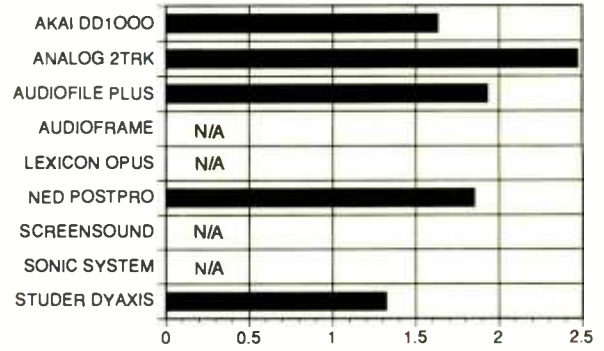

Figure 3. Time compression.

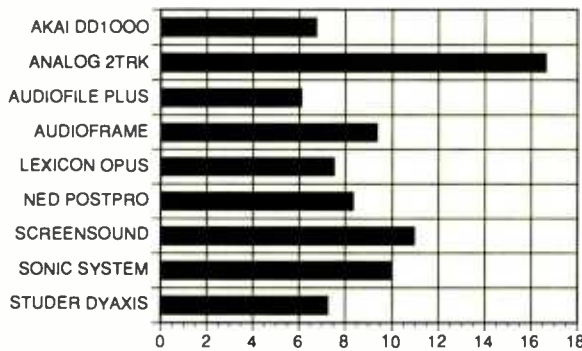

Figure 2. Editing time.

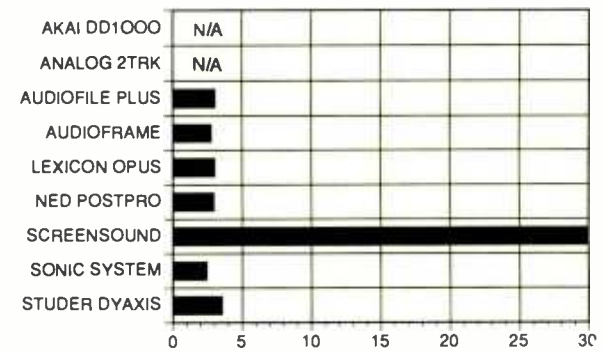

Figure 4. Backup time.

The Test Procedure

PART 1: MUSIC EDITING

A client (masquerading as R•E•P's Rick Schwartz and/or Mike Joseph) books time at a studio to edit a :60 spot into a :30 spot (\pm 3 seconds). The material must be inputted digitally (transferred) from a 44.1kHz DAT in stereo. Points are lost for analog-only inputs. Time compression must be used to make the spot exactly 29.5 seconds. Sound quality will be evaluated. The client requests a 1-second fade at tail.

All elements and playlist/decision list must be backed-up to the house archive system (format of choice). Points will be lost for analog backup or if the playlist is not saved.

PART 2: AUDIO SWEETENING

The client books time to sweeten a 2-minute film trailer. The production audio track ($\frac{1}{2}$ -inch 4-track with code on track 4, or $\frac{1}{4}$ -inch 2-track with center stripe) needs to be synced to the $\frac{3}{4}$ -inch video dub. Additional sound effects and voice-over need to be added. Elements come from two different sources: the production reel, and a DAT with VO and audio FX samples captured from CD. The video transfer house was unable to supply a $\frac{3}{4}$ -inch with VITC or window-burn (of course!).

The workstation is first booted from a cold start (approximating the first session of the day, or how long a client would have to wait if the system crashed). The VO with sync pop is transferred from DAT, sample rate 48kHz (points will be lost if digital transfer not possible). Pop and pre-signal noise (hiss, time code bleed) must be re-

moved without losing sync after alignment (points lost if sync affected).

Next, a 15ips production audio from reel must be transferred, with code from reel used to time stamp sound file, facilitating lock-up. The track is transferred free-running (not resolved to house) with a slight, operator-induced speed variation, and needs to be resolved to pic.

The production audio (with VO) must be sweetened with two stereo samples off DAT at 44.1kHz, with sample rate conversion necessary to match other elements (points will be lost if sample rate conversion not possible).

All elements must be mixed to stereo and converted to mono for non-Dolby theatrical release. All aspects of both scenarios (including system capability, time spent processing and program fidelity) will be considered and evaluated. ■

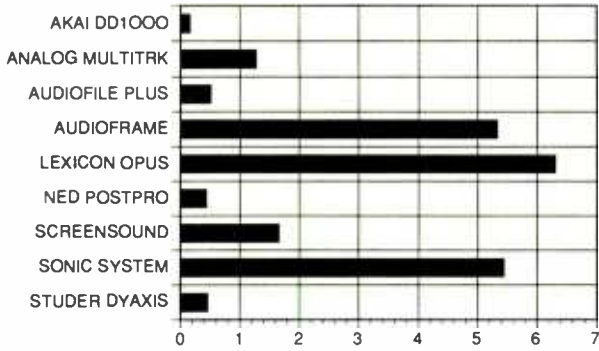

Figure 5. Boot time (cold start).

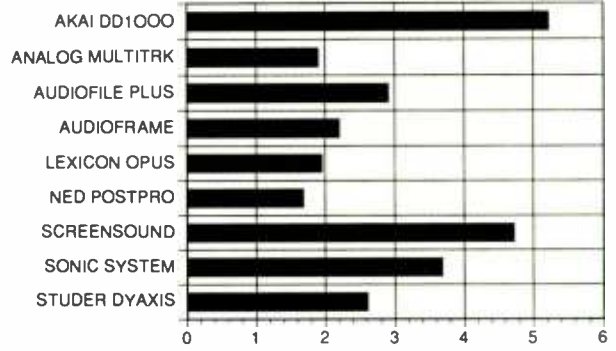

Figure 9. Syncing voice-over.

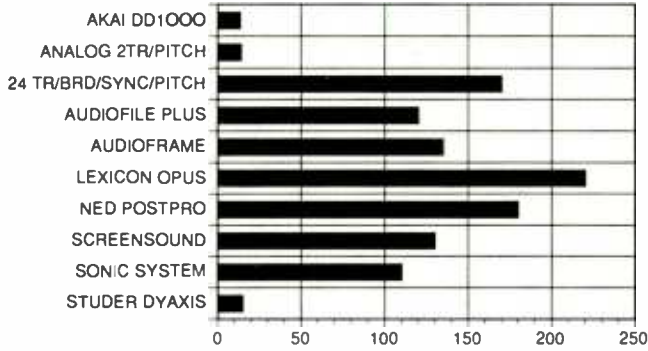

Figure 6. Prices as tested (in thousands of dollars).

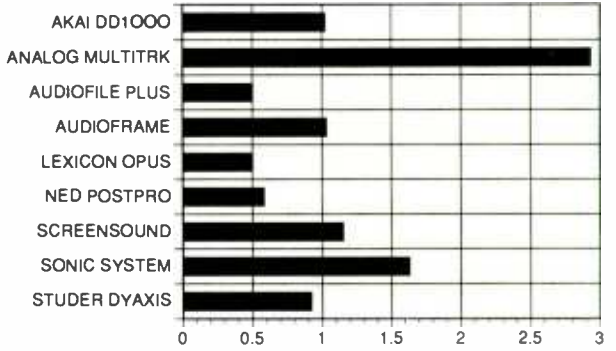

Figure 10. Removing noise.

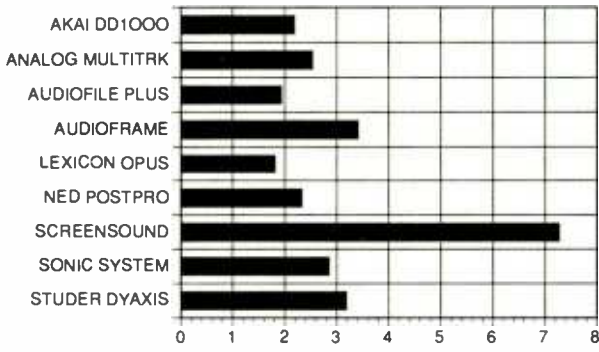

Figure 7. Loading production audio.

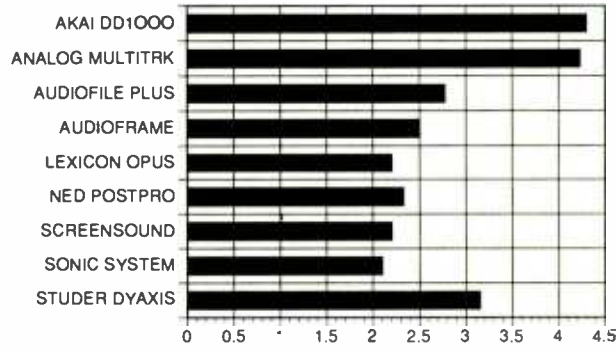

Figure 11. Mixing all elements.

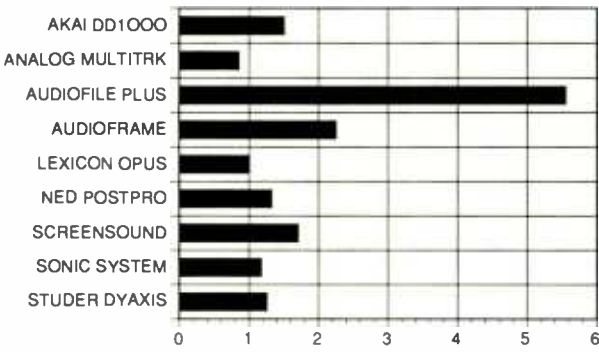

Figure 8. Loading sound FX.

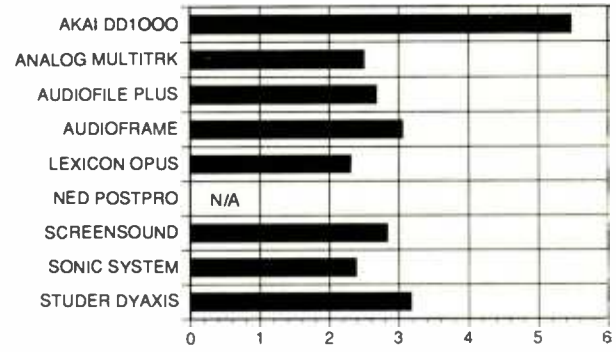

Figure 12. Stereo to mono.

ternal data path. Entire signal path is digital, so bouncing is possible using internal digital bus. Supports real-time sample rate conversion. Includes built-in RAM-based sampler, which has a circular record feature well-suited for recording ADR loops. Has a built-in database for music and sound effects libraries. All mixing functions are real-time and automated, including pans, volume changes, EQ. Users can design their own mixer, which includes digital effects such as reverb and delay. Comprehensive EDLs, with up to 16 numbers per element possible (because of complex envelopes). Has the ability to pitch down RAM-based elements from an EDL. Supports single file backup with multiple search criteria. Has built-in SMPTE calculator. Low cost DOS clones available as platforms.

Weaknesses: DOS-based system requires more typing of control prompts than other systems. Relatively expensive. No waveform display on disk recorder/mixer without first flying it to the sampler, or must scrub to mark edit points. MIDI and disk-based events can't be in the same playlist. Fixed internal sample rate of 44.1kHz mandates the use of sample rate conversion on digital I/O. No time compression. Unit will not slew to LTC. Time code reader does not check incoming time code for a drop frame flag. Could use virtual patch bay. Has long boot time.

AND THE WINNERS ARE ...

Our conclusions on which system did the best job at editing and time compressing a stereo music spot in the simplest, most straightforward way? Without saying they all won, we lean slightly more toward the Dyaxis. Even though every system balanced compromises, the Dyaxis seemed to balance them best at a most reasonable cost. Its relatively simple and intuitive Macintosh interface went far toward making the projects proceed smoothly, even with the less-than-perfect scrubbing that the Mac mouse offers.

Don't get us wrong — all the systems did a great job of editing simple stereo tracks and backing them up. All things considered, both the Akai and the AMS were excellent (and in some ways superior) to the Dyaxis, and, like the AMS, the Lexicon was blazingly fast. None really did poorly at editing alone, however several took an inordinate amount of keystrokes. Some scrubbed better than others. A few had no waveform screens, or screens that did little more than entertain the client. All told, and especially in light of the system cost, we thought the Dyaxis was an overall good choice for a music editing situation.

And audio post-production? The big boys all did as you might expect: Well. Although Lexicon competed with NED as the most expensive, it had a decided edge due to its very effective digital work surface. The console's large number of assignable analog and multi-flavored digital I/Os, combined with simple, straightforward screen implementation (albeit with no

waveform display), clearly presented a clean, well thought-out approach to disk-based recording. Virtually everything happened in real time, predictably, quickly, logically. Especially appreciated was the safety aspect: multiple queries safeguarded the inadvertent loss of a sound file.

Worth special mention are the other big systems — WaveFrame, NED, SSL and AMS — all extremely capable and perfect for their target applications. Their interfaces range from good to excellent, although arguably their unique features are less intuitive to access than the Opus. The SSL ScreenSound seems especially ideal for video or film post, although its inability to chase or time compress kept it out of the top slot. The NED is very expensive for its mix of base features, although again, no other system provides the creative sound design capabilities it offers in conjunction with the Synclavier.

CONCLUSIONS

Many of the systems were very close in total performance, while varying in the process by which they accomplished their chosen goals. All of the workstations performed well in the hands of an experienced operator. Most have a solid track record. All are capable of earning your studio money, today.

If you're seriously shopping, now is the time for you to do your own real-world workstation tests. Until you test a device in your environment, with material you're familiar with, these tests won't hit home. You might find that features you're currently unfamiliar with may become indispensable. And once they are, don't assume every workstation includes it (they don't). Don't assume the systems will be easy-to-use. Many aren't, or they have a long and steep learning curve, requiring a new approach to your work. Allow some serious *mano y mano* time for learning.

Our advice is to look closely at the features offered by the competing systems and realize that many do not compete directly. They all optimize certain specific functions. An apt analogy for you personally may be framed by the question: Which is better, a sports car or a pickup truck? The sports car is useless if you want to move a 'fridge. Then again, the pickup sure won't win any time trials through the S-bends.

Don't get frustrated if a system doesn't function exactly like you expect, or like an analog tape recorder or in-line console. Because once you master a workstation, it's hard to go back to doing things the old way. We know.

If there is one thing we want you to get out of this article, it's this: don't assume that all workstations are created equal. Each has its own strengths and weaknesses. There are some good choices out there now. Don't wait for some revolutionary system to come along — by the time it does (if it ever does) you will be so far behind that it will be hard to catch up. Today's business can't wait. ■

The Operators

AKAI DD1000

Ron Franklin is a sound effects editor in Hollywood; he has been using hard disk recording systems for about three years. His most recent music and dialogue editing has been on the new "Zorro series" (The Family Channel). Previously he worked as music editor, song arranger and guitarist for the NBC animated series "Fraggle Rock." He has also worked as a part-time instructor in the recording arts program at USC, and is currently a digital product specialist for Akai.

AMS AUDIOFILE PLUS

Rich Rauh is a well-known L.A. digital editor currently at Margarita Mix. The newly constructed facility specializes in film and videotape mixing for television commercials. It has five digital mixing suites in an environment designed to look like a Spanish villa. Rich worked as a sound engineer in Chicago until 1985, when he went to work for Waves Sound Recorders in Los Angeles. He has been a longtime AudioFile operator. (Margarita Mix was featured in the July 1990 issue).

LEXICON OPUS

Craig Rettmer is a co-owner of Soundtrek Plaza, Kansas City, MO, where he has been producing audio post for video since 1984. In addition to numerous regional commercial projects, he has produced post audio for major national companies, including McDonalds, Blockbuster Video, US Sprint and many others. Soundtrek Inc. has seven studios at four locations in three states.

NEW ENGLAND DIGITAL POSTPRO SD

David Marcus (aka Dr. Dave) has been a Synclavier operator since 1980. Using the NED system, he cut more than 60 episodes of "McGyver" at Hollywood's Modern Sound, worked on "Star Trek: The Next Generation," as well as other television projects. In 1988,

he returned to New York to design a tapeless studio for Magno Sound. While there, he worked on hundreds of commercials, the film "Blue Steel" and numerous television programs. David is the newest addition to L.A.'s Margarita Mix.

SOLID STATE LOGIC SCREENSOUND

Mark Keats is a digital editor who uses the ScreenSound system to edit dialogue, record ADR, edit music and perform D-2 laybacks. Mark works at SoundCastle/Post Modern in L.A. Working in conjunction with Monterey Post Production, he was able to edit dialogue music and record ADR for 65 episodes of Steven Spielberg's "Tiny Toon Adventures" in less than 52 weeks. Other credits include Warner Brother's cartoon "Batman" and IRS recording artists Cry Wolf.

SONIC SOLUTIONS SONIC SYSTEM

Ric Wilson is a digital engineer with a strong musical performance and production background. Ric has worked on numerous television and film projects including "Frank's Place," "Look Who's Talking" and Michael Bolton's "Soul Provider." In 1989, Ric joined forces with Prosonus Digital and established the Sonic Solutions NoNoise division, where he has processed songs by Jimi Hendrix, the Beach Boys and the Carpenters. He has also worked on the films "Born on the Fourth of July," "Bird on a Wire" and "Postcards from the Edge."

ANALOG MULTITRACK

Gary Joost is chief engineer of Music Animals, Los Angeles. He has been mixing jingles for almost 10 years and has a reputation as being one of the fastest engineers in the business. Before Music Animals, he worked as an engineer at HLC Killer Music. On a busy day he will record and mix four or five jingles, covering every imaginable style, and then work on a record project until the wee hours of the morning. Rock and roll!

STUDER EDITECH DYAXIS

Jim Baldree has been working with the Dyaxis digital editing system for more than three years. He has worked on several CD and album projects and won a student Grammy while attending MTSU. He currently works in Los Angeles as a digital editor at Music Animals, doing sound effects and music editing for the Hanna Barbera show "Wake, Rattle and Roll" and as an as-

sistant music editor for the syndicated cartoon "Widget."

WAVEFRAME AUDIOFRAME

Rob Arbittier has strong backgrounds in both computers and music. He started a successful software company at age 18 and has written several commercially available software packages. For the past five years, he has

been Stevie Wonder's keyboard programmer/synthesist. He owns Arbitone Studios, a digital production studio for records, television and film, equipped with an AudioFrame. As a production and writing partner with Gary Olazabal, Rob has worked with Stevie Wonder, Michael Jackson, Whitney Houston, Neil Diamond, Thomas Dolby and Stevie Ray Vaughn. ■

Launch Your Magna-Tech Reproducer
Into The 21st Century!

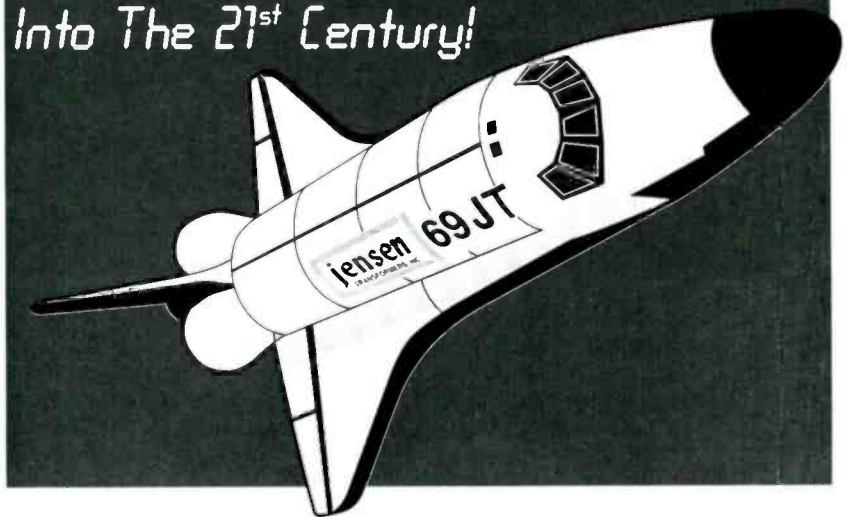

Jensen is Now Producing a High-Performance, Full-Featured Retrofit For The 69C Repr Amp



- ☆ 16 Equalization presets — 8 of which are automatically selected when you change headstacks
- ☆ Adjustable "head bump" equalization
- ☆ Extended bandwidth
- ☆ Low distortion and low noise
- ☆ Simple installation
- ☆ Jensen quality — exceptional performance
- ☆ Under \$600 per channel

Call or write for quantity pricing and delivery information

jensen
TRANSFORMERS, INC.

Jensen Transformers, Incorporated
10735 Burbank Boulevard, North Hollywood, CA 91601
FAX (818) 763-4574 • Phone (213) 876-0059

Digital Storage Technology

By Doug White

As the 1990s evolve, the state of digital recording is making a progressive move. Practical disk-based recording began in the mid-1980s, and with advances in technology, has become affordable to most audio pros. The benefits of this type of recording cannot be ignored, and have been the focus of many recent articles and editorials. Interestingly enough, DSP hardware, software and the user interface have been the main topics of review. These elements are the “engine” of the digital studio. But one of the most critical aspects contributing to the success of the engine is the medium you record to. Large, fast and reliable hard-disk drives are the canvas for today’s audio Picassos.

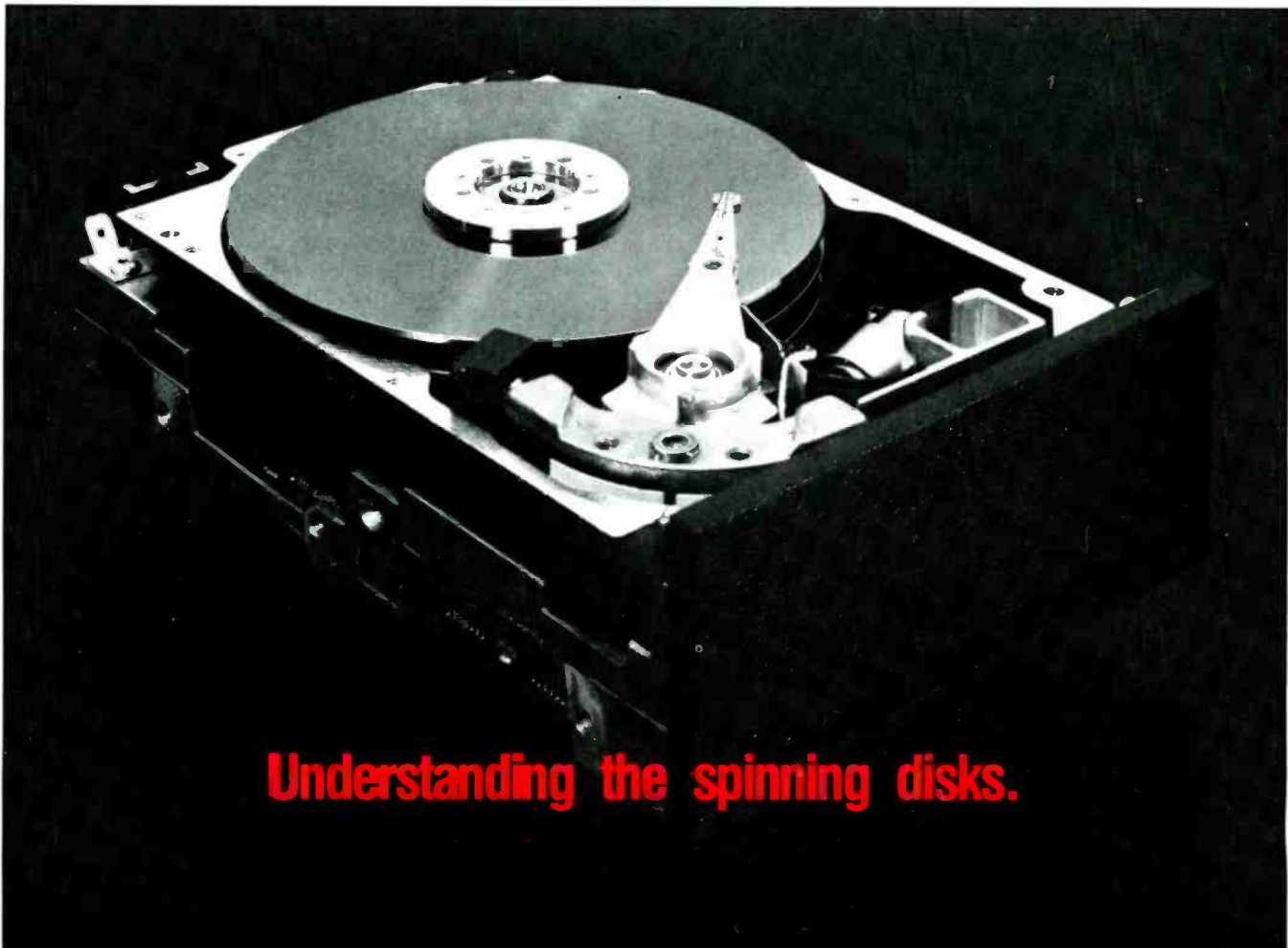

Understanding the spinning disks.

However, larger and faster hard-disk drives alone are not always the immediate solution to digital storage needs in all cases. Different applications can create different needs for mass storage. Size, access speed and cost of media are all important considerations.

One of the first tasks to be considered prior to the purchase of a storage device is that of determining the amount of storage you will need, based on the application that you have. The de facto standard of 10Mbytes per stereo minute doesn't always yield an accurate calculation of the storage needed. The following equations give a more accurate result:

- To find the amount of storage for one channel of digital audio (bits/sec): bits/sec = sample rate (samples/sec) × resolution (bits/sample).

- Example: $44,125 \text{ samples/sec} \times 16 \text{ bits/sample} = 706,000 \text{ bits/sec}$.

- A quick conversion will yield the result in the more familiar megabytes per minute: megabytes/min = (bits/sec × 60sec/min) ÷ (1,024,000 bits/megabit × 8 bits/byte).

- Example: $(706,000 \text{ bits/sec} \times 60\text{sec/min}) \div (1,024,000 \text{ bits/megabit} \times 8 \text{ bits/byte}) = 5.17\text{Mbytes/min}$.

Therefore, the amount of disk space re-

quired for one track of 16-bit, 44.1kHz digital audio is 5.17Mbytes/min.

Suppose your application is a 2-track digital recording for a 20-minute industrial video. The amount of disk space required (at 44.1kHz) is: 20 minutes × 5.17Mbytes/min × two tracks.

Therefore, it will require at least 207Mbytes of disk space to complete the project. As you see, the formula of 10Mbytes per stereo minute is not accurate. If you bought a 200Mbyte hard drive, you would not be able to complete the project. This was just one scenario. If you increase your sampling rate to 48kHz, the storage requirement is greater.

Now that an accurate calculation of disk storage needs has been determined, calculating the largest recording you will be doing is the next step. Is it an album master, a 60-second commercial or a 2-hour motion picture? Each has different storage needs.

Once you have completed the project, the question of archiving becomes an issue. Suppose you are mastering two songs of an album in one session; during the next, you need to lay down a lead vocal track on a different project. How do you store the first session and still be able to bring it back onto your disk drive at a later

date? This question, as well as others, will be answered in the next section.

DEVICE DESCRIPTIONS

Mass storage devices are broken down into three categories: Winchester, optical and tape. There is also a sub-category of Winchester and optical devices called removable, but this is more of a feature than a true category. For the purposes of this article, it will be treated as a category. The specifications for each are as follows:

WINCHESTER

The Winchester storage device is what we call the traditional hard-disk drive. The technology behind the drive is rather simple. The storage medium is a metal alloy platter, or series of stacked platters, that is coated with a magnetic surface. The surface is broken down, or configured, into tracks and sectors of bits of information. The read/write heads ride on a cushion of air over the platter and react to the bit polarity in each track and sector magnetically, just as an analog tape head does by either relaying or writing the information



“I protect my \$150,000 Synclavier with a Furman Line Voltage Regulator”



Starship veteran Mark Morgan doesn't gamble with his investments. That's why he depends on the Furman AR-117 Line Voltage Regulator to protect his precious electronics and recording equipment. An easy choice, since no other power conditioner offers more features for the cost, or provides better protection for sensitive audio equipment than the AR-117.

In a single rack space, the AR-117 automatically converts a wide range of high or low AC voltages to the North American standard 117 volts. It handles a hefty 15 amps, yet it radiates only

a minimal stray magnetic field. The AR-117 is frequency-independent, so it can be used successfully with generators. It filters out spikes, surges, and RF interference — and can even protect you from a disastrous accidental connection to 220V.

Find out why professionals like Mark Morgan depend on the Furman AR-117. See your local dealer or call or write for the complete details.



Furman Sound, Inc., 30 Rich St., Greenbrae, CA 94904 (415)927-1225 or Fax: (415)927-4548

to and from a controller card.

Most disk-based recorders use an SCSI (Small Computer System Interface) controller. The controller card acts as a translator between the CPU and the storage device. It will tell the computer what the drive's specifications are (capacity, manufacturer, number of sectors, etc.) and how to relay information back to the CPU. It actuates a voice coil or stepper type of solenoid that moves the heads to the track and sector destination. It is the brain of the storage system.

The function of the Winchester hard-disk drive in the digital audio environment is that of a workhorse. Speed and size depend on the manufacturer's specifications, but Winchesters are traditionally the fastest access of the various devices. The larger the number of platters and density of the track and sector configuration, the greater the storage capacity. Traditionally, large-capacity hard-disk drives are very large. As platter technology evolves, the hard drives are becoming dimensionally smaller and greater in capacity.

Three factors to keep in mind when sourcing a Winchester hard-disk drive are; the amount of time you need to record in one session, the amount of space you have for hardware and the price point you can afford. I recommend at least 400Mbytes, which allows for "headroom" on small projects and gives some substantial duration for larger projects. Anything under 400Mbytes would limit the user. Also, be cautious about the vendor you decide to purchase from: Support, quality and reliability are worth more than gold. The computer magazines are an excellent source of comparative analysis information and pricing.



OPTICAL

Optical storage devices are relatively new to the computer industry. The original WORM (Write-Once-Read-Many) drives allowed users the luxury of storing large files for archiving. Opticals are renowned for the reliability factor. The original WORM technology developed into the rewritable, or magneto-optical drive (MO or MOD) drive. The MO device has serious potential in the digital recording environment. Most MO devices store at least 600Mbytes of digital data on a double-sided, removable cartridge. The sheer size and transportable nature of MO devices makes them suitable for digital recordings, with some qualifications.

The first totally optical recording devices have shown up in the marketplace from a few digital workstation vendors, including Akai, with the DD1000. The original notion was that the MO devices were not

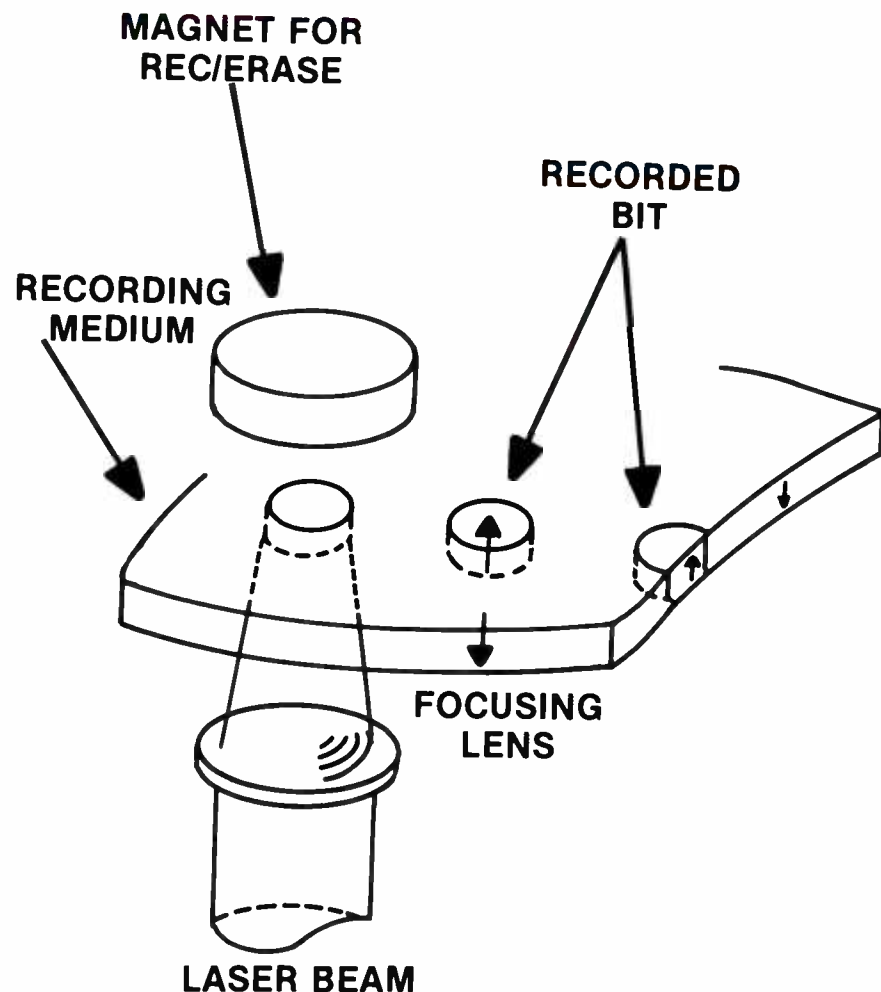

Figure 1. The data storage principle for magneto-optical recording. The medium is formed on a transparent substrate, and the laser is focused through the substrate to accomplish the required localized heating of the medium.

suitable for digital audio because of the slow access times. Companies like Akai are using proprietary drive modifications or custom software drivers to improve on stock performance. An off-the-shelf unit with standard software is too slow. For example, Digidesign's Sound Tools requires a 25ms access time for digital recording in real time. The typical MO devices of today have average access times between 80ms and 100ms.

There are three reasons why the access times are so high. First, the optical mechanism is much different than the fast-paced Winchesters. The laser used on the read/write head is heavier and takes a longer time to travel from track to track. Second, the polarization of the MO drive's magnetic surface is enabled by the laser head, which heats the surface and allows

a reversal of polarity. Third, the MO mechanism verifies each write cycle for data integrity purposes. This is the main reason for the slow write times. It double-takes on the fly. The actual read time is much faster than the write time because of this verification process. It is fast enough to read soundfiles and playlists.

I use an MO device in my own studio to archive and play back my music projects. This solves the basic problem of what to do when you have a project in the works and also need to start a new one. By downloading the file onto an MO cartridge, I free up my entire hard-disk drive for my next project. When I want to go back to the previous project and add to the playlist, I work directly from the MO cartridge. Because most current programs generate or use non-destructive edits, the

raw program material is not rewritten, and access time for read-only is fast. The only time I need to download to the hard drive is when I have to lay down another track, which is different from re-ordering segments for playback.

TAPE DRIVES

I find it humorous to talk to a computer "gearhead" about DAT tapes. Although the recording industry has been using DAT for several years, the computer world is just catching on to this technology. Computer DAT devices are similar to audio DAT devices except in the translation of the bits. A computer DAT cannot do the compromising that audio DATs do for dropouts. Imagine if you are a graphic designer doing the latest cover for a recording artist's new release, and the DAT tape you backed-up to "dropped out" his face. However, computer DAT is an excellent archiving device for digital audio. Most are SCSI-based and can work with your existing hardware. And the media is inexpensive. Backing up your work is critical to good time-management. Nothing is worse than booting up your workstation and finding

no software because a drive crashed. It can take days, if it's possible at all, to recover your software and program material. Back up often.

REMOVABLE

A technology that has caught on rapidly is removable cartridges. The fact that mass storage can be shipped overnight is wonderful. The removable drives on the market today include Winchester and MO devices. The removable Winchester devices are limited in capacity (40Mbytes to 50Mbytes) — just enough space to hold a short pop tune or a dozen 30-second jingles. As for the MO devices, read the paragraph above.

WHAT'S AROUND THE CORNER?

Eventually, we will see media where the head moves and not the disk, card or page. Count on seeing greater bit density, so more information will fit in smaller spaces. Also, count on improved reliability and a move toward common-file sharing or protocol standards.

However, don't count on any one or two types or sizes of devices becoming standard. The technology is changing too fast. Nobody wants to become locked in when the next great thing is right around the corner. Even if it isn't.

The entire world of digital disk-based recording is an exciting place to be right now. If you are a user or a potential user, be aware of what's in the marketplace. Read the computer mags, especially Macintosh-based magazines, where much of the audio and desktop production action is occurring. Your investment in time and money should take you where you want to go. Good luck. ■

Doug White is a keyboardist, digital audio producer and a product specialist at Microtec International in New Haven, CT.

REPRINTS

Interested in ordering article reprints out of this or another issue?* Reprints can be excellent learning tools for your technical staff and great marketing tools for your sales staff. Call or write Denise Kelley at Intertec Publishing Corp., P. O. Box 12901, Overland Park, KS 66212; (913) 888-4664.

*Minimum order 500 copies

ProSamples
VOL.1 259 DRUM SAMPLES
VOL.2 PERCUSSION/BASS
From Award Winning
Producer/Engineer

BOB

CLEAR MOUNTAIN

AVAILABLE ON COMPACT DISC
AND CD-ROMS FOR AKAI S1000
DIGIDESIGN/SAMPLECELL

East ★ West

1.800.833.8339/213.659.2928

Circle (24) on Rapid Facts Card

Hearing Aids for the Stars

By David Scheirman

More than 10 years ago, various system designers began working on a method to give all musicians a personal, miniature monitor system that would confine their own monitor mix to a very small area: their own ears. The immense success of Sony's Walkman gave rise to a vision of tiny, headphone-type monitors. Such a system would have to be a combination of high-fidelity audio, broadcast engineering and hearing-aid technology.

I first encountered such a system about 1981 at a production rehearsal in Los Angeles while mixing stage monitors for a well-known recording artist in preparation for a world tour. An entrepreneur had somehow weaseled his way into the artist's management office, and gained permission to conduct a private demonstration for the primary artist, who insisted that his own sound crew be present to monitor the proceedings, because something seemed fishy.

A close examination of the hardware involved showed it to be nothing more than a Sony Walkman-type FM receiver, picking up a signal from a ham-radio-type dual-mono transmitter with nearly 3W output hidden away in a "secret black box," which featured a fancy faceplate with the developer's name and logo. Other simple, budget parts were of a brand commonly available at any hobby shop. A high-frequency exciter was used on the output mix, along with an inexpensive digital reverb. Shotgun-type condenser mics were available to pick up audience sound and live concert ambience, which would be blended into the mix heard over the budget miniature headphones.

That system seemed over-priced, was illegal according to Federal Communications Commission rules, and caused discomfort for the musicians since the operator was "working out the bugs" while getting RF drift and unexpected level variations. The earpieces were uncomfortable after a few minutes. That artist promptly returned the system.

Fortunately, that artist did not end up

getting hooked into a disreputable scheme. The good thing to note here is that a performer desiring to use such a system today has new options that represent years of responsible, well-intentioned research.

BASIC CONCEPTS

The ideal personal monitoring system, such as the one described above, should address the following:

1. The system should work equally well, whether hard-wired or wireless.
2. Earpieces should be comfortable, non-allergenic and easy to clean.
3. The performer should be able to control the volume control on the belt-pack.
4. If RF, the system should be operating within existing legal guidelines.
5. The system should be available for rent from a legitimate concert sound company as part of an entire system package. If available for direct retail purchase, there should be no expensive, continuing ties to a "personal technician" or "custom-picked system expert."
6. If purchased, the total cost of the system should roughly follow an itemized hardware list of parts actually in use, with an appropriate cost level added for system assembly and profit.

If a system is being proposed to your company, or to a performer you are working with, and the situation seems to violate any of the above guidelines, beware ... it may be time to watch for shark fins.

HISTORY IN THE CONCERT INDUSTRY

About 10 years ago, early systems were pushed through direct contact to rock musicians' personal managers. Often targeted were those 1960's superstars known to have some hearing loss; the system was touted as being a way to "recover that concert excitement in spite of your hearing loss," and/or to lower overall stage volumes by doing away with high-level full-bandwidth speaker systems altogether.

One of the first artists to make use of any type of in-the-ear RF system was Stevie Wonder. Tight-fitting custom-molded earpieces were fitted to Stevie's ears, and a separate stage monitor mixing console was used to combine discrete stage input mixes with ambient sound. Stevie's decision to continue using this type of system helped to pave the way for the acceptance of this general type of technology by other artists.

Some artists funded the development of systems by their own trusted audio technicians. One notable example is the Steve

Miller Band. About 1984, Steve sought a wireless, mini-monitor system for a tour that featured a very clean stage look. No monitor speakers were to appear on stage. His soundmixer at that time developed a custom RF system for four different musicians. Development cost for four systems was approximately \$65,000.

"Steve and the band had a hard time using the system in concert, mainly because it was not stereo, and the same signal in each ear caused aural disorientation and ear fatigue even at low levels," recalls Jerry Pfeffer, owner of Sound On Stage in Brisbane, CA, who ended up supplying a traditional stage monitor system to the artist for the tour.

SPECIFIC SYSTEM DETAILS

Steve Miller did not stop his quest for the ideal personal monitor system. Several years after discarding his first custom system attempt, another system was tried out. It was also eventually discarded. In 1990, the group finally discovered a system called Ear Monitors, and is reportedly very happy with these units, which were used for the latter portion of the 1990 USA tour.

Another artist using Ear Monitors with success for the past four years is Todd Rundgren. In 1986, Crystal-Taylor Systems in the Philadelphia area developed a prototype mono RF system for Rundgren that has been in use on the road, and is still undergoing development. The system has since been converted to hard-wired stereo, using a multiband peak leveler and Crest 1001 headphone amplifier. The monitor console mix, including digital reverb and ambient mics, is given a 10:1 compression ratio.

Still another approach is taken for The Outfield. Drummer Paul Reed is touring with an English system that is sold under the name Personal Radio Systems (UK). This is a stereo RF system, and it was developed for The Stage Radio Company by designer Martin Noar after 10 years of experience with radio mics and five years of work on this project. For U.K. users, the system generates 10mW ERP (effective radiated power) on frequencies currently allotted for the entertainment industry. Maximum output of the receiver is 75mW per channel into each earpiece. The system consists of a 1-rack-space transmitter with a triple-element antenna on a clamp, and has a range of 500 to 600 feet. A tiny battery-powered body-pack receiver with volume control is used. The 9V battery life is said to be about five hours.

David Scheirman is R•E•P's live performance consulting editor and president of Concert Sound Consultants, Julian, CA.

Bose ProFiles

***"My customers
had been traveling with
Bose equipment for years.***

***They knew Bose quality worked
for them on the road, so they
expected the same quality in
their music theater, too."***

*— Thomas Tyson
Audio Acoustics, Incorporated*

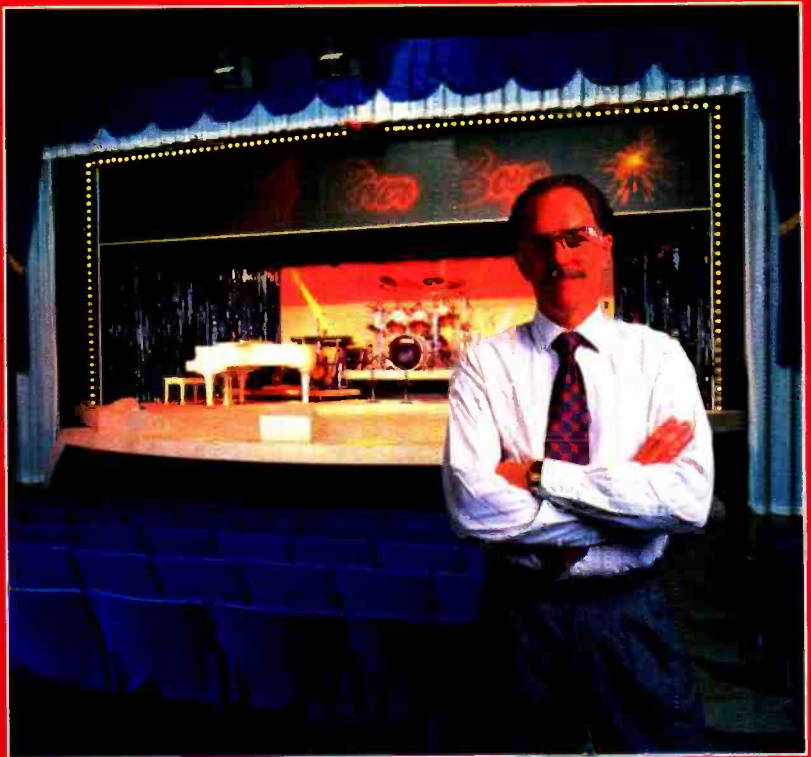

- The Site:** Foggy River Boys Country Music Theater, Branson, Missouri.
- The Challenge:** Design and install a state-of-the-art sound system for a 1200 seat theater with the flexibility to produce sound pleasing to all ages.
- The Contractor:** Thomas Tyson, Audio Acoustics, Incorporated
- The Products:** Central cluster with two Bose Acoustimass® Professional Powered Speaker Systems.
Two 802-II systems on delay for rear-of-house fill.
Two 802/302 systems stage left and right for front fill.

The Result: "When your customers are musicians, they're even harder to please. They have a finely developed ear for sound, and the way music is reproduced is very important to them. Acoustimass speaker technology provided the full, rich bass they wanted without overwhelming the room with equipment, and made their performances even more enjoyable for their audiences. The 'Foggy River' Boys still take their Bose equipment with them on the road, but now they can rely on Bose quality in their permanent installation, too."



*Bose Acoustimass Professional
Powered Speaker System*

For more information on Bose products, call 1-508-875-7330, or write Bose Corp., Dept. REP, The Mountain, Framingham, MA 01701-9168

BOSE
Better sound through research.

Live & Direct

Another system that has seen recent use was developed by A-1 Audio. The company's extensive experience with radio mics for Broadway shows, and use of an in-house RF spectrum analyzer, led to the development of a sophisticated but reliable system. Originally developed for use on tour with singer Engelbert Humperdinck, the system is now available for rent in the company's regular inventory. This personal monitor system features true broadcast-quality electronics, including Sony digital receivers.

POINTS TO CONSIDER

* Environmental sound levels: The louder the noise on stage, the tighter-fitting the personal ear monitors will need to be in order for the artist to hear only the ear-phone mix.

* Health and hygiene: Any ear-insert material must be non-allergenic, which will vary from person to person. The plugs should be fitted by a trained audiologist

and cleaned daily to prevent infections.

* In-ear sound levels: Users can be subjected to temporary or permanent hearing loss because of unexpected signal fluctuations. For the system to be powerful enough to be exciting, it is also strong enough to be dangerous. The best use of such systems is not to pump even louder sounds directly to the ears, but to personalize and achieve control of the stage monitor sound for each performer, thus lowering the overall stage sound level of the show.

* Legal ramifications: The FCC does not currently authorize the optimum radio frequencies in the United States for stereo transmission at required power levels for use in multiple cities. That is one reason that there are not really any commercially available stereo systems for sale in the United States. If you are a provider or system operator of such a system, and the artists sustain hearing injury or loss, who is legally liable during potential litigation?

* Front-end control: The signal must be carefully crafted, and it takes a unique blend of ambient sound, frequency enhancement, dynamics control and left-to-right program placement to be successful. The system's control needs vary from person to person based on the hearing characteristics of the individual.

WHERE TO FIND THEM

Ear Monitors are available through: Marty Garcia, c/o Crystal-Taylor Systems, 1231B Ford Road, Bensalem, PA 19020; 215-638-3440; fax 215-638-3627.

Personal Radio Systems may be obtained from the manufacturer at Unit 2, 12/48 Northumberland Park, London, N170TX; 44-01-801-8133; fax 44-01-801-8139; E-Mail DGS 2210.

A-1 Audio's rental department may be contacted at 6322 DeLongpre Ave., Hollywood, CA, 90028; 213-630-1188. ■

HOLDS UP ON THE ROAD

TYPE 85 FET DIRECT BOX

AMP.

INST.

PICKUP

INPUT

SPEAKER



COUNTRYMAN ASSOCIATES INC.

417 STANFORD AVE.-REDWOOD CITY, CA. 94063-PHONE 415-364-9988

Q101-6

AUDIO PRODUCTION & PACKAGING SUPPLIES

Immediate Shipment • Competitive Pricing

Ask for our Free Catalog

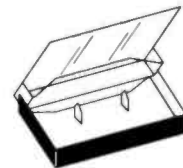

Boxes



Blank Cassettes

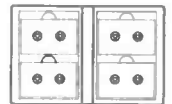

Albums

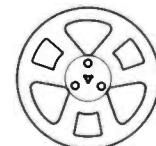

Tape & Reels

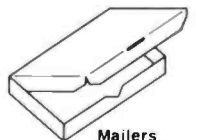

Mailers

PolyQuick

1243 Rand Road Des Plaines IL 60016
Phone: (708) 390-7744 Fax: (708) 390-9886

Circle (26) on Rapid Facts Card

Circle (27) on Rapid Facts Card

By Mark Herman

CLAIR BROS. AUDIO,
LITITZ, PA

Headline Act: Paul Simon

Dates: Jan. 4—late fall
Region: World Tour

PERSONNEL

House Mixer: David Morgan (independent)
Assistant House Mixer: Mike Wolf
Monitor Mixer: "Dr." David Staub
Assistant Monitor Mixer: Dave Skaff
Head System Engineer: Mike Wolf
Technicians: Jim Hores
Technicians: Scott "T.P." Appleton

CONSOLES

House: Gamble EX-56, 56×16×2
Monitor: (2) Harrison SM-5 32×16, (2) Soundcraft 200 16×4×2

AMPLIFIERS

Main FOH: Clair/Carver 1.5
Monitors: Clair/Carver 2.0
Sidefills: Clair/Carver 2.0

MAIN LOUDSPEAKER CABINET

Manufacturer: Clair Bros.
Model: (68) S-4 Series II
Flying System: Clair Bros.

ON-STAGE MONITOR WEDGES

Manufacturer: Clair Bros.
Model: 12 AM
Quantity: 36
Crossover Model: Clair Bros.

ON-STAGE SIDEFILLS

Manufacturer: Clair Bros.
Model: 2
Crossover Model: Clair Bros.

HOUSE RACK

Equalizers: T.C. Electronic 6032 system with (4) T.C. 1128
Crossover: Clair Bros. Coherent Transfer System
Effects: AMSRMX 16, (2) Lexicon PCM 70, (2) T.C. Electronic 2290, Lexicon 480, AMS SDMX
Gates: Drawmer 201, (2) dbx 904
Compressor/Limiters: (2) dbx 165, (16) dbx 903, (2) UREI 7110, BSS DPR 402
Analyzer: Klark-Teknik DN60 RTA
Power Conditioner/Light: Furman PL-8
DAT Machine: Sony DTC-1000ES
Cassette Machine: Yamaha C200
CD Player: Technics SL-P150

ON-STAGE SIGNAL PROCESSING

Equalizers: T.C. Electronic 6032 system with (32) T.C. 1128

MICROPHONES

Main Vocal: Shure Beta 58
Background Vocals: Shure Beta 58
Kick: Shure SM91
Toms: Shure SM 98
Cymbals: Shure SM 98
Overheads: Shure SM 81
Snare Top: Shure SM 57
Snare Bottom: Beyer M201
High Hat: Shure SM 98
Electric Guitars: Shure SM 57
Acoustic Guitars: DI, RF, tube DI
Keyboards: DI, XLR
Bass: Sennheiser 421, tube DI
Trumpet: Beyer M 88
Saxaphones: E-V RE20, RF
Pennywhistle: Shure Beta 58
Accordion: E-V RE20, Countryman Isomax
Ceramic Pots: DI
Cow Bells: Shure SM 57
Wood Blocks: Shure Beta 57, AKG C460
Little Drums: Shure Beta 57
Wind Chimes: VP 88
Conga Drum: Shure SM 98
Bongo Drum: Shure Beta 57
Timbales: Beyer M201
Rotos: Sennheiser 421
Brazilian Snare: Shure SM 98
Bell Tree: Beyer M 201
Direct Boxes: Clair Custom

CABLING

Clair House Snake: (2) 40-pair, (2) 12-pair, (6) 6-pair
Multipair Connectors: G&H 120
Stageboxes: Clair Bros.
Splitter: 3-way passive

Spotlight: Roadworx/Woodworx, Greensboro, NC

Outside of the Southeast, few people seem to know much about Roadworx or Woodworx. But pay closer attention to these two separate but closely related companies, because they are building a tremendous regional reputation.

Roadworx Audio & Lighting Specialists is devoted to sound reinforcement and lighting production; Woodworx manufactures and sells a line of loudspeaker cabinets. Until just recently the two companies shared the same location.

"A short time ago, we physically separated the two companies," says owner Hugh Sarvis. "Roadworx has expanded and moved to a larger facility nearby. Woodworx will remain in the same building as before and take over the entire space."

Woodworx sells six loudspeaker models: the SR-1 full-range main box, WSX 218 subwoofer, Max 1A and 2A small mains and Max-1 and -2 monitors. The JBL-loaded SR-1 has two 12-inch custom JBLs, two 10-inch 2123s and a single 2-inch 2450 compression driver on a proprietary DDS horn. The box is designed around the OEM 12-inch JBL speaker that handles up to 600W. This powerful full-range trapezoidal box is 30" × 36" × 18."

The WSX 218 is loaded with dual 18-inch JBL 2241s. The Max-1 monitor wedge has a 12-inch OEM JBL and 2-inch driver while the Max-2 uses a dual 12-inch and a single 2-inch. Models 1A and 2A use the same components as the Max-1 and -2, but incorporate a FOH main cabinet enclosure. Woodworx's compatible flying system — the Raft 2 — features a lightweight (55 pounds) aluminum beam that can fly the SR-1 boxes two wide and eight deep.

"We believe that with the way the economy and everything is going, concert cabinets should be designed to be very powerful, but compact, to better facilitate an efficient, space-saving truck pack," Sarvis says. "The idea is to use fewer trucks for the tour."

Continued on page 70

Mark Herman is president of Hi-Tech Audio Systems, a sound reinforcement equipment rental company based in South San Francisco.

Loudspeaker rigging comes of age.

HANGIN' HIGH

By Andrew T. Martin

Loudspeaker rigging hardware has become an integral equipment component of mid- to large-scale sound reinforcement rental companies. Rigging is also becoming a larger part of smaller regional companies, not to mention the local contracting markets.

The demand for flyable loudspeakers has created a new area for rental houses and manufacturers to explore. Together, the two parties are making advancements that will change the outlook of loudspeaker flying hardware. Nevertheless, the sound reinforcement industry is relatively immature on the technical subject of flying loudspeakers.

To date, most of the loudspeaker rigging hardware systems have been mustered together with components from the aircraft cargo control industry. Only recently have some manufacturers and rental houses be-

gun to build rigging hardware that is requirement specific for utilization with loudspeakers.

To generalize, slow development of specialized rigging devices in the sound reinforcement industry originated from a lack of experience in the field. Specialists in rigging loudspeakers are few and far between, and those who are experienced are often too busy to share their knowledge with others.

In the hopes of promoting safe rigging practices, this article will touch upon many of the aspects of loudspeaker rigging that affect the practice of flying loudspeakers in both portable and permanent applications.

The primary concern for anyone flying loudspeakers should be safety, a consideration that begins with the loudspeakers themselves. There are many manufacturers of loudspeakers that offer factory-installed rigging attachment hardware, and the user can be fairly confident that a factory loudspeaker set up this way will be adequately braced internally for use in multiple loudspeaker arrays.

However, there are structural limitations to any loudspeaker with rigging hardware, and it is always a good idea to ask the manufacturer for the certified structural engineering specifications prior to rigging anything. If the loudspeaker is of a proprietary design, the entire structure needs to be engineered and certified. On the road, copies of the certified engineering specifications should always accompany the loudspeaker system.

RIGGING DESIGNS

Loudspeaker attachment point methodology varies by manufacturer, thereby

making most loudspeaker rigging systems incompatible. However, there are a few common rigging system designs worth reviewing. Perhaps the most common uses the cargo control pan fitting (see Figure 1). Other common attachment points include extruded aluminum track, stud fittings and threaded plates. Most of these fittings are reinforced on the inside of the loudspeaker enclosure with steel backing plates which help distribute the stress through the loudspeaker cabinet. To further aid with distributing the stress, many loudspeakers have the attachment hardware side mounted, or angular backing plates that channel the weight load to the side of the loudspeaker enclosure directly. Other manufacturers incorporate steel members through the entire loudspeaker, thereby eliminating the need to rely on the cabinet's own structural integrity.

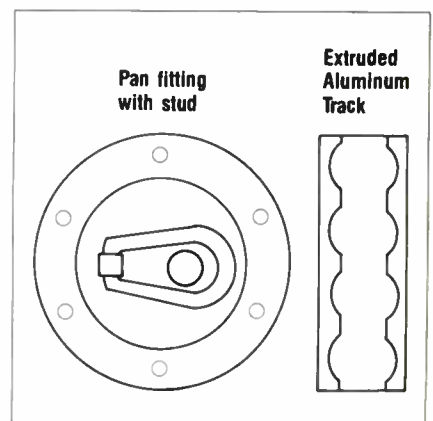

Figure 1. Common attachment points include the cargo control pan fitting (left) and the extruded aluminum track.

Andrew T. Martin is president of ATM Fly-Ware, Carson, CA.

As mentioned earlier, most attachment hardware originates from the aircraft cargo industry and is extremely strong. In most cases, the attachment points are so strong that the loudspeaker cabinet becomes the weakest link in the loudspeaker's rigging system. For this reason, it is important to know the load rating of the loudspeaker enclosure, and what safety ratio the load rating reflects. In the United States, it is reasonable to consider a 4:1 safety ratio as being adequate to appease most safety inspectors. However, a 5:1 safety ratio is developing as a self-regulated industry standard. Some manufacturers are certifying at 6:1 (the cabinet or internal rigging hardware failure point being six times over the typical operating load conditions).

The same rules apply to any loudspeaker rigging hardware external of the loudspeaker, whether it is proprietary, manufacturer recommended, or built to suit. For rental companies, it is important to have copies of the certified structural engineering specifications available at all times that the loudspeakers are being flown. Contractors should maintain complete files with load rating information as well.

Other safety factors that must be realized when dealing with loudspeaker rigging hardware include suspension of the array, load distribution and suspension hardware. Much of the time, the house riggers will be handling everything down to the suspension hardware. However, it's not a bad idea to know what the riggers are doing. There are many informative books from the rigging and construction industry (available at theatrical supply houses) that describe in detail the proper methods for grid attachment and load distribution.

Suspension hardware of importance to the loudspeaker rigger includes items such as wire rope, shackles, carabiners, rigging slings, adjustable pull straps and custom assemblies. A general rule to follow when working with any of these items is to throw them away if they look damaged. Do not use wire rope that is kinked, stretched or rusty. Throw away shackles that feel like they are binding or look elongated; the same holds true for carabiners. All of these items are relatively inexpensive when you consider the possible costs of a failure.

Also, always use the load-listed and labeled variety of suspension hardware if it is available. Components that are not listed may be flawed, and labels will be helpful to inspectors unfamiliar with the componentry. If the component is proprietary or custom-built, it should be rated by a certified engineer and documentation should accompany the system at all times. This is especially true overseas, or in certain large, union municipal events.

While safe rigging hardware is an abso-



WHATCHA-MA COLLET.

What the heck's a COLLET?

Just the best designed, most dependable and stylish general purpose knob in the world. That's what.

If you want a knob that will never break, melt, corrode, or shake loose; a knob with exquisite tactile feel; a balanced, sculptural, classic knob, then you want Selco's COLLET knobs.

Let us impress you. Our COLLET'S matte-finish, precision-molded 94V-2 nylon body is permanently bonded to a solid brass collar. This retains a machined, split-base threaded bushing, also solid brass, that slips over your control shaft and

tightens from the front with a special brass nut. Finally, a nylon cap in one of seven decorator colors snaps on the front.

Simply superior. Not even a set screw mars its elegant exterior. And Selco's COLLETS come in a full range of sizes and types, with all the accessories, too.

If you're a discriminating designer who wants the respect of his most demanding customers, then

furnish your equipment with Selco's COLLETS. The only thing modest about them is the price. Low OEM quantity prices.

Send for our full-color catalog and a sample knob today. You'll collet fantastic!

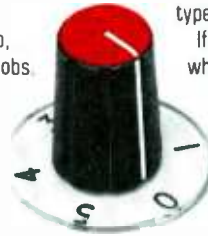

selco
PRODUCTS CO.

7580 Stage Road, Buena Park, California 90621. Phones (213) 921-0681, (714) 521-8673, Toll Free (800) 229-2332. Telex 655457. FAX (714) 739-1507.

Circle (33) on Rapid Facts Card



PROFESSIONAL

- DESIGN • SALES
- SERVICE • PARTS
- INNOVATIVE FINANCING PLANS
- RUSH DELIVERY

INNOVATIVE SOLUTIONS FOR PROFESSIONALS



AKAI A.D.A.M. 12-TRACK DIGITAL AUDIO RECORDER

NEW YORK'S LARGEST PRO AUDIO INVENTORY

• PROCESSORS BY EVENTIDE, LEXICON, DBX, SYMETRIX, VALLEY PEOPLE, ALI SIS, I.C. ELECTRONICS & AUDIO LOGIC • D.A.T. FEATURING SONY, TASCAM, CASIO AND OTHER LEADING PROFESSIONAL BRANDS • SAMPLERS FEATURING THE AKAIS-1000 & S1000HD, THE ROLAND S-770, S-550, & S-330, THE FMU I MAX II, FIII & PROIUS • INTRODUCING D.A.R. DIGITAL WORKSTATION—POSTPRODUCTION POWER TOOL.

A FEW EXAMPLES:

• SOUNDTRACS II/48/ERIC/CMX/MRX STUDIO CONSOLES • AMEK MAGNUM/IAC SCORPION II/BULLFET CONSOLES • C.A.D. 16 TO 48 INPUT, DC SERVO POWERED MIXING CONSOLES • EVENTIDE H-3000S & B • T.C. ELECTRONICS DFATER FEATURING THE T.C. 2290 • AKG ADR 68K DIGITAL REVERB • ROLAND R-880 DIGITAL REVERB & F660 DIGITAL I.Q. • CONDENSOR MICS BY JOSEPHSON, AKG, CROWN, NEUMANN, SONY & SENNHEISER • APPLE MACINTOSH COMPUTERS (NY'S ONLY APPLE MUSIC DEALER) • SOUNDTOOLS DIGITAL AUDIO RECORDING & EDITING SYSTEM • TASCAM MSR-24 1" 24-RACK BREAKTHROUGH PRICE RECORDER • MONITORS BY JANNON, EV, JBI & URI



TASCAM ATR-80 JAPAN'S FINEST 2" 24" RACK

723 SEVENTH AVENUE (THIRD FLOOR)
NEW YORK CITY • 10036 • (212) 719-2640

Circle (34) on Rapid Facts Card

lute necessity, the rigging system must suit the requirements of the user as well. Loudspeaker rigging system flexibility and ease of installation is extremely important if the rigging system is going to be of maximum benefit.

FLEXIBLE ADJUSTMENTS

Another important aspect of the loudspeaker rigging system is tilt and splay angle adjustment (see Figure 2). There are various methods of achieving different tilts and splays. Most system designs will incorporate an adjustable pull strap that attaches to the bottom of the loudspeaker and runs to a top grid suspension truss for adjusting loudspeaker tilt. Some of these systems also use track type rigging hardware, which can tilt the loudspeaker by changing the suspension point in relation to the loudspeaker's center of gravity. With this type of design it is not always necessary to use an additional adjustable pull strap if the tilt is gentle.

The latest advancement in rigging hardware comes from manufacturers that use a movable suspension point that allows greater flexibility than a track-type rigging system offers. These new rigging systems often allow the elimination of adjustable pull straps altogether.

For adjusting loudspeaker splays, most loudspeaker rigging systems will incorporate an overall top grid suspension truss. The top grid truss will have one of a few methods for varying the splay of the loudspeakers it supports. One method is to integrate a series of different attachment points: the user is able to select the proper points for the desired splay. This method is usually designed to keep the loudspeakers touching at all times in order to optimize loudspeaker coupling and sustain a coherent acoustic wavefront.

Another method is to build the top grid truss with a swivel suspension bar. In this design, each column of loudspeakers is suspended from one swivel bar, and the column can then be rotated. This method will allow the spacing of the loudspeakers apart from one another, which results in variable pattern overlap, adjustable low frequency coupling of the loudspeakers and acoustic wavefront alignment.

Yet another method of achieving splay between loudspeakers has been developed by manufacturers using a truss assembly that mounts onto each individual loudspeaker, in conjunction with a second assembly that mounts between the loudspeaker trusses. The two components work together to determine the loudspeaker spacing (see Figure 3).

AESTHETIC CONSIDERATIONS

Of course, even the best loudspeaker rigging hardware system will not be utilized to its fullest potential if it is ugly and ob-

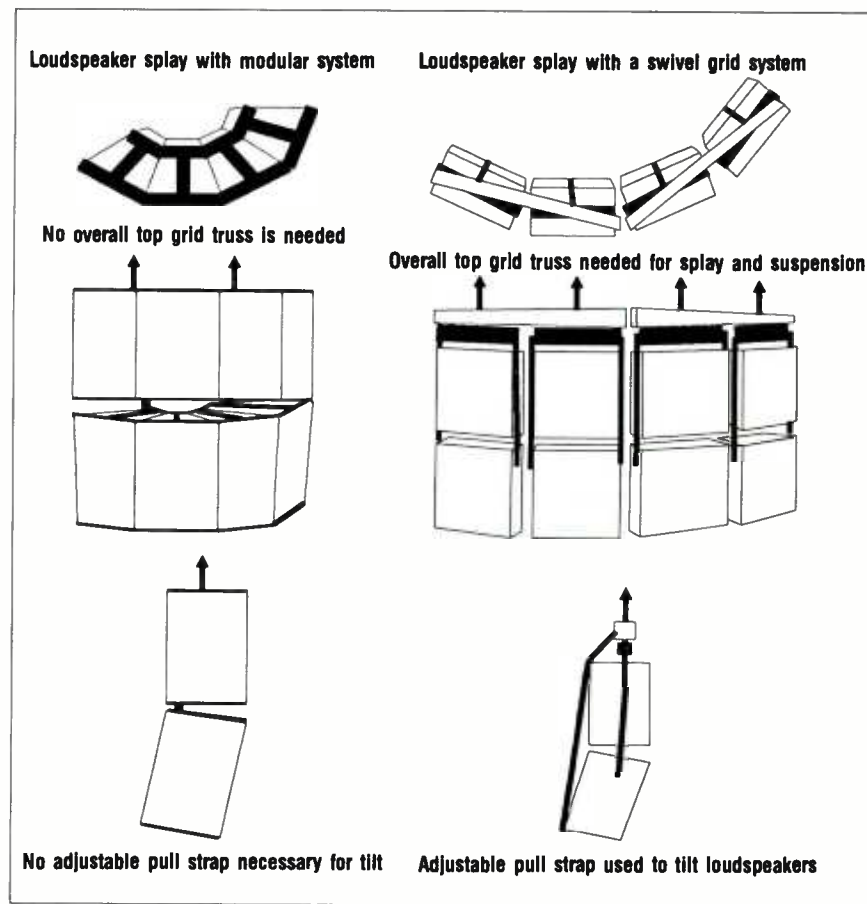

Figure 2. Various methods are available to achieve different tilts and splays.

trusive. Aesthetics play an important part of any rigging system. Not only does the system need to look nice to the client, but it also has to look strong to the riggers and inspectors. It is for this reason that most rigging systems are designed around a bulk appearance. That is, they are built with large aluminum members that look heavy duty, but are then used in a horizontal, flat configuration to make them seem less obtrusive to the client. Flat, top grid suspension trusses are designed along these lines.

Newer loudspeaker rigging designs are incorporating the loudspeaker truss onto the loudspeaker itself. This type of system is extremely unobtrusive, as the rigging truss seems to blend into the loudspeaker and does not extend beyond the footprint of the loudspeaker.

A loudspeaker rigging system that works well and looks good is an enormous asset to the sound reinforcement rental company. However, there are many liabilities that go along with rigging loudspeakers as well. The first liability realized by the user is the cost of flying the loudspeakers correctly. It is very costly to build a loudspeaker rigging system, not only in financial investment, but also in the time investment spent on research and devel-

opment. It is not uncommon for an entire rigging system to take tens of thousands of dollars and years of modifications before it is finished. As a result, the smaller sound reinforcement rental houses and contractors have avoided flying loudspeakers if possible.

The second liability realized by the user of a loudspeaker rigging system is the legal responsibility of flying loudspeakers. The user must have the rigging system insured, and again, the rigging system should be certified as a system. This is for the user's protection, as well as their clients' and the general public attending the production. Insurance packages that cover rigging are not inexpensive, but a cheap insurance plan will not provide the protection necessary. One falling cabinet can wipe out any number of financial resources.

A third, and not so apparent, liability has to do with education for the users of the rigging system. It does not matter how safe the loudspeaker rigging system is if the user is unable to assemble the system correctly and safely. A loudspeaker rigging system can be difficult to teach to an inexperienced stagehand. Patience, guidance and enthusiasm must be present during training to reinforce a cooperative ef-

fort to assemble the rigging system successfully. This will not only assure a safe event, but will also promote safety in future events and for the future of loudspeaker rigging in general.

The future of loudspeaker rigging is important to protect, as the industry is just beginning to develop. The advent of modular designs that are lightweight, perhaps made of alternative materials such as plastics or fiberglass, hold tremendous promise. Loudspeaker rigging systems will become more specialized as loudspeaker manufacturers start to build dedicated rigging systems into the loudspeaker's construction. Also, the future will hold motorized, servo driven adjustment capabilities for tilts, splays and attitudes with computer based controllers.

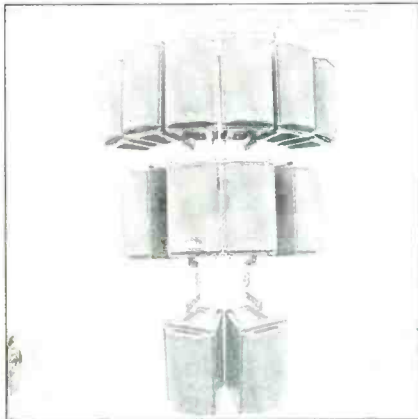

Figure 3. Individual truss assemblies that mount onto individual loudspeakers is another method of achieving splay.

Loudspeaker arrays will be easily designed on computer simulation software, and easily modified to suit each individual application. Loudspeaker array software and room simulation software will be integrated, so that the acoustic effects of modifications in array configurations can be seen on screen, before the loudspeakers are flown and positioned.

Such information as dispersion, directivity and intelligibility estimates will be available to the user for loudspeaker array plotting. And with promising recent developments in computer simulation software, it will be possible to listen to a loudspeaker array's acoustic output in its environment before the array is constructed and placed.

The field of loudspeaker rigging is an exciting area with tremendous potential for creative solutions to many complicated problems. The future holds innovation and efficiency, and above all else, always improving safety margins. ■

Figure 3 courtesy of ATM Fly-Ware.

HEARD BY MILLIONS
BUT SELDOM SEEN

ducer

**Studio Quality Contact
Condenser Microphones**

- SUPERB CLARITY
- TRUE ACOUSTIC SOUND
- COMPLETE ISOLATION
- EASY TO USE, NO HOLES TO DRILL. CAN BE MOVED TO OTHER INSTRUMENTS
- MORE THAN 10,000 USED WORLDWIDE
- LOWER COST AND BETTER PERFORMANCE THAN CONVENTIONAL MICROPHONES



New CP Series
just introduced.
• Super quiet
• computer matched
• miniaturized circuitry
• mics acoustic instruments

Call 1-800-CT-AUDIO

In Canada call 604-688-2444
CT-AUDIO SYSTEMS, INC.
3050 SW 14th Place, Suite 3, Boynton Beach, FL 33426
Tel. 407-738-0622 • Fax 738-0319

Circle (28) on Rapid Facts Card

**NEW FROM
OMNICRAFT**
**GTS Stereo
Noisegate**



Omnicraft's unique optical system has enabled us to design a noisegate with the lowest levels of noise, coloration of any noisegate on the market!! The GTS also features:

- 24dB/Octave hi & lo-pass filters
- Balanced inputs & outputs (on XLR-type connectors)
- Duckling, Keying and 2 modes of triggering
- 2 separate channels can be ganged for stereo
- Low Cost
- ...and many more features.

M-1

MICROPHONE PREAMPLIFIER

SUPERIOR SOUND QUALITY. RE-DISCOVER YOUR MICROPHONES!

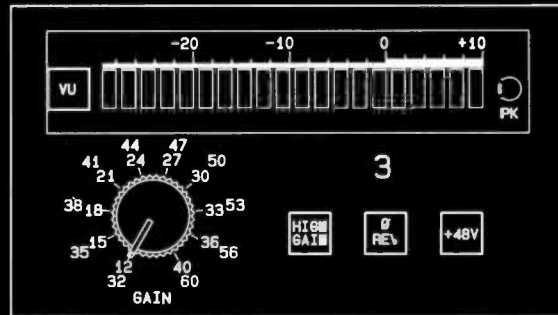

(ACTUAL SIZE)

- THE BEST JENSEN INPUT TRANSFORMER: THE JE-16-B.
- THE BEST OP-AMP: THE 990 DISCRETE OP-AMP.
- DC-SERVO ELIMINATES ALL COUPLING CAPACITORS.
- THE BEST JENSEN OUTPUT TRANSFORMER OPTION: THE JE-11-BM.

- ILLUMINATED SWITCH BUTTONS.
- TOROIDAL POWER TRANSFORMER.
- UNIVERSAL POWER SUPPLY.



- XLR CONNECTORS. GOLD OPTICAL.
- TWO METER OPTIONS. VU-1 SHOWN.
- CUSTOM KNOB & PUSH BUTTONS.

THE JOHN HARDY COMPANY

P.O. Box AA631
Evanston, IL 60204

(708) 864-8060

Telex: 910-380-4670
(JOHN HARDY CO)

Circle (29) on Rapid Facts Card

HANDS ON:

Roland SN-550



By Mack Clark

Here it is: A digital noise eliminator for the rest of us. We all know there are encode/decode packages, and expensive single-ended computer-based systems that can clean up a track after the damage is done. But, a single-pass unit that works in real time, packed into one rack space, and designed for the common man, at an affordable price? This must be progress.

At first glance, the Roland SN-550 Digital Noise Eliminator looks like other 1-space Roland devices. Closer examination

reveals controls labeled with familiar signal processing terms: threshold, bypass and frequency. They are associated with the headings Noise Cancel and Hum Cancel. What looks like an ordinary metering panel has some unusual items that arouse wonder.

Looking to the owner's manual for enlightenment reveals its stated *raison d'être* in the features section: "Noise and hum canceling units to reduce noise generated by musical instruments or variable lighting systems, tape hiss of analog recording equipment, the hum caused by power supplies or picked up by microphones or guitars."

Mack Clark operates MCTech Associates, an audio systems engineering and technical support company in Oakland, CA.

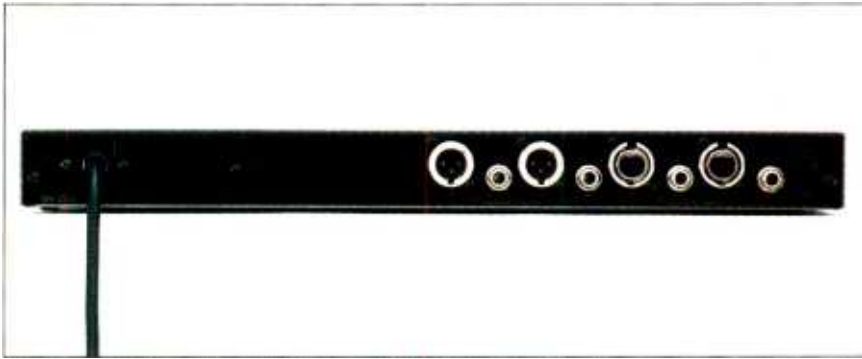

XLR and 1/4-inch jacks on the back panel allow the SN-550 to be interfaced with any type of device.

This 2-channel, non-stereo strapped unit is designed to divide the input signal into five bands and act on reducing the noise in these specific bands individually. The hum canceling section claims to remove hum with minimal tonal alteration. "Unlike other cancelers that reduce hum using a comb filter," the manual continues, "the SN-550 uses a suppressor that works only on the frequency that has the same harmonics as the hum."

The unit is modest in its controls and is easy to operate once you grok the underlying operational concept. The large bypass switch on the left end of the panel is complicated by its similarity to the power switch at the opposite end, a problem shared with other Roland pieces. The potentiometers are stacked rotary types, one deck for each channel.

The internal level controls at left are trims, designed to optimize the operating signal window, and do not affect throughput level significantly. Typically with units such as this, designed to operate at up to a +4dBu level, these controls end up at the MIN setting. A MAX setting will add 20dB of gain internally so that the signal is effectively "moved up" in the window.

You can monitor this positioning on its "Internal Level Meters," but don't expect to hear at the output what you see. You're effectively playing with dynamic range, headroom and signal-to-noise, not output level. However, the clip lights are real — if you set it up inappropriately and your program lights these up, the flash you see is the crash you hear.

The noise cancel section is as simple as could be: there are separate switches to select channels A or B, and stacked threshold controls that determine the level below which the circuit begins to work. There is also a bank of five LEDs per signal channel, one per frequency band in the metering display, which indicates when each of the five bands is working. The hum cancel section has the same ar-

angement, with additional controls that come into play when the hum cancellation frequency is selected manually — normally it tracks ac line frequency automatically.

In this line frequency auto mode, the unit senses the line frequency from the main input and bases its activity on that. In the manual mode, you may select the fundamental frequency yourself with the adjacent pot. An associated character display indicates what frequency you've dialed via a digital frequency counter, regardless of the mode selected, and a little red bar over the frequency LEDs lights up when the hum canceler is working.

A nice convenience designed into this unit is the inclusion of two pairs of inputs and outputs, with XLR connections and 1/4-inch jacks, thereby facilitating interface with anything.

ON THE BENCH

Beginning with the hum section, I patched-in various frequencies of sinusoidal tones to see what would happen. Bringing up the threshold to MAX while feeding a 60Hz tone (with the unit in the Line Frequency mode) resulted in a noticeable drop in level for the fundamental and first eight harmonics (through 480Hz). These later proved to be very narrow notch filters with a reasonable 40° phase shift throughout, at maximum attenuation. Pumping square waves through the 550 showed that harmonic alteration, or the amount of filtering at the higher harmonics, increased as the threshold was increased.

The dial-in frequencies were very accurate, and the "auto lock to line frequency" functioned flawlessly. Although simple in operation, the hum cancellation section is conceivably worth its weight in gold if you absolutely have to remove garbage from program material. It works equally well, without any noticeable side

You Have To Be SHURE To Capture It All!



At Full Compass, we have one of the largest microphone selections in the country. Possibly the lowest prices too!



Full Compass always offers discounted discount prices on highest high quality Shure products, but now for a limited time only, Full Compass will throw in a perfectly **FREE T-shirt** with every Shure mic or mixer order!



1-800-356-5844



Consultation: 608/271-1100
5618 Odara Rd., Madison, WI 53719

Circle (30) on Rapid Facts Card

March 1991 R • E • P 65

effects, on fully assembled tracks or on individual solo tracks.

It is important, however, when working on pairs of tracks meant to operate together (whether stereo, split mono or any program material which may be combined or summed down the road), to position the setting on the two channels close, if not identical, to each other. Why? There is a time domain offset, evident at different frequency and threshold settings. Because this device is operating in the digital domain, frequency settings seem to be clock-related, introducing delays that can clearly be measured in milliseconds. The device could conceivably function as a short-period DDL, if two widely differing hum cancellation frequencies are dialed up and tuned to MAX.

In most circumstances, this latter situation should not be an operational problem, unless a processed track is summed with the original, or played against leakage or signal on another track (such as a direct bass feed on a live recording being de-hummed and then mixed downstream with the mic pick-up of the same instrument). Time-based cancellations can definitely be created.

BAND FILTERING

In the 5-band noise reduction area, it is clear that the same general high quality level of performance has been achieved in the design of the filter section. Various discrete sine wave frequencies applied in specific bands create no distortion or changes in level or phase in those bands until the signal drops below threshold, where the effect in that band is very similar to a soft sloped gate.

However, with the thresholds set to "no effect," there is a slight timbre change to wideband program material when the noise filter section is switched in and out. With discreet tones, the 5-band display indicates that in those areas of the spectrum more than an octave or two away from the input frequency, the noise canceler function is being applied, shutting down the bands where signal is not detected. The filtering starts with the high frequency band and goes down in spectrum.

The application of square waves with a touch of overshoot (high frequency content) proves to be an effective "noise simulation" for this test. In this case, as the threshold level is increased, the high frequency content, which might be characterized as a "buzz," begins to disappear; we are left with a very reasonable facsimile of our original tone — still a nice bright signal. Increasing the threshold to the MAX setting eliminates the buzz sound entirely (higher harmonics) at the

expense of some of the brightness of our original. But the fundamentals are unaffected.

Switching the hum canceler in and out at various threshold levels produced no discernable anomalies in response, although the unit's overall Bypass switch introduces occasional clicks. As the threshold level rises you begin to hear the difference in the high end — the timbre shifts. I want to believe that the subtle difference at first is a reduction in noise, but as the threshold level increases there gets to be quite a change in response, definitely not what most of us would have in mind for a mix. For quieter passages, however, it proved to be an effective noise reducer. When set properly, this device does good work.

LIVE TESTS

Experimenting with a noisy and hum-prone instrument such as a guitar, I pulled out my '61 Telecaster and ran it through my ADA tube pre-amp, then into the unit. Note that this will provide not only the characteristic noise of a single coil pick-up, but also the noise of tube pre-amps when set to "crunch." In this test setup I monitored the output through speakers as well as on an oscilloscope for a visual reference. The pre-amp was set to feed both inputs, so I could monitor the one output with processing and the one without, separately.

Switching in the hum canceler indeed drops the level of hum significantly. If various "sharp" Bb's (60Hz and harmonics) are played, you sense virtually no change in level or response, visually or aurally, to the program material. Playing loud or soft, high or low, dirty or clean, everything sounded like it should, and looked the same on the scope, sans hum.

On to the noise canceler. We all know the kind of noise that is typical of single coil Fender pickups. With the guitar idle and the threshold set modestly, switching this circuit in-line provides a relief from the junk. Playing notes produces no discernable changes in any way, except the kind we are looking for, less noise as the notes decay.

Crank the threshold up and you can hear and see it working—but when it's quiet, it's way quiet. As stated in the manual you must feel around to find the optimum threshold level. There is a spot that does what you need, above which you are compromising your sound quality.

Don't misunderstand — certain types of program material will indeed suffer compromised timbre shift (spectral balance) to get the appropriate amount of noise reduction in a given band. It is the nature of the

beast, and not a shortcoming of the device. With that in mind, the 550 will most likely find its maximum usefulness on individual tracks or sets of channels, whether instrument or voice, and probably not riding across the entire mix.

CONCLUSIONS

All that said, bench and practical testing of the SN-550 has brought me to generally respect this unit, and in fact suggest that it would prove itself priceless in many critical situations. The hum cancellation capabilities are nothing short of amazing.

However, several things did prove weak: the difference in throughput with the bypass mode switched in and out was a significant 5dB-6dB in some situations. Bypass clicked. With complex program material, a "chitter" or rough edge showed up on high frequency content, no doubt attributable to the band-limited gating.

As is the nature of such things, ambience disappears along with the noise. Although digital, the device doesn't differentiate between "no signal" and "air," as a far more complex (and pricey) system like the Sonic Solutions NoNoise would. It therefore has limited use on full-range or dynamically complex, full-band program material. It would be difficult to recommend using this unit's noise reducer where program integrity is critical, but if there are glaring, unacceptable hum or noise problems on specific tracks or with specific instruments that had not previously been resolved, this looks like a good way out.

Solving a problem in a track that is destined for broadcast is also imaginable. It also seems like a plausible way to reduce dimmer buzz without rewiring a club or live sound setup. Ditto sound reinforcement applications, where CD fidelity in the typically high SPL environment is not the norm. I can clearly visualize this as a desirable addition to a guitarist's rack, as it is truly a clean way to cut out the crap.

The anomalies in phase, level and spectral response generated by the SN-550 are so small that it is virtually transparent when properly set up. I have already begun to suggest this unit as an economical problem solver where other alternatives are expensive or non-existent. I heartily suggest you try it. ■

Circle (100) on Rapid Facts Card

Continued from page 7

chunks (1/48,000 of a second at high resolution), just as a word processor does, using cut-and-paste techniques. For example, I recently witnessed the sweetening of a 30-second McDonald's 'later Twist spot on a Lexicon Opus system. The talent delivery was weak on the tag, so the last mention of "McDonalds" was recreated from three previous takes in a different section — one for the "Mc," another for the "Don," still another for the "alds." The middle one had to be dropped in level 1dB, the last had to have its pitch increased a touch. The spot length remained the same.

Total elapsed production time for the edit? Three minutes. Difference from the original read? Night and day. Noticeable side effects? None. Possible to achieve through tape-cutting? Probably not. And certainly not nearly as smoothly, cleanly, transparently and quickly. Agency and client? Totally impressed!

All of the digital audio workstation systems allow time-code tracking of some form, with most delivering multiformat SMPTE compatibility in chase or code generation modes.

Most provide a visual waveform screen to help in the identification of individual sound samples (no matter the length) and in/out edit points, as well as provide a total visual map of the sequence.

Many offer or generate a SMPTE-numbered edit decision list, so insert locations, outs and length can be hard-copied. Several even spit out this EDL info in CMX-compatible form, greatly simplifying downstream video work.

All of the systems provide variable slope or ramping at the edit point, allowing fade-out times or crossfading from instantaneous butt-cut speeds to several minutes duration in some cases.

Finally, several packages provide DSP capabilities on-board, so delay, EQ, slap-back echo, reverb, pitch shift, time shift and other popular and/or necessary effects are right there, on line. Add the virtual on-screen mixing console and automation offered by a number of the systems, and the net result is a complete studio on your desk top. Stick it in a room with a pair of near-fields and a power amp, and start billing.

Who, you might ask, are the players in this arena? Glad you asked! Read on. ■

Mike Joseph
Editor

Sheer Opulence of Sound



TLM 170

The studio microphone which achieves that elusive perfection. There is no comparison. Each one handcrafted by NEUMANN- the world leader in microphone technology for over half a century.



AUDIO SERVICES CORPORATION

10639 Riverside Drive North Hollywood, CA 91602

(818) 980-9891 FAX (818) 980-9911

Outside CA (800) 228-4429

Orlando, FL: Topham Audio, Inc. (407) 649-6444

Circle (35) on Rapid Facts Card

STUDIO QUALITY

*Direct-To-Disk Audio Editing
on PC/ATs with*

MICRO SOUND™

- 2 or 4-track analog 16-bit A/D and 18-bit D/A 64x/8x oversampling converters
- Direct-digital transfers to/from DAT or CD
- Windows 3.0 based graphic waveform editor
- Record from 8KHz to 48KHz rates
- Rearrange segments in any order using crossfading or butt-splicing for linear arrangements playing in real-time
- Disk-Layering™ will mix overlapped segments with unique fade/gain settings, from up to 20 files to play 4, 6, 8...32-track simultaneous mixes
- Zoom from sample level to track-hours to make edits (undoable anytime)
- Hear edits using Play mark, Scrub, Audition and more
- SMPTE/MIDI Chase-Lock to incoming timecode, locking and playing within 1 second
- Overdubbing optional
- Ready-to-use MicroSound™ WorkStations also available

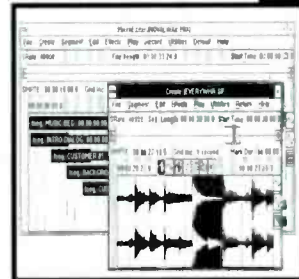

Micro Technology Unlimited

156 Wind Chime Court
Raleigh, NC 27619
Phone: (919) 870-0344
Fax: (919) 870-7163

**You CAN
have a
Digital
Audio
Studio
NOW!**

**To
find
out
how -
CALL
WRITE
or FAX
today - for
a free
brochure
that
explains
how to
meet your
audio
needs.**

Circle (36) on Rapid Facts Card

DAT's the Story

By Laurel Cash-Jones

As of this writing, I have just returned from Las Vegas and the Consumer Electronics Show. Not only is this convention good to attend for spotting new trends in the professional audio world, it is a great indicator of the economy for the coming year, which as you are well aware, affects everyone in the pro world.

The CES show was not as well-attended as the pre-registration might suggest. If there were 70,000 attendees, several thousand were invisible.

This suggests that retailers sent only one or two representatives instead of their usual number; they may be trying to spend as little money as possible, because of the recession. Such behavior is especially important to us in the recording world, because if retailers go into hibernation, they stop spending money on advertising, which means less business for us.

AND NOW, THE NEWS

DAT is beginning to arrive in increasing numbers on these shores. Aiwa, for some strange reason, decided to introduce three new professional DAT recorders, including one with the ability to simultaneously record audio and still video. The first of these decks is the MMD-100, which Aiwa calls its Digital Still Video Tape Recorder. Among the features are a random-access RS-232C interface system, which uses a 4-digit address that allows near-instantaneous storage, retrieval and output of audio and video material. Full-function remote control or front-panel operation is available.

The video input section will accept almost any type of NTSC signal, and the resolution is an amazing 450 lines from an 8-bit recording. But that's not all: It can also function as a studio-type audio-only DAT deck. This unit could pave the way for the use of DAT in training and point-of-purchase displays. Also introduced was the XD-S260, an audio-only mini unit that has all of the standard DAT features.

Now for the portables. First is the HD-S1000. Using the rechargeable battery and

an optional 10 AA alkaline battery pack, you can get a record/playback time in the field of more than 3¹/₂ hours. It weighs 39 ounces and has an AES/EBU input/output and an XLR-S mic input jack. Next is the HD-V2000, which has many of the same features as the MMD-100, but is video-only. With a camera input, the unit is designed to be a portable image gatherer and filer. As many as 3,600 still pictures with audio can be stored on a single 120-minute DAT.

Last, but not least is the HD-X3000, designed to be used as a portable source recorder. Unfortunately, it does not have time-code capabilities, but it does have an AES/EBU in/out jack, uses S1000 (3¹/₂-hours capacity) and weighs only 31 ounces.



These portables are similar to the Aiwa HD-X1, which has been sold on the gray market for some time. (The HD-X1 was also on display, which leads me to believe that it will show up on the market as a home consumer item.) As for how the units sound, you know that the floor of any convention is no place to judge sonic quality. However, all of these units use the latest 1-bit technology.

Circle (119) on Rapid Facts Card

DAT'S SHARP

Sharp also joined the fray with the RX-P1. This unit is perhaps the best-packaged portable DAT I've ever seen, due to the fact that they have included practically every accessory needed to use it at home, in the car or as a portable.

For example, there is a wired remote, a carrying case, car-mounting adapter and cassette-deck interface, ac adapter and batteries, plus an A/D converter. Size- and feature-wise, the unit is remarkably similar to the Aiwa HD-X1 that I mentioned previously.

However, the Aiwa does not have all of the accessories available that are supplied with the Sharp. This little box weighs in at just 15 ounces by itself, and 24 ounces with the A/D converter. The RX-P1 uses dual 1-bit D/A converters with a 256-times oversampling filter for playback and a 64-times oversampling A/D converter module to record from non-digital sources.

All in all, I think you will find this is a great little unit for remote recording or news gathering applications, as well as in the field recording of sound effects.

Circle (120) on Rapid Facts Card

AND THEN CAME ...

... Sony. How could you have a CES without some sort of new digital audio thang from Sony? In addition to its already existing line of DAT recorders, the DTC-75ES and the DTC-700, there is now the TCD-D3 portable DAT Walkman (why didn't they call it the DATMAN?). However, these units were overshadowed by the new DTC-87ES, which is slick! Not only does it have all of the features of the DTC-75ES and the Sony ES component series, it has tape/source monitoring. Sony achieves this by using two heads for recording and two heads for playback. The unit is capable of recording and playing back at either 48kHz, 44.1kHz, or 32kHz, and also offers a long play mode that gives you up to four hours on a 120-minute tape. The unit is also SCMS-equipped and has a special programmable subcode data function that records the actual date and time of recording directly on the tape. A/D conversion is performed via a 64-times oversampling pulse converter.

Circle (121) on Rapid Facts Card

Next month: Recordable CDs at the CES.

Laurel Cash-Jones is R•E•P's editorial consultant and a Los Angeles-based free-lance writer.

AKG V6HP headphone amp

The V6HP delivers high output levels to up to six stereo headphones, arranged in three pairs. Designed for stereo or dual mono mixes, the V6HP provides each headphone pair with its own front-panel mix selector switch for selection among five possible combinations of the two inputs. Other features include individual level controls for each input, power and clipping indicators, and 20V_{rms}, 40kHz-30kHz output amplifiers. Its case is threaded to mount on a mic stand. A removable 3-wire IEC standard power cord is included. Suggested net price is \$425.

Circle (122) on Rapid Facts Card

Tripp Lite OMNI-750 LAN

The OMNI-750 LAN Battery Backup System corrects low-voltage brownout conditions without switching to battery power, thus conserving battery power until a total blackout occurs. Equipped with a Db9 LAN remote interface connector, it provides automatic network shutdown during a power failure when used with UPS monitoring software. The LAN interface features inverter shutdown, which enables the computer to shut the OMNI-750 off and conserve battery power after all files have been safely closed. Built-in spike and line noise filtering are included. Suggested retail price is \$749.

Circle (123) on Rapid Facts Card

Roland DM-80 hard-disk recorder

The Digital Multitrack disk-based recorder is self-contained, including a 1-cable remote graphic editor/autolocator; a 24-bit digital mixer, featuring internally programmable snapshots and external dynamic control; and analog and AES/EBU standard digital I/Os. It acts as a master or slave using SMPTE, MIDI Time Code or MIDI. The 4-track configuration comes with an internal 100Mbyte hard disk providing 19-track minutes at 44.1kHz; the 8-track configuration uses two 100Mbyte drives. List price of the 4-track unit is \$5,500; the 8-track unit is less than \$8,000.

Circle (124) on Rapid Facts Card

Allen & Heath Scepter 2 console

The Scepter 2 series of consoles is available in three frame sizes, ranging from eight to 16 inputs. The Scepter 2 features 3-band EQ with sweepable midrange, four auxiliary sends, two stereo returns and four mono returns. All mixers have rear-mounted connectors; transformer balancing is available.

Circle (125) on Rapid Facts Card

Neotek Encore console

The Encore console for film dubbing and TV post-production retains the sonic performance of its predecessor, the Elite console, but is available with comprehensive machine control, integrated moving fader automation and 4- or 6-track formats. Encore consoles are designed to individual order and are available in versions for one to three operators, with up to 96 inputs. Large Encore consoles start at less than \$200,000.

Circle (126) on Rapid Facts Card

DDA DCM224V console

The DCM224V video post-production console features an input module that is an extended version of the DCM 232 module, but with expanded EQs and an auxiliary system for video post-production. Four stereo subgroups have advanced facilities for routing to other subgroups, and mono and ster-



The Best Gets Better!

The feature list has doubled, but *the price remains the same*. Turtle Beach Systems is now unveiling version 1.2 of our SoundStage software for the 56K Digital Recording System.

If you want to edit CD-quality sound on an IBM computer, there is no better system, no better price, no better choice than the 56K!

New Features

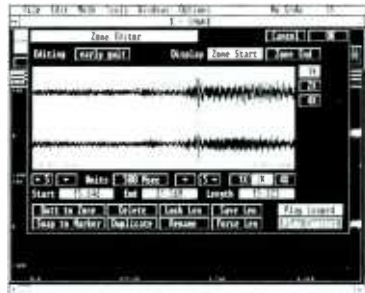

The New Zone Editor

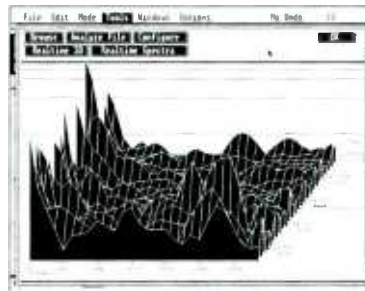

The 3-D Frequency Analysis

- Sample Rate Conversion
- Time Compression/Expansion
- Scrubbing
- 3-D Realtime FFT
- Reverse/Invert
- Mono record left, right, or mix of both channels
- SMPTE Chase Lock
- Record under sampling support (2X, 4X)

We've improved existing functions by adding: realtime playlist scrolling, the ability to define zones and markers "on the fly" during record and playback, a new zone editor, and an assignable playlist preroll. No price improvement was necessary. Still \$2689.00.

Call for a free demo disk or \$15 video.



PO Box 5074, York, PA 17405 717 843 6916 Fax 717 854 8319

Circle (37) on Rapid Facts Card

DISC MAKERS

Complete manufacturing for the audio industry.

COMPLETE PACKAGES FOR:

- Cassette Duplication
- Record Pressing
- Compact Disc Replication

In-house art department for design, type-setting, film work, and printing. In-house mastering department for a great sounding product.



CALL FOR OUR FREE FULL COLOR CATALOG.

1-800-468-9353
(In PA: 215-232-4140)

DISC MAKERS

1650 Broadway, Suite 1010
New York, NY 10019
(212) 265-6662

Circle (38) on Rapid Facts Card

PANASONIC SHARP NAKAMICHI

IN STOCK NOW AT

THE DAT STORE

DIGITAL AUDIO TAPE

DENON GRUNDIG TOSHIBA NEC AWA CLARION

IN BUSINESS SINCE 1988

choose from over 40 models
HOME • PORTABLE
PROFESSIONAL • TIME CODE

DIGITAL AUDIO TAPE RECORDERS

M on Fri 9-6 THE DAT STORE Sat-Sun 1-4
2624 WILSHIRE BOULEVARD
SANTA MONICA, CA 90403
213-828-6487
FAX: 213-470-6176

KENWOOD PIONEER CASIO HITACHI SONY AKAI

FOSTEX TASCAM JVC TECHNICS

Circle (39) on Rapid Facts Card

Continued from page 59

"A good example is a recent Roadworx tour where we had a full 40-box system with 110kW of power, monitors, electronics, consoles — and the lights and band gear — in a 24-foot truck. What we do is first roll in all the racks and stuff, and then put plywood down and ramp up the cabinets on top, five across. It is a very efficient system. The whole idea is to give a company an edge when bidding in today's increasingly competitive touring marketplace."

Woodworx also helped design and manufacture the enclosures for the soon-to-be-released TAD FOH concert loudspeaker cabinet, and has recently been working extensively with TAD on additional loudspeaker developments. Recent cabinet sales have been to Staging Connections, Atlanta; Overland Sound, Washington, DC; National Events, Lorton, VA; and Soundwave Productions, Huntington, WV. Additionally, Woodworx has provided monitor wedges for Alabama's recent tour.

ROADWORX

Roadworx is becoming more active in the touring field and continues to work one-offs, various special regional events and a significant amount of corporate work. The company has been growing and expanding to the point where it now boasts an inventory of more than 100 FOH main cabinets and the capability to handle major touring clients. The company toured arenas and sheds with Ricky Van Shelton and K.T. Oslin during the latter half of last year with a 40-box SR-2 main system. (Roadworx's SR-2 cabinet has double the components of the Woodworx SR-1.)

Roadworx continues to tour with veteran country star Waylon Jennings. The FOH system includes a Soundcraft 8000 40-channel console and 16 SR-1 Woodworx FOH cabinets powered by AB1200 amplifiers. "The new AB1200 is a good-sounding, reliable and very powerful amplifier," Sarvis says. On-stage, Woodworx Max-1 and Max-2 monitors are powered by Crest 8001 and 4001 amplifiers and are controlled by a Soundcraft 40-channel monitor console. These powerful wedges contain a special 12-inch JBL speaker that can handle up to 600W. Needless to say, the wedges can be very loud if Waylon wants more SPL. A TAD TDM-2 cabinet is used for drum monitoring. ■

eo matrix sections. Its in-line design provides up to 104 line inputs for mixdown. Other features include VCA faders and mutes, full automated switching of 24 functions per channel and moving faders. Metering can be either VU or fluorescent bar graph.

Circle (127) on Rapid Facts Card

TOA D-1103 digital delay

The D-1103 One-by-Three digital delay uses 16-bit, 100kHz A/D conversion; the noise floor is greater than -90dB and THD is less than 0.03%. Delay times range from 10µs to 655ms. Ten µs increments are maintained throughout the entire delay range, enabling the D-1103 to achieve the extended delay required by remote speaker/cluster locations while concurrently performing the microsecond delay required for component alignment. Four non-volatile, pre-set memories permit storage of delay information. Suggested list price is \$1,398.

Circle (128) on Rapid Facts Card

Tannoy PS-88 subwoofer

The PS-88 subwoofer is designed for close-field reference applications. Self-powered and designed for placement under a console, it features a sensitivity of up to 93dB/1W/1m. Using a 100W amp, the PS-88 provides a correcting signal to overcome the 12dB/octave roll-off inherent in enclosure-sealed woofers. Other features include active crossover and equalization, adjustable volume control, extended frequency response to 36Hz, high and low impedance inputs accessible through 1/4-inch or RCA inputs, two 8-inch transducers, side mounting and spiked-feet decoupling.

Circle (129) on Rapid Facts Card

Community RS220

The RS220 series of components is designed for compact, lightweight flying arrays. The speaker is operable from 100Hz to 18kHz and posts power-handling figures of 200W pink noise/500W program; maximum output is more than 127dB/1m. An M-200 compression driver employs 1-piece Mylar diaphragms and features 2-inch exit throats. The VBS210 subwoofer contains a pair of 10-inch dual spider drivers that operate between 60Hz and 150Hz when used with the 220 System Controller. The System Controller features IntelliSense circuitry to provide continuous monitoring and dynamic EQ at impending overload levels and as independent compression. ■

Circle (134) on Rapid Facts Card



This won't cut it!

How do *you* edit DAT recordings? Let's face it. Your choices are limited. You can (1) give up, (2) either buy or rent time on a costly dedicated digital editing system, or (3) look into a disk-based editor. The latter is certainly the most flexible and cost effective alternative. And among disk-based systems, none is more widely used and recognized than Digidesign's Sound Tools.™

Sound Tools is a complete system of hardware and software based on the Apple Macintosh® II. Unlike any system of its kind, Sound Tools offers an extensive set of powerful editing and processing tools as *standard features*.

This will



If you're mastering albums or compact discs, you'll find that using Sound Tools to assemble your cuts will save you both time and money. And with our MasterList™ software, you can create a pre-master that's CD-ready on a standard audio DAT — and retain total control over your music!

If you're working with DAT recordings, sooner or later you're going to need to edit that material. Consider Sound Tools. The most flexible, cost-effective solution available.

digidesign

1350 Willow Rd #101
Menlo Park, CA 94025
415.688.0600

© 1990 Digidesign Inc. Features and specifications subject to change without notice. All trademarks are property of their respective companies.

Circle (40) on Rapid Facts Card

Continued from page 26

Such companies as Digidesign, Sonic Systems and Studer Editech (located in Northern California's Silicon Valley) have designed custom circuit boards for the most popular off-the-shelf computers — in this case, the Apple Macintosh. Their installable boards contain dedicated DSP chips that work beautifully in audio applications, taking advantage of the computer's built-in capabilities.

Another reason for using off-the-shelf technology is that the customer can use the computer for purposes other than audio production. Some manufacturers believe off-the-shelf technology gives their products a longer life and provides insurance against early obsolescence. Finally, another advantage is the wide variety of displays available, including large screens, multiple screens, and displays that allow a screen within a screen, which superimposes a video image into your computer display.

THE BRAINS

Modular systems use off-the-shelf computers primarily from Apple, IBM and Atari. The differences between each are not as great as they once were. Those who once claimed "the IBM system isn't friendly" are countered by IBM's new, improved graphical interface.

No matter what kind of projects you handle, tapeless production can help you do them better.

Those who claim "Macintosh is too expensive" are looking over Apple's recently announced lower-cost Macintosh models, including a color system. Facilities that use the Macintosh, the most popular system for audio applications, can choose from a large selection of software.

Atari has provided a reasonably priced machine in the ST and Mega ST, with a large amount of MIDI sequencing and music software available from third parties.

A digital audio workstation is a Swiss army knife for the studio. It's a digital recorder. It's an editor. It's a mixer. It's a signal processing device for digital equalization, time compression and such exotic operations as de-hissing (without resorting to filtering). Most DAWs have built-in synchronizers that make it easy to precision-lock a track to picture in numerous time-code modes.

Digital workstations fit easily alongside analog technology in most production environments. Multitrack isn't exactly the greatest editing medium; razor-blade cutting is destructive and works only when you want all tracks chopped at the same place in the tape. Workstations, on the other hand, offer non-destructive editing (you can't harm the source material) and are perfect for slipping individual tracks in time. The high-resolution waveform displays offer incredible precision editing, down to a single sample level, or $\frac{1}{48}$ thousandth of a second (at the 48kHz sample rate).

Once you've had your hands on a good workstation, you may never want to fly in from 2-track again. You'll even look at album or jingle assembly work differently.

THE BEAUTY

No matter what kind of projects you handle, tapeless production can help you do them better. If you work with voice, a DAW lets you easily move around dialogue, line by line, word by word, even syllable by syllable. You can splice consonants to improve intelligibility. And you spend less time recording extra takes and more time perfecting the read. Lines can be perfectly lined up with picture cuts and stretched or squeezed to fit the length of a tag. One company, Digital Audio Research, offers a program routine that fits the looped or ADR words to a rough spoken cue track automatically.

Music editors are often impressed by the crossfade capabilities of most DAW systems. Music can easily be ducked around a voice-over or sound effects. If your spot runs long, just tell the workstation to make it a :30 and the system will compute the necessary amount of time compression and make the adjustment without affecting pitch. Workstations make it just as easy to shorten or extend sections. Because DAW editing is non-destructive, you never worry about damaging a precious master, no matter how many cuts you make or how the sections are ordered.

If you've been cutting sound effects to screen the traditional way, you'll be surprised by how easy it is to create loops of background fill on a DAW. You can load in effects digitally from hundreds of commercially available sound effects CDs, then play them against picture. You can slip individual effects to find the perfect sync point. You can capture time code numbers from videotape on the fly, which eliminates bothersome typing. Once you load the sound effects for a project into a DAW, it is simple to make changes and present a scene in different ways.

As an editing tool, the DAW is clearly superior to anything analog. On a well-designed system, the operator can work quickly and make perfect edits every time.

DAWs are great with difficult edits, due in part to the fact that an almost unlimited number of crossfade times are available. Try doing a 4-second crossfade using tape — without taking the product down a generation. The typical analog editing block has only three crossfade times: none, fast and very fast. Digital systems allow different rates on fade-in and fade-out times. I, for one, don't miss playing "find the needle in the haystack" with 20 or 30 scraps of tape hanging on a wall. Producers don't miss the gray hairs they got watching novice engineers chop up precious masters. On a DAW, it is difficult to lose a soundfile — even if someone pulls the plug while you're working.

The digital audio system offers additional advantages over the analog audio system. It's great in the transfer room, because digital transfers are clones of the original. You no longer have to consider alignment levels, channel symmetry or any of the other disadvantages of analog transfers, including tape noise and distortion. Digital recordings hold up over time. Gone is the worry of flaking oxide and missing high-frequency response. This makes digital the ideal format for cart-machine applications, including station IDs and sound effects. Digital is also a great archival medium because of its robustness. DAWs are random-access devices, which means you don't have to take a coffee break to change reels.

With a DAW you can "cut" tracks in an off-line environment, then transfer them onto multitrack for flexible mixing. Some people prefer keeping their data in the digital domain, and mixdown straight to DAT.

Clients love this type of flexibility.

AGING GRACEFULLY

What can we expect from DAWs as they mature? Larger and faster hard disks, not surprisingly, and optical disks that continue to work faster and cost less.

Future systems should include more and better documentation, including time sheets, invoices, cue sheets, track lists, tape labels and tape library information. This is one overlooked feature that computers do best. Although no system completely addresses all of the engineer's needs in terms of the paperwork that must be generated to complete a project, a totally integrated package is much easier to achieve on a computer that is simultaneously doing production.

DAW may be one of the hottest buzzwords in the industry these days, but the reality is that it is not a garden-variety item in production facilities yet. Why? Many companies are still waiting to see if some incredible new developments are just around the corner. They're not. There's money to be made with these systems today. ■

Classified

FOR SALE

WHAT COULD YOU HAVE IN COMMON WITH:
 POWER STATION, HIT FACTORY-NY, HIT FACTORY-LONDON, LARRABEE
 SOUND, BATTERY STUDIOS, GEORGETOWN MASTERS, THE TOY
 SPECIALISTS, DREAMHIRE, STUDIO FX (SYDNEY), STEVIE B, JON BON
 JOVI, AND MANY OTHER OF THE WORLD'S FINEST STUDIOS, MASTERING
 LABS, RENTAL COMPANIES, AND TOP RECORDING ARTISTS?



IN STOCK & WAITING FOR A NEW HOME...

CONSOLES!! API 36x16x24, API 16x2, API 16x4
 TRIDENT 80 SERIES 40x24x24, MCI 428 HEAVILY MODIFIED
 WE ALWAYS HAVE TUBE NEUMANNs and AKGs, TUBE COMPRESSORS
 & EQUALIZERS...PULTECS, LANGs, FAIRCHILD, API, NEVE, LA-2As ETC.
 WE BUY, SELL AND TRADE—LIST YOUR FOR SALE EQUIPMENT FREE!!
 WE HAVE LISTINGS ON CONSOLES AND 24 TRACKS, NEVE, SSL, AMEK,
 TRIDENT, API, OTARI, STUDER AND MCI....*"this is not a problem."*

THE CONNECTION, THE SOURCE, THE PROFESSIONALS
 TEL: 617-784-7610 FAX: 617-784-9244

Circle (69) on Rapid Facts Card

"World Class" Tapes & Duplicating

Agfa

- Digital Audio Tape (D.A.T.) In Stock
- Analog Tape, Audio Accessories
- Phone In Order, Ship Same Day
- Great Quality — Great Price
- On-Shell Printing

Call us at

(800) 365-0669

for prices on tapes & duplicating

World Class Tapes

Audio Tape Distributors & Duplicators

670 Airport Blvd., Suite 1

P.O. Box 7611

Ann Arbor, Michigan 48107

(313) 662-0669 (within Michigan)

Circle (50) on Rapid Facts Card

BOOKS BY MAIL

AUDIO-VIDEO-ELECTRONICS-MUSIC
 Books, Tools, Software, T-shirts, Video, Toys
 for a free catalog call 24 hours.

1-800-899-5940

SoundWords
 6532 Cornell, Indpls., IN 46220-1146

STUDIOWORKS

Recording & Broadcast Equipment

FACTORY DIRECT PRICES ON 3M & AMPEX TAPE

AKG	JBL/UREI	RAMSA
ALLEN &	LEXICON	SENNHEISER
HEATH	NEUMANN	SOUNDTRACS
FOSTEX	OTARI	VALLEY INT'L

Over 70 Professional Lines!

SONY

Professional Audio

(800)438-5921

(704)375-1053

Sony used & demo sale

Sony 3036 loaded 32/mon-auto. \$52K w/warranty.
 Sony 3036 loaded 36 w/auto & hard drive. \$75K.

FOR RENT OR SALE

Soundcraft 800B 40x8x8x2

Ray Pro Sound

1902 Wharton Rd.
 Jenkintown, PA 19046

215-885-8885

PHONE

Renee Hambleton

for Classified Advertising Information

(913) 888-4664

Reliable Music

All Items Subject To Prior Sale

Soundcraft 6000 28x24 PB <i>New</i>	\$21,000.
Soundcraft 200B 8x4 <i>New</i>	1,695.
Seck 18x8x2 <i>New</i>	2,195.
Fostex E16 <i>New</i>	4,095.
Fostex E22 <i>New</i>	2,095.
Fostex 4050 <i>New</i>	795.
Fostex 1240 <i>New</i>	1,545.
Tascam M6001616 <i>New</i>	6,995.
Tascam 32 <i>New</i>	1,195.
UREI 809' <i>New</i>	1,095. / pr.
JBL 4430' <i>New</i>	2,125. / pr.

Tascam DA30's *in Stock*
 Panasonic 3700's *in Stock*
 Akai ADAM & DD1000 Systems *in Stock*

704/375-8662

Classified

FOR SALE

FOR OVER 10 YEARS
YOUR BEST BUY IS USED
RECORDING EQUIPMENT
SYE MITCHELL SOUND
22301 CASS AVE.
WOODLAND HILLS, CA 91364
(818) 348-4977
FAX: (818) 704-7031

GET YOUR CABLES TOGETHER



Circle (51) on Rapid Facts Card

STUDIO WIRING

LEARN SOLDERING
VIDEO MAKE CABLES LIKE THE PROS
\$39.95 PLUS SHIP & HAND

RMS RECORDING MAINTENANCE SERVICE
7161 Lindley #100-201
Reseda, CA 91335 • 818-609-7915

24 TR. MCI Auto M. Large 16,000
sq.ft. building & all equipment typi-
cal of large well-established studio.
Mobile. In business for 18 years. In
Springfield, MO (near Branson).
\$200,000 buys all.
417-831-1826

**NATIONAL
Foam
Inc.**

**SUPERCOSTIC
ACOUSTIC FOAM**
1-800-247-4497
In CA (213)650-8906

EXCELLENT SOUNDPROOFING
FOR RECORDING & REHEARSAL
STUDIOS, VIDEO FACILITIES &
HOME STUDIOS

DEPTH	SHEET SIZE	SPECIAL PRICE (\$)	COLOR
2"	74"×32"	\$17.95	custom grey only
4"	74"×32"	\$20.95 \$24.95	blue custom grey

2" depth also available
SPECIAL PRICES!
•BELOW WHOLESALE
•50% LOWER THAN
ANY COMPETITOR

ADD \$350/SHEET S&H
CA ADD 6.75% SALES TAX
IMMEDIATE SHIPPING

MILAM AUDIO

"THE SOURCE"
SINCE 1967

CONSOLES
MULTI-TRACKS
MONITORS

D.A.T. • AMPS
EFFECTS • MICS
USED EQUIPMENT

1470 Valle Vista Blvd.
Pekin, IL 61554
(309) 346-3161
800-334-8187
FAX 309-346-6431

19" ADC TT Patchbays
Balanced/normalised. 144 points each.
Cost \$395.00—Sell \$85.00 each.
EXCELLENT CONDITION / SURPLUS
384 point panels also available.
Call J. Patrick Green
(916) 922-5060

Custom Cases	Acoustic Foam	Custom Stands	Studio Furniture
Request Catalogue 800-343-1433, 516-563-0633 Island Cases, 1121-20 Lincoln Ave., Holbrook NY 11741			

WHO USES THE
TUBE DIRECT

Walter Becker, George Massenberg,
Hugh Padgum, Stanley Clarke, Niko
Bolas, Ocean Way Recorders A&M
Records, Clint Black, Bonnie Raitt,
Lyle Lovett, Brian Ahern, Jackson
Browne, Crosby, Stills, Nash, and
Young, Val Garay, Chet Atkins, Pete
Anderson, The Complex, Ry Cooder
Eddie Van Halan, Sting, & The Who

WHY NOT YOU?

THE TUBE DIRECT IS SIMPLY THE
BEST SOUNDING DIRECT BOX MADE!
ALSO NOW AVAILABLE THE
TUBE MIC PRE-AMP
See Hugh Padgum interview
June 1990 issue R•E•P

**DEMETER AMPLIFICATION/
INNOVATIVE AUDIO SYSTEMS**
(213) 470-6426

Circle (52) on Rapid Facts Card

BLEVINS AUDIO EXCHANGE INC.

We supply the best quality in used studio equipment
Currently needing 24 TRK machines.
"Dealers, call us with your trade ins."

Call for March
Specials! Fax: 615/242-0599

Nashville's Only Full-Service
Professional Brokerage Company

TUBE MICS

Only the finest in tube mics bought and sold.

Call Bill Bradley
(216) 723-6494
FAX (216) 723-6595

TEF ANALYZERS for rent, USED TEFs FOR SALE
Excellent selection and prices
Also we broker STUDIO EQUIPMENT
mics, consoles, tape recorders etc.
Contact Bill Landow (the TEF Broker)

EXPERIENCED AUDIO
18582 US Hwy 20 E • Bristol • IN • 46507
(219) 522-8346 OR FAX (219) 533-8800

FOR SALE, con't.

**BRAND NEW HARRISON
SERIES 10B CONSOLE**

48 module/96 input, w/Mac II automation. One year warranty. It's available shipped direct from the factory for either \$355K cash, or \$365K (\$120K cash and \$245K financed).

Call 415-339-2111



VIDEO/AUDIO/RF

Buy • Sell

Consign • Service

Over 3000 items

in inventory

Burbank, CA 818.845-7000

New York, N.Y. 212.268-8800

Circle (53) on Rapid Facts Card

Studio Liquidation Sale

STUDERS

A80 Mk-IV 24 trk, low hours, mint this is the newest A80 in the U.S.
A810 w/center code track
B67, new heads, excellent

TRIDENT 80B

blonde English Ash trim, beautiful 18 months old, new condition

PLUS

Dolby SR, Neuman, Pultec, Lexicon, JBL, AKG, Hafler, Yamaha, Valley, too much to list

EVERYTHING NEGOTIABLE

Steve Payne (804) 222-5905



SING WITH THE WORLD'S BEST BANDS!

An Unlimited supply of Backgrounds from standard stereo records! Record with your voice or perform live with the backgrounds. Used in Professional Performance yet connects easily to a home component stereo. This unique product is manufactured and sold Exclusively by LT Sound - Not sold through dealers. Call or write for a Free Brochure and Demo Record.

LT Sound, Dept. RP-3, 7980 LT Parkway
Lithonia, GA 30058 (404) 482-4724
Manufactured and Sold Exclusively by LT Sound
24 HOUR PHONE DEMO LINE: 1-404-482-2485

2-GML microphone preamps

with 4-API 550A EQ's w/"lunchbox". Both mounted in five space rack with custom TT patchbay in back.

Great package!

Must sell for \$4500.00 FIRM!

Please call Dennis at 213-665-2500

Portable Sound Panels



- Isolate specific areas
- Many sizes and options
- Panels start at \$19.95/ea Complete w/foam

Island Cases

Write for free catalog

1121-L Lincoln Ave., Holbrook, N.Y. 11741

800-343-1333 • In N.Y. 516-563-0633

DEAD CAMEL SALE

WE SPEAK FLUENT DIGITAL

AKAI ADAM Digital Recorders in stock
AKAI DD 1000 Digital Optical Recorder
PROFESSIONAL DAT Recorders

Warm the reality back into your recordings with **TUBE**



We carry the best!!!

SUMMIT • TUBE TECH • AKG

Lowest Price—Best Service

We Specialize in Studio Packages

Over 300 Product Lines Available!!!

Call to Order

800-522-6787



Call for Information

708-336-6787

Ask for a catalog

OPUS EQUIPMENT

4262 Grand Ave. • Gurnee, IL 60031

The Studio POP Filter

A Great Improvement on a Good Ideal!



Open up the sound of your vocals and voice overs without annoying "POPS" ruining your best takes!

- Standard mic stand adaptor with threaded brass insert
- One piece plastic rims, 5" diameter—in sky blue or black

Only \$2400

With optional Clamp and Gooseneck \$4495

ONE YEAR GUARANTEE plus shipping

AUDIO VISUAL ASSISTANCE

565 Sherwood Road,
Shoreview, MN 55126
Phone: 612-481-9715



Circle (54) on Rapid Facts Card

**Now You Can Afford
THE WORLD'S FINEST
AUDIO TRANSFORMERS**

REICHENBACH ENGINEERING is now marketing their Legendary audio transformers through **BAUER COMMUNICATIONS INC.**

Reichenbach pioneered the technology giving you flat group delay, and the besel response, with no overshoot or ringing. Our low distortion core material eliminates that muddy bottom end.

	1	25	100
RE-115K-E	\$49.01	40.46	31.26
RE-11P-1	\$46.66	38.69	29.75
RE-MB-C	\$39.58	32.82	25.24
RE-MB-D	\$69.23	57.41	44.15

ACCEPT NO SUBSTITUTES
INSIST ON A
REICHENBACH!



Phone (800) 627-7277 Fax (818) 894-0715

(formerly marketed as Jensen transformers)

UNLIMIT YOUR SOUND

Can a \$300 processor (dual channel) make one little amplifier sound like an expensive multi-amplified system?

You bet it can!

The UN-LIMITER by R.K. NACHTRIEB
6392 Park Ave., Garden Grove, CA 92645
(714) 897-2631

Dealer Inquiries invited



RUBBER-NECK™

- No Creak
- Non-glare
- No Ridges
- Smooth Texture
- Black Finish
- Standard Mic Threads

1-800-537-3491 Fax 412-344-0818

Products by: Ac-cetera, Inc., 3120 Banksville Rd., Pittsburgh, PA 15216



Model M-1

Telescopic Adjustable Arm

MICEZE™

Locking System

Shock Absorption Pads

Unbreakable

Model M-4

Power supplies

for almost any tube microphone. If you want your mic to sound the very best, get it a new power supply. From \$275.

Call Bill Bradley

(216) 723-6494

Fax (216) 723-6595

Classified

FOR SALE

WHY GO ANYWHERE ELSE FOR ANYTHING AUDIO...

...when we carry a full range of professional audio and video equipment to match every application and budget. With a focus on personal service, and competitive pricing we can help you get the job done easily & cost-effectively. Put our team to work for you and start saving time and money today!

Take a look at some of our high quality lines...

AIWA-RDAT • ALPHA AUDIO • AKG • AMPEX TAPE • APHEX • ART • AUDIO-KINETICS • BSS • BRUEL & KJAER • COMMUNITY LIGHT & SOUND • DDA • DIC DAT • DRAWMER • EAW • EVENTIDE • FOSTEX • GEPCO • HAFLER • HARDY • HILL AUDIO • JOSEPHSONS ENGINEERING • JUICE GOOSE • KLARK-TEKNIK • MACKIE DESIGNS • MILAB • MOGAMI • MRL • NEOTEK • PINC LINC • RANE • SENNHEISER • SOUNDMASTER • SOUNDTRACS • SONY • SUMMIT AUDIO • SYMETRIX • TANNOY • T.C. ELECTRONICS • TUBE-TECH • TURTLE BEACH SYSTEMS • VALLEY • WHITE •

CALL FOR PRICES ON OUR NEW & USED EQUIPMENT SPECIALS

FOSTEX R8, G16, & G24S IN STOCK I • SONY DAT IN STOCK I • TANNOY PBM 6.5 - SYSTEM 12 IN STOCK I • DRAWMER DS201 GATES \$ 759 • DRAWMER 1960 STEREO TUBE MIC PRE/COMP \$ 2450 • DRAWMER M500 DYNAMICS CONTROLLER \$2K-DEMO • TUBE-TECH PE1C, CLUB, NOW IN-STOCK I • SOUNDTRACS MRX , PC MIDI, & QUARTZ IMMEDIATELY AVAILABLE • DDA D,S & Q-SERIES DEMOS ON SALE • COMPUTER SALE USED SPECIALS - 25 TUBE MICS IN STOCK NOW (2) TELE 251 E-LAM E MINT-CALL • (6) NEUMANN U64 • CALL • NEVE 8068 32x24-CALL • SSL 4040E/RECALL-CHEAP • NEOTEK 44x24 w/PB \$48K • TRIDENT TSM 48x24W/ MOVING FADERS \$80K • TRIDENT 80C-CALL • TAC SCORPIAN 36x12x24 w/boys \$16K • AUDIO FRAME CHEAP-CALL • (2) MCI 636 30X24-AUTO. CALL • TASCAM MS-16 PKGS START @ \$5K • FOSTEX B16D \$4K • (2) OTARI MTR-90-II UNDER \$30K • AMPEX ATR-102 55 • MCI JH-24 W/ALIII \$22K • STUDER A800 24TRK-CALL • AMS AUDIOFILE(LOADED) \$55K • 24 TRACK 2" MACHINES STARTING @ \$9K • (2) U67 TUBE \$4K • AKG TUBE \$1.9K(new) • LEX 480LW/SAMPLING \$9K • YAMAHA C7 GRAND PIANO W/MIDI-MINT \$15K • 61HAMMOND B3 W/LESLIE-MINT \$3K • CALL FOR LISTINGS !!!

THE DIGITAL AUDIO SOURCE

anything audio CALL 617-426-2875
FAX 617-426-2763

professional audio and video systems
 Equipment Sales System Design Installation

LIST YOUR FOR SALE EQUIPMENT WITH US FREE!!!

63 MELCHER STREET BOSTON, MA 02210

Circle (55) on Rapid Facts Card



SONEX-SOURCE

58 NONOTOCK ST., NORTHAMPTON, MA 01060
 'Your Source for Sonex Acoustical Foam'

WIN RIDABOCK

800-484-1003-0032 413-584-7944
 Order Credit Cards Accepted Fax or info

PHONE

Renée Hambleton
 for Classified Advertising Information
 (913) 888-4664



214 Lincoln St.
 Suite 103C
 Boston, MA 02134

**WE NEED YOUR CLEAN
 USED 24 TRACK !!!**

The oldest broker on the East Coast! Otari & Tascam authorized service

CONSOLES 24+ Tracks; Studer A800, \$45K; MICROPHONES & etc.
 SSL 4040E/G, \$150K; 4048 A80, \$20K; MCI JH24, \$20K; JH16/ Neumann U89, \$1.4K; KM84, \$275;
 6064E & more, CALL. Neve 24, \$14K; Otari MX80, call; MTR90 C-414EB/BULS from \$500. TUBES:
 8048, \$57K; 8036, \$35K; II \$30K; Mitsubishi X850, call. 16 Tr TELE 251, Neumann M49, AKG
 Neotek Elite 44/24, \$44K. MCI JH24/16, \$11K; Otari MTR90, C12, call; AKG C12A, \$1.5K; AKG
 Trident 80B, \$33K; CALL for prices \$16K; Tascam MS16, \$5.5K. 2 Tr THE TUBE, \$1.8K; KM56, \$450.
 on Trident, API, Amek, DDA, Otari MTR-12, \$4.5K, Studer A80, Pultecs, CALL; Adams-Smith 2600
 TAC, MCI, Harrison & Soundcraft. \$3.5K; Ampex ATR-102; \$5.9K. 2-mach sys, \$5K; Zeta III, \$2.2K.

New specials on Summit Audio tube EQ & compressors, Eventide, Aphex, Tannoy, Milab, AKG & Adams-Smith. dbx noise reduction in stock.

(617) 782-4838 List Your For-Sale Items Free!! fax (617) 782-4935

Circle (57) on Rapid Facts Card

SALE! PLUS FREE ADHESIVE!

MARKERFOAM™ ACOUSTIC FOAM



GIANT
 54" x 54"

Immediate Shipping

2" Reg \$29.95 Now \$19.99 • 3" Reg \$39.95 Now \$29.99!

KILL NOISE QUICK! High performance, full-size sheets of high density Markerfoam. EZ mount. Blue or gray. Super-effective sound absorption for studios.

WARNING—Don't buy low density bed size mattress foam that has no sound absorbing properties or specs. Markerfoam offers best value, looks professional & is proven in studios worldwide. Request Foam-Buyers Guide Catalog, specs & free samples today. VISA, MC, AMEX, COD. PURCHASE ORDERS. QTY DISCOUNTS.

MARKERTEK BLADE TILES™

HIGH PERFORMANCE

LOW, LOW COST!

\$3.49 per tile, 16x16x2

America's best acoustic tile

value, only from Markertek!

Blue or gray. Also available

16x16x3" as shown \$4.49 ea

MARKERSTIK™ foam adhesive

FREE with any Foam purchase

in this ad! Limited offer

A \$5.95 per tube value.

MARKERTEK VIDEO SUPPLY

SONEX

All the colors and sizes plus great prices!

Get our FREE 150-page catalog of over 5,000 exclusive and hard-to-find supplies for audio & video.

800-522-2025 America's most unique catalog for audio & video!

MARKERTEK™
 VIDEO SUPPLY
 145 Ulster Ave. Saugerties
 New York 12477

Circle (58) on Rapid Facts Card

WE'VE GOT THE GOODS!!

We offer a line of unique products described by many as the most eclectic in the industry. Many are our own design and manufacture. When you need something special, call us.

The Mic Pole
 Cable Keepers
 AKG Boom Parts
 Tall Mic Stand
 RFI Trap
 Boom Weight

The Mic Clamp
 Super Cable Keepers
 Atlas Stand Parts
 Really Tall Mic Stand
 Line to Mic Adapter
 and so much more!!

Call or write for a free catalog!

BLACK
 AUDIO DEVICES

Box 106
 Ventura, CA 93002
 (805) 653-5557

**USE
 R-E-P
 CLASSIFIEDS**

FOR SALE, con't.



ENDLESS WORD™

ADVERTISING PROMOTIONS

O.E.M. DISTRIBUTORS AND DEALERS WANTED
 ENDLESS CASSETTES & TELEPHONE ON-HOLD SYSTEMS
MADE IN U.S.A.—OUR 14th YEAR

• Clear case allows visual inspection of tape & splice • Call and hear the audio clarity of our new On-Hold telephone line adapter in combination with our Hold-A-Call™ Endless cassette player, also inquire about our new volume distributor pricing on endless cassettes and On-Hold equipment.

MANN ENDLESS CASSETTE INDUSTRIES
 P. O. Box 1347 • San Francisco, CA 94101
 (415) 221-2000 Fax: (415) 387-2425

SERVICES



LOUDSPEAKERS—EXCLUSIVE

Factory Authorized Center
 Professional-High Fidelity
 Warranty/Non Warranty Repair. Four
 Day Turnaround For Stocked Kits. All
 Work Done By Factory Trained
 Technicians.

PRICE STEVENSON ACOUSTIC RESEARCH
 1591 Broad Run Rd., Downingtown, PA 19335 (215) 383-1083

American Pro Audio



- Sony/MCI • Trident •
- Tannoy • Eventide •
- Yamaha • Tubetech •
- Fostex • Soundtracs •
- Beyer • Roland • Akai •
- Ramsa • Panasonic •

Mini Lease Program

New or used, trade-ins 24-60
 months with buyout option
 \$5K-25K no financials
 required min. 2 yrs in business.

1-800-333-2172

SERVICES

MAGNETIC RECORDING HEADS—RELAP/REPLACE-

MENT FOR Audio, Video, Time
 Code, Duplication. 29 years of
 head design experience. IEM,
 350 N. Eric Dr., Palatine, IL
 60067; tel (708)358-4622.

EUROPADISK, LTD.

MASTERING / MANUFACTURING

- Compact Disc ● Cassettes
- Vinyl Records ● Printed Graphics
- Digital Mastering Studios

The U.S. most complete facility with a
 20-year reputation for the finest quality.
 Call for our information-packed brochure.

EUROPADISK, LTD.

75 Varick Street, New York, NY 10013
 (212) 226-4401 FAX (212) 966-0456

RCA MICROPHONES—Repair

service on all models. Complete
 sound and cosmetic restoration.
 We also repair other ribbon types.
 ENAK Microphone Repair, 420
 Carew Avenue, Pitman, NJ 08071.
 (609) 589-6186.

ALIGNED AUDIO INC. SUPER QUALITY

- ▶ Audiophile Record Pressing
- ▶ CD Replication
- ▶ Real Time and High Speed
 Cassette Duplication
- ▶ Direct On-Shell Imprint in Colors

COMPLETE PACKAGES

Call Today for your Free Catalogue

☎ **1-800-869-6561**
 OR **1-718-788-6969**
 FAX **1-718-499-0421**

Circle (58) on Rapid Facts Card

STUDER REVOX

FACTORY AUTHORIZED SERVICE CENTER "SUPERLATIVE SERVICE"

Swiss trained in servicing all open reel and
 cassette tape recorders, CD players, and other
 Studer/ReVox equipment. Over 12,000 units
 serviced Nationwide since 1978. Fast 48-72
 hour service w/90 day warranty. Huge parts
 inventory. Capstan shaft resurfacing & head
 relapping service. New & used machines
 available w/warranty. Visa/MC.

STUDIO-SONICS CORP.
 2246 N. Palmer Dr., #100
 Schaumburg, IL 60173
 Phone: (708) 843-7400
 FAX: (708) 843-7493

LOUDSPEAKER REPAIR FOR THE DISCRIMINATING PROFESSIONAL

TekCom, the mid-Atlantic's
 only full-service pro audio
 dealer, is also the Factory
 Authorized/Factory Trained
 speaker recon center for:
 JBL, Electro-Voice, Tannoy,
 Gauss, EAW/RCF, Aitec
 Lansing, Bose Pro., P.A.S.,
 UREI, Cerwin Vega

(215) 426-6700

1020 N. Delaware Ave.
 Philadelphia PA

TEKCOM CORP.

SERVICES

BUILDING A STUDIO??

STUDIO & ACOUSTICAL DESIGN
COMPLETE STUDIO PLANS
WIRING SYSTEM DESIGN
STUDIO INSTALLS & PRE-WIRING
OTARI & TASCAM SERVICE

Have your new room or facility designed
 & built by audio professionals with over
 20 years experience as mixers, produc-
 ers, musicians & studio owners.

db ENGINEERING
 Boston, MA (617) 782-0648

DISC MAKERS

- Cassette
 Duplication
 - Record Pressing
 - CD Replication
 - Video Duplication
- Complete Packages



CALL FOR OUR FREE FULL COLOR CATALOG
1-800-468-9353 (In PA: 215-232-4140)

DISC *MAKERS

1328 North 4th Street
 Philadelphia, PA 10019

Classified

RENTAL EQUIPMENT

A TOTAL EFFECT

Eventide H-3000 SE	<New
T.C. 2290 (32 sec.)	
T.C. 2290 (32 sec.)	
T.C. 1210 spatial ex.	
Publison Infernal 90	Includes remote patchbay.
AMS S-DMX	24 hr. service
AMS RMX-16	
Eventide SP 2016	
Lexicon 480L	7 days a week
480L Larc & Manuals	

All for \$300 a day or \$1200 a week!
(That's \$171.43 a day!)

Call for advance bookings today
(818) 345-4404
Encino, CA

Circle (59) on Rapid Facts Card

The Nation's #1 Co. for Live Console Rentals:

ATI Paragon ***NEW!!!	Yamaha 3000, 1800
Gamble EX56, HC40, SC32	Yamaha 2800, 2408M
Ramsa 852, 840	Soundcraft 800, TOA RX-7
TAC Scorpion I & II	+ other console models!

*MacPherson LPM monitor rigs/*R-DATS
*Intersonics SDL-5 subs / *various EFXs

HI-TECH AUDIO SYSTEMS
Long & short term 415-742-9166

HELP WANTED

TROUBLE REPORT

Technical Engineer—3+ yrs. maintenance experience required. Full/Part-time assignments available throughout the Northeast. Call:

(914) 688-7329

EQUIPMENT WANTED

We want what they want but we want it more.
Top dollar paid for vintage equipment in exceptional condition.
Mercenary Audio
Tel: 617-784-7610 Fax: 617-784-9244

Wanted: Dead or alive
Pultec, ITI, Lang, Sontec EQs, Telefunken, Neumann, AKG or RCA mics. UREI, dbx, UA, Teletronix, Fairchild limiters and other gear. Boxes or tubes; API or Neve consoles and old guitars.
Dan Alexander
5935 Market St. Oakland, CA 94608
415-644-2363 Fax 415-644-1848

Phone
Renée Hambleton
for
Classified Advertising Information
(913) 541-6745

WANTED
NEVE-SSL-API-TELEFUNKEN-SONY NEUMANN-OTARI-MCI-PULTEC-URIE-AMS OR ANY USED CONSOLE, TAPE MACHINE, VINTAGE MIC OR PROCESSOR YOU WANT TO SELL—CALL ANYTHING AUDIO
617-426-2875

EQUIPMENT WANTED
BUY OR TRADE
YOUR USED MULTITRACK RECORDERS AND CONSOLES
EAR PROFESSIONAL AUDIO/VIDEO
(602) 267-0600

FINANCING

EQUIPMENT FINANCING "LOANS BY PHONE"

- NO FINANCIALS REQUIRED FOR TRANSACTIONS UNDER \$35,000
- NEW OR USED EQUIPMENT
- \$2,000 TO \$200,000
- NO DOWN PAYMENT
- SALE-LEASEBACK EQUIPMENT FOR WORKING CAPITAL

TO APPLY OR REQUEST ADDITIONAL INFORMATION CONTACT MARK WILSON

ENF EXCHANGE NATIONAL FUNDING (800) 275-0185
FAX: (214) 235-5452

LANDMARK FINANCIAL GROUP

- Nationwide
- \$5k to \$1mm
- Equipment Leasing / Financing •

(214)644-3297 FAX (214)699-7893

LFCI Equipment Leasing

- \$50,000 with credit app. only
- Provides:
Off-balance sheet financing
Tax benefits
- All types of equipment
- Nationwide
- Dealers welcome

We specialize in A/V equipment
Call : (216) 882-6503

Classified Advertising is available by the column inch (Classified Display): \$40 per inch, per insertion, with frequency discounts available. 1" minimum, billed at ¼" increments thereafter. 10" maximum per ad. Blind ads (replies sent to R•E•P for forwarding) \$25 additional. Reader Service number \$25 additional. Ads 4" and larger will receive a free reader service number and your company's name listed in the Advertiser's Index. Spot color (determined by magazine) \$150 additional. No agency discounts are allowed for classified advertising.

Contact Renée Hambleton, 913-888-4664, for information on frequency and pre-payment discounts, or to place your classified ad. Or send your order and materials to:

Renée Hambleton
R•E•P
9221 Quivira Rd.
Overland Park, KS 66215.

MOVING?

Take us with you.

Just peel off your subscription mailing label and attach it to the address change card inside this issue. Please allow 6-8 weeks to process your address change.

MISCELLANEOUS

THE MOST COMPLETE
SELECTION OF

AUDIO TEST TAPES

All formats including cassettes
Write or phone for free catalog

STL

STANDARD TAPE LABORATORY, INC.
26120 Eden Landing Road #5, Hayward, CA 94545
(415) 788-3546

Circle (60) on Rapid Facts Card

Cassettes AS EASY AS . . .

- 1 REAL TIME DUPLICATION
- 2 HIGH SPEED DUPLICATION
- 3 CUSTOM BLANKS

INTRODUCING:

Full Service Digital Editing
and CD Compilation

ESP Means Quality Full Service
Printing and Packaging, Friendly
Professional Service, Competitive
Prices, Fast Turn-Around and
Highest Quality Raw Materials.



EASTERN STANDARD
PRODUCTIONS, INC.
26 BAXTER STREET
BUFFALO, NY 14207
1-716-876-1454

1-800-527-9225

AUDIO AFFECTS

STUDIO EQUIP. FOR HIRE
Technician on staff 7 a.m. - 1 a.m.

Open 7 days a week
Digital Tape Machines,
Synclavier Systems,
Effects Processors, Reverbs
(213) 871-1104 (818) 980-4006
Ask For Mark

DUPLICATION SERVICES

The Professional Choice In Cassette Duplication

Each order
customized
to fit your budget
and your total needs
High speed - Realtime
& DAT Replication

LORAN

1-800-633-0455

Member of

NAIRID

Call For
Free Sample

CASSETTE TEK, INC.

SPECIALISTS IN PROMOTIONAL
CASSETTES FOR
ARTISTS—PRODUCERS—AGENCIES

- Highest quality custom blanks audio and video VHS cassettes
- Duplication of audio and video
- EMBOSSED on-cassette printing using the PRINT RITE system
- Direct mail services
- Reasonable pricing
- Fast service

1605 THOMASTON AVE.
WATERBURY, CT 06704
TEL. (203) 757-4848
FAX (203) 756-8585

Are you missing over
20,000 potential sales
prospects each month
who don't know about
your business?

Expand Your Market
with R•E•P
Classified Advertising

Call
Renée Hambleton
TODAY
to reserve your space!
(913) 541-6745

Advertisers Index Sales Offices

	Page Number	Rapid Facts Number	Advertiser Hotline
Akai/IMC Pro Emi	31	16	817/336-5114
Aligned Audio	77	58	708/788-6969
Ampex Recording Media	23	13	415/367-3809
AMS Industries	15	9	203/744-6230
Anything Audio	76	55	617/426-2875
Aphex Systems Ltd.	37	19	818/767-2929
Sam Ash Professional	61	34	212/719-2640
Audio Services Corp.	67	35	818/980-9891
Audio Visual Assistance	75	54	612/481-9715
The Broadcast Store Inc.	75	53	818/845-7000
Bose Corporation	57	25	508/879-7330
Community Professional	47	23	215/876-3400
Countryman Associates, Inc.	58	26	415/364-9988
Crown International	IFC	1	219/294-8000
CT Audio	63	28	800/CTAUDIO
DAT Store	70	39	213/828-6487
DB Engineering	76	57	617/782-4838
Digidesign	71	40	415/688-0623
Disc Makers	70	38	216/232-4140
Dolby Labs Inc.	45	22	415/558-0200
East West Communications	55	24	213/659-2928
Eltekon Technologies Inc.	39	20	313/462-3155
Full Compass Systems	65	30	800/356-5844
Furman Sound	53	32	415/927-1225
Hardy Co.	63	29	312/864-8060
Innovative Audio Systems	74	52	213/470-6426
Jensen Transformers Inc.	35,51	18,31	213/876-0059
KABA Research & Development	33	17	415/883-5041
Kurzweil Music Systems Inc.	13	8	
Lexicon Inc.	5	5	617/736-0300
Markertek Video Supply	76	56	914/246-3036
Mercenary Audio	73	69	617/784-7610
M.T.U.	67	36	919/870-0344
N Vision	25	14	916/265-1000
Peavey Electronics Corp.	1	3	601/483-5365
Polyquick Corp.	58	27	708/390-7744
QSC Audio Products	6	6	714/645-2540
Seam Tech	74	51	415/861-6011
Selco Products Co.	61	33	213/921-0681
Shure Brothers, Inc.	IBC	2	800/25-SHURE
Sony Professional Audio	20-21		800/635-SONY
Sony Professional Tape	17	10	201/930-7081
Soundcraft USA	BAC		818/893-8411
Soundtracs Div. Samson Tech	9	7	516/932-3810
Standard Tape Laboratory, Inc.	79	60	415/786-3546
Sunkyoung Magnetic/America	27	15	213/327-8864
Tannoy North America Inc.	19	11	519/745-1158
Tascam	40,41	21	213/726-0303
Technical Audio Devices	2-3	4	213/816-0415
A Total Effect	78	59	818/345-4404
Turtle Beach Softworks	69	37	717/843-6916
World Class Tapes	73	50	313/662-0667

CLASSIFIEDS

Renee Hambleton
913-888-4664
9221 Quivira Road
Shawnee Mission, KS 66215
Telefax: 913-541-6697

SANTA MONICA, CA

Herbert A. Schiff
213-393-9285
Jason Perlman
213-458-9987
Kelly Daugherty
213-451-8695
501 Santa Monica Blvd.
Santa Monica, CA 90401
Telefax: 213-393-2381

CHICAGO, IL

David Ruttenberg
312-435-2360
55 East Jackson Blvd.
Chicago, IL 60604
Telefax: 312-922-1408

NEW YORK, NY

Stan Kashine
212-332-0634
38th Floor
888 Seventh Ave.
New York, NY 10106
Telefax: 212-332-0663

OXFORD, ENGLAND

Nicholas McGeachin
Roseleigh House
New Street
Deddington, Oxford
OX5 45P England
Telefax: (0869) 38040
Telephone: (0869) 38794
Telex: 837469 BES G

FREWVILLE, SOUTH AUSTRALIA

John Williamson
Hastwell, Williamson, Rep.
Pty. Ltd.
109 Conyngham Street
Frewville 5063
South Australia
Phone: 799-522
Telefax: 08 79 9735
Telex: AA87113 HANDM

TOKYO, JAPAN

Mashy Yoshikawa
Orient Echo, Inc.
1101 Grand Maison
Shimomiyabi-Cho, 2-18
Shinjuku-ku, Tokyo 162, Japan
Telephone: 03-235-5961
Telex: J-33376 MYORIENT

"The Beta 58 delivers maximum SPL, to keep the vocals above screaming fans in a loud rock club — without feedback. Yet it has the sensitivity to reproduce the most subtle, breathy whisper for 80,000 people at an outdoor festival. And for guitar amps, the Beta 57 gives me the isolation I need without sacrificing the warmth and tone I want.

For live sound, Shure Beta mics are the state of the art."

Steve Folsom

Steve Folsom, Sound Engineer for Melissa Etheridge and John Hiatt.



Beta 58 Wireless

Beta 58

Beta 57

Shure Beta Microphones. Buy Them On Word Of Mouth Alone.

Before you select a microphone, listen to the leading pros who use the Shure Beta Series on stage. They'll tell you about the benefits of Shure Beta's advanced transducer design, extraordinary gain-before-feedback, and true supercardioid polar pattern, as well as its outstanding sensitivity and low handling noise. But most important, they'll tell you that nothing beats a Beta for live performance. And that's not just talk. Try Shure Beta today and get the final word for yourself. Or call us for more information at 1-800-25-SHURE. The Sound Of The Professionals™...Worldwide.

SHURE

Circle (2) on Rapid Facts Card

If Only More Expensive Consoles Performed As Well.



For a 16 or 24 track studio owner, the future looks very good.

With MIDI systems and digital outboard gear, you're faced with extremely sophisticated productions. But it's very hard to find a recording console to match the requirements without spending a small fortune.

That's precisely why we've developed the new Series 6000, an evolutionary design that clearly demonstrates the forward thinking of Soundcraft. Behind the classic layout is a revelation in performance and capability.

For one thing, it's equipped with enough busses and routing options to make adventurous productions a pleasure, not a nightmare. The 6000 is a full 16 or 24 buss console with six auxiliary sends per channel. The split format of the 6000 means each of the tape returns will double as extra inputs, with EQ.

We've also provided each input with push-button routing, EQ by-pass, and programmable electronic muting that eliminates the clicks produced by ordinary switches. You even get true solo-in-place, sadly lacking on more expensive consoles.

But it's the 6000's sonic performance that really sets it apart from the competition. Our revolutionary input design gives you 2dB to 70dB gain without a pad and virtually unmeasurable distortion, crosstalk, and noise.

Our new grounding system yields superb hum immunity and a routing isolation of 110dB (1kHz). And our active panpot comes close to theoretical perfection, exceeding our competitor's performance by a full 25dB.

The Series 6000 input module gives you programmable electronic muting under optional MIDI control, solo in place to get a clear picture of your progress, and a patented active panpot with isolation of 90 dB (1kHz).

To give you the subtle control it takes to achieve dramatic results, you also get four-band EQ with mid sweeps on each input channel.

When you specify Soundcraft's Series 6000, with options including 16 to 56 channels, stereo input modules, and built-in patchbay, you'll find it an affordable slice of progress. Series 6000, simply the most comprehensive production console in its class.

Soundcraft 6000

Soundcraft USA, JBL Professional
8500 Balboa Boulevard
Northridge, CA 91329