

# REP

The Pro Audio Applications Magazine

# studio design



A38100-1-LUNBE6691 XXXXX REQ  
 F1062089000000 25 06 1  
 THOMAS D LAUNE REC ENGR  
 ARDENT RECORDINGS INC  
 669 S BELVEDERE (REAR)  
 MEMPHIS TN 38104

■ INTERVIEW: MR. X  
 ■ AD OF THE YEAR CONTEST

# YOU CAN'T JUDGE A MICROPHONE BY ITS COVER.



## Step Up To The Unequaled Performance of the N/D857- The World's Premier Concert Vocal Microphone.

The Electro-Voice N/D857 dynamic microphone, flagship of the new N/DYM® Series II microphone line, is the culmination of years of engineering research, input from major concert sound companies and the unwavering commitment to produce the optimum hand-held dynamic microphone. Combining neodymium aligned technology with innovative design refinements and new damping materials, the N/D857 has evolved into the world's ultimate concert vocal microphone.

The N/D857 employs a revolutionary vibration-isolation suspension system, made possible through the utilization of DynaDamp™. A low-Q elastomeric material, DynaDamp substantially reduces handling and cable transmission noise.

A switchable high-pass filter with an 80-Hz corner frequency, set just below the low end of the vocal range, provides a steep, 12-dB-per-octave rolloff to further eliminate handling noise and stage rumble without compromising sound quality.

P-pops are also significantly reduced by

a two-stage filter system, including the placement of Acoustifoam™ on the interior of the Memrflex grille and a secondary pop-filter on the element itself. No other dynamic exhibits more resistance to P-pops.

Furthermore, the addition of a unique acoustical path corrector provides increased sensitivity, more than any dynamic microphone, and an extremely uniform supercardioid polar pattern with superb off-axis rejection and maximum gain-before-feedback.

No other dynamic microphone can deliver the overall sound quality, tremendous output and low-noise handling characteristics of the N/D857.

Step up to the N/D857 and uncover your vocal potential.



# THE POWER PACKAGE

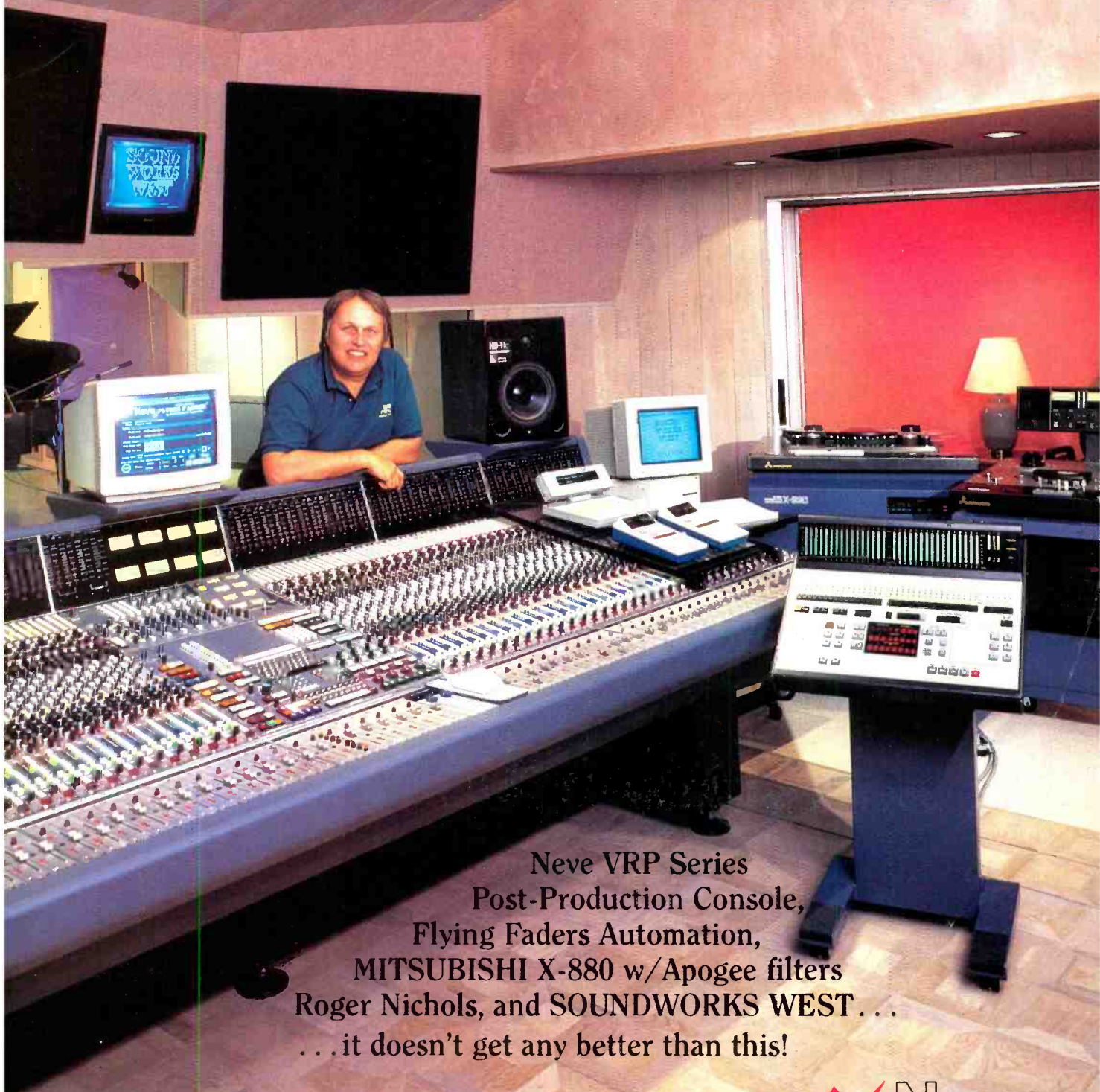

Neve VRP Series  
Post-Production Console,  
Flying Faders Automation,  
MITSUBISHI X-880 w/Apogee filters  
Roger Nichols, and SOUNDWORKS WEST...  
...it doesn't get any better than this!

Studio A: SOUNDWORKS WEST Ltd.  
West Hollywood, California  
Telephone: 213-850-1515

Circle (4) on Rapid Facts Card

 **Neve**  
a Siemens Company

Exclusive North American Distributor of

 **MITSUBISHI**  
DIGITAL PRO AUDIO

CT: (203) 744-6230 ■ NY: (212) 956-6464 ■ TN: (615) 329-9584 ■ CA: (213) 461-6383 ■ TORONTO: (416) 365-3363

## Features

**R•E•P Interview:**  
**22 Mr. X**  
*By Mike Joseph*  
 The owner of an "illegal" studio tells his side of the home/project studio issue.

**30 Yes, It's a Studio**  
*By Brad Leigh Benjamin*  
 L.A.'s Margarita Mix combines world-class design and construction with an unusual flair for atmosphere and decoration.

**Renovating an Existing Studio**  
*By Richard Schrag and Russ Berger*  
**36**  
 Can't afford a ground-up project? Renovating what you have can be a viable alternative.

**Five Questions: Studio Design**  
*By Mike Joseph*  
**44**

**Hands On: Valley International DCE**  
*By Rick Schwartz*  
**54**

## Sound Reinforcement

**46 Live & Direct**  
*By David Scheirman*  
 Computer Control: The Future is Now.

**Computerized EQ Systems, Part 2**  
**48**  
*By Bob McCarthy*  
 Field measurement and correction of sound systems using Meyer's SIM Equalization service.



16

## Departments

From The Top ..... 5  
 Letters ..... 8  
 Random Access ..... 10  
 Fresh Tracks ..... 16  
 The Front Office ..... 18  
 Digital Domain ..... 20  
 First Look ..... 58  
 The Cutting Edge ..... 60  
 Classified ..... 65  
 Advertisers' Index ..... 72  
 Ad of the Year Ballot ..... 73  
 Rapid Facts Card ..... 73  
 Subscriber Cards ..... 75

## On the Cover

Margarita Mix, Hollywood.  
 Photography and floor plan by John Storyk, Walters-Storyk Design Group.

R•E•P (ISSN 0034-1673) is published monthly by Intertec Publishing Corporation, 9221 Quivira, Overland Park, KS 66215. Subscriptions rates are \$26 to qualified readers, \$30 to non-qualified readers per year in the United States, \$50 for qualified and \$60 for non-qualified per year outside the United States. Optional airmail for non-qualified readers outside the United States is also available for an additional \$55 per year. Foreign subscriptions are payable in U.S. funds only by bank check or money order. Adjustments necessitated by subscription termination at single copy rate. POSTMASTER: Send address changes to R•E•P, P.O. Box 12960, Overland Park, KS 66212.

Photocopy rights: Permission to photocopy for internal or personal use is granted by Intertec Publishing Corporation for libraries and others registered with Copyright Clearance Center (CCC), provided the base fee of \$2.00 per copy of article is paid directly to CCC, 21 Congress St., Salem, MA 01970. Special requests should be addressed to Cameron Bishop, group vice president, Intertec Publishing Corporation.

ISSN 0034-1673 \$4.00 + \$0.00

©1990 by Intertec Publishing. All rights reserved.

# Quick Terminations



## “Meet the Fastest Gun in the West”... Switchcraft

In a showdown, no other audio patch panel is “faster on the draw” than the APP Series from Switchcraft.

Bullet quick terminations are achieved with color-coded insulation displacement connectors (IDCs) that provide speedy wiring access of T, R, S, TN & RN termination points. One simple tool eliminates the need for wire stripping and makes connections fast and easy.

*Other sharp shooting features include:*

- **Versatile Configurations:** The APP can adapt to any installation as a full assembly, front panel only with 48 jacks installed and cabled to rear panel, or rear panel only.
- **Easy Wire Management:** Wiring guides and cable



support bar offer convenient wire routing.

- **Many Normaling Options:** Including top and bottom normals, half normals, and others.

Plus, Switchcraft manufactures a complete line of technologically advanced audio components, jacks, cords, connectors, plugs, and audio adapters.

You don't have to bite the bullet and put up with inferior audio products. Insist on genuine Switchcraft audio components "... from the fastest gun in the West."

## Switchcraft

A Raytheon Company

5555 N. Elston Avenue  
Chicago, Illinois 60630

For instant response to your questions or for more information, call our audio department at 312/792-2700 or FAX 312/792-2129.



# Dolby SR. The sound investment for analog multitracks.

When everyone else was making noise about digital, we quietly developed Dolby SR. But it's no secret: Dolby SR makes analog multitrack recording a cost-effective alternative to digital.

## Improves the preferred sound of analog

At both 15 and 30 ips, Dolby SR dramatically increases headroom, and virtually eliminates tape hiss and modulation noise. Dynamic range is improved by more than 25 dB over unassisted analog, preserving all the warmth and purity of the original sound.

## Increases the return on your investment

Dolby SR upgrades your multitrack at a fraction of digital's cost. Add our Model XP SR (configured for up to 24 channels), or update an existing Dolby mainframe with plug-in SR modules. If you are in the market for a new multitrack, Otari and Studer offer models with Dolby SR built-in.

## Simple to use

Set-up is quick and easy with Dolby SR. A unique

Auto Compare feature lets you instantly verify frequency response and playback calibration.

And editing is as convenient as ever, with no need for special equipment.

## Worldwide acceptance

Tapes recorded with Dolby SR can go anywhere, anytime. In fact, with more than 25,000 channels in over 30 countries, analog with Dolby SR is a firmly-established format you can't afford to ignore.

## Put it to the test

Call your Dolby dealer to arrange for a demo at your facility. Hear for yourself why Dolby SR is

the sound investment for analog multitracks in today's competitive marketplace.



100 Potrero Avenue, San Francisco, CA 94103-4813. Phone 415-558-0200. Telex 34409. FAX 415-863-1373. 346 Clapham Road, London SW9 9AP. Phone 01-720-1111. Telex 919109. FAX 01-720-4118. Dolby and the Double-D symbol are trademarks of Dolby Laboratories Licensing Corp. © Dolby Laboratories Inc., 1989. 589/8676

Circle (6) on Rapid Facts Card

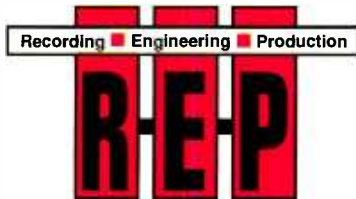

EDITOR

*Dan Torchia*

TECHNICAL EDITOR

*Mike Joseph*

ASSOCIATE EDITOR

*Pamela S. Fleener*

GRAPHIC DESIGNER

*Liz Vetrnick*

SENIOR MANAGING EDITOR

*Tom Cook*

DIRECTORY EDITOR

*Pat Blanton*

CONSULTING EDITORS

*Paul D. Lehrman, Electronic Music  
John Monforte, Technical Consultant  
David Scheirman, Live Performance  
Laurel Cash-Jones, Editorial Consultant  
Sarah Coleman, Washington Correspondent*

GROUP VICE PRESIDENT

*Cameron Bishop*

PUBLISHER

*Dennis Milan*

PROMOTIONS MANAGER

*Evelyn Hornaday*

MARKETING COORDINATOR

*Darren Sextro*

ADVERTISING BUSINESS MANAGER

*Dee Unger*

ADVERTISING PRODUCTION SUPERVISOR

*Mary Birnbaum*

ADVERTISING COORDINATOR

*Sue Edwards*

PRESIDENT

*R.J. Hancock*

CORPORATE CIRCULATION DIRECTOR

*Chuck Rash*

CIRCULATION DIRECTOR

*Sandra Stewart*

CIRCULATION MANAGER

*Doug Wilding*

CUSTOMER SERVICE

*913-541-6633*

CREATIVE DIRECTOR

*Kevin Callahan*

R•E•P is an applications-based publication targeted at professional individuals and companies active in the commercial business of studio and field recording, audio for video, live sound production and related fields. Editorial content includes descriptions and demonstrations of audio production techniques, new products, equipment application, maintenance and audio environment design.

Member, Business Publications

Audit of Circulation

Sustaining member, Audio

Engineering Society

Sustaining member of Acoustical Society of America

Member, International Communications Industries

Association

Associate member of Society of Professional Audio

Recording Services

©1990 by Intertec Publishing. All rights reserved.

# From the Top

## Audio Perestroika

**P**rofound. Permanent. The way things are changing in this industry, we are going to use those kinds of words to describe the transformation of the audio industry. In five years, the industry we now recognize may be changed beyond our recognition.

To paraphrase Woody Allen: The pro audio industry is faced with two choices. One is total annihilation. The other is extreme despair. Let's hope we have the wisdom to choose correctly.

To talk more seriously: We have the opportunity to participate in a kind of audio perestroika, to restructure the industry and make it a viable, independent entity. The alternative is a continual drifting until the video industry absorbs us.

But the changes keep on flying. Consider this recent event involving the Association of Professional Recording Studios in the United Kingdom. For 40 years, APRS has been run by a central board. Now, membership will be divided into four groups: studios, manufacturers, duplicators and the British Record Producers Guild.

The changes are being made in response to a report by the Studio Policy Group. Apparently, the intent of the changes is to make APRS more receptive to the wishes of its membership. The central board will be involved on a strategic level, but will leave policy-making to the various groups.

You know things are changing when the large professional societies restructure. Typically, these groups are the last bastions of the Way Things Were and the Way Things Are Going To Be.

Can we expect similar changes on this side of the Atlantic? It's too early to tell. The Audio Engineering Society is talking to the Society of Motion Picture and Television Engineers about the possibility of combining exhibitions. The Professional Audio Exhibitors Group is drafting a mission statement and a limited agenda for its first year or two. As of this writing, the National Association of Music Merchants will hold its Summer Expo in a few weeks. The number of exhibitors and attendees will tell a great deal about the summer show's viability.

As all this activity is preliminary at this point, it's hard to say if anything will happen. But when change extends this deeply, you know that it's likely to be permanent.

The professional societies have an opportunity to show some leadership and help preserve an independent audio industry. Here are some ideas:

**AES:** Merge the fall convention with SMPTE's and end the idiotic coastal alternating of shows. Get a better venue for the New York show. Offer a real, tangible reason for end users, everyday producers and engineers, to join. AES' role in developing standards is incontrovertible. The shows provide a great opportunity to look at the latest technology. What tangible benefits can AES offer?

**Society of Professional Audio Recording Services: SPARS** is filling a much-needed niche as a clearinghouse for business and real-world technical information. Events such as May's excellent digital workstation conference in Nashville need to occur with more frequency. However, membership needs to be increased to shed SPARS' image of an elite club of top-level studio owners. As with AES, what can SPARS offer a typical facility?

**NAMM:** Turn the Summer Expo into a band instruments-only show. Reserve the Winter show for everything else, including pro and semi-pro audio.

**PAEG:** Continue with its common-sense agenda for the first year or so. Get as many manufacturers involved as possible. Long-term, develop non-trade show agendas, such as continuing education or standards.

And this final point for all societies that host conventions/exhibitions: The attendance needs to be audited by an outside firm so we can get a clear picture of how many people actually attend and what roles they play in the industry.

Credit must be extended to Philip Vaughan and the APRS for having the courage to make changes. In uncertain times, the impulse usually is to do nothing. Hindsight shows that this is often the wrong thing to do. We urge all the U.S. societies to look seriously at the forces at work, make appropriate changes and do their part to ensure the long-term health of the industry.

*Dan Torchia*

**Dan Torchia**  
Editor

It's time to buy a world-class console. But until now, the two or three that you'd consider all carried price tags that you wouldn't.

Catch the M700, the console with unbelievable sound at a price you'll find hard to believe: About \$70,000.\*

When you're looking for a world-class console, your first consideration is,



what does it sound like. And because the final instrument for testing sound quality is your own two ears, you've got to hear the M700. You'll then find out how well it compares to the consoles that defined "great sound."

Then get some hands-on experience. The M700 is designed around familiar industry standards with no

**NOW YOU CAN GET UNBELIEVABLE SOUND  
AT A PRICE THAT SOUNDS UNBELIEVABLE.**





surprises to slow you down. Everything is where it should be, from full parametric EQ to its 12 auxiliary sends, which makes operating speed another of the M700's best features.

You'll get superb routing flexibility, with 40 in-line monitors, 80 inputs, 32 subgroupings and quad outputs.

When you decide to move up to digital, to accompany your console, one option to consider is the DASH format DA800 24-track digital recorder with award-winning ZD circuitry. Currently available for \$99,000\*.

it's destined to be the best-sounding 24-track around.

So before you invest in any console, you owe it to yourself to hear the M700. We think you'll agree that the only thing more unbelievable than the sound of the M700 & DA800 combination is its price tag.

\*Manufacturer's suggested retail price. Actual price may vary from dealer to dealer.

# TASCAM®

©1990 TEAC America, Inc., 7733 Telegraph Road, Montebello, CA 90640, (213) 726-0303.

Circle (7) on Rapid Facts Card

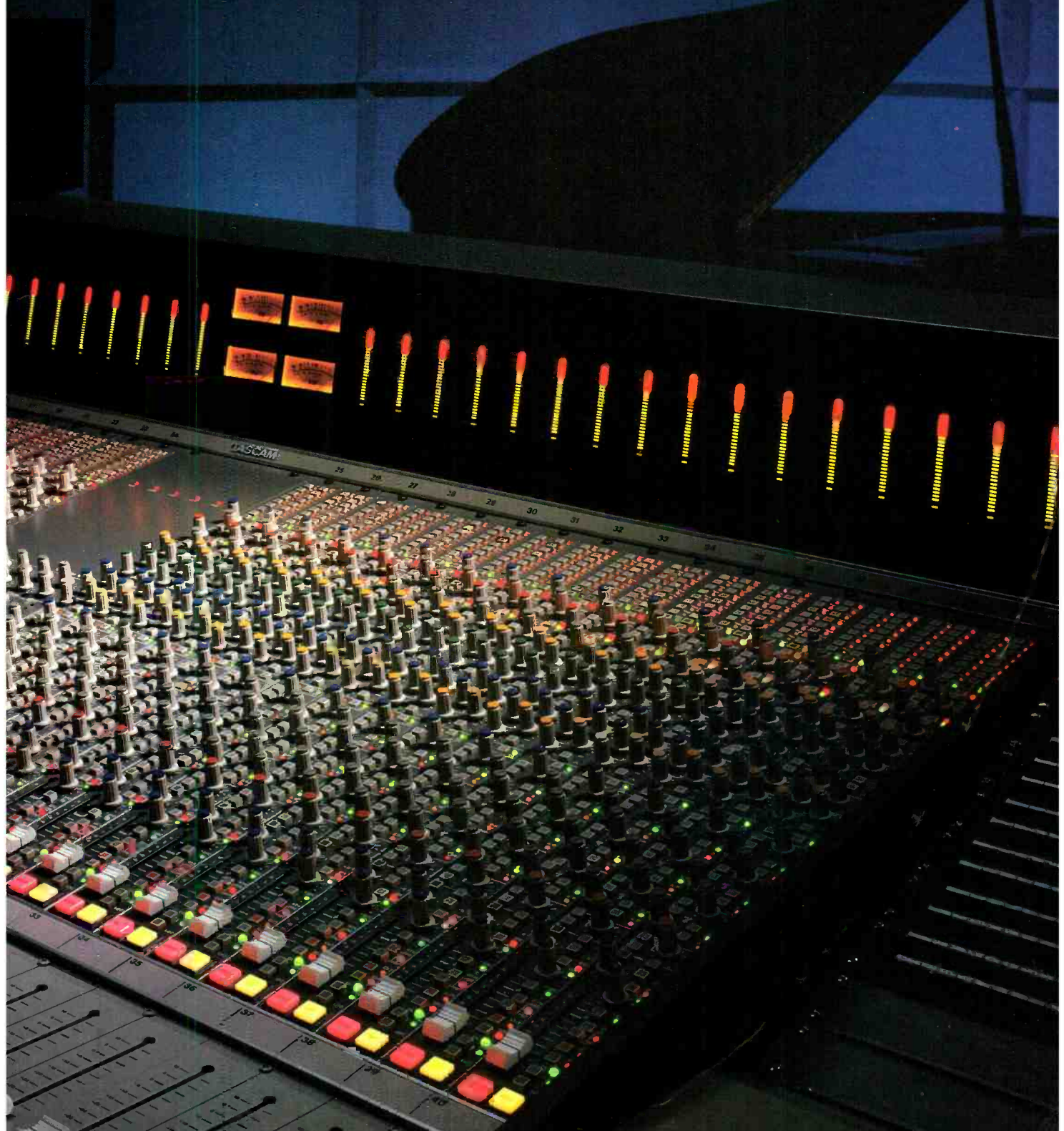

## Alliances Needed

From: Danny Zelonky, Hollywood.

I was very pleased to read Bill Porter's article "The Case for Rental Rooms" in the April issue. I am a programmer/composer/arranger in Hollywood, and for the past few years have managed to do fairly well for myself attracting both professional and demo clients by virtue of my programming skills, musicality and technically sophisticated MIDI system.

While free-lance work has served me well, I have for some time, to no avail, sought to strike up an alliance with an established studio in the hopes of creating a "magnet facility" to which clients seeking professional-quality MIDI production services, in combination with acoustic recording, would be attracted. While all have welcomed the business I've brought them, none have so far had the vision to pursue this avenue, which Mr. Porter so aptly describes as "truly a win-win situation."

I hope that articles such as Mr. Porter's will begin to have an effect on the studio community so that we MIDI people and traditional audio professionals may cooperate and profit together in an atmosphere of mutual respect. If, incidentally, any facility-owners reading this find the idea of such an association to be intriguing, I would be most interested in hearing from them.

(Editor's note: Danny Zelonky can be contacted 213-469-1048; fax 213-469-5624.)

## Processor Update

From John Wiggins, vice president, marketing and sales, Community Professional Sound Systems, Philadelphia.

Regarding David Scheirman's Live & Direct column "What's a Processor?" in the April issue, we seem to have been left out. Community calls its dedicated electronics for the RS880/VBS415 [a compact 3-way enclosure with attendant subwoofer —Ed.] the 880 System Controller. My opinion is that calling a system crossover a "processor" implies that it relies on a microprocessor. If the dedicated controller for a speaker system is not truly computer-based, then it should *not* be called a processor.

David Schierman replies:

Most speaker system manufacturers seem to feel the same way that John does. The word "processor" in both the recording industry and musical instrument mar-

kets is being used to describe special effects devices that have nothing to do with driving a loudspeaker systems.

And my apologies for not including Community's 880 System Controller in the brief survey that accompanies my column. That was certainly not an intentional oversight. With limited space available, we did not try to include an exhaustive study of the entire field.

However, the 880 System Controller, with the compact RS880 3-way enclosure, definitely typifies the approach that many system designers are taking to high-performance speaker system design for the 1990s.

## AM Bandwidth

From: M.L. (Pete) Deets, chief engineer, WFHR/WWRW, Wisconsin Rapids, WI.

I would like to question the accuracy of a statement made in "Five Questions: Broadcast Production" in the March issue.

As a broadcast engineer of 10 years, I can state that the transmitter bandwidth of an AM station was 50Hz to 15kHz until June 30. At that time, by FCC rule, emissions were limited to about 9.5kHz, with a deep notch at 10kHz. This does not take into account the many AM receivers built from the mid-1970s to present that are capable of reproducing only about 500Hz to 4kHz.

Lest I climb on my soapbox about what broadcasters themselves and receiver manufacturers have done to the listenability of AM radio, I would suggest that readers contact Michael Rau, National Association of Broadcasters vice president of science and technology, at 202-429-5346. He can give you the best information on the National Radio Systems Committee (NRSC) transmission standards and AM stereo. Properly handled and with a good receiver, AM stereo is almost indistinguishable from FM stereo.

## Drop-Frame Time Code

From: Eric Wenocur, KLM Video, Bethesda, MD.

At the risk of becoming one of those cranks who have to write letters about every technical point, I feel it is important to clarify the subject of drop-frame time code as discussed by Jeff Burger and Kenneth Mullenix in January's Letters column. This continues to be one of the most misunderstood aspects of time code usage.

Due to rather esoteric factors regarding signal frequencies in NTSC (American) color television, the frame rate is 29.97fps (although it is often thought of as 30fps for simplicity). This does not mean that a "fraction" of a frame exists; it simply means that in one second, only 29.97 frames will have occurred. In other words, it is running  $\frac{1}{10}$ th of 1% slower than 30fps. Consequently, the time code used for television also runs at the rate of 29.97fps; it has to, because each time code frame must correspond to a video frame.

Because the time code runs at 29.97fps, but counts to an even 30, at the end of one real-time hour the code has not yet reached the one-hour count. When the time code finally reaches 1:00:00:00, the program is actually 108 frames (0.1%) too long. The drop-frame system was developed to correct this inequity between the time code count and the true elapsed time. This is done by eliminating the first two frames in every minute, except the tens frames (0, 10, 20, 30, 40, 50), thus reducing the final count by the 108 frames.

I recall hearing that SMPTE originally specified non-drop-frame code to be 30fps, and drop-frame code to be 29.97fps, or some such thing. I believe this was before time code was put into regular use. In actual practice, time code for video *always* runs at 29.97, and can be either drop or non-drop-frame. The *frame rate* is the same; only the count is adjusted. There is also 30fps time code in drop and non-drop versions. Frankly, I do not know what purpose 30fps drop-frame serves, because dropping frames is only necessary when working at 29.97fps!

If one is using time code simply as a means of synchronizing audio transports and sequencers, and identifying tape locations, then any rate code is acceptable. If working with video, 29.97 *will* be used on any video materials. Whether this is drop or non-drop-frame will depend on the need for the code to represent true program length (or what type was chosen when the videotape was created). It is wise to avoid mixing time code rates and types.

Readers may wish to refer to AES Preprint 2876 ("Video Sweetening Basics for Audio Engineers") for further information on video and time code in the audio environment. ■

W E C A R E

# Did you know Record Plant uses

# AGFA



Bonnie Raitt's Grammy Album of the Year, Nick of Time, is more than just overdue recognition. It's a tribute to trust, faith and friends.

Engineer Ed Cherney, producer Don Was, and the Record Plant in L.A. — all helped Bonnie turn out the album of her career, mixed on AGFA PEM 468.

Listen closely and you'll hear a warmth much deeper than guitar licks. A legendary studio, a great team, and a perfect mix on an exceptional audio mastering tape.

Nick of Time. It's more than just the album of the year. And more than any person or product involved. It's testimony to how great music can sound when it all comes together — when an album's recorded with a "Thing Called Love."

**AGFA magnetic tape...  
the hits are on us.**



Agfa Corp., 100 Challenger Road  
Ridgefield Park, NJ 07660 Telephone (201) 440-2500

Left to right: Don Was-Producer Bonnie Raitt-Artist Ed Cherney-Engineer

AUDIO VIDEO PROFESSIONAL

Circle (8) on Rapid Facts Card

**AGFA** 

## The WORKSTATION MARKETPLACE

The exact number of disk-based workstations in the marketplace has been debated in professional audio circles. At the SPARS Business Conference on digital audio workstations, held May 19-20 in Nashville, 11 manufacturers showed their products side by side.

In addition to providing an invaluable opportunity to view design philosophies and capabilities, manufacturers also disclosed how many of their respective systems were in the field. To our knowledge, a comprehensive, numerical list has not been published before. As these companies are presently the major players in the workstation game, it can be safely assumed that the totals are a reasonable estimate of workstations in use to date.

Using these numbers, the total number of these companies' systems in the field is 1,655. It's interesting to note that Digidesign, not at the conference, claims a user base of more than 1,800 for its Sound Tools system, a Macintosh-based hardware/software package available through MI and audio dealers.

At the conference, three of the 11 manufacturers

showed new systems that had no field units at the time of the conference. Alpha Audio's DR2 was introduced at the National Association of Broadcasters convention in April. Otari's DARE system is scheduled for release this summer. The Symetrix DPR-1000 does not have a scheduled introduction date, as it is still in the design stage.

Sony, the other manufacturer that attended the conference, did not show a dedicated, disk-based workstation, but demonstrated that workstation-like results could be achieved with tape-based digital recording systems and digital peripherals. Sony officials at the conference hinted that a Sony workstation is being considered. Other industry sources have indicated that an introduction sometime in 1991 is possible.

According to Shirley Kaye, the executive director of SPARS, the exhibiting manufacturers were so pleased with the conference that they held an impromptu meeting at its conclusion and voted to have another one, most likely in early 1991. ■

### WORKSTATIONS IN USE

800	New England Digital Synclavier/Post Pro
300	Advanced Music Systems AudioFile
300	Studer Editech Dyaxis
100	WaveFrame AudioFrame
60	Digital Audio Research SoundStation II
50	Lexicon Opus
45	Solid State Logic ScreenSound

# PAEG

*update!*

**W**hen we last updated you on the Professional Audio Exhibitors Group, a U.S. group had been formed at Winter NAMM. Since then, an executive committee has been formed, consisting of Fred Ampel, editor, Sound & Video Contractor; Hartley Peavey, president, Peavey Electronics; Ralph Lockhart, vice president of sales and marketing, Biamp Systems; and Bill Windsor, president, Quad Eight Electronics. Dennis Milan, publisher of R•E•P and S&VC, is the executive adviser.

The group has also formed a preliminary mission statement containing these two points, among others:

Purpose: to provide a unified voice to its members, and to address issues and

concerns of its members, primarily related to trade shows/exhibitions.

Main issues: the number of worldwide trade shows, qualified attendance at trade shows, and a reliable method to audit these numbers.

PAEG-US members are working with exhibition/convention sponsors to express its concerns on various trade show issues.

Although this group is for manufacturers, its existence shouldn't be lost on end-users of equipment. Trade show costs are directly reflected in equipment costs. Lower exhibiting costs mean lower equipment costs.

Any manufacturer based in North America is eligible to join PAEG-US. Additional information is available at Box 12901, Overland Park, KS 66212; 913-888-4664; fax 913-541-6697. ■

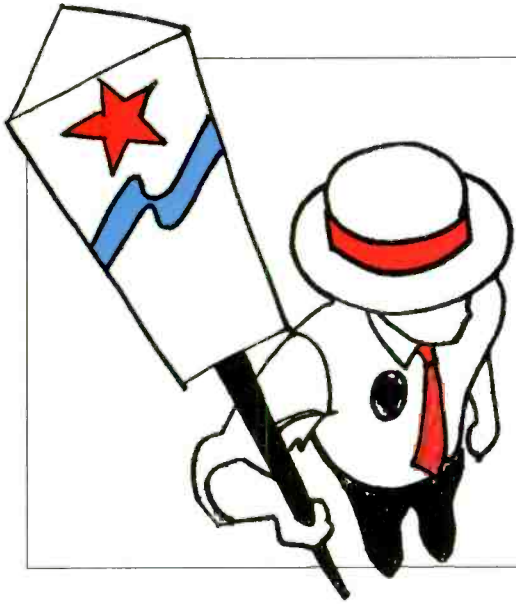

## VOTE!

Readers! How do you feel about the way products in this industry are advertised? Here's your chance to voice your opinion in R•E•P's second annual Ad of the Year Contest.

To vote for what you think is the best ad appearing in the last 12 months, turn to the ballot, which can be found on the first page of the reader service cards located in the back of the issue. Be sure to include your name and address to be eligible for our prize giveaway, courtesy of AKG/Orban/dbx.

Ballots must be returned by Aug. 31. The winner will be announced in the November issue. ■

## PEOPLE

AMS Industries has made the following staff appointments: **Stuart Hirotso**, sales executive; **Julie Straton**, office manager; and **Ridge Nye** of Interface Audio, representative for the AMS product line in the Southeast region. . . **Ralph Jones** has rejoined Meyer Sound as marketing manager. . . WaveFrame has named **Igor Saulsky** sales and applications manager for the L.A. office. . . **Bill Whitlock** has been named president of Jensen Transformers. A long-time friend and business associate of late president Deane Jensen, it was Jensen's wish that Whitlock assume presidency of the company after his death. . . Westlake Audio has promoted **Larry Deeds** to manager for the Professional Audio Sales Group. . . **Roger Patel** has been named international sales manager for Audio Kinetics. . . **Dave DeLeon** has joined Soundcraft as technical supervisor. . . **Nat Hecht** has been named applications engineer at JBL Professional. . . QSC has appointed **Barry Ferrell** applications engineer; **Eric Mendenhall** has been named design engineer. ■

## TRENDWATCH

*Record Labeling:* Although the Recording Industry Association of America introduced in May a standardized parental warning sticker, labeling bills were subsequently introduced in Louisiana and New Jersey. Thirteen states withdrew bills after the RIAA announced a standard label for its members to use.

*Legislation:* Two New Jersey state assemblymen have introduced a bill requiring an advertising and ticket statement informing the audience when portions of live concert are lip-synced to canned vocals. Promoters would be fined up to

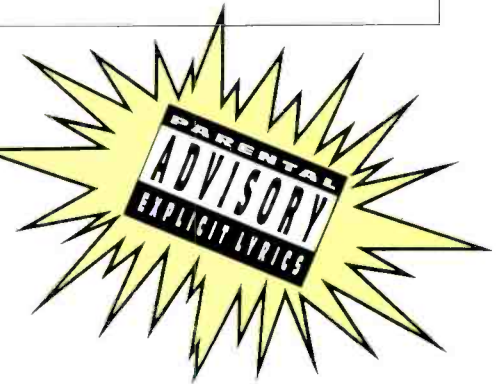

\$50,000 for a violation; the ticket agent, up to \$5,000. Apparently the road crew (including house and monitor engineers), which would be intimately involved in such situations, is not affected by the bill. ■

## QUOTEBOOK

"The history of technology, perhaps more than any other kind of history, is full of premature obituaries. We are prone, especially in this fast-moving country, to what I call the displacive fallacy — to believe that every new technology displaces the old technology; that television will replace radio, that electronic news will replace print journalism, that the automobile will displace the human foot, and that television will replace the book. But each of these new technologies has simply given a new role to the earlier technologies. The development of technology is not displacive — it is cumulative."

—Daniel J. Boorstin, *Librarian of Congress.*



RIQUE ALONSO  
DAVID ANDERSON  
MICHAEL BARBIERO  
DAVE BARRATT  
DAVID BASCOMBE  
DAE BENNETT  
HILARY BERCOVICI  
DEVON BERNARDONI  
MARTIN BIRCH  
JOE BOGAN  
MILAN BOGDAN  
ROB BOZAS  
BOB BROCKMANN  
JAMES BROMFIELD  
GERRY BROWN  
BERNARD BULLOCK  
BOB BULLOCK  
CRAIG BURBIDGE  
RANDY BURNS  
MATT BUTLER  
GREG CALBI  
MARIO CALDATO JR.  
PHIL CASTELLANO  
BOB CLEARMOUNTAIN  
JIM COTTON  
MIKE COUZZI  
ROSS CULLUM  
DAVID DACHINGER  
TERRY DATE  
NICK DAVIS  
VINCENT DAVIS  
ANDRÉ DEBOURG  
DIETER DIERKS  
NEIL DORFSMAN  
DR. DRE  
ALFRED EATON  
STEVE ETT  
DON FEINBERG  
TOBIAS FREUND  
NIGEL GREEN  
JAMES GUTHRIE  
CHRIS HAMMOND  
PETE HAMMOND  
PHIL HARDING  
TONY HARRIS  
JAY HEALY  
SCOTT HENDRICKS  
JAY HENRY  
KAREN HEWITT  
BEAU HILL  
ROSS HOGARTH  
STEVE HOYLAND  
ROD HUI  
JON JACOBS  
NORBERT JANICKE  
TED JENSEN

ANDY JOHNS  
GEORGE KARRAS  
ACAR KEY  
TIM KISH  
DAVID KOWALSKI  
FERNANDO KRAL  
GARY LANEY  
MICHAEL LARDIE  
STEVE LIPSON  
TOM LORD-ALGE  
BOB LUDWIG  
JON MALLISON  
RICHARD MANWARING  
LEWIS MARTINEE  
LEIF MASES  
GARY MCGACHAN  
RAFE MCKENNA  
CASEY MCMACKIN  
GLENN MEADOWS  
ANDREW MILANO  
RODNEY MILLS  
JOHN MORALES  
TAAVI MÔTE  
BRYAN NEW  
LYNN PETERZELL  
CHRIS POTTER  
DENNY PURCELL  
DAVE RIDEAU  
BUD RIZZO  
BOB ROSA  
GLENN ROSENSTEIN  
CHAS SANDFORD  
JOE SCAIFE  
BILL SMITH  
DONOVAN SMITH  
KEITH SWEAT  
IAN TAYLOR  
TERRY THOMAS  
STEVE THOMPSON  
RON TREAT  
LESTER TROUTMAN  
ROGER TROUTMAN  
ZAPP TROUTMAN  
KURT UPPER  
MICHAEL WAGENER  
DUSTY WAKEMAN  
ANDY WALLACE  
GREGORY WALSH  
MICHAEL WANCHIC  
MERVYN WARREN  
ALAN WATTS  
HANK WILLIAMS  
DAVE WITTMAN  
MARK WOLFSON  
D.J. YELLA  
DAVID Z





# MORE ENGINEERS GO GOLD ON AMPEX THAN ON ALL OTHER TAPES PUT TOGETHER



EVERY ENGINEER LISTED HERE HAS EARNED THE PRESTIGIOUS

*Ampex Golden Reel Award for engineering a gold album exclusively on Ampex audio tape. In fact, of all the gold albums released last year—and the year before—most of them were laid down exclusively on Ampex tape. And it's a good bet that most of the others used Ampex for the majority of their tracks, too. • At Ampex, we appreciate the passion and precision demanded of audio engineers. It means pushing yourself to the wall so that every note, every beat, every bar will be perfect. It means taking music...and making magic happen. • We've made our own commitment to provide you with the highest quality, most consistent, most dependable audio tape in the world. A tape engineered with the same uncompromising attention to detail that you bring to your sound. • For all the details on what makes Ampex tape so technically advanced, just call or write for a copy of our new 456 Technical Brochure, and see why Grand Master® 456 is engineered like no other tape in the world.*



**AMPEX**  
A MASTER OF ENGINEERING

Circle (9) on Rapid Facts Card

# Random Access

## STUDIO UPDATE

Facility/Location	Details
<b>NORTHEAST</b>	
Blank Productions/Stamford, CT	New equipment: two Macintosh IICXi computers for CD production mastering and music production; Sound Tools digital software; three Panasonic SV3500 R-DAT machines; Tascam T-2640 multicopy cassette duplicator.
RPL/Camden, NJ	John Miller promoted to operations manager.
Sear Sound/New York	New equipment: a vacuum-tube sub-mixing console.
Soundwave/Washington, D.C.	Studio B renovation including new equipment: a Audio Kinetics Eclipse synchronizer; Studer Revox C-270 1/4-inch; Sony VO 5800 U-Matic SP 3/4-inch video deck; and Apex signal processors.
<b>SOUTHEAST</b>	
The Money Pit/Nashville	New equipment: Otari Diskmix 3 automation package for its Trident 80 Series mixing console.
Studio Center West/Miami	Expansion of Studio Center to second facility located at 6157 N.W. 167th St., Suite F-4, Miami, FL. Craig Powell is general manager of Studio Center West. Facility includes an SSL 6056E 48-channel console; Sony PCM digital mul-titrack recorders; Adams Smith 2600 synchronizers; Neumann U-87 and U-47 condenser mics.
<b>MIDWEST</b>	
Ajax Recording Team/Fort Wayne, IN	New equipment: Panasonic SV-3500 DAT recorder; Oberheim Matrix 1000; Opcode Vision software; Studio 3 SMPTE/MIDI interface; Eventide H3000B/SE; Drawmer 1960 stereo tube limiter; DS-201 gates; 2-channel Dolby SR; two Neve 1089 mic/EQ modules; Tannoy NFM-8s; AKG and Sennheiser mics; and Sound Ideas CD SFX libraries.
Creations/Lansing, MI	Dan Clark named creative director.
Metro Studios/Minneapolis	Addition of second 24-track studio; Tommy Tucker Jr. named chief engineer; Dale Strength and James Walsh named in-house producers.
<b>SOUTHERN CALIFORNIA</b>	
Intersound/Los Angeles	Bryan J. Rusenko named vice president, engineering; Garry Morris named executive director, marketing and publicity.
South Coast Recording/Santa Ana	Relocated to 1513 S. Grand Ave., Santa Ana, CA 92705; 714-541-2397.
Studio 55/Los Angeles	Renamed Powertrax/55 and now the headquarters for the Powertrax Entertainment organization.
<b>NORTHERN CALIFORNIA</b>	
Alpha & Omega/San Francisco	Laura Clark named studio manager.

## NEWS NOTES

**Manny's Pro Audio** has been named the exclusive dealer from Boston to Philadelphia for the Gotham Audio SPL SX2 Psychoacoustic Processor.

**Alpha Audio** has entered into a joint manufacturing and marketing agreement with Charles Krumbain, president of Mid-Atlantic Venture Capital. The agreement is the response to the demand for increased production for the DR-2 hard-disk recorder.

**Avid Technology** has opened an office in Burbank, CA, to support sales and service for the Avid/1 Media Composer to Southern California post-production houses and studios. The office address is 3900 W. Alameda Ave., Burbank, CA; 818-972-1725.

This past spring, **AST Sound** celebrated its 50th year in pro sound sales and service in the New York area.

**Concertech**, a new company formed by Carl Koster (co-founder of N.Y. Musicworks), provides cost-effective audio engineering and equipment rental services for smaller and medium budget acts in the tri-state metro area. Concertech is located at 108 W. 17th St., Suite 7, New York, NY 10011; 212-255-5986.

**ADC Telecommunications** has formed the Professional Audio and Video Group, a part of its Diversified Markets Group. Lonnie Pastor has been named general manager, and Pat Gallagher has been named national sales manager.

**Full Sail Center for the Recording Arts** has opened a West Coast branch in Hollywood. Full Sail West is based at Margarita Mix, where the Full Sail Basic and Intermediate New England Digital Tapeless Studio seminars will be held. For more information, call Karen Schick at 213-465-9527.

**Klark-Teknik** is implementing a leasing program to be managed by the Sigmet Leasing Group. Guidelines are available from Klark-Teknik, 30B Banfi Plaza North, Farmingdale, NY 11735; 516-249-3660. ■



# The Perfect Mix:

John Hiatt—Performer,  
Songwriter, Producer, AMR  
Production Series™ 1600  
Console Owner.

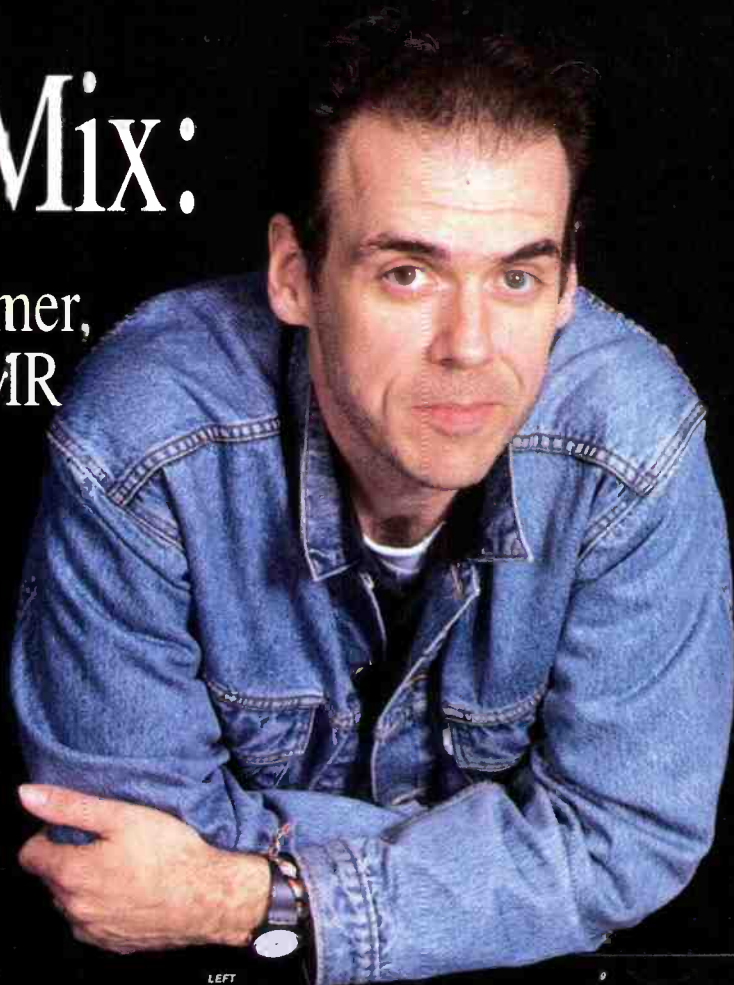

Through continuing contact with professional recording engineers, Peavey Audio Media Research has produced the definitive mixing console with performance, function and features of uncompromising quality. Ask John Hiatt—performer, songwriter, producer—what he thinks of his new Production Series™ 1600 from AMR. Like John, the kind of people that incorporate AMR equipment into their studio design usually have quite a track record of success. Whether you're a seasoned professional or a talented novice, AMR has the right equipment for you.  
Audio Media Research and Success—The Perfect Mix.

**PEAVEY**  
AUDIO MEDIA RESEARCH™  
Circle (10) on Rapid Facts Card

# Fresh Tracks

## Gil Goldstein: "City of Dreams"

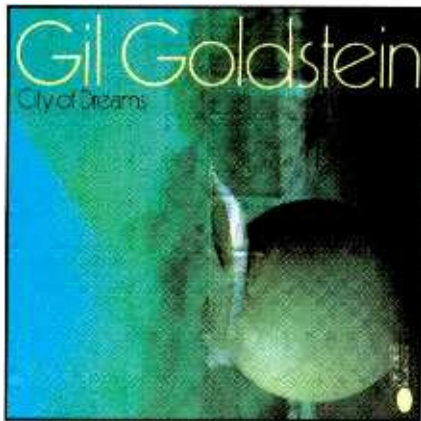

Label: Blue Note  
Producers: Gil Goldstein and Kazunori Sugiyama  
Recorded by: Garry Rindfuss  
Mastered by: Yoshio Okazaki  
Studio: Centerfield Productions, New York  
SPARS Code: Not listed

**Comments:** Blue Note probably conjures images of recording studios in the 1940s and '50s, as engineers recorded multiple takes, after which the best cut was selected for release. This album clearly reveals the technical grasp of the label's musicians, engineers and producers. The tasteful use of MIDI keyboards doubled with accordion, or sampled percussion and French Horn, add depth to an otherwise superb performance.

**Of special interest:** The album sports one of the finest examples of close-miking of an acoustic grand. The stereo imaging is accurate without the side effects of spatial synthesis. The percussive and, particularly, sustained tones are crystal clear and free to wash over the listener without becoming too intrusive. Overdubs are used with care and are not overbearing. ■

Fresh Tracks is a monthly department spotlighting technical and production aspects of recently released albums. R•E•P is pleased to recommend these for quality referencing and listening enjoyment.

## The Notting Hillbillies: "Missing...Presumed Having a Good Time"

Label: Warner Bros  
Producers: Mark Knopfler and Guy Fletcher  
Mixed by: Bill Schnee  
SPARS Code: DDD

**Comments:** Knopfler's solo project before restarting Dire Straits is low-key but enjoyable. As would befit an acoustic-based album of mostly traditional folk and country songs, the recording is straightforward and unobtrusive. One complaint: why the incomplete musician/engineer/studio credits?



**Of special interest:** Guitar tracks from three players are well-placed in the mix, without everything muddying up. Vocal performance and recording on songs like "Blues Stay Away From Me" are almost too casual, but certainly befit the nature of the project. ■

## Foster & Lloyd: "Version of the Truth"



Label: RCA  
Producers: Bill Lloyd, Radney Foster and Rick Will  
Recorded by: Rick Will, assisted by John David Parker and Graham Lewis  
Mastered by: Hank Williams at MasterMix, Nashville  
Studio: Sixteenth Avenue Sound, Nashville  
SPARS Code: DDD

**Comments:** Foster & Lloyd continue to be some of the freshest voices of the newer generation of country artists by combining country-based instrumentation/writing with a well-recorded pop/rock production style. Overall sound is nice and bright, although drums may be placed too aggressively in the mix for traditional country fans (but no problem for younger ears).

**Of special interest:** The instrumental track "Whoa" effectively showcases highly effective drum mic placement and recording techniques. Vocal processing on "Is It Love" and "It's Over" may not be typical for country records, but work just the same. ■

# Take A Few Pointers From Selco.



## Ricky Peterson: "Night Watch"

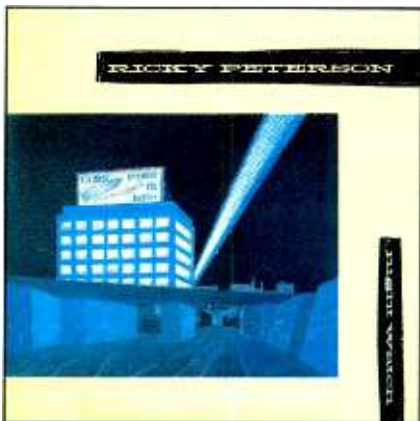

Producers: Tommy LiPuma and Ben Sidran  
Recorded by: Al Schmidt, Bill Schnee, Jonathan Most, Steve Weise, Tommy Fritzie, Tom Tucker and Ken Allardyce  
Studios: Metro Studios, Minneapolis; Hit Factory, New York; Bill Schnee  
Mastered by: Doug Sax  
SPARS Code: Not listed

**Comments:** If not for the superb production efforts of LiPuma and Sidran, buy this album for the MIDI lessons that Prof. Peterson logically leads you through cut by cut. No "over-sampled, highly quantized" rhythmic patterns and melodic sequences. Superbly recorded acoustic instruments are balanced with unusually orchestrated MIDI keyboards.

**Of special interest:** Effects obtained from layering and dynamically processing instruments via the MIDI bus are revealing. Analog tracks like the vocals are supported with judicious amounts of digital reverb with effective pre-delay reverberation and synchro-sonic stereo delay. ■

### A Sound Decision

Here is a high-profile-pointer knob that can be viewed with pleasure and read in the dark. These elegant pointers are ideal for audio mixing consoles, as well as for instruments and general electronic applications.

Precision molded of ABS, the knob bodies are gray or black, with a selection of seven decorator colors for the cap/pointers.

### Freedom of Choice

Selco's pointer knobs come in two styles: a one-piece, double-injected knob, or a two-piece version with snap-on cap/pointers for greater manufacturing flexibility.



**selco**  
PRODUCTS CO.

The standard knob body has a high-quality, satin finish and is available for immediate delivery. A new Velvet Touch™ finish is available on special order.

### Easy to Own

Selco's high-profile-pointer knobs are modestly priced, with OEM discounts in quantities as low as 100 pieces.

For full information on the knobs that achieve a perfect union of form and function, request our full-color 16-page knob catalog.

And get your first pointer absolutely FREE!

Manufactured by SIFAM, LTD.

7580 Stage Road, Buena Park, California 90621. Phones [213] 921-0681, [714] 521-8673, Toll Free [800] 25-SELCO. Telex 655457. FAX [714] 739-1507.

Circle (11) on Rapid Facts Card

c2

Free Catalog of

# Professional SOUND recording & duplicating SUPPLIES

POLYLINE™ EMPTY  
REELS & BOXES

BLANKLOADED  
CASSETTES

BOXES  
ALBUMS  
LABELS

AGFA AMPEX  
3M Scotch  
TDK maxell  
tapes

now from  
**STOCK**  
in  
**CHICAGO**  
and  
**L.A.**

Call Polyline  
**708/298-5300**  
8:30 am - 5 pm Central Time

**Polyline**  
Corp.  
1233 Rand Road  
Des Plaines, IL 60016

Circle (12) on Rapid Facts Card

## Financing Your Future

By Sandy Schneiderman

If you're considering renovating or expanding your facility, you should also consider how you are going to pay for it. Don't overlook this aspect of the project. How you finance your activities can be as important as what sort of changes you decide upon and what kind of equipment you decide to buy.

The following are important requirements when securing financing that the principals and investors should consider:

1. The principals must have solid experience and contacts in the music and video arena and have sound business judgment. Principals should have working experience in another studio, either as an engineer, producer or financial administrator. Knowledge of the complete day-to-day operation of a studio is important.

2. The investors will usually sign or co-sign equipment leases. They should have liquid assets, such as savings accounts, certificates of deposits, U.S. Treasury bills or blue chip stocks for their guarantees to be acceptable.

3. A sizable amount of the investor's cash should be applied to construction of the studio. It is difficult to borrow for construction, because leasehold improvements in the studio are not good collateral.

4. An existing corporation in a related business with a good track record of co-signing/signing the equipment lease is a major plus.

5. Profit and cash flow projections should be professionally prepared. Profit projections should include sources of revenue and major operating expenses for a 3-year period. Cash flow is basically monies from studio operations, less any cash expenditures.

An established studio that plans to construct and equip a new room has many advantages.

1. A profitable track record and retained earnings are important. Retained earnings represent after-tax profits that are reinvested in the company. In other words, don't milk your business if you plan to expand via leasing.

2. Equipment that is used in studios can be pledged as additional collateral, assuming it is owned outright.

3. A good reputation is important. Customer references are helpful.

4. Royalties from producing and arranging music and videos can be pledged as collateral.

5. Personal guarantees of the principals can mean the difference between making or breaking a lease. The principals of the studio are usually required to co-sign/sign the equipment lease. By doing so, the leasing company is assured that the studio owners will continue to devote their full time and energy to maintaining a successful studio. When a personal guarantee is given, the leasing company does not attach liens on the person's assets, such as a house or car. But in the event of a de-

***Personal guarantees can mean the difference between making or breaking a lease.***

fault of a lease, the leasing company will work out an arrangement by which the principals will repay any debts in excess of the borrower's assets.

An alternative method of financing construction is a sale/leaseback arrangement. Equipment that you own can be used as collateral for a construction loan. The term is usually five years. Consoles, tape machines and editing equipment are excellent collateral. Other support equipment is also acceptable. The following are procedures to be taken when considering a sale/leaseback:

1. Take an inventory of all of the equipment you own outright. List it by manufacturer name, model name and number, date acquired and original cost.

2. Have a reputable appraiser give you a written appraisal of the liquidation value of the equipment. The liquidation value is defined as the estimated amount a piece of equipment is worth at an auction

sale. The SPARS office can be helpful in finding appraisers who are knowledgeable and highly respected in the audio equipment industry.

3. A leasing company will probably loan 50% to 75% of liquidated value over a 5-year period, assuming the studio is profitable and has been in business a couple of years. The studio actually sells the equipment to a leasing company, which, in turn, leases that equipment back to the studio. The studio continues to use the equipment and is responsible for insurance and maintenance. The leasing company retains title to the equipment until the final loan payment is made.

During the time a studio is being constructed and the equipment has been ordered, substantial capital outlays for equipment downpayments are necessary. In such cases, the lessee may wish to finance the capital outlay required as part of the lease transaction, but only pay the interest portion of the loan (not the principal) until the studio is ready for operation.

This can be accomplished by entering into an interim funding agreement with the leasing company. In other words, even though the leasing company has paid the manufacturers for equipment, only interest on that money will be paid until the studio is fully operational, at which time both principal and interest payments will commence. This arrangement provides a cash cushion until the studio starts collecting money from its customers.

The future of the audio/video industry rests on the continued hard work of the talented people associated with the studios and the willingness of leasing companies and banks to provide the capital needed to equip studios with the most up-to-date technology. My experiences in this industry have been excellent, from timely collection of lease payments to an increasing awareness of a "professional image" by the studio principals and employees.

My final suggestion: Establish a relationship with a leasing company that understands the audio/video/film industry and has the financial strength to approve loans on its own. ■

Part 2 of this column will appear in the August issue.

The Society of Professional Audio Recording Services is the audio industry's best source of business information. For information on activities and membership, contact SPARS at 4300 10th Ave. N., Lake Worth, FL 33461; 407-641-6648; fax 407-642-8263.

Sandy Schneiderman is president of Terminal Marketing, New York.

# A.R.T. INTRODUCES THE FIRST SIGNAL PROCESSORS OF THE 21ST CENTURY

## THE SGE MACH II

The stunning new Wonder-processor offering 12 effects simultaneously! The Mach II has over 70 different effects including an exciter, equalizer, compressor, limiter, noise gate, expander, sampler, env. filter, pitch transposer, line EQ, stereo panner, stereo chorus and flange, 12 killer distortions, 21 delay types (2 full seconds) and 24 different reverb algorithms! Real time midi, 200 memories and bandwidth to 20 kHz.

## THE DR-X

The all new Studio Digital Reverberator/Dynamics Processor/Pitch Transposer/Sampler offering 160K bytes of audio ram, bandwidth to 20 kHz, sampling, 10 simultaneous audio functions, an exciter, equalizer, compressor, limiter, expander, noise gate stereo panner, stereo chorus and flange, 21 different delays (2 full seconds), 24 reverb algorithms, 200 memories, amazingly comprehensive real time midi control.

## THE MULTIVERB III

A new age of technology and 400% more processing offers digital reverb and spatial enhancement that defies description! The Multiverb III has over 53 effects to choose from (up to four simultaneously) including sampling, stereo chorus and flanging, 21 delay types (2 full seconds), stereo panning, pitch transposing, 24 reverbs, 200 memory locations, full programmability and Performance Midi™.

## THE MULTIVERB LT

The Multiverb LT gives you the power of the Multiverb with the simplicity of 1-touch control. The LT has 192 of the finest studio multi-effect combinations ever created! For those who don't have time for the complexity of programming, the LT gives you all the power you can use at a great price! Midi addressable.

### Export Distributors:

THE NETHERLANDS/Audioscint B.V./Soest/02155-2044/FINLAND/MS-Audiotron/Helsinki/90-5664644/SWEDEN/Muskantor & Co./Molndal/031-878080/France/High Fidelity Services SA/Paris/(1) 42.85.00.40/CANADA/Yorkville Sound LTD./Scarborough/416-751-8481/ITALY/Ital C.I.D.A. SPA/Parma/0521 690158/WEST GERMANY/PME Audio/Hauffweg/07136-6029/SWITZERLAND/Musikengros Gutter/Sissach/061-983757/HONG KONG/Audio Consultants LTE./Kowloon/3-7125251/JAPAN/Nihon Electro Harmonic/Tokyo/033232-7601/THAILAND/Beh Ngiep Seng Musical Instruments/Bangkok/222-5281/INDONESIA/PT Kirana Yudha Teknik/Jakarta/3806222/SINGAPORE/Lingtex PTE. LTD./7471951/SPAIN/Aplicaciones Electronicas Quasar SA/Madrid/6861300/TURKEY/Kadri Cadmak/Istanbul/(1) 1661672/AUSTRALIA/Hi-Phon Distrib. Pty. LTD./Chatswood NSW/024177088/DENMARK/M.I. Musik/Kobenhavn/1-854800/U.K./Harmon U.K./Slough/075376911/NEW ZEALAND/Maser Digitek/Auckland/444-3583/4 ISRAEL/More Productions/Tel Aviv/03-454003-442697/ARGENTINA/Lagos Sarmiento/Buenos Aires/40-6455/NORWAY/AUDIOTEKONI/OSLO/2 35 20 96

APPLIED RESEARCH & TECHNOLOGY INC., 215 Tremont Street, Rochester, New York 14608, (716) 436-2720, TELEX: 4349793 ARTROC, FAX (716) 436-3942

Circle (13) on Fapld Facts Card

The logo for Applied Research & Technology (A.R.T.) Inc. features the letters 'ART' in a large, bold, stylized font. The letters are white with a thick black outline and are set against a dark, textured background that resembles a metallic surface with horizontal ridges. The 'A' and 'R' are connected at the top, and the 'T' is positioned to the right of the 'R'. The overall aesthetic is industrial and high-tech.

## Digital Roundup

By Rick Schwartz

If the record turnout at the recent Macworld Expo is any indication, the Apple Macintosh computer is alive and well. Although the San Francisco-based computer show does not focus directly on audio, there were exciting new developments in optical disk technology, computers and software — developments which will clearly affect digital audio products in the coming months. Other exciting technologies in evidence: SCSI-2 subsystems (a higher-speed Small Computer System Interface protocol), intelligent RAM disks, low-cost Ethernet and, of course, this year's buzzword — multimedia presentation.

### OPTICAL OPPORTUNISTS

At the show, Storage Dimensions demonstrated the fastest and largest capacity erasable optical drive available for the Macintosh. Cartridges come in two flavors — 650Meg and 1Gig. The 1Gbyte has a faster data transfer rate, but does not conform to the ISO standard. Even though you still can't record digital audio continuously on both sides of the disc, each side will store approximately 40 minutes of contiguous stereo.

### FAST TIMES IN CUPERTINO

Although it was no secret by the time Macworld opened, the wicked, fast Macintosh IIx is quick enough to be called the Mac III. With its blazing 40MHz clock (an SE strolls along at 8MHz), it has the capability to impact the disk-based audio workstation market in a major way. Along with the high-speed clock, the IIx includes a fast static RAM cache, which keeps the CPU running at maximum efficiency.

It also has two new purpose-built VLSI chips that accelerate floppy drives and serial I/O. A Processor Direct Slot provides direct access to the CPU bus to accommodate performance intensive expansion boards.

Perhaps the most important new feature of the IIx is the SCSI/DMA (direct memory access) controller, which doubles the machine's maximum data transfer rate and frees up the CPU during disk-intensive tasks, although the current operating system (6.0.X) isn't set up to handle asynchronous I/O.

Because of this, it may be some time before most of the current workstation and MIDI sequencer programs will be developed or rewritten to take into account the different, but ultimately faster, way the IIx handles its serial ports.

The good news is that Apple will offer logic-board upgrades to existing Mac II/IIx users starting this month. The bad news is that your old SIMMs will not work with the new machine; older floppy drives (even 1.4 HDs) aren't as fast as the new drives offered with the IIx. The cost of board replacement is high, among other things.

### REMOVABLE INNOVATIONS

It was disappointing not to see the new SyQuest removable drives at Macworld. The drives, which were announced months ago on the Prodigy Online Network, offer higher storage capacities and smaller size (3.5-inch platters), which would make them perfect for audio applications.

### SOUND TOOLS GOES PRO

Digidesign, makers of the Mac-based Sound Tools, is finally offering an upscale version of its AD IN device, which includes balanced +4 XLR analog ins and outs, Apogee filters, an 18 bit/8x oversampling D/A converter, hardware sync for SMPTE and high-resolution meters in a stereo package. It should be available by the time you read this, and will retail for \$2,995. The company will be offering a trade-in policy for current AD IN owners.

### DIGITAL PORT-A-STUDIO?

If you use a MIDI sequencer but have been frustrated because you were forced to lock up to a multitrack tape recorder for tracking vocals and laying down solos, Digidesign may have an answer for you here, too. DECK, which was developed by OSC (a San Francisco-based technology group), is a 4-channel digital multitrack for the Macintosh II family.

Because it is software based, you will still need the Sound Tools or Audio Media hardware package, and large SCSI hard-disk storage capability. But imagine

being able to bounce tracks digitally, generate automated mixes, EQ and process digital effects in real time, and simultaneously support MIDI file playback. The price? \$349.

Isn't software-based technology great? I saw it demonstrated with Opcode's Vision under Apple's MIDI Manager and playing the new MacProteus (a high-quality digital sound module on a NuBus card) and it was truly impressive.

### WHERE'S THE BEEF, LUKE?

Lucasfilm Ltd. has announced a pact with Sound Ideas to produce six discs of sound effects on CD. If you expect to find many Star Wars F/X on these discs, you are likely to be disappointed. I've heard that only three of the six discs were even recorded at Lucasfilm.

Lucas and New England Digital (of Synclavier fame) will be jointly co-developing a version of the seminal audio production package Sound Droid for operation on the PostPro platform.

The software itself is designed to simplify all the tasks involved in recording, manipulating and assembling ADR, Foley and other audio for vision material, as well as organize and data base the huge amount of paper chasing involved in EDLs, Foley prop lists, scene cue tracking and audio sourcing. The Alpha version is currently being shown around the large film studios for "interest generation." This should open up an entire new world to professional ADR, Foley and audio for film/broadcast production.

### TEACH AN OLD DAT NEW TRICKS

How to get your Panasonic SV-3500 DAT player to display error rates: First, set the TIMER selector to PLAY. Next, insert a DAT tape, rewind to the leader and turn off the power switch. Then, while holding down the RECALL button, power the unit up. It should automatically go into PLAY and the counter will display a 4-digit number. To check the error rate at any time during the playback of a tape, just press and hold the RECALL button.

On a high-quality tape with clean heads, you should read an error count of less than 50. If you read more than 100, clean the heads and check again. The unit will remain in this mode until switched off. ■

Rick Schwartz is a sound designer/engineer and director of post-production for Music Animals. Los Angeles.



## Creative By Design

Creating practical designs for real world facilities is our focus.

We're problem solvers — developing design solutions in functional facility layout, architectural acoustics and sound isolation, wire management and technical systems for the specialized needs of studios, broadcast and production facilities.

With 400+ projects to our credit, we have an established reputation for innovative and appropriate design.

**RUSS  
BERGER  
DESIGN  
GROUP  
INC**

4004 BELTLINE SUITE 110 DALLAS TEXAS 75244 214/661-5222 FAX 214/934-3935

## THE R•E•P INTERVIEW:

# Mr. X

By Mike Joseph

In an effort to promote balanced journalism, R•E•P has endeavored to present both sides of the ongoing issues surrounding commercially directed, so-called home project studios. More of a strong concern in the U.S. major coastal markets, the ethical and legal aspects of low-overhead, for-profit, residentially based audio production facilities need to be discussed, understood, and come to terms with, whatever one's personal or professional feelings.

Residential studios that sell time won't go away, and the proliferation of less-expensive, higher-power hardware merely mitigates the ease with which high-quality work can be accomplished.

---

Mike Joseph is technical editor of R•E•P.



**The owner of an “illegal” studio tells his side of the home/project studio issue.**

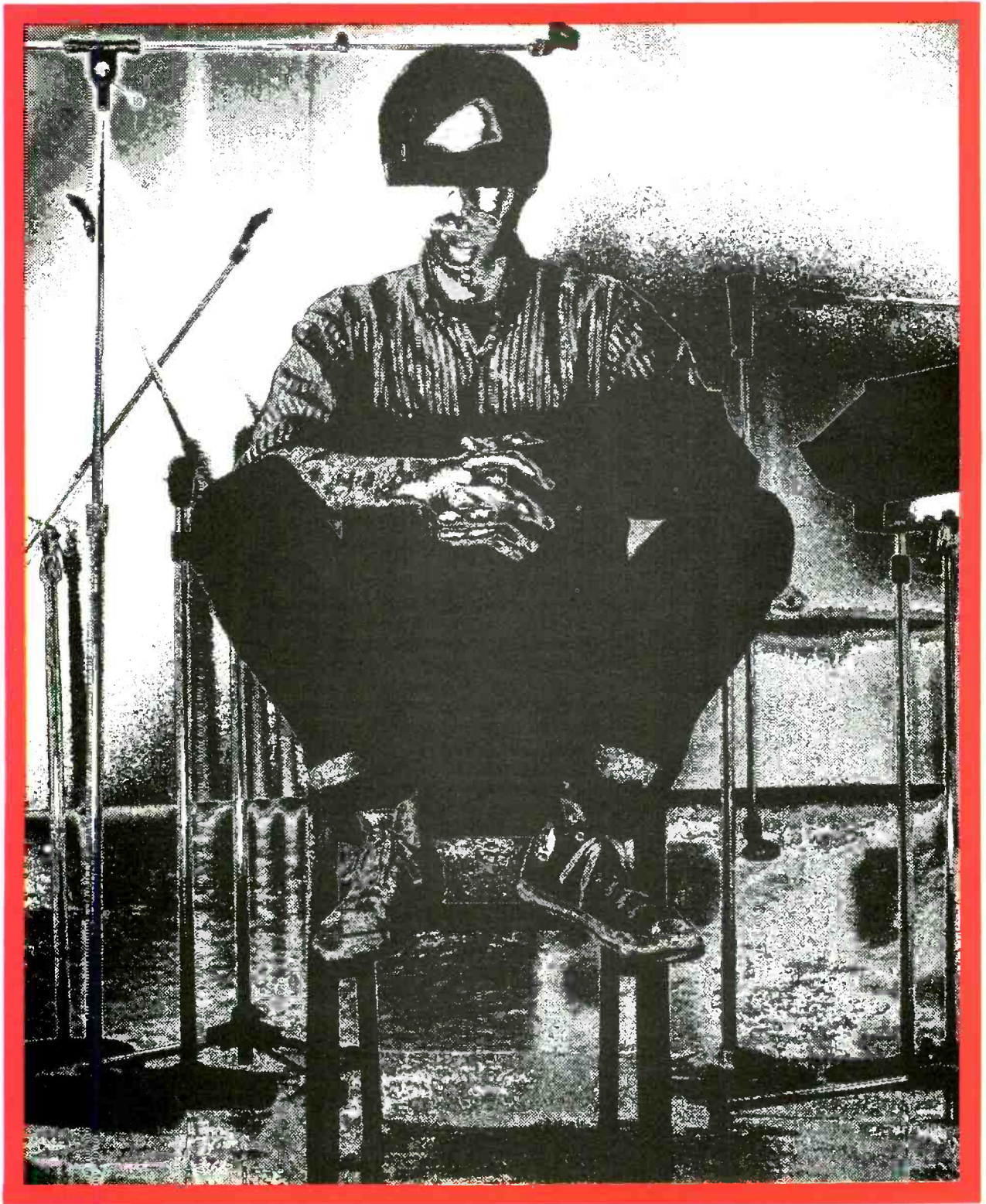

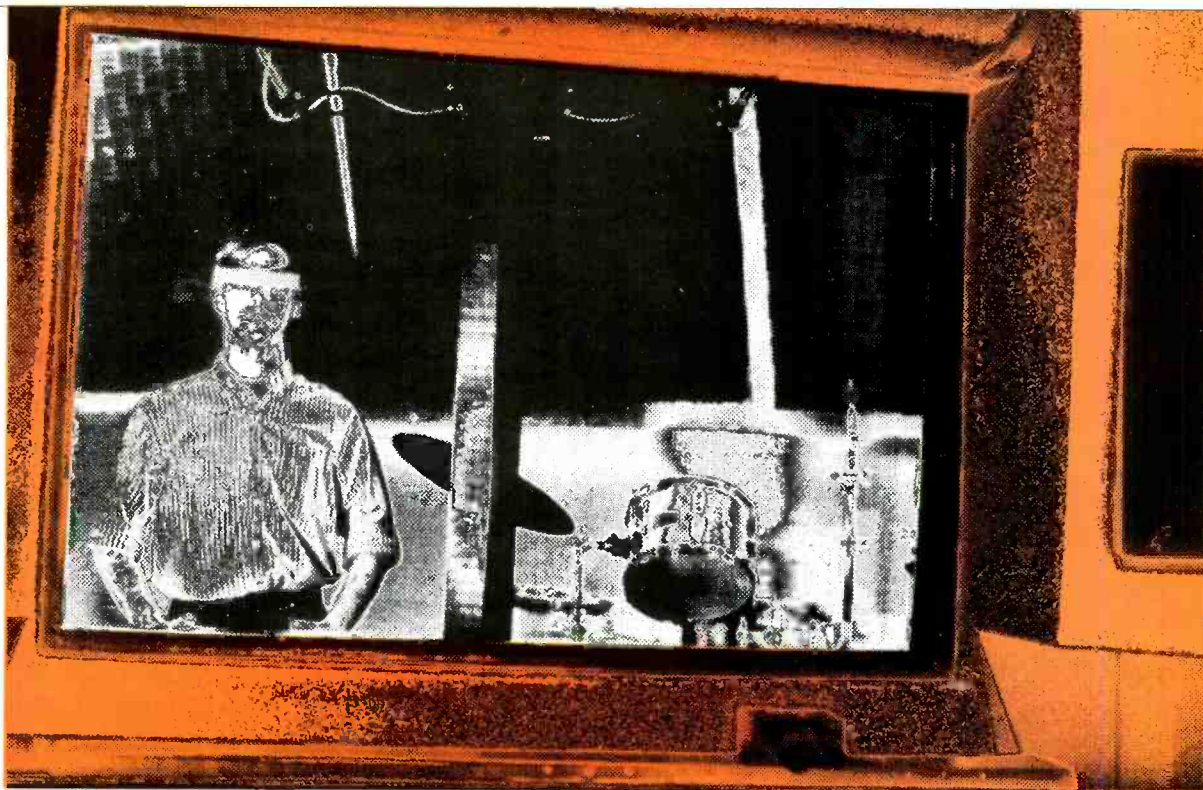

We recently had the opportunity to speak with a gentleman who operates such a facility. As he readily admits, his complex — consisting of four recording rooms and one control room — exists primarily to service his personal productions and projects. Unlike some, he does not advertise commercially, although the facility is available for rent to outside projects with the stipulation that he qualifies the types of projects and people who use his facility. They are, after all, entering his home.

Mr. X, who goes by that moniker at our request, is outspoken, opinionated, intelligent and highly representative of the attitudes we hear as we poll small facility owners, musicians, composers, and independent engineers and producers around the country. Whether or not you're comfortable with it, these rooms are having a positive effect on the industry. If history repeats itself, their genre will grow to fill in the boundaries of a much larger base strata.

They are, to borrow a concept from the study of sociology and cultural development, the New Immigrants, or, if you will, the next generation. They may be commercially disenfranchised, but they are an economic power to both equipment manufacturers and the industry in general.

Ironically, where they are today is also where so many professionally established studios were themselves, not too long ago.

#### **BUSINESS OBJECTIVES**

"I'm in the business of creating music. I'm not in the business of renting acousti-

cally rarefied architecture and electronic signal manipulation devices. I don't think that renting studio time only is a bad thing to be doing; it's just not what I do for a living.

"Better than 50% of the activity in my room is my personal work, material that has my name on it. For me, it's not a good idea to let the business of renting a studio take over my life. What I want to be doing is music. I don't even want the studio to be too successful on its own.

"There is a crew of guys who come in to my studio regularly. Their material is spiritual, Christian music, very contemporary. They are first-class musicians, all of them. They actually make money off their material. At shows and events, they pack the house, big churches, to hear these guys play. After the performance, half of the people come up to buy tapes. It's non-traditional distribution, but it works very well for them.

"What they need, and I provide at a viable price point, is the vehicle to get their stuff onto tape in such a way that it's worth selling. When they come in, I am working with their organization as a producer, although I also function as an engineer and provide recording space. They wouldn't be able to put out product at a viable economic rate if they weren't working with a facility like mine.

"The people who come into my studio have no real alternative. They can't afford to go to a 'regular studio.' The reason this facility exists for me is that my clients and I can't afford other choices. They're too expensive. They're not too expensive for

people who are doing work that is blessed by the high-end record industry or the broadcast industry. But if you are doing creative work that is outside that, then somebody is having to finance that situation out of their pocket. There is more work at that level in America than you think. A majority, I would guess.

"Before I owned my own gear, and long before I owned enough gear to let others record with me, I worked in regular commercial studios. Even when I was totally organized and prepared, when I hit a big studio, I was hustling. Forget about experimenting with this type of reverberation against that kind of horn sound. Forget about it. Just do what you planned to do, because you can't afford to do anything creative.

"Not to mention that at the end of all your money, you have one product to show. And your money is spent. Now I can spend 24 hours a day working on my stuff, and the gear is there tomorrow to continue. There is no end to the number of projects I can afford to do. The point is that you can't go into a regular recording studio today and walk out with an artistic product for a reasonable, personally affordable amount of money. There's no way that my Christian friends, who have a viable business and do it to support themselves, could generate the product that creates their business and get it to the point where it's profitable.

#### **THE ROLE OF SMALL STUDIOS**

"Small studios, whether analog or digital, will contribute new musical ideas. The

**SO SMART,  
IT SPEAKS  
A SECOND  
LANGUAGE.**



Now, there's an audio recorder that talks video. The APR-5003V.

You can actually control the APR-5003V with a video editor. Because its 9-pin serial port communicates with Sony's BVE-9000 or BVE-900 editors. And ease of control is just one of many advantages for video post production.

The APR-5003V also offers a wide range of synchronization features, including resolve on play. Chase synchronization. Timecode generation with video reference. And off-set with bit resolution.

Of course, the first language of any audio recorder is



*9-pin serial port for control by Sony video editors BVE-9000 or BVE-900.*

still audio. And you get the superb sonic quality you'd expect from Sony.

If you're in post production, and you're in the market for an analog recorder, remember whom to speak to. Contact your Sony Professional Audio Representative. East (201) 368-5185; West (818) 841-8711; Central (312) 773-6001; South (615) 883-8140.

Sony Communications Products Company, 1600 Queen Anne Road, Teaneck, NJ 07666. © 1989 Sony Corporation of America. Sony is a registered trademark of Sony.

**SONY®**

PROFESSIONAL AUDIO

flexibility to develop these ideas cannot be fostered by big industry. They have to sell too much lowest common denominator to fuel the machine. They are going to stick with knowns. Madonna will come out, and everyone will pull out their Madonna clones. Chop a piece of the known pie, so they can get a given amount of percentage of a known total. Heaven forbid they have to bake a new pie.

"Where were they when Windham Hill was going it alone? Sitting back, laughing, saying it would never take off. And when New Age became a multimillion dollar industry in its own right? Then it was 'Oh shit, we better cover this! Let's start a label and call it Crystals and Light and get some young Marin synthesist to do string swells for 45 minutes.'

"The new things come to light in small studios, driven by small budgets and distributed by small labels. Driven by the desire of creative people to pursue their musical ideas.

#### QUALITY OF THE END PRODUCT

"When people listen to my albums, they don't say, 'Gee, that sounds very good for being produced in a cheap little room.' If you have the basic gear, and you know how to use it, you can make it sound as good as any music anywhere.

"Bear in mind that a big chunk of what all that is about, of course, is the music itself. That's what the people are listening to. Expensive effects and 20-bit spatial ambience are nice, but people don't buy albums to hear that. It's the music. OK, my 5534 and TLO 72 op-amped board will not give the crystalline dimension that a Trident A series or, even better, a classic discrete Neve will. And my analog 16-track isn't going to put out what a Studer or Sony digital will.

"But what my clients are buying is primarily the ideas, ideas that have been organized and put together artistically well. Musicians who come in and work with me are every bit as good as the guys who work in the big studios. But they can't afford to work there. I couldn't afford to take them in there any more as a producer. They wouldn't have a chance — not enough time or budget to get their ideas across.

"Now, a higher studio rate certainly buys intangibles and behind-the-scenes stuff: phone lines and secretaries, decor and how heavy the service duty cycle is on the tape deck's servo capstan motor. But the average listener doesn't care about the lobby furniture or listen closely to how smooth the top end of the cymbals are. They're listening to the songs. If those songs can't even get delivered to them, in any form — if the artist can't afford to record — then they don't even get to hear it. That, I think, robs the industry.

#### THE NEIGHBORS

"My neighbors are no problem. We maintain a very low profile. We have a driveway that comes down the side of the house, so that when people come in, they park there and unload, and they're in a recording studio. The whole time they're here, except when they step out for a cigarette or something, it's quiet. The studio is soundproof, of course. People can't hear us, we can't hear them. The street has traffic, so we don't impact the neighborhood.

"Most folks probably don't have a clue what's going on here. What would they say if they knew? I don't think they'd care. No more than the corner grocery up the block, or the palm reader or hair stylist a block away. It doesn't impinge on their lifestyle. My business can be operated without undue attention.

#### GUERRILLA TACTICS

"We take every advantage we can to keep costs down. Is some of that illegal? Maybe. That's why you're referring to me as Mr. X. I am using guerrilla tactics to move ahead in an industry that is not very encouraging to independent creative guys like me. Yet the industry would have to admit that it benefits from us at the same time. I develop the music and artists and techniques for presentation to folks at the higher, commercial level, at which point they take it, make huge profits, and grind it up as so much fodder.

"Did rap and house music start in Capital or Warner Bros. studios? No way! Are they making money off of it now, after it's been fully developed by people like me, who barely made a dime off it, after the hard work was done? Damn straight! The industry's a machine, and I'm just another guy on the front line who finds and processes the fuel it runs on. Fortunately, I get off on doing that. A guy can come into our studio and start generating the stuff that makes him attractive to the next layer up.

"Most of the studio owner bitches and moaners don't realize that we are a feeder system, the farm league, for their future income. We are developing the people who hopefully, if their product sells on some level and they get proficient at producing audio, will gather a larger following until somebody recognizes them and injects a budget to allow them the luxury of working in a fancier environment, a more technically equipped facility, like one of the moaner's rooms, under the watchful multimillion dollar eye of A&R. One can only hope the art won't get sucked out.

#### CREATIVE PURPOSE

"I can't over-emphasize that the very basis of the existence of my studio is economy. One, most recording studios are just

too expensive. They usually have to charge what they do, of course. No one's blaming them. I know what equipment costs. I just chose not to do big bank loans to over-reach and have my debt dictate my rates.

"Two, the music industry is a pack of dogs, sniffing each other's butts, and once in a while one of them issues forth with some crap like Milli Vanilli, and the rest of them start chasing their tails to produce their version of the same thing. You cannot, as a creative individual, bust into something like that and get the big budgets that allow you to produce your material if you are coming in with something really unusual.

"If you are a normal creative person, and you create music, and your music is really something that will sell in today's splintered economic environment, then how do you manufacture it? Never mind distributing it to the marketplace. If you have a budget of dollars that you've saved from being a librarian or a construction worker of \$4,000 or \$5,000, you can't go to a regular 16- or 24-track studio. You'll kill your budget and you won't finish your project. You not only won't be able to attract manufacturers and distributors, you won't get something you can deliver to your gigs and sell.

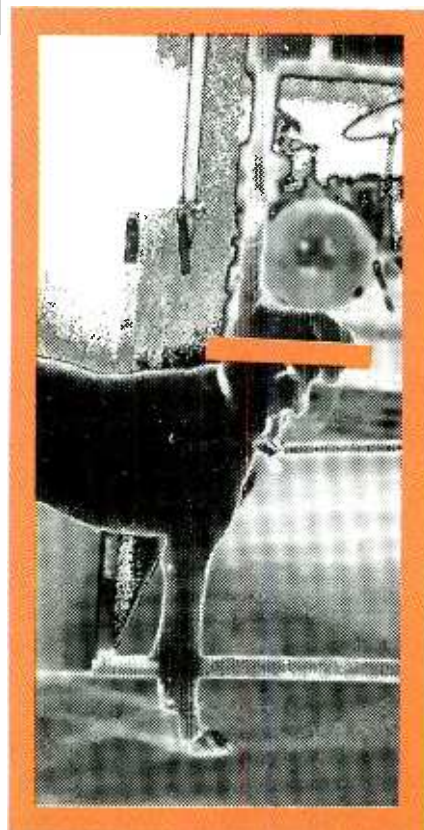

## Rediscover The Art.

Console manufacturers limited what you could buy. Market pressures dictated what you could own. Until today.

Now there's a console that provides what you want: Creative power. Sonic transparency. Highly adaptable integration.

A new artform for expression. From Trident. Because we haven't forgotten what a console is all about. The VECTOR 432.

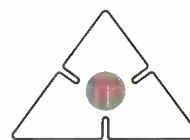

TRIDENT

### ARTISTIC EXPRESSION VS. EQUIPMENT

"The commercial studios will, of course, argue that the level of production, even the artistic skill level of the employees, is better in a commercial studio, and that the level of equipment is better, and therefore the product is better. I completely disagree with this. The level of artistic production, the skills that go into what I work on, artistic expression and creativity, are the same in any room.

"Yes, in an upscale room you can work with more and better tools than we have. Consequently, you are better able to exact higher fidelity individual sounds than we might be able to do, right now. I emphasize *right now* because digital disk-based technology and R-DAT will truly give everyone great fidelity for not much money very soon. But that's not to say that first-rate, marketable, sellable product can't come out of a studio like this, 16-track, small-format analog. Remember the Sergeant Pepper lesson: dual 4-tracks.

"The analogy to all this is the beautiful granite and marble sculptures that the Italian artisans of the Middle Ages created with hand tools, wooden hammers and alloy chisels. The beauty of that art has yet to be surpassed by compressed air-driven chisels and laser etching and alignment tools. Tools are important, but they aren't a substitute for craft. And you can't rush craft. Studio rates, dictating tighter budgets and compressed production schedules on independent projects, of course, rush craft. We don't. Our rates don't cause it. The chisel can't be allowed to become more notorious than the artist. Is it that hard to grasp?

### LEGALITY

"We've spent a fair amount of money putting production into an illegal spot. Actually, we're only quasi-legal. We're zoned for some kinds of business in this neighborhood. There are small corner stores and things, but to be honest with you, I don't know if we're zoned for this kind of business. Am I curious if we are? Not really. I'm going to do it no matter what. We don't really advertise the space for rent. We do produce outside people, but, predominantly, people come to me because they want to be produced by me.

"Note that I am paying my personal taxes, and I tell the IRS that I'm a production company working at home. I'm completely legal there. I don't pay city or county or state business fees, or board of equalization sales tax stuff, but then I don't resell things. People bring in blank tapes that they buy at audio shops. The government can't get me for personal tax evasion, state

or federal. I work with my accountant extensively. That's all legal, except for the business license fees, and maybe zoning.

### THE BUSINESS OF BUSINESS:

"If I wanted to be in the studio business alone, I'd move. I'd want to go upscale, to corporate projects and sponsored sessions that pay real money. And that takes a pretty lounge and wall coverings and a pool table. Otherwise, you'd spend all your time dealing with pubescent head-bangers at \$20 per hour. That makes as much sense



business-wise as spitting in the wind. Studios that bitch about not being able to get all the slices of the pie that they could get five years or 10 years ago are just stupid. They are bad businessmen who deserve to go out of business for not changing with the times.

"At all levels, people who are doing what I'm doing, plus or minus, are having an impact on the recording and production studio world. I'm not going to ever say, 'Hey, I'm not hurting anybody.' I'm not hurting anybody who is running a medium or large studio successfully, that's for sure. Maybe I'm hurting the guys who are selling studio time at the lower levels.

"Well, I would suggest that they take a good look at the economic environment in 1990. The government can't be called on to protect every company whenever there is competition. You can't start running to daddy every time things change and say, 'Make these guys stop.' Look at the U.S. auto industry. They are trying to compete with the Japanese by making the government tell the Japanese how much they can charge for their vehicles on import. They are not competing. They are losing.

### WHERE BIG STUDIOS SHOULD GO

"I understand that commercial studios see a slice of their pie going away with facilities like mine working with artists off

the street, if even on the lower and middle levels. Smart studio owners, if they are willing to come to terms with guys like me, should acknowledge the obvious. If, in their market, there is a lot of business like the kind I do, maybe they should open a budget facility in a less-than-fancy environment. Give the power to the people who can afford it.

"If the market has a limited amount of this business, maybe they should just let go of it and develop their business in other areas, such as corporate, ad work, record company projects or audio post-production. These are all areas I and people like me probably won't get into, for all the obvious reasons.

"They should face up to the fact that their business is being redefined, along with the industry, along with the society and the culture. It's a different world today, with MTV, computers, foreign imports, foreign property holdings, glasnost, you name it. People like me have nice little rooms that work, nice old microphones that work, formats that work and translate well, and we can record all of our stuff in-house.

"We can mix there if we want to, but some really smart guy should open up a franchise of mixdown-only

rooms all across America to take advantage of all the home studios and their lack of investment in DSP devices, reverbs, dubbing capabilities and the opportunity to mix down to the reigning digital format of the hour. Imagine a scenario where an act says, 'We saved all of our money because we worked in our own room, and were able to spend hours and hours getting our saxophone and guitar solos absolutely the way we wanted to, and now we've got a good budget to go into somebody's control room to do a quality mixdown with all the latest toys.'

"A smart businessman could develop this angle and really be profitable, because there are a lot of guys who don't even have the gear I have. A mixdown-only room is a viable business that doesn't exist right now. It's a million dollar idea. [Remember, you read it here first — Ed.]

"Something else a smart studio can do is develop the specialized areas that lend themselves to studio work. Like live albums, jazz, bop, live scoring, classical music. Things that musicians need rooms for when they play together. Become known as the room in town that records quartets, or heavy metal. Do a light show, or pyrotechnics, to let the players feel like it's a real live show. That's a unique market.

"If I was a competitive commercial studio, I might go after something like the religious recording crowd, creating a facili-

ty that was geared to exactly them, spiritual music. Get some recommendations, get printed up in the secular papers and magazines, create an environment, subscribe to the right magazines, do the research, and seriously and respectfully address the needs of that large and barely understood market. Become the mecca for people who deal in that kind of material. Advertise the fact. Tell the world you're sensitive to their needs. In other words, compete through specialization.

"Look at car parts shops: some specialize in 4-wheel drive, some VW, some foreign, some Corvette, some Mopar parts. If you're a customer, you want to talk to someone who knows about exactly what you are doing. Parts shops learned their lesson long ago that you can't be everything to everyone. You have to specialize to succeed. Our infant industry, only fractionally as old as the automotive, is just now learning this lesson. Even tax accountants specialize in personal, small business or corporate clients.

#### WRAP-UP

"It is interesting to consider what will happen to music with the popularization of the new digital technologies, like disk-based recording, where you have the ability to easily and cheaply buy gear that lets you sing one line and loop it and edit it to your heart's content, so that every chorus is a clone of the first chorus, perfect. It has the potential of killing music as we

*New technology always allows you to be creative in areas you were never creative in before.*

know it. But, then again, just like the rhythm technology of the '80s had the potential of dousing all the drummers, you and I both know that there's lots of work out there for drummers. You can't tell a drum machine to 'play it like a bowling ball just fell on your foot.' You can say that to a drummer, and I do say things like that to the players. That interpretive value is there. There will always be a place for the humans, for many of the players to contribute different ideas toward one song at one moment in time.

"New technology always allows you to be creative in areas that you were never creative in before. Before the saxophone

existed, saxy things couldn't be done. It's a new and wonderful world, and although digital technology can certainly be used to turn art into injection-molded plastic music, and it can and will be, it can also allow the creation of stuff that we've never heard before, more human than ever.

"Commercial studios need to realize that it is a brave new world, and the very juice that made them grow and develop from their original garage and basement spaces had better be brought back into play, so they can keep growing and changing to

take advantage of what's happening in the '90s. Lord knows I am, and there are lots more out there just like me. We aren't going to go away. It's a changing world, but there's still lots of room for guys with ideas." ■

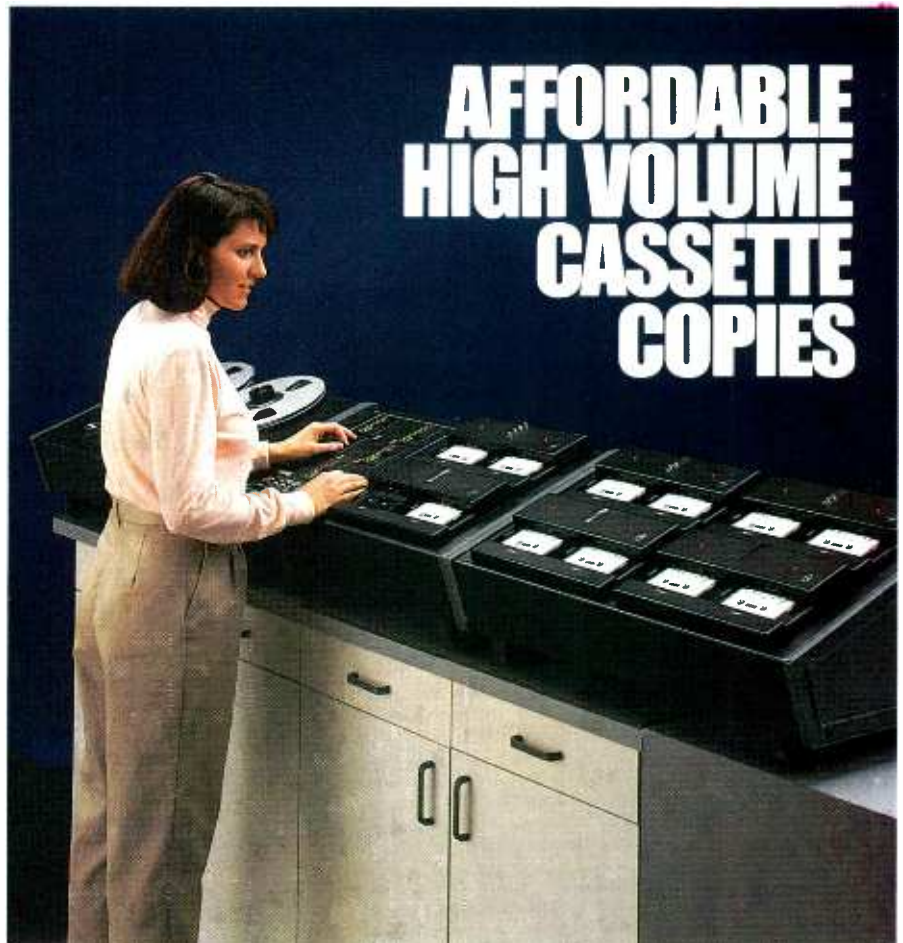

### Telex makes it fast, easy, and cost effective.

The 6120 series from Telex proves that a high speed audio tape duplicator can feature easy one-button operation *and* an affordable modular design that grows along with your needs. As the leader in tape duplicators, Telex blends the quality and convenience of U.S. made products with production speed options that meet your special requirements. For complete details, write to Telex Communications, Inc., 9600 Aldrich Ave. So., Minneapolis, MN 55420.

© 1990 Telex Communications, Inc.

**TELEX**®

Circle (16) on Rapid Facts Card

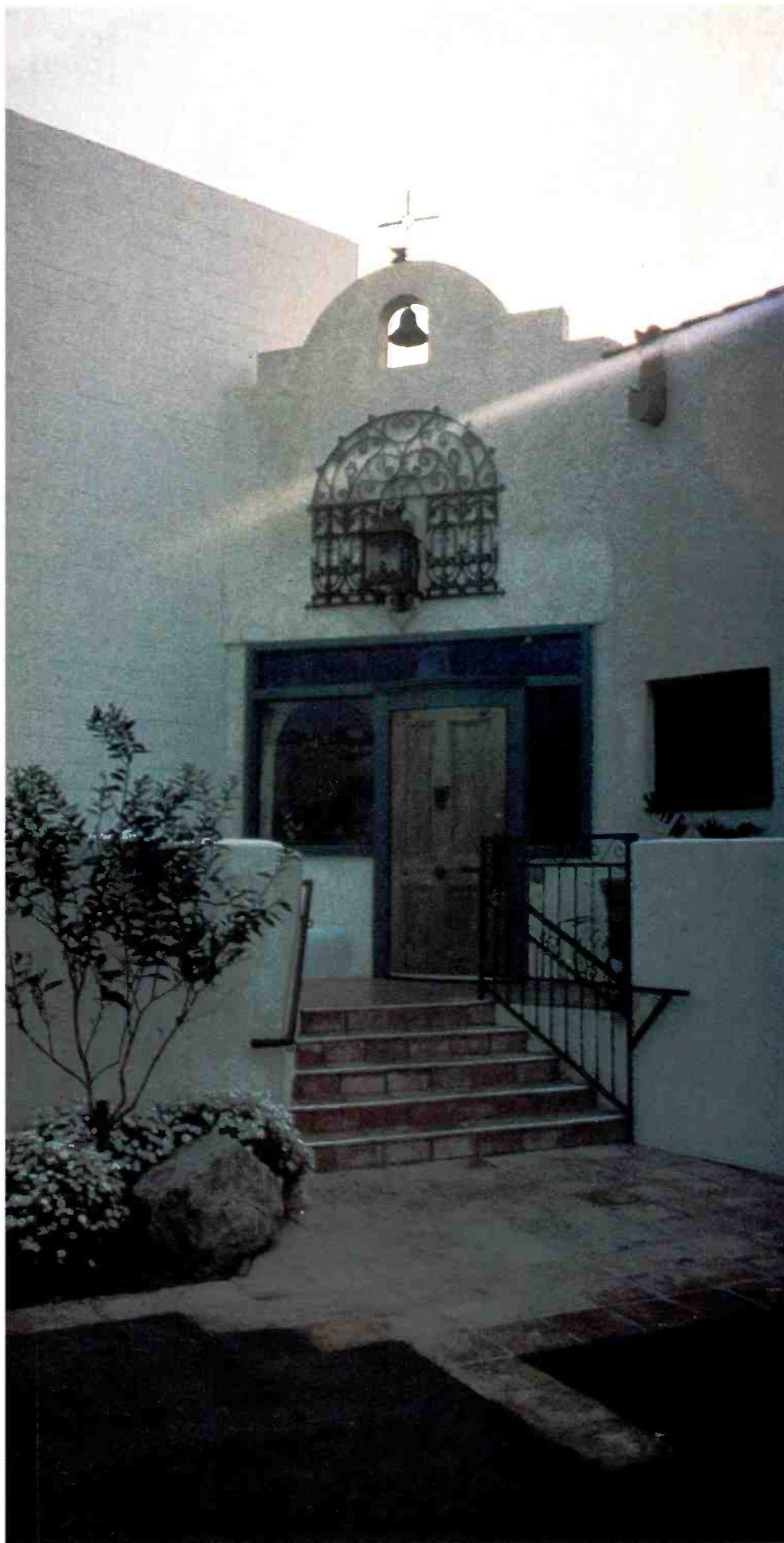

# YES ... IT'S A STUDIO

By Brad Leigh Benjamin

**I**t doesn't look like a recording studio. The floor comprises large brown Saltillo tiles, leading to a labyrinth of hallways and alcoves. Geckos stalk the adobe walls. Lizards, snakes and other reptiles, frozen in time, peer out from behind ancient terra cotta vases. Skylights and high ceilings evoke a feeling of spaciousness, airiness and a sense of being outdoors. Light spills onto a variety of furnishings, covered in animal hide, or carved from gargantuan cypress roots from the coast of Mexico.

This could be a 16th century mission at the edge of a rain forest or on a high desert mesa by the sea. Actually, it's Los Angeles' newest multisuite post-production complex, Margarita Mix, the brainchild of romantic visionary Sunny Blueskies, Jim "Bunz" Bredouw, eccentric Los Angeles interior designer Liberty Blueskies, and studio designer/architect John Storyk.

Brad Leigh Benjamin is a free-lance writer based in Olympia, WA.





## L.A.'s Margarita Mix combines world-class design and construction with an unusual flair for atmosphere and decoration.

Blending the design talents of Storyk with the fantasy-vision erotica of Liberty, Margarita Mix is the culmination of their individual talents. The juxtaposition of their efforts works flawlessly, ultimately melding in Storyk's acoustic wall treatments — hand-painted by Liberty — a myriad of rich, earthen colors, indigenous to the Oaxacan region of ancient Mexico.

### CREATURE COMFORTS

Continuing in the tradition of their well-established facility, L.A. Studios, Sunny and Liberty place a strong emphasis on offering a variety of creature comforts and amenities to their clientele. From the fully equipped commissary at Margarita Mix, nouvelle tropical cuisine is served on a colorful mosaic of hand-painted tiles. Free-standing, sound-reinforced stone pillars from an ancient Mexican ruin emit a continuous loop of audio effects indigenous to a tropical rain forest, including insects, birds and an occasional coyote. An ornate, antique iron birdcage filled with delicate, multicolored butterflies graces the commissary foyer, one of several sub-lobbies designed by Storyk.

Santa Margarita, the madonna of Margarita Mix and patron saint of mixing, represents an alternative for creationists and evolutionists alike. A figure in her likeness (complete with tape-reel halo overhead) gives pause to the possibility that the world was neither created nor evolved, but simply shot, edited and posted in seven days. Film and tape-reel halos, a recurring theme at Margarita Mix,

appear over madonnas, cherubs and winged, mythical specters throughout the facility.

### STORYK'S DESIGN

Margarita Mix occupies what was formerly a warehouse, just south of Santa Monica Boulevard in Hollywood. In designing the facility, Storyk was faced with multiple design challenges. He was required to configure five control rooms, isolation booths, a central machine room, technical support shops, offices, rest facilities and storage into a design program allowing for a full commissary, large lobbies and hallways spacious and airy enough to accommodate Liberty's interior design theme. He was able to accomplish this through a high-density architectural program, a tightly packed suite configuration efficiently optimizing all available area while ensuring effective isolation through the construction, where necessary, of uniquely designed multilayered walls.

"Margarita Mix is one of the densest architectural programs that I have been involved with," Storyk says. "Every multistudio facility has an architectural program. Facilities in the high-powered urban centers of the country will typically require very rigid program demands. Real estate is very expensive in places like New York, Los Angeles and Chicago. The Margarita Mix site, in the heart of Hollywood, is certainly no exception. High real estate costs, combined with the need to have as many studios under 'one roof' as possible, create the need to literally squeeze as

many studios into the site as possible.

"Margarita Mix's owners imposed very definite and specific requirements about client lounges, commissary space and large control rooms. All of these architectural elements, combined with Los Angeles' building code requirements, made for an almost impossible layout solution. This program density created the need to have studios adjacent to each other with higher performance sound transfer class (HPSTC) construction.

"A great deal of time and money is spent planning a studio and certainly in planning and constructing complex 4-partition HPSTC wall systems. While STC values in the 50s and low 60s are indeed high values, and are typically the values that we need to deal with when addressing classic control room-to-studio transfer conditions, there are a number of instances where these values are simply not enough. There is a need for more separation between boundaries, higher performance STC values, when an architectural program and subsequent solution require that completely different recording studios be next to each other in close proximity."

Such is the case with Margarita Mix. The extremely dense plan program forced control rooms D and E to be backed up against each other. The two rooms have a floor/wall/ceiling system designed to have an effective STC rating in the high 70s. A combination of block and drywall construction was originally specified, similar to other HPSTC configurations, such as the recently completed studio A/D wall

at Full Sail/Platinum Post Studio, Orlando, FL.

### CONTROL ROOMS

The post-production suites are a sight to behold. Resplendent with Saltillo covinas and Zapotec rugs from the state of Oaxaca, the control rooms are double-tiered and quite large, allowing for a sizable desk and ample seating. Antique wooden chests of drawers and armoires are used in lieu of storage and microphone cabinets. Marble surfaces are everywhere. Each suite contains a private and comfortable phone booth (with seating) for the clients' exclusive use during sessions.

But do the rooms work? The Margarita Mix engineers unanimously agree that the stereo imaging in all of the suites is incredible, the mix positions razor accurate, and the off-axis listening superb, clearly the result of Storyk's control room design, in tandem with Tannoy Dual Concentric SGM3000 mains, and Tannoy 6.5 near-field monitors.

The post-production suites rely on SSL 4000 consoles and Otari MTR 100 24-track tape machines with Dolby SR. All suites are interfaced to one another and to a central machine room (CMR), through a computer network designed and implemented by Jim Hite, main engineer and chief mixer.



Control Room C, one of five in the Margarita Mix complex.

"It was an extremely difficult challenge to correctly locate the CMR and remain consistent with the dense program requirements," says Storyk. "After careful planning, it actually ended up right in the center of the complex."

### CLIENT DEMANDS

Margarita Mix's client base reads like a who's who in advertising: Nike, Reebok, Avia, McDonald's, Coca-Cola, Budweiser, American Express, Isuzu, Toyota, Honda, Nissan, Mazda, Porsche, Acura, New York

Telephone, Pacific Bell, Southern Bell, U.S. Sprint, DuPont, Chevron, Singapore Airlines and Century 21. Speed is truly of the essence for the staff.

Most commercial ad spots are shot on 35mm film. Film editors often bring the individual elements of their audio mix (dialogue, effects, voice-overs), each on its own reel of sprocketed 35mm full-coat mag tape. The individual tape elements, running synchronously, constitute a mag group. Each suite is capable of addressing an Otari MTR 100 and a mag group. Modern synchronizers synthesize the bi-phase impulses of the mag machine's servo motors into time code, enabling the synchronizer to see the mag group as a time code-based tape machine.

Visual program information can be brought in by the client on a variety of formats, including 1-inch C-format videotape, 3/4-inch off-line, or, in the case of film editors, 35mm optical film, which is stepped up to a time code-based format. All video sources originate from the CMR and can be accessed via the suites' computer/synchronizer.

While watching the visual program information on the suite's high-resolution monitor, the editor can move individual audiotape elements of the mag group independently forward or backward in frame increments until the elements are satisfactorily locked to picture. Although dialogue elements are basically a straight-forward lock, prerecorded voice-overs and

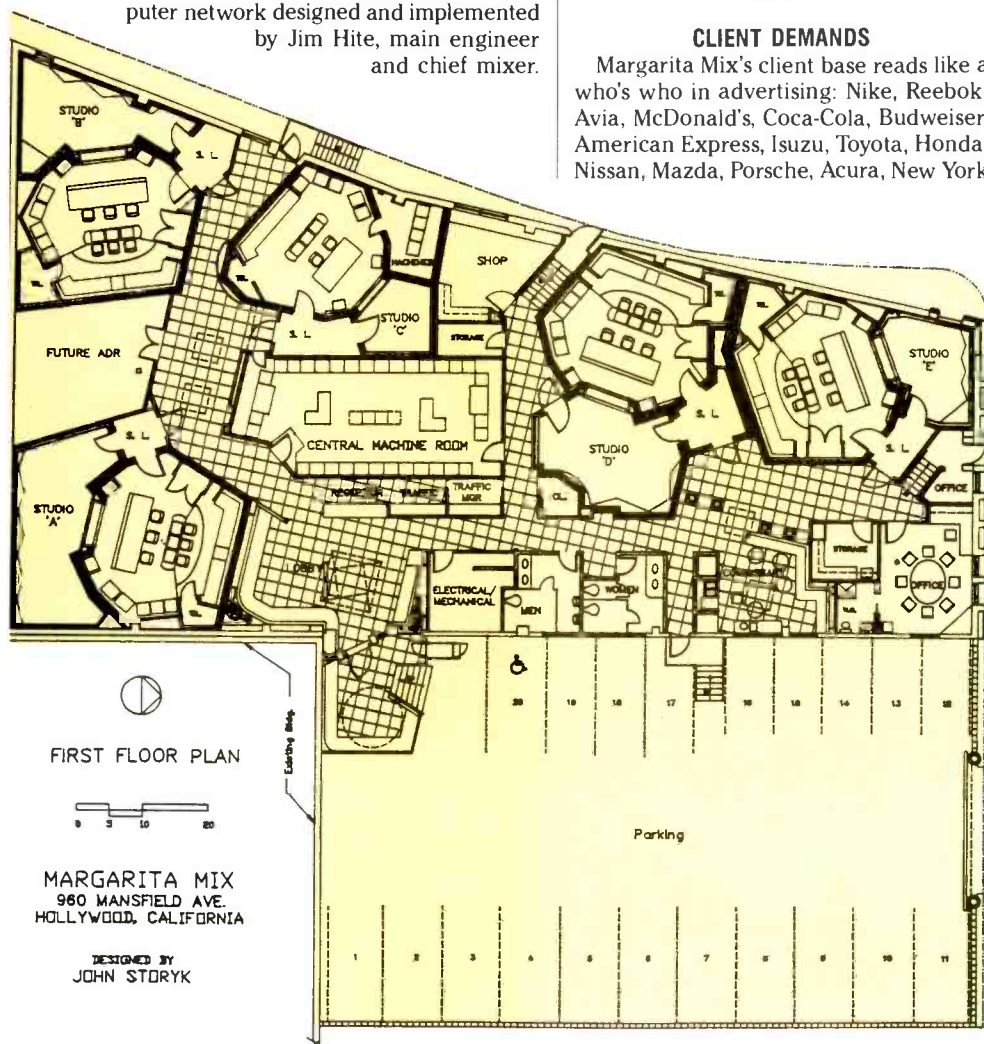

The first floor plan of Margarita Mix

# In an age of disk and digital, why buy analog?

We know there are some applications where our 32-channel digital machine, the DTR-900, is the only answer. But if your business is such that you can do anything you want to do in the analog domain, and at the same time do less damage to your budget, then our brand new analog 24-channel MTR-100A may be the perfect machine for you.

When you consider that the MTR-100 will literally *change forever* the way engineers interface with audio machines, and

transport is pinchrollerless to give you the legendary tape handling ballistics of our MTR-90.

What's more, with its optional EC-103 chase synchronizer, the MTR-100 maintains frame-lock in forward and reverse from 0.2X to 2.5X play speed,

and will typically park with zero frame error.

Then, there's the sound. New cylindrical-contour heads built by Otari especially for the MTR-100 result in remarkably low crosstalk and outstanding low-frequency performance. Pre-amps are located directly beneath the heads to further improve frequency response, and HX-Pro\* is built-in for enhanced high frequency headroom. (An optional internal noise reduction package houses Dolby\* SR/A.) Add all these features to gapless, seamless, punch-in, punch-out, which is also built-in, and your

MTR-100's sonic performance will rival, or beat any digital machine in the world.

So there you have it. With these powerful benefits available in analog, does it make sense to go digital? Sure, for some applications. But analyze your needs carefully before you buy. For many applications, a hot

analog tape machine like the

MTR-100 is the right choice.

And because we can see both sides of the question, put us to work. We have information that can help you make the right decision. Call Otari at (415) 341-5900 for the "Technology You Can Trust".



Reel motors that approach one horsepower are driven by pulse-width modulation amplifiers to tape speeds up to 474 ips.



The MTR-100's auto-alignment saves you hours of time by eliminating constant tweaking and re-tweaking between sessions.

that this new way will save you hours spent in non-productive time, the analog choice begins to make even more sense. You see, the MTR-100 features full Auto-Alignment that allows total recalibration of the record and reproduce electronics. This means you can compensate for different tapes in a *fraction* of the time that it previously took, and your studio is not bogged down with constant tweaking and re-tweaking between sessions.

And if you think digital machines have a corner on high performance transports, think again! The MTR-100's new transport incorporates reel motors that approach one horsepower—you'll get fast wind speeds of up to 474 inches per second! Of course, the

**OTARI**®



Trademark Dolby Laboratories Licensing Corporation

effects might be bumped a few frames forward or back for the sake of timing or aesthetics.

When all elements of the mag group are locked to the editor's satisfaction, each element is transferred to its own track on the Otari MTR100, whose pinchrollerless transport works quickly, eliminating further use of the more cumbersome mag machine, an unfortunate but necessary evil indigenous to the sprocket-based film industry.

The clients' prerecorded music often arrives at Margarita Mix on a 1/2-inch, 4-track audiotape format. The tracks are generally designated lead vocal, group vocal, music and time code. These individual mono tracks (with the exception of time code) are also transferred, each to its own track on the Otari MTR100. Additional MTR100 tracks are used for voice-overs or dialogue replacement (AVR). There is also a sound design suite at Margarita Mix, selected by Full Sail Center for the Recording Arts and New England Digital as the exclusive West Coast training center for all NED technology. The suite features an NED Synclavier 6400 and a Post-Pro direct-to-disk recorder, which can be accessed from any post-production suite for a variety of applications, including the generation of sound effects and music.

The overall multitrack mix can be taken directly down to 4-stripe, full-coat mag (a preferred format in the L.A. ad post-production market) or to a stereo mix on its Digidesign HD-based digital recording system, boasting Microtech 300Mbyte hard disks with Wren drives. The drives are located in the CMR and are addressable through the suite's computer. From the Digidesign stereo format, the mix can be laid back, in the CMR, to a variety of formats, including a 1-inch video master, 1-inch audiotape or 35mm full-coat mag.

Ad clients tend to go right down to the wire with their session time. The Digidesign format allows them time to creatively manipulate the mix right up to the last minute of their session. The mixer can then take the mix down to Digidesign with no generation loss, and shuttle it over to the CMR for layback while setting up for the next client. The initial client picks up the layback in the CMR and hasn't had to waste precious session time laying back in the post-production suite. The suite is reconfigured and recalibrated for the next client right on schedule, facilitating smoother client-to-client transitions.

Any mix stored in the Digidesign format can be retrieved from any post-production suite in the complex. Information and data pertaining to any tape or session can be accessed from every computer in the complex, including tape index, storage location and remaining time, on 2-inch masters.



*This hallway leads into the central machine room, located in the middle of the facility.*

#### **NOISE CONSIDERATIONS**

The noise criteria for these control rooms was critically determined and accounted for in Storyk's design program. He contends that NC levels of 25 are the absolute highest that are acceptable. For control rooms, he recommends NC levels between 20 and 22. At Margarita Mix, NC levels vary between 18 and 22, well within industry standards.

"Typically, two areas of construction will cause problems in adhering to low NC levels — the isolation between the control room and the 'outside' ambient world, and the HVAC control, specifically, airspeed and machine noise," Storyk says. "HVAC control is typically a much more difficult element to effectively design for and simultaneously accomplish low NC levels."

At Margarita Mix, there are separate air handlers for each studio, as well as a complex design of acoustically lined positive and return air ducts. Silencers have been installed in each duct, to and from each acoustic space. All duct runs are through sound locks. According to Storyk, this is the only way to ensure low NC levels and still maintain enough air circulation to effectively air-condition the spaces and to introduce enough fresh air.

#### **WORKPLACE ERGONOMICS**

Because Sunny and Liberty equally weighed the facility's ambience and decor with the individual studios, Storyk's design had to take this into account. The special hallways, lobbies and phone closets were particularly difficult to integrate into the floor plan, Storyk says, taking into consideration the rigid Los Angeles building codes and handicap requirements. Through careful planning, these special areas were eventually incorporated into the program, contributing to the smooth client-workplace ergonomics.

And as far as Storyk is concerned, his design is a success.

"I have observed the facility in use on two or three occasions," he says. "It's exciting to see the clients using all of the circulation and public spaces while the studios are simultaneously in full operation. Although you are as sure as you can be that all of this planning will work, you're never completely sure until the doors open and people use the spaces." ■

# If Only More Expensive Consoles Performed As Well.



For a 16 or 24 track studio owner, the future looks very good.

With MIDI systems and digital outboard gear, you're faced with extremely sophisticated productions. But it's very hard to find a recording console to match the requirements without spending a small fortune.

That's precisely why we've developed the new Series 6000, an evolutionary design that clearly demonstrates the forward thinking of Soundcraft. Behind the classic layout is a revelation in performance and capability.

For one thing, it's equipped with enough busses and routing options to make adventurous productions a pleasure, not a nightmare. The 6000 is a full 16 or 24 buss console with six auxiliary sends per channel. The split format of the 6000 means each of the tape returns will double as extra inputs, with EQ.

We've also provided each input with push-button routing, EQ by-pass, and programmable electronic muting that eliminates the clicks produced by ordinary switches. You even get true solo-in-place, sadly lacking on more expensive consoles.

But it's the 6000's sonic performance that really sets it apart from the competition. Our revolutionary input design gives you 2dB to 70dB gain without a pad and virtually unmeasurable distortion, crosstalk, and noise.

Our new grounding system yields superb hum immunity and a routing isolation of 110dB (1kHz). And our active panpot comes close to theoretical perfection, exceeding our competitor's performance by a full 25dB.

*The Series 6000 input module gives you programmable electronic muting under optional MIDI control, solo-in-place to get a clear picture of your progress, and a patented active panpot with isolation of 90 dB (1kHz).*

To give you the subtle control it takes to achieve dramatic results, you also get four-band EQ with mid sweeps on each input channel.

When you specify Soundcraft's Series 6000, with options including 16 to 56 channels, stereo input modules, and built-in patchbay, you'll find it an affordable slice of progress. Series 6000, simply the most comprehensive production console in its class.

**Soundcraft**  
**6000**

Soundcraft USA/JBL Professional  
8500 Balboa Boulevard  
Northridge, CA 91329

# RENOVATING AN EXISTING STUDIO

By Richard Schrag and Russ Berger

**Can't afford a ground-up project? Renovating what you have can be a viable alternative.**

**W**hen it comes to renovations, some studio owners are constantly tinkering — adding a little more fiberglass here, a little more Sheetrock there — so that their facilities have not so much a design as an evolutionary history.

Other owners shudder to think of altering anything, not wanting to upset their particular balance of acoustical magic. Some facilities seem to spend more time upgrading their rooms than recording. And in some, were it not for the occasional piece of current electronic gear, you'd be hard-pressed to tell from the finish-out which decade you are in once you've passed through the front door.

Most studios, however, go through periodic upgrades — whether acoustical, electronic, cosmetic or some combination — where distinct improvements are expected. Adding new equipment and making



*Before: The front of 30th Street Studios' control room. Note ceiling soffit resonator to be removed and non-laminated glass to be replaced.*

Russ Berger is president and Richard Schrag is an associate of the Russ Berger Design Group, Dallas.

aesthetic enhancements are usually an attempt to keep current with technology or maintain a contemporary, comfortable environment for clients and staff.

Acoustical renovations, on the other hand, are usually motivated by existing shortcomings, so change for change's sake is not enough. Predictable results are essential.

Renovation can be a cost-effective means of improving existing rooms without incurring the expense of ground-up construction. Before a renovation project is undertaken, however, it is important to establish appropriate expectations for the achievable improvements and to understand the consequences of the renovation process.

It's certainly not possible to discuss how to upgrade your facility or even to establish a surefire way to go about initiating

a renovation. The approach must be tailored to your current situation and specific needs. However, it is possible to outline the pertinent issues that can affect a renovation, using examples of successful past projects.

We have selected three recently renovated but distinctly different facilities to illustrate the range and scope of improvements that a renovation can pursue and to point out some of the idiosyncrasies that accompany every project. The three examples are: 39th Street Studios, New York; Blue Jay Recording, near Concord, MA; and the Edit 7 suite in NBC's Rockefeller Center studios, New York.

### 39TH STREET STUDIOS

A facility renovation can be as comprehensive as building entirely new rooms within an existing facility, or as simple as

redistributing finish materials and re-mounting the monitor loudspeaker system. The first example falls closer to the latter end of that spectrum, and shows how a relatively minor upgrade can result in major acoustical improvements.

Located in midtown Manhattan, 39th Street Studios is a single-room music recording and production facility. Owner Mike Carp determined that the primary goal for this facility upgrade was to improve the monitor reference at the mix position.

Secondarily, he wished to reduce the HVAC noise in the control room and studio, add a new technical power and grounding system, and cosmetically upgrade the control room. It was important that these changes be accomplished as inexpensively as possible, but still produce a significant "bang for the buck."



*After: Note the acoustical shaping of 39th Street's front wall, including sound-rated laminated glass, new monitor soffits and isolated concrete mounts.*



*Blue Jay Recording's completed control room, showing the rear diffuser and central machine room beyond.*

Work on the monitor wall of the control room was the first order of business. The geometry of the monitor soffits, side walls and ceiling near the loudspeakers was modified to provide more appropriate sound propagation through the room, and acoustical finishes were added to improve the monitor reference and expand the listening area.

At the same time, mass was added to the walls and ceiling to reduce resonances and to make a minor improvement in the sound transmission loss through the front wall construction.

To isolate the monitors while maintaining a solid support, new concrete block pedestals and "spike" mounts were constructed. The new monitor enclosures were designed so that the loudspeakers could be changed quickly and easily without requiring further renovation of the room. Additional modifications to the doors, door seals and rear wall afforded improved sound isolation from adjacent rooms and the building's exterior.

To reduce noise from the air-conditioning systems, the distribution of the supply and return ductwork was modified, and quieter terminal devices were installed. Appropriate isolation devices were installed at the room's air handler and compressor to reduce structure-borne vibration.

Finally, for the new console and support gear, a technical power and grounding system was installed including a new isolation transformer.

#### **BLUE JAY RECORDING**

For some studios, renovation projects take a more comprehensive approach.

The acoustical upgrade of Blue Jay Recording involved reworking the interior finish of the control room and studio, but avoided major modifications to the layout and basic construction of these rooms.

Originally constructed about 12 years ago, Blue Jay is a single-room facility built underground in an earth berm. It primarily serves the record and music mixing/recording client. Owners Bob and Janet Lawson determined that an acoustical and technical system upgrade was in order. Their goal was to improve an already well-received room in order to maintain their

existing client base and to appeal to new music project work.

Renovation was undertaken in the studio and control room. Changes in the control room were coordinated with the installation of a new Solid State Logic console, the addition of video monitoring for the console automation and the creation of a new machine room.

The improvements sought for the room's acoustics included an increase in the size of the "sweet spot" to encompass the width of the new console and to extend back through the client area behind the operator. A smoothing of the low frequency amplitude response, and an increase in the bandwidth and dynamic range of the monitoring environment, were also desired.



*The preparation of NBC's Edit 7 floating isolated floor system, with technical wiring interconnect troughs for the concrete pour.*



*The completed Edit 7 control room.*





## Not your average woofer and tweeter.

Loudspeakers are wholly man-made devices. In the evolutionary calendar of man, the loudspeaker is just milliseconds old. By sheer ingenuity, man has refined a system which is capable of mimicking natural sounds.

The degree of realism, and hence the quality of natural reproduction, can simply be defined as **characteristics added** to the original sound. The quantification of these clues given to the human ear, decipher whether the sound is real

or reproduced by a loudspeaker on the end of an audio system.

The design and production of high quality loudspeakers is dependent on being able to measure, assess and therefore, rank and quantify these **added characteristics**. Having assessed the characteristics, the next and most important step is to select materials and techniques which will minimize or eliminate these

added characteristics altogether.

**Differential Material Technology**- An essential in the realization of Advanced Reference Monitoring.

For more information on Differential Material Technology call or write:

### TANNOY

Tannoy / TGI North America Inc.  
c/o Bill Calma  
300 Gage Ave., Unit 1, Kitchener,  
Ontario, Canada N2M 2C8  
(519) 745-1158 Telex 069-55328  
Fax (519) 745-2364



Tests in the control room before the renovation determined that the existing shell construction and finishes were contributing to the lack of accurate imaging and the low-frequency anomalies. Additional mass and damping materials were used to limit the resonance of the existing ceiling panels, and a diaphragmatic ceiling absorber that had been installed with the original construction was removed. Some of the original acoustical materials were found to be reflecting sound rather than absorbing it, as desired,

and were replaced with more efficient sound absorption.

Diffusing elements were specified to increase the return of diffuse energy back into the listening areas. The rear wall of the control room was originally a 7-foot picture window, which afforded a splendid view of the local countryside. To maintain this view and the natural ambient light that filters into the control room, a custom-designed, optically pure, plexiglass quadratic residue diffuser was provided by RPG Diffusor. Additional diffusing ele-

ments were added to the left and right rear wings of the control room to further widen the area of good listening and to provide the desired acoustical character.

The control room monitors underwent structural modifications and acoustical improvements. The individual drivers were shockmounted, the cabinet bracing was increased and limp mass damping was added to the exterior. Monitor pedestals were constructed of grout-filled concrete block with a poured concrete topping slab. Because the control room slab was effectively isolated from the studio, the monitors could be point-loaded and acoustically grounded directly to the slab with a mechanical connection through the pedestals.

As the studio is naturally quiet, thanks to its underground construction, the room's ambient decay could be increased without the fear of emphasizing noise problems. The center ceiling area was raised and the space filled with 21 quadratic residue diffusers; their sound distribution patterns were arranged to maximize the diffuse energy in the wood floor areas. An alcove that was originally absorptive was reconstructed out of stone to further add to the diffuse nature of the space. The ceiling above this alcove was covered with quadratic residue diffusers.

The resulting acoustical environment in the studio was free of the flutter echo and tonal resonance which had hampered the original design. Blue Jay's high-profile track record continues to be recognized by leading contemporary artists and engineers. Most recently this facility was selected to record the soundtrack for the motion picture "Dick Tracy."

#### NBC EDIT 7

A third type of renovation project involves the creation of a new room as part of a larger facility, working within an existing shell and adjacent to other ongoing functions. Such was the case for the construction of Edit 7 at the NBC studios in New York. Edit 7 is the audio post and support space for "Saturday Night Live," and comprises an audio control room, voice-over booth, machine room and support area.

The portion of the building selected for renovation into the new facility was the "Children's Studio," as it had been reserved exclusively for children's programs when the studio was constructed in 1933.

Since then, the space had gone through a second incarnation as a radio studio complex. Located directly above the David Letterman set and adjacent to the SNL studio support areas, this space requires considerable attention to noise control techniques.

In preparation for the new design, the existing construction was removed back to the exterior shell. New interior floors,

## SAMPLE PERFECTION.

Sony's professional portable DAT recorder is a digital sampling musician's dream come true. About the size of a hardback book and weighing less than five pounds, the TCD-D10 PRO delivers the extraordinary sound of DAT with a dynamic range exceeding 85dB. To find out where you can sample one, call 1-800-635-SONY.



### TCD-D10 PRO

- Light weight: 4 lb., 7 oz.
- Measures only 10" X 2 1/4" X 7 5/8"
- Continuous operation of 1.5 hours on one rechargeable battery
- Easy-to-read large back-lit LCD multi-function display
- S/P and AES/EBU digital I/O
- Professional balanced MIC/Line XLR Input

**SONY**®

Sony Communications Products Company,  
1600 Queen Anne Rd. Teaneck, NJ 07666.  
© 1989 Sony Corporation of America  
Sony is a registered trademark of Sony

PROFESSIONAL AUDIO

walls and ceilings were constructed to provide a completely free-floating interior enclosure. The ceiling height on this floor is extremely limited, so extraordinary efforts had to be made to maintain every possible inch of clearance. To this end, the suspended drywall sound isolation ceiling was built around, rather than under, the existing concrete beams. False beams were constructed to maintain the acoustical symmetry of the control room.

Although the construction allowed the rooms' sound isolation and interior acoustics to be optimized to the available space, the design of the Edit 7 rooms had to be adapted to the existing mechanical and electrical services. The capacity of the air-conditioning system provided for this space proved adequate to cool only the control room, and a second "computer room" unit was installed in the machine room to handle the remainder of the heat load.

Because a full TV production schedule continued in the adjacent spaces throughout the construction of Edit 7, it was critical that the renovation work be scheduled to have minimal noise and vibration disturbances during working hours.

#### DON'T TRY THIS AT HOME

How, then, can you begin a renovation

that will be appropriate for your facility? Whether you have in mind an upgrade that doesn't even require covering the equipment, or a new concept that turns the studio into the control room and vice versa, the key is planning.

Nearly every time a renovation project encounters problems, the difficulty can be traced to ambiguous goals, unrealistic expectations or inadequate preparation, particularly when it comes to "saving" money. One studio owner clearly illustrated this point during the recent construction of his facility's central machine room.

The floor slab in the room was depressed below grade, as it was to receive an access floor. Having heard that concrete is often acid-etched in this application, and having received what seemed a high quote from a local contractor for the work, the owner determined that he could save a few dollars by doing the work himself. So the next Friday evening he armed himself with a 35-gallon drum of muriatic acid, kicked it over on the concrete floor, and left for the weekend.

What he hadn't understood is that acid for etching floors is usually in a 10% to 15% solution, not 95% pure the way it comes from the supply house, and that it is applied to the concrete via a wash, not submersion. When he returned a couple

of days later, his eyes started burning as soon as he opened the building's front door. Noticing that the copper electrical connections throughout the facility were now green with oxidation, he soon found his way to the central machine room, where the acid had turned to a murky soup.

The owner discovered that he didn't have any means of cleaning up the mess. In a panic, he put on his hip waders and proceeded to core a series of holes in the exterior wall of the building until the acid ran out into the parking lot. Unfortunately, he hadn't realized that just on the other side of the wall was the building's main electrical service. Before all was said and done, two large transformers, several electrical feeders, the facility's technical ground reference, and a significant amount of concrete had to be replaced.

Of course, it's possible to avoid this type of catastrophe. All that's required is to study the issues before you start so that you can establish clear goals and rationale for the work that follows.

#### QUESTIONS TO CONSIDER

Before undertaking a renovation project, it is essential to consider the following questions:

1. What are the existing problems?

## SAMPLE STEREO.



Sony's ECM-MS5 stereo microphone puts high quality stereo miking from a single point within your reach. Incorporating Sony's MS (Mid-Side) capsule technology, the MS5 brings true stereo imaging to your recordings. Coupled to Sony's TCD-D10 PRO portable DAT recorder, the MS5 provides digital sampling results of startling clarity and realism. To find out more call 1-800-635-SONY.

#### ECM-MS5

- Three matched condenser capsule MS design
- Light weight: 7.6 oz.
- Six position adjustable directivity (0-127 degrees)
- Accepts 12-48V external power
- Optional DC-MS5 DC power supply allows 20 hour operation on a single AA alkaline battery
- Low-cut roll off switch

**SONY**®

Sony Communications Products Company,  
1600 Queen Anne Rd., Teaneck, NJ 07666  
© 1989 Sony Corporation of America. Sony is a registered trademark of Sony

PROFESSIONAL AUDIO

Are mixes not relating to the final product or to outside references? Do you have to turn to the producer to say, "Trust me. It will sound fine when we're finished?" Are there noise problems that disturb the recording or monitoring process? Are you disturbing your neighbors? Is there enough room for your clients or the talent? Does the space look like Stonehenge? One of the critical elements to a successful facility renovation is identifying specific, feasible goals.

2. What is the likelihood of fixing the existing problems?

This partially depends on the nature of the problems. Cosmetic upgrades that also improve acoustics can be quite inexpensive, but cannot overcome the basic limitations of room volume, shape or orientation. In simpler terms, "band-aids and perfume" can't change physics. Improvements can almost always be realized but expectations must be reasonable.

For the same reason, renovating a room (without completely rebuilding within an exterior shell) is typically not an effective means of improving sound isolation, unless an obvious weak link, such as a leaky door or penetration, has been identified. Sound transmission through existing partitions and floors/ceilings is usually limited by the basic construction or by structural transmission through a common slab. It is extremely difficult and expensive to decouple existing construction or to modify structure to improve acoustical isolation.

Making HVAC systems quieter is similarly difficult within the confines of an existing system. Modifications are limited by the capacity of the existing units and by the balancing, volume and velocities in the distribution system. However, in some cases it is possible to redistribute air within a room to improve local ductborne or air-flow noise or to provide better cooling of the technical equipment or occupants.

3. How will this renovation improve my facility?

What gains are expected with regard to the facility's profit centers, booking rates, etc.? How will your clients perceive the change? Will the modifications attract new clients or address a new market? Although there are many benefits to a facility upgrade having to do with more than just the bottom line, it is important to maintain realistic financial expectations when compared with the cost of the renovation.

4. How extensive should the renovation be?

Every renovation project is unique, and it is essential that the desired improvements be matched to the cost of accomplishing them. Many times there are several discrete levels of upgrade possible within a given facility, so it is prudent to choose a path which maximizes the benefit realized for each dollar spent.

## "Haunted" Facilities

Many times we're called in to correct imaging problems that have a common symptom — female voices appear to drift or jump back and forth about the mix center, or other instruments appear to violently shift their location in the sound field. Even though this is exciting to listen to, it's not particularly desirable if it's not what is on tape or what the producer intends.

By performing tests in such seemingly haunted facilities, we have discovered that heat flow between a loudspeaker and a listener is often the problem. One culprit can be seen in the accompanying photo, which shows good electrical practice in that the audio amplifiers are mounted as close as possible to the monitor speakers.

As we all know, this improves the amplifiers' electrical ability to control the speaker's mechanical motion, particularly at low frequencies. However, what's good for electrons can be bad for acoustics.

Heat flow in a sound field can create acoustical image shifts in much the same way that heat rising off hot pavement will distort an optical image. If located directly beneath the monitor speakers, amplifiers will vent a significant amount of turbulent hot air directly in front of the monitor speakers and cause considerable audible distortion of the image.

For similar reasons, critical placement of air-conditioning supply and return grilles is necessary to minimize their interaction with the monitoring field.



*At Blue Jay Recording, the monitor speakers were originally mounted with the power amplifiers directly underneath, causing imaging problems from convected heat. This problem was solved by placing the amplifiers in the central machine room.*

In most cases, electing to renovate an existing facility rather than pursue new construction is motivated by a desire to spend less. If so, expectations for the scope of the upgrade should be similarly modest.

5. How long will the renovation take?

Obviously, the time required for facility upgrades varies with the extent of the changes and the difficulties in making them. Simple cosmetic and finish upgrades can be accomplished as quickly as a few days; completely rebuilding a room can take several months. If the renovation takes an existing room out of service, it is particularly critical to balance the amount of downtime against the desired results.

Often, the renovation's sequence and the established work schedule can have a significant effect on the duration and cost of the upgrade. If the work will be accomplished by several contractors, it is important to consider the coordination of the different trades.

6. How much will the renovation cost?

Again, each project is unique, but the key is to establish upgrade budgets that target practical, tangible results. Throwing money at a problem without first establishing the anticipated results produces motion, not progress.

Keep in mind that on an item-by-item basis, renovations are generally more expensive than new construction. A certain amount of demolition is required, and the work must adapt to an existing facility. Building a new room within an existing facility or completely redoing an existing room is typically more expensive than ground-up finish-out, although it avoids the cost of building a new shell.

A well-planned, cost-effective renovation includes change only where change is required, without losing sight of what it takes to keep the rest. Sometimes more money and effort is spent working around the current conditions than it would take to rebuild them.

7. How will the renovation affect my existing facility?

What effect will this have on ongoing functions, either in-house or adjacent? How will the dust, dirt and disruption of construction affect my clients and staff, not to mention technical systems and equipment? It's not enough to compare the results with the current facility; the inevitable aggravations of the transition between the two and working conditions in the meantime must also be considered.

A successful renovation will improve what needs improving and will fix what needs fixing without disturbing the best of what an existing facility has to offer. ■

# A Woof and a Tweet just can't compete...



## Music Workstations of the 90's demand new **MONITOR STANDARDS.**

When you've spent a small fortune on sampler and synths, and the Steinway, Bosendorfer and Baldwin samples all sound like a tack piano...

it's time for **MONITOR STANDARDS**

When a decent scratch mix on your small monitors sounds completely different on the mains...

it's time for **MONITOR STANDARDS**

When you're sick and tired of "fixing it in the mix" or worse yet, you're in mastering, and discover that the snare's lost somewhere in the ozone...

it's time for **MONITOR STANDARDS**

While other speaker manufactures were busily touting benefits of exotic metals, "new" materials technology, and reaching amazing new heights of hyperbole...

*RADIAN has quietly introduced the most significant advancements in small monitor systems in decades! Premium performance point-source coaxials.*

Call for the name of the nearest Authorized Dealer to arrange for a demonstration in your studio.

**RADIAN**  
AUDIO ENGINEERING, INC.

MONITOR STANDARD is a registered trademark of RADIAN Audio Engineering, Inc.

4520 Eisenhower Circle, Anaheim, CA 92807  
TEL: 714-693-9277 FAX: 714-693-9278

Circle (19) on Rapid Facts Card

## FIVE QUESTIONS:

# Studio Design

By Mike Joseph

**Q.** What options exist for treating my control room acoustically?

**A.** Acoustic treatment, whether actively targeting low or mid/high frequencies, can take many forms. Low-frequency treatment, often referred to as bass trapping, can vary from building resonant sympathetic chambers (emulating Helmholtz resonators) to constructing active, large, vibrating diaphragms (flexible wall sections, resonant wood slats, etc.), all designed to convert the energy of vibrating air molecules into vibrating mass, which becomes heat.

The primary goal in active low-frequency trapping is to diminish long wavelength standing waves and room resonances. Designs for successful constructions are not easily had, as each specific room situation requires a unique approach and technique.

Many of the studio design books (see April's Five Questions) have construction

ideas and basic formulas, applicable to typical or common situations.

Much easier to address is high-frequency passive acoustic treatment, which takes two forms: absorption and diffusion. The goal in this surface form of treatment is to control the "brightness" of a room, specifically the reflective or flutter/slapback characteristics. An absorptive material's effectiveness is related to the wavelength of the frequencies being addressed.

For example, 2-inch foam or packed fiberglass is of primary effectiveness above approximately 1.8kHz, or the quarter wavelength of the depth of the material.

Diffuser technology, while of itself not directly diminishing the total quantity of a given frequency in a room, can smooth the room's response by altering reflective patterns, the goal being to uniformly equalize (make the same) the SPLs of all pertinent frequencies around the room. This form of acoustic treatment has gained considerable success of late, owing to the relatively new-found capabilities to measure specific room performance parameters and improved understanding of high-mass, floating construction techniques.

**Q.** What companies supply acoustic surface treatment materials?

**A.** The two common types of treatment available off the shelf are high-

frequency absorptive material, typically manufactured out of foam or fiberglass batten, and diffusion structures, designed to scatter or diffuse sound in a controlled manner. Some suppliers to contact are:

- Alpha Audio Acoustics: 2049 W. Broad St., Richmond, VA 23220; 800-782-5742.
- ASC-Tube Traps: Box 1189, Eugene, OR 97440; 503-343-9727.
- Illbruck: 5155 River Road NE, Minneapolis, MN 55421; 612-521-3555.
- RPG Diffusor Systems: 12003 Wimbeldon St., Largo, MD 20772; 301-249-5647.
- Systems Development Group: 18601 Darnestown Road, Poolesville, MD 20837; 301-972-7355.

**Q.** What's involved in finding the right consultant for measuring and designing a room for proper acoustic consultant? Virtually everybody who sells equipment calls themselves a "studio designer!"

**A.** As in all things, experience counts. Designers that cut their teeth before TEF, TDS or FFT analysis learned the hard way — do the math, cut and try. Those lessons were hard-won. The more studios they've built that you can actually walk into and give a listen, the better.

Today, a solid understanding of materials technology, construction techniques and past industry-wide successes (and failures) is crucial. Also important is a sol-

Mike Joseph is technical editor of R•E•P.

id, practical knowledge of TEF measurement techniques. Our understanding of acoustics in small room environments has greatly contributed to taming room/glass, window/equipment and rack/console top reflections, vibration and transmission control, standing wave pressure modes, the Haas effect, psychoacoustic phantom imaging, speaker placement, coupling, etc. Your designer should be up to speed on these things.

Good questions to ask to prospective designers: Do they do TEF or related TDS/FFT measurements? Are they licensed? What rooms have they done? How many like yours? How long have they been designing? Do they own their own measuring gear? What services do you get for your money? What's the performance guarantee?

**Q.** Ever since we moved to a new city location in a newly built control room, we have been hounded by hums and buzzes. Everything is properly grounded. What gives?

**A.** Noises emulating poor ground come from a limited number of sources, typically:

1. Induction onto or into circuitry or wiring.

2. Current flow in an audio path, usually the result of poor grounding on an unbalanced or improperly terminated signal path, or current flow between devices via a signal path, or a total system ground relative to earth or ac ground.

3. Clock noise (high-frequency square waves) from a synthesizer, computer or sync generator.

4. Radio frequency/television frequency interference (RFI/TVI), a phenomena known to do strange things like beat against tape deck bias oscillators, video signals, or be demodulated courtesy of processing gear (don't forget to look for large microwave dishes pointed at your building).

5. Video/computer monitor interference and crosstalk, including routing RF signal through an audio patchbay, audio amplifier proximity to high-frequency video power supplies, etc.

The usual solutions still apply, such as clean star or serial ground, separate or solid rack ground/signal ground, separate ac/RF/MIDI/audio cable runs, balancing throughout. (Use transformers if all else fails.)

There is no shortage of potential monsters in the closet. We heard of one studio that tore down, rewired and replaced

virtually everything, decided to live with the background noise, and discovered that the local broadcast cable TV feed was inputted to Video Aux B on the control room video monitor, wired-in behind the soffit (late night MTV for those second engineers!), which of course was grounded to the Sony 3/4-inch VTR, whose audio feed was hard-wired to the patch bay, which was the board ground. Always check everything. Need we say more?

**Q.** Now that we've got high- and low-level balanced and unbalanced audio, video, computer feeds, MIDI, VITC and fiber-optic LAN for remote control and data running all over our control room, how do we route this stuff without going crazy? A patchbay won't do it any more.

**A.** Thanks to modern design, you may want to look into some of the very interesting new ways to move signals around, combine them, separate them, and generally clean up the jumble. Some companies making this technology are:

• Akai/IMC: Box 2344, Fort Worth, TX 76113; 817-336-5144.

• Lone Wolf: 1505 Aviation Blvd., Redondo Beach, CA 90278; 213-379-2036.

• RTS Systems: 1100 W. Chestnut St., Burbank, CA 91506; 818-566-6700. ■

# Sonex. Ship Shape Sound.

SONEX, when your sound matters. Now available in new sizes that *ship* UPS. SONEX, the *shape* that works; in a variety of depths, colors, and materials—plus ceilings, barriers and composites. SONEX, for the truest *sound*—call today for all the information.



**illbruck**

Minneapolis, Minnesota

**1-800-662-0032**

(In MN: 612-521-3555)

©illbruck, inc., 1990

## Computer Control: The Future is Now

By David Scheirman

In the not-too-distant past, sound reinforcement professionals used to joke about the time when computers would take over setting up and running large systems. It was assumed that, someday, oft-repeated tasks such as tuning an equalizer or turning multiple amplifier channels on and off would somehow be done with the flick of a wrist at a computer terminal. While this seemed as if it would be expensive, and certainly complicated, most of us probably did not really think that the computer could ever muscle its way in at the control position of a complex sound reinforcement rig.

Surprise. The future is here. The 1990 concert sound touring system marks the introduction of certain computer-operated system functions, and forward-looking equipment manufacturers have been working overtime to work out the bugs on audio products and software that allows system operators to use a personal computer to interface with familiar hardware like graphic equalizers and power amplifiers.

This column will be limited to the "drive components" of a sound system, those items that are used to present and distribute a program mix to the audience via a loudspeaker system. While interesting things are happening with certain special effects devices (digital reverberators, delays, etc.) and many such devices are now being MIDI-linked for program changes and such, I'm going to concentrate on the use of the personal computer to monitor, adjust and control the sound reinforcement operations downstream of the mixing console.

### PROGRAMMABLE EQ/SPECTRUM ANALYZER

The Danish company T.C. Electronic has been mating equalizers with the comput-

er, and advertising them as "intelligent microprocessor-based tools for the professional sound contractor and sound reinforcement engineer." While the company also manufactures and distributes digitally controlled effects devices, the most appropriate SR product is probably the TC 1128.

*There is an ever-increasing amount of crossover between personal computers and pro audio gear.*

Combining interactive equalizer and analyzer circuitry, and driven by proprietary software, the 1128 is a 28-band equalizer with an on-board computer. The company's EQTALK software allows bidirectional communication with the equalizer. In other words, the unit is able to monitor its own functions and communicate them to an outboard computer. The system operator can use this same computer to give the EQ operational instructions.

The 1128 also features an automatic feedback "Search and Destroy" function. The internal spectrum analyzer can be used to identify transient narrow-band peaks, and the unit can be set to cut specific frequencies at a pre-determined level. While the 1128 has been making the rounds of various sound companies for more than a year, 1990 marks an increasing number of units appearing in the major concert market.

Look closely. You may see a pair of 1128s at the house mix position in a Maryland Sound system with Chicago, while sound mixer Pablo Wheeler works on beta-test software to control and record his main house EQ settings with a Macintosh computer. Showco monitor mixer Pete Buess uses an 1128 on his personal monitor cue bus, scanning a dozen or more stage monitor mixes to nail feedback spikes for Milli Vanilli.

Clair Bros' stage monitor systems for Fleetwood Mac and Don Henley have an entire rack of TC-1128-C units (specially modified for Clair Bros.), all capable of being adjusted with a special remote zone to another by the monitor mixer. An IBM-

compatible computer sits near the monitor console and is linked to the rack of 1128s.

With up to 99 memory storage settings and a motorized fader system mated to the 28-band graphic EQ, the 6032 remote head, developed and manufactured for Clair Bros., has ushered in a new era in the control of stage monitor systems. A major sound firm was scheduled to accept 30 of these control heads by June 30, to go with 130 new TC 1128s already shipped.

### POWER AMPLIFIERS

Typically, power amplifiers are not very exciting. A necessary, functional part of the sound system, amplifiers are usually noticed only when they are running too hot or when they fail.

After several years of development, Crown International has refined the IQ System 2000, a hardware/software system that combines a personal computer for system control with PIP (Plug-In Panel) modules that are installed at each amp in the system. Up to 2,000 separate power amplifiers can be monitored and controlled from a single computer keyboard.

Originally configured for use with the Macintosh and now IBM PCs, the system allows the operator to place the computer wherever it is most convenient and then uses only a pair of 2-conductor lines to tie into each group of amplifiers. For example, only four snake lines could be used to link house left and house right amplifiers to the mixing position. PIP modules are daisy-chained, creating a linked network of "intelligent" power amps that respond instantly to computer commands.

The software was designed to be easy to use. The graphics can be tailored to suit a user's individual needs. Pull-down menus, setup and status windows, and a choice of individual or grouped amplifier monitoring and control functions make the system quick to set up and simple to understand. The system can also control auxiliary devices such as cooling fans or lighting fixtures.

All Crown power amplifiers brought to market since the Micro-Tech (including Macro-Tachs and Com-Techs but not PSA-2s or D-Series units) will accept PIP modules. In addition to allowing the amplifier-computer interface, the PIP modules come with a wide variety of configurations. These include balanced-input combining, isolation transformers, crossovers and a variable-threshold compressor function. Soon to come are goodies such as true dig-

David Scheirman is R•E•P's sound reinforcement consulting editor and president of Concert Sound Consultants, Julian, CA.



ital inputs and individual channel delay capabilities.

While the system does seem to be well-suited for large, complex permanent installations, it is being used in touring systems. Eighth Day Sound in Cleveland recently fielded the first IQ System 2000 on the road for Alice Cooper.

#### OTHER SYSTEMS

For several years now, personal computers have been used to keep track of information such as cue sheets, video displays of song lists and MIDI program patch changes. This has helped clean up the paperwork problem, and made it easier to keep track of show information, or to change signal routing for effects devices.

Complicated signal-routing between console inputs and outputs and digital special effects devices is beginning to get cleared up with the availability of computer-controlled systems. Richmond Sound Design and Real World Systems offer hardware/software packages that let system operators rely on a computer to set up, remember and control matrix switching. Video driver cards and a personal computer can be used to create large, color displays that monitor operating functions or specific units within the sound system.

For example, Sennheiser wireless microphone systems can be monitored at the mixing position using special software available from the manufacturer. Both audio and RF level can be seen in bar-graph displays, for up to 16 separate wireless mic systems.

There is sure to be an ever-increasing amount of crossover between personal computers and pro audio gear. The value of this equipment for fixed system operators is obvious. What these systems can offer to the touring sound industry is still being debated. Even as industry veterans contemplate what it means to touch a computer keyboard instead of an EQ unit or crossover, software developers are hard at work at projects applicable to this field.

The time will come when most aspects of setting up and adjusting the operating parameters of a multiway large-scale sound system can be accomplished, in real time, by the same personal computer that I used to write this column. ■

# M-1

## MICROPHONE PREAMPLIFIER

SUPERIOR SOUND QUALITY. RE-DISCOVER YOUR MICROPHONES!

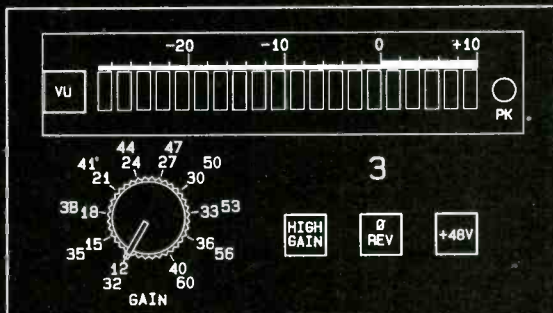

(ACTUAL SIZE)

- THE BEST JENSEN INPUT TRANSFORMER: THE JE-16-B.
- THE BEST OP-AMP: THE 990 DISCRETE OP-AMP.
- DC-SERVO ELIMINATES ALL COUPLING CAPACITORS.
- THE BEST JENSEN OUTPUT TRANSFORMER OPTION: THE JE-11-BM.

- ILLUMINATED SWITCH BUTTONS.
- TOROIDAL POWER TRANSFORMER.
- UNIVERSAL POWER SUPPLY.



- XLR CONNECTORS. GOLD OPTIONAL.
- TWO METER OPTIONS. VU-1 SHOWN.
- CUSTOM KNOB & PUSH BUTTONS.

### THE JOHN HARDY COMPANY

P.O. Box AA531  
Evanston, IL 60204

(708) 864-8060

Telex: 910-380-4670  
(JOHN HARDY CO)

Circle (21) on Rapid Facts Card

- DESIGN • SALES
- SERVICE • PARTS
- INNOVATIVE
- FINANCING PLANS
- RUSH DELIVERY

P R O F E S S I O N A L

INNOVATIVE SOLUTIONS FOR PROFESSIONALS

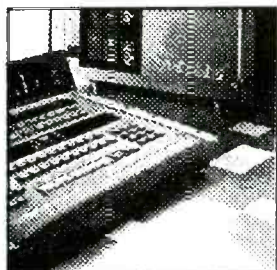

AKAI A.C.A.M. 12-TRACK DIGITAL AUDIO RECORDER

#### NEW YORK'S LARGEST PRO AUDIO INVENTORY

• PROCESSORS BY EVENTIDE, LEXICON, DBX, SYMMETRIX, VALLEY PEOPLE, ALESIS, T.C. ELECTRONICS & AUDIO LOGIC • D.A.T. FEATURING THE SONY TC-D10 PRO & PCM 2500 AND THE PANASONIC SV-3500 & SV255 • SAMPLERS FEATURING THE AKAIS-1000 & S1000HD, THE ROLAND S-770, S-550, & S-330, THE EMU EMAX II, EIII & PROTEUS • INTRODUCING D.A.R. DIGITAL WORKSTATION - POSTPRODUCTION POWER TOOL.

#### A FEW EXAMPLES:

• SOUNDTRACS IL48/ERIC/CMX/MRX STUDIO CONSOLES • AMEK MAGNUM/TAC SCORPION I/UBULLET CONSOLES • C.A.D. 16 TO 48 INPUT, DC SERVO POWERED MIXING CONSOLES • EVENTIDE H-3000S & B • NY'S EXCLUSIVE T.C. ELECTRONICS DEALER FEATURING THE T.C. 2290 • AKG ADR 68K DIGITAL REVERB • ROLAND R-880 DIGITAL REVERB & E660 DIGITAL E.Q. • CONDENSOR MICS BY JOSEPHSON, AKG, CROWN, NEUMANN, SONY & SENNHEISER • APPLE MACINTOSH COMPUTERS (NY'S ONLY APPLE MUSIC DEALER) • SOUNDTOOLS DIGITAL AUDIO RECORDING & EDITING SYSTEM • TASCAM MSR-24 1" 24-TRACK BREAKTHROUGH PRICE RECORDER • MONITORS BY TANNOY, EV, J3L & UREI

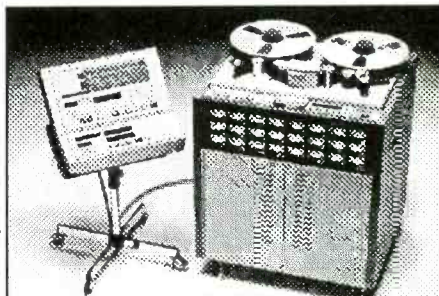

TASCAM ATR-80 JAPAN'S FINEST 2" 24-TRACK

723 SEVENTH AVENUE (THIRD FLOOR)  
NEW YORK CITY • 10036 • (212) 719-2640

Circle (22) on Rapid Facts Card

Field measurement and correction of sound systems using Meyer's SIM Equalization service.

# Computerized EQ Systems

By Bob McCarthy

**M**eyer Sound has been engaged in field research providing SIM (Source Independent Measurement) Equalization services since 1984. In that time, the tools and techniques of SIM have evolved to enable increasingly intricate alignment procedures with greater speed and accuracy.

Previous articles on the subject, in *R•E•P* and other publications, have focused primarily on its most conspicuous aspect: the capability to conduct measurements using music or voice as the test signal. Taken alone, this feature amounts to a special case of dual-channel FFT analysis.

In contrast to off-the-shelf, dual-channel analyzers, however, SIM encompasses a broader methodology that is optimized for high-speed alignment of elaborate sound systems in their true environment — the

audience-filled room. In addition to a spectrum analyzer, SIM incorporates an array of proprietary hardware that provides automated multiple-point access to the measured system, and a dedicated software package that guides the operator through the alignment procedure.

This article examines the role of the system in field measurement and correction of sound reinforcement systems. Secondary to this, we will discuss the viability of automated equalization.

## BASIC PRINCIPLES

SIM equalization seeks to achieve three simple goals:

1. To match, in both amplitude and phase, the acoustical output of the speaker system in its actual operating environment to the electrical signal at the console output.

2. To provide this matched acoustical response, within close tolerances, throughout the maximum possible seating area of the hall.

3. To verify that these goals have been achieved during performance with an audience present, and to implement any corrections that may be required to compensate for the effect of the audience.

The first goal might be questioned by advocates of "house curves." It is important to understand that room equalization is correction to a technically verifiable standard, rather than imposition of an overall spectral tilt, which some may regard as subjectively pleasing.

SIM seeks to provide the mix engineer with a fully corrected and linear loud-

speaker system that will faithfully reproduce its input signal. A single master equalizer can still be used by the mixer as an artistic means of imposing a "house curve" throughout the system, and would be considered part of the console.

The second goal ensures that the audience enjoys the same level of sound quality as the mix engineer. We regard this as foremost aim of sound reinforcement. To achieve it, measurements must be made in the audience area, and the sound system must be configured in a way that allows the response in audience areas to be measured and corrected separately.

The third goal can be realized only if measurements are taken throughout the hall during the performance, using the source material (e.g. music and voice) as the test signal. The only current measurement and equalization system that fulfills all of these criteria simultaneously is SIM.

## ACOUSTICAL EFFECTS AND COMPENSATION

Aberrations in an installed loudspeaker system's amplitude and phase response may have a number of causes, including interactions among multiple loudspeakers; fixed boundary conditions (e.g. walls, floors); changing boundary conditions (e.g. the audience); temperature and humidity variations; and open microphone regeneration.

These factors combine in complex ways to determine the sound system response. The fact that they will combine differently in separate areas of the hall, and will change over time, dramatically expands the scope of measurement and correction.

This article is the last of two parts on computerized EQ systems. Part 1, covering the Apogee CORRECT system, appeared in the July issue.

Bob McCarthy is director of SIM engineering at Meyer Sound Labs, Berkeley, CA.

Acoustical compensation for the effects of these factors can take a number of forms, including speaker position adjustments; architectural modifications (absorption, diffusion, etc.); gain structure and/or delay line adjustments; and electronic equalization.

We list equalization last, because it is truly a measure of last resort: It is not a panacea. Attempts to apply equalizers to problems that system operators cannot possibly fix will inevitably be disappointing.

Most important, the speaker system must meet certain criteria in free field before attempts are made to characterize and correct its response in rooms:

1. Distortion must remain below 3% under all conditions (distortion products cannot be equalized).

2. The loudspeakers must be arrayable, so that destructive interaction is minimized. (See "Large Arrays: Measured Free-Field Polar Patterns Compared to a

Theoretical Model of a Curved Surface Source," Seidel and Meyer, Journal of the Audio Engineering Society, April 1990.)

3. The system must not introduce dynamic compression. (This is mandatory if music is to serve as the test signal.)

4. The amplitude response must be nominally flat. (Cancellations internal to the speaker cannot be removed by equalization.)

5. The phase response must be nominally flat. (The relationships of time vs. frequency must be preserved throughout the audio band.)

6. The array's directional pattern must be controlled. (The direct sound must predominate over the reflected sound, or measurements will not be valid.)

#### THE MEASUREMENT SYSTEM

The heart of the SIM system is the dual-channel FFT spectrum analyzer. The role of the analyzer has been described in detail in previous articles ("Equalization Us-



**SHURE**  
**BUY IT**  
**FOR A**  
**SONG!**

And we're not just whistling dixie here. At Full Compass Systems we have one of the largest microphone selections in the country. And that means you can select any Shure microphone for a price too low to advertise, for sure!

**& GET A**  
**FREE**  
**T-SHIRT**

From Full Compass with every Shure microphone and mixer purchased.

*Hurry! T-Shirt Supply Large But Limited.*

**1-800-356-5844**  
Over 300 Product Lines  
Audio • Video • Lights



Consultation 608-271-1100  
5618 Odana Road • Madison, WI 53719

#### Dual Channel Measurement of Frequency Response

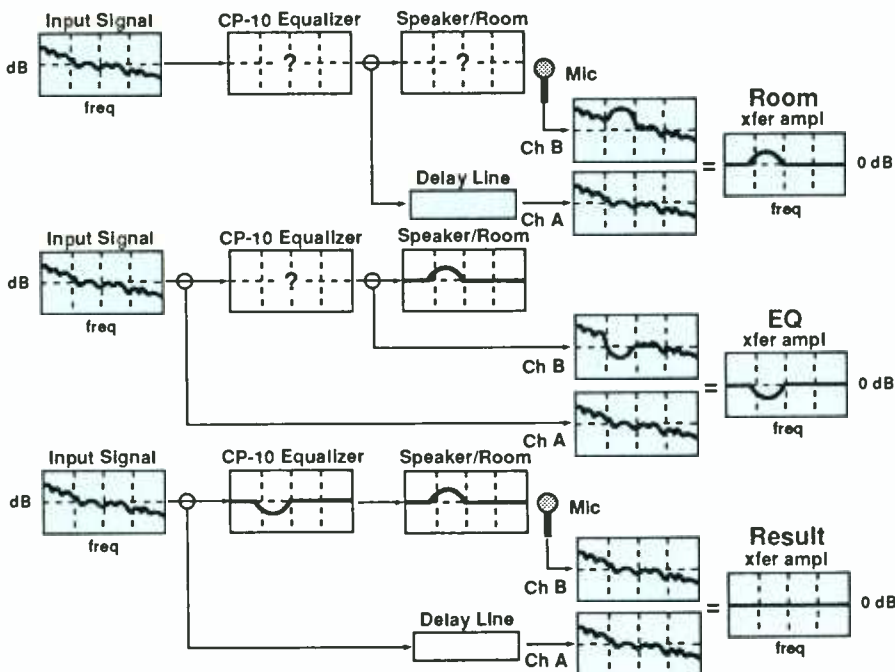

Figure 1. Dual-channel measurement of frequency response.

ing Music and Voice as the Source," Meyer, AES Preprint #2150 [1-8], 76th Convention, 1984; and "Acoustical Measurement Techniques for Sound System Equalization," Jones and Meyer, RE/P June 1988).

Briefly, the essential features of the FFT analyzer in SIM may be summarized as:

1. High resolution in the frequency domain.
2. Phase response measurement capability (relative time vs. frequency).
3. Coherence measurement capability (the relative data reliability vs. frequency).
4. Dual-channel, cross-spectrum computation, enabling the use of music as the test signal.
5. Time-windowing capability to preserve resolution at low frequencies and to simulate the ear's response.
6. Fastest possible capture time.

The FFT analyzer performs all of the measurements in SIM. The remaining components of the system provide the analyzer with access to the sound system under measurement and maintain the data collected on-site.

#### MEASUREMENT TECHNIQUE

In conventional equalization practice, a microphone is placed at a single reference point, and the frequency response is viewed while the equalizer is adjusted to obtain a desired response. This process is tedious at best, and can sometimes feel like sawing the legs of a table in order to get it level.

Moreover, if the microphone is moved to another position, a different response appears, raising a significant question: Are the response aberrations at the new location caused by the speaker/room or by the equalization (which was optimized for a different measurement position)?

To answer this question, we need a method of differentiating among three separate networks: the speaker/room, the equalizer and the combined response of both. This translates colloquially to "what you started with, what you did, and what you have now."

During the setup phase, we have the option of bypassing the equalizer to measure only the speaker/room system. But what about during the show?

In SIM, we provide automated switching among three points in the system — the equalizer input, the equalizer output and the measurement microphone. Signals from these points are routed to the analyzer inputs in different combinations (see Figure 1) to enable independent measurements of the unequalized speaker/room, the equalizer and the equalized speaker/room. (In the SIMCAD software, these measured quantities are respectively referred to as ROOM, EQ and RESULTANT.)

In practice, the ROOM amplitude and

phase response are measured and stored in computer memory. The real-time EQ response is then displayed simultaneously with the stored ROOM response. The equalizer is adjusted to generate an inverse function of the ROOM response. (Because we are viewing the response of the equalizer directly, we make no assumptions based on its front panel markings.) Finally, the RESULTANT is viewed to verify that the corrections have been effective.

The microphone may now be moved to a new position, and a second ROOM response may be viewed against the existing equalization. Typically, the equalizer settings will be appropriate in some frequency ranges and contradictory in others, indicating that the corrections for one measurement position are hindrances for another. What can be done in the face of these mixed messages? Ignore one position? Average the two?

The conventional method is to retreat to a single point of reference — the mix position — with the expectation that calibrating the system to that position will yield superior results over an arbitrarily chosen area. This decision calls into question the usefulness of the entire process of measurement-based equalization, however.

If we presume that mix engineers will make judgments by ear based on the sound quality that they hear, then the loudspeaker system is, in effect, self-calibrating for the mix position. Given sufficient time, the engineers will derive their sound by adjustments of channel and/or house equalization, without regard for either how the system was voiced initially or how it sounds in the audience areas.

If only one position is to be calibrated, then the measurement system and the position of the measurement microphone are largely irrelevant. Whether the system is equalized with an SM 58 and the "Test, one, two" mantra, or by a fully automated self-equalizing computer, only the starting point for the mix will be affected. The result will be the same.

#### MULTIPLE MICROPHONE MEASUREMENTS

Sound system alignment to a single reference point relies on the assumption that the audience at large will benefit from good sound at the mix position. Unfortunately, this is true only if the response in the audience area matches that at the mix position. In reality, this may be far from the case.

To provide tangible benefits for the audience, it will be necessary to align parts of the system independently so that the mix position and audience areas can be matched — and the only way to characterize the loudspeaker system's response in audience areas is to place multiple microphones there and measure. This brings

us back, however, to the question of how best to deal with contradictory readings in different measurement positions.

The available solutions are reduced to three options: ignore, average or separate. In actual practice, it is possible to use all three to your advantage.

First, you should not assume that all data are equally valid. For example, the apparent response peak that is caused by a stagehand talking next to the measurement microphone will not yield to equalization, and should be ignored. The relative reliability of the data in each frequency range must therefore be known. In SIM, this judgment is facilitated by the Coherence function of the FFT analyzer. The Coherence function calculates the confidence level at each frequency for the data being measured, and clearly indicates spurious data caused by distortion, extraneous sound leakage, or other factors. Data with low coherence will not yield to equalization, and is therefore smoothed out of the response plot or ignored.

Some response aberrations, although varying in different parts of the hall, will always appear to some degree. For instance, low-frequency peaks are normally caused by acoustical resonances in the space. Even though their amplitude may be position-dependent, they can affect large areas of a hall. In such cases, it may be best to average readings from a number of positions to obtain an equalizer setting that works for the majority of the measurement points.

To eliminate localized acoustical effects, the loudspeaker system must be broken into separately adjustable subsystems with independent level controls, equalizers and (as necessary) delay lines. It is advantageous to break the system into as many parts as possible. If the budget allows, the system can be broken down to the level of individual speakers.

In truth, this is the only way to derive real benefits from multiple-microphone measurements. The common practice of employing a single equalizer to tune even large and complex systems merely imposes an averaged response on the system as a whole: The difference between the mix position and the audience areas remains unaffected. Because it is this difference that is precisely the problem, subdividing the sound system becomes the most important strategy in the alignment process.

#### CONNECTIONS AND PROTOCOL

In order to measure and adjust each subsystem equalizer independently, the equalizer inputs and outputs must be brought to the measurement inputs of the analyzer without significant loading. In the SIM system, this is accomplished by Meyer Sound MS8x2L line switchers, which incorporate a proprietary ISO-input

circuit to prevent ground loops. Independent measurement microphones are accessed, in turn, via the Meyer MS8x2M mic switcher. An MS1x1D delay controller synchronizes the analyzer input signals to compensate for the propagation delay between speakers and microphones. Finally, a central computer remotely controls all of the measurement equipment, enabling full system control from the keyboard. (See Figures 2 and 3.)

The arrangement shown in Figures 2 and 3 allows the SIM operator to measure each loudspeaker subsystem separately, using multiple microphones to find an average response for its coverage area. (The critical process of merging subsystem data into a composite response is guided by the SIMCAD software.) The operator may use phase response measurements to set delay lines with better than 10 $\mu$ s accuracy, and compare the relative SPL at all frequencies (500 points across the audio band) for accurate gain structure adjustments. Interactions among subsystems can be monitored and minimized with the help of the library of data in computer memory.

With the help of the SIM system, a trained operator can align a reinforcement system of 16 separately equalized loud-

speaker subsystems in as few as four hours. The effects of the audience presence can be identified and compensated within the first few minutes of a concert.

Any tool, however, is only as good as its operator — human or computer. Operating the SIM system requires advanced skills. Engineering candidates attend 32 hours of classroom training, followed by in-house practice and on-the-job training (typically 40 hours), before being certified to run the system on their own. All machines are owned by Meyer Sound, ensuring that only qualified personnel perform SIM services.

#### AUTOMATED EQUALIZATION

It is curious that an industry that is generally skeptical toward equalization — particularly if it is guided by measurement instrumentation — would be so interested in self-equalizing automation. The skepticism is well-founded, however, because the results achieved with conventional techniques tend to reinforce the feeling that it is just as effective simply to equalize by ear.

Alignment purely by ear might be termed something of a "black art." Its practitioners are masters of subjective alignment methods. At the opposite extreme

**SIM System Block Diagram**

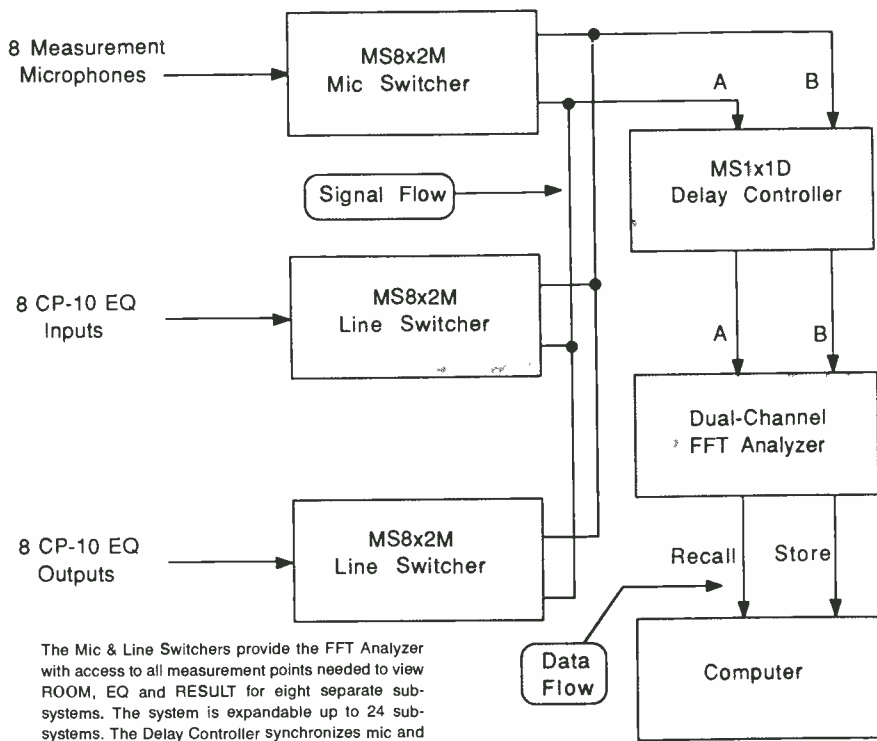

The Mic & Line Switchers provide the FFT Analyzer with access to all measurement points needed to view ROOM, EQ and RESULT for eight separate sub-systems. The system is expandable up to 24 sub-systems. The Delay Controller synchronizes mic and line inputs to compensate for propagation delay. The Computer controls all hardware and serves as a data library.

**Figure 2.** SIM system block diagram. The mic and line switchers provide the FFT analyzer with access to all measurement points needed to view ROOM, EQ and RESULT for eight separate sub-systems.

**We'll  
Put  
Our  
Shirt  
On  
Your  
Back...**



**AND**

**\$\$\$**

**In  
Your  
Pocket.**



**SHURE®**

## "Two For A Song" Mic Rebates

1. \$15 Rebate On Shure's SM58 MIC. Offer ends 8/4/90.

2. \$10 Rebate on Shure's SM57 MIC. Offer ends 8/4/90.

3. And a FREE Shure T-Shirt From Full Compass Systems With Every Shure Microphone or Mixer Purchased.

**1-800-356-5844**

300 Product Lines: Audio, Video, Lights  
Everyday Discount Prices



Consultation: 608-271-1100  
5618 Odana Rd, Madison, WI 53719

Circle (24) on Rapid Facts Card

is the purely objective method of the self-equalizing computer — the "black box."

As long as conventional single-point measurement and correction techniques are employed, there is no difference in the result and no tangible benefit for the audience. Is it worth the cost and risks of computer control to achieve the same result?

The application of the advanced techniques discussed dramatically expands the level of sophistication required to properly align systems. Any program that seeks to automate equalization decisions must take into account all of the facets discussed, and act on the data unambiguously. Furthermore, the automation system must be protected against scenarios that will mislead it, or it will cause problems instead of correcting them.

This implies that the sound design will have to adhere to the rules of the computer program, rather than the other way around. If the limitations of the automation system significantly compromise the sound design, then the automation's usefulness is greatly diminished. Unfortunately, there are many ways in which a measurement system can be misled.

The most serious problems involve signal contamination. An equalizer can only affect the response of a loudspeaker that is in its signal path. Spectral energy from

other sources may enter the measurement microphone, however, and cause a peak in the response. Attempts to remove this peak will degrade the response of the affected speaker.

Dual monaural speaker systems will exhibit fixed interactions, limiting the contaminated region (and the resulting equalization errors) to specific frequency ranges. On the other hand, stereo operation will produce a modulating interaction between the speakers that will change with the source material, and the result will be modulating filters chasing the interactions in both channels. Multichannel systems (such as those with discrete orchestra, vocal and effects speakers) will be even more severely compromised, because there is less shared information among the channels.

Stage sound leaking into the measured areas will also produce errors. Because stage leakage will cause aberrations that will not respond to system equalization, the result will again be auto-modulating equalization. (The bright side of this effect is that it may prove to be the most convincing argument ever to get the musicians and monitor engineers to turn down!) Similar problems can be expected if the speaker system produces distortion or is allowed to run into overload.

All of these factors complicate the

equalization process, regardless of whether it is automated. But any automation system must act literally, based on the data presented to it, without regard for the possibility of extraneous contamination. A human operator may realize that the stage leakage from the bass player's amplifier is affecting his measurements, and he may decide not to remove the entire low end from the PA. A self-equalizing system, on the other hand, might not be so lucky.

## CONCLUSION

There are SIM systems with trained operators at work in Japan, Europe, the United States and Canada. Our track record includes more than 500 shows, with many of the world's most discerning artists, in notoriously difficult venues.

Our understanding of the nature of room equalization continues to evolve, and the techniques likewise are becoming more advanced. Yet, the farther we get, the more evident it becomes that we have farther to go. At the start of the SIM project, we envisioned automation on the next horizon. Six years later, however, it appears much more distant.

Our foremost goal remains that of learning better ways to solve the complex problems of sound systems in the field. The extent to which automation technology will further that goal remains to be seen. ■

## Accessing the Sound System for SIM®

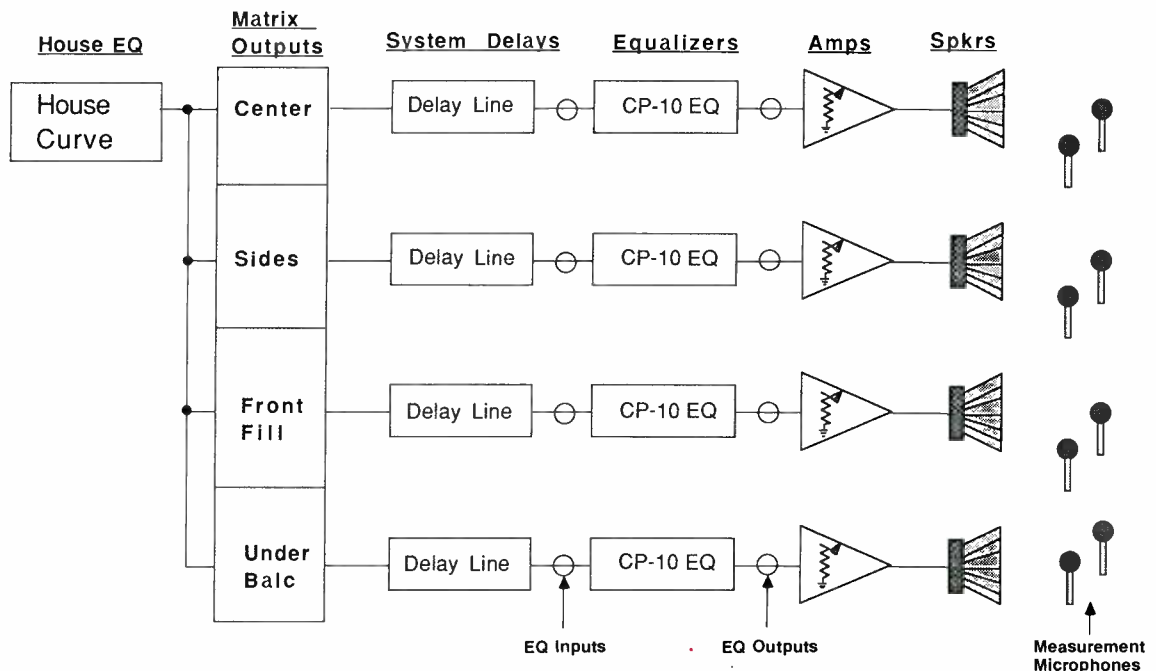

**Figure 3.** Accessing the sound system for SIM. Each subsystem is measured separately with microphones placed in its coverage zone. The EQ inputs and outputs are paralleled to the line switchers. This enables the engineer to align the delay, EQ and amp level of each subsystem. The systems will then be merged to obtain the most consistent level and minimal interaction.



# Both methods record incredible stereo. Crown's SASS-P makes it fast and easy.

Crown's new Stereo Ambient Sampling System™ (SASS™) and the DAT recorder combine to create a new generation of stereo recording. Unlike traditional recording methods, this powerful new combination is easy to use, more dependable and less expensive. The result is a system that records natural, beautifully imaged stereo just as your ears would hear it.

Crown's SASS-P\* eliminates traditional stereo recording compromises in sound quality, ease-of-use, and cost. No longer do you have to settle for weak low-end or off-axis coloration common to Midside, X-Y and near-coincident pair mics. Assembly and positioning time is also reduced significantly compared with conventional stereo mic'ing techniques.

Lightweight and easy to set up, the SASS/DAT combination is a high-quality portable recording system that goes everywhere.

The SASS-P features switchable battery or phantom power and Crown's finest studio-grade PZM® capsules. You'll enjoy full ambience without coloration, excellent sum to mono, and extraordinary broad frequency response. With SASS's superb imaging capabilities, every sound is audibly reproduced in its precise position, resulting in a stereo experience of uncanny realism.

Readily adaptable to all common stands, the SASS includes a carrying case and accessories.

No matter what your stereo recording requirements—from sampling to electronic news gathering to remote recording of live events—you'll find the SASS-P the clear choice.

See your Crown representative for more information or call toll-free: 1-800-535-6289.

### SASS Sample CD!

Now you can hear for yourself just how great SASS sounds. This CD includes a wide selection of live and studio music, stereo sound effects and samples, including A-B comparisons with some of the best stereo mics available. The SASS CD is free, but we must charge \$4.95 for shipping and handling charges. Send check or money order to: Crown SASS CD, P.O. Box 1000, Elkhart, IN 46515-1000. Please allow 3-4 weeks for delivery.



Name \_\_\_\_\_  
 Title \_\_\_\_\_  
 Company \_\_\_\_\_  
 Street \_\_\_\_\_  
 City \_\_\_\_\_ State \_\_\_\_\_ ZIP \_\_\_\_\_  
 Phone \_\_\_\_\_



Crown International, Inc. • P.O. Box 1000  
 Elkhart, Indiana 46515-1000 • 219/294-8000

© 1990 Crown International  
 SASS and Stereo Ambient System are trademarks and  
 PZM a registered trademark of Crown International.

\*Also available as SASS-B for use with B&K 4003/4006 microphones (not supplied).

**HANDS ON:**

# Valley International DCE

By Rick Schwartz

It's ironic that the better digital recorders get, the more we need good compression. Any signal being broadcast on the air needs some form of level control. If you don't do it, the transmitter will, because FCC regulations limit the amount of power a radio or TV station can transmit. (See "From Lacquer to Layback" in the March issue.)

Another consideration is that average level can play an important part of how people interpret the way things sound. Advertisers are well aware of this fact. By applying subtle compression in a controlled environment, the mixing engineer is able to adjust EQ and levels, minimizing any side effects of the compression.

I've noticed that when you start with a well-recorded digital source, you find yourself going to great lengths to keep the signal digital as long as possible. The reason for this is not that digital is sonically superior to analog as much as the fact that the A/D circuit is the weakest part in the sampling process.

The main reason for this is the steep filtering that is needed to prevent aliasing.

Rick Schwartz is a sound designer/engineer and director of post-production for Music Animals, Los Angeles.

Even oversampling filters can affect phase response and may add distortion to the signal. But let's face it, until digital mics and speakers are commonplace, it is inevitable that you must go through at least one stage of A/D and D/A. Multiple conversions from analog to digital should be avoided to maintain signal purity.

Although there are quite a few multiprocessors on the market that include some kind of digital limiting, the Valley International DCE is the only full-featured digital dynamics processor I have seen. The DCE is housed in a 1U rack-mount package and operates on either 115Vac or 230Vac. Clean power is important to digital devices. I found the DCE to be sensitive to power surges and was able to crash the unit by powering up a nearby power amplifier.

The front panel is clean, with a minimum of controls. Most parameters are adjusted using two select keys and a multiturn potentiometer. Menus are accessed by a large LCD backlit display. The DCE also has separate LED displays for compression and expansion, as well as switchable peak metering of the input and output signals.

## INPUTS/OUTPUTS

The back of the unit contains all of the digital I/O. Balanced digital signals are accessed using a DB15 connector, and unbalanced signals via five BNC connectors. I was disappointed that the unit does not support S/PDIF, which would allow it to be used with any DAT recorder. (Few support S/DIF-2.) I was also frustrated by the

fact that the DCE would not mix formats like my workstation does.

For example, I would have found it useful to have an S/DIF input and S/PDIF output for DAT transfers. Furthermore, to use the unit with an analog input, the user must select the Valley International Format (VIF) on the digital I/O menu, which eliminates the possibility of using the unit with digital inputs and analog outputs.

Even though the DCE automatically mutes the inputs when you connect it to the Valley Analog Interface, it is important to note that digital devices should not be "hot-patched." Always turn off the power before connecting audio cables to save your speakers from the loud burst of noise that can sometimes occur.

In addition to the audio connections, there are three MIDI jacks on the rear panel. All operating parameters can be dynamically controlled using MIDI. Settings can be changed on the fly and replaced (using a sequencer) without any "zipper noise." According to the manufacturer, remote control can be accomplished using a Lexicon MRC MIDI controller, or via computer and the built-in RS-232/422 serial interface.

The DCE appears to be well-constructed. The case is made of nickel-plated steel to contain RF emission. All of the ICs are socketed, and the circuit board seems to be well laid out (with the absence of any wire jumpers, cut traces, etc.). All DSP is handled by an AT&T chip with an internal resolution of 36 bits. As with any piece of digital hardware, the unit runs warm and should be given at least 1U of air



# SIZZLING SUMMER SALE !!



Fostex 8-Track MIDI Controlled Recording System.

**FOR A LIMITED TIME JUST \$2999.  
YOU SAVE \$1186\*!**

**This is the best multitrack deal you'll probably ever have. The acclaimed Fostex R8 is the standard for 8-track technology with a host of automation features and built-in full remote control. With the MTC-1 MIDI/SMPTE interface unit the R8 can be controlled by MIDI commands, and with the Fostex Desk Accessory MidiRemote™ you**

**can run the R8 with either an Atari™ or Macintosh™ personal computer. Add the 454 8 x 4 Recording Mixer with phantom powering, parametric EQ, input and output solo, two effects sends--mono and stereo--plus a whole lot of patching flexibility and you have an unbeatable 8-track package at a sizzling summer price!**

The fine print: Offer good at Participating Fostex Dealers only from June 1 through Aug. 31, 1990. Package sales only: R8, 454, MTC-1 and MidiRemote, \$2999.00 plus tax. \*Savings of \$1186 based on current list prices (\$4185). MidiRemote carries no warranty and

hardware restrictions also apply, so check with your Participating Dealer or Fostex regarding your specific application before purchase.

Atari and Macintosh are registered trademarks.

**Fostex®**  
Participating Dealers

For the name of your nearest Fostex Participating Dealer call (213) 921-1112.

space.

I like the fact that Valley included an internal jumper to separate digital grounds from the chassis and ac grounds. This is to prevent digital noise from bleeding into the ac lines.

### PROCESSING PARAMETERS

All signal processing parameters are shown on three screens. The first contains compression parameters; the second, expansion parameters; and the third, static parameters. The compression parameters

but is calibrated in relative units instead of absolute units. Another unexpected control to find on a compressor is MIX. By changing the blend of compressed and uncompressed signals, the depth of the processing can be optimized with a single knob.

At first, I was confused by the fact that I would change a parameter and then press the enter key and the device would take me into another screen. Moving the left or right arrows will enter parameter data and move to the next value.

ital expander, which did a great job of removing noise and ambience. However, it was harder to set than an analog gate and seemed to add a small amount of distortion to the signal (although I could not confirm this with test gear.) I feel that the expander would benefit from a frequency-sensitive threshold adjustment, like some of the Drawmer gates have.

### OTHER FEATURES

Because the DCE is digital, it has some unique features that are not found in tradi-

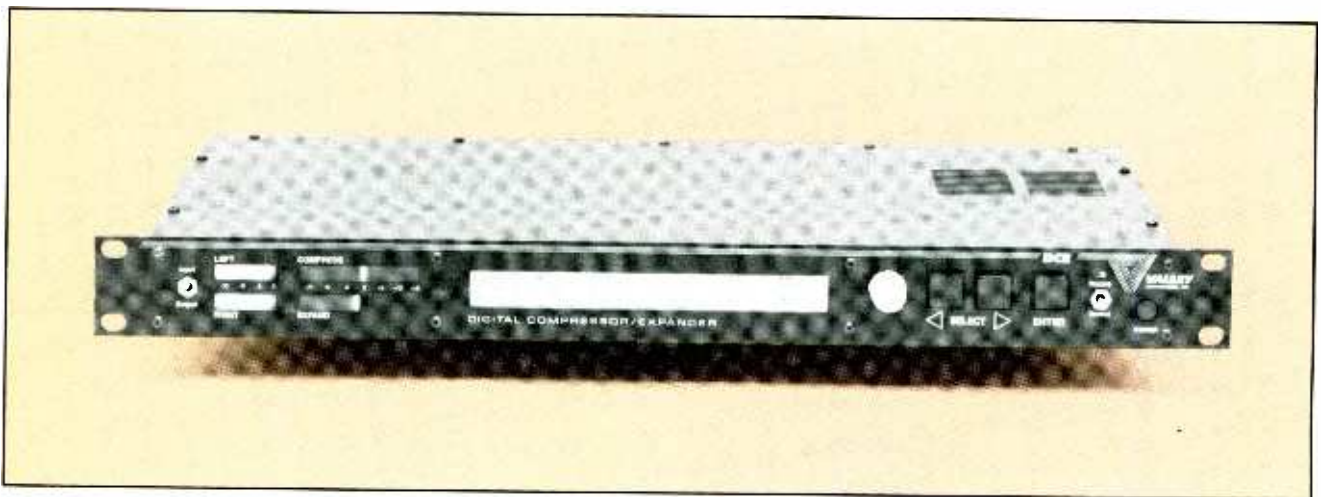

Figure 1. The DCE's front panel.

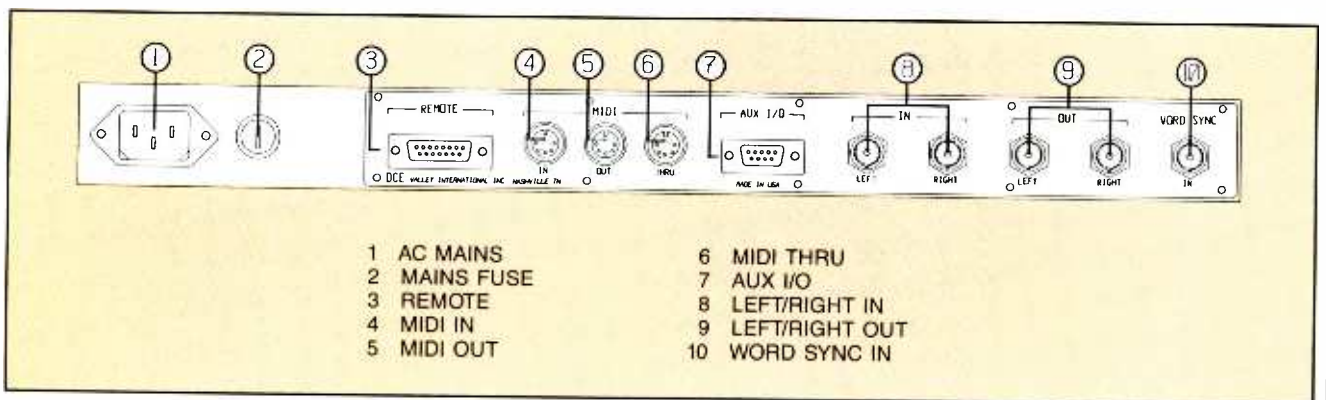

Figure 2. The DCE's rear panel.

are familiar with one exception: Set point (SETPT). Traditional compressors have threshold and ratio controls. The user must add gain to compensate for the attenuation and to maintain a uniform rotation point. Every time the ratio is changed, the gain must also be changed to keep the average volume constant.

SETPT works like a threshold control,

I must confess that I used the unit for some time before I found the second and third screens. Occasionally, I found myself trapped in a screen with the device asking me to rename a preset. The addition of a page key could eliminate any confusion and streamline operation.

The DCE is more than just a compressor/limiter. It also has an independent dig-

ital dynamics devices. One of the most interesting is the 3ms "look-ahead" feature. By inserting a small delay in the audio path and leaving the detector inputs undelayed, the device has the sonic advantage of a moderate attack time with a good response time.

This was not the only unusual feature. One of the static parameters called

WIDTH allows the user to control the stereo spread — all the way from mono to expanded stereo. Expanded stereo seemed to change the phase relationships to accentuate out-of-phase material like reverb. I found the WIDTH control useful to check for mono compatibility and creating mono mixes of stereo material without leaving the digital domain.

The DCE allows the user to store and load up to 99 presets. Because it has battery backup, all of the presets, setup information and active parameters are retained when power is removed, so you don't have to worry about losing any of your settings. I especially liked the unit's built-in clock, which date- and time-stamps all the user presets so you can always tell which one is the most current. There is even an AUToload feature, which is capable of automatically loading a preset and a certain SMPTE location using MIDI Time Code as a timebase.

The DCE's manual was very comprehensive, including an overview of the device and all of its parameters. Best of all was the section on interfacing with connection examples for every machine the device interfaces with. For us techies, there is even a section on hardware and theory of operation.

Digital compressors have the potential to overcome problems exhibited by some analog counterparts, like the loss of high end and the addition of noise that can occur due to the fact that low-level sounds are increased as part of the compression process. A digital device offers the theoretical advantage of not adding additional noise to a signal.

However, this may not be the case in practice, because a closer look reveals that a digital device adjusts levels by performing math functions on the digital numbers that make up the sound. Because a computer cannot figure results out to an infinite number of digits, it sometimes has to chop off or truncate the digital numbers. This is one of the reasons that there is so much talk about 18- to 24-bit systems because you need 18 bits to get *true* 16-bit performance.

I tested the DCE on mixed music, lead vocals and even an announcer track. The unit does a fine job of limiting and compression. Although I found the SETPT and GAIN controls to be confusing at first, they could probably be mastered with additional practice. I also found that attack and release times greatly affected the amount of compression applied to a signal. By changing the attack and release times, I sometimes had to change the set point to provide the same amount of signal processing.

Although the device can work quite well, I found it harder to use than a typical analog compressor. It seems that the unit would be most useful in CD master-

ing applications because the Sony PCM-1630 uses an S/DIF-2 interface. In addition, its digital limiter can squeeze a lot of level out of 16 bits and will eliminate the possibility of digital overload.

Although the DCE is not exactly cheap (with a list price is \$3,250), it is in the same price range as other high-end compressors like Neve or GML. The company was extremely helpful throughout this review, and acknowledges that the DCE is a relatively new device and can be improved.

Circle (104) on Rapid Facts Card ■

### Still in Business

Although Valley International in February filed for protection under Chapter 11 of the bankruptcy code, the company is still in business. (See News in the May issue.) According to company president Norman Baker, the filing was the result of a dispute with a supplier, and not because of financial difficulty. The company is shipping product and will continue to do so.

## Saki vs. Otari 24-track Replacement Heads: You'll Like the Difference.



Ours.

Otari's own MTR-90 record and playback heads are excellent. Proven Permalloy cores and shields. Clean response with low crosstalk. Troublefree.

Just like Ours.

In fact, we guarantee to deliver the same mechanical and performance specs to your 100% satisfaction, or your money back.

So why change to Saki when replacement time comes? Because our Made in U.S.A. heads are priced about 25% less than Otari, and we offer immediate delivery from stock.

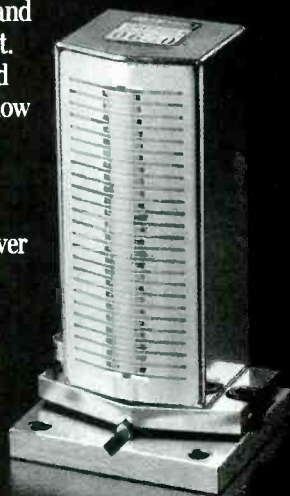

Theirs.

Ours vs. theirs—the difference is worth a closer look.

Call us now for all the details.



**SAKI MAGNETICS, INC.**

26600 Agoura Road, Calabasas, California 91302  
Phone: (818) 880-4054 Telex 244546 Fax (818) 880-6242

Circle (27) on Rapid Facts Card

# First Look

By Laurel Cash-Jones

## STUDIO TO GO

Forget home studios; now there's a complete sound and video studio in a portable self-contained traveling case. The Compile Box, available sometime this summer from Pierrick of Switzerland, contains a studio-in-a-box composed of Sony components. Here's a partial list:

- One TCD-D10 portable DAT machine.
- One CD player.
- One (GV-8) 8mm Video Walkman.
- Two Walkman cassette recorder/players.
- Two self-powered speakers.

Also, the Compile Box contains headphones, microphone, camera, and audio in and out connections for all of these devices. After spending a few moments

Laurel Cash-Jones is R-E-P's editorial consultant and a Los Angeles-based free-lance writer.

with this marvelous box, you get the idea that it would be equally at home if you were out on tour with a band, recording sound effects on location, giving a business presentation or doing live broadcast work.

Circle (100) on Rapid Facts Card

## KEEP TRACK OF YOUR EVENTS

If you have trouble keeping track of events, especially if SMPTE or MIDI is involved, the Fostex 4020 SMPTE/MIDI event controller comes to the rescue. The 4020 has eight relay contacts that are programmable (on-off) by SMPTE time code for up to 999 events, plus it also runs MIDI commands. So by using a combination of relays and MIDI, you can start cart machines, change programs on your MIDI-controlled reverb or effects device, start a sequencer, drum machines, etc.

The unit also sports its own SMPTE time code generator, a built-in SMPTE-to-MIDI time code converter, and a wideband time

code reader (1/50 to 100x speed). You can program the unit via its own front-panel alphanumeric keypad with LCD display, or you can program it via MIDI commands.

As far as connections on this unit, there are two RS-422 serial ports, one of which can be switched RS-232, and MIDI In, Out and Thru connectors. The eight relay contacts are available on a 37-pin D-sub connector and can be programmed to be normally open or normally closed. There is also a Fostex standard 20-pin remote connector for use with other Fostex products.

Circle (101) on Rapid Facts Card

## MORE FROM FOSTEX

Also from Fostex is the new G-16 16-track recorder with integrated synchronizer. It's a 1/2-inch 16-track machine that uses a built-in Dolby C noise reduction circuit. The G-16 has 10 1/2-inch reel capacity, runs at 15ips, and has a ±12% pitch control, 10 memory positions with auto play, auto locate and auto return.

# HOLDS UP ON THE ROAD



**COUNTRYMAN ASSOCIATES INC.**

417 STANFORD AVE. - REDWOOD CITY, CA. 94063 - PHONE 415-364-9988

Circle (28) on Rapid Facts Card

# DATRAX™ 60

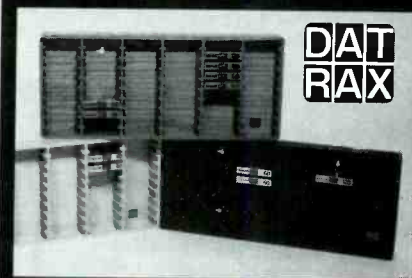

Store your DAT tapes in a beautiful, contemporary wall/table mountable unit that holds up to 60 tapes.

AVAILABLE IN SOLID OAK AND DESIGNER FINISHES

ALSO AVAILABLE:

**DAT Custom Flight Cases**

For information or to order ▼

TEL: 818.783.9133

FAX: 818.783.9318

BRYCO PRODUCTS, 13444 Moorpark St., Suite 23, Sherman Oaks, CA 91423



Circle (29) on Rapid Facts Card

Sounds like it's just another ordinary multitrack recorder that uses a small-format tape width, right?

Wrong. Here are just a few unique features of this little baby. It has the ability to be controlled by computer via a serial communications port using either RS-422, RS-232 or MIDI.

That's right, with the addition of the sync card, transport functions can also be controlled from any MIDI keyboard or sequencer. Commands available via this unique interface include play, stop, locate, review, rewind, cue on/off, fast forward, punch-out and loop.

Another unique feature of this machine is that the entire front panel can be removed, thus becoming the unit's remote control. When the front panel is removed, you will find that all of the calibration and alignment adjustment controls are easily accessible, unlike most machines of this type.

About the only drawback I see is that

this is only a 2-head machine, which makes the alignment procedure a bit tricky. However, with all that the machine has to offer in the way of features, I think that Fostex will have a hard time keeping the G-16 in stock.

Circle (102) on Rapid Facts Card

#### SPEAKING OF SPEAKING

Beyer is introducing the MC 742 stereo condenser microphone. This new mic has five patterns that can be manually adjusted separately for each capsule. It also has a 10dB attenuation switch and a built-in bass roll-off filter at 35Hz at 12dB per octave.

The upper condenser capsule can be rotated 360° in relation to the lower capsule, which allows you to use a rather large range of recording techniques, such as stereo, MS and XY. Plus, when you use the MSG 740 power pack, the patterns can be remotely adjusted.

In addition to the new stereo mic, Bey-

er is also bringing out the DT 158 single earphone and DT 159 dual earphone, both of which are available with a boom-mounted microphone. Both headsets are available with either condenser or ribbon elements, which should handle close proximity and high SPLs without distortion while reducing off-axis sound.

The headphone portions of these units are available in a black matte finish, which will reduce glare and reflections. The microphone portions are finished in matte nickel, which should be of interest to all on-air broadcasters.

The DT 158 and the DT 159 come in a variety of impedances so they can be quickly interfaced to any remote or studio application. Primary use of these new headsets should be in on-camera or behind-the-scenes broadcast applications, remote ENG/EFP, news, sports and entertainment programming, which might have a high or low ambient noise environment.

Circle (103) on Rapid Facts Card ■

## ANNOUNCING THE RPG DIFFUSOR CEILING SYSTEM



Tent Records, London

#### OMNIFFUSOR™

The new 2-D QRD® diffuser is based on 2-dimensional number theory sequences which provide identical performance in the horizontal and vertical planes, for truly omnidirectional coverage.



RPG Diffusor Systems, Inc. 12003 Wimbledon Street, Largo, Maryland 20772



Rhinoceros Recording, Sydney

#### NEW ACOUSTICAL CEILING

Now you can have the low installation cost of lay-in ceiling panels and the broad-bandwidth sound diffusion only RPG can offer. Order the 1-D QRD® DIFFUSOR™ for controlled diffusion or the new 2-D QRD® OMNIFFUSOR™ for hemispherical coverage. Both panels are available in 2' x 2' and 2' x 4' standard suspended ceiling grid sizes.



WQXR, New York

#### APPLICATIONS

Choose QRD® diffusion to enhance music and traditional absorption to control noise in recording studios, live broadcast studios, rehearsal spaces, music education, band rooms, and performance facilities.



Phone 301-249-5647 Fax 301-249-3912

Circle (30) on Rapid Facts Card

# Cutting Edge

## Shure VP88 stereo mic

The VP88, the first model in a new line of video production mics from Shure, is a single-point stereo condenser mic that incorporates two condenser microphone cartridges mounted in a coincident fashion

to produce a stereo signal that is fully mono compatible. In stereo mode, the mic's on-board matrix produces separate left and right stereo signals with three switch-selectable stereo images. In MS mode, the VS88 sends discrete, fully sepa-

rated Mid and Side cartridge signals to its output for external processing. The VP88 can also be used as a single-output cardioid or bidirectional microphone in this mode. User net price is \$995, which includes battery, carrying bag, foam wind-screen, swivel adapter and Y-splitter cable.

Circle (110) on Rapid Facts Card

# DIGITAL PROOF!

The demands of digital monitoring have driven many "old standby" coaxial speakers to bits. Instead of singing the blues, more and more studios are replacing their blues with Gauss coaxials.

The Gauss coaxials were designed neutral so they wouldn't color the music. The cosh horn and time coherent design eliminate the need for time correction and greatly reduce fatigue. The carefully matched drivers require little or no EQ, provide the widest possible frequency response and 200 watts of power handling (400 peak) without self-destructing.

For more information on how you can bring your old coax systems up to the digital 90's, see your authorized Gauss dealer, or call us today.

## gauss

a MARK IV company  
9130 Glenoaks Blvd.  
Sun Valley, CA 91352  
(213) 875-1900  
Fax: (818) 767-4479

© 1990 Gauss

Circle (31) on Rapid Facts Card

## Tascam DA-30 DAT recorder

The DA-30 features analog-to-digital converters that use Delta-Sigma modulation and 64x oversampling, and digital-to-analog converters with 18-bit technology with 8x oversampling. Combined, this results in an S/N ratio of more than 94dB. Other features include AES/EBU digital I/O, a full-function programmable remote control, start ID positioning, head-room margin display, +4dBm balanced inputs and outputs, and -10dBv unbalanced ins and outs. Sampling frequencies of 48kHz, 44.1kHz and 32kHz are available. Retail price is \$1,899.

Circle (105) on Rapid Facts Card



## Tascam M-3500 console

The M-3500/24 ST in-line mixing console, the stereo addition to the M-3500 series, provides added monitoring capability for multiple stereo source units. The console features eight group buses, an in-line distributed monitor section with linear fader and mute, four fully assignable effects returns and eight stereo channels. For sonic control on each channel, the board incorporates a 4-band equalizer with two mid-range frequency sweeps and a high-pass filter. List price is \$9,499.

Circle (108) on Rapid Facts Card

## JBL ES Series power amps

The ES Series (ES150, ES300, ES900 and ES1200) features reduced weight, compact size, low feedback and low distortion circuits. Output power ranges from 75W/channel to 600W/channel. All ratings specified for 4Ω, 20Hz to 20kHz, both channels driven.

Circle (109) on Rapid Facts Card

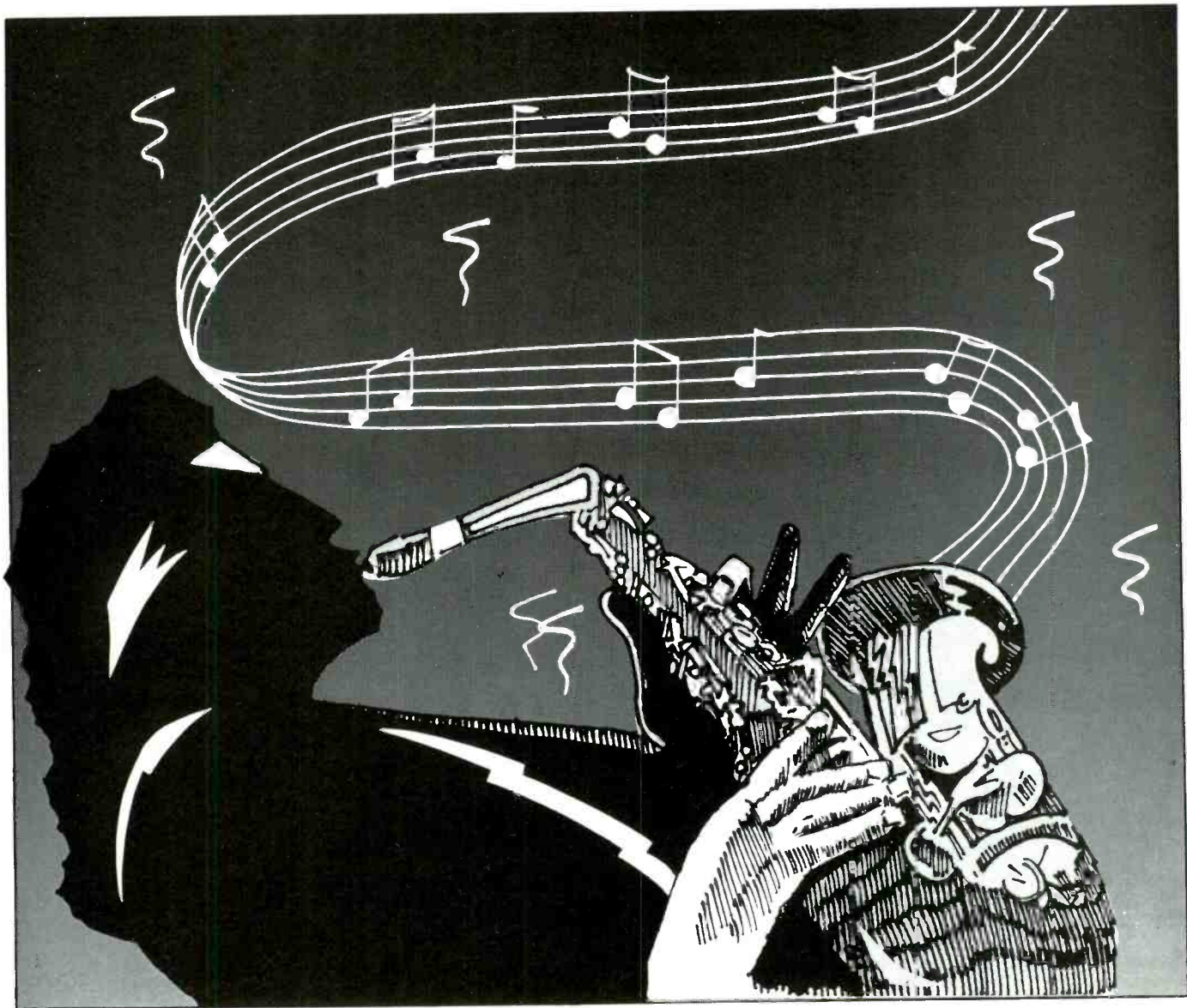

# Hot Cakes That Cook.

Producers want their duplicated recordings to sound as hot as the master. So, you've got to use tape that lets their music really cook. Tape that's especially hot on the top end.

CintasCHROME™ pancakes really stack up to BASF\* and AGFA\* when it comes

to delivering those steamy hot highs, low noise and consistency, pancake after pancake.

There's just one difference. When you use CintasCHROME Audio Duplicating Tape, you'll save a lot of dough. For your free samples, call Bob Piselli at (904) 445-5545.

**MANUFACTURING PLANT**  
 Av. 19 Norte No. 130-13  
 Centro Industrial Los Pinos  
 La Mesa, Tijuana, B.C.  
**Fax USA: (619) 575-6814**

## CintasVAC®

A Division of Cintas Technologies, Inc.

Circle (32) on Rapid Facts Card

# Cutting Edge

## Nemal Electronics International audio snake cables

The new line of multipair audio snake cables from Nemal Electronics International includes cables in 2- through 24-pair constructions, all of which comply with

the National Electric Code CL2 requirements. Each pair consists of two 22-gauge stranded conductors plus a drain wire, foil shield and individually numbered jacket. Prices starts at \$179/1,000 feet for the 2-pair version. The cable is available both

in bulk and precut terminated lengths.

Circle (106) on Rapid Facts Card

## Agfa SR-XS cassette

The SR-XS studio reference cassette is available in C-60 and C-90 configurations and is Type II chrome formulated, which uses highly coercive magnetic particles. The cassette features a 2-component laminated shell that allows exact phase relationship. The SR-XS' MOL rating is 6dB, and its SOL rating is -7dB. Bias noise is measured at 61.5dB, and its S/N ratio is 67.5dB.

Circle (107) on Rapid Facts Card

## T.C. Electronic PC control

This PC software package, for the control of up to 100 TC 1128 programmable graphic equalizers, includes a MIDI board that fits into any IBM/compatible PC equipped with an EGA monitor. All settings can be drawn with a mouse, and the software will instantly display the actual response curve to each setting. The PC will display real-time analysis on each channel, switchable between input and output. The software is also capable of displaying the phase response curves of each setting.

Circle (112) on Rapid Facts Card



## Two World Powers Team Up To Make You #1

The **Institute of Audio Research**, the world's top audio school and **Solid State Logic**, the world's top audio equipment designer bring you a new dimension in state-of-the-art audio education. Through this unique arrangement, **IAR** students receive hands-on training on the acclaimed **SSL G** series console and Studio Computer.

**IAR** also offers one-day **SSL** seminars to working engineers on console operation and automation software, as well as five-day courses in **SSL** console maintenance.

**Solid State Logic**

**IAR** is proud of its special relationship with **SSL**. We're also proud of our 1990 **TEC** award nomination. We encourage everyone - beginner and pro alike - to take advantage of the opportunities created by this groundbreaking linkage. For further information contact:



**Institute of Audio Research**

64 University Place • New York, NY 10003-4595

800 544-2501 • (NY, NJ, CT.) 212 777-8550

Circle (33) on Rapid Facts Card



## Prosonus Percussion 1 CD

The Percussion 1 is a CD containing 43 bands of unique percussion sounds, all created on prepared piano. Offering both pitched and unpitched sounds, each band has anywhere from three to 26 different versions of a particular prepared sound, including various pitches, timbres, clusters, scrapes and arpeggios. All recording was done digitally and in stereo.

Circle (111) on Rapid Facts Card

## Peavey PRM 308SL monitor

The PRM-308SL 3-way studio reference monitor features a rear-mounted response select switch, which provides for selection of reference or equalized response modes; dual vent-tube approach for accurate tuning; an integral flush acoustic foam blanket; 4Ω impedance; an 8-inch woofer; a 5 1/4-inch mid-range component; a 1-inch



# Duplicate our success.

To celebrate entering the sixth year of supplying the world's most cost-effective audiophile quality duplicating system, we'll help you duplicate our success by offering you everything you need to duplicate, imprint and package your own audiophile quality cassettes.

For a limited time, we'll offer you this complete package of quality KABA equipment, including a 10 slave 4-track real time and 2X duplication system consisting of the master control deck, 5 dual transport slave decks, a pad printer, ultraviolet platemaker, plates, inks, cassette fixture bar sealer, heat gun and a 2000' roll of shrink film, all at a price that can't be duplicated. Now one person can duplicate, imprint, assemble and shrink wrap over 300 tapes a day, quickly and economically... for an amortized cost of

equipment and maintenance of as low as 3.1 cents\* each.

**SAVE \$2,300**

Call today for details, and start duplicating success in your business **1-800-231-TAPE**

From California & abroad  
(415)-883-5041



Complete KABA cassette duplicating, imprinting and packaging system

**\$9,995**

offer expires Aug. 31, 1990



**KABA**  
**Research & Development**

24 Commercial Blvd., Novato, CA 94949 (415) 883-5041  
1-800-231-TAPE FAX (415) 883-KABA

\*Based on 10,000 hours operation @ 2X with factory maintenance package every 2500 hours.)

## STAR QUAD MULTI-CHANNEL AUDIO CABLE



Worldwide  
exclusive

L-4E4-16AT

Request full  
line catalog

- Unique 4 conductor channel design combats RF and EMI noise
- Ideal for studio or stage
- Crosslinked polyethylene and foil shields for Quick and Easy assembly
- >130 dB crosstalk; 2 to 24 channels

**CANARE**

CANARE CABLE, INC.

511 5th. St., Unit G, San Fernando, CA 91340  
Phone: (818) 365-2446 FAX: (818) 365-0479

Circle (35) on Rapid Facts Card

## DISC MAKERS

### Complete manufacturing for the audio industry.

#### COMPLETE PACKAGES FOR:

- Cassette Duplication
- Record Pressing
- Compact Disc Replication

In-house art department for design, typesetting, film work, and printing. In-house mastering department for a great sounding product.



CALL FOR OUR  
FREE FULL COLOR  
CATALOG.

1-800-468-9353  
(In PA: 215-232-4140)

## DISC MAKERS

1650 Broadway, Suite 1010  
New York, NY 10019  
(212) 265-6662

Circle (36) on Rapid Facts Card

# Cutting Edge

tweeter; and crossover frequency response of 300Hz to 3kHz. List price is \$599.99.

Circle (113) on Rapid Facts Card

### Peavey TAX-4D crossover

The TAX-4D is an all-digital, spatially aligned 4-way electronic crossover that features an 18-bit 48kHz sample rate, over-sampled input, balanced inputs and outputs, selectable filter type, more than 500ms of input delay, up to 10ms of output delay, a 20-character by 2-line LCD, relay turn on/off transient muting, test mode, selectable phase reversal and muting, a built-in security lock, storage of up to 100 complete setups, and remote operation and storage of parameters via MIDI.

Circle (114) on Rapid Facts Card

### VGS Quadracontrol chair

The Quadracontrol is a workstation chair designed to prevent operator back problems and provide better controlled support and comfort. The chair features a larger orthopedically designed 1-piece shell for the head and neck, with lumbar support for the back; generous seat height adjustment for different height people and arm width adjustment for different body sizes; and four adjustment controls for constant support regardless of seating position. The chair can be locked at any position at any time. List price is \$895, gray cloth; \$1,695, black leather.

Circle (124) on Rapid Facts Card



### Oxmoor RMX-44 and RMX-62 mixing matrix systems

The RMX-44 and RMX-62 buffer, mixing and distribution amplifiers are designed for stand-alone operation or for external control from a microprocessor system. All assignments between inputs and outputs can be controlled via standard logic com-

mands. Front panel controls include input gain trim pots (four for the RMX-44 and six for the RMX-62), providing  $\pm 15$ dB of gain adjustment. Electronically balanced and ac-coupled outputs feature a 150 $\Omega$  source impedance, and can drive up to +24dBu into 600 $\Omega$ . Internal jumpers allow each output to be unbalanced independently.

Circle (127) on Rapid Facts Card

### Sunkyoung UCR duplicating tape

The UCR pure chrome duplicating tape has high-frequency saturation properties, resulting in clean highs with no sibilants, pumping, splatter or other problems of high-frequency compression. Chrome tape offers denser packing in the coating, better alignment and a smoother dispersion. The UCR tape is compatible with all slaves and heads at any duplicating speed ratio.

Circle (128) on Rapid Facts Card

### Zap It/EZ Winders

Zap It, For Strings and Zap It, For Drums are two new devices available from Kaman Music and are designed to fit any cordless powered screwdriver or 1/4-inch manual socket-driver. The For Strings socket is designed to restring guitars and similar stringed instruments in a more uniform setting, with less initial slippage or tuning difficulty. The For Drums socket is designed to do lug winding; a cordless screwdriver in lock position makes fine-tuning easy.

Circle (129) on Rapid Facts Card

### Studer Revox A723 studio monitor

The A723 3-way speaker features three crossovers, each with a 100W amplifier with negative output impedance. Group delay compensation and electronic time-alignment are also featured. Stable stereo imaging is achieved through the use of all-pass filters, which stabilize the directional lobes. The A723 is adjustable to different individual and professional listening level requirements by means of course and fine trimmer potentiometers.

Circle (117) on Rapid Facts Card

### Ariel PC-32 and PC-32M co-processors

Based on AT&T's 50MHz DSP32C, the Ariel PC-32 and PC-32M floating-point digital signal processing co-processors provide 32-bit floating-point and 24-bit fixed-point data formats while delivering 25 million floating-point operations per second. Both models come standard with 6,144

bytes of internal memory and 64Kbytes of zero-wait state memory, both include a 16Mbit/sec buffered serial I/O port and both are compatible with the Ariel digital microphone, which offers stereo 16-bit analog input. Also provided with the models are upload utilities, drivers for Microsoft and Turbo C, and demonstration software. Sun OS software drivers for the SUN 386i Workstation are also provided. U.S. list price for the PC-32C is \$1,995; for the PC-32M, \$2,795.

Circle (118) on Rapid Facts Card

### Shape environmentally responsible cassettes

Shape has developed environmentally responsible audio and video cassettes that can be easily disassembled and recycled. All cassettes include identification marks to show the type of plastic that was used in manufacturing the product. These marks will allow the handicapped and visually impaired to assist in the recycling process.

Circle (119) on Rapid Facts Card

### RPG Diffusor Omnifusor

The Omnifusor consists of a 2-dimensional array of square cells with a 4-fold rotational symmetry. The depth of the wells is based on a 2-dimensional quadratic residue number theory sequence that ensures identical diffusion performance in

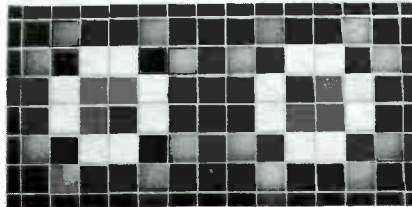

the horizontal and vertical planes. This omnidirectional scattering results in a steady state energy which is half of that obtained from an equivalent 1-dimensional QRD. The Omnifusor is available in lightweight 2' x 2' and 2' x 4' architectural acoustic panels, and in natural lacquered, painted wood or translucent acrylics.

Circle (121) on Rapid Facts Card

## Publications

### SSL ScreenSound demo

A 20-minute demonstration video for the Solid State Logic ScreenSound digital audio-for-video editing system is now available. It is free to production facilities.

Circle (130) on Rapid Facts Card

### Webster's New World Dictionary of Media and Communications

Published by Prentice Hall Trade, the 592-page hardcover book was written by Richard Weiner. This book is a comprehensive listing of more than 30,000 definitions of technical terms and jargon in advertising, exhibitions, graphic arts, marketing, media, public relations and other communication fields. Included are phonetic pronunciations, names and locations of major companies, industry data, the origin or trade practices, 19th century printing terms now being used, simple explanations of technical processes and more. List price is \$29.95.

Circle (131) on Rapid Facts Card

### LA/90 production guide

The LA/90 production guide lists more than 3,500 companies servicing the production and post-production industries in Southern California. Each listing includes telephone and fax numbers, description of services, freeway directions with closest

exit, major cross streets, Thomas Guide map coordinates, hours of operation and days closed. Two versions are available: the Coordinator, a 3-ring vinyl binder with pockets, which sells for \$50; and the Producer, a genuine leather organizer that is fully zippered, which sells for \$125.

Circle (132) on Rapid Facts Card

### Island Musical Supplies catalog

The 22-page Island pro audio catalog includes products from Audio-Technica, Nady Systems, Shure, Furman, Atlas-Soundolier, Neutrik, Gorilla and others.

Circle (133) on Rapid Facts Card

### The Platinum Rainbow video

Produced by Mike Craven and hosted by Bob Monaco, The Platinum Rainbow is now available on video. Nearly 10 years ago, the book hit the stands; more than 200,000 copies were sold. The video includes informative segments about the realities of the music industry: The Song, The Demo, The Team, Music Lay, Record Labels & Producers, and Promotion, Marketing & Video. Interviews with top music industry professionals are featured. List price is \$29.95.

Circle (134) on Rapid Facts Card

Classified Advertising is available by the column inch (Classified Display): \$35 per inch, per insertion, with frequency discounts available. 1" minimum, billed at 1/4" increments thereafter. 10" maximum per ad. Blind ads (replies sent to R+E-P for forwarding) \$25 additional. Reader Service number \$25 additional. Ads 4" and larger will receive a free reader service number and your company's name listed in the Advertiser's Index. Spot color (determined by magazine) \$150 additional. No agency discounts are allowed for classified advertising.

Contact Renée Hambleton, 913-888-4664, for information on frequency and pre-payment discounts, or to place your classified ad. Or send your order and materials to:

Renée Hambleton  
R-E-P  
9221 Quivira Rd.  
Overland Park, KS 66215.

## HELP WANTED

### AUDIO SWEETENING

Major NYC Video facility seeks audio engineer with experience in multitrack sweetening. Send resume to:

P. O. Box 2258, Dept. Audio  
Times Square Station  
NY, NY 10108-2050

## TOP HAT, WHITE GLOVES REQUIRED!

Studio Center is looking for a director, a producer, an editor, an engineer, an interpreter, a copy doctor, a politician and someone with an ear for music plus a good knowledge of ad agencies and what they expect. Frankly, if you can do all that, then you're the magician we're looking for. And if our client list including AT&T, CBN, Dodge, GE, Kentucky Fried Chicken, GMC Trucks, Hardee's, McDonalds and NAPA Auto Parts impresses you, write us. No phone calls please. Send resume and 10 of your best radio spots to:

Mr. Bob Jump, Executive VP  
Studio Center Corporation  
200 West 22nd Street  
Norfolk, VA 23517 E.O.E.

## DUPLICATION SERVICES

### CASSETTE TEK, INC.

SPECIALISTS IN PROMOTIONAL CASSETTES FOR ARTISTS—PRODUCERS—AGENCIES

- Highest quality custom blanks audio and video VHS cassettes
- Duplication of audio and video
- EMBOSSED on-cassette printing using the PRINT RITE system
- Direct mail services
- Reasonable pricing
- Fast service

1605 THOMASTON AVE.  
WATERBURY, CT 06704  
TEL. (203) 757-4848  
FAX (203) 756-8585

# Classified

## FOR SALE



**POP FILTERS**

**An absolute necessity for every studio**

**\$49.95 Includes screen, clamp, gooseneck and shipping**

Call or Write for Free Brochure

Outside CA (800) 446-7677  
Inside CA (818) 788-3635

**POPPER STOPPERS**

P.O. Box 6010—658, Sherman Oaks, CA 91413

DEALER INQUIRIES WELCOME

SATISFACTION GUARANTEED

**MILAM AUDIO**

**"THE SOURCE"**

SINCE 1967

CONSOLES  
MULTI-TRACKS  
MONITORS

D.A.T. • AMPS  
EFFECTS • MICS  
USED EQUIPMENT

1470 Valle Vista Blvd.  
Pekin, IL 61554  
(309) 346-3161  
800-334-8187  
FAX 309-346-6431

**Harrison MR-4 Console**  
36 Inputs. Excellent condition.  
Large patchbay; producer's desk;  
Lots of Extras!  
**\$32,500**  
**312-664-5353**

**3M**  
Audio, video & digital tapes  
Full line of accessories  
DAT recorders.  
Orders shipped within 24 hours.

**R & M PRO AUDIO**  
1080 Pacheco, S.F., CA 94116  
(415) 665-8480

**PROFESSIONAL 24-TRK STUDIO  
in Van Nuys, CA**

Close to Hollywood, Burbank, Beverly Hills and Los Angeles. 3,750 square feet. 7½ years left on the lease. Solid client base. Many gold and platinum records. Call and leave message:

**818-360-4589**

**Portable Sound Panels**



- Isolate specific areas
- Many sizes and options
- Panels start at \$19.95/ea. Complete w/foam

**Island Cases** Write for free catalog  
1121-I Lincoln Ave., Holbrook, N.Y. 11741  
800-343-1433 • In N.Y. 516-563-0633

**ACOUSTIC FOAM**



**GIANT 54" x 54"**  
**\$19.99**  
Per Sheet!!

**KILL NOISE QUICK!** Soundproof studios, rehearsal spaces, vans, rooms with super-effective, E-Z mount, 2" thick studio gray or natural blue (specify color) Markerfoam offers outstanding sound absorption qualities. Immediate shipping. Add \$3.50/shipping. NYS residents add 7% tax. MC/Visa • Amex. COD/Check Terms 3-Inch sheets also available at \$29.99.

**800-522-2025** America's most unique  
(In NY 914-246-3036) catalog for audio & video!

**MARKERTEK™**  
145 Uster Ave. Saugerties  
New York 12477 U.S.A. **VIDEO SUPPLY**



**Reliable**

No Fancy Ads  
Just Good Service & Prices  
All Major Lines

**704 375 8662 Ext 737**

**Brand New 19" ADC  
tt Patchbay Panels**

Balanced/normalled, 144 points each.  
Cost \$300—Sell \$175 each, 2 for \$300 or  
3 for \$400.

Call Roger Cordell  
(818) 763-8301

**db ENGINEERING new specials  
from the oldest broker in the East.**

**PROCESSING; TUBE-TEC, Aphex, Massenburg, Sontek, Orban, Eventide. MONITORS: TANNOY, Klipsch, Auratone. AMPS; Crest, Hafler, Ashley all @ best prices. db is also your source for; Klipsch, AKG, Neumann, Adams-Smith, Beyer, Studiomaster, Sennheiser & most major brands. Call for quotes.**

Phone (617) 782-4838  
Fax (617) 782-4935

**48-TRACK RECORDING SUITE  
IN THE HEART OF HOLLYWOOD**

Neve-Studer-Sony—Adams/Smith  
huge control room w/Mac sequencing  
many synths, outboard processing,  
flexible patchbay & sync-to-video  
many extras — \$665K

**(213) 461-0734**

**Circle (40) on Rapid Facts Card**

**E.A.R.S.™, Inc.**  
**STUDIO SPECIALISTS**  
(617) 783-5229

- Studio Design
- Acoustical Consultation
- Turnkey Installations
- Custom Electronic Engineering
- Studio Maintenance Services
- TEF™ Room Analysis
- Pro Audio Equipment Sales
- Custom "Production" Furniture

**E.A.R.S.-THE STUDIO DESIGN  
and INSTALLATION COMPANY**

15 Years of Design & Installation  
Experience Assure High Performance

System Layout, Cable Harnesses  
Custom Patchbays, Wall Panels,  
Cue Systems, Modifications, Service

Many famous brands of Pro Audio  
Equipment - from Analyzers to XLRs  
API to White...A FULL SERVICE Company!

Leasing Options / Mastercard / Visa  
CALL for our company brochure.  
Boston, MA (617) 783-5229  
FAX (617) 254-8781

**E.A.R.S.™, Inc.**

**You, too, can get more sales leads  
for fewer classified dollars!!**

Combine R•E•P's—

Lowest industry rates—\$35/column inch  
Targeted circulation—Pro-audio engineers and producers and . . .

**You'll get more leads for your money!**

Call Renée Hambleton regarding Classified Advertising at 913-888-4664 and enjoy these benefits plus the new bordered format.

Circle (41) on Rapid Facts Card

**FOR SALE, con't.**

# MICROPHONES

**Best Price On...**

AKG C-414B/ULS  
EV PL-20  
Milab DC-96B  
Neumann U-87a  
CAD Equitek II

## OPUS

4262 GRAND, GURNEE, IL 60031  
**1-800-522-6787**

### WE'VE MOVED

to a new, larger facility.  
Call us to see what's HOT  
in the latest Used Equipment.  
B.A.E., Inc., (BLEVINS AUDIO EXCHANGE)  
**1-800-899-2234**  
Ask for Randy or John



DO YOURSELF A FAVOR  
**CALL NOW!**  
**(318) 989-1000**  
4416 Johnston St., Bldg., 9A  
Lafayette, LA 70503

**FOSTEX RECORDING EQUIPMENT**  
**MACINTOSH & IBM Computers**  
& compatibles  
MUSIC SOFTWARE  
Monitors & Printers  
**DISCOUNT PRICES**  
**DATAWARE, INC.**

(we ship world wide)  
P. O. Box 1122  
Hollywood, CA 90078-1122  
(818) 996-1161



*Audio Transformers*

**Reichenbach Engineering Co., Inc.**

*SPECIALISTS IN QUALITY AUDIO TRANSFORMERS*

6887 Farmdale Avenue - Building 10  
North Hollywood, CA 91605  
(818) 765-6040

In 1989, Madisound Speaker  
Components processed 20,000  
orders.

**VIFA DYNAUDIO**  
**FOCAL MB QUART**  
**PHILIPS AUDAX**  
**EUROPA PEERLESS**  
**MOREL SOLEN**  
**KEF ETON**  
**PERFECT LAY**  
**SIDEWINDER**  
**ELECTROVOICE**  
**SLEDGEHAMMER**

Shouldn't your business take  
advantage of these fine  
product lines?



Madisound Speaker Components  
8608 University Green  
Box 4283 Madison WI 53711  
Phone: 608-831-3433  
Fax: 608-831-3771

**Custom Cases Acoustic Foam Custom Stands Studio Furniture**



Request Catalogue 800-343-1433, 516-563-0633  
Island Cases, 1121-20 Lincoln Ave., Holbrook NY 11741

## American Pro Audio

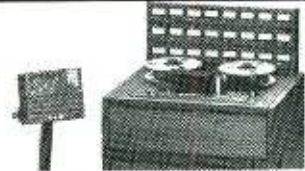

- Sony/MCI • Trident •
- Tannoy • Eventide •
- Yamaha • Tubetech •
- Fostex • Soundtracs •
- Beyer • Roland • Akai •
- Ramsa • Panasonic •

### Mini Lease Program

New or used, trade-ins 24-60  
months with buyout option  
\$5K-25K **no** financials  
required min. 2 yrs in business.

**1-800-333-2172**

### NEW, USED, DEMO EQUIPMENT

TRIDENT, SOUND WORKSHOP,  
AMEK/TAC, SOUNDCRAFT CONSOLES,  
TASCAM MSR-24, DIGIDESIGN SOUND  
TOOLS, TASCAM DA30 DAT, ROLAND  
R880, EVENTIDE H3000SE, DYAXIS  
320MEG, TASCAM RDAT's, CAD CON-  
SOLES, TAC MAGNUM, ROLAND S770,  
D70's, ROLAND/AKAI SAMPLERS.

COMPETITIVE PRICING • UNCOMPROMISED  
SERVICE • LEASING SPECIALISTS • EXPERIENCED  
STAFF • INSTALLATION/SYSTEM DESIGN

**EAR PROFESSIONAL AUDIO/VIDEO**

**(602) 267-0600**



214 Lincoln St.  
Suite 103C  
Boston, MA 02134

The oldest broker on the East Coast !!

PHONE (617) 782-4838  
FAX (617) 782-4935

### WE NEED YOUR CLEAN USED 24 TRACK !!!

SL4048E 3 yrs, recall, \$190K; 4064G 3 yrs, mint, call; 4056E/G LH patch, call;  
6064E/G VU, \$275K; Neve 8128, 48 in 56 fr w/Necam \$175K; 4000E Modules,  
\$3.3K. Amek, API, Neve, Trident, Call. 24+Tracks; Studer A800 MKIII, \$38K  
MCI JH24 lo hrs, \$20K; Mitsubishi X-850, call; 3M dig 32tr, \$35K; Otari MTR90,  
MX-80 many, call. Otari MX5050BII, \$1.7K; Pultec pre/eq, \$1.4K; EQP1A, \$1.8K  
Neumann U-89s from \$1.1K; KM-84, \$550/2; Telefunken ELAM 251 mint, CALL;  
AKG C12A (tube), \$1.5K; C414EB/BULS, \$650. dbx noise reduction in stock.

List Your For-Sale Items Free !! Otari & Tascam authorized service  
All major brands available new at great prices!!

# Classified

## FOR SALE

### The Studio POP Filter

*A Great Improvement on a Good Ideal*



Open up the sound of your vocals and voice overs without annoying "POPS" ruining your best take!

- Standard mic stand adaptor with threaded brass insert
  - One piece plastic rims, 5" diameter—in sky blue or black
- Only **\$24.00**  
With optional Clamp and Gooseneck \$44.95

ONE YEAR GUARANTEE

**AUDIO VISUAL ASSISTANCE**  
565 Sherwood Road,  
Shoreview, MN 55126  
Phone: 612-481-9715

Circle (43) on Rapid Facts Card

### dbENGINEERING

Call and ask why the consoles by ARIES are the industry's best buy !!

English quality for less \$\$\$ than Trident, Soundcraft or TAC !! Prices for 16/8/16 start under \$5,000. New modular range 24/8/16 w/meters, 4 band EQ and 8 sends from \$12,500. Call for 8/12 buss, 16/24 monitor pricing up to 40/12/24.

Phone (617) 782-4838  
Fax (617) 782-4935

### CUSTOM MIDAS CONSOLE

Ex-Oscar Peterson, 16 x 8 recording, 8 PRO5, 8 PRO3 w/updated amps, Remix option, 6 LED option, NTP peak meter, patch bay, flight case. \$9,500.

Hank (916) 284-6929

### Manhattan Recording Studio and Luxury Apartment For Sale

Established studio. 24 tracks +. Excellent acoustics, looks great, wired and ready to go. Also has MIDI room, office, shop, lounge and storage. With or w/o equipment. Four bedroom, 2 1/2 bthrm apartment in same building. Spacious living rm and dining rm. Sunny. Sold separately or together. Qualified buyers only.

(212) 362-7840

### HILL AUDIO CONCEPT SERIES

Demo consoles used for trade shows only. Configurations available for recording or reinforcement: Series 4400 40/8/2 with 4 VCA groups and 8x8 matrix, Series 8400 32/24/24 with full patchbay, and Series 8400 36/24/24 with full patchbay. All consoles in excellent condition and with full warranties.

National Sound Engineering  
(404) 447-0101

### SYNCLAVER

32 Poly - 8 FM - 8 out, 16 meg RAM, 240 meg storable, clock module. 2 x 8 MIDI, VP keyboard w/custom Formica console cabinet. Mint condition. \$65,000.

516-669-1872

## "World Class" Tapes & Duplicating

Agfa BASF 3M

- Digital Audio Tape (D.A.T.) In Stock
- Analog Tape, Audio Accessories
- Phone In Order, Ship Same Day
- Great Quality — Great Price
- On-Shell Printing

Call us at

**(800) 365-0669**

for prices on tapes & duplicating

## World Class Tapes

Audio Tape Distributors & Duplicators

670 Airport Blvd., Suite 1  
P.O. Box 7611

Ann Arbor, Michigan 48107  
(313) 662-0669 (within Michigan)

Circle (44) on Rapid Facts Card



On-Line MIDI Production Support for:  
• ATARI ST • COMMODORE/AMIGA  
• APPLE/MACINTOSH • IBM/COMPATIBLES

#### ECM™ FEATURES:

- PROGRAMS • WORLD-WIDE
- PATCHES • E-MAIL SYSTEM
- SAMPLES • AND MUCH MORE!

Call or write for more information:

**EAST COAST MIDI™**

21 September Street • Coram, New York 11727

**1-800-736-0181 (voice info) 9am-5pm EST**  
**516-928-4986 (data) 24 Hours**

• R•E•P's total readership of over \*50,000... .

• low, low rates of only \$35/ column inch... .

and

• readership studies show average magazine retention of over 2 years for longer exposure of your ad message

—means you get results for a very small investment!—

Call Renée Hambleton at 913-888-4664 to place your classified ad in the very next available issue.

### THIS IS THE 90'S.... DO YOU NEED DIGITAL ?

**anything audio** offers a full range of professional Digital Audio products for every application and budget. Let our staff of sales engineers and technicians design a system to meet your facilities needs, from R-DAT to multi-track digital, new or used we have what you need to get the job done easily & cost-effectively. We carry a complete line of new & used audio and video equipment with prices and services unmatched nationwide. Call today and start saving time and money now! Take a look at some of our quality product lines...

ALPHA AUDIO DR-2 Hard Disk Recorder & Boss-2 Editing System • AUDIOMATION Moving Fader Automation • DIGITAL DESIGNS • AUDIO-KINETICS-MASTER MIX II Automation • AKG • VALLEY • T.C. ELECTRONICS • BSS • SOUNDTRACS PLC • KLARK-TEKNIK • NEOTEK • EVENTIDE • HAFLEK

USED SPECIALS - API 32x16x24 w550aCALL-MCI JH-24-\$23.5k • 4 AKG C-60 Tube w/6 caps-\$2.5k • Studer A820-24 1 yr. \$65k • Sony APR-24 Like new \$37.9k-Mits X-850 \$87k-Neumann U47Tuba-CALL • MCI-428 20 in. -\$6.5k-AMS Audiofile Loaded \$55k • Many Tascam MS-16 \$5-7k • Fairlight II \$7.5k • Quantec QRS \$6k • 2-Pultec EQP1 \$1.9k • Tascam M-520 (New) \$4.5k • WE WANT YOUR USED AND TUBE EQUIPMENT-CASH PAID!!! List your 4-sale equip w/us FREE!!

## anything audio

professional audio and video systems  
Equipment Sales System Design Installation

THE DIGITAL AUDIO SOURCE  
NEW • USED • RARE • BUY • SELL • TRADE  
PHONE 617-426-2875 FAX 617-426-2763  
63 MELCHER STREET BOSTON, MA 02210

Circle (45) on Rapid Facts Card

**FOR SALE, con't.**

**EQUIPMENT FINANCING  
"LOANS BY PHONE"**

- NO FINANCIALS REQUIRED FOR TRANSACTIONS UNDER \$35,000
- NEW OR USED EQUIPMENT
- \$2,000 TO \$200,000
- NO DOWN PAYMENT
- SALE-LEASEBACK EQUIPMENT FOR WORKING CAPITAL

TO APPLY OR REQUEST  
ADDITIONAL INFORMATION  
CONTACT MARK WILSON

**ENF** EXCHANGE NATIONAL FUNDING (800) 342-2093  
FAX: (214) 235-5452

**THOUSANDS OF PIECES  
OF USED GEAR**

Ocean Audio Must Sell **280** Consoles, 68-Multi-Track Recorders and thousands of pieces of Audio and Video equipment at **LOW clearance prices**. To list your equipment **FREE** or receive custom listings from us,

Call Toni or David at  
(213) 459-2743 or Fax 454-6043



VIDEO/AUDIO/RF  
Buy • Sell  
Consign • Service  
Over 3000 items  
in inventory  
Burbank, CA 818.845-7000  
New York, N.Y. 212.268-8800

Circle (48) on Rapid Facts Card



Ask for  
**The "DATAFILE"**

Equipment reviews, buying guide, new & used deals. Chicago's source for PRODISK Hard Disk Recorder; OTARI; SUMMITT; TANNOY; NEUMANN; API; SOUNDCRAFT; SONY & PANASONIC DATS; J.L. COOPER; ADAM-SMITH; TIMELINE; MEYER; AKAI; LEXICON

Chicago's Leading  
Pro-Audio Dealer  
708-339-8014

Harrison MR3, Soundcraft 600, Steinway M (1927), UREI 539s, RX5, DPX1, MSB+, Masterbeat, Crown DC300, DC150, EV Sentry 100As, JBL 4401s, Bel BD80, Orange County Comp/Imtr, dbx 161, Ampex 350/Inovonics 2 tk, Pioneer RT1050 2 tk, Crown PZM, MXR ddl. . . . . (212)362-7840

**GET YOUR CABLES  
TOGETHER**



Circle (46) on Rapid Facts Card

**RECORDING STUDIO EQUIPMENT**

- E-MU EMAX II Keyboard \$4200.00
- E-MU Emulator III 4 meg \$6999.00
- Meyer 833 monitor system \$3800.00
- Fostex E2 (2 track) \$2800.00

**TEKCOM CORPORATION**

1020 N. Delaware Ave., Philadelphia, PA 19125  
215-426-6700

**STUDIOWORKS**

Recording & Broadcast Equipment

**FACTORY DIRECT PRICES  
ON 3M & AMPEX TAPE**

AKG	EVENTIDE	RAMSA
ART	JBL	OTARI
DBX	LEXICON	VALLEY INT'L
EV	NEUMANN	OTHERS

**SONY**

Professional Audio  
(800)438-5921 / (704)375-1053

**THE PRO AUDIO SOURCE**

AKAI ADAM  
ALPHA AUDIO  
AMEN/TAC  
APHEX  
BROOKE-SIREN  
BRUEL KJAER  
BRYSTON  
CROWN

DOLBY  
DRAWMER  
DYAXIS BY STUDER  
EVENTIDE  
JBL/UREI/SOUNDCRAFT  
KLEARK-TEKNIK  
LEXICON  
MEYER SOUND

NAKAMICHI  
NEUMANN  
OTARI  
RAMSA  
SONY PRO AUDIO  
SOUNDTRACS  
SUMMIT  
TANNOY

T.C. ELECTRONICS  
TIMELINE-LYNX  
YAMAHA PM-3000  
ANALOG, DIGITAL, DAT,  
& PCM RECORDERS  
ALL FORMAT CONSOLES  
NEW & USED



**Washington  
Professional  
Systems**

11157 VEIRS MILL RD  
WHEATON, MD 20902

TEL: 301-942-6800  
FAX: 301-946-3241

Circle (47) on Rapid Facts Card

**Stamp Out SCR  
Buzz. Forever.**

Diff amps may work - when far from SCR dimmers and RF transmitters. When you're up close, you'll need a good transformer.

**jensen transformers**  
INCORPORATED

10735 Burbank Blvd. • North Hollywood, CA 91601  
FAX (818) 763-4574 Phone (213) 876-0059  
TELEX 6502919207 MCI UW  
(Mon-Thurs, 9am-5pm Pacific time)

Circle (49) on Rapid Facts Card

# Classified

## SERVICES

**KDISC**  
mastering

**COMPLETE MASTERING SERVICES:**  
DMM and Lacquer Cutting

**COMPLETE DIGITAL SERVICES:**  
Editing, Format Conversion, CD Preparation  
6550 Sunset Boulevard, Hollywood, California 90028  
(213) 466-1323 • FAX: 213-466-7237

**REAL TIME CASSETTE DUPLICATION  
AT HIGH SPEED PRICES.**

1000 C-24 (or less) chrome tape with direct printing on clear shells, full color inserts and shrinkwrap at the low price of \$998.00.

**FASTTRACK RECORDS**  
4220 Broadway, Denver Colo. 80216  
(303) 292-2115

**RCA MICROPHONES**—Repair service on all models. Complete sound and cosmetic restoration. 35 yrs. experience with RCA. ENAK Microphone Repair, 420 Carew Avenue, Pitman, NJ 08071. (609) 589-6186.

**MAGNETIC RECORDING HEADS**—RELAP/REPLACE-MENT for Audio, Video, Time Code, Duplication. 29 years of head design experience. IEM, 350 N. Eric Dr., Palatine, IL 60067; tel (708)358-4622.

**LOUDSPEAKERS—EXCLUSIVE**  
East Coast Authorized Center Professional-High Fidelity Warranty/Non Warranty Repair. Four Day Turnaround For Stocked Kits. All Work Done By Factory Trained Technicians.

**PRICE STEVENSON ACOUSTIC RESEARCH**  
1591 Broad Run Rd., Downingtown, PA 19335 (215) 383-1083

**STUDER  
REVOX**

**FACTORY AUTHORIZED SERVICE CENTER  
"SUPERLATIVE SERVICE"**

Swiss trained in servicing all open reel and cassette tape recorders, CD players, and other Studer/ReVox equipment. Over 12,000 units serviced Nationwide since 1978. Fast 48-72 hour service w/90 day warranty. Huge parts inventory. Capstan shaft resurfacing & head relapping service. New & used machines available w/warranty. Visa/MC.

**STUDIO-SONICS CORP.**  
2246 N. Palmer Dr., #100  
Schaumburg, IL 60173  
Phone: (708) 843-7400  
FAX: (708) 843-7493

**ALIGNED AUDIO INC.**  
**SUPER QUALITY**

- ▶ Audiophile Record Pressing
- ▶ CD Replication
- ▶ Real Time and High Speed Cassette Duplication
- ▶ Direct On-Shell Imprint in Colors

**COMPLETE PACKAGES**

Call Today for your Free Catalogue

☎ **1-800-869-6561**  
OR **1-718-788-6969**  
FAX **1-718-499-0421**

Circle (50) on Rapid Facts Card

**DISC \*\*MAKERS**

- Cassette Duplication
  - Record Pressing
  - CD Replication
  - Video Duplication
- Complete Packages



**CALL FOR OUR FREE FULL COLOR CATALOG**  
1-800-468-9353 (in PA: 215-232-4140)

**DISC \*\*MAKERS**

1328 North 4th Street  
Philadelphia, PA 10019

**TRAINING**

**READY TO  
IMPROVE YOUR  
RECORDING  
SKILLS?**

**THEN SIT NEXT TO A TOP FLIGHT  
ENGINEER AS HE DEMONSTRATES  
ALL THE ELEMENTS THAT GO  
INTO GREAT RECORDING**

The *SHAPING YOUR SOUND* series is five indispensable new videotapes covering multi-track recording, mixing, signal processing and microphones. They bring better studio technique to life using the power of video to do "WHAT NO BOOK ON THE SUBJECT HAS EVER BEEN ABLE TO ACCOMPLISH!" (Mix Magazine)

Every tape is packed with demonstrations and examples that cut through time consuming book study and get you down to better recordings.

**CALL FREE TO FIND OUT MORE  
ABOUT SHAPING YOUR SOUND,  
THE PROFESSIONALS' TRAINING  
PROGRAM.**

**1-800-777-1576**

FIRST LIGHT VIDEO PUBLISHING  
374 N. Ridgewood Place, L.A., CA 90004

Circle (51) on Rapid Facts Card

## RENTAL EQUIPMENT

*Check This Out !!*

**Rack Attack™**  
∞ Audio Processing Systems ∞

**Lexicon 480L**  
**Lexicon PCM-70**  
**Lexicon PCM-42**  
**Eventide H-3000**  
**Yamaha SPX-1000**  
**Yamaha REV-5**  
**T.C. 2290**

*All 7 devices*  
**\$165/day**

All systems include  
remote patchbay

**Outboard Rentals**  
**(818) 998-1024**

Hollywood, CA

Circle (52) on Rapid Facts Card

**HI-TECH AUDIO SYSTEMS INC.**

The national specialists in Live Pro Audio Mixing Console & Signal Processing equipment rentals. A wide selection of large & medium main frame consoles.

• Gamble • Yamaha • Soundcraft • Ramsa EFX and R-DAT units, available for national & regional tours, special events, & long/short term leasing.

**415-726-2428**

San Francisco — Orlando — Chicago



**ADVANCED  
AUDIO**

**Pro Audio Rentals**

- Digital Recorders
- Analog Recorders
- Dolby Noise Reduction
- Outboard Processing Gear

- Competitive Rates
- Well-Maintained Equipment
- Exceptional Service & Support

**(818) 985-6882**

11120 Weddington St., N Hollywood, CA 91601



## RENTAL EQUIPMENT

### A TOTAL EFFECT

Eventide H-3000 SE

T.C. 2290 (32 sec.)

T.C. 2290 (32 sec.)

T.C. 1210 spatial ex.

Publison Infernal 90

AMS S-DMX

AMS RMX-16

Eventide SP 2016

Lexicon 480L

480L Larc & Manuals

<New

Includes remote patchbay.

24 hr. service

7 days a week

All for \$300 a day  
or \$1200 a week!

(That's \$171.43 a day!)

Call for advance bookings today

**(818)345-4404**

Encino, CA

Circle (53) on Rapid Facts Card

## MISCELLANEOUS

### AUDIO AFFECTS

STUDIO EQUIP. FOR HIRE

Technician on staff 7 a.m. - 1 a.m.

Open 7 days a week

Digital Tape Machines,

Synclavier Systems,

Effects Processors, Reverbs

(213) 871-1104 (818) 980-4006

Ask For Mark

### THE MOST COMPLETE SELECTION OF

## AUDIO TEST TAPES

All formats including cassettes

Write or phone for free catalog

**STL**

STANDARD TAPE LABORATORY, INC.

26120 Eden Landing Road #5, Hayward, CA 94545

(415) 786-3546

Circle (54) on Rapid Facts Card

## EQUIPMENT WANTED

Wanted: Dead or alive. Pultec EQs; Fairchild & Teletronix limiters; Neumann, Telefunken, AKG, RCA, and Scheps microphones. Tube Macintosh or Marantz amps and pre-amps. Sontec, ITI, and Lang EQs. Neve or API equipment. Boxes of old tubes. UREI, Orban, United audio, dBx, and other outboard gear. Ampex ATR-102 or 104. Parts for MCI JH-110/114 recorders. Altec 604s/crossovers/Tannoy speakers, JBL 2231; Altec 288-H driver; misc. equipment of all types.

Please call Dan Alexander

2944 San Pablo Ave., Berkeley, CA 94702  
415-644-2363 Fax 415-644-1848

## EQUIPMENT WANTED

BUY OR TRADE  
YOUR USED MULTITRACK RECORDERS  
AND CONSOLES  
EAR PROFESSIONAL AUDIO/VIDEO  
(602) 267-0600

## FINANCING

### Lease Financial Consultants, Inc.

—\$50,000 with credit app. only

—Provides:

Off-balance sheet financing  
Tax benefits

—All types of equipment

—Nationwide leasing

We specialize in A/V equipment.

Call: (216) 882-6503

## MISCELLANEOUS

### ENDLESS WORD™

ADVERTISING PROMOTIONS

VOLUME IN STORE P.O.P. and TELEPHONE

ON HOLD MESSAGES

IDEAL FOR HI-SPEED or REAL-TIME

DUPLICATING



- Made in U.S.A. & Quality tested before shipping.
- Lengths from 20 sec. to 20 min.
- Special non-stretch tape.
- Plays vertical or horizontal.
- Clear case permits visual cuing.
- Ask about our new volume discount pricing & low cost endless cassette promotional players and new F.C.C. approved multi-line telephone adapter for messages on hold tape players.

**MANN ENDLESS CASSETTE INDUSTRIES**  
P.O. Box 1347 • San Francisco, CA 94101  
(415) 221-2000 Ext. 2  
Fax: (415) 387-2425

## Cassettes AS EASY AS . . .

- 1 REAL TIME DUPLICATION
- 2 HIGH SPEED DUPLICATION
- 3 CUSTOM BLANKS

### INTRODUCING:

Full Service Digital Editing  
and CD Compilation

ESP Means Quality Full Service  
Printing and Packaging, Friendly  
Professional Service, Competitive  
Prices, Fast Turn-Around and  
Highest Quality Raw Materials.

**ESP** EASTERN STANDARD  
PRODUCTIONS, INC.  
26 BAXTER STREET  
BUFFALO, NY 14207  
1-716-876-1454

1-800-527-9225

Phone  
*Renée Hambleton*  
for  
Classified Advertising  
Information

**(913) 888-4664**

# Advertisers Index

# Sales Offices

	Page Number	Rapid Facts Number	Advertiser Hotline
A Total Effect	71	53	818/345-4404
Agfa Corporation	9	8	201/440-2500
Aligned Audio, Inc.	70	50	800/869-6561
Ampex Recording Media	12-13	9	415/367-3809
Anything Audio	68	45	617/426-2875
Applied Research & Technology, Inc.	19	13	716/436-2720
Audio Engineering Society	48A-48B		212/661-8528
Audio Visual Assistance	68	43	612/481-9715
Bryco Products	58	29	818/783-9133
Canare Cable, Inc.	64	35	818/365-2446
Cintas Vac	61	32	904/445-5545
Cooper, JL Electronics	IBC	2	213/306-4131
Countryman Associates	58	28	415/364-9988
Crown International	53	25	219/294-8000
db Engineering	67	42	617/782-4838
Disc Makers	64	36	212/265-6662
Dolby	4	6	415/558-0200
E.A.R.S., Inc.	66	41	617/783-5229
Electro-Voice, Inc.	IFC	1	613/382-2141
First Light Video Publishing	70	51	800/777-1576
Fostex Corp. of America	55	26	213/921-1112
Full Compass	49,51	23,24	800/356-5844
Gauss	60	31	213/875-1900
Hardy Co.	47	21	708/864-8060
Illbruck	45	20	804/358-3852
Institute of Audio Research	62	33	800/544-2501
JBL Professional	BAC	3	
Jensen Transformers, Inc.	69	49	213/876-0059
KABA Research & Development	63	34	415/883-5041
Markertek Video Supply	66	40	800/522-2025
Neve, Inc.	1	4	203/744-6230
Otari Corp.	33	17	415/341-5900
Peavey Electronics Corp.	15	10	601/483-5365
Polyline Corp.	17	12	708/298-5300
Rack Attack	70	52	818/998-1024
Radian Audio Engineering, Inc.	43	19	714/693-9277
RPG Diffusor Systems, Inc.	59	30	
Russ Berger Associates	21	14	214/661-5222
Saki Magnetics, Inc.	57	27	818/880-4054
Sam Ash Professional	47	22	212/719-2640
Seam Tech	69	46	415/334-9511
Selco Products	17	11	714/521-8673
Sony Pro Audio	25,40,41		800/635-SONY
Soundcraft USA	35		818/893-4351
Standard Tape Laboratory, Inc.	71	54	415/786-3546
Switchcraft, Inc.	3	5	312/792-2700
Tannoy North America, Inc.	39	18	519/745-1158
Tascam Div./Teac Corp.	6-7	7	213/726-0303
Telex Communications, Inc.	29	16	612/887-5531
The Broadcast Store, Inc., (BCS)	69	48	818/845-7000
Trident USA Inc.	27	15	213/533-8900
Washington Professional Systems	69	47	308/942-6800
World Class Tapes	68	44	800/365-0669

## CLASSIFIEDS

*Renee Hambleton*  
913-888-4664  
9221 Quivira Road  
Shawnee Mission, KS 66215  
Telefax: 913-541-6697

## SANTA MONICA, CA

*Herbert A. Schiff*  
213-393-9285  
*Jason Perlman*  
213-458-9987  
*Kelly Daugherty*  
213-451-8695  
501 Santa Monica Blvd.  
Santa Monica, CA 90401  
Telefax: 213-393-2381

## CHICAGO, IL

*David Ruttenberg*  
312-435-2360  
55 East Jackson Blvd.  
Chicago, IL 60604  
Telefax: 312-922-1408

## NEW YORK, NY

*Stan Kashine*  
212-332-0600  
38th Floor  
888 Seventh Ave.  
New York, NY 10106  
Telefax: 212-332-0663

## OXFORD, ENGLAND

*Nicholas McGeachin*  
Roseleigh House  
New Street  
Deddington, Oxford  
OX5 45P England  
Telefax: (0869) 38040  
Telephone: (0869) 38794  
Telex: 837469 BES G

## FREWVILLE, SOUTH AUSTRALIA

*John Williamson*  
*Hastwell, Williamson, Rep.*  
*Pty. Ltd.*  
109 Conyngham Street  
Frewville 5063  
South Australia  
Phone: 799-522  
Telefax: 08 79 9735  
Telex: AA87113 HANDM

## TOKYO, JAPAN

*Mashy Yoshikawa*  
Orient Echo, Inc.  
1101 Grand Maison  
Shimomiyabi-Cho, 2-18  
Shinjuku-ku, Tokyo 162, Japan  
Telephone: 03-235-5961  
Telex: J-33376 MYORIENT

# How To Get The Perfect Mix.

With MAGI II Console Automation Series from J.L. Cooper Electronics.

The mix down process isn't what it used to be. Recording engineers are finding it increasingly difficult to maintain calm, creative control over both the console and the battery of outboard gear. As these demands escalate, the need for console automation is further amplified by the need for perfection. The MAGI II and MAGI III Console Automation Series from J.L. Cooper Electronics are designed to save you time, money and give you the ability to achieve perfection!

## Freedom Of Choice

Both MAGI II and MAGI III interface with virtually any console to provide precision SMPTE-locked automation for 8 to 64 channels. The MAGI II is an outboard system for the audio facility preferring "portable" automation that can be moved from desk to desk. The MAGI III is an internally installed system that uses the console's existing faders.

## Flexibility & Control

MAGI II memorizes fader, mute and other real time events. These events can be performed in as many passes as you wish, or you can work on the mix one section at a time, or even one track at a time. MAGI II can be used to automate effects sends and sub-groups as well as controlling your outboard effects processors. The MAGI II allows



MAGI II External System

a very complicated mix to be quickly constructed, edited, and refined in real time or off-line with absolute accuracy. In addition, these mixes can be saved to disk for future use.

## Fast, Intuitive & Transparent!

Every aspect of MAGI II has been designed for the working engineer. MAGI II features a straight ahead user-interface incorporating clean, uncluttered moving fader graphics that make it extremely easy to learn and use. Even a "guest engineer" can be up and running in 15 minutes!

## MAGI II and MAGI III Features:

Both the MAGI II and MAGI III feature high quality dbx VCA's for audio transparency. The MAGI II Controller reads and generates all SMPTE formats. The powerful software program runs on either a Macintosh or Atari computer.

standard music recording, to film, TV, broadcast, commercial and live sound. MAGI is automating consoles from Trident, Soundcraft, Allen & Heath, Harrison, D & R, Biamp, Neotek, Tascam, DDA, Soundworkshop, Soundtracs, AMEK/TAC and Ramsa.

## Guaranteed Satisfaction!

J.L. Cooper Electronics and its Authorized Dealers are confident that once you own MAGI II, you'll never go back to manual mixing again. So confident that we're putting our money where our mouth is. For a limited time, our participating dealers are offering a money back guarantee\*. If you're not totally satisfied within 30 days, return the system and they'll refund your money.

With the cost of perfection finally within reach, why wait? Call us today for the location of a dealer in your area. It's time to see what MAGI II can do for your mixes.

Mixes may be performed and edited in real time, or off-line with MAGI II's powerful cue list. Cut, Copy, Paste, Merge, Undo, Redo, and other precise numeric edit decisions are fully supported. Our MIDI Event Generator allows the recording and triggering of all types of MIDI events. Film and Video composers can take advantage of our hit list to spot cues in real time. No other automation system gives you this flexibility!

## The Bottom Line

Other manufacturers would like you to believe that an automation system must have a high price tag to be on the cutting edge. The MAGI II dispels that myth. The MAGI system with its wealth of professional features starts at just \$5,000.00, and it works! That's the bottom line.

MAGI is being used in a number of applications from

## The Video

You can preview the MAGI II with our video demonstration. This Video offers a complete overview of the system's operation. It's just \$13.95 and can be charged to your VISA or MasterCard. To order, contact J.L. Cooper Electronics at:

**(213) 306-4131.**

**JL COOPER ELECTRONICS**



# Turn Your Next Tour Into A Pleasure Cruise.



You know the feeling. Another night, another show. And you've got a few hours at best to get your system up and running. Imagine how much easier your job could be if every component in your system had been originally designed to work flaw-

lessly with each other. From power amps and signal processing to monitor and house mixing consoles to the loudspeaker systems themselves.

With a perfectly matched system, your next tour could be a pleasure cruise. Well, the same thought has occurred to us, too. The advantages are unmistakable.

Our concept is one of a fully integrated system, incorporating JBL, UREI, Soundcraft and Seck products. The payoffs include fast set-up and tear-down, effortless soundcheck, superb performance, maximum dependability and total support from your JBL dealer backed by a company that cares about how you sound.

So, before you make any final decisions about your sound reinforcement system, whether you're starting from scratch or adding on, stop by your JBL Professional dealer. Let them show you a pure JBL system and get ready to cruise through your next tour.



Soundcraft SECK

JBL Professional  
8500 Balboa Boulevard, Northridge, CA 91329

 A Harman International Company