

August 1988

Recording ENGINEER/PRODUCER

The Applications Magazine for Audio Professionals

\$4.00

AN INTERTEC PUBLICATION

Studio Design

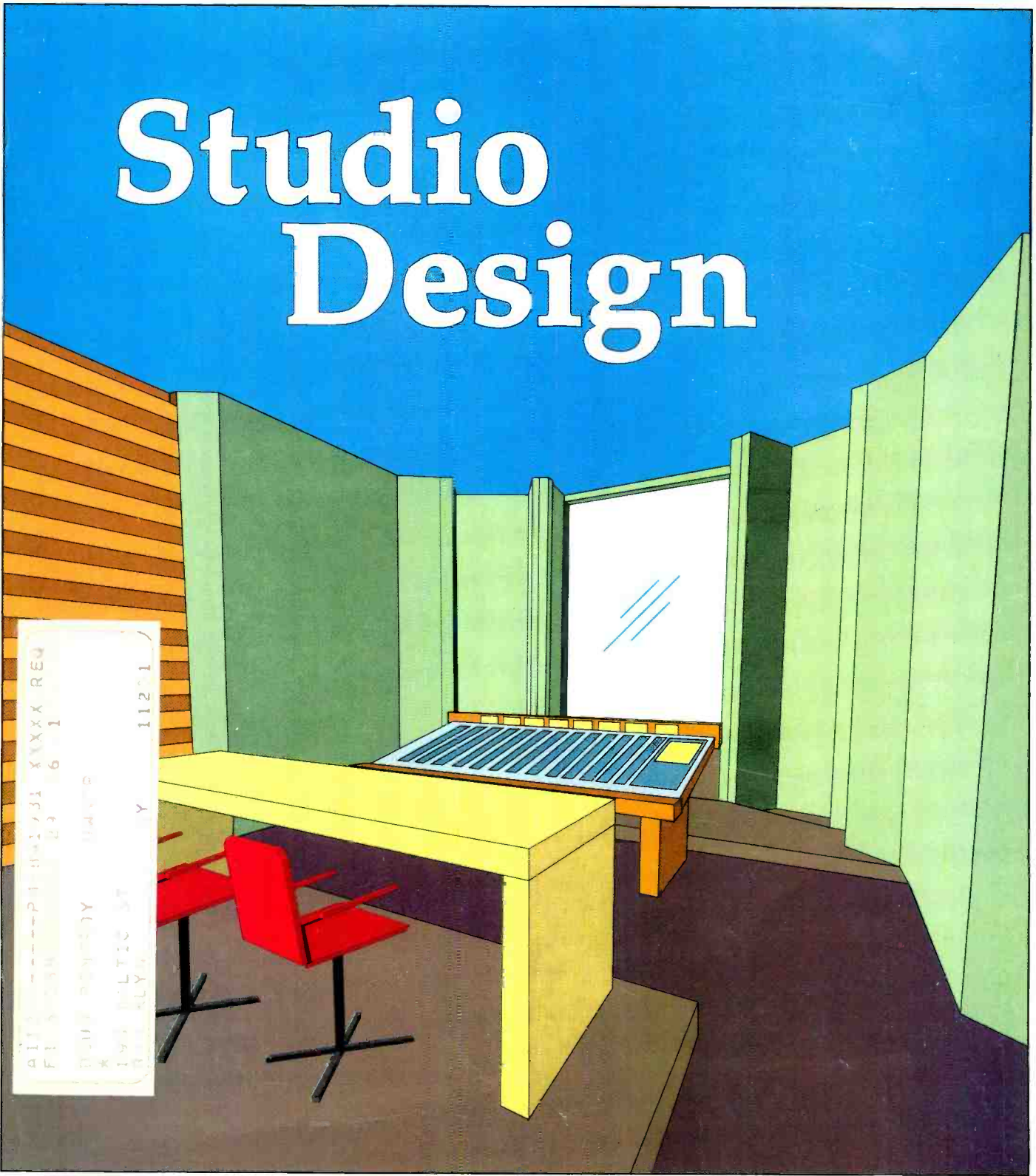

A112 ---P1 041731 XXXX REQ
F1 034 03 6 1
* 0000 0000000Y 000000
198 JUL TIC ST
TULY Y 11201

TOTAL AUDIO BRILLIANCE



- Up to four incredible studio sounds simultaneously!
 - Reverberation
 - Arpeggiated Effects
 - Reverse Gates
 - Easy to use front panel controls
 - 200 user memory locations
 - Over 100 studio-crafted presets
 - Fully programmable
 - Full parameter control
 - Random access keypad
 - Ultra-wide bandwidth
 - Full midi with battery back-up
 - Remote footswitch jack with preset increment
- Pitch Transposition
- Digital Delays
- Pitch Shift Doubling
- Chorusing
- Imaged Doubling
- EQ



Total Audio Brilliance! ART takes digital processing into the 21st century. Four effects at the same time. Full parameter variability. Thirty-two character LCD for operational simplicity. Create custom programs. Stack multi-effects. Store them in 200 memory locations! ART's NEW ultra-high resolution circuitry yields audio performance unequaled at any price.



We Put It All Together...

Applied Research & Technology
 215 Tremont Street
 Rochester, NY 14608
 (716) 436-2720
 TELEX: 4949793 ARTROC
 FAX: (716) 436-3942

Circle (1) on Rapid Facts Card

Export Distributors:

THE NETHERLANDS/Audioscript B.V./Soest/02155-20400/FINLAND/MS-Audiotron/Helsinki/90-5664644/SWEDEN/Muskantor & Co./Molndal/031-878080/ FRANCE/High Fidelity Services SA/Paris/(1) 42.85.00.40/CANADA/Yorkville Sound LTD./Scarborough/416-751-8481/ITALY/Ital C.I.D.A. SPA/Parma/0521 690158/ WEST GERMANY/PME Audio/Hauffweg/07136-6029/SWITZERLAND/Musikengros P. Gutter/Sissach/061-983757/HONG KONG/Audio Consultants LTD./Kowloon/ 3-7125251/JAPAN/Kanda Shokai Corp./Tokyo/(03) 254-3611/THAILAND/Beh Ngiep Seng Musical Instruments/Bangkok/222-5281/INDONESIA/PT Kirana Yudha Teknik/Jakarta/3806222/SINGAPORE/Lingtec PTE. LTD./7471951/SPAIN/Aplicaciones Electronicas Quasar SA/Madrid/6861300/TURKEY/Kadri Cadmak/Istanbul/ (1) 1661672/AUSTRALIA/Hi-Phon Distrib. Pty. LTD./Chatswood NSW/024177088/DENMARK/M.I. Musik/Kobenhavn/1-854800/U.K./Harmon U.K./Slough/075376911/NEW ZEALAND/Maser Digitek/Aukland/444-3583/4/ISR AEL/More Productions/Tel Aviv/03-454003-442697/ARGENTINA/Lagos Sarmiento/ Buenos Aires/40-6455

Simple Intelligence



Let's assume that results are what's important, not which tools you use.

Audio production is at least as much art as science; there will always be those who ascribe a magical aura to certain pieces of equipment. But if your client list is built on quality and consistency rather than techno-voodoo, the DCM 232 in-line console with CAT automation can give you more of both.

You need more console, not more headaches.

You're working for more demanding clients, on bigger projects, with tighter deadlines. You need greater flexibility, expanded features, enhanced performance. What you don't need is a "mega-star" console—or the jumbo mortgage that goes along with it.

DDA's AMR 24 has already set new standards of audio performance and versatility in the "classic" split configuration. Now the in-line DCM 232 combines the accuracy of digital-quality audio, the flexibility of digital control and the capacity to handle a pair of synchronized digital 32 tracks.

CAT Central Automation Terminal: engineered to speed your work flow.

The DCM 232's Central Automation Terminal controls one of the most ingenious automation systems ever to shorten a mixing session. Along with the precise fader and muting control you'd expect, the CAT system includes advanced functions like *Channel Copy* that lets you duplicate a channel's signal flow as many times as you need to. The computer will recall a "snapshot" of most console switch settings manually or via SMPTE code.



With all of its convenience functions, this CAT won't leave footprints all over your tracks. The DCM 232 maintains an overall dynamic range of 100 dB with at least 22 dB headroom at each stage, thanks to exacting calculation of every circuit component.

A console investment that instantly doubles your returns.

Each of the DCM 232's channels, including the *four band EQ section*, can be split during mix-down. So a 56 channel frame can handle as many as 112 inputs from samplers, synths and digital storage media. You'll probably run out of control room space before the DCM 232 runs out of inputs.

The advantages of the DCM 232 in-line console with CAT automation are explained more fully in our brochure.

To get a copy, write on your letterhead to the appropriate address below.



DDA DCM 232 

Klark-Teknik Electronics Inc., 30B Banfi Plaza North
Farmingdale, NY 11735 (516) 249-3660

Unit #1, Inwood Business Pk., Whitton Rd.
Hounslow, Middlesex, UK TW3 2EB
01 570 7161

Circle (4) on Rapid Facts Card

www.americanradiohistory.com

CONTENTS

Studio Design

Acoustic Design: Noise Control

Noise control is the science of reducing noise and vibration transmission through a building's structure or boundary surfaces.

By Vin Gizzi..... 49

Studio Design: Ergonomic Considerations

Ergonomics is defined as the relationship between workers and their environment. Good ergonomic design can encourage creativity and streamline the work flow.

By Andy Munro and Michael Fay... 59

Basic Design Factors for Remote Recording Facilities

Weight, suspension, console orientation, and stringent ergonomics are examples of the unique considerations needed for the mobile environment.

By Christopher Danley and Patrick Murray..... 63

CAD Facility Design

The ability to integrate many disciplines and functions—such as project and facilities management, and engineering design—makes the CAD workstation an invaluable tool in systems design.

By Curtis Chan..... 68

HVAC for Audio Facilities

A well-designed AC system will keep the temperature, humidity and air quality at comfortable levels for your clients and optimal levels for your equipment.

By Jeff Blenkinsopp..... 72



Other Features

Facility Profile: Lucasfilm's ► Skywalker Ranch

The capabilities of the Technical Building were arrived at by determining the requirements of making five stereo feature films a year.

By Larry Blake..... 20

Nashville: Old Traditions, New Frontiers

This special project between RE/P and the Nashville Entertainment Association spotlights the elements that make Nashville a unique production center.

By RE/P and the NEA..... 33

Artificial Reverberation: Simulating Natural Acoustics

Proper use of digital reverb allows you to simulate natural acoustic environments, in addition to providing special effects in live situations and in the studio..... 75

Hands On: Audio Precision System One

The System One is a single monolithic test unit that is controlled by an external computer. The physical design is expandable, not only to the user, but to its designers as well.

By Jim Rogers..... 80

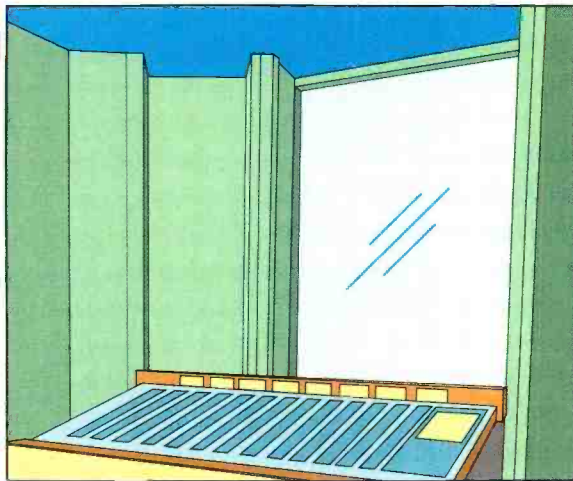

◀ Touring with a Reggae

Festival in Africa

Several West African nations were host to a series of outdoor concerts billed as the world's largest touring reggae festival.

By David Scheirman..... 83



Departments

Editorial.....	4
Letters.....	6-10
News.....	12
Managing MIDI.....	14
SPARS On-Line.....	16
Understanding Computers.....	18
Studio Update	
Talkback.....	90
Studio Update.....	91-92
New Products.....	93-94

◀ On the Cover

The use of CAD software for designing studio and remote facilities is a relatively recent development. The rapid evolution in this area is attributable largely to the increased power and lower cost of personal computers.

Volume 19, No. 8

RECORDING ENGINEER/PRODUCER is published monthly by Intertec Publishing Corporation, 9221 Quivira Road, P.O. Box 12901, Overland Park, KS 66212-9981. Second-class postage paid at Shawnee Mission, KS, and additional mailing offices. POSTMASTER: Send address changes to Intertec Publishing Corporation, P.O. Box 12901, Overland Park, KS 66212-9981.



Announcing a new product with serious repercussions.



As a sound engineer, you've heard it all. Now hear this. Yamaha, the leading manufacturer of drums and just about everything else musical, introduces not one but two professional drum microphones. The MZ204 and the MZ205Be.

The MZ204 is a dynamic microphone designed especially for kick, floor and bass drums, and anything bigger than a 13" tom.

Its counterpart, the MZ205Be, is a dynamic mike with a special beryllium diaphragm.

In case you forgot some of your high school chemistry, and who hasn't, beryllium makes for a lightweight yet rigid diaphragm. So it's perfect for high hats, snares, or tom-toms smaller than 13."

There are a few other elements, however, just as important as the microphones themselves.

One is that they've been mechanically designed and built from the cable up, specifically for drums. Not just by an engineer, but by an engineer who's a drummer. So they sound good with very little, if any, EQ.

And we know that a drum mike, no matter who made it, is absolutely no good if it's not in the right position. So we also painstakingly created our own pan and tilt mechanics and a sidemounted connector. Which not only lets you position the mike among all the other hardware, but keeps it out of the way at the same time.

The last element, of course, is you. Because a mix is often judged on the drum sound. And because specs, diagrams and calculated rationalization can't convey the hair-raising, toe-curling, goosebump rush you get when the drums finally sound just right.

That very feeling is available in the MZ204 and MZ205Be, and at your Yamaha Professional Audio dealer. So drop on by and give them a listen.

The mikes won't skip a beat. But your heart just might.

Yamaha Music Corporation, Professional Audio Division, P.O. Box 6600, Buena Park, CA 90622. In Canada, Yamaha Canada Music Ltd., 135 Milner Avenue, Scarborough, Ontario M1S 3R1.

YAMAHA
Engineering Imagination™

Circle (5) on Rapid Facts Card

www.americanradiohistory.com

Alternative Design Options

Acoustic and architectural design make up a very important element in the functional and aesthetic success of a recording studio. Sonic, ergonomic and economic elements are ideally balanced in a cohesive environment used for critical recording and listening, as well as being used as a creative habitat.

There are a number of philosophies surrounding the issue of studio design. They range from the attempted development of a "perfect" listening environment into which people and machines are placed to the "ideal" ergonomic environment, around which acoustic treatment and hardware exist. Unfortunately, there are trade-offs with each.

Although basic laws of physics must be considered, no single "right way" exists to design and build a good-sounding studio or control room. Even slight changes in the physical space will result in a different-sounding environment. In fact, two rooms built from the exact same plans will result in environments sounding somewhat different because of disparities in finish materials, furniture and audio hardware.

While this may seem like an unfortunate situation, it is really one of the wonderful aspects of acoustics. An *artistic* threshold to studio design exists that is not fully revealed until after the first few recording projects are in the can.

The art of acoustic design has evolved through many generations. First, there were theaters and other live performance venues. Next were large, lively studios of the early radio days. These were followed by an era of the first purpose-built recording studios that were often smaller versions of the radio halls.

From the late 1960s through the 1970s, the development of multitrack recording caused a radical change in recording-studio design philosophy. In many ways, this era was the "dark ages" of recording. Nearly anechoic rooms were built so that sounds could be captured as discrete elements. Producers wanted to have total control over each instrument, and the multitrack machine provided the storage

medium to capture the individual performances for later manipulation.

For those of you who missed this period in recording history, there was no harder environment in which to get good, natural sounds than in a studio with an RT₆₀ of half a second or less.

Thank goodness we are now pretty much out of that era and have moved on to some very "live" and exciting times. In both the studio and the control room, designers are developing ways to keep the life in the room acoustics and control the reverberant fields through geometry, diffusion, active trapping and various construction and finish materials.

So far, so good. But as technology leads us into the all-electronic media, the designer/acoustician faces new challenges. Specifically, as production control rooms become significantly larger and incorporate computer-based MIDI workstations, it becomes increasingly difficult to fill the room with clean, smooth sound from the main monitors, control the sound once it is in the reverberant field and provide an acceptable monitoring "window" for all parties actively involved in the creative process.

Because of these challenges, I believe we are on the verge of yet another design era. This era will further attempt to resolve many of the acoustic, economic and ergonomic complications that still exist in most control rooms today. Frankly, I have never seen a control room that effectively addresses even two of these elements simultaneously.

What I'm about to propose will come as a shock to some and will be misinterpreted by others, so I want to make the following point very clear. *This design is not for every studio*; its development is aimed at commercial production, audio-video post and computer-based MIDI control-room applications.

The key to this era will be the elimination of large, soffit-mounted studio monitors—to be replaced by a close-field/subwoofer configuration. I know this sounds blasphemous, but consider these ramifications:

- *Acoustic*: As you may know, much of the elaborate acoustic design and treatment in today's control rooms is necessary to control and contain the high sound-pressure levels of the main monitors. In a close-field/subwoofer set-up, massive acoustic treatment becomes less critical, and, in many cases, monitoring accuracy increases.

- *Economic*: It's not unusual to spend more than \$100,000 for the design, materials and labor to build a high-quality control room. This grand expenditure is becoming less and less acceptable as studio owners face mounting economic pressures. Doing without the mains could reduce this figure by 30% to 50%. In addition to the potential savings in construction costs, factor in the additional savings created by reducing the large-scale monitoring system. The near field/subwoofer system should require much less power, a less complex crossover network and, quite possibly, no EQ.

- *Ergonomics*: Efficient ergonomic design is becoming increasingly important. The days of sticking the synthesist off in a corner, under the mains or behind the engineer may finally be over. Current design philosophy suggests that the keyboardist be located behind the engineer—at the producer's desk. This may be O.K. for the musicians, but does little to benefit the engineers (unless they've got eyes in the back of their heads), or the "evicted" producers.

I know of a prototype control-room design that provides three discrete listening/working positions with full-frequency monitoring; eye-to-eye contact for the engineer, producer and a work station operator; three separate wrap-around consoles providing audio/video monitoring, computer terminal(s) and display(s); clock and communication controls; and, for the engineer, a direct field of vision to the studio area.

As mentioned earlier, this design is not for everyone. But for those who are interested, the tradeoffs are good sonic, economic and ergonomic performance—at the expense of brute power and extreme low-frequency response below 40Hz.

Sometimes it takes a radical departure from established methodology to make quantum improvements in the way we work. The next generation of control-room design is now.

RE/P



Michael Fay
Editor

If Only More Expensive Consoles Performed As Well.



For a 16 or 24 track studio owner, the future looks very good.

With MIDI systems and digital outboard gear, you're faced with extremely sophisticated productions. But it's very hard to find a recording console to match the requirements without spending a small fortune.

That's precisely why we've developed the new Series 6000, an evolutionary design that clearly demonstrates the forward thinking of Soundcraft. Behind the classic layout is a revelation in performance and capability.

For one thing, it's equipped with enough busses and routing options to make adventurous productions a pleasure, not a nightmare. The 6000 is a full 16 or 24 buss console with six auxiliary sends per channel. The split format of the 6000 means each of the tape returns will double as extra inputs, with EQ.

We've also provided each input with push-button routing, EQ by-pass, and programmable electronic muting that eliminates the clicks produced by ordinary switches. You even get true solo-in-place, sadly lacking on more expensive consoles.

But it's the 6000's sonic performance that really sets it apart from the competition. Our revolutionary input design gives you 2dB to 70dB gain without a pad and virtually unmeasurable distortion, crosstalk, and noise.

Our new grounding system yields superb hum immunity and a routing isolation of 110dB (1kHz). And our active panpot comes close to theoretical perfection, exceeding our competitor's performance by a full 25dB.

The Series 6000 input module gives you programmable electronic muting under optional MIDI control, solo-in-place to get a clear picture of your progress, and a patented active panpot with isolation of 90 dB (1kHz).

To give you the subtle control it takes to achieve dramatic results, you also get four-band EQ with mid sweeps on each input channel.

When you specify Soundcraft's Series 6000, with options including 16 to 56 channels, stereo input modules, and built-in patchbay, you'll find it an affordable slice of progress. Series 6000, simply the most comprehensive production console in its class.

Soundcraft 6000

Soundcraft USA/JBL Professional
8500 Balboa Boulevard
Northridge, CA 91329

© 1988 - JBL Incorporated, A Harman International Company

LETTERS

Phase Shift

From: Ralph Jones, independent composer/producer and co-author of the "Yamaha Sound Reinforcement Handbook."

Terry Pennington's article, "Phase Shift... Should We Worry?" (May) represents stunning proof that "a little knowledge is a dangerous thing."

Mr. Pennington has set out to convince readers of *RE/P* that the time-delay response of audio systems is irrelevant—and that, therefore, the efforts of audio designers to minimize non-linear phase shift in their products are wasted. As evidence, he presents a simple mathematical explanation of the absolute phase shift that is attendant upon the propagation delay between a loudspeaker and a listener. His explanation is technically correct—as far as it goes—but in no way does it support his thesis.

One is tempted to call this article a grave disservice to our industry. Some good may yet come of its publication, however. Everyone who has had any significant involvement with audio has heard precisely this same misinformed line of "reasoning" many times. We have here a rare opportunity to answer it in a public forum.

Every practical audio network exhibits a net time-delay response that has two components: a linear delay, which is the same at all frequencies, and a non-linear delay, which varies with frequency. The former is benign; the latter is destructive. The following "thought experiment" should clarify the difference between the two.

Imagine a perfect recording system. We input a simple square wave to this system, record it, and play it back two weeks later. Comparing the input signal to the output signal and calculating the absolute phase difference, we observe an enormous amount of phase shift, which is an expression of the 2-week delay, and which varies with frequency. The waveform remains unchanged in every respect, however, since the absolute time delay is the same at all frequencies. This is an example of non-destructive, frequency-independent delay. The propagation delay that Pennington describes falls into this category.

Now, let's insert an active crossover after the squarewave generator, recording the high-pass and low-pass outputs on separate perfect recorders. We then play back the two recordings at random, with any arbitrary time relationship—the highs on a Tuesday, for instance, and the lows on

the following Sunday. Again, we observe substantial phase shift. But the time delay for the high-frequency component of the signal is different than that of the low-frequency component, and the two cannot add to reconstruct the original squarewave. This is an example of destructive, frequency-dependent delay (there is also a non-destructive, frequency-independent delay component in this example).

Now, if Mr. Pennington's thesis that "phase doesn't matter" is valid, then the latter recording method is just as good as the former, and there should be absolutely no audible difference between the two. But I would hate to be manning the customer service phone at Warner Brothers if they started releasing their catalog in this format! Obviously, frequency-dependent delay is destructive, and is audible.

Obviously, frequency-dependent delay is destructive, and is audible.

In my 10 years of association with John Meyer, I have been privileged to participate in many experiments in which I have clearly heard the destructive effects of very fine amounts of non-linear delay. Responsible audio design engineers seek to minimize this delay component in their products—and, believe me, this is no simple task when you're dealing with a complex, real-world design. That Pennington would attempt to trivialize their good-faith efforts, which provide our industry with more accurate tools, is unconscionable.

It is important to note that Terry Pennington's argument illustrates the fundamental problem with phase measurements that do not isolate the frequency-dependent component of a network's time-delay response. Such simple phase measurements cannot provide a meaningful picture of a system's characteristics.

Readers who are interested in learning more about this topic should obtain a copy of "High-Frequency Phase Response Specifications—Useful Or Misleading?" This highly readable paper by Deane Jensen, which was presented at the 81st AES Convention, offers a clear and accurate explanation (with minimal mathematics) of some of the issues surrounding time-delay measurements. It may be obtained directly from Jensen Transformers, 10735 Burbank Blvd., North Hollywood, CA 91601. The

phone number is 213-876-0059.

My thanks to Deane Jensen, who graciously consented to review this letter for technical accuracy.

Cosigned by: David Andrews, Andrews Audio Consultants; Lee Carroll, Network Production Music; Michael Dosch, Pacific Recorders; Lee Furr, Lee Furr Audio; John Hardy, The Hardy Company; Steve Hogan, Jensen Transformers; Bill Isenberg, Marshall Long/Acoustics; Deane Jensen, Jensen Transformers; Edward M. Long, E.M. Long Associates; John Meyer, Meyer Sound Laboratories; Robert Orban, Orban Associates; Stephen Paul, Stephen Paul Audio; Saul A. Walker, ROH Division, Anchor Audio; Bill Whitlock, Jensen Transformers.

From: John Monforte, director of recording services, University of Miami, Coral Gables, FL.

Terry Pennington correctly points out that as sound passes through air, it is delayed in time, and this time delay can also be measured in units of degrees of phase shift. He also notes that since different frequencies have different wavelengths, the amount of measured phase shift is different for each frequency.

His conclusion is that phase shifts in audio are completely benign unless combined with the same signal without delay or with a different delay. While these "linear phase" time delays are in fact as described, Pennington bounds to the spectacular conclusion that all phase shifts occurring from all sources are similarly innocuous and irrelevant. He concludes that the only way to rid the world of phase shift is to change the speed of sound.

This sweeping generalization ignores the fact that there are numerous other sources of phase shift that are not linear with frequency. Pennington claims that "(When listening) only the frequency components of the signal are discriminated from the cacophonous elements of sound. Timing, as in phasing, is of little or no importance. As an example, if the harmonics of a tone are scattered about in time from the fundamental, the sound will be the same." Personally, I prefer to hear the treble of my favorite music at the same time as the bass, and in the same order as well.

Consider for a moment the perfect pulse. The mathematically ideal pulse has infinite height and zero duration and occurs at a single instance of time. Fourier says this pulse has a frequency spectrum identical to noise where all frequencies are

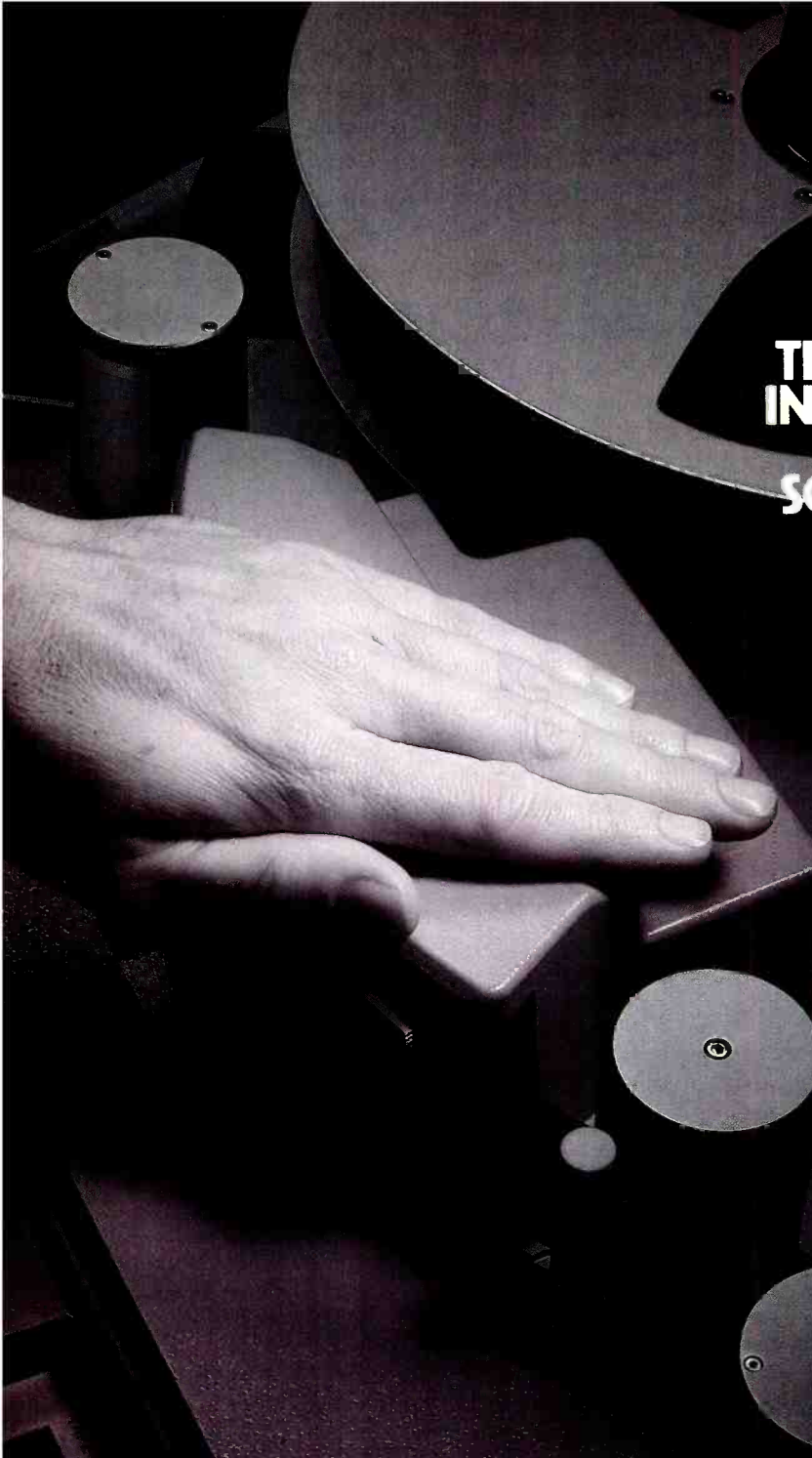
A black and white photograph showing a close-up of a person's hand resting on the control panel of a Tascam ATR-80 24-track audio recorder. The hand is positioned over a large, dark, circular control knob. The background is dark, with some circular elements of the machine visible.

THE LATEST TECHNOLOGY IN 24 TRACK PRODUCTION MAY COST YOU SOME OF YOUR FAVORITE PRECONCEPTIONS.

You may think you know which 24 track gives you the most advanced technology and design. But you're probably in for a surprise.

It's the ATR-80.

The ATR-80 is a production dream come true. It's got features that make audio-for-video editing faster and easier than it's ever been before in a 2-inch, 24 track format.

Look at the speed. Unique samarium-cobalt motors in the ATR-80 start the capstans quicker and then shuttle at a lightning-fast 380 ips. Lockup time is limited only by your other equipment.

Tascam's proprietary head technology allows you even more production speed, with head quality so uniform that EQing decisions can be made right in sync without rewinding to repro. Special circuitry provides transparent punch-ins for completely gapless and seamless edits.

But there's only so much of the ATR-80 that can be described in features. For the rest you must sit down in front of it and lay your hands on the controls. That's when you'll sense the craftsmanship and quality of it's design. The power, the speed, the smooth response of the transport.

See your Tascam ATR-80 dealer. After you use it, you won't miss those preconceptions one bit.



TASCAM

© 1988 TEAC Corporation of America, 7733 Telegraph Road, Menlo Park, CA 94025. 213/726-0303

Circle (7) on Rapid Facts Card

LETTERS

present at all amplitudes. While the real world is admittedly populated with band-limited noise and finite pulses, the approximation is still valid. What makes a pulse sound so radically different from noise? At the instant of the pulse's occurrence, all the frequency components cross zero and head in the same direction. This special phase relation causes the components to add constructively at that instant and average out to zero everywhere else.

Music depends on pulse-like signals, known as transients, that are contained in a great many of the sounds we hear. Since sound travels in air at the same speed for all wavelengths, time delays that are frequency-dependent alter the signal in an unnatural manner and cue the ear that it is listening to a reproduction.

Concern for a type of frequency-dependent phase shifts known as group delay began as the Bell system introduced amplified phone lines. Researchers at Bell Labs quantified these phase shifts and evaluated their detriment to speech intelligibility. Their work was fundamental in establishing criteria for equipment used in long distance telephony, and these studies are just as timely and well regarded as the work of Haas and Fletcher-Munson.

Pennington bounds to the spectacular conclusion that all phase shifts occurring from all sources are similarly innocuous and irrelevant.

The ultimate conclusion should be that although phase shift can be directly measured, the results are not meaningful until the linear phase contributions are removed. The remaining phase shifts represent destructive alterations to the signal. The problem is not in the parameter but in the measuring technique.

From: A.J. Martin, Seque Services, Merrifield, MN.

I just completed reading the May issue and would like to make a general comment. While several of the articles reported on knowledge gained through practical experience, which is probably accurate, when technical explanations were offered to explain these items, they were very

often inaccurate, misleading or incomplete.

One statement that especially sticks in my mind implies that it isn't very important to consider or control phase shift in audio equipment. I can think of several experiments to show that phase shift is indeed important! In another article, it seemed the author just didn't understand the technical points he was trying to explain.

Perhaps you could engage an electronics engineer to work with the authors to review their articles, and correct or clarify the technical or theoretical aspects so the articles would have more value as reference materials.

Except for this one complaint, I find your magazine interesting, informative and quite useful in my work.

Terry Pennington replies:

Several readers have taken the time to write letters concerning "Phase Shift... Should We Worry?" And I do appreciate their comments. I also appreciate their approach to the subject and to their understanding of the science involved. I do not believe that any misstatements were made in the piece. I admit, due to space limitations, there was a lack of detail to support the claims made.

It is quite possible that the article should have appeared as an editorial rather than as a routine article or statement of fact. This piece did present more of an opinion rather than a listing of pure facts preceding a conclusion based solely on physical evidence.

It has never been proved, at least to my satisfaction, that phase *in and of itself*, lends anything positively or negatively to the quality of sound. As stated in the article, when two pieces of a like signal are allowed to interact, acoustically or electrically, the *amplitude* of the signal will be changed through the vector summation of the two phases, and the result will be different than originally intended. If this sort of phase anomaly is allowed to occur, the frequency response of the original program material will be altered and it will *sound different*. What is being heard is the relative change in frequency-dependent amplitude, not the change in phase. If, on the other hand, the phasing of a broadband signal is altered without any change in amplitude (i.e., as in an all-pass filter), the human ear/brain perception machinery will not detect a difference. This is true

for a single-channel (mono) signal or if both channels of a dual-channel (stereo) signal are equally manipulated.

The importance of this "spectacular conclusion" is that phase, by itself, is one of the last things one should consider in judg-

It has never been proved, at least to my satisfaction, that phase in and of itself lends anything positively or negatively to the quality of sound.

ing the accuracy of a sound system component. Yes, I know this is blasphemous to many. Just hang in there and let me explain. As has been stated many times in various published articles, the ear, due to a first-order approximation, is a spectrum analyzer. A real-time spectrum analyzer at that. It is primarily capable of telling one's brain what the relative difference is between frequencies across its rather limited bandwidth.

A well-trained ear/brain combination can, in some instances, even correlate received frequencies and musical notes. The same highly educated ear, however, will *not* detect a difference between a repetitive succession of identical triads played on a piano with equal attack and sustain. These triads will all have different relative timing between the notes due to the inaccuracy of timing between the player's fingers. This will radically alter the *relative* phase of the three notes involved. It will not change the sound. If the reader is tempted to think that this phasing has some effect on the beat frequencies that are so noticeable on a piano, it does not. Beat frequencies heard in the sustain of the chord are a function of the differences in resonances between the strings of individual notes and may even be present between intervals of notes. They have nothing to do with relative timing.

There are many other examples that could be presented to intuitively illustrate the irrelevance of the timing of dissimilar signals. I am not sure that presenting example after example would satisfy many of those who took issue with the original story. It is my experience that much of the sensitivity to the article is more a matter of faith than of science. I have made my feelings on this subject known in previous

imagination.



Imagine a digital reverb that is so good you can make records with it. And is so affordable you can easily put several in a 4 track home studio.

You've just imagined MICROVERB® II. The almost impossible combination of professional sound quality *and* affordability. 16 classic digital reverb programs. The cream of the crop in one box. What could be more simple? Or useful. For records, demos, on stage; anywhere and everywhere your music needs to sound inspired.

From sparkling vocal chambers and natural ambient rooms to deep instrumental washes and explosive gates. With the simple turn of a knob you choose the right one. As your imagination sees fit.

A personalized statement is hard to come by in music. It takes sweat, guts, a passion for excellence. And imagination. It also takes the right equipment.

MICROVERB II lets your imagination run wild.



LOS ANGELES:

Alesis Corporation • 3630 Holdrege Avenue • Los Angeles, Ca. 90016

LONDON:

Alesis Corporation • 6, Letchworth Business Center • Avenue One, Letchworth, Hertfordshire SG6 2HR

LETTERS

articles and papers (i.e., "Perceptions of Audio Perception," presented at the 79th convention of the AES) and hopefully do not need to reiterate them here. Suffice to say that when one believes a particular element of sound to be important, such as amplifying with tubes rather than transistors, for instance, no outside influence is going to have much of an effect. Faith means to accept without proof. Supplying opposing facts will do little other than to promote bad feelings.

Those who reached the conclusion from all of my heresy that I believe phase should not be considered when designing an audio product or an audio system have inserted a few too many assumptions between my lines. The fact is that unusual phase response in an electronic product almost always indicates that the designer made a mistake. A mistake that usually carries with it a proportional amplitude error. The realities of electronics are such that any wild phase deviations without corresponding amplitude variations are very unlikely. If it does occur, it should most likely be rectified to ensure the integrity of the product. The real impetus behind the article in the first place was my contention that product evaluators tend to measure phase shift first and then all other parameters be colored by these phase measurements. Especially their subjective impressions of the product. A phase deviation of *both channels* of a digital audio

system (compact disc player, tape machine, etc.) at 20kHz or 10° or 15° will not alter its sound quality. This phase response is usually due to the impending amplitude roll-off at a higher frequency and is to be expected. Nevertheless, many designers of such devices will go to great pains and consumer expense to rid the product of the phase deviation. This is usually harmless, but its relevance to sound quality is questionable.

To further bolster my position, I would like to insert a quote from Stanley Lipshitz. He made the following comments during his digital theory demonstrations given at the 79th AES Convention in New York in October 1985: "The ear is phase deaf above about 1kHz to 2kHz. You may not like the fact, but it is demonstrable, and I know of no evidence that anybody can hear phase shift between 10kHz and 20kHz."

He went on to say, "I read a great deal in the press—popular press—about what they hear in the phase behavior of these different filters, but it's a different matter between saying something and trying to demonstrate it.

"So, one can come reasonably close to a good brick wall filter using analog technology. The only significant deviation is the phase shift at the upper end of the frequency band, which will cause waveform distortion, but there is no evidence it is audible to anybody."

Conclusion? Well, you may conclude that a little knowledge is a dangerous thing and I have proved so. I would prefer the conclusion be the votes are not all counted yet. I have attempted to demonstrate that phase shift is abundant in nature and that a few degrees added in either direction by audio componentry is not normally of great concern. There are so many other parameters that should be attended to first as to make any discussion of phase secondary. I am not advocating the complete dismissal of phase shift as a criteria for evaluation. I would submit that in most instances, phase shift is the mechanism that causes frequency response deviations, and without any change in amplitude, phase is unlikely to be detected subjectively.

Oh yes, one might wonder about the contribution of phase differences between our ears to the perception of direction. And rightly so. It has been demonstrated that this is one area in which phase is important. I agree. I have made no attempt to discredit the work of others in this area. It should be noted that a 2-channel system with identical phase performance in both channels will do nothing to our ability to determine imaging or directionality.

REP

Send letters to RE/P, Suite 107, 8885 Rio San Diego Drive, San Diego, CA 92108. Letters may be edited for length and clarity.

EDITORIAL

Michael Fay, *Editor*
 Frederick J. Ampel, *Editorial Director*
 Dan Torchia, *Staff Editor*
 Tom Cook, *Senior Managing Editor*
 Linda Stuckey, *Associate Editor*
 Kathy Mickelson, *Editorial Assistant*
 James McWard, *Editorial Assistant*
 Pat Blanton, *Directory Issues Editor*

ART

Alecia Wright, *Graphic Designer*

BUSINESS

Cameron Bishop, *Group Vice President*
 Dennis Milan, *Publisher*
 Stephanie Hanaway, *Promotions Manager*
 Cynthia Sedler, *Marketing Coordinator*
 Laurel Cash, *Executive Consultant*
 Dee Unger, *Advertising Business Manager*
 Tami Bartocci, *Advertising Coordinator*

Sales offices: See page 96.

ADMINISTRATION

R.J. Hancock, *President*
 Doug Riemer, *Circulation Vice President*
 Jane J. Powell, *Circulation Director*
 Jo Ann DeSmet, *Circulation Fulfillment Manager*

Barbara Clare, *Reader Correspondent*
 Kevin Callahan, *Creative Director*

TECHNICAL CONSULTANTS

Jeff Burger, *Computers*
 Paul D. Lehrman, *Electronic Music*
 David Scheirman, *Live Performance*

RECORDING ENGINEER/PRODUCER is edited to relate recording science to recording art to recording equipment, as these subjects, and their relationship to one another, may be of value and interest to those working in the field of commercially marketable recordings and live audio presentation. The editorial content includes: descriptions of sound recording techniques, uses of sound recording equipment, audio environment design, audio equipment maintenance, new products.

CORRESPONDENCE

Advertising and Subscription:
 9221 Quivira
 Overland Park, KS 66215
 913-888-4664
 Telex: 42:4156 Intertec OLPK
 Fax: 913-541-6697

Editorial:
 Suite 107
 8885 Rio San Diego Drive
 San Diego, CA 92108
 619-299-6655
 Fax: 619-692-9097

SUBSCRIPTIONS

Qualified:
 United States (Domestic Only) \$24.00
 Foreign \$45.00
 Non-qualified:
 United States (Domestic Only) \$30.00
 Foreign \$60.00

Optional airmail for non-qualified readers is also available for an additional \$55.00 per year. Foreign subscriptions are payable in U.S. funds only by bank check or money order. Adjustments necessitated by subscription termination at single copy rate.

Recording Engineer/Producer is not responsible for any claim by any person based on the publication by Recording Engineer/Producer of material submitted for publication.

Photocopy rights: Permission to photocopy for internal or personal use is granted by Intertec Publishing Corporation for libraries and others registered with Copyright Clearance Center (CCC), provided the base fee of \$2.00 per copy of article is paid directly to CCC, 21 Congress St., Salem, MA 01970. Special requests should be addressed to Cameron Bishop, group vice president.
 ISSN 0034-1673 \$4.00 + \$0.00.

Member, Business
 Publications Audit of
 Circulation



Sustaining member of Acoustical Society of America

©1988. All rights reserved.

In the E-Series
E is for Excellence.



Audio professionals everywhere are turning to the Fostex E-Series recorders for their production and post-production needs. So much so, you hear the results of their work nearly every day — in movie soundtracks, commercial and cable television shows, industrial and educational films and videos and, of course, hit records.

The E-Series features gapless "punching" so there's no blank space after the punch-out point. Only recorders which are much more expensive offer this sophisticated function. But since you can't run a fully automated system without it, Fostex includes gapless punch-in/out as standard equipment on the E-Series.

Also standard is a synchronizer port which will interface with all SMPTE time code based systems. When used with the Fostex synchronizer, Model 4030, you can then use our software program to perform sophisticated audio assembly editing.

Models E-8 and E-16 are multitrack recorders with built-in noise reduction.

Models E-2 and E-22 (not shown) are 2-track master recorders with a third, center channel for SMPTE time code control. This is a standard feature, not an option. You will have complete compatibility with existing 2-track tapes, plus the ability to run computer derived edit decision lists and full automation.

Servo control of the reels in the edit mode will help you pin-point cues and spot erase. When the pitch control is engaged, the exact percentage of speed deviation is displayed so that when you need to re-set the control, you can do so precisely, and the real-time counter features search-to-zero even from the negative domain.

The E-2 uses 1/4" tape at 7-1/2 & 15 lps (15 & 30 lps speeds are optional); the E-22 uses 1/2" tape at 15 & 30 lps.

When an E-Series recorder is used with Fostex Model 4050 — autolocator and SMPTE to MIDI controller — you have programmable punch-in/out, 100-point autolocate capability, 10 programmable edits, a SMPTE time code generator / reader (all four formats), plus the ability to locate to the bar and beat.

So if you're looking for a professional recording instrument, here's a Fostex E-Series recorder that can help you with two important "E" words: Efficiency and Effectiveness. The E-Series can also help you achieve the most important "E" word of all: Excellence.

Fostex

15431 Blackburn Ave., Norwalk, CA 90650
(213) 921-1112

©1988 Fostex Corporation of America

Circle (9) on Rapid Facts Card

www.americanradiohistory.com

48-track DASH machine to be introduced

Rumored for some months to be in the final planning stages, a 48-track, ½-inch DASH machine is expected to be released before the end of the year, it was announced in June at a press conference in Tokyo. Given by Sony, Studer and TEAC, the press conference updated the industry on future plans to support the DASH format.

Details of the 48-track machine were few, but Sony and Studer plan to introduce machines as early as possible, and at least one product announcement is expected to be made before the end of the year. TEAC will also display a prototype 48-track machine before the end of the year.

The machine is the result of joint engineering work conducted by Sony and Studer. Present and future-generation 24-track machines will be fully compatible with the 48-track, and tapes recorded on 24-track machines can be extended to 48 tracks on the new machines.

Also announced was Sony's introduction of the PCM-3324A, an upgrade of the 3324.

West L.A. Music hosts keyboard show

West L.A. Music's second keyboard and MIDI show, Sept. 24 and 25 at California State University Northridge, will feature seminars, clinics, demonstrations and exhibitor booths. Last year, more than 90 companies exhibited at the show, which was attended by more than 3,000 people. Additional information is available from Jeff Rosenfield, West L.A. Music, 11345 Santa Monica Blvd., Los Angeles, CA 90025; 213-477-1945.

Northern California fair set for September

The third annual San Francisco Music Fair, scheduled for Sept. 10 and 11 at the San Francisco State University creative arts building, will focus on "High Technology in Music." Sponsored by the San Francisco chapter of NARAS, the fair will include exhibitors, seminars and performances. For more information, contact Beverly Sommerfeld at 415-681-1170.

SPARS schedules conference on personnel management

Various aspects of personnel management in studios will be covered at the next SPARS conference, titled "Personnel Man-

agement: Cultivating Your Most Potent Resource." Coordinated by Bruce Merley, president of Clinton Recording in New York, the conference will be held Sept. 17 and 18 at New York University in New York City.

Topics to be covered include hiring and firing, interviewing prospective employees, employee benefits, writing procedures manuals and policies, and various legal issues surrounding personnel management. For more information, contact Shirley Kaye at SPARS, 4300 10th Ave. N., Suite 2, Lake Worth, FL 33461; 305-641-6648.

UCLA plans engineer courses

UCLA Extension has scheduled two engineering courses for the fall semester. "Introduction to Audio Engineering" will run on Mondays from Sept. 19 to Nov. 14 and is designed for artists, writers, producers and record-company personnel who seek an understanding of the recording process. It will be taught by engineer Michael Braunstein.

"Recording Engineering Theory" will meet on Wednesdays from Sept. 28 to Dec. 14 and will cover basic electricity and electronics, magnetic effects, acoustics, microphones, speakers, magnetic recording, console design, special-effect electronics and studio maintenance.

For more information, contact UCLA Extension at Box 24901, Los Angeles, CA 90024; 213-825-9064.

News notes

Sandy Brown Associates, a London-based acoustic and architectural consulting company, has recently completed the following projects: TV-am, London; MTV, London; NBC, Seoul, South Korea; Australian Broadcasting Corporation, Hobart, Australia; Australian Broadcasting Corporation, Sydney, Australia; Novosti Press Agency, Moscow; RRI, Djakarta, Indonesia; and JRTV, Jordan.

Agfa-Gevaert donated PEM 469 mastering tape for a recent benefit performance in New York. Proceeds will be donated to six organizations helping AIDS patients. The performance will be released on an album and concert video.

Alpha Audio has donated a BOSS automated audio editors to the Berklee School of Music, Boston.

RAMSA has awarded David Henderson of Pro Audio Associates the RAMSA/Panasonic Eastern Regional Representative of the Year award for outstanding personal effort in 1987. Everything Audio, Burbank, CA, was awarded Outstanding Sales Achievement in the recording and broadcast products group category.

Soundcraft Japan is now the exclusive distributor in Japan for Rebis equipment, the British manufacturer announced.

Max Kay Public Relations, a public relations company serving the pro audio industry, received *Backstage* magazine's award for greatest press contribution for the promotion of the music scene in the Benelux countries. The award was presented at the Belgian Music Fair in Brussels.

EdgeTech U.S. has formed a subsidiary company, EdgeTech Distribution Corporation, which is handling the U.S. distribution for BSS Audio and Turbosound. All three companies are owned by the same U.K. parent company, Edge Technology Group.

Shape Incorporated has started production of DAT cassettes at its Shape Optimedia CD manufacturing plant.

Graham-Patten has delivered 12 ESAM edit suite audio mixers to NBC for use at the Summer Olympics in Seoul, South Korea.

Martinsound Technologies has announced that it is in the final development phase of a new moving fader console automation system called Flying Faders.

People

Pat Chupko has joined the staff of AST Sound as a sales engineer.

Bill Hall has been named engineering product manager at Graham-Patten Systems.

Audio Kinetics has announced two appointments. **Simon Bohannon** has been named CSD manager, and **Tim Harrison** has been named technical sales engineer.

Jeff Radke has been named Midwest regional sales manager for AKG Acoustics.

RE/P

Everything else is 12 seconds behind the times.

You won't find 12 seconds of 16-bit stereo RAM-based memory in every digital recorder. Or a built-in electronic editor, or 2 speeds, or 3 sampling frequencies, or CD mastering standard meters either. But you'll find them all in the Sony PCM-3402 2-track digital recorder. And more.

For audio sweetening there's nothing better. It can read, generate, convert and chase many types of time-code. It has digital fader and balance controls plus millisecond-accurate dynamic sync offset adjustment. It gen-locks, performs time-code based auto-cuing and auto-time fit, and time-code triggered audio sampling. And it even comes with multiple digital format I/Os.

For a demonstration of the digital recorder that makes all others sound like history, contact your Sony Professional Audio representative. Or call us at 800-635-SONY.

SONY

Professional Audio



MANAGING MIDI

By Paul D. Lehrman

Q&A, Part 3

More common questions and answers about MIDI:

• *Why can't I "mult" MIDI lines the way I can my audio lines, and why can't I merge two MIDI lines together with a Y-connector?*

The MIDI specification says that the MIDI data line must be maintained at +5V. To do this, every MIDI Out and MIDI Thru jack has a buffer stage attached to it, whose purpose is to make sure the voltage of the outgoing signal is correct. MIDI In jacks expect to receive a 5V signal, and they dismiss anything substantially less as noise. If you split a MIDI line after the output buffer, the voltage will drop in half, and the input stage won't read it at all. To split a MIDI line properly, you need what's commonly called a Thru Box, which has one MIDI In jack and several MIDI Thrus, each with its own buffer.

Besides voltage conflicts, there's a second reason you can't merge two incoming lines: synchronization. Even if both lines use a common clock and phase lock, there is no way for one line to know what the other is doing. For example, both may send a high bit at the same time, and one of those bits will be ignored. In the world of MIDI, this situation is an unmitigated disaster.

Even if this situation were avoided, there is still the problem of interrupting commands. MIDI commands can consist of anything from two bytes to thousands of bytes (in the case of patch or sample bulk dumps), and any interruption inside a command results in a gross error. If you try to combine two lines, one line will have no way of knowing when a command on the other line is complete, and, once again, you have disaster. For this reason, "MIDI Merger" boxes require a certain amount of intelligence, and, therefore, tend to be expensive.

Paul D. Lehrman is RE/P's electronic music consulting editor and is a Boston-based electronic musician, producer and free-lance writer.

• *What is All Notes Off for?*

All Notes Off is actually a special case of MIDI continuous controller known as a Channel Mode Message, a class of command that also includes Omni On and Off, Poly and Mono Modes, and Local Control. It is controller number 123 (decimal). When sent, it is always followed by a "value" of 0.

In theory, having such a command is not a bad idea. It would be convenient to be able to tell a sound generator to shut up without having to send it individual note-offs, because then you don't have to keep track of *which* note-offs to send. MIDI processing devices with "Panic" buttons send out the All Notes Off command on 16 channels to unstick stuck notes. But life isn't always so straightforward.

MIDI In jacks expect to receive a 5V signal, and they dismiss anything substantially less as noise.

First of all, the MIDI spec says that manufacturers don't have to program their devices to recognize an All Notes Off at all, which limits the usefulness of the command. In addition, if a synthesizer is holding a note using a Sustain Pedal On command, the All Notes Off will not turn that note off; only a Sustain Pedal Off (Controller 64 at 0) will do that.

There's also a problem with overdubbing tracks in a sequencer. Say you record one pass of a keyboard line, and insert an All Notes Off command at the end. Then you record a second pass on the same channel, but you want to hold a chord past the end of the first pass. You can't, because the previously recorded All Notes Off will cut the chord short.

In general, using All Notes Off is more trouble than it is worth, and many sequencer, processor and synthesizer manufacturers have wisely chosen to ignore it. Representing a major fly in the ointment, however, is one Japanese company that insists on using it constantly. Every time you take your hands off one of its keyboards or stop singing into one of its

pitch converters, the thing sends out a controller 123. If you are working with a sequencer that doesn't filter the command out while it's recording, you will have to find it later and filter it out by hand. And, of course, not all sequencers are so sophisticated, so you may end up with flying All Notes Off commands constantly cutting off your beautiful legato lines and otherwise wreaking havoc with your tracks.

By the way, the MIDI spec also says that when you send any other mode message (except Local Control), it *implies* an All Notes Off. This message represents no practical problems that I know of.

• *What are the outside pins on the MIDI connector used for?*

They're not *supposed* to be used for anything. Those pins (labeled 1 and 3), are to be left unconnected, according to the MIDI spec. Most manufacturers adhere to that convention, which means you can safely use "true" MIDI cables, having only the three middle pins connected, or old-fashioned "European" stereo DIN cables, having all five pins hooked up, and which are available at your neighborhood Parts 'R' Us.

As always, however, there's a catch: On Atari ST computers, pins 1 and 3 of the MIDI Out connector act as a MIDI Thru. This is a pretty clever idea (especially because there just wasn't room for a third MIDI jack), and the Thru signal is easily accessible with a homemade Y-adaptor to split up the two pairs.

If you don't want to use that feature, and as long as everything connected to the computer ignores what's on those two pins, there's no problem with this variation. But some manufacturers of low-power devices, such as keyboard controllers, use pins on their MIDI Outs for the dc power supply. As it stands now, one should never encounter a situation of the Atari MIDI Out being connected to one of these "powered" MIDI Outs, but if some foolhardy manufacturer decides to vary the technique slightly and, for example, put dc onto a MIDI In jack, and then you hook the device up to an ST with a 5-pin Parts 'R' Us cable, you're on your way to MIDI Hell.

This is another chapter in the continuing saga of why the MIDI spec should be left alone. C'mon guys—let's be careful out there.

RE/P

Professional

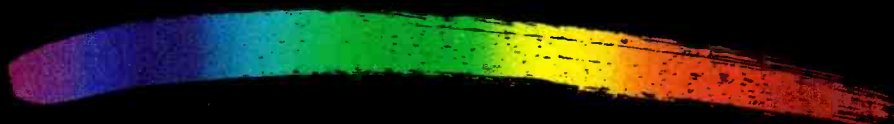

The Telex 6120XLP.
A new audio tape duplicator with
8X speed and tougher specs.



New, tougher specs for a difference you can hear.

Telex is still the leader in high speed duplicating (16X speed) with its famous 6120XL series, providing outstanding audio quality, unlimited expandability and highly profitable production capability. However, if you have higher critical audio needs, the new Telex 6120XLP with 8X speed and XL Life heads should be your choice. For full details and specifications or even a demo tape, call or write to: Telex Communications, Inc., Minneapolis, MN 55420.

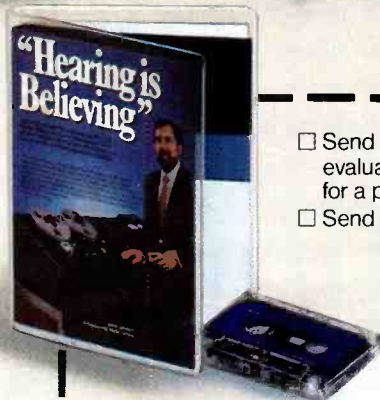

- Send me a free demo cassette for my evaluation— Include my reservation form for a personal demonstration.
- Send me literature only at this time.

Telex Communications, Inc.
9600 Aldrich Av. So.
Minneapolis, MN 55420

Name _____

Company _____

Address _____

City _____ State _____ Zip _____ Telephone _____

TELEX®

Circle (11) on Rapid Facts Card

SPARS ON-LINE

By Dwight L. Cook

Marketing an audio service company

SPARS recently conducted another in its comprehensive series of business conferences. Titled "Marketing Diversified Recording Services," the seminar was held at UCLA's Graduate School of Management and focused on developing a marketing plan and selling studio services.

I can't tell you how many times I've heard someone say, "I just opened a recording studio. Now how do I get some customers?" This is a recurring saga: the opening of audio businesses without a clear marketing strategy, and sometimes without previous studio experience.

SPARS's goal is to promote excellence through education, communication and innovation. Education can never be substituted for experience, but instruction from the veterans can be extremely valuable.

Guy Costa, president of SPARS, and Shirley Kaye, executive director, chose a cross-section of board members from across the country to speak on marketing. The speakers were: Chris Stone, Record Plant, Los Angeles; John Rosen, Fanta Professional Services, Nashville; David Porter, Music Annex, San Francisco; Nick Collieran, Alpha Audio, Richmond, VA; Dick Trump, Triad Productions, Des Moines, IA; and the author.

Each speaker had a different set of marketing subtopics to cover, but a common thread connected their ideas throughout the day: Marketing is more than just sales, and it begins with the definition of product, pricing promotion, strategy and research. Sales is an important part of marketing and should be developed before a business is launched, and it needs constant re-evaluation for the business to operate successfully.

A marketing plan should analyze markets and competition. Seek direct customer feedback and investigate new markets. Review your services and constantly fine-

tune them. Be flexible and change your plans if they don't work. Aspects of everyone's presentations included "niche marketing" and the "mothership concept." [Author's note: These topics are covered in depth in the SPARS papers, a collection of articles written by SPARS members and available by contacting the SPARS national offices at 4300 10th Ave. North, Lake Worth, FL 33461; 305-641-6648.]

"Niche marketing" means getting to know your clients' needs and fulfilling them. Perhaps no one in your market can do dialogue replacement or cassette duplication. Are your customers going out of town for these services? Would you attract more customers if you provided specialized services? A niche is not necessarily a specialization, but it requires you to be flexible enough to recognize and meet your clients' changing needs.

The "mothership" is the central aspect of an audio business that effectively serves the needs of its satellite operations. For example, the central business (music recording studio) can direct business to your satellite operations, such as a publishing company and a sales company that sells equipment to personal-use studios.

The "mothership" concept describes the studio as a wheel's hub and the ancillary businesses as its spokes. Seek to develop satellite businesses apart from your central studio operation to meet your clients' needs. For example, you may wish to offer talent or duplicating services. However, be careful *not to compete with your customers* as you develop these new areas.

Advertising and promotion are a critical aspect of marketing and may take many forms, including direct mail, magazine articles, display ads in trade magazines, company newsletters, handout material, trade-show presence, trade organizations, and a sales staff.

No single promotion method works for everyone. Success depends largely on your business niche, market area and your clients. Educating your clients about your service is easily the most expensive type of promotion. However, educational advertising can position you as the expert.

Display advertising in trade magazines can be more effective when announcing a new service to existing clients or pursuing new clients. Handout material can also be effective in promoting your services. Most customers do not use all of the services you provide, and it's possible to promote additional services to the existing

clientele.

Attending trade shows is an effective way to promote business and make new contacts. For example, cassette duplication services can be marketed at trade shows to people who need cassettes, such as music schools. Ask your clients what trade organizations they belong to and get involved.

It may be necessary to employ a dedicated salesperson to promote business. When hiring, be very careful to find the right person for your business. Remember that *every* person on your staff should be involved in selling/promoting the business. Their daily conversations with clients present new sales opportunities. Commissions work by rewarding people for their skills in "closing deals." You can judge the effectiveness of your promotion by setting measurable goals (quotas).

What is your image? It should be clearly defined in your marketing plan before proceeding with any promotion. Your marketing plan will help you define your image. Your company's name, logo design, decor, and employees' appearance can all play a part in creating and maintaining your image, which may dictate the services offered and price schedules. Are you "discounting" or selling "quality"? Federal Express advertises speed and dependability; however, if you stop and think about it, the company is really promoting an image: peace of mind.

An effective marketing plan is a major part of your business plan. How long has it been since you created a business plan or considered the questions of the planning process? Be honest. Define your promotion, financing, direction and business strategy. Will they get where you want to be?

The next conference will be in New York City at New York University Sept. 17 and 18. The theme is "Personnel: Cultivating Your Most Potent Resource." People are the key factor in making or breaking a business. Anyone can buy equipment, but it takes a talented staff to make it work effectively and profitably.

Management trainer, Burton Hall, of Burton Hall Associates, will speak on hiring, firing and management styles. A panel of insurance industry professionals will discuss issues such as the COBRA law, labor laws, and union laws. (For information, call SPARS now at 305-641-6648.) I'll see y'all there!

RE/P

Dwight L. Cook is secretary of SPARS and president of Cook Sound and Picture Works, Houston.

SUPERNATURAL CONTROL

Ultra-High Performance
Equalizers from Rane.



Now you can bring the crisp, dynamic sound of the studio to the stage, with advanced equalizer technology from Rane.

OUR CONSTANT-Q GRAPHIC EQUALIZERS can sweeten the sound and minimize feedback because of consistently sharper filter response. And less interaction between sliders means you'll save time and effort.

HIGHLY FLEXIBLE PARAMETRICS kill feedback with the surgical precision of extremely narrow notch filter capacity. Five fully independent bands give you the power to both sweeten and control feedback simultaneously.

SOLID TECHNOLOGY from right here in the U.S.A. has earned Rane a reputation for reliability. Super natural sound is why demanding professionals choose Rane.



RANE

10802-47th Ave. W.,
Everett, WA 98204.
(206)355-6000.

Circle (12) on Rapid Facts Card

UNDERSTANDING COMPUTERS

By Jeff Burger

Microprocessors

Probably one of the greatest quantum-leap inventions in the history of mankind has been the advent of microprocessors. They make your microwave programmable; give your VCR memory; access, store and retrieve data from digitally controlled signal processors, synthesizers and samplers; and, yes, they make personal computers possible.

In previous columns we covered read-only memory (ROM) and random-access memory (RAM)—places to read instructions and data from and addresses to send them to. We need an engine or “brain,” however, to do the actual manipulation. The microprocessor, also known as the central processing unit (CPU), is the clearing house or central terminal through which all active data must eventually pass.

The biggest differences between CPUs are the rates at which they are clocked, their instruction sets and their architecture with respect to data handling. Microprocessors are typically driven by a crystal clock running in the megahertz range. Each clock cycle triggers the processing of the next instruction. The faster the clock, the quicker the processing rate and the greater the throughput of data. All other things being equal, a CPU running at 14MHz can process twice the data in a given time period as the same processor running at 7MHz.

CPUs have temporary holding areas, called registers, for the data that they work with. The instruction set is a series of commands inherent to a microprocessor that execute instructions and perform operations on data in various memory locations and CPU registers. For an oversimplified example, let's say that we want to add to the number being held in memory location \$6000, a value equal to the number 1. A first command might signify “load the

CPU's X-register with the contents of location \$6000”; the second might say “increment the contents of the X-register by 1”; and the third would finish the job with “store the contents of the X-register in memory location \$6000.”

Don't worry, we're not going to try to teach you how to become a hexadecimal programmer. Inquisitive readers, however, may be wondering just how a stream of numbers issues these commands. Just as the English language uses nouns, adjectives and verbs to create coherent sentences, the microprocessor's native language, its “assembly language,” allows different hexadecimal numbers to signify specific commands that relate to an intrinsic number of bytes that follow.

When we speak of the CPU's architecture, there are three elements to consider, all of which concern data handling capabilities.

- First, the internal architecture refers to the size of a word (8-bit, 12-bit, 16-bit etc.) that the microprocessor can hold and manipulate. The larger the register size, the fewer the instructions that have to be processed to perform mathematical operations. Translation: faster number crunching.

- Second, the address bus determines which memory location is being addressed, so the bus size dictates how much memory can be accessed. For example, the largest number that can be described by 24 bits is approximately 16 million, so 16Mb is the maximum amount of memory that can be addressed by a 24-bit address bus.

- Third, the data bus holds the value that is sent to or received from the memory cell (RAM or ROM) specified by the address bus. The size of the data bus dictates

the maximum word size or value that can be passed at any given moment. Table 1 gives an overview of the microprocessor chips that are currently being used in the marketplace.

The advanced processors such as the 80386 have the ability to address something on the order of 4Tb (terabytes, equal to 4,000Gb) of virtual memory. Virtual memory is non-physical address space; the CPU can treat hard-disk space as additional RAM, above the 4Gb limit, and access it by swapping hard-disk data with blocks of data in validly addressable RAM space. In effect, the hard disk becomes extra memory on an as-needed basis.

We should also touch on the concept of wait states. Just because a processor is clocked at a high rate and has impressive architectural specs doesn't mean that it's not all dressed up with no place to go. The RAM itself may not be fast enough to keep up with the CPU. In that case, the processor has to wait for the number of cycles that it takes for the RAM to respond (hence, the term *wait states*). The solution to this problem is faster RAM, which, you guessed it, costs more money. RAM speed is measured in nanoseconds (ns), typically in the 100ns to 150ns range.

As we've seen, clock rate, internal architecture, instruction set and memory speed all interact in a CPU's performance. There are even more mundane factors that go into comparing microprocessors. The way most professionals determine their efficiency is to give the computer a common benchmark program or problem that has been measured on other machines. Even this process isn't foolproof, and probably the best test is that of the specific application you wish to run under the conditions that will prevail during your work.

REP

Processor	Internal (bits)	Data Bus (bits)	Address Bus (bits)	Maximum Memory
Intel 8088	16	8	20	1Mb
Intel 8086	16	16	20	1Mb
Intel 80286	16	16	24	16Mb
Intel 80386	32	32	32	4Gb
Motorola 68000	16	16	24	16Mb
Motorola 68020	32	32	32	4Gb
Motorola 68030	32	32	32	4Gb

Table 1. Microprocessor specifications.

Jeff Burger is REP's computer consulting editor and president of Creative Technologies, Los Angeles.

YOU'VE NEVER HEARD A TAD SPEAKER AND YOU NEVER WILL.

With TAD speakers, technicians get the purest, most powerful reproduction of sound in the industry. And nothing more. Because the TAD division at Pioneer Electronics prides itself on being colorless.

Our Professional Sound Lab insures the outstanding quality of our products through a series of tests, including Doppler lasers, holography lasers and anechoic chambers. Products are also tested by computer for phase uniformity, transient response and frequency response. Then, using only the finest



materials available, every component is assembled by hand, allowing for tolerances down to a millionth of an inch.

At Pioneer, we put so much more into our TAD speakers, they don't sound like speakers at all.

For more information regarding TAD

speaker components, please contact Leon Sievers at Pioneer Electronics (USA) Inc.

TAD Technical
Audio Devices

Professional Productions Division of Pioneer Electronics (USA) Inc.,
2265 E. 220th Street, Long Beach, CA 90810 (213) 816-0415

Facility Profile:

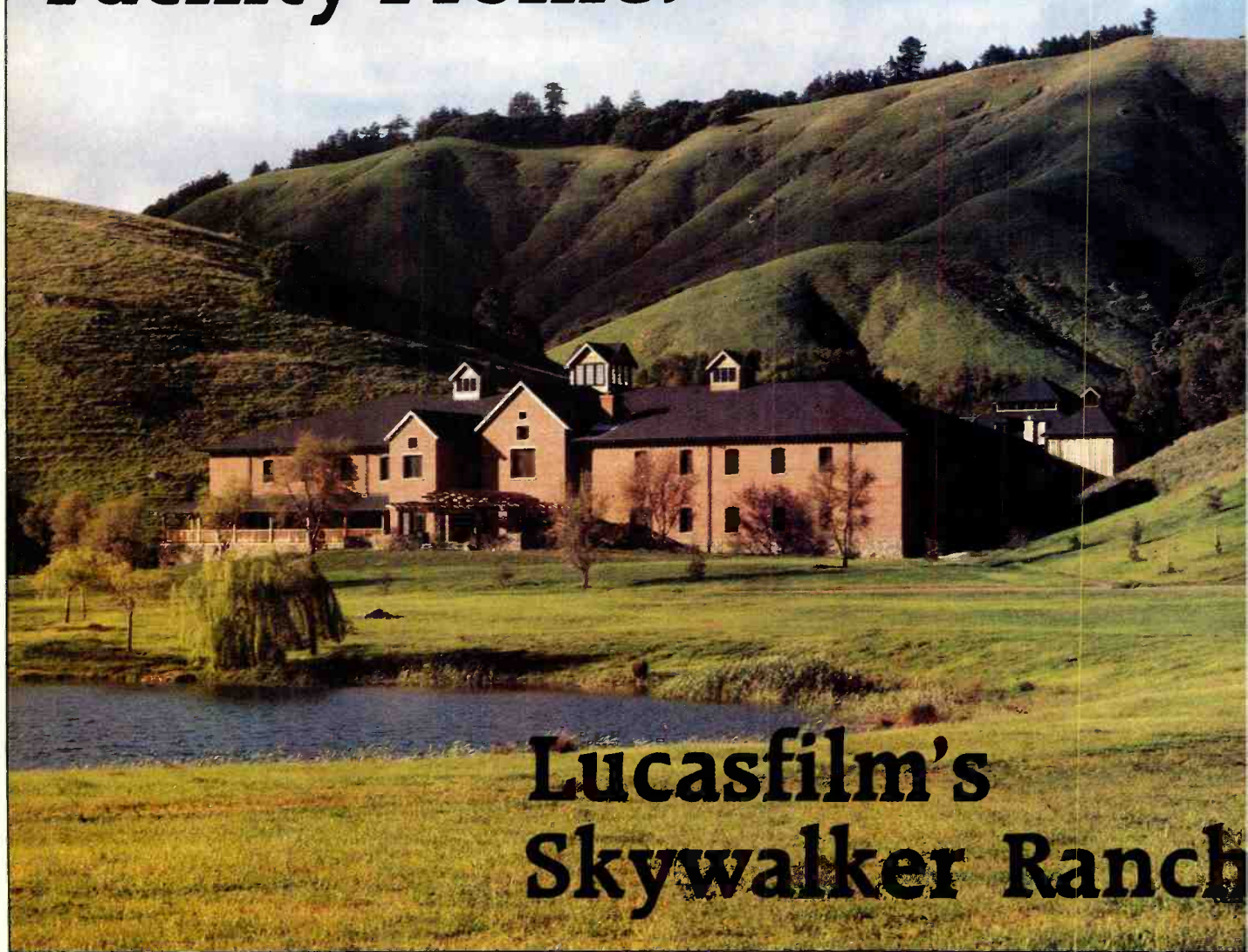

Lucasfilm's Skywalker Ranch

By Larry Blake

The capabilities of the Technical Building were arrived at by determining the requirements of making five stereo feature films a year.

In 1981, Lucasfilm Ltd.'s post-production branch, Sprocket Systems, built a dubbing stage/post-production facility in San Rafael, CA. Although it was certainly a quality operation, close inspection would have led one to believe that this facility would not be Lucasfilm's last word on sound post-production: no dedicated Foley, ADR, music recording, small machine rooms or 70mm projection, not to mention that it was placed in an anonymous industrial park.

Indeed, George Lucas and company did have something up their sleeves: Skywalker Ranch, a 2,949-acre spread in Nicasio, CA, 15 miles north of San Rafael, a 45-minute drive from San Francisco.

Having begun with Lucas' first purchase of land in 1978, the ranch now contains all of Lucasfilm Ltd. facilities except the visual-effects wing, Industrial Light & Magic. Yet, despite Lucasfilm's position as one of the more visible film companies, little of the ranch is devoted directly to the nuts and bolts of a movie studio; it has none of the familiar soundstages, prop or wardrobe departments.

The only representative of roll-up-the-sleeves filmmaking on the ranch is the Technical Building, Lucas' 150,000-square-foot monument to post-production, his favorite part of the filmmaking process. The focal points of the building encompass two mirror-image east and west wings, each of which contains a dubbing stage; a smaller, but similarly equipped "premix" room; a local machine room; and enough space (16 rooms) to house the picture and sound editorial staff for epics such as Lucasfilm's "Star Wars" and "Indiana Jones" series.

Shared by both wings are two centralized machine rooms containing mag dubbers and video equipment. In addition, one finds the capabilities the San Rafael building lacks: ADR and Foley recording areas, a large (4,500-square-foot) scoring stage and a 300-seat screening room.

Lucasfilm Corporate technical director Tomlinson Holman notes that the capabilities of the Technical Building were determined by evaluating the requirements of making five stereo feature films a year. Although many facilities in Hollywood and New York can meet this mandate for work, few of them offer such a high percentage of, as Holman says, "human spaces. The atrium, entertainment area, lounges and other amenities are all areas that George added." He also notes that by grouping the sound-editing suites near their dubbing stage, sound editors "who might never go to the mix are now en-

couraged to do so by the physical nature of the building."

Construction and acoustical design

Despite the drawn-out gestation period of the Technical Building, the staff at Lucasfilm, along with the architects and myriad subcontractors, decided to "fast-track" the construction process. In this 3-phase project, construction on the foundation began even before blueprints existed for interior spaces. Phase 2 was the build-out of sound isolation assemblies, and the third phase was the interior design and finish work. The dates for contractor design documents were November 1984 for Phase 1, June 1985 for Phase 2 and February 1986 for Phase 3.

Holman drew up a technical program



Photo 1. Ceiling isolator. The "room-within-a-room" design is applied to all recording stages in the building. The spring isolation hanger shown above is the resilient structural connection between the concrete scoring stage roof-deck above and the sound isolation ceiling below.

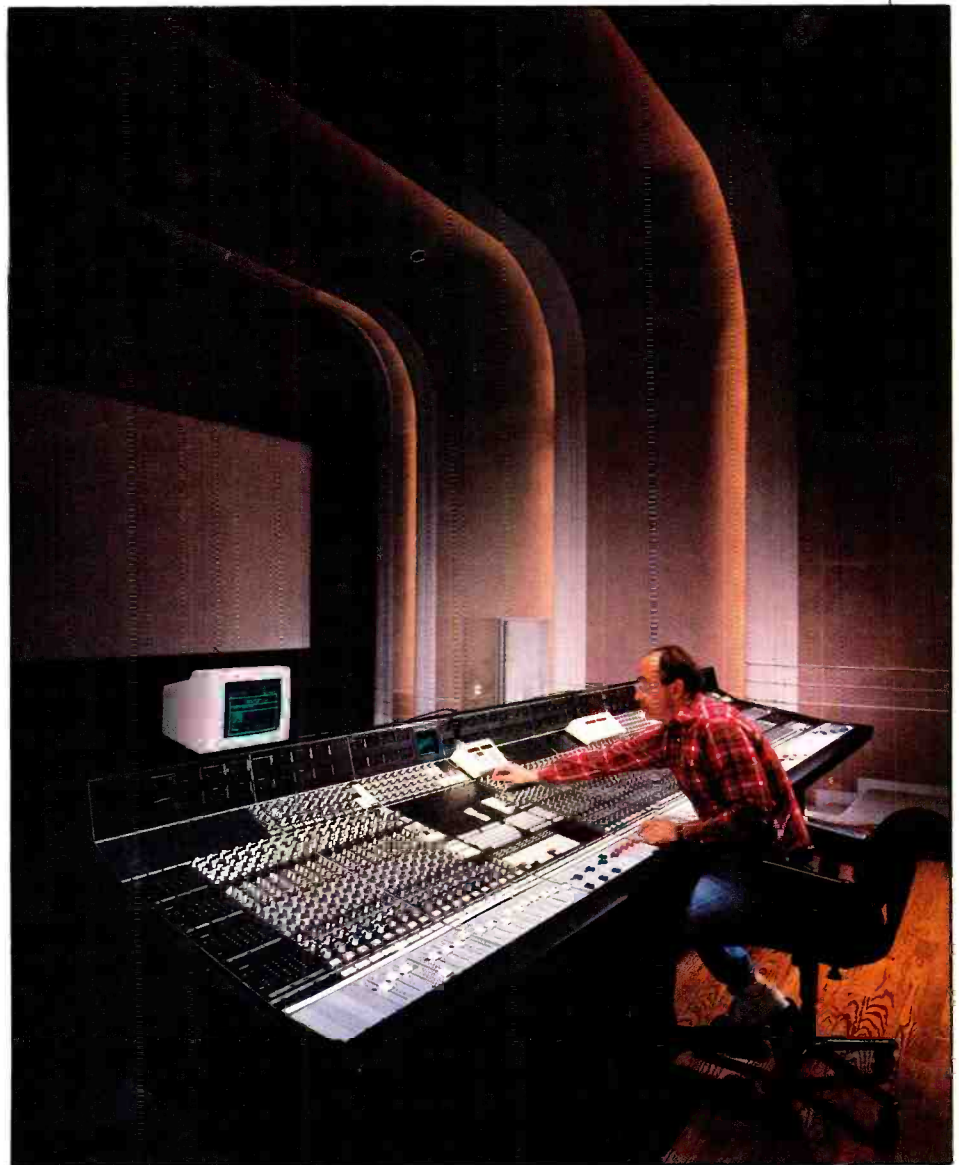

Photo 2. A mixing room.

Larry Blake is a sound editor and mixer at Weddington Productions, North Hollywood, CA. Early next year, he will publish a second edition of his book, "Film Sound Today," an anthology of his articles that have appeared in *RE/P*.



Photo 3. The scoring stage.

outlining his criteria for all areas. "I tried to set pretty rigorous standards for every issue that could come up: flutter echoes, reverberation time, background noise level, absence of discrete tones in background noise level, and so on. So I stated the objectives, but specified virtually nothing as to how the objectives were to be achieved. That's the professional engineer's role: 'We need XYZ to meet these criteria.'"

Participating closely with Holman in writing the program were Sprocket Systems engineers Brian Kelly and Howie Hammermann. Bob Calderwood drew up the architectural specifications with Holman.

Charles M. Salter and Associates of San Francisco was hired to draw up the specifications for acoustic design and noise control. Heading Salter's team were David Schwind and Tom Schindler. (For further information on their work on the Technical Building, refer to preprints 129-81 and 129-82 from the 129th SMPTE Technical Convention.)

Noting the importance of the technical programs such as the one Holman prepared, Schwind says, "Any time there was a decision to be made, he (Holman) said 'What does the program say? That's what we want.' When you are doing complex work involving acoustics, a precise program like Tom's can avoid expensive mistakes."

Schindler emphasizes the distinction be-

tween "the program for a project, which exists between the owner and the design team, and the specification, which exists between the design team and the contractor. The program says what is wanted, and the drawings and specifications tell exactly how to put it together. The process goes from being very creative to very restrictive."

Along these lines, Schindler recommends that any owner/builder have representatives on site to supervise construction and to integrate the responsibilities of the various subcontractors. He says, "Ernie Sachse (Lucasfilm's on-site person, and, for years, CBS's construction supervisor) is extremely knowledgeable in construction in the practical sense. He has gone through the ranks and seen virtually every type of job. This was good because, with the exception of a palm-frond-thatched roof construction, every conceivable type is in this building. It behooves the owner to have someone like him on site in the event that one of the subcontractors says, 'Trust me, this is the way to do it.' And, if you have someone on your side who has seen it all, he can smile and point to the spec."

Detailed specifications even existed for the editing rooms, which, although they now contain standard moviolas, were originally designed as digital sound-editing suites. Holman says that one of his ideas that wasn't implemented called for angled walls in the editing suites, somewhat like

those of mixing rooms. George Lucas felt uncomfortable with the idea of non-perpendicular corners. Nevertheless, the edit rooms were built to what Schwind calls "high-end condominium" isolation, which translates to an STC (sound transmission class) rating of 60. (See "Acoustic Design for the Rest of Us" on page 49.)

To test the isolation between edit rooms, construction was accelerated for one room, and the sound isolation of intervening walls and floor-ceiling assemblies was measured. Once this isolation tested out acceptably, Schwind felt that he could tell the contractor, "You can build this level of construction and it will be acceptable. Now build the rest of them this way, and we're going to hold this one up as a level of performance."

In another case, Schwind and Schindler tested a one-tenth scale model of a final mix room specifically to check flutter echoes using a 40kHz tone, reproduced by a piezo-electric tweeter and measured with a precision microphone with an 1/8-inch diaphragm.

Impeding the ability of Holman, Schwind and Schindler to isolate the building and keep the NC levels within spec was the issue of stability during earthquakes. (Although the ranch is about 7 miles from the San Andreas fault, the considerations were the same as they would be almost anywhere in earthquake-conscious California.) As a result, Holman notes, "A lot of the money is 'invisible' because it's in earthquake-damage control." One design compromise that had to be made in the interest of safety was that Holman would have built the ceiling of the scoring stage control room a few feet higher if it hadn't been under a structural support diaphragm that would have cost \$150,000 to reposition.

The importance of sound isolation was constantly debated, and Holman recalls meetings with the structural engineers when he finished off their sentences with the caveat "... resiliently!" Where the structural engineer wants to "screw everything down tight," Holman says, "you can't have that if you want noise control. Because of the box-within-the-box design, the inner box may be structurally sound unto itself, but if it starts going side to side in an earthquake, then you have to 'snub' that action at the top of the walls." (See Photo 1.)

Although both style mix rooms (final and premix) are small compared to their counterparts in the San Rafael facility, not to mention Hollywood mix rooms, Holman is quick to point out, "We know a lot more now about the sound field in rooms and how to get them to match in level, timbre and spatialization so that you can make judgments, even in the 15' x 25'

EVOLUTION

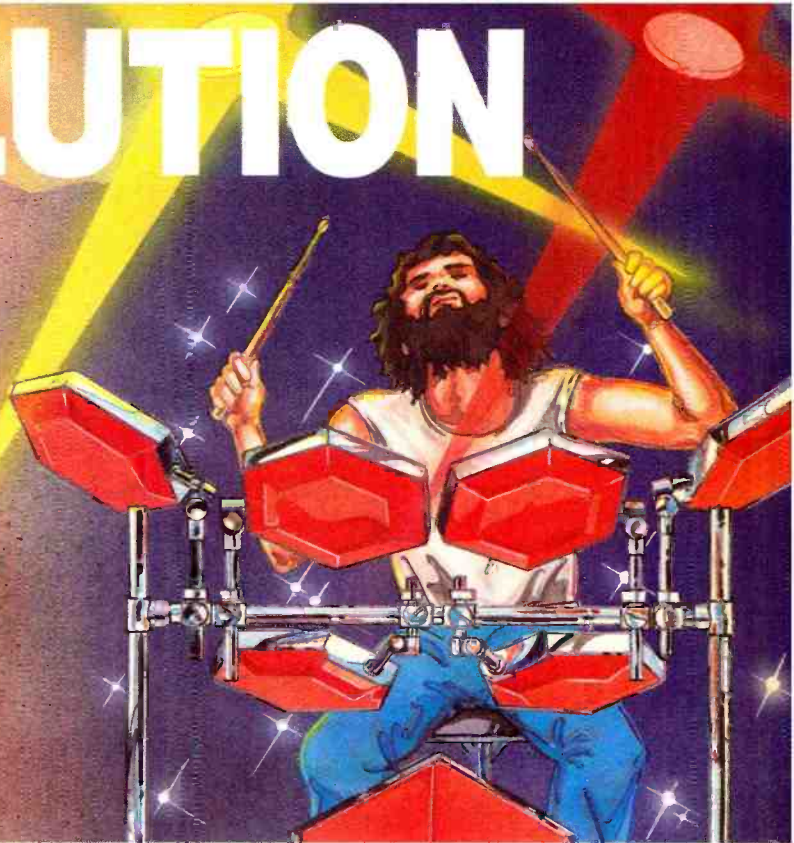
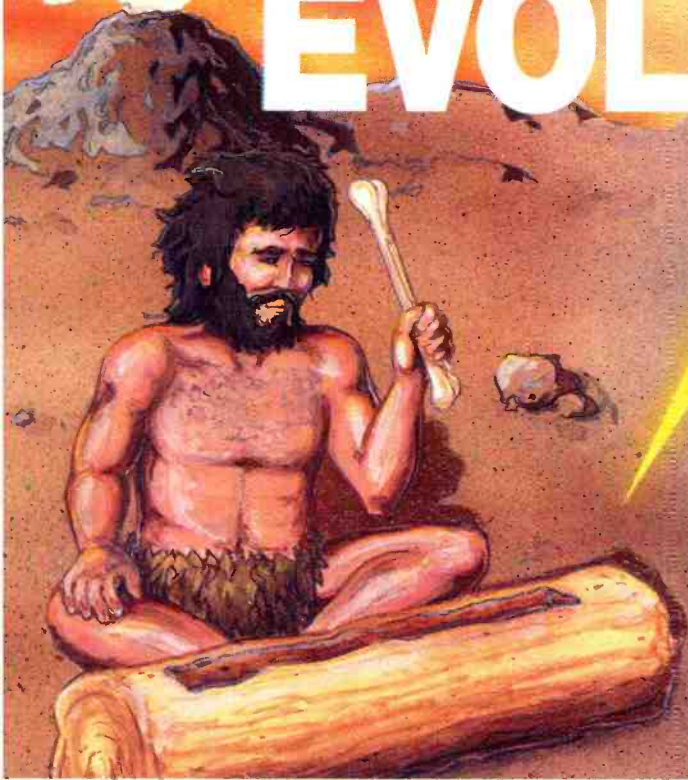

IN THE BEGINNING THERE WAS RHYTHM

Rhythm is the basis of life. It is waves lapping steadily on every shore. Perhaps rhythm was discovered by some caveman who tried to flush wild game out of a hollow log by pounding on it with a stick and was surprised by the booming sound pattern that echoed back. Hence, the first drum was born.

Today, the modern drummer has entered the computer age. MIDI—musical instrument digital interface—represents the epitome of today's musical technology. MIDI software enables the composer to store, edit, cut, and paste electronic drum riffs as easily as a word processor can perform these feats.

TIMELESS QUALITY

For 40 years Switchcraft has played an important role in the evolution of recorded sound. In session after session musicians and audio engineers insist on our state-of-the-art audio components. Not only is Switchcraft counted on to meet the latest technology, Switchcraft is relied on to provide the most durable, reliable components in the recording and broadcast industries. Our commitment to making only the finest audio accessories has made Switchcraft the most-asked-for name in the market.

WHY SWITCHCRAFT IS THE INDUSTRY STANDARD

Our jacks, plugs, adapters, cable assemblies, microphone connectors—

no matter what sound accessory you need—all offer our unchanging commitment to quality components.

For example, our 1/4" guitar plug has set new standards in quality. Switchcraft features one-piece construction and cable clamps to prevent breakage. Our guitar plug has been copied by our competitors. Don't be fooled by the counterfeits. Switchcraft construction outlasts the others. Ask for it by name.

Our Q-G, or "quick-ground," connector features our exclusive

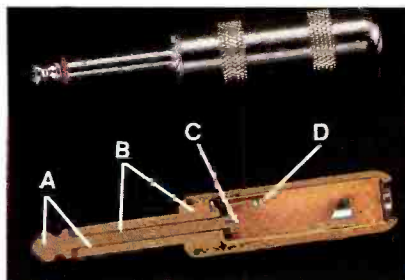

- A. 1 PIECE TIP AND TIP ROD:** Cheap imitations use 2 piece construction which is a "weak link."
- B. 1 PIECE SLEEVE AND BODY:** Cheap imitations use tubing pressed into body which is a failure point.
- C. ANTI-ROTATIONAL TAB:** Prevents tip rod from turning which can create a weak solder joint.
- D. ELECTRO TINNED TERMINALS:** Makes for easy soldering with good electrical connections.

ground terminal which eliminates noise at connection. The Q-G's housing stands up to abuse, while providing full shielding and protection to the cable. Lost insert screws are eliminated by our captive design insert screw.

INTERFACE WITH THE FUTURE

Enter the dawn of a new age in recording and broadcast equipment quality. Famous Switchcraft quality. You can depend on it.

Send me information on your quality components:

- Please have a representative contact me
- Please send me your General Line Catalog covering the complete Switchcraft line.

My area(s) of interest is:

- Switches Connectors Power Cords
- EAC Receptacles Jacks/Plugs
- Molded Cable Assemblies Patch Panels

My application is Current

Future (date) _____

Name _____

Company _____ Title _____

Address _____

City _____ State _____ Zip _____

Telephone (_____) _____

Mail To: Marketing Communications Dept.,
Switchcraft, Inc.
5555 N. Elston Ave.,
Chicago, IL 60630

REP 8-88

Switchcraft

A Raytheon Company

5555 N. Elston Ave.
Chicago, IL 60630
(312) 792-2700

Circle (14) on Rapid Facts Card

www.americanradiohistory.com



Photo 4. The screening room.

comfortable looking at films.”

Although the mix rooms have small “footprints,” Holman points out that the volume is large. “You want reverberant energy distributed evenly over the entire audio spectrum. This distribution occurs naturally as the room volume gets larger. With the premix room, we took what might be normal height-to-width-to-length measurements and tipped it on its side. The cubic footage is kept under control visually by having a lot of air volume above the cloth ceiling. If we had built it to the conventional (H×W×D) ratios, we would be tempted to put another story above it, and you’d have a noise control problem with footfall from above.”

Screening room and recording areas

The two largest work spaces in the Technical Building are the scoring stage and the screening room. As conceived by Holman and Ted Schultz, movable baffles on the scoring stage allow the reverberation time to be altered from 0.7s to 3.5s in the midrange. Allowing for the sound absorption caused by the players in a full-sized orchestra, a maximum RT_{60} of 2.5s is to be expected, which is still the equivalent of a long concert hall reverb. (See Photo 3.)

The variation of reverberation time vs. frequency is, according to Holman, “as uniform as we know how to make it. As to how long you can make the reverb time, at the high end, you inevitably run up against air absorption.”

Design factors aside, one might wonder why Lucasfilm is constructing one of the largest scoring stages in the world—60' × 75', large enough for a 120-piece orchestra—in the middle of nowhere. Holman readily admits, “It’s a grand and elegant idea, a complete and utter entrepreneurial risk because scoring five feature pictures a year does not justify the construction costs.” Obviously, one goal is to attract other major projects from the outside. This is one reason the ceiling was built with a load-bearing capacity sufficient to accommodate a lighting grid for film and video shooting.

At this point, the scoring stage has no console. The final decision depends on the direction that the room will take. Tom Scott says that the first two recording sessions at the scoring stage (an album for the San Francisco Ballet orchestra and an album by the Grateful Dead, using Guy Charbonneau’s Le Mobile remote truck) indicate “the kind of diversity we’d like to continue to tackle.”

The 300-seat screening room is completely outfitted to play back virtually any format, composite or interlock, from 16mm to 70mm, using classic Norelco 16mm and AA-II 35/70 projectors. As with



Photo 5. Foley stage. The design of the foley stage required the highest degree of sound-isolating construction to reach the background-noise criteria of NC-5, the single lowest background-noise criteria of the project.

premix room, that will pretty much carry across to the theater. It won’t be identical, but I can claim that you will make the same level and equalization judgments.” (See Photo 2.)

Further consistency between rooms was accomplished by having the mix consoles subtend a 45° angle between the outer

speakers. In a conventional control room, the subtend angle is usually 30°; that is, the mixer bisects the 60° angle of an equilateral triangle, with the monitors representing two of the three points of the triangle. “When we start involving the picture, we block that off at ±22.5°. That’s pretty much as far as most people are

It's Time To Rack Up Another Hit.



It's hard to follow a great act. Expectations run high. The performance must be flawless. When we decided to carry the legacies of our LA-2A, LA-4 and 1176LN into the next generation, we knew exactly what we were getting into.

Our new 7110 Limiter/Compressor incorporates the characteristics of its predecessors, is the natural addition to a legendary line and has all the potential to become a major hit in its own right. The 7110 combines both peak and average limiting action, producing smooth, predictable RMS style performance like the LA-2A and LA-4 with the precise automatic peak control of the 1176LN.

The 7110, with our exclusive program dependent Smart-Slope™ gives you adjustable compression curves from 1.5:1 through infinity:1. You set

threshold, attack, release time and output level—the 7110 automatically rides the gain with split second response.

To make set-up as simple as possible, we've included an Automatic Preset function. Punch the button on the front panel—the 7110 automatically defaults to program dependent attack and release times, and presets the peak threshold and ratio to consistently used settings. Perhaps the best news of all, the 7110 produces crystal clean sound and is virtually transparent.

Just another limiter/compressor? We don't believe so. After you've heard it for yourself, we think you'll agree. Stop by your local JBL/UREI dealer and give it a listen. And, get ready to rack up another hit.



The 7110 combines the smooth predictable RMS style performance of the LA-4 with the precise automatic peak control of the 1176LN.



**UREI
ELECTRONIC
PRODUCTS**

Circle (15) on Rapid Facts Card

JBL Professional
8500 Balboa Boulevard, Northridge, CA 91329
© 1988 - JBL Incorporated A Harman International Company

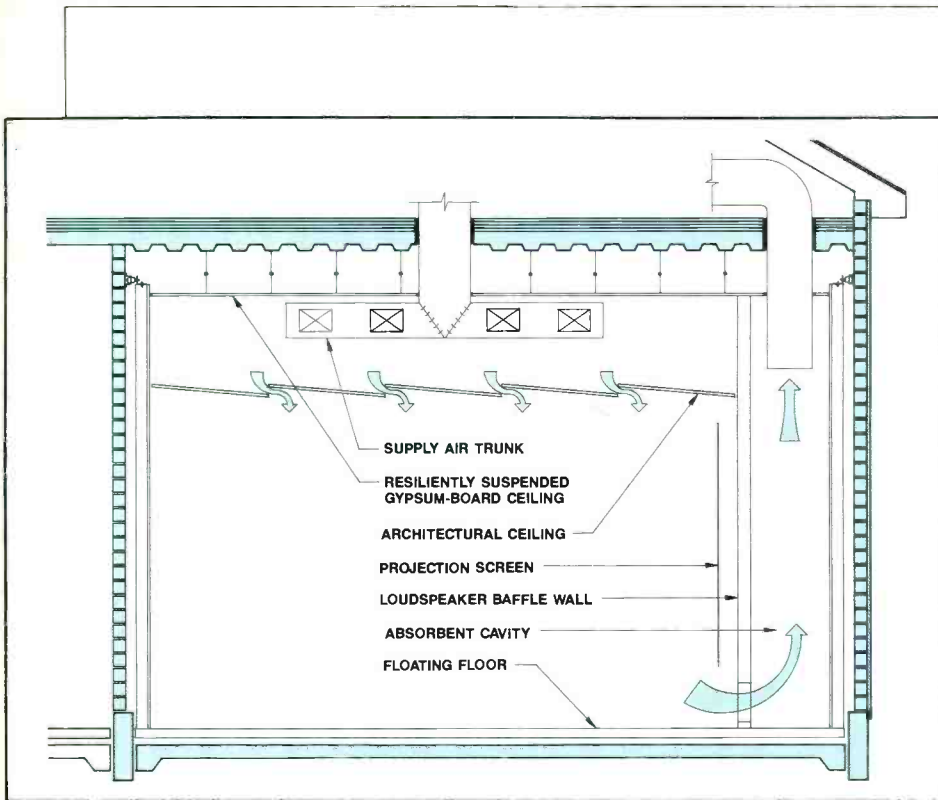

Figure 1. Isolation/ventilation section. "Room-within-a-room" construction can provide a very high degree of sound isolation using common building materials. Details such as the resilient structural connections of the inner envelope to the outer envelope, penetrations of both envelopes by ventilation ducts, and electrical and audio cabling must be carefully considered.



Photo 6. An example of the many wiring troughs.

the scoring stage, everyone asks of the design: Why isn't this also a dubbing stage? Tradition in Hollywood (at MGM, 20th Century-Fox, Disney and Glen Glenn, for example) the main studio theater serves dual duty as the premier mixing arena. To this end, Holman notes almost with glee that it will cost a fortune to convert the

screening room to dubbing because "there isn't one stick of conduit into the room to allow that. It is that deliberate. Multipurpose spaces are really tough (to schedule), and you would like to have the luxury of having a place where you can always come in and run a screening as in a perfect theatrical environment without inter-

rupting a mix." (See Photo 4.)

Whereas the mixing and screening rooms in the Technical Building are fairly dead, the foley studio was built to industry standards: as dead as possible. The "dead" acoustics give the foley walkers and mixers a chance at creating believable footsteps and movement to fit the most dead exterior, while reverberation can always be added to simulate live interiors. (See Photo 5.)

The same is usually thought true of the design of ADR stages, with no audible "room impression." Holman says that experience of others has shown that if a room is too dead, actors have to shout to get enough sound back to their ears. "The trick in ADR (room design) is to make it a little more lively than it should be for the equivalent room volume in the THX-outfitted theater, but to make the reverberant field very diffuse." To this end, the three windows in the studio (including one that looks outside!) are tilted downwards so that reflected sound from the voice is directed away from the microphone.

Power and HVAC

As many may recall, the original intent for the Technical Building was to do away with analog mag film and multitrack tape completely, and to store, edit and record all sound onto a network of hard disks and optical drives, all run via the SoundDroid that Lucasfilm was developing. The idea was that each editing station would require 15kW because of power-hungry, high-speed logic in the SoundDroid architecture. Because of the high power usage, the air conditioning in both the central and local machine rooms is overkill compared to the requirements of dubbers and multitrack recorders. With the dream of digital editing still alive at Lucasfilm, we felt it was wise to build for worst-case situations. The main service into the building is 12,000V, 3-phase, with 1,000A per leg. Uninterruptible power supplies connect to emergency lighting, the SSL computers and Unix file servers.

"All HVAC, plumbing, electrical, fire and security, and control lines, are in the ceiling," notes Holman. "There is higher floor-to-floor spacing in this building than is ever typical. This allowed us to dedicate the area under the floor for technical services. The wiring not only extends from the central and smaller machine rooms, but also to individual editing rooms because of the need for audio and control lines to every digital sound editing station." (See Figure 1.)

The HVAC "chillers" are buried under the parking lot because of their vibration-producing nature. Hot and cold water is then sent to air handlers throughout the plant. Air handlers extract the heat and

What LA's

Largest

Pro Audio

Dealer

Can Do

For You

With over 200 different brands of pro audio/video equipment, we offer you the best selection in the west. And we carry a much larger inventory so chances are we have what you need in stock.

We'll keep you abreast of new developments, new options, and updates for your equipment so you're always current and usually ahead of the rest of the industry.

New Demonstration Rooms

Since we moved to larger quarters here in Burbank we've opened *two* new fully equipped showrooms. In the Pro Room are three complete, operating production systems—consoles, monitors, tape machines (including 32 track digital), and signal processing/effects gear. Our second room has three more complete production systems set up to hear and compare. This room caters to the

audio/video needs of musicians and production studios.

Just the Facts, Ma'am

Things change quickly in pro audio. To make sure everyone here knows all the facts about the latest equipment, we've added a Product Specialist to our staff. His *only* job is researching equipment—reading brochures and tech manuals, going to trade shows, talking with manufacturers—and sharing that knowledge with our customers.

New Central Location

We're easy to get to from Hollywood, LA, and the valleys. And with more room, we've enlarged our technical and parts departments for even better service and support.

Come by and visit us in our new building. Turn some knobs in the demo rooms. Or just call and we'll be happy to discuss your pro audio needs.



Office Staff (l to r): Niki Simpson (Accounts Payable), Carol Gumbel (Controller), Shanah Metzelaar (Receptionist), Darrin Miller (Purchasing), Michele Schwartz (Accounts Receivable), Jim Kropf (Delivery), Front: Brian Cornfield (President)



Sales Staff (l to r): Nat Hecht, Paul Freudenberg, Paul Svenson (Sales Manager), Karyn Thomas (Sales Assistant), Philip Celia, Mark Lever, Vanessa Perea (Tape and Accessories), Garth Hedin, Robert Corn, Ben Ing (Product Specialist), Constantino Psorakis



Our Pro Demo Room: Three different fully operating production systems, plus a vast array of outboard gear



Technical Staff (l to r): Steve Smulian (Service Manager), Paul Hulse (Senior Technician), Rik Shannon (P.O.M.P.), Greg Dougan (Parts Manager), (Not Pictured: Nello Torri)



Sales/Service/Design

ea Everything Audio
Advancing with Technology

2721 West Burbank Boulevard • Burbank, California 91505
Phone (818) 842-4175 or (213) 276-1414 • Fax (818) 953-2908

Circle (16) on Rapid Facts Card

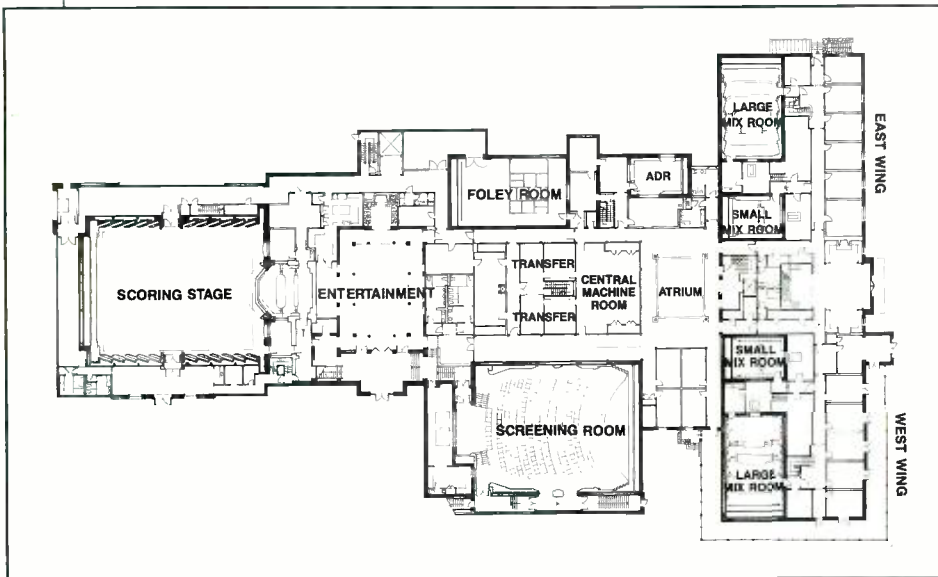

Figure 2. Plan view of the Technical Building.



Photo 7. Duct isolator. Field inspections during construction are necessary to avoid improper construction and installation. If detected before the installation of finished materials (ceilings and wallboard, for example), conditions such as the misaligned ventilation duct hanger shown above can be corrected easily.

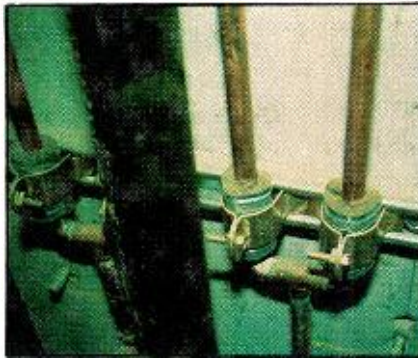

Photo 8. Plumbing isolation. Effective noise control requires attention to detail. Even small water pipes (shown above) are isolated with felt collars.

cold from the water pipes and distribute the conditioned air to the various rooms. With this system, each room can be individually climate-controlled. Kelly notes that although the size of the units are a bit much for current needs, "we don't want to turn around in 10 years and say, 'okay, let's knock the building down and start again.' Systems such as this are hard to put in later; it's real easy to run it on a low cycle at a third of its normal speed. When we do get rack after rack of TTL electronics that dissipate 10kW, we can crank it up for greater cooling."

The decision to use standard analog technology was made "so late that it was impossible to modify the floor plan," according to Holman. At that point, Phase 3 had been drawn up, although not finished. As noted before, reverting to analog

resulted primarily in design overkill at times; the only area in which conventional analog systems taxed the design was in console heat dissipation. It had been assumed that the heat dissipation needs of the SoundDroid digital consoles would come from the power supplies in the local machine room; the large SSL consoles dissipate most of their heat in the studio.

Once it was decided to have the whole mechanical system (computer equipment, machine rooms and air handling) placed centrally in the building, Schwind says that four schemes for vibration isolation were evaluated for results and cost-effectiveness.

SSL SL 5000M film consoles

In late 1985/early 1986, the search for a film-dubbing console began. After discovering the high cost of producing cus-

tom consoles and meeting resistance from several manufacturers to modify their existing consoles, the Sprocket Systems staff began discussions with Solid State Logic about modifying the modular SL 5000M series broadcast consoles. "Even though they do not do custom work, they wanted to get into this new realm (film re-recording), and what we needed to use was exactly what they needed to create for themselves," says Scott. Working closely with SSL on the design of the consoles was Brian Kelly.

In the final tally, Lucasfilm ordered five consoles, with two large consoles in final mix rooms, plus a smaller one (36 inputs) in the west premix room. In addition, there is an SL 5000 foley console. The fifth console went to the San Rafael facility.

The large mix consoles contain 64 mono faders plus six 4-track returns, which are designed to bring 4-channel effects devices or premixes into the board without needlessly taking up prime fader real estate. In addition, each dub room also has 24 "mix-in-context" inputs that normally route premixes directly into the monitor chain so that further premixing can be done against them, hence, "in context."

The primary difference between the Lucasfilm SSL film consoles and the "stock" 5000 film board is the monitor section. The Sprocket Systems boards were delivered without monitoring facilities, and, instead, the Lucasfilm staff designed a custom monitoring system that they dubbed a "CP-250," in deference to the amount of Dolby Laboratories recording and monitoring equipment that is normally housed in a dubbing stage in a hot-rodged CP-200 theater processor. Gary Kephart was the project engineer of the "CP-250."

Basically a rack-mounted PC that sends commands to two sets of 64x8 Integrated Media Systems crosspoint switchers, the CP-250 allows instant resetting of the multitude of recording and monitoring modes demanded by film sound post-production. In addition, the CP-250 allows for every conceivable form of "real-world" noise, distortion, and equalization simulation, including the optical track simulator designed by Terry Beard of Los Angeles.

Wiring design

One of the first questions in designing any sound or video facility is whether studios will share a central machine room or, instead, will have their own dedicated machines ("distributed"). The design of the Technical Building has incorporated parts of each approach, with all mag film reproducers (40 currently, with wiring in place for an additional 16) in a large machine room in the middle of the building. Local machine rooms are equipped with 6-track

mag recorders, four currently in the west wing and two in the east.

Although Sprocket Systems currently has 13 full-time people on its engineering staff, the staggering amount of wiring necessitated hiring subcontractors. David Carrol Electronics was brought in to handle all low-voltage wiring and the interface design. DCE's on-site representative, Michael Stocker, and Sprockets engineer John Brenneis supervised the planning and installation of the wiring.

Early on, it became apparent that long runs from the main machine room would benefit from lower capacitance than otherwise available in off-the-shelf cabling. To this end, David Carroll, working with Paul Miller at Belden and the Sprockets engineering staff, specified that the insulator be made of Datalene instead of the standard polypropylene. Final reduction of capacitance was calculated to be approximately 20%.

As long as they were having cables custom-made, Carroll specified much thinner jackets than are usually the case with multipair cable, resulting in much greater flexibility and less bulk, all the easier to lay in the maze of troughs. (See Photo 6.) The only problem was that Datalene is softer than normal insulation. "Screwing down tight for strain relief could distort the insulation enough to cause a short," according to Kelly. "Datalene works because it's in expanded form, and, therefore, it's soft. If you crush it hard enough, you can give yourself problems." Outside jackets were color-coded, with blue indicating 26 pairs, green 16, yellow eight, red four and single-pair wiring standard gray.

The word "custom" usually implies great expense, but Carroll says that, in fact, the cost on a per-foot basis was substantially lower than that of Belden's standard multipair. A primary reason for this was that the short ends that result during the manufacturing process were always used. In addition, Belden didn't have to pass on the cost of storing and inventorying leftover cable because DCE purchased an entire production run.

Scott notes that because DCE put the connectors on and tested the cabling off site, it "lent itself to a kind of production-line testing procedure. For the hundreds of thousands of connections, there were only a handful of reversed-phase problems. Typically, when we found something wrong, it was a mistake that we had made in the ordering and the paperwork."

From the dubbers in the central machine room to the console, the signals follow a Byzantine path through three patch bays and two ADC UltraPatch cross-connect racks. (See Photo 9.) Briefly, from the XLR output on the dubber, the signal



Photo 9. ADC cross-connect wall in a local machine room.

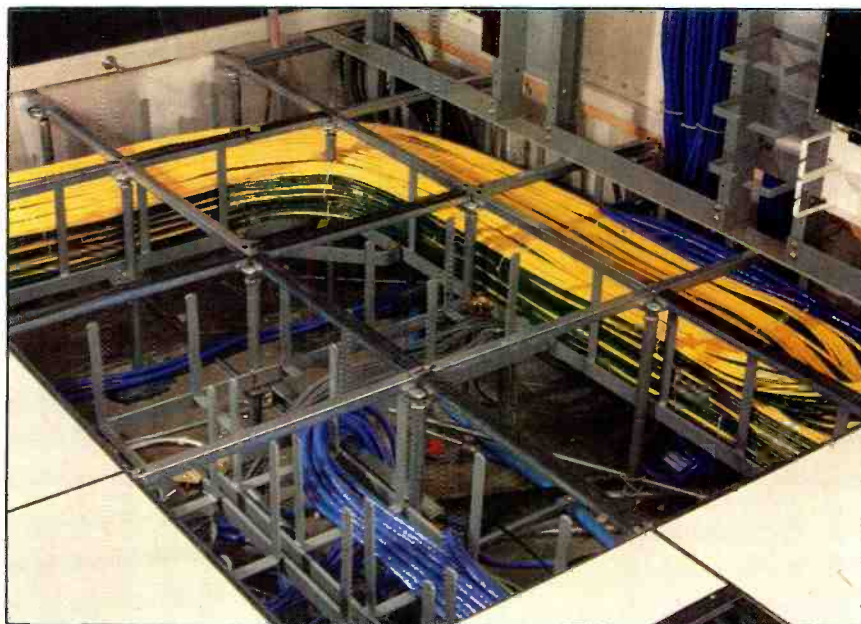

Photo 10. A wiring trough. Each wire is measured for its relative position in the trough.

THE BEST SOUNDING WILL ALSO PREVENT FROM BECOMING

Announcing the Wendel Jr. from Roger Nichols' Wendel Labs.



Three reasons why Wendel Jr. sounds better:

1) A 50 kHz sampling rate, unsurpassed in this industry, gives you a real **25 kHz frequency response!** Beware of units that claim a sampling rate of 30 kHz — the true usable audio frequency range is only half the sample rate.

2) These samples weren't recorded by some second engineer, but by **Roger Nichols, one of the best engineers in the world.** They were recorded direct to the 3M Digital Mastering System and then transferred directly to the EPROMs used in the Wendel Jr. So Wendel Jr. samples have *always been in the digital domain!* (Many drum machines' samples are from analog tapes.)

3) **Incredibly long samples** give you unmatched realism and sound quality, superior to any drum machine at any price. Just listen to other ride or crash cymbals and compare them to the Wendel Jr. You'll find that their typical cymbal

sounds last only 2-3 seconds, while the **Wendel Jr. Ride cymbal is 8 seconds long!** The most expensive drum machines in the world can't even come close to Wendel Jr.'s long samples.

The world's fastest trigger!

Wendel Jr. does *not* use MIDI triggering because it's too slow (as most of you sophisticated MIDI users have already found out). Instead, Wendel Jr. drum sounds are triggered by an incredibly fast circuit. It is so fast that you can listen to the original drum sound and the triggered Wendel Jr. sound side-by-side and you'll hear **no timing difference!** The trigger input can take virtually any signal (drum machine output, tape signal, shorted footswitch, etc.).

Drum sounds so real, they have that human feel.

The optional "Snare Pair" cartridge gives a "left hand-right

hand" feel to the snare rolls. This is a subtle effect, but it makes your drums sound human — as opposed to machine-like. **The Wendel Jr. is the only product that is capable of giving you this incredible "two-hand" feel.** When are other manufacturers going to realize that nobody plays all the drums with just one hand?*

Prevent your drum machine from becoming obsolete:

Wendel Jr. is a percussion replacement device, not a drum machine. As mentioned earlier, you can use your existing drum machine output(s) to drive the Wendel Jr. Or, for example, let's say you wanted to replace the mediocre snare drum sound on track 3 of your recorder. Just take the track 3 tape output to the trigger input of Wendel Jr. and record the new Wendel Jr. snare sound on another track. You don't have to keep buying a new drum machine every year. Perhaps more important-

*Rick Allen notwithstanding

DRUMS YOU CAN BUY YOUR DRUM MACHINE BEING OBSOLETE!

ly, you can now use the drum machine that's easiest for you to program, and then replace key sounds with the Wendel Jr. as needed.

The ultimate drums for sound reinforcement:

Wendel Jr. is the perfect answer for sound reinforcement problems. Just use "trigger" mics on the real drums to feed a rack of Wendel Jrs. patched directly to your PA mixer. Bingo, you have incredible drum sounds without any feedback loops. All in a matter of minutes, not hours.

How to audition the Wendel Jr.:

Just listen to "Hey Nineteen" on Steely Dan's "Gaucho" album. Or try other albums by Steely Dan, Steve Winwood, Rod Stewart, Starship, Al Jarreau, Stevie Wonder, Kenny Rogers, Diana Ross, Duran Duran, Huey Lewis,

Toto, Miles Davis, Pink Floyd, Heart, Supertramp, George Benson, Paul Simon, Christopher Cross, Bruce Hornsby and the Range, David Foster, etc.

Now here's the deal:

Roger used to sell the Wendel Jr. with one cartridge (kick and snare) to his dealers for \$720 with a suggested retail price of \$1000. **But direct from us, the Wendel Jr. is NOW ONLY \$600!** And if you decide to buy before September 30, 1988, we'll send you a second cartridge free. So take advantage of this offer now! *Many* optional sound cartridges are available.

BUY DIRECT AND SAVE!

- 40-60% off typical retail prices.
- Every product tested before shipment.
- 5-day trial period - return shipping extra.
- Money Back Guarantee if not fully satisfied.
- 2-day turn-around on service - we fix everything right here.
- Always on the lookout for unique products like the Wendel Jr. - hot tips are welcomed.
- Sneak Preview: Incredible savings on highly rated N.I.H. Labs PA gear and the amazing R-16 Digital Effects Processor.

Wendel Jr. Percussion Replacement Device

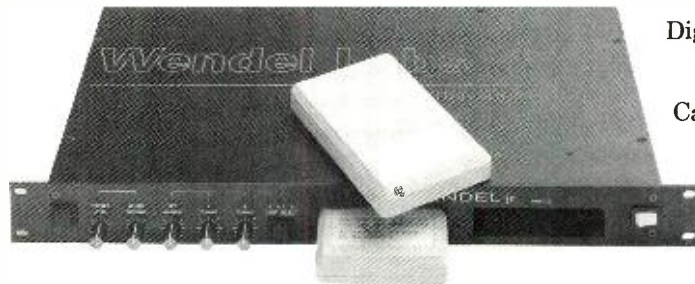

Digital Software Based
 • 50 kHz Sampling
 Hewlett-Packard™
 Cartridges • Designed
 and engineered by
 Roger Nichols.



- I want the Wendel Jr. and love your price. I've enclosed
 cashier's check
 money order payable to Industrial Strength Industries;
 bill my Visa Mastercharge American Express
- Account Number _____ Expiration Date _____
 Signature _____ Date _____
 Calif. residents add 6.5% sales tax (\$639.00 Total).

- Sounds great but I'd like more information. Please send me a product review and excerpts from the owner's manual, written by Roger Nichols.

Name _____

Address _____

City, State, Zip _____

Mail to:

INDUSTRIAL STRENGTH INDUSTRIES™

13042 Moore St. • Cerritos, CA • 90701

Call TOLL FREE: 1-800-537-5199

In CA: 213-921-2341 Hours: 8 am-5 pm Pacific Coast Time

Circle (17) on Rapid Facts Card

August 1988 *Recording Engineer/Producer* 31

www.americanradiohistory.com

Equipment List

Sprocket Systems, Technical Building at Skywalker Ranch

Studios D and G

Consoles are custom SSL 5000 series with 88 automated inputs and a 24-input side mixer. All the 35mm sprocketed equipment is from Magna Tech Electronics of New York. Each room provides:

as many as four 6-channel 35mm recorders, all with Dolby A or Dolby SR

as many as 36 dubbers (1-, 3-, 4- and 6-track) all with Dolby A or Dolby SR

Otari MTR-90 24-track with Dolby A or SR

Otari MTR-10 2-track with Dolby SR and time code

high-speed 35mm projection to a 24' x 10' screen image

video-synchronized playback available

machine control via JSK Engineering controller and Lynx synchronizer

reverb devices: Lexicon 224Xs, Lexicon 480 XL, Quantek QMS limiters and expanders: dbx, SSL, Drawmer, Aphex, UREI, Dolby

THX sound systems with sub-woofer and stereo-surround channels

CSC power amps

Rane equalizers
programmable intercom system from McCurdy Radio, Toronto
time code equipment from Skotel and Timeline

Studio E

Same as Studios D and G, but only 36 automated inputs and a screen size of 15' x 6½'. Also includes Alpha Audio's The Boss synchronizer controller and a synclavier.

Studio H

(sound effects workshop)

24-input Soundworkshop console

16-track Otari MX-70

Otari MTR-10 2-tracks

Lynx time code synchronizers

Sony video playback

MIDI equipment

Scoring stage

5,000-square-foot floor, 29-foot ceiling, adjustable acoustics, 48' x 20' screen

microphone pre-amps: George Massenberg, Deane Jensen, Focusrite, API

microphones: Neumann, Telefunken, Schoeps, Sanken, AKG, Sennheiser

Meyer Sound Labs monitor speakers

Hafler power amps

ADR stage

MTE ADR controller, 6-track 35mm and 1-track 35mm recorders with Dolby SR

2-track and 24-track Otari with Dolby SR

35mm projection and video

Foley room

1,600-square-foot room, water tank and different floor surfaces

35mm projection and video

SSL 5000 console, Otari MTR-90 24-track with Dolby A or SR

Screening room

300 seats, 48-foot screen, 35mm and 70mm projection, magnetic or optical sound playback

double system sound also available (1-, 3-, 4- or 6-track), as well as time code synchronization

Dolby Cinema Processor CP-200

THX Theatrical playback system

QSC power amps

Wiring

prewired patchbays from Audio Accessories and custom cable from Belden

custom ADC Ultrapatch panel for cross-connect termination

goes to the rear of an ADC panel, which assigns it to a patchbay in the machine room. Through a patchcord, the signal is sent to an input channel of a given console, and, if that signal is SR-encoded, no further patches are necessary. There are Dolby channels dedicated to all console inputs, and non-encoded material is played with the channel placed in "bypass."

From the 56-pin Elco/Edac connector at the rear of machine room patchbay, the console inputs travel approximately 200 feet to the cross-connect rack in the local machine room of each wing. (See Photo 10.) The cross-connect rack also accomplishes equipment-bay-to-patchbay normalizing with the signal going through the TT patchbay in the machine room. The patchbay routes the signal through the Dolby XP racks to the console credenza patchbays.

Multitracks may be connected almost anywhere required because the premix

machine rooms in each wing have two multitrack stations. Two multitrack stations are in front of each final mix console, and one is at each premix console. Patching to and from multitracks, primarily to the "B" inputs of the consoles, is handled at 90-pin Elco/Edac patchbays in the local machine rooms, with 84 connectors each.

All of the patchbays and patchcords for the facility have nickel-plated connectors to avoid the tarnishing problems associated with brass. (Audio Accessories made the patchbays and ADC, the patchcords.) Brian Kelly notes that because of the small contact area of TT-style connectors, brass connectors are very susceptible to dirt and oxidation.

Recent development at the ranch includes a video department, headed by Dale Miner. In addition to video transfers and sync distribution, the video machine room also has a film chain for film-to-tape transfers.

By keeping work in-house, chief engineer Wayne Wagner hopes to avoid the all-too-prevalent standard time code and sync problems. "In a place like this, where you start on film and finish on film, and sort of make a detour over into the video world and back, we want to be very careful about everything that goes on." Wagner says that although Sprocket Systems is generally thought of as an audio facility now, his goal is eventually to "behave in a professional video manner, with video lines timed, equalized and using a routing switcher."

The Technical Building at Skywalker probably represents the largest 1-time investment in post-production sound and certainly sets a standard for the design of 1-stop post-production sound. Only time will tell how Lucasfilm will benefit from the intricate design of the facility.

RE/P

Recording
ENGINEER/PRODUCER

Nashville
ENTERTAINMENT
ASSOCIATION

NASHVILLE

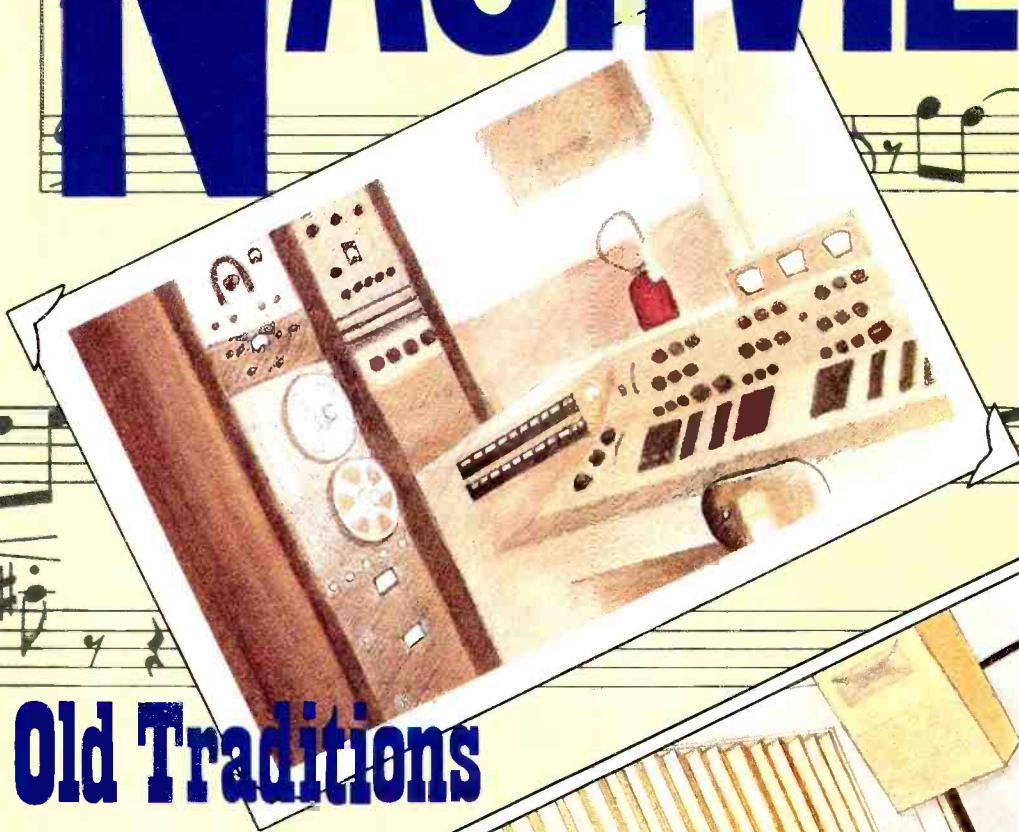

Old Traditions



NEW FRONTIERS

Nashville's Finest

The Castle



SL 4056 G Series; 48 Channels
SSL G Series Studio Computer with Total Recall™
(615) 791-0810

Emerald Sound Studios



SL 4064 E Series; 56 Channels
SSL G Series Studio Computer with Total Recall™
(615) 321-0511

Masterfonics

SL 4064 E Series; 48 Channels
SSL Studio Computer with Total Recall™
(615) 327-4533

Sixteenth Avenue Sound

SL 4056 E Series; 48 Channels
SSL Studio Computer with Total Recall™
(615) 327-8787

Sound Stage

SL 4056 E Series; 48 Channels
SSL Studio Computer with Total Recall™
&
SL 4056 E Series; 46 Channels
SSL Studio Computer with Total Recall™
(615) 256-2676

Solid State Logic

Begbroke, Oxford, England OX5 1RU • (08675) 4353
1 rue Michael Faraday, 78180 Montigny le Bretonneux, France • (1) 34 60 46 66
Via Cesare Cantu' 1, 20092 Cinisello Balsamo, Milan • (2) 612 62 81
320 West 46th Street, New York, NY 10036 • (212) 315-1111
6255 Sunset Boulevard, Los Angeles, California 90028 • (213) 463-4444
Toll Free • (800) 343-0101 (10am-6pm EST)

SSL Representatives • Acustilab, Venezuela (58) 2-987-4845 • Audio Consultants Co Ltd, Hong Kong (852) 3-7125251 • Siv Ing Bernum A/S, Norway (47) 2-145460 • Cinac, Eastern Comecon (41) 24-71-1600
EMT, West Germany (49) 7825-1011 • Dr W.A. Günther, Switzerland (41) 1-391-3939 • Savana Comunicacoes Ltda, Brazil (55) 21-274-5009 • Studer Revox Japan Ltd, (81) 3-320-1101
Syntec International PTY Ltd, Australia (61) 2-406-2700 • TER, Turkey (90) 41-380296 • Trans European Music, Belgium (32) 2-569-1823

GREAT INPUT, GREAT OUTPUT

***Kim Carnes • Amy Grant
Hank Williams Jr. • Randy Travis
Reba McEntire • Rodney Crowell
Steve Earle all have one thing
in common...something
very uncommon...***

Emerald Sound Studio

**We have the most technically advanced
recording facility in Nashville**

Featuring

- Solid State Logic SL4000 E Series Recording Console with 56 input modules and the *G Series Computer Update*
- Two 32 track digital/analog multitrack tape machine capability
- LYNX time code synchronization system
- More in-house outboard gear than any other Nashville studio
- On-site IDB Satellite Uplink/Downlink to send or receive tracks, overdubs and demos
- Nashville's most comfortable, relaxed atmosphere with a "cool out" lounge, kitchen area, meeting room, total security---and a putting green.

We're making tomorrow's hits today

***Emerald
Sound Studio***

**1033 16th Avenue South
Nashville, TN. 37212
Tel. (615) 321-0511
Circle (19) on Rapid Facts Card**

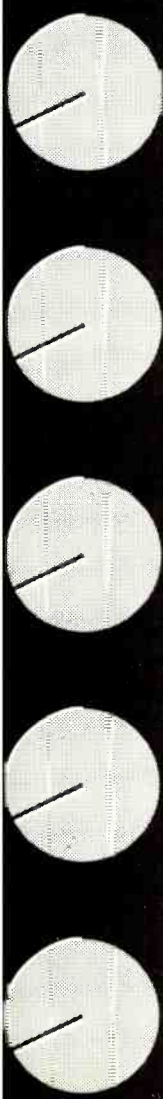
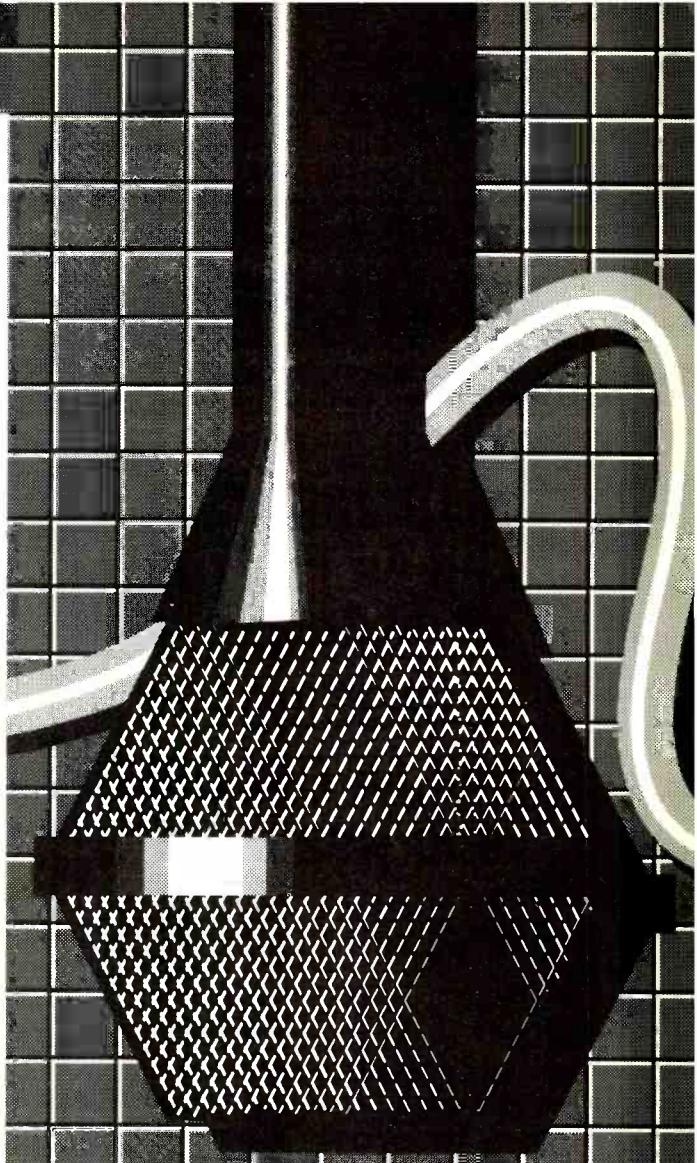

Promoting Nashville

By uniting the different facets of the entertainment industry, the NEA promotes the city as a total production center.

The Nashville Entertainment Association may have started out promoting only music, but its scope has broadened as Nashville's has. As Nashville has evolved into a total entertainment/production center, the NEA's mission has become an entertainment Chamber of Commerce.

The studio community is an integral part of the NEA's base. Studio owners sit on the board of directors, facilities are corporate members, engineers and producers are individual members. This supplement is a way to salute the factor that has propelled Nashville into national and international prominence as a total production center: the studios.

The association started in 1980 as the Nashville Music Association, with the goal of promoting the music industry. In succeeding years, it started working with other parts of the Nashville arts community, and the name was changed in 1986 to reflect this growth.

Today, the NEA is comprised of 1,000 corporate and individual members. A 60-member board sets general policy and direction; two paid staff members handle day-to-day activities.

Part of the NEA's ability to promote all aspects of the industry is because the membership is divided into 13 categories. When members join NEA, they choose what membership category they want to be in. When board elections are held each year, members can vote only in the cate-

gory in which they belong. For instance, only producers can vote for other producers to represent them.

The result is that the 26 board members (two from each category) tend to approve projects and policies that benefit all the membership, rather than a heavily represented group.

After the annual board is elected, it chooses an additional 23 vice presidents to round out the body. This is a non-elective office; vice presidents run committees, and are chosen as a way to groom future directors.

Day-to-day operations are handled by Lynn Gillespie, executive director, and Diane Rankin, director of special projects. Both started at the NEA (Diane as an intern and Lynn as a secretary/receptionist) after which they went to various jobs in the industry and returned to NEA full-time.

One of the services NEA provides is helping people new to the community find jobs. Many times, volunteers at NEA are able to find jobs through contacts they made while working at NEA. And like a film commission, NEA also helps individuals and companies that are in Nashville temporarily for a project.

Other activities

Some of the NEA's other activities:

- NEA Forums: a series of topical discussions for information and education, fea-

turing leading members of the entertainment industry.

- NEA Spotlights: a series of showcases for selected new and developing artists who are ready for recording contracts and who perform before members of the industry.

- The NEA Film & Video Committee: produces public service announcements promoting the arts, in conjunction with the Tennessee Arts Commission.

- Master Award: given to the person or persons contributing the greatest influence in establishing and developing Nashville as an entertainment center.

- MIDEEM and New Music Seminar: NEA exhibits at these premier music industry events, promoting the Nashville and Tennessee entertainment communities.

- Producer/Publisher Nights: Publishers can't get their songs to the producers; producers aren't getting good songs. NEA brings the two groups together at Producer/Publisher Nights, at which publishing companies submit their best songs, which are then heard by the area's producers. By acting as a broker, NEA speeds up the process for both the publishers and the producers.

Individual memberships are \$40 per year; corporate memberships are available at various donation levels. For more information, contact the NEA at Box 121948, Nashville, TN 37202; 615-256-4435.

RE/P

A project between Recording Engineer/Producer and the Nashville Entertainment Association.

Cover design by Alecia Wright.

RE/P

Dennis Milan, Publisher
Michael Fay, Editor
Fred Ampel, Editorial Director
Dan Torchia, Staff Editor
Linda Stuckey, Associate Editor
Kathy Mickelson, Editorial Assistant
Alecia Wright, Graphic Designer
Mary Tracy, Marketing Manager

NEA

Lynn Gillespie, Executive Director
Diane Rankin, Director of Special Projects

1987/1988 NEA Board

Chairman: Brenda Haynes, Performing Artists' Workshop.
President: Richard Thrall, Multimedia Entertainment.
Executive Vice President: Johnny Rosen, Fanta Professional Services.
Secretary: Betty Clark, Talent & Model Land.
Treasurer: Tom Rashford, Gelfand, Rennett & Feldman.

Directors

Cal Bean, WPLN Radio; Barry Beckett, Beckett Productions; Jay Bell, Northport Group Inc.; Teena Camp, Teena Shirts; Bob DiPiero; Cathy Gurley, Cathy Gurley & Associates; Al Hagaman, O'Neil, Hagaman & Co.; Jimmy Hall, Jimmy Hall Enterprises; Randy Himes, AFTRA; Ted Johnson; Jim Kellam,

Commerce Union Bank; Bob Kirsch, Welk Music Group; Tari Laes, Tari Laes Co; Paul Lohr, Buddy Lee Attractions; Ken Mansfield, Main-Mansfield; Mark O'Connor; Jim Owens, Jim Owens Entertainment; Sue Patton, New Clarion Music; Eddie Reeves, Warner Bros. Records; Martha Sharp, Warner Bros. Records; Roger Sovine, BMI; Ken Wendrich, W.O. Smith Nashville Community Music School; Kay West, Kay West Company; Keith Newcomb, Belmont College student chapter president; David Conrad, Almo/Irving Music; Mary M. Matthews, Studio Productions Inc.; Frances W. Preston, BMI; David Skepner, David Skepner & the Buckskin Co.

Vice presidents

Alan C. Bernard, MTM Music Group; Dr. Anne Brown, Metro Nashville Arts Commission; Vincent Candilora, SESAC; Paul Corbin, The Nashville Network; Bob Doyle, ASCAP; David Earhardt, WTVF Channel 5; Robert Frye, Show Stopper Productions; Dan Harrell, Blanton/Harrell Productions; Pat Higdon, Warner/Chappell Music; Mike Hollandsworth, Zomba Enterprises; Kathy Hooper, Greil-Hooper Mgmt.; Michael Joyce, Across The Room; Brian Kelly, Third Coast Management Group; Steve Miller, Benson & Siman, Attorneys; Kerry O'Neil, O'Neil, Hagaman & Co., CPAs; Grace Reinbold, World Wide Media & Management; Priscilla Riggs, Priscilla Riggs & Associates; David Ross, Music Row Publications; Bennett Tarleton, Tennessee Arts Commission; Steve West, Go West Presents; Brian Williams, Third National Bank.

1988/1989 NEA Board

Chairman: Kay West, Kay West Company.
President: Joe Moscheo, BMI.
Executive Vice President: Johnny Rosen, Fanta Professional Services.

Secretary: Priscilla Riggs, Priscilla Riggs & Associates.
Treasurer: Tom Rashford, Gelfand, Rennett & Feldman.

Directors

Cal Bean, WPLN Radio; Teena Camp, Teena Shirts; Betty Clark, Talent & Model Land; Charlie Feldman, Screen Gems/Colgems-EMI Music; Clarke Gallivan, Studio Productions; Cathy Gurley, Cathy Gurley & Associates; Al Hagaman, O'Neil, Hagaman & Co.; Randy Himes, AFTRA/SAG; Jimbeau Hinson, American Romance Songs; Michael Joyce, Across The Room; Bob Kirsch, Welk Music Group; Paul Lohr III, Buddy Lee Attractions; Kirke Martin, Martin & Associates; Joe Moscheo, BMI; Roger Murrain, Collins Music; Neil Pond, Music City News; Eddie Reeves, Warner Brothers Records; Janet Rickman, MCA Records; Johnny Rosen, Fanta Professional Services; Paul Ross, Ross Productions; Michael Schusselle, Scene Three Video; Skip Stevens, Skip Stevens Promotions; Judith Lovin Stiles; James Stroud, MCA Records; Kay West, Kay West Company; Steve West, Go West Presents; Keith Newcomb, Belmont Student Chapter President.

Legal Counsel

Jim Harris, Harris & Baydoun; Mike Milom, Gilbert & Milom.

Honorary Lifetime Board Members

Bob Beckham, Bob Beckham Enterprises; Jimmy Bowen, MCA Records; David Conrad, Almo-Irving Music; Brenda Haynes, Performing Artists' Workshop; Mary M. Matthews, Studio Productions Inc.; Frances W. Preston, BMI.; David Skepner, David Skepner & the Buckskin Company; Richard C. Thrall, Multimedia Entertainment.

©1988 Intertec Publishing. All Rights Reserved.

A collection of Ampex audio tapes and a digital cassette. In the foreground, there are three large reels: one labeled 'AMPEX 406', one labeled 'AMPEX 456', and one labeled 'AMPEX 467'. The '467' reel is a digital tape cassette. The background shows more reels and a CD/DVD disc.

All the best to our friends
in Nashville and Memphis.

Our greatest hits

There's only one way to build a great reputation. And that's to do it consistently, hit after hit.

We set the analog standard with Ampex Grand Master® 456. We pioneered a new digital standard with Ampex 467 digital mastering tape. And we developed Ampex 406 for outstanding performance in a wide range of analog mastering applications.

When it comes to analog and digital mastering tapes, nobody offers a wider selection.

More great performers record their hits on Ampex tape than any other tape in the world. While opinion may vary on what it takes to make a hit, there's no argument on what it takes to master one.

AMPEX

Ampex Corporation, Magnetic Tape Division,
101 Broadway, Redwood City, CA 94063, 415/367-3809.

Circle (20) on Rapid Facts Card
www.americanradiohistory.com

Nashville....

Neve's Got Your Number

- **8232 SERIES**
Affordable Multitrack Recording
- **542 SERIES**
Video Post or Portable
- **51 SERIES**
Mainframe Broadcast or Video Post
- **V SERIES**
Neve's Flagship console for Music/Post
- **DTC-1**
Digital Tape Transfer console
- **NECAM-96**
Moving Fader Automation

Whatever your requirements, Neve has a console series that will fit your particular needs.

And in Nashville, that could mean starting your production project on our V-Series console, MIDI and vocal overdubs on our popular 8232 Series, with mixdown assistance from NECAM-96 moving fader automation.

Your entire digital product can then be processed for compact disc mastering through the DTC-1, our Digital Tape Transfer console.

When you need sales, parts, service or support you won't be dialing long distance either. That's because Neve has made a long-term commitment to Nashville and it's future as a world renowned recording center. In fact, our new Nashville sales and service facility is right around the corner. Give us a call.

TOM SEMMES
MARLA LEVITAN
FRED HILL

Southeastern Regional Sales Mgr.
Administrative Assistant
Technical Support

**and Nashville,
You've Got Ours
615 329-9584**

Neve

1221 16th Avenue South Nashville, TN 37212
Fax (615) 329-1473

CT (203) 744-6230 NYC (212) 956-6464 CA (213) 874-8124

Circle (21) on Rapid Facts Card

Old Traditions, New Frontiers

By Kay West

From the beginning, the Nashville recording industry has been based on a diversity of projects, ready acceptance of new technology and healthy reverence for a song.

It all begins with a song.

This motto, taken from the Nashville Songwriter's Association International, neatly sums up the history and success of the Nashville recording industry.

Forget what you've heard in the past—that Nashville studios are technically backward, that the only music recorded here is country, that no one really on the creative edge would want to work here.

Come to Nashville and you'll find a vibrant city scene, with some of the best studios in the world recording the best music to be found anywhere.

Industry's roots

The roots of the Nashville studio biz can be traced to a jingle recorded in 1947 at the city's first recording studio. That first session, however, was a long time coming to the small southern city then recognized as the "Athens of the South."

In the 1920s and 1930s, the major music centers were New York, Los Angeles and Chicago. Country music, still developing as a musical category, had a regional popularity, but it didn't extend to those metropolitan areas.

Although the big country stars of the time, such as Vernon Dalhart and Elton Britt, were often brought to New York to record, most country recordings were accomplished in the field. The earliest instances of recording in Nashville took place in 1928, when Victor (now RCA) came to the city to record selected Grand Ole Opry singers and string bands. These sessions were held at the WSM Radio studios in the National Life Building on Capitol Hill.

At that time, the Grand Ole Opry was not as successful as its competitor, the Chicago WLS National Barn Dance. When the Opry finally went on weekly nationwide radio on NBC in the early 1940s, an aggressive talent search landed such stars as Bill Monroe, Ernest Tubb, Eddy Arnold, Red Foley,

Kay West is a free-lance writer and publicist in Nashville.

Minnie Pearl, Hank Williams, Kitty Wells, Hank Snow and Roy Acuff.

It was Acuff who, in 1942, staged a personal rebellion that sparked an industry revolution. Acuff had already scored several huge hits and was the undisputed star of the Opry. Disenchanted and dissatisfied with his treatment by music publishers based in New York and Chicago, Acuff formed, with Fred Rose, Acuff-Rose Music. Not long after, Julian and Gene Aberbach established Hill Music and Range Music (they later merged). These publishing companies were the beginning of what would become the cornerstone of Music City and the studio community.

By the mid 1940s, there was some recording taking place at WSM's old broadcasting studio. Victor was again at the forefront, recording Eddy Arnold there in 1944.

By then, the foundation was laid. The Grand Ole Opry had surpassed the Chicago Barn Dance in popularity and harbored an incredible pool of singing stars and musicians. A national market existed for records from those Opry stars, and, of course, the fledgling publishing concerns were eager to supply material.

First studios

Taking the giant leap for Nashville were three WSM engineers who had conducted the recording sessions at the station. In 1947, George Reynolds, Carl Jenkins and Aaron Shelton opened their own studio in the Tulane Hotel at Church Street and Eight Avenue. They called it Castle Studio, from the WSM slogan, "The Air Castle of the South."

The first session there was the ad jingle (presaging one of the most lucrative areas of Nashville's recording business) for Shyer's Jewelers. The vocalist was Snooky Lanson; backing him up were pickers Owen and Harold Bradley and George Cooper, three men who would prove vital to Nashville's development.

It didn't take long for the New York-based record labels to recognize the economic benefits of recording country music in its home base. Castle Studio soon became one busy place. Supply followed demand, and in 1948, the Brown Brothers Transcription Service opened for business at the corner of Fourth and Church and was used extensively by Victor.

The Bradley Brothers opened Bradley Film and Recording Studio at Second and Lindsey in 1952. After a brief move to Hillsboro Road, they ventured into the uncharted territory of 16th Avenue (now Music Square East), a rundown residential area.

The Quonset Hut, Music Row's first studio, was just that, an Army Quonset hut that looked like a corrugated metal airplane hanger. Built in 1955, the Hut was instantly beloved. Decca (now MCA) booked all its sessions there, and Capital and Columbia used it frequently. Its presence sparked a rush to that area by publishing companies, talent agencies, and, eventually, record labels.

In the spring of 1957, RCA hired Chet Atkins to oversee its Nashville recording operations, and in November of that year, opened Studio B at 17th and Hawkins (now Roy Acuff Place). It was here, and in the Quonset Hut, that the Nashville Sound was born.

Pop roots

Although Nashville is primarily thought of as a country town, pop recording coexisted with country from the beginning. Francis Craig's 1947 recording of "Near You" spent 12 weeks at No. 1 on the national pop charts. In 1948, Nashville enjoyed its first hit by a visiting pop star. The Dinning Sisters came to town, and one of the cuts recorded here, "Buttons and Bows," climbed to the No. 7 spot on the Hot 100.



RCA Studio B opened in 1957 in the heart of Music Row. Considered to be the birthplace of the Nashville Sound, it operated as an active studio for 20 years. Since 1977, it has been a museum operated by the Country Music Foundation.



Bob Dylan's "Blonde on Blonde" album, recorded at Columbia Recording Studios in Nashville, remains one of the most critically acclaimed albums from the 1960s.

The 10 years between 1956 and 1965 were the boom time. The city helped launch the careers of stars like Elvis Presley, Gene Vincent, Buddy Holly, the Everly Brothers, Brenda Lee and Roy Orbison. The Nashville Sound embraced Patsy Cline, Jim Reeves and Eddy Arnold. In 1963, Nashville also hosted several black musicians who recorded major hits: Brook Benton's "Hotel Happiness" and the Dixiebell's "Down at Poppa Joe's" both hit the pop Top 10.

In 1966, Bob Dylan came to town to record "Blonde on Blonde." The double album remains one of his most critically acclaimed projects; more importantly, it set the precedent for rock artists to record in Nashville.

In the 1970s, the Outlaw Movement, spurred by Kris Kristofferson, Willie Nelson and Waylon Jennings, declared war on the Nashville label recording system, insisting on using their own musicians, their own songs and doing it their way. Their revolt was supported by tremendous success that their albums enjoyed across the board. (Coincidentally, it also set a precedent for the engineering community. Nashville studios used to have a staff of several engineers, whose services were included in the daily rate; today, independent engineers are the rule. Their role is extremely important, often influencing what equipment a studio will buy and which studios a producer and artist will use.)

Old guard remains

Quonset Hut was sold to Columbia in 1962 and closed by CBS in 1982, and RCA Studio B has been operating as a museum since 1977. But four long-time veterans still are enjoying success with updated equipment and a variety of projects.

Music City Music Hall has been in operation in the basement of RCA Records since 1963. Studio manager Michael Bevington says 80% of its business is still country, but

some of it is international.

Bradley's Barn, opened in Mt. Juliet in 1964 (and recently rebuilt after a fire), is making media news these days as the studio where k.d. lang recorded her album "Shadowland." More significantly, she persuaded Owen Bradley to come out of retirement to produce.

East Nashville's Woodland Studio was converted from a movie theater 20 years ago to a two-studio facility. While most of their business is in the country area, re-

cent non-country projects have included Dave Mason and the Royal Court of China.

Sound Emporium, a 15-year veteran, has welcomed some of rock's newest faces. Its location off the beaten path in Green Hills hasn't stopped Jason and the Scorchers, the Shakers and REM from finding its door.

New client bases

Nashville's newer studios, such as Emerald Sound and Sixteenth Avenue Sound, are also attracting a fair share of rock, along with the bread-and-butter country recordings. Some, such as Digital Recorders, are making a concerted effort to go after non-country artists. Still others are finding niches not ordinarily associated with Nashville studios.

Westpark Sound, a new studio run by former gospel artist Tom Reeves, depends on jingles and contemporary Christian music. Westpark is for the "MIDI crazy" and has more than 10,000 keyboard sounds in its Macintosh-based system. The studio has jumped on a new trend that shows no signs of slowing down—children's recordings. Recent projects have included "A Child's Gift of Lullaby" from the J. Aaron Brown Company (which has sold more than 150,000 in nine months) and children's projects for Brentwood Music International.

Jingle production has been a vital part of the Nashville music industry for more than 20 years, says Pat Patrick of the Patrick Creative Group. He estimates that more than 30% of all recording done in Nashville is jingle-related, but says that some people have estimated as high as 60%.

But what makes Nashville studios the right place to be for so many out-of-town clients? There are several factors. Recording technology is on par or surpasses anything to be found in any other city. Rates are competitive not only with other cities, but within Nashville itself, because of the great number of studios located here. Accommodations are far less expensive than elsewhere.

Finally, the single most important thing that is drawing national attention and out-of-town clients to Nashville more than ever before is the talent base located here. Nashville has the greatest concentration of engineers, producers, musicians, vocalists, technicians and, of course, songwriters, packed into little more than one small neighborhood, than any other city in the world.

And when everyone works together, the results are magic. It may start with a song, but when you add everything else, you get a product unlike any other. No matter what the final form, whether an album, jingle, corporate score or children's recording, if it's done in Nashville, it's bound to be unique. Nashville's time is now.

REP

"YOU HAVE EVERYTHING ON THE FAIRLIGHT SERIES III. IT SOUNDS GOOD AND WORKS QUICKLY."



Josef Nuyens, composer/songwriter/producer and owner of Castle Recording Studio and Productions, one of Nashville's few studios specializing in rock, pop and R&B.

"In composing, the Series III is good for laying a pattern down quickly. You have all the instruments available and you don't need 25 synthesizers and drum machines in order to start a song structure.

And going into the studio, you can prepare everything on the Fairlight. It saves a great deal of time and money in the studio. **It's a great tool, very compact, user-friendly and reliable."**

For further information on the remarkable Fairlight Series III, contact your audio consultant or your nearest Fairlight Office.

Fairlight

FAIRLIGHT INSTRUMENTS INC.

AUSTRALIA
15 Boundary Street,
RUSHCUTTERS BAY 2011
Phone: (02) 331 6333 Fax: (02) 332 3362

ENGLAND
Kimberley Road,
LONDON NW6 7SF
Phone: (01) 624 6000 Fax: (01) 372 6370

Fairlight is a registered trademark of Fairlight Instruments Pty. Ltd.

U.S.A.

2945 Westwood Blvd.,
LOS ANGELES CA 90064
Phone: (213) 470 6280 Fax: (213) 474 9716
110 Greene Street,
NEW YORK NY 10012
Phone: (212) 219-2656 Fax: (212) 334-6153
Suite 201, 49 Music Square West,
NASHVILLE TEN 37203
Phone: (615) 329 0414

TREBLE JOHNS + MORE

Circle (22) on Rapid Facts Card

FAIR 0067 C

Honing The Cutting Edge

By Dan Torchia

Nashville studios continue to acquire new technology, taking the state of the art to new places.

The Nashville studio community has always been laid back. People do their work, do a good job and go home at the end of the day. While this ethic contributes to Nashville's appeal—it's a livable city with a healthy competition between studios, but without a cutthroat pace—it also contributes to something of an image problem.

While studios in other cities boasted of

Dan Torchia is staff editor of RE/P.

their digital capability, Nashville was generally overlooked, until somebody did a little counting and came up with an interesting discovery: Nashville was the digital leader. While most major pop and rock albums recorded in New York and Los Angeles were being tracked and mixed in analog, most of the country projects, meaning Nashville projects, were tracked and mixed in digital.

Although which studio received the Nashville's first digital multitrack is open

to some interpretation (The Castle was first if you include Franklin as part of the Nashville area; Treasure Isle was first if you don't), what's more important is that these studios had the foresight to recognize the future of digital recording.

The acceptance of new technology isn't limited to digital multitracks. Nashville studios are leading the way in the use of other technical innovations such as studio computers, digital workstations, R-DAT machines and satellite dishes.

Setting aside the question of who was first, both the Castle and Treasure Isle saw digital as a way of doing things a little differently than what was then the standard in Nashville.

From its inception, the Castle has tried to find its own niche in the recording community, to do things a little differently than its competition. As an example, its console/multitrack combination of a Solid State Logic 4000E and a Mitsubishi X-850 was not being done anywhere in Nashville, which was a main factor in purchasing decisions, says Jozef Nuyens, studio owner. The studio will mark another milestone in August, as it is scheduled to install Nashville's first SSL G Series console, with 56 inputs and the G Series computer. In conjunction with the installation, the acoustic treatment will be redone in all three of Castle's rooms.

Treasure Isle's decision to add digital recording also was based on imported design ideas. In 1983, when the studio was searching for a new location, Fred Vail, Treasure Isle president, and David Shipley, his partner and the studio's chief engineer, wanted to build a studio that was technologically current.

Some of this translated into Nashville's first LEDE-style control room and the purchase of two 3M DMS 32-track machines.

"We listened to all of them, and we liked the sound of the 3M best," Vail says. "It also had an attractive financing plan, which was something we had to consider."

One of the most technically advanced facilities is The Nashville Network, whose \$17 million facility rivals those found on either coast. Its first priority is television production, but its audio facilities are equally impressive.

Studio A, for example, contains a Harrison TV-3 48-input console, a Soundcraft 800B console for foldback, EAW and JBL power amps, Ampex tape machines and a wide variety of outboard gear. Also available are two additional studios, three remote trucks, two edit bays, and uplink and downlink capabilities.

Undergoing one of the more comprehensive renovations in the area is Emerald Sound Studio, which is in the middle of a \$1 million-plus renovation, including a control room redesign by Tom Hidley. The

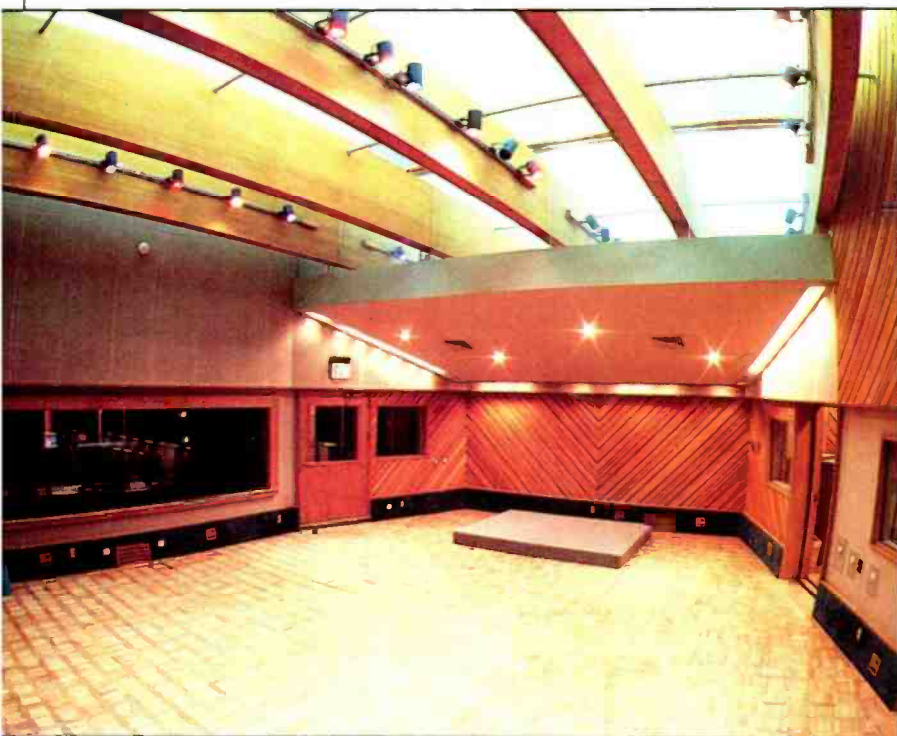

Emerald Sound is in the middle of a \$1-million-plus renovation. Tom Hidley redesigned the control room, which was gutted, enlarged and given a new geometry.

Home Office: Nashville, TN

Although many pro audio companies are located on the East or West Coast, Nashville has its own share of companies with offices in the area. These fall into two categories: companies with corporate headquarters in Nashville, and companies that have branch offices to serve the recording community and the Southeast region.

A review of companies that call Nashville home:

Studer Revox America: Studer moved to Nashville in 1975, two years after moving North American operations from Toronto to Buffalo, NY. All North American operations, including sales, service, warehousing and quality control, are located in Nashville.

When deciding where to move, the company discounted moving to Los Angeles, citing the nine-hour time difference between California and Switzerland, and New York, because of the high cost of doing business.

Valley International: The company started its existence in Los Angeles as Allison Research. While on

a business trip, the company president at the time went through Nashville, liked it and decided to relocate.

In addition to Nashville's recording and live sound market, company president Norman Baker also cites a strongly competitive broadcast market as another source the company can rely on. All of the company's operations, including final product assembly and quality control, are based in Nashville.

Harrison Systems: The console manufacturer began its existence as Studio Supply Company, the Nashville-based pro audio dealership now under different ownership. Dave Harrison, company president, decided to launch the console business because of Studio Supply's established client base.

Branch offices

Manufacturers with branch offices serve the entire Southeast, not just Nashville, but the city's recording community makes it the logical place to locate.

Here is a rundown of companies and the services they provide:

Ampex: The tape manufacturer maintains one of eight regional offices in Nashville. Aside from housing Southeast operations, the office maintains an active customer service for local studios.

Fairlight: The maker of the Series III opened its Nashville office in the spring, providing sales, service and user training to Nashville and the Southeast. Fairlight opened the office as part of its ongoing marketing efforts and because of strong sales in the Southeast.

Mitsubishi: The X850 and -80 are a particularly strong format in Nashville, and Mitsubishi has had an office in town for about five years. The office offers equipment sales, technical support, training seminars and some parts stocking.

Neve: The console manufacturer, which has had a Nashville office for three years, recently moved to a new location and expanded its service. The office houses sales, service and technical support for the Southeast. In addition to repair, the office also offers computer-aided design services for console installation in

For privacy, for personal attention, and for absolute state-of-the-art digital recording, computer-assisted mixing and electronic music synthesis, Tennessee proudly boasts one of the world's great residential studios.

THE CASTLE

1393 Old Hillsboro Road • Franklin, Tennessee 37064 • (615) 791-0810 FAX 791-1324

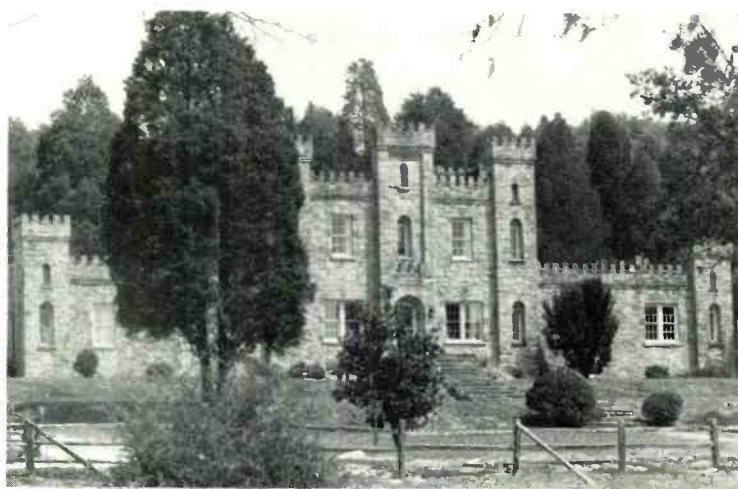

And we're proud to say that The Castle is equipped with an SL4000 G-Series Master Studio System with 56 channels of Total Recall! Plasma Bargraph Metering
For information call
Jozef Nuyens

Circle (23) on Rapid Facts Card

new or existing facilities.

New England Digital: The maker of the Synclavier and Direct-to-Disk is represented by Songbird Digital, the exclusive distributor for the Southeast. Songbird has been in business for six years, three in Atlanta and three in Nashville. The office has demonstration facilities that allow people to do an entire project to show the system's capabilities.

Otari: The company's Southeast regional sales manager has been a 1-man office for two years, serving rep firms and dealers throughout the region. Future plans are to expand the Nashville office to include technical support and seminars.

Sony: Sony's office houses three sales specialists, one each for analog tape machines and consoles, wireless/RF mics and small mixers, and digital equipment. A technician, who works for Sony's service division, also works out of the office. Some parts are stocked for the repair service, but it is not a parts warehouse.

control room was gutted, enlarged and given a whole new geometry.

Emerald recently upgraded its Solid State Logic 4000E console with the G Series computer, the first studio in Nashville to employ the new computer system. The studio is also breaking new ground with the radio show "Nashville Live," which is recorded on an R-DAT machine and is transmitted to Los Angeles through an on-site satellite dish. [See the story "More Than A Studio" for more information.]

Another studio using R-DAT machines is AMR, formerly known as Audio Media Recorders, which has been using the Sony 2500. According to studio manager Warren Peterson, the main use has been for CD preparation. Mixes will be recorded to R-DAT and transferred D/D to the Sony 1630 system.

"We also make copies for producers to take home, which gives them an exact representation of what was recorded in the studio," Peterson says. "It's a better reference."

Hidley's renovation of Emerald was one of three studios he did in a four-month period in 1986. Perhaps the most unique design was Front Stage, one of two rooms at Sound Stage Studio. [Masterfonics was

the third Hidley room; see "More Than A Studio" for more information.] Contrary to most designs, Front Stage has no division between the control room and the studio: Both are in one room.

This open room, called Front Stage, and a second, conventionally designed room, called the Back Stage, feature SSL 4000E consoles, Mitsubishi X-850 multitracks with Apogee filters and Hidley/Kinoshita monitors. In Front Stage, acoustic treatment above the monitors extends 20 feet, trapping bass notes and providing adequate separation.

Various iso booths are located in front of and behind the console for vocals and other instruments. Drums are usually recorded in the main room, Treat says, with other instrumentalists and vocals in the iso booths. Keyboards and guitars are usually DI into the console.

Perhaps the most unique thing about the studio community is the range of technology available. From the unlimited budget to the most restricted, a well-equipped, well-staffed studio is available to all. Studios will work with clients to make sure that the best possible product is made within budget.

RE/P



sound emporium

(615) 383-1982 3102 Belmont Blvd. Nashville, TN 37212

Circle (24) on Rapid Facts Card

WOODLAND SOUND STUDIOS...

An Old Friend,
A New Attitude.

Now Featuring

- NEVE
- GML Automation
- STUDER



For more information
or studio bookings,
call Tim Farmer or
Traci Sterling at

Woodland

SOUND STUDIOS, INC.

1011 Woodland St.
Nashville, TN 37206
(615) 227-5027

Circle (25) on Rapid Facts Card

More Than A Studio

By Dan Torchia

Nashville studios are expanding into music publishing and radio shows, in addition to acquiring new studio clients.

The studio business is no longer just the time-renting business. In cities across the country, studios are finding that it makes good business sense to diversify.

In Nashville, many studios are getting into such ventures as music publishing, artist development, radio shows and record companies. And Nashville is no longer just a place to make country records. The entire range of audio production, from jingles to video post to corporate/industrial have developed, bolstering the city's growing reputation as a total audio production center.

From recording studio to record company

Nashville's rock and R&B scene has been bubbling under the surface for a few years and is just starting to gain national attention.

One studio that has gone that route and has become one of the most visible examples of branching out through its music publishing and production companies, is Castle Recording. Three Castle acts have landed record deals this year: rock acts Stealin Horses and Walk the West, and R&B group Sepia.

For Castle owner Jozef Nuyens, the production company exemplifies his philosophy for the recording studio. Nuyens uses

Dan Torchia is staff editor of RE/P.



Johnny Rosen, president of Fanta Professional Services, in Fanta's 40-foot mobile recording truck. The console is a 40-input Sphere; the equipment rack to Rosen's right is used for TV sweetening work.

both the production company and studio to fill niches that he sees are being unmet by other studios.

"Why not try and fill those gaps?" he says. "We use the studio for the production company, and both the production company and the studio feed business to each other."

Another area studios are moving into are radio shows. Emerald Sound Studio is the originating point of "Nashville Live," a weekly radio show from the MCA Radio Network broadcast by more than 125 radio stations.

The arrangement is notable because Emerald is the only studio in Nashville with a satellite dish. In 1987, Emerald joined forces with IDB Communications Group to install a 1.8-meter Ku-band earth station, which is used to transmit the show to Los Angeles.

The show originates at the studio, which is recorded live onto a Sony PCM-2500 R-DAT machine. It is then uplinked to MCA Radio studios in Los Angeles, where the program is edited and broadcast.

Treasure Isle is another studio that is participating in radio shows through its president, Fred Vail, who is the host of "Starmaker's Radio Showcase." The local show plays 12 to 14 songs, with a panel of judges discussing the merits of each one. A wide range of music is presented, although the majority is country, and the sound ranges from master-quality to boom-box.

There are times when studios can anticipate technical developments; sometimes the march of technology will dictate the direction a studio should go. For Masterfonics, a major change in direction came with the introduction of the compact disc. For 11 years, the facility's business was mainly mastering and digital equipment rental. In 1986, Masterfonics decided to add a mixing room.

"We knew that our laquer cutting business was going to be limited in the coming years," says Glenn Meadows. "We also felt that no one had built a great control room. We made a conscious decision to go after the high end of the market."

Scene Three is a multitrack audio suite with synchronization to any format videotape. It also has an on-line one-inch edit suite. Equipment includes an Adams Smith 2600 AV audio editing system, 46-input Harrison TV 3 console, 28-input Harrison TV 4 console, Audio Kinetics Mastermix automation, Studer multitracks, Sony 1610/1630 two-track digital system, a variety of outboard gear, noise reduction and mics. *1813 Eighth Ave. South, Nashville, TN 37203; 615-385-2820.*

Shook Shack is a demo studio located in the heart of Music Row. Equipment includes a 16-track Ampex MM 1000 tape machine, and hourly or block rates are available. *802 18th Ave. South, Nashville, TN 37203; 615-242-1421.*

Sixteenth Avenue Sound has completed control room renovations in Studio A. The front wall soffett was redone to install Tannoy FSMU monitors purchased earlier in the year. Other plans for Studio A call to add an analog 24-track machine in addition to its Mitsubishi X-850 digital multitrack. *1217 16th Ave. South, Nashville, TN 37212; 615-327-8787.*

The Song Cellar has recently expanded to 16 tracks and upgraded its equipment list. New equipment includes a Tascam 1-inch machine, a Kurzweil K-1000 digital grand piano/synthesizer and live drums. The facility provides demo production services for songwriters, publishers and record companies. *803 18th Ave. South, Nashville, TN 37203; 615-321-5005.*

Soundshop Recording has purchased new equipment and rewired its control room. New equipment includes Tannoy LGM monitors and a Yamaha REV-5; Mogami cable was used for the rewiring. Owned by Tree Publishing, the facility has two 24-track rooms in one location and a third in the Tree building. *1307 Division St., Nashville, TN 37203; 615-244-4149.*

Spotland Productions has been providing audio production for advertising, radio and TV broadcast, film, video and A/V for 20 years. Services include two multitrack recording studios, phone patching capabilities for out-of-town clients, and a comprehensive sound effects and music libraries. On The Spot Music Productions, a division formed in 1985 to provide music and audio production for commercials, corporate presentations and film, recently won the 1988 Nashville Ad Federations's top award winning spot for Purity Premium Ice Cream. *1443 12th Ave. South, Nashville, TN 37203; 615-385-2957.*

Studio Supply Company has marked its 16th year as a pro audio equipment dealer and now sells equipment from more than 75 manufacturers. In addition to equipment sales, Studio Supply has two other divisions. EARS rents equipment for studio or road use, and Studio Builders provides studio design and construction services. *1717 Elm Hill Pike Suite B9, Nashville TN 37210; 615-391-0050.*

Westpark Sound is a 24-track MIDI workstation featuring 10 in-house keyboards, two Macintosh computers for sequencing and sound/patch work. Staff includes two programmers, Ted Wilson and Tom Reeves, and two engineers, Wilson and Dan Wujcik. Reeves is the studio manager. *3212 West End Ave., Second Floor, Nashville, TN 37203; 615-292-5838.*

Nashville Update is a special adaptation of RE/P's Studio Update department, which appears every month. Send your studio's latest news to Studio Update, RE/P, Box 12901, Overland Park, KS 66212.



If your production doesn't need an ocean, you don't need either coast.

—THE NASHVILLE NETWORK
NASHVILLE, TENNESSEE

For the best in television production, look inland...to Nashville, Tennessee! If you're looking for a full-service production company with the top technology and personnel in the industry—plus every perk and amenity you can imagine, from office space to catering and security—look inland. ■ Look to Nashville, Tennessee. ■ It's just east of Burbank, just west of the Hudson. You can't miss it. Call us, (615) 889-6840, with any questions, or if you just need directions. ■ We guarantee, it's one of the best on the continent.



THE NASHVILLE NETWORK
2806 Opryland Dr
Nashville, Tennessee 37214

Circle (26) on Rapid Facts Card

NASHVILLE HOTLINE The Creative Source Book

A hot creative sourcebook for a hot market!

More than 4,000 researched listings!
If it's not in the book, we'll find it for you!

Nashville has the professional and experienced technicians, equipment, and support services for your production.

Curious? Why not save money on your next location budget. Give us a try!

\$27.95 plus \$2.63 S&H



The Nashville Hotline
9 Music Square West
Nashville, TN 37203
(615) 255-0011

Circle (27) on Rapid Facts Card

August 1988 *Recording Engineer/Producer* 47

IN PART

From the record and playback heads, right down to the machine screws, the A820-24 is entirely Studer-engineered and manufactured to Studer specifications. For the past four decades—in the tradition of the Studer A80 and the A800—that's the way it's been.

IN CONCERT

From its fully microprocessor-automated audio alignment, to its menu-programmable transport, the A820-24 stands unchallenged among multitrack recording systems for easy, practical setup and studio use.



Studer
A820
Multichannel
Recorder

IN ITS OWN QUIET WAY.

For audio quality and character, the A820-24 with its optional fully integrated C4 or SR noise reduction cards, has become the multitrack— analog or digital—to equal or better.

Take it piece-by-piece, take it all together . . . the Studer A820-24 is precision-built with the kind of quality that professionals world-wide recognize as synonymous with the Studer name. And that same quality extends beyond both hardware and software to our factory sales engineer who installs your A820-24 onsite.

Studer. Orice again with the A820-24, setting the standard. In our own quiet way.

Automatic & simultaneous audio alignment for all 24 channels. Alignment parameters stored in non-volatile memory for 2 tape types.

Long-lived amorphous metal heads.

Brushless capstan motor with dedicated microprocessor control.

Sophisticated servo control systems allow tape spooling speeds up to 50 f/sec. with quick acceleration & deceleration.

Programmable transport operating keys with choice of over 40 assignable functions.

Comprehensive digital control systems.

Noise reduction cards - Dolby® SR or Telcom® CA.

STUDER REVOX

STUDER REVOX AMERICA INC.

1425 Elm Hill Pike • Nashville, TN 37210 • (615) 254-5651

Offices: Los Angeles (818) 780-4234 / New York (212) 255-4462 / Chicago (312) 526-1660 / San Francisco (415) 930-9866

• Circle (31) on Rapid Facts Card

Acoustic Design: Noise Control

By Vin Glzzi

Noise control is the science of reducing noise and vibration transmission through a building's structure or boundary surfaces.

The design and construction of a recording studio, control room, MIDI room or any other type of critical listening facility is a project so fraught with perils and pitfalls that I often wonder why anyone takes it on. Funny talk from a studio designer? Well, yes, partially.

I often make the analogy that a novice, both to acoustics and construction, has about as much chance of successfully designing and building a properly isolated,

good-sounding room as he does of building his own atomic reactor—and surviving. The fact is, a large number of people in the audio business have built their own rooms and pulled it off. Some of them have been lucky, others have nearly killed themselves in the process, and a large percentage have just learned to live with the dismal results.

How did the lucky ones do it? What should the others have done? The details are far beyond the scope of any single article, but the principles of basic noise control, commonly called “soundproofing,” are the basis for this article.

Acoustics and architecture are fundamentally related; in fact, they are inseparable. Acoustics is one of the components in the signal path of architecture. This is a point that needs to be made and understood. The acoustic character of a space is determined by the architecture of that space: the location, geometry, construction and finish of the surfaces. If these elements aren't right, the acoustics won't be right. It's that simple. Accepting that a studio project is an architectural design project, albeit a highly specialized one, the first step is to choose a designer. Generally, in the audio business that means deciding between one of the few experienced professionals in the field or doing the job yourself.

Experienced studio designers have learned not only how to produce good rooms, but also how to avoid costly mistakes and unnecessary expenses. They can easily put their fingers on all the details and specifications needed for unusual and specialized materials. The do-it-yourselfer probably has no experience in the field, will fall into 50% of the awaiting traps and will spend days and weeks trying to locate the needed materials.

The designer will charge a fee that amounts to 10% to 15% of the total construction cost, and will do his best to keep within budget. Owner/builders probably have no real budget because they have no experience with the actual costs for studio construction; furthermore, they will waste 25% of what is spent correcting mistakes, overbuilding and using expensive, un-

Vin Glzzi is a partner in Benchmark/Downtown Design, a New York City-based firm specializing in the design of recording studios and control rooms.

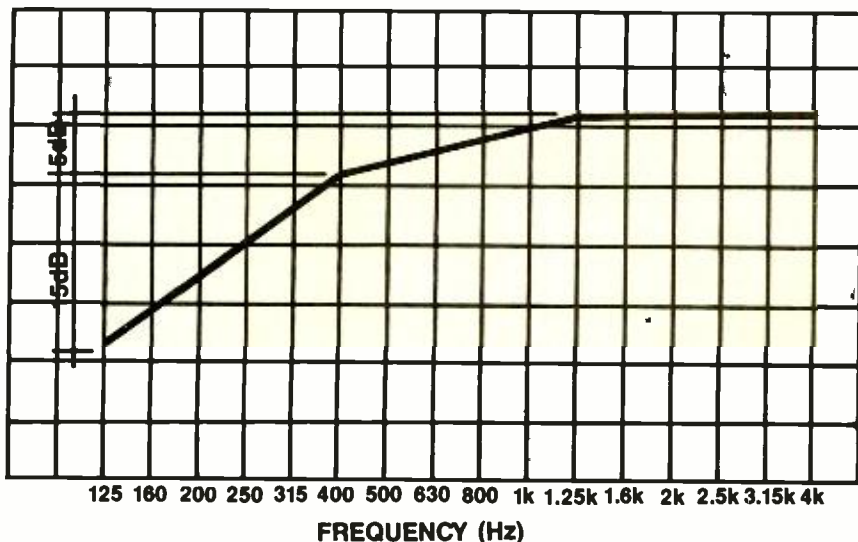

Figure 1. The STC (Sound Transmission Class) curve.

I admit, as a design professional, to some bias on this subject, but I promise now that I've had my say, I won't bring it up again. Let's assume that some people have perfectly valid reasons for undertaking these projects themselves, and I'll do my best here to keep them on the right path.

Acoustics

First, the bad news. Good acoustic construction is expensive. Studios need massive boundaries that are carefully (slowly) erected, sealed and finished. The most economical (general) building systems are lightweight, assemble quickly and require minimal finishing. There are exceptions, however. Some construction techniques used in many studio environments are reasonably cost-effective. Drywall, for example, often called sheetrock, is readily available, economical and easy to work with. When used properly in frame construction, the results closely match those of

masonry at about one-third the cost.

Because acoustic construction is costly, it's important to know exactly what you need. Selecting the right amount of noise isolation is fairly straightforward, using the

A large number of people in the audio business have built their own rooms and pulled it off.

large pool of test data available on the noise-reduction characteristics of most construction materials.

Noise control

Noise control is the science of reducing noise and vibration transmission through a building's structure or boundary surfaces. The measure of effectiveness at reducing airborne sound is Sound Transmission Loss (STL), generally specified by oc-

tave or 1/3-octave bands. The more abbreviated "TL" (transmission loss) will be used when referring to sound transmission loss.

A rating system common in the construction industry is the Sound Transmission Class (STC), which assigns a single-number rating based on the combined TL in the 125Hz to 4,000Hz, 1/3-octave bands. (See Figure 1.) The STC was developed primarily to rate the effectiveness of construction types in reducing speech transmission and is sometimes called the Speech Transmission Class. It is, therefore, very tolerant of, and imprecise about, low-frequency transmission. A wall rated at an STC 50 could have as little as 27dB of TL at 125Hz and much less at lower frequencies where the STC does not dare to tread.

A less-used, but more effective, rating system is the MTC (Music Transmission Class) pioneered by Stan Roller at US Gypsum. This system requires stricter standards at 125Hz and 160Hz and would rate the wall mentioned above at only MTC 42.

The third important abbreviation in noise control is NC (Noise Criterion). Again, this is a single-number rating system for classifying ambient, or broadband, background noise levels weighted according to typical hearing characteristics. (See Figure 2.) The well-known Fletcher-Munson tests showed that humans are less sensitive to very low and very high frequencies. An ambient, steady-state background level that is perceived as evenly balanced throughout the audible spectrum actually measures nearly 30dB higher in the 63Hz band than the 1,000Hz band. The NC curves reflect this contention very close to the A-weighting curves at the lower ranges.

Generally, an NC between 30 and 35 is acceptable in an urban residence, while 15 to 25 is the desirable range for a studio or control room. The NC curve is valuable in determining the acceptability of ambient levels only when the spectral pattern of the background noise matches the NC curve fairly well and contains no pure tones. In a room with an NC 15 background level, an exhaust fan producing a 250Hz hum 10dB above the NC curve would be very obtrusive, and the room should be rated at NC 25. Subjectively, it will seem much noisier than that because the 250Hz tone is not integrated into the noise curve.

Using the rating systems

Now, how do we use these rating systems? The concept is simple, or at least sometimes it is. Basically the desired NC will be achieved when it equals the maximum external noise level minus the combined STC of all intervening construction. Thus, if the desired NC in a room is 30 and the maximum external noise is 80dB SPL,

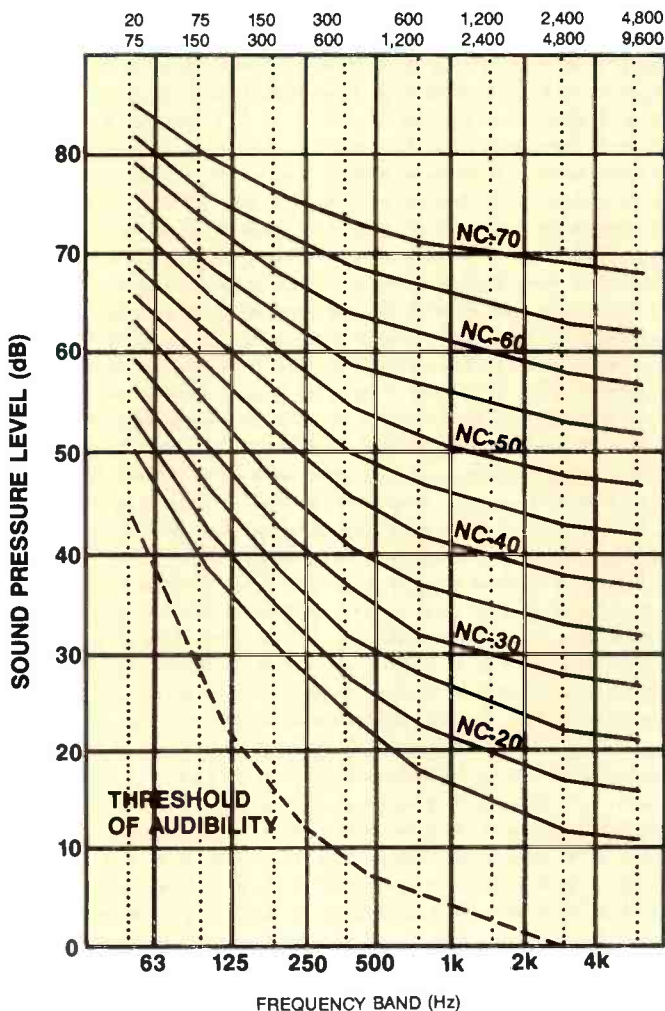

Figure 2. The NC (Noise Criterion) curve.



AKG's C747. Small Size. Big Sound.

AKG's new C747 "pencil-type" condenser microphone sounds a lot bigger than it looks. In fact, its unique miniaturized transducer design and acoustically-tuned interference tube give the C747 sensitivity and uniform frequency response superior to mics many times its size. You'll like that on stage, TV, above a church choir or on a podium, where you need to capture performances without obscuring them. And you'll like it in the studio, where the C747 will go places other mics are just too big to follow. Clear lows, shimmering highs, tight pick-up pattern and mounting accessories that provide total convenience in any recording or sound reinforcement situation — with the C747 you get everything you need. Small size. Big sound.



Focusing on new technology.
77 Selleck St. Stamford, CT 06902
(203) 348-2121

© AKG 1988 Akustische und Kino-Geräte GmbH, Austria

the combined sound rating of the walls, floor and ceiling must be STC 50.

The problem is that none of these rating systems focus enough on low-frequency transmission. (Remember, they were originally intended primarily to ensure speech privacy.) Note especially that the STC scale doesn't go below 125Hz, and there's a lot of musical energy below that frequency. In order to get adequate isolation at low frequencies, we need to take a closer look at some actual measurement data.

Let's start with a typical wall used in commercial construction, rated at STC 50. It is composed of 5/8-inch gypsum wallboard on both sides of a 3/8-inch metal stud with fiberglass insulation filling each stud cavity. (See Figure 3.) Its TL characteristics (See Figure 4) are pretty good above 250Hz. But, at 125Hz, it attenuates only 29dB and at 63Hz only 12dB. If the source noise we're isolating is rock music reproduced on high-quality monitors at an average level of 80dB SPL, there may well be 80dB of energy in those bands. That means 51dB of noise gets through the wall at 125Hz, which would raise our NC in the receiving room to about 35. But things are even worse in the 63Hz band where 68dB of noise is transmitted, raising the NC to 45. This environment is completely unacceptable for any type of recording or critical listening.

Conversely, if the goal is to keep noise from leaking out and disturbing neighbors, this amount of isolation is also far short. In the previous example, I've assumed monitor levels of only 80dB SPL, which is very moderate. Typical mix levels, even on close-field monitors can be between

90dB and 105dB. Clearly, a much better system will be necessary to maintain even modest isolation. An STC rating in the 65 to 75 range and good low-frequency performance is the goal.

Major components of a studio

Let's take a look at the three major components of a room—the floor, walls and ceiling. The floor slab in a typical high-rise building is 4 to 6 inches of poured concrete, rated at STC 45 to STC 50. Your first instinct might be to increase this thickness to improve the floor's performance, but the Mass Law shows that doubling the mass (pouring an additional 4 to 6 inches of concrete) will only raise the STC by 5dB to 6dB. That increase is not sufficient to im-

Acoustics is one of the components in the signal path of architecture.

prove performance for the expense involved. Meeting the goal of an STC 65 to STC 75 will require an additional floor, separated several inches from the existing slab. This construction has the two ingredients necessary for noise isolation: mass and separation.

Practical considerations, however, often make these two ingredients very difficult to incorporate. A lot of mass is expensive and sometimes beyond the load-bearing capacity of the floor structure. Raising the floor reduces available height—a valuable

commodity in audio rooms. So the design process becomes a balancing act: trying to keep isolation, space and cost in reasonable proportion.

Resilient mounting

First, let's review the basics of a resilient mounting system. Meeting the conditions of mass and separation requires a heavy secondary-floor layer with minimal contact to the primary-floor slab. Ideally, it should "float" in space with no support points tying it to the slab below. The common technique for platform construction, using slot lumber on end ("sleepers") as the spacing material, would not be effective here because the sleeper faces provide too much contact between the two floor surfaces.

Resilient mounts make good supports when properly loaded, providing deflection of sound and vibration traveling through the floor surface. A relationship exists between the isolator's "static" deflection—the amount of compression under normal load—and its "natural frequency"—the rate at which it would oscillate freely. A greater deflection, and lower natural frequency, is desirable because the isolator's effectiveness for our purposes begins at five to 10 times its natural frequency.

To put these concepts together then, we want a floor material of maximum mass, separated as much as possible from the building slab and supported by resilient mounts with the lowest possible natural frequency. The best system is a poured concrete slab (good mass), with a 4-inch air gap (good distance), on springs (natural

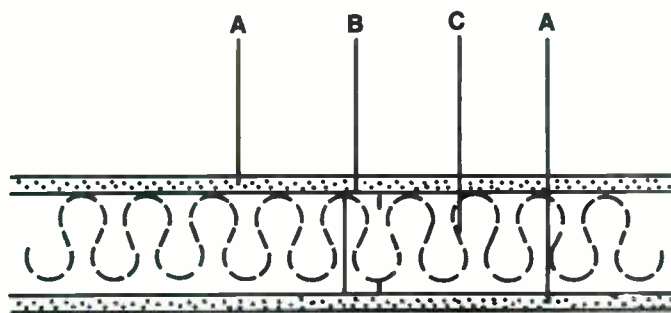

SOUND RATINGS: STC-50/MTC-45

A. 5/8-INCH SHEETROCK BRAND FIRECODE "C" GYPSUM PANELS

B. 358ST USG STEEL STUDS 24-INCH OC

C. 3-INCH THERMAFIBER SAFBs

**WEIGHT: 5.9 POUNDS
PER SQUARE FOOT
THICKNESS: 4.875 INCHES
CAVITY: 3.5 INCHES**

Figure 3. STC 50 wall, composed of a single layer of 5/8-inch drywall on each side of a 3/8-inch steel stud with insulation in the cavity.

15,000 channels in 31 countries.

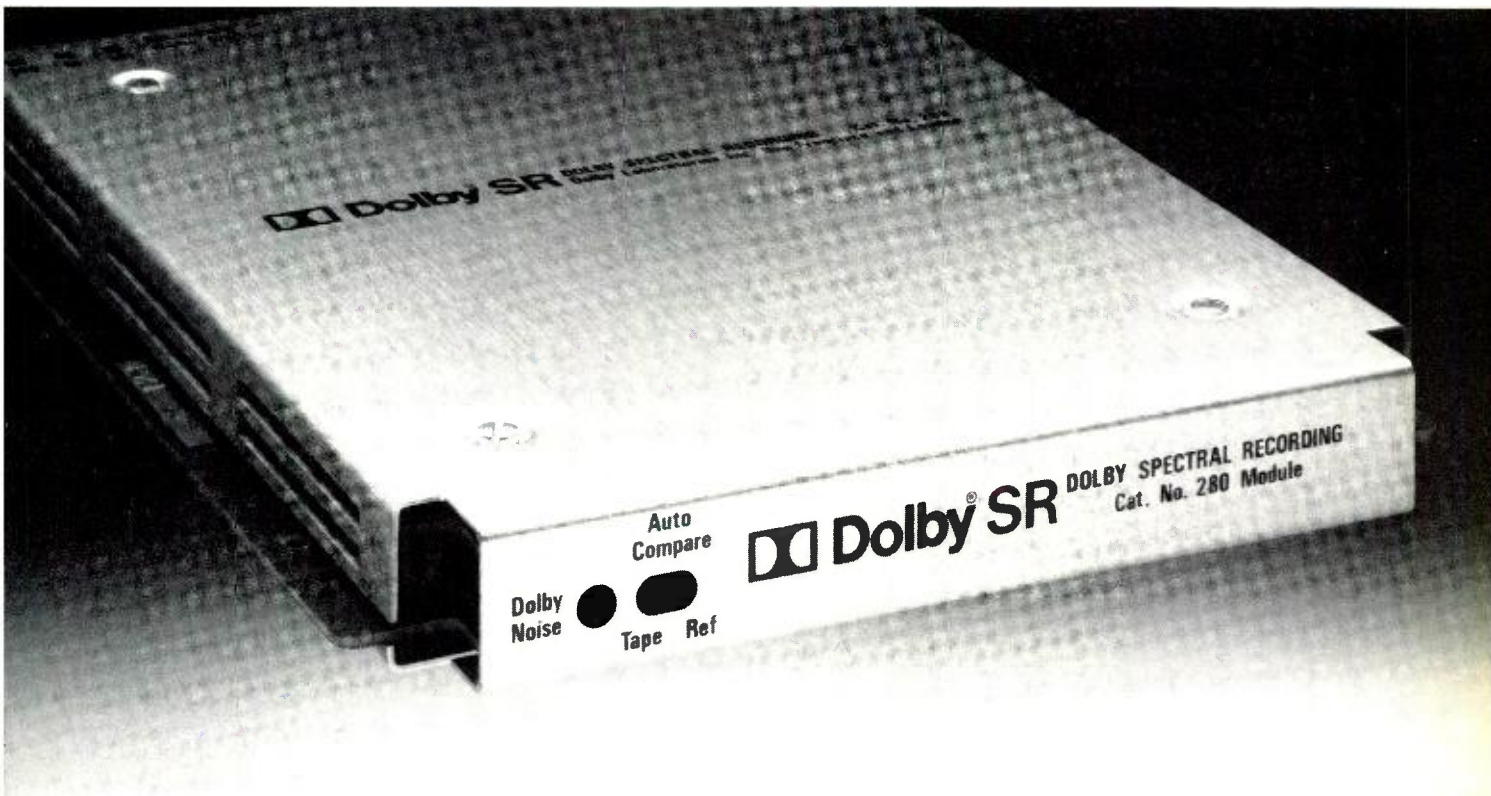

No other recording system has been so quickly adopted throughout the world. Dolby SR provides a substantial extension of headroom, increased signal-to-noise ratio, and distortion-free recording at a cost far below the digital alternative. And, with the increases in our San Francisco and London production teams, delivery usually takes less than a month.

DD Dolby[®] SR
spectral recording

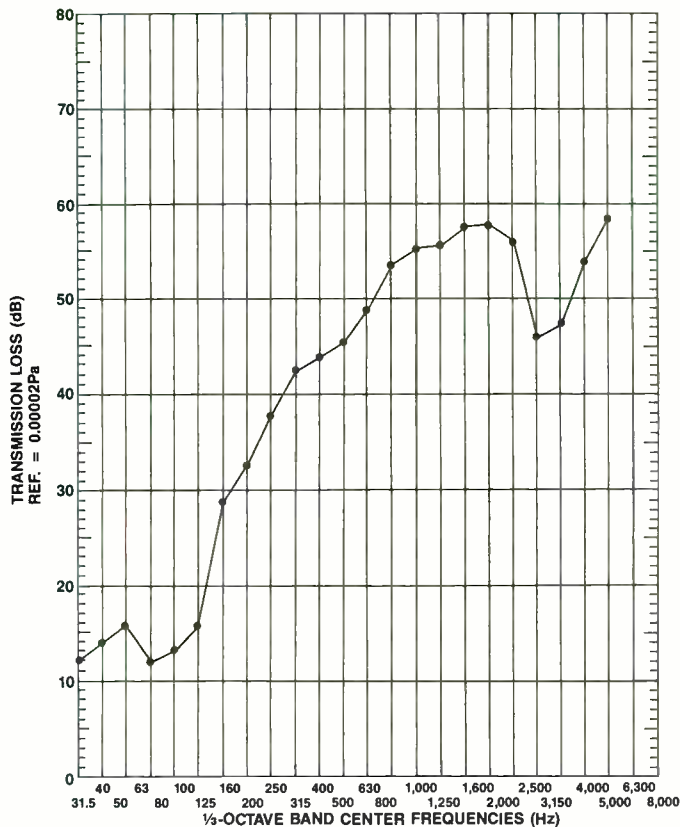

Figure 4. Transmission loss by 1/2-octave bands for wall construction shown in Figure 3.

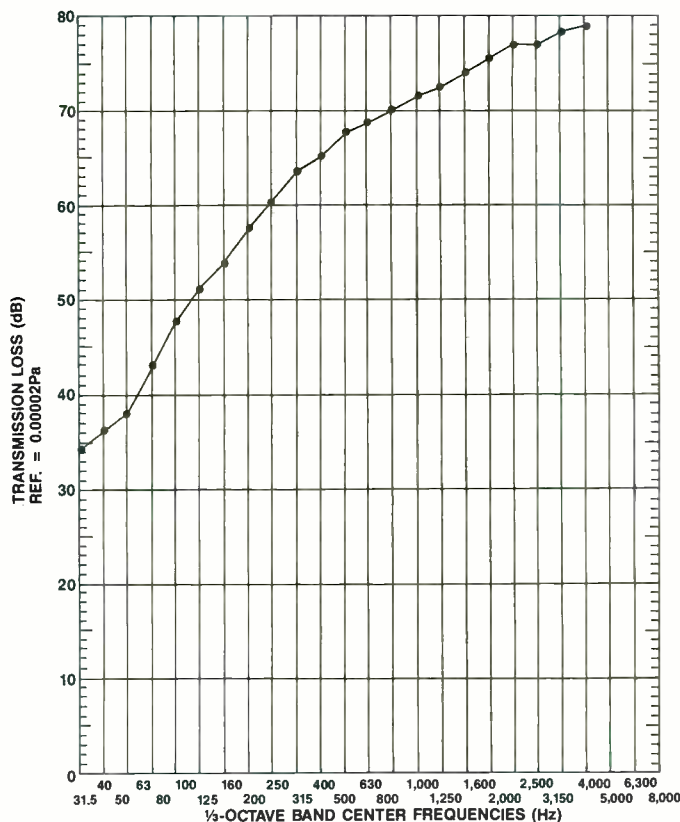

Figure 5. Calculated transmission loss by 1/2-octave bands for sandwich floor, on a 6-inch concrete slab.

frequency between 3Hz and 4Hz). As often is the case, the best is also the most expensive, and if we can't afford it, we must look for alternatives.

Alternatives

A good compromise for most applications where occasional noise intrusion can be tolerated is a secondary floor made of 3-inch drywall, sandwiched between layers of 1/2-inch plywood, and supported on neoprene pucks or compressed-fiberglass cubes.

Pucks, which are manufactured by Mason, Kinetics and others, are 2 to 5 inches high and can have natural frequencies between 6Hz and 9Hz when optimally loaded. However, that optimal load is closer to the weight of poured concrete than the drywall we plan to use, so we should count on a natural frequency at the high end of the range.

An STC rating in the 65 to 75 range and good low-frequency performance is the goal.

Cube isolators, manufactured by Kinetics, also have a natural frequency around 10Hz and are available in 1-inch to 4-inch sizes. The plywood top and bottom layers are needed to attach a finish material to and to prevent crushing of the bottom drywall layer.

As shown in Figure 5, the calculated minimum rating for this system is STC 64. The TL at 63Hz is 43dB and at 125Hz, 53dB. These are very respectable numbers and would protect a neighbor downstairs, for example, from the sound levels produced by most musical instruments and monitoring levels of up to 100dB.

Ceiling system

For a ceiling system, the same concepts apply as for floor mass and separation. But it is not practical to get as much mass in a ceiling, because of limitations both on the weight that can be added to the floor above and the maximum span of a ceiling structure. Either a new ceiling is hung on a grid supported by the floor above, or separate ceiling joists are installed on the walls of the isolated room.

With the first system, spring or neoprene isolators, similar to those used for the floor, are hung from the ceiling joists or structural slab overhead. A grid of wood or steel is attached to them and layers of drywall then are installed on the grid. Three layers of 5/8-inch drywall is

Programmed for everything but obsolescence.

When the Kurzweil 250[®] was introduced in 1984, it set the industry standard for sampling excellence and programming sophistication. But what may have been a crowning achievement for others was just a starting point for us. The K250[®], you see, is being updated continuously to keep pace with future technological advances.

For example, we've recently developed powerful, portable RAM cartridges that vastly extend the K250's memory. We've just released our ninth sound library and have more on the way. Also, the option of having twelve separate outputs for unprecedented versatility in using those renowned K250 voices is available.

Things have changed a lot since 1984, but the K250 and 250RMX[®] (rack mount expander) are still on the leading edge of music technology. So when you buy a K250, you know you're investing in an instrument that will continue to earn the admiration of music makers everywhere.

Visit your nearest Kurzweil dealer today. By the time you get there, he'll have more exciting updates to tell you about.



KURZWEIL
Music Systems

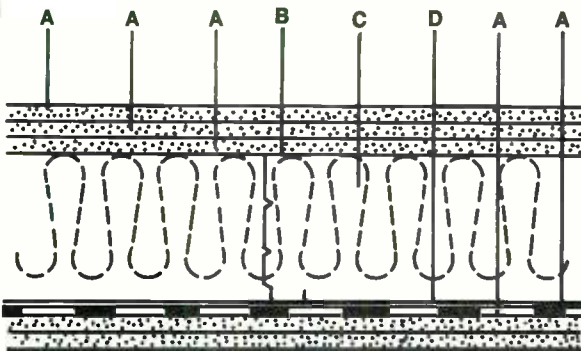

**WEIGHT: 14.0 POUNDS
PER SQUARE FOOT
THICKNESS: 9.625 INCHES
CAVITY: 6.5 INCHES**

SOUND RATINGS: STC-63/MTC-59

- A. 5/8-INCH SHEETROCK BRAND FIRECODE "C" GYPSUM PANELS
- B. 60SJ20 USG STEEL STUDS 24-INCH OC
- C. 5-INCH THERMAFIBER SAFBs
- D. USG RC-1 RESILIENT CHANNELS 24-INCH OC HORIZONTAL

Figure 6. STC 63 wall composed of three layers of 5/8-inch wallboard on one side of 6-inch steel studs; two layers on the other side over resilient channels, insulation in cavity.

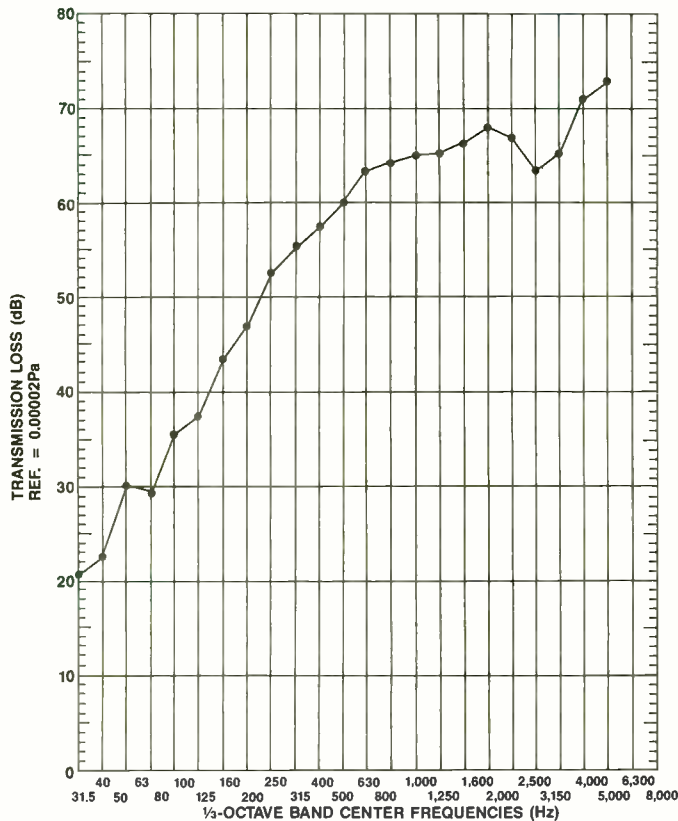

Figure 7. Transmission loss by 1/2-octave bands for wall construction shown in Figure 5.

usually the practical limit for either ceiling type, and it is important that fiberglass insulation go into the cavity above the hung ceiling.

Quite a bit of data exists on the effects of different types and thicknesses of insulation within cavities, all of it demonstrating that greater thickness and density of material improves TL. Because of its high density and moderate cost, the preferred insulation is Thermafiber from US Gypsum, but this type can be hard to find in small quantities. As a general rule, ceiling cavities should be filled to at least half their depths with fiberglass insulation of 3pcf (pound per cubic foot) density. If practical, add additional amounts; it will improve the noise specs.

Wall construction

There are probably as many theories about proper wall construction as there are about who really invented flanging. Theories are likely to be numerous on any subject when little hard data is available to prove or disprove them. Only within the past few years has thorough and systematic acoustic testing of wall types been done. Most of the testing was conducted under the direction of Stan Roller, at US Gypsum, and provided extremely valuable information about the performance of different systems.

To begin with, excellent studio walls can be built with either steel or wood studs. The ingredients for success are the now-familiar mass and separation, with a lot more interest in stiffness. Partitions constructed of lightweight, thin steel studs have surprisingly good, low-frequency TL because of the flex in the whole structure. The quality is not good, however, when considering the sonic performance of a room. We don't want the walls acting as imperfect, low-frequency absorbers, radiating harmonics in a complex and unpredictable way. A stiff and massive wall will contain the low-frequency energy without coloring it. The thickness of the stud is important, as it will affect the stiffness of the wall and the separation between leaves. A steel stud will perform just as well as wood if it is at least an 18 to 20 gauge.

We've all heard about bizarre-sounding combinations of wall surface materials that promise incredible performance. Maybe some of them work. But for low-cost mass, you can't beat drywall. There are some tricks that will improve its performance considerably.

A resilient channel installed horizontally between one face of the stud and the drywall can raise the STC by as much as 10 points, although most of the improvement is at high frequencies. I don't recommend this system if the resilient channel face of

the wall is in an acoustic space. The reason is that the channel is quite flexible (that's why it improves TL), so it will contribute the same artifacts as a lightweight stud. This would not be a problem for a wall between a studio and hallway or office as long as the resilient channel was on the hallway or office side.

Another significant improvement can come from using 1-inch-thick drywall, usually called "shaftliner," as the base layers with a standard 1/2-inch or 5/8-inch finish layer. The method of attaching the panels also can be improved by applying a bead of caulk to the stud flange before installing the base layer. On all subsequent layers, apply small dabs of caulk on 8-inch centers between drywall panels. This application serves dual purposes of laminating and damping the layers. All seams between panels also must be caulked carefully.

Insulation

As in ceiling construction, the amount and type of insulation in the stud cavity is very important. The same guidelines apply here—fill all cavities completely with fiberglass insulation of 2pcf to 3pcf density.

A good partition for use between an acoustic and non-acoustic space with moderate isolation required is shown in Figure 6. Its TL by 1/3-octave bands is shown in Figure 7. Three layers of drywall are attached to the face of a 6-inch steel stud with two layers attached to a resilient channel on the other face. All layers are laminated, and stud cavities are filled with

Laminated glass outperforms standard plate and should always be specified.

6 inches of Thermafiber insulation. This type of construction is sometimes called "unbalanced" because there are more layers of material on one side than the other, which has an important effect on the coincidence dip.

All materials have a "critical frequency" at which they offer less resistance to sound waves of the same frequency striking at certain angles. This critical frequency results in a coincidence dip or an area of the band with reduced TL. For wallboard panels, the coincidence dip falls in the 1,000Hz to 3,000Hz range, depending on the thickness of material and whether the layers are laminated. In Figure 7, for the wall described above, note the reduction in TL of about 5dB at 2,500Hz, attributable to the coincidence dip. It's not significant in this case because the TL of

the wall is very high in this frequency region. However, for other types of construction, particularly windows, the dip can be greater in amplitude and more serious.

For more demanding applications, a double-stud wall with 2 1/2-inch drywall on one face and 2-inch drywall on the other will outperform the wall in Figure 6 by 5dB to 10dB. Although the 16-inch thickness may be difficult to incorporate into

the design, it is an important factor in the effectiveness of this wall. Reducing it also will decrease low-frequency TL.

Doors

A paradox exists here somewhat because these walls, with such terrific sound ratings, must be penetrated in several places for such essentials as doors and windows. But if chosen and installed "carefully", they will not ruin the isolation system

Audio/Video Switcher AVS-481



- Wideband - High Quality
- Incredible Specs
- Sensible Price (from \$ 895.-)
- Remote Control (option)

Use it for

- Program Monitoring
- Picture Matching
- Test Signal Switching
- VTR Input Selection
- And more ...

*Choose the works...
or only what you need!*

Chances are you'll want a fully loaded 8 x 1 switcher for video and stereo audio. But, you can start with just video for glitch-free vertical interval switching. Add one or both audio channels later. Flexibility is key! You don't need the video module if audio is all you want to switch.

The front panel is uncluttered and functional. Tactile feedback pushbuttons, separate video and audio LEDs, a replaceable designation strip, 3-position toggle to select married (audio - follow - video) or audio/video only switching, and a REMOTE tally. Ask for our illustrated brochure. It tells the whole story.

LEITCH

For more information contact your local LEITCH dealer or call:

In U.S.A.: 1-800-231-9673

or (804) 424-7920

In Canada: 1-800-387-0233

Circle (42) on Rapid Facts Card

that we've been working on so hard. They will lower the overall sound rating for that section of construction because a door or window rated at 60dB to 70dB is rarely within the means of the average recording facility. There are many ways to maintain the design goal for isolation, however.

The most practical and effective door systems use two composite-core steel or wood units, each rated at STC 40 to STC 45, installed in a sound lock. Two doors

separated by several feet of space (remember the mass and separation criteria) will have a combined STC rating that is nearly the sum of their individual ratings.

Sealing a door properly is essential for maintaining its rating. The preferred seals are made of compressible neoprene around the door jambs and a thick felt-type material on the bottom, used in conjunction with a cam hinge that literally lifts the door as it opens. An alternate bottom

seal is a mechanical "drop" type in which a pin extending through one side of the seal cover forces a rubber strip down when the pin contacts the door jamb. Drop seals are tricky to set properly and require periodic readjustment; like all moving parts, they also are prone to failure.

Windows

Windows are equally important, and vulnerable, elements of the studio. The acoustic principles that apply to them are our old friends, mass and separation. The advantage here compared to wall construction is that no studs are used between panes and, therefore, there is no contact except at the perimeters. The disadvantage is that it's impractical to equal the mass of several inches of drywall.

A window with an STC rating in the low 50s, however, can be achieved using two panes of heavy, laminated glass separated by an average distance of 5 inches. Laminated glass outperforms standard plate and should always be specified. Using two different thicknesses (for example, 3/8-inch and 1/2-inch) will reduce the coincidence dip problem we discussed earlier.

Lastly, following the analogy to wall construction, insulation will improve the TL by absorbing cavity resonance. This application is rather tricky because obviously we want to look through the window and not use it as a display case for fiberglass insulation. The answer lies in the reveals, the portions of the frame visible between the panes. They must be covered with a minimum of 2 inches insulation. This application will require a tricky frame detail, then covering the insulation with fabric. Sloping the panes, long a tradition in studios, is useful for reducing flutter echoes with reflective wall surfaces and controlling light reflections, but this technique does not improve the TL. The volume of the cavity between panes, regardless of its shape, is the important factor.

I hope this article doesn't seem like a crash course in studio design; it would be impossible and foolish to condense that complex process into a few pages. Understanding these principles, though, will be helpful whether you plan to build or remodel yourself, or hire a consultant.

Noise control is becoming quite an exacting science. We know how to control noise transmission, but designing a good-sounding room is less calculable. In a future article, we'll explore design elements that influence the sound of a particular acoustic space.

RE/P

Silence is Golden and less work with telcom c4.

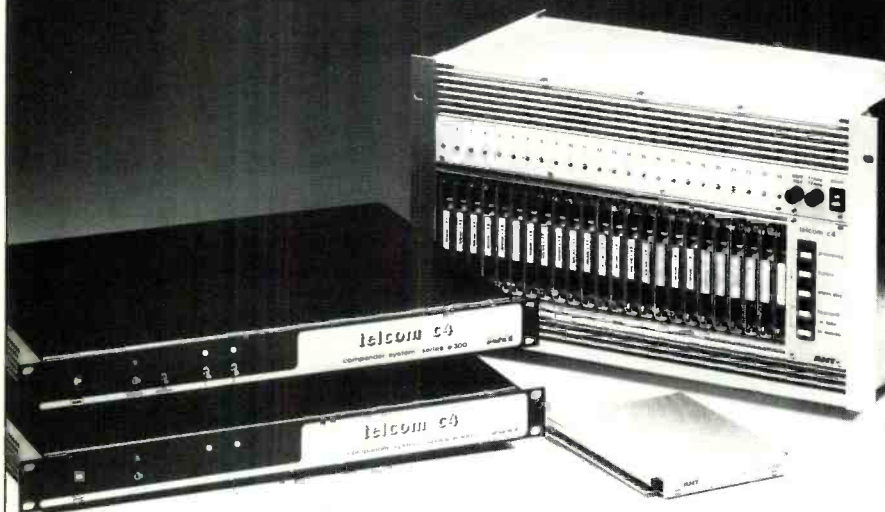

The NR system you just set and forget.

- A product of ANT Telecommunications, Inc.
- No wasting time lining up — not even for tape exchanges.
- Up to 118dB dynamic range — the widest dynamic range available in any noise reduction system today.
- Over 15,000 channels in use worldwide.
- No breathing or pumping.
- No overshooting.
- No pre or post echo.

telcom c4
Silence by Design

Distributed by:

RAM BROADCAST SYSTEMS INC.

346 W. Colfax Street, Palatine, IL. 60067

New York (516) 832-8080

Chicago (312) 358-3330

Tennessee (615) 689-3030

Circle (34) on Rapid Facts Card

Studio Design: Ergonomic Considerations

By Andy Munro and Michael Fay

Ergonomics: The relationship between workers and their environment.

There can be few working environments more complex than the modern multi-track recording studio. A matrix of up to 100 microphones, sampled sounds and effects channels, multiplied by up to 64 groups creates an unprecedented demand on the engineer whose task it is to produce a finished product. Added to this scenario are the commonly seen array of keyboards and computer control devices.

Much research has been applied to recording hardware without due consideration to its operation. It is a valid argument that every functional system in a control room should be operable from one comfortable, seated position in much the same way that a pilot controls an aircraft. But, there is a point in the design of any studio when a conflict arises between purely acoustic or engineering considerations and ergonomics.

Good ergonomic design can make an enormous difference to the successful integration of control room functions, starting with the flexibility of working positions. The engineer, producer, programmer and musician work long hours together in highly interactive ways, often sharing the responsibility for producing the right sound, at the right time, in the right place. To balance these ingredients, it is possible to resolve design ambiguity by applying a combination of logic and experience to each aspect of the project in hand. This requires a consensus approach that includes client, designer and hypothetical users in a systematic analysis of every aspect of the studio.

The following examples illustrate that successful music projects are not limited by technology, nor are they directed by it.

1) U2 produced one of the most refreshing rock albums in years by recording al-

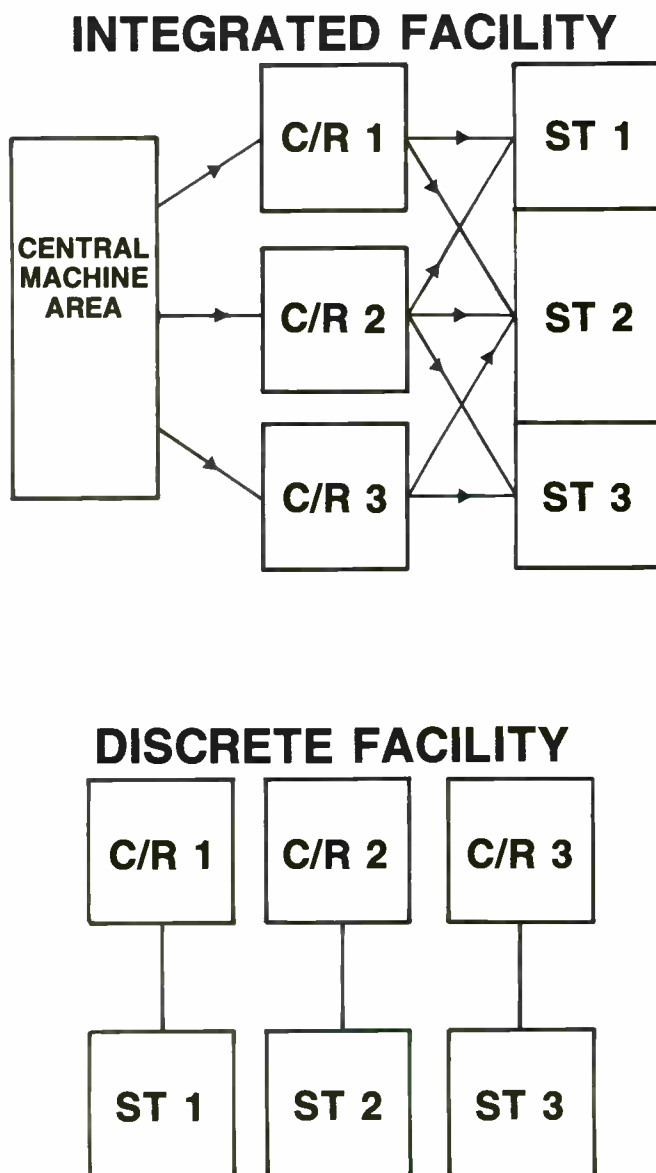

Andy Munro is a partner at Windmill Munro Design, London. Michael Fay is editor of *RE/P*.

Figure 1. Two types of facility design.

most everything "raw," in several Dublin houses and other unconventional locations in the country. Much of it was re-recorded and finally mixed together at Windmill Lane, but the essential feel is not a product of a studio environment alone.

2) Peter Gabriel spent two years in a converted barn, in the company of two digital multitracks, compiling an album that, again, is conspicuous by its success.

3) George Michael used the combined facilities of Puk Studios to create a deceptively simple sound based on using equipment representing the near-limit of existing technology.

Each situation was entirely different, and yet the result is million-selling albums, each highly acclaimed. The common thread in these examples is that the environment, not the equipment, was a primary factor influencing the creative process.

The successful studio carefully matches facilities to demand and, therefore, must offer a flexible approach to the use of its own resources.

The working space

There has been a trend for at least five years toward larger control rooms capable of fulfilling the need to both mix at a console and to play a wide variety of keyboard instruments. Yet, most control rooms are expected to be operated by one person or, at most, two people. It is, therefore, desirable to make the engineer's job as easy as possible. Several factors can influence the viability of a 1-operator room:

1. The ever-increasing number of fans in power supplies and microprocessors has led to the need for remote machine rooms, which house multitracks and other hardware. The system design for such facilities must incorporate adequate provision for remote metering and control of tape machines and other devices.

2. There is often a requirement for linking together several ATR and/or VTR machines; therefore, synchronizer systems are a must.

3. Remote-operated doors, lighting and ventilation should be considered a necessity, and not just a luxury.

4. Outboard equipment should be mounted within easy reach of the mix position but in such a way as not to create acoustic interference. For this reason, overhead racking is not recommended unless there are overriding considerations, such as mobile trucks.

Each of the traditional signal-processing rack locations has advantages and disadvantages for the engineer: When located behind the engineer, it is necessary to turn 180° to make an adjustment, then turn back again to face the monitors. To many,

this is considered the best rack location. Other options are side racks (extending perpendicular to the console, on either side) and wall-mounted racks.

Side racks are often the most convenient, but offer limited space (typically two 19-inch rack spaces wide, by 24 inches to 30 inches high). Ergonomically, wall-mounted racks are the least desirable. This configuration requires the engineer to walk across the room to make adjustments or view any metering. Wall-mounted racks, however, use the least floor space around the console, which may be desirable.

5. Seating in control rooms is often planned around the space left over, but this is not sufficient to satisfy the needs of musicians and production personnel who need to make accurate quality judgments concerning the recording.

6. The ubiquitous sofa at the back of the room invariably sits in an area of excessive bass boost, obscured top-end and imprecise imaging. Low-frequency localization has always been a significant problem in control-room planning. Standing waves induce large changes in low-frequency sound pressure, which vary enormously with location. Many control rooms have large sofas placed in a strategic model point where there may be a relative energy increase of 15dB! This effect can be reduced by even distribution of low-frequency damping and geometric design, but the laws of acoustics dictate that the bass will always be louder in the corner, so put the coffee machine there.

Thoughtful acoustic design can create a wide, stable image for a reasonable number of people who should be provided with adequate seating, but the sofa is seldom an area for critical listening.

Alternative sofa locations can be considered if the studio is still in the planning stages. Another common location is in front of the console. This location isn't good for monitoring either, but when square footage is precious, the sofa may need to be the first to move.

Placing the sofa to the side of the control room is a much less common location, and additional care must be taken if this idea is considered. To maintain an even spectral balance between the left and right monitors, it is important to have similar surfaces, opposite one another, on the side walls. This probably means identical sofas on each side of the room.

The subject of lighting has received recent attention, thanks to the flow of well-designed, low-voltage (LV) Italian systems. Although five times more efficient, the following warnings should be heeded in respect to LV lighting.

1. The lamps and reflectors become very hot. Allow adequate ventilation around

them and use the resistant mounting baffles.

2. LV wiring must be short and heavy-duty. Mount transformers as close as possible to the light fittings (preferably central to each group or bank).

3. Beware of transformers. Mount them at right angles when adjacent and test for radiant EMI field strength!

4. Always use one more light than you think you need.

Caution should be taken with all forms of dimmers, and none should be specified without rigorous testing for RF interference. Similarly, fluorescent lighting should be properly suppressed.

Natural elements can be as important as the technical environment being created. Natural daylight filtering into studios together with a neutral color scheme are ingredients for a relaxed working atmosphere.

Monitoring

The same neutrality should be applied to monitor speakers and the way in which they interact with the mixing space. Natural acoustic instruments and voices should sound as if no transduction has been employed in their reproduction. Any coloration is ultimately fatiguing.

There is an ergonomic aspect to monitoring, too. TDS (Time Delay Spectrometry) allows accurate assessment of the effects of room boundary relationships to the direct sound of the speakers. The result is the evolution of very wide control rooms with main speaker positioning that eliminates precise mirror images or "hot spot" reflections. Although this room/monitor relationship is commendable, it creates large amounts of redundant space, given that most activities must occur within the central stereo picture.

Due consideration should be given to the acoustic design in relation to working space, and, if appropriate, absorption or diffusion should be used to eliminate unwanted early reflections.

Loudspeaker directivity must also be taken into account when planning a control room with soft dome monitoring, which gives significant advantages in coverage at the expense of efficiency. Horn-loaded systems often create high-frequency beaming that must be anticipated when planning keyboard areas behind, to the side or inside the monitor focal point. A response curve or polar plot that looks good on paper may sound unacceptable to the trained ear. Do not trust data sheets for this information. Measure it first!

Video monitors can be placed locally for synchronization and control information. A large screen between the monitors is also acceptable. In either case, it is impor-

tant that the key production personnel can see the visual monitor(s) easily, and that adequate video patching or switching is available.

Ventilation is frequently left too low on the priority list, and it is easy to dismiss the effects of poor air quality as part of the lifestyle many studio engineers experience.

By completely changing the air in the studio at least eight times an hour, it is fairly easy to measure the benefit in alertness and concentration over very long periods. Of course, this is assuming that the system provides proper filtration and humidity, and also may have ionization capabilities. Air velocity should be kept below 500ft/m to eliminate turbulence, which can be both noisy and irritating.

Temperature control should be variable, and more than one thermostat is often desirable. It may be difficult to maintain a desired temperature constant if load conditions are different for various parts of the control room, studio and building, or if the conditions are constantly changing because of outside weather conditions. (For more information on HVAC, see "HVAC for Audio Facilities" on page 72.)

Hypothetically, the perfect facility uses

all its resources equally, with no bottlenecks or redundancy unless preplanned. This presupposes that each recording space is dedicated to *one* control room while another control room is used for mixing only. Other areas might be designated as programming or preproduction rooms with instant access to multitrack machines and ancillary equipment.

Again, in an ideal setup, a central

technical area would control each session to ensure proper allocation of resources. The experience of video and television systems designers may be followed to produce this centralized concept.

Obviously, a need exists for multitasking within the recording process, which has a parallel in computer networking. When the recording medium becomes fully disk-based and consoles are totally

Ergonomic Checklist ✓

- | | |
|---|---|
| <input type="checkbox"/> Sight lines | <input type="checkbox"/> Doorways |
| <input type="checkbox"/> Elbow room | <input type="checkbox"/> Steps, ramps and elevators |
| <input type="checkbox"/> Machine locations | <input type="checkbox"/> Hallways |
| <input type="checkbox"/> Location and convenient operation of outboard equipment | <input type="checkbox"/> Loading doors and studio/control access |
| <input type="checkbox"/> Audio monitoring positions for those other than the first engineer | <input type="checkbox"/> Lighting |
| <input type="checkbox"/> Video monitoring positions | <input type="checkbox"/> HVAC |
| <input type="checkbox"/> Client's or guest's seating | <input type="checkbox"/> Foot traffic, wanted/unwanted |
| <input type="checkbox"/> Communication systems | <input type="checkbox"/> Storage: cases, mics, stands, cables and tapes |
| <input type="checkbox"/> Placement of artists rack(s), keyboards and computers | <input type="checkbox"/> Lounge area |
| | <input type="checkbox"/> Security |

The Jensen Twin Servo® 990 Mic Preamp

Clearly the World's Finest Microphone Preamplifier

- Winner of Every Listening Test
- 18 to 60 dB Gain
- 0.4 Hz to 140kHz
- Phantom Power



Deane Jensen's best mic preamp is now available in half or full rack versions, with 2, 4 or 6 channels. The new standard for audio perfection. Hear it at Audio Rents (LA), The Rental Company (NY) or at your competitor's studio. Write or call for a technical data sheet.

Manufactured for Jensen by Boulder Amplifiers.

jensen transformers INCORPORATED

10735 Burbank Boulevard • North Hollywood, California 91601
FAX (818) 763-4574 • TELEX 6502919207 MCI UW

Phone (213) 876-0059

Closed Fridays, visitors by appointment only

"Twin Servo" is a registered trademark of Jensen Transformers, Inc.

Circle (35) on Rapid Facts Card

August 1988 *Recording Engineer/Producer* 61

assignable, then the traditional control room layout will be obsolete. Once the console is reduced or removed altogether, everything else changes.

Communications

Good talkback communications are absolutely vital. Some studios incorporate remote talkback and clock panels in several locations, which allows for convenient communications in a variety of areas. A company known as Brainstorm has developed a wireless talkback button. This allows the client or producer to have access to the talkback button anywhere in the control room and frees the engineer from the "talkback guessing game."

The relationship between studio and control room deserves some consideration. Musicians need to know what is required of them and, therefore, good communication is vital. Foldback systems can be integrated with a local "black box" whereby the musicians can mix both content and level to their own requirements.

Good visual communication with the control room is more important during large sessions than for soloists, but, in general, there is an improved working relationship if people can see each other.

This is especially true in an environment where 2-way verbal communication is restricted and often cluttered. Quick hand signals can usually deliver a message from engineer to musician, when the noise level in the studio or control room makes it impossible to hear.

Movement between studio and control room should be as easy as possible, and remotely operated, motor-driven doors are not necessarily an extravagance. A 50dB door with a spring closer, opened 50 times a day, expends many ERGs! (An ERG is the unit of work expended when the force of one dyne moves an object a distance of 1cm.)

Unproductive areas

Circulation space is often underestimated in a studio complex design, and, despite its non-productive nature, it can be used to good effect. Wide corridors create useful storage areas for flight cases, music stands or chairs and can create acoustic buffer zones between studios. Careful zoning can increase isolation by an equivalent cost factor of up to 50%. It can also reduce the frustration of overlapping sessions if equipment can be stored next to the studio.

The value of a lounge area is often overlooked. This may look like waste of valuable floor space, but it isn't. The lounge serves many functions. It provides artists/clients with a place to congregate before, during and after a session that is unobtrusive to the operation of the rest of the facility. The lounge can also serve as a warmup room for musicians, a meeting room or a place to sleep during an all-night session.

Good ergonomic design requires as much careful planning as it does money and labor. With a good design, an audio facility can maximize its use of time and space. In many ways, time is the limiting factor for a studio and, therefore, it is necessary to improve the efficiency of the operation wherever possible.

The fatigue factor also comes into play here. A studio that is comfortable, efficient and sounds good is conducive to creativity and repeat business.

The art of professional studio design has reached a fairly sophisticated point in most top-line facilities. However, there is still room for improving the relationship between man, monitor, machinery and environment, and the introduction of new standard interfaces.

REP

The Industry Standard For Excellence

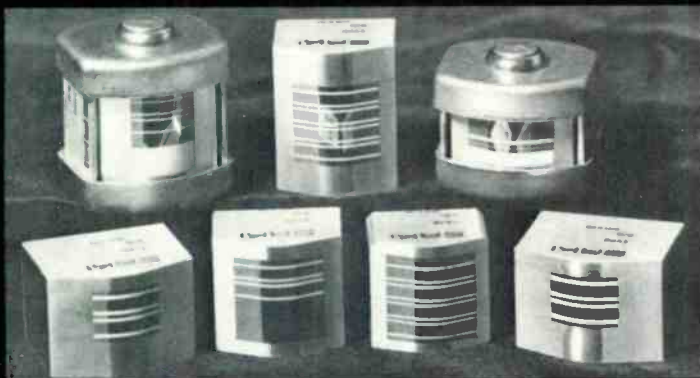

Saki Ferrite Audio Replacement Heads

Hot-pressed, glass-bonded ferrite for superior sound and long life. Fully compatible with original manufacturer. 1/4" and 1/2", 2 and 4 track applications. For Ampex, MCI, Mincom, Otari, Revox, Scully, Studer, Technics, and others. Call now to order.



SAKI MAGNETICS, INC.

26600 Agoura Road, Calabasas, CA 91302

Phone (818) 880-4054 Telex 244 546 FAX (818) 880-6242

Circle (36) on Rapid Facts Card

BIG BOOST SMALL BOX



Only Aerco provides a microphone preamplifier with world-class performance in a 22 cubic inch package.

The 500 KHz switching power converter provides standard Phantom power for 12 to 48 Volt microphones and delivers 8 to 12 hours of continuous operation from the internal 9 Volt batteries. The noise performance of our 1 nV $\sqrt{\text{Hz}}$ amp is truly phenomenal. Great quality at a small price—\$429.00

For ordering or for more information, please contact



P.O. Box 18093, Austin, TX 78760
(512) 451-5874

Circle (37) on Rapid Facts Card

Basic Design Factors for Remote Recording Facilities

By Christopher Danley and
Patrick Murray

Weight, suspension, console orientation and stringent ergonomics are examples of the unique considerations needed for the mobile environment.

Small, cramped spaces overflow with electronic gear. Speakers hang from the ceiling, and a maze of wire twisting like spaghetti rests on the floor behind the multitracks. Engineers, producers and various non-essentials breathe smoke-filled air, getting on each other's nerves. Are these the images that come to mind when you hear "remote recording"?

Modern professional remote trucks are obviously a far cry from this scenario. In fact, some of the finest facilities today are found on wheels. The rapidly increasing need for audio-for-video and the constant growth of live broadcasts are creating a growing demand for quality mobile audio.

Studios and remote trucks have several common areas in electrical and audio design principles, but some parameters involved in mobile design do not occur in the studio domain. Weight distribution, vehicle suspension, console orientation and the necessity of stringent ergonomic planning are examples of the kinds of unique needs that must be considered for the proper mobile environment.

The purpose of the truck sets the path for its design, which should be determined, to a large degree, by the company's direction and the needs of its perspective clientele. Although it is true that a good remote should be able to handle any task, different companies may wish to pursue particular areas of the mobile market.

A studio is generally designed from the control room outward, but a remote is designed from the shell inward, and this design is becoming modular. A "module" is a room or area intended for a specific use or group of people, such as control, lounge, vocal booth, tech space and



Christopher Danley and Patrick Murray operate Guns For Hire, a database of independent engineers and technicians. They are currently on tour with Miles Davis as monitor and house engineer, respectively.

The Metropolis Audio mobile recording and broadcast van features two Optro 1000 24-track recorders, an Otari MX5050 2-track, 24 channels of Dolby "A" and SEDCO distribution amps.

Introducing Panasonic Professional Digital Audio.

The difference between a purchase and an investment.

Digital technology is here now. And without a committed investment in the necessary digital hardware, audio professionals won't be able to cut it in the competitive world of audio production.

Panasonic is a service-oriented organization that's committed to a substantial, long-term investment in the future of digital production.

Our first offering is a quartet of digital audio tape and compact disc products that answer the specific demands of professional environments. Rugged, reliable, hard working designs incorporating the essential features and high quality you need to make your investment pay off.

New from Panasonic are a pair of professional DAT machines. The portable SV-250 for field and location recording, and the rack-mount SV-3500 for studio and permanent applications.

The SV-250 Portable DAT: 3.5 pounds internal battery mic/line inputs high-precision metering dual MASH A-to-D 64-times oversampling digital filters



SV-250 Portable DAT.



SV-3500 Studio DAT.

headphone monitoring. The SV-3500 Studio DAT: high-speed search full programming functions multiple-repeat mode wired remote XLR ins/outs CD/DAT digital interface.

For demanding industrial CD applications, the rackmount SL-4300 Single-CD and SV-4700 Magazine Compact Disc players feature heavy duty transports, four-times oversampling and dual DACs for ultra-linear replay quality.

The SL-4300 CD Player: direct access to any track in under a second playback sequencing with up to 20 selections automated series play mode. The SL-4700 CD Player: a removable magazine holds six CDs 36-event random access to any CD track on any disc full-feature remote control unit.



SL-4300 CD Player.

SL-4700 CD Player.

If you're considering the purchase of a studio quality DAT recorder or CD player, spend a few minutes talking to a Panasonic dealer. The investment could pay off for the rest of your career.

For the name of your nearest dealer, call 714-895-7278 now, or write to us at Panasonic AVSG, 6550 Katella Ave., Cypress, CA 90630.

Panasonic
Professional Audio Systems



The Metropolis van features a Harrison 40/32 console, Tannoy and Auratone monitors, dbx 160, 160X and 162 compression and limiting and communication facilities.

storage. These areas can overlap, and most trucks currently operating have been adapted to changing needs by modifying areas to serve more than one function. Zones can be distinguished by actual walls, by changes in carpeting, wall treatments, color or by the placement of machines and racks.

Along with modularity comes the need for efficient use of space. Years of experience are providing for greater know-how in using every last inch of space effectively, and with a much better feel for *human engineering*. Currently, two basic approaches seem to be emerging in overall design: the "super control room" and the "total studio on wheels."

The super control rooms are generally built in straight trucks, and have 48 to 64 tracks, 60 or more inputs, superior acoustics, video and time code links, lots of processing and good ergonomics. The total studio on wheels may or may not place as much emphasis on the control room, but attempts to offer the client the same options and flexibility as a regular recording studio. These facilities are usually housed in trailers and have different zones.

The shell

Several choices are available for the vehicle or shell of a remote truck:

Trailers—Typically, they are 40 to 48 feet long. The trailer's main advantage is that it is separate from the cab. If mechanical breakdowns occur, the trailer can be attached to another cab, thus minimizing

downtime. Trailers are the largest boxes available and are usually split-level, having a raised section called the dance floor at the front of the box, where the cab is attached. The dance floor is normally used for lounge, tech or storage space. Drop-frame trailers or moving vans are well suited for remotes, because they have the best interior height.

Straight trucks—These vehicles average 24 to 36 feet long including the cab and yield around 18 to 30 feet of floor space, although anything down to a step-van should be included in this category. Straight trucks get better gas mileage, are more maneuverable and less expensive than tractor/trailer combinations. This type of truck is basically converted into a control room, simply because it doesn't have enough interior space to support separate rooms properly.

Buses—The average bus is about 40 feet long. Its interior dimensions offer internal length closer to that of trailers, but it is narrower and has less headroom than trailers or straight trucks. This length makes it possible to have more than one zone, usually offering a lounge in addition to the control room. Buses also have luggage bays that are easily converted into storage compartments. A bus gets good gas mileage, has a smooth ride, and a good used bus may be a viable way for a new company to enter the business.

The first phase of design and construction starts with the empty shell. Two main considerations are present here: structural

and shielding. The shell is the mobile's foundation, and the general layout and weight distribution should be considered before it is purchased. Structurally, certain areas may need to be more flexible or rigid than others to accommodate different load requirements, and the shell construction needed depends on the stresses incurred during transit to and from jobs. They are available with varying rigidities and can be modified to suit the needs of the design. A shell that is too rigid may result in internal structural and equipment damage.

Thermal insulation of polyurethane foam or fiberglass may be needed to keep operating temperatures stable within the shell. Many times this insulation doubles as part of the acoustical treatment. The top of the shell should be waterproofed.

Many existing trucks have no specific shell treatment for EMI shielding, which is a credit to their wiring and the fact that many boxes are made of steel or aluminum, which serves as the shield. An increasingly popular treatment is lead shielding, available as foil or foam. Although lead guarantees shielding, it is also expensive.

Suspension

The suspension is another critical consideration. Generally, air-ride systems are becoming a standard requirement to ensure minimum shock transfer to the on-board electronics. Part of the suspension scheme depends on the weight distribution of the equipment. Typically, HVAC units are located at the very front of the truck, just above the wheels. The console and tape machines are usually located in the middle of the truck, and the rear of the truck, behind the axle, is suitable for storage. Once the equipment is in place, the truck will need to be secured by jacking it up and leveling it.

Door placement is important in terms of traffic flow, artist/engineer comfort and general session sanity. Door locations should provide access to particular zones without interfering in the activity going on within that zone.

Some operations are currently experimenting with expanding boxes as a means of enlarging the operating area without changing the traveling size. This concept involves a sliding section from 12 to 24 feet long that increases the truck width by 3 to 5 feet and is often used in video production trucks. However, this may be too expensive for an audio truck.

Power and HVAC

Stable, clean power is necessary for any remote recording facility, and all trucks should carry their own isolation transformer and distribution system,

which incorporates some kind of voltage regulation, filtering and spike protection. A growing number of trucks are carrying heavy-duty generators capable of supplying the truck's complete power needs. Although these units are not generally used daily, they do eliminate down-time from outside power failures. Generators should be treated as air-conditioning compressors—shock-mounted, well away from the mix position or tape machines.

HVAC compressors are important in the successful operation of any studio environment, and the remote is particularly dependent on a system with sufficient capacity to keep operating temperatures stable, regardless of outside conditions. Normally, trucks are single-zone systems, but they may have a duplicate compressor to provide backup. External mounting is the most popular method of isolating compressor noise. Ductwork follows similar rules as in studios. (See "HVAC for Audio Facilities," page 72.) Some designs integrate the ductwork into a floating floor to help maximize headroom.

Control room

The control room is the heart of the remote operation and the main focus of the design. The objective is to achieve the best possible acoustics and optimize the working environment. Generally, good control-room layout comes from common sense. Zones should be determined according to who will be working where, and then gear should be positioned to facilitate that design. A major consideration in remote control-room design is the placement of the console and monitors.

The most popular configuration places the console widthwise, facing the front or rear of the box. This method allows some distance between the monitors and the engineer and makes use of the greater distance to the back of the control room, which allows better development of low-frequency waves. The main monitors are usually located in a soffit built against the front or rear wall. However, because the maximum speaker width can be only about 8 feet, the stereo imaging may be less than ideal.

Placing the console lengthwise in the box offers greater separation between the monitors, which improves stereo imaging. It also allows the engineer greater visibility to other areas of the truck. However, in this configuration, only about 8 feet of depth is available to accommodate the engineer, console and monitors, so the main monitors are more in the close-field class. Because close-field monitoring is so popular with most engineers, this should not often prove to be a major drawback.

Placement of the tape decks and out-

board gear is more subjective, but will ultimately be based upon the layout of the console. You should remember that the second engineer must move quickly and must reach tape decks and patch bays without interfering. The standard approach in a widthwise configuration is to have tape decks and outboard racks opposite each other, just behind the console. This plan helps to isolate the engineer from traffic flow.

Placing the multitracks under the monitor soffit allows the engineer to read the multitrack meters directly, assuming the console does not completely traverse the width of the truck. In a lengthwise configuration, tape machines may be on one side of the board with the most popular outboard gear mounted over the console as part of the soffit. Video monitors are typically placed between the audio monitors. There is an increasing desire to have two or three small, black-and-white monitors for visual links to the stage, as well as a large color monitor for playbacks or broadcast monitoring.

The basic acoustic and isolation principles that apply in non-mobile studio control rooms also apply in trucks, but the materials and methodology are different. A box is a natural habitat for standing waves, and the control room design should address this problem. Curved surfaces with mass and diffusive areas are useful in controlling standing waves and energy build-ups at wall and ceiling junctions. Tube traps are gaining popularity because they are small and effective.

Control rooms in mobile trucks have been pretty dry in the past, but more and more rooms are beginning to parallel fixed studios in the use of more ambient mixing environments. This should probably be approached on a trial-and-error basis after most of the control-room construction has been completed.

Less-absorbent control rooms are desirable when mixing for video or tracking from an artist's house, for example. The engineer must be able to judge appropriate levels of reverb in the mix.

An aspect not to be forgotten is the finish of the interior design. Aesthetic trim is important to provide a comfortable atmosphere, because many hours will be spent in this small space.

Storage, lounge and tech areas

Other areas of the remote truck will vary in size and location, depending on space limitations imposed by the size of the control room and, ultimately, the size of the box. Several options exist for storage areas, such as bins beneath the box. These bins are used for storage of multicore reels, mic stands, isolation



A view of the Metropolis van, showing the on-board voice-over/overdub booth.

transformers, generator and similar equipment. In larger trucks, it's common to have rooms, usually at the front or the rear of the trailer, dedicated as storage or lounge areas.

Many of the larger trucks have specific lounge areas in keeping with the studio-on-wheels concept of offering clients all the comforts of the recording studio. These areas are vital in keeping non-essential sound out of the way of production. Lounges are wired for audio and can serve as announce areas or isolation booths when doing with remote broadcasts or vocals.

Finally, quality of the people behind the equipment makes a company successful. This is true for the designing and construction, as well. If proper attention and sufficient time are given to these areas, a truck can be built that satisfies engineers and clients and will not become outdated.

REP

The authors would like to thank the following people for their help in preparing this article: Steve Colby, Evening Audio Consultants; Bob Demuth, Westwood One; Randy Ezraty, Effanel Music; Fritz Lange, Remote Recording Services; Ron Lorman, Hartke Systems; Kooster MacCallister, Record Plant (NY); Dave Roberts, Le Mobile; John Voci, GBH Productions; and John Rosen, Fanta Professional Services.

Photos courtesy of Metropolis Audio Pty. Ltd., Melbourne, Victoria, Australia.

CAD Facility Design

By Curtis Chan

The ability to integrate many disciplines and functions—such as project and facilities management, and engineering design—makes the CAD workstation an invaluable tool in systems design.

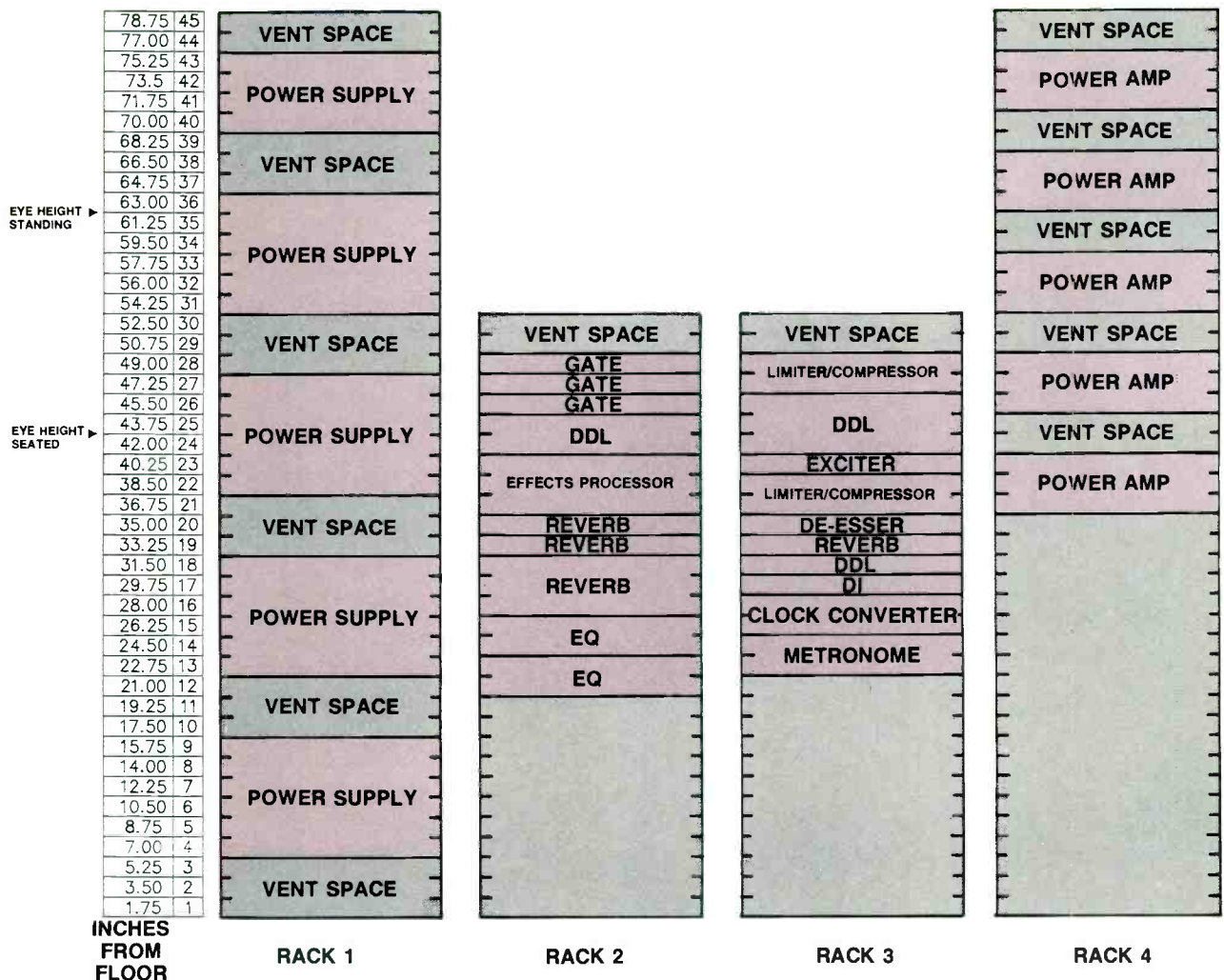

Figure 1. Using CAD to lay out rack elevations.

Within the last decade, fixed and mobile facility design have become increasingly complex. The advancement of production and post-production technologies have led to a higher level of creative freedom and a divergence from past operating methodologies. With the advancement and integration of analog and digital audio technologies coupled with recent progresses in storage and distribution, systems design has taken on a new meaning. Fortunately, computer technology has advanced enough that designers can use it as a cost-saving design tool, with the aid of CAD (computer-aided design) or CAE (computer-aided engineering) software.

Benefits of CAD in systems design

In the past, systems designers were confronted with many repetitive tasks when doing a project. The tasks were the same whether the project was a circuit, architectural or systems design. The common tasks were the tracking and updating of equipment and parts, continual updating of drawings and repetitive calculations. These tasks of handling large amounts of data and the need for continuous updating are ideally suited to a computer. With the advent of the CAD workstation, design companies have taken advantage of this technology to increase their efficiency. Over the years, CAD has received tremendous support such that its applications can now be found in disciplines such as engineering, architecture, facilities management, graphics and project management. The result is major cost and time savings to both the designer and the client.

The ability to integrate many company disciplines and functions (such as project and facilities management, inventory control, database management, word process-

Curtis Chan is vice president, marketing and product development, for Centro Corporation, Salt Lake City.

ing and engineering design) makes the CAD workstation an invaluable tool in systems design. With properly skilled people working with CAD, project lead times, budgets and manpower constraints can be minimized.

Any design, whether it's a fixed recording facility or mobile unit, requires common engineering, design and updating tasks. These tasks encompass floor and space planning, equipment listing, signal flows, power loading, rack elevation (See Figure 1.) considerations, HVAC (heating, ventilation, air conditioning), and even the selection of color schemes for interior design. For a facility or designer not having CAD or CAE tools, the amount of repetitive labor, as well as the incident for error, is increased. As an example, the equipment list must be updated as design changes occur. As a result, there is a parallel effort for the updating of drawings and repetitive calculations for power loading and the like.

If the drawings are in 3D rendered form, modification or replacement of the complete drawing is required. If the client asks "what if" questions, drawing and cost estimation times are also increased. The entire design process becomes more complex if different departments do each task, because the communications must be coordinated to avoid errors and bottlenecks.

Design applications without CAD

The benefits and features derived from the use of CAD can best be illustrated by examples of steps taken by typical projects. As a first example, let's look at a system design without the use of CAD.

In this simplified scenario, the approved project design objectives are given to the engineering department. After the designer draws the first revision of the system signal flow, it is handed to the drafting department. There, tasks such as

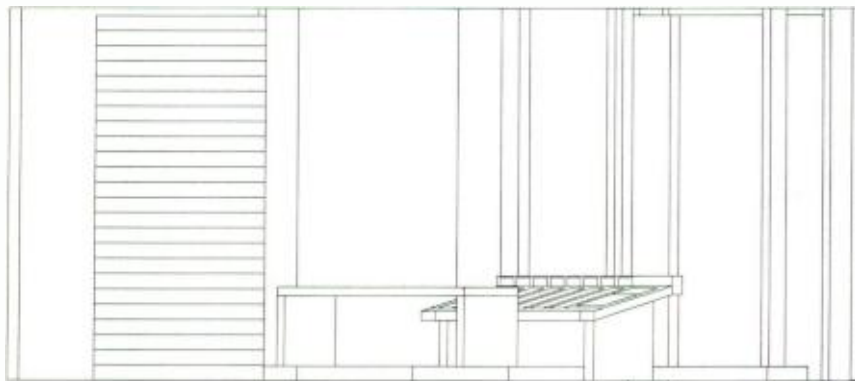

Figure 2. Southeast elevation of issue cover. Side and rear walls have been removed to expose interior.



REGISTER! NOW



**3RD ANNUAL
CARPENTER'S
HOME CHURCH
AUDIO &
MUSIC
SEMINAR**

Featuring

PHIL DRISCOLL

and Top Industry Representatives

October 6 • 7 • 8

CARPENTER'S HOME CHURCH

Lakeland, Florida

SEMINAR WORKSHOPS

- DESIGNED FOR AUDIO ENGINEERS, PRODUCERS, MUSIC DIRECTORS, MUSICIANS, AND TECHNICIANS.
- SPECIAL GUEST PHIL DRISCOLL will conduct a How To Workshop on Incorporating today's electronic music technology into your praise & worship music.
- OTHER WORKSHOPS conducted by top industry representatives and the Carpenter's Home Church technical staff: Music/Video Production, Understanding and programming Synthesizers, Midi Clinics, Choir Microphone Placement and Microphone Application, Understanding Equalization and Signal Processing, Mixing Console Function and Operation, High Speed Cassette Duplication, Multi Track Recording, the use of Wireless Microphones and Wireless Hard of Hearing Systems, Noise Reduction, Click Track Application, and many more.

Special exhibits and instruction by: Aiphone, AKG, Audio Technica, AYL, Accoustical Treatment, C-Tape, Cetec-Vega, Clear Com, Community Light and Sound, Crowne, Industrial Research, Klark Teknik, Nakamichi, Neumann, QSC, Rane, Sennheiser, Shure, T.A.D., T.O.A., Viking Cases, Williams Sound and Yamaha.

REGISTER FORM **Clip & Mail**

\$95.00 REGISTRATION FEE INCLUDES ALL WORKSHOPS, LITERATURE AND DAILY BREAKFAST AND LUNCH.

Name

Address

City/State

Zip Phone ()

THE CARPENTER'S HOME CHURCH

777 Carpenter's Way, Lakeland, FL 33809

FOR MORE INFORMATION CALL

DENNIS (813) 859-1477

Circle (39) on Rapid Facts Card

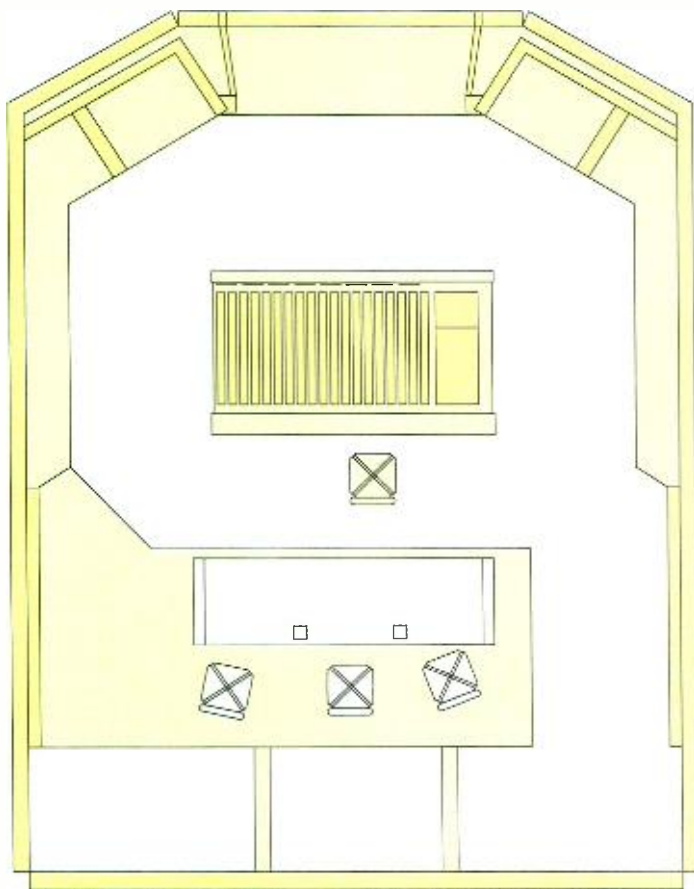

Figure 3. Plan view of issue cover.

numbering, cable counts, equipment insertions or deletions and the aesthetics of blocking out the complete system are done manually. When the drafting department finishes with the drawing, it is usually given back to the designer to check for errors. If an error in drafting occurs, it is sent back to drafting and rechecked by engineering until all errors are corrected. Parallel to this effort, the bill of materials is being updated. This repetitive, time-consuming loop is necessary with a manual system. If the client wishes to add or delete equipment from the initial order, this usually results in an engineering change, which means that all affected drawings and equipment lists must be updated.

The process is both tedious and time-consuming. If the example given is expanded to include facility design, the workload and the incident for error increase. Aside from engineering-based documents, most facility designs have 3D renderings drawn by a design artist.

Modifications to the renderings can be slow and expensive. The same is true for updated cost estimations, and equipment and materials ordering. This results from a manual database of information in which everything is hand-tracked, thus increasing the likelihood for human error.

Obviously, the common denominators that may result in lost revenue when designing manually are the tracking of large quantities of equipment and components, the continual updating of drawings and equipment lists, and the repetitive math operations needed to reflect engineering and design changes. These tasks can best be handled by a cost-effective, computer-based system capable of easing the transition from an all-manual operation to one that is semi-automated.

Advantages of system design using CAD

For the individual designer or company, investing in a CAD workstation can increase revenue, which results from the in-

tegration and use of many software packages that optimize specific, repetitive operations. Since the introduction of AutoCAD software in 1982, many design barriers have been overcome. Now various CAD programs are available that can run on most 16-bit computers and several 32-bit models, thus bringing the power of high-performance CAD to design professionals for a fraction of traditional mainframe computing required for CAD operations.

CAD software allows the designer many options in drawing, editing, coloring and setting one or more light sources. Many of the tools that a designer, draftsman and artist uses are inherent in the software package. Likewise, some CAD features cannot be duplicated in the real world, for example, layering and the ability to zoom, with ratios of 10 trillion:1 between the largest and smallest objects in the drawing.

CAD drawings can be exchanged with other applications software, databases, and mainframe CAD systems. With a specific version of LISP programming language, AutoCAD users can create custom menus and command strings that tailor the software to their particular needs. This facilitates the development of applications and utilities that aid productivity.

The advantages in using CAD for systems design can best be shown by taking the previous examples and incorporating the use of CAD applications software. For systems design, initial signal flow diagrams are done once. In addition, repetitive sections or blocks of drawings along with their symbols can be individually stored for later retrieval.

Linking various software

With additional software, cable counting, numbering and engineering calculations can be automatic. Because software databases can be linked, data entry from the drawing to the database can also be automatic. This data can then be used for different applications, such as predicting and forecasting "what if" situations, as well as updating the bill of materials and the product management schedule under each new circumstance. When an engineering change occurs, drawings can be updated simply by removing, inserting and manipulating respective sections of the original drawing. The ability for the designer to recall often-used blocks and symbols helps to facilitate this process. The process then carries through to the elevation drawings with the same ease of operation. (See Figure 2.) Additionally, all equipment and component lists are updated automatically. Some specialized versions of CAD and CAE allow system

designers to test their models dynamical-ly before manufacturing.

With facility design, the same is true with other added benefits and features. Software packages allowing 3D rendering can quickly update "what if" situations. In addition, advanced systems mutate 2D drawings into 3D form such that drawings can then show color, perspective, surface shapes and features. This is exactly how the cover of this issue was generated. Though the design on the cover is quite rudimentary, it demonstrates some of the capabilities available. With architectural software, CAD workstations allow the designer to create complete sets of drawings. Global commands from the master template can insert, modify and update sections of the drawing automatically.

This is a great advantage in ergonomic design. The CAD system can place equipment and people in the drawing in simulated scale, then check the different views for ergonomics. Designers can create and modify schematics and then have them converted to floor plans without any added labor. (See Figure 3.) Additionally, shapes and symbols can be extracted and fed into a database for quick, accurate generation of contracts and documents. Because drawings and order entries are kept on a common database, several advantages exist. The CAD workstation can automatically track all equipment, calculate repetitive engineering functions (such as rack loading, weight distribution and power loading), give accurate cost estimations and generate a variety of reports. Finally, because the information is stored on computer disks, users then have compact, consolidated archives of their work that can be updated, copied or stored easily and efficiently.

CAD workstations and associated software offers several advantages to the designer. The applications software allows accurate tracking of equipment, quick engineering analysis, accurate cost analysis, easily updated databases and drawings, and the ability to generate a variety of reports and documents from a common database. As computer processing technology increases in performance and decreases in price, CAD workstations will become a viable addition to many designers and companies. The benefits, shorter project lead-times and smaller budget variances will have a favorable impact on the client.

RE/P

Professional SOUND recording & duplicating SUPPLIES

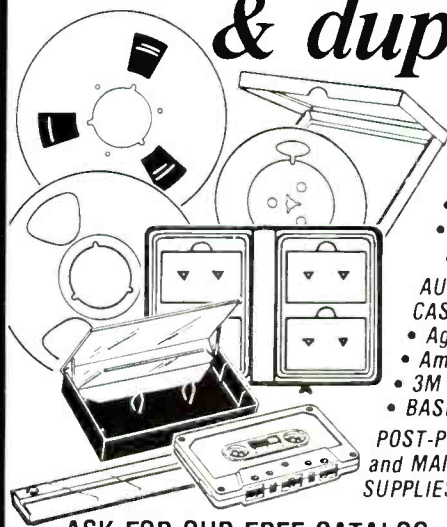

POLYLINE
• Blank-loaded audio cassettes
• Empty reels and boxes
• Audio cassette boxes and albums

AUDIO TAPE and CASSETTES from
• Agfa • FUJI
• Ampex • Maxell
• 3M • TDK
• BASF

POST-PRODUCTION and MAINTENANCE SUPPLIES

SHIPPED FROM STOCK WITHIN 24 HOURS
under normal circumstances

ASK FOR OUR FREE CATALOG

Call Polyline
312 / 298-5300
8:30 am - 5 pm Central Time

Polyline Corp.
1233 Rand Road
Des Plaines, IL 60016

Circle (40) on Rapid Facts Card

DON'T GET ZAPPED!

Investing in a Control Room or Studio?
PROTECT YOUR INVESTMENT

Power up with . . . **Z-LINE**

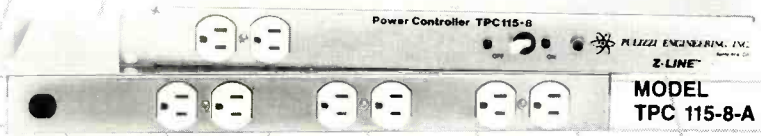

Protect your expensive equipment with our **Z-LINE AC Power Distribution and Control System.**

POWERFUL • AFFORDABLE • STACKABLE • EASY TO INSTALL
COMPACT • QUIET • LIGHTWEIGHT • EMI/RFI FILTER
GROUND ISOLATION • SPIKE AND SURGE PROTECTION

Order now . . . Priced at only \$160.00
Distributor Inquiries Welcome

PULIZZI ENGINEERING INC.
3260 S. Susan St., Santa Ana, CA 92704-6865
(714) 540-4229 FAX (714) 641-9062

Circle (41) on Rapid Facts Card

HVAC for Audio Facilities

By Jeff Blenkinsopp

A well-designed AC system keeps the temperature, humidity and air quality at comfortable levels for your clients and optimal levels for your equipment.

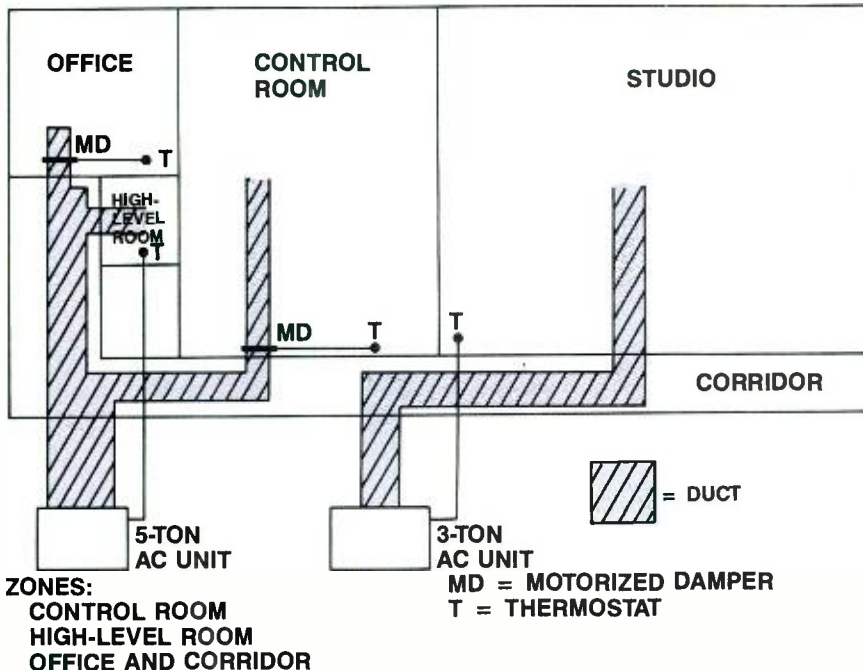

Figure 1. Having two AC units eliminates crosstalk between studio and rest of area.

The studio environment should be comfortable, with minimum disturbance from the outside world. It should also provide your equipment with clean, climate-controlled conditions.

The air-conditioning (AC) system plays an important part in a studio's overall atmosphere, and yet its importance is often overlooked. A well-designed AC system keeps the temperature, humidity and air quality at comfortable levels for your clients and optimal levels for your equipment. This is especially important because soundproofing essentially makes your environment air-tight. With outside air eliminated, the heat from the equipment, lights and people is trapped inside the acoustic shell.

When designing the air-conditioning system for a studio, contact a reputable dealer or consultant in your area early in the system-design process. If you choose a company that hasn't done any studio installations, beware that most HVAC (heating, ventilation, air conditioning) engineers have very little knowledge of the specialized considerations necessary in an

Jeff Blenkinsopp is owner of J.B. Audio, an audio consulting company in New York.

audio environment. When listing the system requirements, state how important these are to you. Once a system is installed incorrectly, it is difficult and expensive to correct it.

When selecting from among HVAC companies, ask whether they have installed any systems for computer or clean-room applications. They require specialized installation and design with similar demands (constant operation, clean air, and tight temperature control) to those found in a recording studio. Also, beware of companies that are really just sales offices and subcontract out all of the work. You can save a lot of time, money and irritation by acting as your own contractor and getting the electrical, plumbing, masonry and other similar work done by your own subcontractors. The HVAC company usually marks up the sub's fees and does not always give the sub's work the attention you would if you hired directly. You are also controlling the sub's payment, which can help ensure the job is done right and on time. Hiring your own subs only works if the details of your system are well defined and you have a competent HVAC company working with you.

Selecting a system

Different types of systems are commonly available:

Window units—These are the type used in apartments and are fitted in a window or through a wall opening. They're noisy, and, in most cases, duct work cannot be connected to them. They are not generally acceptable for studio use.

Self-contained units—These can be mounted outside on a concrete slab, in an attic or can be free-standing. Simple duct work can be connected to them, and they are suitable for studio use if positioned correctly.

Split systems—These have the condensing section remote from the cooling section. The condenser is mounted outside and the refrigerant lines run to the cooling units. The main noise-generating part is the condenser, but the cooling sections have a small fan to move the air. They can be used in studios, but beware of the fan noise. A split system could be used in less critical areas (for use in less critical environments).

Heat pumps—Similar to the split system, these have a reversible feature that allows the heat to be pumped in or out, depending on the need.

Rooftop units—These are self-contained units with electric cooling and gas heating. They can be mounted on a roof or at ground level on a concrete pad; they can be ducted and come in many sizes and configurations. These are used in a lot of studio applications.

Water-chilled units—Similar to split systems, these are usually used only on large studio projects, in multistory buildings or where a rooftop cannot be fitted. The chiller unit is mounted outside or next to a window, and pipes run to the cooling/fan units, which are mounted in the duct work.

Zones and heat load

The size of the systems is an important requirement. If there isn't enough AC, you'll never get your facility as cool as you want, and if the system is too big, you're paying for equipment and cool air you don't need. The number of systems is also an important consideration. Divide your facility into separate zones (for example, control room, live room, machine room, amp closet and offices), and then decide how to supply the climate control that each zone requires. (The zones are determined by their cooling requirements and audio consideration.)

For example, the control room will probably require year-round cooling, but your office space will need to be heated in the winter. If the control room and live room are cooled by the same unit, sound leakage can be a problem. (See Figure 1.)

Air conditioning units are usually measured in "tons," and 1 ton of refrigeration equals 12,000Btu/hr. So, the greater the tonnage, the more cooling power. The HVAC company or consultant will calculate the size and number of systems required, but you have to give accurate in-

formation on the requirements, especially heat loads, operating conditions and zones.

The heat load of the space is the heat generated by the equipment, lights, people and heat transmission through walls or windows in that area. The HVAC contractor will need an estimated heat load from you to calculate the size of the system. Prepare a list of the following to give to the HVAC contractor.

1. Number of people using each area. Give a maximum number. If the studio can hold a 40-piece orchestra, allow for this many people.

2. Number and types of lights in each area.

3. Total electrical wattage of equipment in each area. The wattage of each piece of equipment is usually found in the owner's manual or on the back of the equipment. Add these individual figures to obtain the total. Some manufacturers can tell you the load for their equipment if you call them. (While you're checking the wattage on your equipment, note the power fuse rating and keep a log. It will come in handy when you're trying to work out what fuses to keep in stock.)

4. Set of drawings of the facility showing layout, wall construction, doors and windows.

From this information and the answers to a few other questions, the HVAC contractor should be able to calculate the studio's heat loads. The average 24-track control room will require 3 to 5 tons of AC.

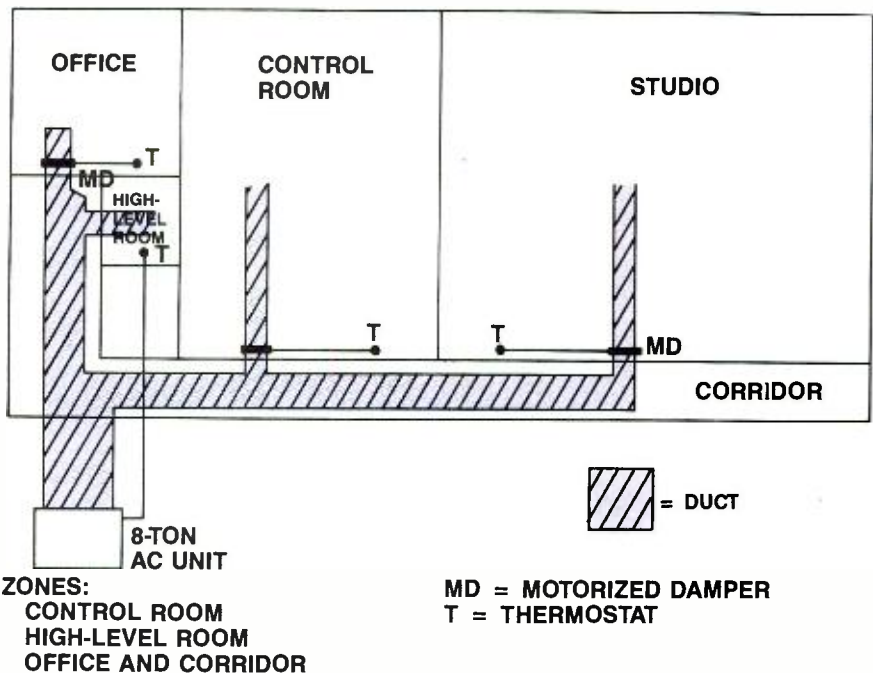

Figure 2. Using a single AC unit allows noise to travel between areas.

If your facility is running 24 hours a day, tell the contractor; it will affect his choice of equipment.

Acoustic considerations

The acoustic environment places unique demands on an AC system. When installing your system, consider:

System noise—An AC system generates noise in several ways, including vibration, equipment-generated noise and air-generated noise.

The AC equipment is motor-driven and mechanical. When used, it vibrates, usually at low frequencies, and this vibration will be transferred to whatever the units are mounted on if care is not taken. If the units are coupled directly to the floor or roof, vibrations will travel through the building structure and interfere with your recording. It's best to mount the units away from the building structure. If the unit has to be mounted on the building, use vibration mounts. These come in a variety of types and sizes (rated by load weight and vibration transmission).

The vibrations from the unit will also travel along any duct work connected to it. This problem can be eliminated by decoupling your duct work by means of a flexible coupler. Any water, gas or drain pipes will also transmit the vibration, so it's best to run these away from your acoustically sensitive areas.

To prevent noise from entering the acoustic environment, mount the units away from the building. This is the best location, but if it isn't feasible and the units must be inside the facility, they should be enclosed in a soundproof room. Remember, the unit has to have access to outside air (usually a window) to work correctly.

The air movement through the duct system also creates noise. To reduce this noise, low air velocities must be used. Typically 400ft³/min to 500ft³/min using the largest duct possible will reduce air-generated noise. The duct work should be lined internally with acoustic material. A combination of rigid (internally lined) and flex duct is acceptable. Use a sound-absorbent plenum after the fan to reduce the air noise before it enters the main duct work.

The air going through the diffusing grilles can also cause noise, so select grilles that do not rattle or buzz, and maintain low air velocities. Noise travels between areas through AC duct work. If two areas share the same system, sound can enter the duct in one area and be transmitted through the duct into the other area. (See Figure 2.) If these two areas are the control room and the live area, you can imagine the problems. This type of transmission can be eliminated by the use of sound traps and by putting several bends in the duct work. Correct planning of the

zones and duct layout is essential to reduce this problem.

For your acoustic areas, the entire length of the duct work should be hung on vibration hangers. This will reduce the transmission of sound and vibrations (especially high-impact sounds) into the acoustic environment.

The air leaving and returning from your grilles can interfere with your sound. If the grilles are near the monitor, the airflow causes a disturbance with the monitors' sound waves, and if the grilles are positioned near your microphones, the same problem occurs. To eliminate these problems, place the grilles away from these critical areas.

Other considerations

The air entering your space, especially the control room, should be clean. Any dust that enters can get into your equipment and will eventually cause problems. The AC air is cleaned by filters, which are inserted in line of the airflow. These filters

A backup system and/or an alarm should be fitted in high-level areas so if they do get too hot, you know about it.

are usually located near the main AC equipment. Numerous types of filters are available. Most mechanical filters are either reusable or disposable. There are also electronic filters. Discuss these choices with the HVAC contractor and decide on the best type for your installation and budget.

If the system is heating an area in the winter, humidity should also be controlled. Optimizing the humidity reduces static electricity, helps acoustic instruments (especially pianos) stay in good condition, and reduces variables in the acoustic areas. (See "Effects on the Speed of Sound," April, pg. 38.) Control of humidity is achieved by using humidifiers, which are mounted in the duct work of large systems or free-standing in small systems. In smaller facilities, dehumidifiers can be used in summer if the AC system is marginal. Different types of units are available, but make sure they operate quietly.

Thermostats are the main sensing and control element of your HVAC system, and care should be taken in choosing their type and location. The thermostat setting and tolerance controls your environment's temperature, which is critical for both people and equipment. Remember, they should be out of the reach of prying fingers, preferably under lock and key, and

fixed, with a narrow band of adjustment. The system may have master thermostats and auxiliary ones controlling automatic dampers. The masters should definitely be locked, but the auxiliaries can be accessible. (If there's an adjustment that can "melt down" your facility, someone is going to find it.)

Amplifiers and mainframe computers are kept in high-level areas. They generate a high heat load and need to be kept cool. A backup system and/or an alarm should be fitted in them so if the area does get too hot, you know about it. In simple backup systems, the fans kick in at a certain temperature, pulling in air from a different zone to circulate within the high-level area. The alarm can be a buzzer and light that are connected to a thermostat, which activates them at the set temperature.

Installation tips

As when working with all contractors, watch and monitor their work. Simple mistakes that aren't remedied easily during construction can cause serious problems later. With HVAC systems, make sure any duct work that should be lined is lined, and any acoustic wall that is penetrated with duct work or thermostat wires is sealed with acoustic caulk, and so on. If isolation hangers are used, make sure they are hung correctly and the hanging duct is not touching anything it shouldn't be touching.

HVAC is a specialized industry. Although this article can help you understand it, I cannot stress strongly enough the importance of consulting with specialists in the HVAC field to get your system right.

REP

For further information, contact the Air-Conditioning and Refrigeration Institute, 15-01 Wilson Blvd., 6th Floor, Arlington, VA 22209.

For further reading, "Refrigeration and Air-Conditioning," 1987, is available from Ben T. Colt, College Marketing Department, Prentice-Hall, Englewood Cliffs, NJ 07632.

"Acoustical Designing in Architecture," Knudsen & Harris.

Artificial Reverberation: Simulating Natural Acoustics

Proper use of digital reverb allows you to simulate natural acoustic environments and provides special effects in live situations and in the studio.

Reverbation is all around us. It forms part of our everyday lives, and although we may not always be aware of it, a short visit to an anechoic chamber will demonstrate just how much of what we normally hear is, in fact, reflected sound.

A sound stripped of its accompanying reverberation can be very disquieting to the listener. So it follows that in any dis-

cipline of acoustic engineering, it is desirable to maintain control over the character of reverberation that contributes to the overall sound.

Modern studio recording practice tends to make extensive use of close micing techniques, and, consequently, much of the reflected sound is excluded. Combined with the fact that, in the past, studios have often been designed to minimize reflected sound, this means that some form of artificial reverberation must be added to restore some semblance of natural sound.

Furthermore, production trends in pop-

ular music have elevated reverberation to the status of a special effect. Reverberation now fulfills two purposes, one corrective and one creative. To satisfy these needs, an artificial reverberator must be able to simulate a wide variety of natural acoustic environments and must have the scope to produce the special effects required of it.

Understanding the basic goals and design parameters of reverberation simulators will help the applications engineer get the most from these digital devices.

Identifiable components

Design engineers are concerned with simulating natural reverberation by artificial means, so it is necessary to break down the mechanism of reverberation into separate building blocks, which gives an indication of how it should be synthesized.

First, a finite delay or predelay exists between the initiation of any sound and the time the first reflection from that sound reaches the listener. Second, this first reflection is followed by other discrete early reflections, the spacing and intensity of which depends on the physical properties of the room and the position of the listener relative to the sound source.

However, these early reflections are surrounded by a halo of reverberation themselves, because of diffusion occurring at reflective surfaces. As we shall see later, these early reflections will need to be considered separately from the main body of reverberation.

The characteristics of the room also determine the way in which the frequency content of these reflections will be modified, so it is necessary to find a way of simulating this effect.

Adapted from "Artificial Reverberation: A Developed Digital Method," researched by Terry Clarke, technical director, Klark-Teknik. Copyright 1986, Klark Teknik. Used with permission.

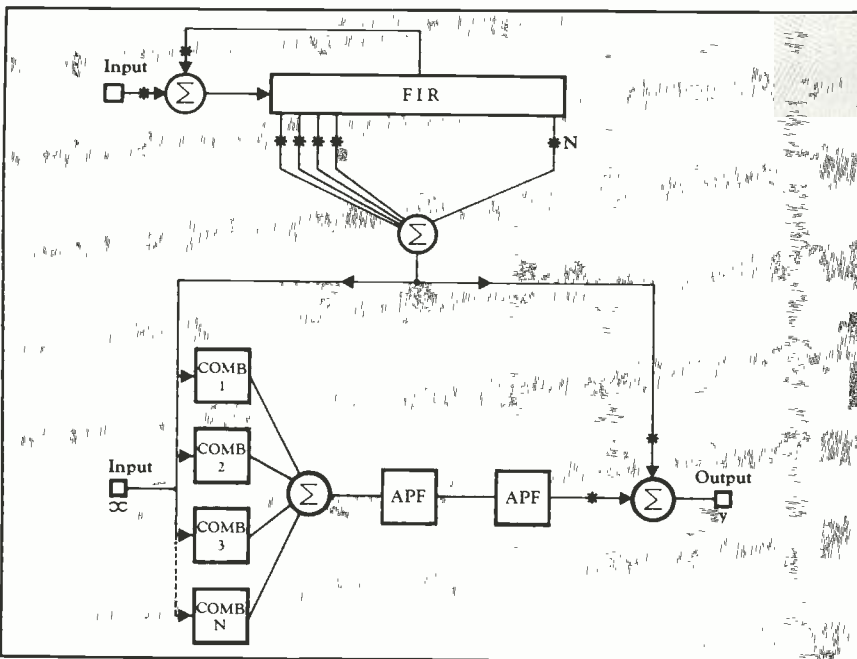

Figure 1. Reverb unit with FIR plus comb and all-pass filters.

Finally, the process of reflection and re-reflection causes these early reflections to build up into a dense statistical clutter of decaying amplitude, the frequency content of which is further modified by the reflective characteristics of the wall materials and the air absorption within the building. The combination of these aspects indicates a need to build and im-

plement a statistical clutter generator.

The actual decay time is a function of the reflective properties of the walls, the contents of the room and the room dimensions. To make the hypothetical reverberator capable of simulating a variety of natural acoustic environments, not only must these parameters be simulated, they also must be variable.

Moorer

Moorer's 1979 paper, "About this Reverberation Business" took up from where Schroeder had left off and, with the help of the more advanced computer technology that had developed in the intervening years, set out to narrow the gap between natural and synthetic reverberation. The first step was to examine the problem areas in Schroeder's original designs, which were as follows:

1. With a reverberator built up only from a number of all-pass filters in series, the decay does not start with a dense sound and die out exponentially. In fact, the higher the order, the longer the echoes take to build up to a pleasing level. This lag in reverberation can be as much as several hundreds of milliseconds.

2. Even slight changes in delay time between the successive filters can cause the smoothness of the overall decay to vary enormously.

3. The tail of the decay exhibits a metallic ringing.

These parameters defy precise mathematical analysis, and the most satisfactory combination of values has to be arrived at empirically.

In his paper, Moorer examined the properties of the Boston Symphony Hall, widely held to be a particularly good example of concert hall acoustics, and published the following observations.

The reverberation time of more than 1.7s suggests that the sound has traveled more than 600m before dying away and, given typical atmospheric conditions, the 4kHz signals are attenuated about 60dB more than the 1kHz signals. This shows the importance of simulating the correct frequency characteristics for the late decay.

Furthermore, to simulate a good listening environment, the reverb must be smooth and dense, with no apparent resonances. And, to simulate the early reflections accurately, they would have to include a halo of reverberation to simulate the effect of diffusion at the reflecting surfaces.

Then Moorer, using a finite impulse response filter, moved on to consider the simulation of these early reflections. In effect, this is a tapped delay line in which each of the taps has separate gains. The spacing of the taps must be irregular to avoid any obvious periodicity in the reflection pattern, but the optimum delays have to be chosen empirically; attempts to calculate mathematical spacings based on prime numbers or to simulate the behavior of actual rooms did not prove satisfactory. These taps may then be summed and treated with an all-pass/comb reverberator to build up the required density.

Taking all this into account, the block

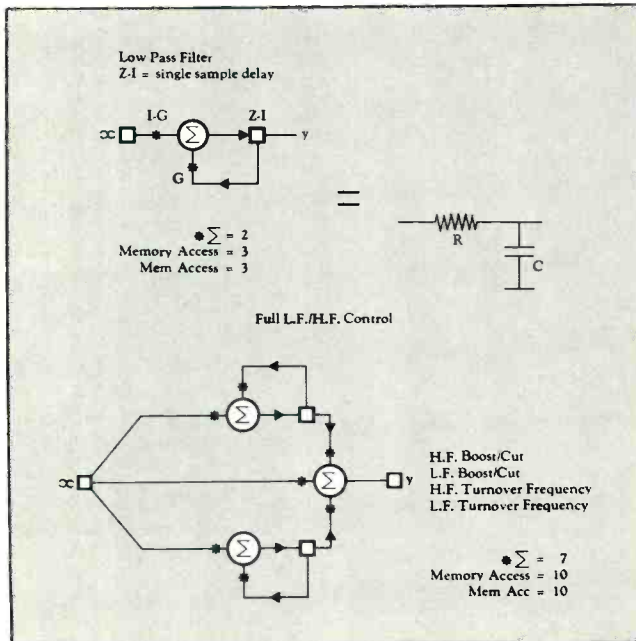

Figure 2. Low-pass and LF/HF control filters.

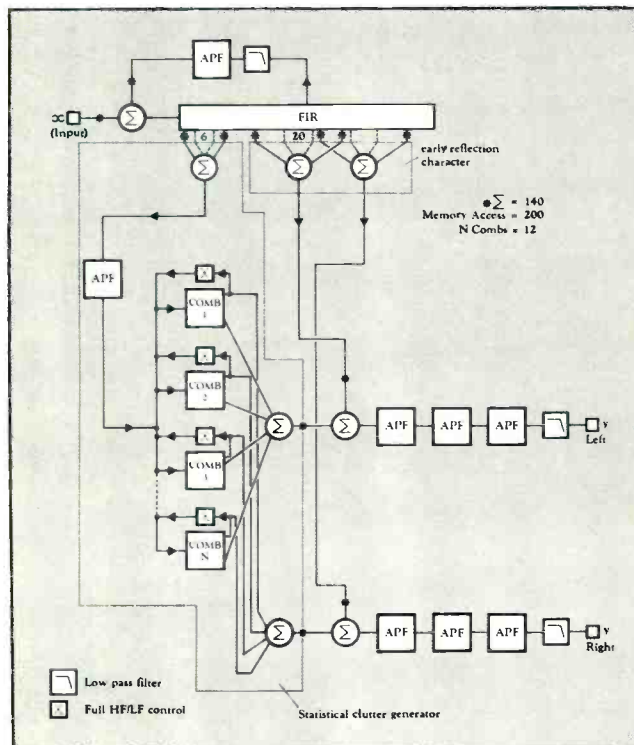

Figure 3. A complete digital reverberator.

decay little, if at all, before being abruptly cut off. This is exactly what a non-linear program does.

Furthermore, the length of the burst can be varied using a single control, and, consequently, no external gate is needed. A further advantage of this digital method is that the effect remains independent of input level.

One occasion in which a separate gate can be used in conjunction with a reverb unit to advantage is in producing an effect sometimes known as "splash reverb." Here, a signal, often a vocal part, is treated with the addition of a modest amount of reverberation that increases during loud passages. This is sound obtained by using a gate that can attenuate when closed, rather than simply shut off, and which is connected in series with the output of the reverb unit.

A stereo gate is, of course, required if the reverb is to be in stereo and if the side control circuitry is triggered from the original program material via the sidechain access input. The attenuation is then set so that when the gate is closed, it attenuates the reverb level to the desired background amount. When the gate opens, the reverb level passes through unattenuated and effectively increases in level. The gate's attack and release settings can be adjusted according to the effect required, but a fairly fast attack and medium decay are good starting points.

Reverse reverb

A refinement of this effect is the reverse program. For this, the intensity of the burst of reflections actually builds up to a peak and then ceases abruptly. Because most naturally occurring sounds have a fairly fast attack and a longer decay, an illusion of a sound being played in reverse results. Of course, this method can't generate true reverse reverb, in which the reflections occur before the original sound is generated (You still have to turn the tape over to do that trick.), but the illusion is remarkably similar. Again, this treatment is particularly well suited to percussive sounds but is also useful for creating an eerie atmosphere on vocals and other instruments. A typical reverse pattern is illustrated in Figure 5.

Applications

Most reverb applications are similar whether you are in a live sound application or in a recording studio. Generally, reverberation is added for the benefit of the end listener, but there are exceptions. For example, some musicians find playing in tune is easier in some rooms than others, and current thinking suggests that the early reflections within a room are used subconsciously to help attain accurate intona-

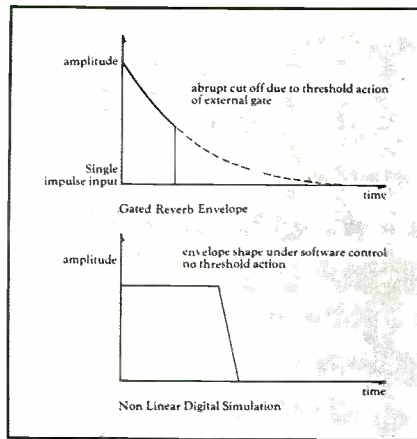

Figure 4. A gated reverb envelope and non-linear envelope.

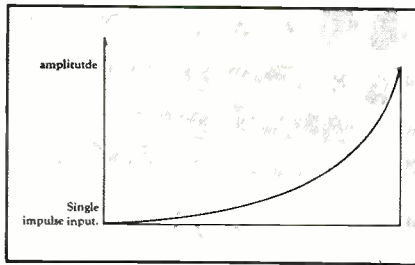

Figure 5. A typical reverse pattern.

tion. Feeding a pattern of early reflections generated by a digital reverberator to a stage monitoring system often improves intonation.

A parallel situation occurs in the recording studio, where a singer may perform better when a little reverb is added in the headphone mix, even though it may not be recorded. Use caution here because it is just as common that too much reverb in the phones will make good intonation more difficult. And, some groups of singers (such as those who sing on jingles) want their vocal mix kept totally dry while tracking.

Though there may be no apparent presence of reverberation in the accepted sense, much of what we normally hear is reflected sound, even in a fairly dead room. However, these reflections give the original sound much of its identity, and a dryly recorded or close-miced sound can be brought alive by adding a short reverberation treatment.

At decay times of up to half a second or so, the addition of reverberation creates the effect of a room without the listener being aware that any processing is taking place. This can be a useful treatment for voice in a broadcast situation and makes the program sound more natural without reducing intelligibility. Likewise, in music production, close-miced drums or drum machines can be given a sense of "life" without being obviously effected.

How many units?

You might think that one good reverb is all you will ever need, but there are occasions when you may want to use different reverb treatments on different parts of a mix at the same time. In a live situation, you may compromise by choosing an in-between setting, but in the studio, compromise is less acceptable. You can, of course, record the effects directly for part of the production, but this means that you are going to have to use up two extra tape tracks for each different setup if maximum flexibility (and stereophony) is to be maintained.

When it comes to mixing, the reverb is now free to produce the second effect, but what happens if you can't afford to use up two tape tracks or you need more than two different reverb effects? Here, you really need more than one reverb unit, but if this is impractical, you can record your original sound with its reverb all onto one track in mono. Then overdub the other parts again with the reverb recorded onto the same track in mono until the composition is complete. The unit can then be used during the mix on a short ambience setting to add depth to these mono tracks. This method works surprisingly well. The main problem is that there is no way of altering the amount of effect that was originally printed. Once recorded, the effect balance cannot be changed.

For sound reinforcement or recording applications, two units are a distinct advantage and offer a great deal of additional flexibility.

The future

The music and broadcast industries may be subject to fashion, but in many respects they are very conservative. Nevertheless, fashions in sound do change, which is one reason why many manufacturers have adopted an open-ended approach whereby software updates can be made available to users as soon as they are developed. In this way, the units are not going to become obsolete just because a new reverb effect becomes popular.

In the field of sound contracting, some interesting developments have taken place. Whereas concert halls were once selected for their suitability toward a certain kind of performance, the current thinking is that it might be possible to give a hall a very dead acoustic and then create the desired reverberation characteristics electronically via artificial reverberation devices and banks of loudspeakers. This way, a single hall could be optimized for different types of performance on consecutive nights without anyone having to compromise.

RE/P

Hands On: Audio Precision System One

By Jim Rogers

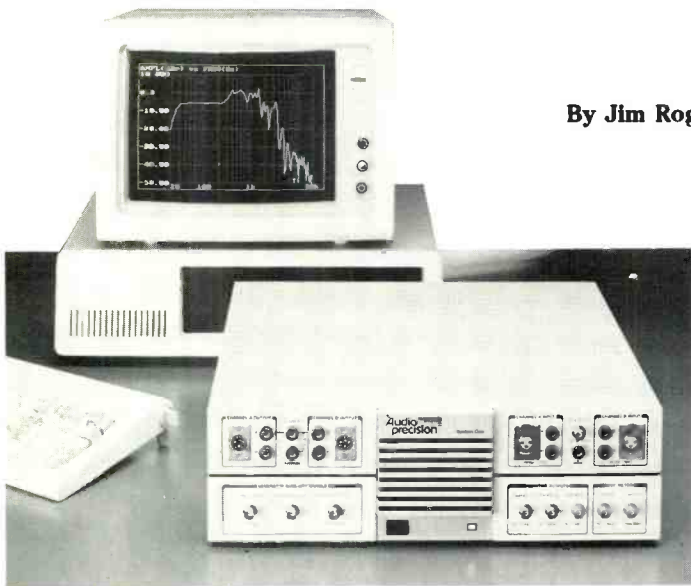

The System One is a single monolithic test unit that is controlled by an external computer. The physical design is expandable, not only to the user, but to its designers as well.

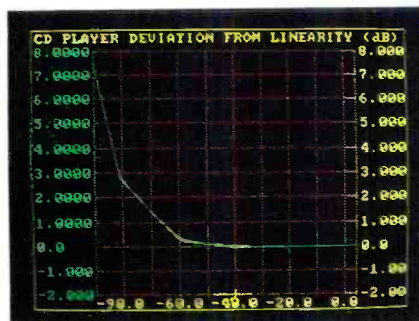
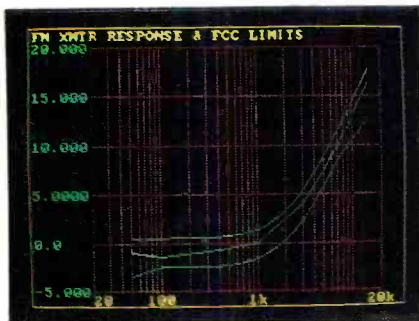

The world of audio is growing and changing rapidly and, consequently, audio equipment is becoming more and more complex with each succeeding generation. The test gear in maintenance shops around the world is having greater demands placed on it almost daily.

What were once thought of as great pieces of test gear are now becoming paperweights (or boat anchors) before they are fully depreciated. More often than not, today's complex audio equipment requires a minor laboratory of test equipment to accomplish everyday repairs. An ever-increasing amount of new, more complex gear makes its way into audio establishments daily, putting greater demands on maintenance departments that are already overworked and often ill-equipped.

As consumers demand greater reliability from lower-priced equipment, manufacturers find themselves facing similar problems. As the cost of labor continues to rise,

management is driven to find more efficient ways for engineering, assembly and test departments to carry out their work.

The optimum solution to these problems is to combine the power of the computer with a broad array of test equipment and make it all fit in a compact space. However, that's easier said than done. Some manufacturers put everything into one box with a dedicated computer to control all the functions, while other manufacturers make separate test boxes and controllers. Another approach is to make a single, monolithic unit that is controlled by an external computer (giving the user the best of both design philosophies). This is the approach taken by Audio Precision with its System One.

Physical characteristics

System One is a stand-alone unit constructed of steel, painted tan and measuring 5"×17"×17". A large, grille-covered cooling fan is centered in the front panel of the mainframe, above the power switch and indicator light. To the left of the fan are the generator output(s) with the

Jim Rogers is chief technical engineer at Spectrum Studios, Portland, OR.

analyzer input(s) to the right. (Both the generator outputs and analyzer inputs are brought to the front panel in the standard XLR connector of appropriate gender, as well as banana connectors.)

Associated BNC connectors for sync output, monitor output and trig/gate input are below the generator section. Beneath the analyzer inputs are monitor outputs for each of two analyzer channels and a buffered output of the final signal that goes to the detector stages (for all of us mad scientists to have something else to play with). In addition, an output and an input are provided for user-supplied external filters. The mainframe may also be rack-mounted for user convenience.

System One is available in a number of configurations: one or two generator outputs, one or two analyzer inputs and with or without the burst noise-square wave output, SMPTE/CCIF/DIM distortion measurement or wow and flutter options. The most useful general-purpose system will be configured such that it will have two generator outputs and two analyzer inputs. This basic system will put you in

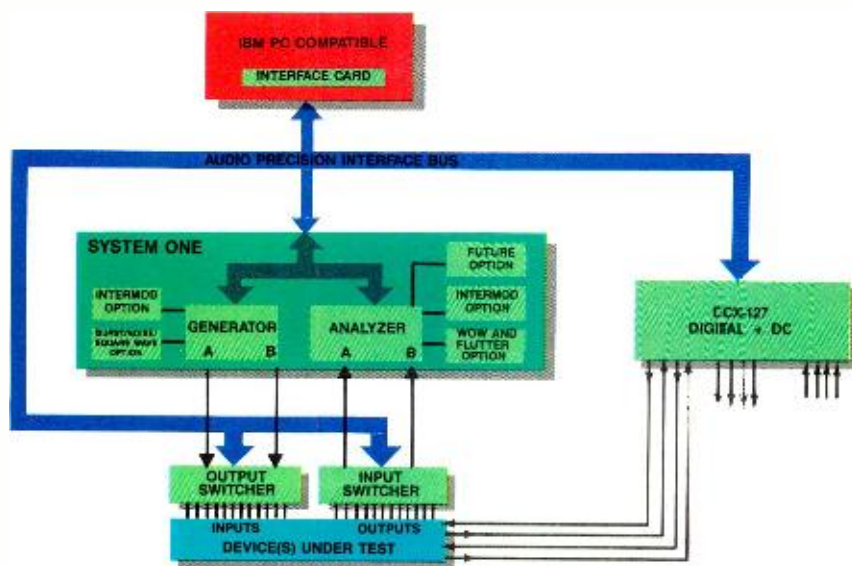

System One flow chart.

Nevertheless, within an hour of initially unpacking the system, you will find yourself running (and beginning to write) quite complex tests on all sorts of equipment using the very comprehensive library of tests that are included.

The menus can be navigated through very easily by using either the cursor keys or by merely typing the first letter of the menu selection (much the same as with Lotus 1-2-3). The software also supports the use of a mouse.

The front panel of System One is devoid of any controls, so they all show up on a "soft" front panel on the CRT. The left side of the screen contains the control parameters for the generator (GEN 1). The signal generator sweeps from 10Hz to 200kHz with 0.03% accuracy. The generator frequency value can be selected by direct numeric entry to test. The generator's output is similarly controlled by the software to change output impedances (600Ω, 150Ω, and 50Ω), balanced/unbalanced or common-mode configured outputs, floating or grounded outputs and whether A, B or both outputs will be on or off. The burst-noise/square-wave option also allows the instrument to generate tone bursts from 20Hz to 100kHz, square waves from 20Hz to 20kHz and random noise (pink, white and 1/2-octave filtered pink noise that can be continuously swept).

The output is transformer-coupled and can deliver amplitudes up to +30dBm into 600Ω with a nominal distortion of 0.005% (0.0005% being the system limit).

The analyzer section allows the user to control a wide range of parameters. User-selectable parameters include whether

one will measure amplitude, bandpass, band-reject, THD+N, SMPTE/CCIF/DIM, wow and flutter, crosstalk or phase. It also displays the currently measured level (in user-selectable units of V, dBm, dBV, dBu, dBr or W), frequency (expressed in Hz or in numerous comparative units) and analyzer/voltmeter reading. The software also allows the user to select what the analyzer's input will be (front panel input or generator monitor), as well as the termination impedance. The analyzer module is an extremely powerful part of

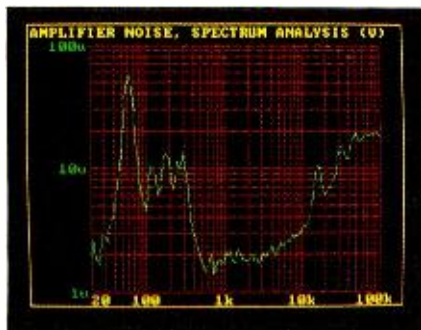

the I-gotta-have-it zone (for example, "I gotta have the wow and flutter option"), but will solve a great percentage of your audio test requirements.

The one outstanding physical design feature is that the unit is made to be expandable not only to the user but to its designers, as well. The internal mainframe is divided into four sections, three of which are filled when the system is purchased fully loaded, leaving room for future designs, which are certainly forthcoming.

System One is controlled by an IBM PC, PC/XT, PC/AT or any number of clones that have a minimum of 512k of memory (640k preferred) and operate with DOS version 2.0 or later. Only one expansion slot is necessary for Audio Precision's proprietary controller card.

Operating the unit

The software for controlling System One is written to be user-friendly because it is menu-driven. (Refer to "System One Menu Tree.") The levels of complexity of the system's software are quite numerous.

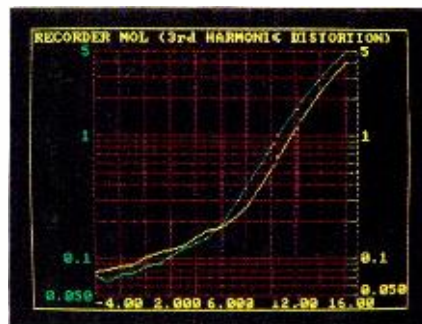
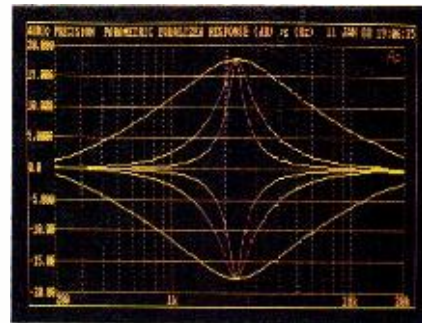

Menu Tree

Run—Run procedure, test or graphs.
 Procedure—Run a procedure.
 Test—Measure and graph new data.
 Graph—Graph stored data.
 Bar graph—Display readings on bar graph.
 Local—Cause all instruments to be Local.
 Remote—Enable Remote Instruments.
 Slave—Split-site slave mode.

Panel—Display instrument front panels.

Load—Load test, data or text from disk.
 Test—Load entire test from .TST file.
 Limit—Load entire test from .LIM file.
 Sweep—Load entire test from .SWP file.
 Comment—Load comments from disk.
 Procedure—Load procedure from disk.
 Macro—Load macro from disk.
 Data—Load ASCII data from .DAT file.
 EQ—Load entire test from .EQ file.
 Image—Load image from .IMG file.
 Overlay—Load entire test except punch-outs from .OVL file.

Save—Save test, data or text to disk.
 Test—Save entire test to .TST file.
 Limit—Save entire test to .LIM file.
 Sweep—Save entire test to .SWP file.
 Comment—Save comments to .TXT file.
 Procedure—Save procedure to .PRO file.
 Macro—Save macro to .MAC file.
 Data—Save ASCII data to .DAT file.
 EQ—Save entire test to .EQ file.
 Image—Save stored image to .IMG file.
 Overlay—Save entire test except punch-outs to .OVL file.

Append—Append test or data from disk.
 Test—Append data from .TST file.
 Data—Append data from .DAT file.

Edit—Edit text or data.
 Comment—Edit comment buffer.
 Procedure—Edit procedure buffer.
 Data—Edit data buffer.
 Macro—Edit macro buffer.

Help—Show help menu choices.
 Special—Show special functions help screen.
 Overlay—Show overlay (partial load) help screen.

Editor—Show text editor help screen.

XDOS—Call DOS. Type "exit" to return to S1.

DOS—Execute one command under DOS.

Names—Select compare limits, title, etc.
 Upper—Select file for upper compare limit.
 Lower—Select file for lower compare limit.
 Sweep—Select file for sweep source table.
 Gen1#1-EQ—Select file for generator EQ.
 Error-file—Select file for error reporting.
 Off—Disable error reporting.
 Title—Select title for graphs.
 Rename-test—Select new test name (won't affect disk).
 Clear—Clear Upper, Lower, Sweep, Err and EQ.
 Delta—Select file for Compute Delta.

If—Conditional execution in procedure.
 Error[—Do only if test error (end with | character).
 Noterror[—Do only if not test error (end with | character).
 Above[—Do if above limit (end with | character).
 Below[—Do if below limit (end with | character).

Util—General utilities.
 Restore—Restore hardware after power cycle.
 Out—Write to output port.
 Wait—Wait for value at an Input port.
 Delay—Delay for specified time.
 Break—Put a break in procedure.
 Learn—Begin learning (recording) procedure.
 End—End recording procedure.
 Prompt—Make prompt to be used in procedure.
 Message—Make message to be sent to error file.

Quit—Quit program and return to DOS.

Compute—Select data computation.
 Normalize—Normalize data at the value specified.
 Invert—Invert (reciprocate) Data-1.
 Smooth—Smooth data.
 Linearity—Compute deviation from best fit line.
 Center—Center data between limits.
 Delta—Subtract Delta file from data.
 2-Sigma—Compute maximum value, excluding peak 5%.
 Exchange—Exchange Data-1 and -2.

the system because of all the data analysis that it actually carries out. (Use of the system for a short time will prove this to be true.)

The third and final section of the front panel allows users to include any sweep test definitions that they desire. The definitions can be changed at any time before or after the test and can even be altered months later, after the test and/or data have been saved on a disk.

Another software feature enables you to enter data from the outside world without the system interfaced to your computer and output a dot-matrix hard copy of your data. (Even though it takes just as long as before, at least the graph paper gets skipped.)

Studio applications

In the studio, the unit can provide the maintenance department with data to

make its job a bit easier. With the multiple sweep capability of the software and a couple of SWR-122 switchers, multitrack machines can be documented as to their effective head life, wow and flutter, and response evenness track-to-track. The new generation of remotely alignable machines can complete alignments fully unattended and provide hard copy documentation of the results. Studio equipment that's aging can also have fast, effective performance tests run on it to aid maintenance in keeping it at peak performance.

If you think that this is just a glorified-tape recorder checker, think again. System One can also be run by an unskilled operator to perform pass/fail tests and provide hard copy for each unit (whether it passes or fails), allowing manufacturers to provide technicians with good guides to save them time in trouble-

shooting and to provide end-users with solid proof-of-performance verification.

Although I'm not an owner, I am a frequent user, and I must say that the unit is extremely easy to use. Last month's "Hands On: Analog Noise Reduction" (July, page 44) was written after having completed over 45 complex tests with the unit. The series of tests only took a day to write and run, with another afternoon used to rerun some of the tests to double-check the results. I've also used it to conduct shoot-out-style tests, the results of which were used to make a final decision as to which of two major-manufacturer consoles to purchase.

In addition to the internal options available, external options are available. The two that are currently offered are the SWR-122 2x12 switcher, which is available in an input and output version (the computer can control up to 16 of each configuration at once), and the DCX-127 multifunction module, which can measure dc volts and ohms (with 4½-digit accuracy). The DCX-127 has a programmable dc voltage output (that's accurate to four decimal places) and a parallel digital port with 21-bit programmable input/output capability (perfect for A/D converter tests) and three 8-bit parallel ports to use as device controllers for relays, test fixtures or whatever.

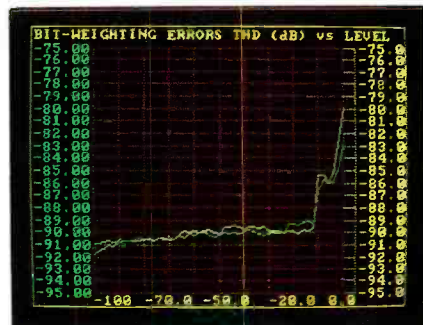

Future options

Planned for fall release is the DSP option, which will allow the unit to be a true "1-stop" test system. The DSP option (an internal option) will enable users to perform measurements such as the ones Crown's Techron system can now perform, but all in one system, thus keeping the test equipment "body count" to a bare minimum.

The product can be a useful system with a great many capabilities, and, at the same time, is configured to be a building-block system. This test equipment will definitely grow with your needs regardless of the application and is not destined to become obsolete.

REP



Touring with a Reggae Festival in Africa

By David Scheirman

Several West African nations were host to a series of outdoor concerts billed as the world's largest touring reggae festival.

Pop music is rapidly becoming one of the most dominant forms of communication around the world. Musicians, musical art forms and lyric content more rapidly affect social structures and attitudes than the printed word ever did. Nowhere is this more true than in the newly developing, Third World countries. Here, a fast-growing market exists for the latest in a wide variety of musical styles. Currently, one of the most popular of these styles is reggae.

To present concerts that feature reggae and other popular musical forms in Third World nations, well-designed, portable sound systems that are easily transportable must be supplied. Such systems are usually shipped in for use on specific projects and are drawn from sound reinforcement rental firms in North America, Western Europe, Japan or Australia.

World's largest reggae tour

In February and March, a group of Jamaican performers that comprised the world's largest touring reggae festival (modeled after the popular Reggae Sun-

splash, a yearly event staged in Jamaica) "joined hands" with two of Africa's most popular music groups. An entourage of more than 125 people journeyed to such West African nations as Liberia, Nigeria and Zaire to present a series of outdoor festivals.

Artists such as Yellowman, Judy Mowat, Chalice, Burning Spear, U-Roy, and Sly and Robbie represented Jamaica. King Sunny Ade and his band, along with Fela and his 30-piece Nigerian entourage, represented Africa's music. Although the African audiences were familiar with reggae music because of extensive local radio airplay,

David Scheirman is *RE/P*'s live sound consulting editor and president of Concert Sound Consultants, Julian, CA.

COMPONENTS

- (2) 15-INCH LOUDSPEAKERS
- (1) 2-INCH EXIT COMPRESSION DRIVER
- (1) FLAT-FRONT HF HORN
- (4) COMPRESSION TWEETERS

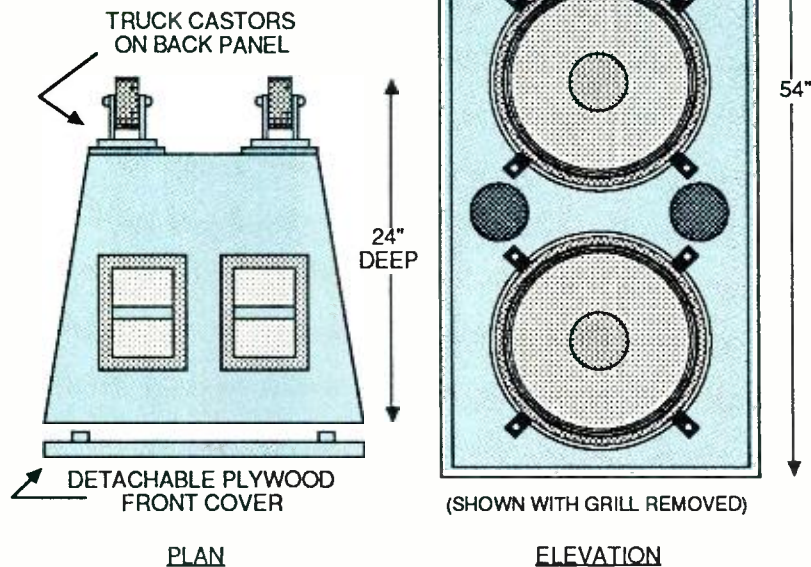

Figure 1. The Steradian 3-way loudspeaker enclosure.

most had never experienced this style of music in a large, outdoor festival format. So the crowd response was expected to be enthusiastic.

The sound crew for the tour was made up of three system technicians and several soundmixers associated with various groups, including Jamaicans David Rowe and Robert "Chuckles" Stewart. This crew had at its disposal a complete, portable sound reinforcement system that was transported by air to Africa.

This system needed to reproduce live program material accurately for both indoor and outdoor venues. For any single performance, a maximum crowd of 50,000 was anticipated, and most performances were to be held in open-air sports stadiums.

The length of the tour was to be five weeks, and an additional week was scheduled before and after for air cargo transport time of the sound, lighting and stage gear. Two large diesel generators were reserved for the project in Los Angeles, but in the end, these did not make the trip. Because of budgetary considerations, representatives of the event promoter decided to rely on locally available power supplies.

Thirteen performances in 10 different countries were scheduled. Each concert was planned as a 16-hour-long event, to begin in midafternoon and end the following morning. An extra day at each location was scheduled for setup and teardown.

Sound system supplier

The event's production staff realized that a well-designed, well-integrated, compact and portable sound system package would be required because setup time would be at a premium. After a survey of several sound system packages available from the United States, the production team contracted with Schubert Systems Group (SSG) of North Hollywood, CA.

"We really didn't get the final word on this until the very last minute," said technician Gary Whitelock of SSG. "Last summer we supplied a system for the Reggae Sunsplash tour dates in the United States, so we knew what to expect regarding the various bands and the show format. Taking a system to Africa, though, was something completely new."

Weight and size restrictions for the tour's overall equipment package helped the sound company plan the total mass of the sound system to be used. Rather than supplying the variety of equipment that might be used for such events in the United States, with large amounts of signal-processing gear, the system was trimmed down to a package that could be used to its operating limits for extended periods

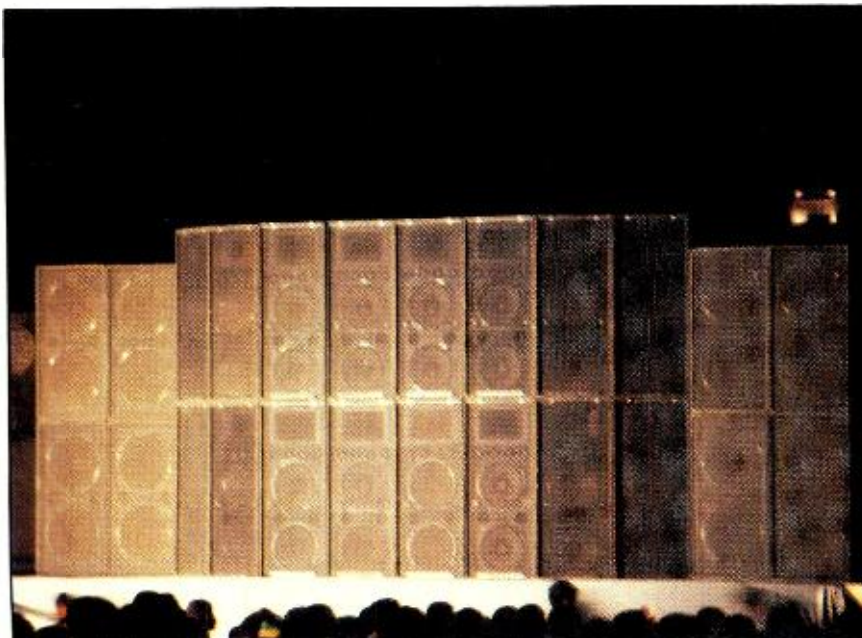

Photo 1. The Steradian loudspeaker enclosures supplied by Schubert Systems Group were set up in an arced array, 16 per side with subwoofers at each end.

without component failure.

The resulting sound system package included both front-of-house and monitor mixing gear, an 8-mix stage monitoring system, an electrical power distribution system and all required microphones, stands, cabling and spare parts. The main loudspeaker system, designed by SSG, consisted of 32 3-way enclosures and 16 subwoofer enclosures.

Upon receipt of advance payment from the African tour promoter, the sound and lighting companies sent the gear by truck from Los Angeles to an air cargo facility in New York City. From there, it was flown by wide-body commercial jet to the tour's first stop in Monrovia, Liberia.

Shipping weight for the total sound system was 25,655 pounds. The total volume was 1,419 cubic feet. Each case appeared on the shipping manifest along with contents and value. This information proved to be of great value when dealing with air shipping agents and particularly the Nigerian Airways charter jet pilot, who expressed concern about the type and weight of the unusual shipment.

Upon arriving in Liberia, sound-system technicians supervised the removal of the equipment from the air cargo pallets and its loading into metal shipping containers. These containers proved to be ideal for storage and land transport because they offered a secure means of trucking the system in areas where most commercial-freight hauling is done with open trailers.

The containers also were used as on-site storage at the open-air stadiums. Storage became a necessity in some instances, when the concerts were delayed for political or economic reasons, and the gear needed to remain at the site for an extra day or two. The entire sound system fit into approximately one and a half 20-foot container units.

Loudspeaker system

The main loudspeaker system is the part of a concert sound rig that usually takes up the most shipping space. As such, it is important that the speaker system be as compact, lightweight and easy to handle as possible during load transfers. So, nearly all sound systems transported for international projects today rely on direct-radiating speaker design technology.

SSG relied on its Steradian system, so named because each trapezoid-shaped, 3-way loudspeaker enclosure represents a solid angle (or steradian) of an ideal spherical sound source. When multiples of these cabinets are coupled in a stacked or suspended configuration, an array is formed that imitates a single, curved, direct-radiating loudspeaker baffle. (See Photo 1.)

These 3-way enclosures weighed approximately 265 pounds each and could

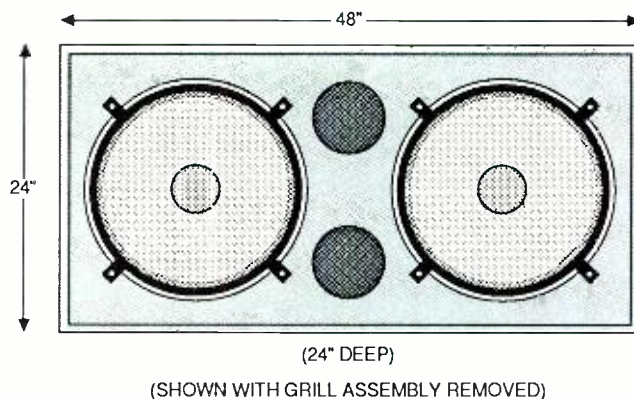

Figure 2. The subwoofer enclosure houses a pair of JBL 2445 18-inch loudspeakers.



Photo 2. Compact rack for powering sidefill monitor enclosures includes amplifiers from Carver and Crest.

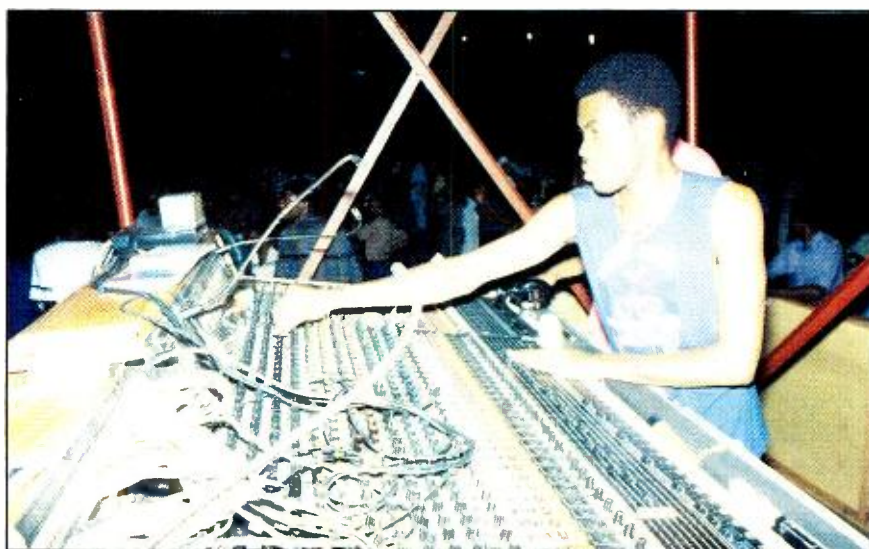

Photo 3. Jamaican soundmixer David Rowe at the Gamble HC-40 console.

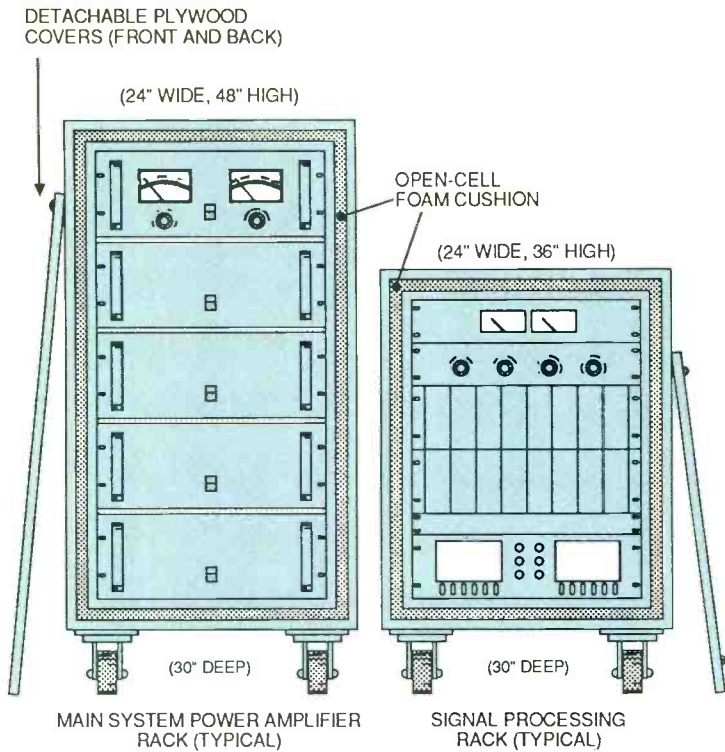
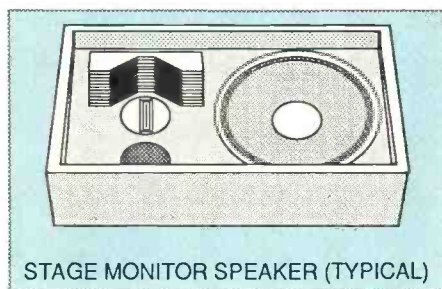

Figure 3. Power-amplifier and signal-processing racks are built of birch plywood. The double-shell design includes a layer of foam to protect the electronics in transit.



STAGE MONITOR SPEAKER (TYPICAL)

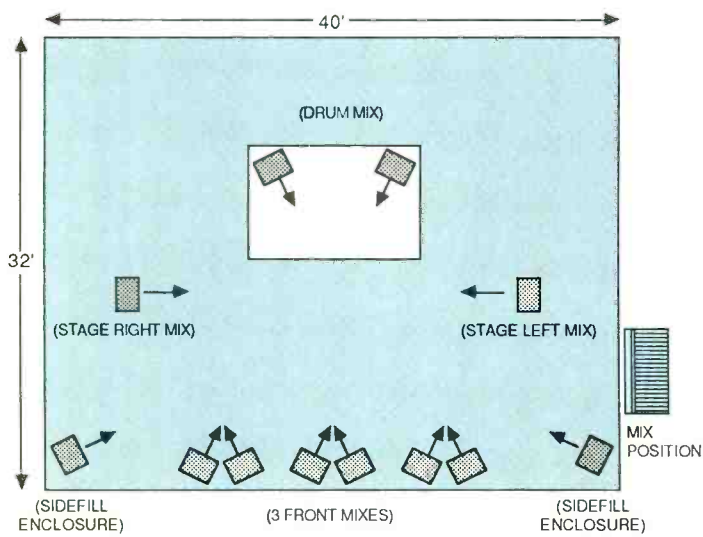

Figure 4. Stage monitor system.

thus be handled by a crew smaller than other modular sound-system enclosures weighing up to 500 pounds. The box has a total enclosed volume of 16.5 cubic feet. Its exterior dimensions are 54" h x 22" l x 24" w. (See Figure 1.)

These ported boxes housed a pair of modified JBL 15-inch woofers that cover the frequency range of 90Hz to 1kHz. A single, 2-inch JBL 2441 compression driver was mounted on a JBL 2385A horn in each cabinet and supplied signals of 1kHz to 10kHz. A total of four (JBL 2402) high-frequency compression tweeters were arrayed within each cabinet, offering extended response to 22kHz.

The 3-way enclosures were supplemented by subwoofer units. Each housed a pair of JBL 2445 18-inch bass loudspeakers. This vented, direct-radiating box weighs approximately 220 pounds and has a total enclosed volume of 16 cubic feet. This box measures 48" h x 24" l x 24" w. (See Figure 2.)

System power amplifiers

The main loudspeaker systems were powered by either Crest or Cerwin-Vega dual-channel amplifiers. The amps were installed in custom-built, heavy-duty, birch plywood road racks, with rugged, all-weather carpeted exteriors. A single rack weighs approximately 510 pounds and measures 48" h x 24" l x 30" w. A foam inner lining separates the cases' double-walled construction, which protected the electronic equipment during transport. (See Figure 3.)

The African tour project used eight such racks, each housing five Cerwin-Vega power amplifiers. All racks were interchangeable, with the level sensitivity of each input channel being calibrated. A ninth rack was brought as a spare.

Custom-built frequency dividing networks, designed by Dirk Schubert, were optimized for minimum signal delay, optimum phase coherence and transient response. Valley People Gain Brain II limiter units were inserted on each crossover output band, and their action could be observed on the crossover metering.

"The crossover is the most important piece of electronics in the PA system," Schubert advised. "Amplitude response and system headroom, as well as the level of power response that is sent to the amplifiers, are functions of the selected crossover points. It is best to match a crossover to the speaker system with which it is used."

The stage monitors, with the exception of the sidefill enclosures, were powered by compact Carver amplifiers housed in smaller racks. These larger sidefill enclosures used the Crest 8001 amplifiers to



Photo 4. Keeping cool. Production technicians improvise a shady resting area in the equatorial heat.

power the lower frequencies. (See Photo 2.)

A total of 10 identical floor wedges were provided for the on-stage area. Another pair of boxes was supplied for the monitor mix position and as a spare unit. Each stage monitor contained a single 15-inch JBL speaker covering 50Hz to 1.5kHz, a JBL 2441 2-inch compression driver on a JBL horn covering 1.5kHz to 10kHz, and a single JBL 2405 compression tweeter, offering response to 22kHz. (See Figure 4.)

The sidefill enclosures were placed in each down-stage corner of the performing area, two per side. These boxes housed a pair of JBL 2225 bass loudspeakers and a JBL 2441 driver on a 2385 flat-front horn.

To simplify the stage monitor system for the African tour, a total of eight monitor mixes from the 16 available were used. Monitor mix equalization was done with the Gamble console's onboard, adjustable, 4-band parametric EQ circuits. This saved space in the shipping package by eliminating outboard EQ racks and simplified the monitor system cabling scheme, allowing setups and teardowns to be more efficient.

Although several different soundmixers and technicians were available to assist with the stage monitor systems during the show, Jamaican monitor mixer John "Bugs" Parkinson chose to man the console from start to finish. He took on a marathon feat of endurance, running the 16-hour concerts.

A 40-input house mixing console from Jim Gamble Associates was chosen for the African project. Featuring eight auxiliary-bus outputs and an additional eight effects

inputs, the Gamble HC-40 is equipped with electronically balanced microphone channel inputs. It accepts mic-level stage signals from a multipair trunk cable that is connected directly to the stage monitor console. The stage monitor console also serves as the audio grounding point for the sound system. (See Figure 5.)

SSG's Whitelock advised, "With the Gamble consoles' on-board patchbays and our snake system, repatching can be done very quickly in case of an emergency. For instance, if the house board were ever to crash, we could have a mix on the monitor board standing by for patching to the house crossovers. If the monitor board goes down, auxiliary buses can be patched up to the stage from the house console."

A variable line voltage transformer (Vari-ac) was positioned at the house mixing platform, offering daily adjustment of the electrical power voltage level at the end of the 200-foot snake cable run.

Signal processing

The signal-processing gear supplied for this project included a Lexicon 224 digital reverb, a Lexicon Super Prime Time and a pair of Yamaha SPX-90s. Compressors and noisegates (dbx 900 series) were available for channel insertion as needed.

The process of mixing reggae music is somewhat different from jazz, rock or other concert-performance styles. Reggae features a prominent bass guitar and kick drum sound. Underlying low-frequency impulses support basic, steady drum beats and guitar/keyboard syncopated riffs. Special, recognizable snare-drum echo effects or delay repeats, done in "dub" fashion, require a keen ear for timing,

FLUSH MOUNT 75 OHM BNC CONNECTORS

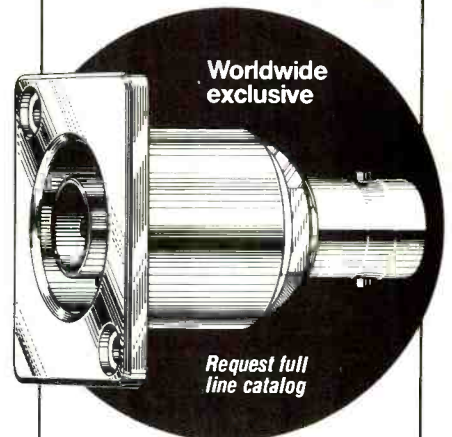

Worldwide
exclusive

Request full
line catalog

- Recessed panelmount less prone to damage.
- Fully isolated. Compatible with all other manufacturers BNC connectors.
- Beryllium copper external contact with gold coated center contact pin.
- VSWR characteristic (<1.1) up to 2 GHz.

CANARE

CANARE CABLE INC.
832 N. VICTORY BLVD. • BURBANK, CA 91502
(818) 840-0993 • FAX (818) 842-7548

Circle (48) on Rapid Facts Card

EUROPADISK, LTD.

DMM LP MASTERING

State-of-the-art, Direct Metal Mastering, a quantum leap in LP quality

LP PRESSING

DMM audiophile quality—Teldec vinyl

DIGITAL SERVICES

- Neve Digital Console—EQ, Limiting/Compression
- Sony Editing
- Digital Format Conversion
- Analog-to-Digital Transfer
- CD Master Tapes
- DAT Copies

COMPACT DISC PRODUCTION
CASSETTE DUPLICATION
7 INCH SINGLES

Complete packages with printing



EUROPADISK, LTD.

75 Varick Street
New York, NY 10013
(212) 226-4401

Circle (47) on Rapid Facts Card

along with quick auxiliary bus cues.

Soundmixer David Rowe commented, "Having worked with many of these musicians as they developed this music in the recording studio, I've become familiar with what they require in a live setting." (See Photo 3.)

Adequate security for the house mixing position was a major consideration. Tour contract specifications called for a sturdy, single platform to house both the sound and lighting control areas; spotlight positions would be on the upper level of the same platform so that all production technicians working in the audience area were in the same vicinity.

At each venue, the sound crew set up the main loudspeaker system in a curved array of 16 boxes per side, flanked at each end with a group of four subwoofers. One entire day was budgeted for the setup and testing of the production gear; the performance was then set for midafternoon of the following day.

The hot, equatorial sun caused temperatures that averaged more than 100°F daily. This made the working conditions somewhat more stressful than sound crews usually encounter. Although space blankets can help protect the sound equipment, it turned out to be more important to protect the health of the workers. Air-

conditioned spaces or cool motorhomes were not available, so improvisation led to some interesting ways of providing shade. (See Photo 4.)

In each location, work crews were hired to help move, set up and tear down the sound, lighting and stage equipment. Generally enthusiastic, the local African crews were easily motivated by gifts of T-shirts and athletic shoes, and friendships formed quickly. (See Photo 5.)

Electrical power

In West Africa, 220V power systems are the norm, and 110V systems are practically non-existent. The American sound system was specified to operate on a 5-wire, 3-phase, 400A electrical service with 120V per leg, 50 or 60 cycles. Local agents were to supply large stepdown transformers and generators, if needed.

Locating an adequate electrical power source for each performance turned out to be the tour's primary challenge. Sometimes, an entire day was spent locating and hooking up a power source, even when local contacts had assured all parties that "it was covered." In cases requiring generators, the search often led to marine shipping yards, army bases, foreign embassies and TV stations. (See Photo 6.)

In one instance (Monrovia, Liberia), the government-controlled power company was brought in to erect a separate "mini-substation" for the concert, drawing power from the 2,400V utility grid lines.

SOG technician Larry McCall was designated as the tour electrician. His U.S. military experience with field electrical power plants came in handy more than once. Encountering new challenges daily as he worked to locate hardware and explain concepts to electricians, he acted above and beyond the call of duty.

"I don't like to rely on generators as a general rule," he explained. "As it turned out, we had to take whatever we could get. The generators can be preferable, sometimes, to the unreliable local utility companies that we encountered."

In one unforgettable incident in Kinshasa, Zaire, an entire day was spent in the basement of the Parliamentary Palace, adjacent to the government parade grounds. A travel agent who translated English to French relayed questions and instructions to a building administrator who translated French to Chinese. This man spoke with a Chinese generator technician who was in charge of an ancient power plant. An attempt was made to disconnect the water pump electrical supply lines for the parade ground fountains, and to use the 1,000-foot electrical service cable to get generator-powered ac to the outdoor stage area where the performance area had been set up in advance of



Photo 5. Part of the local stage crew in Lagos, Nigeria. Stage manager Ron Byrd from Los Angeles is in the center (white socks).



Photo 6. The search for electrical supply parts led to some interesting places. Here, the Nigerian Army pitches in with a portable 110V stepdown transformer for use with band gear.

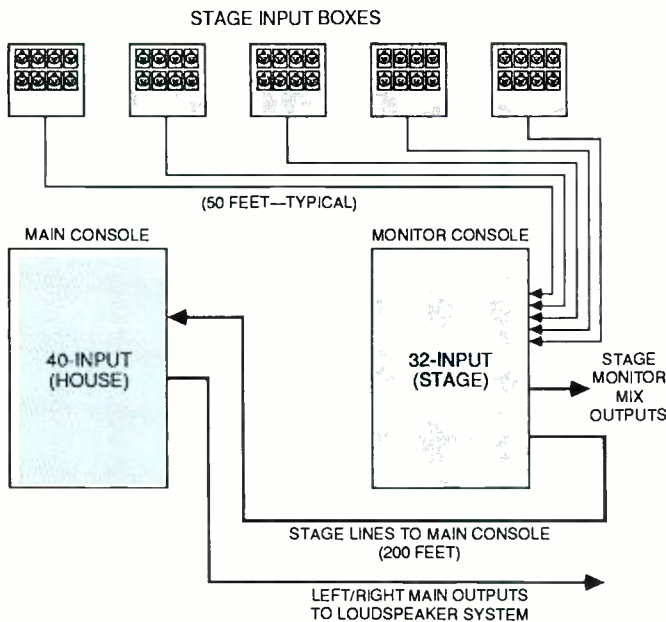

Figure 5. Mixing consoles and interconnect cabling scheme.

the show's arrival.

After this experience, the production crew unanimously agreed that in the future, if the shows are to take place on time, concert-scale sound and lighting equipment bound for Africa must be completely self-contained with regard to ac power supplies. A "knowledge gap" appeared to exist in this case; the promoter's contractors did not actually realize what it was they were agreeing to be responsible for.

Tour conditions

Despite on-site production, advance work and a tremendous amount of inter-continental communications, difficulties can obviously still exist when attempting to take a contemporary concert production package into developing nations. Besides language barriers, currency exchanges and cultural differences that can complicate matters, another barrier encountered was that most people in Third-World countries just cannot grasp the scale upon which entertainment events are conducted in developed regions of the world. This means support elements that entertainment groups and production crews may take for granted under normal touring conditions just cannot be provided if the events are to be profitable for local promoters.

The African reggae tour was a severe test of both equipment and personnel. Heat, humidity, dust, uncertain political and economic trends from day to day, and the relaxed concept of time held by people in West African cultures all combined to make the entire project more difficult than most.

Sound reinforcement firms that become

involved in projects such as this should budget more time and money than expected for problem solving in this department.

On the lighter side, the chance to become acquainted with other cultures can be an eventful opportunity. The African crew members sincerely appreciated simple gift items such as cassette tapes, American magazines, flashlights and ballpoint pens. Polaroid photographs of the stage crews were an instant hit and cemented friendships on the spot. Often, the stage crews' loyalty rested with the visiting tour staff, and they completed loadouts despite the event organizers' lack of agreed compensation.

After the show was up and running, the results were very gratifying. The sound system performance expectations were met. The system was set up and used for as long as four days at a single performance site; during the entire 5-week project, only two loudspeaker voice coils and a single compression driver unit suffered fatigue to the point that replacement was required.

When touring in developing nations, thorough advance planning and preparation greatly increases the chances of success. Although sound system technicians operating in such environments may confront unexpected challenges, system design and performance expectations can be met.

REP

Author's note: This feature is written with reader interest and education in mind. The specific mention of brand names of equipment is not to be taken as an endorsement by the author, *REP* or Intertec Publishing Corporation.

The art of shaping sound.

SONEX is a high-performance acoustical foam that upgrades your studio inexpensively. Ideal for a temporary isolation booth, it can also eliminate slap echo and harsh resonances in the main room or silence noisy tape equipment in the control booth. Write for our color brochure today.



Alpha Audio

2049 West Broad Street
Richmond, Virginia 23220 USA
(804) 358-3852
FAX: (804) 358-9496
Telex: 469037 (ALPHAUD CI)

Acoustic Products for the Audio Industry

Circle (48) on Rapid Facts Card

YOU DEMAND THE BEST
WE SUPPLY THE BEST.



Cal Switch And Switchcraft®
The Popular Demand

- Audio Connectors
- Cable Assemblies
- Jack Panels
- Multi-Switch® Switches

(800) CAL-SWCH

CAL SWITCH

13717 S. Normandie Avenue
Gardena, California 90249

Circle (49) on Rapid Facts Card

STUDIO UPDATE

Talkback

Wired and Wireless Micing for Videotaping

By Roy Stuewe

I have a customer whose sole business is the making of video training tapes for industry. Many of his clients have assembly lines using heavy machinery. He usually shoots with only one camera. He started one project with an omni mic and 50 feet of cable shared by the client rep who explained the machine operation and another person who asked questions. The machine noise and the lack of communi-

cation with the cameraman led him to call me for a solution.

I equipped him with a standard, wired-headset intercom system. This setup allowed everyone individual listen volume, as well as a mic on/off switch. This system met his needs, and business boomed. He added a floor director and then called to ask about going wireless, but keeping it simple.

The solution was the addition of VHF highband wireless, a mic mixer, and a 72MHz system for the hearing-impaired—all mounted in a road case. The client rep, talent and floor director still wear their single-muff headset, but they are now plugged into the transmitter and receiver. The three wireless mic receivers are mixed via the rack-mounted mixer, with channel 4 accepting the wired intercom system audio. One output of the mixer drives the camera; the other drives the hearing-impaired transmitter. **RE/P**

Roy Stuewe is sales engineer at Sound/Com Corporation, Cleveland.

Have you encountered a problem or unusual request during a recent job that required a unique solution? We would like to share it with the industry. Sent to "Talkback"; if we use it, we'll pay you \$50. "Talkback" is a forum for sharing your solutions to difficult production situations other engineers may encounter. In a continuing effort to educate, we feel that this type of information is helpful and will display your professional abilities. This is not a tech tips column; rather the focus is on solutions to problems—technical or non-technical.

To submit in 1-2 pages, describe the job, what the problem was and what you did to solve the problem. Include any supporting documentation, such as diagrams or photos, that would help explain the situation. If we publish your entry, you and your company will be fully credited.

Send material or inquiries to Michael Fay, Editor, *RE/P*, 8885 Rio San Diego Drive, #107, San Diego, CA 92108.

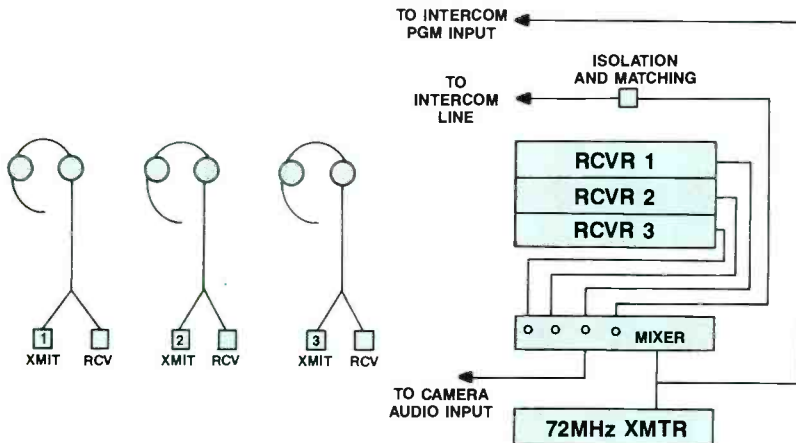

What you see is what you get...

For a catalog and a list of over 60 dealers in the USA and Canada, contact J. G. (Jay) McKnight at:

Magnetic Reference Laboratory, Inc.
229 Polaris Ave., Suite 4
Mountain View, CA 94043
(415) 965-8187

Exclusive Export Agent: Gotham Export Corp.,
New York, NY

The MRL Calibration Graph is your proof of the quality control that goes into every MRL Reproducer Calibration Tape. We guarantee each one to exceed the performance requirements of IEC, NAB, AES, and EIA Standards.

MRL Calibration Tapes are designed and supported by experts in magnetic recording and audio standardization... we helped write the standards. Each tape comes with detailed instructions and application notes.

The MRL catalog includes tapes for all studio applications. In addition to the usual spot-frequency tapes, we make single-tone tapes, rapid-swept frequency tapes, wideband or 1/3rd octave-band pink random noise tapes, and difference-method azimuth-setup tapes. Most are available from stock.



Circle (45) on Rapid Facts Card

STUDIO UPDATE

Studio News

Northeast

Production Masters (Pittsburgh) has named Jack Bailey as audio operations manager. 321 First Ave., Pittsburgh, PA 15222; 412-281-8500.

Squires Productions (White Plains, NY) has announced two appointments. Chris Cassone has been named chief engineer/producer, and Donna Gibbons has been named account executive. 196 Maple Ave., White Plains, NY 10601; 914-997-1603.

NFL Films/Video (Mt. Laurel, NJ) has purchased Otari mastering recorders, a Lexicon 480L digital effects processor, Eventide H-949 and SP-2016, AMS DMX and RMX processors, and a TAC Scorpion console. 300 Fellowship Road, Mt. Laurel, NJ 08504; 609-778-1600.

Century III Audio (Boston) has added Chris Anderson to its staff as engineer. Mark Henderson has been appointed post producer. 651 Beacon St., Boston, MA 02215; 617-267-6400.

Star Mix Studios Ltd. (Massapequa, NY) has taken delivery of an additional Sony/MCI JH-24 24-track recorder. New MIDI gear includes an Emulator III, Oberheim Matrix 12, Roland Super JX, Yamaha TX-802 and an Apple Macintosh SE-20 computer with Mark of the Unicorn software. 4160 Merrick Road, Massapequa, NY 11758; 516-541-1222.

ASL Mobile Audio (Flushing, NY) has expanded and updated its equipment. The control room has been expanded, and all signal-processing gear is accessible by way of two front and rear ceiling racks. New equipment includes a Sony DTC 1000ES DAT deck, 40-channel Brooke Siren System active splitter network, two BSS DPR-502 MIDI gates, two Klark-Teknik DN-410 dual parametric EQs, BBE 802

processor, 16-channel Hill Multimix and a 16-channel Roland M160 mixer. Box 791, Flushing, NY 11352; 718-886-6500.

Dreamland Recording (Bearsville, NY) has renovated Studio A. New equipment includes a Lexicon PCM 70, UREI LA2, Neumann M49 and U67 mics, Pultec MEQ-5 and an Eventide 3000 Super-Harmonizer. Box 383, Bearsville, NY 12409; 914-338-7151.

The Tape House, Photomagnetic Division (New York) has ordered a custom Neve V series console, the studio's third. It will be housed in Studio C. 222 E. 44th St., New York, NY 10017; 212-687-6230.

Trackworks Recording Studios (New York) has added two people to its staff. Bob Liebert, former president of Delta Recording Studios, is an engineer and producer. Carmen Liebert, formerly Delta's marketing and casting director, performs the same duties for Trackwork. 2 W. 45th St., New York, NY 10036; 212-921-7878.

Moving?

TAKE US WITH YOU.

Just peel off your subscription mailing label and attach it to the address change card inside this issue. Please allow 6-8 weeks to process your address change.



STEP UP TO THE FUTURE

10 Vol. CD Sound Effects Library
10 Vol. CD Music Library

FOR A FREE COMPACT DISC SAMPLE
CONTACT:

27TH DIMENSION, INC., P.O. BOX 1561, JUPITER, FLORIDA 33468
FLORIDA COLLECT — 305/746-2222 OUTSIDE FLORIDA — 800/634-0091

HOLOPHONICS IS A TRADEMARK OF ZUCCARELLI HOLOPHONICS, INC.

Circle (50) on Rapid Facts Card

August 1988 *Recording Engineer/Producer* 91

STUDIO UPDATE

Southeast

Orion Post-Production (Miami) has broadened its client base. In addition to post-production and music scoring, the facility has diversified to include music videos, foreign translation and dubbing, and corporate-image films. *17 Palmetto Drive, Miami, FL 33166; 305-888-2481.*

Here Here Studios (Asheville, NC) has installed a Soundcraft TS12 console; UREI 809 Time-Align monitors; JBL 4301 monitors; and a UREI 1176LN Peal Limiter.

Flood Zone Studios (Richmond, VA) has upgraded to 24 tracks with the addition of a Studer A80 MkIV tape machine. *11 S. 18th St., Box 7105, Richmond, VA 23220; 804-644-0935.*

Key Studios (Jacksonville, FL) has remodeled and expanded its main control room. New equipment includes a Neotek Series III 28x24 console, Tannoy LGM 12 monitors and a Neumann TLM 170i condenser mic. *2969 Edison Ave., Jacksonville, FL 32205; 904-388-8273.*

Georgetown Masters (Nashville) has purchased a Monster Cable Genesis 1000 Phase-Corrected Moving Coil Cartridge, said to be the first mastering house in the country to make such a purchase.

Midwest

General Television Network (Oak Park, MI) has announced that Gary Pillon, senior sound mixer, won an Emmy Award for best audio for video shot on location for "The New Historians," a half-hour documentary.

Studio A (Dearborn Heights, MI) has upgraded its New England Digital Synclavier with 32 polyphonic sampling voices, 160Mb Winchester disk, 8Mb of RAM and a Synclavier Phase II sound library. In addition, the 24-track Synclavier/MIDI room has also added a Roland D-50 and two Focusrite 110 modules. The 24-track main room has added two Yamaha SPX-90s, Tannoy NFM-8 monitor speakers, two dbx 160X compressor/limiters and three dbx 263 de-essers. *5619 N. Beech Daly, Dearborn Heights, MI 48127; 313-561-7489.*

Hatchery Studios (Warren, MI) has purchased a Valley International Gatex. *2175 Michael, Warren, MI 48091.*

Motion Picture Sound Incorporated (Detroit) has installed a 32-channel, three-man mixing console for film re-recording, with 10 inputs for dialogue, 16 for sound effects and six channels for music. The board was designed and engineered by Jerrell Frederick, the studio's president. *3026 E. Grand Blvd., Detroit, MI 48202; 313-873-4655.*

Sound Images (Cincinnati) has added a MIDI room, featuring a Kurzweil K250, and a third production room. The third room, Studio C, is an 8-track facility designed to complement the facility's two other rooms. John F. Murray has joined the staff as chief engineer for Studio C. *602 Main St., Cincinnati, OH 45202; 513-241-7475.*

Smith/Lee Productions (St. Louis) has installed an MCI 24-track recorder in Control A and has upgraded the console's I/O module capacity to 32 channels. In Control C, an Audio Arts console and an Ampex 16-track machine have been added. New on the staff is Sean McMahon, chief music recording engineer. *7420 Manchester Road, St. Louis, MO 63143; 314-647-3900.*

Southern California

Larson Sound Center (Burbank) has completed its first year in operation. Future plans call to expand services into the movie-of-the-week market, in addition to series television, and to add three more electronic sound-editing rooms, a 2-mixer dubbing stage and another 3-mixer dubbing stage. *4109 Burbank Blvd., Burbank, CA 91505; 818-845-4100.*

Music Grinder (Los Angeles) has installed a Neve 8108 console with 48 inputs and GML automation. Other additions include an Eventide H3000 Super Harmonizer and a T.C. Electronics 2290 sampler delay. *7460 Melrose Ave., Los Angeles, CA 90046; 213-655-2996.*

Custom Duplication (Inglewood) has installed professional real-time DAT duplication, labeling and packaging equipment. *3404 Century Blvd., Inglewood, CA 90303; 213-670-5575.*

Northern California

Dave Wellhausen Studios (San Francisco) has added an Apple Macintosh SE computer with Performer software and an

Opcode SMPTE-to-MIDI interface. *1310 20th Ave., San Francisco, CA 94122; 415-564-4910.*

Northwest

The Music Source (Seattle) has upgraded its facility to three rooms. Studio A is 48-track automated, Studio B is 24-track automated and Studio C is a 24-track MIDI and voice recording room. Studios A and B have added Adams-Smith 2600 synchronizer systems with compact controller; Studio C has a Zeta 3 chase system. *615 E. Pike St., Seattle, WA 98122; 206-323-6847.*

Canada

The Master's Workshop (Rexdale, Ontario) has received two Golden Reel Awards from the Motion Picture Sound Editors of Hollywood. Awarded were "Captain Power and the Soldiers of the Future," for best sound editing for a half-hour TV series, and "Ford: The Man and the Machine," for best sound editing in a TV miniseries. *306 Rexdale Blvd., Unit 5-7, Rexdale, Ontario, Canada M9W 1R6; 415-741-1312.*

Manufacturer announcements

Neve has recently installed consoles at two facilities: House of Music, West Orange, NJ, a V Series with 60 channels and Necam 96; and Fame Recording Studios, Muscle Shoals, AL, an 8232 with Audio Kinetics Mastermix automation.

Mitsubishi has installed two X-850 digital 32-tracks in two U.K. studios: Brook House Studio and Genetic Studios.

Soundtracs has received orders for its In Line console from Pace Studios, Aosis Studio, New Studio, keyboardist Paul Fishman's private studio and CGD Records.

AKG Acoustics has delivered ADR 68Ks to Unique Recording, New York; Sri Chinmoy Centre, Jamaica, NY; and Anthony Michael Personal Studios, Liverpool, NY.

Lyrec has delivered three TR-533 24-track recorders to BBC Scotland. Britain's Capital Radio has taken delivery of three FRED audiotape editors.

REP

NEW PRODUCTS

Sanken CMS-9 MS-stereo mic

The CMS-9 is a portable mic that incorporates a mid-side sum and differencing processing circuit, and outputs normal stereo signals that can be input to a field recorder or portable DAT machine equipped with L-R and 48V phantom power. The cardioid response is on-axis. Dynamic range is 108dB, self-noise is 19dB or less, and frequency response is flat.

Circle (131) on Rapid Facts Card

SSL HarrySound digital audio editing system

HarrySound results from a collaboration between Solid State Logic and Quantel, and is designed to extend the power of Quantel's Harry video editing system. The system uses the control pen and tablet from the Harry system, and operational principles overlap as much as possible. Digital audio soundtracks are transferred via the AES/EBU interface; analog soundtracks are interfaced using SSL's proprietary A/D converters.

Circle (151) on Rapid Facts Card

Evertz Emulator II

The unit allows VHS or S-VHS machines to be used in a professional editing environment by communicating directly to an edit controller or computer and providing transport control at all speeds. An optional VITC and LTC reader permits frame-accurate editing.

Circle (160) on Rapid Facts Card

ADC Telecommunications cable organization network

ICON stands for Integrated Cable Organization Network and uses the company's QCP insulation displacement for gas-tight, secure cable termination. The network is available in rack- and wall-mounted versions. The rack-mount version provides up to 192 terminations in two rack spaces and features rear trunk terminations and front cross-connections.

Circle (161) on Rapid Facts Card

Panasonic R-DAT tapes

The tapes use high-coercivity metal particles and a specially developed binder system that the company says delivers excellent recording and reliability. Available lengths are 60, 90 and 120 minutes.

Circle (162) on Rapid Facts Card

PRC videocassette mailer

The mailers ship two videocassettes in hard library boxes and are available in white. Made of corrugated cardboard, the mailers are shipped flat to save on shipping costs.

Circle (173) on Rapid Facts Card

Audio Services Corporation power supply

The MP-48 PH Stereo is a mic-battery power supply designed for use with the Neumann 190i mic. The unit provides 48V phantom power with a switchable 15dB pad and low-cut filter (-6dB at 100Hz).

Circle (169) on Rapid Facts Card

Mass Micro Systems Data Pak

Designed for use on the Macintosh, Data Pak is a removable hard disk containing 44.5Mbytes. Average access time is 25ms on an SE and 16ms on a Mac II. Several configurations are available, ranging from 44.5Mbytes to 160Mbytes of storage.

Circle (166) on Rapid Facts Card

Publications

Video directory and buyer's guide

Available from Palm Springs Media, the 1988 "Official Video Directory & Buyer's Guide" includes a buyer's guide, manufacturer directory, distributors list, company profiles, accessories and video services. Also included are a master index, industry members cross-reference, and toll-free and fax numbers.

Circle (182) on Rapid Facts Card

E-Z Hook catalog

The 116-page catalog details the company's line of electronic test accessories and includes specifications, configuration diagrams, application examples and ordering information. Products include test connectors, test lead interfaces, BNC and DB coaxial test cables, and type N connectors and cable assemblies.

Circle (183) on Rapid Facts Card

HOLDS UP ON THE ROAD

TYPE 85 FET DIRECT BOX

AMP. INST. PICKUP

INPUT SPEAKER

COUNTRYMAN ASSOCIATES INC.
424 STANFORD AVE. - REDWOOD CITY, CA. - 94063 - PHONE 415-364-9988

Circle (51) on Rapid Facts Card

NEW PRODUCTS

Hardware, software updates

Aphex Compellor, Dominator improvements

The Compellor and Dominator now incorporate the Aphex VCA1001 as their dynamic control element. The new VCA1001 offers a dynamic range of 110dB and distortion levels below 0.005% at any audio level. It also operates as a Class A amplifier at all times, eliminating crossover distortion of Class AB and B circuits of other VCA technologies, according to the company.

Circle (175) on Rapid Facts Card

Intelligent Music M 2.0

Version 2 of the MIDI software for the Macintosh contains several new features, including easily manipulated screen controls, interactive pattern editing, automatic conducting, Record Modes that interpret MIDI input in various ways, Time Distortion, which allows for rhythmic nuance, Snapshot quantization and Slideshows, which allows users to record control settings. Compatible with the Macintosh II and MultiFinder, the upgrade is free to registered users of earlier versions.

Circle (176) on Rapid Facts Card

UREI 7510B mic mixer

The 7510B, an update of the 7510A, includes several new features. Switches and LED indicators are prealigned and fixed to a subplate for simple insertion to the main frame. A new chassis design allows quicker setup and wiring, and the unit has a new input amplifier, output amplifier and phantom power supply. Two units can be linked together to create a 48-channel system.

Circle (179) on Rapid Facts Card

Sola electronic power conditioner

The EPC is designed to protect electronic equipment from almost all ac power problems except a total power failure. It is available in output capacities of 500VA, 1,000VA and 2,000VA. At full load, the EPC can offer 94% efficiency, and also has high-inrush overload capacity.

Circle (174) on Rapid Facts Card

NED Direct-to-Disk software enhancements

Three features have been added to the Direct-to-Disk system. Waveform Editing provides a graphic waveform of the source material being edited. Word Alignment allows an editor to move any audio event, including a single note or syllable, without disturbing the timing of the surrounding material. Dynamic Output Allocation allows outputs to be assigned via software, which permits independent routing of each edited segment of audio material to an output for processing.

Circle (178) on Rapid Facts Card

Jensen 990 pre-amp update

The Twin Servo 990 mic pre-amp now uses a 22-transistor version of the original nine-transistor 990 discrete op-amp. The additional circuitry includes power supply regulation, dc offset compensation and input bias rejection with thermal tracking. According to the company, the new 990s are better-suited for the dc servo feedback circuitry, which eliminates ac coupling capacitors.

Circle (180) on Rapid Facts Card

Tatum Labs software update

The company's analog circuit simulation program, ECA-2, is now available for Macintosh computers having at least 512k of RAM. Features include ac, dc, transient, Fourier, temperature, worst-case and Monte-Carlo analyses. A demo disk is available. Also available is EC-Ace, a subset of ECA-2 that excludes some functions such as Fourier, worst-case and Monte-Carlo analysis.

Circle (181) on Rapid Facts Card

Technical Arts Click Kicker

Click Kicker is a metronome output conditioner that upgrades low-level metronome outputs from external devices such as sequencers or sync boxes and also can directly drive loudspeakers or power amps. Output pulse level is $\pm 9V$ and lasts 1ms. The triggering threshold is rated at $\pm 200mV$.

Circle (167) on Rapid Facts Card

Patch Bay Designation PatchPrints

PatchPrints are custom labels for audio and video patchbays, control panels, racks, mixing boards, rear-illuminated button switches and all field-designation areas. The plastic labels are printed on a white background with black lettering or vice versa and may be color-coded. The company can make labels from customer-supplied blueprints or a company-supplied layout sheet.

Circle (171) on Rapid Facts Card

HH Electronics TA series loudspeaker systems

The series consists of the TA2 and TA3 Full Frequency systems, TA3-1 sub-bass system and C-1 controller. The TA2 and TA3 are two-way and four-way systems respectively; the sub-bass unit can be added to extend bandwidth below 40Hz. Frequency response alignment, crossover and limiter functions are performed by the C-1. The systems are designed for use in both music playback and sound reinforcement systems.

Circle (165) on Rapid Facts Card

AKG Acoustics MicroMic series

MicroMic consists of five microphones, each smaller than a thumbnail. The C401/B and C402/B are vibration-contact pickups that mount directly to the instrument body. The C408/B, a miniature version of the D112, is for percussion instruments. The C409/B is a clip-on instrument mic with a swivel joint for precise positioning. The C410+B9 is a headset mic designed for vocal applications, based on the C410 and equipped with a 9V power supply.

Circle (163) on Rapid Facts Card

U.S. Audio PHMS-1

Standing for Personal Headphone Monitor System, the PHMS-1 is a modular network for headphone monitoring and mixing. The basic cue mix is set up on the master module (a 12W "control console" with four inputs, volume and pan controls, and bus insertion jacks) and sent to satellite modules that have two discrete channels and two jacks for headphone outputs. Up to eight satellites, totaling 32 sets of headphones, can be daisy-chained and powered by one unit. All units are connected with standard mic cables.

Circle (155) on Rapid Facts Card

REP

CLASSIFIED

Advertising rates in Classified Section are:

\$1.00 per word per insertion. Initials and abbreviations count as full words. "Blind" ads \$25.00 additional. Minimum classified charge \$20.00. Classified is also available at \$122 per inch. Order must be accompanied by payment to ensure publication.

Classified columns are not open to advertising of any products regularly produced by manufacturers unless use^d and no longer owned by the manufacturer or distributor.

Classified Advertising should be sent to RE/P, Advertising Department, 9221 Quivira Rd., Shawnee Mission, KS 66215.

FOR SALE

NEW 19" ADC ft patchbay panels, balanced/normalised, 144 points each, \$150 each or 3 for \$375. Roger Cordell, 10818 Hortense, North Hollywood, CA 91602. (818) 763-8301
8-88-11

SYNCLAVIER: FOR SALE. 16 voice polyphonic sampling system w/24 FM synthesis voices; hard disk; music printing; never moved & never "down"; digital guitar interface; cost \$126,000—must sell: \$70,000. Phone 214-869-0592.
8-88-11

AVR GROUP

The Widest Selection of Used Gear
*Neumann*Pultec*UREI*Teletonics*

PCM 501DAT IN STOCK***

Otari MX5050 BII-\$1.6k; Otari MkIII-8-\$3.5k; Revox A77-\$650; Ampex MM1200/16 track-\$9k; Ampex AG440B-\$1695; Ampex MM1200/24 track-\$9k; Tascam MS-16 (w/everything)-\$9.3k; Tascam 32-\$1k; Tascam ATR-60/8-\$5k; Sony TCM-5000EV-\$325; Neve 8058 20x16-\$84k; Neve 8056 16x8x16 w/4-band eq-\$22k; Soundtracs MRX 32x8x16 (as new)-\$10k; Ramsa T820-\$3.5k; Soundcraft 200B 24x8-\$3.8k; Soundcraft 500 16x4-\$6k; Necam 1 w/32 faders-\$21k; JBL 4425-\$1.3k; Lexicon 224 (latest rev.)-\$3k; EMT 140 stereo plate-\$3k; EMT 240 "Gold Foil"-\$4k; Neumann U-87 (mint)-\$1.3k; AKG C-34-\$1.6k; AKG 414 EB-\$675.

We BUY and TRADE!!

All used gear warranted and calibrated to factory specifications or your \$\$\$ back. Call for discount prices on new items.

(617) 332-1441

MISCELLANEOUS

WANTED: PULTEC EQ's. We will pay \$1,000 for almost any Pultec program EQ models EQP1/EQP1A/EQP1A3. Also wanted EQH2/EQH3/MEQ5/MAVEC/MB1/any tube or ribbon microphones and limiting amps. Please call or write to: Dan Alexander Audio, 2944 San Pablo Ave., Berkeley, CA 94702, (415) 644-2363
7-88-4t

WANTED TO BUY: Multitrack tape recorders, Otari, Studer Ampex, 3M and MCI. Dan Alexander Audio, 2944, San Pablo Avenue, Berkeley, CA 94702. (415) 644-2363. TLX. (650) 291-8567 UCI.
8-88-11

Use the
Rapid Facts Card
in the back
of this issue!

EMPLOYMENT

AUDIO SERVICES ASSISTANT DIRECTOR. Oberlin College invites applications for the position of Assistant Director of Audio Services. The person in this position is responsible for professional recording, concert sound, administrative work and assistance in maintenance of equipment. Desired qualifications include Baccalaureate Degree, recording studio environment work experience, oral and written communication skills, familiarity with musical notation or instrumental technique and knowledge of classical music. Thorough knowledge of electronics relating to audio required. To ensure consideration, apply by October 1, 1988 to Thomas Bethel, Director of Audio Services, Oberlin College, Oberlin, OH 44074. Include three letters of reference with your letter of application. Salary commensurate with experience; range 16k to 22k. Affirmative Action, Equal Opportunity Employer
8-88-11

IN HOUSE MUSIC AND AUDIO PRODUCTION Talented Composer/Producer with extensive commercial production and management experience seeks director level position with busy production house or agency. Relocation, no problem. Box 354, 2120 Crestmoor Rd., Nashville, TN 37215.
8-88-3t

THE HOTTEST NEWS IN THE MUSIC INDUSTRY!

Personics offers the latest in music retailing. We develop and manufacture computerized systems so that customers can make personalized cassette tapes from selected cuts right in the store. Soon to expand nationwide with our innovative music machine, we are seeking individuals who really want to play an important role in our growth.

FIELD SERVICE ENGINEERS

San Francisco Bay Area
Los Angeles Area

Fantastic opportunities for career advancement are possible in these positions. Prior experience in repairing and maintaining Pro Audio Recording equipment and familiarity with standard audio test and measurement techniques and equipment are necessary. Computer hardware/software knowledge is required to the level of installing and troubleshooting systems and board level products, and installing systems and applications software.

Make a difference and join our team!

Send your resume today to:

**Personnel Department,
Personics Corporation, 120 Scott Drive, Menlo Park, CA 94025.** EOE.
Principals only. No Phone calls



THE PERSONICS SYSTEM

CREATIVE RECORDING, INC.

2806 Azalea Place
Nashville, TN 37204 (615) 385-0670

A 24 Track Recording Studio
"THE MOUNTAIN ROOM"

Circle (52) on Rapid Facts Card

THE MOST COMPLETE SELECTION OF

AUDIO TEST TAPES

All formats including cassettes
Write or phone for free catalog

STL

STANDARD TAPE LABORATORY, INC.
26120 Eden Landing Road #5, Hayward, CA 94545
(415) 786-3546

Circle (53) on Rapid Facts Card

EUROPADISK LTD.

- Direct Metal Mastering
- Audiophile LP Pressing
- Compact Disc Pressing
- Cassette Duplication
- Digital Tape Studio
- CD Master Tapes
- Digital Format Conversion
- Analog-to-Digital Transfers
- Digital Clones
- Neve Digital Console
- Sony Editing
- DAT Cassette Dupes

EUROPADISK, LTD.
75 VARICK STREET
NEW YORK, NY 10013
(212) 226-4401

Circle (54) on Rapid Facts Card

Highest Performance Audio Transformers!

- Wide bandwidth • Low hysteresis distortion
- Flat group delay • No overshoot or ringing

Call for free applications assistance
(Mon-Thurs, 9am-5pm Pacific time)

jensen transformers
INCORPORATED

10735 Burbank Blvd. • North Hollywood, CA 91601
FAX (818) 763-4574 Phone (213) 876-0059
TELEX 6502919207 MCI UW

Circle (55) on Rapid Facts Card

VIDEO SUPPLIES

CABLES • CONNECTORS • CANARE • BELDEN • SWITCHCRAFT • D.A.S. • TIES • BATTERIES • NEUTRIK • SO INTERFACE BOXES • TAPE • 500 DIF TAPE LABELS • GAFFERS TAPE • CASES • PATCH BAYS • LIGHTS • ACOUSTIC FOAM • FORMS • MICROPHONES • SONY • STANDS • MOUNTS • WIND SCREENS • ZEPPELINS • FIBRE OPTICS • ROCKS • DUCT • REELS • TESTERS • FILTERS • CHEMICALS • TOOLS • ON-AIR LIGHTS • DEGAUSSERS • INTERFACE DEVICES • HEADPHONES • CLIPS • SWITCHES • CAM & S-VHS CABLE

Very Unique Professional Catalog FREE!

MARKERTEK VIDEO SUPPLY
145 Usher Ave., Saugerties, NY 12477 U.S.A.
TOLL FREE 1-800-522-2025
In NY: 914-246-3038

Circle (56) on Rapid Facts Card

ADVERTISERS' INDEX

SALES OFFICES

	Page Number	Rapid Facts Number	Advertiser Hotline
Aerco	62	37	512/451-5874
AKG Acoustics, Inc.	51		203/348-2121
Alesis Corp.	9	8	
Alpha Audio	89	48	804/358-3852
Ampex Corp.	37	20	415/367-3809
Applied Research & Technology	IFC	1	716/436-2720
Canare Cable, Inc.	87	46	818/840-0993
Carpenter's Home Church	69	39	813/859-1477
The Castle	42	23	615/791-0810
Cetec Gauss	78	44	213/875-1900
Countryman Associates	93	51	415/364-9988
Creative Recording	95	52	615/385-0670
Dimension Music Library	91	50	800/634-0091
Dolby	53	32	415/558-0200
Emerald Sound Studio	35	19	615/321-0511
Europadisk, Ltd.	87,95	47,54	212/226-4401
Everything Audio	27	16	818/842-4175
F.I.R.S.T.	45	29	615/794-3660
Fairlight Instruments US	40	22	212/219-2656
Fostex Corp. of America	11	9	213/921-1112
Industrial Strength Industries	30-31	17	800/537-5199
JBL Professional	IBC	2	
Jensen Transformers	95	55	213/876-0059
Kaba Research & Development	77	43	800/231-TAPE
Klark-Teknik Electronics, Inc.	1	4	516/249-3660
Kurzweil Music Systems, Inc.	55	33	617/893-5900
Leitch Video of America, Inc.	57	42	416/445-9640
Magnetic Reference Laboratory, Inc.	90	45	415/965-8187
Markertek Video Supply	95	56	800/522-2025
The Nashville Hotline	47	27	615/255-0011
The Nashville Network	47	26	615/889-6840
Neve, Inc.	38	21	615/329-9584
Panasonic (Ramsa Div.)	64-65	38	714/895-7278
Polyline Corp.	71	40	312/298-5300
Pro Sound	89	49	213/770-2330
Pulizzi Engineering, Inc.	71	41	714/540-4229
QSC Audio Products	25	15	714/645-2540
Ram Broadcast Systems, Inc.	58	34	312/358-3330
Rane Corporation	17	12	206/774-7309
Saki Magnetics, Inc.	62	36	818/880-4054
Solid State Logic	34		212/315-1111
Sony Broadcast Products Co.	13	10	800/635-SONY
Sound Emporium	43	24	615/383-1982
Soundcraft USA	5		818/893-4351
Soundshop	45	30	615/244-4149
Spotland Productions	46	28	615/385-2957
Standard Tape Laboratory, Inc.	95	53	415/786-3546
Studer Revox/America	48,BC	31,3	615/254-5651
Switchcraft	23	14	
TASCAM Div./Teac Corp.	7	7	213/726-0303
Technical Audio Devices	19	13	213/420-5700
Telex Communications, Inc.	15	11	612/887-5531
Woodland Studios	44	25	615/227-5027
Yamaha Intl. Corp.	3	5	

OVERLAND PARK, KS

Mary Tracy
913-541-6637 or
913-888-4664
P.O. Box 12901
Overland Park, KS 66212
Telex: 42-4256 Intertec OLPK
Telefax: 913-888-6697

SANTA MONICA, CA

Herbert A. Schiff
213-393-9285
Jason Perlman
213-458-9987
Chris Woodbury Leonard
213-451-8695
501 Santa Monica Blvd.
Santa Monica, CA 90401
Telefax: 213-393-2381

NEW YORK, NY

Stan Kashine
212-702-3401
29th Floor
866 Third Ave.
New York, NY 10022
Telefax: 212-702-7802

OXFORD, ENGLAND

Nicholas McGeachin
Roseleigh House
New Street
Deddington, Oxford
OX5 45P England
Telefax: (0869) 38040
Telephone: (0869) 38794
Telex: 837469 BES G

FREWVILLE, SOUTH AUSTRALIA

John Williamson
Hastwell, Williamson, Rep.
Pty. Ltd.
109 Conyngham Street
Frewville 5063
South Australia
Phone: 799-522
Telefax: 08 79 9735
Telex: AA87113 HANDM

TOKYO, JAPAN

Mashy Yoshikawa
Orient Echo, Inc.
1101 Grand Maison
Shimomiyabi-Cho, 2-18
Shinjuku-ku, Tokyo 162, Japan
Telephone: 03-235-5961
Telex: J-33376 MYORIENT

QUALITY

*the process begins
here...*

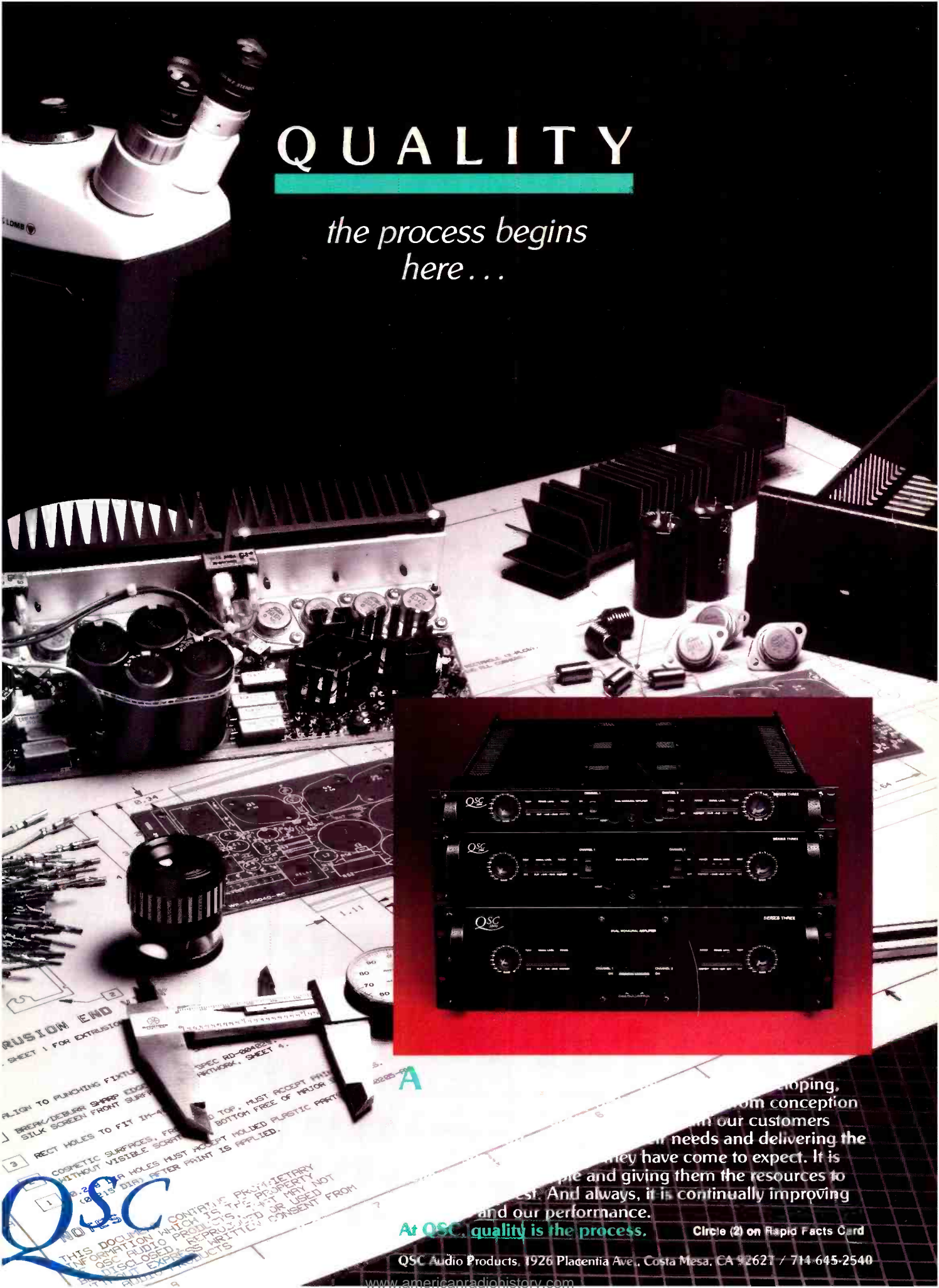

QSC
NO TSC
THIS DOCUMENT CONTAINS PROPRIETARY
INFORMATION WHICH IS THE PROPERTY
OF QSC AUDIO PRODUCTS. IT IS NOT
TO BE DISCLOSED OR USED FROM
WITHOUT EXPRESS WRITTEN CONSENT FROM
QSC AUDIO PRODUCTS.

A... developing, from conception
... our customers
... needs and delivering the
... they have come to expect. It is
... and giving them the resources to
... And always, it is continually improving
... and our performance.

At QSC, quality is the process. **Circle (2) on Rapid Facts Card**

QSC Audio Products, 1926 Placentia Ave., Costa Mesa, CA 92627 / 714-645-2540
www.americanradiohistory.com

Standard on ours is "N/A" on theirs.



Every recorder in the C270 Series comes *loaded* with professional features that aren't available—not even as options—on “comparable” machines from other manufacturers . . .

- Dolby HX Pro® Headroom Extension and proprietary phase compensated audio electronics
- Seamless and gapless punch-in and punch-out
- Integral scrape-flutter filter in head assembly
- Constant tape tension on both spooling motors
- One-hand cueing under full servo control
- Fully modular audio electronics allowing quick interchange of individual circuit elements
- Front access to all audio electronics, even when rack-mounted
- Plug-in record and reproduce equalizers for optimal performance and easy speed pair conversion
- 3 peak LED indicators: +6, +9, +12 dB (C270)
- Adjustable Mute-to-Play time of audio output from 50 to 990 msec
- Built-in variable speed allows -33% to +50% range
- Selectable library wind and record inhibit
- Optical End-of-Tape Sensor
- 1-year parts and labor warranty

Plus, other features *standard* on the C270 Series that are available *only* as options on other machines . . .

- Fader start circuitry
- RS 232 serial port allows full control of all machine functions
- Rack mount adapters

The C270, 274 and 278 all have 3 tape speeds (3 3/4, 7 1/2 & 15 ips), any pair of which can be selected and quickly changed in the field.

Low speed versions (15/32, 15/16 & 1 7/8 ips) of the C274 and C278—especially suited for logging applications—come with a built-in time and date code generator and reader with search capabilities.

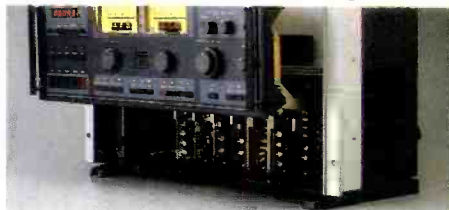

All audio electronics fully accessible through front panel.

The C270 Series is designed to give you what you need, *included*—on every machine . . . pro transport functions, pro audio quality and pro construction (rugged die-cast deck-plate, head assembly and chassis). Add overall value to because that's very much what the C270 Series is about—giving the professional more for less. (Accessories and options, you need them, *are* available—autolocators, remote controls, floor consoles and SMPTE center track time code.)

But one feature built into the C270 Series no one else has *ever* been able to offer . . . the Studer Revox 40-year reputation for reliability and unequalled performance.

Available from Studer Revox Professional Products Dealers. Or contact: Studer Revox America, Inc. 1425 Elm Hill Pike, Nashville, TN 37210. (615) 254-5651

STUDER REVOX

Circle (3) on Rapid Facts Card

www.americanradiohistory.com