

# R-e/p

INCLUDING: CONCERT SOUND REINFORCEMENT

VOLUME 4 NUMBER 6  
NOVEMBER / DECEMBER



SOUND 80 MINNEAPOLIS

RELATING RECORDING SCIENCE • TO RECORDING ART • TO RECORDING EQUIPMENT



# Altec, we challenge you.

Any company that achieves a position of leadership must be prepared to meet the challenge of innovation. In the recording industry, this is a particularly crucial factor – because constantly evolving musical material demands ever newer and better recording techniques.

For nearly 30 years, one name has dominated the studio monitor market. Altec. In 1973, Altec had more than twice as many speakers in recording studio use in the U.S. than its nearest competitor. And nearly as many as all other brands combined. (Source: Billboard's 1973 International Directory of Recording Studios.) That's leadership without question.

Now someone is about to challenge that leadership. Us.

Our first step: introduce three all-new monitor loudspeakers. They're a whole new breed, designed for tomorrow's recordings. And they exceed the performance characteristics of every monitor ever made. Including Altec's.

They're packed with improvements and specs guaranteed to satisfy the goldenest of ears. Improved accuracy and definition. Better transient response. Flatter frequency response. Greater bandwidth. Greater power handling. And much more.

Add to all that our 37-plus years in the field of sound reproduction, and we think we're ready to challenge the leader.

Even if we have to do it ourselves.

**ALTEC**

*the sound of experience.*

1515 S. Manchester  
Anaheim, Calif. 92803

## The challengers.

From front to back, it's the 9849A, the 9846-8A and the 9848A. If you listen for a living, you should know more about them.

Write or call. We'll send you all the facts and figures.



**POWER AMPLIFIERS**  
**AUDIO AMPLIFIERS**  
**COMPRESSORS**  
**EQUALIZERS**  
**LIMITERS**  
**FILTERS**

**AUDIO**  
**CONTROL**  
**CONSOLES**  
**STUDIO**  
**SYSTEMS**

SPECTRA SONICS audio products are the culmination of research and the application of advanced concepts in electronic circuitry. Performance is measurably superior and is most apparent in the ultimate test for all audio products: that of listening!

SPECTRA SONICS audio products are consistent producers. Superior quality in audio processing is achieved through design, pre-assembly component testing, and strict discipline in the fabrication process: quality that is strikingly evident!

SPECTRA SONICS products provide reliable, dependable hours of trouble free operation and are "on the line" for the maximum productive time: reliability that is unequalled!

For additional data on SPECTRA SONICS products and services, write to:

770 Wall Avenue  
Ogden, Utah 84404  
(801) 382-7531

6430 Sunset Blvd., Suite 1117  
Hollywood, California 90028  
(213) 461-4321

**SPECTRA SONICS**

LEADER IN ADVANCED TECHNOLOGY



# RECORDING

engineer/producer

- the magazine to exclusively serve the recording studio market . . . all those whose work involves the recording of commercially marketable sound.
- the magazine produced to relate . . . RECORDING ART to RECORDING SCIENCE . . . to RECORDING EQUIPMENT.



Editor/Publisher . . . MARTIN GALLAY  
 Associate Editor . . . . . WAYNE YENTIS  
 Engineering Editors . . . . . RON MALO  
 WILLIAM ROBINSON  
 GARY DAVIS  
 Business Manager . . . . . V.L. GAFFNEY  
 Circulation Manager . . . . D.S. WILLIAMS  
 Art Director . . . DENNIS LEATHERMAN



RECORDING engineer/producer is published bi-monthly and is sent free to qualified recipients in the United States. Subscriptions for other than qualified individuals or companies may be purchased at \$5.00 per year. (All foreign subscriptions: \$6.00 per year.) Material appearing in R-e/p may not be reproduced without written permission of the Publisher.



RECORDING engineer/producer is not responsible for any claim made by any person based upon the publication by RECORDING engineer/producer of material submitted for publication.



Controlled circulation postage paid at Los Angeles, California.  
 RECORDING engineer/producer  
 6430 Sunset Boulevard  
 P.O. Box 2287  
 Hollywood, Ca. 90028  
 (213) 461-7907

NOVEMBER/DECEMBER 1973  
 VOLUME 4 - NUMBER 5

THE 3 WAY CONTEST  
 FOR A 4 CHANNEL  
 FORMAT 15 Gary Davis

WHY  
 MINNEAPOLIS? 35

USING NOISE—  
 REDUCTION TO  
 REDUCE DISC SURFACE  
 NOISE 39 Larry Blakely

THE CONCERT  
 SOUNDMAN 43 Jim Coe  
 Paul Stark

Letters and Late News 10  
 Notes on Demagnetizing 13  
 New Product News 51  
 Classified 57

## ADVERTISERS INDEX

	Page		Page
AKG	53	MAZE	13
ALLISON	24	NEUMANN/GOTHAM	11
ALTEC	2-3	NEVE	9
ARTCRAFT	57	PARASOUND	12
AUDIO DESIGNS	19-20-21-22	QUAD-EIGHT	27-41
AUDITRONICS	29	SCOTT INSTRUMENT	47
BURWEN	8	SCULLY/METROTECH	37
CETEC	49	SHURE BROS.	CVR 4
COUNTRYMAN	58	SPECTRA SONICS	5
CROWN	42	STUDIO SUPPLY	CVR 3
DBX	16	TABER	44
ELECTRO-VOICE	14	TASCAM	38
GOTHAM AUDIO	11	3-M MINCOM	50-51
INOVONICS	40	UREI	10-58
		WESTLAKE . . . . .	31-32-33-34

# Who would want to own...an 80dB dynamic range record?

*You would, once you heard one.*

Examples of records selling because of superb sound, alone, are becoming more numerous. And small wonder!

For, in a recent survey of customers who already own high-quality, home sound systems, over 80% of those who responded to a request for suggested improvements said, "Do something to get better sounding records, tapes and FM."

How can records of 80dB dynamic



range be produced? The fact is that only the Burwen Noise Eliminator makes such recording possible... and it's expensive! You will be convinced, as we are, that it can boost your record sales 10% to 20%... and decide that it is more than worth the investment.

To get complete facts on the Burwen Noise Eliminator, Model 2000... just call or write:

 **Burwen**  
LABORATORIES, INC.

209 MIDDLESEX TURNPIKE, BURLINGTON, MA. 01803/TEL. (617) 273-1488

Circle No. 103

Re/p 8

[www.americanradiohistory.com](http://www.americanradiohistory.com)

# Neve presents the 3-in-1 console.



**An unbeatable 8-track console.**

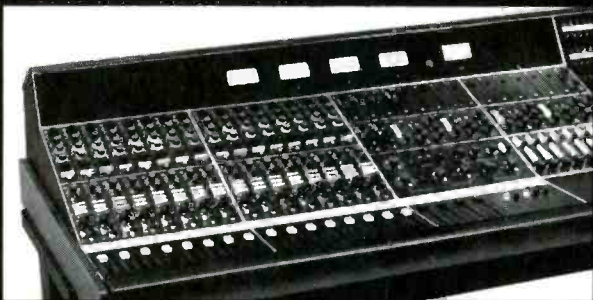

**A deluxe quadraphonic mixdown console.**

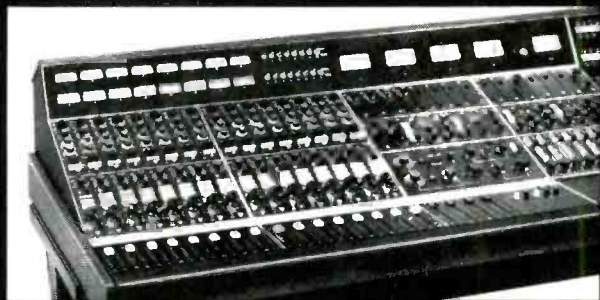

**A great 16-track console for small studio budgets.**

It's the Neve 8014. Take your choice of three different meter configurations (shown above). Whether you need a 4-track or 8-track or economy 16-track console, the Neve 8014 will meet your needs to perfection. If you wish, start small and expand later. This versatile console can "grow" as your studio grows.

Fully fitted, the 8014 features 16 input channels; 4 Pgm, 2 Rev and 2 Cue mixing buses; 8-track monitoring and metering; 4 limiter/compressors; talkback and slating; test oscillator; and solo function. Delivery is almost immediate. As in all Neve Consoles, total harmonic distortion is guaranteed to be less than 0.075%.

The sound of Neve is worldwide. Our audio control

consoles are used for music recording, film production and broadcasting in studios in 40 countries. Call or write us for more facts. Chances are, we can help you record some new highs in profits.

**Rupert Neve Incorporated**, Berkshire Industrial Park,  
Bethel, Conn. 06801. (203) 744-6230  
**Hollywood:** Suite 616, 1800 N. Highland Ave.,  
Hollywood, Ca. 90028. (213) 465-4822  
**Nashville:** Telephone (615) 255-4315  
**Rupert Neve of Canada, Ltd.**, 7528 Bath Rd., Malton,  
Toronto, Ontario, Canada. (416) 677-6611  
**Rupert Neve & Co., Ltd.**, Cambridge House, Melbourn,  
Royston. Herts, England.

# Neve

# Ray Moore says, "Bravo!" for our little dipper

**CBS  
RECORDS**  
A Division of Columbia Broadcasting System, Inc.  
51 West 52 Street  
New York, New York 10019  
(212) 785-4221

Lockwood Road; R.R. #2, Box 65  
New Canaan, Connecticut 06840  
June 5, 1973

United Recording Electronics Industries  
11922 Valerio Street  
No. Hollywood, California 91605

Gentlemen:

Bravo to you for your "Little Dipper" (565 Filter set).  
The unit works very well and is a "God-send" as an audio  
corrective tool.

Last summer it fell my lot to work on Columbia's Joseph  
Szigeti's Six Record package. If you know the package,  
you know that the original source material was taken from  
78's recorded from 1908 to 1936. After transferring most  
of the material to tape, we received our "Little Dipper."  
I decided to recopy all the material over again, after  
experimenting with your unit, in order to improve the  
transfers. Once released, the package was well-received  
and several critics praised the package for the disc-to-tape  
transfers - with "tender-loving care," as one critic put it.

Most recently, we had another problem. It seems that while  
mixing the Quadraphonic version of Haydn's Mass, In the  
Time of War (Bernstein's performance), some 60 Hertz hum  
found its way onto the track that had the cello, basses,  
vocal soloist and other low frequency instruments. Enlisting  
the aid of the "Little Dipper," we solved the problem  
better than I would formerly have thought possible. I  
am sold. (I even think John McClure was surprised.)

We take equalizing, limiting and many signal shaping devices  
for granted. Until recently. I could not take what the  
"Little Dipper" can do for granted in all my thirteen years  
at Columbia Records.

Again, Bravo!

Sincerely yours,

*Ray Moore*  
Ray Moore



keep those  
cards &  
letters  
coming!

**Urei** company

11922 Valerio Street, No. Hollywood, California 91605 (213) 764-1500

## Letters &

### Late News

From: EDWARD J. GREENE  
MGM Recording Studios  
Los Angeles, Ca.

Two things have disturbed me greatly since your last issue's articles concerning the Frank Sinatra sessions. First and foremost was the omission of our discussion regarding the work of Wally Heider's crew on the television remote. The broadcast simply would not have happened without them. I would hope that this could be printed in a later issue.

The other was the local Los Angeles transmission of the show. If nothing else, the distortion was unbearable. I had been able to view the show prior to broadcast on video-cassette and the sound quality was reasonably well preserved from our mixed master. At least it was reasonably clean. But locally on the air it appeared to be compressed and have incredible high frequency distortion. Interestingly enough, I had a call from an engineer friend in the East before local airtime and he commented that in New York the show looked and sounded good. The New York Times

### From the READERS \_\_\_\_\_

An editorial material rating of the most useful feature article, as gathered from the Reader Service Cards received prior to press time.

#### SEPTEMBER/OCTOBER ISSUE:

Recording the FRANK SINATRA  
TV SPECIAL and ALBUM  
... interviews with Ed Greene,  
and Don MacDougall  
by Wayne Yentis . . . . . 33.3%

Mastering for TAPE  
DUPLICATION  
by Peter Butt . . . . . 20.6%

The TUBE VS  
TRANSISTOR CONTROVERSY  
by Russell Hamm . . . . . 46.1%



reviewed the show and record in a subsequent article, and the reviewer, for my money, was able to understand the concepts and ideas the producers intended.

I can only imagine how the review would have read if the reviewer heard what I heard here in L.A.

. . . *the mis-placed paragraph:*

*ED GREENE: ". . . all the gear was provided by WALLY HEIDER, not only the gear, but his crew is unbelievable. Of course, as important as the gear is its the crew that makes that kind of an operation work . . . and, Wally and his people are just unbelievable. Let's see, on the crew there were Miles Weiner, Jack Crymes, Terry Stark, Ken Caillat, Biff Dawes and Bill Broms from Wally's."*

#### CLEVELAND RECORDING CO., VICTOR CO. OF JAPAN IN QUAD PATENT DISPUTE OVER CD-4

Cleveland Recording Company has announced that it had informed JVC America, Inc. and its parent company, the Victor Company of Japan, Ltd. through its patent attorneys that JVC's CD-4 Discrete Quadradisc system is in apparent infringement of a patent issued to Kenneth Hamann, President of Cleveland Recording. U.S. Patent No. 2,849,540, applied for in 1954, and granted in 1958 to Mr. Hamann, specifically covers the use of a 30 kHz sub-channel signal to record multi-channel audio information on discs, and other mediums, and defines certain electronic means to decode that information into a listenable form. JVC America was invited to enter into licensing arrangements with Mr. Hamann for the use of the invention covered by the patent that pertains to the JVC CD-4 Discrete Quadradisc system.

Mr. Hamann is a pioneer in multi-channel stereophonic recording techniques. It is thought that Mr. Hamann produced and engineered the first 4-channel live broadcast in history on October 27, 1958, when the "Dukes of Dixieland" were presented in a program using the facilities of two AM and two FM broadcast stations in Cleveland, Ohio.

In 1963, Mr. Hamann produced a series of live and recorded three-channel stereophonic broadcasts, featuring such artists as Igor Stravinsky performing at Oberlin College. These experimental three-dimensional sound broadcasts used an FM stereo and an AM broadcast station for transmission to Northern Ohio.

Mr. Hamann's suggestion that the home listener place the third channel (AM) speaker behind him was the precursor of the present 4-channel listening format.

Cleveland Recording Company is preparing to celebrate its 40th anniversary next year, which makes it America's oldest independent recording studio.

Among programs planned for this event is the formal dedication of a new 4-channel quadrasonic recording and mixdown studio designed and constructed by Mr. Hamann and the staff of Cleveland Recording Company. Featuring a custom 48 input channel console of unique state-of-the-art design, the facility will offer a combination of the best new technical equipment and proved engineering expertise to the recording industry.

#### ATLANTA'S SOUND PIT STUDIO HONORED BY AMPEX

R.E. Douglass, Jr., Southeast District Sales Manager for AMPEX Magnetic Tape Division in Atlanta, recently presented a special award of merit and appreciation to Sound Pit recording studio's engineers Glenn Meadows (center) and Milan Bogdan (left) for their outstanding work in assisting in the development of the new Ampex 406 and 407 audio recording tape.



According to Tomy DiMaria, General Manager of the studio, one of the newest recording studios in the Southeast, "We ran a very comprehensive testing program on this tape, and were able to make several constructive suggestions to Ampex, at their request."

"The Sound Pit", according to Ampex Sales Engineer, Jim Drummond, and Southeast Sales Manager Bob Douglass, "was selected to conduct the testing program because of the studio's qualified staff of engineers as well as the excellence of their recording equipment."

The \$1.2 million facility was built in 1973 by President, Michael Thevis.

#### 1974 CATALOG OF NEW AND USED VTR PRODUCTS ISSUED BY MPCS COMMUNICATIONS INDUSTRIES, INC.

MPCS Communications Industries, Inc. just published a brand new 1974 catalog of new and used VTR equipment being offered at discount prices. The catalog



## "SETTING A PATTERN"

How can OMNI or NON-DIRECTIONAL mikes solve problems?

Ask the people who selected our NEUMANN KM 83 omni for Frank Sinatra's hand-held mike on his recent TV special. They found out very quickly that OMNI DIRECTIONAL pressure transducers (not to be confused with the omni directional positions of multi pattern microphones) are completely free of proximity effects such as popping, low-end boost, and high-end edginess.

*How about leakage, though?* Leakage is the relationship between wanted and unwanted information. You can prevent leakage in one of two ways: a) use a directional mike which will suppress unwanted sound from the back by some 26 dB, and keep the singer at a respectful distance to prevent cardioid bass boost, popping, and sibilants or b) move him in close to an omni mike with no coloration problems, and increase wanted signal by 26 dB and more!

When should I use a figure-8 pattern...

If I only want to use it for sound from one direction? Is there anyone out there who still remembers the RCA 44-BX ribbon and the decades of nothing but figure-8 patterns in the studio? The fact of the matter is, that you're likely to get less leakage from a figure-8 even with its "live back," than from a cardioid. One of the reasons is that a figure-8 is pure, meaning its pattern is almost identical at all frequencies, and the two dead sides are down more than 33 dB from front or back. A cardioid, on the other hand, changes its pattern more severely over the frequency range and has a front-to-back rejection of only about 26 dB. So why not switch to figure-8 and get a surprise!

We'll be happy to send you a color brochure describing all our NEUMANN condenser mikes, if you'll drop us a line.

Stephen F. Temmer  
President, Gotham Audio Corporation

**GOTHAM**  
AUDIO CORPORATION

Headquarters: 741 Washington Street,  
New York, NY 10014 (212) 741-7411  
West Coast Sales Office: 1710 N. LaBrea Ave.,  
Hollywood, CA 90046 (213) 874-4444

may be obtained free by writing to MPCs at 424 W. 49 St., New York, N.Y. 10019, or by phoning (212) 586-3690.

Featuring Sony equipment for the most part, the catalog also includes videotape products of other leading manufacturers such as Panasonic, Magnavox, Akai, Ampex, Shintron, and others.

Recorders, monitors, and cameras — both color and B&W, special effects equipment, editing and production consoles, film chain adapters . . . nearly every type of videotape component is represented. Among the cameras featured are portable battery operated units and hand held color cameras, as well as studio units for both color and black and white.

MPCS COMMUNICATIONS IND., INC.  
424 WEST 49 STREET, NEW YORK,  
N.Y. 10019

#### GEOFFREY LANGDON BECOMES PROFESSIONAL PRODUCTS MAN- AGER OF AKG

The AKG Division of North American Philips Corporation has announced the appointment of Geoffrey M. Langdon to the newly created position of Manager for Professional Products. His responsibilities will include consultation, assistance and liaison with professional users of AKG products.

Mr. Langdon, an active member of the Audio Engineering Society and member of the A.E.S. standards committee, comes to AKG from the United States Marine Band where he served for four years as chief engineer of the audio and recording department.

---

*Continued from the Sept/Oct issue:*

#### NOTES ON DEMAGNETIZING

*(This discussion appears courtesy of  
the R.B. Annis Co., Indianapolis, Ind.)*

When starting to demagnetize, it is often advantageous to shift angular relationship between the steel work and the demagnetizing field. This can be accomplished by turning the work or by a slight lateral "waving" of the demagnetizer probe before separation. This will insure optimum demagnetizing.

Another important point concerning cyclical demagnetizing is that there must be no interruption of the power to the demagnetizer during separation or the incremental reduction period, even momentarily. If this occurs, the steel will be left in a highly magnetized condition as a result of being magnetized by the last half-cycle prior to interruption. When this occurs, demagnetizing must be re-

peated.

A third point to remember is that complete demagnetization of steel cannot be accomplished while it is still under the influence of the original magnetizing field or any other stray unidirectional field of any consequence. You can't demagnetize components remaining in the vicinity of a "hot" loud speaker field. On very critical work, even the "bias" caused by induction from the earth's magnetic field can prevent complete demagnetization without the use of special procedures. This effect is particularly noticeable when working with some of the stainless steels and others in the middle hardness range.

The author has had the opportunity to check a number of the probe type "head" demagnetizers and found that their demagnetizing field intensity only averaged 70 to 80 oersteds, with a top of 100 oersteds, when measured at a standard 1/4" distance from the probe. These values of demagnetizing field strength are too low to attain that necessary high initial intensity required for successful cyclical demagnetizing.

In view of the above apparent need for a more effective probe type demagnetizer, an experimental engineering approach led to the evolution of a considerably more effective, hand held, double ended demagnetizer having a con-

# A REALLY GOOD DE-ESSER SHOULDN'T DO ANYTHING ELSE.

De-essing's too important. Much too important to be tossed in as an afterthought on equipment designed to do something entirely different.

A really good de-esser should do just that. Period. And do it well.

That's what our new Dynamic Sibilance Controller does: reduce sibilants to levels that sound natural and right. Without distortion, swishing, or pumping. And without control errors caused by insufficient filter selectivity.

It's so quiet and distortion-free you can leave it patched in all the time. And it's simple to operate: One knob for threshold control. An in/out switch to defeat control action without clicks, pops, or gain changes. An LED that lights whenever gain reduction occurs. No other controls to worry about.

If you're into cinema, you already know you need one.

And if you're into records . . . remember when you wanted to put more top on the vocal, but couldn't

because the esses got out of control? Or the problems you had getting certain sibilant vocalists onto disc or cassette without high-frequency overload? You need one too.

The Orban/Parasound 516E Dynamic Sibilance Controller contains three independent channels and sells for \$495—\$165 per channel. That's not bad for something that does what it's supposed to do—for a change.

## ORBAN/PARASOUND DYNAMIC SIBILANCE CONTROLLER THE DE-ESS SPECIALIST

Write or call Parasound, Inc., 680 Beach Street, Suite 495, San Francisco, CA 94109. (415) 776-2808  
or contact your local Orban/Parasound distributor.

veniently curved probe at one end with a demagnetizing field intensity of 350-400 oersteds at 1/4". The opposite, flush pole end, measures over 800 oersteds, so powerful it can be used for limited bulk demagnetizing of tapes up to 1/4" wide if a regular bulk tape eraser is not available. In the interest of demagnetizing efficiency, this new "Han-D-Mag" unit made generous use of the best magnetic materials along with increased power input and a carefully designed configuration for practical intermittent operation. Mention of this more efficient demagnetizer created so much interest that it was tooled for production and is now available from R.B. Annis Co. Indianapolis, Ind. 46202 at a price of \$21.00 in U.S.A. Export model for 230 volts 50/60 Hz @ \$24.35 plus shipping charges for two pounds.

The Han-D-Mag is so powerful that it is not necessary for the plastic coated probe to touch the work, just bring it near, within 1/8" to 1/4" of small magnetized steel parts, wave the tip sideways slightly, then remove slowly, while still energized, at a rate no faster than 3" - 4" per second, to a distance of at least 12" before turning the power off.

Considerable care should be taken with any energized demagnetizer not to bring it too close to valuable recorded tapes. Bulk erasers and the powerful

Han-D-Mag should be kept at least 12" away from such tapes. VU meters, ear phones and magnetometers etc. may be considered safe at 1" distance from the probe end and 2" distance from the flush pole end of the Han-D-Mag. Recorded tape should not be brought too close to other strong magnetic field sources such as unshielded loudspeakers, magnetic hooks and paper clamps etc.

The difference between good and bad demagnetizing procedure and equipment can be quickly determined with the pocket magnetometer. When using the magnetometer, the bottom, test edge of the instrument is brought in contact with the part being checked. If the part is magnetized, the instrument pointer will move from its normal center-zero scale position. The direction of pointer deflection indicates magnetic polarity of the part being checked. The amount of deflection is a measure of the intensity of magnetization of the steel part.

Magnetometers in the 2 to 5 gauss range are excellent for detecting and measuring residual magnetism in tape recorder components. These instruments, being fairly sensitive, may also show a noticeable response to the earth's magnetic field which amounts to about 1/2 gauss. If desirable, this response can be eliminated by tipping the instrument until its staff is aligned parallel with the direction of the magnetic field in the

area prior to approaching the work with the test edge. In any event, whether it is convenient to align the staff for zero reading or not, the important thing to note is the change in reading as the work is approached and touched.

Purely as a rule of thumb, any capstan, head or tape transport component that reads much over one gauss should be suspect, when measured with the test edge of the magnetometer in contact with the component, as described above. To explain this more fully, these magnetometers actually measure magnetic field strength in the area of the movement staff which is located some 1/2" to 5/8" from the bottom test edge.

The magnetic field emanating from a small source is non-uniform due to its considerable divergence with distance. Therefore the field intensity at the very surface of the capstan, for instance, will always be of a higher order than the value measured at the instrument staff. While this non-uniform field effect is at a maximum for small size parts, it becomes progressively less as the measured source grows larger and is non-existent in a uniform field. The magnetometer reading is valuable however, as it is directly relative to values of magnetism in the parts being checked. Acceptable levels that are consistent with good recording practice are quickly determined.

*Continued on page 58*

# Money talks

WHETHER YOU'RE SPENDING IT, OR SAVING IT

That's why it makes good dollar sense to consider the 100B-16 console for your operation. It's a completely professional 16 in-16 out unit with features you can't believe possible in a \$9500 console. There are no extras to buy and no hidden costs.

- All Solid State OP Amp Design
- Sixteen Track, Wet Monitor-Dry Record, Monitoring
- Nine Frequency Equalization (Low-Mid-High) on each input
- Plus 29 dbm headroom
- Distortion less than 0.1% at rated output
- 20 VU Meters
- 144 Patch Points
- Studio Talkback
- 2 Cue Systems
- Pan Pots on each input
- Conductive Plastic Linear Attenuators
- Compact Size: 28 x 48 x 15 inches
- Frequency Response: +1 DB 20 - 20,000 Hz.

**M MAZE CORPORATION**

P.O. BOX 6636 BIRMINGHAM, ALABAMA 35210 PHONE (205) 591-4000

OFFICES AND WAREHOUSE, 514 ALTON ROAD BIRMINGHAM, ALABAMA

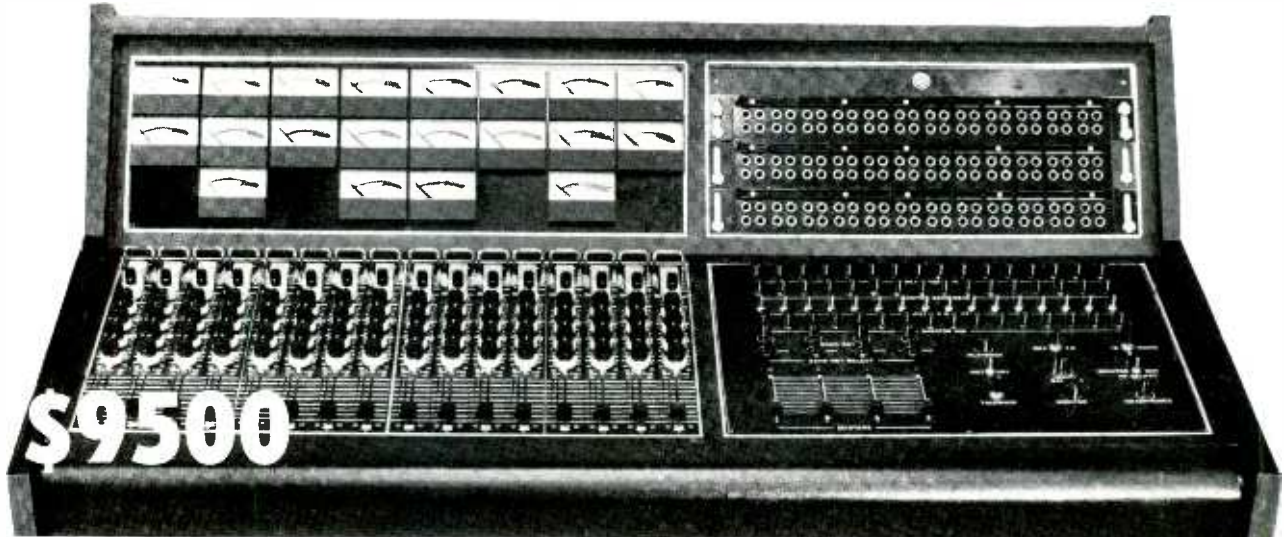

Circle No. 107

Re/p 13

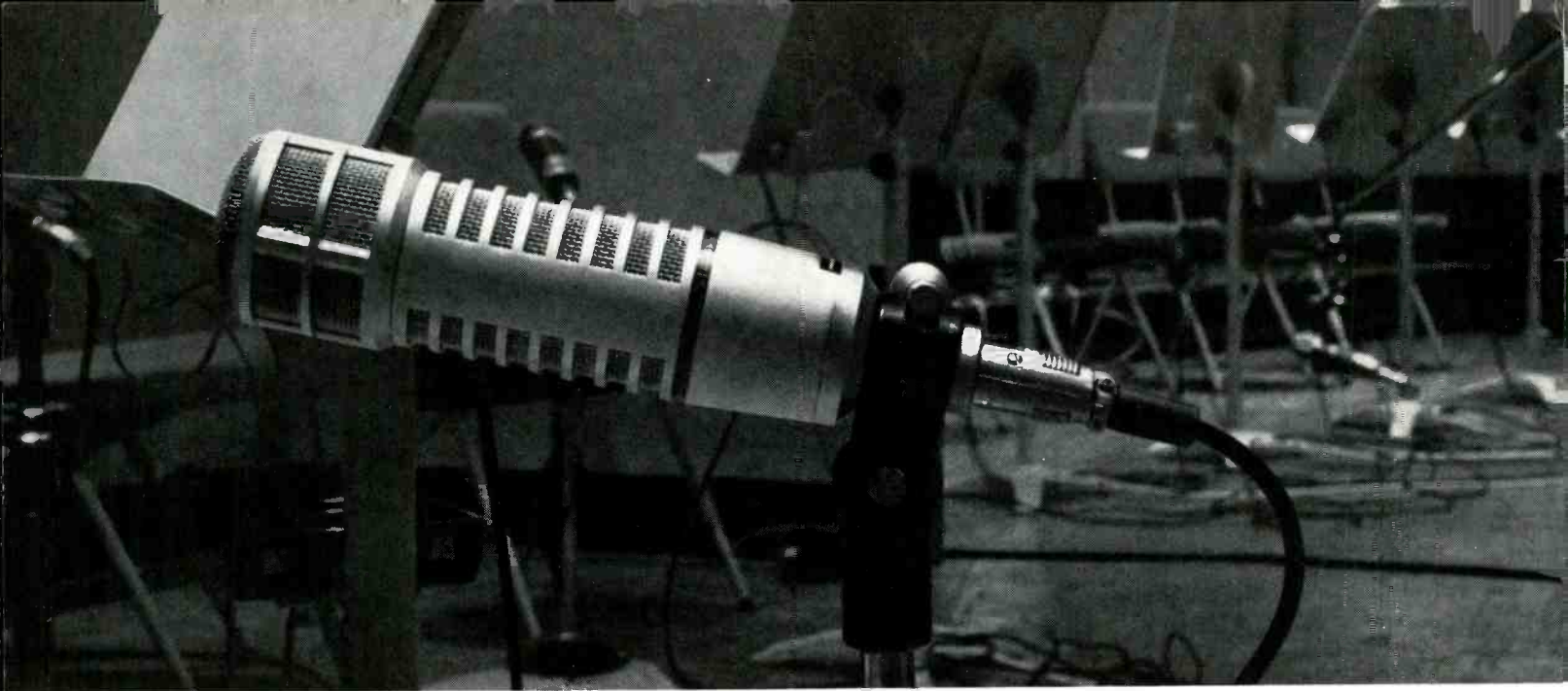

# How good is the new Electro-Voice RE20 studio dynamic microphone?

## Here's proof from the new scoring stage at Glen Glenn.

**E-V** The fine reputation of Glen Glenn Sound Company rests on their knowledge of sound... their ability to turn a full symphony orchestra into a perfect sound track for TV, the movies, or a new album. And their desire to be first with the finest.

So for their new scoring Studio M, Glen Glenn engineers asked to see the latest products in every category... tape, film, electronics, and — of course — microphones. Especially a new E-V dynamic cardioid microphone which they had seen in prototype form earlier.

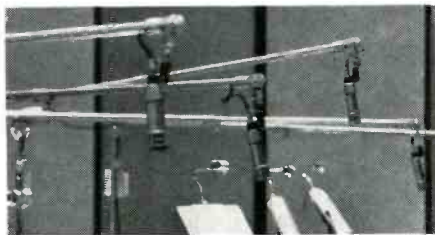

Glen Glenn put the RE20 to the test. Including days of studio experiments and actual sessions that pitted the RE20 against every type of musical instrument. Plus a searching critique by the musicians themselves. The RE20 passed every test with flying colors.

As a result, when Studio M was completed, RE20's were on the booms... almost four dozen of them from our first production run.



Since then, Glen Glenn has scheduled a number of major recordings with RE20's. And the RE20 has often been used where previously an expensive condenser was the automatic choice. Why? Because the RE20 has proved itself a significant advance in microphone design. With wide-range, peak-free response on axis (even the off-axis response is better than many other studio microphones on axis). Transient response rivals any other studio microphone, regardless of design. Directional control is uniform and predictable from every angle. Yet proximity effect is virtually eliminated (a problem that plagues almost every cardioid — except E-V Continuously Variable-D® microphones).

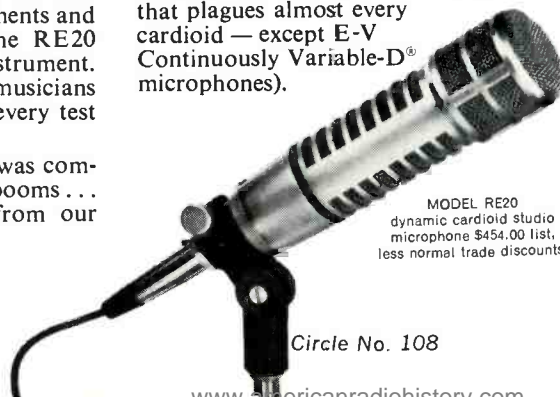

MODEL RE20  
dynamic cardioid studio  
microphone \$454.00 list,  
less normal trade discounts.

In short, the RE20 does everything a good condenser does, and some things better. Without the complication of power supplies. Or special cables. Or shock mounts or windscreens (they're both built in). Or the need for equalization just to overcome design faults.



It's simple. It's flat. It's rugged. It's clean. With a 2-year performance warranty unmatched in the industry (it's spelled out completely on the spec sheet). The RE20. For the studio looking for better sound. Your E-V microphone specialist will gladly loan your studio an RE20 to make any tests you like. Call him today.

P. S. For full technical data on the RE20, write us today. To find out more about Studio M, write Joe Kelly, VP, Engineering, Glen Glenn Sound Company, 6624 Romaine St., Hollywood, Calif. 90038

ELECTRO-VOICE, INC., Dept. 1131RP  
686 Cecil Street, Buchanan, Michigan 49107

**Electro-Voice®**

A SUBSIDIARY OF GULTON INDUSTRIES, INC.

# THE 3-WAY CONTEST FOR A 4-CHANNEL FORMAT

BY GARY D. DAVIS

Currently three systems are competing for the quadrasonic market in the United States; Sansui's QS system, Japanese Victor Company's (JVC) CD-4 system, and Columbia's (CBS) SQ system. Additionally Nippon Columbia Company of Japan, unrelated to CBS here, has proposed a fourth system for quad recording which was developed in cooperation with Dr. Duane Cooper of the University of Illinois — the QMX Carrier Channel Disc. Despite the promise and the favorable comments we have heard, the Nippon Columbia system does not seem to be under serious consideration by any artist or record company we have encountered.

Before analyzing the practical usefulness of each of the systems, it might be constructive to review the basic operational characteristics of all three systems. JVC's CD-4 system utilizes a high frequency carrier to multiplex (frequency and phase modulation) two additional channels of information on the left and right channels of a disc. Each side of the stereo groove of the disc is analogous to an FM radio signal, where instead of a left-right multiplex, there is a front-back multiplex, so that the twin multiplexed signals contain four channels of information. Sum and difference matrices are used in the CD-4 system, and the disc is

known as a "Quadradis," or a "discrete 4-channel disc." A demodulator in the playback system recovers the four channels from the disc.

Columbia's SQ system utilizes an asymmetric phase matrix to encode four channels into two, on a tape or disc, as well as for broadcast. The matrix blends differing proportions of the four corner signals into each of the stereo channels, and phase differences are created to correspond with positions around a 360° field. The asymmetric nature of the SQ matrix refers to the non-linear change in phase angle as the signal position is moved around the 360° circle. A decoder (not to be confused with a demodulator) in the playback system is then used to sort the information into four channels.

Sansui's QS system utilizes a symmetrical amplitude and phase matrix to encode four channels into two, in a manner that is similar but by no means identical to SQ. The symmetrical nature of the QS matrix refers to the linear change in phase angle as the signal position is moved around the 360° circle. A decoder in the playback system is then used to sort the information into four channels. But the QS and SQ decoders are different, due to the differences in

the encoding of each system.

SQ and QS are matrix systems, and matrices, mathematically speaking, provide less theoretical channel separation than the CD-4 system. Psychoacoustic methods are used by both Sansui and CBS to enhance the perceived separation of matrix recordings: Both matrix systems use the illustration of the NTSC color television standards, where perceptual requirements have been satisfied with less color resolution than is theoretically possible, to build a case for psychoacoustic capability. \* A great deal of technical information, as well as emotion and promotion, is available concerning all three systems, and sources are listed at the end of this article.

In attempting to sort out the common criteria and to provide some clues to what we believe are the key questions in the controversy of quad, we have tried to

*\*The chrominance (color) of a television picture has only about ten percent of the resolution of the luminance (brightness). This practical compromise permits narrower signal bandwidth, and the end result appears to be quite acceptable. The analogy with matrix psychoacoustics is that the reduced information content of a matrix is not necessarily detrimental to perception of adequate separation.*

# noise reduction takes a giant step forward with the dbx 216

With the dbx 216 professional tape noise reduction system, you get every one of these advantages over less advanced approaches:

- in excess of 30 dB of noise reduction which gives you an extra safety margin and lets you forget about noise build-up even in 24 channel applications
- 10 dB headroom improvement eliminates tape saturation or tape recorder overload worries
- 100 dB dynamic range makes level setting less critical
- no pilot tones or level matching required, just turn on and record
- true RMS level sensing guarantees perfect code/decode tracking and transient reproduction throughout the record and playback cycle
- simultaneous record and playback functions eliminate mode switching, remote control necessity, just plug-in operation
- spare two-channel module supplied with a 16-channel system reduces down-time to near zero
- complete cable assemblies with prewired mating XLR connectors make installation a simple 30-minute plug-in operation
- expandable modular design allows purchase of as few as four channels, with easy subsequent expansion to 8, 16, 24, or any number of channels
- typical 16-channel simultaneous record/playback noise reduction system with spare module and cables, ready to install costs \$8,200
- available from professional audio dealers or the factory



dbx, Incorporated, 296 Newton Street, Waltham  
Massachusetts 02154

**dbx**

analyze some of the very complex arguments set forth by the various protagonists. With manufacturers busy selling equipment, and the Federal Communications Commission considering action which may strongly influence the future of quad, we find the current state of affairs disturbing. We are disturbed because we believe that the artist, the record company, and even the consumer should guide hardware and legal interests, and not, as it seems to be, vice-versa. For this reason, we have focused on the similarities and differences between QS, CD-4 and SQ, allowing the individual to arrive at his own well informed decision.

We have made every effort to be honest and thorough in our research and presentation, leaving as many conclusions as possible to the reader. Ultimately we do expect one system to emerge as a standard, whether official or otherwise. The sooner this happens, the sooner we will be able to concentrate on the real issue — making records that give the most pleasure to the greatest number of listeners.

#### CRITERIA FOR EVALUATION OF A QUAD SYSTEM

There are numerous criteria which immediately come to mind when we consider quad; separation, frequency response, image localization, stereo/mono compatibility, broadcast compatibility, and cost. The tendency has been to treat certain of the specifications as absolute "musts" and to ignore other aspects as being marginal — a tendency which shifts depending upon which system is involved. But the most important single consideration, it seems to us, is that of broad practicality. For example, does a system really hinder an artist's freedom? Does it provide more options? How difficult or straightforward is it to produce the quad product? What does the system offer to the consumer, and what does it demand of him? In our search for the answers to these questions, we often learned that what appears to be theoretically correct is not always the best practical solution: Practical requirements may sometimes be fulfilled before theoretical limits have been approached.

#### SEPARATION

JVC has termed CD-4 the only "discrete" disc, and infinite separation has been implied by phrases such as, "(CD-4 will) faithfully reproduce all four channels of the original sound field in all their undiluted and independent glory . . ." [1]. CBS has speculated that SQ decoding logic will ultimately be developed to yield infinite separation, ac-

ording to claims in a recently published paper [2]. Sansui has indicated that they have already achieved 40 dB of separation in the laboratory, and that even more is theoretically possible with QS [3]. Without disputing these claims, and they are certainly open to debate, we should inquire about how much separation is necessary, and how much is now really available?

The signal to noise ratio (SNR) of most recordings is 60 dB or even less, so that separation beyond that figure is meaningless in practice. As another point of reference, currently stereo discs average only 20 dB to 25 dB left-right separation for good quality recordings. One reason for the limited separation is the crosstalk inherent in playback cartridges. Another reason, which will be even more critical with quad than with stereo, is that some inter-channel blending is often desirable so that the listener does not have to sit in an extremely small central area for the intended balance to be heard. With a quad recording there is more than one way to describe separation, as illustrated in figure 1. On the basis of these factors, we can probably assume that if 20 dB of separation (in all directions) is achieved from a quad disc, there is no reason to expect that consumers or even artists will need more.

Tom Nishida, resident engineer at the JVC Cutting Center, Inc., Hollywood, has told us that CD-4 currently provides 20 dB of separation in all directions, and other sources confirm that this 20 dB includes phantom (non-speaker located) centers.

The two matrix systems, QS and SQ, may be decoded on relatively simple circuits, providing limited (less) channel separation for significantly lower cost. Increasingly complex logic may then be applied to the basic matrix decoders, producing considerable increases in separation for somewhat more money. The most complex matrix logic, however, currently costs only about half of what CD-4 demodulation now costs. Addi-

tionally, matrix playback systems require no special stylus or cartridge. With CD-4, virtually no compromises in cost or complexity are available which will yield less separation for less money.

#### MATRIX SEPARATION SPECIFICATIONS

There is considerable confusion about the separation specifications claimed for SQ and QS systems, with and without logic (circuitry which enhances apparent separation through various means). Without going into great detail, it is acknowledged that considerably less front-back separation is available with a basic matrix decoder than with a CD-4 demodulator. When CBS SQ-with-logic is used, 20 dB of corner (adjacent) channel separation can be achieved [4]. However, only 7.7 dB left center to right center separation is provided. QS logic, which Sansui refers to as a *vario-matrix* achieves 20 dB of corner channel separation, with essentially the same side center limitation as SQ [5]. But the nature of the separation in SQ and QS is very different, and deserves the following additional comment.

The SQ matrix, also known as a phase matrix, was developed to increase the limited front channel separation that could be achieved from basic decoders (non-logic units) and from stereo playback. This increase was achieved at the expense of rotational symmetry. On the other hand, the QS matrix, introduced two years prior to SQ, is an amplitude-phase matrix. While it offers somewhat less front channel separation than SQ on a basic (non-logic) decoder, it is rotationally symmetrical. This is why the Japanese Record Industry Standard (RIAJ) describing Sansui's QS encoding refers to it as RM, or Regular Matrix [6]. Even a basic QS decoder provides infinite (their terminology, not ours) separation between diagonally opposed channels.

SQ logic is available with F-B (front-back) and W-M (wave matching) elements. A V-B (variable blend) method has been proposed, and CBS expects commercial availability in Summer, 1974. SQ logic with F-B and W-M elements is known as "full logic," and with the addition of V-B it will be known also as a "paramatrix" decoder. The SQ logic uses the psychoacoustic principles of back image contraction, front source dominance, and quadrature image shift to achieve greater apparent channel separation [7]. In simplified terms, a loud sound in the front causes the gain of the rear channels to be reduced. This increases the apparent front-rear separation. However, if a low level signal is present in the rear channels when this occurs, it

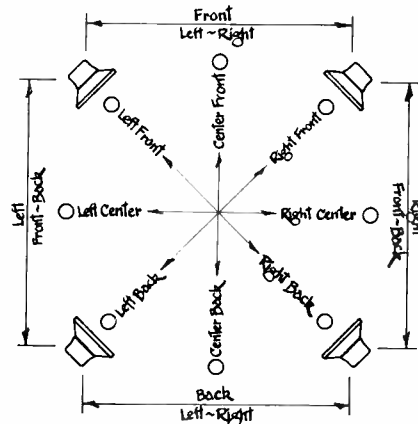

Fig 1 - Basic Separation Relationships for Quad recording

will decrease to the point where it may disappear. This amounts to a "switching" action, which may become noticeable if the listener faces the rear speakers, according to the comments of numerous critical SQ listeners. Therefore the 20 dB of SQ separation is predicated on the listener being critically oriented with respect to the front speakers.

QS logic consists of a *variable-matrix* which has recently been improved to deliver a full 20 dB of adjacent channel separation [8]. QS logic uses the psychoacoustic principle of directional masking to achieve its separation, whereby the *vario-matrix* controls the blending coefficient of the four channels without altering the gain of the decoding amplifier. In other words, the total sound output shifts in direction, but not in content, in order to increase apparent separation: QS is, in this respect, unlike SQ gain control. QS is symmetrical, and the listener may face in any direction and continue to hear equally well defined separation [9]. We refrain here from offering our personal opinion of CD-4, SQ or QS separation, although we have spent considerable time listening to all three systems under a variety of circumstances, and we do believe our statements are correct.

## FREQUENCY RESPONSE

The frequency response of a CD-4 disc is restricted by JVC to between 30 Hz and 15 kHz [10]. The absolute level of lower frequency information is further reduced for diagonal placement, due to tracking problems that result in intermodulation distortion [11]. CD-4 terminology is sometimes confusing, and when we speak of the *bass band* we are referring to the left or right sum signal, recorded between 30 Hz and 15 kHz: When we speak of the *carrier* or the *carrier band*, we are referring to the left or right difference signal, recorded on the 30 kHz carrier frequency so that the information is actually located between approximately 22.5 kHz and 37.5 kHz. The bass band is equalized to the RIAA curve, whereas a JVC standard is used for the carrier band. It has been observed that the low frequency response of a CD-4 quad disc is somewhat diminished in quad playback. However, we cannot verify this observation in any existing CD-4 literature.

Both SQ and QS matrices offer specified frequency response that compares with ordinary stereo discs, extending on the high end to 20 kHz. It should be pointed out that the RIAA equalization curve extends only to 15 kHz, and the JVC 15 kHz cut-off frequency may be justified to some degree by this fact.

However, higher frequencies are being created and recorded in the studio: Whether or not higher frequencies can be accurately placed on any disc-stereo, QS, or SQ - is a controversial issue. The point is that CD-4 limits the response with sharp filters, unlike either matrix system.

## QUADRAPHONIC PSYCHOACOUSTICS

Four channel sound may be composed, performed, recorded, mixed, and played back in infinitely varied ways. This is really the core of what quad means, and it would unfortunately require more space than we can provide to adequately treat the subject. However the basic advantage of a quad system is that it purportedly increases the ability to recreate a 360° sound field in a playback situation; one which more closely represents either the original sound field or the sound that the producer and mixer have chosen to develop. It is so far not known whether four or eight or forty-eight speakers are sufficient to create a 360° sound field with totally unambiguous "realistic" dimensions. But it is probably safe to assume that four speakers can undoubtedly do a better job than two.

How is the location of sound actually perceived? It seems that a combination of phase and level differences (where phase is related to the arrival time of sound in each ear) are the primary cues that the sensors (ears and brains) utilize. Either phase or level may alone be used, although it is known that phase differences provide less precise directional information than do level differences. Research in this area falls under the general heading of "psychoacoustics."

Anyone who has inadvertently wired one of two stereo speakers out of phase may have observed the divergence of the phantom sound images. This is an illustration of how we perceive phase relationships (assuming, that is, that the acoustic levels remain unchanged - which, because there is acoustic cancellation in the room, may not be the case). Conventional stereo and quad pan pots create level differences to achieve sound image placement (whereas X-Y and MS techniques achieve image placement with both level and phase information).

A paper by Dr. Helmut Haas, in 1951, described the basis for a very significant psychoacoustic principle, now known as the Haas (precedence) effect. Stated simply, signals from spatially separated sources fuse into an apparent single image located at the position of the nearest source [12]. Benjamin B. Bauer of CBS states that the Haas effect "...recognizes that when equal sound patterns emanate from two sources the ear tends to credit

the nearest source with the origin of the *total* sound, at the same time allowing us to trade intensity for time," [13]. Although a mixer or artist need not understand the Haas effect to use it, the design of quad systems must certainly incorporate an understanding of this and other principles.

Sansui, for example, cites a recent study which determined that loud sounds mask the directionality of smaller sounds when both sounds arrive at the same time [14]. Moreover, a *backward masking* effect occurs where an interfering sound arrives later than a principle sound, causing obscured directionality for both sounds.

We could continue to describe the various psychoacoustic effects, but again, it would require far more space than we have available: The references cited at the conclusion of our article can provide considerable enlightenment for the interested reader.

The term "psychoacoustic" is commonplace, and yet it often stirs waves of antagonism, and sometimes uncomfortable reactions, when it is merely mentioned. Really the word, or the concept, is symbolic of a scientific attempt to understand and to quantify some of the areas where the recording industry has long been dominated by subjective thinking: It may be that when subjective judgements are exposed to objective measurements, a challenge is felt. This is not to suggest that any one theory is definitive, but quad has promoted a healthy trend toward fostering a better understanding about how we hear - an understanding that can be used to improve all forms of audio presentation. And, it is essential to realize that, despite some claims to the contrary, all quad systems depend upon psychoacoustic principles for the localization of sound images: The different systems merely depend upon varying aspects of psychoacoustics.

## IMAGE PLACEMENT

Theoretically CD-4 permits the most precise image placement of the three systems. To the extent that speaker-referenced placement is unaffected by signal phase, CD-4 placement may be considered less phase dependent than the matrix systems. But for correct phantom image location, even CD-4 recordings require careful attention to the phase relationship of all components in the system. The non-phase dependent chan-

---

*PSYCHOACOUSTICS* An article on sound localization by Mark B. Gardner of the Bell Telephone Laboratories contains an extensive bibliography on this subject. See M.B. Gardner, "Some Single and Multiple-Source Localization Effects," *J. Audio Eng. Soc.*, Vol 21, No. 6, p. 437, (July/Aug 1973).





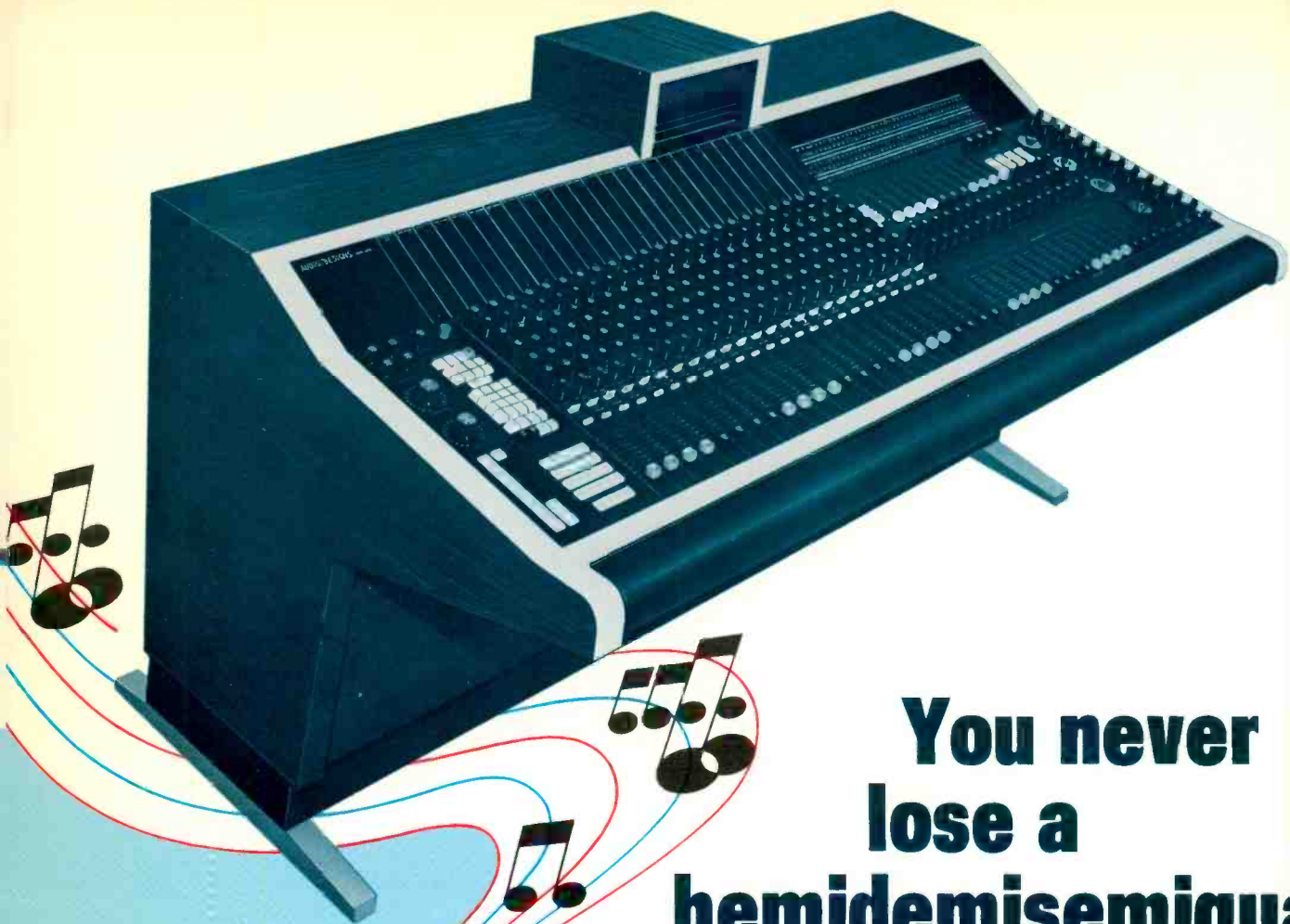

**You never  
lose a  
hemidemisemiquaver  
with Audio Designs  
Consoles and Components**

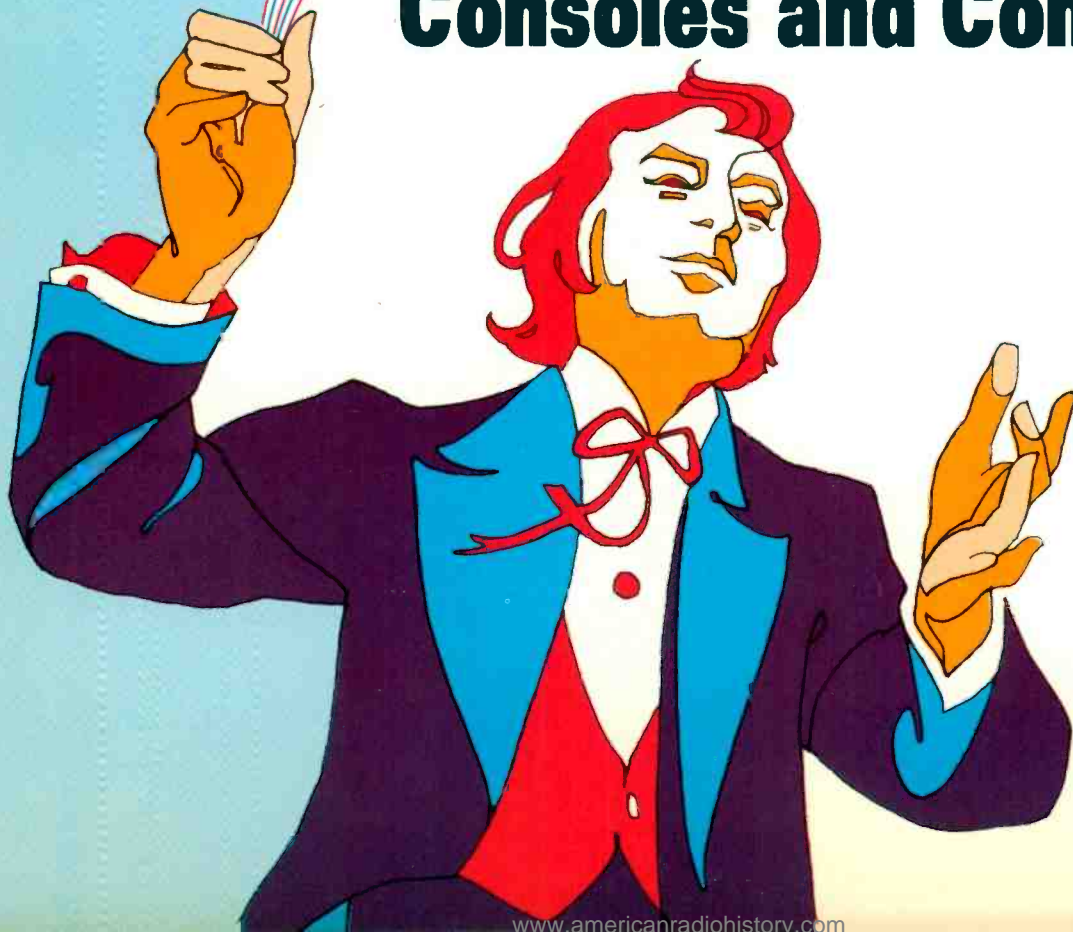

# ADM NRC SERIES CONSOLES

## hit a high note in Quality . . . Versatility

## . . . Performance

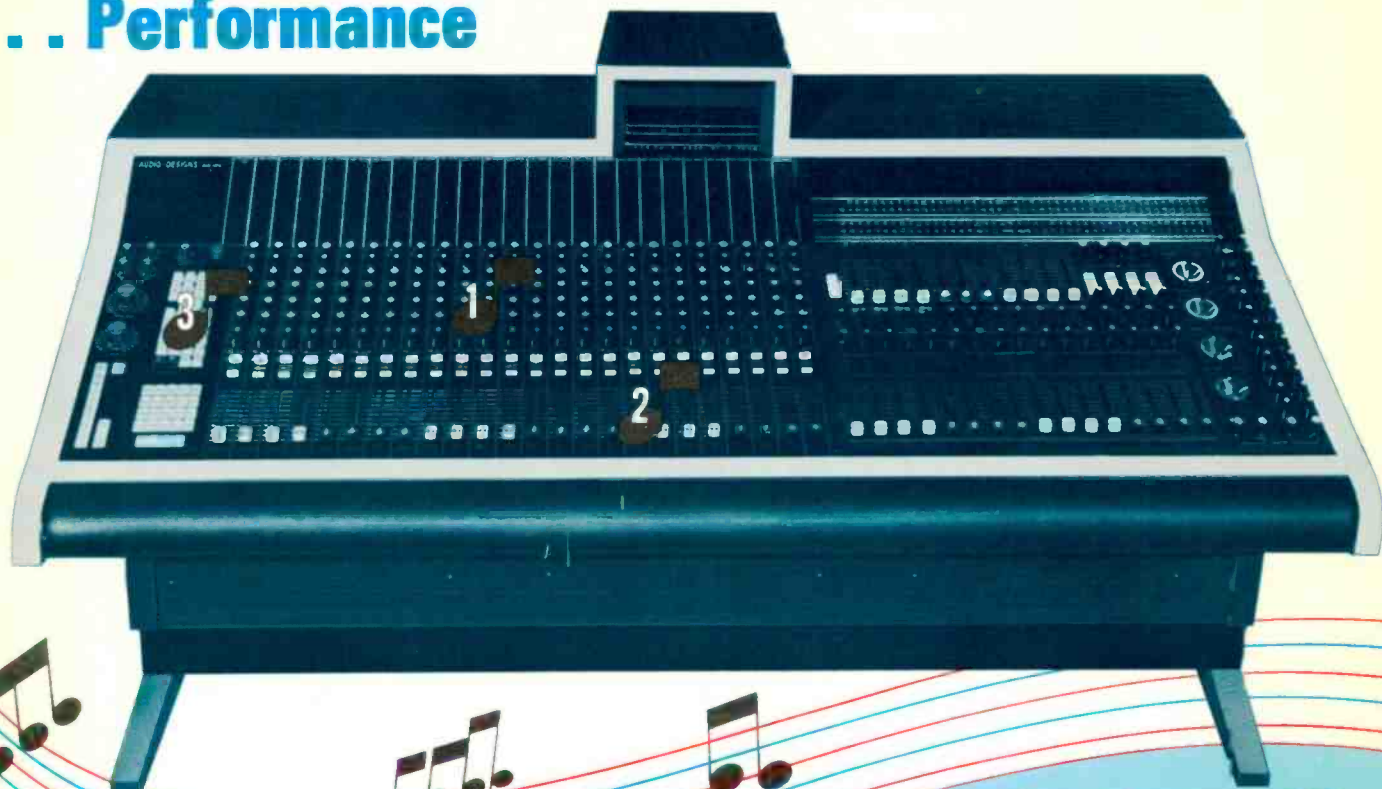

### Full-featured 8-16-24 Channel models at amazingly low prices

No one gives you more for your money than ADM. All ADM NRC Series Consoles are professionally engineered with such precise controls that you never miss or mess up a note. Yet we have held prices down through use of trouble-free "Mother Board" construction that eliminates literally miles of costly wiring . . . without sacrifice of quality, performance or "state-of-the-art" specifications.

You get high reliability features that ADM engineers into its custom consoles, including Slidex, Audex, four Cue Busses, two Solo Systems, complete Sync System, complete Tip, Ring and Sleeve Patching, Full Quadraphonic Capabilities including four Joy Sticks. And you get the flexibility and convenience of interchangeable plug-in modules, which make it easy to expand your console for future needs.

Chances are that one of our NRC models will meet your needs nicely. If not, we will be glad to work with you to integrate our components into your existing system, or in designing a custom console to your exact requirements.

### Interchangeable Plug-in Modules for complete flexibility



**1 INPUT MODULES**  
Versatile input strip features op-amp circuitry and 10LR-section equalization. Input overload light and Solo button are also included. Everything required at an input is in one convenient plug-in module.

**2 SLIDEX**  
Unique, noise-free attenuator uses sealed elements. No contacts to clean. Even spilled coffee won't cause noise problems. Guaranteed free from noise or other defects for five years.

**3 AUDEX**  
Ultra-reliable switching system uses magnetic reeds governed by this compact control panel. Switch modules, mounted above inputs, include illuminated readouts for instant reference.



# ADM VUE-SCAN

Sweet music for frustrated  
"head swivelers"

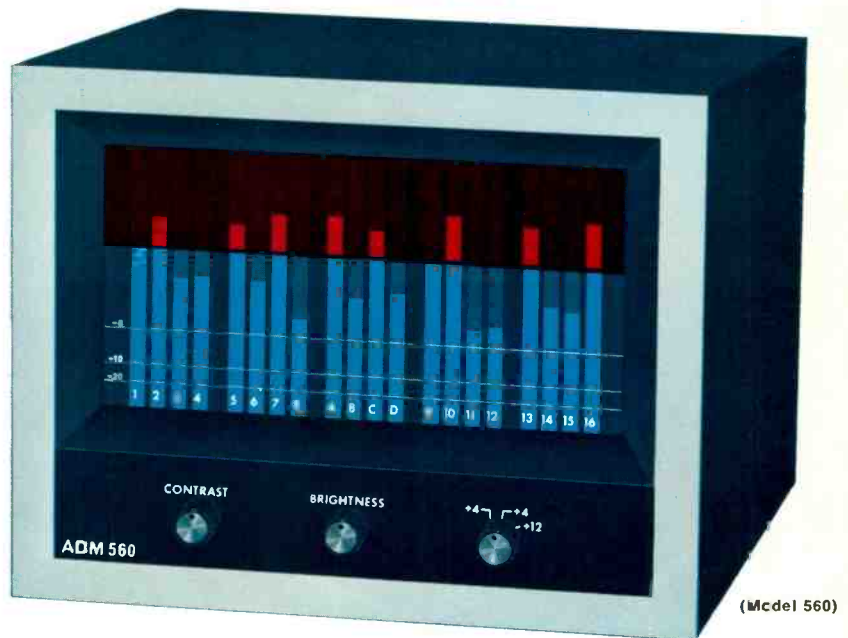

## Replaces up to 28 VU meters with an easy-to-read bar graph monitor

ADM's new Vue-Scan solves one of the most troublesome and annoying problems of multi-channel recording . . . visual monitoring of the recording channels. Vue-Scan takes up to 28 channels of audio information, and displays each channel as an easy-to-read bar graph on a TV monitor screen.

Each illuminated bar represents one analog channel. The vertical bars are always present as a background hue—the lower two-thirds in blue and the upper one-third in red. As the level of a channel increases, the bars representing that channel increase in height and intensity—making it almost impossible to overlook an overloaded channel.

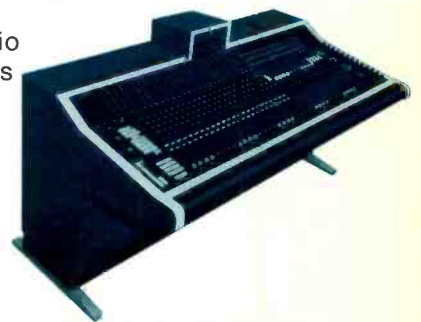

Vue-Scan is standard on all NRC Series Consoles, replacing VU meters, and is also available as an option on Custom Consoles. In addition, it can be used as a self-contained accessory with any ADM or competitive console.

# More sound ideas from ADM

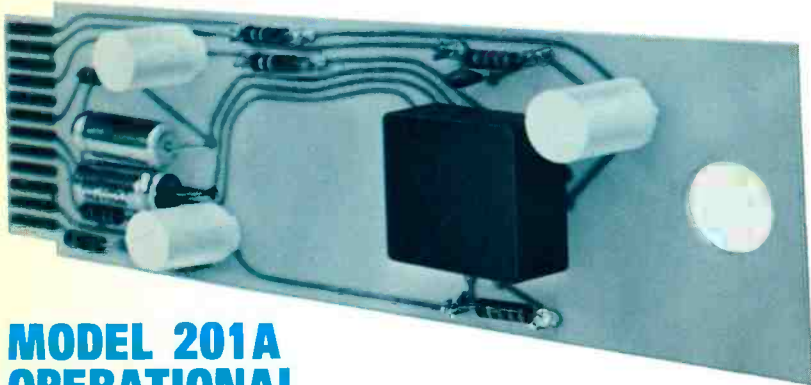

## MODEL 201A OPERATIONAL AMPLIFIER CARD

An audio operational amplifier designed on a 2.5" x 7.5" plug-in card, which can serve as a pre-amp, line amp or booster amp. Feedback stabilization is provided by "state-of-the-art" feedforward technique, providing the fastest possible response, and extending the frequency at which maximum feedback is available. Specially designed for low noise, and includes short circuit protection in the output stage.

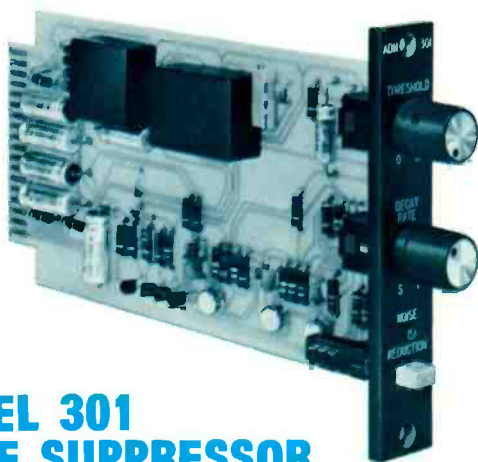

## MODEL 301 NOISE SUPPRESSOR

A new, fast gain expander that puts silence where previously there was noise. It will turn on from dead silence with a cymbal crash and not miss a single cycle of sound. Because it is a true gain expander, with a continuously varying gain, there are no threshold clicks, nor is the ear aware of the threshold. Extremely fast attack time, and smooth operational characteristics. Packaged on a 4" x 7½" card.

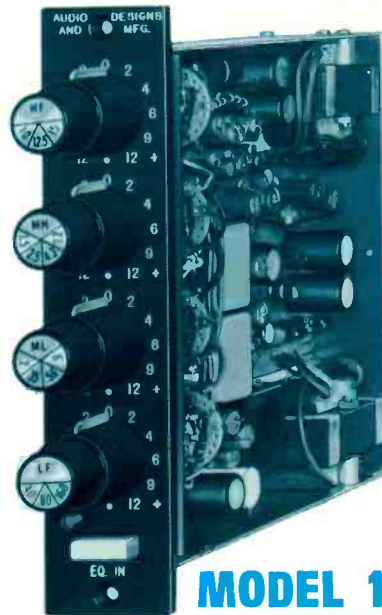

## MODEL 1500/1501 EQUALIZER

A unity gain equalizer, designed to provide EQ anywhere in an audio system. Features ADM's exclusive four band equalizer, providing reciprocal EQ functions in low frequency (LF), low mid frequency (LMF), high mid frequency (HMF), and high frequency (HF) bands. Four bands and reciprocal functions provide absolute control over the entire frequency spectrum. Model 1500 is designed for vertical mounting in a console; the 1501 mounts horizontally in the CH15 Frame.



16005 Sturgeon  
Roseville (Detroit), Michigan 48066  
Phone: (313) 778-8400

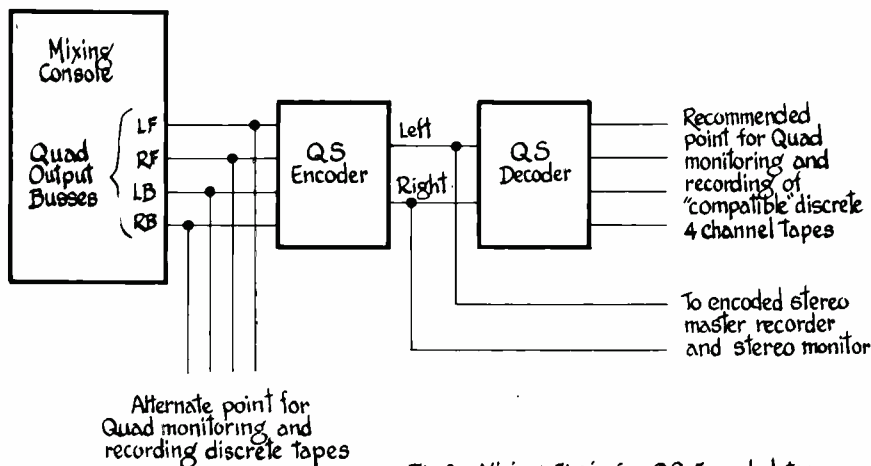

Fig 2 ~ Mixing Chain for QS Encoded Tapes

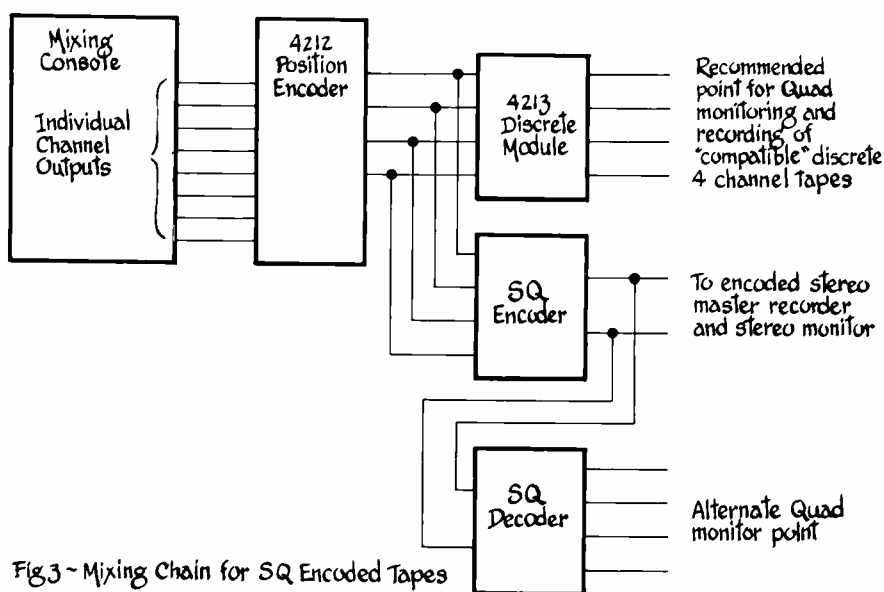

Fig 3 ~ Mixing Chain for SQ Encoded Tapes

nel placement of CD-4 permits a four track tape which has been previously mixed (such as for Q-8 cartridge release) to be transferred to a CD-4 disc without special remixing to correct the image placement.

Sansui's QS matrix offers virtually the same flexibility and accuracy as CD-4, insofar as encoding of existing four track tapes is concerned. ABC-Dunhill Records, for example, is making discrete four track tapes (for Q-8 cartridge release) by using the same mixes which are QS encoded for *Impulse* quad discs; they have observed no compatibility problems [15]. With the QS symmetrical matrix, a sound may be panned 360° or placed anywhere within that circle by conventional (sine-cosine) panning. Sansui does recommend monitoring the mix through their encoder and decoder so that optimum placement may be established for a particular mix. See Figure 2.

Columbia's SQ matrix claims the abil-

ity to allow direct quad encoding of existing four track tapes. Yet CBS literature describes an additional position encoding module which assists in making a quad product with more precisely controlled image placement. This device, an add-on module to the SQ encoder, is packaged as a set of eight special pan pots, with switching to allow two panning configurations. Special phase shifting circuitry in the CBS 4212 Position Encoder is required for optimal placement of any sound. When the position encoder is used to pan a sound, the level and the phase angle are modified so that the SQ matrix will yield the desired position after decoding. Because additional phase shift is introduced by the position encoder, the four channel output of the encoder represents a quad mix that is less than ideal for discrete tape release. Recognizing this situation, CBS offers their 4213 Discrete Module which corrects the phase so that a simultaneous encoded SQ tape and a tape

suitable for discrete four track release may be obtained. See Figure 3. According to Jerry Budelman of CBS, the position encoder may not be used to optimize the placement of a previously mixed four track tape. Moreover, optimum placement of sound may only be achieved with the position encoder [16]. It would therefore appear that previously mixed four track tapes cannot be optimally encoded through the SQ system.

Phase reversal of any input on either an SQ or QS master will definitely cause incorrect image placement. However, this will be immediately obvious if the mix is monitored through the encoder and decoder, as is recommended for both systems. Although such a phase reversal will not cause incorrect channel placement on a CD-4 master, it will shift the image of the perceived sound. Therefore the phase of any recording and playback system is critical to good quad sound (which is also true of stereo).

We feel it is important to note here that Sansui has maintained the same encoding scheme since its introduction in 1969. The only improvements have been in the decoding, and these have not changed the relative image location of previously recorded material. SQ has presented several encoding schemes, and when asked about specific changes, they replied that the SQ 4/2 code has not been changed since its introduction. However, the SQ code specifies only center-front, center-back, and corner encoding data, and it appears that some modification of the sides and other areas is possible without violating the SQ code. CBS further appears to draw a distinction between "correct" encoding, which we understand to be that which satisfies the SQ code, and "proper" encoding, which we understand to be that which will be decoded and perceived in the intended (optimum) location [17] [18].

#### STEREO COMPATIBILITY

The viability of a quad system depends upon good stereo compatibility. Yet what is meant by compatibility is not clearly defined. There are three major aspects to compatibility of a quad disc, with respect to stereo (or even mono) reproduction; fold-up compatibility, physical playback compatibility, and artistic playback compatibility.

The artistic aspect is important because music mixed for four channel reproduction does not always sound good when it is played through one or two speakers, regardless of the method used to reduce it to fewer speakers. Just as stereo recordings are monitored and mixed with some compromises to increase mono compatibility, so apparently must compromises be made with quad recordings. The nature and extent of these



**ALLISON RESEARCH**  
 PO Box 40288  
 NASHVILLE, TENN.  
 37204



compromises is different with the three quad systems due to variations in image location, frequency response, and program content which occur when the number of playback channels is reduced.

### CUTTING LEVEL

Physical compatibility refers to the disc and the playback equipment. If we consider the stereo disc as a standard, then quad discs cannot be cut with equal level and time. CD-4 *quadradiscs* are the most limited in this respect due to three carrier-related characteristics [19]:

1) *The inner diameter must be held beyond approximately 5-1/2-inches in order to maintain the velocity required to reproduce the 30 kHz carrier portion of the signal. Stereo discs have about a 4-3/4-inch inner diameter limit.*

2) *The overall level of the bass band is restricted by the level limitations of the carrier, which are in turn limited by the cutting system and the tracking capability of the playback equipment. Although stereo equipment does not track the carrier, it must be there for the quad, and it imposes level limitations that do affect the stereo.*

3) *The presence of heavy low frequency information can cause intermodulation of the carrier band, which is related to No. 2 above.*

Although CD-4 cutting level has been improved by several dB since its introduction here in 1970 (by cutter head improvements and by dynamic distortion correction), the best product to date remains some 7 dB below the average "hot" stereo cutting. Although JVC claims their cutting is only 3 dB down,

this is with reference to a zero dB level, and stereo discs average 4 dB above that reference.

SQ and QS discs have no carrier-imposed limitation on the cutting level. But they both contain significantly more vertical modulation than their stereo counterparts; the vertical content caused by the matrix encoding processes. Since vertical modulation is difficult to track, a matrix disc should be cut at least 2 dB below the stereo reference level to avoid skipping upon playback [20].

CBS claims that their SQ disc can be cut 2.3 dB higher in level than the RM (in other words QS) encoded equivalent [21]. However, discussions with record companies and cutters who have worked with SQ and QS have not shown this to be the case, and SQ actually does depend on vertical modulation for a significant portion of its encoding. The differences between SQ and QS vertical modulation are related to the relative signal positions that cause the modulation: Therefore, while one mix might indeed cause less vertical modulation on SQ, another mix will cause less vertical modulation on QS.

The point being made is that any quad disc will probably have somewhat less level than a stereo disc, although the difference is less with the matrix products. And, matrix discs can be cut to the same center diameter as stereo discs.

### FOLD-UP COMPATIBILITY

Fold-up compatibility, for lack of a better term, is what occurs with the electronic and acoustic combination of four channels into two or one. The CD-4

disc played on stereo equipment yields a rear speaker to front speaker combination for each side. The side centers seem to move inward slightly, depending upon the mix. Generally the CD-4 fold-up provides accurate stereo image placement, with good separation of front channels.

JVC has been working toward higher cutting levels since CD-4 was introduced here. The level was not so much of a problem in Japan because Japanese LP's are all cut at lower levels than U.S. releases.

QS was first developed as a means for enhancement of stereo recordings, and this may explain why QS folds up to give what many consider to be a pleasant stereo effect. The nature of the image location is illustrated in figure 4. Note that the rear channels move outside the stereo speakers, the side centers become the stereo speaker images, and the front speakers move slightly inside: This appears to "unfold" the room, and provides added depth to the stereo program.

SQ discs employ an asymmetric phase matrix which, when played in stereo, causes some image shift. This is due to the tendency for the image to move toward the speaker with leading phase, given a particular balance of level [22]. As illustrated in figure 2, the rear corner images move toward the center, and the side images move toward the center.

CBS claims that because a quad playback situation has back image contraction (the listener hears less apparent separation in the rear than in the front), that the rear speaker images should be folded to the inside of the stereo speakers [23]. As a result, the stereo SQ fold-up has more centralization of sounds than either QS or CD-4, and despite the 20 dB of stereo speaker separation there appears to be added monauralization.

Monaural compatibility is primarily important for broadcast of quad recordings, and this subject is treated toward the end of this article.

### EASE OF MIXING & REFERENCES

While CD-4 proponents claim that whatever is on the master tape will go on the *quadradisc*, and therefore no quick reference is required, it is also the case that no reference is readily available. The limitations and anomalies of a CD-4 disc, whatever they may be, will therefore require at least a day or more to confirm [24]; only three CD-4 cutting facilities are currently available in the U.S., and with a \$125K price tag, others are likely to proliferate slowly [25].

With both SQ and QS matrices, preliminary quad effect, stereo and mono compatibility may be assessed by mixing through an encoder and decoder. As a practical matter, it appears that rather than hindering a mix, the encode-decode

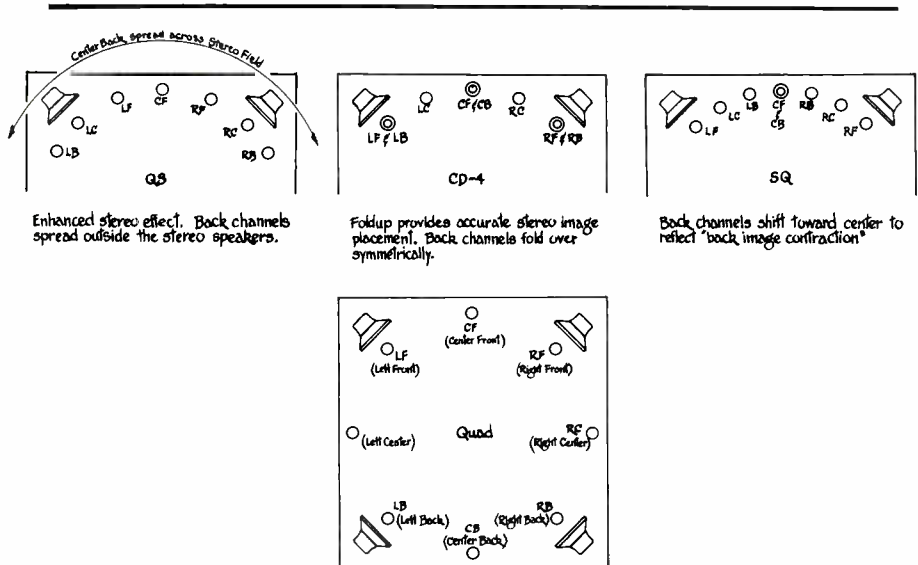

Fig 4 - Quad to Stereo Image Foldup for CD-4, QS, and SQ Systems

set up is a welcome means for initial and continuous evaluation of the mixing. A quick and inexpensive reference cut may then be made at any cutting facility by furnishing an encoded two track tape: The encoded tape does not necessarily require an additional generation, since it may be recorded simultaneously with the four track master (although SQ requires an additional Discrete Module).

### PROFESSIONAL SQ MATRIX HARDWARE

SQ encoding has been presented with a number of schemes, depending upon the particular encoder and the type of effect desired. The older CBS Model 4200 encoder had a switch for "normal" or "interior" modes, which changed the phase relationship of the rear channels with respect to the front channels. The newer 4211 Model has been described as a four input/two output device; but it actually has twelve inputs, corresponding to "normal" (SQ 4/2 code), "forward looking" and "backward looking" encoding. These various configurations are designed to optimize one or another effect, at the expense of others. CBS calls the three modes a "universal encoding set," [26].

SQ encoding is further complicated by the introduction of the so called "position encoder" or the "pan pot module," Model 4212. The Position Encoder may be used for panning around the 360° field in 24 segments (15° increments), or an (X)-pan switch permits diagonal or left-right front/left-right rear pans. The Position Encoder nominally consists of eight pan pots, and may be expanded in sets of eight. In order to encode a sound inside the 360° circle, other than on a diagonal between speakers, at least two of the pan pots must be used; the relative signal level and position setting of each panner may then be used for locating the sound. See Figure 5. While the 4212 provides a means for achieving a quad mix from a stereo mixing console, it is primarily required for any quad panning where optimum SQ encoding is desired. Its output, because it is phase shifted, will not usually provide optimum positioning for discrete four track tapes [27].

If simultaneous discrete four track tape and encoded SQ two track tape masters are required, the Model 4213 Discrete Module must be added to the encoding system. This module compensates for the phase shift of the Position Encoder so that a four track tape with optimal positioning can be obtained while making an optimally encoded SQ tape.

The SQ professional decoder, Model 2400B, now incorporates full SQ logic, W-M and F-B (a prototype of the paramatrix has been demonstrated).

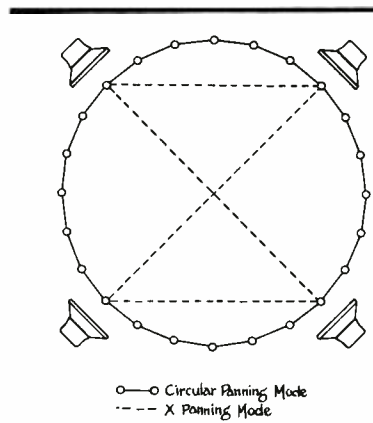

Fig 5- Panning Modes of 4212 Position Encoder

The price tags on SQ equipment are as follows: 4211 SQ Encoder, \$2800; 2400-B SQ Decoder, \$2800; 4212 Position Encoder, \$1800 per 8-input module; 4213 Discrete Module, \$1600. The 4211 encoder will be available in limited quantities, beginning in January of 1974, according to Benjamin Bauer of CBS Laboratories. The 2400-B decoder is now in stock. Judging from these prices, a minimum investment for optimum SQ encoding, 8-channel Position Encoder included, and decoding is \$7400 [28].

### PROFESSIONAL QS MATRIX HARDWARE

Sansui offers a six input (four corners and the side centers) QS encoder, designated Model QSE-4. It provides optimal encoding when used with any conventional mixing console equipped with standard pan pots. While the corner inputs are normally used, the side inputs are available where added stereo separation is required, or for panning a 180° arc with a stereo pan pot.

Optimal positioning of the encoded QS tape, since it is entirely done by the

encoder, allows the four track output of the mixing console to be utilized for making a simultaneous four track master tape, with no additional special equipment.

The Sansui QS professional decoder, with the latest *vario-matrix logic* is designated Model QSD-4. It contains provisions for special decoding of existing QS recordings with good monaural quality, as well as means for checking stereo and monaural compatibility.

The total price for a complete QSE-4/QSD-4 encoding-decoding pair is \$5000, with immediate availability from Sansui [29].

### CUTTING A QUAD DISC

CD-4 cutting requires a highly specialized laquer channel. In addition to a Neumann lathe with the latest SX-74 (or SX-68/4) head, and the associated four track tape machine, a variety of unique cutting electronics must be used. These electronics are required because the high-frequency carrier system is generated and processed with the audio at the cutting stage of CD-4 recording. Moreover, because only half-speed cutting is now possible with CD-4, associated signal processing such as noise reduction systems and equalization, must be special half-speed versions. Four monitor channels must be provided (although this is certainly desirable with QS or SQ, it is mandatory with CD-4). The cost of the special CD-4 cutting electronics, which occupies three full racks, is quoted by JVC at between \$62K and \$67K, with a delivery schedule of no less than four months. See Figure 6.

Besides the additional cutting equipment costs of CD-4, the system requires at least twice the mastering time of conventional systems. The current half-speed system represents an improvement over the original third-speed version (still be-

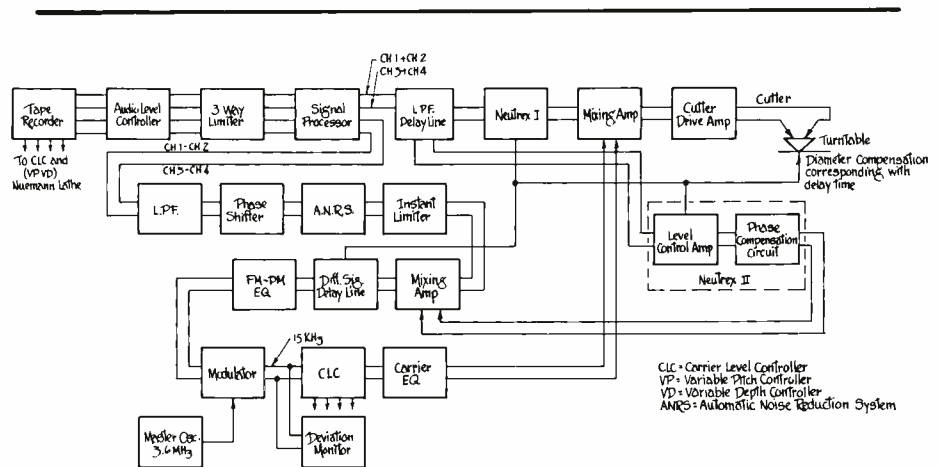

Fig 6 - Half Speed Cutting System



ing used at RCA in New York). Although JVC and Neumann are working toward real time cutting capability, both John Pudwell of RCA and Tom Nishida of JVC concede that there is no way to predict when or if this will be perfected. Half-speed cutting actually reduces the productivity of a laquer channel to less than half because cutting equalization cannot be effectively monitored during a cut. CD-4 is therefore considerably more expensive than stereo mastering. Representative rates, from the JVC Cutting Center in Los Angeles, are \$100 per side (14-inch Master) plus \$30 per hour of client time [31].

The cost for cutting SQ or QS is comparable to the rates for stereo discs, roughly half that of CD-4. This is true because no special equipment or techniques are required, and cutting may be done at full speed from an encoded two-track tape. A four track tape may be used, in conjunction with an encoder, although this is subject to the limitations discussed in the section of this article dealing with ease of mixing and references.

Where an encoder and decoder are desired, the laquer channel's added investment is relatively limited, under \$6K. Any lathe or cutter head may be used, although phase integrity of the system should be held to close tolerances.

#### PRESSING A QUAD DISC

Pressing any disc is more of a problem these days, due to the vinyl shortage. A number of labels have announced that they are no longer accepting independent work. Other labels are making fewer masters and/or pressing fewer copies. The most obvious impact of the shortage may be felt by CD-4 because these discs require an unusually pure, quiet, and durable compound. JVC had considered importing Japanese vinyl, which is purported to be better than domestic compounds, but the vinyl shortage in Japan has grown so severe that these plans have been set aside [32]. When CD-4 is pressed on regular vinyl the playing life and sound quality are adversely affected. So, despite advances in technology and chemistry associated with CD-4, pressing may be limited by practical considerations. Also, concentricity and lack of warping are critical for CD-4 discs.

QS and SQ discs may be pressed by any facility, using conventional vinyl. Naturally the better quality vinyls will yield better sounding discs, as is the case with stereo.

#### CONSUMER ASPECTS OF QUAD

As with the marketing of any product, the consumer ought to be given the best

quality for the least money. With quad, he should be able to enjoy quality that is at least as good as stereo now provides. There are some costs that remain the same for all three quad systems; four speakers and four channels of amplification: Elsewhere the systems differ.

CD-4 requires an expensive cartridge and stylus (the Shibata stylus has specially designed geometry for optimum tracking of the ultrasonic carrier frequencies) [33]. If the consumer already owns a good stereo cartridge, he must still spend another \$50 to \$75 to replace it. Since CD-4 demodulators depend upon phase and frequency modulation to recover the rear channels, a turntable of at least moderately good quality should be used. There is now no way to obtain inexpensive quad sound from a CD-4 disc, and any demodulator costs upwards of \$100.

Another consideration for CD-4 users is that the demodulator must be carefully adjusted to a test record in order to obtain correct results. This can only be done by the consumer, since the stylus, cartridge, tone arm, and wiring are all part of the system which the adjustments affect. Future developments may reduce the cost of demodulators, but the stylus and turntable quality will have to be maintained [34].

Both SQ and QS discs may be played with conventional stereo cartridges and

**versatile and compact  
easy-to-use,  
consider the reverberating  
things you can do.**



**RV-10**  
**a small number for a  
big system.**

**quad/eight electronics**

11929 Vose Street □ North Hollywood, California 91605 □ 213/764-1518

stylii, on virtually any turntable, for quad reproduction. Obviously a better cartridge and turntable will provide better sound quality, and a high-compliance system is especially desirable for optimum tracking of the additional vertical modulation. A basic matrix decoder will provide some degree of quad sound for only a few dollars of added cost in an amplifier or tuner package. Integrated circuit (IC) chips are available from Sansui and from CBS for relatively inexpensive manufacture of full-logic, optimum separation matrix decoders. The price of the four chips and associated discrete components necessary to manufacture a Sansui QS *vario-matrix* decoder (OEM) is \$12 [35]. The price of the three chips and associated discrete components necessary to manufacture a CBS SQ-with-logic decoder (OEM) is \$10 [36]. Both of these 20 dB decoders should sell for \$50 to \$80 as part of another component; separately packaged electronics will cost slightly more (based on the addition of labor costs and cost-to-retail mark-up).

Although no special set up is required for matrix decoders, it is important that the phase integrity is maintained throughout the system. Moreover, although it is not mandatory, the cartridge should be perfectly parallel to the disc so that the tracking angle best follows the encoding angle. Really, this is true with CD-4 as well as with matrix systems.

Beyond the cost factor, there is the question of how well the quad disc will resist repeated playings. SQ and QS should last as long as a stereo disc. CD-4, when pressed on the specified vinyl, will last for at least 100 playings, according to JVC-National Panasonic literature [37]. This life has been verified by at least one CD-4 user we interviewed [38]. We do not know what repeated playings of CD-4 on conventional stereo systems will do to the carrier, although there has been some speculation that the carrier could be "wiped" from the grooves, preventing later quad demodulation.

What about the consumer's stereo recordings? Can he use his quad system to achieve enhanced sound from stereo? With CD-4, only four channel stereo may be obtained, which does add some fullness to the sound. SQ-with-logic may be used to enhance a stereo recording, and it will tend to place any ambience or other anti-phase information in the rear channels. However, SQ logic tends to detect random clues in the stereo recording, sometimes causing a drift of sound images which can be disturbing [39]. QS decoding through the *vario-matrix* is now available to the consumer with two modes for stereo synthesis of quad sound: a Hall effect, where the ambient information is placed in the rear speakers; and a Surround effect, where the program

material is spread so that it partially surrounds the listener, placing him in the midst of the performance. QS decoding does not appear to exhibit any wavering of sound image — as mentioned earlier, QS was first conceived as a means for stereo enhancement.

In all fairness to both Sansui and CBS, the particular four channel effect achieved from any stereo recording is largely dependent upon the specific nature of that recording.

## BROADCAST OF QUAD

Our discussion of quad systems would be incomplete without some mention of quad broadcasting. An increasing number of FM stations are experimentally broadcasting SQ, QS, and CD-4. CD-4 is transmitted with the Dorren system, named after its designer Louis Dorren. The system requires the use of an additional FM subcarrier, obtained by sacrificing an SCA channel. Special receiver modification is necessary to receive Dorren broadcasts, and a special CD-4 demodulator is also required. Proponents of CD-4 claim that the results are excellent, despite the complexity and cost. Some CD-4 is being broadcast by demodulating the disc at the studio, encoding it in one of the matrix formats, and broadcasting the two-channel matrix signal with the conventional FM stereo signal: The extra signal processing required is naturally a source of quality degradation, and the consumer is given the disadvantages of both CD-4 and matrix systems. CD-4 is more easily mixed for monaural compatibility than is QS or SQ, which is the primary advantage it offers the broadcaster (providing that the Dorren or a similar method is adopted).

While some proponents of discrete four channel broadcast systems point to the regulations concerning phase correlation of FM channels as an obstacle to matrix broadcasting, it is not in fact a problem. For one thing, these standards concern the phase relationship of the hardware in the station, and matrix phase relationships are considered an esthetic factor in the program material, which avoids conflict. For another thing, the phase correlation of CD-4 broadcasts is very critical due to the requirements of the demodulation process. The point is that if the broadcasting equipment meets broadcast standards, then any quad system is acceptable in principle.

QS proponents point to the fact that the Sansui system may be broadcast without any additional expense to the station, and without sacrifice of an SCA channel. The consumer can use a standard FM multiplex receiver, and the same decoder that is used for discs.

SQ is broadcast and received with essentially the same methods and costs

associated with QS. Both of the matrix systems will experience complete loss of any signal that has been placed in the center back position when the quad broadcast is received on a monaural system, due largely to the phase relationship between the rear corner channels. The SQ matrix, when reduced to mono, will give good rear quadrant reproduction to within about 15° of the center, and then a sharp cut-off is sustained. The QS matrix, when reduced to mono, will begin a gradual fall-off behind the side center locations, reaching complete cut-off in the back center.

Recognizing that the monauralization of the matrixed quad has back center limitations, both Sansui and CBS have provided some means for improving monaural modes, and both methods sacrifice quad and stereo placement. The CBS SQ "Forward Looking" encoder mode is designed to increase back channel transmission for monaural compatibility. This is achieved by bringing the rear quadrant forward, overlapping the front quadrant, and hence the quad effect is shifted forward. The "Forward Looking" mode is primarily of value for broadcast of discrete four channel material, or for encoding of material that is intended for broadcast. It may not be used to broadcast previously encoded SQ material. The Sansui QS "Mono Broadcast" mode is a decoder function, whereby a 90° right channel phase shift is used to obtain a mono signal that maintains 360° signal content to within 3 dB [40]. The "Mono Broadcast" mode does not provide a stereo or quad signal, but it is valuable because any previously encoded QS material may be used for totally compatible monaural broadcast, and no sacrifices in quad encoding are required.

Monaural compatibility, although it is important, will probably not be the deciding factor in the selection of a quad system. It is the quality of the quad and stereo sound that is most important. Moreover, as is done with single releases in today's stereo reality, a DJ disc with a mono mix on one side can be provided to broadcasters. In any event, it is difficult to obtain a stereo disc that is artistically acceptable in mono, and this obstacle will be more noticeable with quad discs.

## SINGLE INVENTORY

RCA announced several months ago that they would single inventory CD-4 albums, meaning that quad albums would not have stereo counterparts. This has not occurred, and John Pudwell of RCA confirms that there have been some second thoughts about the decision [41]. Ben Bauer has told us that Columbia will probably wait five years before single inventory of SQ is considered [42].

There are some technical and some marketing reasons for these decisions.

It is more expensive to produce a quad album, due to the added mixing and producing time in most cases. With the majority of today's market still limited to stereo playback, it would be unfair to pass the added cost on to the stereo listener. So a surcharge is placed on quad discs, which are issued with separate stereo releases in most cases.

On the other hand, single inventory can mean substantial savings to the record company and retailers because only one product need be mixed, cut, pressed, and stocked. This is a strong argument in favor of single inventory.

One drawback of single inventory is the possibility that the stereo sound of the quad disc is not up to a par with ordinary stereo discs. It is difficult to assess whether this is, in fact, the reason for lack of single inventory in today's market.

Quad equipment sales are increasing rapidly, and the market may soon warrant more serious attention to single inventory. But the question then, even more pressingly than now, will be "what system?"

#### WHAT NEXT?

We will not spend a lot of time explaining why one or another quad

system is incompatible with the others: Representatives of the three companies generally agree that optimum results are obtained when a product is limited to their system only. Any matrix decoder can derive four channels of sound from any matrix disc. But intended image placement and separation is not necessarily achieved. CD-4 demodulation is useful only for CD-4 discs, and matrix techniques do not work well in combination with CD-4 [43]. Bruce Morgan of Elektra Records summarized the reason for Nippon Columbia-QMX disregard, "They had a glorious idea . . . and they just went asleep on the switch . . . They were so far behind, not in the theory, not in their design, but in their manufacture. They had nothing for the consumer," [44].

It is likely that one system will be adopted as an industry standard. Now is the time to seriously consider that choice. Only then will mixers and artists be able to concentrate on the finer details of quad music: There will be no ambiguity about the limitations and the possibilities, and the consumer will face a clearer choice in what is now a hopelessly confusing market.

(1) Victor Company of Japan, Ltd., "All You've Ever Wanted to Know About the CD-4 Disc System," brochure printed by JVC and National Panasonic. (Jan. 1973)

(2) B.B. Bauer, G.G. Allen, G.A. Budelman, D.W. Gravereaux, "Quadraphonic Matrix Perspective-Advances in SQ Encoding and Decoding Technology," J. AUDIO ENG. SOC., Vol. 21, No. 5, p. 349-350, (June 1973)

(3) From comments by John Mosely, professional system consultant to Sansui; at quadraphonic meeting (described in note No. 9).

(4) B.B. Bauer, et. al., "Quadraphonic Matrix Perspective-Advances in SQ Encoding and Decoding Technology," p. 349.

(5) Sansui Electric Co., Ltd., "Improving The Encode-Decode System For Matrix 4-Channel Reproduction," SANSUI TECHNICAL MANUAL, p. D4-1 to D4-12. From a paper originally presented by Sansui engineers to a meeting of the Society for Electro-Acoustics, Japan. (March, 1973)

(6) Record Industry Association of Japan, Engineering Sub-Committee Standard, "Technical Standard For Regular Matrix 4-Channel Sound Reproduction System," prepared March 23, 1972. Reprinted and translated from the original Japanese document by Sansui.

(7) B.B. Bauer, D.W. Gravereaux, A.J. Gust, "A Compatible Stereo-Quadraphonic (SQ) Record System," J. AUDIO ENG. SOC., Vol. 19, No. 8, p. 639-641. (Sept., 1971)

(8) From personal interview with John Mosely, consultant to Sansui, Los Angeles, Oct. 26, 1973; from personal interview with Jerry Feree, engineer with ABC-Dunhill Re-

## OUR NEW GRANDSON IS A SWITCH HITTER

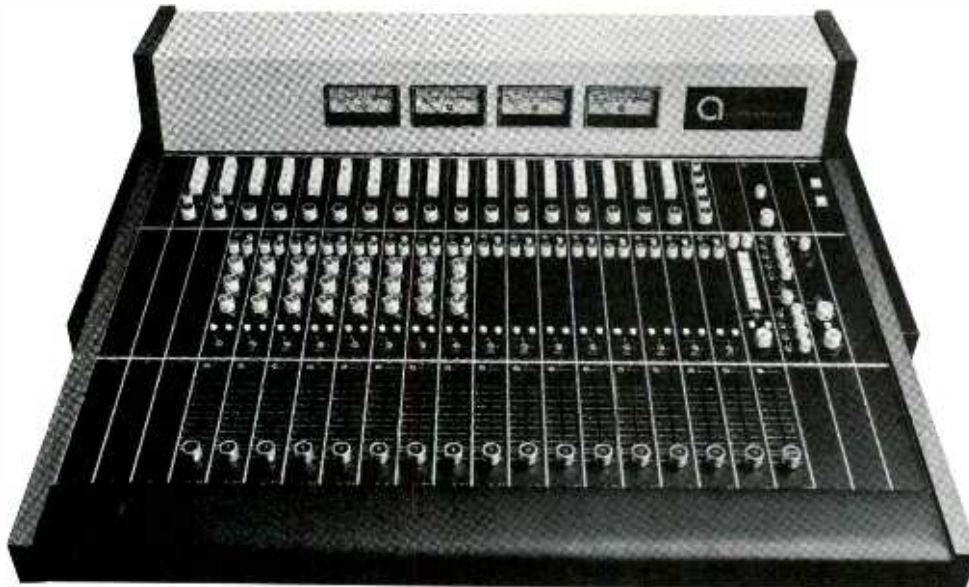

GRANDSON does two big jobs . . . complex big sound multi-track production work and on-air work. This new console fills the gap between sophisticated recording equipment and older standard broadcast consoles. Up to 18 mixing inputs . . . 4 plus 7 outputs . . . EQ on each position if you like. All modular construction is the ultimate in flexibility. Let us tell you all about our new GRANDSON.



**auditronics, inc.** P.O. Box 12637 Memphis, Tn. 38112 901-276-6338

cords, Los Angeles, Nov. 26, 1973; also, refer to note No. 9.

(9) From comments and conversations with John Pudwell, new products manager for RCA, speaking for CD-4 and John Mosely, professional systems consultant to Sansui, speaking for QS, Burbank, Ca. (Oct. 24, 1973)

(10) From JVC literature, including the brochure cited in note No. 1.

(11) According to John Olsen, RCA cutting engineer working with JVC; comments during an interview and tour of the JVC Cutting Center, Hollywood, Ca. (August 14, 1973)

(12) H. Haas, "The Influence of a Single Echo on the Audibility of Speech," J. AUDIO ENG. SOC., Vol. 20, No. 2, p. 145-159, (March, 1972). Originally appeared in German in ACUSTICA, Vol. 1, p. 49-58 (1951).

(13) See note No. 7.

(14) M. Ebata, T. Sone, T. Nimura (Tohoku University), "Temporal Masking of Directional Information," in reports of the Spring meeting of The Acoustical Society of Japan (1972), from the SANSUI TECHNICAL MANUAL.

(15) From conversation with Jerry Feree of ABC-Dunhill (see note No. 8).

(16) From a personal demonstration and explanation of SQ equipment by Jerry Budelman of CBS Laboratories; at the Century Plaza Hotel, Los Angeles, prior to a demonstration and lecture for record company engineers (November 27, 1973).

(17) B.B. Bauer, G.A. Budelman, D.W. Gravereaux, "Recording Techniques for SQ Matrix Quadraphonic Discs," J. AUDIO ENG. SOC., Vol. 21, No. 1, p. 20-26, (Jan/Feb., 1973). Originally presented Sept. 14, 1972, at the 43rd convention of the Audio Eng. Soc., N.Y.

(18) See note No. 16.

(19) See note No. 11.

(20) From a personal interview with Bob McLoed, owner of Artisan Recording in Hollywood, a custom disc mastering laboratory; Mr. McLoed stated that he has had extensive experience in cutting SQ and QS, although he appears to favor the CD-4 system (which is not used at Artisan). (November, 1973).

(21) See note No. 17.

(22) See notes No. 16 and No. 9.

(23) See note No. 7.

(24) From a personal interview with Bruce Morgan, chief engineer of Elektra Records (one of the WEA companies committed to CD-4), Aug. 29, 1973. The specific comments were as follows:

This is one of the difficulties of the CD-4 system. It requires very meticulous mastering. But if you are willing to do that, as a manufacturer, you have something you can offer the consumer, in terms of separation . . . At this point the producer is best off to avoid the mastering

sequence because there are so many problems in the quad disc that his best chance is to let the technicians work with these problems; and to recognize that no matter what quad system he's going with he's going to have compromises. It's merely our feeling that he will have less compromises with CD-4. But there are compromises, and you can't go up (to the JVC Cutting Center) and stand and wait for them to do it; because it takes them all day to cut a couple of sides, and you're listening to things going half-speed — it doesn't sound very good, anyway.

(25) From conversation with Tom Nishida, JVC Cutting Center resident engineer (L.A.), Nov. 1973.

(26) See notes No. 16 & No. 17.

(27) See note No. 16.

(28) From a conversation with Benjamin Bauer, CBS Laboratories (Stamford, Conn., Nov. 20, 1973); concerning prices, features, availability, and related topics.

(29) Conversation with Mr. Nakayama, Sansui Electric Co., Gardena, Ca. (Nov. 20, 1973); concerning prices, features, availability, and related topics.

(30) From T. Inoue, I. Owaki, Y. Ishigaki, K. Goh, "Half Speed Cutting of the CD-4 Discrete Four-Channel Records and Other Improvements of the System," J. AUDIO ENG. SOC., Vol. 21, No. 8, p. 629, (Oct. 1973).

(31) Rate Guide For CD-4 Mastering, JVC Cutting Center, Inc. 6363 Sunset Boulevard, Hollywood, Ca. (September, 1973)

(32) The JVC plans were revealed in a telephone conversation with James Mochizuki, vice president of the JVC Cutting Center, Hollywood, (Nov. 1973). We feel it is important to explore the current vinyl shortage. Vinyl is produced from a petroleum by-product, the same monomer used to manufacture PVC (polyvinyl chloride) pipe. This pipe is in great demand, especially following recent legislation which legalizes it for new construction in this country. It appears that the monomer (the chemical building-block for vinyl) is being sold to PVC manufacturers in a larger percentage than in the past, causing a reduction in availability of vinyl for record pressing and other uses.

Speculation has it that the federal price controls favor PVC sales, and/or that the PVC market demands less precise quality control for the monomer. In any case, the total vinyl consumed by record pressing is only about 3% of all vinyl use, and it would be unfortunate if some sort of action were not taken to guarantee an allocation to sustain the second largest industry in the country.

(33) T. Inoue, N. Shibata, K. Goh, "Technical Requirements and Analysis of Phono Cartridges for Proper Playback of CD-4 Discrete Four-Channel Records," J. AUDIO ENG. SOC., Vol. 21, No. 3, p. 166-171, (April, 1973). Also, see note No. 1.

(34) If the demodulator were an integral part of the turntable-cartridge-stylus package,

factory adjustment might be possible. Such a unit is not currently available to consumers.

(35) See note No. 29.

(36) See note No. 28.

(37) See note No. 1.

(38) John Windt, independent audio engineer, whose business is also conducted under the name "Windt Audio," has played some CD-4 discs over 100 times without noticeable degradation. He has been meticulous about cleaning the discs prior to each playing.

(39) E.T. Canby, from AUDIO magazine (July, 1973): quoted by B. Bauer, "The SQ System of Quadraphonic Broadcasting," an address before the Bay Area Broadcast Engineers' Society, San Francisco (July 25, 1973). The specific quotation is printed below:

The same standard stereo sound via SQ-with-logic tends toward more variable randomness, as the logic circuits grasp for clues as to how to act — and find only happenstance. (The normal recording has no specific SQ-encoded message but contains a lot of random triggering information.) On logic SQ, the standard stereo sound seems to wave gently in the breeze, so to speak.

While Mr. Canby found this to be a pleasant effect, others have not been similarly pleased by the drift.

(40) Sansui Electric Co., from the QSD-4/QSE-4 operational literature.

(41) See note No. 9.

(42) See note No. 28.

(43) See note No. 9.

(44) See note No. 24.

#### SOURCES FOR ADDITIONAL INFORMATION

CD-4 James Y. Mochizuki, JVC America, Inc., 1011 West Artesia Boulevard, Compton, Ca. 90220. Phone (213) 537-6020

QMX Takayasu Yoshida, Nippon Columbia Co., Ltd.; 14-14, 4-Chome, Akasaka; Minato-Ku, Tokyo 107, Japan. Phone (584) 8111. Cable: Columbiarecords Tokyo. Telex: J28280 Mainola.

QS Naokatsu Nakayama, Sansui Electronics Corp., 333 W. Alondra Boulevard, Gardena, Ca. 90247. Phone (213) 532-7670. Telex: 67-7551.

OR

Mr. Nakakita, Sansui Electronics Corp., 32-17 61st St., Woodside, N.Y. 11377. Phone (212) 721-4408. Cable: SANSUILEK NEW YORK. Telex: 422633 SEC UI.

SQ Jerry Budelman or Benjamin Bauer, CBS Laboratories, Stamford, Ct. 06905. Phone (203) 327-2000.



# Planning to Build a Professional Recording Studio?

From 4 to 24 Track • For Live Recording, Mix Down, Remote or Mastering.

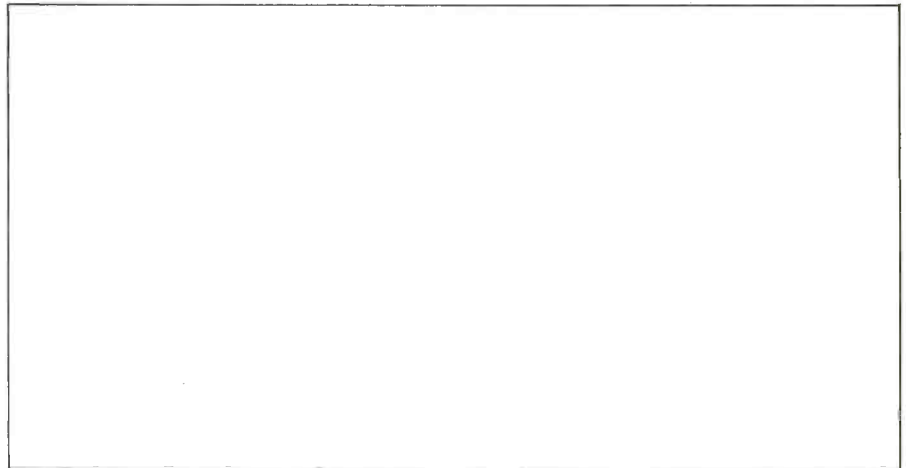





STUDIO IN THE COUNTRY  
Bogalusa, Louisiana

## JOIN THE GROWING LIST OF MAJOR PACKAGE AND TURN-KEY INSTALLATIONS BY **Westlake Audio**

RECORD PLANT	Los Angeles	2 Studios
RECORD PLANT	New York	3 Studios
MGM RECORDS	Los Angeles	1 Mastering
WARNER BROS. RECORDS	North Hollywood	3 Studios
WESTLAKE AUDIO	Los Angeles	2 Studios
PREMORE, INC.	Chicago	1 Mastering
PREMORE, INC.	Los Angeles	1 Control Room
LOCATION RECORDERS	Burbank	1 Studio
CARIBOU RANCH	Nederland	1 Mastering
DEVONSHIRE SOUND	North Hollywood	1 Studio
WEST MINST'R SOUND	Iowa	1 Studio
BEARSVILLE SOUND	Bearsville	1 Studio
WALLY HEIDER	Los Angeles	1 Studio
NEIL YOUNG	Redwood City	1 Remote Truck
PACIFIC VIDEO	Los Angeles	1 Studio
KAYE-SMITH RECORDING STUDIOS	Los Angeles	1 Remote Truck
SOUND LABS	Seattle	2 Studios
SAUSALITO MUSIC FACTORY	Hollywood	1 Studio
ELEKTRA RECORDS	Sausalito	2 Studios
STUDIO IN THE COUNTRY	Los Angeles	1 Studio
STUDIO TEMPO	Bogalusa	1 Studio
LAGAB	Montreal	1 Studio
OSMOND BROTHERS	Mexico City	1 Studio
MIKE NESMITH	Provo	1 Mastering
MIKE LLOYD	Los Angeles	1 Studio
RECORD PLANT	Los Angeles	1 Studio
MIKE ALLSUP	Los Angeles	1 Remote Truck
KENDUN RECORDERS	Los Angeles	1 Studio
MUSIC RECORDERS, INC.	Burbank	1 Mastering
SOUND HOUSE	Hollywood	1 Studio
ALLMAN BROS.	Chicago	1 Studio
FRED KARLIN	Georgia	P.A. System
ARTISAN SOUND	Los Angeles	1 Studio
PIG FOOT MUSIC	Los Angeles	2 Mastering
AUDIO ARTS	Los Angeles	1 Remix
SOUND PIT	Atlanta	1 Studio
CAPRICORN SOUND STUDIOS	Atlanta	1 Control Room
RANDY WOOD	Point Reyes	1 Control Room
MOODY BLUES	Los Angeles	1 Studio
BLIND MAN SOUND	London	2 Studios
	Honolulu	2 Studios
		1 Remote Truck

**MORE SCHEDULED - Hawaii to New York,  
Canada to South America**

from acoustic design  
to down beat...

**Westlake  
Audio**

6311 Wilshire Blvd.  
Los Angeles, California 90048  
(213) 655-0303

# SERVICES AVAILABLE TO OUR PACKAGE AND TURN-KEY CLIENTS

**PRE-PLANNING:** Which markets are you going after? One studio or two? What is the sound character desired? How much multi-track separation? Your budget? Future expansion? These are just a few of the questions discussed at this stage. From the answers, we'll provide you with a comprehensive proposal covering our recommendations and the cost for the entire project.

**SITE EVALUATION:** If you're planning to build from the ground up or within an existing shell, we'll help you to select the best building or location in terms of size, demolition and construction costs, zoning, noise transmission problems and those "hidden" costs. Remodeling an existing studio? We can show you how to get the best results from your space.

**DESIGN:** Acoustical design is the key to the success of a studio. Westlake Audio's geometric and acoustic designs will provide you with a winning "sound." **Prior to construction,** we will guarantee the performance of your studio and control room with respect to isolation, response, decay time in various frequency bands and dispersion.

**EQUIPMENT SELECTION:** We have carefully evaluated the many products on the professional audio market to provide our clients with a broad selection of the finest recording equipment available. From consoles, automation and tape machines to monitors, microphones and support equipment, we have the lines to satisfy your requirements and budget.

**FINANCING:** We work closely with several companies whose specialty is providing clients with a lease or conditional sales plan tailored to your needs.

**CONSTRUCTION:** As the proper implementation and execution of the geometric and acoustic designs requires unique construction techniques, Westlake Audio will provide a construction foreman to oversee and work with your local construction crew and electrical and air-conditioning subcontractors.

**WIRING:** Our technical crew will install all the audio wiring throughout the studio complex and tie down the wiring to the microphone, headphone and tape machine panels, echo chambers, console, amplifier room and monitors.



RECORD PLANT Sausalito, California

**SYSTEM INTERFACE:** Our engineers will install all the recording equipment and interface the entire system to the console. A total system checkout is performed from microphone phasing to monitor equalization and balancing.

**TRAINING:** Technical and mixing engineers will train your personnel in the operation and maintenance of the studio and equipment.

**STUDIO MANAGEMENT:** Upon request, Westlake Audio will offer guidelines and suggestions for all facets of studio management including rates, booking procedures and controls, personnel requirements, wages, work orders, tape legends, library systems and credit.

**NO OTHER PROFESSIONAL AUDIO DEALER CAN OFFER THESE UNIQUE SERVICES AND THE EXPERIENCE GAINED FROM BUILDING THIRTY-NINE MAJOR FACILITIES.**

From a splicing block to an automated console, a home studio to an extravaganza

WRITE OR CALL AND WE'LL SHOW YOU HOW TO EARN A 50% RETURN ON YOUR INVESTMENT.



from acoustic design  
to down beat...

**Westlake  
Audio**

6311 Wilshire Blvd.  
Los Angeles, California 90048  
(213) 655-0303



ON ANY NUMBER OF OCCASIONS R-E/P HAS BEEN PARTY TO CONVERSATIONS PONDERING THE BEST USE OF A COUPLE OF ODD MEGA-BUCKS.

WHAT, WE HAVE BEEN ASKED, DID WE THINK WAS THE POTENTIAL FOR BUILDING A NEW 'ULTRA' GENERAL SERVICE RECORDING COMPLEX? CAN A REALLY FIRST CLASS OPERATION BE SUCCESSFUL OUTSIDE OF HOLLYWOOD, NEW YORK, NASHVILLE ...?

WHO SHOULD KNOW THE ANSWERS TO THESE AND OTHER QUESTIONS BETTER THAN PEOPLE LIKE HERB PILHOFFER, AND TOM JUNG WHO RECENTLY OPENED 'SOUND 80' IN MINNEAPOLIS.

WHY

# MINNEAPOLIS



Herb Pilhofer is a composer/arranger/producer who migrated from Germany to Minneapolis in the '50s and started making his living as a jazz piano player on the night club circuit and recording occasional record albums with his quartet. Advertisers and agencies sought him out to create their music, so he took an office in a local recording studio. Simultaneously he taught at the University of Minnesota and was musical director at the then brand new Tyrone Guthrie Theatre.

It was during his Guthrie days that he recognized the need to enhance theater sound. Tom Jung was engineer of his studio sessions, and they began to work together on multi-channel sound. This mutual effort evolved into a partnership and the building of Sound 80 studios in 1970.

For this report R-e/p focused attention on an Ovation Records project. Johnson/Drake, the composers and recording artists. Pilhofer the arranger-producer. Tom Jung, engineer.

*R-e/p: Are artists like Tom Johnson and Guy Drake a part of your reasons for building a studio in Minneapolis?*

PILHOFFER: Absolutely. But let me reply to that question this way: Minneapolis is our home . . . mine, Tom's, Johnson and Drake's. Despite the conceptions and misconceptions about this City . . . this area of the Country, we believe in it . . . in its people. Attitudes of the people, for example, are, I think, influenced by the weather. It gives one a sense of pride to have survived a Minnesota winter! For us, winter kind of cleans the air mentally as well as physically. And the distinct change of seasons inspires creativity. But a lot of excellent talent has left this area for no other reason than the fact that they couldn't get jobs here, and this is one of the things we want to not

only stop, but reverse. We want to bring some of them back. We employ studio musicians on a per-job basis, and that is steadily increasing. Johnson and Drake may become major recording artists, but we will still continue to use them on broadcast commercials and background voices for other singers here. We want them to be able to do their thing, but still make Minneapolis home base.

This is a strong Country music area, too. We've cut Country sessions from which we've drawn musicians and singers for studio work . . . our steel guitar man, for example.

Many of our sessions are done with men who are more steadily employed by the thriving Minnesota Orchestra and St. Paul Chamber Orchestra. The Guthrie Theater provides us with superb announcers. As a matter of fact, we recently

encouraged formation of LIPSERVICE, a company of eight male and female announcers — several of whom are Guthrie actors.

JUNG: So many of the producers and arrangers who come here from out of town comment on how nice our musicians are to work with. It's true . . . they are. And I sometimes wonder if it's because they're not up tight, not desperate. They all have other things going for them, so these sessions are not a matter of life and death. Between Sound 80 and the other, steady, job they stay more flexible . . . and cooler.

*R-e/p: How great is your out-of-town traffic?*

JUNG: Herb is always doing commercial work for out-of-town ad agencies and businesses. But we do have our share of record dates with people from elsewhere. This past week, for example, we've been working with people who came directly here from Germany . . . just because they were impressed with Sound 80's credentials.

In Billboard Magazine's recent "Spotlight on Canada", it was pointed out that Minneapolis is the logical recording center for that nation's music industry. Of course we hope that's what's ahead for us. We have done quite a bit of Canadian work. As a matter of fact, A&M Records of Canada have an album titled "Sound 80". I should also say that I don't want to sound like the Chamber of Commerce, but it's easy to get to Minneapolis by air, and there's no hang up between the airport and our studios.

PILHOFFER: When we started to build this studio from the ground up, we knew we were playing the odds by doing it outside already-established "recording centers" . . . but that was part of the challenge.



Pilhofer

Schory

Jung

R-e/p: That reminds me of something I once heard . . . that if there is a Minneapolis sound, it is best described as "clean" . . . sometimes too clean. What do you think of that judgment?

JUNG: It's a compliment. It's something we try very hard to get and I'm happy to see people recognize it. We have been doing some sessions right to disc, and if you really want to hear clean sound, you should try that!

R-e/p: Are you recording right to disc now, on this session?

JUNG: Oh no. This album will be released on Ovation records in stereo and quad. From microphone setup thru record mastering, we're handling the whole thing, so we're really having to put our technical know-how to work here.

R-e/p: On this session, did you record drums any differently?

JUNG: On setting up the mikes for the drums, we've been there and back. That is, we've tried all the way up to 10 and 12 microphones for some of the larger sets. But we've come back to basically three — two dynamics and a condenser — because the multi-mike setups cause phasing and cancellation problems. On this session we're using our regular setup, except on some tunes we're overdubbing the tom fills . . . we do this in the middle of the studio so we get some natural room acoustics.

R-e/p: You've built your own monitors. Why?

PILHOFER: In order to make accurate musical judgments. I have to be able to rely on what I hear, without any untrue colors. We could easily buy monitor systems that would be flattering to us, but, frankly, we've gone through that stage. What interests us, finally, is — first and foremost — the end product. I consider it as I would a camera lens. I don't want anything that beautifies, glamorizes or unduly distorts what I record. On the tune "Carry it On" for this album, for example, we used an ostinato bass. With this sub-octave, continuous low C, the monitoring could have been deceivingly overwhelming.

JUNG: Technically what we've done is this; we use Altec 604E's and take a little different approach to powering it with electronic crossover and shelving equalizer to extend the response of the system. We now feel we have a monitoring system which will not fool a producer. He'll know, when he leaves the studio with his tape, that he will have exactly the same product when he puts it on the playback equipment in his office.

PILHOFER: It sounds like a big little speaker. What Tom and his staff have achieved here is a monitor which is at point zero . . . there is no additional

color. I can always, then, depend on the technical portion of a recording session and focus my attention on the music.

R-e/p: What then, Herb, do you require from a console?

PILHOFER: Tom can answer that better than I. My feeling — and he agrees — that none seem flexible enough.

JUNG: As a result, under construction in our Systems lab are two new voltage-controlled elaborate recording and mixing consoles. Something this Johnson/Drake project really points up is the need for computerized mixing.

PILHOFER: We shouldn't, for example, have to compromise the strings while focusing attention on the textures. We have to be able to concentrate on subtle things without losing the overall mix. Ideally, we could originate a sound from a very dry to a very wet signal and then immediately return to a dry signal. The overall mix, computerized, will become more refined.

R-e/p: Tom, I understand that you do not favor 24-track, and that you've developed your own 32-track system.

JUNG: For us, 24-track is just not practical because distortion, S/N and crosstalk make it imperative to use noise reduction in the original recording. And I can't see compromising quality for the few times you need more than 16 tracks. Instead, we took what we think is the best approach to achieving more than 16-track. Ours is an interlock system between two 16's. It puts a sync track on

one channel of each machine, and basically makes one machine a slave to the other.

R-e/p: Isn't there a point of diminishing returns with the number of tracks becoming usable? Where will it all end?

PILHOFER: Ideally, you wish you had an unlimited number of tracks available; on this project, for example, where a complex string texture was phased and panned and required four channels to achieve a sound. But in the total music texture, it was a subtle effect — not miking quad . . . nevertheless it took up the four channels.

From a compositional point of view you are thinking of planes of sound sources and textures much as a director in the theatre might stage a play.

JUNG: While it may seem impractical to lock up three 16-tracks, it is possible for us to do it if the situation warrants it.

R-e/p: That sounds a bit expensive. So you have recorded rhythm tracks and you've done sweetening; now you have four-part counterpoints in the vocal and now you're going to spend a lot of time in the studio tying up two 16-tracks?

JUNG: We're conditioned to working with practical solutions in mind. On the "Riverboat Song" we worked several days with only a single 16. We recorded vocals later and, because we needed a complex vocal texture, we filled one 16-track with rhythm and sweetening and transferred a cue track to one of the

continued on page 55

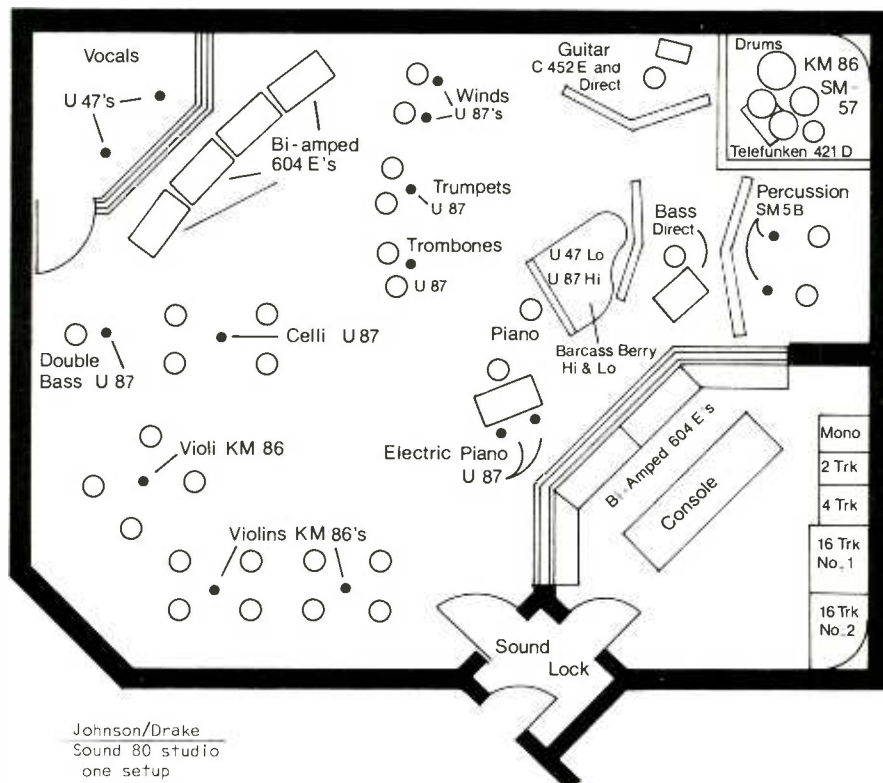



## “Meet our new Recorder/Reproducer. You’ll call it fantastic. We call it the 280-B”

What’s so great about it? First off, it’s really up to the state-of-the-art. In electronics, control logic and architecture. Everything’s changed but the transport. (Why mess with that? It’s field proven.)

Here’s what you get:

S/N ratios at a consistent 72 dB at mastering speeds on full track, .25 inch tapes. Improved headroom and increased record level for maximum signal utilizing high output tapes.

Band widths are just about flat at  $\pm 2$ dB, 30 Hz to 18 KHz. Tape handling is incredible. Our new motion sensing system (OPTAC™) gets rid of deck top sensor mechanisms. Internal logic lets you select a new mode and activate it without having to hit the STOP button. And enter and leave RECORD while the transport’s in PLAY.

Maintenance is a snap, too. We got rid of all the spaghetti and replaced it with plug in IC’s. And TTL logic for high reliability and low power consumption. Test and adjustments are made without bending all over the place. Individual channel modules come out easily. And all electronics are in slide out drawers.

Oh yes. Selectable synchronization with extended response. Standard on 2 and 4 channel machines.

You can get all the specs (or a machine) by writing or phoning (415) 968-8389 TLX 345524 475 Ellis Street, Mountain View, California 94040

▶ **Scully/Metrotech**  
Recording Divisions of Dictaphone



If you're seriously into music or sound reinforcement you want more than hi-fi products can give you. But full professional studio gear costs an arm and a leg, and you pay for a lot of things you may not really need.

## You pay for what you need

up to four additional input modules and other optional accessories including talkback, remote transport control, quad panner, and headphone monitor.

That's why there's a TASCAM Model 10. It's an 8-in, 4-out mixing console, and it's just \$1890.

With the Model 10 you get what you have to have. Without sacrificing a single necessary function.

Each input module gives you mic and line attenuation, three bands of peak and dip equalization (two with frequency selection), pre- and post-echo send and receive circuitry, pan function, and a unique straight-line fader.

Each of the four submasters has a meter control switch (line/echo), independent monitor level control, echo receive level control, and a straight-line fader. You also get a master gain module and 4" VU meters with LED peak indicators. Plus pre-wired facilities for

That's what you need and that's what you pay for. Some things, however, you may or may not need, and we leave that choice up to you. For instance, the basic Model 10 is high impedance in and out, but studio line impedances are available optionally. You'll probably want low impedance mic inputs, but you may not need all low impedance line inputs. So we don't make you pay for them. You can order any combination of high and low input/output impedances according to your application.

Details and specs on the Model 10 are available for the asking. At the same time we'll tell you about our new Series 70 Recorder/reproducers.

We've got what you need.

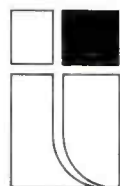

**TASCAM CORPORATION**

5440 McConnell Avenue  
Los Angeles, California 90066

# USING NOISE-REDUCTION TO REDUCE DISC SURFACE NOISE

In today's recording studios, music with wide dynamic range is being successfully recorded. Certainly, the recent advent of various noise reduction systems has even further increased the ability to record a wider dynamic range.\* At the same time, consumer equipment has steadily improved, and the average listener seems to be increasingly aware of the improved quality of recorded music. However, until now there has been no practical means for the reduction of surface noise on discs, which may become particularly significant if the quality of pressing compounds deteriorates due to the enforced use of lower quality materials because of the world-wide shortage of virgin vinyl.

There are several reasons why noise reduction for discs has been ignored. In order to make such a system commercially feasible, several requirements must be fulfilled. For example, the disc should not require extremely expensive or complicated playback equipment. At the same time, the reduction of the disc surface noise should be substantial enough to make the system attractive, even if at a somewhat higher price. Moreover, the production of noise-reduced discs should present no major changes in the recording and manufacturing processes. The dbx noise reduction system meets these requirements, and has already been used on commercially released discs.

Ideally, it would be best if noise-reduced discs were compatible, which is to say that they would sound good with conventional playback equipment, but, of course, much, much better with the proper noise reduction components added to the playback system. The major drawback of any compatible system is that only a limited noise reduction would be possible. While the dbx system is not

\* Dynamic range is defined as the difference between the maximum recorded peak signal and the minimum significant program material, expressed in decibels. Therefore, as the noise level is reduced, the available dynamic range increases proportionately. Without entering into a major discussion of dynamic range, it is generally acknowledged that wider dynamics in recordings permit more realistic and more exciting reproduction of sound.

compatible, it requires a decoder for suitable playback, it does provide a very significant reduction in surface noise for encoded discs.

How much of an improvement can be obtained with a dbx-encoded disc? To answer this question, the quietest and noisiest U.S. pressings that could be found were obtained. These discs were measured for surface noise with standard RIAA playback, and then with dbx decoding. The results indicate that dbx provides more than 35 dB of surface noise reduction. This is illustrated by figure 1, where the 0 dB reference level is 7 cm./second.

A unique (patented) linear decibel compression and expansion scheme encodes and decodes material in the dbx process. The encoding process uses an RMS responsive level sensor, and a voltage controlled amplifier connected for a 2:1 linear decibel compression characteristic over a 100 decibel range. Frequency weighting is used to reduce tape modulation noise. Further weighting in the level sense channel prevents over-recording of material with high energy, high frequency components. The decoder uses the same components to form a 2:1 linear decibel expander. No matching of levels is required for accurate decoding. Thus, the linear expansion provides a large overall noise reduction, and restores

the original dynamics of the program material.

Compression-expansion noise reduction systems, also known as compander type systems, are noted to have a potential drawback for disc applications. If the system is sensitive to level changes, referenced to the threshold of the encoded signal, then variations on playback or pressings might result in noticeable sound degradation. This type of problem would tend to be even more critical if the noise reduction system were the multi-band type, companding of the audio spectrum in frequency bands. Such systems would require careful level matching and calibration which are impractical for a consumer product. This potential problem is overcome by the dbx system because level matching is not critical: dbx is insensitive to variations in the level that can be expected from the cutting and playback.

In order to make an encoded disc, the encoding would normally be done only once, at the time the stereo master tape is made. The encoded tape is then transferred to a disc with essentially conventional mastering techniques. Pressing of encoded discs is identical to conventional pressing, although as previously noted lower quality materials may be used to obtain quiet playback from what would otherwise be excessively noisy compounds.

While the encoding and decoding of a disc will considerably reduce surface noise, even greater benefits can be realized if noise reduction is utilized in all phases of the recording process. In this regard, any noise reduction system may be used, so long as the final encoding to the disc is done with a dbx encoder for the reasons stated previously. If dbx noise reduction is used throughout, an audibly noise-free playback results. Figure 3 illustrates a typical sequence for production and playback of encoded discs.

It should be noted that while the encoded disc is incompatible, requiring a decoder for proper playback, the encoded stereo master tape may be used to cut compatible discs. This is done simply by decoding the tape prior to cutting, which happens to be exactly the process that is now being used for noise reduc-

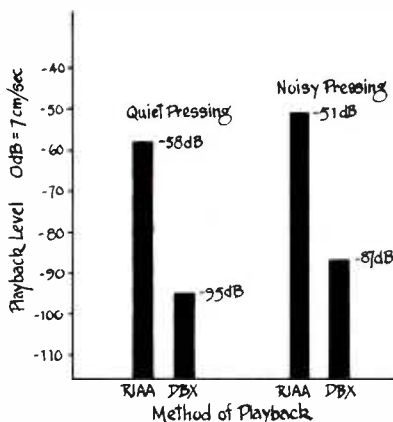

Fig 1~ Comparison of Surface Noise on Quiet and Noisy Vinyls using Conventional and DBX Playback Systems ("A" Weighted Scale, Unmodulated Groove)

BY LARRY BLAKELY  
dbx CORP.

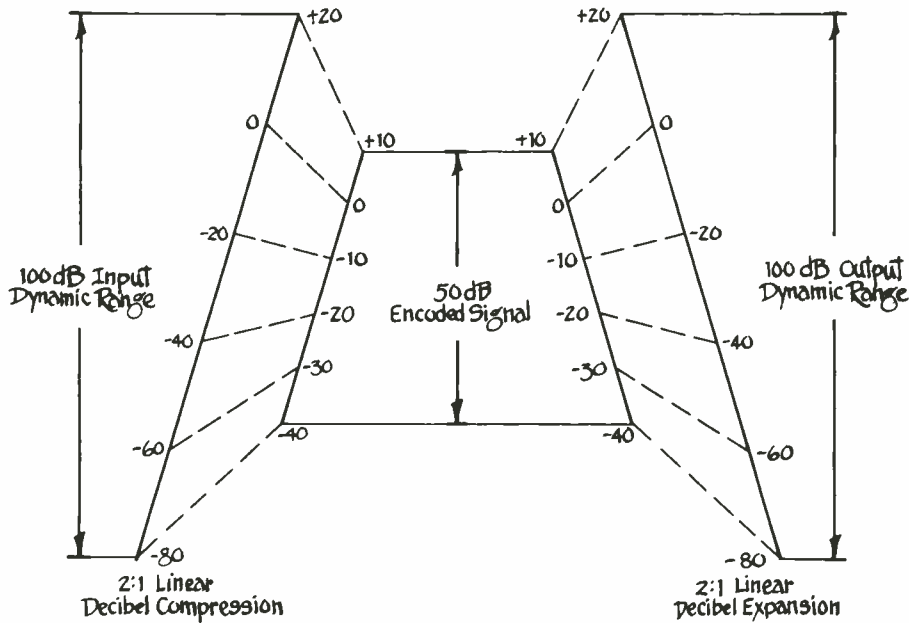

Fig 2 - DBX System Compression and Expansion

tion of tapes. Many studios which already use dbx noise reduction on their tapes will be able to cut encoded discs without any further processing. In fact, any noise reduction system is usable when the complementary decoder is used prior to dbx encoding, so that existing tapes are

invariably suitable for dbx encoding on a disc.

At least one connoisseur record company has already released a dbx encoded disc, demonstrating the feasibility of the method. Hal Powell of Klavier Records, Hollywood, expresses great enthusiasm

about his first dbx release. He has plans to press additional dbx encoded discs. In addition, dbx has already discussed release of noise-reduced discs with several other record labels.

One of the attractive features of the dbx system is that the same method of encoding and decoding is used in all professional and consumer models; so that the application of the system to a disc requires no new hardware for current users of dbx equipment. Of course the prospects for profitable sales of encoded discs will improve as more decoders are brought into the consumer market.

In January '74, dbx will introduce a consumer decoder that will retail for less than \$200. By mid-1974, dbx has plans to market a consumer decoder in the \$100 price range. To extend the availability of consumer units, dbx further anticipates licensing arrangements for consumer hardware manufacturers sometime in the near future. The parts cost for a dbx decoder should be only slightly higher than existing consumer-licensed noise reduction systems.

Noise reduction for discs is commercially attractive for a number of reasons. As mentioned previously, noisier vinyl compounds can be utilized to achieve a greater signal to noise ratio than virgin vinyl recorded conventionally. Even where the best virgin vinyl is used, there are tremendous advantages. For example, the disc could be cut 10 dB lower in level than conventional *hot* discs, permitting increased program time with less potential distortion from cutting and playback equipment and no requirements for peak limiting in disc mastering. Furthermore, even with the lower cutting level, at least 25 dB of noise reduction would be available. It is therefore practical to remaster many existing 12" L.P.'s to 10", resulting in about a 30% vinyl savings.

Ultimately the impetus for quieter discs will come from the consumer. Once he has been exposed to the emotional impact which is created by a noiseless disc, the listener will probably clamour for more. The same kind of revolution occurred when the LP replaced the 78.

Dave Blackmer, president of dbx, and the inventor and developer of this system says, "We had intended the encoded disc as a limited distribution medium for the connoisseur. I am amazed at the overwhelmingly favorable response of disc recording specialists who have previewed this system. Many have expressed a conviction that this process will receive broad acceptance. The preservation of all peaks without limiting, compression, or gain riding, and the virtual elimination of background noise provide an exciting new listening experience. The emotional impact often exceeds that of the live performance."

## state-of-the-heart

YOU'LL LOVE ITS FEATURES!

**INOVONICS MODEL 355**



**DUAL-CHANNEL TAPE ELECTRONICS: \$1200**

This high-performance package is ideal for original installations or for upgrading existing systems

Features include:  Conservative design criteria and distortion-reducing circuitry to assure highest quality recordings.  Capability for remote control of all recording and monitor functions.  Solid-state switching to eliminate punch-in and contact noise

Individual SYNC and reproduce amplifiers for optimum SYNC performance

Versatile 3-speed EQ for all NAB and IEC standards

Check out the Model 355. You'll love its features and performance!

Call or write today



**INOVONICS**

INCORPORATED

1630 Dell Ave., Campbell, CA 95008

Phone: (408) 374-8300

Fig.3—Typical Method For Producing Low Noise Discs.

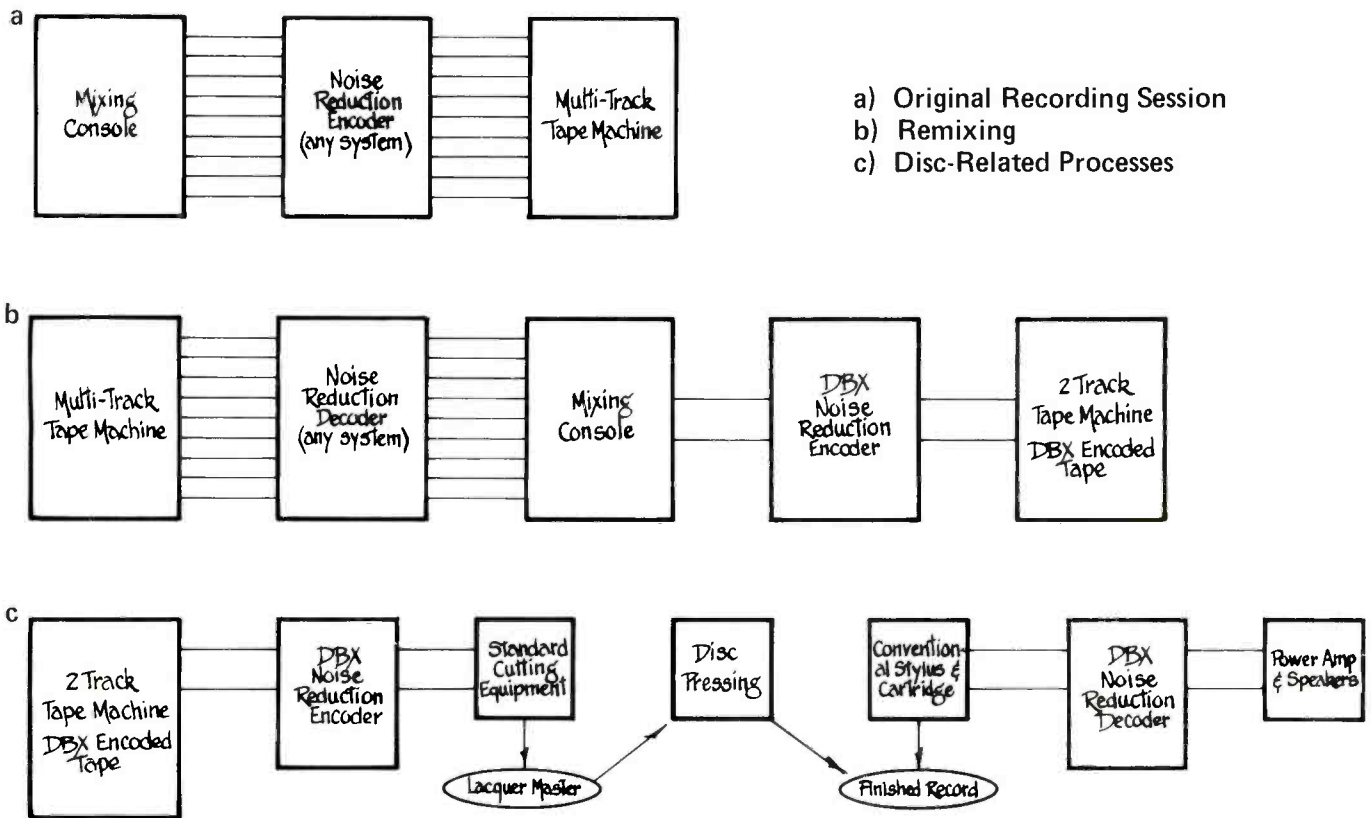

In 'a' and 'b', any noise reduction system may be used, although a complementary encoder and decoder are necessary.

# Mixdown tonight. 16 track. How's your memory?



## compumix™

The Number's Game.

Check our bingo number and, in addition to complete technical data on Compumix™ we'll send you a free copy of "Automation Arithmetic - or How to Slice-up the Automation Pie". It discusses the basics of digital information storage as applied to audio. We hope it will help you understand this new technology for sound recording.

Above, the Compumix™ controller. Our memory helper. Trust it. It's designed to interface any mixing console to our digital processor. 46" long, 16" deep, and 2" thick. Small. Everything's there. More than enough level and switching control for the heaviest 16 track mixdowns.

 **quad/eight  
electronics**



# THE PROBLEM SOLVER

Say farewell to the grand old DC300, and welcome to THE PROBLEM SOLVER, the amp that is going to make your job easier and your customers happier. The original model DC300 was a great amp — the first super-power low distortion amp in the world, when Crown introduced it five years ago. Meanwhile, top sound systems designers have used it successfully in hundreds of demanding situations, and made some excellent recommendations for improvements. The response of the Crown design team was *not* an updated DC300, but a totally *new* and different amplifier, the DC300A. It is the *only* high power low distortion amp specifically *designed* for commercial sound applications. (CAUTION: *There are some large consumer-type amps attempting to sell in the commercial sound field without providing adequate continuous power for all load impedances.*)

#### Power You Can Count On

The New DC300A has *double* the number of output transistors, effectively twice the muscle of the old DC300 at the same price. Each channel has eight 150-watt devices for 1200 watts of transistor dissipation per channel. The DC300A is rated at 150 watts per channel continuous into 8 ohms or 300 w/ch continuous into 4 ohms (both channels driven) and 500 watts continuous into 2.5 ohms (single channel driven).

#### Two Amplifiers in One

As a dual-channel amplifier with separate level controls and circuitry for each channel, the DC300A is almost *two* amplifiers in one. This gives you additional flexibility in controlling your speaker load, as when driving separate front and back speaker systems in a large auditorium, or when bi-amping a system. For 600 watts continuous output at 8 ohms, the DC300A converts to a mono amp with two plug-in parts. This makes it possible to drive a 70-volt line directly without a matching transformer.

#### Superior Output Protection

The DC300A output protection circuitry is a radically new design which completely eliminates DC fuses and mode switches and further reduces service problems to the negligible level. It is superior in every way to the old VI-limiting circuit pioneered by Crown and now used by most other high power amplifiers, since it introduces *no* flyback pulses, spikes or thumps into the output signal, whether operating as a single-or dual-channel amp.

Gone too is the need to baby the amp by carefully juggling load configurations. The Problem Solver can drive *any* speaker load — resistive or even totally reactive — with *no* protection spikes! Parallel speakers with no deterioration of sound quality, since changing the load impedance only affects the maximum power available, not the ability of the amp to keep on producing clean sound.

#### Lowest Distortion and Noise

Also new is the DC300A's IC front end, which sets new world's records for low distortion and noise. At the 8-ohm rated output, IM and harmonic distortion is less than 0.05% full spectrum; hum and noise is 110db below. Servicing — if ever necessary — is a snap, since removing the front panel accesses the entire circuitry.

Although it is a completely redesigned model, the DC300A has inherited some characteristics from its predecessor:

**PRICE** - still under \$700. As two amps in one, it will probably give you or your customers a welcome cost/break when you design your next multiple-amp system.

**WARRANTY** - three years, covering all costs of parts, labor and round-trip shipping.

**COOLING** - excellent heat dissipation provided by massive cooling fins and the entire chassis itself.

**DEPENDABILITY** - stringent pre- and post-inspection and testing proves every electronic component, every circuit module and every finished unit, to bring you one step closer to install-and-forget field dependability.

**PEOPLE** - the same innovative design team and careful craftsmen who made the DC300 such a sound success. And the same knowledgeable customer-service men ready to discuss your special application and send you detailed technical data. Phone 219 + 294-5571 or write Crown International, Box 1000, Elkhart, Indiana 46514.



## CROWN

MADE ONLY IN AMERICA





# THE CONCERT SOUND MAN

by JIM COE & PAUL STARK

The soundman's job is best typified as comprehensive, rather than specialized. His basic tools are his understanding of electronics, acoustics, impedance matching grounding and shielding, A.C. power, and existing contemporary sound systems. These and other intellectual tools must be used in unpredictable ways to solve the many real-time problems confronted in the live performance situation.

The soundman will be found working in any of several distinct responsibilities. He may be a houseman working for a specific concert environment; a concert hall, a night club, a college or university auditorium, etc. A soundman may be employed by one of the numerous independent sound service contractors who must also provide a soundman and assistants along with the sound systems which they rent to the Promoters of a concert or tour. Then, too, many of the larger bands employ one or more soundmen. The equipment roadie with a smaller band might also double as their soundman.

It is important to consider the responsibilities and concerns of these dif-

ferent types of soundmen: The houseman works directly for the promoter, often as a substitute to avoid the extra expense and bother of providing a favorite independent sound service for the headline acts. The house-man must, therefore, strive to satisfy each band (act) while keeping expenses at a minimum. The soundman working for the independent sound service operator is primarily responsible for delivery, set-up and functioning of the system. He is most concerned with his reputation for reliability and the preservation of his equipment. He operates as a businessman in a very competitive field. The band's soundman, on the other hand, is over-whelmingly concerned with sound quality (even when it costs more), and with tailoring the system provided by the Producer to his band's particular needs. He bears the final responsibility for the sound quality of his group's performance.

Keeping this brief profile of the Soundman in mind it is our objective in this article to outline several of the Soundman's problems . . . In describing our experiences and operations to, perhaps, suggest several countermeasures,

alternatives and answers . . . Finally, to introduce an idea, the fulfillment of which might be a great aid to all of us . . .

## HARDWARE AND TECHNIQUES

Needless to say, setting up and planning for a tour is very important. Poor preparation can lead to all sorts of hassles at the show. A primary method of assuring consistent quality of the sound system is the contract between the artist and the promoter. A 'sound rider' is attached to the contract specifying the detailed preparations the promoter is obligated to accomplish for the concert. Details such as stage size, required lighting, power requirements, sound system specifications, and time and crews required for set-up are set forth as obligations the promoter must fulfill. The contract rider we use goes so far as to specify which sound contractor will be used. In this way we can be assured of dealing directly with a familiar quantity, the contractor we have selected.

Two months or so before the tour

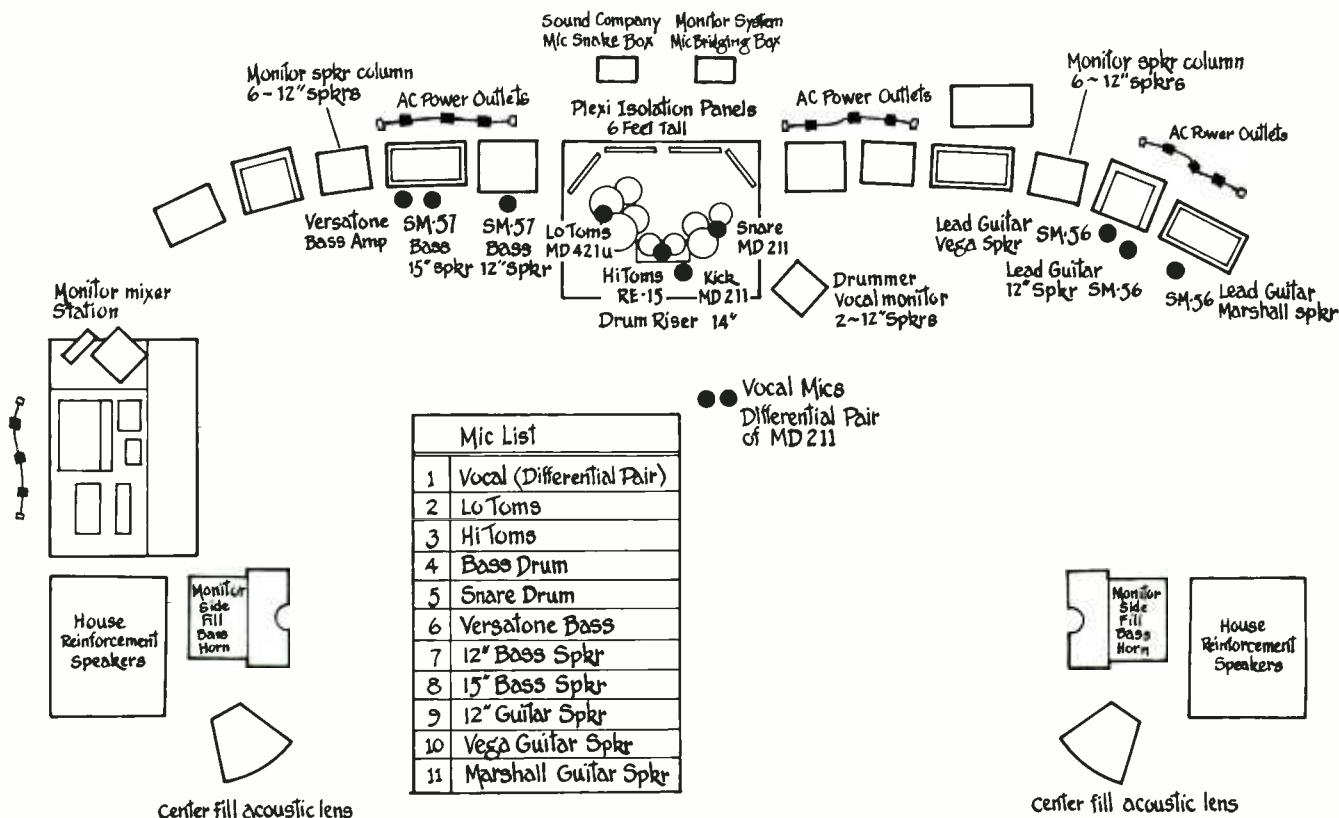

Mic List	
1	Vocal (Differential Pair)
2	Lo Toms
3	Hi Toms
4	Bass Drum
5	Snare Drum
6	Versatone Bass
7	12" Bass Spkr
8	15" Bass Spkr
9	12" Guitar Spkr
10	Vega Guitar Spkr
11	Marshall Guitar Spkr

Fig 1 - HOT TUNA - Stage, Mic, and Monitor Plan

the group's agents and managers conspire to secure firm dates and locations for the one dozen, or so, performances that

comprise the tour. The promoters of the different concerts are then contacted by the soundman and told which sound

company will be used. Likewise we contact the sound contractor and arrange for scheduling of a system to meet our specifications giving to him a list of performances and particulars. Since the promoter is put in the position of having to pay for a sound service he knows little about, it occasionally takes a great deal of diplomacy to assure him that we know what we want and that everything will be alright.

For the Hot Tuna tour of last November it was decided we should use ACTIVATED AIR, a sound service operating out of Philadelphia. A total of eight performances were scheduled over a two week period, all within 350 miles of New York City. The halls in which the performances were to be given varied from pre-fab sheet metal college gymnasiums, to an acoustically bizarre dome-shaped assembly hall, to old ex-vandeville movie theaters.

The Activated Air Audio System is highly unique in the sound business. Most sound system speaker arrays are composed of massive plywood boxes, requiring much volume, and suitable for stacking. The Activated Air system is made up entirely of fiberglass horns, unenclosed. The horns are all manufactured by Community Light and Sound Co. in Philadelphia. The bass horn is the Leviathan model with low frequency extensions. The horn with the extension is very efficient in the frequency range 60-800 Hz with good dispersion throughout that range. The bass horn is driven

# Listen to the Sound of Accuracy

STL test tapes are rated tops for accurate Azimuth Reference . . . the most accurate and dependable tapes you can buy.

In addition, they are available in more sizes than that offered by any other manufacturer in the world.

Produced independently to the highest standards, STL test tapes are internationally acclaimed . . . accepted as basic reference tools of unexcelled quality.

All audio widths from 150 mil. to 2-inch. Prompt delivery insures freshness.

For the distributor in your area—Call or write:

**TABER** Manufacturing & Engineering Company  
 2081 Edison Ave. • San Leandro, Ca. 94577 • (415) 635-3831  
 Minneapolis distributor: Sound 80, Inc.

by two JBL 2220 15" drivers. The high frequency horns are also by Community Light and Sound (model RH60) coupled to the JBL 2440 compression driver. The very high frequencies are augmented by JBL 2405 slot radiators capacitively connected to the high frequency amplifier output above 10 kHz.

Since the speakers are not in boxes some method of stacking and arraying them is necessary. The solution is ingenious. The bass speakers sit inside or on top of a four foot by eight foot painters scaffold about six feet tall. On top of the scaffold is an aluminum tube structure like a child's playground set, aptly named 'Jungle Gym'. (photo No. 1) The high frequency horns are secured to this structure wherever appropriate by a lighting grid clamp and swivel mount that allows the horn to be pointed in almost any desired direction. The vhf drivers are likewise mounted in arrays of three, on rods welded to grid clamps.

There are six bass horns, sixteen high frequency horns, and twelve very high frequency units in the system. This system has been found more than adequate for our use in halls to six thousand capacity. The amazing thing is that the entire setup of this system can be accomplished by two men in about one and one half hours.

The amplifiers for the system consist of two racks of Phase Linear 400's four in each rack, one rack for each side of the stage. The speakers only require the use of one and one half amplifiers per side. The high frequency drivers are connected to an amplifier by means of an auto-transformer. Since Hot Tuna carries its own monitors there were more than a few spare channels of amplifiers.

The mixer for the system is a 20 input, 2 group, simultaneous mono-stereo board manufactured by Alice in England. Equalization is provided on each input at three frequencies; 50 Hz, 3 kHz, and 10 kHz, -12 dB. There is a stereo Compressor/limiter on each of the two stereo sub groups, and a mono output. The signal was then patched to a UREI 1/3 octave graphic equalizer and returned to an electronic crossover in the board. The crossover frequency was selectable for 500 Hz or 800 Hz, at 18 dB per octave. The send levels to the amplifiers were monitored by PPM meters on the highs and lows. An intercom and solo monitor headphone system are built into the board. A cassette tape deck was connected to auxiliary inputs to provide intermission music during the set changes.

The processed signals return to the stage through the same multi-pair cable as the incoming mike lines. A.C. power for the mixer was obtained from the stage. This was done to insure the security and quality of current. The multi-pair cable is wound onto a large reel to

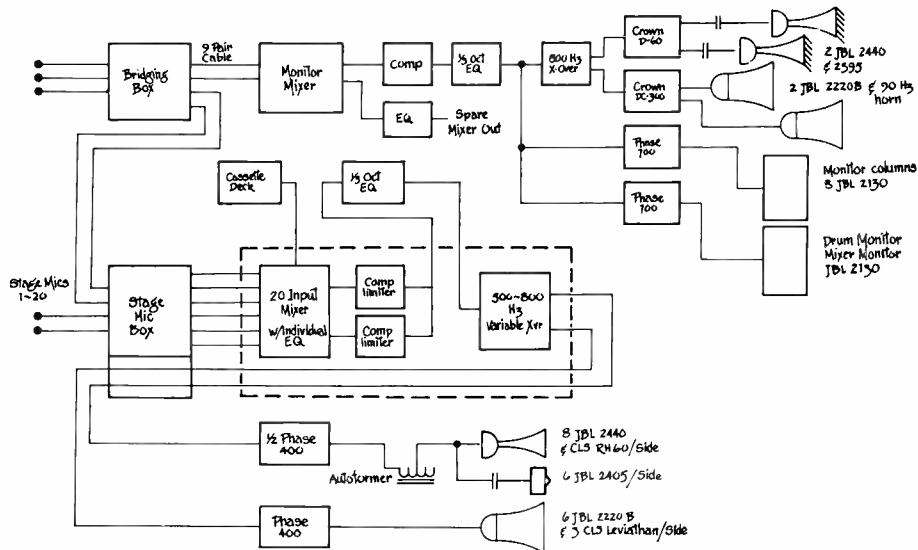

Fig. 2 - System Signal Flow Diagram

avoid kinking and excess cable on the stage. This cable is connected to a microphone stage box with inputs for 20 mikes and smaller multi-pin connectors for the cabling to the power amps and intercom units on stage.

Part of the system of monitors Hot Tuna owns is a microphone bridging box. This splits the signal from up to nine stage microphones to the monitors. The box employs low loss bridging transformers which provide variable grounding configurations for the two outputs of each microphone input. (Fig. 4).

The monitor system is designed as a two part system. (Fig. 2). One set of speakers placed on each side of the stage facing into the center wash the whole stage. Two columns of speakers sit behind the musicians facing forward and are concentrated on the center and upstage area. This is to provide extra intensity in the area of the vocalist and back near the instrument speakers. A by product of the forward facing speakers is excellent vocal quality in the first few rows of seats. With proper equalization the acoustic gain possible in this system is startling. Normal conversational levels at the microphone can be understood clearly in a reverberant hall while there is music playing on the main system at uncomfortably high levels.

The monitor mixer has nine inputs and two output channels. One channel is routed through an API 550 equalizer and is used only occasionally with other bands as a second channel for special monitor mixes. The main channel output goes thru an API 525 comp/limiter to an Altec 9860A 1/3 octave filter set. Here the signal splits to the two systems. The side fill is biamplified crossing over at 800 Hz at 12 dB octave. The bass horn is a 90 Hz fiberglass coated plywood box. The single JBL 2220b is driven by 1/2 of a Crown DC-300. Integrally mounted in this box is a JBL 2440 compression

driver and 2395 horn. The acoustic lens portion of the 2395 is removable for shipping in its own box. The HF amplifier is a Crown D-60. The rear system is two columns of six JBL 2130 12" speakers. There are also two cabinets of two 2130 each for the monitor mixer and the drummer. All these are driven by a pair of Phase Linear 700 amplifiers. The monitor system audio power output totals nearly 2KW RMS, the main system 1.2 KW.

Allowing for a 50% efficiency in the amplifiers this means the system consumes 6 KW maximum. The musicians' amplifiers draw about 3 KW more. (yes 3 thousand watts, Hot Tuna is very loud.) 9 KW then is the maximum continuous power draw of the amplifiers, that is about 90 amperes at 110 volts. Current demand on peaks has yet to be determined. Our power distribution system weighing in at some 300 pounds is rated at 100 amperes continuous. Yet panel lights on power amplifiers still go dim on severe peaks.

The power distribution (Fig. 3) system was built for us by Swanson Sound Service in Oakland, California. The feeder cable is protected at the head end by a 2 pole 50 ampere circuit breaker. There is a short pigtail for connection to the power source. Connection is normally made to a 220 volt Single Phase A.C. service with a split neutral, providing dual, 50 amp 110 volt circuits. We can also parallel the two input legs and connect both to a single 110 volt 100 amp service. Or occasionally we connect to two legs of a 3 phase 'Y' circuit, with 110 volts between each leg and the neutral. Many times we are told by house electricians that the neutral is ground or "bonded". This is not sufficient for audio system grounding. It is necessary to take the ground to earth. A cold water pipe is pretty good but even these cannot be trusted in the days of plastic pipe.

Fig 3 - AC Power Distribution

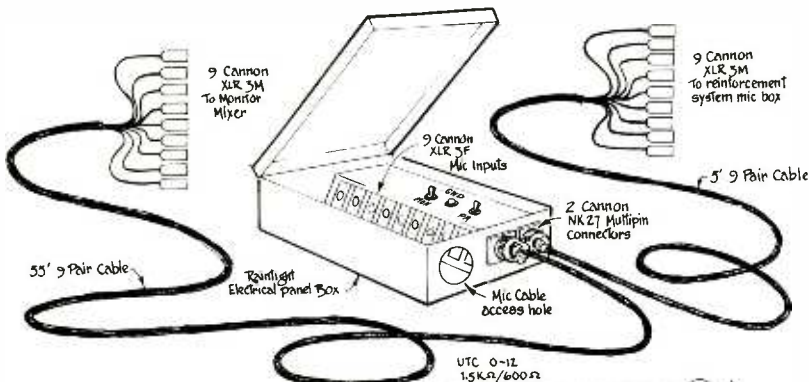
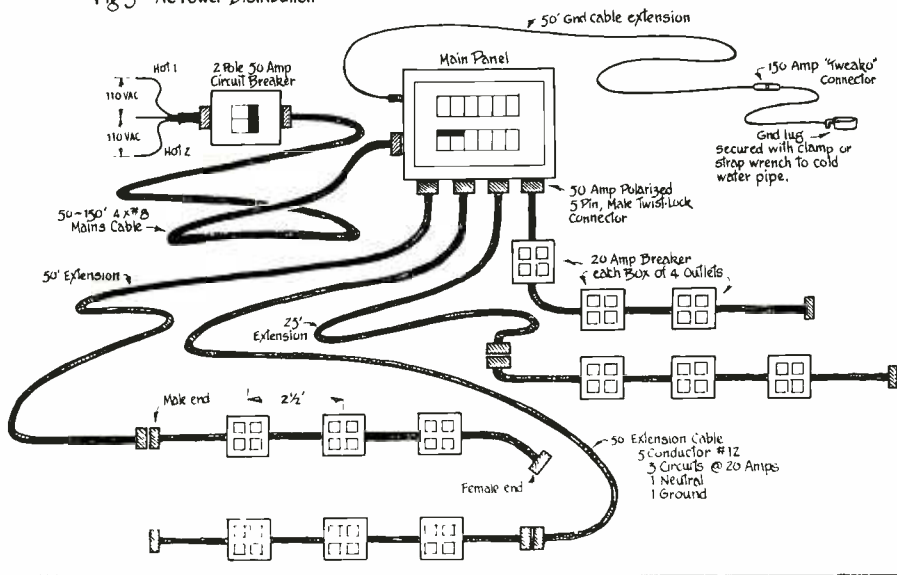
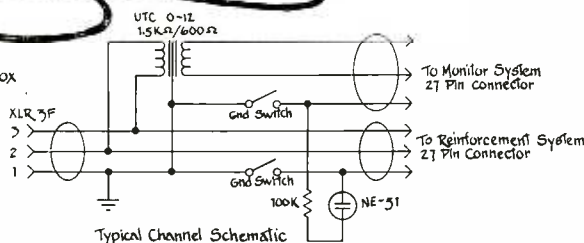

Fig 4 - Monitor Microphone Bridging Box



The main panel has 14 circuits individually rated at 20 amperes maximum each. These circuits are divided up between two busses corresponding to the two input legs. 12 of the circuits are sent to the stage on 4 cables. The outlet boxes have 4 plugs per box, each box is one 20 amp circuit. The boxes are arranged stringer fashion on the cable. Standard length extensions are available to bring the power to where it is needed. All circuits in a cable carry through to the end so that any stringer can be extended, (i.e. 2 stringers could be attached end to end to give 8 plugs per circuit.) A third pin ground wire is at each plug and is brought back to a ground buss in the main panel. This ground buss has a 150 ampere rating. The ground wire is brought out to both the main feeder cable and a separate "tweako" connector on the side of the panel. This connection is sent off to the cold water pipe through a No. 6 in-

insulated cable to a copper lug secured by a strap wrench to the pipe. A fire department standpipe is usually a good bet in any hall. We cannot over emphasize how much trouble can be saved by having consistently good, clean, reliable power.

Very often in our pursuit of technical perfection surrounding all facets of performing arts technology we become enamored of ever increasingly complex electronic solutions to our problems, ignoring the acoustics. One very important contribution to the sound is the drum riser and the transparent 'isolation-reflection' panels behind the drums. (Fig. 1). Clear plexiglass panels framed in aluminum tubing about six feet tall and hinged on two and one half foot centers surround the drums from behind. The drummer can at last hear his own drums with definition, and the drum sound in the hall has improved markedly as this set-up allows us to use fewer mics than

would otherwise be necessary. The riser is made of 2 panels of plywood with an aluminum frame. It sits on twelve molded plastic fixtures resembling toadstools originally intended to be plant boxes. This unique design is the genius of Peter Quaintance, an acoustical consultant in Mill Valley, California.

Another example is the solution to the problem of definitive monitoring of the monitors, by the monitor mixer in an ambient sound field approaching 120 dBc SPL. The solution is to take a pair of Sennheiser 414 headphone elements and mount them in David Clark ear protectors like those worn by jet airliner ground crews. Necessity is truly the mother of invention.

#### A TYPICAL PERFORMANCE

For the authors, the day of a performance begins with a call to the promoter or stage manager of the show in question to make sure that the stage size, electrical power, and other minimums will be met, and that the stage call time for load-in is set.

The load-in is the work of the stage crew, but much time and effort will be wasted if they are not efficiently directed in unloading and helping to set up the sound systems. Because we have our own stage monitoring system and two soundmen, one of us helps with the set-up of the main system, directing the aiming of the horns and the mixer positioning in the hall, and handling the A.C. power distribution, while the other works with the state monitors. The stage diagram shows the placement of the components of the monitor system, so suffice it to say that everything is cabled up and the monitor speaker enclosures are aimed toward the vocal position. At about this time the soundman working with the main system will have found time to hook up the A.C. power distribution system, with the help of the house electrician, and will have found and tied the ground to a cold water pipe. This often includes a consultation with the lighting crew to solve any potential A.C. noise problems. Once A.C. power is up, a monitor speaker balance is achieved by plugging a long unterminated mike cable into the mixer input to provide sufficient gain to measure the resulting hum from the speakers with a sound level meter. The speakers are balanced for slightly louder signal into one ear since this has been shown to improve intelligibility in the presence of masking or ambient sound. After all the headline act band gear is arranged, and conditions are as close as possible to those at the actual performance, the 1/3 octave equalizer is adjusted to give a flat response, and the monitor tuning begins. (Fig. 1, A&B)

Tuning the monitors (or more prop-

erly the stage area) involves plugging the monitor mikes used during the show into the bridging box (which should be terminated by the main system mixer) and raising the gain of the monitor system until it begins to feedback acoustically.

The system (including the stage area) will feedback at a frequency that must represent a peak in the acoustic response of the stage area. After a feedback howl is established, it's frequency is read from the digital frequency meter or real time spectrum analyzer and the appropriate 1/3 octave filter is used to attenuate that frequency slightly more than required to stop the feedback howl. Notes are kept of the frequency and order of the peaks encountered as the system gain is increased, and each peak is dealt with accordingly.

This method differs from the more common pink noise excitation and 1/3 octave equalization of a room in its intent and procedure. Our approach is simple and pragmatic. Rather than attempting to judge the flatness of the stage area response with pink noise, on the theory that a flat response precludes feedback peaks, and accepting the inaccuracies of and the exceptions to this rather simple theory, we just make the system feedback, and then make it stop. Our intent is not so much a stage area that sounds flat, but rather a lack of feedback. This is primarily because our band operates at sound pressure levels higher than most, and thus some monitor fidelity is traded off for higher level and intelligibility. A rather bass-heavy equalization is also preferred, since it allows more acoustic power on stage with no danger of resulting feedback. The figures show charts of the monitor feedback tuning of a stage area judged 'good' compared with a difficult area. These charts are kept for each performance, and are referred to both during the performance (as conditions sometimes change) and afterwards. When we work with quieter groups than our own, or acoustic acts, we are able to concentrate on monitor sound quality exclusively and need not concern ourselves with the problem of acoustic feedback. \* The differential mike deserves mention here in its role as a canceller of feedback as well as stage ambient sound. After feedback tuning, the monitor mike(s) position(s) are marked in the stage with tape to insure the same relative positions during the show.

Even in the most acoustically disastrous environments, response peaks below about 1 kHz will be rejected by the differential mike with further development of this use of microphones it

Jim Coe, "DIFFERENTIAL MICROPHONES," R-e/p, May-June 1973 issue; Page 13ff

should be possible to eliminate feedback problems altogether. Even now, only the poorer rooms are a problem in this respect.

After the "monitor tuning", the 1/3 octave equalizer is finally adjusted for overall balance by somewhat attenuating the lower frequencies to compensate for any great notching in the mid highs, and highs.

The main system is balanced by listening to familiar recorded intermission takes and/or by pink noise excitation of the hall. Feedback tuning as used for the monitor system has also been used successfully. The major room peaks found when tuning the monitor system will naturally, also be found with the main system. It is important when listening to the main system to move about the hall checking the projection and relative balance of the horns. Some changes in the aiming are almost always indicated.

At about this point mike lists and charts are drawn up for each of the bands which also indicate which mikes will be bridged into the monitor system. The mike lists must be coordinated to insure the simplest mike changes between acts or chaos can be the result of careless mike placement plans.

In our mike placement, we now use omni mikes for our drum set in the snare and floor tom positions and just inside the kick drum. The snare and

floor tom mikes are thus able to pick up the cymbals and hi hat as well, with balance achieved by careful placement. This allows complete miking of the drum set with only four mikes and a great reduction in phase cancellation problems, clutter, and leakage. The cardioid mikes used for the instruments are placed with their area of least sensitivity toward the cymbals; the greatest offenders from the point of view of leakage. The differential mike is, of course, inherently immune to leakage even though near the drum set, except for the highest frequencies.

By now, it will be the appointed time for the sound check and the groups will come on to set up and test their gear and the monitor system in the reverse order of their appearance. A few minutes are taken to tune the monitor system for each group, since different mikes and placements will be used and gear rearranged in the stage area. A separate chart is kept for each.

No final judgement of the main system is attempted at this time for two reasons. First, the musicians are most of all interested in whether they themselves can hear the stage monitor system and most have experienced many poor systems. Second, the acoustics of the hall will change considerably, (usually for the better) as the absorption factor of the audience is added. Temperature changes in the air and in the electronics and

## new pocket sized professional sound level meter for under \$100



The new Scott 451C sound level meter is the first truly professional instrument that fits in your pocket and costs only pocket money.

It gives instant readings at the touch of a button to ANSI type S3C accuracy with industry standard "C" weighting for flat response. Its range of 45 to 130dB SPL lets you check ambient background levels as well as the signals of interest. It measures the complete range of sounds likely to be encountered by the audio engineer or the advanced audiophile.

It's got a handsome, rugged all metal case and a big meter face that's easy to read. It's also a lot of fun to use. Its battery lasts all year. It lasts indefinitely and it's fully guaranteed for two years. It costs only \$98.00. It's available from distributors whose names we'll send you with full product specifications.

**Scott  
Instrument  
Laboratories**  
Division of Eastern Air Devices  
30 Cross Street  
Cambridge, MA 02139



other effects will also help to make a pre show 'empty room' judgement invalid during the show.

There is usually time at this point for a dinner break before the doors are opened. This lead time is important since it is used for repair or replacement of defective equipment when necessary. The systems cannot be checked until they are completely set up, so a late load-in and set-up can mean a late show if trouble develops. Few indeed are the companies that produce gear capable of standing up for long to the tremendous wear and tear of life on the road. The only insurance against constant troubleshooting before the show is thoughtful modification and packaging of the equipment.

During the performance, the soundman for whichever group is playing mixes the main system and is more or less in charge. He may have a partner who operates the stage monitor system, or a sound service employee may do this. Usually an intercom supplied with the system connects the two system operators so that minor problems are more easily spotted and cleared up. When the acts are changed, one man stays at the main mixer to run mike checks and play intermission music takes, while his partner places the mikes for the next group. We have found that more than two men placing mikes tend to confuse each other. This of course is when careful preplanning pays off in a fast and accurate set change.

During the first part of a set the soundmen will be optimizing the sound quality and the balance of the elements of the group, and the experienced soundman will soon reach a balance he considers right, and will leave it alone until some condition requires a change. The operator who continually plays with the system will find it difficult to retain some point of reference. After all, a change is not necessarily an improvement. Most often, helpful members of the audience will make more or less kind suggestions to the soundman and he must weigh these against his own perceptions, remembering that different locations in most rooms sound considerably different. The soundman will 'walk the room' once or twice during the performance, when the mixing console is under control to evaluate these differences.

Each set change is a break-down and load-out for the group that has just finished, but the sound service soundman and the headline band's soundman are the last to leave. In spite of the tendency to hurry the load-out and be done with it, care must be taken in packing to avoid transit damage and to insure a fast set-up at the next performance. The truck packing must also be watched over by someone with a personal interest in keeping the system whole.

Murphy's Law applies to concert touring as well. The rate at which things can go wrong is inversely proportionate to the time you have to fix them, multiplied by the distance between you and the problem. On the November tour we had our trial by fire.

The first concert was at Alfred University in upstate New York. To start things off the promoter had not arranged for our usual two o'clock access to the gymnasium before the concert. The athletic department had a track practice scheduled until 5:30, and the stage was nowhere in sight. The show was to begin at 8:00 p.m. Diplomacy was applied and the stage was actually completed by 5:30. As the 10,000 pounds of equipment was coming off the truck it became obvious that we were in for a rough night. The band gear and monitors had just arrived from across the continent. The sound reinforcement system had only been in the truck from Philadelphia but, the cases appeared as if they had gone around the world 10 times. Handles were missing, castors had been ripped off or driven through the bottoms of cases, and latches were sprung or missing. We had 2 hours to set the gear up, find what was working

and what was not, and then repair the broken items. Then we could proceed to adjust the systems for the performance. Needless to say we were a little late. We did the show on about a 3/4 system. Only quick troubleshooting and lots of spares allowed us to put on the show at all. These problems with physical damage to the equipment, in spite of the extraordinary packaging schemes, was attributed to the fact that the truck was much too large for the job. Being loaded to about 1/3 of its weight capacity, it was jumping all over the place whenever it hit a small bump on the road. For the first concert of the tour the sound was good. The acoustics of the gym were pleasant. It was an old wooden structure with a low arched roof and packed with people. These factors combined provided the necessary acoustic absorption, to give the technicians some control over the sound.

The acoustic of halls to date is like the weather, much talk, but nobody does anything about it. Admittedly it is tough not knowing what we are talking about except that such and such a hall had bad echos, or just plain doesn't sound good. Alfred is an unusual example of how

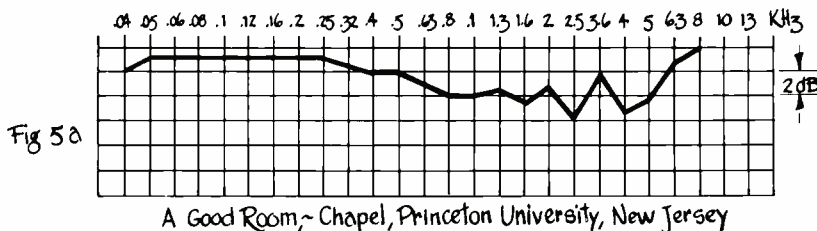

A Good Room, ~ Chapel, Princeton University, New Jersey

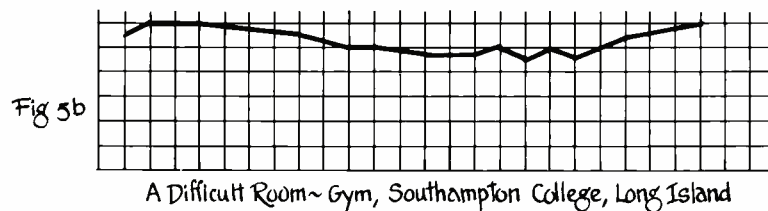

A Difficult Room ~ Gym, Southampton College, Long Island

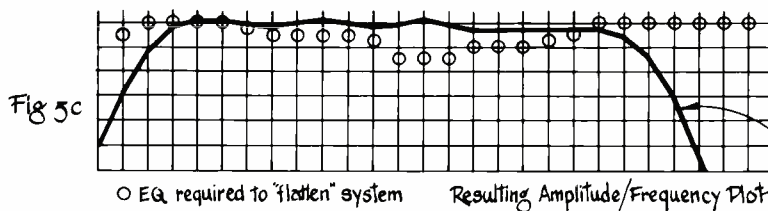

○ EQ required to 'flatten' system      Resulting Amplitude/Frequency Plot

Fig 5 ~ Monitor System Equalization

good acoustics make the work easier. Another example of this was the performance in the Schubert Theatre in Philadelphia. This hall was designed as a classical concert hall and had the most remarkably even distribution of sound from the stage area I have ever heard. The performance sounded essentially the same in the back of the uppermost balcony as it sounded by the mixer near the rear of orchestra seats. Likewise the musicians rated the Schubert as having the best stage environment and monitors of the tour.

Aside from the problem of enforcing the contract rider specifications the extreme variability of the acoustic remains the only difficulty in presenting a consistent stage environment and re-enforcement situation. The advent of 1/3 octave, equalizers and analyzers has helped to some extent. Relatively narrow band equalization allows us to compensate somewhat for severe reflections and peaks in the response of the room to our audio stimulus. Some equalization graphs are shown in figure 6 (A&B). These are not typical, as there is no typical room. They do show what we considered to be good examples of a subjectively good or poor hall. Along with these are two graphs depicting the response of the system components fig 6 (C&D). From these one might draw some inferences about the spectrum of the reverberant field in the hall. One must recall however that some of the notches are to eliminate ring modes due to standing waves and direct reflections particular to the specific vocal microphone and monitor speaker positioning in the room.

Concert sound technology is both complex and challenging. No two performances are ever alike. No hall's acoustics are like any other's. The variables involved in each situation stagger the mind. Sometimes the best course is to just mix it till it sounds right and don't try to figure out why something is happening a certain way. Fix it if it needs fixing and mix it when it needs mixing.

Presently under investigation by these authors and the editors of R-e/p is a method to communicate quantitatively various soundmen's experiences in some of the more popular halls; the problems and their solutions. Acoustic considerations are a relatively unexplored area. The present techniques practically ignore acoustics because little can be done with a hall for a single performance. If it were common knowledge that a certain hall had real problems then it could perhaps be avoided or pressure could be brought against the hall management to change the acoustics. At least if some kind of sound signature of a hall existed it might help the sound technician if he knew a certain difficulty existed and could prepare himself and his equipment. We would appreciate hearing from anyone with ideas about how this would best be accomplished, or from anyone with knowledge of a unique hall. This information may be published featuring a particular hall per issue.

A possible method might be time sequence analysis of single frames of a motion picture taken of the display screen of a one-third octave real time spectrum analyzer. The analyzer would display the output of a microphone placed in various positions in a hall. The excitation signal could be delivered by intermittent pink noise delivered to a standard speaker in a standard position on the stage. The rate at which the sound levels in the one-third octave bands decayed would provide a unique acoustic signature for every hall. The significance of the various rates of decay at different frequency bands could then be related to subjective impressions of the acoustics. We would like to hear from readers as these articles will serve as an information file for your reference.

Upcoming, an article specifically about small rooms and small 'club' sound systems. This type of equipment and situation is one that almost everybody has to deal with sooner or later, usually early in ones career, as many groups and technicians start out in small clubs.

#### HOT TUNA TOUR NOVEMBER 1973

CONCERT DATES	PLACE	REMARKS
Wed. Nov. 7	Gym, Alfred University Alfred, New York	not confirmed until Nov. 1, 'breakosis'
Fri. & Sat. Nov. 9 & 10	Academy of Music New York City	the big gig real pro. stage crew
Mon. Nov. 12	Gym, Southampton Coll. Southampton, L.I., N.Y.	Terrible acoustic
Tues. Nov. 13	The Dome, C.W. Post Coll. Greenvale, L.I., N.Y.	Bizzare but tolerable acoustic
Wed. Nov. 14	Palace Theatre Albany, New York	Good acoustic stage-crew got drunk
Fri. Nov. 16	Schubert Theatre Philadelphia, Pa.	Excellent acoustic stage and audience
Sun. Nov. 18	Orpheum Theatre Boston, Mass.	Crew split before load out

## Largest Tape Box Manufacturer in the West

In stock and made to order.

Available for immediate  
delivery 500,000

**10" - 7" - 5" and 3"**  
reel to reel tape boxes.

Prices quoted upon request.

### Kent Printing & Paper Co.

8103 S. Beach St.  
Los Angeles, Calif. 90001  
(213) 589-8613

Circle No. 122

## Stereo Audio Mixer



- True Stereo Operation
- Extremely low noise
- Built-in set up oscillator
- Equalization on program outputs

The E-802 is designed for use in any high quality recording, broadcasting, or sound reinforcement application. The mixer has 8 inputs which can be switched to the left, center (both) or right output channels. Inputs 1 and 3 can be switched to true stereo input operation. Unit is available in attractive walnut formica cabinet, rugged carrying case for portable use, or rack mounted. Designed for the discriminating user who has maximum requirements and needs the ultimate in quality.

**Cetec** INC  
a subsidiary of Computer Equipment Corp

13035 Saticoy St. N. Hollywood, Calif. 91605  
Phone: (213) 875-1900 TWX: 9104992669

Circle No. 123

# With your great ear, maybe you can get perfect sound sync. But can you really afford it?

Getting sound sync by ear is costing you a lot more than it has to. Because now you can get sound sync that's right on the money, instantly.

By using the SMPTE Edit Code and the new 3M Series 79 Synchronizer.

No more trial-and-error tape positioning, no "rocking and rolling," no time-wasting-tweaking of tape speeds until they sound right.

Just fast and easy sound sync, because with the edit code on your video and audio tapes, you've got split-second, absolute identification of the entire tape length.

For VTR editing, first transfer the sound track and edit code from your master tape (quad or slant track, mono-chrome or color) to any multitrack 3M Professional Audio Recorder.

Then manually park the tapes to within half a minute of each other using the Synchronizer's built-in edit code reader and start your VTR. The audio recorder automatically slaves to your VTR and locks into perfect sync, with no drift, no knob twisting no matter how long the tapes.

With this kind of precision, you can build a useable sound effects track by using the edit code for effect location. Get a high quality sound track by re-recording video and the code on your VTR, sound and the same edit code on a separate audio recorder. Build your own 24-track audio recorder by locking an



8-track and a 16-track unit together.

And, of course, your audio recorders should be 3M Series 79 Professional Audio Recorders. Mono through 24-track, they give you precise tape handling, extremely low

wow and flutter and signal-to-noise ratios that are state-of-the-art.

Used together, the 3M Series 79 Synchronizer and Professional Audio Recorders give you the sound quality and split-second accuracy you need for editing, dubbing and sweetening. Faster and at a much lower cost.

And what could be sweeter than that?

Professional Audio Products, 3M Company, 3M Center, St. Paul, MN 55101. Tel.: (612) 733-7323. TWX: 910-563-3712.



**We've been there.  
And brought the answers back.**

**3M**  
COMPANY



Give a listen at any  
of these 3M dealers:

- Accurate Sound Corporation  
2702 National Circle Road  
Garland, Texas 75041  
214/278-0553
- Aengus Engineering, Inc.  
50 Oak Hill Road  
Fayville, Mass. 01745  
617/481-7600
- Audio Designs & Mfg., Inc.  
16005 Sturgeon  
Roseville, Mich. 48066  
313/778-8400
- Audio Recorders of Arizona  
3830 No. 7th St.  
Phoenix, Arizona 85014  
602/277-4723
- Automated Processes, Inc.  
80 Marcus Drive  
Melville, N.Y. 11746  
516/694-9212
- Auditronics, Inc.  
180-B South Cooper Street  
Memphis, Tenn. 38124
- 207 Summit Street  
Memphis, Tenn. 38124  
901/276-6338
- Audio Graphic Labs  
16400 E. Truman Road  
Independence, Mo. 64050  
816/836-4000
- R. A. Dimier & Assoc.  
4613 Elm Ridge Drive  
P.O. Box 1643  
Garland, Texas 75040  
214/272-5055
- Fidelity Sound Company, Inc.  
GSA Dealer  
1200 18th St., N.W., Suite 105  
Washington, D.C. 20036  
202/296-9110
- Gill Custom House, Inc.  
8813 W. 95th St.  
Palos Hills, Ill. 60465  
312/598-2400
- High Fidelity Showroom  
6383 Clayton Road  
Clayton, Missouri 63117  
314/721-6500
- Houston Electronics  
8000 Harwin, Suite 275  
Houston, Texas 77036  
713/785-5511
- Jackson Sound Productions, Ltd.  
1403 S. Lipan  
Denver, Colorado 80223  
303/722-7019
- The Maze Corporation  
1900 First Ave. No.  
Irondale, Birmingham, Ala. 35210  
205/591-4800
- Milam Audio Corp.  
700 West Main St.  
South Pekin, Ill. 61564  
309/348-3112
- Martin Audio  
320 West 46th Street  
New York, N.Y. 10036  
212/265-6470
- Pams, Inc.  
4141 Office Parkway  
Dallas, Texas 75204  
214/827-0901
- RCA Corp.  
Bldg. 17B1  
Delaware & Market Streets  
Camden, N.J. 08102
- Sound Specialties  
2009 Naudain St.  
Philadelphia, Pa. 19146  
214/732-7250
- Seco Labs, Inc.  
206 South 44th St.  
Omaha, Nebraska 68131  
402/553-1166
- Seneca Sound, Inc.  
116 Killewald Ave.  
Tonawanda, N.Y. 14150
- Westlake Audio, Inc.  
6311 Wilshire Blvd.  
Los Angeles, Calif. 90048  
213/655-0303

# NEW PRODUCTS



## AUDITRONICS MODEL 110 "GRANDSON" CONSOLE

Model 110, is a new expandable, completely modular professional recording/remixing/on-air audio control console from Auditronics, Inc. of Memphis. Designed to accommodate up to 16 track recording and on-air applications, the free standing unit is expandable to 18 mixing positions — 36 inputs — in only 36" width. It offers complete metering, two echo send/receive channels, talkback communications, separate control room and studio monitoring, test oscillator, and a full line of matching accessories including a plug-in patch bay.

A unique second generation, full capacity system at a moderate price, fills the gap between conventional broadcast consoles and sophisticated recording consoles. The most recent integrated circuit designs as proven in the widely accepted Model 501, Son of 36 Grand, are utilized.

Monitoring functions and muting circuitry are TTL logic controlled and may be reprogrammed by the owner to meet specific requirements. To accommodate the exceptional dynamic range requirements of this multi application device,

20 dB headroom is provided over + 4 dBm output and each input position may be ordered with a stepped input sensitivity control handling levels from - 70 dBm to + 20 dBm, a 130 dB dynamic range.

Each input position provides a plastic element linear motion attenuator in either mono or stereo configuration as required. Mono input positions are available with an optional 3 knob, six frequency equalizer providing 12 dB boost or cut at 80 Hz or 150 Hz, 1.8 kHz or 4 kHz, and 7.5 kHz, or 12 kHz, in/out switch, and Hi-Lo cut. Stereo inputs provide for one line level pair and mono inputs provide switchable selection between two inputs which may be either microphone or line level. All inputs and outputs are transformer isolated. An on-off switch with indicator light and controls for echo sends A and B appear on each position. The unit is available with 2, 4, or 8 program output channels. A stereo pan-pot and multi station switches at each input position provide assignment to one or more program output busses simultaneously.

AUDITRONICS, INC., 180-B SOUTH COOPER ST., MEMPHIS, TN. 38104

Circle No. 125

## NEW CASSETTE RECORDER FOR TIME COMPRESSION/EXPANSION OF SPEECH

Lexicon, Inc. announces its new Varispeech<sup>(TM)</sup> machine which allows speech recorded on tapes to be played back at any speed between half and two and one-half times original recording speed without affecting pitch or speaker's identity.

For example, a full hour cassette may



be audited in just 24 minutes for a quick perusal of its content. On the other extreme, a garbled or excessively rapid passage may be slowed to permit a detailed syllable-by-syllable analysis.

The Varispeech machine compresses and expands playing time through electronic signal processing by means of a small special purpose computer built into the unit. The tape handling components are rugged and reliable industrial grade units. The machine is lightweight, easily portable, and simple to operate.

Typical applications for the Vari-speech machine include speed listening, professional refresher courses, education, motion picture sound tracks, time justification of broadcast commercials, dictation and transcription, language study. LEXICON, INC., 60 TURNER STREET, WALTHAM, MASS. 02154.

Circle No. 126

### SHURE SM7 HIGHEST QUALITY PROFESSIONAL MICROPHONE

Shure Brothers has announced the Model SM7 Unidirectional Dynamic Microphone, designed for the most exacting music and speech requirements in professional audio applications.

Field-tested in the prototype stage for seven years at major recording studios and scoring stages, the Shure Model SM7 is said to deliver superior performance in the most critical audio applications — including vocal and instrumental pickup in recording studios, broadcast, broadcast announcing and production, motion picture and television scoring, news and talk shows, narration and boom applications.



A unique response tailoring system allows users to choose any of four response curves for optimum performance: (1) flat response from 40 to 16,000 Hz; (2) response boosted in the mid-range frequencies for additional presence to emphasize voices or certain musical instruments; (3) response cut at low frequencies to produce a bass roll-off; and (4) combination response with both presence boost and bass roll-off. Dual slide switches control not only the response tailoring but also provide a

visual frequency response curve readout which graphically shows the response setting of the microphone.

Other features of the new Model SM7 include an extremely effective "pop" filter to sharply reduce explosive breath sounds, as well as an internal air suspension shock mount that reduces mechanical noise to negligible levels. The cardioid pickup pattern of the Model SM7 is uniform with frequency and symmetrical about the axis to provide maximum rejection and minimum coloration of off-axis sound.

Professional user net price is \$240. SHURE BROTHERS INC., 222 HARTREY AVE., EVANSTON, ILL. 60204

Circle No. 127

### ELECTRO-SOUND ES-505 PROFESSIONAL RECORDERS

Initial deliveries are now being made of the ES-505 operator engineered audio tape recorder in 1/4" or 1/2" format, one to four tracks by Electro Sound.

According to Ted Wuerthner, Vice President, Marketing of Electro Sound,



the ES-505 is the first professional audio tape machine specifically designed with the needs of the studio or broadcast engineer in mind. The ES-505 the company claims incorporates many functional features that are new to this class of equipment, at a competitive price. These features include a built-in audio oscillator that speeds alignment and testing; a motion sensing system that prevents tape damage in case of improper sequencing of controls; a disappearing head gate that locks in open position, then closes automatically in play and record; and an accessory third reel that simplifies editing. Other advanced features are a non-slip capstan that improves timing accuracy to  $\pm 0.1\%$  and a viscous damped flywheel that lowers flutter 20 to 25%.

Electro Sound is one of the world's leading manufacturers of high speed tape duplication equipment, theatre, and custom professional sound systems.

ELECTRO SOUND, INC., 725 KIFER ROAD, SUNNYVALE, CA. 94086

Circle No. 128

### KMAL MICROPHONE STANDS FROM AUDIOTECHNIQUES

KMAL (Keith Monks (Audio) Ltd., England) microphone stands having achieved studio approval during many years of use in English and European markets are now available in the U.S. market, through Audiotechniques, Inc., from Professional Audio Dealers, Sound Contractors and many music and high fidelity dealers.



All KMAL stands feature the exclusive single lever control for adjusting boom length, boom angle and rotation. A unique drum boom enables an additional microphone to be mounted on microphone stands. KMAL offers a full line of microphone stands, boom arms, cable reels and accessories in chrome and non-reflecting black.

AUDIOTECHNIQUES, INC., 142 HAMILTON AVE., STAMFORD, CT. 06902

Circle No. 129

### NEW ELECTRO-VOICE LO-Z TO HI-Z MICROPHONE LINE TRANSFORMERS

Smaller, lighter, more conveniently connected, the new Electro-Voice 502C and 502CP provide an ideal way to go from Lo-Z mike line to Hi-Z input. The flat 20-15 kHz response of the new 3/4" diameter transformers and their easy plug-in connectors make them a pleasure to use.

The transformers are designed to match low impedance microphones to high impedance inputs. Their use becomes necessary when the microphone preamplifier is designed to accept a high impedance microphone and it is necessary to use the microphone some distance from the preamplifier. Low im-

### COUNTRYMAN TRIANGLE WAVE OSCILLATOR

Phasing effects can be created automatically by plugging this handy triangle oscillator module directly into any Countryman Associates Model 968 or 968A Phase Shifter. Powered contin-



uously for one year by a self contained 9 volt battery, the Model 969 triangle wave oscillator covers an unusually wide frequency range from 1 cycle per minute to 100 cycles per second, allowing it to create useful effects that go far beyond basic phasing.

COUNTRYMAN ASSOCIATES, 424 UNIVERSITY AVENUE, PALO ALTO, CA. 94301

Circle No. 132

### FREQUENCY SELECTIVE LIMITER INTRODUCED BY INOVONICS

A new limiter for mastering applications FM and TV audio, that require



independent control of both high-frequency program energy and broadband program peaks has been introduced by Inovonics, Incorporated, of Campbell, Ca. Inovonics' Model 210 features a Fast Peak Limiter and a Frequency Selective Limiter in a single rack-mounted unit.

The Fast Peak Limiter has separate controls for Peak Ceiling and Attack and Release timing, and unique ripple - cancelling circuits to assure very low distortion, even at low frequencies.

The Frequency Selective Limiter uses plug-in inserts to complement a wide variety of high-frequency overload characteristics. Both stock and custom-tailored inserts are available.

Panel controls on the Model 210 include Power, Input Gain, Peak Ceiling, Attack, Release, and frequency selective limit Threshold. The panel also has indicators to display peak limiting and high frequency gain reduction. A remote-mounting gain reduction meter and an input isolation transformer are optional.

The Model 210 operates on 50/60 Hz 105-130 VAC at 10 watts.

Price: \$490.

INOVONICS, INCORPORATED, 1630 DELL AVE., CAMPBELL, CA. 95008

Circle No. 133



pedance microphones used with 502C Matching Transformers prevent high frequency roll-off and the introduction of hum when long mike cables are used with high impedance inputs.

The 502CP has an A3F professional three-pin connector on the Lo-Z side and a standard phone plug on the Hi-Z output side plus a loose Switchcraft A3M connector for the output end of a microphone cable. The 502C meets the need for an MC-type connector on the output side. Packaged loose with the 502C are both A3M and MC1 connectors for use in mike line hookup.

Price: \$13.20 for the 502C and \$14.40 for the 502CP.

ELECTRO-VOICE, INC., 600 CECIL ST., BUCHANAN, MI. 49107

Circle No. 130

### HAECO PURE SILVER WIRE CUTTER-HEAD COILS

Wound of a special grade of pure silver wire onto an anodized aluminum coil form, fully insulated, with no wire/coil-form separation, these recently introduced 7 ohm coils are said to improve the ability of the cutterhead to cut exceedingly high-level records without self-destruction.



HAECO - HOLZER AUDIO ENGINEERING CORP., 14110 AETNA STREET, VAN NUYS, CA. 91401

Circle No. 131

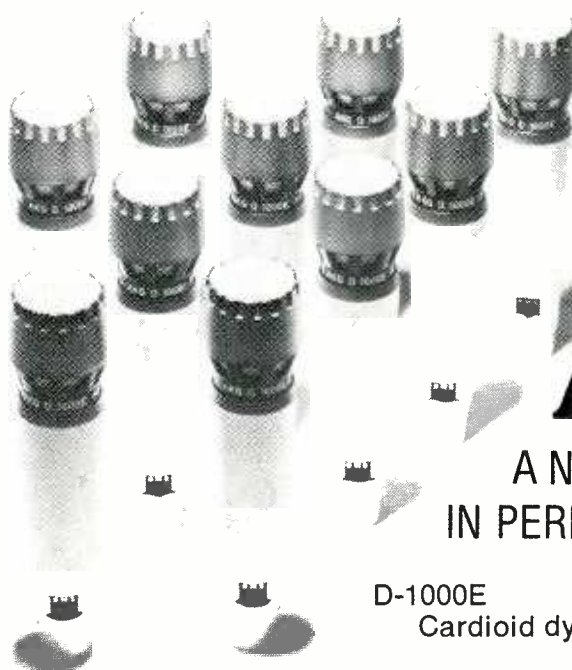

# AKG

A NEW STANDARD  
IN PERFORMANCE

D-1000E  
Cardioid dynamic microphone.

For information on the entire  
AKG product line call or write



AKG MICROPHONES · HEADPHONES

DISTRIBUTED BY  
NORTH AMERICAN PHILIPS CORPORATION  
100 EAST 42nd STREET, NEW YORK, NEW YORK 10017  
TEL: (212) 697-3600 TWX: 212 867-5624

Circle No. 134

Re/p 53

**ALLISON VOLTAGE CONTROLLED AMPLIFIERS MODELS VCA2-1 AND VCA2-5**

These new devices are primarily designed for automated mixdown, electronic music and other applications requiring a high precision voltage controlled gain element.

Significant improvements in noise and distortion characteristics, over other such devices, are claimed by the manufacturer. A partial list of typical specifications for VCA2-1 are: Range of control; 40 dB gain to 130 dB attenuation. Control inputs; multiple 20 dB per volt logarithmic. Signal to noise ratio; 111 dB unity gain (on noise), 123 dB at max attenuation (off noise). Distortion; .05% at all attenuation settings. VCA2-1 price; approx. \$50.00 in O.E.M. quantities.

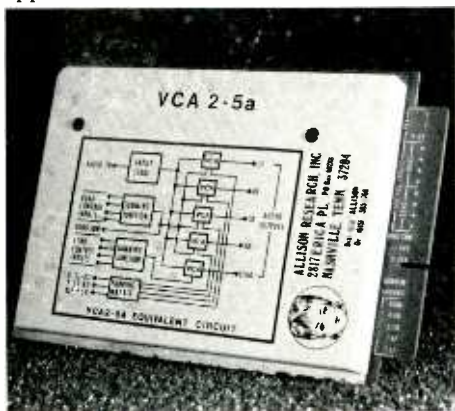

VCA2-5 is the five output version, and exhibits the same specifications and is designed for applications requiring voltage controlled level, echo and quad panning, while using only one VCA.

VCA2-5 price; \$150.00 in O.E.M. quantities.

**ALLISON RESEARCH, INC., 2817 ERICA PL., NASHVILLE, TN. 37204**

Circle No. 135

**NEW ELECTRO-VOICE HI-PASS FILTER FOR MIKE LINES**

Electro-Voice announces the smaller, lighter, more attractive, and more economical design of the new 513A Hi-Pass Filter. The new unit is said to be most valuable where microphone pickup is plagued by excessive low-frequency room reverberation, ambient noise, the mechanical noise of air conditioners, or other equipment - even sixty cycle hum and wind noise. Installation is as simple as plugging in a short extension cord with balanced line, professional cable connectors in and out.

The 513A is a sharp cut-off filter that does not "roll off" the bass with the obvious audible change that makes the presence of other type filters so apparent. The sharp cut-off below 100 Hz does not disturb the subjective quality of the vocal spectrum and makes no change in any program material above 200 Hz. The attenuation of low fre-



quencies in microphone outputs, with the 513A, will many times improve intelligibility and increase gain-before-feedback immediately.

**ELECTRO-VOICE, INC., 600 CECIL STREET, BUCHANAN, MI. 49107**

Circle No. 136

**NEW NAGY SPLICER**

A tape splicer that shears rather than cuts the tape has been announced. The manufacturer claims that shearing results in better and faster splices. The unit which is self-sharpening can be had in standard 1/4 inch groove or cassette 0.150 size. A splicing tape dispenser is attached facilitating the splicing operation.

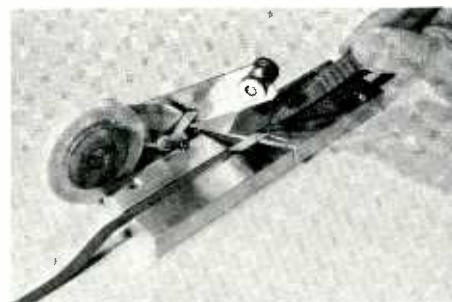

Price: \$24.95 plus \$1.00 for postage and handling. Includes a roll of splicing tape and tweezer.

**NAGY RESEARCH PRODUCTS, BOX 289, MCLEAN, VA. 22101**

Circle No. 137

**WHY MINNEAPOLIS ?**

— continued from page 36

channels of the second machine. Thus we could work with only one 16-track while recording the vocals in a smaller studio.

JUNG: One other area that we are extremely concerned with right now is also brought to the foreground by this quad LP project. With quad we find far more sophisticated echo systems in terms of digital delay. We have a quad EMT and are building a quad live chamber, each with variable delay at input and output. PILHOFER: When the industry went from mono to stereo, it went through a "ping pong" stage. We're trying to avoid that with quad. In other words, I see textures emerge: a sound might be in one corner, fill the room, narrow down . . . mono to stereo to quad, etc.

The first rule is that there is no rule.

We have to make the technical capabilities work. Not everything from the past is suddenly passe'. We have to have the good sense to not overuse quad. It is not necessary . . . and can be stifling . . . to feel you always have to fill all of the tracks.

R-e/p: Is quad being treated as a fad? PILHOFER: Much of it is. But opening sound up is very functional to us. We had to create and record and reproduce four-channel a long time ago . . . before quad was a household term. We didn't get on the bandwagon and get into it because the thing to do . . . it is much more functional for us.

JUNG: We've had to struggle with a lot of quad systems through the past few years. This LP calls for a laborious mixing job, and it only makes us hope that, while we produced this one on the Sansui system, whatever system survives in the industry, it will allow us to not be taken up with its shortcomings and get on with.

R-e/p: Going back to multi-track recording: Do you provide it on location?

JUNG: Yes. One of our control rooms virtually unplugs. We can have the whole thing in a truck in an hour. We like to set up in the actual concert hall (or whatever), though. Since monitoring in trucks is less than ideal, we find headphones not much more of a compromise.

R-e/p: It's not true, then, that you do mostly advertising work?

JUNG: We are doing increasingly more major label work. But we don't want to get locked into any one so-called specialty. We like having the St. Olaf College Choir in one day, going to Denver to record the symphony the next, and returning to a rock session. The same "ear" to all of those can't help but contribute to the openness we strive for. We want to stay loose, but within a reasonable balance with a reliable technical base. At all times we want quality control.

R-e/p: How can you maintain quality control from microphone input to disc? Isn't there some point along the way where Sound 80 has to depend on someone else for it?

JUNG: Yes . . . record pressing. But it's ours all the way through mastering. We have our own computerized lathe, and most of the time the recording engineer takes the tapes to the mastering engineer and works right along with him through that critical transition stage. PILHOFER: Which points out the most important thing of all . . . the conscientiousness of the technically capable Sound 80 engineering staff . . . all Minnesotans, incidentally.

# Classified

## CLASSIFIED ADVERTISING RATES

Prepaid\* with submitted copy:  
 One column inch (1" x 2 1/4") ... \$20.00  
 1/2 column inch (1/2" x 2 1/4") ..... 14.00  
 \*(If billing is required add 20%.)

Send for FREE Catalog  
 and Audio Applications



**OPAMP LABS**  
 172 S Alta Vista Blvd  
 Los Angeles, Calif 90036  
 (213) 934-3566



Circle No. 152

## MULTI-TRACK

8 and 16  
 TRACK RECORDING CONSOLES  
 THE SOUNDEST DOLLAR SPENT  
 IN PRO AUDIO TODAY  
 1965 CHEREMOYA AVE.,  
 HOLLYWOOD, CALIF. 90028  
 P.O. Box 3187, Hollywood, CA. 90028  
 (213) 467-7890

Circle No. 153

## EQUIPMENT AVAILABLE

ONE STOP FOR ALL YOUR PROFESSIONAL  
 AUDIO REQUIREMENTS.  
 BOTTOM LINE ORIENTED.  
**F. T. C. BREWER COMPANY**  
 P. O. Box 8057, Pensacola, Florida. 32505

PROFESSIONAL RECORDING AND  
 TEST EQUIPMENT for recording studios  
 and broadcasters - Altec, Ampex,  
 3M, GR, HP, Tektronix - new & used.  
 Free equipment list, or drop in.  
**CHAS. E. WASHBURN CO.**  
 6114-R Santa Monica Bl.  
 Hollywood, CA. 90038

AUDIO EQUIPMENT NEW AND USED  
 whatever your needs. Whether you're  
 building a new studio or re-modeling  
 your present one, check us first for a  
 package price. We will not be undersold.  
**AMBOY AUDIO ASSOCIATES, 236**  
 Walnut St., South Amboy, N.J. 08879.  
 (201) 721-5121

FOR SALE: AG 350-2 Ampex recorder.  
 Please call for complete description  
 Scott Kent, BKM Assoc.,  
 (617) 658-6565.

— 16 TRACK CONSOLE —  
 16 in/16 out New—Never used—Auditronics  
 with all plans, delivery, installation, guar-  
 anty card, spares, connectors, etc. COM-  
 PLETE! reasonable! Extras: Quad Panners,  
 patch cords, p.s. cables — for details call  
 (215) 395-5511

BUILD YOUR OWN highest quality  
 microphone mixers, consoles, phono  
 preamps, crossovers, equalizers, or vol-  
 tage controlled devices, using modules.  
 Free catalog. **BURWEN LABS., 209**  
**MIDDLESEX TURNPIKE, BURLIN-**  
**GTON, MASS. 01803.**

I.C. COMBINING AMPLIFIERS from  
 \$40.00. Fully tested and guaranteed  
 for 10 years. Distribution amps, line  
 amps, mic preamps, xfmr cards. Card  
 files, power supplies. Electronix cross-  
 overs. Equalizers. **DIRECT FROM**  
**MFG., NO DISTRIBUTOR MARK-UP**  
**IXTLAN ENGINEERING, Box 323,**  
**LOMBARD, ILL. 60148**

### FOR SALE

DEMONSTRATOR EQUIPMENT with new  
 warranty. Recording console, Spectra Son-  
 ics components. Eight input, four output,  
 with equalization, echo send, attenuation,  
 and track select on each input. Complete  
 monitoring and patching facilities. Custom  
 walnut Formica cabinet complete with ten  
 API VU meters. Eight feet wide, 44" high,  
 32" deep. Best Offer.

SPECTRA SONICS Model 610 Compli-  
 mitters with stereo interconnect (2) \$795.00  
 USED EQUIPMENT — Pultec EQH-2 Equal-  
 izers (2) \$235.00 each. Pultec EQP-1 Equal-  
 izers (2) \$295.00 each. Altec 604E speakers  
 in cabinets (2) \$150.00 each.

RECORDERS — (1) Ampex AG 350-4 in  
 console, \$2850.00 (1) Ampex 351-2 in  
 rack, \$1450.00.

POWER AMPLIFIERS — Dynaco Mark III,  
 60 watts, (4) \$45.00 each. Stereo 70's  
 35 watts/channel, (2) \$50.00 each. Will sell  
 all of the above items as a complete, ready-  
 to-go four track studio, or individually.  
**AMBOY AUDIO ASSOCIATES, 236 WAL-**  
**NUT STREET, SO. AMBOY, N.J. 08879**

NEUMANN AM-131 LATHE with  
 variable electric pitch drive. Has  
 possibility of automation, \$2500.00.  
**DICK MCGREW RECORDING SER-**  
**VICE, 7027 TWIN HILLS AVENUE,**  
**DALLAS, TX. 75231, (214) 691-5107**

FOR SALE: 4 track recording studio to  
 best reasonable offer. Ampex AG440B-4  
 & AG440B-2 recorders. Ampex mixers and  
 monitors. UREI eq's and limiters. Neuman  
 & Electro-Voice mics. plus lots of extras.  
 All equipment in as new condition. Original  
 inventory price over \$17,000.00. **JOHN**  
**ANDERS, SAGE PRODUCTIONS, P.O.**  
**BOX 1441, MONTROSE, COLO. 81401**

FOR SALE: Custom-built Spectra-  
 Sonics 16 in — 8 out console. Fine  
 board, fine price. Write for info.  
**COOKHOUSE RECORDING, 2541**  
**NICOLLET AVE., MPLS., MN. 55404**

FOR SALE: Audio Designs Console.  
 16 in/16 out. 3 years old. \$15,000.00  
 Call (312) 644-1666 for further in-  
 formation.

FOR SALE: Twelve-track head as-  
 sembly for Scully 284. \$1,700. Exc.  
 cond. Also 12-channel sync-masker.  
**PHONE (415) 457-2740**

# our "little dipper" cleans up sound pollution

for less than \$500!

The Universal Audio Model 565 "Little Dipper"  
 Filter Set cleans up problem tracks made  
 under adverse conditions: Whistles, hetero-  
 dynes, hum, camera noise, and general  
 background noise.

Also, the versatile 565 can be used for:

- "Phasing" and other unique effects
- Sharp enhancement of any audio frequency
- Simultaneous elimination of any two audio frequencies
- Harmonic distortion filtering
- Wave analysis

FEATURES • Two variable width notch/pass filters,  
 lo-pass filter, hi-pass filter, all continuously tunable  
 • Zero insertion loss or 20 dB gain • Extremely low  
 noise and distortion

See your dealer or write for complete specifications.



11922 Valerio Street, No. Hollywood, Calif. 91605  
 (213) 764-1500



## Cut it in half

Half the cost, time,  
 and worry, at  
 Dick McGrew  
 Recording Service in Dallas.  
 Dick beats the  
 competition with record master costs like \$30  
 per side for stereo 12 inch 33 1/3 rpm, and  
 \$10 per side for 45's. The day he receives  
 your tape, he'll groove your master with the  
 Neumann SX 68 cutter, the ultimate in cutting  
 machines. Dick'll give it the individual and  
 expert attention of a man who does a lot of  
 producing himself.

For no extra charge, Dick will provide equal-  
 ization, reverberation, or other special services  
 at your request. And he's used to giving atten-  
 tion to problem tapes.

Interested in album pressing or singles?  
 Dick's got a competitive price list for these  
 services, too. Let us hear you!

**Dick McGrew**  
 recording service

7027 TWIN HILLS AVE. • DALLAS 75231 • 214 691-5107

Circle No. 138

Circle No. 139

## EQUIPMENT AVAILABLE

**FOR SALE:** 1 brand new 3-M, M-79 4-track recorder/reproducer. Full factory warranty, less than 3 weeks old. \$4950. CALL CHARLES SOLAK AT (215) 363-7844, (607) 797-3909.

**FOR SALE:** Ampex 307 Recorder/Reproducer Console with meter control panel, record playback, power amp MP2340 — \$750.00. QUARTER-MASTER, 3408 W. WASHINGTON, LOS ANGELES, CA. 90018.

Excellent selection of good used recording consoles — Electrodyne, Lan-gevin, others. Available now. FRONTIER AUDIO CORP., 3103 ROUTH, DALLAS, TX. 75201 Phone (214) 651-0152

**FOR SALE:** Tascam 1/2", 4-track, tape deck. \$1,500 only 10 hrs. use. JOHN CROW, 2000 BECK BLDG., SHREVEPORT, LA. 71101. (318) 424-2678.

**TAPE SALE:** Scotch 203, 1 inch (3600') \$15.00 per reel; Scotch 202, 2 inch (2500') \$25.00 per reel. THE VILLAGE RECORDER, 1616 BUTLER AVENUE, WEST LOS ANGELES, CA. 90025

**SPLICE FASTER, BETTER BY SHEARING REPLACES RAZOR.** Has attached splicing tape dispenser. Professional quality. Specify 1/4 inch or cassette groove. Price: \$24.95 plus \$1.00 for handling. Distributors wanted. Details: NRPR, BOX 289, MCLEAN, VA. 22101

**FOR SALE:** MCI JH 416 consoles . . . 24x24, \$19,000. . . 20x20, \$14,500. . . JH 16 16-track with auto locator, \$10,900. SOUND 80, 2709 E. 25 ST., MPLS., MN. 55406, (612) 721-6341

## EMPLOYMENT

**PRO SALESMAN** wanted by prominent manufacturer of professional audio products. Must be heavy weight, willing to travel fastest growing territory in market. Excellent fringe benefits and commission plan. Unusual career opportunity with high income potential. Send resume to BOX MT, R-E/P, P.O. BOX 2287, HOLLYWOOD, CA. 90028.

**HELP WANTED:** Needed immediately, two recording engineers by old established studio Portland, Oregon. Prefer experience in radio spots and motion picture sound tracks work. Salary open — rush full resume BOB LINDAHL, NORTHWESTERN INC., 011 S.W. HOOKER STREET, PORTLAND, OREGON 97201

Your audio engineers don't understand digital logic? I'm a logic design engineer who understands audio! Let me put my experience in logic design to work for you. I'm interested in a position in recording console design in the audio field in Calif. Contact BOB LORD, SENIOR ENGINEER, BUNKER-RAMO CORP., 31717 LATIENDA DRIVE, RM. 2131, WESTLAKE VILLAGE, CA. 91361

### MARKETING DIRECTOR

We are looking for an experienced sales manager to market our new line of recording consoles and components. We are offering an exciting opportunity for an ambitious person with a thorough knowledge of all phases of professional audio. If you are prepared to lead the next phase of communications technology and have a successful track record in equipment sales, we would like to hear from you. Call or write: GORDON RUDD, CLOVER SYSTEMS, 6232 SANTA MONICA BLVD., HOLLYWOOD, CA. 90038 (213) 463-2375

**HELP WANTED:** Large midwest Recording Studio (16 track), wishes to interview mature professional engineer between 25 and 35 yrs. of age. Must be take charge man, with good business sense and technically competent. Career position for right man. Send full particulars listing qualifications. BOX MRS R-E/P BOX 2287, HOLLYWOOD, CA. 90028

continued from page 13

# THE PHASER

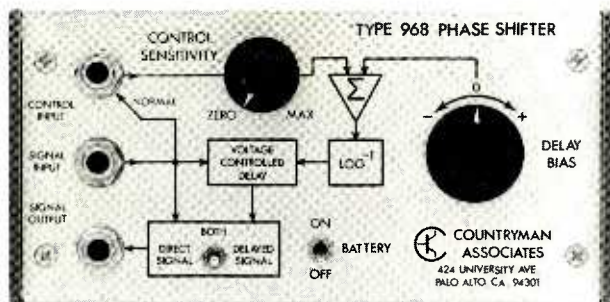

Would you use phasing and flanging effects more often if they were less difficult to obtain? Now you can produce these effects without tape machines, reproducibly and with complete control.

The Type 968 Phase Shifter electronically delays an input signal and then mixes the delayed and undelayed versions together. It allows you to add the striking "turning inside out" effect of Phase cancellation to any audio signal live or recorded, in the studio or in performance, in minutes instead of hours.

 **COUNTRYMAN ASSOCIATES**

424 University Avenue  
Palo Alto, Calif. 94302  
Phone 415-326-6980

## NOTES ON DEMAGNETIZING

Where recessed components are to be checked and it is impossible to contact them with the test edge of the magnetometer, it is quite helpful to attach a magnetically soft probe to the test edge of the instrument so as to better "conduct" magnetism from the recessed component to the magnetometer movement. Readings taken with the probe interposed will not be as high as if the test edge of the magnetometer proper were touching the component but its use will improve remote sensitivity from 4 to 6 times when checking small, inaccessible components that can only be reached with the end of the probe.

Clip-on probes are now available as an accessory for Pocket Magnetometers. The probe assembly consists of a spring clip with a flat, vinyl coated search probe about 1 3/4" long which can be readily bent or formed with the fingers so as to better contact recessed components.

It has been said that one really knows very little about a problem until it can be reduced to figures. You may attempt to demagnetize but until you actually measure residual values of magnetism, you really don't know where you are. You have not reduced the problem to figures.

# WHERE THE BOOK ENDS STUDIO SUPPLY EXPERIENCE BEGINS



**EXPERIENCE** — wrought from extensive years of hard work by many people participating in all phases of recording. People now brought together to serve you.

**KNOWLEDGE** — gained from long successful involvement in mixing, studio management, maintenance, equipment design, accoustical consultations, and turn-key studio construction that uniquely qualifies us to mold an unlimited selection of the world's finest recording gear into a facility that fits you.

**WISDOM** — dictating that our designs and specifications are generated after careful consultations as to your style of recording, personal room and equipment preferences, and your fiscal requirements.

**STUDIO SUPPLY** designs and equips rooms that feel good, sound good, and work good. After all, isn't that what a good studio is all about?

**STUDIO SUPPLY HAS ACCESS TO MANY LEASING PLANS AND OTHER SOURCES . . .**

**CALL DAVE, STEVE, EMIL OR CLAUDE TODAY . . .**

(615) 327-3075

**studio**  
SUPPLY COMPANY

P.O. BOX 280  
NASHVILLE, TENN. 37202



NY 10022

10022PMEES9XDO  
DOUG POMEROY  
49 EAST 52ND ST  
NEW YORK

## Wally Heider and friend.

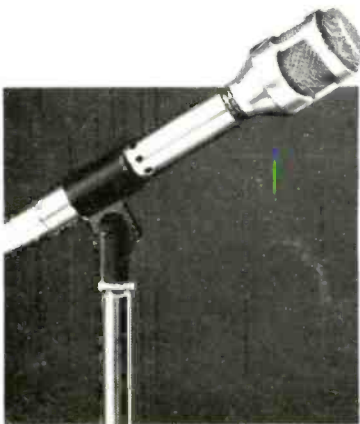

When Wally Heider, the internationally known master of the art of location recording, talks about recording techniques, we're very frank to admit that we listen! Imagine how pleased we were to hear him talking about our own SM53 unidirectional dynamic microphone in terms such as these: "The loudest guys in the world, screaming into them, won't break them up"; or "They sound good on any assignment"; or "The front-to-back characteristics are excellent"; or "Whenever I'm not locked into a performer's own pet microphone, I prefer to use the SM53." We can tell you about eight provable advantages that can make the SM53 your most effective and reliable recording microphone.

Shure Brothers Inc.  
222 Hartrey Ave., Evanston, Ill. 60204.



Circle No. 142

[www.americanradiohistory.com](http://www.americanradiohistory.com)