



RECORDING engineer / producer

relating recording science • to recording art • to recording equipment

10022PMEEEX9XDD
D POMEROY
COLUMBIA RCDDG
49 E 52 ST
NY

L

NY 10022

NUMBER 1!

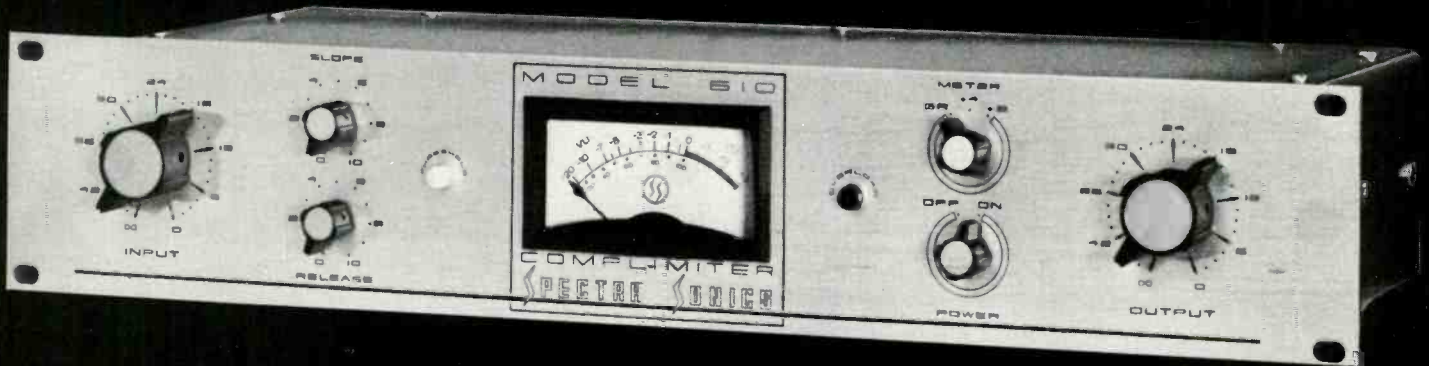

"COMPLIMITER"™

PERFORMANCE: The SPECTRA SONICS Model 610 "COMPLIMITER"™ can accomplish, independently or simultaneously, limiting and compression functions with performance that is unequalled by most *linear amplifiers*. The minimal noise inherent in this system assures a low threshold of -40dBm and permits an input sensitivity substantially greater than other systems. Through the use of the most advanced circuitry, the Model 610 "COMPLIMITER"™ has the fastest attack time (100 nanoseconds to 2 microseconds). The "COMPLIMITER"™ allows undistorted recording and transmission at levels that are measurably higher than those commonly in use. In tape recording, for example, this "limiting only" mode eliminates approximately 6dB usually set aside for tape overload protection.

RELIABILITY: The extensive use of the "COMPLIMITER"™ in the audio industry confirms the highest order of confidence in reliable, consistent operation.

Today's competition can only be met through the most advanced designs — "Beyond The State Of The Art." For more information on audio products of superior performance contact SPECTRA SONICS at:

770 Wall Avenue
Ogden, Utah 84404
(801) 392-7531

6430 Sunset Blvd., Suite 1117
Hollywood, Calif. 90028
(213) 461-4321

SPECTRA SONICS

LEADER IN ADVANCED TECHNOLOGY





Broken connector on the Fender, one side of the drummer's headset is dead, vocalist keeps coming in a measure too early, seven straight takes and not one is a keeper. If it weren't for your Ampex MM-1100, you'd take a job as a used car salesman.

Faithful recording without any hassle. That's our whole story. The Ampex MM-1100 multi-channel tape recorder works so reliably and so faithfully that you can turn it on and forget it.

Forget that the MM-1100 has the kind of superb electronics we made famous in the MM-1000 and the AG-440 series. Forget that the capstan servo stabilizes tape motion in half a second at 15 ips and holds speed to $\pm 0.05\%$. Forget about 2" tape capacity worries because the MM-1100 handles 14-inch reels.

Forget about tape tension adjustments because a servo controls tape tension past the head.

Forget about input problems, because the MM-1100 is available in 8, 16, and 24-channel configurations. Sel-Sync[®] System lets you play back on some channels while recording on others. The entire control panel lifts out for remote operation. Whether you're interested in variable speed or synchronized operation with film or video equipment, the MM-1100 has it all.



16-TRACK MM-1100

Go ahead and fix the drummer's headset. When you're ready for another take, your Ampex MM-1100 will be ready. Let someone else sell cars; Ampex will keep you in the recording business.

AMPEX

Ampex Corporation
Audio-Video Systems Division
401 Broadway
Redwood City, California 94063
(415) 367-2011

The hungry leader.

At Altec, we're not taking our leadership position for granted. We're always trying harder – challenging ourselves to develop studio monitor speakers that stay a step ahead of constant improvements in the contemporary recording process.

Throughout the United States, recording industry professionals – engineers, producers, A&R men, musicians – have responded to our continuing ability to produce the finest monitor loudspeakers by installing more Altec systems in studios than any other brand.

And we can prove it. Here's the latest data on monitors installed in U.S. studios, as published in Billboard's 1973 International Directory of Recording Studios.

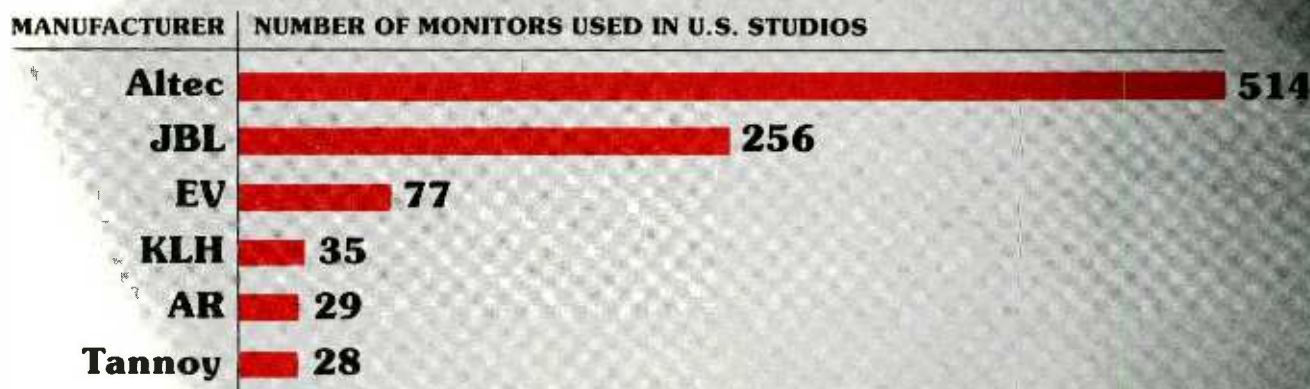

But we're not really satisfied – even with this impressive track record. We're still trying to better ourselves. In fact, Altec has three all-new studio monitors available right now. They're a whole new generation of speakers designed to meet the whole new range of tomorrow's dynamic recording techniques. Your studio may need them. Why not call your local Altec representative to find out?

Or write us for full details.

Altec gives you the best of both worlds: proven leadership, plus an unrelenting commitment to doing a better job. That's because we've really grown to enjoy being #1 in studio monitor sales during the past three decades. And we intend to stay right there for at least the next three decades by always being our own biggest competitor – in research, in quality, in service and in satisfying the demanding needs of an ever-evolving industry.

Altec. We're the hungry leader.



**Number one.
And have been for
nearly 3 decades.**

Circle No. 103

ALTEC
the sound of experience.

1515 S. Manchester, Anaheim, Calif. 92803

Re/p 7

INTRODUCING: THE AMAZING EVENTIDE OMNIPRESSOR[®]

CHART OF FUNCTIONS

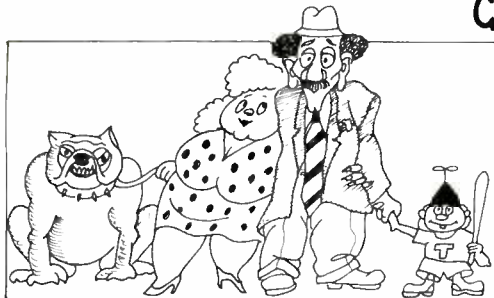

THE INFINITE COMPRESSOR



VARYING
INPUT LEVELS,
RESULT IN **UNIFORM**
OUTPUT LEVEL!

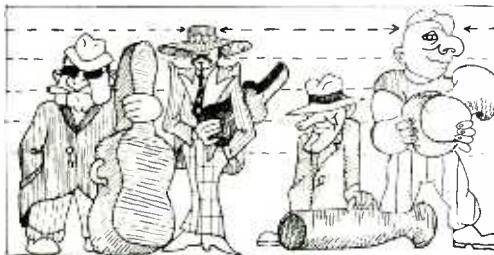
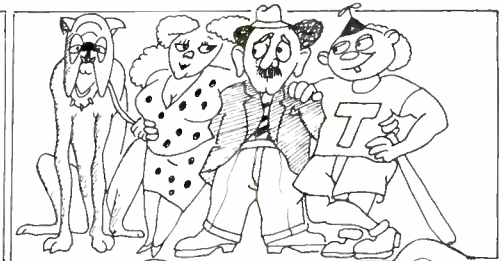

THE EXPANDER



URNS A LIMITED
INPUT-DYNAMIC-RANGE
INTO A **W-I-D-E**
OUTPUT-DYNAMIC-
RANGE!

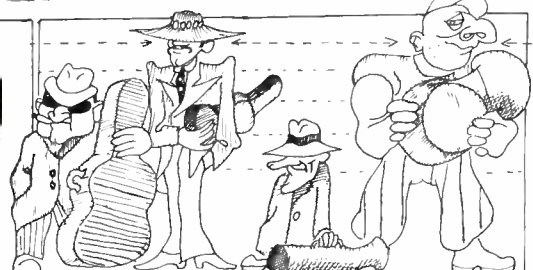

THE NOISE GATE



SET A THRESHOLD
LEVEL! ANYTIME
THE SIGNAL FALLS
BELOW THAT, THE
PESTY BUGS GO IN
DA' GARBAGE!

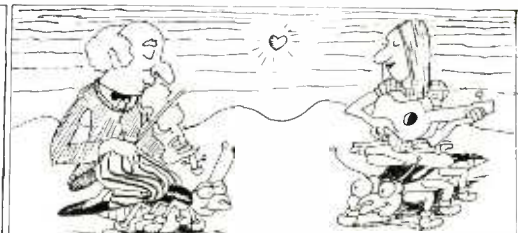

THE LIMITER



UNITY GAIN TO
PRESET LEVEL; ABOVE
THIS LEVEL, BIG INPUT
CHANGE PRODUCES ONLY
A **WEE-LITTLE** OUTPUT
CHANGE!

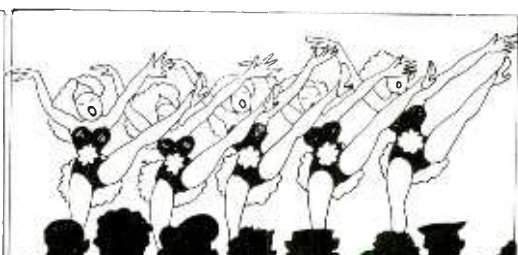

THE DYNAMIC REVERSER



MAKES
LITTLE
SIGNALS
BIG AND
BIG ONES
LITTLE!

MAKES
DRUMS SOUND
BACKWARD!



THE OMNIPRESSOR[®] \$600 FROM
THOSE WONDERFUL FOLKS WHO
BROUGHT YOU THE INSTANT PHASER[™]
AND DIGITAL DELAY LINE

Eventide
the next step

CALL OR WRITE FOR SPECS + NAME OF DISTRIBUTOR NEAREST YOU ---
EVENTIDE CLOCK WORKS, 265 WEST 54TH STREET, N.Y. CITY 10019 212-581-9290



JULY/AUGUST 1973
VOLUME 4 - NUMBER 4

RECORDING

engineer/producer

—the magazine to exclusively serve the recording studio market... all those whose work involves the recording of commercially marketable sound.

—the magazine produced to relate RECORDING ART to RECORDING SCIENCE to RECORDING EQUIPMENT.

Editor/Publisher MARTIN GALLAY

Associate Editor WAYNE YENTIS

Engineering Editors RON MALO
WILLIAM ROBINSON
CHUCK DAVIS

Business/Circulation
Manager V. L. GAFFNEY

Art Director GERRY SADOWSKI

RECORDING engineer/producer is published bi-monthly and is sent free to qualified recipients in the United States. Subscriptions for other than qualified individuals or companies may be purchased at \$5.00 per year. (All foreign subscriptions: \$6.00 per year.) Material appearing in Re/p may not be reproduced without written permission of the Publisher.

RECORDING engineer/producer is not responsible for any claim made by any person based upon the publication by RECORDING engineer/producer of material submitted for publication.

Controlled circulation postage paid at Los Angeles, California.
RECORDING engineer/producer
6430 Sunset Boulevard
P.O. Box 2287
Hollywood, CA 90028
(213) 461-7907

I'M OKAY...

YOU'RE OKAY...

the relationship between a
Producer and a Freelance Engineer

Interviews with
engineer DON GOOCH and
artist/producer GRAHAM NASH

17 Gary Davis

A SIMPLE LOW-PASS FILTER

26 Wayne Yentis

46th 'AES'
CONVENTION PROGRAM

33

CREATIVE MIXING for
BETTER DISC MASTERING

35 Leo deGar Kulka
Bob McLoed
Ron Malo

A MODIFIED EDITING
FUNCTION for the
SCULLY 280/284 SERIES DECK

41 Peter Butt

LETTERS & LATE NEWS 10
NEW PRODUCT NEWS 49
CLASSIFIED 55

ADVERTISERS INDEX

	Page		Page
AKG	42	NEVE	18
ALLISON	50	PACIFIC RCRDRS	47
ALTEC	6-7	PARASOUND	10
ARTISAN	56	PENTAGON	52
AUDIO DEVICES	40	QUAD-EIGHT	13-45
AUDIO TECHNIQUES	15	REVOX	44
AUDITRONICS	53	SCOTT	24
AUTOMATED PROCESSES	28	SCULLY/METROTECH	34
CETEC	14	SENNHEISER	21
COUNTRYMAN	54	SHURE	CVR 4
CUSTOM FIDELITY	26	SPECTRA SONICS	CVR 2
DBX	55	STUDIO SUPPLY	CVR 3
ELECTRO-VOICE	16-41	3-M MINCOM	48-49
EVENTIDE	8	TABER	20
GARNER	39	TASCAM	36
MAZE	11	TOYCHEST	25
MILAM	23	UREI	12-56
MULTI TRACK	44	WESTLAKE	29-30-31-32

LETTERS and LATE NEWS

From: WALTER G. JUNG
Forest Hill, Maryland

I read with some interest your article on Differential Microphones in the May/June issue of R-e/p. I'm particularly int-

From the READERS

An editorial material rating of the most useful feature article, as gathered from the Reader Service Cards received prior to press time.

MAY / JUNE ISSUE:

DIFFERENTIAL MICROPHONES

by Jim Coe 49.12%

SURVEY OF STUDIO MONITORING PROBLEMS

by Eargle & Engebretson 45.03%

AUTOMATING TAPE TRANSPORT CONTROL

by Jim Furman 05.85%

erested in your experience with the figure 3B circuit, as I don't believe it will work as shown.

The input amplifiers should have a bias resistor to ground if the coupling capacitors are used, otherwise they will saturate. Also, the common (pin 3) side of the mikes should be referenced to ground by some means.

As a more practical suggestion, I include a detailed schematic which I believe will suit your needs.

R3 provides single resistor gain control (10-30dB), and R7 will cancel the common input. This allows standard (non-precision) types for R2, R5, R6, as

well as R1 and R4. If you get a chance to try it, let me know how it works out. I don't think you will have any overload problems, but if you do, you can reduce gain by the equations.

Hope the above is helpful.

Jim Coe's reply:

Mr. Jung is quite right, the circuit of figure 3B is not a practical one. The practical embodiment of this circuit is that of Mr. Jung's drawing.

I have been experimenting with essentially this same design for some time for use with different microphones. In test-

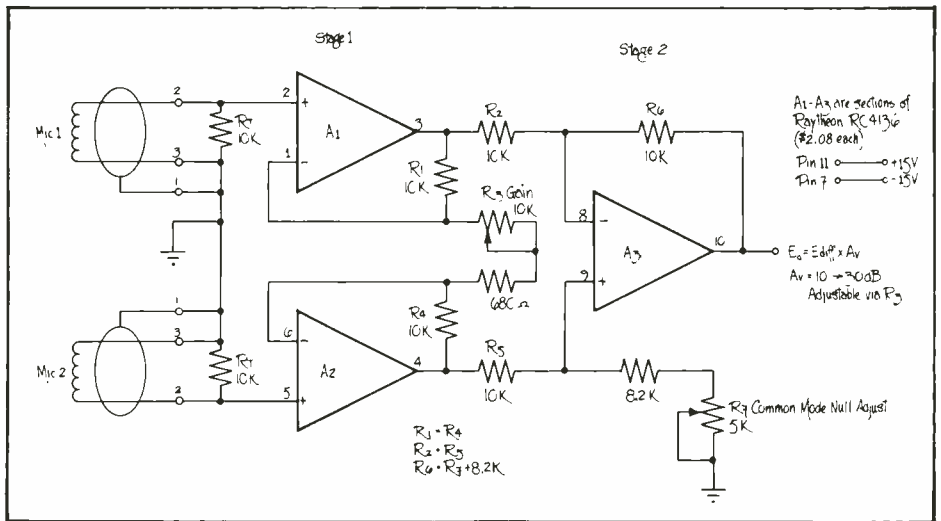

a small american success story urban/parasound reverberation

What with our roads full of Japanese cars, and our studios full of German microphones, it is refreshing to come upon an American product that offers such good value for the money that it has achieved wide success both in the U.S. and abroad. Urban/Parasound is reverberating not only back home, but also in Canada, Mexico, South America, England, and the Continent. And we are reverberating people like the Jefferson Airplane, the Grateful Dead, Emerson, Lake, and Palmer, the Youngbloods, Stevie Winwood, Tony Bennett, and almost two hundred others—live in concert and recorded. We have echoed our way into radio stations, electronic music studios, and recording studios small and large.

Urban/Parasound Reverb uses ingenious electronics to attack the classic faults of spring reverbs, including excess noise, flutter, peaky frequency response, and popping on transients. To handle the last problem, we invented the "Floating Threshold Limiter", which also protects against input overload. We build to the highest commercial standards, put the works in your choice of three ultra-compact packages, and charge \$595/channel—the same as we did two years ago. Today, after all the inflation and revaluations, Urban/Parasound Reverb is a bigger bargain than ever.

For an exciting free brochure, contact:

PARASOUND, INC., 680 Beach St. Suite 495, San Francisco, Calif. 94109 or your Urban/Parasound distributor.

ing Mr. Jung's version, however, I found the two unique features very helpful.

1) The null pot R7 does indeed allow one to match resistors which would otherwise have to be 0.1% units for best Common Mode Rejection, and will correct for greater than 30% mismatch of R2/R5 and R6/R7.

2) The quad amp offers a smaller, less expensive circuit with lower thermal drift and mismatch, while providing better Common Mode Rejection than second generation (741) type op-amps (though not so good as three individual fourth generation devices, of course.)

In my tests, the quad 4136 op-amp provided 92dB of Common Mode Rejection Ratio for electrical signals of 10Hz and 60dB at 100Hz, while set for 30dB gain. With a Sennheiser MD211 microphone pair, the CMRR for pink noise was about 20dB; which translates to 30-35dB for Rock music with its much greater content of low frequency energy. (The microphones cancel the low frequencies much more effectively.)

Incidentally, this quad package might lend itself to use in the "state variable" three op-amp filter circuit and the fourth amp on the chip would be useful as an output buffer, or to derive a second isolated output for monitor buses, etc..

Mr Jung's drawing shows unbalanced mike inputs, while I prefer to ground the shield separately from the signal return/power supply common "ground".

CMRR vs FREQUENCY for ZERO or 30 dB GAIN

kHz	SIGNETICS NE 748		RAYTHEON RC 4136		HARRIS HA 911	
	Low Gain	High Gain	Low Gain	High Gain	Low Gain	High Gain
01		86.6	68.5	92.0	92.3	99.2
1		83.6	67.8	90.0	90.3	97.4
10		64.0	63.1	73.3	75.3	96.0
15		60.8	62.8	69.6	74.3	95.5
20		58.0	58.7	67.4	73.4	95.3
50		49.6	51.4	59.8	68.3	89.6
100		42.9	45.4	59.6	67.6	81.3

dB CMRR = 20 Log₁₀ COMMON MODE INPUT VOLTS OUT / SINGLE ENDED INPUT VOLTS OUT

All with 50 Ohm source & 50K Ohm load at ± 15V supply at room temperature.

Thanks to Mr. Jung for his helpful letter, and to R-e/p for opening a valuable channel of information for all who need, and can generate this type of information.

NEW RICHARDSON PLASTIC FORMULA SAID TO DOUBLE PHONOGRAPH LIFE

A new plastic formula for the injection molding of phonograph records, which the company claims has twice the wear resistance of conventional compounds, has been introduced by the Polymeric Systems Division of The Richardson Company.

Designated R-600, the new plastic is said to effectively double the life of

phonograph records.

William B. Basile, Richardson Co. president, states that the new formula results from an earlier breakthrough; a technique for precisely measuring record (disc) wear. Armed with technical data derived from these precise wear measurements which were previously unavailable, to such degree Richardson engineers developed the long-wearing polystyrene formula.



Selwyn R. Mather, Richardson's Research Manager verifies longer wear of 45 RPM record made with the company's new product.

Money talks

WHETHER YOU'RE SPENDING IT, OR SAVING IT

That's why it makes good dollar sense to consider the 100B-16 console for your operation. It's a completely professional 16 in-16 out unit with features you can't believe possible in a \$9500 console. There are no extras to buy and no hidden costs.

P.O. BOX 6636 BIRMINGHAM, ALABAMA 35210 PHONE (205) 591-4000

OFFICES AND WAREHOUSE, 514 ALTON ROAD BIRMINGHAM, ALABAMA

- All Solid State OP Amp Design
- Sixteen Track, Wet Monitor - Dry Record, Monitoring
- Nine Frequency Equalization (Low-Mid-High) on each input
- Plus 29 dbm headroom
- Distortion less than 0.1% at rated output
- 20 VU Meters
- 144 Patch Points
- Studio Talkback
- 2 Cue Systems
- Pan Pots on each input
- Conductive Plastic Linear Attenuators
- Compact Size: 28 x 48 x 15 inches
- Frequency Response: + 1 DB 20 - 20,000 Hz.

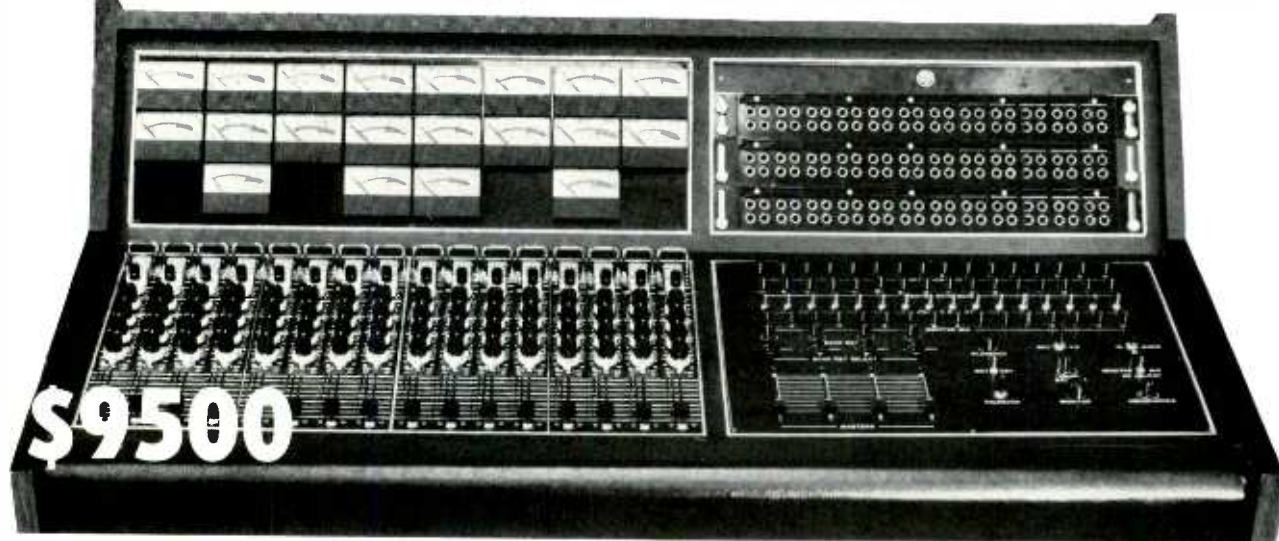



Sonipulse

The Coherent Method of Room Equalization

SONIPULSE is the newest approach to measuring sound reinforcement or playback systems including their environments. It provides complete analysis of frequency response over the full audio spectrum in less than three minutes. Self contained generator produces a pulsed coherent signal, — no averaging time required. Ideal for recording studios, auditoriums, theaters, road shows... Small, compact, portable. SONIPULSE equals the accuracy of expensive real-time spectrum analyzers.

Model 527-A ACTIVE GRAPHIC EQUALIZER (no insertion loss) provides 27 precise 1/3 octave reciprocal equalizers covering the entire audio spectrum from 40 Hz to 16 kHz, making the 527-A compatible with all current room equalization measuring equipment. Ideal also for spectrum contouring or correction.

Send for complete technical information today.

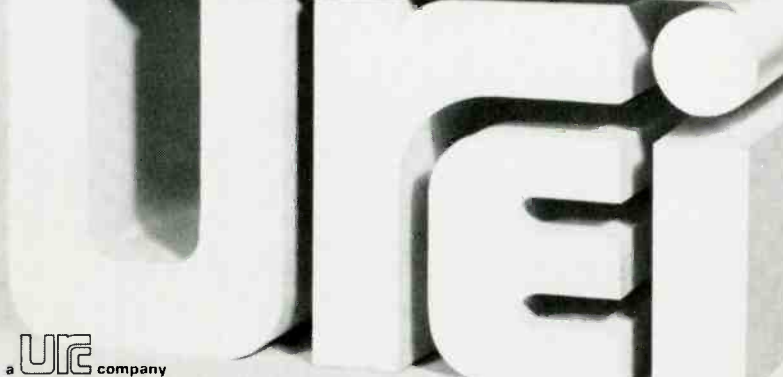
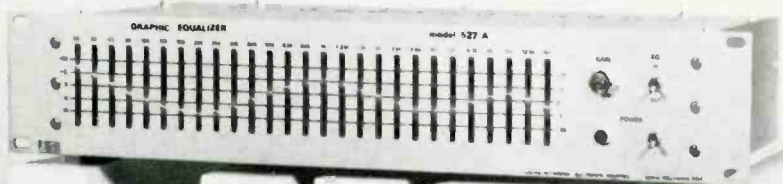

a **UIC** company

11922 Valerio Street, No. Hollywood, California 91605 (213) 764-1500
 Exclusive export agent: Gotham Export Corporation, New York

Approximately one half of all 7 inch 45-rpm records are compression molded from polyvinylchloride (PVC), the other half are injection molded from polystyrene, a less costly material. The new polystyrene compound is seen as encroaching on the PVC half of the market. **POLYMERIC SYSTEMS DIV., THE RICHARDSON COMPANY 2400 EAST DEVON AV, DES PLAINES, ILL 60018**

BLAKELY NAMED SALES MANAGER AT dbx, INCORPORATED

Announcement of the appointment of Larry Blakely as Sales Manager of dbx, Inc. was made by David E. Blackmer, president.



BLAKELY

Blakely had previously operated Integra Corporation of Glendale, California designers and installers of recording studio equipment. Before that he had been a recording engineer/mixer with Sunset Sound Recorders in Hollywood.

dbx, Inc. makes tape noise reduction systems and other electronic products for both professional studios and semi-professional recordists.

INSTITUTE OF AUDIO RESEARCH ANNOUNCES LOS ANGELES BASIC AUDIO SYSTEMS COURSE SET FOR OCTOBER 16 - NOVEMBER 10

The Institute of Audio Research, Inc. will present its Studio Technology and Practice Course in Los Angeles this October 16 through November 10. The recording studio engineering training course, to be given in separate morning and evening classes, will cover recording fundamentals, magnetic tape recording, studio consoles, signal processing equipment and stereo disc recording.

The Institute of Audio Research's Studio Technology Course is one of several offered by founders Albert Grundy and Irv Diehl. Others include Practical Disc Recording, Producer's / Arranger's Studio Workshop, and Audio Systems Design Seminar. All are held on regular schedule throughout the year in New York, and plans are under way to bring these other courses to Los Angeles.

Those interested in the Studio Technology and Practice Course to be given in Los Angeles can contact the Institute of Audio Research, Inc. at 64 University Pl., New York, N.Y. 10003.

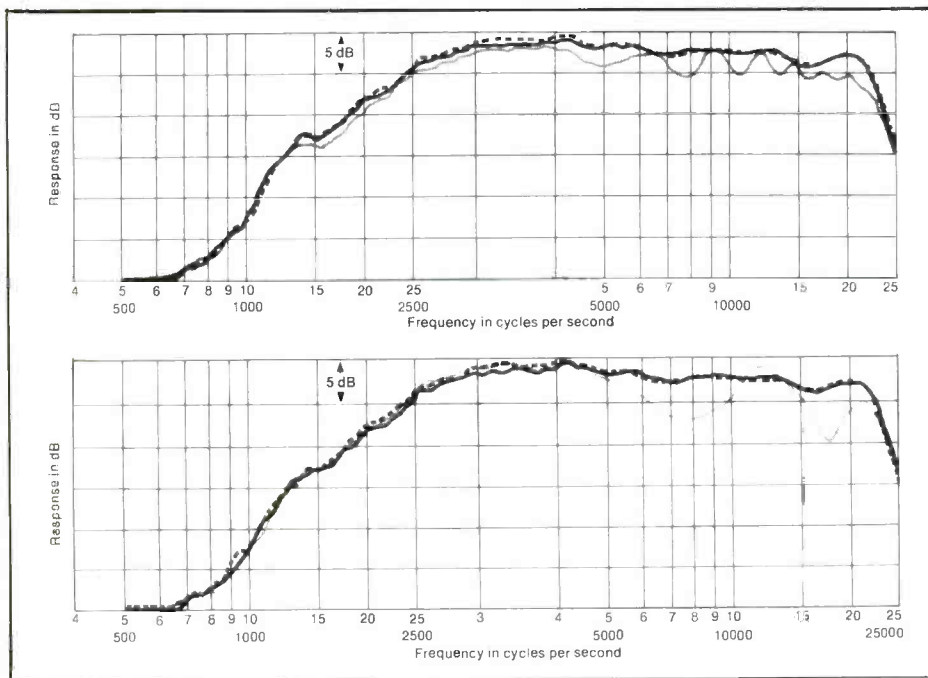

SCOTT PAPER COMPANY RELEASES STUDY OF POLYCOUSTIC FOAM ACOUSTIC TRANSPARENCY

These graphs show response curves which depict the acoustical transparency of POLYCOUSTIC foam, a product of the Foam Division of Scott Paper Co. On both graphs, the black line is the bare tweeter, with no grille impeding the acoustical radiation; the broken line is

the same tweeter with the POLYCOUSTIC foam grille in place, and the gray line is with a conventional grille cloth. At some points the gray line exceeds the output of the bare speaker. This is the result of the grille aiming more of the off-axis energy radiated by the tweeter toward the microphone, (Graphs and test information courtesy KLH Research and Development Corporation.)

POLYCOUSTIC foam is a reticulated, open-cell polyurethane material, available in pore sizes from 10 to 80 pores per inch, which provides greater acoustical transparency than cloth. It also provides the user with a grille material that can be sculpted into three-dimensional shapes and painted to any color.
**FOAM DIVISION, SCOTT PAPER CO.
 1500 EAST SECOND ST., CHESTER,
 PA. 19013**

McLEAN JOINS GOTHAM AUDIO

Mike McLean formerly chief engineer at Motown Records in Detroit from 1961 through April 1972 joins Gotham in the capacity of Engineering Manager of the Service Laboratory.

His duties at Gotham began with a comprehensive product indoctrination at the NEUMANN and EMT engineering and manufacturing facilities in West Germany.

DICTAPHONE ANNOUNCES GLENN MAXWELL AS NEW SCULLY/METRO-TECH DIVISION DIRECTOR OF ENGINEERING

As announced by Vice President and General Manager of Scully/Metrotech, Earl J. Peterman, Maxwell will have responsibility for all engineering programs. He was previously Manager of Mechanical Engineering for Data Handling Corporation of Santa Ana, California. He is a graduate of the University of California and received a Master's Degree from Cal Tech.

Maxwell is a member of Sigma XI, and

A good mix. Our boards. Your talent.

Our boards are made so that creative engineers and producers can get behind them and work behind them. We feel we're an important part of your artistry. Good sounds, flexibility, reliability and human engineering are what you expect from a professional recording system.

We make some of the best (and most sophisticated) systems and signal-processing devices one would find in any good studio. Like our 2082 mixing console (it can be automated). Next session, get behind us.

**quad/eight
electronics**

11929 Vose Street □ North Hollywood, California 91605 □ 213/764-1516

Get your mind out of the clutter.

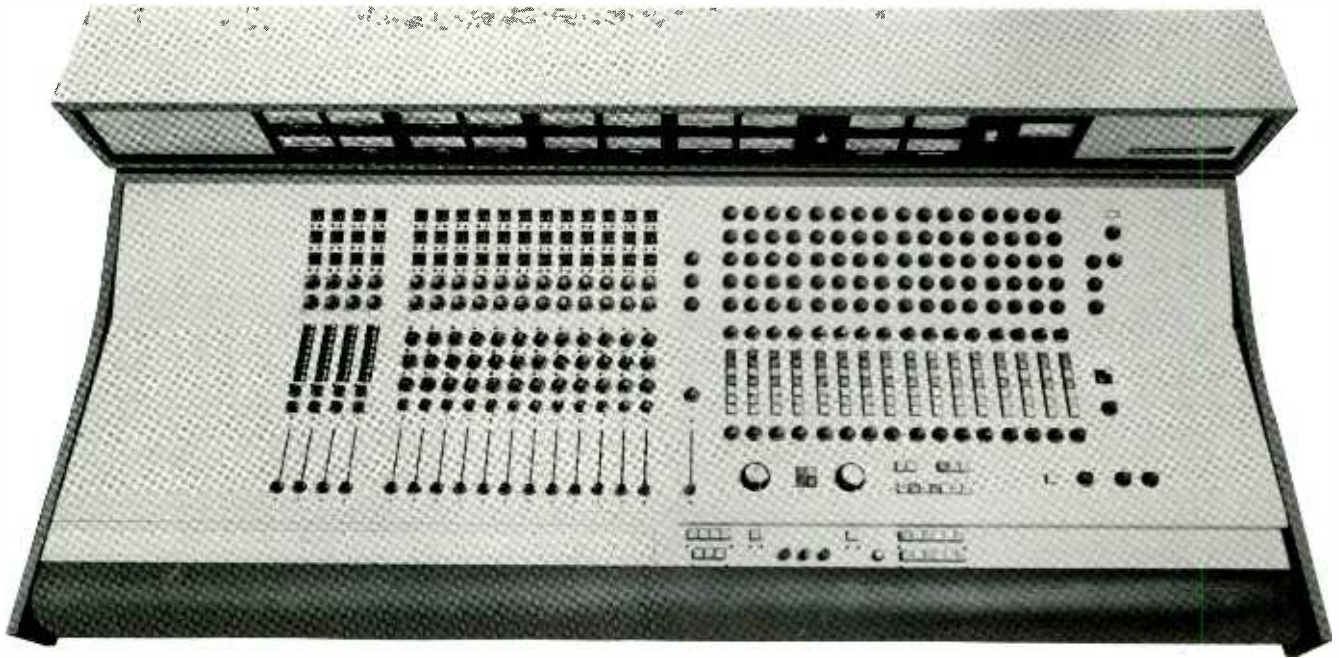

Taping a performance presents enough problems without worrying about being on the right track — that's why the Electrodyne Series 2000 was developed with you in mind.

But don't let that simplified panel layout fool you — A console doesn't have to look like a 747 instrument panel to be functional and effective.

This control board was so arranged that every operation can be reached from one sitting position (No Co-Pilots needed here!) Yet the functions are engineered to fit a man sized hand.

For example, the exclusive Electrodyne SML-20 channel assign

switch module incorporates up to 24 assignment positions, 4 echo-send selections, program and echo quadrasonic pan pots and solo button, yet this compact panel is only 1½" by 9". And talk about curves! — The Electrodyne 712 input module's 9 frequency graphic equalizer will really put your sound in shape.

These and many other characteristics put you in command while freeing you to add the necessary creativity. After all — you're the man behind the board and you want results — not clutter.

That's why we've developed the Series 2000!

Cētec
INC.
a subsidiary of Computer Equipment Corp.

13035 Saticoy St. • North Hollywood, California 91605 • Phone (213) 875-1900 • TWX: 9104992669

MAXWELL

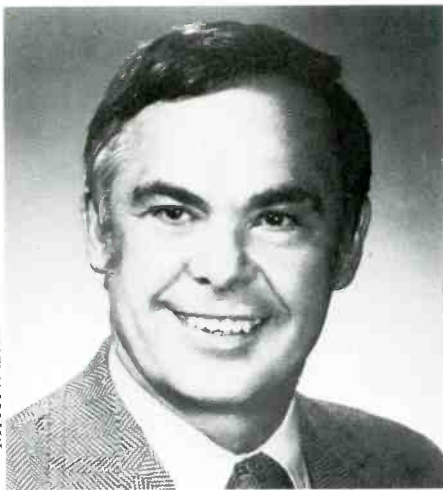

IEEE, and is a registered Professional Mechanical Engineer. He is the author of "Development of a Portable Magnetic Tape Recorder for Precision Data Recording."

... an excellent idea from:

**TROD NOSSEL
SYNCHRON SOUND STUDIOS
WALLINGFORD, CT.**

Want an inexpensive, easy way to tame an overly splashy drum set? Well, here's a technique that will supplement the usual rug and baffles. Buy a large beach umbrella (preferably with plastic-impregnated canvas), remove the shaft, and suspend it from the ceiling directly over the drums at a height of 5 or 6 feet.



SYNCHRON SOUND STUDIOS

The umbrella will "contain" the drums, resulting in a tighter sound and less leakage onto other tracks.

The decorative possibilities are obvious. (See photo.) Since beach umbrellas come in many colors and styles, they can be chosen to complement the motif of the studio.

HERVIC NEW U. S. STELLAVOX AGENT

Hervic Electronics, Inc. of Los Angeles has been appointed the exclusive U. S. agent for the complete line of Stellavox precision tape recorders and accessories. The line includes: the SP-7, a modular mono/stereo recorder suitable for filming and other portable applica-

tions; the SM-7, an extended frequency-range version of the SP-7; the S-17, an extremely wide-band version of the SM-7 with two channels and an optional central cue track; the SQ-7, a 4-channel version of the SP-7.



Hervic has a complete stock of replacement parts, as well as a factory-trained service facility. For further information, contact Mr. George Rose, marketing manager.

HERVIC ELECTRONICS, 1508 COTNER AVE., LOS ANGELES, CA. 90025.

3M OFFERS QUICK, CLEAN MAGNETIC SIGNAL VIEWER

A tool for viewing the recorded signals on magnetic tape used in audio and video recording is available from 3M Company.

The Plastiform magnetic viewer is a 1-7/8-inch-diameter, clear acrylic disc filled with ferrous oxide particles in solution. When the disc is placed on a magnetic tape the particles align themselves

in the direction of the field.

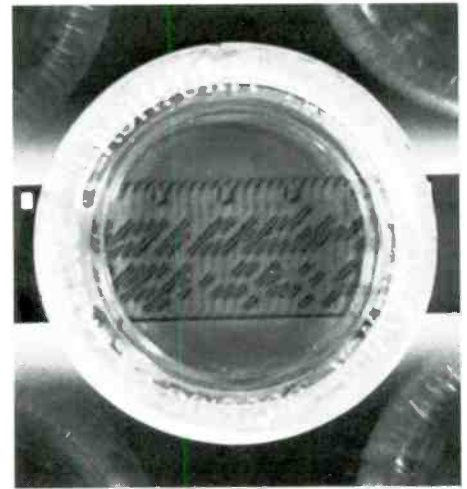

The viewer is simply placed on the tape to read recorded signals and can be used to check head alignment of 4 or 8-track tape, examine the pattern of recorded sound in audible range applications and synchronize the audio track on a video recorder. The viewer even can be used to determine whether tools, heads or guides are magnetized. Other applications in which 3M says the viewer is valuable are editing and splicing recorded tape.

3M COMPANY, DIELECTRIC MATERIALS & SYSTEMS DIVISION, DEPT. D13-30B, BOX 33686, ST. PAUL, MINN. 55133

Circle No. 111

8 IN 4 OUT AT 1/2 THE PRICE

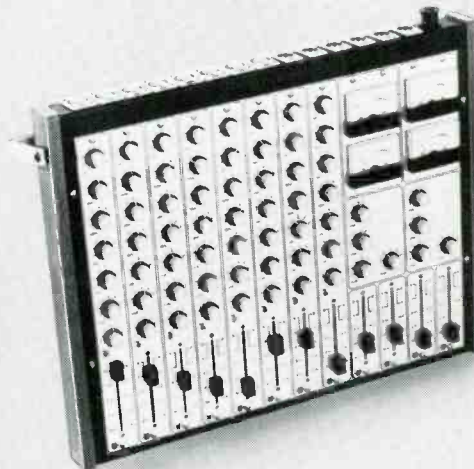

(... or 10 in 2 out!)
The Allen & Heath 248 professional mixer has all the features of the well-known Mini-Mixer* plus quad panning, Low Z inputs, XLR type connectors... \$1295.

*Allen & Heath Mini-Mixer users include Pink Floyd, War, Uriah Heep, Yes, America... and hundreds more!

An exclusive British import by...

audiotechniques, inc.

142 Hamilton Avenue, Stamford, Conn. 06902 Tel: 203 359 2312

DL42

It does more
than just reach.

It helps you to
better sound.
Every take.
Every day.
Anywhere.

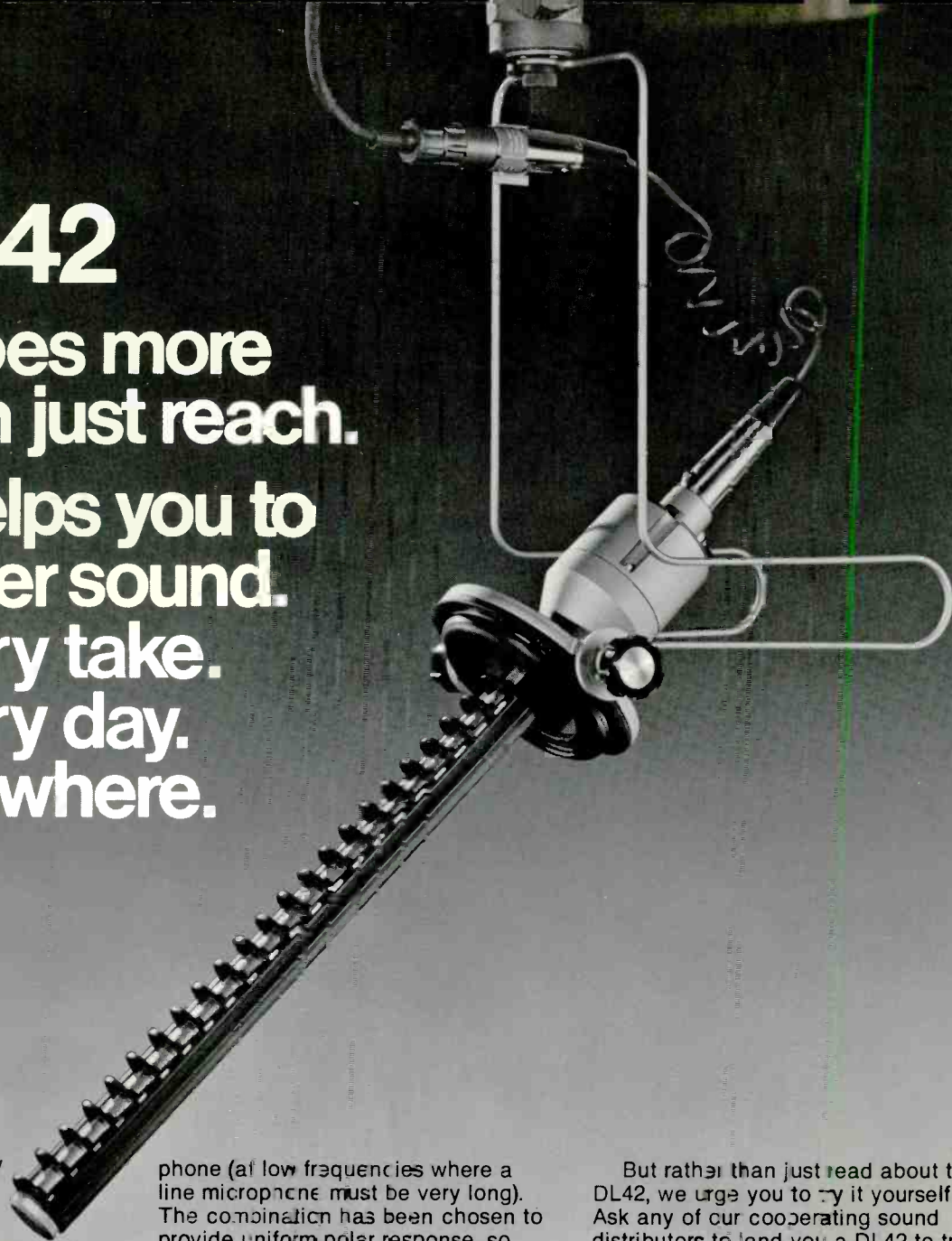

Since 1962 when the E-V Model 642 earned an Academy Award certificate for contributions to motion picture sound, there have been a lot of attempts to better this pioneering design.

Admittedly, some similar-appearing microphones were lighter and a bit smaller. But often it was at the expense of uniform polar response and wide range. Now there's a long reach microphone that's both smaller and lighter, yet maintains wide range response even off mike.

It's the E-V DL42.

Weight has been reduced to 1/4 of the 642... even less than most highly-directional condenser microphones. And size has been shaved wherever possible. The DL42 is a unique combination of line microphone (at the high frequencies) and cardioid micro-

phone (at low frequencies where a line microphone must be very long). The combination has been chosen to provide uniform polar response, so important to consistent sound quality. Off-mike pickups even sound good (although lower in level), a particular advantage to documentary units and free-wheeling shows where the unexpected is always happening.

The good pickup quality off axis has another practical benefit in the studio. Because maximum rejection is at the sides (where most of the noise comes from) you can work at a remarkable distance when necessary. So when a long shot is called for, the DL42 can be moved upward and cover the entire area with good quality and level. In fact the DL42 is more like a super-super-cardioid. And it covers with less racking and panning of the microphone than you ever needed before.

But rather than just read about the DL42, we urge you to try it yourself. Ask any of our cooperating sound distributors to lend you a DL42 to try on your next production. No cost or obligation to serious professional users. Write today for a DL42 technical data sheet. Good reach with good sound. We think you'll like what you hear.



Electro-Voice®

a **Gulton**
COMPANY

Model DL42 Cardline® Dynamic unidirectional microphone including shock-mounted bail, noise-isolating coil cord, screw-on handle for hand-held use, Acoustifoam™ 2-piece windscreen, and carrying case, \$300 suggested professional net.

I'M OKAY! YOU'RE OKAY!

AUTHORS NOTE: The purpose of this article, when it was being planned was to explore the function and nature of the freelance mixer, and his special relationship to his clients. DON GOOCH made an excellent subject for this inquiry because in addition to his track record, knowledge and experience, Don is very expressive. He has obviously spent some time thinking about what it is he does . . . and why he does it.

GRAHAM NASH, being one of Don's clients, was kind enough to add his comments from the producer and artist point of view.

Don Gooch is a freelance engineer, currently working out of San Francisco. His career began when he received technical training during his five years in the Canadian Air Force. Don then went into radio, where he "got the feel of working with sound." Since radio severely limited his creativity, Don went to Detroit and joined Motown. There he spent 3 ½ years getting his basic training in sound mixing. Don worked with all the Motown groups, including; Diana Ross & The Supremes, Gladys Knight & The Pips, The Four Tops, Stevie Wonder, The Temptations, and R. Dean Taylor. Don moved on from Motown to Invictus Records and Holland-Dozier-Holland. After spending a year with them, he moved to California, where he spent a year and a half as a staff mixer for Wally Heider Recording, in San Francisco. Ultimately Don decided to freelance. He has mixed for The Jefferson Airplane, Hot Tuna, and more recently, for Graham Nash and David Blue. Don has worked with a variety of producers, including Barry Gordy, R. Dean Taylor, Norman Whitfield, David Mason, Holland-Dozier-Holland, and Graham Nash.

INTERVIEWS with Engineer DONALD GOOCH, and Producer/Artist GRAHAM NASH.

by GARY D. DAVIS

Since Don mixes for Graham, we asked Graham why he chose to work with freelance mixers.

NASH: I've never worked with a mixer that I didn't trust. I have very strong opinions about who I consider to be good engineers. And I always work with who I consider to be the best at the time. There are several engineers that I consider to be really good. And you've got to understand they're maybe not technically as brilliant as some engineers; but they have the quality of being technically brilliant with the quality of being personality-wise compatible with the way I work. Obviously there are some engineers who are brilliant technically, and who I could never work with. There has to be the best rapport. I have to be able to not speak, and he knows what I'm doing.

Looking at the other side of the relationship, we asked Don what makes a freelance mixer valuable to a producer or a group. He replied:

GOOCH: It's mostly the rapport that you have with them. I'd say 75% of it is the rapport.

g. d.: Don, when you are putting together a mix, does the producer let you set it up, and then he evaluates it? Or do you work to build it together?

GOOCH: Some producers will start from scratch with the engineer and build it. Other producers will let you get a basic thing up there, and then correct it and modify it.

g. d.: Which approach do you prefer?

GOOCH: Well, that depends on the tune. If I feel very strongly about how a tune should sound, I would prefer to set up a mix, a rough thing, and then we'll dissect it from there. But if I'm totally lost, or I have no idea what the producer is going for, then I'd rather have him build it with me. It depends on how well I know the producer.

g. d.: Graham, how do you work with a mixer?

NASH: Well, I've got to confess that I basically like to do my own mixing. I think everybody I've ever worked with has already known how I work, right up in front. I try to do as much as I can. Obviously, on the technical end, I need assistance, although I know a great deal about it. At first I like to mix, and then, when I see where the cat's at that I'm mixing with, if I trust him, then I'll let him do it. I like to bring out the best in people all the time. It's the only way to make good records.

g. d.: Don, I've noticed when you are doing mix-downs that the producer has said, "How does it sound to you?" or "What do you think it needs?" It appears that he really values your opinions.

GOOCH: Well, it's got to be a teamwork thing. It's the producer, the group, and the engineer, as a team, in the studio. A producer will usually use a certain engineer because he knows where his head's at. He knows where he's coming from. He must value the guy's opinion, or he wouldn't use him.

Neve presents the 3-in-1 console.



An unbeatable 8-track console.

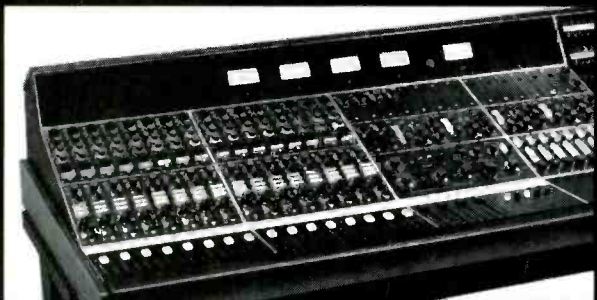

A deluxe quadraphonic mixdown console.



A great 16-track console for small studio budgets.

It's the Neve 8014. Take your choice of three different meter configurations (shown above). Whether you need a 4-track or 8-track or economy 16-track console, the Neve 8014 will meet your needs to perfection. If you wish, start small and expand later. This versatile console can "grow" as your studio grows.

Fully fitted, the 8014 features 16 input channels; 4 Pgm, 2 Rev and 2 Cue mixing buses; 8-track monitoring and metering; 4 limiter/compressors; talkback and slating; test oscillator; and solo function. Delivery is almost immediate. As in all Neve Consoles, total harmonic distortion is guaranteed to be less than 0.075%.

The sound of Neve is worldwide. Our audio control

Re/p 18

consoles are used for music recording, film production and broadcasting in studios in 40 countries. Call or write us for more facts. Chances are, we can help you record some new highs in profits.

Rupert Neve Incorporated, Berkshire Industrial Park,
Bethel, Conn. 06801. (203) 744-6230
Hollywood: Suite 616, 1800 N. Highland Ave.,
Hollywood, Ca. 90028. (213) 465-4822
Nashville: Telephone (615) 255-4315
Rupert Neve of Canada, Ltd., 7528 Bath Rd., Malton,
Toronto, Ontario, Canada. (416) 677-6611
Rupert Neve & Co., Ltd., Cambridge House, Melbourn,
Royston, Herts, England.

Neve

Circle No. 113

Don and Graham both considered the rapport to be crucial to the existence of the freelance mixer. Looking for more specific elements that reflected their relationship, we asked Graham what he looked for in a good mixer.

NASH: I think a good mixer tries to get as natural a sound on to the tape as possible. He tries to make it feel as natural as he can without it being too contrived.

Since Graham was looking for natural sound, Don was asked what kind of sound he was after. We specifically wanted to know about the use of equalization.

GOOCH: I may be from an old school, I don't know. But I try to cut things pretty straightforward. I try to use as little EQ as possible . . . only when necessary. I don't go in for a lot of gimmicks. With a lot of EQ, you're getting phase shifting, you're getting other things. If your mike technique is good, you really shouldn't need it. There are enough microphones, with enough different characteristics, on the market today that, in a studio well equipped with mikes, you shouldn't have to use excessive EQ. And you get a more natural sound. I see some guys with 12 dB of boost here, and 10 dB over there, and they don't get that natural a sound. You're getting a plastic sound. So I try to cut things straightforward, not using echo on the monitor. Because then you're hyping yourself, and you really don't know what you've got.

g. d.: You seem to be hinting that the basic tracks are much more important than the mixing, or at least that they are very different operations.

GOOCH: I've got a theory about recording and mixdown. I think it should be a separate thing. I don't necessarily agree with mixing in the same studio you cut it in. I do all the mixing I can at Steiner's (Sound Labs, Hollywood). Their place is set up strictly for mixing, so I basically feel that I can cut just about anywhere, in any studio, within reason, and take it there. And any deficiencies that have come up, due to lack of equipment or whatever it is in these other studios, I can correct at Steiner's.

g. d.: But do you really think it's a good idea to try to correct deficiencies in the mix? Why not do it right in the original track recording?

GOOCH: It is preferable to get the best thing you can during the session. But if circumstances dictate that you work with

"You are not doing a recording to perfect your techniques . . . you're doing a performance."



studios that are less than state of the art, at least it's comforting to know that you're going to be going somewhere else where you can overcome these things.

g. d.: You were talking about natural sound. Is there such a thing in the studio reality? How do you know when you have it?

GOOCH: Usually you get an idea of what the group actually sounds like. I definitely go out in the studio while I'm cutting. I think what they're sounding like live, in the studio, is very important. You've got to get out there and hear it, and then try to recreate that, technically. I even prefer to hear a group play on stage. If I'm going to spend a lot of time cutting that group, I want to find out their concepts, and how they're going about it. And then I use that approach in the studio.

Graham and Don both agreed about going for a natural sound, and it was interesting to see whether they also agreed about the importance of the session. So we asked Graham:

g. d.: How much of the success of an album lies in the basic tracks, and how much in the mixdown?

NASH: Oh, it's 90-10. If you cut the right tracks, it's easy as ---- to mix.

g. d.: So you can't make it happen in the mix if it hasn't happened in the studio?

NASH: No, definitely not. You can fake it, but it isn't real.

Graham's comment about faking it led us to ask Don whether he could help make it happen in the studio, although this is traditionally thought to be the role of the producer.

g. d.: Don, what can you do, or what do you do to improve the sound of a group?

GOOCH: If it's not happening out in the studio, the sound is not happening, it's not going to happen in the control room.

We're not miracle workers. It's like a house: If you've got no foundation, your house is not going to make it. If it is happening out there, you just take and enhance that. Some groups will come in and expect that they can plug in any amplifier, and it's going to come out sounding great; they can put up any set of drums, and not tune them, and it's going to sound great. It's not, there's just no way. We've got limits.

The areas we had already discussed were certainly central to the function of the freelance mixer. But there are other areas that distinguish the freelancer. He may treat some things differently because he is independent. He may gain greater creative freedom. But what of his financial security? Before allowing our discussion to drift too far into technical areas, we wanted to ask Don about some of these more personal and less technical subjects.

g. d.: Don, do you feel that you now have more freedom, in a creative sense, than you had as a staff mixer?

GOOCH: Oh, definitely. I think the client benefits, too, from somebody who's freelance.

g. d.: In what way?

GOOCH: Well, when you work as a staff engineer, your first loyalty has to be to the studio you work for. You're looking out for the studio, and you're also trying to please the client. Where, if you're freelance, you're working for the client. When you go into the studio, you're actually a client, too. So your main interest is toward the client. You do things for his benefit.

g. d.: Isn't there more security in working for a studio?

GOOCH: It's more stability. It's secure to a certain extent. Whereas, freelance you have to hustle, and you have to be on your toes because there's a lot of people out there waiting to take over

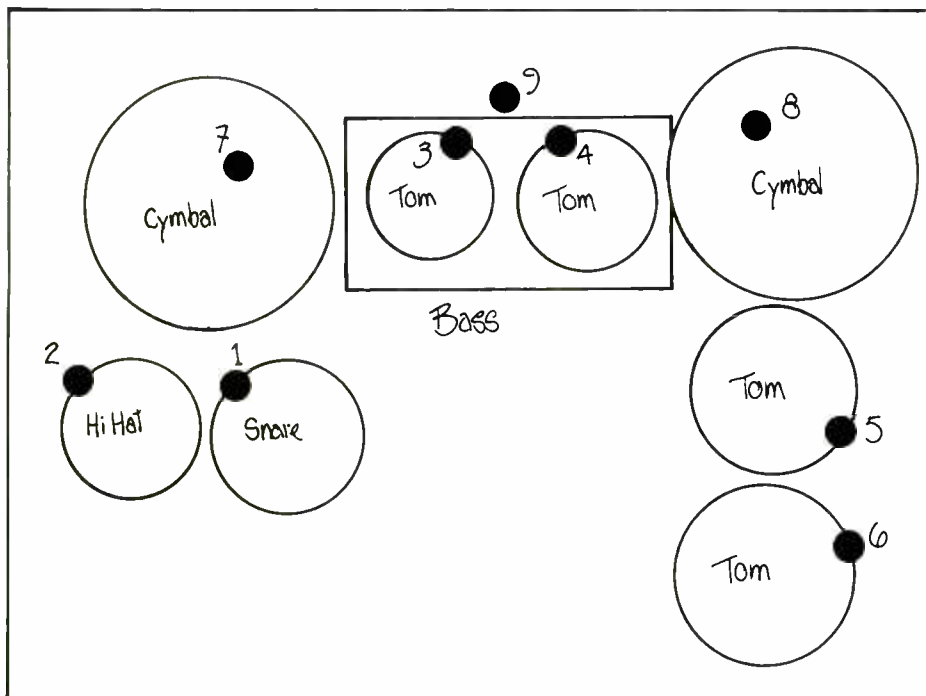

“FREELANCE . . . If you can live with the insecurity . . . you’ve got more freedom. You can pick and choose who you work for . . . the music you are doing . . .”

your clients. I prefer to be freelance. An in-house engineer, as long as he performs his job, is relatively safe, in that he is going to get his paycheck every week. Freelance, if you can live with the insecurity, you’ve got more freedom. You can pick and choose who you work for, the music you’re doing, and to a certain extent where you work. It’s like working for yourself, really.

g. d.: Without getting too personal, how does it work out financially?

GOOCH: Well, it depends. If you’re really successful, you can make out far better than you would as a staff engineer. You get higher pay, as well as more tax deductions. Your pay is what you ask. In other words, although you don’t have an overtime situation, your hourly rate is considerably higher; two, three, or four times higher in some cases. So you can work less hours and make the same amount of money, and have more free time. Or, you can work more hours and make a whole chunk of money -- if you want to, and you’re good at it.

g. d.: You’ve mixed for a number of groups. How do you get work? Is it word of mouth?

GOOCH: It’s reputation and, in some instances, being in the right place at the right time. I’m usually contacted.

g. d.: In terms of the time span, or the unity of a job, are there any advantages to being a freelance mixer?

GOOCH: When you work for a studio, the group books in for a certain amount of time, so it doesn’t matter whether you work for the studio or the group. But as a freelance engineer, working for the group, you have the option of moving to different studios or different locations for specific reasons. For using outside musicians, or for time reasons, or whatever, when they move they can have the same engineer. And, as I said, I prefer to follow a thing all the way through.

g. d.: Apparently you do move around from one studio to another. Does it cause much difficulty when you cut in one studio and mix in another? Does it become difficult to hear things in a changing frame of reference?

GOOCH: It can cause problems, but you form a kind of reference. My point of reference right now is Steiner’s place (Sound Labs).

g. d.: Do you ever carry a reference tape or disc with you when you go to an unfamiliar room?

GOOCH: I always do, I usually bring a 15 ips tape copy of the last thing I’ve

TYPICAL DRUM MIKING SET-UP USED BY DON GOOCH: All mikes used on drums are Shure 546’s, placed roughly 3” in from the edge of the drum, and as close to 45 degrees as possible to the drum head. High-Hat mike (Beyer M-160) is aimed away from the drum set, at the edge and very close to the open high-hat. Overhead mikes are U-87’s or KM-86’s,

and are quite close to the cymbal, just off the center ridge. Theoretically these mikes are just for the cymbals. Track and position assignments: Mike 1 on a separate track. Mikes 2,3,7, on the left. Mike 4 in the center. Mikes 5,6,8, on the right. Bass drum mike (9) is also on a separate track. Drums are panned from the drummers position.

Change Sound to Silence with a **TABERASER**



This rugged, heavy duty bulk tape eraser wipes sound from all magnetic tapes, cartridges, cassettes and magnetic film stock; handling up to 2”.

It erases with minimum residual noise because the field automatically diminishes at the end of each 30-second cycle.

A thermal control and blower keeps the unit below 71° C.

Priced at only \$395.00.

For the distributor in your area—Call or write:

TABER Manufacturing & Engineering Company
2081 Edison Ave. • San Leandro, Ca. 94577 • (415) 635-3831

done, or something I'm really familiar with. And I'll spend 20 minutes or a half hour playing back two or three cuts of the stuff that I know. And from that I can get a point of reference.

g. d.: Are there any things you'd like to see more standardized, so that when you do move around, it would be easier for you?
GOOCH: Not so much non-standard things. You'll find some studios are better equipped than others. And at times, I carry a lot of my own gear for that reason; things like microphones, small limiters, this type of thing. Some engineers even carry their own EQ. Every control board is different, every studio is different, and every engineer develops a preference for certain pieces of gear. I prefer a lot of dynamic mikes, as opposed to condensers. Other engineers prefer condensers. Well, studios can cater to a certain extent. Heider's (Wally Heider Recording) probably has the best selection of mikes that I've run into.

g. d.: Your answer got into outboard gear. I was thinking more in terms of standardization of the studio design itself. Monitors, for instance, are the most critical link between the studio and the mixer. Is there a preference you have for room design or frequency response curves?

GOOCH: I don't like an EQ'd monitor system. I find it puts funny stuff in the monitors, and it's another form of *hype*. I like the Sound Labs. They have the best monitor system that I have heard. It's a 604E sound, which I'm used to, and yet it's true. A normal 604E has a very heavy peak in the midrange, and you have a tendency, cutting on a flat 604E system, in a room that's not tuned to those speakers, to come out with some really funny sounding tapes. They will sound great in that room, but take them somewhere else, and you'll go, "wow, that's not what I had!" With the Mastering Labs Crossover, you've got that basic 604 sound, but it's smoothed out. Then the room is tuned to those speakers. When you mix in that system, you're in the sound. You're not listening to it coming from two or four speakers up on the wall. You are part of the sound, you are in it, and when you take it out of there, you've got the same thing. You're balances don't shift.

g. d.: Places like the Sound Labs notwithstanding, the trend toward artists building their own studios seems to be increasing. What do you think that's going to do to the industry, and especially to your work?

GOOCH: It's going to help it.

g. d.: In what way?

GOOCH: It's going to give the artist more creative freedom. It's going to be a boost to the freelance engineer because most artists aren't that heavily into engineering, and they will have to rely on the freelance engineer.

g. d.: On the creative side, do you think that performers are apt to be more relaxed in their own studios, and can get better results?

GOOCH: Yes, it's more relaxed. You don't have the pressures. You don't have to worry about time. You've got your own studio, and you book what time you need. You can go down and create when you want to, basically. Graham has got a great studio, probably one of the best I've ever worked in. But you can't mix in there. I mean, the room is state of the art, as is the equipment. But size, when he built the studio, dictated how close the speakers are, and where they are; as such, you can't mix in there. But I can cut as good basic tracks there as you'll cut anywhere. And then you combine that at a place like Sound Labs, and you've got a great product, without half the hassles.

g. d.: Earlier, you were talking about there being limits to what you could do in the studio. I think it was with respect to the expectations of groups. What do you do in a situation where the group might want to bring 2000 watts of amplifier into a small studio?

"If it's not happening in the studio . . . it's not going to happen in the control room. We aren't miracle workers."



Which MD 421 made this curve?



Response curve made with five random-selected MD 421 microphones.

ALL 5 OF THEM!

UNUSUAL? Not for Sennheiser.

The fact that the response curves of the five microphones are almost identical is commonplace for our engineers. And the individually-plotted curve we provide with each unit will confirm the fact. For besides the rigorous check of a response curve, each and every Sennheiser professional microphone undergoes numerous other inspections, to insure its absolute acoustical, electrical and mechanical integrity.

Perhaps this uniformity and unusual performance influenced the major recording companies in choosing Sennheiser microphones for both field and studio use (and made ours the 'standard' microphones of the continent).

You may think this kind of quality control is unusual for a production instrument. However, we are very particular about the kind of equipment bearing our name. Shouldn't this kind of 'insured performance' be built into your audio facilities, or those you install?

For further details, including full technical specifications, and a list of microphone accessories available for the MD 421, please write or call.



SENNHEISER

ELECTRONIC CORPORATION

10 West 37th Street, New York, N.Y. 10018 (212) 239-0190
Manufacturing Plant: Bissendorf, Hannover, West Germany

*“... at the end of, let's say,
five hours, I'll look at the EQ on
the board, and everything
will be jacked up.
I'll know I'm in trouble.
The best thing then is to stop!”*

GOOCH: You tactfully try to talk the group into cutting down on the amount of equipment. Most musicians, and most groups, I've found, are so used to standing right in front of this massive bank of amplifiers and speakers that they are feeling the sound as well as hearing it. And when they come back into a studio, they expect all that sound, and the same effect. It doesn't happen. They're used to such astronomical levels that a lot of them are very disappointed when they come back into the control room to hear it -- because it just doesn't have the energy you've got on stage.

g. d.: Does that mean that in a mixdown the group tends to want to hear it monitored at higher levels than you prefer to work with?

GOOCH: No, because I'm in the habit of monitoring fairly loudly.

g. d.: Don't you find that causes fatigue problems?

GOOCH: Yes, I'm very tired when I come out of a session. If I find myself spending over, say, three hours, then the high end of my hearing is going to go down. I can usually take a tune for only three hours. After that the mixes aren't going to get that much better. If I've got it pretty well together, then we can do a rundown, and catch little things. But if I have to EQ things at a loud level for an extended period of time, it's going to definitely degrade the product.

I've seen some people get in there and spend ten or fourteen hours straight on one tune. I can't do that. You reach a point of saturation. If I do that, I wind up putting more and more EQ on. At the end of, let's say, five hours, I'll look at the EQ on the board and everything will be jacked up. I'll know I'm in trouble. The best thing then is to stop.

g. d.: Getting back to the limitations of a studio, are there other things that should be done in the studio, and which groups aren't always aware of?

GOOCH: There are some problems you just can't solve. If a guy is going to put a bank of amplifiers out there and expect you to record them so they're going to sound the same as that bank of amplifiers, that's technically impossible. But it's difficult to get this across to groups, especially groups that have never been in the studio before.

g. d.: What can be done to get around that situation?

GOOCH: There is a studio way to play. On stage, for instance, a drummer has to

be very flashy. He has to hit a lot of cymbals. There's a lot of movement. This is great because on stage you've got a visual as well as an audio thing for the audience to relate to. But on a record you have strictly audio. So if you put a lot of cymbals, and a lot of crash, it's just going to clutter. There is a difference between playing on the stage and playing in the studio.

g. d.: Can you give a more specific example?

GOOCH: If a musician is used to playing very hard, very loud, and very flashy, and he tries to do this in the studio, it gives the engineer tremendous headaches. So you've got to somehow arrive at a compromise where they still play with the same feeling. If you try to tell them they only need a wee little amplifier, and it may sound like shit but it's really technically alright, then the guy will always be thinking, while he's playing, "boy, that sounds terrible." and it's going to show in his playing.

g. d.: You're describing a situation where a group wants to sound the same on the album as they sound on stage. Aren't there groups that like to sound differently on their albums?

GOOCH: Yes, most of them do, for the simple reason that they can't reproduce the albums on stage. An album is an album thing, unless you're doing a live album, of course.

g. d.: Even if a musician does get used to playing at somewhat lower levels in the studio, it seems that the demand for isolation can be an awful obstacle to getting it on. I've seen studios arranged so that the artists can't even hear one another, except through cue phones. How do you deal with this kind of isolation?

GOOCH: In most cases I think this will produce a more sterile product. I like separation, but I'm not going to go crazy on baffles, because I think you can overcome a lot of that with mike placement. There are instances where you can't.

g. d.: When is mike placement inadequate for separation?

GOOCH: I've cut Airplane where everybody played loud, and they wouldn't allow me to put up one baffle, and we were darn near knocking tiles off the wall. In that case, the only thing you can go for is a total sound, which is actually the best way. The important thing is for the group to be comfortable playing. That's primary, and whatever problems that presents an engineer, it's up to the engineer to work around them. You work together with the group. But you've got to remember that they have got to play it right. And if you put up a bunch of baffles, they're not going to have contact. The music is going to suffer more so than if you have leakage, and I don't think it's worth sacrificing the per-

formance for clean tracks. *You're not doing a recording to perfect your techniques, you're doing a performance.*

*“Automation? . . . I don't
consider it a gimmick . . .
I think it's a NECESSITY . . .
especially with the number
of tracks coming out.”*

g. d.: The subject of isolation is part and parcel with multi-track recording. Do you think that the increasing number of available tracks are really doing anything for the product?

GOOCH: It's a lot harder to mix a mono or a two-track thing, live. That's the old school, and the old school mixers were far superior to the new school. But your sound quality is a lot better. In those days you had to commit yourself early, and there was no going back on it. 16 and 24 track are allowing you to put off committing yourself forever. It's a habit that everybody slips into -- put it off. Nobody likes to make a decision right on top of it. You can use multi-track, but you have to use it intelligently, not as a cop out.

g. d.: Do you think that automation will help you to use multi-track intelligently? Or is it just another gimmick?

GOOCH: I don't consider it a gimmick. I think it's a necessity, especially with the number of tracks coming out.

g. d.: What kinds of things do you want automated?

GOOCH: That's a good question. An engineer has two hands. He can only control so many things, and beyond that, it's impossible. How do you click on 18 tracks, spread across a console? You don't. And unless they come up with a trained octopus, it's just about impossible to do a complicated mix. With automation, you can go back and save a lot of time.

g. d.: You have pointed to a real need for automation. Another area that is new, and which some people believe to be of questionable value, is quad. Do you think that performers or producers are very interested in the four channel format?

GOOCH: No, I think the major push is coming from consumer products manufacturers. It is inevitable. It's going to happen. But I don't know how much it will really benefit the performer. I'm not really sold on quad. But it is going to happen. I think you'll find, initially, a lot of swirling. Just like when stereo first came out, stuff will be bouncing back and forth to make damn sure that whoever is listening knows that it's quad. It will be gimmicky, but that phase will pass. Then you'll get down to mixing normally in quad, just like we mix in stereo now. I don't know what problems there will be because it's too new.

g. d.: Since we're discussing the value of new tools, and of the quantitative approach to mixing, I wonder how you feel about the extensive use of noise reduction systems with hard rock music? I can

"Not quite beyond the state of the art"

(unmeasurable response)

This set of headphones is part of a humorous collection of creations we have discovered in studios around the country attempting professionalism.

What is not so funny is that this kind of workmanship can be found in many forms in facilities claiming professional standards.

High freq. osc., r.f., hum, cross-talk, pops, clicks and other installer created problems can destroy the critical quality of equipment soon after it leaves the crate.

The fantastic capability of solid state circuitry can only be realized if the installer's knowledge of grounding, cable routing, level matching, equipment placement and other critical necessities match the painstaking design of the manufacturer.

Under the heat of modern professional competition, some pretty sweet deals can turn painfully sour.

MILAM AUDIO would appreciate the opportunity to help you compete in this specialized industry. Our many fine lines of products and designs are matched by our ability to install them to perform.

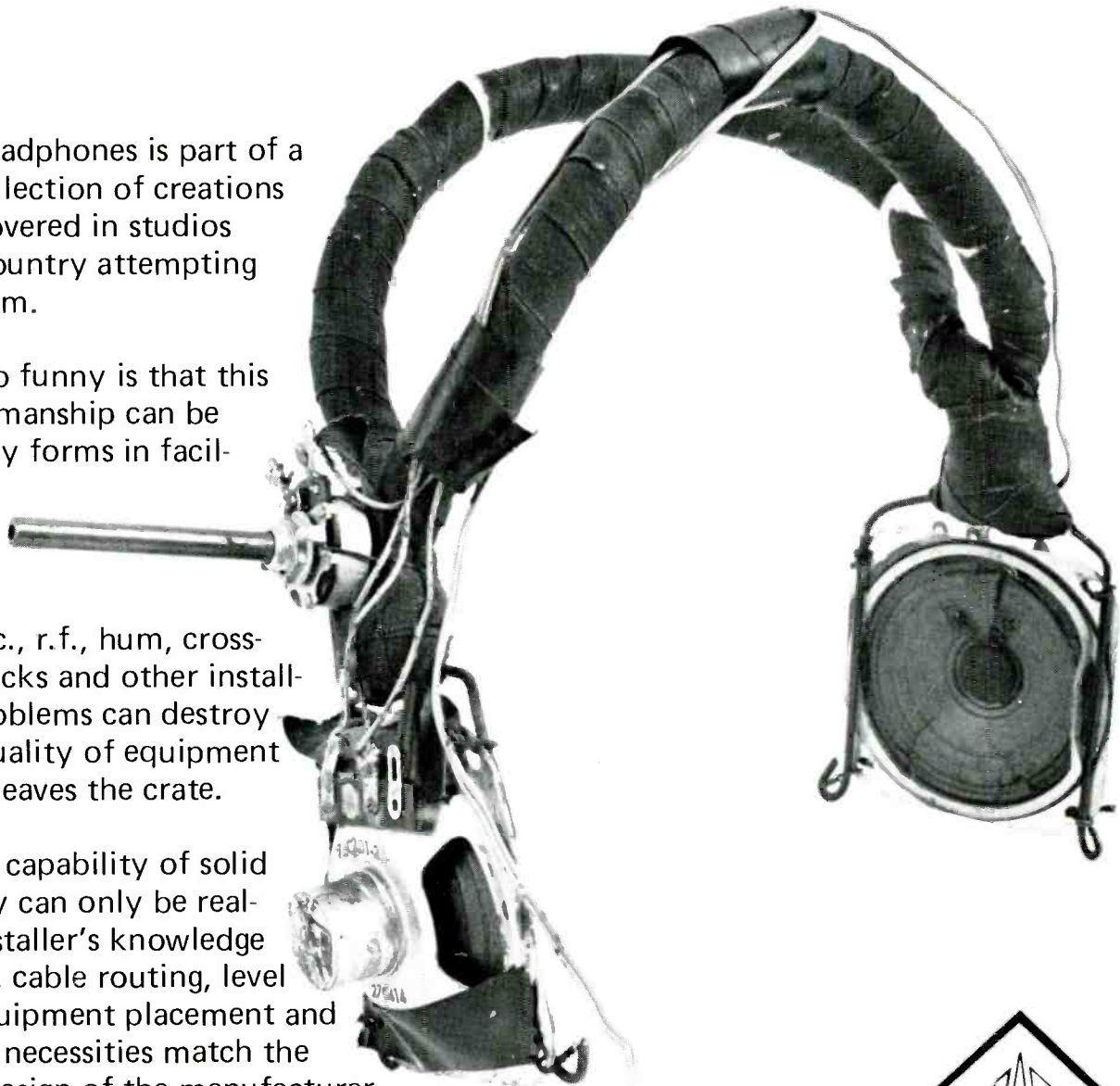

Engineering - Sales - Consulting

Please contact us at 700 West Main St.

South Pekin, Illinois 61564

Ph. (309) 348-3112

Jerry Milam

Circle No. 116

Re/p 23

“... an engineer who is very technically oriented... will make a lousy mixer! I've had all my technical training... but thankfully, I've forgotten it.”

understand the problems involved in getting an orchestra with 120 dB dynamic range onto tape. But how much of a problem are the noise and range limitations of modern equipment when rock is the material?

GOOCH: It's not a problem. I don't think it's important. When I did the "Long John Silver" album, we did that at 30 ips with Dolby. Well, that was the first full 16 track Dolby session I did, and I don't think it made a bit of difference, except on one tune. The rest of the time we might as well have gone 15 ips without the Dolby, for all the difference it made. Noise reduction is great for acoustic work and for light stuff. But when you get into hard rock, I don't think it's necessary because you won't hear the difference.

We seemed to be drifting into pretty technically oriented subjects. I felt that we should get back to the mixer-producer chemistry.

g. d.: You and Graham are very much aware that your job is creative. I get the feeling sometimes that people whose

job is technically oriented, like a mixer's job, lose sight of the ultimate goal of their work.

GOOCH: With mixing, I've seen Ray Charles sit down at the board. He mixes his own stuff, and he cuts his own sessions, except when he's playing, of course. Now I've seen some guys sit down, and as far as I can see, they're mixing by the meters. I use the meters as a guideline. If I'm really pinning that meter, it may draw my attention to listen for distortion. And when I know it's wrong, I will try to back down. But if that thing hits the pin once in a while, it's not going to bother me, as long as I don't hear it.

g. d.: That doesn't sound like a very technically inspired attitude. And I know you have a good technical background.

GOOCH: Perhaps with the exception of Armin Steiner, an engineer who is very technically oriented will make a lousy mixer. He will start nit-picking technically. He'll say, "I know that amplifier has a certain bit of distortion," so he'll patch around it. He will go after all these problems that you really don't hear. You're going for the end product. I've had all my technical training, but thankfully, I've forgotten it. Really, I know enough to be dangerous, which is a thing I am still trying to overcome. If I take it up, and I'm clipping an amp, but I'm getting the sound I'm looking for, I really don't care if I blow that amp. I hope I don't. I try not to. But if that's

what's giving me the sound, whether from a technical point of view it's right or not, that's what I do.

g. d.: As long as we're back to the technical point of view, I wonder if you have any preferences for specific miking techniques?

GOOCH: I like close miking very much. I'm into dynamic mikes. For instance, on drums I'll use dynamic mikes on everything but the overhead -- not every time, but generally speaking. There are some drums where you have to go to a different mike.

g. d.: Do you like to keep everything on separate tracks, or do you do any mixing before you lay it down?

GOOCH: I use four tracks, primarily, for drums. I like to keep my snares separate. I like to keep my foot separate. And then the other two tracks are a stereo blend of the other things. Everything else I usually like to keep on separate tracks. With tight miking you can get good separation, and then if you want to change any parts, you can. You don't have to commit yourself at that time, and I've found a lot of producers really don't want to commit themselves. If they want to change something later on, this gives them the freedom to do so. It also uses up a lot of tracks. Also, in tight miking the sound of the room isn't that critical, so I don't have to hassle with leakage, and I can do the mixdown faster.

Since Don had some strong feelings about microphone usage, I felt it would be interesting to see what Graham's view's on the subject were.

g. d.: Graham, are you concerned, as an artist or producer, about microphone placement?

NASH: Yes, of course. Those are the subtleties of it all. And I've worked mainly with four engineers: Larry Cox, Bill Halverson, Elliot Mazon, and Don Gooch. They all have totally different ways of miking things. But between their way, and what I want, we've got it.

g. d.: Don, we've been dealing with the overlap of technical and of creative areas. Disc mastering is basically a technical realm, with the object being to get the creative effort of the tape onto the disc. Do you ever get involved with the mastering of your mixes?

GOOCH: The stuff that I do I follow all the way through. I wish I knew how to cut discs. I just know the basics. If I knew how, I would go in, and do that, too. Although I would only do my own stuff. But it takes probably more time to become a good disc cutter than it does to become a good engineer.

g. d.: Is the follow through with the disc something you couldn't do as a staff mixer?

GOOCH: There's no way, unless the studio does the total thing, and there aren't many around. When I was at Heider's, the engineer would sit in at the disc mas-

new pocket sized professional sound level meter for under \$100



The new Scott 451C sound level meter is the first truly professional instrument that fits in your pocket and costs only pocket money.

It gives instant readings at the touch of a button to ANSI type S3C accuracy with industry standard "C" weighting for flat response. Its range of 45 to 130dB SPL lets you check ambient background levels as well as the signals of interest. It measures the complete range of sounds likely to be encountered by the audio engineer or the advanced audiophile.

It's got a handsome, rugged all metal case and a big meter face that's easy to read. It's also a lot of fun to use. Its battery lasts all year. It lasts indefinitely and it's fully guaranteed for two years. It costs only \$98.00. It's available from distributors whose names we'll send you with full product specifications.

Scott Instrument Laboratories
Division of Eastern Air Devices
30 Cross Street
Cambridge, MA 02139



tering, like when we cut the Airplane.

g. d.: Do you think many engineers know much about disc mastering?

GOOCH: Not enough. It's a totally different field. I've been associated with it. I couldn't go in and cut a master disc if my life depended on it. But I know what I want, and I work with the cutter. I know what he should do and what he shouldn't do.

g. d.: What are some of the things you do with the mix to get a better disc?

GOOCH: There are a lot of subtle things that you can do in the mix that will make it easier to get it on disc. For instance, you may have a mix with a lot of bass. If you chop it off at 70 cycles, you won't really hear that loss. But it will enable you to get it on the disc much better. A lot of cymbals are deadly for a disc. It's subtle, and it's hard for me to pin it down for you. You can use apparent loudness rather than actual loudness.

g. d.: Does the producer sit in on the disc cutting with you?

GOOCH: Yes, but he's relying on the engineer. There may be times when I don't want the thing limited. You know what you do and don't want done to it. It's a crutch, a way that they can get higher levels without working as hard. There's an easy way, and there's a hard way. Throwing a limiter in, or chopping off the bottom end is the easy way, and that can be a cop out. It's messing with a product that has my name on it, and which I'm responsible for. The end result is what the public is going to hear, and that will reflect what I do. So I want to be sure that's right.

g. d.: As long as we're on the subject, do many artists you know follow the record through the disc?

GOOCH: Not as many as should. I think they should follow it through.

g. d.: Of course you get into the role of the artist, which I think is really to be creative.

GOOCH: Unless the artist has total faith in other people handling his material, I think that he should be involved. I don't say that the artist should go down and watch the disc being cut. But what I do think is that he should be interested enough in his product to listen to a reference disc, and if he's got any comment, we can discuss it.

g. d.: Do your clients listen to their discs?

GOOCH: Yes, and that's good. I'm not going to go on an ego trip, and say that I want it done that way because technically that's right. That's not where it's at. You work with the artist.

Again, searching out the common ground between the mixer and the producer, I asked Graham Nash:

g. d.: Do you follow a tape through to the finished album?

NASH: I master the album myself. I'm there when it's cut, too, because it can get messed up totally. I go as far as I can, and I'm going further every day.

g. d.: Would you say that part of the reason for your success has to do with following through?

NASH: No, it's just a part of me being a person. It's the way I live my life. I like to follow it through as close as I can get it.

g. d.: We have talked about creative decisions, about relationships with artists and producers, and about technical ideas. In your opinion, Don, what part of your job is creative, and what part is technical?

GOOCH: It's mostly creative judgement. If I want a particular sound, I've got to know how to get it, so they do work

hand in hand. If I turn a knob, I've got to know what I'm doing. But then that becomes second nature. If I know that guitar's not coming through, without dissecting it I know it's being masked by such and such. I also have to know technically, for instance, that if you EQ two guitars in the same range, you are not accomplishing what you want, because you get a masking effect. So if I'm EQ'ing this guitar at 5 kHz, to get more bite, and the other one still doesn't have enough bite, then I won't go in and EQ it at 5 kHz. I'll do it at 3 kHz or 7 kHz or some other frequency. I'm not thinking from a technical point of view so much as I am thinking subconsciously and getting the sound that I want.

g. d.: It seems that a mixer, or an engineer, is not really a full description of what you do. How would you describe your job?

GOOCH: Oh, depending on the mood I'm in. It's nebulous, and I really don't care. I love what I'm doing, and I wouldn't do anything else. I'll put up with all kinds of hassles to be able to do it. I consider myself very lucky to be able to do what I'm doing and get paid for it. If I had to go to work at 9 and come home at 5, and know what I'm going to be doing 6 months from today, they'd put me in a cookie jar. I love what I'm doing, I'd like to continue to do it, and to get paid for it. It's great!

g. d.: I'm about out of questions for now. Thank you for being so cooperative. Are you satisfied with what we've covered?

GOOCH: It's funny, when you've got to think about those things. When somebody asks you questions, you've really got to get your mind clicking, and thinking, "exactly what is my point of view on that thing?" And sometimes you surprise yourself.

the TOY CHEST UNIVERSAL LIMITER

arriving on your tracks

- Universal because it works with any system — anywhere — anytime. And the price is good enough for anybody.
- Adjustable gain bridging input works from virtually any system, even Hi Z low level simi-pro gear.
- Low source output drives any load.
- Phono pin plug in and out for easy hookup.
- Large VU meter monitors gain reduction.
- Performance exceeds units costing twice as much.
- Quiet, clean, advanced op-amp/FET design with internal AC supply.



AVAILABLE NOW CALL TODAY

Audiotechnique (203) 359-2312
Stamford, Conn.

Martin Audio (212) 265-5470
New York, N. Y.

Studio Supply Co. (615) 327-3075
Nashville, Tenn.

Westlake Audio
Los Angeles, Calif.
(213) 655-0303

ORDER TODAY

\$197



**BOX 280 —
NASHVILLE,
TENN. 37202**



Planning a STUDIO?

Yes! You can have a completely modern, well equipped, acoustically correct recording studio for less, (much less), than the meg-a-buck price you've probably gotten from that expensive fellow.

No! You don't have to be content with one of the stripped down, bare bones systems from "those guys" either, in order to remain within a reasonable allocated budget.

Custom Fidelity's studio packages provide you with all of the capabilities necessary for today's complicated recording sessions without sacrificing versatility in performance or human engineering.

Write today for the big, new studio planning kit from Custom Fidelity — free, of course!



7925 Santa Monica Blvd. / Hollywood, CA 90046 / (213) 654-7267

A SIMPLE LOW-PASS FILTER

by: WAYNE YENTIS
RAINBOW RECORDING
SANTA BARBARA, CA.

Clicks, pops, buzzes and radio stations creep into every audio system from time to time and many of them ride in on the 115 VAC power lines. Regulated and filtered power supplies in studio equipment usually sift out the hash on well grounded supply lines, but sometimes heavy power transients (a refrigerator or air conditioner turning on) show up on the loudspeakers when you'd rather they didn't. Making things worse, older supply line installations are often poorly referenced to a stable ground, making them more susceptible to carrying electrical noises from the electric drill or cash register next door.

Filtering the power lines directly can help. Essentially all the objectionable interference is many octaves above the 60 Hz line frequency and a simple low pass LC filter with a minimum series impedance of 60 Hz is a very effective suppressor.

The optimum values for L and C depend on the magnitude of the load X, and maximum values can be calculated for maximum filtration with minimal power transfer loss.

The inductor L in the simple Low Pass Filter presents an impedance Z_L in series with the load X. This series impedance decreases the power transfer to load X and should be no higher than $\frac{X \text{ (Ohms)}}{70}$

at 60 Hz for a nominal 2% power transfer loss at the load. For loads of 25 to 200 watts, practical values of L range down from 25 to 3 mH with coil resistances no more than .5 to .05 Ohms respectively. The coil resistance must be small compared to the inductive reactance.

The capacitor C presents an impedance in parallel with load X. This should be no less than 10X (Ohms) at 60 Hz for a combined LC network power transfer loss of less than 3%.

As loads increase beyond 200 watts the DC resistance of the inductor becomes more significant and limits the

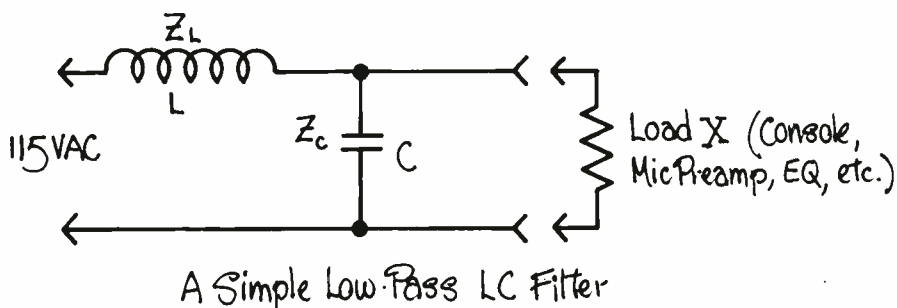

Load Power Rating	25 W	50 W	100 W	200 W
Load Impedance X	611 Ω	305 Ω	152 Ω	76 Ω
Inductive Reactance $Z_L = \frac{X}{70}$	8.7 Ω	4.4 Ω	2.2 Ω	1.1 Ω
Maximum L = $\frac{Z_L}{2\pi f}$	24 mH	12 mH	6 mH	3 mH
Capacitive Reactance $Z_C = 10X$	6.1 K	3 K	1.5 K	750 Ω
Maximum C = $\frac{1}{2\pi f Z_C}$.45 μF	.9 μF	1.8 μF	3.6 μF

effectiveness of the filter network.

The chart shows maximum values for L and C for given load power ratings. These values should not be exceeded, but lower values can be used with somewhat less filtering efficiency, and less power transfer loss.

Amplifiers with high gain, such as mike, phono, and tape preamps are typically more sensitive to power line noise than amplifiers operating at line level. Sensitive elements in the audio chain should have their supply lines filtered individually, or be grouped together in clusters of 50 watts or so with the supply lines to each cluster individually filtered.

For installations where the neutral terminal of the AC power is poorly grounded, it may be necessary to put filter sections on both terminals and run

the capacitor shunts to a solid ground in the studio, the customary water pipe or metal structural member that goes deep into the ground.

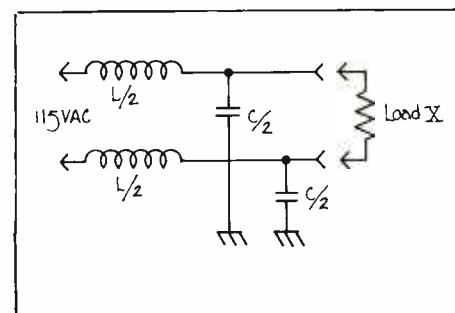

In this case each L and C should be one half the values shown in the chart.

MagLink[®]

SYNCHRONIZER

An indispensable tool in multi-track audio production, video mixing, editing and "sweetening," film sound track production, and foreign language overdubbing.



MagLink is a completely new approach to fast, efficient tape synchronizing, position logging and editing. Videotape, multi-track audio, and magnetic film machines may now be locked in synchronism, offset, or stopped and started at preset positions with an

accuracy not formerly attainable. A master and any number and any type of slave machines may be controlled by MagLink and will remain synchronized even in REWIND and FAST FORWARD modes.

Please send for further information.

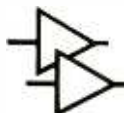

AUTOMATED PROCESSES, INC.
80 MARCUS DRIVE, MELVILLE, NEW YORK 11746 • 516-694-9212

West of Rockies: WESTLAKE AUDIO
 Los Angeles, Calif.

Europe: 3M FRANCE
 Paris, France

Japan: NISSHO IWA1
 Tokyo, Japan

Planning to Build a Professional Recording Studio?

From 4 to 24 Track • For Live Recording, Mix Down, Remote or Mastering.

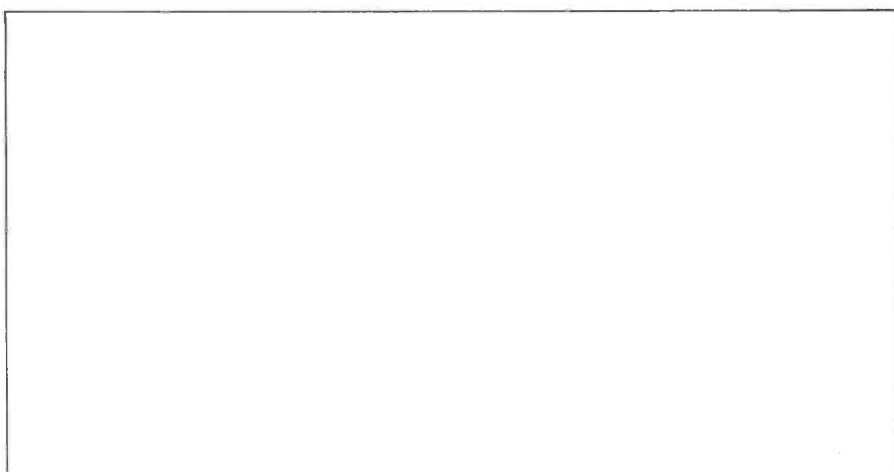





STUDIO IN THE COUNTRY
Bogalusa, Louisiana

**JOIN THE GROWING LIST OF MAJOR
PACKAGE AND TURN-KEY
INSTALLATIONS BY
Westlake Audio**

RECORD PLANT	Los Angeles	2 Studios
RECORD PLANT	New York	3 Studios 1 Mastering
MGM RECORDS	Los Angeles	3 Studios
WARNER BROS. RECORDS	North Hollywood	2 Studios 1 Mastering
WESTLAKE AUDIO	Los Angeles	1 Control Room
PREMORE, INC.	Chicago	1 Studio
PREMORE, INC.	Los Angeles	1 Studio
LOCATION RECORDERS	Burbank	1 Mastering
CARIBOU RANCH	Nederland	1 Studio
DEVONSHIRE SOUND	North Hollywood	1 Studio
WEST MINST'R SOUND	Iowa	1 Studio
BEARVILLE SOUND	Bearsville	1 Studio
WALLY HEIDER	Los Angeles	1 Remote Truck
NEIL YOUNG	Redwood City	1 Studio
PACIFIC VIDEO	Los Angeles	1 Remote Truck
KAYE-SMITH RECORDING STUDIOS	Seattle	2 Studios
SOUND LABS	Hollywood	1 Studio
SAUSALITO MUSIC FACTORY	Sausalito	2 Studios
ELEKTRA RECORDS	Los Angeles	1 Studio
STUDIO IN THE COUNTRY	Bogalusa	1 Studio
STUDIO TEMPO	Montreal	1 Studio
LAGAB	Mexico City	1 Studio 1 Mastering
OSMOND BROTHERS	Provo	1 Studio
MIKE NESMITH	Los Angeles	1 Studio
MIKE LLOYD	Los Angeles	1 Studio
RECORD PLANT	Los Angeles	1 Remote Truck
MIKE ALLSUP	Los Angeles	1 Studio
KENDUN RECORDERS	Burbank	1 Mastering
MUSIC RECORDERS, INC.	Hollywood	1 Studio
SOUND HOUSE	Chicago	1 Studio
ALLMAN BROS.	Georgia	P.A. System
FRED KARLIN	Los Angeles	1 Studio
ARTISAN SOUND	Los Angeles	2 Mastering 1 Remix
PIG FOOT MUSIC	Point Reyes	1 Studio
AUDIO ARTS	Los Angeles	1 Studio
SOUND PIT	Atlanta	1 Control Room
CAPRICORN SOUND STUDIOS	Macon	1 Control Room
RANDY WOOD	Los Angeles	1 Studio
MOODY BLUES — SHEPPERTON STUDIOS	London	2 Studios
BLIND MAN SOUND	Honolulu	2 Studios 1 Remote Truck

**MORE SCHEDULED - Hawaii to New York,
Canada to South America**

from acoustic design
to down beat...

**Westlake
Audio**

6311 Wilshire Blvd.
Los Angeles, California 90048
(213) 655-0303

SERVICES AVAILABLE TO OUR PACKAGE AND TURN-KEY CLIENTS

PRE-PLANNING: Which markets are you going after? One studio or two? What is the sound character desired? How much multi-track separation? Your budget? Future expansion? These are just a few of the questions discussed at this stage. From the answers, we'll provide you with a comprehensive proposal covering our recommendations and the cost for the entire project.

SITE EVALUATION: If you're planning to build from the ground up or within an existing shell, we'll help you to select the best building or location in terms of size, demolition and construction costs, zoning, noise transmission problems and those "hidden" costs. Remodeling an existing studio? We can show you how to get the best results from your space.

DESIGN: Acoustical design is the key to the success of a studio. Westlake Audio's geometric and acoustic designs will provide you with a winning "sound." **Prior to construction,** we will guarantee the performance of your studio and control room with respect to isolation, response, decay time in various frequency bands and dispersion.

EQUIPMENT SELECTION: We have carefully evaluated the many products on the professional audio market to provide our clients with a broad selection of the finest recording equipment available. From consoles, automation and tape machines to monitors, microphones and support equipment, we have the lines to satisfy your requirements and budget.

FINANCING: We work closely with several companies whose specialty is providing clients with a lease or conditional sales plan tailored to your needs.

CONSTRUCTION: As the proper implementation and execution of the geometric and acoustic designs requires unique construction techniques, Westlake Audio will provide a construction foreman to oversee and work with your local construction crew and electrical and air-conditioning subcontractors.

WIRING: Our technical crew will install all the audio wiring throughout the studio complex and tie down the wiring to the microphone, headphone and tape machine panels, echo chambers, console, amplifier room and monitors.



RECORD PLANT Sausalito, California

SYSTEM INTERFACE: Our engineers will install all the recording equipment and interface the entire system to the console. A total system checkout is performed from microphone phasing to monitor equalization and balancing.

TRAINING: Technical and mixing engineers will train your personnel in the operation and maintenance of the studio and equipment.

STUDIO MANAGEMENT: Upon request, Westlake Audio will offer guidelines and suggestions for all facets of studio management including rates, booking procedures and controls, personnel requirements, wages, work orders, tape legends, library systems and credit.

NO OTHER PROFESSIONAL AUDIO DEALER CAN OFFER THESE UNIQUE SERVICES AND THE EXPERIENCE GAINED FROM BUILDING THIRTY-NINE MAJOR FACILITIES.

From a splicing block to an automated console, a home studio to an extravaganza

WRITE OR CALL AND WE'LL SHOW YOU HOW TO EARN A 50% RETURN ON YOUR INVESTMENT.



from acoustic design
to down beat...

**Westlake
Audio**

6311 Wilshire Blvd.
Los Angeles, California 90048
(213) 655-0303

AUDIO ENGINEERING SOCIETY EXHIBITS

BOOTH NOS.

AKG MICROPHONES - NORTH	
AMERICAN PHILIPS CORP	89,90
ALLISON RESEARCH INC.	31
AMPEX CORP.	85,86,87,88,88A
ARP INSTRUMENTS	72
AUDIO DESIGNS & MFG.,INC.	4
AUDIO DEVICES,INC.	7,8
AUDIOTECHNIQUES, INC.	45,46,55,56
AUDITRONICS,INC.	52,53
AUTOMATED PROCESSES, INC.	41,42
BASF SYSTEMS,INC.	11
B & K INSTRUMENTS,INC.	35
BOSE CORP.	43
R.T. BOZAK MFG., CO.	DEMO RM 5W
BURWEN LABS.	DEMO RM 5V
CAPPS & COMPANY,INC.	76
CERWIN-VEGA ASSOCIATES	DEMO RM 5L
CBS RECORDS	DEMO RM
CROWN INTERNATIONAL	2,3
THE CUSTOM FIDELITY COMPANY INC.	18,19
DBX,INC.	61,62,63
DOLBY LABS.,INC.	15,16
DUNCAN ELECTRONICS CO.	6
ELECTRO SOUND,INC.	79,80,81
ELECTRO-VOICE, INC.	DEMO RMS 5G,5H
ELPA MARKETING IND.,INC.	82
E.P.I.	DEMO RM 505
EVENTIDE CLOCK WORKS	54
FAIRCHILD SOUND EQUIPMENT CORP.	57
GATELY ELECTRONICS	20,21
GOTHAM AUDIO CORP.	DEMO RM 5S
HARVEY RADIO CO ,INC.	64
INTERFACE ELECTRONICS	5
INTERNATIONAL TELECOMM INC.	25
JVC AMERICA,INC	DEMO RM 502
MARK LEVINSON AUDIO SYSTEMS	DEMO RM 5X
MARTIN AUDIO CORP.	1
MCI,INC.	12,13,14
NAGRA MAGNETIC RECORDERS, INC.	84
RUPERT NEVE INC.	39,40
NIPPON COLUMBIA CO.,LTD.	DEMO RM
PENTAGON IND.,INC.	24
PRATT-SPECTOR CORP.	28
QRK/REK-O-KUT	26,27
RCA	9,10
RECORTEC,INC.	17
REVOX CORP.	60
SANSUI ELECTRIC CO,LTD.	44 & DEMO RMS 507,509
SCULLY/METROTECH, DIV.OF DICTAPHONE CORP.	58,59
SHURE BROTHERS INC	36,37,38
SPECTRA SONICS	33,34
STANTON MAGNETICS,INC.	51
STEPHENS ELECTRONICS,INC	77
TAPEMAKER SALES CO.,INC.	73
TASCAM CORP.	DEMO RM 501
3M CO., MAGNETIC PRODUCTS DIVISION	47,48
3M CO.,MINCOM DIVISION	49,50
TRIDENT	65,66,67,68
UNITED RECORDING ELECTRONICS IND.	22,23
WATERS MFG.,INC.	83
WESTLAKE AUDIO,INC.	29,30
XEDIT CO.	32

TECHNICAL SESSIONS

**SESSION A
BROADCAST AUDIO
MONDAY, SEPT. 10, 9:30 A.M.
JADE ROOM**

A-1	Statistical Analysis Of Broadcast Audio Signals
A-2	Sources Of Distortion In Broadcast Signal Processing Equipment
A-3	F M Broadcast Modulation
A-4	QFMX-Quadruplex FM Transmission Using The 4-4-4 QMX Matrix System
A-5	A Sub-miniature Electret Microphone Of New Design



AUDIO ENGINEERING SOCIETY

Forty-Sixth Convention . . . Exhibition of Professional Products . . .

Waldorf-Astoria
New York City

REGISTRATION

Sunday	September 9 – 5:00 P.M. – 9:00 P.M. (Exhibitors only)
Monday	September 10 – 8:00 A.M. – 10:00 P.M.
Tuesday	September 11 – 8:30 A.M. – 9:00 P.M.
Wednesday	September 12 – 9:00 A.M. – 5:00 P.M.
Thursday	September 13 – 9:00 A.M. – 5:00 P.M.

EXHIBIT HOURS

Monday	September 10 – 1:00 P.M. to 10:00 P.M.
Tuesday	September 11 – 11:00 A.M. to 10:00 P.M.
Wednesday & Thursday – September 12 & 13 11:00 A.M. to 5:00 P.M.	

TECHNICAL SESSIONS

Jade Room: Sessions A,B,D,E,G,I,J,K,M
Astor Gallery: Sessions C,F,H,L

**SESSION B
TRANSDUCERS
MONDAY, SEPT. 10, 2:00 P.M.
JADE ROOM**

B-1	Subminiature Electret Microphone In A Tie Tac
B-2	Mechanical Deformation In Loudspeaker Cones
B-3	Doppler Distortion In Loudspeakers
B-4	A Motional Feedback Loudspeaker System
B-5	System Theory For The Passive-Radiator Loudspeaker
B-6	The Scientific Design Of A Three-Driver Loudspeaker System
B-7	Optimum Horn Mouth Size
B-8	Optimizing Horn Loudspeaker System Performance

**SESSION C
AUDIO IN MEDICINE
MONDAY, SEPT. 10, 2:00 P.M.
ASTOR GALLERY**

C-1	The Artificial Larynx Revisited
C-2	Amplitude Compression In Hearing Aids
C-3	Subminiature Directional Microphones
C-4	Improvements In Hearing Aid Evaluation And / Or Performance - A Panel Discussion
C-5	Audio Technician As A Medical Technician In Biomedical Technology - A Panel Discussion
C-6	Advances In Stethoscope Performance - A Panel Discussion

**SESSION D
HOME MUSIC PRODUCTION
MONDAY, SEPT. 10, 7:30 P.M.
JADE ROOM**

D-1	New Measurement Standards For High Fidelity Components
D-2	The Role Of Specifications In Product Design
D-3	Distortion In Home Music Reproduction Systems
D-4	Directivity Of Loudspeakers For Monitoring And Home Reproduction
D-5	Record Warps And System Playback Performance
D-6	Integration Of The CBS SQ Logic System

**SESSION E
ELECTRONICS AND AUTOMATION
TUESDAY, SEPT. 11, 9:30 A.M.
JADE ROOM**

E-1	A Fully Automated Remix System
E-2	New Methods Of Automated Flutter Analysis
E-3	A New Approach To Synchronization And Spliceless Editing
E-4	The Synthesized Console: A Software-Oriented Approach To An Audio Control Console
E-5	Field-Type Acoustic Waitmeter

**SESSION F
NOISE CONTROL
TUESDAY, SEPT. 11, 9:30 A.m.
ASTOR GALLERY**

F-1	Noise And Uncle
F-2	New York City Noise Reduction Program
F-3	Estimating Noise Exposure For Site Selection And Exterior Wall Design
F-4	Noise Control In Recording Studios
F-5	Noise Reduction With The Use Of Viscoelastic Damping Materials
F-6	Design of Noise Barrier Walls
F-7	Magnetic Tape Recording From Sound-Level Meters

**SESSION G
ARCHITECTURAL ACOUSTICS AND SOUND REINFORCEMENT
TUESDAY, SEPT. 11, 2:00 P.M.
JADE ROOM**

G-1	Acoustical Renovation Of St. Peter's Episcopal Church, Bay Shore, Long Island
G-2	Reproduction Of Concert-Hall Sound In A Concert Hall
G-3	Performance Criteria For Theatrical Sound-Effects Systems, Part II
G-4	Stacking Horns For Control Of Low-Frequency Directivity
G-5	The Tradeoff Between Intelligibility And Fidelity In Sound Reinforcement
G-6	Power Output For Speech Reinforcement Amplifiers
G-7	Shattering Goblets With Amplified Singing

**SESSION H
DIGITAL TECHNIQUES
TUESDAY, SEPT. 11, 2:00 P.M.
ASTOR GALLERY**

H-1	A Demonstration Of Extreme Dynamic Range Recording Using Digital Methods
H-2	Application Of Bucket-Brigade Delay Lines To High Fidelity Systems
H-3	The Application Of Dither To The Quantization Of Speech
H-4	An Investigation On Quantization Noise
H-5	Dynamic Range And S/N Considerations In Digital Representation Of Audio Signals
H-6	LSI Reality In Consumer Electronics
H-7	Production Test Concept For Custom LSI Music Chips
H-8	Digital Speech Coding For Computer Voice Response
H-9	A Demonstration Of The Restoration Of The Voice Of Enrico Caruso Via Digital Signal Processing

**SESSION I
TUESDAY, SEPT. 11, 7:30 P.M.
JADE ROOM
A SPECIAL EVENING
"LOOK WHAT THEY'VE DONE TO MY SONG, MA!"**

**SESSION J
MAGNETIC RECORDING
WEDNESDAY, SEPT. 12, 9:30 A.M.
JADE ROOM**

J-1	Optimizing Tape Transport Motion Control Using Operational-Amplifier Analog Signal Processing
J-2	The Wear Rate Of Different Heads With Iron Oxide Versus Chromium Dioxide Tapes
J-3	Development Of An Advanced Gamma-Ferric Oxide Cassette Tape Coating
J-4	AC Bias Recording Theory

Continued on page 55



“Meet our new Recorder/Reproducer. You’ll call it fantastic. We call it the 280-B”

What’s so great about it? First off, it’s really up to the state-of-the-art. In electronics, control logic and architecture. Everything’s changed but the transport. (Why mess with that? It’s field proven.)

Here’s what you get:

S/N ratios at a consistent 72 dB at mastering speeds on full track, .25 inch tapes. Improved headroom and increased record level for maximum signal utilizing high output tapes.

Band widths are just about flat at ± 2 dB, 30 Hz to 18 KHz. Tape handling is incredible. Our new motion sensing system (OPTAC™) gets rid of deck top sensor mechanisms. Internal logic lets you select a new mode and activate it without having to hit the STOP button. And enter and leave RECORD while the transport’s in PLAY.

Maintenance is a snap, too. We got rid of all the spaghetti and replaced it with plug in IC’s. And TTL logic for high reliability and low power consumption. Test and adjustments are made without bending all over the place. Individual channel modules come out easily. And all electronics are in slide out drawers.

Oh yes. Selectable synchronization with extended response. Standard on 2 and 4 channel machines.

You can get all the specs (or a machine) by writing or phoning (415) 968-8389 TLX 345524 475 Ellis Street, Mountain View, California 94040

► **Scully/Metrotech**
Recording Divisions of Dictaphone

Scully and OPTAC are trade marks of Dictaphone Corporation. Rye, New York.

CREATIVE MIXING FOR BETTER DISC MASTERING

*KULKA, McLOED, MALO

"The record would have been a smash hit . . . maybe even record of the year . . . IF . . . it had only sounded as good as the master tape."

Every time this sad and painful commentary is heard there is always the obvious implication that the producer's and/or the engineer's great work was somehow sabotaged in the transfer process from magnetic tape to disc. While the statement that "the record did not sound as good as the tape" may indeed be an accurate description of the result of the transfer to disc, the responsibility for whatever was lacking is not necessarily that of the mastering engineer. Indeed, the mastering engineer very often has the heartbreaking assignment of attempting to make an outstanding record from a master tape containing many audio components which rather than enhancing the probability of making a good disc transfer . . . inhibit it. Thus, many of the problems leading to the complaints may very well have their origins back in the recording studio; both before the first inch of tape passes over the record head, as well as through the whole studio process of set-up, record, mix and re-mix.

What follows, as a guide, is a discussion of several of the basic recording problems as they relate ultimately to disc mastering . . . their causes . . . and perhaps a few cures.

Problem Area:

LEVELS AND CHANNEL BALANCE

Typical Complaint:
THE LEFT SIDE IS TOO LOUD; THE RIGHT SIDE IS TOO SOFT; OR THE LEVEL IS TOO LOW!

In the days of mono discs it was relatively easy to tell what level and mix the mastering customer wanted, or had on the master tape. Now, in the stereo age in which we live, unless there are some fairly rigid guides and instructions the mastering engineer might easily be left to *second-guess* what the client had in mind when the master tape was recorded. Perhaps the last thing in the world the mastering engineer wants to have to do when he is cutting a disc is *second-guess* his client.

POSSIBLE SOLUTION:

The most positive way to *lock-in* the producer/engineer channel balance judge-

ment, and remove any subjectivity at the disc mastering stage, begins with a precise tape recorder alignment procedure in the recording studio.

Prior to making the master tape it ought to be mandatory practice to align the machine on which the master tape is going to be recorded (or mixed down on) by using a high quality standard alignment tape. After having adjusted the playback levels, the tape machine can be calibrated to record so that the VU meters on the console read the same as those on the tape machine being used.

Most importantly, then, a set of three test tones; 1 kHz, 10 kHz, 100 Hz, preferably in that order, ought to be recorded at the beginning of the master tape.

1 kHz:

When the mastering engineer receives the master tape the 1 kHz tone will indicate the recording level, and tell him the exact channel balance as determined by the engineer and producer.

With or without this balancing tone the mastering engineer will almost always do his best to make the left and right sides equally loud, and he will almost certainly try to adjust the vocalist (if there is one) to be in the *phantom center* . . . if that is where the engineer/producer put that signal. However there are clients who want the soloists or certain instruments just off center, on one side or the other. To further insure that these signals appear where the engineer/producer wanted them, it is an excellent idea to make such a notation on the tape box, ie: "intend to have vocalist (or drums, etc.) left of center."

10 kHz:

The 10 kHz tone is used to confirm that the playback azimuth of both the playback machine and the studio recorder are the same, as well as to correct the mastering reproducer's high frequency equalization to match that of the studio recorder.

100 Hz:

The 100 Hz tone is used to confirm the low-frequency EQ setting of the playback machine.

Using these suggestions in preparing the master tape should eliminate a good many of the channel balance and level

problems that have been known to occur.

Problem Area:

TOO WIDE A DYNAMIC RANGE

Typical Complaint:

THE RECORD IS NOISY!

In illustrating this problem consider the typical case of a master tape of the recording of a large orchestra with a massed choir and soloists.

The conductor insisted upon the proper dynamics for the program so that the solo vocalists would be in the power ratio versus the fully massed orchestra and choir. Consequently, after the recording engineer had set the microphones in the auditorium, the conductor had the loudest passages (FFF) played. The engineer then set his levels for '0' on the VU meters. In doing this, we can only surmise, that the engineer had forgotten that whereas the orchestra-choir has a dynamic range of more than 90 dB, the tape machines have a typical signal to noise ratio of only 50 to 60 dB. The result in this case was that the pianissimo passages were actually recorded **BELOW** the noise of the tape!

Since only about 10 to 15% of the average classical performance is in the fortissimo range, and the balance is in the mezzo-forte or piano-pianissimo ranges, the majority of the performance may be "noisy" on the tape.

POSSIBLE SOLUTION "A":

With distant miking techniques, particularly in reverberant halls, this problem is at its worst. Moving the mics in closer, or using additional mics to highlight soloists, will reduce the dynamic range to a workable level.

POSSIBLE SOLUTION "B":

The recording engineer would have to explain to the conductor (and very possibly to the producer too) that the maximum dynamic range of a commercial phonograph record is in the order of 60 dB. Therefore, some softening of fortissimo passages would be desirable. This, of course, would allow a higher recording level, and the pianissimo passages will then fall above the noise level.

Obviously a record made in this manner will be much less noisy.

POSSIBLE SOLUTION "C":

Use a noise reduction system such as

* **EDITOR'S NOTE:** This article, rather than being the judgement of a single author on this critical subject, reflects the views of three highly regarded individuals in the recording industry.

LEO deGAR KULKA is the owner of Golden State Recorders in San Francisco, as well as a lecturer on the Audio Arts at The California State University at San Francisco.

BOB McLOED is the owner of Artisan Recording in Hollywood, a leading custom disc mastering laboratory.

RON MALO is an independent recording engineer/mixer/producer, whose business is also conducted under the name 'Total Concept Sound.' Ron is also a consulting engineering editor for R-e/p.



If you're seriously into music or sound reinforcement you want more than hi-fi products can give you. But full professional studio gear costs an arm and a leg, and you pay for a lot of things you may not really need.

You pay for what you need up to four additional input modules and other optional accessories including talkback, remote transport control, quad panner, and headphone monitor.

That's why there's a TASCAM Model 10. It's an 8-in, 4-out mixing console, and it's just \$1890.

With the Model 10 you get what you have to have. Without sacrificing a single necessary function.

Each input module gives you mic and line attenuation, three bands of peak and dip equalization (two with frequency selection), pre- and post-echo send and receive circuitry, pan function, and a unique straight-line fader.

Each of the four submasters has a meter control switch (line/echo), independent monitor level control, echo receive level control, and a straight-line fader. You also get a master gain module and 4" VU meters with LED peak indicators. Plus pre-wired facilities for

That's what you need and that's what you pay for. Some things, however, you may or may not need, and we leave that choice up to you. For instance, the basic Model 10 is high impedance in and out, but studio line impedances are available optionally. You'll probably want low impedance mic inputs, but you may not need all low impedance line inputs. So we don't make you pay for them. You can order any combination of high and low input/output impedances according to your application.

Details and specs on the Model 10 are available for the asking. At the same time we'll tell you about our new Series 70 Recorder/reproducers.

We've got what you need.

 **TASCAM CORPORATION**
 5440 McConnell Avenue
 Los Angeles, California 90066

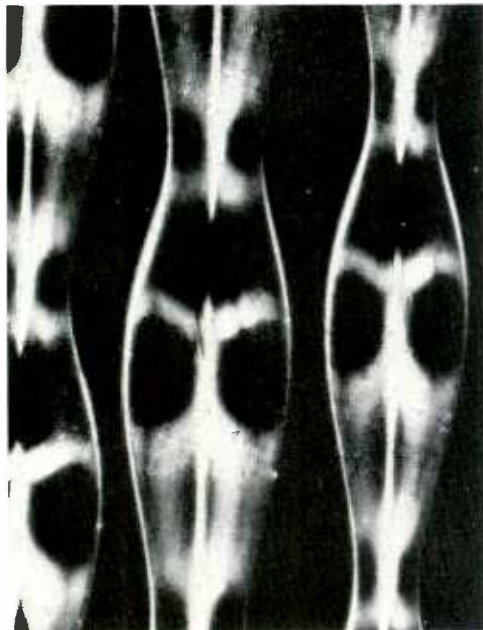
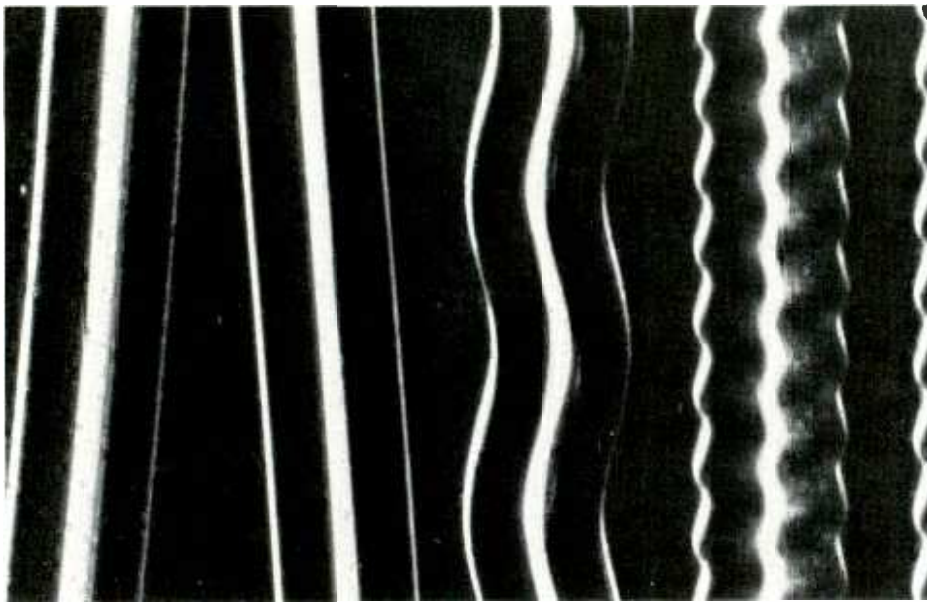

↑
TONES (From Left to Right): First two grooves, **LOW FREQUENCY** (Complete wavelength is too long to show in a single photograph). Third groove, **MID-FREQUENCY**. Fourth groove, **HIGH FREQUENCY**.

EXAMPLES OF GROOVE CONFIGURATIONS CREATED BY TONES AND ACTUAL PROGRAM MATERIAL

↑
↑ TONE: VERTICAL MODULATION (out-of-phase).

TONES (From Left to Right): First groove, **LEFT CHANNEL ONLY**. Second groove, **BOTH CHANNELS (center)**. Third groove, **RIGHT CHANNEL ONLY**.

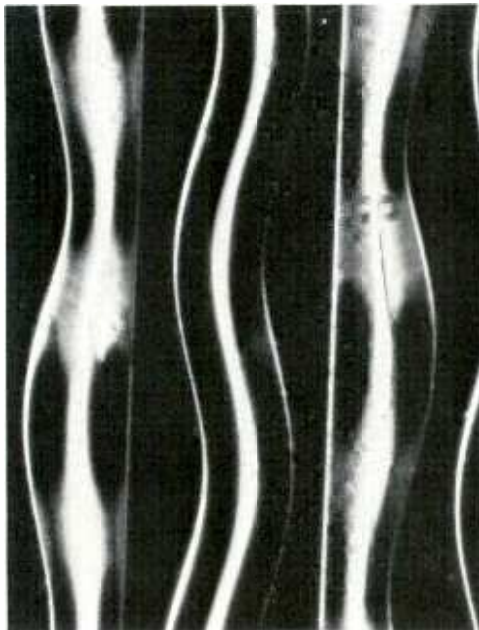

DOLBY or DBX, keeping in mind, however, that noise reduction does not reduce dynamic range. Too wide a dynamic range may still pose problems to the mastering engineer, as described above.

ANOTHER PROBLEM AREA:

Another problem relating to dynamic range is apparent level on the disc. In most popular or rock recordings, the level is rather constant (loud!) from the beginning to the end. But often the music builds from a relatively quiet introduction to a crashing close. At commonly used studio monitoring levels, the music comes through in all its stunning glory. But, when played back at levels suitable for home reproduction, these dynamics don't work. Therefore if the maximum level (whatever it may be) is set for the closing passages, the introduction then becomes too low.

The only real solution to this problem (besides monitoring at realistic levels) is to reduce the intensity of the climax. Use the *intensity* to create the build up, and not the actual recorded level (as observed on the meters). A good check is to rewind the tape immediately after having listened to the ending, and at the same monitoring level, see if the beginning is still in proper perspective.

There are other reasons for noisy records. Although acetate masters are incredibly quiet, noise can be introduced at the plating stage, which the test pressing will quickly reveal. This can be in the form of ticks and pops, hiss, or low frequency rumble (which is often incorrectly blamed on mastering.) In most circumstances the plate maker will be happy to re-do the work, as he too desires a quiet groove.

Then, too, as elemental as it seems, there are reported instances of clients who have actually taken their acetate masters and played them before sending them on to the platers. The disastrous noise or loss of high-end which results when the pressings are made from these masters is quite predictable. Needless to say, **ACETATE MASTERS TO BE USED FOR PLATING SHOULD NEVER BE PLAYED.**

Problem Area:
HIGH FREQUENCIES

Complaint:
MY RECORD DOES NOT HAVE THE BRILLIANCE THAT MY MASTER TAPE HAD

As a general rule if the head azimuth and high frequency equalization of the tape machines used were properly aligned a disc should then turn out to be equally as brilliant as the master tape from which it was made; *unless* situations occurred in the recording studio which made it impossible to achieve a brilliant high end on the disc.

A couple of examples may serve to illustrate the point. Consider the typical case of a tape of a jazz oriented group or orchestra. The muted trumpets were recorded at maximum recording level. The absence of a bright high-end horn

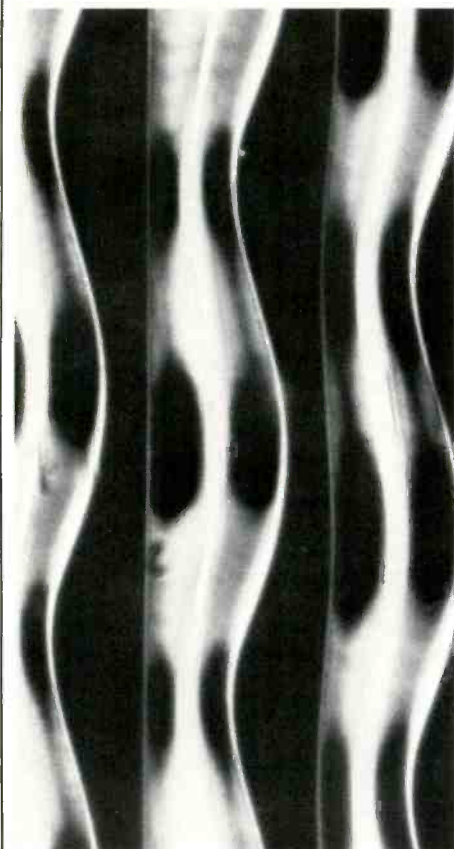

TONES (From Left to Right): Second groove, **RIGHT CHANNEL ONLY**. Third groove, **CHANNEL SEPARATION REDUCED** to create a more lateral groove. Note that the left edge of the groove is curved slightly.



PROGRAM MATERIAL: HIGH LEVEL, very difficult to track.

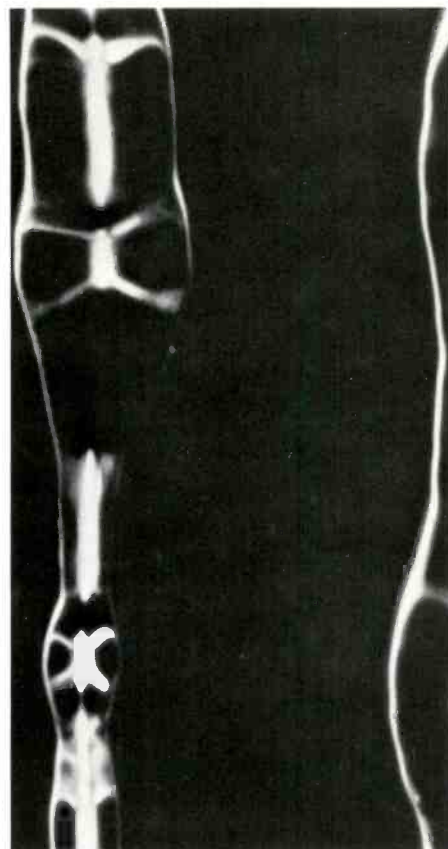

PROGRAM MATERIAL: HEAVY VERTICAL MODULATION created by an out-of-phase signal. This could cause skipping on inexpensive phonographs, and must be corrected in mixing.

sound on the disc disappointed both the producer and the engineer.

In an analysis of this sort of thing, it would seem, that when the passage was recorded it was obviously not understood that muted horns possess overtones which go well beyond the range of human hearing, and that the transient component of the sound is actually at a much higher level than the VU meters will indicate. Had there been this understanding, it would have been recognized that high frequencies recorded at '0' level are almost impossible to cut on a disc without blowing the overload breakers which keep the cutting amplifier from burning up the coils of the cutter. The result: The mastering engineer either has to roll-off the high frequency response at around 10 kHz to be able to cut the disc, or use an appropriate low-pass filter, or a treble (HF) limiter to be able to cut the disc. The use of high frequency roll-off and/or a low-pass filter has the obvious disadvantage of reducing all of the high frequency information contained in the passage. The advantage of using the treble limiter, at this stage, is that it will only operate on the problem when it occurs, thereby leaving the remainder of the program with the original high-end balance.

Another illustrative situation is one which might involve a tamborine recorded *plenty hot*. True, with helium cooling, the cutter head is fully capable of cutting the sudden attack of high frequencies attendant to the sound which instruments like the tamborine deliver . . . but, no playback stylus can trace these velocities without complete break-up.

POSSIBLE SOLUTION:

It should be understood that the VU meter is not a reliable indicator of the level of high frequency, short duration, program material. The engineer should be aware of this deficiency in VU monitoring, and make appropriate compensation to record this kind of material at a lower indicated level. The ear is generally a considerably more accurate indicator of the relative loudness of high frequency transients. Actual recorded level could be better determined by using a peak reading meter, or an oscilloscope.

Another problem area (and probably the worst), is excessive sibilance on "S" sounds. The best place to correct this is at the microphone, but if the problem still persists at the mixing stage, it is advisable to roll off the highs on the vocal mic. Otherwise, the mastering engineer may have to roll the highs off the

entire mix, instruments and all.

Problem Area:

LOW-END, BASS FREQUENCIES

Typical Complaint:

WHY DOESN'T THE RECORD HAVE AS MUCH BASS ON IT AS MY MASTER TAPE?

Typically this kind of situation is, perhaps, due to the actions of the mastering engineer being forced to reduce excessive amounts of extreme low, low bass (i.e.: below the 100 Hz region recorded on the master tape.) The reason for doing this at the mastering state, it should be understood, is that playing time and level are directly related. The low, low frequencies physically require a greater lateral (side to side) excursion of the stylus to cut the groove, thereby consuming more space on the surface of the disc. Obviously wider grooves reduce the total playing time available per record side. To safely transfer low frequency material to the record at a standard disc recording level without using excessive space on the disc it is necessary for the mastering engineer to use low frequency roll-off to reduce the low frequency information, especially in this region below 100 Hz.

In making this correction it might only have been necessary to deal with just an individual instrument; say, a bass guitar or the bass drum. But, in making the correction in this overall way at the mastering stage it follows that the low frequency content of the entire recording is affected. The low, low bass region, although largely inaudible in and of itself, importantly lends a great deal of *feel* to the record. Surely, all of the low, low bass shouldn't be eliminated from a well balanced record. Thus, it would seem to be a better solution to have corrected only the sound of the problem instruments during the original recording.

POSSIBLE SOLUTION:

The apparent sound emanating from bass instruments is predominantly that of the overtones or harmonics. These audio components are the ones which ought to be emphasized in the recording of bass instruments.

Generally speaking, equalizing below 60 Hz does little more than to increase the level of the fundamental frequency. As a general rule, it would probably be better to reduce the response at 60 Hz and then equalize in the 200 to 1.5 kHz region. The result would be an increase in apparent loudness, along with better definition of the bass instruments. What this does, essentially, is to reduce the fundamental, and thus the wide lateral cutter excursion on the disc; thereby eliminating the need for the mastering engineer to either reduce the level, or use the roll-off technique.

Problem Area & Complaint:

PLAYBACK TRACKING DIFFICULTIES DUE TO EXCESSIVE VERTICAL EXCURSION!

If a mixer inadvertently allows low frequency audio components to be recorded out-of-phase, this condition will cause excessive vertical excursions of the cutting stylus at the disc mastering stage. Obviously, excessive vertical excursions make playback of the disc either difficult or, in extreme cases, impossible. As was noticed previously this condition is extremely critical in the low frequency region because of the already wide excursions that even in-phase low frequencies produce.

To reduce the severity of this problem the mastering engineer must use a low frequency cross-over device which essentially transforms all frequencies below a selected point (approximately 150 Hz) into monophonic signals. This generally does not present any great aesthetic listening problems in that bass sounds are non-directional anyway.

SOLUTION:

Rather than to rely on the crossover technique at the mastering stage it is probably better practice for the mixer to use some method of monitoring phase relationship of the channels during recording (oscilloscope or phase meter.) Such monitoring would insure immediate correction of phase relationships during the original recording.

ANOTHER PROBLEM AREA:

Another problem which can occur with

regard to playback tracking and skipping is commonly caused by the transients of percussion instruments. The steep wavefront of a bongo drum, for example, can look like a brick-wall to a playback stylus. That is, the groove will make an almost 90° change in direction.

The newest and most sophisticated disc cutters are indeed quite capable of transferring these steep wavefronts to the disc, but . . . even the newest playback cartridges have difficulty in reproducing (tracking) this almost perpendicular change of groove direction; it is almost a mechanical impossibility for a playback stylus to accept such an abrupt course deviation.

POSSIBLE SOLUTION:

This phenomena can be partially alleviated by judicious microphone placement. Both an increase in microphone to instrument distance, or placement of the microphone off center axis (even as much as 45°) can be of great help. The effect of doing this is to minimize the direct transient impact on the microphone diaphragm. The reasoning behind this is that the initial transient is of a much greater magnitude than the total musical sound of the note. Reducing this steep wavefront eliminates the problem.

Judicious use a limiter will also help.

Continued on page 47

SPEED AND QUALITY

The new GARNER table-top Model 1056, a heavy-duty, precision reel-to-reel copier, makes five quality copies from the master reel. Ideal for mass production of professional quality tapes by commercial or institutional organizations.

A single capstan drives master and all copies. New two-speed drive allows slower speed for higher fidelity. Solid state electronics, special heads and mechanical excellence, provide good frequency response. Extra-fast rewinds of master tape speeds production.



Model 1056 High Speed Professional Tape Copier



Rep. territories available.
Call 402/466-1816

GARNER ELECTRONICS

A SUBSIDIARY OF GARNER TOOL & DIE

4200 N. 48th Street

Lincoln, Nebraska 68504

At last, a studio mastering tape that's better than the one everybody's been using.

A while ago, someone came along with a new tape that, admittedly, was a better mousetrap. But it was not the ultimate mousetrap.

There were problems with that tape, good as it was. Problems which we at Audio Devices have been able to solve.

First problem:

How do you get even more energy out of each particle?

Solution:

By improving the dispersion.

Poorly dispersed particles clump

together causing magnetic losses due to interaction and energy cancellations.

The new Audiotape HOLN has higher output and lower noise than the tape you switched to years ago. The new Audio tape iron-oxide particles deliver more energy.

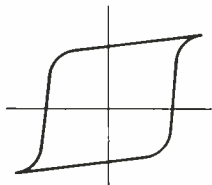

Hysteresis loop of Audiotape HOLN.

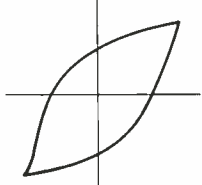

Hysteresis loop of poorly dispersed tape.

Second problem:

How do you reduce print-through?

Solution:

Uniform particle size and dispersion are part of the solution.



Audio's secret processes are the other part. The results aren't secret, though: Audiotape HOLN has reduced print through by at least 2 dB, and typically 3 dB over the tape you switched to a few years ago.

Third problem:

How do you reduce headwear?

Solution:

Use a smooth coating surface with a built-in permanent lubricant. That'll reduce your headwear.

Fourth problem:

How do you improve handling and storage reliability?

Solution:

Use a backcoating that's super-durable. Cushion-Aire™ backcoating, with its controlled surface texture, improves high-speed handling and winding, and eliminates the causes of cinching, spoking, and other pack deformities.

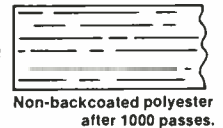

Non-backcoated polyester after 1000 passes.



Cushion-Aire backcoating after 1000 passes.

Another problem is maintaining consistency of product. We've solved that too. By having a superior degree of quality control.

For a complete discussion of the improvements Audiotape features over the leading backcoated tape, send for our detailed literature.

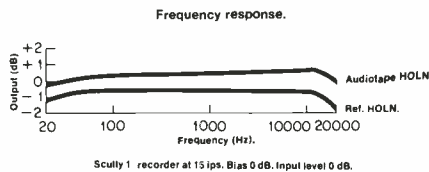
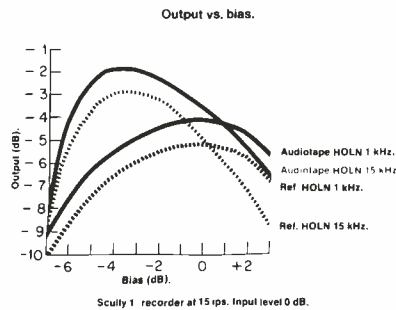

audiotape™

Audio Devices, Inc., A Capitol Industries Company, 100 Research Drive, Glenbrook, Conn. 06906

A MODIFIED EDITING FUNCTION FOR THE SCULLY 280/284 SERIES DECK

by PETER BUTT, Chief Engineer
SUPERSCOPE RECORDED TAPES

Greetings, Scully owners and users across North America and throughout the Occident. Have you, or those you know, been plagued with short tempers, aching wrists, and sliced fingers as a direct result of long hours at the old editing transport, fighting those very-effective Scully disc brakes, seeking the proper splice points for that all-important master tape? In short, have you or those you know, ever wished your Scully has that dual-function edit/cue feature much-loved and cherished among Ampex AG-440 users? (Some Ampex users don't even realize those edit goodies are there. Shape-up, Ampex users!)

Of course, we all have, from time to time. I have, at the very least. In fact, the frustrations resulting directly from the complications of repeated threading, editing and leadering of tapes on Scully's of

my acquaintance has led to the suppression of my best leave-well-enough-alone instincts and to the development of the modification procedure which I now present to the world at large.

The requirement for this editing modification came about during my association with Mattel, Inc. The nature of master tape production in connection with Mattel's "talking toy" line, (edits to one-hundredth of a second, etc.) made freedom of reel movement imperative for their editing application. Also, we wanted to take advantage of the excellent Scully recording characteristics that don't seem to be available in other machines of that price range. A lot of you folks who don't get involved in that sort of tight-editing non-sense can flip the page and go on to bigger and better things. After all what can you expect

**PETE BUTT will write next on 'MASTERING FOR TAPE DUPLICATION' in the September/October issue of R-e/p.*

One of a series of brief discussions
by Electro-Voice engineers



Creating truly fundamental bass with an acoustic suspension speaker system is often an exercise in frustration. It requires substantial power, plus a speaker that can move extreme distances without distortion. And as the woofer cone area is reduced the problem becomes more and more acute.

Luckily the typical distribution of energy in the lowest octaves for most music is usually modest, so that speakers are called upon to produce deep bass much less often than commonly supposed, even when reproducing organ and orchestral music. Nevertheless, the capability to accurately reproduce the lowest octaves is one greatly sought after and highly prized.

A re-examination of audio basics, primarily inspired by research by A. N. Thiele, has led E-V to develop new speakers based not on the ubiquitous sealed box concept, but rather on a sophisticated analysis of the vented enclosure. The first new system using this basic approach is the Interface: A. Unlike small sealed systems, the woofer excursion for this system actually diminishes as the system approaches resonance, thus permitting an extension of low frequency response without major penalties in efficiency or increased size.

To achieve the low frequency limit of 32 Hz (3 dB down point) from this 6th Order Butterworth-tuned system, research results suggested the use of an 8-inch woofer, matched to the enclosure volume with the equivalent of a 10-inch diameter, 20-foot long vent. But examination of the system reveals neither vent nor duct! Instead a vent-substitute is employed. This takes the form of a 12-inch cone assembly that is controlled in mass and compliance to be the mechanical analogue of the desired acoustic vent system. It has no voice coil or magnet but moves solely in response to the motion of the 8-inch woofer. It is fascinating to watch the 12-inch vent-substitute moving vigorously at 32 Hz in response to the woofer whose motion is barely detectable!

In combination with an active equalizer that adds a modest 6 dB boost at 35 Hz, Interface: A extends low frequency response well below that of a sealed system of equivalent size and efficiency, yet without increasing woofer excursion.

The same principles of vented system design have also been applied by Ray Newman, E-V Senior Product Engineer, in creating the new Sentry III monitor system. In this instance, high efficiency for studio use was a major design goal, and it is achieved with a larger enclosure, a 15-inch woofer and a "real" vent. The result is a system capable of low frequency performance uncommon in past high level monitor systems.

For reprints of other discussions in this series,
or technical data on any E-V product, write:
ELECTRO-VOICE, INC., Dept. 833RP
674 Cecil St., Buchanan, Michigan 49107



**PHONE
TODAY
FOR MORE
INFORMATION**

CALIFORNIA, NO.
(415) 937-1482
CALIFORNIA, SO.
(213) 559-2591
COLORADO
(303) 934-2123
CONNECTICUT
(203) 322-9202
FLORIDA
(305) 754-5475
GEORGIA
(404) 458-3616
(404) 451-3471
ILLINOIS
(312) 685-2338
IOWA
(712) 243-1626
KANSAS
(913) 648-5191
MARYLAND
(301) 622-0300
MASSACHUSETTS
(617) 873-8550
MICHIGAN
(313) 547-4771
MINNESOTA
(612) 926-3861
MISSOURI
(314) 428-0300
NEW YORK, METRO.
(212) 585-2027
NEW YORK, UPSTATE
(315) 437-2992
OHIO
(216) 333-9955
OREGON
(503) 292-9145
TEXAS
(713) 772-0961
WASHINGTON
(206) 284-1121
PUERTO RICO
(809) 765-4021

AKG 38

For your microphone requirements turn to AKG—the first choice of professional in recording, radio and TV broadcasting, sound reinforcement and entertainment.

Studio Condenser Systems
FET Condenser Systems
Directional Dynamics
Omni-directional Dynamics
Lavalier
Noise Cancelling Dynamics
Shotgun Dynamics
Dynamic Headphones



AKG MICROPHONES • HEADPHONES

DISTRIBUTED BY
NORTH AMERICAN PHILIPS CORPORATION
100 EAST 42nd STREET, NEW YORK, NEW YORK 10017

AKG WEST COAST REPRESENTATIVE: (213) 655-4433 NEW YORK OFFICE: (212) 697-3600

www.americanradiohistory.com

Re/p 42

Circle No. 127

from someone who worked in a toy factory?

Before I get into the mechanics of the modification itself, I think it is fitting and proper that a few words be expended in definition, description, and applicability of the procedure and the inclusion of a precaution or two.

First, let us turn our attention to the normal behavior of the ubiquitous Ampex AG-440. As most of us know, the reel motor brakes on the Ampex can be released at will by simply depressing the EDIT button, provided the tape-break arm is actuated. The result is that the supply and take-up reel turntables can

then be turned freely without interference from the reel brake mechanisms. Tape threading and manual cueing or splice-point determination require much less effort than if attempted in the normal STOP mode. Depression of the STOP button returns the deck to its normal STOP mode and the brakes are re-applied. We shall, for convenience, refer to the preceding operating mode as the CUE mode. The second Ampex EDIT function may be described thusly: If a normal PLAY mode is initiated, by depressing the PLAY button, with the tape properly threaded, and the EDIT button is then depressed, the take-up reel brake will be applied and the tape will spill from the tape drive capstan and pinch roller. Depression of the STOP button restores the deck to its normal STOP mode with both brakes applied. Let's refer to this second EDIT function as the SPILL mode. The Play or Spill modes may not be initiated directly from the cue mode.

As most of us also already know, the Scully 280 and 284 series decks, with and without motion sensing, also have an EDIT mode. And as you may already have guessed, the Scully EDIT mode differs somewhat from the Ampex EDIT mode. It does so in that only the SPILL mode is normally available on the Scully as supplied from the factory. The newer Scully model 280-B deck retains the same EDIT feature as its predecessors. It is important to state that this modification procedure is applicable only to the older Scullys and cannot be used on the new 280B because the 280B deck control logic differs substantially from that of the earlier models. The Scully SPILL mode differs slightly from the Ampex SPILL mode in that it can be initiated from either PLAY or STOP modes.

It also should be added that this modification has been successfully performed on Scully decks having the motion sensing option as well as on those without. It has also been applied to the 280-4 1/2-inch and to the 284 1-inch machines without unseemly incident. I must caution, however, that strict attention be paid to the soldering and insulating operations as the relay socket terminals are situated rather close together. A stray bead of solder or a scorched wire may cause all manner of unhappiness.

The name of our game, then, is to have the best of both EDIT modes embodied in a single Scully deck. Toward that end, let us prepare the way by gathering together a few simple materials with which to render all of these things a reality. We shall need four or five feet of number 20 or 22 wire, two 1N4003 (or similar) diodes, and a foot or so of heat-shrink or other kind of 1/8" diameter insulating tubing. Of course, the normal hand tools, soldering iron and solder will also be required.

Without further delay, let us embark upon this much-heralded procedural adventure.

- 1) Disconnect the AC power cord and remove screen from the relay control chassis.

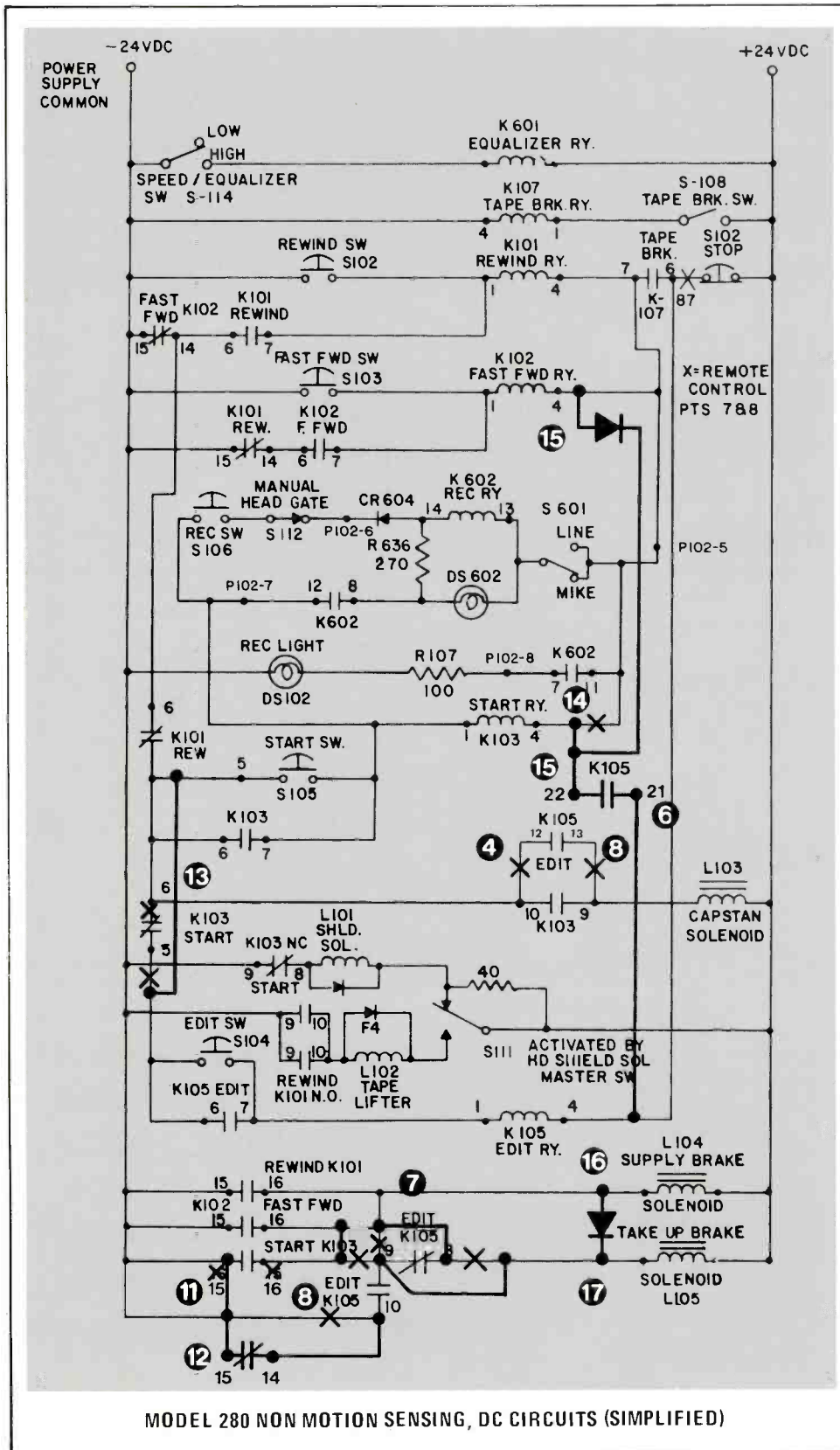

Nothing is beyond your reach with Beyer mike stands and booms.



As one of the world's leading manufacturers of quality microphones, Beyer believes that a microphone is only as good as its stand.

After all, it doesn't make much sense to spend hundreds of dollars on a microphone only to find you can't put it exactly where it's needed.

That's why we've designed a line of booms and stands that enable you to place a mike almost anywhere. From ground level to 13½ feet above the studio floor.

These very rugged, beautifully finished stands and booms combine rock-like stability with maximum flexibility. And at a price you can afford.

Why make do when you can make good with Beyer?

Beyer mike stands and booms from \$14 to \$88.

Another innovation from Beyer Dynamic, the microphone people

**Revox Corporation
155 Michael Drive
Syosset, N. Y. 11791**

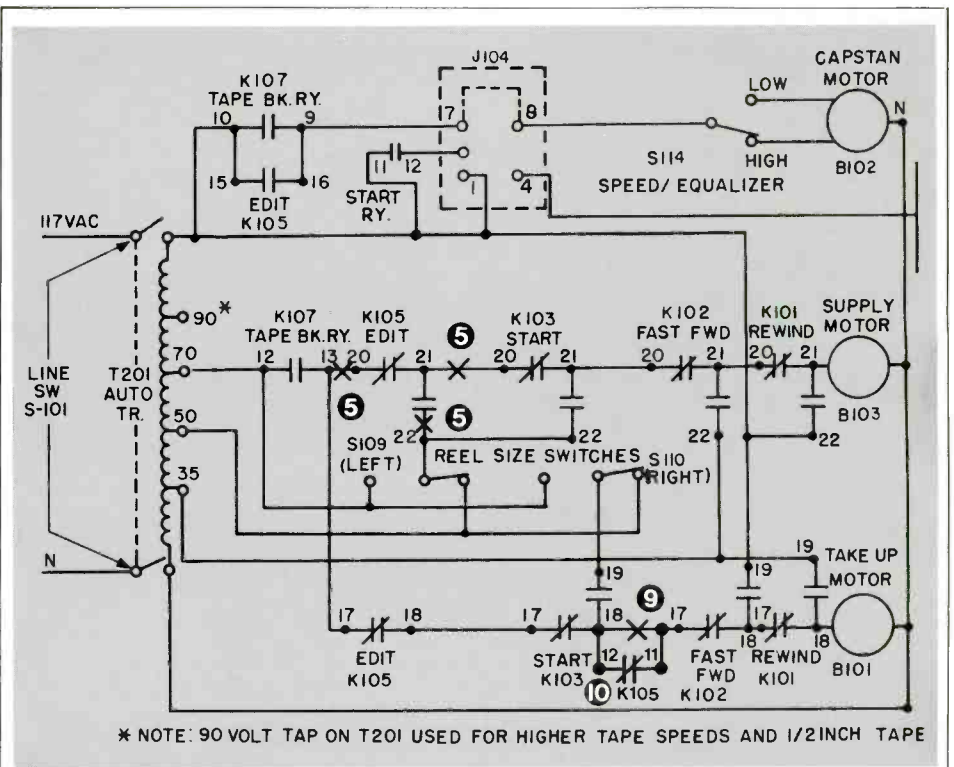

MODEL 280 NON MOTION SENSING, AC CIRCUITS (SIMPLIFIED)

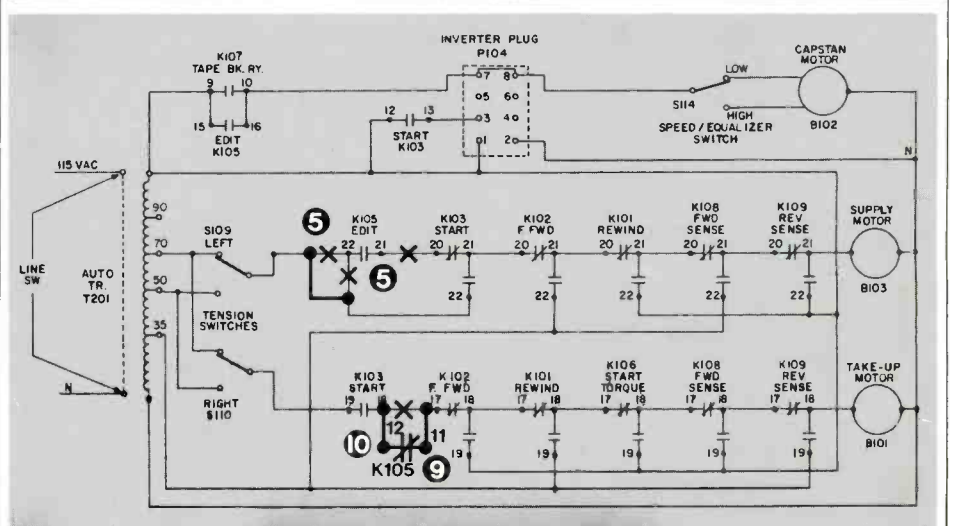

MODEL 280 WITH MOTION SENSING, AC CIRCUITS (SIMPLIFIED)

Presenting The

VARI-BAND SWEEP EQUALIZER!

Equalization any way the ear can hear it.

Continuously variable bandcenter, bandwidth (slope) and amplitude at a price comparable to non-sweeping equalizers.

MULTI-TRACK

P. O. Box 3187, Hollywood, CA 90028
1965 Cheremoya Ave., Hollywood, CA 90068
(213) 467-7890

Circle No. 128

	22	12	13
BOTTOM VIEW OF	20	21	11
SCULLY RELAY	19	9	10
SOCKET TERMINAL	17	18	8
NUMBERING	16	6	7
SYSTEM	14	15	5
	—	—	—
2 and 3 MISSING	4	3	2
ON MOST MODELS			1

- 2) Locate the EDIT relay (K105), start relay (K103), and CAPSTAN SOLENOID HOLD relay (K110).
- 3) (This step applies to motion sense machines only. Go on to step 4 in the case of non-motion sense machines). Locate the CAPSTAN SOLENOID HOLD relay, K110. Remove the 2 violet wires from K110 pin 17 and K110 pin 18. Connect the 2 violet wires together and insulate. This permits activation of edit relay when capstan solenoid is activated.
- 4) Remove the 2 white/green wires from K105 pin 12. Leave the two connected together and insulate.
- 5) Remove the 2 blue (slate on some models) wires from K105 pin 22. Leave the two connected together and insulate. Remove and insulate

the white/slate wire from K105 pin 21. These wires will no longer be used. On non-motion-sense models, remove the wire from K105 pin 20 and insulate.

- 6) Connect a new wire from K105 pin 21 to K105 pin 4. Sleeve-insulate the wire at pin 21.
- 7) Remove white/violet wire from K105 pin 8. Remove the white/blue wire from K105 pin 9 and connect it to K105 pin 8. Connect the white/violet wire removed from K105 pin 8 and connect it to K105 pin 9. This step and steps 9, 11, 15, 16 and 17 permit selective operation of the brake solenoids.
- 8) Remove the 2 black wires from K105 pin 10. Leave the 2 black wires connected together and insulate. Remove the 2 black wires from K105 pin 13. Leave the 2 black wires connected together and insulate.
- 9) Locate START relay K103. Remove the white/brown wire from K103 pin 18. Connect the white/brown wire and the available lead of the transient suppression network to K105 pin 11. Sleeve insulate both ends.
- 10) Connect a new wire from K105 pin 12 to K103 pin 18. Sleeve insulate both ends.

so long, SPLATTER! bye-bye, BREAKUP!

If you're into TV audio, FM, or mastering for prerecorded 'carts and cassettes, you're well aware of the problems in coping with today's wide range program material.



Not just another DE-ESSer, or "equalized" limiter, the Inovonics 210 Frequency Selective / Broadband Peak Limiter provides independent control over both high frequency program energy and broadband peaks.

For more information, write:

INOVONICS (408)
INCORPORATED 374-8300
1630 Dell Ave., Campbell, CA 95008

Circle No. 130

versatile and compact
easy-to-use,
consider the reverberating
things you can do.

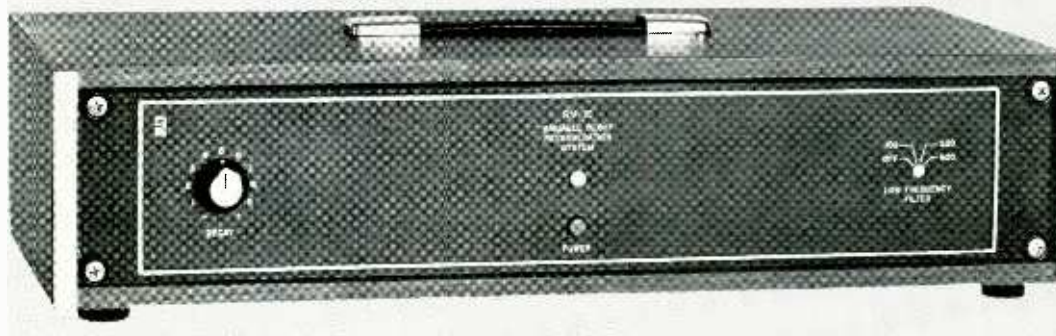

RV-10

a small number for a
big system.

quad/eight electronics

11929 Vose Street □ North Hollywood, California 91605 □ 213/764-1516

arm switch is activated.

16) Locate J105, the Supply Reel Torque Motor connector on the left of the chassis. Connect a new wire from the J105 terminal already connected to the ANODE of CR106. CR106 is the existing transient suppression diode for the Supply Reel Brake Solenoid, L104. Run this wire along the front top of the chassis and connect it to the vacant terminal closest to the terminal already having the 0.1 uF capacitor and wire connected to it on J106. J106 is the Take-up Reel Torque Motor connector. These connectors have no terminal number designations, so be careful to select the proper terminals.

17) Sleeve insulate the leads of a diode. Connect the CATHODE of this diode to the J106 terminal already having the other lead of the 0.1 uF capacitor of Step 16 and the wire connected to it. Connect the ANODE of the diode to the terminal having the new wire of Step 16 connected to it.

18) Replace chassis cover screen and re-connect the power cord.

This completes the modification. By way of further explanation in the event trouble may be encountered, I should mention that much of the wiring changes concerning K103 and K105 are mostly for the purpose of re-arranging the relay contacts so that the AC power to the Rewind and Take-up Reel Motors and the brake solenoid DC power could be switched from the movable contacts rather than from the fixed contacts, as originally wired.

If all has gone well, your Scully deck should behave in the following manner: If the deck is in the STOP mode, depression of the EDIT button will cause the supply and Take-up Reel Brakes to be released. This will occur whether or not the tape break arm is actuated. (This differs slightly from the Ampex CUE mode.) If the PLAY button is depressed while in the CUE mode, the SPILL mode will be initiated, applying the brake to

IF YOU OWN TASCAM
(or are planning to buy!)

There now is a limiter built for your TASCAM equipment. For more information turn to **page 25.**

Attending AES?
 For a demonstration see **EMIL Booth 14.**

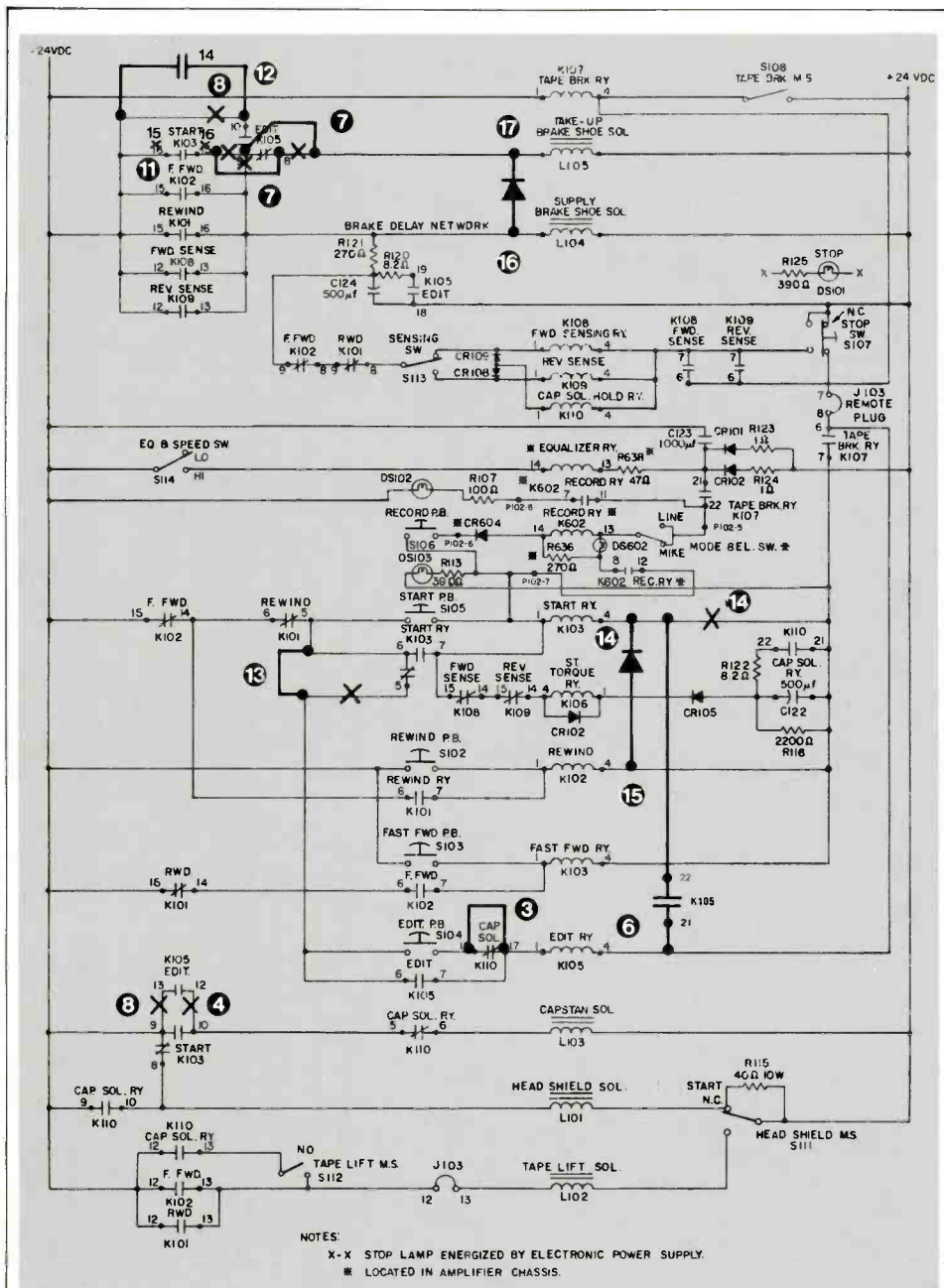

MODEL 280 WITH MOTION SENSING, DC CIRCUITS (SIMPLIFIED)

- 11) Remove the 2 white/blue wires from K103 pin 15. Remove the 2 black wires from K103 pin 16 and re-connect the 2 black wires to K103 pin 15 and sleeve insulate. Re-connect the 2 white/blue wires removed from K103 pin 15 to K103 pin 16 and sleeve insulate.
- 12) Connect a new wire from K103 pin 14 to K105 pin 10. Sleeve insulate both ends.
- 13) Remove the white/violet wire and the white/yellow wire from K103 pin 5. Connect the two wires together and extend the junction to the terminal of the START push-button switch (S105) having 2 white/green wires previously connected to it.
- 14) Remove the 2 white/red wires from K103 pin 4. Connect the 2 white/red wires together and insulate. Leave the transient suppression network, if any, connected to pin 4. Connect a new wire and the CATHODE lead of a diode to K103 pin 4. Sleeve insulate both diode leads.
- 15) Connect the ANODE of the diode of Step 14 to K102 pin 4. Connect the new wire of Step 13 to K105 pin 22. Insulate this end of the wire. This step permits actuation of the start relay without permitting activation of the FAST FORWARD, REWIND, or START TORQUE relays. It is then impossible to put the deck into any of the modes that could result in tape damage unless the tape break

the take-up reel. The capstan motor will run at all times while in either EDIT mode. If the machine is in the PLAY mode, depression of the EDIT mode will also apply the take-up brake and spill tape.

As the FAST FORWARD, REWIND, START TORQUE, FORWARD SENSE, TAPE BREAK, and the REVERSE SENSE relays are not involved in this modification, there is no change in these normal functions. Further, in the case of motion sense machines, it will be impossible to enter either EDIT mode from FAST FORWARD or REWIND. The safety from indiscretions of tape handling afforded by the motion sense option are thus preserved. You folks with non-motion sense machines will just have to continue to watch yourselves as before.

NOW FOR THE BAD PART

Installation of this modification will tend to accentuate a minor problem typical of Scully's having some hours of use on them. That is the stickiness of the brake solenoids. I suggest that, in any event, the brake solenoids be removed periodically and the solenoid slugs be cleaned with a light abrasive to eliminate any burrs or grit that may have accumulated with time. Upon re-installation, the solenoids and their mounting plates should be carefully positioned before tightening to prevent any binding of the slugs as they rest inside the solenoid coils. Well, there you have it, Scully users. A complete, kitchen-tested recipe. In closing, I strongly recommend that no maintenance or modification functions be attempted on the Scully or any other piece of equipment unless it has been completely disconnected from the AC power. The life you save . . .

Continued from Page 39 . . .

**CREATIVE MIXING FOR . . .
BETTER MASTERING.**

CONCLUSION:

A couple of factors are worthy of final comment. Axiomatically, it would seem that the more we hear the phrase, ". . . we can fix that when we get to mastering", the more we are going to hear the lament, ". . . if it had only sounded as good as the tape."

Finally, what should be ultimately understood is that disc playback and disc cutting is an electro-mechanical method of audio reproduction, with the attendant physical limitations inherent in mechanical movement. These limitations are not factors in electro-electronic reproduction from magnetic tape. The limitations of the one system to the other are not great, but they do exist, and properly reckoned with they are not insurmountable problems.



**YOU'RE RIGHT...
IT'S LEFT-HANDED**

PACIFIC RECORDERS DESIGNED THIS LEFT-HANDED RECORDING CONSOLE SPECIALLY FOR RON COMPTON AT FANFARE RECORDING STUDIOS IN SAN DIEGO. PACIFIC RECORDERS IS THE RECORDING EQUIPMENT SUPPLIER... LET US DESIGN A STUDIO TO MEET YOUR REQUIREMENTS...

CALL US, OR WRITE FOR MORE INFORMATION:

PACIFIC RECORDERS AND ENGINEERING CORPORATION
 11760 SORRENTO VALLEY ROAD, SAN DIEGO, CALIFORNIA 92121
 TELEPHONE (714) 453-3255 TELEX 695008

THE TOTAL EQUIPMENT SUPPLIERS!

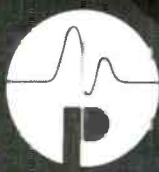

With your great ear, maybe you can get perfect sound sync. But can you really afford it?

Getting sound sync by ear is costing you a lot more than it has to. Because now you can get sound sync that's right on the money, instantly.

By using the SMPTE Edit Code and the new 3M Series 79 Synchronizer.

No more trial-and-error tape positioning, no "rocking and rolling," no time-wasting-tweaking of tape speeds until they sound right.

Just fast and easy sound sync, because with the edit code on your video and audio tapes, you've got split-second, absolute identification of the entire tape length.

For VTR editing, first transfer the sound track and edit code from your master tape (quad or slant track, monochrome or color) to any multitrack 3M Professional Audio Recorder.

Then manually park the tapes to within half a minute of each other using the Synchronizer's built-in edit code reader and start your VTR. The audio recorder automatically slaves to your VTR and locks into perfect sync, with no drift, no knob twisting no matter how long the tapes.

With this kind of precision, you can build a useable sound effects track by using the edit code for effect location. Get a high quality sound track by recording video and the code on your VTR, sound and the same edit code on a separate audio recorder. Build your own 24-track audio recorder by locking an



8-track and a 16-track unit together.

And, of course, your audio recorders should be 3M Series 79 Professional Audio Recorders. Mono through 24-track, they give you precise tape handling, extremely low

wow and flutter and signal-to-noise ratios that are state-of-the-art.

Used together, the 3M Series 79 Synchronizer and Professional Audio Recorders give you the sound quality and split-second accuracy you need for editing, dubbing and sweetening. Faster and at a much lower cost.

And what could be sweeter than that?

Professional Audio Products, 3M Company, 300 South Lewis Road, Camarillo, Calif. 93010. Telephone: (805) 482-1911. TWX: 910-336-1676.



**We've been there.
And brought the answers back.**

3M
COMPANY

Give a listen at any
of these 3M dealers:

Dealers:

- Accurate Sound Corporation
2702 National Circle Road
Garland, Texas 75041
- Aengus Engineering, Inc.
50 Oak Hill Road
Fayville, Mass. 01745
- Audio Designs & Mfg. Inc.
16005 Sturgeon
Roseville, Mich. 48066
- Audio Recorders of Arizona
3830 No. 7th St.
Phoenix, Arizona 85014
- Automated Processes, Inc.
80 Marcus Drive
Melville, N.Y. 11746
- Fidelity Sound Company, Inc.
GSA Dealer
1200 18th St., N.W., Suite 105
Washington, D.C. 20036
- Gill Custom House, Inc.
8813 W. 95th St.
Palos Hills, Illinois 60465
- High Fidelity Showroom
6383 Clayton Road
Clayton, Missouri 63105
- Houston Electronics
5709 Savoy Lane
Houston, Texas 77036
- Jackson Sound Productions, Ltd.
1403 So. Lipan
Denver, Colorado 80223
- Martin Audio
320 W. 46th St.
New York, N.Y. 10036
- The Maze Corporation
1900 First Ave. No.
Irondale, Birmingham, Ala. 35210
- Milam Audio Corp.
700 West Main St.
South Pekin, Ill. 61564
- Pams, Inc.
4141 Office Parkway
Dallas, Texas 75204
- Sound Specialties
2009 Naudain St.
Philadelphia, Pa. 19146
- Westlake Audio, Inc.
6311 Wilshire Blvd.
Los Angeles, Calif. 90048

Sales Offices:

- 3M Company
P.O. Box 76
West Caldwell, New Jersey
- 3M Company
P.O. Box 28158
Dallas, Texas
- 3M Company
220 E. 21st Street
Chicago, Illinois

International Sales Offices:

- Sumitomo 3M Ltd.
3M Building 1-21 Akasaka 7
Chome Minatoku
Tokyo, Japan
- 3M Canada Ltd.
Mincom Products
P.O. Box 5757 Terminal "A"
London, Ontario, Canada
- 3M U.K. Ltd.
3M House
Wigmore Street
London W1A IET England
- Mincom Products, Sales and Service
410 Taunton Road
Greenford, Middlesex, England
- 3M France
135 Boulevard Serurier
75019 Paris, France

NEW PRODUCT NEWS

**NEW HIGH EFFICIENCY 'SENTRY III'
STUDIO MONITOR SYSTEM FROM
ELECTRO-VOICE**

Designed primarily for studio monitoring where high sound pressure level output is necessary, the Sentry III has a walnut-finished furniture type cabinet with attractive black grillcloth making it appropriate also for home use.

The low-frequency section of the new unit is driven by a newly-designed 15 inch woofer installed in a direct-radiator vented enclosure with fourth-order Butterworth response characteristics. Response extends to 40 Hz (28 Hz with optional SEQ electronic equalizer) with sound pressure levels of 113 dB measured at 4' on axis with 50-Watt input. This combination of extended low-frequency response and efficiency has not generally been available in speaker systems used by professionals.

The same midrange and high-frequency sectoral horns as used in E-V's Sentry IVA professional system are incorporated into the cabinet of the Sentry III. These newly designed horns and drivers represent a significant advance in the state of the art, providing remarkably constant dispersion to 120 degrees and uniform total acoustic power output at all frequencies.

The Sentry III employs a tweeter protection circuit which interrupts signal to the tweeter in case of dangerously high input power. Tweeter rolloff (4



position) is provided, which also increases effective power handling capacity. Response is 40 (28 Hz with optional SEQ electronic equalizer) to 18,000 Hz.

Size: 36¼" high, 28½" wide and 20½" deep, including removable pedestal base. The unit weighs 156 pounds.

Suggested Professional Net Price is \$600.00. Sentry III is now available. **ELECTRO-VOICE, INC., 600 CECIL ST. BUCHANAN, MI. 49107**

Circle No. 134

**AUDIO DESIGNS ADM MODEL 560
VUE-SCAN**

Said to solve one of the most troublesome aspects of multi-channel recording - the visual monitoring of the recording channels. ADM's new, exclusive Vue-Scan takes up to 28 channels of audio information and displays each channel as an easy-to-read bar graph on a TV monitor screen, replacing up to 28 VU meters. In addition, it solves the high frequency distortion created by the non-linear load of a standard VU meter.

A 12" or 16" television monitor is divided into 20 or 28 vertical bars. Each

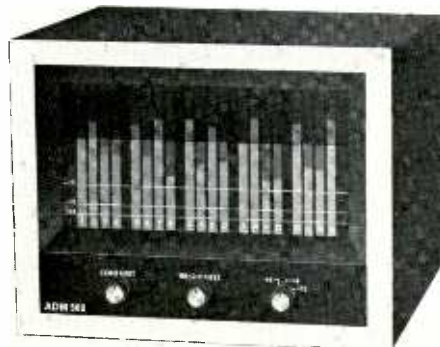

Circle No. 135

illuminated bar represents one analog channel. The vertical bars are always present as a background hue - the lower two-thirds area of the monitor is blue and the upper one-third is red. As the level of a channel increases, the bars representing that channel increase in both height and intensity. Levels in the red area immediately identify channel overload - making it almost impossible to overlook the overloaded channel.

Vue-Scan may be used as either an averaging (VU-ballistics), or peak reading metering system. Selection is by a front panel switch.

The range of Vue-Scan is from -20 to +8 dBm. A range extender is also available, increasing the upper range to +14 dBm (+10 dBm extended range) appear in blue while all levels above appear in red.

The Vue-Scan is standard on all Audio Designs NRC Series Consoles, and is also available as an option on Custom Consoles. In addition, it can be used as an accessory with any ADM or competitive console. Accessory Vue-Scan Models are self-contained.

AUDIO DESIGNS, 16005 STURGEON, ROSEVILLE (DETROIT), MI. 48066.

* memories little helper™



* IS JUST AROUND THE CORNER



AUDITRONICS DUAL ACTIVE PROGRAM EQUALIZER

Known as the model PEQ-82, the two independent equalizers are packaged on a single 1 3/4" x 19" rack mount panel. The equalizers are transformer isolated and operate at levels from -20 dBm to +4 dBm.

Designed for extremely low noise and distortion, circuits operate at unity gain with a maximum output level of +24 dBm. Each equalizer may be silently switched in and out. Controls are infinitely variable with continuous adjustment from -20 dB to +12 dB at each of four frequencies simultaneously. Each control may be switched to operate at either one of two frequencies: 80 Hz or 150 Hz, 300 Hz or 600 Hz, 1.6 kHz or 4 kHz, and 7.5 kHz or 12 kHz.

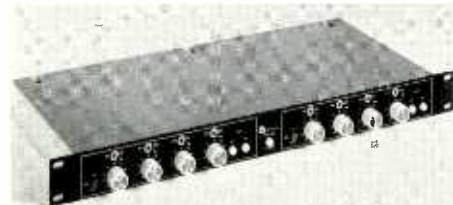

In addition, each channel provides a HI and LO filter with -3 dB points at 80 Hz and 10 kHz.

The unit is covered by a one year warranty and moderately priced at \$325. AUDITRONICS, INC., 180 B SOUTH COOPER, MEMPHIS, TN. 38104.

Circle No. 137

AUDIO DEVICES INC. 'HOLN' LOW-NOISE PROFESSIONAL MASTERING TAPES AT AES SHOW

Designed as high-output, low-noise tapes for all studio and duplicating mastering applications, the tapes (type 2506 and type 3607) use a new iron oxide, a new binder system, and a new dispersion process.



The tapes feature Cushion-Aire™ back-coating to provide maximum handling and storage reliability, and are the product of rigorous quality control and engineering tests under field usage conditions.

Audio Devices claims that the new tapes will meet all critical requirements of modern recording and duplicating practices, and are ideally suited for copying, overdubbing, duplicator masters, and

other applications demanding repeated and hard usage.

The new HOLN tapes are available in two base thicknesses and lengths. Both come in 1/4-inch, 1/2-inch, 1-inch and 2-inch widths. Type 2506 has a base of 1.5 mil polyester, is 2500 feet long, while type 3607 is 3600 feet long with a base of 1.0 mil polyester. The reel diameters for both tapes is 10 1/2-inches.

AUDIO DEVICES, INC., 100 RESEARCH DRIVE, GLENBROOK, CT. 06906

Circle No. 138

ORBAN/PARASOUND DYNAMIC SIBILANT CONTROLLER

Essentially a limiter with a frequency dependent feedback loop, the DSC features low noise and distortion as well as extreme operational simplicity. Overload/noise ratio is typically 100 dB with harmonic distortion typically below 0.1%.

There are only two operating controls: a THRESHOLD control to determine the level at which the sibilants start to be controlled . . . and a switch to defeat the action without clicks or gain changes. An LED lights up to indicate when control is taking place.



The DSC has unity gain at low frequencies and at high frequencies below the threshold. Its 1 ms attack time and 50 ms release time are faster than light-dependent resistor devices, and permit extremely tight, inaudible control action.

The DSC is supplied with 3 independent de-essing channels on a 1 3/4" rack panel.

Priced at \$395.00.

PARASOUND, INC., 680 BEACH ST., SAN FRANCISCO, CA. 94109.

Circle No. 139

NAKAMICHI ANNOUNCES THEIR NEW 3-HEAD CASSETTE SYSTEMS

The new Nakamichi Models 1000 and 700, are said to be the world's first 3-head cassette systems permitting instantaneous off-the-tape monitoring with a guaranteed minimum frequency response of 35 - 20,000 Hz ± 3 dB (with CrO₂ tape.)

Nakamichi's exclusive Tri-Tracer development employs a dual-motor drive system and solenoid-action feather touch controls with IC logic system. The Tri-Tracer project was made possible by the development of a 3-head configuration and a specially constructed recording and playback heads. The 3-head cassette mechanism is designed to compete in performance and reliability with professional 15 ips. reel-to-reel machines.

The closed loop driven double capstan, with large staggered flywheels, maintains extremely stable tape speed and professional low wow and flutter performance (less than 0.10% under DIN 45507 Weighted Peak). All tape motion controls originally developed for expensive computers.

The Nakamichi 1000 is equipped with 2 noise reduction systems, the indepen-

dent record and playback Dolby B Noise Reduction circuitries and the Phillips Dynamic Noise Limiter (DNL) circuitry. The DNL circuitry is especially useful in reducing noise on pre-recorded non-Dolby cassettes. Signal to noise ratio is better than 60 dB with Dolby.



Another of the more dramatic features of this Cassette System is the built-in Recording Head Azimuth Alignment System together with its Peak Limiter. Featured is a 3-Point Sound Pick Up capability (the third input is for the blend microphone which can be controlled independently from the other two microphone inputs).

Among other special features are Pitch Control and Professional dB Peak Level Meters, Memory Rewind, Automatic Rewind, Automatic Rewind (at end of tape), Automatic Shut-off, Instant-acting Jam Proof Device and (optional) Remote Control.

PRICE: Model 1000 - \$1,100; Model 700 \$690.

NAKAMICHI RESEARCH (U.S.A.) INC. 220 WESTBURY AVE., CARLE PLACE, NEW YORK 11514

Circle No. 140

MODEL 950, 50 WATT POWER AMP FROM ELECTRO SOUND

A new 50 watt power amplifier for professional sound applications has been announced by Electro Sound of Sunnyvale, Ca. Designated the Model 950, the new amplifier is another in Electro Sound's line of components for professional sound systems.

Of all solid state design, the Model 950 is said to be intended for continuous non-attended service in installations where trouble free operation over long periods of time is required. The Model 950 has several design features that make it especially useful for applications requiring long term reliability; the unit has an internal current sensing circuit which protects the unit from overloads and holds

its output within safe operating ranges even if an accidental short should occur. This design feature, along with massive oversized heat sinks for the output transistors, assures maximum protection and reliability.

The unit occupies only 3 1/2 inches of vertical rack space, yet provides a full 50 watt rms output with less than 0.5% total harmonic distortion. Frequency response is ± 1 dB from 40 to 15,000 Hz at 50 watts or ± 1 dB from 20 to 20,000 Hz at one watt. Standard output impedances of 4, 8 and 16 ohms are provided, plus 100 ohms (70 volt line).



The unit is powered by a standard 117 volt AC input voltage, of either 50 or 60 Hz, and will operate at ambient temperatures up to 55 degrees C. ELECTRO SOUND, INC., 725 KIFER RD., SUNNYVALE, CA. 94086.

Circle No. 141

ITI PARAMETRIC DISK MASTERING EQUALIZER

The MES-430 is the first precision tracking equalizer specifically designed to equalize master tapes for disk transfer. Using it with a stereo disk mastering

system, the MES-430 will equalize the preview and program information simultaneously and enable the cutting system computer to maintain accurate pitch and depth control for maximum conservation of available groove area. It is possible to optimize sound characteristics at any point within the entire audio spectrum using high reliability positive detented switches on all controls.



The 72 frequency positions are divided into three overlapping ranges (11-570 Hz), (120-6800 Hz), (3400-25, 600 Hz), with boost or cut up to 12 dB in 1.0 dB increments. Selectivity or "Q" controls vary the frequency bands skirt characteristics from 5 to 15 dB/octave in steps of 5, 6, 9, 11 and 15 dB/octave while maintaining peak frequency amplitude. The Shelving section provides 12 dB boost or cut in 1.0 dB increments at 10 kHz, and 50 or 100 Hz (switch selected). For added convenience in mastering, the "equalization in/out" function can be automatically controlled by the banding logic in the Neumann Mastering

System. Additionally, for the ultimate in flexibility, two units may be cascaded and automatically switched during banding, thus allowing the use of different equalization settings on each band.

The noise level is less than -84 dBm, with distortion less than 0.03% THD, at any level from 0 dBm to +24 dBm (10-40,000 Hz). Crosstalk between any two channels is less than the self noise level of the unit. Level tracking error between channels is ± 0.1 dB; frequency tracking error less than 3%.

Exclusively distributed through GOTHAM AUDIO CORP., 741 WASHINGTON ST., NEW YORK, N.Y. 10014.

Circle No. 143

ELECTRODYNE SERIES 2000 CUSTOM RECORDING CONSOLE

The series 2000 is said to present a composite of the features most asked for by customers who order custom consoles. By incorporating these features into the Electrodyne production model, the company is able to offer the flexibilities and functions required by the industry at a realistic price.



Features of the Series 2000 include Electrodyne's exclusive 712L 9-frequency graphic equalizer input module and the compact SML-20 channel assign switch module which incorporates up to 24 assignment positions, 4 echo send selections, program and echo quadraphonic pan pots and solo selector. This board is equipped with 8, 16 and 24 output buses, separate quad bus and 3 mono buses for headphone distribution. The completely independent quad monitor mixdown has the quad encode/decode and mono/stereo compatibility test functions required by the modern day studio. Other standard features are a patchbay wing, 5 frequency test oscillator, talkback and slate controls, tape recorder remote controls and many others.

CETEC, INC., 13035 SATICOY ST., NORTH HOLLYWOOD, CA. 91605

Circle No. 144

NEW EECO 'DUAL CUE RECORDER' CONTROL

Designed for use with EECO's BE450 Wide Range Synchronizer, the new BE-460 Dual Cue Controller provides individual or simultaneous automatic cueing of two audio or video recorders.

The BE450 Wide Range Synchronizer introduced in 1972 automatically synchronizes two mag tapes, whether quad or slant-track video, sprocketed, or unsprocketed audio. Teamed with the BE 420 Edit Code Reader, it has produced excellent results in exact synchronization or exact front-panel controlled *offset* of two recorders from any starting point

New for '73

high speed
in-cassette
and
open reel
duplicators



"Quick Copy" (Stereo)
Cassette to Cassette duplicator
Model C-140

Pentagon now offers 8-Times and 12-Times duplicator speeds. In fact, we offer the fastest and most complete line of high speed in-cassette and open reel tape duplicators in the world. And as always, Pentagon quality is built into each and every duplicator. With over 54 different models to choose from, we feel certain, you'll find a duplicator model best suited to meet your every need.



Tri-Master "Editor"
(Stereo) Duplicator
Model C-1343-12



At last . . . a cassette specifically designed to meet the needs of both the EDUCATOR and INDUSTRIAL user alike. Whether it be voice, music, pulse tone, or a combination of program requirements, Pentagon cassettes have proven repeatedly to be one of the few reliable ones. And surprisingly—it's modestly priced!

An eight page brochure is available upon request covering Pentagon's complete line of duplicators and cassettes. Write or call

Pentagon
Industries, Inc.

4751 NORTH OLCOTT AVENUE
CHICAGO, ILLINOIS 60656
(312) 867-9200

Creators of quality in cassette duplicators



within a 30 second capture range. Primary applications of the BE450 have been in the conversion of two 16 track ATV's into a single recorder, audio sweetening of video tapes, and FM/TV simulcasting.

The new BE460 Dual Cue Controller now replaces the BE420 which required manual pre-roll parking of recorders prior to actual synchronization. The Dual Cue Controller provides pre-set and automatic location of desired tape parking points.

Price : \$4,850.
EECO, BROADCAST PRODUCTS GP.,
 1441 E. CHESTNUT, SANTA ANA, CA.
 92701

Circle No. 145

dbx ANNOUNCES 16 CHANNEL TAPE NOISE REDUCTION SYSTEMS

Two new 16 channel professional tape noise reduction systems are being introduced by dbx. Both systems improve headroom by 10 dB, provide in excess of 30 dB of noise reduction, and are compatible and interchangeable with other dbx professional noise reduction systems.

Model 216 provides simultaneous re-

cord, play and bypass functions controllable from the panel or remotely. Price, including a spare Model 310D two channel module, is \$8,200.



Model 116 is switchable between record and play and sells for \$6,200. **dbx, INCORPORATED, 296 NEWTON STREET, WALTHAM, MASS. 02154.**

Circle No. 146

ALEMBCI PROFESSIONAL PRE-AMP FOR STRINGED INSTRUMENTS

The two channel professional quality preamplifier for guitar, bass or other stringed instruments is designated model F2B.



The tube-type unit, which may be used with any professional quality power amplifier, accepts low-level signals from any standard pickup. Each channel has two inputs. While input No. 1 is normal, input No. 2 is padded 6 dB. Separate

volume control and brightness switch is provided for each channel, as well as tone controls for bass, midrange and treble. Both mono and stereo outputs are available on the back panel.

The preamp, which may be rack mounted, is packaged in a sturdy blue metal enclosure with etched black face plate.

Price: \$295.
ALEMBCI, INC., 60 BRADY STREET,
SAN FRANCISCO, CA. 94103

Circle No. 147

SPECTRA SONICS 'ULTIMATE-73' SERIES AUDIO CONTROL CONSOLES

This advanced line of audio control consoles provide extensive flexibility and unmatched quality, and are operator oriented to assure maximum productivity.

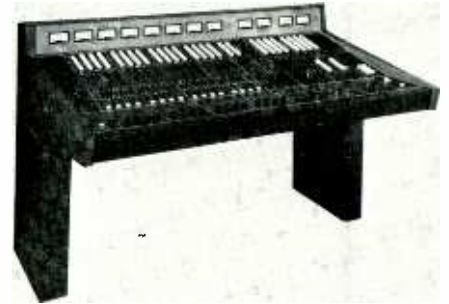

The typical system performance, from input to output, which the user may rely upon is: Maximum output +25 dB; frequency response \pm 0.5 dB, 20 Hz to 20 kHz at +18 dB; signal to noise ratio, not less than 80 dB below +4 dB output,

What you need is a console that works when you get it.

That's the
"Son of 36 Grand"



auditronics, inc.
 P. O. Box 12637
 Memphis, Tenn. 38112
 (901) 276-6338



Distributed By:
Auditronics Systems Division,
 Memphis (901) 272-9641
Milam Audio,
 South Pekin, Ill. (309) 348-3112
Westlake Audio, Inc.,
 Los Angeles (213) 655-0303

AMPLIFY THE PIANO NOT YOUR PROBLEMS

A Countryman Associates Piano Pickup allows you to amplify or record a full rich sound from any grand piano. Its exclusive electrostatic pickup principle works directly from the strings instead of the sounding board, to completely eliminate problems from feedback or leakage of other instruments, even bass guitar and drums.

Sound impressive?

The most impressive claims come from its users.

ALLMAN BROTHERS BAND
BADFINGER

BREAD

JOHN BALDRY

THE BAND

BARNSTORM

ELVIN BISHOP GROUP

DAVID CASSIDY

CLAIR BROTHERS AUDIO

JOE COCKER

COMMANDER CODY

COPPER HEAD

CROW BAR

STEVE FAULKNER

LARRY FOX

DAVID FREIBERG

J. GEILS BAND

THE GUESS WHO

JO JO GUNNE

GRATEFUL DEAD

NICKIE HOPKINS

ITS A BEAUTIFUL DAY

JEFFERSON AIRPLANE

CAROLE KING

LED ZEPPELIN

JOHN LEWIS 'MJO'

NILES LOFGRIN & GRIN

LUCKY MUD

MALO

MANA

LEE MICHAELS

GLENN MITCHELL-MONDO WILLY

MODERN MUSICAL SERVICES

GRAHAM NASH

PROCOL HARUM

RARE EARTH

RASPBERRIES

ROLLING STONES

LEON RUSSELL

SAVE

SHOWCO

SPIRIT

ROD STEWART & THE FACES

TOM TAFFEE

TRAFFIC

NEIL YOUNG

**COUNTRYMAN
ASSOCIATES**

424 UNIVERSITY AVENUE
PALO ALTO, CA 94301
(415) 326-6980

Circle No. 149

with -50 dB input, normal attenuator setting 20 Hz to 20 kHz, unweighted; crosstalk unmeasurable at 1 kHz (below noise), better than 70 dB at 20 kHz; total harmonic distortion and noise, .01%, 1 kHz at +18 dB, .035%, 30 Hz to 20 kHz at +18 dB.

Spectra Sonics invites inspection of these professional quality audio consoles by professionals at Booths 33-34 at the New York AES Convention.
SPECTRA SONICS, 770 WALL AVE., OGDEN, UTAH 84404

Circle No. 150

NEUMANN CUTTER DRIVE LOGIC SAL 74 STEREO CUTTERHEAD SX 74

Gotham Audio is now showing its latest Disk Mastering package featuring 600 Watt per channel output capability. The resulting exposure of the cutterhead to potential thermal overload has made it necessary to design an entirely new protective circuit breaker which also indicates temperature directly on a panel meter. Also included is a new acceleration limiter system replacing the HK-66 high frequency limiters used heretofore. The TS-66 Tracing Simulator is a standard feature of the SAL 74 package.

Also released is the SX 74 Stereo Cutterhead featuring expanded feedback frequency range (7 Hz - 14 kHz), increased sensitivity by 1.4 dB and increased

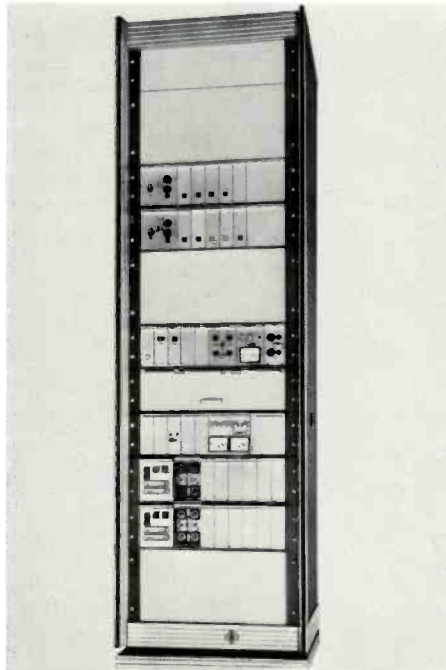

temperature tolerance from 120° to 200° C. The SX 74 has a response range of 7 Hz to 25 kHz \pm 3 dB making it eminently suitable for the cutting of DC-4 discrete quadrasonic masters.

GOTHAM AUDIO CORP., 741 WASHINGTON ST., NEW YORK, N.Y. 10014

Circle No. 151

TOY CHEST UNIVERSAL LIMITER

The Toy Chest Universal Limiter is designed and packaged to interface with any recording equipment, specifically the Hi-Z, low level machines and consoles recently introduced into the market.

Operation of the Toy Chest is simple



and virtually goof-proof. Internal line operated power supply and rugged attractive housing allow the Universal Limiter to be placed anywhere and use virtually any system.

The unit has over 40 dB of gain reduction, with a -78 dBm noise level at the output.

Price: under \$200.00. Dealer inquiries invited:

PANDORA, P. O. BOX 280, NASHVILLE, TENN. 37202

Circle No. 152

RAMKO DA-6 AUDIO DISTRIBUTION AMPLIFIER

The new DA-6 distribution amplifier will bridge or match a 600 ohm audio line, balanced or unbalanced, and provide six completely isolated balanced outputs.

Other Ramko models provide 16 or 32 balanced outputs and 8 balanced inputs, individual line level controls, switchable front panel line level metering and headphone monitor.

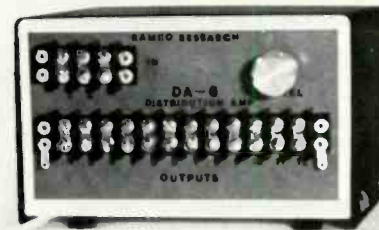

Integrated circuits are used throughout to achieve excellent performance characteristics: 25 dB gain; +20 dB output maximum; 0.1% or less distortion; \pm 0.5 dB response; 10 Hz-20 kHz. The unique circuitry allows the outputs to work into any impedance over 125 ohms without affecting either response or distortion.

Tabletop or rack-mounted versions are available. All units contain their own internal power supply and operate off 115 VAC/60 Hz.

Price: \$95.00 to \$425.00.

RAMKO RESEARCH, 3516-B LAGRANDE BLVD., SACRAMENTO, CA. 95823

Circle No. 153

BEYER DYNAMIC NEW UNCONDITIONAL WARRANTY

In a recent announcement BEYER has amended their warranty policy on all Beyer microphones. Should any difficulty occur during the first year of use, no matter what the cause, Beyer will replace it immediately with a brand new microphone of identical type. This warranty covers both accidental damage, and also damage caused by misuse of overload.

After the first year, Beyer will replace the microphone immediately, but with a factory reconditioned model in perfect condition at a nominal charge.

This warranty is effective on all Beyer microphones. In addition, to insure that customers do not initially purchase a microphone that does not meet with their precise requirement, Beyer have produced a microphone application chart showing each microphone's optimum suitability for 22 different types of general recording, and specific recommendations for recording 69 different musical instruments.

For further information on the warranty and a free microphone application chart, contact:

REVOX CORP., 155 MICHAEL DR., SYOSSET, NEW YORK 11791

Circle No. 154

Continued from page 33

SESSION K

TAPE DUPLICATION

WEDNESDAY, SEPT. 12, 2:00 P.M.
JADE ROOM

- K-1 Duplicators As Seen By The Tape Manufacturer
- K-2 Tape Duplication — A Brazilian Experience
- K-3 The Tape Manufacturer Interfaces With The Tape Duplicator
- K-4 Mastering Technology — Today And Tomorrow
- K-5 Leaderless Cassettes

SESSION L

DISK RECORDING AND REPRODUCTION

THURSDAY, SEPT. 13, 9:30 A.M.
ASTOR GALLERY

- L-1 An Integrated Tone Arm
- L-2 Variable Pitch / Depth Lathe Control Without Using An Advance Head
- L-3 A Regulated Low-Pass Filter Based On Pulse Width Modulation
- L-4 SAL 74 And SX 74: A New Disk Recording System Which Meets The Present Requirements Of The Disk Cutting Industry

SESSION M

ELECTRONIC

MUSIC/ELECTRONICS IN MUSIC EDUCATION

THURSDAY, SEPT. 13, 2:00 P.M.
JADE ROOM

- M-1 A Comparison Of Amplitude And Phase Relationships Of Partials Generated In Various Types Of Synthesized Oscillators
- M-2 A Computer-Assisted Music Facility
- M-3 The ARP Pro Soloist Synthesizer
- M-4 Applications Of Synthesizers In Music Education
- M-5 What Is And What Is Not Required In Audio Visual Teaching
- M-6 Automated Music Instruction: Devices & Strategies
- M-7 A Digital Sequencer In Music Teaching

CLASSIFIED

CLASSIFIED ADVERTISING RATES

Prepaid * with submitted copy:

One column inch (1" x 2 1/4") ... \$20.00

1/2 column inch (1/2" x 2 1/4") 14.00

*(If billing is required add 20%.)

Send for FREE Catalog
and Audio Applications



OPAMP LABS

172 S Alta Vista Blvd
Los Angeles, Calif 90036
(213) 934-3566



Circle No. 155

MULTI-TRACK

8 and 16

TRACK RECORDING CONSOLES THE SOUNDEST DOLLAR SPENT IN PRO AUDIO TODAY

1965 CHEREMOYA AVE.,
HOLLYWOOD, CALIF. 90028
P.O. Box 3187, Hollywood, CA. 90028
(213) 467-7890

Circle No. 156

PLANNING A NEW . . . RECORDING STUDIO?

Our new STUDIO PLANNING KIT can be most helpful. Write for free copy today.

CUSTOM FIDELITY CO.
7925 SANTA MONICA BL.
HOLLYWOOD, CA. 90046

Circle No. 157

EQUIPMENT AVAILABLE

ONE STOP FOR ALL YOUR PROFESSIONAL
AUDIO REQUIREMENTS.
BOTTOM LINE ORIENTED
F. T. C. BREWER COMPANY
P. O. Box 8057, Pensacola, Florida. 32505

FOR SALE: 16 brand new MCI I.O. modules (the old model for the JH-416 console)--\$500 each. Call or write Alan Kubicka, Sound House, P. O. Box 135, Roselle, Illinois, 60172. Phone: (312) 529-1001.

NEUMANN VMS-66 Computer Controlled Disc Mastering Lathe, complete with VG-66s Solid State Cutting System, HK-66 High Frequency Limiters, and SX-68 Stereo Cutterhead. This equipment represents the highest state-of-the-art technology, and is in mint condition.

\$39,500 complete

Current price for the equivalent new system approximately \$58,000.

(213) 461-2751

dbx 157 offers

professional studio quality noise reduction at a modest price. The dbx 150 series is compatible with all other dbx noise reduction systems. Features include 10dB headroom improvement and 30dB noise reduction. Walnut case is standard, or two units may be ganged for rack mount. RCA phono connections facilitate the interface with semi-professional recorders, mixers, etc. Model 157 is two channel, simultaneous record and play, \$567. Model 152 is two channel, record OR play, \$410. Model 154 is four channel, record OR play, \$646. Available from professional audio dealers or direct from dbx, Incorporated, 296 Newton Street, Waltham, Massachusetts 02154 617/899-8090.



dbx inc.

Circle No. 158

Re/p 55

there will be a slight delay

(two of them, in fact)

UREI's unique Cooper Time Cube gives you TWO completely independent audio delay lines, at less than one-third the cost of a single channel digit unit.

The Time Cube is the ideal creative tool for: recovery of hidden ambients to produce Quadriphonic product; loudness enhancement; delaying reverb send; and changing apparent source-to-mike distances.

Model 920-16 Time Cube is the only acoustical delay line system of professional quality. It is designed specifically for recording studio applications and for anticipatory noise reduction in optical film recording.

See your dealer or write for complete specifications.



UREI company

11922 Valerio Street, No. Hollywood, California 91605
(213) 764-1500

Circle No. 159



ARTISAN SOUND RECORDERS

- * The finest available equipment.
- * Careful attention to detail.
- * Audibly superior record mastering.

In ten years of service to the record industry, we have gained an international reputation for quality tape-to-disc transfer. By tasteful use of sophisticated electronic technology, we are often able to create a disc that sounds better than the master tape. Find out what we can do for *your* next release!

6430 Sunset Blvd., Suite 1516
Hollywood, California 90028
Phone: (213) 461-2751

Circle No. 162

EQUIPMENT AVAILABLE

NEUMANN DISC MASTERING SYSTEM AM-131 LATHE
HAECO AUTOMATION SYSTEM WITH VARIABLE PITCH.
GRAMPHON SYSTEM WITH TABLE.
Excellent Condition . . . \$4700. FOB Omaha
(402) 553-1164
'GRANT'

SCULLY Lathe \$3,000
WESTREX 2A Cutter \$500
WESTREX Driver Amp and System \$500
AMPEX 350-2 Recorder. . . . \$750
AMPEX MX-10 Mixer \$300
SHURE Audio Master \$75
SHURE Reverb Mixer \$75
770 N. Main, Unit G
ORANGE, Ca. 92668
(714) 532-4127

MCI JH-16 SIXTEEN TRACK TAPE MACHINE, PLUS AUTO LOCATOR AND SPARE ELECTRONIC CARDS . . \$10,500
CAPRICORN SOUND STUDIOS
548 BROADWAY
MACON, GA. 31208
(912) 745-8516

RECORDING CONSOLE FOR SALE
Due To Expansion Of Facilities
CUSTOM BUILT . . 16 in/8 out
Sold new for \$40,000. Asking \$9,000.
FOR MORE INFORMATION CALL:
MARK XVI RECORDING STUDIOS
(901) 526-2194

PROFESSIONAL RECORDING AND TEST EQUIPMENT for recording studios and broadcasters - Altec, Ampex, 3M, GR, HP, Tektronix - new & used.
Free equipment list, or drop in.
CHAS. E. WASHBURN CO.
6114-R Santa Monica Bl.
Hollywood, CA. 90038

FOR SALE: Electrodyne 1608 console 16 in, 8 out - phantom microphone supply, limiters, pan pots, mix-downs, patching, many other features.
BOX MC R-E/P BOX 2287 HOLLYWOOD, CA. 90028

WANTED TO BUY
Audiotechniques, Inc. wants to buy your used Scully Model 280 series tape recorders, any width from quarter inch to two inch. Write or phone Bob Berliner or Ham Brosious giving condition, serial number and configuration.
AUDIOTECHNIQUES, INC., 142 Hamilton Avenue, Stamford, Conn. 06902 (203) 359-2312.

EMPLOYMENT

WANTED:
RECORDING ENGINEER
\$12,000 - \$18,000 Negotiable

- * Do you have a total knowledge of all aspects of audio recording?
- * Can you appreciate all forms of rock and soul and get along with all types of personalities?
- * Can you take raw musical talent and convert it into sellable product on tape?
- * Are you willing to work fifty hours a week and love it?
- * Do you know the sound of a hit? Do you want to cut hits? Do you want success bad enough to eat every top selling single and LP chart you're not on?
- * Is a sampling of your past work available in any record shop?
- * In short, are you a born winner?

If you can honestly answer yes to all the above, we want you to join us and we'll pay whatever's fair. Track Recorders has had eight national chart records in the last year. Washington, D. C. is the last major music frontier and we're the leaders. Our studio has all the standard quality equipment - 3M 16 track, 25 in 16 out custom console, EMT reverb, JBL 4320 monitors, Dolby, Kexep, varispeed, grand piano, Hammond B3 organ, amps, drums, excellent test gear and maintenance. Your weekends will generally be free. The Washington area offers great entertainment and social life plus Blue Ridge Mountains, Shenandoah Valley, Chesapeake Bay, Atlantic Ocean.

Call or write to: TRACK RECORDERS, INC. 8226 Georgia Ave. *11-2 Silver Spring, Md. 20910 (301) 589-4349

Wanted:
EXPERIENCED SENIOR ENGINEER with solid following or small broad based studio/production house, to join forces with growing top quality studio.
Contact:
JERRY KORNBLUTH
A&J AUDIO/VISUAL SERVICES, INC.
119 WEST 57 STREET
NEW YORK, NY. 10019

REGIONAL SALES MANAGER . . .
Establish and maintain distribution of audio recording equipment and direct sales efforts to recording studios and broadcasters. Experience in selling to studio and distributor market preferred and the right person should have knowledge of professional audio recorders. Will travel within established region.
Please call or write Ernie Olson, (415) 968-8389.
SCULLY/METROTECH
875 ELLIS STREET
MOUNTAIN VIEW
CA. 94040

ENGINEER - 12 years mixing experience. 2 chart records at present. Seeking freelance or permanent position. Willing to relocate for the right opportunity. Contact Stan Agol (213) 655-5927.

WHERE THE BOOK ENDS STUDIO SUPPLY EXPERIENCE BEGINS

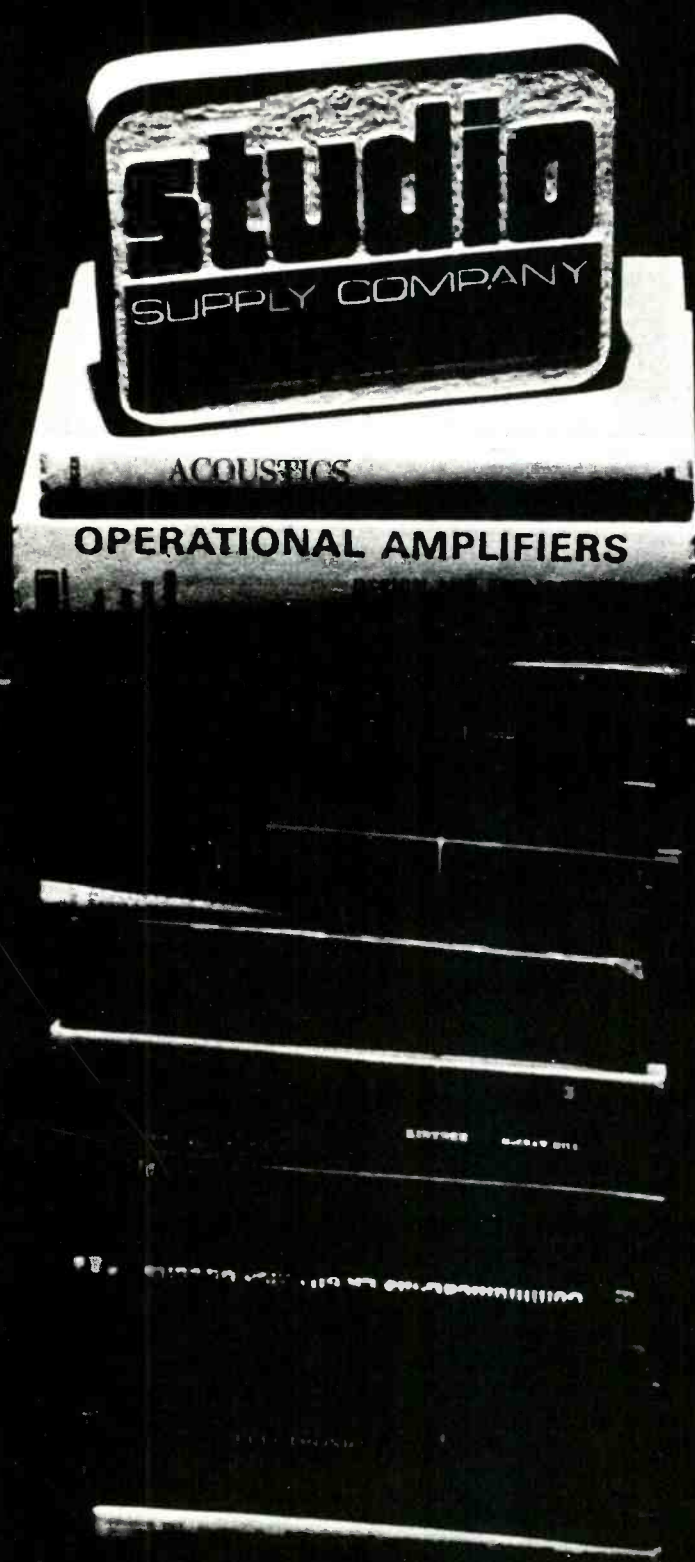

EXPERIENCE — wrought from extensive years of hard work by many people participating in all phases of recording. People now brought together to serve you.

KNOWLEDGE — gained from long successful involvement in mixing, studio management, maintenance, equipment design, accoustical consultations, and turn-key studio construction that uniquely qualifies us to mold an unlimited selection of the world's finest recording gear into a facility that fits you.

WISDOM — dictating that our designs and specifications are generated after careful consultations as to your style of recording, personal room and equipment preferences, and your fiscal requirements.

STUDIO SUPPLY designs and equips rooms that feel good, sound good, and work good. After all, isn't that what a good studio is all about?

STUDIO SUPPLY HAS ACCESS TO MANY LEASING PLANS AND OTHER SOURCES . . .

CALL DAVE, STEVE, EMIL OR CLAUDE TODAY . . .

(615) 327-3075

studio
SUPPLY COMPANY

P.O. BOX 280
NASHVILLE, TENN. 37202

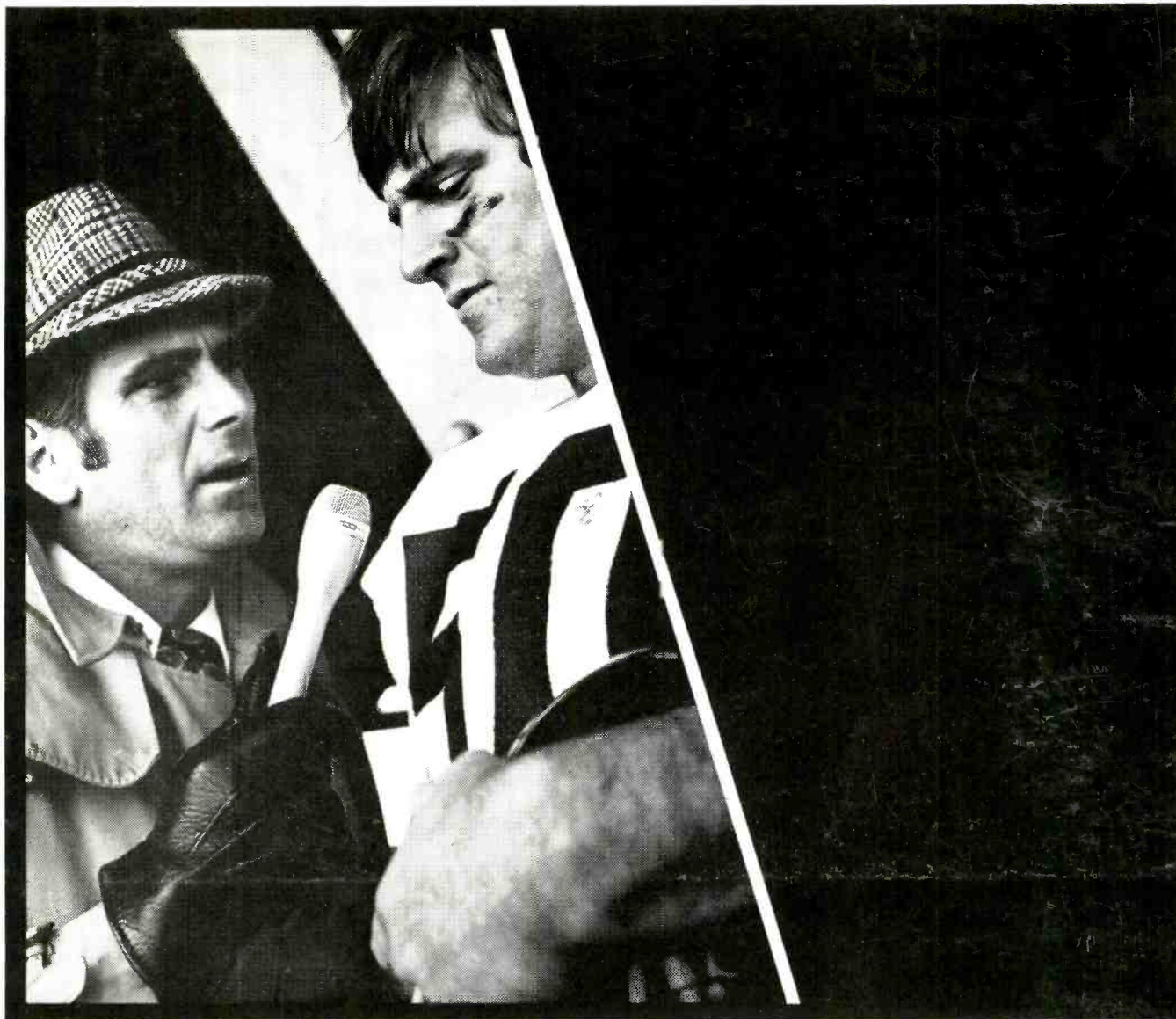

The Quiet One...



Time was when hand-held microphones could mean a handful of problems. Now, the Shure SM61 professional omnidirectional dynamic microphone combines sleek good looks with *extraordinary* reduction in cable and handling noises. The SM61 is built around a shock mount that *effectively reduces cable, handling and mechanical noises to insignificant levels*. A super-efficient "Blast Barrier" cuts wind and breath noise to a negligible minimum. Smooth, wide-range response produces an extremely natural, coloration-free sound that does great things for speech, vocal music and instrumental pickup. The SM61 is beautiful to look at, a delight to work, a pleasure to hear. Write for a complete data sheet to:

Shure Brothers Inc.
222 Hartrey Ave., Evanston, Ill. 60204
In Canada: A. C. Simmonds & Sons Ltd.



Circle No. 161