

MARCH/APRIL 1971
VOLUME 2 - NUMBER 2

\$1.00

RECORDING engineer/producer

relating recording science • to recording art • to recording equipment

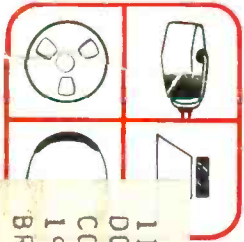

11201PMEBL93DD
DOUG POMEROY
COLUMBIA RERDS
193 BAL TIC ST
BROOKLYN

NY 11201

L



**JOIN
THE
HITMAKERS**

JOE COCKER
R. B. GREAVES
TAMIKO JONES
LINDA RONSTADT
WILSON PICKETT
ALBERT KING
LLOYD PRICE



MUSCLE SHOALS SOUND STUDIO

CONSOLES & ACOUSTICS

..... by



FLICKINGER

DANIEL N. FLICKINGER & ASSOCIATES, INC.

40 SOUTH OVIATT STREET

HUDSON, OHIO 44236

(216) 655-2400



RECORDING
engineer/producer

—the magazine to exclusively serve the recording studio market . . . all those whose work involves the recording of commercially marketable sound.

—the magazine produced to relate . . . RECORDING ART to RECORDING SCIENCE . . . to RECORDING EQUIPMENT.

Editor/Publisher MARTIN GALLAY
Engineering

Editor . . . WILLIAM ROBINSON
Associate Editor . . . PETE SENOFF
Business/Circulation

Manager V.L. GAFFNEY
Art Director G.J. SADOWSKI

RECORDING engineer/producer is published bi-monthly and is sent free to qualified recipients in the United States. Subscriptions for other than qualified individuals or companies may be purchased at \$5.00 per year. (All foreign subscriptions: \$6.00 per year.) Material appearing in Re/p may not be reproduced without written permission of the Publisher. Copyright © by RECORDING engineer/producer 1971.

Controlled circulation postage paid at Los Angeles, California.
RECORDING engineer/producer
6430 Sunset Boulevard
P.O. Box 2287
Hollywood, CA 90028
(213) 461-7907

RECORDING the PIANO 9 *an Re/p forum*

MICROPHONES 19 *lou burroughs*
the need for a
consistent performance
monitoring program
. . . a basic 'A-B'
method for monitoring
response characteristics.

RECOGNITION-1970 25

'BI' and 'TRI' AMPLIFICATION 27 *albert siniscal*

New 3-M 'H-e' Tape 6

Bonneville Broadcasting
Selects E-V Quad Encoder System 6

BYU Audio Recording Seminar 7

AES Spring Convention Program 30

New Products 33

Cartoon 40

credits — cover: TRICI VENOLA
cartoon: WAYNE YENTIS
Allison Research

Play at 15 i.p.s.

Yamaha C7 Grand.

When you're laying down the master, you'd better be sure your piano is air quality. That's what the Yamaha C7 Grand is all about. It's a 7'4" concert instrument that ranks among the world's great pianos. Just ask the talent at your next session.

Yamaha U1-D Upright.

The closest you can come to a grand piano without a grand piano. Four feet high and nearly five feet wide, it has full, rich tone and response crisp enough to please the most finicky talent. It stays that



way through month after month of masters, rehearsals and spilled drinks, too.

Yamaha Electone

E-3. It's a symphony orchestra in a box for just \$2,395. With fewer controls, the E-3 gives you more

sounds, more music than organs costing as much as \$8,000. What's more, it's a regular sound effects machine. Think about *that* the next time you have to synthesize some sounds.

NEW '3M' TAPE SYMBOL TO IDENTIFY LATEST GENERATION OF "HIGH ENERGY" MAGNETIC TAPES.

Development of this proprietary cobalt-modified ferric oxide formulation, according to Daniel E. Denham, general manager of the 3M's Magnetic Products Division, amounts to a major technological breakthrough.

Initially, the new "High Energy" audio range tape will be released in consumer cassettes.

Denham says, "Our 'High Energy' tape is designed to bring reel-to-reel sound to cassettes. The new oxide will offer a greater undistorted output at all frequencies and an increase in dynamic range from 2dB at low frequencies to 6dB at the high end."



The stylized logo symbolizes the new family of "High Energy" tapes. Letters 'H' and 'e', for high energy are separated by the graphic symbol for the hysteresis loop, which defines the relationship between the magnetizing force used to record a tape and the magnetism retained by the tape.

BONNEVILLE INTERNATIONAL PICKS 'E-V STEREO-4 ENCODING' FOR FM STATIONS

Electro-Voice, Incorporated has announced that final arrangements have been made with Bonneville International Corporation of Salt Lake City, Utah, enabling them to begin four channel stereo broadcasting on their chain of FM stations, using the Electro-Voice Stereo-4 encoding process.

The Bonneville FM stations which will use the Stereo-4 process are in six major markets across the United States. The four-channel broadcasts are scheduled to begin within the next thirty days. The stations involved are KSL, Salt Lake City; KBIG, Los Angeles; KIRO, Seattle; KMBR, Kansas City; WCLR, Chicago; and WRFM, New York City. Station KSL in Salt Lake City originates the weekly radio broadcast of the Mormon Tabernacle Choir, and it is anticipated that this program, too, will ultimately be aired in four channels.



YAMAHA

YAMAHA INTERNATIONAL CORPORATION
P.O. Box 6600 • Buena Park, California 90620

Send for complete specifications and dealer information.

- C7 Grand Piano Name _____
- U1-D Upright Piano Business _____
- E-3 Organ Address _____
- Other _____ City _____ State _____ Zip _____

CUTTING QUADRAPHONIC ALBUM WITH THE STAN KENTON BIG BAND TO BE HIGHLIGHT OF 5TH ANNUAL, 1971, 'BYU' AUDIO/RECORDING SEMINAR.

Working with Stan Kenton while cutting a quadraphonic album will be one of the highlights of Brigham Young University's fifth annual Audio/Recording Seminar to be held July 12 through Aug. 16.

The class will also feature leading authorities in the audio/recording industry throughout the nation. Milton T. Putnam, president of the United Recording and Electronics Industries, will focus on the theoretical and practical considerations of the acoustical problems in studio and control-room design.

Jerry Ferree, sound engineer for United Recording Corporation, will emphasize the proper maintenance of electronic equipment while William L. Robinson, Sunset Sound Recorders, will discuss the theory, design and use of recording studio equipment.

Bill Blanton, who is associated with "The Cavalcade of Disney," will present the latest techniques and equipment for good sound reinforcement.

The seminar will also cover the legal and business aspects of the recording industry, disc recording, hearing loss and damage, creative audio and quadraphonic acoustics. Other topics include synchronous sound in recording and television audio, reverberation devices, classical music recording, electronic music synthesizer and quadraphonic recording.

While the actual seminar week featuring Stan Kenton will conclude the sessions, students participating for the full five weeks can receive six credit hours in Engineering Technology 271 and 272.

The first four weeks of the seminar will cover topics such as the relation of music to the audio/recording technician, electronics for the audio/recording technician, musical acoustics and the recording environment and business practices. Participants will also discuss the use and abuse of microphones, sound reinforcement techniques, the art of recording music and speech, broadcast sound techniques, motion picture sound, important aspects of speech and drama in recording, disc recording and mastering, tape duplication and cassettes and the maintenance of audio/recording equipment.

"This five-week session will not only provide an opportunity to earn six credits, but it will provide a knowledge that will be important in helping participants to design, purchase and operate professional recording equipment and facilities in their own studios," says special assistant Ralph Kennard.

Participants can enroll for the full five-week program or just for the final week of the seminar. For further information write the Fifth Annual Audio/Recording Seminar, Department of Special Courses and Conferences, 242 Herald R. Clark Building, Brigham Young University, Provo, Utah, 84601.

Which
MD 421
made
this
curve?

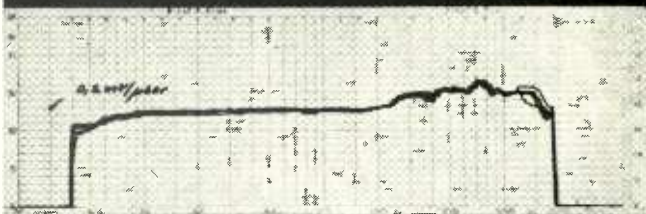
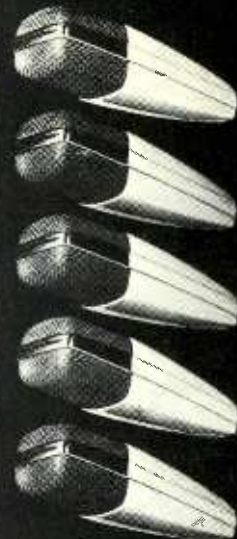

Response curve made with five random-selected MD 421 microphones.

ALL 5 OF THEM!

UNUSUAL? Not for Sennheiser.

The fact that the response curves of the five microphones are almost identical is commonplace for our engineers. And the individually-plotted curve we provide with each unit will confirm the fact. For besides the rigorous check of a response curve, each and every Sennheiser professional microphone undergoes numerous other inspections, to insure its absolute acoustical, electrical and mechanical integrity.

Perhaps this uniformity and unusual performance influenced the major recording companies in choosing Sennheiser microphones for both field and studio use (and made ours the 'standard' microphones of the continent).

You may think this kind of quality control is unusual for a production instrument. However, we are very particular about the kind of equipment bearing our name. Shouldn't this kind of 'insured performance' be built into your audio facilities, or those you install?

For further details, including full technical specifications, and a list of microphone accessories available for the MD 421, please write or call.



SENNHEISER

electronic
CORPORATION (N. Y.)

500 Fifth Avenue, New York, N. Y. 10036 • (212) LOnacre 4-0433
PLANT: BISSENDORF / HANNOVER, WEST GERMANY

Circle No. 103

**If performance
turns you on
turn on the Scully 100**



**Then
to really blow your mind
look at the price tag**

It's a fact. Scully *has* put it all together. A 16-track, professional studio recorder/reproducer that actually out-performs recorders costing at least twice the 100's \$13,700.

The big secret? Like simple. Take the same Scully engineers that design the studio equipment that's been the standard of the business for years. Let them come up with the first really modular unit that lets you buy *only* what you need. Forget all the factory-loaded accessories and extras if you already have them on your consoles. Add them if (and when) you need them.

Then let Scully offer a totally new combined record/playback head, spill-proof silent switching, and a completely new solid-state electronics package. The result? The 100 Series. Half the size and half the cost of available equipment. And performance specs that are outta' sight!

Re/p 8

For a demo that'll let you see and hear what we're talking about, write Scully, 480 Bunnell St., Bridgeport, Conn. 06607 (203 335-5146). We'll send you complete 100 specs, and the name of your nearest friendly Scully distributor or Sales/Service office. (There's probably one a dime phone call away.)

What can you lose . . . except all your ideas about how big and how expensive professional recorders really are?

▶ Dictaphone

Scully Division

Circle No. 104

mca tech leads live group

Six well-known performers.
Each a technical and creative
specialist in electronics.
The best mix of professional
audio equipment and acces-
sories.

Result — the range and quality
of sound that makes for success.
Success for distributors. Suc-
cess for buyers. Success for
engineers. Success for record-
ing artists.

With one name, you get six live
performers.

mca tech

Gauss, Electrodyne and Langevin
invite you to preview their latest
innovations in audio equipment—
at MCA TECH's Booth #130 at the
AES Show.



GAUSS

World leader in the manufacture of high-speed tape
duplicating systems, speakers and professional record-
ing equipment.



LANGEVIN

Nearly 50 years of manufacturing high quality audio
components, amplifiers, controls, switches and sound
reinforcement equipment.



ELECTRODYNE CORPORATION

Engineering, development and manufacture of profes-
sional custom audio control consoles and components.



OPTIMATION

Custom design and manufacture of secondary stan-
dards, amplifiers, power sources and calibration systems.



**UNIVERSAL DATA
ACQUISITION
COMPANY**

Manufacture of tape cartridge systems for the computer
industry.



SAKI MAGNETICS

Design and crafting of the finest audio and digital mag-
netic heads in the industry.



mca tech
an mca inc. company

Corporate Offices:
13035 Saticoy Street
North Hollywood, California 91605

TRANSIENT PROBLEM

Marc Aubort of New York's Elite Recording, just returned from recording the Salt Lake Symphony, explains it this way, "...any part of the chain that has a distortion problem will certainly show up in the piano ... probably due to the transients. Transients on the piano are extremely sharp and they do not show up in the VU meters."

This view was shared by others, among them Ron Malo on behalf of his piano experiences with Ramsey Lewis and many others of the Chess artists he recorded during his years in Chicago, "...piano is probably the loudest acoustic instrument in the studio ... with a very steep waveform ... a very intense attack. The sound we read on the VU meter is way below the initial transient. By the time you read '0' on the VU meter you may well be 20dB over recorded ... or well into saturation.

The problems that both of these statements refer to are the distortion effects of peak overload. This distortion is audibly reflected as a definite dullness of the piano sound, a buzzing sound, and at its extreme, a complete drop-out of tones. This dynamic distortion is practically impossible to measure with any static tests because of the dynamics, or the transitory nature of the succession of varied short time base transients. The problem becomes very evident when there is a decided level drop when the sound of the piano is compared by listening live and then again as it has been recorded.

If the sound is distorted the transient material is simply being clipped right off the top, awaiting peak load recovery, at either the microphone or the first stage amplifier.

Aside from peak limiting, and padding, neither the pure electronic answers to allowing the free passage through the system of an unmodified wave form, the answer seems to be in more 'headroom.' To this end, console and equipment manufacturers are raising their design centers upward to around -40dB from the older figure of -60dB.

Brian Ingoldsby, taking a break while working on the new Jimmy Webb album at MCA Studios, acknowledges the attack problem with the warning that, "If you are getting into trouble with attack, then it's probably because you are miking too close. The best true piano sounds are achieved by getting further away from the piano ... further away from the hammers."

CLOSE MIKING

Still, every *authority* acknowledges that there is a need, depending on the circumstances, where close-in miking is necessary, and even beneficial. Owen Bradley (Bradley's Barn outside of Nashville) can't remember how far back it was that they first began to put microphones right down into the tuning board holes, "you can't mike any closer to get," as he describes it, "that country, raunchy, thin sound ... a little dirty sound."

Among others, Ron Capone at Stax in Memphis, updates the in-the-hole technique on Isaac Hayes' Yamaha grand. As shown, he uses the AKG C-451 in

the hole at the high end, and a Neumann KM-84 on the low end. With the piano lid up, on the short peg, according to Ron; "We can put Isaac, who has lots of dynamics, right in the studio, without a screen (baffle) in front of him ... and the drum is not that far away ... and we get no leakage. We are using the two microphones for separation of both a very heavy bass sound and a very bright high sound. We use two mikes if the high end and the low end are very important, then neither one of them gets lost.

"In soul music piano almost doubles bass ... piano strengthens the bass line. We have got to get a lot of the low end ... the rhythm in the low end."



In-the-hole miking at Stax, Memphis

In his analysis of the brand of soul music represented by Wilson Pickett and his 1970 Grammy Award winners, The Delphonics, Joe Tarsia, owner and chief engineer of Sigma Sound Studios in Philadelphia points to piano as, "A pulsating dynamic tool, carrying the melody, accenting the dynamics, pushing the rhythm with melodic bursts of sound. Piano is the corner stone of the R&B rhythm track.

"When recording our 7 foot Steinway grand live we have found that the AKG D-119-E placed very close to, and pointing at the third hole from the high end, equalized at +4dB at 5KHz, and +4dB at 100Hz gives



Three microphone set-up at Sigma, Philadelphia

THE OLIVE AUTOMATED REMIX CONSOLE: SUDDENLY "GOOD ENOUGH" ISN'T GOOD ENOUGH ANY MORE.

Quite honestly, and without exaggeration, we believe our remix console with the automated programmer will revolutionize the recording industry.

Freed from the physical limitations of trial-and-error mix downs, the producer can control and refine up to 64 functions simultaneously or individually! Simply choose what you want to automate. For example, on a 24-track mix down you could have independent operational control of 24 level functions, 6 echo returns, 8 sub masters, 16 panning controls and quadraphonic positioning.

Like a computer, the programmer condenses information onto one track of the master tape, "remembering" each and every console operation on all channels. The producer can make a dry mix to establish levels on the channels then, when remixing, listen to the tape, making chosen modifications to each track individually. The Remix Programmer monitors and stores these adjustments for automatic repeat on any future mixes. The final mix can be modified at any time without endangering the master.



The Series 2000 Console, our modular multitrack recording and remix centre, incorporates numerous innovations and refinements. Our latest is automation — available in a module that just plugs in.

Automated Remix Programmer Specifications:

- Channel capacity: 16, 32, 48 or 64 depending on your requirements.
- Accuracy: levels will be accurate to less than 1 dB over the first 40-dB range. Accuracy greater at top of range (working range) and less at lower end, similar to accuracies normally found in a fader.
- Response: information is updated better than 10 times per second. Thus the fastest operator reactions will be preserved.
- Resolution: the system will recognize and reproduce changes

smaller than 1/10 dB over the working range (0 to 40 dB).

- Storage medium: may be any audio bandwidth tape recorder channel. The multitrack master tape would be the most convenient source for this channel.

The benefits to a studio operator are enormous. Now one man can do a complex mix of 16 . . . 24 . . . 32 tracks with complete freedom. Approximately 75% of the time and effort presently put into mix-down sessions is eliminated. A new and unmatched creative potential is released. The perfect mix is a dream? No more!

Look for the revolutionary Olive Automated Remix Programmer with the Olive Series 2000 Console at the AES Convention in Los Angeles, April 27th to 30th. If you can't make the show write or phone us. Olive Electro Dynamics Inc., 2670 Paulus, Montreal 386, Quebec, Canada. Tel. (514) 332-0331.

olive
WHENEVER THERE IS A NEED

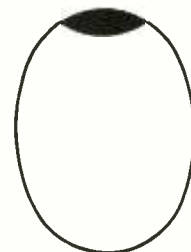

us the best results; the kind of isolation we need, and more than that, the kind of sound we are looking for.

"When using the Steinway for overdubbing we use three microphones. Two are Neumann U-87's which are used directly over the high and low ends, close to the hammers. A third microphone, the main pick-up mike, a U-84 linear admittance microphone is placed three feet outside the open lid of the piano, pointed toward the center of the harp. The two U-87's are adjusted for accenting the highs and lows."

THE EFFECT OF THE STUDIO

From Nashville, Mort Thomasson (Monument), Scotty Moore (Music City) along with Jim Williamson, Bradley's chief engineer, all agreed that in most of Nashville's studios the need for close miking is not great due to an emphasis on acoustically 'dead' studios . . . to insure "a natural separation or isolation." According to Mort and Scotty, "You won't see blankets thrown over the pianos in Nashville. Generally we aren't after that kind of separation, isolation, in country music anyway."

In Thomasson's words, "...but if we had a leakage or isolation problem we would start looking for a studio fault before anything else. Your studio has to be something you can depend on, under all circumstances. An acoustically dead studio doesn't change its characteristics. You can always count on it to be the same, 'dead.' Say, you have a live studio with only six players in it . . . it is still live. With 35 players in it, absorbing all those standing waves, you have a problem trying to figure out what your studio is acoustically under those circumstances. If the studio is variable, that's just another problem to work out.

"I think that part of the problem with recording the piano, particularly, is that you are not hearing what you think you are hearing. The point that I am making, is that 'flat is flat' . . . your interpretation of 'flat' may only be a deficiency in your own hearing. Today, we are fortunate in having a piece of gear which will accurately show us what we have in the speaker system and the control room, an analysis of 1/3 octaves, instead of full octaves. We are fortunate because if you look at full octaves you are still kidding yourself. A full octave analyzer will still not show you the drastic holes and peaks in your reproducing system . . . that is your speakers. (The first thing I ever learned was that the speakers were the weakest link in the recording system . . . but over the years you learned to live with them day in and day out.) Since we have had our speakers tuned to the control room with third octave filters, we can go back and play some tapes which we thought were bad when we had originally mixed them, but when we played them back on our 'Lectracoustics' system that we had installed we found that we had, indeed, gotten the sound on the tape electrically. We were just never able to recover as much of it as we should have been able to. I think that this voicing system has made our mixdowns much easier for us.

"On the matter of EQ-ing piano, or anything else, when you can't hear the playback properly then you

are going to be addicted to EQ-ing. You really shouldn't have to try to outguess your system with EQ."

Confirming the 'no-blankets', 'dead-room' attitude in Nashville is Owen Bradley's comment, "...we don't like that (blankets) . . . I'd rather give the sound some room to roll . . . and if I was bothered by what it was rolling into (other microphones) I'd do one of two things . . . let it roll into something dead . . . like our soft wooden walls, or a dead baffle that's always, away. Or, I'd isolate what the piano is rolling into. I think that the piano has to have some room to range in."

Again from Nashville, at RCA this time, Tom Pick and Ray Butts use another two microphone set-up for their Floyd Cramer sessions. The first microphone, a transistorized U-47 in cardioid position (they were unhappy with the original 'nu-vista' modification) is used over the second tuning hole from the front, and, about a foot above Cramer's nine foot Baldwin grand. They use some boost, about +4dB at 7KHz with a 50Hz cut-off. "One of the reasons we use the high frequency EQ", comments Pick, "is that the 47 also has a built in sibilance filter in it too. Without the filter we would probably just use it flat." "The U-56 in omni pattern over the third hole from the back is used without EQ for the low end pick-up. We use limiting on both, but just for peak limiting protection. The fact that Cramer records on the same piano every time he is in the studio, allows us the luxury of an almost standard set-up for him. There are marks on the piano which we use as guides for lining up the microphones."



Floyd Cramer's Baldwin at RCA, Nashville

Returning to the subject of 'damping': "But," as Bill Lazarus of Sunset Sound points out with regard to the need for damping with a blanket, "there is nobody in that room who is playing any note that the piano doesn't have, and won't reproduce. There are times when you damp the piano to keep sounds from leaking out onto other instrument mikes, and there are times when you have to keep other sounds out of the piano itself. The piano with all those strings and the sounding board can be one big acoustic magnet. The piano is a naturally reverberatory device."

Illustrating the reverberatory qualities of the piano is the sometimes used technique of having a vocalist sing directly into the open lid of the piano, across the strings, with the sustain pedal depressed. Marc Aubort discusses this technique as used on a recent recording of George Crum's "Voices Of The Ancient Children." The effect from the sympathetically resonating strings is one of an eerie, wild, from the ages kind of sound.

Aubort is fond of using a relatively obscure European microphone, the Schoeps microphone, for many of his recordings of the piano. He describes this microphone as being very even, with a warm coloration to the sound produced. In Aubort's words, "I chose these microphones because they give me an unpeaked sound. It is my feeling that the piano is a most beautiful instrument, and that you cannot do anything better than to *stay* with a good piano. Whatever you try to do to enhance it is going to be detrimental to the instrument itself . . . in a very fine instrument there is no need for fiddling around. All you are doing is introducing variables, which are harder to handle.

"I prefer to use two microphones on the piano, and position these so that I have a compromise between the actual presence or closeness and what I want to hear coming back from the room . . . the walls."

A variation of the two microphone set-up which we hadn't seen very much before, is Doug Botnik's over-the-hammers set-up using two Neumann M-49-c's in fan configuration, caught during a session with 'Earth, Wind and Fire' at Sunset Sound. Botnik EQ's the mikes through a Pultec at +4dB at 60Hz, and +4dB at 8KHz, along with +2dB at 5KHz of peaking EQ. "The 49 series microphones, widely used for symphony recording," comments Doug, "has an extremely wide pattern . . . picks up more overtones . . . reputedly has the largest diaphragm of any condenser microphone."

M-49's in fan configuration

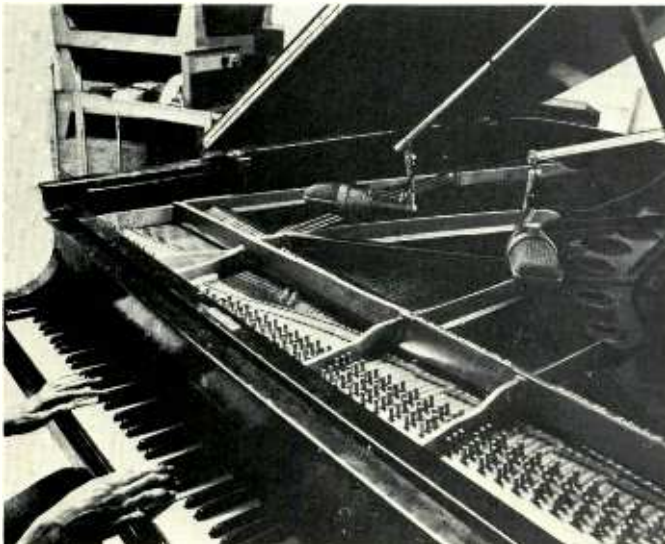

From National Recording Studios in New York, where for the past few years he has had the engineering responsibility for Ferrante and Teicher

sessions, Frank Kulaga comments on recording duo piano. "I have the problem of making it appear that Ferrante and Teicher are playing on pianos with keyboards 80 feet long . . . that's the kind of sound that they want. They select their pianos for exceptional brilliance, and I suspect have them tuned a shade sharp. This says to me that I want to mike them as closely as possible so that all the keys across those 80 feet of keyboard can be heard. On the first try I'm generally a little too close over the hammers, which favors the brilliance they want, but is less than the kind of natural, more legitimate sound that they want. We wind up generally a couple of feet down from the hammers.

"We are using padded U-67's, one over each piano, and since we have feedback controls on all of the pre-amps it's really possible to load them up without overloading the pre-amps. Ferrante and Teicher are very sensitive to distortion.

"You would think that in this situation the closeness of the pianos to each other, and we try to get them as close as possible, might be a problem. It isn't, when we try to keep the microphones as close to the hammers as we can. We get the brilliance that they want as well as keeping more bottom. The Ferrante and Teicher sessions are pretty much straight ahead. We don't have to do very much once we get them on tape. Whatever they want to hear in a piece they are going to write into it . . . the dynamics are not artificial . . . they are the real thing, just as they are being played."

Or, as Bill Lazarus points out in discussing some of the same things, "If you want a less piercing piano sound, move back from the hammers. Get back to where the strings finally have the chance to react from the pure percussion attack. Give the long overtones a chance to sound. If you are not too concerned with isolation you might try miking from below the piano . . . you will get a rich, fuller set of tones with very little of the percussive transient. In doing this you will have to open your module way up, to get all the subtleties of the sound, because this is not one of the prime directions in which the piano projects its sound. With the level of the module wide open, or nearly so, you are in danger of picking up everything else in the room." (A good deal of TV piano miking is done with the microphone under the piano to keep the microphones as invisible as possible.)

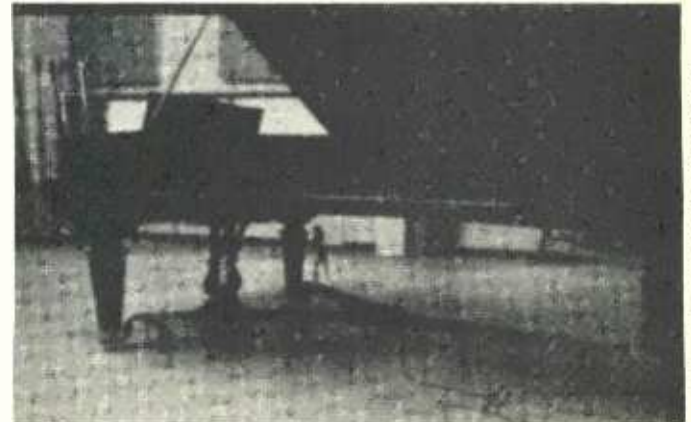

Under the sounding board at Sunset, Hollywood

Ingoldsby, again, with an idea voiced by several others, "If the long overtones (sustain) are a problem in a particular set-up you can always ask the piano player not to use the pedal, with the assurance that you can add just the right amount of echo later. It's sometimes easier to control the sustain with echo rather than to have the player control these long overtones with his pedal."

If brilliance and brightness are the qualities that seem to be most in demand, and close miking over the hammers doesn't seem to be the answer, it is the advice of almost all to look a little more closely at the piano itself. There are several things that can be considered, among them, tuning sharp, sanding or shaving the hammer felts, and hardening the hammers.

Each of these techniques does increase the attack transient significantly, but with the manipulation of the hammers, either sanding, shaving or hardening, it is said that there is some sacrifice of sound volume. The thinner the sound the fewer long overtones.

TUNING

Concerning the practice of tuning sharp, there are reports of tunings of from 441 to 444. Nobody seems to know how the practice got started, but there are tales about some of these extreme tunings that go way back in symphony experience, from which the practice was adopted by the big bands in their era, to today's use in the studios. It is most commonly said that the reason for tuning sharp is to get the whole band "charging." From another general quote, "nobody could lay back, or they would get lost."

While there is still quite a bit of sharp tuning on straight-ahead band sessions, the technique just doesn't work at all well when sharp piano is played against electronic instruments which cannot change intonation to get up with a sharp piano, or sharp strings.

Mort Thomasson observes about the choice of a piano, "... in a piano you separate the goats from the sheep from middle 'C' down. Most pianos seem to be pretty much the same from middle 'C' up. At the low end, down there, that's where the balls, the guts come from. A good piano in that low area is a big help, especially in some of those semi-country, country-rock things with those 4/4 shuffles where you need that low end. In our kind of music, any time the piano drops out on a shuffle for a fill you can certainly miss it. It sures leaves a hole in the recording."

UPRIGHT PIANOS

Two basic upright piano set-ups are exemplified by the photos supplied by Sigma's, Joe Tarsia and MCA's, Brian Ingoldsby. Separated by a continent, Philadelphia to Los Angeles, they never-the-less have come up with approximately the same microphone selections for their different placements. Tarsia uses a Neumann U-87 in the top of the upright, slightly favoring the high end. If a fuller sound is desired, a Sony C-37 is placed facing the sound board in back of the piano. The Sigma upright, a Cunningham, is

It's MCI's new total-logic JH10.

The logic is so total, not even a power failure (much less an engineer failure) can break or spill the tape.

"Sudden" is the most accurate word we can find for JH10's acceleration from "Stop" to any commanded tape function.

And for its conversion time from one- to two-inch, and vice versa.

Practically everything is plug-in for fantastically simplified maintenance and expansion from, say, 8 to 24 tracks.

Constant, electronic (not mechanical) tension control sensing reduces head wear, wow, flutter and speed variations.

Prices start at \$3,500.

Write: MCI, 1140 N. Flagler Dr.,
Ft. Lauderdale, Fla. 33304 • 305/524-3318.
Distributed West of Rockies: Westlake Audio,
1047 Twinfoot Court, Westlake Village, Cali-
fornia 91361 • 805/497-7924

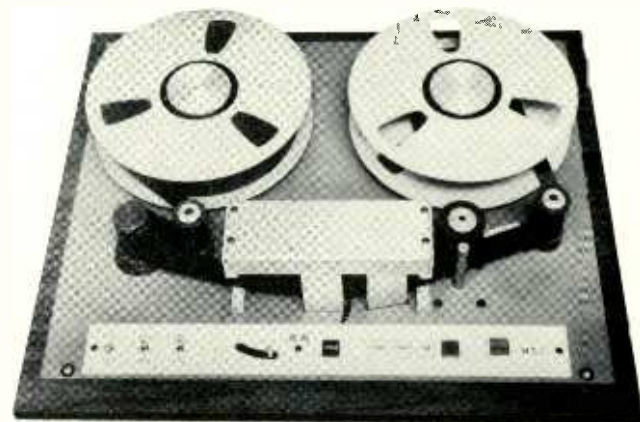

treated in two ways. First, the hammers have been hardened with two or three coats of shellac (some use acetone), and second, the third strings of the high end notes have been tuned "slightly sharp." "Both of these treatments," says Tarsia, "give the piano a very bright sound which can be buried in a mix and still cut through and be heard." MCA's Ingoldsby arrived at his upright miking set-up a couple of years ago when doing Joe Cocker's "A Little Help From My Friends" with their 'tack" piano. Ingoldsby, too, uses a Neumann U-87 with a Sony 107, both in cardioid position, placed between the back (sounding board) and an absorbent baffle. "By using two different types of microphone we are able to pick-up different acoustic characteristics while eliminating the chance of phase cancellation effects. Because of the spread of the microphones across the back of the crisscrossing string patterns in front of the sounding board, this set-up yields a very even coverage of all of the octaves."



← Upright miking at Sigma



Upright miking at MCA
Recording, Hollywood →

Lazarus, at Sunset, when overdubbing the upright, removes the front panel facing the player and hangs a microphone, generally a Sennheiser 405, over the shoulder of the player facing the strings. This placement, he says, "produces a sound similar to the over-the-hammers sound of the grand, when used on the upright." The percussiveness of the attack is greatly emphasized. However, removal of the front panel increases the possibility of leakage, thus the use of this method more in overdubbing than otherwise. In positioning the microphone the playing freedom of the player must be respected as well as an allowance made for the player's breathing sounds, with the microphone that close to him.

ELECTRONIC PIANO PICK-UPS

The search for ways to record the piano naturally, with great brightness, and coverage of the full keyboard has led to some great inventiveness, as well as unique adaptation.



Countryman piano pick-up

One has to wonder, if you had never seen the thing before, what it is they are pumping into the piano on which sits a Countyman Piano Pick-up. After hearing good things about the unit from David Freiberg of Quicksilver Messenger and Jazz Player Denny Zeitlin, we asked Carl Countryman for a few words on his rig. Countryman explains, "Our electrostatic piano pick-up works in a very similar way to a condenser microphone. Most condenser microphones operate by placing an electrically conductive diaphragm a few thousandths of an inch away from a relatively massive metal plate. This forms an electrical capacitor capable of storing a charge when a voltage is impressed between the diaphragm and the stationary backplate. Sound pressure moves the light diaphragm varying the interplate distance and the electrical capacity. The microphone element is placed in a circuit which will not allow the charge on the element to vary at audio frequencies. The changing capacitance cannot vary the charge, so that the voltage varies instead. This varying voltage is amplified and constitutes the audio output signal from the microphone.

"The electrostatic piano pickup works in much the same way. It, however, uses the piano strings themselves as the movable electrode in the condenser microphone. The fixed plate is hung on ceramic insulators and suspended about 0.1" away from the strings. As the strings vibrate their distance to the plate varies. The plate is attached to a small box housing the plate charging circuits and field effect transistor preamplifier, which are similar to those used in a standard condenser microphone. Because the pickup senses string motion directly, it is particularly insensitive to external sound.

"These pickup plate assemblies are attached to the piano with an extremely versatile frame made from 1/2" aluminum bars and die cast connecting clamps.

This mounting system has fit easily on every grand type piano any of the pickup's users have encountered on tour. The preamps are connected electrically to a central power unit that can be seen sitting on the piano to the left of David Freiberg, in the photographs. This unit powers the preamps, mixes their outputs together with gain control on each pickup to allow balancing the piano's response, provides basic low and high frequency equalization, and drives several isolated output lines to feed P.A., stage monitors, tape recorders, etc. . . ." Or, as David Freiberg recommends, ". . . the best thing about it is that it makes a piano sound like a piano."

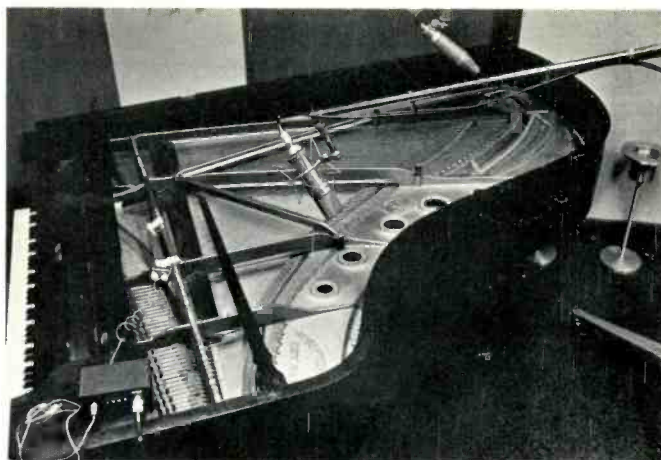

Autoharp pick-up at MCA

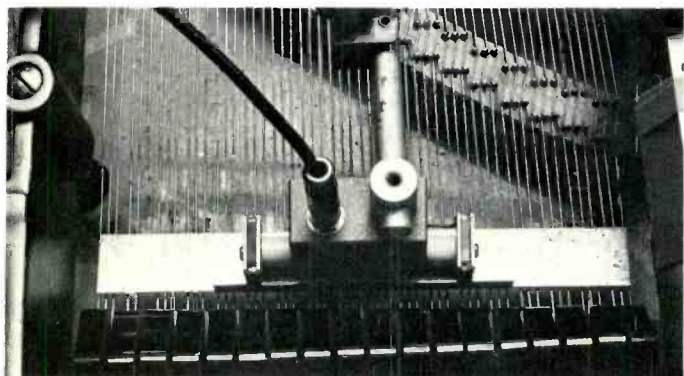

Brian Ingoldsby, as shown, has adapted a DeArmand Model 1300 Auto-Harp pick-up for use in combination with two U-87's. The pick-up is attached

to the frame over the hammers, with nothing more than some tape, and covering the one principal octave in which the tune is being played . . . the octave which the player is going to return to throughout the piece. "We used this set-up on Jim Webb's last album, 'Words and Music.' We picked up one of the U-87's on the left channel, and the other one on the right channel . . . and the auto-harp pickup we used as a blend between the two. The quality of the sound? It's almost an electric sound, but it has the timbre of the true piano sound. However, you can change the tone quality, if you want to, by adjusting the tone control on the unit. We operate the pickup full open for the most natural sound."

END



© COPYRIGHT GENERAL FOODS CORP.

COME AND SEE ALLISON AND HER FRIENDS, AND THE GAIN BRAIN AT THE A.E.S. CONVENTION. KEPEX WILL BE THERE TOO.

Exclusive export agent: GOTHAM AUDIO DEVELOPMENT CORP., NEW YORK, N.Y.



ALLISON RESEARCH, INC.
7120 SUNSET BOULEVARD
HOLLYWOOD, CALIF. 90046
(213) 871-6615

Circle No. 108

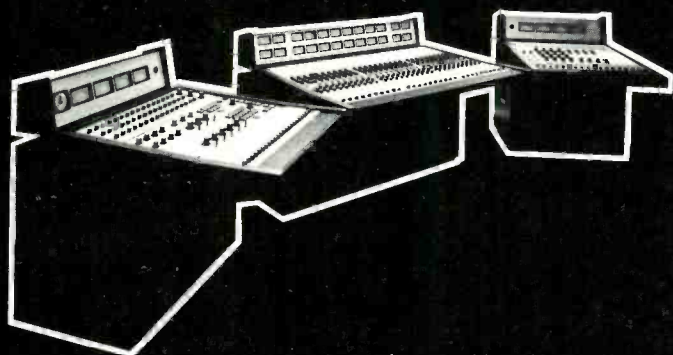
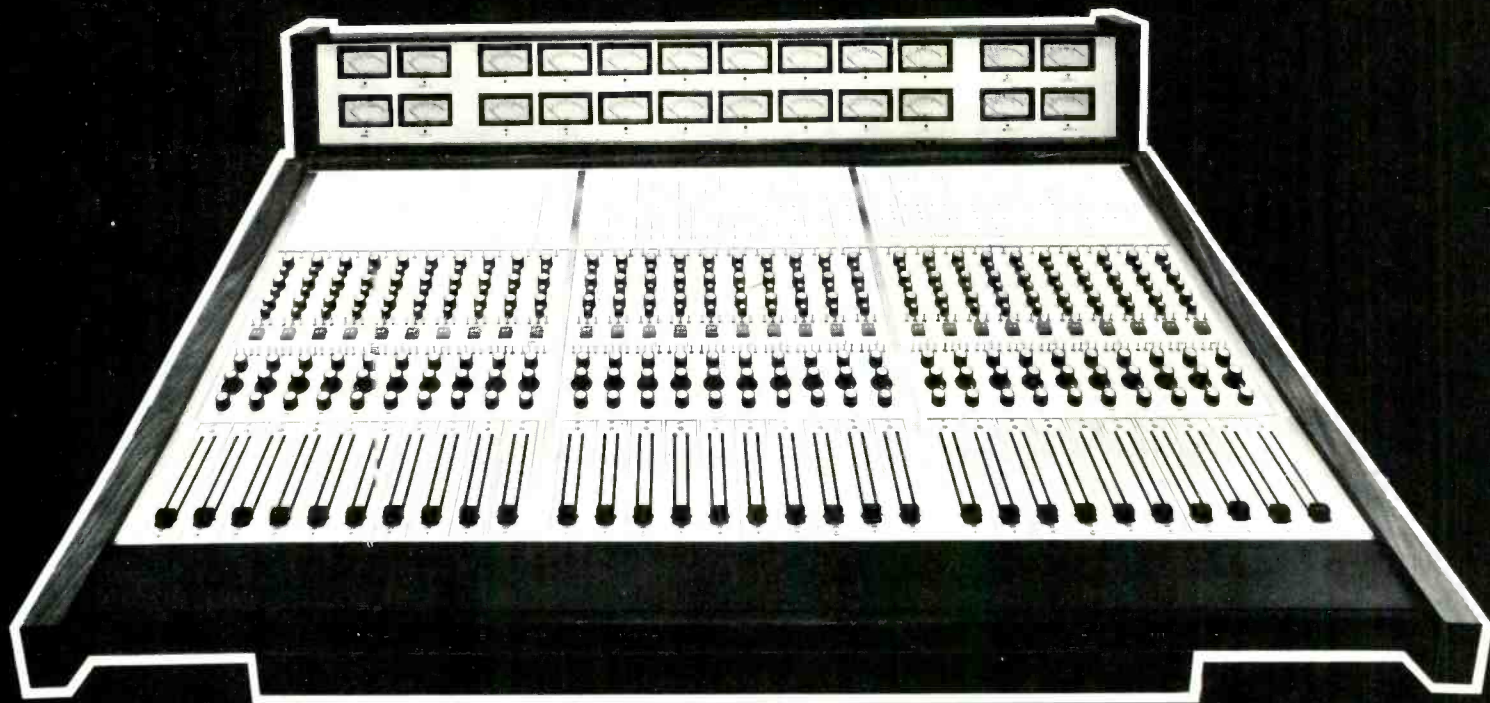

Latest addition to the ever increasing number of "Beyond the State of the Art" audio control consoles, this custom system was designed, fabricated, and installed by SPECTRA SONICS for RECORD PLANT in New York. Representing the ultimate in sophistication, three separate consoles perform the individual functions of: input control, master output control, and monitor control. Designs of advanced flexibility and performance, such as these, are the only guarantee against obsolescence with the passage of time.

For information on custom or production consoles that are both functionally and measurably "Beyond the State of the Art", contact SPECTRA SONICS at 770 Wall Avenue, Ogden, Utah 84404 (801-392-7531) or at 6430 Sunset Blvd., Hollywood, California 90028 (213-461-4321).

SPECTRA SONICS

LEADER IN ADVANCED TECHNOLOGY



MICROPHONES . . . the need for a consistent performance, monitoring program . . . a basic 'A-B' method for monitoring response characteristics.

Perhaps a typical case history, from a full file of similar experiences, gathered over the years, will serve best to illustrate the need for a consistent microphone maintenance program. Or, if not an inhouse maintenance program, at least a consistent microphone performance monitoring program.

Some time ago while visiting with the chief engineer of a prominent recording studio, a discussion of microphone maintenance was triggered by observation of several assorted microphones lying about on a dusty riser, in preparation for mounting on stands and booms for that day's sessions.

All of those microphones were about two years old. They had been in almost daily service. All were considered to be in normal operating condition.

After a cursory inspection of each microphone, and on learning that the studio would be shut for a two week vacation, we offered to run curves on all of them and service those which needed servicing. This offer was made in return for the opportunity to study the frequency responses of this batch of microphones which had been in 'normal' service over this period of time.

As a result of our offer twenty eight microphones were shipped to us. On their arrival, the very first thing we did was to run curves on each of them. Then all diaphragms and grills were properly cleaned.

OUR FINDINGS:

Of the eight condenser microphones received, the response of each was found to be degraded. After cleaning, the two containing metal diaphragms returned to normal response. The six which contained metalized plastic diaphragms improved considerably after cleaning, but the response of no two was alike, and none were measured equal to a new microphone of the same make and model.

The eleven dynamic microphones were examined, and all were found degraded. After cleaning only the dust filters protecting the diaphragm, eight of them were returned to normal response. Three (of another make) had permanently warped diaphragms due to ferric dust accumulation above the voice coil gap.

Of the nine ribbon microphones, all were found loaded with ferric dust and ribbons stretched beyond repair.

In comparing curves of new units of each model with those curves of the ones sent to us, only a few were recognizable as the same microphone before cleaning.

It seems incredible that reputable and recognized recording studios, and, we must stress again that the foregoing case history is only one of many very similar to it, are depending, inadvertently, we are sure, on degraded microphones to reproduce quality sound. If Equalization had not been available, several of these microphones could not have been used at all.

We have had users of large quantities of microphones, such as TV networks, ask for information on our anechoic chamber and curve tracing equipment with the idea of duplicating our set-up, to be able to cull out their own degraded microphones. A reproduction of our laboratory would certainly supply the answers, but the cost would be prohibitive to all but the largest users. Too, reproduction of such a set-up would yield little useful information that the microphone user cannot now obtain through use of existing equipment in all studios equipped with multi-channel consoles.

We will describe this simple method for verifying the response of microphones after just a brief word concerning Dynamic Microphones.

THE DYNAMIC MICROPHONE

Simply stated the dynamic microphone employs a magnet without which it would not operate. The magnetic flux supplied by the magnet so necessary for its operation can inadvertently be the means of its failure.

Let's suppose that a dynamic microphone has just been acquired. The carton is about to be opened on a work bench in a maintenance department in preparation for soldering a connector to the far end

of the cable.

At this point "STOP!" Go no further until it has been made certain that all dust has been cleaned from the bench, and then make doubly certain by spreading a piece of clean newspaper. Then and only then should the microphone be removed from its container and placed upon the bench. This procedure must be followed with microphones containing magnets since the always-present stray magnetic field will attract ferric dust to the microphone. Whether this dust will cause immediate damage depends on how well the manufacturer of this particular microphone has protected its diaphragm. Some units have practically no protection from dust, just a grille screen and a piece of cloth. If the diaphragm can be seen through the grille screen, there is little or no dust protection. The grille of this microphone should be covered with some additional protection such as a pop filter or wind screen.

Even those microphones that have several stages of dust filters built-in should not be exposed unnecessarily. This is important in all types and makes. Since the grille must be sufficiently porous to admit full range sound, it will most certainly admit dust, ferric or otherwise, and all types of dust can load a diaphragm and degrade response. This is usually a slow accumulative process resulting in a slow degradation of response. This degradation is so slow at times that the user seldom realizes what has occurred until an occasion arises when a new microphone of the same make and model is directly compared.

continued

by LOU BURROUGHS
VICE PRESIDENT
ELECTRO-VOICE, INC.

Never, never allow anyone to blow into a microphone of any type. One puff may force more dust through to the diaphragm than would normally penetrate in months of use. Breath moisture and saliva also will penetrate the grille, causing otherwise free dust to mat and stick to the grille cloth and dust filter. We have seen many microphones returned for service with grille cloth and filters so completely loaded with caked-on dust that frequency response was seriously degraded. Some of these only required new filter sections to return their response to normal.

When dynamic microphones are not equipped with adequate dust protection, airborne ferric dust (the most damaging type) will gradually sift through and accumulate on the diaphragm above the voice coil gap, which is the area of greatest magnetic flux concentration. If the accumulation is fairly well distributed around the voice coil, it will cause a stiffening of the diaphragm with a resulting reduction in low frequency response. The loss in low frequency response will increase as the quantity of dust increases.

Should the ferric dust accumulate on one side of the voice coil or at one spot, the diaphragm will move freely only on one side and will cause peaks and dips to

appear in the response. This accumulation does little or no permanent damage to the diaphragm unless it is allowed to remain. When the diaphragm is held in a deformed position for a matter of weeks, it will take a permanent set and will not return to normal when the dust is removed. In this case, only a new diaphragm will return the response to normal.

AN 'A-B' COMPARISON TEST FOR VERIFYING MICROPHONE FREQUENCY RESPONSE

The equipment required for this frequency response test is as shown in Figure 1. The comparison standard must, obviously, be a new microphone or one known to be in like-new condition, and both units must, of course, be of the same make and model. The method:

Mount the two microphones side by side as shown. Place the one to be used as the test standard in 'A' position. There must be little or no space between them. Connect each to a separate mixer channel. Connect microphone 'A' to channel 'A' using a normal microphone cable. Connect microphone 'B' to channel 'B', with a *cable wired electrically out of phase with 'A'*. The two channels are then fed to one volume-level meter.

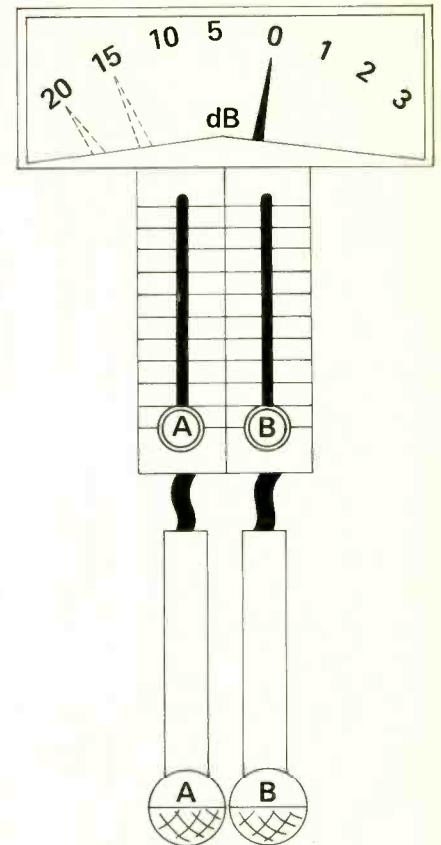

Locate the microphones on the console or in a position where they may be spoken to at a distance of approximately one foot and directly between them, where the gain controls may be reached and the meter seen without changing position when speaking.

Begin the test by setting both gain controls at zero. Then saying "one . . . one, one" over and over, advance gain control A until the meter reads zero. Repeat saying "one" with sufficient rapidity that voice level is easily maintained. This is very important. When level at zero has been established, turn off gain control A and repeat the procedure with B. Do not stop talking until the test is complete. When you have established the level of both microphones at zero, turn them both on at this level. If the response of the two is a near match, the level on the meter will drop below -15 db. The closer the match, the more the level will drop. When the meter indicates above -15 db, the response is sufficiently mismatched to warrant its return for service.

The answer to maintaining microphone response is simple. Keep them covered when not in use. Place them in their boxes or cover with a canvas or felt bag containing a zipper or drawstring. Do not use plastic bags as the microphone may sweat.

END

THE PHASER



Would you use phasing and flanging effects more often if they were less difficult to obtain? Now you can produce these effects without tape machines, reproducibly and with complete control.

The Type 967 Phase Shifter electronically delays an input signal and then mixes the delayed and undelayed versions together. It allows you to add the striking "turning inside out" effect of Phase cancellation to any audio signal live or recorded, in the studio or in performance, in minutes instead of hours.



**COUNTRYMAN
ASSOCIATES**

424 University Avenue
Palo Alto, Calif. 94302
Phone 415-326-6980

Circle No. 110

Announcing the recorder with 10 times normal head life.



How the Norelco Pro 36
Studio Recorder keeps its
heads when all about
are losing theirs.
(And their sound quality too.)

Conventional recording and playback heads wear out within a couple of thousand hours of use. But long before then, their electrical characteristics change . . . so your sound changes too. With the Pro 36 studio tape recorder, these problems are non-existent.

Reason: Norelco's exclusive glass-bonded Ferroxcube heads. Made of material almost diamond-hard, they take 10 times the wear of conventional heads. But that's not all. The unique glass-bonded construction maintains precise gap width and electrical characteristics in spite of wear. Amplifier adjustments are virtually never needed. And precision head mounting also makes azimuth adjustment a thing of the past.

The rest of the Pro 36 lives up to the heads. It's the only professional tape recorder with 3 speeds. You get 15, 7½ and 3¾ IPS. Electronically switchable.

Then there's the new ultra-stable Servo tape transport control. A photocell counts capstan revolutions, compares them to line frequency, (or external 1 volt reference source) and provides instantaneous speed-correction signals. To this, Norelco adds constant capstan loading. Plus automatic tape tension control. All together, they hold wow and flutter down to 0.04% maximum.

Other features: total remote control, push-button semiconductor switching, NAB and CCIR equalization, provision for fourth head, controlled tape lifters, horizontal or vertical operation, and much more.

Every broadcast studio, production studio, and sound studio deserves the tape recorder that keeps its head . . . so you won't lose yours. The Pro 36! Contact Norelco for all the technical data now.

PERFORMANCE SPECIFICATIONS

Wow and Flutter:

weighted peak value at 15 in/s: max. 0.04%

Overall Frequency Response (NAB Specs):

at 15 in/s: 30 . . . 15,000 Hz ± 2 dB

at 7½ in/s: 30 . . . 15,000 Hz ± 2 dB

at 3¾ in/s: 50 . . . 10,000 Hz ± 2 dB

Signal-to-Noise Ratio: NAB unweighted (reference standard operating level)

62 dB at 15 in/s

60 dB at 7½ in/s

56 dB at 3¾ in/s



Glass-bonded Ferroxcube heads make possible an incredibly precise gap width and hold that precision throughout a wear life 10 times longer than conventional heads. The Pro 36 is the only studio tape recorder that has them.



One Philips Parkway, Montvale, N.J. 07645 (201) 391-1000

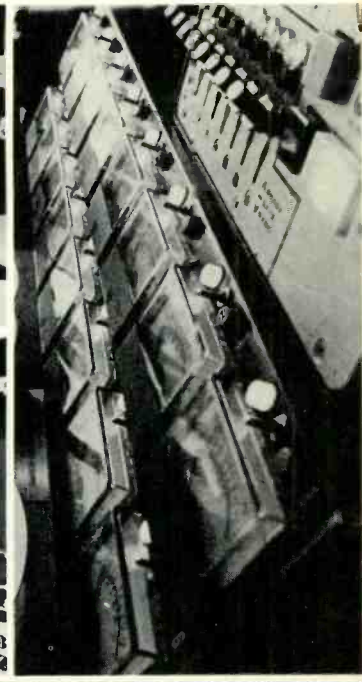

Wally Heider's studios are all 3M.

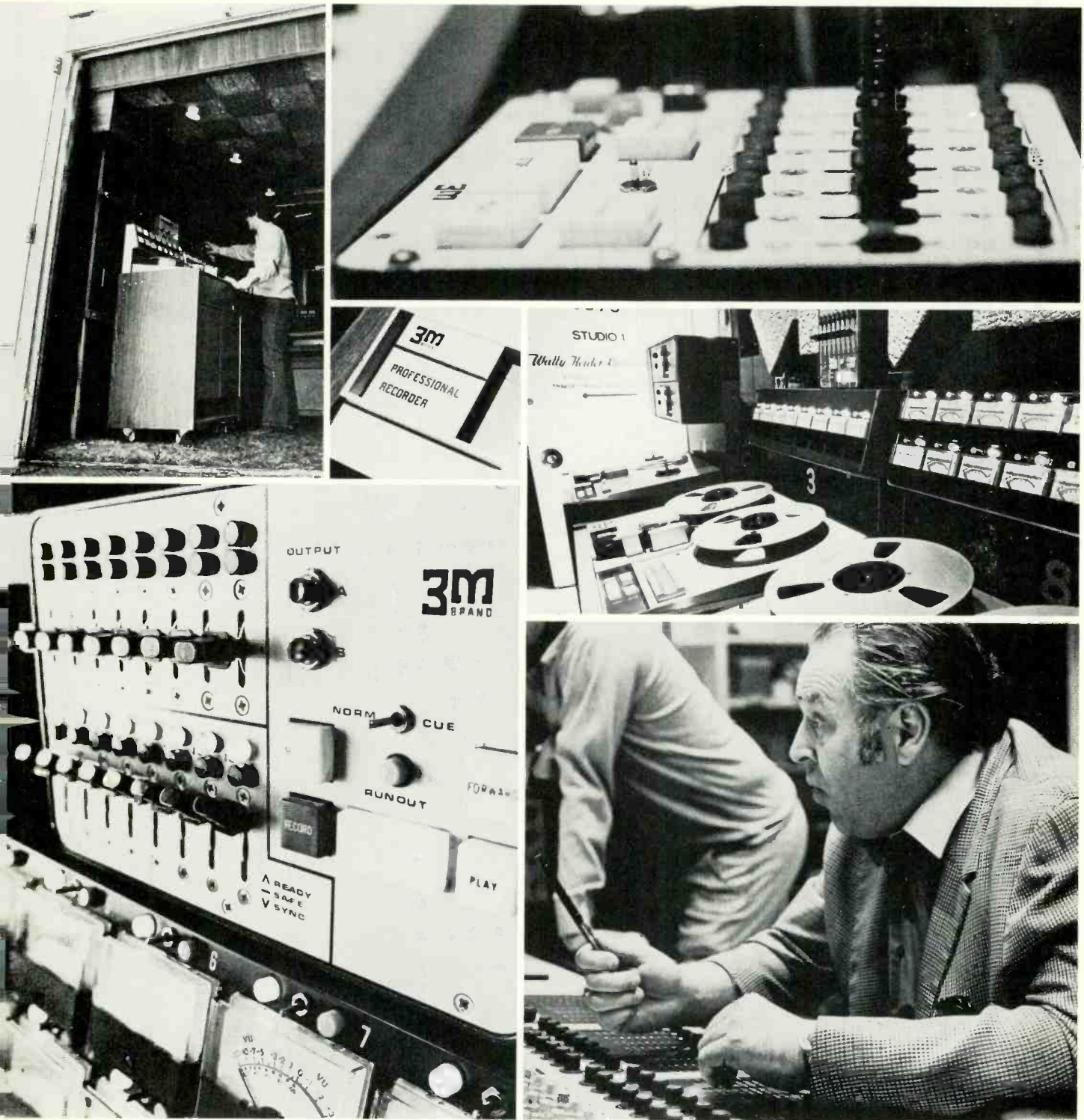

Here's why:

"Tape speed accuracy, for instance. Take any machine, record a tone on the head and tail of the reel, remove the unused tape in the middle, splice the ends together and — unless you've got a 3M machine — listen to the pitch change. This test works on any machine from mono to 16-track. There's no other machine I know of that can pass this test.

"And besides, people who work with us prefer to work with 3M, both in the studio and on remote, so what else can I say?"

Wally Heider,
 Wally Heider Sound Studios, Hollywood

Circle No. 112

The studio console you're now dreaming about

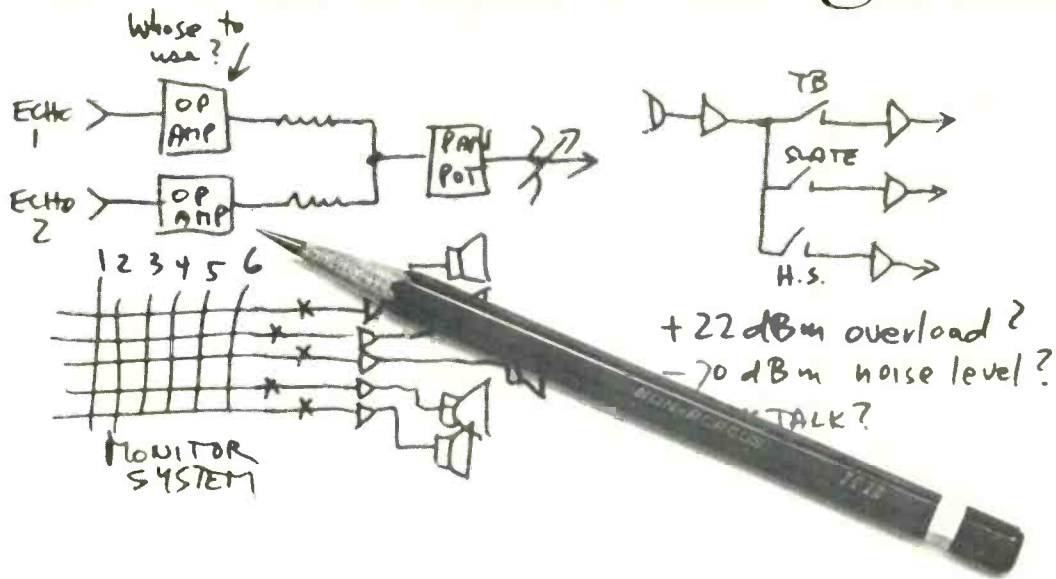

can be delivered next week.

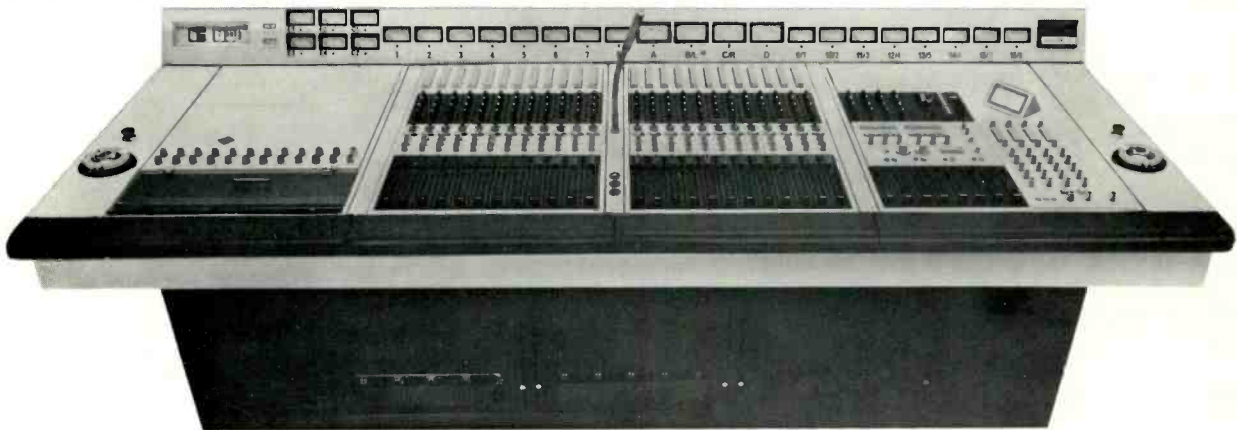

Stop doodling and start making money. We have your 16-track dream board in stock. Ready to go to work for you, just as soon as you give the word. (Five 8-track boards are already in service from coast-to-coast.)

This remarkable unit was designed and built for us by Neumann, the finest name in audio equipment. It has every important feature you'd specify if you were having it custom-made. Plus a few even the most designing engineer might overlook. Consider these features:

Twenty-four inputs, and sixteen output channels, with mix-down to 8-track, quad, and stereo simultaneously.

Plus: 16 pan-pots, 2 cue and 4 echo channels, 4 remote echo controls, 4 remote tape controls, talk-back limiter, day-date-time digital

clock, digital electronic stop timer, U-79 Correlation Meter (Compatibility Guide), full 312 jack patch bay, and phantom powering for your Neumann FET-80 microphones.

It even has two cigarette lighters and ash trays. Unless you insist on using the faders for that. They don't mind.

The price? No, it's not inexpensive. This console is built, after all, to the same standards as Neumann microphones. For continuous service-free performance. So, call us today. You'll sleep better tomorrow if you do.

GOTHAM
AUDIO CORPORATION

2 West 46th Street, New York, NY 10036 (212) CO 5-4111
1710 N. LaBrea Ave., Hollywood, CA 90046 (213) 874-4444



A SALUTE TO THE ENGINEERS THE PRODUCERS, THEIR STUDIOS ... FOR THE PARTS THEY PLAYED IN 'MAKING' THE RECORDINGS WHICH WON THIS YEAR'S NARAS AWARDS

RECOGNITION 1970

BEST ENGINEERED RECORDING (non-classical)

ALBUM OF THE YEAR

RECORD OF THE YEAR

engineer: ROY HALLEE
producers: PAUL SIMON, ARTHUR GARFUNKEL, ROY HALLEE
studio: STUDIO 'A', COLUMBIA, HOLLYWOOD
recording: BRIDGE OVER TROUBLED WATER

BEST ENGINEERED RECORDING (classical)

engineers: FRED PLAUT
RAY MOORE
ARTHUR KENDY
THE CLEVELAND ORCHESTRA, Pierre Boulez
STRAVINSKY: LE SACRE DU PRINTEMPS

nominees for best engineered recording

engineers: RAY GERHART
DICK BOGERT
producer: JACK DAUGHERTY
studio: A&M, HOLLYWOOD
recording: CLOSE TO YOU

engineer: PETER KLEMT
producer: MILT GABLER
studio: HAMBURG, GERMANY
recording: THE KAEMPFERT TOUCH

engineer: ARMIN STEINER
producer: TOM CATALANO
studio: SOUND RECORDERS, HOLLYWOOD
recording: TAP ROOT MANUSCRIPT

engineers: DEREK VARNALS
ADRIAN MARTINS
ROBIN THOMPSON
producer: TONY CLARK
studio: DECCA, LONDON
recording: TO OUR CHILDREN'S CHILDREN

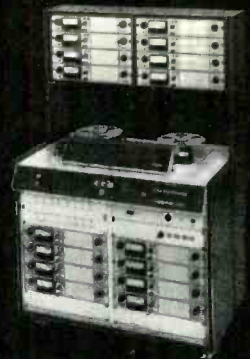

All together now...

Every beat, every note, tone, nuance faithfully reproduced. Every machine faithfully reproducing in sync. Ampex, leader of the 16-channel revolution, strikes again!

Now! The MM-1000 gives recording studios and teleproduction houses a new spectrum of creativity and quality. Now! The MM-1000 provides time and money-saving features offered by no other multichannel recorder.

Recording studios can lay it down like never before with the MM-1000's exclusive Capstan Servo accessories. Through the reel timing accuracy. Precise pitch. Variable speeds. Every sound the same because record and playback are exactly matched: whether standard 7½, 15, 30 ips, or varied. Plus, 16 fully calibrated channels and the rugged reliability of the recording world's most popular multichannel recorder.

Teleproduction houses can attain multichannel sync like never before with the MM-1000's new Auditec System. Auditec, coupled with an automatic programmer provides direct synchronized linking of multichannel audio recorders with videotape recorders and station sync pulse. For the first time, multichannel audio can be recorded, programmed, and played back in automatic broadcast sync with other video and audio recorders. Producers and clients can change, correct, and approve synchronized sound and picture in one quick, convenient session.

Get right on with the MM-1000's. Ask your Ampex Representative about a Lease/Purchase Option, or write:



Ampex Corporation, Professional Audio Products Division
M.S. 7-13, 401 Broadway
Redwood City, California 94063

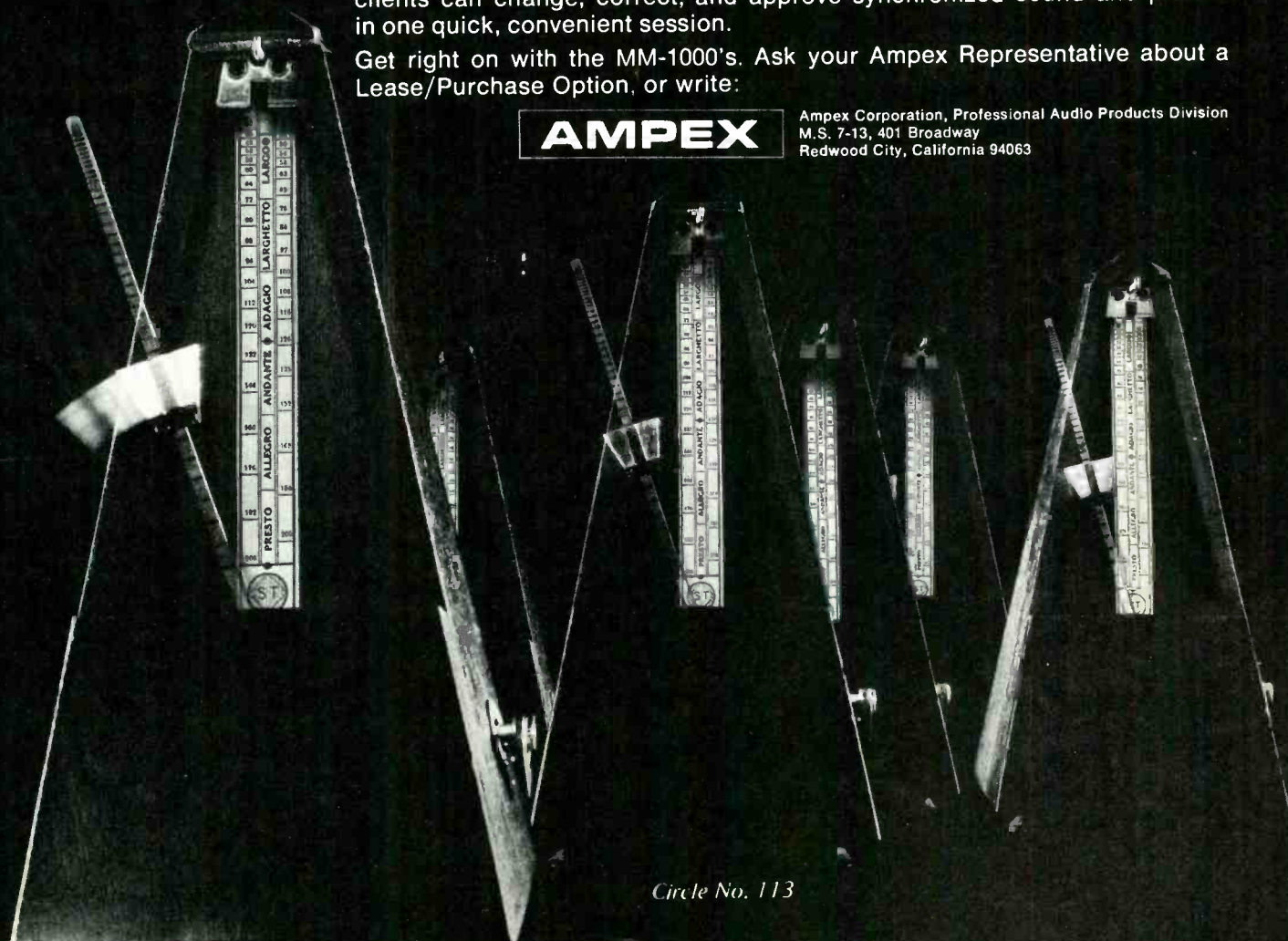

Circle No. 113

Bi and Tri AMPLIFICATION

by ALBERT SINISCAL
SPECTRA SONICS

One of the major goals in a sound reproduction system is the precision division/conversion of the full audio spectrum, at line power levels, into partial audio spectrum segments at the high power levels required to drive partial range acoustic transducers.

Both amplification and division must occur but, no longer necessarily in that order.

Amplification/frequency division has most commonly been accomplished by using one high power amplifier and channeling its full force first to a passive crossover network, usually mounted in the speaker enclosure, and finally to the individual acoustic transducers.

Conversely, frequency division/amplification is accomplished by first dividing the audio signal at a lower, non-critical level, with an electronic or passive crossover, after which separate power amplifiers for each frequency range are coupled directly to each individual acoustic transducer. Depending on the number of frequency divisions selected for separate amplification, two or three ranges, this latter method is commonly called bi- or tri-amplification.

Figure 1, illustrates the typical amplification/frequency division arrangement.

Figure 2, illustrates a frequency division/bi-amplification configuration similar to that being used in many top quality professional recording studio monitoring systems and broadcast studios such as Motown Records and Larrabee Sound in Hollywood and National Public Radio in Washington, D.C. Performing arts applications include such users as the Denver Symphony. Figure 3 illustrates an electronic crossover/tri-amplification configuration.

Figure 4, illustrates a high power/intensity electronic crossover/tri-amplification variation. Either system is extremely flexible and can be utilized to drive a number of different speaker systems with different purposes. For example, the system in Figure 4 is being used for fine quality recording by LONDON DECCA in Vienna, Austria. On the other hand, it is also being used for the performing arts sound reinforcement as typified by the TORONTO PAVILION, Toronto, Canada. And finally, because of the tremendous increase in effective power, it has been used often to drive very high intensity sound systems required at outdoor rock concerts and other permanent outdoor systems such as those at the HOLLYWOOD BOWL, Hollywood, California.

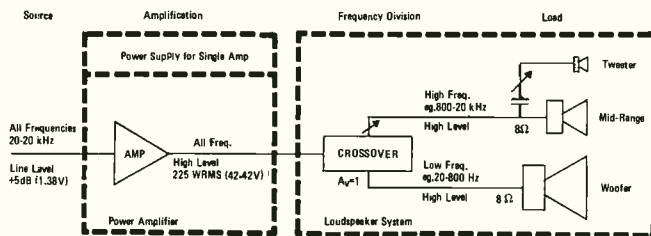

Figure 1 Single Amplification

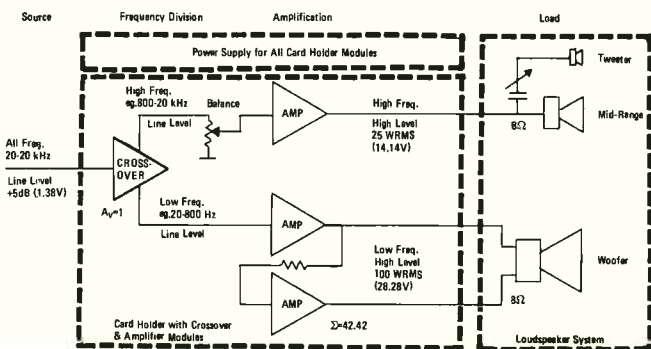

Figure 2 Bi-Amplification. The peak power available with a 25 WRMS and a 100 WRMS amplifier in the bi-amp configuration 2, is equivalent to a 225 WRMS amplifier in the single amplification configuration 1. -Approx. a 2 to 1 available peak power increase for the biamp!

The amplifiers utilized in the installations are solid state, modular, plug-in units. A single amplifier will deliver 25 WRMS or greater to an 8 ohm load. For complete flexibility, two of these modular plug-in power amplifiers used together in a bridged (push-pull) configuration will deliver greater than 100 WRMS to an 8 ohm load. Therefore, all amplifiers are the same, whether used: 1.) singly for low power; 2.) in bridged pairs for high power; and/or 3.) in bi- or tri-amplification configurations for very high power. In addition each plug-in power amplifier module is individually fused on the output. This provides maximum safety for each individual loudspeaker component plus the amplifier module.

Power and Dynamic Range Advantages

The effective power increase offered by bi- and tri-amplification is much more than just a marginal improvement that only a select few can hear.

Referring to Figure 2), let us assume that the demand on the amplifier system simultaneously required both the full 100 watts RMS for the low frequency section and the full 25 watts RMS for the more efficient mid/high frequency section. Since:

$$P = \frac{E^2}{R} \quad \begin{array}{l} P = \text{Power, watts RMS} \\ E = \text{Amplifier output, volts RMS} \\ R = \text{Load Resistance, ohms} \end{array}$$

we develop the following:

For figure 1.

$$\frac{(14.14 + 28.28)^2}{8 \text{ ohms}} = \frac{(42.42)^2}{8} = 225 \text{ WRMS}$$

For figure 2.

$$25 \text{ WRMS} = \frac{(14.14 \text{ volts})^2}{8 \text{ ohms}}$$

$$100 \text{ WRMS} = \frac{(28.28 \text{ volts})^2}{8 \text{ ohms}}$$

$$125 \text{ WRMS}$$

Therefore, a 25 WRMS and a 100 WRMS amplifier in the bi-amplification configuration can provide the equivalent peak power of a 225 WRMS amplifier being utilized in the single amplifier configuration! This is a startling increase in available power and dynamic range of approximately 2 to 1! In many cases the cost of a single 225 WRMS amplifier (at 8 ohms) will be more expensive than the 25 and 100 WRMS amplifiers (at 8 ohms). Adding another amplifier for tri-amplification as shown in Figure 3 increases the available power ratio to approximately 2.5 to 1!

Referring to Figure 4 and making the same calculations the 25, 100, and dual 100 WRMS amplifiers in a high intensity tri-amplification configuration can provide greater peak power than that available in approx. a 1000 WRMS amplifier used in

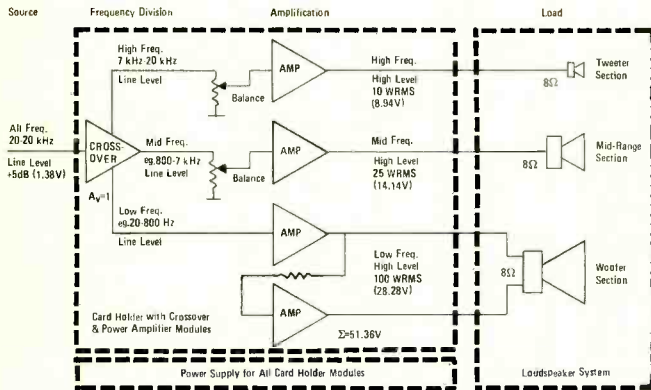

Figure 3. Tri-Amplification. The peak power available in this 135 WRMS tri-amp is equivalent to a 330 WRMS amplifier in the single amplification configuration—Approx. a 2.5 to 1 available peak power increase for the tri-amp!

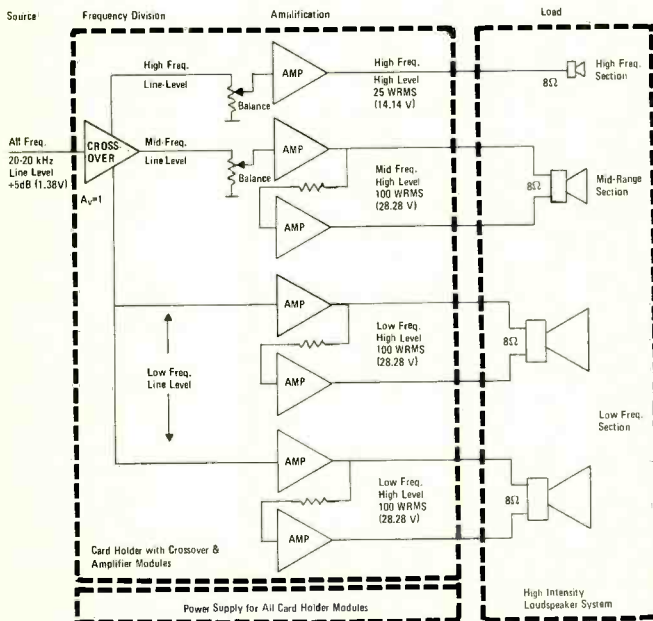

Figure 4. High Intensity Tri-Amplification. Available peak power in this 325 WRMS high intensity tri-amp is equivalent to approx. 1000 WRMS amplifier—Over a 3 to 1 available peak power increase!

the amplification before frequency division configuration. Now the increase in available power is well over 3 to 1! Thus via bi- and tri- amplification one may obtain greatly increased peak output listening levels not available using single large power amplifier methods. This increased peak output performance often may be obtained without a commensurate increase in power amplifier cost.

Lower Distortion and Improved Transient Response

In the amplification/frequency division setup, when any one single frequency overloads the amplifier (eq. a drum beat, or cymbal transient) all frequencies passing through the one massive amplifier will be distorted until the amplifier recovers. When this occurs, the higher frequency distortion is most objectionable and results in listener fatigue within a very short period. In the case of the frequency division/amplification method (ie. bi- or tri-amplification) the frequency sections are amplified separately and thus overload is restricted to a smaller portion of the total program bandwidth.

Obviously, the transient response/rise time also is improved dramatically when the frequency division occurs at a lower non-critical level, and when the amplifiers are coupled *directly* to the individual acoustic transducers. Elimination of large passive crossover iron core inductors, resistive, and capacitor circuits from between the amplifier and individual loudspeakers greatly improves the rate at which the

END

high level power amplifier energy can be transferred directly to each voice coil.

Similarly, as seen from the individual loudspeaker terminals, the physical removal of the high level crossover network improves the damping factor and eliminates inductive and capacitive reactance loading on the power amplifier.

Lower Signal-to-Noise

Rather than an in depth signal-to-noise discussion, it will perhaps, suffice to point out that in bi- or tri-amplification, each of the amplifier sections only need be of intermediate power and may operate over a restricted bandwidth. These two factors contribute to a better signal-to-noise ratio for the amplifier used in bi- or tri-amplified systems.

Summary

In summary, it apparent that frequent division before amplification (bi- or tri-) configurations offer significant advantages. Particularly in the areas of available peak power/dynamic range, distortion/transient response, damping factor, and signal-to-noise. The state of the art plug-in modular electronic crossover and amplifier format generally used in manufacture today lends itself to both electronic and functional flexibility.

Certainly, bi- and tri-amplification deserve a closer investigation when monitoring and sound reinforcement systems are either being planned or improved.

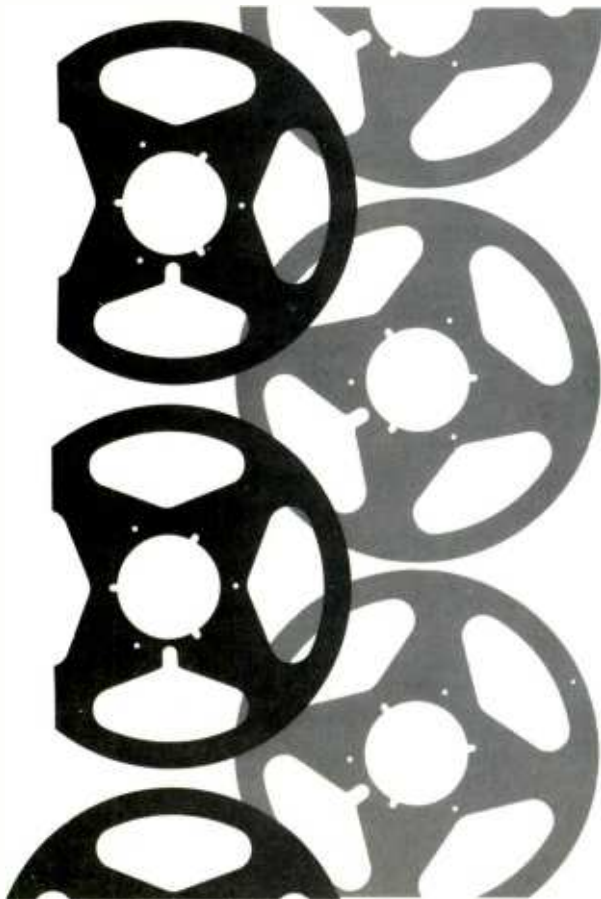

5TH ANNUAL AUDIO RECORDING SEMINAR

Brigham Young University Provo, Utah

PART I

Four weeks of intensive training in Audio Recording

PART II

One week of workshops with leading professionals including Stan Kenton and his orchestra

Part I July 12 - August 6, 1971

Part II August 9 - August 13, 1971

Those who attend Part I and Part II receive six semester hours of college credit.

Fees: Part I and II \$180.00
Part II only 75.00

For further information and registration, phone or write:

Alton E. Sigman
Brigham Young University
242 HRCB
Provo, Utah 84601
Phone (801) 374-1211 Ext. 3784

Registration for Part II must be received by July 30, 1971



AUDIO ENGINEERING SOCIETY

Fortieth Convention... Exhibition of Professional Products...

Los Angeles Hilton Hotel
Los Angeles, California
April 27 through 30, 1971

Registration Hours

Monday, April 26—1:00 to 5:00 P.M. EXHIBITORS ONLY
Tuesday, April 27—8:00 A.M. to 8:00 P.M.
Wednesday, April 28—8:30 A.M. to 8:30 P.M.
Thursday, April 29—9:00 A.M. to 5:00 P.M.
Friday, April 30—9:00 A.M. to 5:00 P.M.

For Recording Studio Workshop Registration will be at the door.

SESSION A TUESDAY, APRIL 27, 1971, 9:30 A.M. GOLDEN STATE ROOM MAGNETIC RECORDING AND REPRODUCTION

- A-1 A HIGH ENERGY CASSETTE TAPE WITH COMPATIBLE MAGNETIC PROPERTIES
- A-2 A SERVO CONTROLLED RECORDER FOR STUDIO APPLICATIONS
- A-3 CHROMIUM DIOXIDE AUDIO TAPE
- A-4 THE FRINGING RESPONSE OF MAGNETIC REPRODUCERS AT LONG WAVELENGTHS
- A-5 MUSICASSETTE QUADRASONIC: TAPE RECORD COMPATIBILITY

SESSION B TUESDAY, APRIL 27, 1971, 9:30 A.M. LOS ANGELES ROOM AUDIO MEASUREMENTS AND NOISE CONTROL

- B-1 THE APPLICATION OF IMPULSE MEASUREMENT TECHNIQUES TO THE DETECTION OF LINEAR DISTORTION
- B-2 30 BAND 1/3 OCTAVE SPECTRUM ANALYZER
- B-3 A 1/3 OCTAVE REAL TIME ANALYZER USING CALIBRATED METER READOUT
- B-4 INSTANT RT60
- B-5 AIRPORT NOISE MANAGEMENT
- B-6 APPLICATION OF ACOUSTICALLY TERMINATED TUBE FOR THE MEASUREMENT OF HORN-LOUDSPEAKER-DRIVER CHARACTERISTICS AND COMPARISON OF DISTORTION MEASUREMENT METHODS

AUDIO ENGINEERING SOCIETY EXHIBIT

	BOOTH Nos.
AGFA-Gevaert, Inc.	52
AKG—Division of North American Philips Corporation	70/71
Allison Research Company	117/118
Altec	Mission Room
Ampex Corporation	115/116/119 120/123/124
Automated Processes, Inc.	85/86
B & K Instruments, Inc.	55
The R. T. Bozak Manufacturing Company	81
Carl Countryman & Associates	96
Crown International	53
The Custom Fidelity Company, Inc.	67
Dolby Laboratories, Inc.	64/65
DuKane Corporation	125/126
Electro Sound, Inc.	75/76
Electro-Voice, Inc.	New York Room
Elpa Marketing Industries, Inc.	54
Daniel Flickinger & Associates, Inc.	90/91
Gotham Audio Corporation	92/95
Harvey Radio Company, Inc.	122
Holzer Audio Engineering Corp.	98
Infonics Inc.	79
James B. Lansing Sound	Foy Room St. Louis Room
Lipps, Incorporated	99
MCA Technology, Inc. Electrodyne Division Gauss Electrophysics Division Langevin Division	129-131
Mattis-Martin, Inc.	74
Rupert Neve & Company Limited	84
Olive Electro Dynamics Inc.	101/114
Otari of America Ltd.	69
Parasound Incorporated	66
Pentagon Industries, Inc.	97
Quad-Eight Sound Corporation	72/73
Scully Recording Instrument Co.	87/100
Sennheiser Electronic Corporation	80
Shure Brothers, Inc.	83
Spectra Sonics	132
Stanton Magnetics, Inc.	113
Superscope	127/128
Systron-Donner Corporation— Microwave Division	48
Taber Manufacturing and Engineering Company	82
Teac Corporation of America	102
3M Company	77/78
Tonus Incorporated	51
United Recording Electronics Industries	111/112
Vega Associates	Boston Room and 110
Westlake Audio	107/109

SESSION C
TUESDAY, APRIL 27, 1971, 2:00 P.M.
GOLDEN STATE ROOM
DISC RECORDING AND REPRODUCTION

- C-1 A NEW DYNAMIC FEEDBACK STEREO CUTTER-HEAD WITH ASSOCIATED SOLID STATE DRIVING SYSTEM
- C-2 FURTHER IMPROVEMENTS IN PERFORMANCE OF THE WEST-REX 3D-II STEREO DISK SYSTEM
- C-3 GROOVE ECHO IN LACQUER MASTERS
- C-4 DEVELOPMENT OF SKEW-SAMPLING COMPENSATOR FOR TRACING ERROR
- C-5 ANALYSIS OF CROSSTALK IN STEREO DISCS
- C-6 THE EDUCATION AND TRIBULATIONS OF A PRECURSORY DISC RECORDING ENGINEER
- C-7 A CONSOLE APPROACH TO QUAD-SOUND DISC MASTERING

SESSION D
TUESDAY, APRIL 27, 1971, 7:30 P.M.
GOLDEN STATE ROOM
STUDIO RECORDING TECHNIQUES TODAY

- D-1 ON THE PROCESSING OF TWO AND THREE-CHANNEL PROGRAM MATERIAL FOR FOUR-CHANNEL PLAYBACK
- D-2 STUDIO RECORDING TECHNIQUES OF A SMALL RECORDING STUDIO
- D-3 DUAL-TRIPHONIC MATRIX STEREO SYSTEM
- D-4 TWO EARS, ONE MIND, AND THE STEREO SYSTEM
- D-5 DESIGN CONSIDERATIONS FOR A NEW STUDIO COMPLEX
- D-6 A STEREO-QUADRAPHONIC SYSTEM
- D-7 ON THE ACOUSTICS OF MULTI-TRACK RECORDING STUDIOS

SESSION E
WEDNESDAY, APRIL 28, 1971, 9:30 A.M.
GOLDEN STATE ROOM
TRANSDUCERS

- E-1 A HIGH QUALITY ALL HORN-TYPE TRANSDUCER
- E-2 IMPROVED MEASUREMENT OF LOUDSPEAKER PARAMETERS
- E-3 A MOBILITY ANALYSIS OF THE CLOSED BOX AND REFLEX LOUDSPEAKER ENCLOSURES
- E-4 TRANSDUCERS AND INDUSTRIAL ESPIONAGE
- E-5 GRADIENT LOUDSPEAKER FOR LOW FREQUENCIES

SESSION F
WEDNESDAY, APRIL 28, 1971, 2:00 P.M.
GOLDEN STATE ROOM
SOUND REINFORCEMENT AND ARCHITECTURAL ACOUSTICS

- F-1 THE WORLD'S MOST POWERFUL SOUND SYSTEM
- F-2 BLOSSOM MUSIC CENTER
- F-3 THE ALTERATION OF THE REVERBERATION TIMES IN A SMALL THEATER AND A CONCERT HALL USING LOUDSPEAKER EQUIPMENT
- F-4 A COMPLEX SOUND SYSTEM EQUALIZATION
- F-5 SOUND REINFORCEMENT SYSTEMS FOR THE MODERN HIGH SCHOOL AND COLLEGE GYMNASIUM COMPLEX
- F-6 ACOUSTICAL DESIGN OF POPPI STUDIOS

SESSION G
WEDNESDAY, APRIL 28, 1971, 2:00 P.M.
LOS ANGELES ROOM
AUDIO IN AM, FM AND TV BROADCASTING

- G-1 THE DORREN COMPATIBLE FOUR-CHANNEL FM BROADCAST SYSTEM
- G-2 A TAPE CARTRIDGE RECORDER SYSTEM EMPLOYING INTEGRATED CIRCUIT LOGIC AND DC SERVO MOTOR DRIVE
- G-3 A SOUND AUGMENTATION SYSTEM
- G-4 THE MEASUREMENT AND CONTROL OF LOUDNESS LEVELS OF BROADCAST SOUNDS
- G-5 PANEL DISCUSSION: THE CONTROL OF LOUDNESS IN BROADCASTING

SESSION H
THURSDAY, APRIL 29, 1971, 9:30 A.M.
GOLDEN STATE ROOM
SIGNAL CONTROL-SYSTEMS

- H-1 A DIFFERENT APPROACH TO MULTI-CHANNEL HOME RECORDING SYSTEMS
- H-2 A NEW DISC MASTERING CONSOLE DESIGNED FOR FLEXIBILITY
- H-3 DOUBLE SOUND SYSTEM
- H-4 SOUND EFFECT SYSTEMS, SIMPLE AND COMPLEX
- H-5 A FUNCTIONAL REVIEW OF THE NEW AUTOMATED 16 TRACK RECORDING CONSOLE AT CAPITOL RECORDS STUDIO A HOLLYWOOD
- H-6 PORTABLE MIC-MIXDOWN CONSOLE KIT

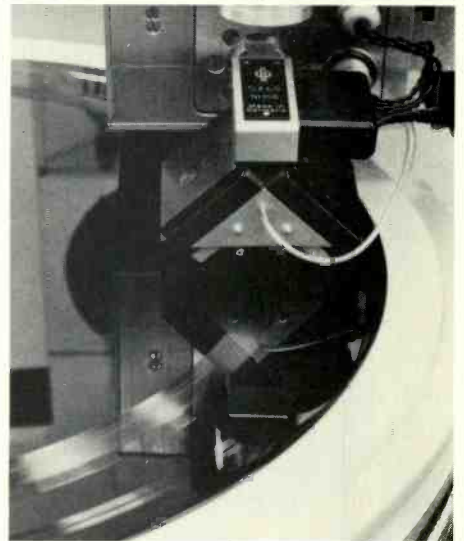

We do it all at our place

We invite you to use all or any part of Capitol's unlimited know-how and modern facilities to express your musical statement.

We offer you our creative engineers, the finest equipment, including our partially computerized marvel, the new Quad 8, 16-Track Console, remix and SX-68 disc-cutting facilities. And if you wish, Capitol will even wrap up your entire sound package, from recording to jacking. So for the most professional and complete deal anywhere... bring your sound to Capitol.

Circle this ad number on the reader service card and we'll send you our rate card.

CAPITOL CUSTOM SERVICES, A Department of the Special Markets Division.



Hollywood: 1750 N. Vine
Hollywood, Calif. 90028
(213) 462-6252

New York: 451 W. 46th
New York, New York 10036
(212) 582-8040

Circle No. 115

**Multi Track
Tape**

**Multi Track
Consoles**

Synthesizers

**Reverb
Systems**

**Noise
Reduction
Systems**

**EVERYTHING YOU
NEED FOR YOUR
STUDIO WHEN
YOU NEED IT IS
AVAILABLE FROM**

**HARVEY
RADIO CO.**
444 MADISON AVENUE
NEW YORK, NY 10022
212-832-8675

SESSION J
THURSDAY, APRIL 29, 1971, 2:00 P.M.
GOLDEN STATE ROOM
ELECTRONIC MUSIC

- J-1 THE ELECTRICAL DESIGN AND MUSICAL APPLICATIONS OF AN UNCONDITIONALLY STABLE COMBINATION FILTER/RESONATOR
- J-2 SYNTHESIS OF MOVING SOUND SOURCES

SESSION K
THURSDAY, APRIL 29, 1971, 2:00 P.M.
LOS ANGELES ROOM
AUDIO AND MEDICINE

- K-1 THE ORIGIN AND POWER SPECTRUM OF FETAL HEART SOUNDS
- K-2 A DOPPLER ULTRASONIC METHOD FOR MONITORING FETAL CARDIAC ACTIVITY
- K-3 A NEW APPROACH FOR TESTING THE HEARING OF THE NEWBORN
- K-4 SPECTRAL ANALYSIS OF VASCULAR MURMURS
- K-5 CHARACTERISTICS OF ACOUSTICAL HOLOGRAPHY AS APPLIED TO MEDICINE

SESSION L
FRIDAY, APRIL 30, 1971, 9:30 A.M.
LOS ANGELES ROOM
AUDIO INSTRUMENTATION

- L-1 MEASUREMENT OF MICROPHONE CHARACTERISTICS
- L-2 WIDEBAND MICROPHONE CALIBRATOR
- L-3 LOW POWER DRAIN INSTRUMENT PREAMPLIFIER
- L-4 DETERMINATION OF LOUDSPEAKER SIGNAL ARRIVAL TIMES
- L-5 GROUP AND PHASE VELOCITY REQUIREMENTS FOR AUDIO SYSTEMS
- L-6 OSCILLOSCOPE ADAPTOR PRESENTS TWENTY-FOUR SIMULTANEOUSLY DIFFERENT VOLTAGES OR EVENTS FOR COMPARISON

SESSION M
FRIDAY, APRIL 30, 1971 2:00 P.M.
LOS ANGELES ROOM
SIGNAL CONTROL—CIRCUITRY

- M-1 A VARIABLE DECAY REVERBERATION SYSTEM
- M-2 THE FOSTER FREQU—A NEW TOOL IN AUDIO
- M-3 ELECTROMECHANICAL LINE TRANSDUCER
- M-4 AN AUDIO DELAY SYSTEM USING DIGITAL TECHNOLOGY

SESSION N
FRIDAY, APRIL 30, 1971 7:30 P.M.
GOLDEN STATE ROOM
A RECORDING STUDIO WORKSHOP

Chairman: WILLIAM L. ROBINSON
Sunset Sound Recorders, Hollywood, California
A RECORDING STUDIO WORKSHOP—Bill Lazerus, Recording Workshop Participant, Senior Mixer, Sunset Sound Recorders; Brian Ingoldsby, MCA Recording Studios, Recording Studio Participant; another to be announced later.

Three of the top recording engineers will present a live recording session, a mix-down session from sixteen track. A detailed explanation will be given for the use of signal processing equipment, microphone techniques, and the use of specialized equipment. A question and answer period will follow each phase of the workshop.

MAIL TO: Recording engineer/producer
Box 2287 hollywood, calif. 90028

Please include a Recording engineer/producer address label whenever you write to us about your subscription. The numbers on your address label are essential to insure prompt and accurate service.

(attach label here)

CHANGE OF ADDRESS

Please let us know six weeks before you move. Place your current Recording engineer/producer address label in the space provided above and print your new address below.

Name

Address

City State Zip

NEW PRODUCT

NEWS

NEW SONY PROFESSIONAL MICROPHONE INTRODUCED. The Special Application Products Division of Superscope, Inc. has announced the addition of the C-37P to the line of Sony Condenser Studio Microphones.

The Sony C-37P Variable-Directivity Condenser Studio Microphone is an improved version of the Sony C-37A. Most significant improvement is the incorporation of a new low-noise FET amplifier which provides a dynamic range of 130 dB. Noise level has been reduced by 10 dB (C-37A = 34 dB SPL equivalent, C-37P = 24 dB SPL equivalent) and the overload point has been increased by 20 dB (C-37A = 134 dB SPL equivalent, C-37P = 154 dB SPL equivalent).

The C-37P utilizes standard phantom powering, and may be used with any 48 Volt Phantom supply with 2.5 mA or greater capacity.

Frequency response and directional characteristics remain unchanged in the new microphone.

Other features include a built-in shock mount which effectively prevents vibra-



tions from the microphone stand being transmitted to the microphone.

The C-37P is supplied with carrying case and microphone cover. It will sell for \$295.00. An optional power supply, the Sony AC-148A is available for \$99.95. SUPERSCOPE, 8150 VINELAND AVENUE, SUN VALLEY, CALIF. 91352.

Circle No. 117

NEW 450 WATT POWER AMPLIFIER SYSTEM FROM FLICKINGER which delivers 450 watts RMS into an 8 ohm load with less than .05 percent IM distortion at any level. These high power amplifiers were designed to provide the extra headroom necessary for tuned and voiced speaker systems in a minimum amount of space. Three 450 watt monitor amps can be mounted in a 5¼" relay rack. Peak power level for each amplifier is in excess of 1,000 watts. DANIEL N. FLICKINGER & ASSOCIATES, INC., 40 SOUTH OVIATT STREET, HUDSON, OHIO 44236.

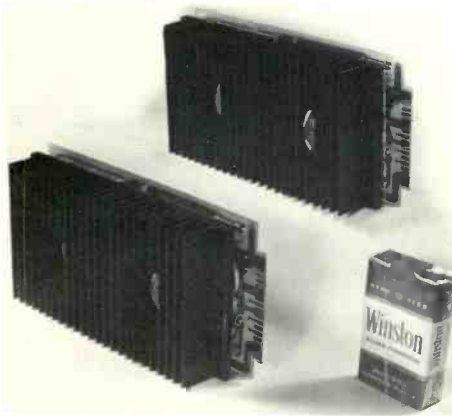

Circle No. 118

FAST ATTACK, FAST RELEASE with Langevin's AM-7A Limiter/Compressor.



This unit, designed for use with speech or music inputs, employs the latest FET and 1-C for maximum reliability and for minimum distortion and noise. This extremely versatile unit contains an automatic low-frequency gate and a three-position de-essing circuit. Stereo sync terminals provided. The Langevin AM-7A Limiter/Compressor is designed for use in 600/150-ohm systems, has a self-contained 24-Vdc 150-ma power supply, and will fit the standard 19-inch relay rack. The AM-7A will be on display in Booth 130 at the AES show. LANGEVIN—MCA TECH, AN MCA INC. COMPANY, 13035 SATICOY STREET, NORTH HOLLYWOOD, CALIF. 91605.

Circle No. 119



MICROPHONES • HEADPHONES

DISTRIBUTED BY:
NORTH AMERICAN PHILIPS CORPORATION
100 EAST 42ND STREET, NEW YORK, NEW YORK 10017
AKG CANADA • DIVISION OF DOUBLE DIAMOND ELECTRONICS • SCARBOROUGH, ONTARIO



D-900E

**Shotgun Dynamic
Microphone**

\$149.00 Net

Put an AKG on the job.

It will sound better!

Circle No. 120

110

Altec introduces a 4-foot control console with up to 28 inputs and 16 outputs.

It's built to your specs...delivered ready to use.

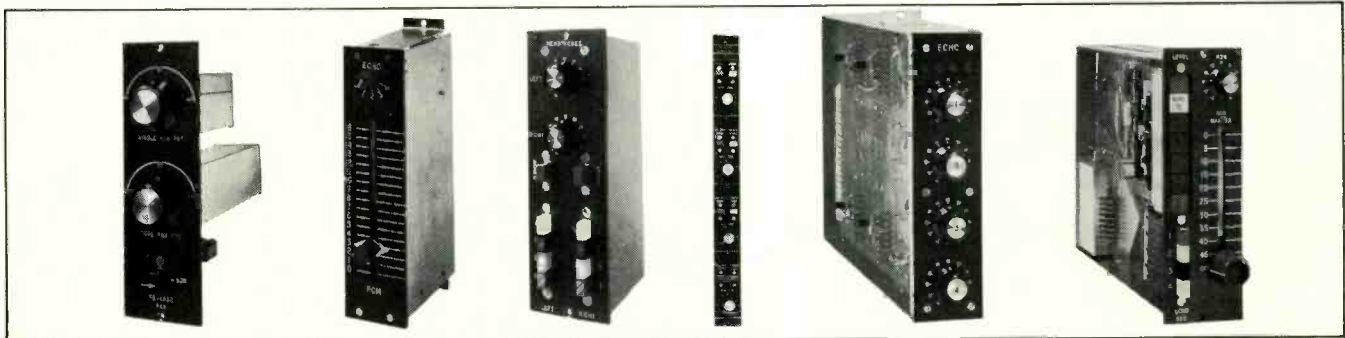

It's the all-new, all-solid-state Altec 9300A control console. Only 51½ inches long, it features direct-plug-in modular construction that lets you custom tailor your own board by simply selecting the specific modules you need.

The new Altec 9300A gives you up to 28 inputs and up to 16 outputs. And any input may be connected to any output by means of a switching matrix on each input channel.

Here are some exclusive features designed into the new Altec 9300A.

- Channel Check provides an individual instant check of all input lines without interrupting the program.
- A Pre Cue pushbutton transfers signals from the output buss to the cue buss.
- A Modulite[®] Visual Volume Level Indicator on each module tells exactly how much level is being fed to tape machines.
- Echo Facilities permit selection of internal or external reverb devices and a bright or soft timbre.
- Color-coded knobs enable fast and easy matching of input channels with correct output selector modules.
- 22 dB of headroom.

Mail this coupon for all the details on the new Altec 9300A console.

To: Altec Lansing, 1515 South Manchester Ave.
Anaheim, California 92803.

Please send me all the details on the all-new Altec 9300A control console—including information on how its unique modular design will let me simply plug in different modules as I need them.

I'd like to hear more. Please get in touch with me.

Name _____ Phone _____

Position _____ Studio _____

Address _____

City _____ State _____ Zip _____



A QUALITY COMPANY OF LTV LING ALTEC, INC.

THE GOTHAM DELTA-T 101 ELECTRONIC AUDIO DELAY SYSTEM represents a technical break through in audio signal processing. The GOTHAM DELTA-T 101 accomplishes audio delay digitally without any moving parts! The unit is available with up to 5 separate outputs controllable in 5 ms steps for a maximum delay of 320 ms, 12 kHz band width, 60 dB signal-to-noise and 0% wow and flutter. This electronic system employs the latest MSI circuit for analog

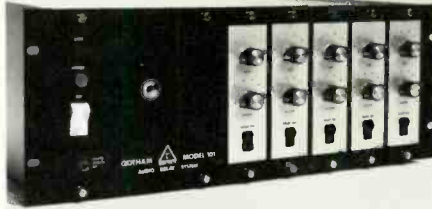

to digital to analog conversion. GOTHAM AUDIO CORP., 2 W. 46 ST. NEW YORK, N.Y. 10036, & 1710 N. LA BREA, HOLLYWOOD, CA. 90046.

Circle No. 122

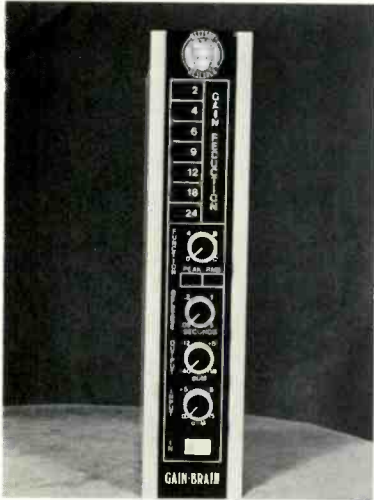

ALLISON RESEARCH INC., will show its new "GAIN BRAIN" limiter at the AES spring convention. The feature of the "GAIN BRAIN" is that it is two limiters in one; A high ratio peak limiter and an RMS limiter with the attack and release times coordinated. The threshold of the RMS limiter may be moved as much as 12db below the peak limiter threshold. The "GAIN BRAIN" features a sequential light gain reduction indicator and peak and RMS indicators. All lights are solid state and will never have to be replaced. The "GAIN BRAIN" is the same physical configuration as the Allison's KEPEX and will fit into all of the same hardware. ALLISON RESEARCH, INC., 7120 SUNSET BOULEVARD, HOLLYWOOD, CALIF. 90046.

Circle No. 123

MATIC MODEL 521 CASSETTE COPIER FROM MCA TECH, enables the operator to load a master and 50 cassettes . . . the copier does the rest. The master is duplicated at the rate of one every 2½ minutes, including recycling time. Compactness, good fidelity and operational ease make the Model 521 ideal for duplicating information. For use in classrooms, sales, libraries, research, training, classroom and home study, guided tours for travelers. See the AUDIO-MATIC 521 in booth 130 at the AES show. MCA TECH,



AN MCA INC. COMPANY, 13035 SATICOY STREET, NORTH HOLLYWOOD, CALIF. 91605.

Circle No. 124

OLIVE REMIX PROGRAMMER. Many new concepts of signal routing/processing monitoring and equalization are beneath the surface of the superbly engineered

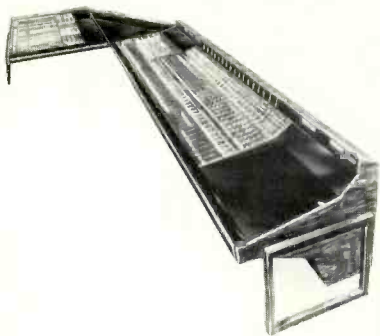

Olive Series 2000 Console component modules. This is emphasized by the introduction of a revolutionary new Automated Remix Programmer module. Simply by plugging it in you can automate mix-downs on any Olive Series 2000 Console. Modify any track of the original dry mix at will. The automated remix programmer "remembers" all adjustments made by the engineer and will duplicate them on future mixes . . . automatically. At a later date modifications are just as simple with this information all stored on the master tape. OLIVE ELECTRO DYNAMICS INCORPORATED, 2670 PAULUS, MONTREAL 386, QUEBEC, CANADA.

Circle No. 125

VERSATILE!



Model 550 Equalizer

- Shelving or peaking curves independently selectable for upper and lower ranges.
- Transformer coupled output to +28 dBm.
- Low noise and distortion.
- Panel mounting 1½" x 5¼".
- Utilizes Automated's 2520 Op Amps.

The Model 550 Equalizer is designed as a channel module with reciprocal equalization at 11 frequency points in 5 steps of boost or attenuation to a maximum of 12 dB. These points are divided into 3 ranges, with the upper and lower ranges individually selectable as either peaking or shelving. A band-pass filter (50 Hz to 15 kHz) is switch selected independent of all equalization settings, and a push-button In or Out switch with tally light inserts or removes equalization without clicks or program interruption.

The virtually limitless range of repeatable curve shaping combinations provided by the Model 550 makes it ideally suited for all types of music or voice enhancement and effects equalization.

AUTOMATED PROCESSES, INC.
35 CENTRAL DRIVE
FARMINGDALE, N.Y. 11735
516-694-9212

Circle No. 126

The Dolby 360 Series

Nearly a thousand of these new units are already in use.



Each Series 360 unit is only $1\frac{3}{8}$ inches (44 mm) high. 16 channels therefore require only 28 inches of rack space.

Full compatibility with the A301

Models 360 and 361 are single-channel A-type (professional) noise reduction units which process signals identically to the two-channel A301. The new units are small in size and are designed for simplified installation and use of the Dolby System with 16-track recorders. The cost of the 360 series is somewhat less than that of the A301 for an equivalent number of channels.

Automatic record/play changeover in the 361

The Model 360 is a single-channel noise reduction processor unit. The Model 361 is identical to the 360 in size and appearance, but contains facilities for automatic record/play changeover controlled from the recorder. In the new series, the operating mode is set and clearly displayed by illuminated push-button switches.

Internal oscillator

An internal "Dolby Tone" oscillator is provided for establishing correct operating levels. The characteristic modulation of the tone also identifies Dolby-processed tapes. All oscillators in a multi-track installation can be controlled by a single switch.

High stability

The circuit is highly stable and does not require routine adjustment. A removable front panel allows input and output levels to be adjusted from the front of each unit. The panel also provides access to relays and the noise reduction module.

Single-module design

The noise reduction circuitry is contained in a single module which can be purchased separately. Should failure ever occur, plug-in substitution will restore operation of the system in seconds with no adjustments necessary.

Prices, delivery information and complete specifications are available from



DOLBY LABORATORIES INC

333 Avenue of the Americas New York NY 10014
(212) 243-2525 cables: Dolbylabs New York

UK and International
346 Clapham Road London SW9
(01) 720-1111 telex: 919109 cables: Dolbylabs London

GATELY ELECTRONICS announces the introduction of its new MM-8 Monitor Module for use in 8 track recording consoles.

This new addition to the Gately Series 8 line of professional audio equipment accomplishes the following functions:

Talkback, Slating, Studio Monitor Level, Control Room Monitor Level, Studio and Control Room Monitoring, Bus/Play monitoring of up to 4 recorders, Illuminated Sync Monitoring of the 8 track recorder, Monitoring of two overdub buses, Solo Monitoring, Individual Level Control of 8 inputs, All monitoring is of the 4 channel type, Trimming of the signal level to the 4 monitor speakers, Derivation of the Sync Signals for the new Scully, 100 series recorders.



Use of this monitor panel eliminates the requirement to come back through the console when doing overdub or sync recording freeing the channels normally used for recorder return for use as additional microphone inputs. GATELY ELECTRONICS, 57 W. HILLCREST AVENUE, HAVERTOWN, PA. 19083.

Circle No. 128

THE QUAD-EIGHT RV-10 is a new and patented Variable Decay Reverberation System. A 55 millisecond transducer delay resembles the artificial delay times used on other devices for modern recording studio techniques.

Front panel adjustments of the decay time and low frequency filtering allow this system to match other reverberation systems and to create new effects.



The RV-10 is housed in a 3½" x 19" rack mounting frame. The construction and design have developed an almost total immunity to mechanical shock and outside acoustical pick-up. This device can be used in the control room if you wish.

Related electronics are self contained. The input sensitivity is +4 dbm. However, levels down to -20 dbm can be accommodated by internal strapping.

The price will be under \$800. Delivery in quantity will be after May 15, 1971. QUAD-EIGHT ELECTRONICS, 11810 VOSE STREET, NORTH HOLLYWOOD, CALIFORNIA 91605.

Circle No. 130

THE STUDER A-80-16 16 CHANNEL 2" TAPE RECORDER measures only 6 ft. tall and 28" wide. Its solid state motion logic insures that a constant tape tension of less than 75 grams is maintained in all modes. Its separate sync playback amps



can be used simultaneously with the regular playback and they are correctly equalized so that you can use them for a mix. The basic deck can handle from ¼" to 2" tape. GOTHAM AUDIO CORP., 2 W. 46 ST. NEW YORK, N.Y. 10036, & 1710 N. LA BREA, HOLLYWOOD, CA. 90046.

Circle No. 129

A NEW, COMPACT, SOLID-STATE MIXER AMPLIFIER with self-contained 120/240 VAC, 50/60 Hz power supply and external 24/28 VDC battery operation capability is announced by Altec of Anaheim, California.



Maximum versatility is obtained with two inputs which accept plug-in accessories. Accessories are available for microphone, magnetic phono pickup, or high level sources.

The output of the 1589B is also transformer isolated, providing balanced 150 ohm or 600 ohm line level output. Power output is +18 dBm at less than .5% THD 20-20,000 Hz and +20 dBm at less than 1% THD 20-20,000 Hz.

This compact unit occupies only one unit of rack space (1¾"). The front panel contains the mixer controls, power switch and AC line fuse. For an engineering data sheet, please write to MARKETING SERVICES DEPARTMENT, ALTEC, 1515 SOUTH MANCHESTER AVENUE, ANAHEIM, CALIFORNIA 92803.

Circle No. 131

STUDIO MONITOR AMPLIFIERS

by *Crown*

D40



compact

delivers 40w RMS/channel at 4Ω
takes 1¾" rack space, weighs 8½ lbs.
IM distortion less than 0.3% from
1/10w to 30w at 8Ω
S/N 100dB below 30w output
price - \$229 rack mount

D150



universal

delivers 150w RMS both channels 8Ω
IM distortion less than 0.1% from
1/10w to 75w at 8Ω
S/N 100dB below 75w output
takes 5½" rack space, weighs 20 lbs.
price - \$429 rack mount

DC300



power

delivers 300w RMS/channel at 4Ω
IM distortion less than 0.1% from
1/10w to 150w at 8Ω
S/N 100dB below 150w output at 8Ω
Lab Standard performance and
reliability
price - \$685 rack mount

All Crown amplifiers are warranted 3 years for parts and labor. They are 100% American-made to professional quality standards. All are fully protected against shorts, mismatch and open circuits. Construction is industrial grade for years of continuous operation.

Crown 

BOX 1000, ELKHART, INDIANA 46514, U.S.A.

Circle No. 132

Re/p 37

The best microphone money can buy.

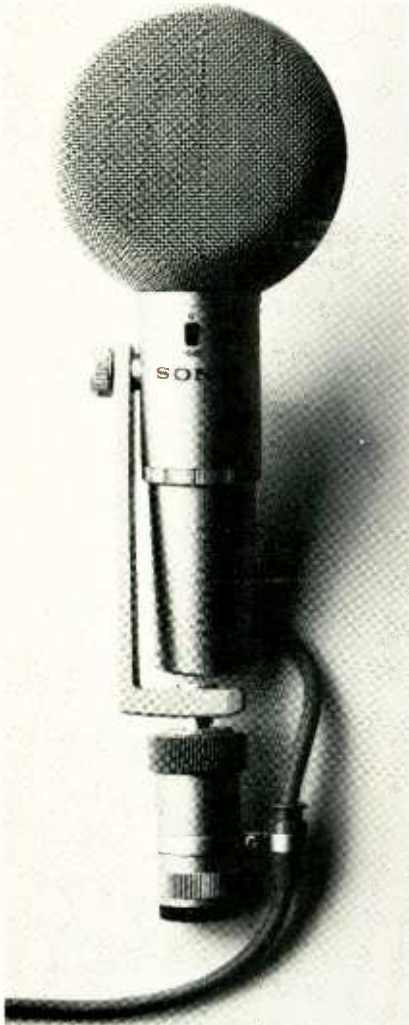

Recently Sony engineers measured the distortion* of the Sony C-500 and its most prestigious competitor. Here's what they found:

SPL	Sony C-500	Most Prestigious Competitor
100dB	<.05%	.8%
110dB	<.05%	2.3%
120dB	<.05%	>10 %
130dB	<.05%	>10 %
140dB	.05%	>10 %
150dB	.97%	>10 %

If you think the most prestigious competitor sounds good up close, imagine how the Sony C-500 sounds! Better yet — see your nearest Sony / Superscope Special Application Products Dealer. Or write: Sony / Superscope, 8132 Sunland Blvd., Sun Valley, Calif. 91352.



*Intermodulation Distortion: 70Hz and 7kHz; 4:1 ratio; applied to input of impedance transformer at level which is equivalent to capsule output at specified SPL.
© Superscope, Inc.

Circle No. 133

NEW INPUT MODULE by Electrodyne will employ graphic equalization. 8 frequencies are provided, all simultaneously available with a boost of 12 db and 15 db of attenuation. Electrodyne Model 712E is electrically and physically interchangeable with previous Electrodyne input modules. This new Electrodyne unit will be previewed in Booth 130 at the AES show. ELECTRODYNE CORPORATION —MCA TECH, AN MCA INC. COMPANY, 13035 SATICOY STREET, NORTH HOLLYWOOD, CALIF. 91605.

Circle No. 134



Circle No. 135

THE STUDER 189.040 MIXING CONSOLE has 18 inputs, 4 master outputs, 2 echo send outputs and 2 echo return inputs. It features separate line and mike inputs with relay switch-over; four adjustable compressors. All this in only 51½", with state of the art specs. Also available with 16 inputs and 8 outputs. GOTHAM AUDIO CORP., 2 W. 46 ST. NEW YORK, N.Y. 10036, & 1710 N. LA BREA, HOLLYWOOD, CA. 90046.

TRANSIENT-FREE SWITCHING OF ACTIVE AUDIO CIRCUITS is provided by a new solid state switch announced by Macan Engineering, Chicago, Illinois. Since it is completely free from disturbing and potentially damaging spikes or "thumps" on both make and break, the new device is ideally suited for audio circuit switching in commercial broadcast, TV and professional recording studios, as well as for such demanding scientific applications as biomedical electronics.

Frequency response of the new device, termed the "Silent Switch" by the manufacturer, is 10 Hz to 50 kHz. Insertion loss is 6 dB and open circuit isolation is 97 dB at 1 kHz, rolling off to 74 dB at 20 kHz. Standard input impedance is 8 k ohms, output impedance 10 k ohms, and total harmonic distortion less than .1%.

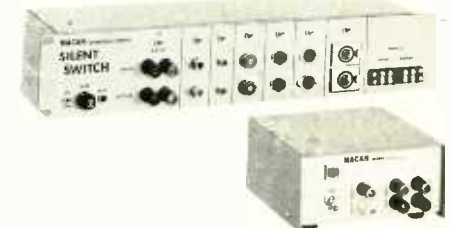

The single channel "Silent Switch" is housed in a 6-1/2" w. x 3-3/8" h. x 7" d. cabinet and operates from 115 V, 50-60 Hz AC. Both remote and local control are provided. A wide variety of configurations, including rack mounted multiples and battery operated portables, are available. Single unit price on the one channel model is \$330, with delivery from stock. MACAN ENGINEERING COMPANY, 1564 NORTH DAMEN AVENUE, CHICAGO, ILLINOIS 60622.

Circle No. 136

A UNIQUE CONCEPT IN CASSETTE DUPLICATING SYSTEMS, incorporating the heavy-duty, high performance mechanism of the Wollensak audio-visual cassette recorder, has been developed by 3M Company.

The modular system permits placement and operation in a variety of work layouts or space arrangements. Because the system is designed on a modular, plug-in basis, the user can start small—with a single master and copier—and add units as his needs develop.

Either of the two master units—reel-to-reel (Model 6040 AV) and cassette (Model 2750 AV)—can drive up to 10 cassette copiers or slaves (Model 2760 AV).

Two unique and patented features provide automatic high-speed rewind of

copies and automatic sensing of stalled tape. Suggested list prices are \$499.95 for the master units and \$299.95 for the copiers. 3M COMPANY, ST. PAUL, MINNESOTA 55101.



Circle No. 137

MARKETING OF 3M BRAND PROFESSIONAL AUDIO RECORDERS/REPRODUCERS, which are used by recording studios for original mastering, is being expanded to the educational music and recording fields.

The quarter-inch two-track machine is especially suited to music education and on-campus recording services. The two-inch four-track recorder is useful for multi-media presentations.

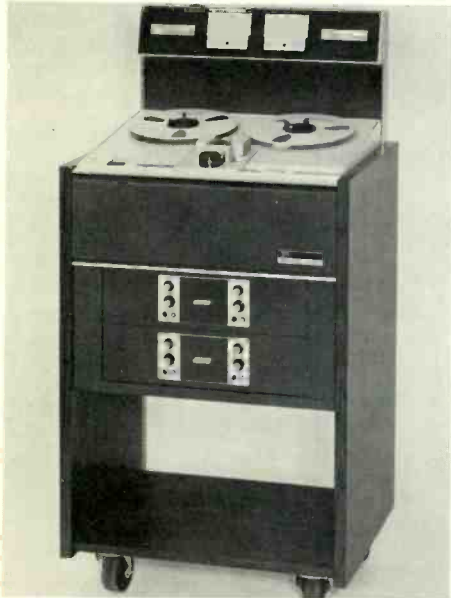

The recorders incorporate the unique 3M "Isoloop" tape drive to provide the lowest wow and flutter in the recording industry, John Overton, professional audio recorder project manager for 3M Company's Mincom division, said. The tape drive maintains tape tension automatically throughout the entire reel of tape.

The quarter-inch two-track machine is priced at \$3,500, and the four-track unit at \$5,500. 3M COMPANY, ST. PAUL, MINNESOTA 55101.

Circle No. 138

EASE . . . ACCURACY . . . SPEED

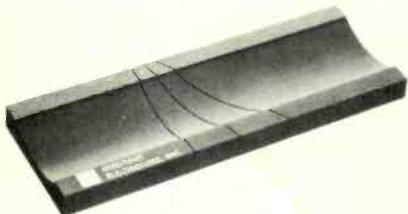

Two-inch tape editing block, hard anodized aluminum with satin finish, straight or angular cuts of 15° and 30°, 7 3/4" long and 1/2" high, in stock for immediate delivery, \$55.00 per block, post paid.

Make checks payable to:
Stephens Electronics, Inc.
3513 Pacific Avenue
Burbank, California 91505

THE QUAD-EIGHT AUTO-MIX 23B is two independent 3B Compressors in a MH-24, (modular housing) which provides the necessary external connections and 28 V.D.C. Bi-Polar power supply.

Features of the 3B are, the elimination of Concentric Knobs, each function has its own control; 10 curves of DE-ESSING on a selector switch; an output attenuator; a larger GR meter.



The Auto-Mix 23B occupies 3 1/2" of rack space. It is self powered, and provisions have been made for an extension GR meter for console installation.

Price as shown, approximately \$800. Delivery in quantity will be after May 15, 1971. QUAD-EIGHT ELECTRONICS, 11810 VOSE STREET, NORTH HOLLYWOOD, CALIFORNIA 91605.

Circle No. 139

POWERFUL SPEAKER BY GAUSS produces the highest continuous power ever attained by a commercial speaker. A finned magnetic pot structure creates the high power capability . . . continuous ratings are 200 watts, 350 for short term use. Exclusive double-spider construction gives high efficiency. A variety of different cone styles are available to match the



sound of existing speakers. Tonal characteristics can be tailored to individual requirements. Available in 12", 15" and 18" size in lead and bass types. This outstanding speaker by GAUSS, Model 1222, will be on display in Booth #130 at the AES SHOW. GAUSS ELECTROPHYSICS-MCA TECH, 13035 SATICOY STREET, NO. HOLLYWOOD, CALIFORNIA 91605.

Circle No. 140

THE ELECTRIC MUSIC BOX, series 200, is a comprehensive collection of precision electronic modules for generating, processing, and directing sound. Applications include electronic music composition and performance, special effects generation for recording and broadcast studios, multitrack to quadrasonic mix-down, and environmental control for theater and mixed media.

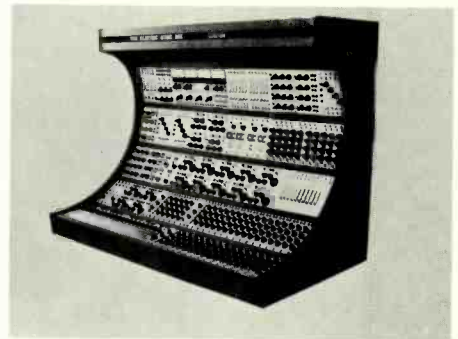

The system features unusually high functional density, extended dynamic range, self-contained monitoring (pre-view) facilities, and unrestrained expandability. Interesting new techniques for polyphonic signal generation, dynamic spectral and timbral modification, complex pattern generation, and control of spatial location and movement are introduced.

Connections within the system are made with color-coded patchcords, for maximal graphic visual feedback and zero crosstalk. A consistent distinction, both in modular function and in interconnection, is maintained between sound (signals) and structure (control voltages and timing pulses). Prices range from \$4250 to \$14,200. BUCHLA ASSOCIATES, P.O. BOX 5051, BERKELEY, CALIF. 94705.

Circle No. 141

ADVERTISERS INDEX

AKG	33
ALLISON RESEARCH	17
ALTEC-LANSING	34
AMPEX CORP.	26
AUTOMATED PROCESSES	35
BRIGHAM YOUNG UNIV.	29
CAPITOL RECORDS	31
COUNTRYMAN ASSOCIATES	20
CROWN INTERNATIONAL	37
DOLBY LABORATORIES	36, 40
ELECTRO-VOICE INC.	COVER 4
FLICKINGER ASSOCIATES	COVER 2
GOTHAM AUDIO	24
HARVEY RADIO	32
MCA TECHNOLOGY	10
MCI	15
OLIVE ELECTRODYNAMICS	12
OPAMP LABS	40
PHILIPS BROADCAST EQUIP	21
SCULLY RECORDING EQUIP	8
SENNHEISER ELECTRONIC	7
SPECTRA SONICS	18
SUPERSCOPE, INC.	38
TEAC CORP. OF AMERICA	COVER 3
3-M COMPANY	22-23
YAMAHA INTERNATIONAL	6

EMPLOYMENT OPPORTUNITY



Noise Reduction
In Recording

Dolby Laboratories manufacture professional noise reduction equipment which is widely used by all major record companies. The main laboratory and manufacturing facility is in London, but the company has a sales and distribution office in New York City. Dolby Laboratories is six years old and now comprises one hundred people. Growth prospects are excellent.

**SENIOR
SALES
ENGINEER**

The company has a requirement for a Senior Sales Engineer, who will be based in the New York office. The post will be a new extension to the sales effort in the US, which is now mainly handled by regional distributors. The new Sales Engineer will be contacting customers directly, arranging demonstrations and technical training, negotiating sales, and advising on systems and installation engineering. In addition, he will be in contact with the regional distributors, supervising and assisting them with their own sales efforts. The successful applicant will be trained in London upon joining, but he should already have experience of recording studio practice, and in particular multi-track techniques. He will have a degree, will probably be aged around 30 and should be free to travel. He will certainly have a high level of enthusiasm for all types of music. An ability to communicate effectively with engineers, musicians and producers will be more relevant than proven sales experience.

Write with brief details or telephone:

Marc Aubort, Vice President

Dolby Laboratories Inc., 333 Avenue of the Americas, New York, N.Y. 10014.

Tel. (212) 243-2525

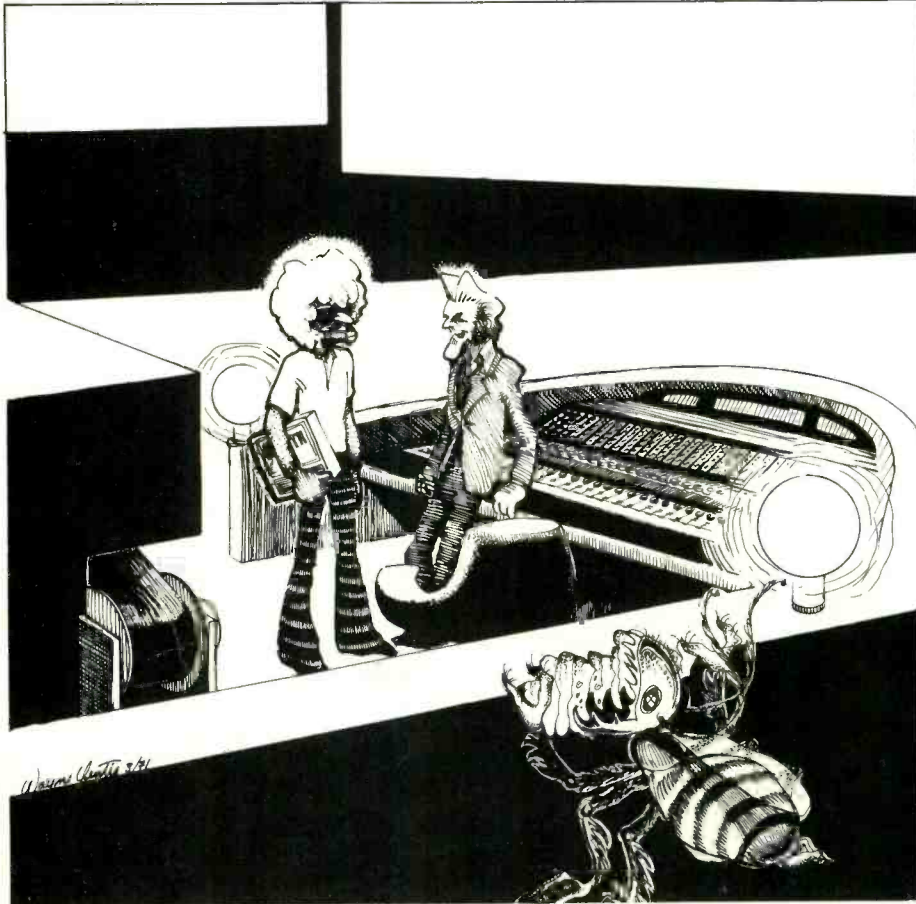

... but there's still one nasty bug we gotta work out!

CLASSIFIED

Send for FREE Catalog
and Audio Applications



OPAMP LABS

172 S. Alta Vista Blvd.
Los Angeles, Calif. 90036
(213) 934-3566



Circle No. 142

EQUIPMENT AVAILABLE

FOR SALE: NATIONALLY KNOWN RECORDING STUDIO. 8-TRACK OPERATION (Can be used for 16-track) LOCATED IN MUSIC CITY, U.S.A. (Nashville) 5 going labels, 2 publishing companies. \$100,000 gross annual custom business. Reason for sale: Owner desires to devote full time to electronic manufacturing. Write Box V, c/o Re/p.

WESTREX/SCULLY STEREO DISC MASTERING SYSTEM complete including Scully variable pitch automated lathe, Westrex 3D system, (2) Pultec EQP-1A equalizers, (2) Pultec HLF-3C Filters, Ampex 300-2 Recorder with preview assembly, Fairchild Conax, Gates Limiter, McIntosh MC-275 Monitor Amp, JBL Speaker systems (2), plus other miscellaneous cutting equipment mounted in four Bud Rack Units. System is completely wired and ready to cut. Call or write for more information. Frankford/Wayne, 212 N. 12th Street, Philadelphia, Pa. 19107 Mr. Steele (215) 561-1794.

NOTICE

INDIVIDUALS seeking employment in the recording industry may submit their qualifications for FREE publication in *RECORDING engineer/producer*.

Listings will be limited to 30 words, and will be limited by available space. Listings will be selected for publication on the basis of earliest postmark. Listings will not be automatically repeated or carried over to the succeeding issue.

PERSONNEL AVAILABLE:

ALL AROUND STUDIO ENGINEER. Mixing, maintenance, construction, design, and mastering. 3½ years experience, 24 years old. Contact Greg Hanks, (714) 893-4217. 13611 Siskiyou, Westminster, Calif. 92683.

CHIEF ENGINEER with former ownership of small studio, seeking a regular job with good pay. 6 years' experience. Have special talent for phasing, mixing, editing, etc. Please no "BIG SHOTS". Let me do my own thing. William R. Coleman, Jr., Coleman Productions, Apt. 101, 906 Sans Souci Dr., Raleigh, N.C. 27609.

Circle No. 143



If spec sheets are among your favorite reading, we don't blame you for getting confused at times. Columns of figures aren't always too eloquent on their own, only in context or comparison with other specs. And statistics can be used to support anything — especially statisticians.

So it's nice to know how to read between the lines of a spec sheet. To know, for instance, that not all makers use the same measuring standards. Take overall frequency response: ours is measured at a -10dB level, the accepted broadcast standard. Yet certain other brands measure from as low as -24 dB .

Unfair to us? Yes. But more important, it's unfair to you.

Of course, there are other ways to play the numbers game. We say go ahead and compare specs till your head spins. But do it right: consider your own overall needs and objectives. Consider specs in relation to other specs on the same component. Compare that unit spec for spec, *standard for standard*, with competing models. Then go give a listen.

True, you can't be a computer.

But you shouldn't have to be a speculator, either.



TEAC

TEAC Corporation of America • 2000 Colorado Avenue • Santa Monica, California 90404

NUMBERS GAME.



**Free loan-for-trial.
Free repairs for the first two years,
no matter what happens.
Plus a lifetime guarantee.**



We're very confident. But then we've been offering all this for years!

(E-V) A careful study of guarantees can tell you quite a bit about a company. And that's why we're so proud of ours. For instance, every E-V Professional-line microphone has a 2-year UNCONDITIONAL warranty against malfunction; regardless of cause. Even accidental damage is covered, no questions asked. All absolutely free—except one-way postage. And for a modest charge we'll even hide the scars!

But that's just part of the story. Every

Electro-Voice microphone is also guaranteed for the life of the unit to be free from factory defects in workmanship and materials. To show you we're really serious, we've printed the entire guarantee below. There's no finer in the industry.

How can we afford such liberal guarantees? By making products that have served for decades as the yardstick of reliability in studios throughout the world. And by creating designs that really solve your sound problems, day after day.

Which brings us to our other unusual offer.

Did you know that most Electro-Voice distributors will loan any E-V Professional product to responsible firms for trial without cost or obligation? You can make every test you want under actual working conditions. And in the rare event that you aren't satisfied, just return the unit. Your distributor then exchanges it for fresh stock from us. No cost to either him or you. We've found this simple system helps you choose the products that really solve your problems. And we're happy to help.

A great guarantee and a time-tested loan-for-trial program. Plus a broad line of professional products that fit almost every studio need. We wouldn't want to do business any other way.

ELECTRO-VOICE, INC. Dept. 311RP,
674 Cecil Street, Buchanan, Michigan 49107

In Europe: Electro-Voice, S.A., Less-Strasse 55,
2560 N. dau, Switzerland 1

WARRANTY

Electro-Voice Professional Broadcast and Recording Microphones are guaranteed unconditionally against malfunction for two years from date of purchase. Within this period Electro-Voice will, at its option, repair or replace any E-V Professional microphone exhibiting any malfunction regardless of cause, including accidental abuse. This warranty does not cover finish or appearance. Also, every Electro-Voice microphone is guaranteed for the life of the microphone to be free of factory defects in materials and workmanship, and will be repaired or replaced (at our option) at no charge if exhibiting malfunction from this cause. Microphones for warranty repair must be shipped prepaid to Electro-Voice, Inc. or its authorized service agency, and will be returned prepaid.

high fidelity systems and speakers • tuners, amplifiers, receivers • public address loudspeakers
• microphones • phono cartridges and styli • aerospace and defense electronics

Electro-Voice®

a GULTON subsidiary