

# ONE TO ONE

DADC Austria

Recording Levels

Mastering at PRT

FOR PROFESSIONALS IN MASTERING, PRESSING & DUPLICATING

LINK HOUSE PUBLICATION

£2.00

Novel

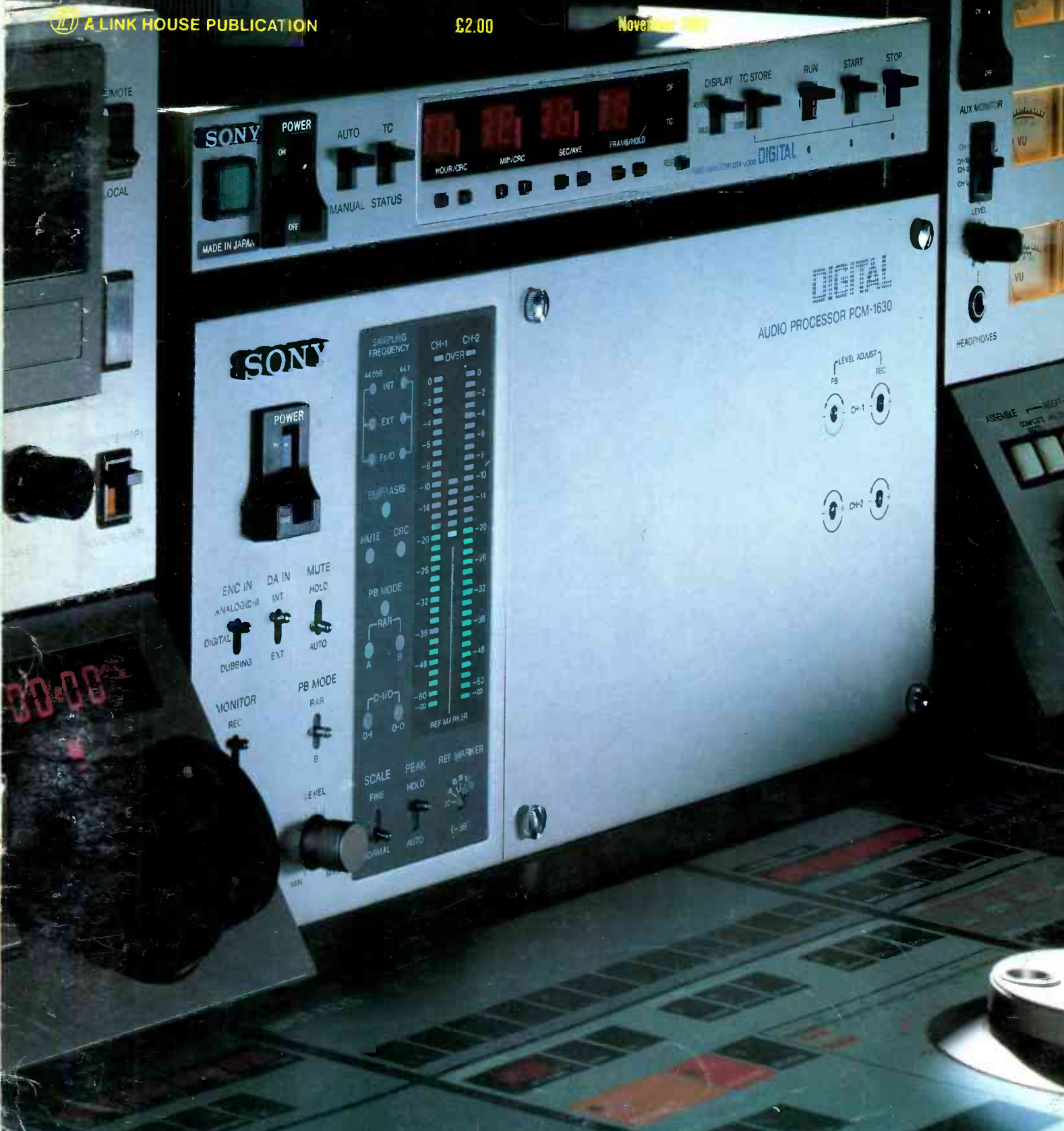

CDMA

DIGITAL AUDIO PROCESSINGS



**COMPACT DISC TAPE MASTERING CENTRE**

Rue des Deux Eglises, 46 - B-1040 BRUSSELS - BELGIUM - Tel.: Int. + 32-2/217.45.89 - Telex: 20558 dig kr b.

# ONE TO ONE

## FOR PROFESSIONALS IN MASTERING, PRESSING & DUPLICATING

### EDITORIAL

Editor:  
Carl A Snape

Production Editor & Design  
Ann Horan

Production Assistant:  
Carrie Love

Secretary:  
Cecilia Farrelly

Contributory Writer (US):  
Susan Nunziata

### ADVERTISEMENTS

Advertisement Manager:  
Adrian Tippin

Production Manager:  
Sue Chambers

USA Advertising/Commercial Manager: Robert  
J Sinnott, 2 Park Avenue, 10th Floor, New  
York, NY 10016. Tel: (212) 779-1212

Japan and Far East Agent:  
Media Sales Japan Inc, Tamuracho Building,  
3-3-14, Shimbashi, Minato-ku, Tokyo, Japan.  
Tel: (03) 504-1925. Telex: J25666.  
Fax: (03) 595-1709. Contact: Mikto Tsuchiya.

Deputy Publisher:  
Phil Guy

Director:  
Douglas G Shuard

Editorial and advertising offices:  
LINK HOUSE, DINGWALL AVENUE,  
CROYDON CR9 2TA GREAT BRITAIN  
Tel: 01-686 2599  
International: +44 1 686 2599 Telex: 947709  
Fax: 01-760 0973 E-mail: 78-DGS1071  
© Link House Magazines Ltd 1987  
All rights reserved  
November 1987  
ISSN 0268-8786 ISBN 0-86296-040-1



Cover courtesy of Sony.

**5** **Editorial:** The future of vinyl depends on a healthy supply of cutting lacquers. Carl A Snape reviews the situation.

**8** **Pre-emphasis:** News, comment and information on industry matters around the world.

**12** **US Report:** Susan Nunziata from our New York office, reports on current US news and developments.

**14** **Equipment:** New and recently introduced products.

**18** **Disc Cutting at PRT:** Janet Angus talks to Malcolm Davies and Noel Summerville at PRT.

**22** **The Importance of Dolby Level:** Graham Carter looks at the whole question of duplicating and Dolby level.

**26** **The Opening of DADC Austria:** Sony has opened a new CD plant in Europe. Report by Carl A Snape.

**30** **Anti-copying — The Future:** Dave Laing, press and information

officer of the IFPI, replies to Barry Fox's comments about Copycode and other matters.

**34** **Analogue Clone:** Dave Lawrence, outspoken advocate of realtime duplicating, talks to John Seabury about Clone Systems.

**36** **Tape Care:** Gwyn Price of 3M (UK) plc offers some useful advice on caring for tape.

**38** **Alternative to Tape:** Bill Foster looks at the hard disk for mastering purposes.

**42** **New Research into Polycarbonate:** Dr Mark Whitman details the setting up of Mobay's new US research laboratories.

**46** **A New Technique for Metallising Compact Discs:** Denton Vacuum believe they have eliminated some of the production problems associated with metallising CDs.

**49** **Three-year Index:** A cross-referenced index to all our previous issues.



Lacquer production

# Your name on top of Swiss quality.

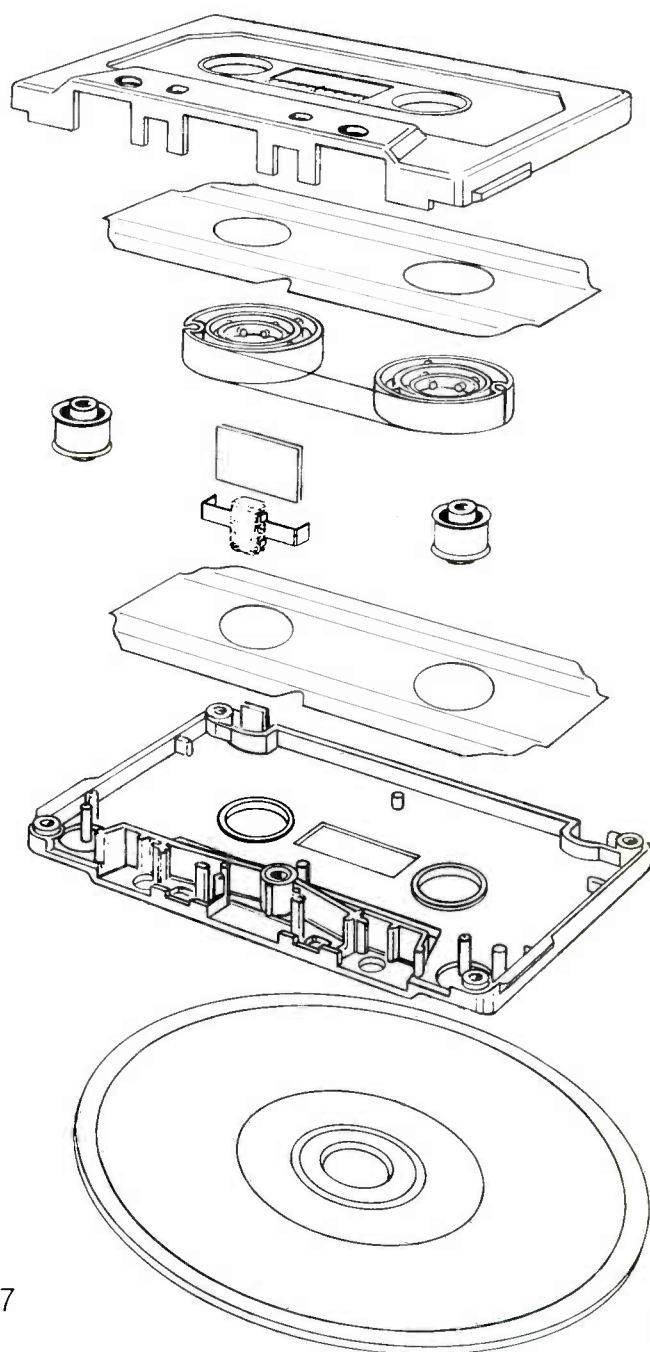

For details regarding  
cassettes/boxes  
please refer to:

ICM Ltd.  
Mühlebachstrasse 27  
CH-8800 Thalwil  
Switzerland

Telephone 41 1 720 29 42  
Telex 826805 icm ch  
Telefax 41 1 720 37 97

For details regarding  
compact discs  
please refer to:

ICM Diessenhofen Ltd.  
CH-8253 Diessenhofen  
Switzerland

Telephone 41 53 787 87  
Telex 45 896 416  
Telefax 41 53 784 41

**ICM**  
SWITZERLAND

## The axe man cometh

Over the past few years one of the most popular pastimes with arm-chair pundits has been vinyl baiting. Everyone and their dog has had some sort of opinion as to when the black vinyl record will finally die and most will venture the cause. Highest on the list is, of course the ever-increasing penetration of compact disc into the consumer market place and undoubtedly there is no question that CD is contributing to reduced vinyl sales. But will it strike the final blow that will kill off vinyl forever? Don't make me laugh. That privilege will be reserved for just three or four company directors sitting in various boardrooms around the world. Wittingly or unwittingly it is they at the end of the day who stand ready, axe in hand, as judge and executioner.

So who are these faceless men? Record company accountants? High-tech Japanese industrialists? Senators or Euro-MP's? No, not this time — they are the lacquer manufacturers. Over the years the number of lacquer producers has fallen. Today there are only four manufacturers supplying the entire world's requirements. One major company has just ceased production and I hear strong rumours in London that a second may follow suit. It remains to be seen whether or not these rumours prove false but in any event this does not change the fact that sooner or later someone, somewhere may well decide there's more profit to be had elsewhere.

Put in the context of a large corporation the manufacturer of lacquers is not the easiest of things to justify. Considerable expenditure is required. Stringent standards are required both within the factory and from outside suppliers and the product requires very careful handling and stable manufacturing conditions. Lacquers also need to be incredibly consistent. They need to be cured before they can be sold and they have a critical 'sell-by' date making stock control, storage and transportation a real headache, particularly if the highest quality standards are to be maintained.

A poor batch of lacquers creates almost immeasurable problems within the industry. Cutting engineers are up in arms because the frequency response is all over the place or the lacquers are too noisy. Plating shops throw their arms up in despair because they can't clean the lacquers properly. Pressing plants complain because the metalwork isn't up to par and so it goes, on and on. Tight release dates mean that you go with a less than ideal product to the market place or you lose your production slot and go back to square one. Whenever there is a hitch like this, no one wins.

Over the years experience has shown where the danger signs lie. People in the industry have learned to live with the day-to-day problems and respond quickly to the odd bad batch that is less than ideal. At the end of the day the real worry, of course, is what happens when supplies are so limited that the less than ideal lacquer is all that you can find? Total chaos. And from what I hear, if we haven't already reached this situation it's not that far away.

So are the lacquer manufacturers to blame? To the casual observer the obvious solution would be to improve the quality control or

increase production. I'm sure they'd love to but all this costs money and where is that going to come from? There are probably only two places the money can come from: a vast increase in price or record company subsidies. I'll re-phrase that, there's probably only one place the money can come from: a vast increase in price. With some record companies prepared to accept lower standards, how could disc cutting facilities possibly justify passing on a whacking great increase? They couldn't. It's a real dilemma and it's not the first time something like this has happened.

One of the crucial components during manufacture is the base which supports the lacquer coating and provides rigidity. It is made of aluminium and is manufactured to extremely high tolerances. The finish has to be better than mirror perfect, the slightest defect will show through on the surface of the lacquer resulting in a rejected disc or possibly a problem later on at the cutting or processing stage. Getting high quality finished aluminium discs is neither easy nor cheap.

Some years ago the entire industry was threatened virtually at a stroke when the source of these finished aluminium discs was threatened. It virtually caused a heart attack for everyone and the memory is probably still painful to this day. US disc cutters were particularly badly hit and the repercussions went right across the world. Most manufacturers decided 'never again' and invested in their own aluminium finishing equipment.

Even with good aluminium discs, that is only the start of the manufacturing difficulties. The slightest dust, a change in temperature or humidity and a batch can become useless. Some superficial blemishes won't necessarily affect the cut but they could be reproduced on the final pressings giving the impression of a faulty disc. In fact there may be no audible degradation, but this doesn't inspire customer confidence.

There's a solution of course — do away with the lacquers all together and this, of course, is exactly what happens in the DMM process where a copper blank is used and the cutting is done directly into the metal. Not everyone, however, has invested in DMM. Those with foresight will reap the benefits but what is to become of the rest of the industry when demands for lacquers way outstrips the supply? There is still plenty of work for the conventional cutting system and undoubtedly there will continue to be a demand for vinyl records especially in overseas markets where CD has yet to make an impact.

Within the industry there has been a confident feeling that lacquers would probably be available for at least another 5-7 years when the situation would be reviewed. But who can predict changes in the economic climate that may affect medium to long term planning?

Perhaps the major record companies should consider investing in their vinyl future. With all the publicity about DAT affecting CD sales, who is showing any concern for the future of the black vinyl record?

One major company has already gone. How long will it be before the final axe man cometh?

Carl A Snape

# On the right tracks in the music centers of the world... it's nice to be listened to



A lot of the world's music is recorded on our ferric, cobalt, magnetite and pure chrome tapes. More than you realize. We've some fussy customers in the music centers of the world. And we're proud our tape is made in Australia at a price that makes good music for your ears. Talk to us today.

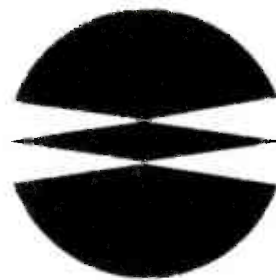

GREENCORP

Greencorp Magnetics Pty Ltd. 80 Perry St, Matraville Australia 2056. Telephone (02) 661 6511 Telex 21761 GCORP Fax (02) 661 6997



**Schneider — Reels and Cassettes  
for Audio, Video and Data Tape.**

For Schneider products in the UK:  
Reflex Audio Systems Limited  
P.O. Box 10, St Neots, PE19 4TF.  
Telephone (0480) 87239 - Telex 825697

**SCHNEIDER**

## FOUR TO ONE

- 4** C-O's TYPES - Screwed & Welded.
- 3** BOXES TYPES - Polybox. *Clear; Clear/Black;*
- 2** WINDOWS TYPES - *Soft; Hard.*
- 1**'ST HIGH QUALITY

Arkal C-O's are moulded and assembled by means of modern equipment, using materials of the highest quality. This combination guarantees the accuracy of all cassette parts and a final product which exceeds internationally accepted quality standards. The Arkal C-O is easily loaded with even the fastest cassette loaders.



**ARKAL**

Technical Plastic Products  
Kibbutz Beit-Zera, D.N. Emek Hayarden, ISRAEL  
Tel. 972-6-755331. Telex: 6665 Arkal IL, Fax: 972-6-751333

**M**  
**MUSICBOX**  
 C-O COMPACT CASSETTES



**V**  
**VIDEASON**  
 VIDEOCASSETTE

I-25050 Rodengo Saiano (Brescia) Via Castegnato, 8 bis  
 Phone No 30-610921-610931  
 Fax No 30-611395 · Telex No 303056 VIDSON I.

**Alfasound**

**CUSTOM WOUND  
 BLANK CASSETTES AT  
 AMAZING PRICES !**

C1-C135

**REAL TIME CASSETTE DUPLICATION  
 CASSETTE LABELS  
 AND INLAY CARDS**

**CALL FOR DETAILS AND FREE PRICE LIST**

**061-969 7618**

Alfasound, St. Martins Studio  
 Greenbank Road, Ashton-on-Mersey,  
 Sale, Cheshire M33 5PN.

**Look for this name.  
 We have all the answers.**

Video winder · Duplication system · Audio winder · Labeller · Boxer · Line-up unit · Autofeed shuttle system

**TAPEMATIC®**

Office and factory:  
 Via Vimercate 32  
 20060 Ormago/Milan/Italy  
 Tel. 039 · 6010145/Tlx. 340233

**TAPEMATIC SERVICES (UK)**  
 13 Elm Road  
 Faringdon/Oxon/England  
 Tel. 0367 · 20262/Tlx. 858623

## High Street CD plant

Virgin Records in London's Oxford Street and Denton Vacuum of New Jersey, have announced the installation and operation of the Denton Vacuum *Discline-500* compact disc metalliser in the Virgin Records Mega Store, Oxford Street, London, England.

The *Discline-500* metalliser is one component of a 'Monoline' system designed by Advent Engineering.

Mark Gostick, director of Advent Engineering, describes the monoline as a combination of the best available CD manufacturing equipment. The equipment includes a Netstal injection moulder and a Denton Vacuum *Discline-500*, in combination with a top coater and

printer designed by Advent Engineering. The Monoline at Virgin also includes a robotics system for automatically moving the discs from the injection moulder to the metalliser, coater and printer. The entire line is located in the retail record store, behind glass walls, allowing the customers to see the entire manufacturing process. Because of the close proximity of the Netstal press and the Denton Vacuum *Discline-500*, cleanroom requirements are minimised.

Gostick says because the discs are transferred immediately from the moulder to the metalliser, coating adhesion is extremely good and pinhole count, even without a sophisticated cleanroom, is extremely low.

## Telex corrections

Telex Communications Inc have written to clarify a couple of points concerning the *Telex 6120 XLP Pro* series audio tape duplicator reported in the July issue:

1 There are three options available in the *6120* series but only the *XL* and the *Pro* versions feature *XL Life* heads. The standard version uses a *Hy Mu*

metal type head which is of a totally different construction.

2 The payment programme referred to in the July item is limited to the USA and is only available to end users through participating Telex dealerships.

3 The suggested list price quoted is ex-factory and therefore does not include freight, duty or local tax charges.

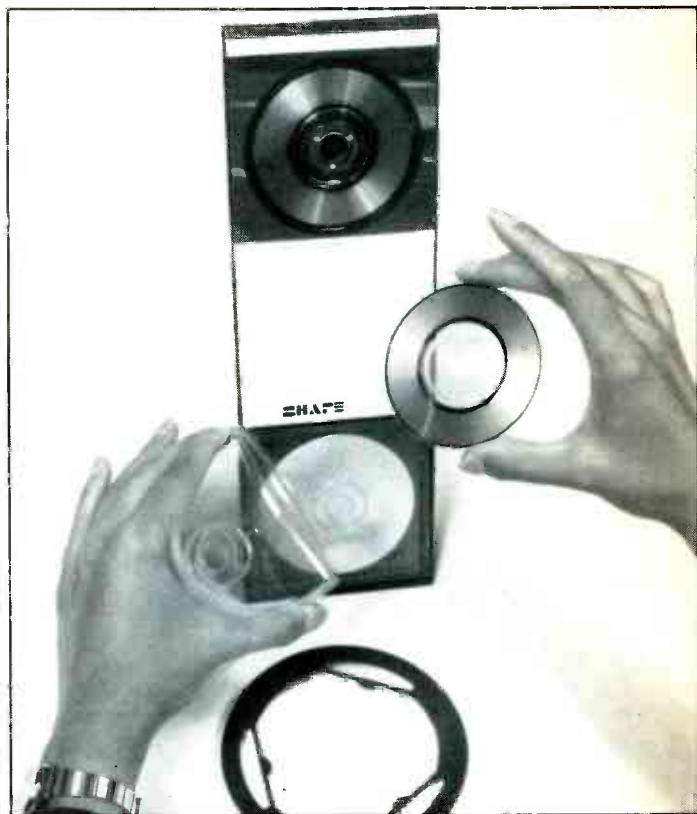

## Shape 3 inch singles

Shape Optimedia has begun manufacturing 3 inch compact discs and Delos International is the first record label to be involved in this programme.

All discs are manufactured using Shape Optimedia's fully integrated Unit Disc Manufacturing System (UDMS).

The 3 inch compact disc is a portable configuration of the conventional 5 inch disc and contains up to 20 minutes of music. Because the 3 inch CD is not compatible with all players, adapters are necessary to increase its outside dimensions to those of a conventional CD. "A patent pending adapter designed by SHAPE will allow a 3 inch disc to be compatible with any known

player," says Dennis Hannon, Shape Optimedia marketing manager, and Shape's 3 inch CD storage case fits nicely into your shirt pocket."

Shape Optimedia have also designed a cost effective retailer package for the 3 inch CD that is injection moulded. The retailer measures 4 x 12 inches, and is designed to conform to current industry standards, allowing for compatibility with other forms of CD packaging in the retail store. There is adequate room on Shape Optimedia's 3 inch retailer to supply graphic messages that are either specific to the artist and/or generic to the music label. Cost is estimated to be in the 25c range.



## New office for Fraser Peacock

Video duplicator Fraser Peacock has opened a northern office and increased its sales department, in order to provide a faster, more responsive service to clients.

Richard Keogh has been appointed representative for the North and Scotland, based in

Manchester. Denise Kreuchen joins Karen Ansell in the industrial and commercial markets sales team. And ex-Blackrod production services executive Sally Blower joins the Wimbledon-based company as corporate production controller.

## Change of name

From October 1st, 1987, Leybold-Heraeus will be known simply as Leybold AG. This is due to the withdrawal of WC Heraeus GmbH and Metallgesellschaft AG

as shareholders. The registered offices have moved from Cologne to Hanau and Degussa is now the sole owner.

## Praxis appointment

Tony Tuxford, executive vice-president and chief operating officer of Praxis Technologies Inc has announced the appointment of George L Schrijver as vice-president of operations. Schrijver

comes to Praxis after many years of managerial manufacturing experience gained at Novatel Communications and Northern Telecom Canada Ltd.



**COPY A HUNDRED**  
**C-60 CASSETTES IN**  
**UNDER 90 MINUTES!**

(USING 5 COPY POSITIONS)



THE  
**TELEX**  
**CD SERIES**

a versatile range of cassette duplicators which can easily be expanded up to 11 copy positions with the addition of slave units. Ideal for heavy duty use with multi features including auto-rewind and built-in erase.

AVCOM SYSTEMS LTD  
 STANLEY LAKE NEWS, LONDON W12 7HS  
 FOR A FREE DEMONSTRATION  
 OR FURTHER DETAILS,  
 CONTACT:  
**01-740 0051**



**QUALITY YOU CAN TRUST!**  
**For All Your Duplication Needs**

- C-Zeros (Sonic 5-screw, All-Clear) & V-Zeros
- Audio & Video 'Pancakes' & Webs
- Bulk loaded Audio & Video Tapes
- Norelco & Library Cases
- Components & Accessories

- U.K. (01) 8942788 • Pakistan (21) 723401 • Saudi Arabia (03) 8417371
- U.A.E. (4) 375881 • U.S.A. (213) 3931572 • Spain (03) 7113884
- France (61) 34-695314 • Portugal (01) 7587072 • Australia (03) 3389106



**UNIMAGNETIC PTE LTD**

An Audio Subsidiary

No. 7 Fourth Chin Bee Road Jurong Town Singapore 2261  
 Tel: 2685166 (5 lines) Fax: 3395983  
 Telex: UNIMAG RS 35131 Cable: CASETCO

**ASONA** for Complete Cassette Production

The new semi-automatic WINDER 2015 compliments the ASONA line of loop-bin/slave duplication systems.

Approximately 950 C-60 cassettes can be produced per shift with one winder.

The winding and splicing phases are fully automated, enabling two winders to be operated by one person, or five machines by two persons.

Length preselection is provided for blank tape, automatic cue-tone detection for recorded tape.

Robust construction, with a minimum of moving parts.

Low maintenance requirements, low personnel costs.

**ASONA**  
**Winder 2015**

The WINDER 2015 is designed for universal installation. Completely self-contained; may be plugged in wherever needed. No compressed air or external vacuum required. Compact, completely self-contained with...



**We can tailor a cassette production system to your needs.**  
**Write or call for a proposal.**

ASONA is manufactured in West Germany by ASONA AUDIO - TECHNIK GmbH & Co. KG, Bahnhofstraße 60, D - 7634 Kippenheim  
 Tel.: (0)78 25 - 1068, Telex: 75 43 25 auvis d

## Ampex appointment



Ampex Corporation's Magnetic Tape Division have created a new position to better reflect the company's commitment to providing customers with an integrated sales and customer service support programme. The new position, director of sales and customer service, will be filled by Richard A Antonio who, for the last 11 years, has been national sales manager.

In his new position Antonio will continue to direct all division sales in addition to overseeing the development of the new programmes.



## AMS AudioFile CDs

According to AMS in Burnley, Lancashire, compact discs are now beginning to appear bearing the AMS *AudioFile* logo as an indication of the *AudioFile*'s role in the pre-mastering process.

The new cut and splice software has now made the random access, hard disk based editing system ideal for mastering compact discs claim AMS. The first CD release to benefit from its

editing capabilities is *Cathedral Oceans* by John Foxx. This has been released by Quiet Man Records and carries the AMS *AudioFile* emblem.

Also recently mastered on the *AudioFile* is the first CD release by EMI's Deep Purple *24 Carat Purple*. This was mastered by Ian Gillespie at Tape One Studios in London.

## Discovery sales offices

In furthering its plans for expansion of services to its compact audio disc customers, Discovery Systems has announced the opening of its New York and Raleigh, NC offices.

"In addition to our corporate office in Dublin, OH and our Los Angeles office, we now have added two East Coast offices to adequately cover the US",

explained Michael Ward, vice president, CD Sales.

Account executives for the new offices are Al Cohen, located at 437 Madison Avenue, Suite 2000, New York, NY 10022, USA. Tel: (212) 888-2220 and William M Weber, 4601 Six Forks Road, Suite 518B, Raleigh, NC 27609, USA. Tel: (919) 881-0066.

## Appointments at Electro Sound

Two new appointments have been made at Electro Sound. Bob Becker has been appointed plant manager and reports directly to Electro Sound president, Bob Barone. Becker, a 10 year veteran in directing electronic assembly plants assumes immediate responsibility for all day to day plant operations and responsibilities.

Gary Johnson has been appointed manager, audio engineering and also reports

directly to Barone. Johnson has a wide background in audio design through past project work with Dolby Laboratories and Ampex. He also has extensive audio and video experience in broadcast applications.

According to Barone these appointments are part of Electro Sound's overall plan to develop an upper management team in line with engineering development applications.



## NED/Analogic technology agreement

New England Digital Corporation, manufacturer of the *Synclavier* digital audio system, have announced that they have entered into a joint technology development agreement with the Analogic Corporation, Peabody, MA, manufacturers of analogue to digital converters, signal processing equipment and medical products.

Under the agreement, the two companies will now work together in developing a new generation of extremely fast A/D converters and signal processing products that will be incorporated into the *Synclavier* system. Analogic Corporation's founder and president, Bernard M Gordon, invented and developed the first high speed, high precision A/D converter in 1953.

"We are very pleased to make this announcement," explained Sydney Alonso, co-founder and chairman of New England Digital Corporation. "Since its formation in 1969, Analogic has always led the data conversion and signal

processing marketplace with one major breakthrough after another. The alliance of NED and Analogic promises to produce the next wave of technology that will take the *Synclavier* digital audio workstation into the next century."

Co-incident with this announcement New England Digital Corporation also revealed that the company had received its seventh patent on the *Synclavier*. According to Alonso, an eighth patent is still pending and several new patent applications are now being readied by the company.

"The *Synclavier*'s leadership position in the marketplace today depends, to a great extent, on the product's continuing ability to provide features and capabilities that simply cannot be duplicated," Alonso said. "We are committed to ensuring that the *Synclavier*'s unique performance capabilities always remain unique. Toward this end, we are now readying additional patent applications."

## PRE-EMPHASIS

### Anton offers CD test service

Anton Labs are now offering compact disc testing services. This testing service, say Anton Labs, will provide accurate and unbiased information needed for compact disc purchasing and manufacturing requirements.

Anton Labs is associated with Shape Systems Design which is a division of Shape Inc, the international design and manufacturing company producing high technology components and assemblies for the audio, video, computer and optical media industries worldwide.

The tests cover five different areas: decoder errors, cosmetic defects, dimensional conformance, replication integrity and optical integrity.

Results will normally be mailed along with the sample discs within five working days after receiving

the discs. If a higher priority is needed or less than 20 disc tests are required, a reserved priority will be assigned. In many cases, testing will be completed within 24 hours and the results will either be FAX transmitted or verbally phoned to the customer. In all cases, test turnaround time will be quoted at the time of the order. All testing results and samples are treated as strictly confidential.

Most of the testing equipment is designed and built in-house, industry standard methods are used where available, and the most accurate instruments possible are utilised. For more information contact: Neal Prescott, Anton Labs, 125 John Roberts Rd, South Portland, ME 04106, USA. Tel: (207) 879 0550.

### Optical report

The *Optical Memory Report* provides detailed information on a wide variety of products and companies concerned with the optical memory market. Compiled by Rothchild Consultants, San Francisco this annual source book also contains market forecasts, projections for future technological developments, product specifications, shipments

and prices of all optical drives, media turnkey systems, subsystems and of course CD-ROM and videodisc.

The cost of *The Optical Memory Report* is \$1995. Additional copies are \$250. Further details from the publishers, Rothchild Consultants, PO Box 14817, San Francisco, CA 94114-0817, USA. Tel: (415) 621-6620.

### Change of address

Invue Sound Inc, the New York CD-V mastering and video post-production facility have moved to

247 East 32nd Street, New York, NY10016, USA.

### Shape move into CD-ROM

Shape Optimedia Inc have announced the manufacture at CD-ROMs for the information storage market. "Our background in the compact disc digital audio field has given us the expertise in data integrity of CD media," explains marketing director Dennis Hannon.

Shape Optimedia are providing a complete CD-ROM service from data tape to disc, which includes mastering, electroforming, disc replication, full graphic capabilities, packaging and distribution. Premastering

capability for CD-ROM was scheduled for last month and this month Shape Optimedia plan to acquire a data encoding and disc simulation system.

Tom Brown, manager, CD-ROM development, adds: "The integrated production process of the UDMS (Unit Disc Manufacturing System) gives us the competitive advantage in the CD-ROM market. We have established a separate CD ROM area, and have dedicated one UDMS line to CD-ROM."

### New appointment at Otari

Otari Corporation have recently announced the appointment of David Ruttenberg to the position of central regional sales specialist.

Ruttenberg is a graduate of the University of Miami Music Engineering and Technology Program and is an experienced

production engineer.

In his new position Ruttenberg will be based in the main Otari office in Belmont, CA until Spring next year at which time he will open a new Otari regional office in Chicago.

## SPECIALIST MANUFACTURERS OF AUDIO PACKAGING

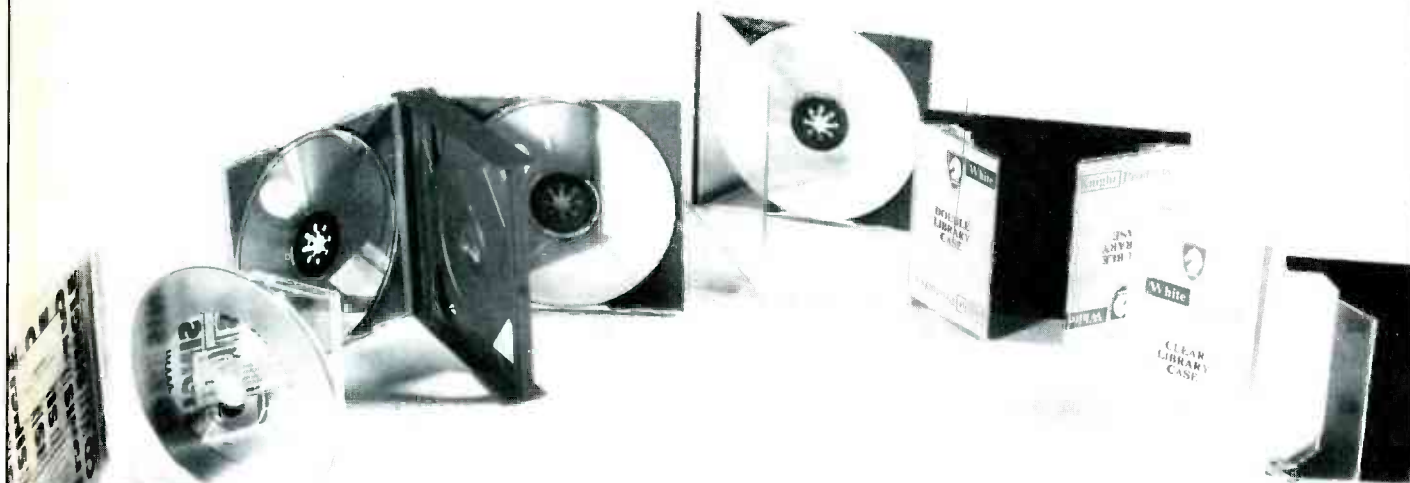

**White Knight Products Ltd**

33 STATION ROAD INDUSTRIAL ESTATE  
HAILSHAM - EAST SUSSEX - BN27 2EB - ENGLAND.  
Telephone: (0323) 841936 - Fax (0323) 440118

## US REPORT

### Digital Magnetics with digital audio

As home viewers and video cassette recorders become more sophisticated, greater attention is being paid to the audio quality of pre-recorded material. Digital Magnetics in Hollywood, CA, is fully aware of that heightened sensibility, having produced digital audio tracks for such movies as *ET*, *Poltergeist* and *The Color Purple*.

Until recently, producing a digital soundtrack for a movie meant recording two master tapes, one for video and one for audio and properly synchronising them for broadcast or duplication. For a recent project, however, Bruce Botnick, owner/producer at Digital Magnetics, used Sony's new *BVH-2830* VTR with built-in digital audio recording capability. The *BVH-2830* was used to create the master for the movie *Howard The Duck*, which is a home video release from MCA Home Video.

"The master tape was used for home video duplication, pay television, free TV and debut network syndicated video," said Mike Fitzgerald, technical director for MCA Home Video.

MCA was the first company to use digital audio throughout the home video mastering process, according to Fitzgerald, who encouraged the Digital Magnetics engineers to use the *BVH-2830*. "They were most impressed with the digital processing capability of the 1 in Type C VTR, which rivals the quality of the *PCM-1630* digital audio processor," said Fitzgerald. "It's like listening to the original because of the elimination of all the customary analogue audio generations.

"We started with the actual Dolby 2-track stereo printer master on full coat magnetic film. The process remains digital until the final cassette is made at the duplication house. Typically, a home video master undergoes as many as five generations of analogue audio."

Botnick explained the process in more detail. "We transfer and conform from 35 mm mag to the *1630* or the new *PCM-3202* 2-track reel-to-reel in sync with the picture," he said. "From there, we created a *PCM-3324* multitrack with all the various soundtrack formats for mono, stereo, surround sound, and foreign language. Then we lock up the multitrack with the *BVH-2830* to make the duplication masters. Since most theatre-goers are hearing optical soundtracks, the home viewer will now be even closer to listening to the original audio."

### Laserdisc sales increase

A 133% increase in second quarter sales of laser videodiscs to consumers over the same period last year has been reported by Laser-Disc Corporation of America, a division of Pioneer Electronic Corp, Ridgewood, NJ.

"Sales results have been on the rise

continually and have jumped significantly from quarter to quarter," said John Talbot, vice-president of marketing for LDC America.

### AMS/Ampex interface

Ampex has reached development agreement with AMS regarding an interface for that company's *AMS AudioFile*. The interface is designed to permit simultaneous cutting of audio and video, according to Steve Krampf of Ampex.

### Duplication Specialists formed

To meet the needs of realtime duplicators, David Schwartz has formed Duplication Specialists in Long Beach, NY. The new company will address the needs of area artists, studios and others.

"What we're trying to do is stay within the confines of what should really be done for duplicators without cutting corners," said Schwartz. "Most people bring in source masters that are distorted and noisy. We're capable of putting realism and life back into the recordings before duplication."

In addition to its Nakamichi *MR-1* cassette deck and Technics *RS-1520* 1/2-track 1/4-inch open reel recorder/reproducer, the facility utilises a Sony *ES-601*. Its outboard gear includes Dynaflex *DX-2* single-ended noise reduction and Aphex Type *C Aural Exciter*.

Duplication is done on 32 remote-controlled Onkyo *TA-2028* cassette machines, which are aligned and biased for Ampex and Agfa tapes, and Dolby *B* and *C* can be encoded, according to Schwartz.

Duplication Specialists is located at PO Box 54, Long Beach, NY 11561, USA. Tel: (516) 432-2325.

### ESG for WCI

Working to improve the quality of its audio cassette tape, The Warner Group has added 10 Electro Sound *4800* systems to its WCI plant. The addition is part of a process the company undertook five years ago to improve its audio cassette quality profile, according to Ed Outwater, executive director, quality assurance, WCI Record Group.

"We are monitoring, maintaining, and increasing the quality of cassette product," said Outwater, who added that the company has upgraded its cassette shells, mastering tape and duplicating tape. "We regard top-of-the-line master and slave duplicating as a key link in the reproduction chain. If it's not on the master tape, for example, it won't be on the cassette. Exact A-B reproduction from these masters is vital."

Pre-recorded cassette tapes accounted for more than \$2.5 billion for the recording music industry in the US last year — the highest percentage dollar and unit sales.

Susan Nunziata, New York office

### CD-ROM Distributors

#### BELGIUM

Philips Data Systems  
Brussels Tel. 32.2.5256111  
Mr. M.A. de Ridder

#### FRANCE

TRT/TI  
Paris Tel. 33.1.43201502  
Mr. C. Délécourt

#### ITALY

Philips S.P.A.  
Milan Tel. 39.2.67523083  
Mr. N. Binaghi

#### THE NETHERLANDS

Philips Data Systems  
The Hague  
Tel. 31.70.482699  
Mr. L. van Rijn

#### SWEDEN

Philips Försäljning  
Stockholm  
Tel. 46.8.7821000  
Mr. B. Gauffin

#### U.K.

Philips Interactive Media  
Systems  
Croydon Tel. 44.1.6892166  
Mr. A. Lambert

#### WEST GERMANY

Philips Kommunikations  
Industrie  
Siegen Tel. 49.271.4040  
Mr. B. Schüttforth

#### CUSTOMER SERVICE CENTRE

Hannover—West Germany  
Tel. 49.511.73060

#### MARKETING CENTRE

Nieuwegein—  
The Netherlands  
Tel. 31.3402.78911

For other countries, please  
contact PDO's Marketing  
Centre in Nieuwegein, The  
Netherlands.



PHILIPS AND  
DUPONT OPTICAL  
COMPANY



## Now PDO meets your CD-ROM needs even faster.

Introducing two new customer-oriented services from PDC: One-Day Delivery. And our Five-Day Development Disc Service, guaranteed to save you time and money.

### **ONE-DAY DELIVERY.**

Need CD-ROM discs in a hurry? Just bring us your tapes in the morning, and we'll deliver up to 50 discs the following afternoon—and up to 1,000 discs on the next day. It's premium service at a reasonable cost.

### **FIVE-DAY DEVELOPMENT DISC SERVICE.**

The routine way to check your CD-ROM disc software is to produce a direct disc. When satisfied, you have to make a new master disc for manufacturing.

No longer. There's now a better way. With the PDO Development Disc Service, we'll deliver five software inspection discs in five days or less. If you're satisfied with your software, the master used for the development disc can be used for your production order. Easily. Economically. Immediately.

### **LEADERS MOVE FASTER.**

PDO is Philips and DuPont Optical. Two leaders in technology united by one absolute commitment to service. In less than one year, PDC has improved the industry's turnaround time from 20 days to just 30 hours. In an industry where standard delivery is ten days, that's not just evolution. It's a revolution.

Whatever your application, PDO can take you step-by-step through the preparation, mastering and replication of your CD-ROM optical disc. With applications research, development and manufacturing facilities for media located throughout Europe and the U.S.A.

PDC can put the instant retrieval capabilities of CD-ROM at your fingertips, to give you the power to manage your vital information—today and tomorrow. Because optical discs are where information is going, PDO is where your system begins.

To find us, just follow the leader. See our listing opposite this page to find the PDO distributor nearest you.

P H I L I P S   A N D   D U P O N T   O P T I C A L



## Otari T-700 video duplication system

Otari Corp has announced the availability of a very high speed video duplication system, the *T-700*, using Thermal Magnetic Duplication (TMD) technology. This technology was originally developed by the EI DuPont De Nemours Company. The *T-700* is the culmination of a joint programme between Otari, DuPont, and Bell and Howell/Columbia Paramount Video Services. The *T-700* is capable of producing video copies at up to 150 × normal speed and utilises a master loop bin that allows this duplication rate to be maintained for continuous production.

The TMD system uses a laser to instantaneously heat chromium dioxide tape to its Currie

temperature — the point at which it loses its own magnetic properties. The heated portion of the tape is pressed against a mirror image master tape, from which it acquires the magnetic image of the original.

Otari emphasise that an important aspect of mirror image duplication is that with the development of new, higher quality video formats, such as SVHS and Super Beta, only the master-making machine requires change. The *T-700* itself will require no modification.

**Otari Corporation, Industrial Production Sales, 2 Davis Drive, Belmont, CA 94002 USA. Tel: (415) 592-8311.**

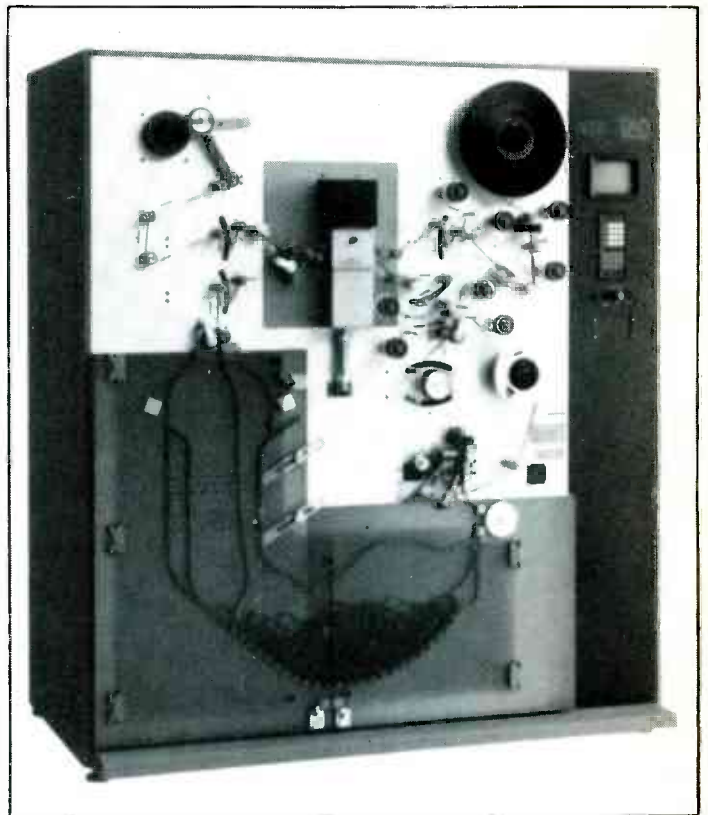

Otari T-700 video duplication system

## DOCdisc rotary CD printer

DOCdisc BV have developed equipment for the rotary printing of compact and optical discs and have begun to offer (in Western Europe) complete production lines for the rotary printing of compact discs. One line includes: handling of feedstock, printing of the disc structure, metallising and protecting the disc, punching and transport to the packing group.

One line can produce 1000 discs per hour. It employs five to six people and takes care of the full production, including stamper preparation and testing of the discs. The production set-up requires 400 ft<sup>2</sup>, which can be a

part of a standard production plant: no cleanroom is required.

Cost in Western Europe is Dfl 1,750,000 and each line is approved according to the Red Book specifications.

The rotary printing unit, according to the manufacturer, is suitable for first releases, production on demand for distributed production. This is due to the very low depreciating costs per CD produced, and the ability to exchange one stamper for another within seconds.

**DOCdisc BV, PO Box 573, 5900AN, Venlo, Netherlands. Tel: 077-87 22 00.**

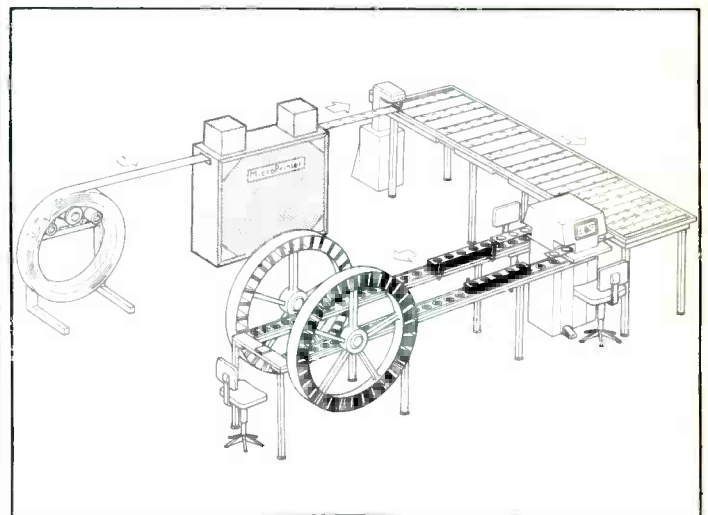

DOC disc rotary CD printer

## DISC reference CD

Reference compact discs are now available from Digital Intelligence Systems Corporation (DISC), Santa Ana, CA.

Similar to vinyl test pressings in concept, this new service provides a reference CD which is playable on any standard CD player. With the disc it is possible to verify exactly how a given CD will sound weeks, or months, before the mass produced CD becomes available from replication plants.

The DISC CD reference disc uses a glass substrate with the same dimensions as a pressed CD. After 'cutting', the disc is metallised and given a protective coating as with pressed CDs. It looks and plays like a standard, volume-produced CD.

All that is required to produce a CD reference disc is a 3/4-inch

U-Matic digital master tape which has been recorded in the *PCM 1610/30* format. DISC enters the PQ codes on Audio Track 1 from the cue sheet. Indexing accuracy is guaranteed to be within ± 1 SMPTE time frame.

Prices for one CD Reference Disc with up to 72 minutes playing time range from \$750 with a 24-hour turnaround to \$500 for a 5-day service, excluding shipping time. Quantity discounts are available.

While this service is primarily for CD audio discs, CD-ROM reference discs are also available provided the master data programme is supplied on the U-matic tape format.

**Digital Intelligence Systems Corporation, 2865 Pullman St, Santa Ana CA 92705, USA. Tel: (714) 261-5654.**

## Leybold ZV 6000 sputtering system

The *ZV 6000* is claimed to offer a vertical sputtering system of compact modular design. Its modularity makes for ready replaceability and expandability of the various process components.

The *ZV 6000* is expandable from a system devoted to individual processes right through to a fully-fledged production system.

The system and process are controlled by a microprocessor, and important process data are displayed on a CRT screen (in the

cleanroom). Main features include specifications to Class 10, space-saving design, dynamic, static and oscillatory sputtering, with the possibility of substrate rotation on either one or two-sides.

According to the manufacturer a high degree of reproducibility and great operator convenience is ensured by highly advanced microprocessor software.

**Leybold AG, Wilhelm-Rohn-Strasse 25, 6450 Hanau 1, Postfach 1555, West Germany. Tel: (061 81) 34-0.**

## EQUIPMENT

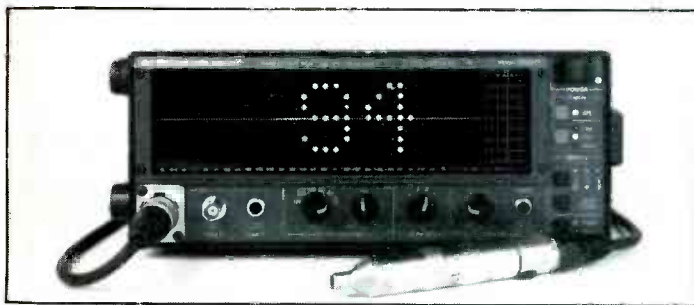

### ACI SA-3050A analyser

Audio Control Industrial have developed an enhanced version of their  $\frac{1}{3}$ -octave realtime analyser. The new model, designated the SA-3050A, has the additional features of peak hold on the spectrum display, averaging of any or all six non-volatile memories, full screen digital SPL including peak hold. The package also includes a calibrated condenser microphone.

As with the SA-3050, the new SA-3050A has a 30-band display with a large, easy-to-read 270 dot matrix grid, resolution controls of 1, 2, 3 and 4 dB/step, and fast, medium and slow decay integration. The total display range is  $-56$  to  $+36$  dBm and the unit uses double-tuned, fourth order filters meeting ANSI Class II standards.

Other standard features are six non-volatile memories with read, write, freeze, and RTA-memory

comparison functions. Any combination or all of these six memories may be averaged including weighting of certain memories to allow for centre versus side-of-room effects.

Three inputs are standard: a phantom powered balanced XLR input, an instrumentation BNC input, and a balanced bridging  $\frac{1}{4}$  inch line level input. In addition, the SA-3050A includes a precision digital pink noise generator with adjustable output that has the power to drive a speaker or crossover directly.

Other options include an internal rechargeable battery package which permits portable operation, a parallel IBM/Epson-type printer interface, rack mount frame and a soft carrying case.

**Audio Control Industrial,  
6520 212th Southwest,  
Lynnwood, WA 98046, USA.  
Tel: (206) 775-8461.**

### Tape Automation TAP-CODE

A new system which promises to revolutionise the video duplicating industry is set for an early 1988 launch.

TAP-CODE, developed by UK loader manufacturer Tape Automation, aims to solve many of the problems suffered by publishers, distributors and duplicating houses. According to Tape Automation TAP-CODE will eliminate mislabelling and intensive quality control viewing, dramatically reduce labour costs and for the first time, make it possible for duplicating houses to introduce a high degree of automation in labelling and sorting.

TAP-CODE is a magnetic coding system designed to be used with the Sony *Sprinter* and Tape Automation's *ETD* pancake duplicator.

The beginning of the code starts after the end of each duplicated programme. The code is completely separate from the

programme and does not modify it in any way.

When the pancake is loaded, sections of the code are transferred to a barcode label on the spine of the cassette. This, say Tape Automation, makes it possible to automate the subsequent sorting, labelling and QC processes. Publishers and distributors will be able to trace the production history of any of their cassettes, months after they have left the warehouse, even if the cassette has been severely abused.

TAP-CODE is currently going through intensive testing, and it is hoped that the full system will be available towards the end of March 1988.

**Tape Automation Ltd, Unit 8,  
Haslemere Industrial Estate,  
Coldharbour Road, The  
Pinnacles, Harlow, Essex  
CM19 5SY, UK. Tel: 0279  
635300.**

# XENON

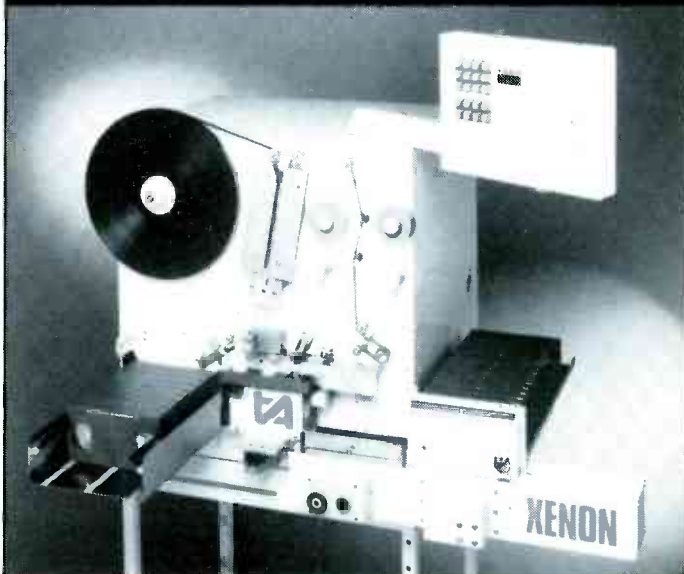

## VIDEO LOADING IN THE 1990s

A revolutionary approach to splicing.

Computer control and monitoring.

Ultra high speed.

And a whole range of automated feed and collection options.

**PLUS – cue-tone option for pre-recorded pancake loading.**

XENON is the most advanced video cassette loader in the world.

XENON is fast – a 3 hour tape loads in just 30 seconds. And microprocessor control, highly sensitive tension management, automatic fault and reject detection plus perfect splicing, give you the highest pack quality possible.

XENON is flexible – banks of up to 10 machines, all operating automatically under a single micro computer, give you full production control and stock reports too.

XENON is reliable – easy maintenance, fully automatic operation, computer control and monitoring, and cue-tone loading options, give you high output with minimum fuss.

**XENON delivers the goods**

**Tape Automation Limited**  
Unit 8 Haslemere Industrial Estate  
The Pinnacles HARLOW  
Essex CM19 5SY UK  
Telephone Harlow (0279) 635300  
Telex 818442 TAPE G.  
FAX Harlow (0279) 411573



**the leaders**

EUROPE • USA • ASIA

# TELDEC-

## *Direct Metal for Compact the new mas*

*DMM CD shapes the future of the recording industry. This revolutionary CD mastering process makes complicated and inefficient manufacturing steps obsolete. It eliminates the expensive clean room environment.*

- *The DMM CD Blank is economical and was specially developed for CD manufacturing simplicity.*

- *The recording system uses a new procedure to emboss the EFM-Code (Eight-to-Fourteen Modulation) in REAL-TIME onto the master blank. This Embossing Recording System is both easier to operate and cheaper than present methods.*

- *The DMM electroplating technique produces a very sturdy sandwich of non-ferrous and precious metals. The "released" metal part may be used directly as a stamper or as a father to produce many more stampers.*

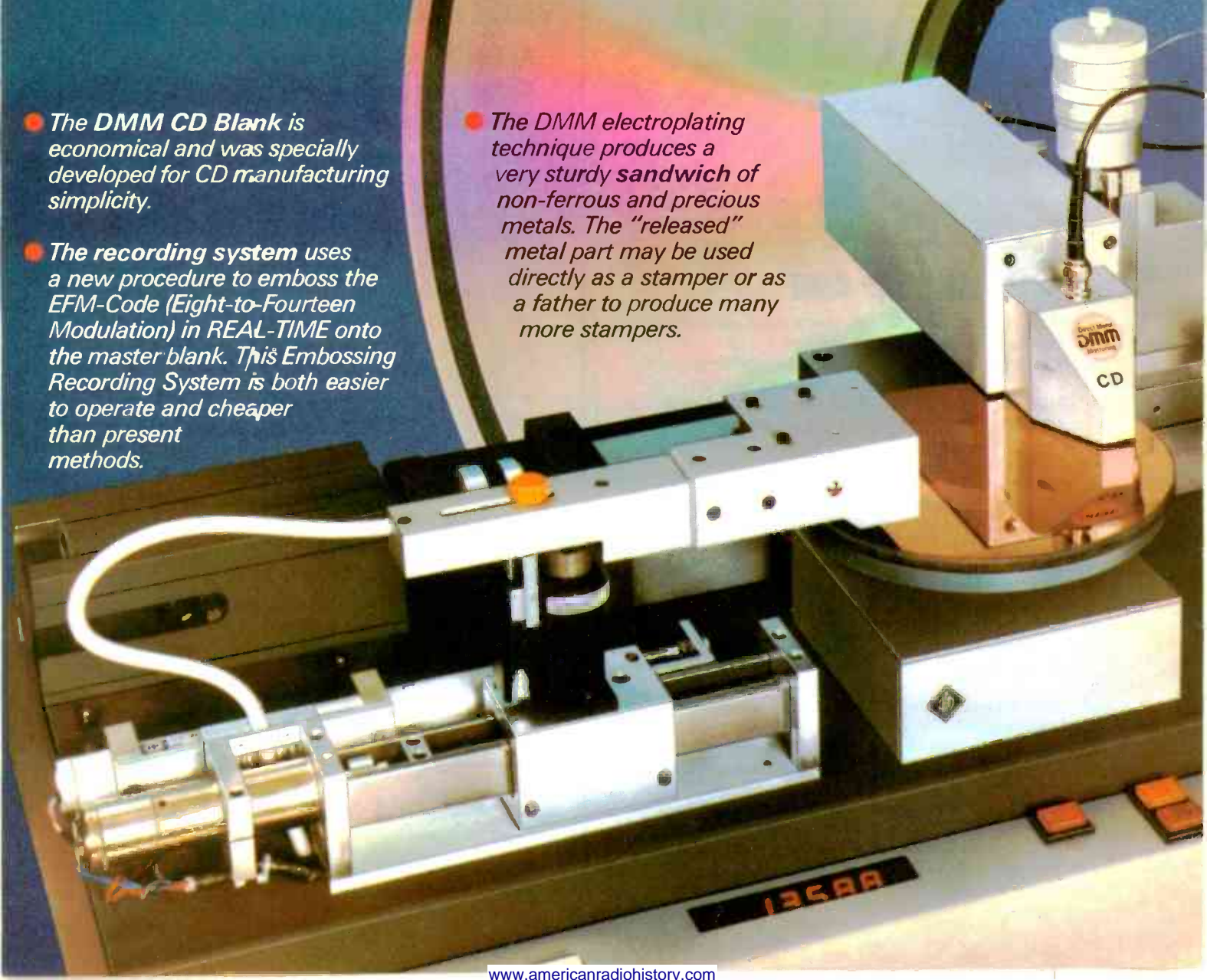



# DMM CD TECHNOLOGY

*Mastering  
Disc –  
Mastering generation.*

# NEW

- *The mastering lathe is very lightweight, small in size, and does not need a clean room. It will fit into any studio.*

*Size:  
30 inch x 12 inch  
x 17 inch*

*Weight: 60 kg*

Please contact us.

## TELDEC

Schallplatten GmbH  
Heußweg 25 · P.O. Box 2012 51 · D-2000 Hamburg 20  
Phone: (40) 4 90 62-0 · Telefax: (40) 4 90 62-267  
Telex: 213 545 · Telegram: Teldec Hamburg

## TELDEC STUDIO

Finckensteinallee 38 · D-1000 Berlin 45  
Phone: (30) 83 00 05-0 · Telefax: (30) 83 00 05 49  
Telex: 186 202 · Telegram: Teldec Berlin

## Georg Neumann GmbH

Charlottenstr. 3 · P.O. Box 6104 69 · D-1000 Berlin 61  
Phone: (30) 2 59 93-0 · Telefax: (30) 25 99 31 08  
Telex: 184 595 · Telegram: Neumannacoustic Berlin

## Audio Export · Georg Neumann & Co GmbH

Badstrasse 14 · D-7100 Heilbronn  
Phone: (71 31) 8 22 75-76  
Telefax: (71 31) 6 87 90  
Telex: 728 558

# Disc cutting at PRT

**Disc cutting engineers Malcolm Davies and Noel Summerville represent two generations. Both practise their art in central London's PRT, both maintain similar**

**philosophies and strive for similar goals, yet their feelings for the art are quietly different. Both talked to Janet Angus about their experiences and philosophies**

**M**alcolm Davies started cutting at EMI in 1958 where he worked for 10 years (cutting, among other things, most of the Beatles' singles). He went to Apple for seven years and finally came to roost at PRT for the last 12. He, along with other cutting engineers such as Tony Bridge contributed to Summerville's training which explains their basically similar outlooks.

Davies' love of vinyl was best summed up in a joking remark: "Digital editing? You could teach a monkey to do that in a matter of a few days. Take your life into your hands with a pair of scissors and a piece of tape, that's what it's all about."

Old-fashioned values include respect for other people's work and subsequently a wariness of criticising it. He nevertheless feels deeply the changes that have taken

place within the music and audio industries over the past few decades.

"I was just being flippant but I do feel that the life and liveness has gone out of recording. You would think that with all the technology available the tapes should come into the cutting room, what with all the multitrack equipment we've got these days, digital and everything — the final master should be perfect. It is not nearly as good as it was 25 years ago. The general standard of engineering is probably at an all time low."

Equipment comes in for similar treatment. Having started at EMI cutting 78s, then 45s, then 'pop music' on a Scully lathe, and later at Apple an early Neumann lathe he is now cutting on a VMS70, which Pye acquired in 1970. Summerville uses a VMS70 with a PolyGram pitch amplifier mod but Davies

sees no reason to upgrade.

"The average studio in this country is far too quick to change and buy in equipment. Some of the hottest guys in America are still using old Scully lathes and all the rest of it. In England there tends to be tremendous awareness of fashion, just as there is in the studios. Some of the best work around is being done on old lathes. This equipment could have been written off years ago but there is no need to. Apart from cutting very long sides (over 30 minutes) I would put this lathe up against any other in town."

Commenting that cutting technology has not made any earth shattering advances during its short life and that there has been no necessity for improved techniques he says that, if anything, cutting has become easier.

He gets fun out of using an older lathe, which requires a bit of adrenalin and brain power.

"The final product is not a lot better than it was many many years ago; it is just much easier. You just sit back and press a button now: the cutting engineer doesn't really have to work. Before all this, if you had a long side you had to do it manually, it was a struggle. Now the equipment does it all for you."

The spontaneity of early cutting and indeed recording days is what Davies most sadly laments.

"It was great fun. Everything was live: they would make the master on the session, bring it upstairs for cutting and that was it. Everything was moving, it was exciting. Now they take three weeks just to mix a record.

"Play some of those records now and they still stand up: *Hey Jude*, the *Abbey Road* album, John and Yoko, loads of them. They are louder than anything we are doing now and it was all live. Even music which is not recorded on a computer these days sounds like a computer because of some of these modern desks. Real instruments sound like they have been sampled."

Early cutting engineers did not enjoy very elevated positions in the respective companies and, according to Davies, had to stay in their rooms and get on with the job. He therefore has no knowledge as to what equipment other companies were using. He recalls, however, being very envious of some other people's work — especially records coming out of America which seemed to be louder and cleaner than anything he was able to produce at EMI.

"I always felt that the cuts at Decca for example were better than ours. I don't know what it was. Pye was cutting louder and cleaner. The Americans were much louder than us; we couldn't match some of the stuff coming from there — Tamla records and VJ records' *Big Girls Don't Cry* for example. The levels some of them were putting on were phenomenal. You would try to match them but couldn't get anywhere near."

Part of the problem was that EMI cutting rooms were working with 15 W EMI cutting amplifiers.

"It was tough. I was disappointed with most of my work at Abbey Road even though



Noel Summerville and Malcolm Davies

we had number one after number one."

Even today he is envious of the American cut, deeming them to be more creative and adventurous in their work.

"Certain American studios are still better. They are far more creative, work harder and produce brighter, louder records than us."

PRT was formerly called Pye Studios before the record label changed hands to its present ownership. Pye as a label was extremely successful in the '60s with artists such as The Kinks, Status Quo, The Searchers, Petula Clark, Donovan and many more. Although the company is not putting out much new product these days, the back catalogue is constantly being reworked and the singles from those heydays continue to sell as well as ever.

The facilities at PRT today comprise two 24-track recording studios (with 32-track Mitsubishi digital available to either room), two cutting rooms and a newly installed CD mastering suite equipped with the Sony DAE-1100 system.

Summerville resides in Cutting Room One with his aforementioned upgraded VMS70 lathe, Neumann cutting console with Neumann equalisers, and Klein + Hummel equalisers. Cutting amps are SAL74Bs.

Studer A80 ¼ or ½ in plus a B62 for those now rare analogue copies complete the tape machine complement along with the Sony 1630 mastering system.

"We did have a few problems with the Sony when we first got it at the end of '86. There were a lot of drop-outs. Sony replace the pinchrollers and that seems to have cured it. We have never had problems with Betamax, although it is not very easy to work with — difficult to cue up and completely uneditable as it is. A lot of studios, however, seem to be coming up with Betamax masters, so it is a good thing to have."

Monitoring is Lockwood/Tannoy. There is nothing he would particularly like to change apart from the removal of transformers in the desk which would improve the bass end phase and quality of the sound.

"Quite a lot of work goes out of this room to the CD mastering room. Regularly copying for export quite often goes out in that format. Most people seem to mix to ½ in still but the subsequent EQ'ed and export copies will often be on 1630. It is a definite improvement when making analogue masters."

Summerville agrees with Davies that there is not that much to the actual physical learning of the cutting process.

"Learning the mechanics is fairly simple, it is just the ability to transcribe the tape to disc as good sounding as possible, enhancing or modifying as and where necessary. The rest is just down to ears, just as it is with any record producer or engineer. You must know the limitations of disc which is quite different to tape. You can record most things on tape cleanly. Disc is quite a different medium.

"Treat each case as it comes in. If you are presented with a master which is 100%, then you just transfer that to disc without any degradation of quality. Not everything which

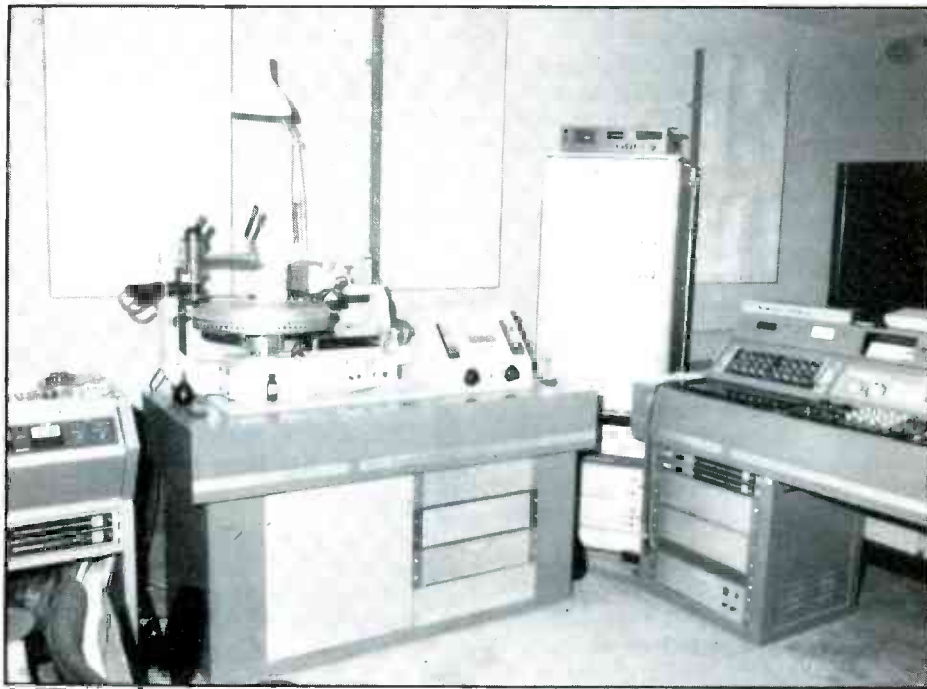

Main cutting system

comes in is 100% perfect unfortunately. It is not very often that you can cut something absolutely flat; there are degrees, some need more work than others. Nine times out of 10 you have got to do something.

"You can EQ to get it sounding better or right, or you can EQ to get it on disc. Most often we are EQ'ing to get it sounding better. Usually the tape is a little dull, for instance. You just strive to get it sounding as good as possible."

Record companies are still releasing more singles than albums and this is reflected in the type of work that comes into PRT. It is not unusual for the cutting engineer to be asked to make a 12in out of a 7in or vice versa, bringing his present day role into the realms

### **The inevitable sacrifices and compromises which the job calls for are discouraging.**

of post-production rather than simply cutting. It is perfectly possible for Summerville's day to be spent editing. He puts this new trend partly down to indecision on the part of record companies/producers and partly down to sheer lack of time and last minute changing of minds.

"We would also make suggestions sometimes if we think that a song is too long or something. We are very experienced in knowing what a single should sound like and often because we are coming in with fresh ears it is easier for us to see what is needed."

Requests go the whole gamut from simple to outrageous — a recent example of the latter being a casual demand for overdubbing the vocal. Needless to say the client was gently persuaded to go back into the studio.

"We would generally cut a single louder than an LP, especially a 12in. You have to be a little careful of what you put on the disc.

You might have to trim off more of the high frequency content for a 12in. A disco record is going to be cut 100% louder than an album.

"The idea is that whatever you do it should be audibly invisible. The tape should sound good, never mind what you do. Knowing when to leave tapes alone is as much a part of the knack as anything. Certainly some of the stuff which synthesisers put out can sound dull. You feel you want to put more top on but when you look at the cutting amps you realise you can't. There is a lot of energy which is hard to cut. For example, an electronic hi-hat can be ticking away, not particularly loud, but it will be doing something drastic on the cutting amps. Yet if you have something acoustic like a jazz quintet with lots of top end and cymbals tingling away quite brightly it will still not be difficult to cut. Natural acoustic instruments are relatively easy to work with."

Although Summerville's career hasn't spanned the whole process from 78 R1'M he has nevertheless seen his role change considerably over the years.

"It has changed from ¼ inch 15 or 30 ips, with or without Dolby (copy tapes were always ¼ inch with Dolby) to much more of a performance. You get some tracks on ¼ inch, some ½ inch, some digital. It can be more time consuming just getting everything on 1 inch format so you can work with it. If an LP comes in from several different studios, even though they may all be on ½ inch tape it might not be the simplest idea to join them all together. What I would tend to do is transfer them all to 1630 U-matic and make a production master."

The inevitable sacrifices and compromises which the job calls for are discouraging.

"If you are cutting long albums, especially over 30 minutes, you need to roll-off some of the bass end to fit it on and the sound can

## DISC CUTTING

suffer. You have to cut at a much lower level than for an 18 or 20 minute side."

Most discouraging of all though is the fact that the man in the street perhaps doesn't even notice the difference. The records sell, so one wonders whether it is worth bothering about it.

It can also be discouraging to witness what has happened during the pressing process.

"The standard often isn't as good as it could be. Often when you hear the finished pressing there is too much surface noise, or an abundance of clicks and pops, and it is sad after all those months in the studio and all that money using all the latest equipment that it ends up on a very inferior record player. That's where CD comes in."

As far as Summerville is concerned the compact cassette doesn't come into the equation in spite of sales figures indicating quite the contrary.

"In terms of what comes closest to the master, vinyl disc and CD can be very very good. The cassette never is. For example I have heard that Michael Jackson is supposed to have stipulated that his *Bad* album be duplicated in realtime. Can you imagine the cost of that?"

"In terms of how good a vinyl cut can be, if all the fear has been set up properly disc can sound just as good as the master tape; that is the potential of vinyl. Personally I like it and I don't have a CD player at home. I suppose I

will have to get one one day but not till I have to. I am not saying that there is anything wrong with CD but there are a lot of our clients, especially small labels, who don't even release cassettes, they just love vinyl."

Some people are of the opinion that modern recording techniques are creating more problems than they are solving. Davies brought up an idea, which he attributes to Doug Sax, that contemporary master tapes are displaying what he refers to as 'a kind of distortion'.

"Nearly all the tapes you get have a sort of distortion or out of phase component — you

**'Quite apart from everything else, digital mastering is a lot less fun than working a lathe.'**

can't put your finger on it but it's there. It is present in nearly all the tapes you get in. Really the more basic the studio, the cleaner the tape tends to be."

The consistency of lacquer quality also appears to have dropped during the last few years. With the threatened shortage of lacquers precipitated by the recent demise of Capitol and emphasised by the high rejection rate (up to 50% according to Summerville), the danger of the great CD takeover is ever more imminent.

Summerville: "It is mainly classical releases

which have gone over to CD or else they are using direct metal mastering. In the popular music market CD has not replaced vinyl yet."

Although not as vehemently opposed to CD and digital recording in general as Davies, Summerville still resists.

"Quite apart from everything else, digital mastering is a lot less fun than working a lathe."

Being realistic he points out that as a mastering engineer, the demise of vinyl will not indicate the demise of the mastering engineer: "If vinyl goes someone will still have to do the mastering."

"A lot of people mastering CD's don't know what they are doing," added Davies. "If a CD master is put together by a cutting engineer it will always sound better. There are no phase, sibilance or high frequency problems to worry about on CD but it is still the same techniques involved, especially when you are putting together a compilation album." Unable to resist a final dig: "Digital is not the definitive language; we're not there yet."

One day vinyl will have to give in gracefully but to what is still not clear. Summerville however is in no doubt:

"I can't see that all the companies who set up CD plants are going to write that off and go into digital cassette. It is going to have to be CD, I think."

Davies, however, has the last word: "From 78 to CD, I had the best years." ■

## You can tell a superior CO by the perpendicularity of its azimuth

And you won't find a more perpendicular azimuth than ours. That superior azimuth is just one little detail that gives us the edge for quality in an increasingly quality-conscious market. For us the industry standard is just a starting point. Not the end of the track.

What's more you can enjoy CBS quality at extremely competitive prices thanks to a £ multi million investment in the most advanced production plant. And you also get it - fast - whether you need a million COs or a gross - delivered to your door in Aberdeen or Abu Dhabi.

For COs think CBS.

Contact Allison Ogles for full details and a sample pack (complete with our equally fine library cases).



CBS Precision Mouldings,  
Waterton Industrial Estate, Bridgend,  
Mid Glamorgan, Wales CF31 3YN.  
Telephone: Bridge rd (0656) 61411.  
Telex: 497966 BRIG. Facsimile: (0656) 59211

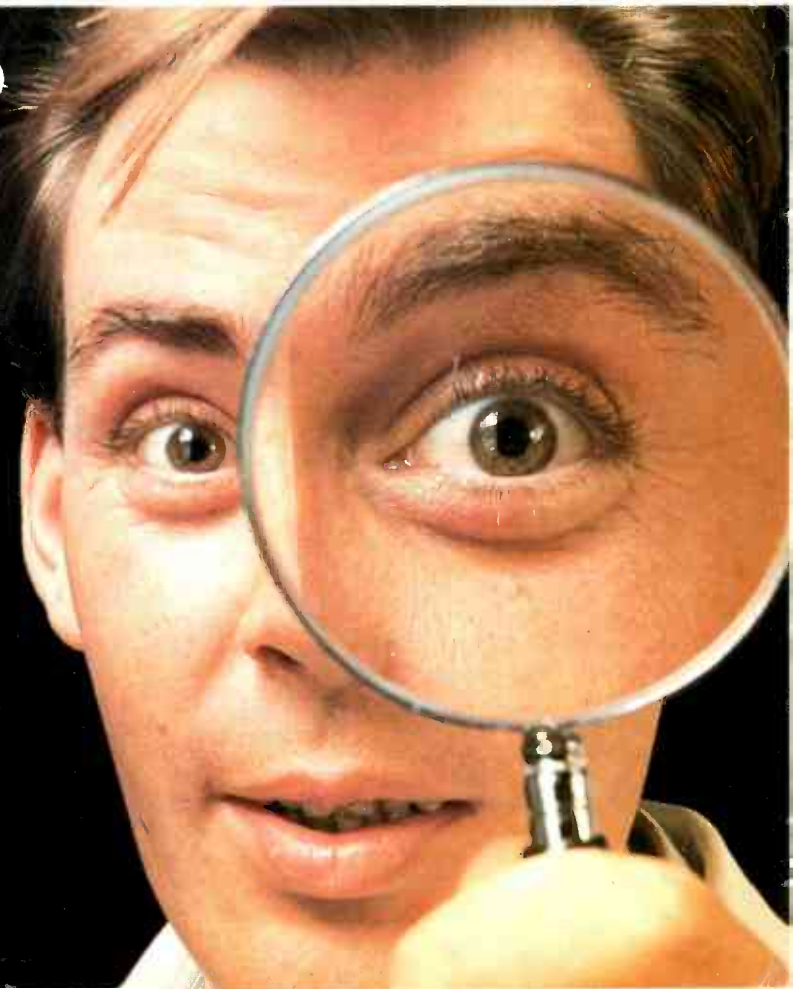



## Alex Frederiksen of TOCANO, keeps them firing on all twelve – in business and pleasure!

Secure in the knowledge that his six Lyrec twin copying units can accelerate past all his customers production targets, Alex can relax behind the wheel of his 12 cylinder Jaguar and enjoy another smooth running performance.

### The Lyrec P-2500 high speed tape duplication system.



**Lyrec**  
OF DENMARK



Lyrec (U.K.) Ltd., 'Ardhaven House', Old London Road, Milton Common, Oxford OX9 2JR. Tel: (08446) 8866 Fax: (08446) 8810 Tlx: 838725 LYREC G  
Lyrec Manufacturing A/S Hollandsvej 12, DK-2800 Lyngby, Denmark. Tel: +45 2 876322 Tlx: 37568 LYREC

# The Importance of Dolby Level

All the elements in the cassette duplication chain are coming under increasing scrutiny in the quest to improve the quality of the compact cassette. One of the necessary elements for better reproduction of pre-recorded cassettes is the correct operation of the noise reduction system, in order to preserve the dynamic range and the frequency response of the original material.

Described very simply, the Dolby noise reduction systems work by increasing the level of quiet signals in a precisely defined way prior to the recording process — the encoding or compression stage. Those signals are then reduced along with any noise added by the tape, etc. by an equal amount on playback — the decoding or expansion stage.

All the Dolby noise reduction systems process the audio signal differently depending upon the level and frequency of the incoming signal: for B-type noise reduction, only the low level high frequency signals are treated, the high level signals generally pass through the system unaffected. In order to restore the encoded signal to its original form the playback system must be calibrated in some way so that the expansion of these low level signals in the decoder is exactly equal and opposite to the compression generated in the encoder.

**The concept of Dolby Level still remains shrouded in mystery for many. As duplicators review operating procedures in the light of other improvements, Graham Carter of Dolby Labs looks at the requirements for duplicating cassettes encoded with B-type noise reduction.**

## Dolby Level and Dolby Tone

To make this task easier in the professional environment, the ideas of Dolby Level and Dolby Tone, were developed.

Dolby Level is simply a reference voltage in the circuitry, defined at a convenient point on the characteristic noise reduction curve, so that both the record and playback process can be accurately matched. During manufacture the noise reduction circuits are carefully

adjusted so that during encoding Dolby Level always corresponds to a specified voltage at a certain point in the circuit. If during playback the same level is present at this same point, the the decode process will precisely track the encode process.

Dolby Tone is an easily recognisable warble tone generated within the noise reduction encoder at Dolby Level. Thus in a studio environment Dolby Level (as embodied by Dolby Tone) can be defined as a certain line level through a mixer and as a certain magnetic flux level recorded on tape. Whatever electrical or magnetic level corresponds to Dolby Level within any studio is immaterial as long as that level corresponds to the correct electrical level within the replay circuit when the signal is replayed. When a recording is made and played back on the same machine this level match is easy to achieve.

Because the absolute level for Dolby Level is not particularly critical, the level can vary widely between different recording studios and different sectors of the professional audio industry. In practice, Dolby Level may be at a line level of -4 dBm, 0 dBm, +4 dBm or +8 dBm, which in turn is recorded on tape at perhaps 200 nWB/m, 250 nWB/m or any other convenient and known value.

When considering a consumer software



Dolby tape duplication unit

## PREPARATION OF DUPLICATING MASTER

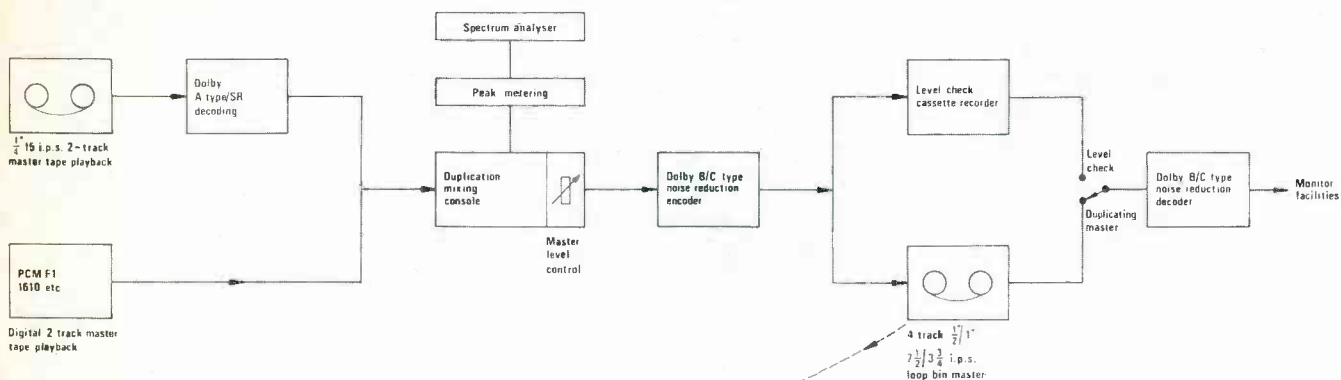

## DUPLICATION

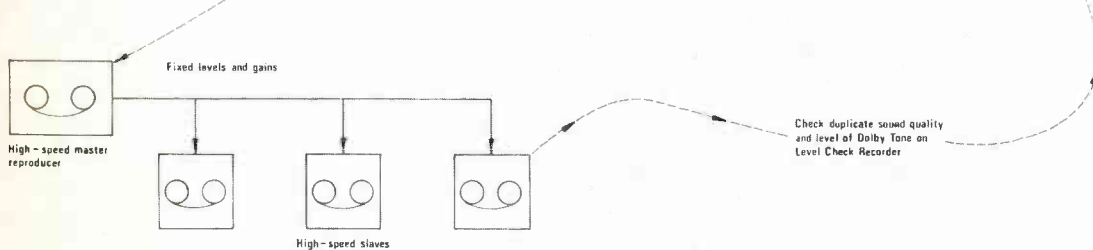

USE OF DOLBY NOISE REDUCTION IN DUPLICATION CHAIN

format such as the cassette encoded by *B*-type noise reduction, it is obviously essential that some form of worldwide standard is adopted: cassettes recorded in any country in the world must be played back correctly on any cassette machine manufactured in any other country.

The playback characteristics of the medium is now defined by the IEC (Prague 1981) curves. Although a flat overall frequency response is a necessary requirement for the correct operation of *B*-type noise reduction, correct replay level is equally important.

Thus for the purposes of standardisation it was necessary to define a standard tape flux level on compact cassette corresponding to Dolby Level. Historically this magnetic flux level was chosen as 200 nWb/m ANSI. This standardisation on cassette tape does not impose any restrictions on the choice of Dolby Level elsewhere in the duplication system.

### When is 200 not 200?

Unfortunately the figure of 200 nWb/m is not the end of the story, because there are two 'standard' methods of determining tape flux levels which, given the same piece of recorded tape, produce different numbers.

The ANSI measurement method relies on a calibrated high-efficiency head and effectively measures only the magnetisation close to the surface of the oxide layer. The DIN measurement method involves cutting the tape to be measured into small pieces and

passing these through a vibrating magnetometer. This method measures the total magnetic flux recorded on the tape and always produces a figure higher than that measured by the ANSI method.

Tape flux levels can be treated in dB terms just like electrical levels and the differing measurement methods produce a consistent difference of about 1 dB (actually 0.8 dB), which should be allowed for when using the available test tapes.

Japanese hardware and software manufacturers generally use specific Dolby Level test tapes with a tone at 200 nWb/m ANSI. However, in Europe the BASF level test tape is used much more frequently and this tape has a reference section recorded at 250 nWb/m DIN. A simple calculation suggests a difference in level between 200 nWb/m and 250 nWb/m of 1.94 dB (about 2 dB), however, because of the different measurement methods employed for these tapes, the difference in level is in practice only about 1 dB. Dolby Level is about 220 nWb/m DIN — approximately 1 dB below 250 nWb/m DIN.

### Dolby Level in practice

In order to produce finished cassettes that comply with the agreed standard for Dolby Level, it is essential that the relationship between Dolby Level on the loopbin master and Dolby Level on the cassette pancake is understood and adhered to. Once a loopbin master tape has been recorded and encoded with Dolby noise reduction, then the level at

which this is transferred to the slaves must remain fixed, so that Dolby Level flux on the master always produces the correct Dolby Level flux on the pre-recorded cassette.

Even if it is found that the level on the cassette tape can be increased without distortion or saturation effects, the attenuator setting on the loopbin master playback machine cannot be changed, since this would also change Dolby Level as recorded on cassette. A new loopbin master tape must be made instead, with the signal level increased prior to the noise reduction encoder.

For any loopbin tape, the relationship between Dolby Level on the loopbin and Dolby Level on cassette must remain fixed. The actual programme level recorded on the loopbin master should be varied to take full advantage of the capabilities of the cassette tape. A loopbin master made with chrome duplicating tape in mind should not be duplicated on ferric tape simply by turning down the replay level on the loopbin playback machine: this would change the Dolby Level which gets transferred to cassette and cause mistracking when the cassette is replayed.

It is normally the case that 1/4 inch master tapes will arrive encoded with Dolby SR or A-type noise reduction. In these circumstances it is important not to confuse the Dolby Level on the two formats: treat each as an individual system.

There is no absolute standard for Dolby Level on open reel tapes and it is not therefore possible to expect any consistent relationship between Dolby Level on 1/4 inch and Dolby Level on cassette. The two

# TAPE DUPLICATION

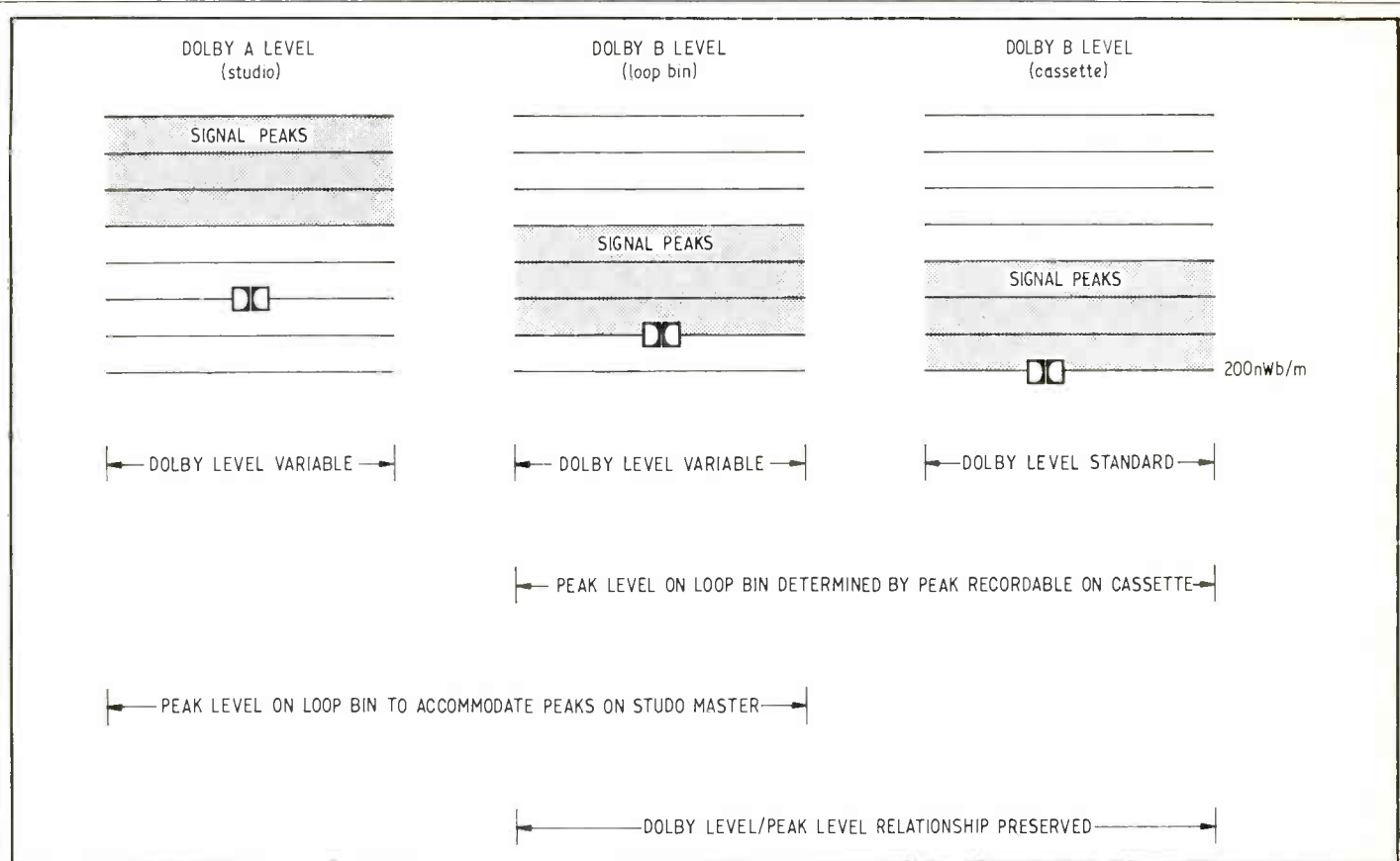

## Relationship of signal peaks

systems must be thought of completely separately. Because of the different 'standards' occurring within the professional audio world, it is always necessary to go through a line-up procedure, which as well as frequency response and azimuth checks will also include lining up the *A*-type or *SR* decoder units using, respectively, the Dolby Tone or Dolby Noise included on the master tape.

All professional *B*-type noise reduction encoders include a circuit to generate Dolby Tone. The familiar warble tone heard at the beginning of most encoded master tapes is *A*-type Dolby Tone based upon an 800 Hz signal — *B*-type Dolby Tone is based on 400

Hz and so may be easily recognised. The level at which Dolby Tone is generated within the noise reduction circuitry is very carefully controlled during manufacture of the encoder card and is specifically related to the action of the compressor within the noise reduction system.

To ensure that the duplication of *B*-type encoded cassettes adheres to the recognised standard present within the consumer hardware is a simple, vital, but often overlooked, exercise. To check the operation of this part of the process entails pressing the button marked Dolby Tone on the *B*-type encoder and recording a short section of Dolby Tone on the loopbin master. If this is

then duplicated on to cassette in the normal way this tone should play back at exactly the same level as a 200 nWb/m ANSI test tape (or 1 dB below a 250 nWb/m DIN test tape).

A major error of several dB in Dolby Level as recorded from the loopbin master will result in audible mistracking of the noise reduction system — 'breathing', 'pumping' or perceptible frequency response errors. Because of the design of the *B* and *C*-type noise reduction systems, small errors in Dolby Level result in very little degradation, however, although an error of 1 dB or so in Dolby Level may not seem very large when considered in isolation, when combined with other small errors in the duplication chain and in the playback machine the cumulative error may be significant. Reducing any error in the duplication chain can lead to improvements in the quality of the finished cassette: this can only be of benefit to the whole industry.

## Conclusion

Whatever standard operating procedure has been established within a duplication plant, it should not be difficult to incorporate the necessary safeguards to ensure that programme material is transferred at the correct Dolby Level. If levels at the loopbin are simply left to the operator's discretion, then errors are certain to occur and poor quality cassettes result. It takes only a little extra care in setting up to produce accurately encoded cassettes.

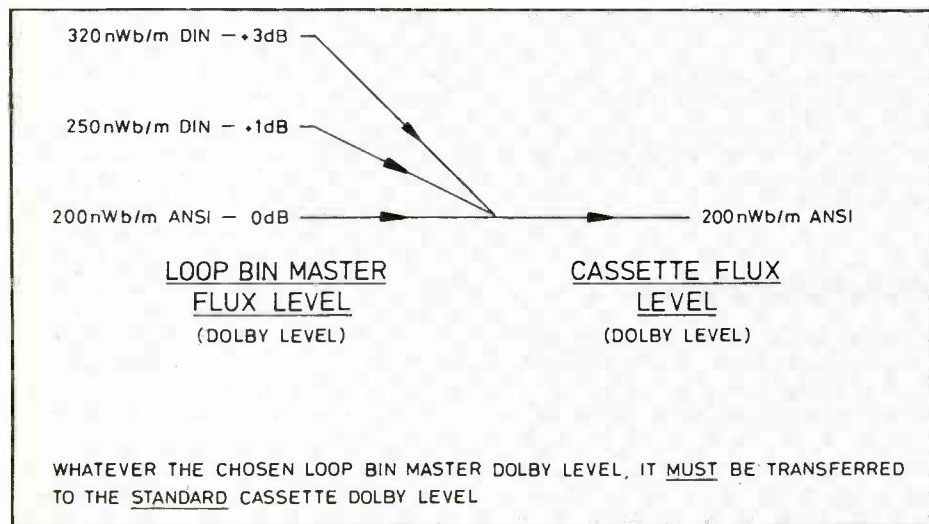



# Why doesn't someone design a console which is perfect for:

multi-track music recording and mixdown  
video post production  
film scoring and dubbing  
live radio and television  
broadcasting



# which has:

perfect stereo matching  
instant total reset of all controls with snapshot memories  
and dynamic fader automation linked to SMPTE timecode  
and which doesn't add any noise or  
distortion to digital recordings?

# NEVE HAS!

NEVE ELECTRONICS INTERNATIONAL LIMITED, CAMBRIDGE HOUSE, MELBOURN, ROYSTON, HERTS, SG8 6AU.  
TEL: 0763 60776. TELEX: 81381. FACSIMILE: 0763 61886.

RUPERT NEVE INC, BERKSHIRE INDUSTRIAL PARK, BETHEL, CONNECTICUT 06801.  
TEL: (203) 744 6230. TELEX: 96-9638. FACSIMILE: (203) 792 7863.

## The Neve DSP:

Up to 96 dual mic/line inputs. 48-track mixing. Fully assignable faders, equalisers, dynamics, filters, inserts and routing. 28-bit processing and 32-bit mixing.

## The Neve DTC:

Digital stereo mastering console. 28-bit filters equalisers and dynamics, with 250 snap-shot memories linked to SMPTE timecode. 48 and 44.1 kHz, optional pre/de-emphasis.



A SIEMENS COMPANY

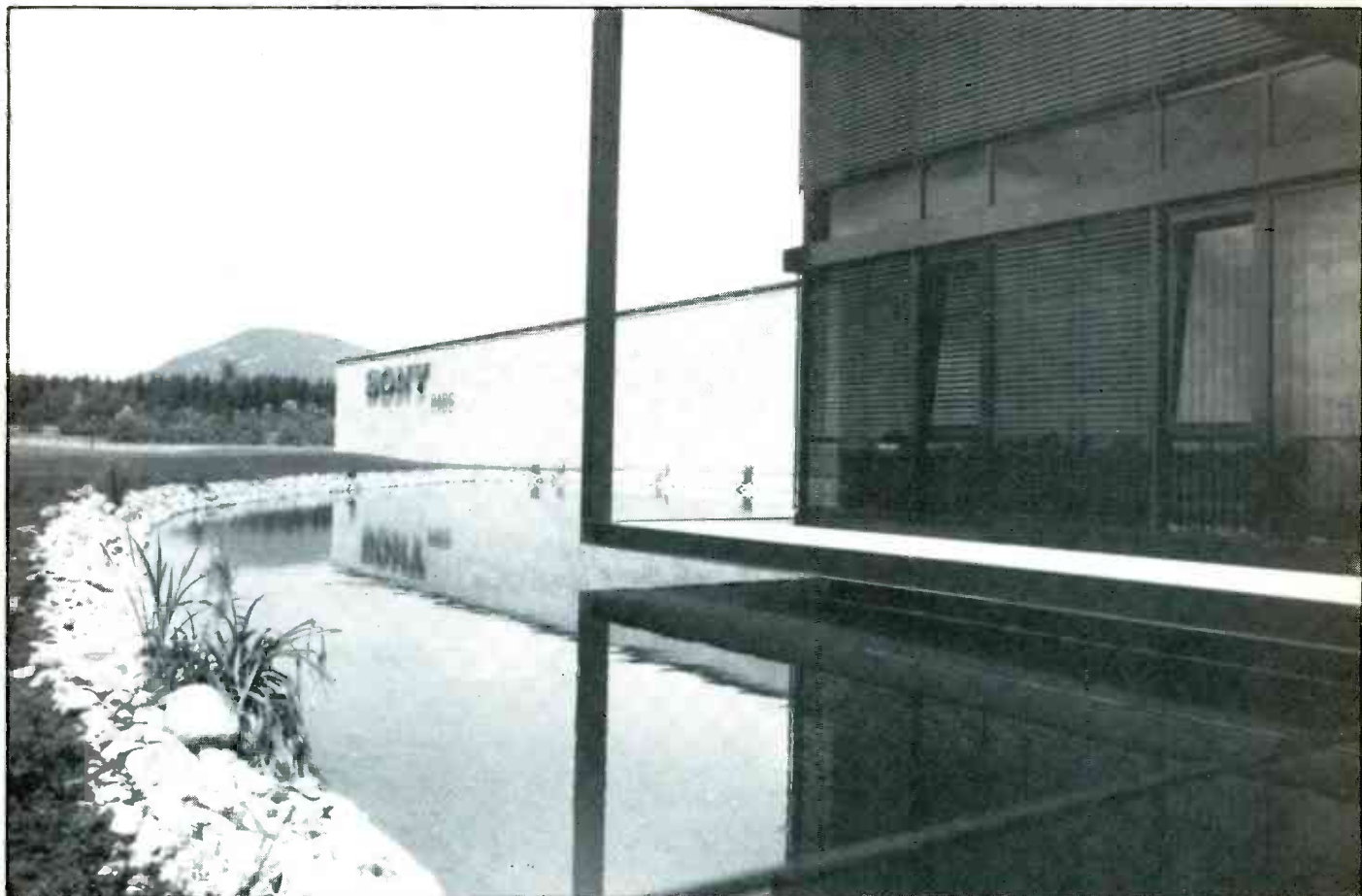

# The opening of DADC Austria

**W**hen you are investing millions of dollars on a new production facility one of the critical decisions is where to locate it. Get that decision wrong and you could end up with higher than necessary overheads. With CD manufacturing facilities already in Japan and the US, Sony's decision to move into Europe could almost have been seen as a foregone conclusion but the intriguing question was, where?

Sony's investment in Europe at the time of the decision was already substantial. They had five manufacturing plants (two producing magnetic tape, the remainder producing consumer electronic products) and at least 10 sales companies. In all some 6,000 people were employed by Sony and between them they produce \$8 billion — 20% of Sony's total worldwide sales.

Overall, 20 possible production sites were shortlisted including locations across the Netherlands, through Germany and down as far as Austria. Many factors were considered including geographical location, availability of a suitable workforce, good labour relations, suitable support systems and infrastructure, good communications links with their main customers and the rest of Europe and of course the availability of subsidies. At the end of the day, however, it was the economic

**Just outside the city of Salzburg in the small Austrian town of Anif is one of Sony's answers to their commitment to CD. Officially opened at the end of July this year, DADC Austria is Sony's third, and arguably their most impressive, CD plant to date. Carl A Snape reports on this £29 million (\$47m) investment.**

reasons that played the decisive role with 19.5% of the total investment coming from the Austrian Federal Government and the Province of Salzburg. Further support — primarily for the infrastructure — was provided by the town of Anif itself.

Having made their decision Sony did not want to waste any time. Norio Ohga, president and chief operating officer of the

Sony Corporation, saw the site originally in April 1986. At that time it was just an open field. By the end of April the decision to go ahead had been made. Within one month of the decision a general contractor had been appointed (Taneka Komuten, Dusseldorf) and in the same month over 150 drawings had been made and submitted to the Austrian authorities despite the fact that the whole team had returned to Japan to prepare the necessary drawings.

Ground breaking was on July 14th, 1986 and in May 1987 the building was practically finished. On July 16th, 1987 — just one year and two days after ground breaking — the first Austrian compact disc was produced. Given the complexity of the project (13,000 m<sup>2</sup> of floor space on a 46,000 m<sup>2</sup> site including specialist manufacturing requirements and basic services) this was no mean feat.

As Mr Ohga noted, "I think this is a world record. Projects of this complexity usually take at least 18-24 months." In all, some 250 construction workers were involved in the project.

### Production

DADC Austria currently has a staff of 180 and

is equipped with Sony's most advanced production and quality control technologies. During the past year key personnel have been undergoing training at CBS/Sony in Japan and DADC in the US to ensure that the plant quickly achieves target production of 1 million discs per month. By 1988 this is expected to be increased 2 million discs per month with staffing levels increased to about 300.

Naturally DADC Austria have benefited from the production experience gained in Japan and the US. Being purpose-built the system has been designed to provide the highest quality standards with the maximum throughput. Production equipment is a combination of both Japanese and European products.

Two main air handling systems have been installed: one for the pressing and finishing (Class 1000) section and a second (Class 100) for mastering and plating. These are manufactured in West Germany. Air temperature is kept at a nominal 22°C with relative humidity at 55%.

Raw polycarbonate (highest grade Teijin) arrives at the rear of the plant and is pumped into two large storage silos in the unloading bay. After drying, the polycarbonate is heated to 100°C and pumped through well-insulated pipework into the pressing room. Automatic systems sense production requirements and ensure sufficient quantities of polycarbonate are held in the supply hoppers at all times. Faulty discs are ground, bagged and disposed of.

Two Sony laser cutting machines are used at Anif and along with the plating section are located in the super clean area of the plant well away from the outside air and the pressing and finishing departments. Glass masters are currently imported directly from Japan.

At this stage of the production process intensive QC checks under cleanroom conditions are performed at each stage of the cutting and plating process. These include visual appraisal plus computer checks on all physical parameters as well detailed analysis of the recorded data stream.

Subsequent production is contained within one large working area. Ten Meiki presses are currently in use at Anif — with the

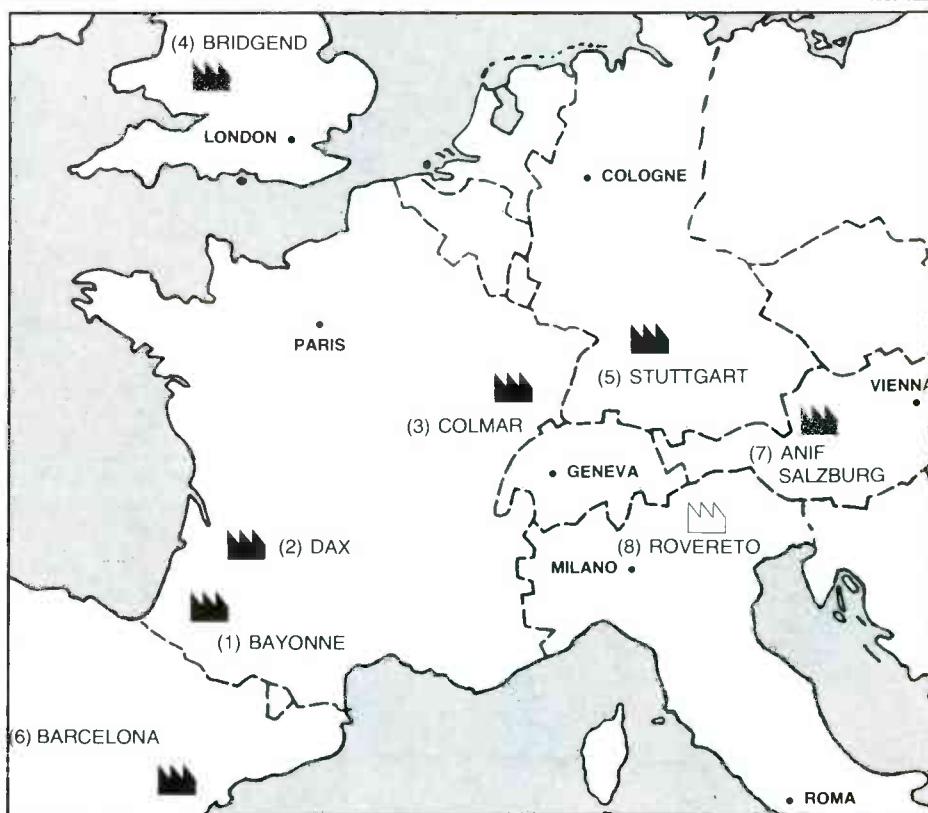

Location	Type of product	Production start		Employees
(1) Bayonne (France)	Audiocassette tape	December	1980	370
(2) Dax (France)	Videocassette tape	September	1984	210
(3) Colmar (France)	8 mm video	November	1986	160
	Hi-fi/CD players	January	1987	
(4) Bridgend (UK)	Colour TV	June	1974	1,400
	Colour Picture Tube	April	1982	
(5) Stuttgart (W. Germany)	Audio	February	1975	640
	Colour TV	February	1980	
	Video	May	1982	
(6) Barcelona (Spain)	Audio	October	1973	250
	Colour TV	February	1985	
	Video	February	1985	
(7) Anif (Austria)	Compact discs	June	1987	180
(8) Rovereto (Italy)	Audiocassette tape	Beginning	1988	150

**Sony's European manufacturing operations**



**Norio Ohga, Sony's President**



**Otto Zich, DADC's Managing Director**



**Jack Schmuckli, Sony Europe's President**

## CD MANUFACTURING

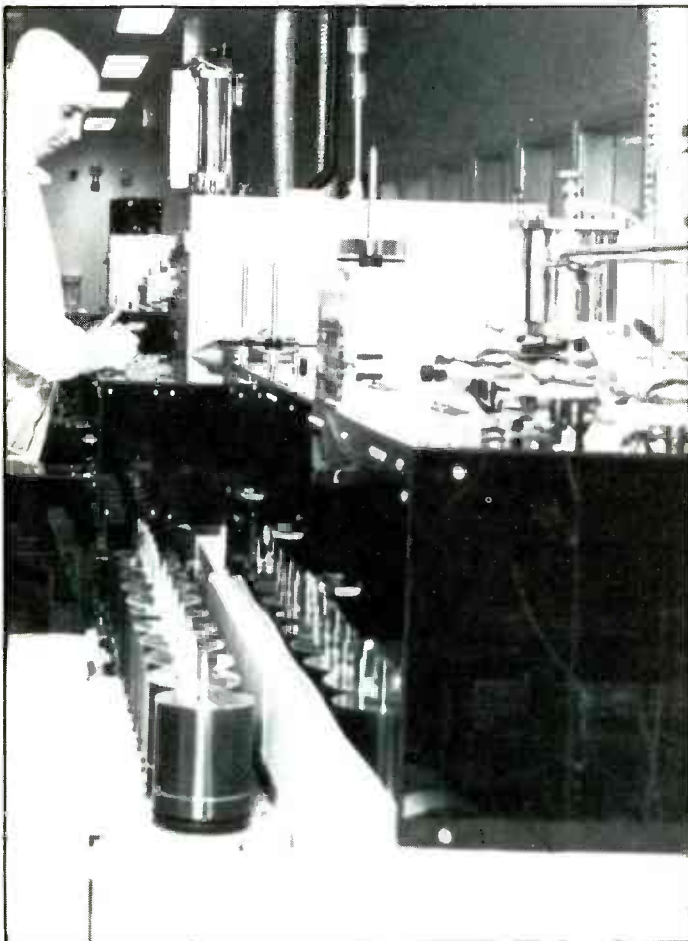

Disc transport and feeding of automated production equipment

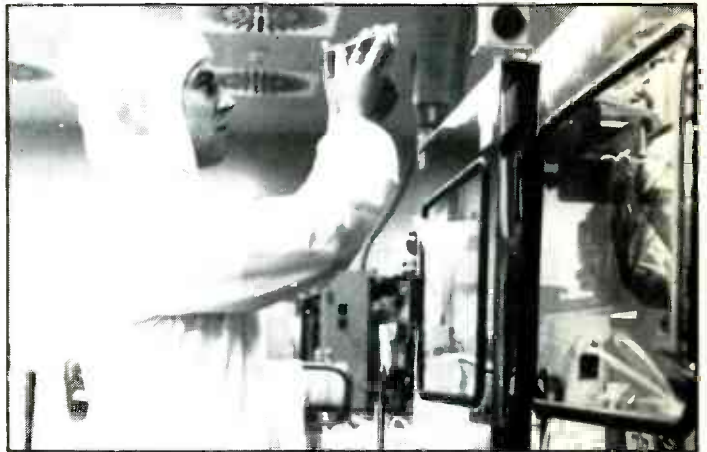

Monitoring the quality of injection moulding



Quality check performed by specially adapted disc players and computers

potential space to almost double this number, as and when required.

After the actual pressing process, unloading equipment locates finished discs on special transport spindles (up to 100 discs per spindle, where they then proceed to the reflective, printing and UV coating sections. Currently two German printing machines are used (Kamann) along with Tokuda metallising equipment and Yoshizuka spincoaters.

When all the production processes are complete each disc is checked by Sony CDC equipment. The Complete Defect Checker — not available unfortunately outside Sony CD plants — reads at high speed, all the data on each disc, checks each parameter and automatically rejects any that do not come up to the prescribed standard.

One of the interesting aspects of the CDC line is the fact that each disc has to go through three completely different check points in order to pass through the system as satisfactory. This makes it particularly easy to immediately notice what, if any, specific production problems are occurring further down the line. A quick visual check on the reject spindles at each testing point is all that is needed to alert the production staff to any number of specific problems. In this way a particular line or machine can be shut down, the problem resolved and brought back on stream with the minimum of delay. Computer printout of the data also enables all the Sony

plants to note similarities and differences at a local or international level.

Having passed the data and parameter checks the fault-free discs are then subjected to a final visual inspection, packed and moved to the storage area ready for despatch. On average each person checks about 5,000 discs per shift.

### Policy

Having toured the plant I asked Dieter Daum, technical director of DADC Austria, where the plant stood in relationship to the other Sony CD plants: are they in friendly competition with each other for example?

"Oh yes, but in terms of productivity and yield we also exchange information. We are exchanging headcount information and of course all the production quantities uptime information. Uptime is a very important factor. When we are evaluating our discs we are also evaluating the discs from other Sony factories and the discs from other European pressing plants."

And what about the plants themselves, were there any interesting differences?

"Well, of course, you can never compare them that easily because they were built at different times and on a different basis. The Japanese plant and the US plant were both existing record pressing facilities which were

expanded to make CDs.

"This is the first and only factory that has been built from scratch so it is totally dedicated, and in the planning stage we did not have to pay attention to 'we need this' or 'we already have this'. We could plan from zero and I think we are therefore lucky and we should do a little better in these respects than our colleagues in Japan and the USA."

Naturally, with all the best equipment in the world you still need customers. Where was DADC's strength in Europe with regard to this?

"I think a plant of this size really needs a close affiliation to one major customer who can provide a significant load otherwise the amount of organisation would be pretty cumbersome. We have very close links with the operational people at CBS and we have excellent co-operation with them. We also have our own sales department and our sales manager is travelling quite a lot."

So what exactly is DADC Austria setting out to achieve? Managing director Otto Zich summed it up succinctly: "Sony is, I think, the only corporation which offers a worldwide service and this chain of plants will help to react quickly to the music industry's demands. We think that capacities will increase in Europe and therefore we need flexibility, the highest quality plus short delivery times and these three factors will guarantee our success in the future."

# Raise Your Expectations

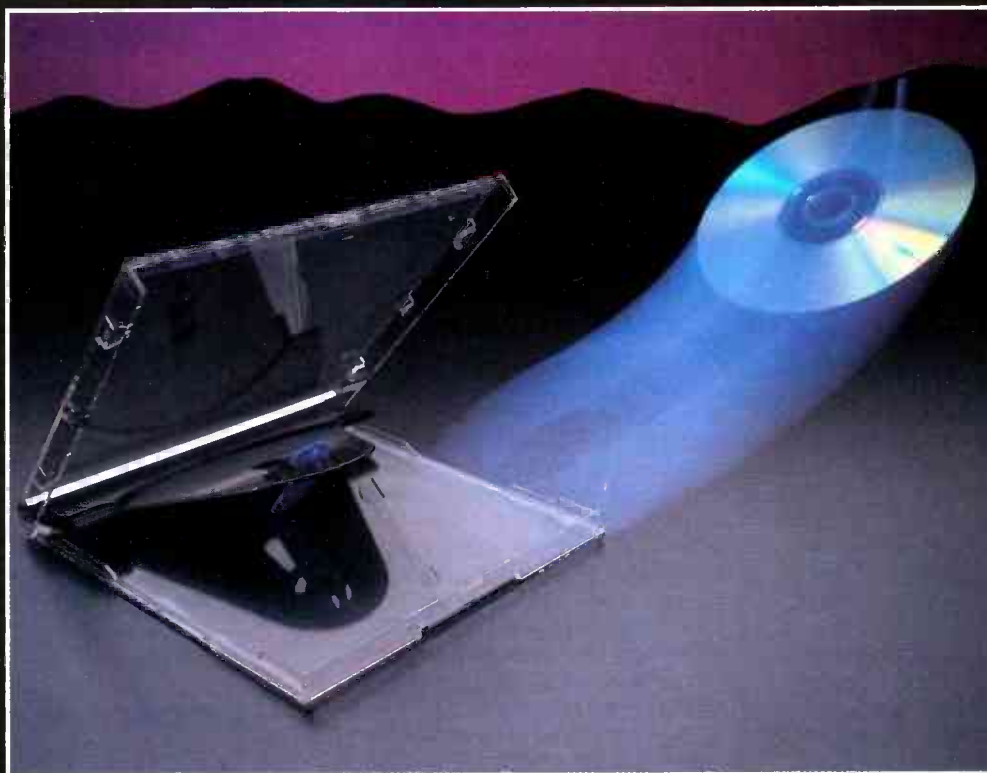

## The **SHAPE** **CD LIFT/LOCK™**

SHAPE introduces the next generation in CD packaging, the innovative LIFT/LOCK™ CD case. The new LIFT/LOCK™ case features a patented lift mechanism which raises the disc as the case is opened for easier disc removal and replacement. A reinforced hinge improves durability and increases product longevity.

The CD LIFT/LOCK™ case by SHAPE - an uplifting new dimension in CD packaging design.

**SHAPE**®

For more information contact:

SHAPE Technologies, Ltd.  
Bridgend Industrial Estate  
Kingsway Building  
Bridgend Mid Glamorgan CF31 3SN  
South Wales, U.K.  
011-44-656-59212

Biddeford Industrial Park  
Biddeford, Maine 04005 USA  
207-282-6155  
Telex 944325 SHAPE INC BIFD

# Anti-copying—The Future

**T**here are 400,000 people in Europe whose jobs depend directly or indirectly on the health of the music industry, and about the same number in North America. They include musicians, songwriters, composers, studio engineers, record company employees, staff at manufacturing plants, transport workers, retailers and even specialist journalists and broadcasters. If the issue of when, how, and with what safeguards consumer DAT equipment is to be introduced is resolved at the expense of the music industry it could also be at the expense of a considerable number of those 800,000 jobs.

Thanks primarily to the buoyancy of the CD market, the music industry in Britain has started to see light at the end of the tunnel after a decade in which its progress has been blighted by the exponential growth in home taping. As album sales declined, factories and studios were shut and fewer new artists had a chance to record. Even now rising blank tape sales show that home taping is still on the increase. DAT copies, whether digital-to-digital (DD) or digital-to-analogue-to-digital (DAD), will be of near CD quality. The widespread availability of DAT recorders without adequate copyright protection will provide a new boost to the home taping sphere and a renewed threat to the music industry.

So DAT and Copycode are fundamental issues for the future of our industry. The problem with Barry Fox's article is that, once one gets past the references to such exotic figures as Magic Alex and Gerry Bron, it deals with just one small part of the issue: is Copycode audible? While dealing with that point, I want to put it in its proper perspective by looking at Copycode as a whole and, first, by briefly explaining the significance of three other systems to which Barry Fox misleadingly refers.

## The MITI Guidelines

According to Barry Fox, Japanese DAT manufacturers have 'generously' prevented DD copying by making DAT equipment with a sampling frequency different to that of the CD. This decision is an entirely voluntary one and is based on a set of guidelines (not rules) drawn up by the Ministry of International Trade and Industry (MITI) in Tokyo. However, Hitachi and Sharp have already

**In the September issue we invited the IFPI to comment on Barry Fox's article Anti-copying: Past and Present. Dave Laing, press and information officer, IFPI Secretariat, London, puts the case for the IFPI.**

stated their intention to manufacture DAT equipment with a 44.1kHz sampling frequency, identical to that of the CD, while there are reports that JVC is already selling such equipment in Switzerland.

More pertinent, though, is the fact that even a copy made through an analogue converter (DAD) is to all intents and purposes of equal quality to the original digital disc. In a paper given to a seminar held by the European Copyright Unit in London in May 1987, Ralph Cousino of Capitol-EMI Technology Development used **Table 1** to explain the varying loss of quality involved in different copying systems.

This shows clearly how small is the reduction in the case of DAD (number 3) compared to DAA (number 2). Even where the MITI guidelines are being adhered to, then, the copying threat is scarcely smaller than where direct digital copying is possible.

## The EMI system

Thorn-EMI's current research is devoted to developing an electronic identification code for recordings. It has no connection with Copycode or any other projects designed to develop anti-copying systems. It is therefore not clear why Barry Fox chooses to drag the EMI project into an article concerned with digital home taping. Moreover, his comments display a penchant for precisely the kind of 'conspiracy theory' against which he so rightly warns in his opening paragraphs. Thorn-EMI are not behaving in a sinister way when they keep certain details of their work confidential while research is still in progress. This is surely standard practice in any industry, as indeed is the use of a consumer panel upon which a prototype of a new

product can be tested. By the way, the results of the EMI tests to which Barry Fox refers are not 'overdue'. I understand that they have yielded valuable data for the continuing progress of the project.

## The Philips approach

As a hardware manufacturer which has worked closely with Japanese counterparts on both the development of CD and of technical standards for R-DAT, the Philips attitude towards the DAT controversy is instructive. While never denying its own intention to manufacture DAT, the company has made it clear that this will not be until the copyright problems have been resolved. Unlike other hardware interests, Philips has the foresight to realise that a new format that deals a blow to the suppliers of software can only in the long run be detrimental to the interests of the hardware companies themselves. It is in this spirit that Philips have approached the DAT issue, but since they have not yet made public any details of any technical system Barry Fox's description of a 'Philips proposal' should be regarded as speculation.

## Copycode

By now the method by which Copycode operates is well known. Master tapes are encoded by intermittently removing an extremely narrow sliver of sound energy from the upper middle portion of the audible sound spectrum at a frequency of 3838 Hz. The notch is cut so as to fall between the fundamentals, overtones or harmonics of notes on the musical scale. The decoder or Copycode Scanner is a small part of an integrated circuit chip designed to be built into the circuitry of DAT recorders. When an attempt is made to copy a CD with a DAT recorder, the scanner searches the music for the encoded notch. When the notch is detected, the scanner locks on and tracks it for a few seconds to ensure there is no mistake. An electronic switch within the scanner chip then inhibits the recording function for about 25 seconds. The cycle is then repeated; if the scanner finds that the notch is still present, the recording function is interrupted for a further 25 seconds. An attempt to tape material from any source protected by Copycode will therefore consist of brief segments of recorded music periodically interrupted by 25 second 'dead bands' without sound.

Much of the opposition to Copycode is based on a purely theoretical opinion that the use of a 'notch' in the sound spectrum will *automatically* invalidate a recording. People who hold such views will necessarily have their minds made up to oppose any anti-

TABLE 1

Method	Bandwidth	Dynamic Range (dB)	
		Master	Copy
1 Album/cass-analogue-cass	Reduced	65	61
2 R-DAT/CD-analogue-cass	Reduced	95	65
3 R-DAT/CD-analogue-R-DAT	Slight reduction	95	91
4 R-DAT/CD-digital-R-DAT	Unchanged	95	95

# EXCEPTIONAL FREQUENCY RESPONSE

AT 1 7/8 IPS (REAL TIME)

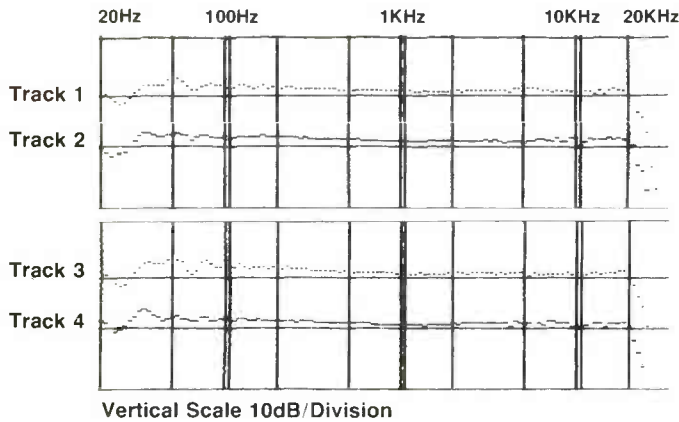

**TEST METHOD** A 40KHz to 20Hz sweep at -20dB from a Sound Technology 1510-A was recorded at 1 7/8 ips in a KABA slave deck on TDK SA tape. The tape was played back at 1 7/8 ips in the KABA master control deck and the output displayed on the Sound Technology. The curves represent the **SUM** of the record and playback response of the KABA system at 1 7/8 ips.

No. 2 of a series —

Some reasons why KABA, the ultimate in real time and 2X  
**CASSETTE DUPLICATION**  
 IS ATTRACTING SO MANY USERS (and customers to those users)



**KABA Research & Development**  
 (a division of Kenneth A. Bacon Associates)  
 Toll Free (800) 231-TAPE

24 Commercial Blvd., Novato, CA 94947  
 in CA call (415) 883-5041

# EXCEPTIONAL FREQUENCY RESPONSE

AT 3 3/4 IPS (DOUBLE TIME)

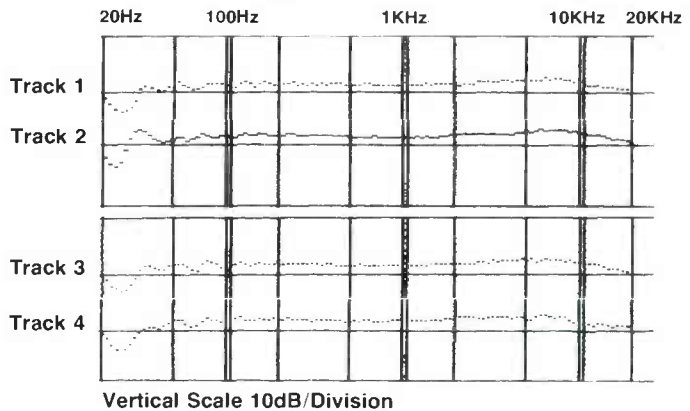

**TEST METHOD** Same as above except the sweep was recorded at 3 3/4 ips on the KABA slave deck and played back at 1 7/8 ips on the master control deck. Highest frequency on playback was 20KHz so there is no response beyond 20KHz.



RTDS-4TM MASTER CONTROL DECK



RTDS-4TS DUAL TRANSPORT DECK

FOUR TRACK REAL TIME AND 2X DUPLICATION SYSTEM

## COPYCODE

copying system before it is even examined or tested.

The only sensible criteria to apply in assessing Copycode are twofold:

Will it effectively prevent the widespread home taping of encoded software?

Is the sound quality of such encoded software acceptable to the average consumer of pre-recorded music?

Nearly everyone is agreed that Copycode satisfies the first criterion. There is likely to be a small minority of electronics boffins who will find a way round or through any preventive system, but this will not be the case with the other 95+ % of consumers.

Backed by legislation to make it a criminal offence to manufacture and market anti-Copycode equipment, the system would work.

As Barry Fox emphasises, it is the second aspect that has caused the most comment on Copycode. But when one wades through the many alarmist press reports, it is clear that the adverse criticism emanates from a very small, highly specialised group of people who have set themselves up as guardians of the purity of recordings.

Let us be clear about this purity. There never has been and is never likely to be a situation where recordings are made in a limbo where all that counts is an engineer's notion of perfect sound quality. There are inevitable constraints: of time, of money, of the limits of the equipment available and of the limitations of the performers. Very few classical or popular recordings are one seamless take. The task of splicing together bits of different takes is now standard practice, where once it was anathema. It is also not so long ago that eminent experts were telling us that digital recording was destroying the essence of music. And now that digital technology is accepted, it is well known that even this technology must compromise purity in the implementation of error correction. The technique of interpolation does not provide an exact replay of the original signal yet this is not sonically evident even to the most skilled listener. When muting is required in error correction, this literally cuts a notch in the audio signal. However, it is usually of such short duration that the ear does not detect it.

As far as the audibility of Copycode is

concerned, the record industry has responded to criticism by submitting the system for independent testing, as Barry Fox admits in his article. In the United States, the highly respected National Bureau of Standards is carrying out rigorous tests and the record industry there has announced that it will accept the NBS findings. It is extremely unlikely that the Bureau will agree with Barry Fox that the acid test of Copycode is his piano note example which was demonstrated at the Abbey Road meeting last May. As David Stebbings of CBS pointed out on that occasion, if it is found that the notch distorts sound quality in that (rarely used) register, then that section of the recording would not be encoded. For copycode to be effective the notch need only be inserted into part, not all, of a recording. The acid test for the record industry and all who are dependent on its economic viability is whether the average consumer (not the elite of hi-fi journalists and golden-eared engineers) will find Copycoded material unacceptable.

(Dave Laing is Press and Information Officer, IFPI Secretariat, London).

My article, in the September issue of *One to One*, analysed how Ian Thomas, director general and chief executive of the IFPI, had been unable to substantiate his claim that "leading figures in the recording studio world" and "technical experts from PolyGram and Philips" had conducted tests on Copycode which led the IFPI to adopt the system.

I also warned that by lobbying so hard for the Copycode system, the IFPI (and RIAA) could have pulled the rug from under the record companies' hard won case for a tax or levy on blank tape.

The article ended by saying "... the buck now sits stationary on the desk of Ian Thomas in Regent Street". Very properly, Mr Thomas was given the opportunity to reply. Instead of this he passed the buck to Dave Laing who on November 16th leaves his job as press and information officer for the IFPI, to join *Music Week* as a journalist.

Dave Laing has done a fine job as press officer for the IFPI (similar to that once done by Terri Anderson for the BPI) and has done an especially fine job of trying to defend the apparently indefensible position of Ian Thomas. Record companies that fund the IFPI may well wonder if this wasn't perhaps one time when the director general and chief executive should have done his own defending. They will wonder even more now that the IFPI's posturing on Copycode has helped lose the record industry its chance of a tax or levy on blank tape.

What are these reports about JVC selling a 44.1 kHz DAT recorder in Switzerland?

What evidence is there to suggest that "a considerable number" out of 800,000 jobs in Europe and the USA will be lost if DAT is sold?

What matters most when you make an

## Barry Fox replies:

analogue dub from CD on to DAT, is not the marginal loss of quality. It's the loss of all the user conveniences available from CD, like track indexing and timing.

The Philips proposal for a 'one copy' system was described at the European Copyright Unit's seminar in London on April 29th, by Peter Plompen of Philips. The Dutch company subsequently welched on the promise given by Plompen, that paying delegates would get a written copy of his speech. The Philips press office first said that Plompen's text was of such poor English that it needed re-writing. After months of reminders, and an offer of cash from me to buy them a dictionary, the Press Office just stopped saying anything and simply refused to release the document. But those present at the seminar heard what Plompen said and that was what I reported. I was not 'speculating'.

It is not 'theoretical opinion' that Copycode will spoil the sound of a recording. I, and others, have heard what it does to music. What it does to solo piano is wholly unacceptable. There is every reason to suppose it will do the same to solo guitar, voice and flute. At a demonstration of Copycode given by CBS at Abbey Road Studios, recording engineers, eg from Decca, heard the effect of Copycode on commercially available CDs — and clearly did not like what they heard.

I dragged in the Thorn-EMI IFPI work on identifying recordings, by putting digital code in a notch, because the Copycode notch would double as the Thorn-EMI-IFPI-notch.

Yes, I know that the results of the tests are now available. The reason they have

not been released for publication, is that they showed the notch and code to be audible as interference.

Technically it is wrong to say that error correction in a digital recording compromises purity. When errors are corrected, they no longer exist because they have been repaired by the use of redundant information read from the disc.

It is only when error concealment, by interpolation or muting, takes over that the effect may be audible.

I am amused to see the IFPI now compare the effect of Copycode with the muting of uncorrectable digital errors. I am also amused to see the IFPI quote David Stebbings of CBS as now admitting "if it is found that the notch distorts sound quality" it will not be used. This is a far cry from those original claims that Copycode was inaudible.

Recently CBS has been working on a digital encoder which slices a very much thinner notch which may well be virtually inaudible. But will the scanner in the recorder still work reliably? Is the decoder available at a price anywhere near the \$2000 mark quoted by CBS for analogue decoders? Will it work in real time or need to cook overnight?

Be on your guard if a fresh round of claims is made.

The thrust of my article was that it is worrying to see the record industry represented by trade bodies that so easily get out of their depth when talking about audio technology. I believe that the IFPI's response merely confirms that the IFPI will rue the day it climbed into bed with CBS on Copycode.

Meanwhile, if those of us who have questioned the wisdom of Copycode, are to be dubbed 'guardians of purity' then I for one take it as a compliment.





*The art of Sound Duplication*



All art recognises Great Masters. But music also demands equally great copies - So don't settle for a hazy impression of your master tape. With Capitol Magnetic duplicating tapes, you'll hear every detail, every nuance of performance, reproduced with stunning fidelity, every time - Because every Capitol product is tested under the most demanding conditions to ensure exceptional batch-to-batch consistency - So now every copy can be a masterpiece.

**Capitol**  
MAGNETIC PRODUCTS

CAPITOL MAGNETIC PRODUCTS LTD., 1-3 UXBRIDGE ROAD, HAYES, MIDDLESEX UB4 0SY. TEL: 01-561 0922  
AND CAPITOL MAGNETIC PRODUCTS INC., 6902 SUNSET BOULEVARD, HOLLYWOOD, C.A. 90028, U.S.A. TEL: 0101 213 461 2701

# Analogue Clone

**T**he quality of cassettes that we as an industry are serving the public is appalling — I've heard cassettes from major record companies on which it was difficult to recognise the artist involved. It seems to me an incredible hypocrisy that an industry falling over itself to produce CDs is prepared to produce cassettes which are such rubbish. We *must* push to increase the quality dramatically."

Those are the words of Dave Lawrence, co-founder of Making Waves and now managing director of Nada Pulse Music Productions Ltd. He has recently set up an ambitious realtime cassette duplication plant, Clone Systems, in the north of England and is in no doubt about the benefits of realtime duplicating. "Under our system, we can get very close to CD quality," he says.

Clone Systems have a custom-built arrangement with 100 Nakamichi *BX300Es* controlled from a central console, and offer Dolby *C* as well as Dolby *B* copying. Most of their work is done on BASF chrome tape (120  $\mu$ s equalisation) though ferric is available on request. Production masters are in PCM digital form on Betamax video cassettes, replayed via Sony *PCM-701ES* or *PCM-F1* adaptors.

Because realtime is slower and more labour-intensive than loopbin manufacture, it must be at a cost disadvantage. So what exactly do Clone Systems offer their customers? "We aim to offer the highest levels of quality at a price similar to that of good loopbin copying. This we achieve — partly through economy of scale, partly through the financial incentives which apply in a development area like this (County Durham). But the area can have its disadvantages, business-wise, and we're still talking about a 6-figure investment.

**Dave Lawrence, MD of Nada Pulse Music, talks about his realtime cassette duplication operation — Clone Systems — and explains to John Seabury the importance of striving to achieve the best.**

"We offer a complete package, including 4-colour inlay, labels, case and shrink-wrapping. If you take the cost of one of the better loopbin operators and add on the cost of printing — inlays and labels — then on a small-ish run, up to 5,000 cassettes, we are no more expensive. But the quality is streets ahead."

Realistically, though, what's the capacity of a realtime plant with 100 decks? "We're into a second-shift system now, and we're looking to go into a three-shift system. With an average length of C-40 to C-44, we can produce 15,000 to 17,000 cassettes per week. Realtime can never replace loopbin, because it just hasn't got the capacity, though there are some very large realtime operations (1,000+ decks) running successfully in the US."

## Forming the company

"We were lucky to have the services of Mike Skeet as consultant engineer during design and installation. Mike is an expert and has helped other realtime operators to set up, notably David Wright at Gemini Sound, whose cassettes are reckoned to be among

the finest in the world. Many of the lessons learned by David Wright were incorporated into the Clone Systems' set-up."

The expensive Nakamichi *BX300E* machine was chosen both for its engineering quality and for a number of specific features. The quality of the capstan motor, the dual-capstan drive arrangement, and the fact that the pressure pad within the cassette is lifted out of the way in use, were all important, and of course it's a logic-controlled, three-head machine with full off-tape monitoring. Also, the azimuth and head height are adjustable separately, for both the record and replay heads, from the front of the machine.

The decks are arranged in 10 racks of 10 with a couple of extra *BX300Es* running as 'insurance'. Each rack is connected to the console via four control modules, designed and built by Mike Skeet. They include: an Input module, with low impedance circuitry; a Monitoring module, which includes a headphone socket, rotary selector switch for the 10 decks, and a 'source' button; a Function module, to allow the decks to be primed for record, or fast-forwarded, etc, from the console; and an Eject module, allowing the operator to eject 10 cassettes simultaneously (thanks to the solenoid Mike fitted into each deck).

Clone Systems looked carefully into the ergonomics of the set-up before installation began. They were keen that every deck should be visible from the console, and that the operator should be able to 'feed' all the decks without kneeling down.

It was also recognised that listener fatigue might creep in. As Clone Systems' resident engineer and chief operator Mike Dawson, points out, the quality of a master might leave something to be desired and the music itself may not be to the operator's taste. That



General view of duplicating area



Managing Director, Dave Lawrence

could make concentration difficult on repeated play-throughs, especially if the operator is expected to sit virtually motionless at the console most of the time.

The solution? At the start of each side, the operator moves round the racks, listening via headphones to the off-tape signal from each deck and comparing it with both the signal from the other decks and the source (the production master). For the rest of that side, he listens via speakers to check for glitches, and so on.

Console equipment includes a BBC-type twin-pointer PPM, and a device called *The Box* by Tapetalk. *The Box* features a multi-coloured LED array and gives easy-to-interpret level and frequency data across the stereo field. Very handy for checking azimuth, Mike Dawson explained. A Nakamichi *T-100* test set gets regular use, too.

The choice of cassette shell was investigated in depth, and welded shells were favoured. "Consistency of azimuth is vitally important," says Dave Lawrence, "and we're currently using Schneider shells. CBS shells are also good. We've been disappointed with several well-known makes; in fact, some of the flashy and expensive shells, such as the transparent Shape Technology one, turned out to be the least satisfactory. But of course we'll use whatever shell the customer specifies."

### Mastering arrangements

"Some of our customers, like Gef Lucena at Saydisc, will prepare their own PCM Betamax masters, equalised for cassette duplication. In other cases we're given 15 ips tapes and we master from a Revox *PR99* machine on to Betamax format for production."

To preserve dynamics, Mike Dawson uses manual gain-riding techniques rather than a compressor, and where EQ is necessary it is applied sparingly. Dolby *A* decoding is



The Nakamichi *T-100* test set

available. "For large runs we make multiple production masters, to avoid the problems of replaying a PCM Betamax tape too many times," explained Dave Lawrence.

Cleanliness must be very important. "Yes, we get through a lot of isopropyl alcohol. Fortunately the BASF chrome tape sheds very little indeed — but we're still obsessive! As regards general 'mess' in the rest of the building, we still have some work to do. This year we've simply had to get on with production. But on the things that really matter — cleanliness of heads and absence of foreign material on the tapes/masters — we're fastidious."

What about the problems? The two main set-backs concerned PCM tracking problems on second-hand Sony VTR machines, and a fault on a Tapematic *2000* series winder which put the machine out of action for more

than two weeks. "The Sony machines were bought from a reputable London dealer, who had been assured by the vendor that they had been serviced to full spec. The winder broke down because of a mistake we made here; it's an excellent machine but the back-up we received was poor. In both cases we lost production time."

### Customers

"It started off with people who share our approach to quality — people like Gef Lucena. The first jobs were for classical labels, but we're finding there's interest further afield. Through our friends The Producers, for example, we have just done our first job for Mute Records. That was a rock release."

Surely, with new media like CD-V and DAT coming into the market-place, investing in realtime capacity is unwise? "No," says Dave Lawrence. "I believe there's 7 to 10 years' life left in the cassette medium. The high quality cassette will certainly hold its ground, and Dolby *C* is a tangible leap forward."

What is the reaction of Clone's customers to being offered Dolby *C*? "Some are going for it. Often a customer will take a proportion of the order, say 20%, on Dolby *C*, the rest on *B*. We charge no more for *C*, incidentally. It's going to take a while to educate the public but we're very committed to Dolby *C*. We don't think the compatibility problem is that great — and by using decks like the *BX300E*, a lot of the drawbacks at the manufacturing stage are side-stepped."

"Undoubtedly, there's a lot of life left in cassette if it's done properly, though there's no life in either vinyl or cassette if the industry continues to produce what amounts to a load of old tat. Any industry prepared to be so complacent doesn't deserve to survive."



Adjustment of azimuth on the *BX300E*

# Tape Care

**M**odern magnetic tape coatings can retain the information recorded on them for an indefinite length of time. The recording is basically permanent, unless changed by the presence of a large magnetic field. However, like another archival record which has proved its ability to survive — the parchment and script of the Domesday Book — a magnetic tape and its recording can only be preserved in its original form if it's looked after.

Curiously, the curators of the Public Records Office in London, the present home of the original Domesday Book, will tell you that the same things that cause the deterioration of an archival document will also significantly deteriorate magnetic tapes.

The recording can be threatened by:

- Dirt and dust on the tape surface.
- Damage to the edges of the tape by abrasion.
- Damage to the edge of the tape by folding.
- Stretching or distortion of the base film.
- Cartridges or cassettes distorted by excessive exposure to heat.
- Tape splices deteriorating due to excessive heat.
- The recording area may be scratched.
- The running characteristics of the tape may be affected by condensation.

There's also a general belief that the recording on a tape can be affected by exposure to X-rays, or accidentally erased by the proximity of magnetic fields.

Experiments have shown that a tape is *not* affected by exposure to even large doses of X-rays. Also, accidental erasure due to the presence of magnetic fields will only occur if the field is massive, and the tape is very close to the source.

Although any kind of magnetic tape — from the domestic compact cassette to the high performance tapes used to store computer data — will suffer if exposed to these problems, the impact will be more quickly noticed in professional use.

## Tape damage

Physical damage to the base film of the tape, caused when the edges of the tape get buckled or folded, can occur as the result of a number of problems.

In a perfect situation, the tape is wound in an even pack without stepped sides, and clear of the sides of its reel. If the tape comes into contact with the reel, this may happen because the sides have been bent by being dropped, or the tape guides are incorrectly adjusted. However, there's a simpler reason for a scattered tape wind. The normal shuttling between points on the tape which

**Not everyone, it seems, knows how to look after their tape. Glwyn Price of 3M (UK) offers some useful advice for all those who use, store or deal with magnetic tape**

involve starting and stopping the tape transport, or any abrupt changes in the speed of a tape wind, may cause adjacent layers to scatter sideways, making the edges vulnerable to folding or buckling.

When the tape pack is subjected to undue acceleration or deceleration, inertia — coupled to the low coefficient of friction between one layer and the next — causes the tape to cinch, and the pack to develop uneven mechanical stresses throughout its length. Careful and smooth operation of the tape deck will reduce the problem. Nevertheless, after a session where the tape has been partially run through the recorder, scattered winds can be eliminated by running the tape to the end, and completely rewinding. It's also important to secure the free end of the tape to the next wrap, rather than taping it to the reel flange.

## Storage

Large variations in temperature will cause distortion of a cassette shell. The combination of temperature change and excessive humidity levels can cause tape splice adhesives to ooze, or dust and dirt to stick to the tape surface. Thus, environmental changes should be minimised. Where there's a significant variation between the tape storage area and the equipment room, time should be given for the tape to adjust to the new conditions.

A recording area should resemble a cleanroom environment. This means careful control of temperature and humidity, and the maintenance of a positive air pressure to prevent dust entering when doors are opened.

Where tapes are to be stored for long periods, random samples should be inspected at periodic intervals to search for evidence of damage.

With modern polyester tape backings, it's no longer necessary to rewind reels regularly to relieve internal pressures but large changes in temperature or humidity should be avoided.

Finally, for archival recordings, more extreme care may be needed, including storage in a sealed container filled with inert gas.

This article was originally prepared for 3M's *Head to Tape* magazine.

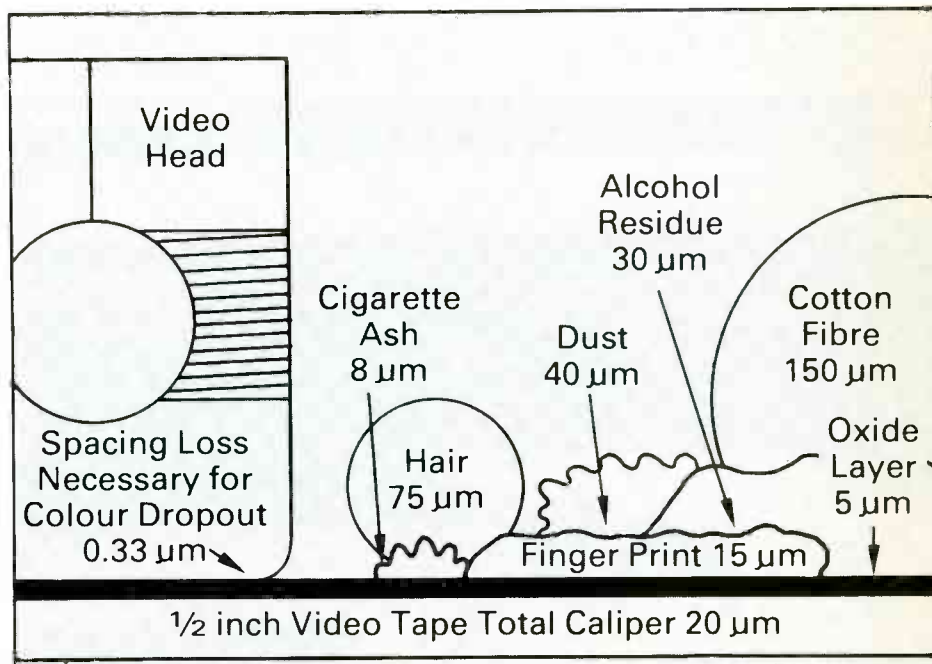

The importance of cleanliness

# THE NEW

## ...TO 50,000 SQ. FT. OF FAITH IN THE FUTURE

The combined audio/visual expertise of Mayking Records and Videoprint is now under one 50,000 sq. ft. roof in Battersea

Our superb new headquarters, incorporating offices, plant and warehousing, underlines a commitment to customers and to the future with an expanding range of services and facilities, including the very latest advances in both fields, from one of the most advanced technological bases in Europe.

This full spectrum of activities is backed up by the same friendly professionalism, with systems designed to speed response and ensure optimum quality and security at all stages.

If you're looking for a committed approach, quality products and state-of-the-art techniques, we'd like to discuss a positive future with you.  
For Mayking Records, call Brian Bonnar on 01-924 1661.  
For Videoprint, call Simon Knight on 01-924 1333.

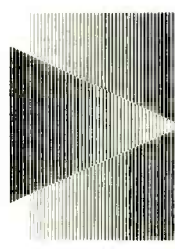

VIDEOPRINT

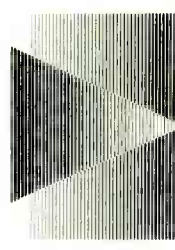

MAYKING RECORDS

VIDEOPRINT, TEL: 01-924 1333, TELEX: 935 100, VIDPRIG, FAX: 01-924 2118. MAYKING RECORDS, TEL: 01-924 1661, TELEX: 208 384, MAYKING, FAX: 01-924 2147.

# Alternative to tape

**F**or the past 40 years magnetic tape has been very much a part of our lives. The speed with which it was accepted by the recording community all those years ago was remarkable — the indecisive approach to digital in this technologically advanced decade being surprising by comparison.

For the recording engineer of the time it was a release from bondage. With tape came editing. No more four-minute retakes because the bass player hit one 'bum' note. Some sticky tape and a pair of scissors and, *presto!*, no mistake.

Naturally, tape had its limitations then. A 78 rpm disc had a far wider dynamic range and greater frequency response but, with the stereo LP just around the corner, these trade-offs were considered acceptable.

By comparison, today's recording tape is truly state-of-the-art; the culmination of 40 years' research and refinement. And, suddenly, it's in danger of becoming a dinosaur. Why? Because of some very exciting developments in the computer business.

Most computers, barring the domestic models, now utilise a storage system known as the Winchester drive. This is a hard disk unit (as opposed to floppy), which has the capacity to store nearly a million bytes of data in one unit. Couple a few of these together and the storage capacity is multiplied proportionately. Winchester drives are very reliable, effectively error free, and due to economies of scale, not outrageously expensive.

Some audio companies have seen the potential of Winchester drives as a means of manipulating digital audio. (I deliberately avoid the term 'store' — more in a moment.) Building an audio device using Winchester drives is not a particularly big problem. Digital audio signals can, very easily, be transcoded into computer format; many are already recorded that way. The greatest headache is what to do with the signals afterwards. While it's perfectly OK for the Inland Revenue to have all their data listed sequentially on screen, few recording engineers would want to scroll through an on-screen list to find the right bar in a take.

'Instant' access, and the ability to jump to any part of the programme material, are an intrinsic part of any disk system. Also, the data retrieval rate can be varied (a feature that has been used to great advantage for slow motion effects in video). It's after this that the problem becomes interesting — and where the various companies that have designed disk-based audio devices have diverged into their own realms of creativity.

Probably the biggest problem they face is how to represent the audio on a VDU. Some have taken the graphic route, depicting a

**The competition for hard disk mastering and editing systems is hotting up. Bill Foster considers some of the advantages — and disadvantages.**

piece of tape that can be 'cut up' and 'stuck on the wall' for insertion elsewhere. Another company shows a musical notation, which allows the musician to create a composition note by note.

The intended application for the product also influences design. The now defunct *Sound Droid* was tailored for the film business and hence had many features not required for audio studio work. Lexicon, not content with just producing an editing system, which also offers digital mixing and will ultimately feature EQ and limiting.

There is one unfortunate aspect of the hard disk story. Very few units are actually available. AMS *AudioFile* was probably the first in the field — although early units were little more than 'events' controllers. NED/Synclavier now produce a system offering up to 16 tracks of audio, controlled by a piano-style keyboard.

So what, if any, are the advantages of using a Winchester disk instead of tape? The key one is flexibility. Any section of the programme can be played, replayed, linked to any other, or even deleted. Test edits are

easily done because the system is non-destructive. In other words, nothing is lost unless it is deliberately overwritten. No more scrabbling on the floor for the bit you didn't think you'd need. A section can be used twice, or even looped. The disk will read any section as often as required without the need for copying.

Some systems allow for more than one set of data to be read simultaneously, offering the possibility of mixing. This is particularly useful for compiling continuous programme material — a live concert, for example. The following scenario would require three access points to the disc:

The original master recording has the following sequence:

- First title ends on applause
- Applause dies away
- 'Thankyou' from singer
- Musicians tune up



AMS AudioFile



Synclavier Digital Audio System

# Drum up more business

At MIDEM '88  
Music's International Marketplace.  
Palais des Festivals, Cannes. Jan 25-29 '88

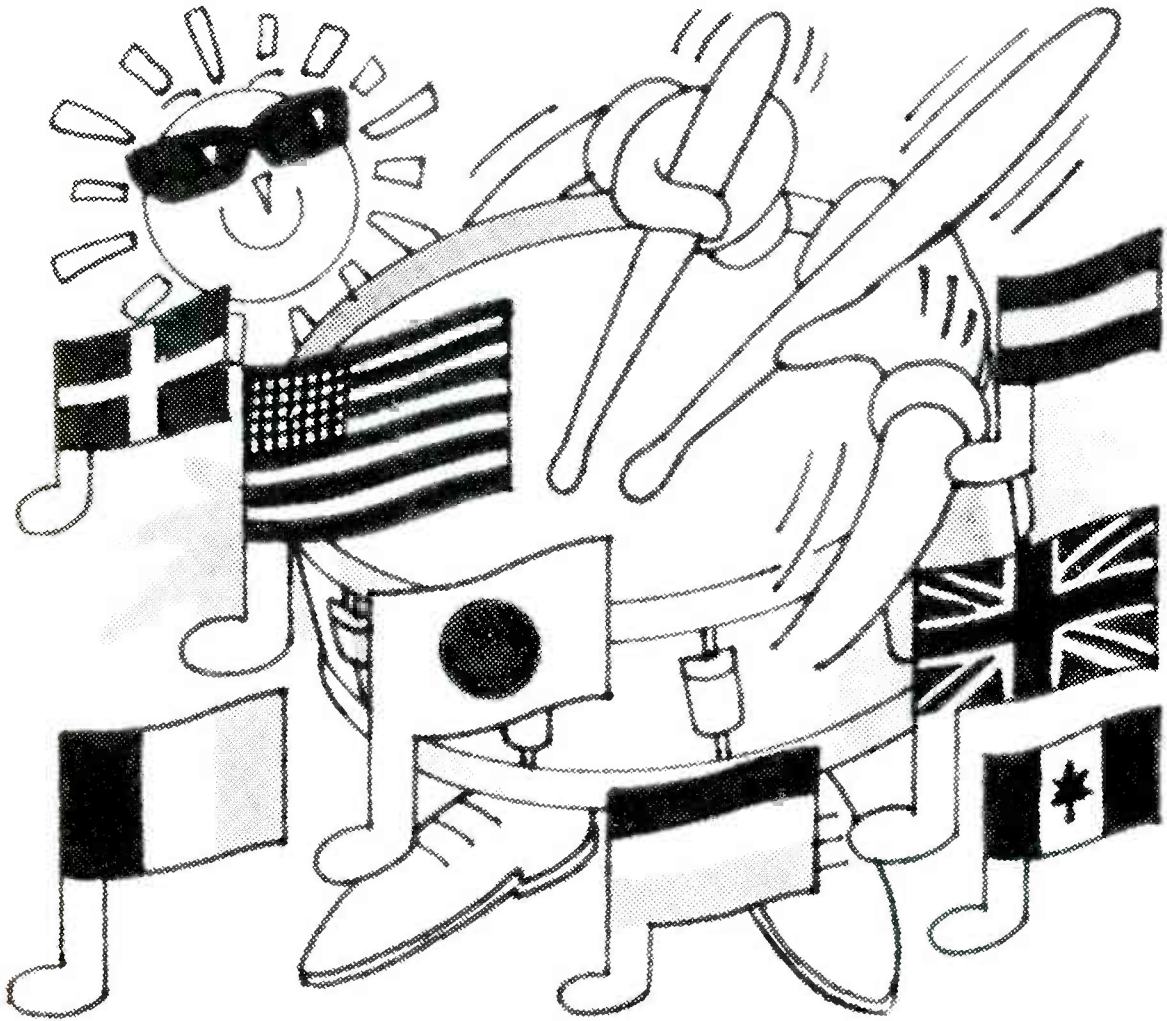

All the Big Names will be exhibiting at MIDEM '88. So will many of the smaller companies who play such a vital role in the world's music industry. Why not join them? As an Exhibitor, you're not just part of MIDEM you are the show, ranking with the biggest names, and with all the business pull of the music industry's greatest international marketplace.

**LIAISE.** MIDEM is where global deals are struck that build company prosperity. It's where you'll find all the top producers, record companies, publishers and independents from over 50 countries.

**LOOK.** MIDEM is the place for viewing or screening the latest video promos. It's where you'll find out all about Compact Video Discs and be updated on state-of-the-art studio equipment and hardware. Nowhere else comes close for promoting records, catalogues and artists.

**LISTEN.** And where else can you attend the famous MIDEM Galas, or see so many top bands performing live? Or attend the MIDEM MIP RADIO — the fifth great International Radio Programme Market?

The rest of the world always has a special welcome for MIDEM's British Exhibitors (and that includes the 700+ international press and TV journalists).

**LEARN.** Ring Peter Rhodes right now on LONDON 01 499 2317. He'll tell you all you need to know about exhibiting at MIDEM '88. Almost everything is done for you — including fully equipped and furnished stands with phone and hi-fi equipment. All in all you will be surprised by how little it costs to exhibit at MIDEM '88.

## MIDEM'88

I like the sound of MIDEM '88. Please rush me details.

Name \_\_\_\_\_

Company \_\_\_\_\_

Title \_\_\_\_\_

Address \_\_\_\_\_

Phone \_\_\_\_\_

International Exhibition Organisation Ltd., 4th Floor, 9 Stafford Street, London W1X 3PE. Tel: 01-499 2317. Telex: 25230.

# AUDIO POST-PRODUCTION

## RUNNING ORDER OF ORIGINAL MASTER

END OF 1ST TITLE & APPLAUSE "THANK YOU" TUNE UP COUNT IN START OF 2ND TITLE

## REQUIRED SEGMENTS AS THEY MIGHT APPEAR ON A TYPICAL HARD-DISK EDITING SYSTEM'S VDU

DISK 1	END OF 1ST TITLE & APPLAUSE	
DISK 2		COUNT IN START OF 2ND TITLE
DISK 3	"THANK YOU"	

- Count in
  - Second title starts
- After editing:
- First title ends on applause
  - 'Thankyou', over applause
  - Just before applause dies away count-in is heard and second title starts

This comparatively simple exercise would require a large amount of pre-dubbing if it were to be done on 2-track analogue, and would be almost impossible to string together on a U-matic system.

The effect could be achieved on a multitrack machine but with one significant disadvantage. Hard disk systems allow the movement of events in time without affecting any other part of the programme. So, if in the above example the producer decided after hearing the run-through that the second title should come in later, it only requires a new set of numbers to be punched into the computer and it's done. On a U-matic based

system, adding 5 seconds between the first two titles would necessitate the re-transfer of the entire remaining programme.

Having waxed lyrical about all the advantages of a hard disk system — and before you throw away all your other systems — I think it's only fair to detail some of the potential disadvantages.

Probably the biggest drawback, and the one most often cited by the system's opponents, is the upload and download time involved. Except for the home studio/workshop type of operation, it is uneconomic to lay tracks direct to disk. A Winchester cannot be removed and so the system is effectively 'locked out' until all the post-production work has been done. Write-once optical disks (WORMs) will change all that but at present these are not really viable from an economic standpoint. Before any work can be performed on a hard disk unit it is indeed necessary to transfer everything across from

the source tape.

Operationally, in fact, the upload/download requirement does not seem to present a major problem. A producer will usually want to listen through the available material during upload, while at the same time the engineer can 'mark' the likely takes. On download the whole programme can be checked for continuity and a listening cassette/F1/DAT made.

In my opinion, on balance the convenience of hard disk system outweighs any disadvantages. But, it's early days. Soon we will have RAM-based units and, eventually, RAM storage in the mixing console itself. Then, with the possibility of high speed data transfer, uploading to an editor will take minutes, not hours.

Ultimately, of course, all studio work is about creativity and any piece of equipment should be designed to complement this goal. Experience so far with hard disk seems to indicate that the manipulation of audio achievable with these devices, allows for far greater flexibility than was hitherto possible using tape — especially the cumbersome videocassette-based systems.

An alternative to tape? For the time being I don't think so. But, as a means of taking some of the 'drudge' out of the post-production process, while allowing more creative work to be carried out, I would say definitely, yes.

## SIBERT INSTRUMENTS

AT

THE CENTRE OF

S

CD

PRODUCTION

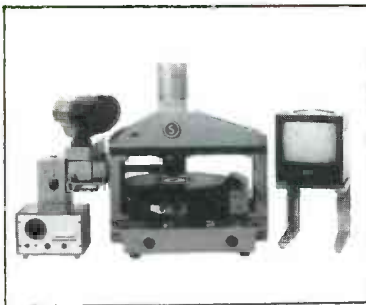

CENTRE PRESS



OUTSIDE DIAMETER PUNCH



TEST TABLE

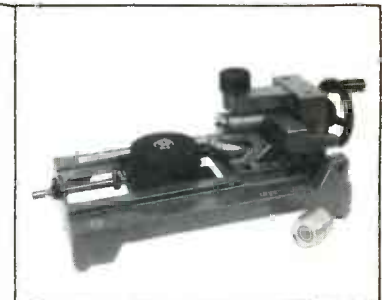

TRIMMER

**P & J SIBERT & CO**

RIDGWAY HOUSE, RIDGWAY, PYRFORD, WOKING, SURREY GU22 8PN, UK  
TELEPHONE: 09323 51921  
TELEX: 894223 SIBERT G



DENTON INTRODUCES

# METALIZING WITHOUT A CLEANROOM

Denton's compact DiscLine-500 metalizes 500 compact disks an hour. In line. 24" from the molder. 24 hours a day. With far less maintenance and downtime. Cost: About \$200,000 instead of over \$600,000. It's a revolution.



Denton's amazing new DiscLine-500 moves discs continuously from atmosphere to high vacuum and back again. No valves, no doors, no cleanroom.

The Denton DiscLine-500 is designed to be used, one on one, right with your injection molding machines. So it saves cueing, storage and contamination headaches.

**UTTER SIMPLICITY.** The comparison to other metalizers is astounding. Only three simple air cylinders constitute the internal drive of the DiscLine-500. And it has just three pumps (no turbos) instead of five or six.

The nth-degree simplicity is why there's so much less maintenance and downtime with a DiscLine-500. Not to mention having no cleanroom costs at all.

If one unit does have trouble, it won't put your entire line down. And, if you want a backup, one inexpensive DiscLine will cover any number of units.

**BEAUTIFULLY COMPACT & AUTOMATIC.** The Denton DiscLine-500 is fully automatic and so compact you can put it on castors and easily move it wherever

it's needed. It is fully computer controlled with 20mb hard disk for auto data logging.



**SEVERAL SYSTEMS** The Denton Compact Disc systems include master coating units (DV-CDM), "One-Minute Metalizers" for rapid cycle Q.C. (DV-502QC), batch coating units, and optical monitors for measuring disc reflectivity/transmission. Please call or write for more info today.

The revolution is waiting.

## DENTON VACUUM INC.

2 Pin Oak Lane  
Cherry Hill, NJ 08003-4072  
Phone: (609) 424-1012  
Telex: 9103809894 Fax: (609) 424-0395

Decades of R & D in Thin Film Manufacturing

# New research into polycarbonate

**T**he way we hear music, as well as the way we record and access data, has been revolutionised by laser-read optical disc technology.

Compact discs were an instant success from their introduction in 1983. Worldwide sales last year were approximately 200 million units, while sales in the US soared from a 6 million unit level in 1984 to a 48 to 50 million unit rate in 1986. A US demand of 350-400 million audio discs is forecast by 1990 and a global demand of one billion is projected.

The increasing sales pace of CD players reinforces these estimates. In the US, 2.3 million units were sold in 1986, up from 35,000 units in 1983; 1987 is expected to show an increase to more than 3 million units, a climb of 50%. In 1990, 12 million disc players are expected to be sold, bringing the installed base of players to approximately 25 million.

In 1984 there was only one North American audio CD manufacturer with an estimated annual capacity of 2 million discs. According to studies by Mobay, nine additional plants were brought on stream in 1986, bringing the North American annual disc pressing capacity to 40 million discs per year. By the end of this year, total capacity is estimated at 170 million with the introduction of new plants in 1987.

The market for audio CDs alone is expected to create a North American demand for 20 to 25 million pounds of high-purity polycarbonate by the early 1990s.

## Optical data storage discs

Similar signs of dramatic growth have been seen in the optical data storage disc segment since its introduction in 1985. Under 5,000 polycarbonate CD-ROM (Read Only Memory) discs were sold during that first year. In 1986, sales grew to approximately 20,000. As the installed base of CD-ROM players increases, CD-ROM sales could approach 10 million discs per year during 1990.

In addition to being widely used for audio CDs, Makrolon CD-2000 polycarbonate is also currently being utilised for the manufacture of CD-ROM and WORM (Write Once Read Many) discs. An erasable disc utilising Makrolon CD-2000 as the substrate should be commercialised by the end of 1987. The WORM and erasable technologies make

## Dr Mark Whitman reports on the setting up of an optical media research and customer service laboratory in Pittsburgh

use of proprietary, thin-film active layers which are deposited on the surface of the disc.

The erasable magneto-optical (MOP) disc relies on a reversible, laser-induced change in local magnetic field. Optical media based on reversible colour (dye-in polymer) or amorphous-to-crystalline phase changes are also under development.

An estimated 40,000 units of optical data storage media worldwide (including glass WORM and erasable optical discs) have been sold in 1986. By the early 1990s optical discs of all types will become recognised as the digital storage media of choice with sales in the order of 40 million units.

The optical media field's great potential can be appreciated by considering the staggering storage capacity of a CD-ROM disc. Only 4.75 inches in diameter, one disc can store the equivalent of 26 volumes of the

*Encyclopaedia Britannica*. The key to the high capacity of any optical disc is the manner in which the digital information is encoded on its surface. Millions of microscopic indentations, or pits, approximately 0.1 microns in depth, 0.5 microns in width, and one to three microns in length, are moulded into the surface of the disc to form a spiral track, which starts at the centre of the disc and runs to its outer rim. The moulded surface then receives a 500 Angstrom reflective aluminium coating necessary for readout of the digital signals. This is then followed by a thin coat of lacquer for protective purposes.

## Optical media lab

Mobay, prompted by the prospects of two new markets for optical discs, established an optical media laboratory in Pittsburgh, PA. Ensuring the realisation of these dynamic market prospects through a response to new technology and technical service is the laboratory's objective. Included in the laboratory is a complete state-of-the-art facility capable of moulding playable CDs. In addition, the facility is equipped with an array of testing and research apparatus for evaluating disc quality.

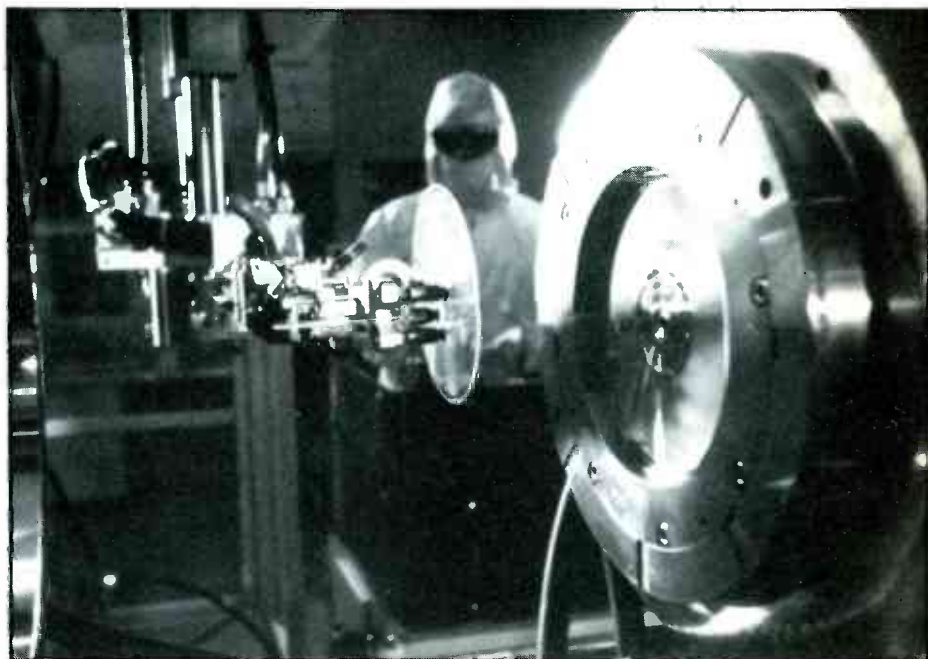

Savior robot removes disc from mould

# AVAC CD 12 Metallizer for HIGH QUALITY CD manufacture

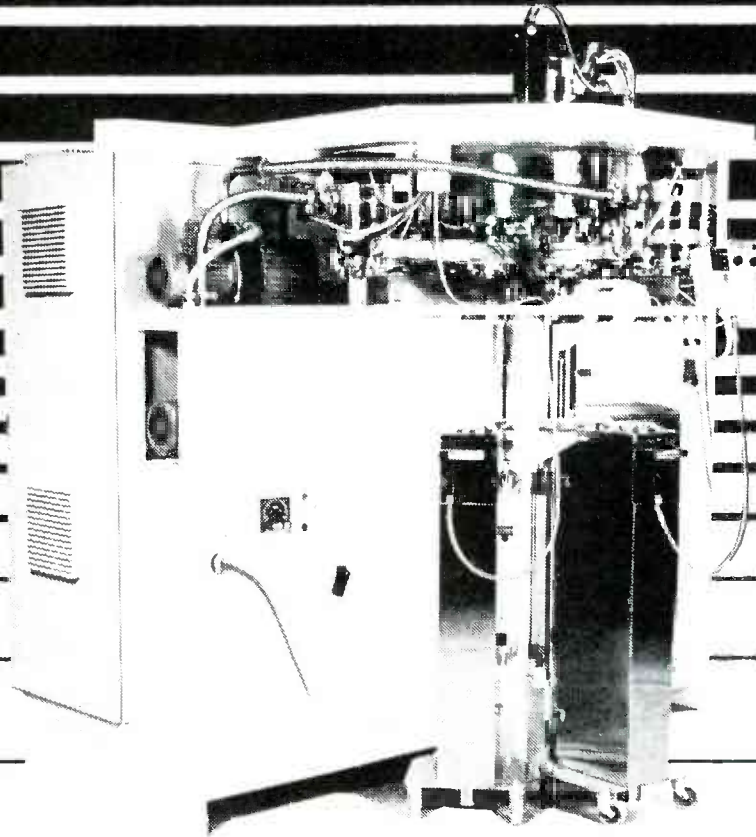

## More than just a Metallizer:

- Metallizing without cleanroom.
- Forget your pinhole reject.
- Unique transport system, safe and clean handling.
- Flexible and continuous production.
- Thoroughly tested in production.
- We also offer you education, after-sales market, service contracts and financing.

*High technology requires knowledge and cooperation.  
Let's start talking, - we have the knowledge!*





Applied Vacuum Scandinavia AB  
Box 5047, S-580 05 Linköping, Sweden  
Telephone +46 13 11 51 70 • Telefax +46 13 10 41 90  
Telex 8155094

# Sound Formats

by Dolby Laboratories

## Established worldwide

 **Dolby® A-type** Over 100,000 tracks of professional noise reduction in use in music, broadcast and film recording studios around the world.

 **DOLBY B-C NR** More than 180 million cassette recorders and players with B or C-type noise reduction manufactured by over 130 licensees. More than 450 licensed producers of pre-recorded cassettes.

 **DOLBY STEREO**® Over 1,300 feature films using Dolby Stereo optical soundtracks, plus foreign language versions, produced by 80 studios in 19 countries. Four channels reproduced in the cinema.

## New but proven

 **Dolby® SR** More than 3,000 tracks already in use worldwide. Dolby spectral recording offers sound quality superior to that of 16-bit PCM, with the practicality and economy of analogue recording. Available to anyone with a professional analogue recorder – everywhere.

 **Dolby® ADM** High quality digital stereo sound for television and radio broadcasting, distribution, DBS and teleconferencing. Over 15,000 decoding channels currently employed. Users include ABC (Australia), A L Williams, AT&T, Aussat, Australian Dept of Communications, Australian Telecom, Bonneville, British Telecom, California Racing Commission, Coca Cola, Computerland, Federal Express, Ford, Ford Aerospace, General Motors, Golden West Network, Hewlett Packard, HI-NET, IBM, Kodak, K-Mart, Mayo Clinic, Merrill Lynch, MicroAge, MTV (USA), New York Gaming Commission, Satellite Leisure Services, SBS, Swan 9, TV Globo.

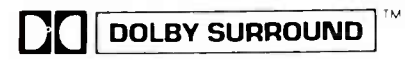
 **DOLBY SURROUND**™ Stereo sound programmes for television and video, with centre and surround channels encoded in the two conventional channels. Many stereo TV broadcasts and pre-recorded videos draw on the library of over 1,300 Dolby Stereo films. Successfully used with original television drama and live broadcasts. About 500,000 decoders already in use and now becoming available in TV sets, video control centres and video cassette recorders.

### Dolby Laboratories Inc

100 Potrero Avenue, San Francisco CA 94103-4813  
tel 415-558-0200 tlx 34409

346 Clapham Road, London SW9 9AP  
tel 01-720-1111 tlx 919109

Dolby, Dolby Stereo, Dolby SR and Dolby Surround are trademarks of Dolby Laboratories Licensing Corp.

**Quality + Practicality + Economy**

## CD PRODUCTION

The Mobay laboratory will serve customers on a global basis and was designed to complement, rather than duplicate, the equipment in its optical media laboratory in Europe. In this way, the broadest possible base of injection moulding and disc manufacturing equipment can be evaluated and offered to customers.

One phase of the lab's agenda will be developmental in nature, as it will be devoted to the optimisation of existing formulations, the development of new polymer systems, and to the development of new and/or improved processing technology.

The laboratory will also provide backup technical service for the manufacture of both audio CDs and optical data storage media. This service will include the evaluation of new mould designs and equipment, the troubleshooting of process- or quality-related problems, defining routes to improved productivity, the training of customer

personnel, and a variety of other technical services.

### Processing studies

Processing studies hold an important position on the agenda of the new CD laboratory, with the objective of improving production economies by advancing quality and reducing cycle times. Current cycle times in the industry are in the range of 10 to 13 seconds, and Mobay believe that a further reduction of 4 to 5 seconds is attainable.

Another area of interest will be formulation of resins with still lower birefringence. Although discs with very low optical path differences (less than 10 nanometers single pass) can be produced from Makrolon CD-2000, further improvements may be needed for many of the erasable optical media currently being developed. This must be achieved without sacrificing the absolutely

essential properties of the substrate, such as superior dimensional stability, resistance to moisture, high transparency, lot-to-lot consistency, high heat deflection, and good toughness.

A Meiki 140-ton injection moulding machine, capable of moulding discs up to 8 inches in diameter, is utilised in the CD laboratory, with Sailor robotics used to remove the discs from the mould. Other principal equipment includes Leybold vacuum metallising chamber, spin coater and a whole variety of optical imaging devices and measurement equipment. Other state-of-the-art mould, injection moulding, and associated manufacturing and testing technology will be evaluated in the laboratory in addition to the present equipment.

### Cleanrooms

A Class A 100 cleanroom is used for the moulding and metallising of discs in the laboratory. This ultra-pure environment is maintained by a high-quality HEPA dust filtering system designed to filter particles down to 0.3 microns, better than the 0.5 required for the A 100 classification.

Mobay and Bayer's extensive corporate analytical and polymer physics facilities are being made available to assist with product development and for the troubleshooting of customer problems. Almost any thinkable analytical method is available in the facilities, including scanning electron microscopy (SEM) with energy dispersive X-ray capability (EDX), various surface methods such as ESCA and LAMMA, Fourier transform infrared and NMA techniques, as well as automated particle analysis, all of which can be called upon at short notice.

If for example a CD manufacturer is having a disc contamination problem, he is often unsure of its cause. Sources can vary from the moulding machine to an outside source such as a transfer line to, possibly the resin itself. In one case, the source of contamination was breakthrough of the desiccant in the drying equipment.

Scanning electron microscopy and energy dispersive X-ray techniques are used to analyse and identify the micron-sized foreign particle and determine the cause of the contamination. With this information, the customer is able to take corrective action and bring the line back into production with a minimum of downtime.

### Onward thrust

A high premium has been placed on polymer development and processing innovation due to the onward thrust of technology and the inevitable, changing demands of the marketplace. The CD laboratory puts the company in a position of prompt and effective reaction to the changing needs of the optical disc industry and helps us provide our customers with the most cost-effective raw materials, processing know-how and technical service.

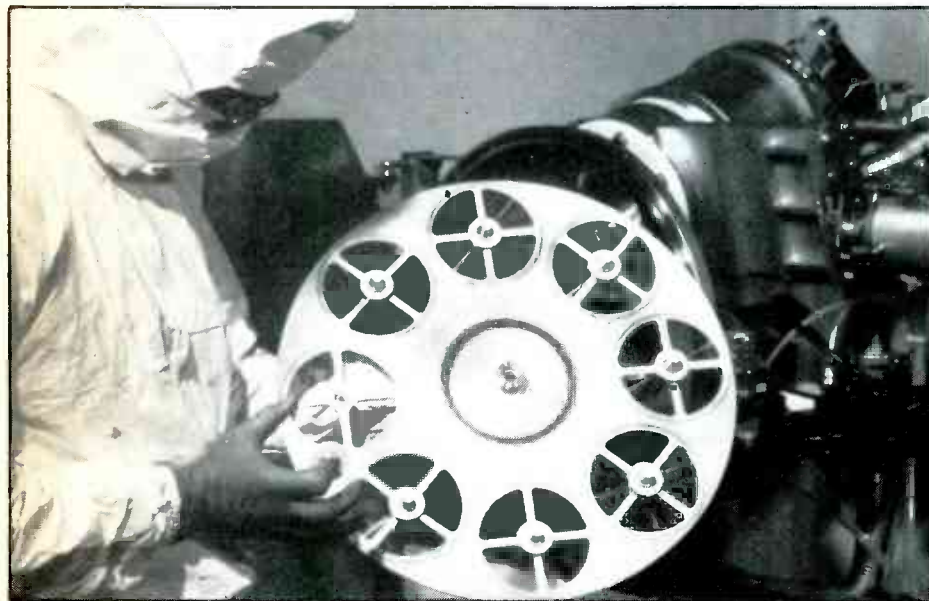

Laboratory size metalliser has an eight-disc capacity

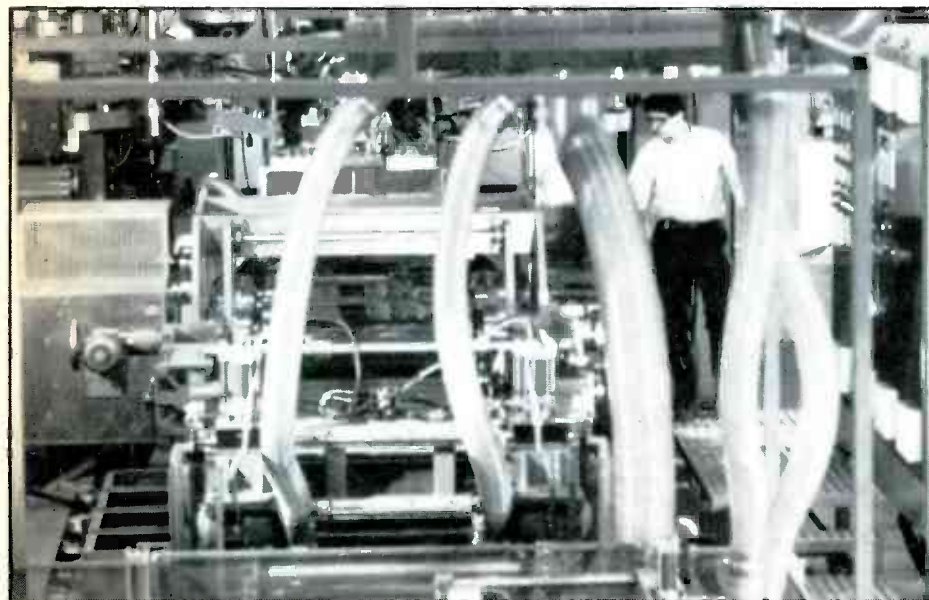

Multipurpose extruder to develop new resins and products

# A New Technique for Metallising Compact Discs

**D**enton Vacuum Inc of New Jersey have recently introduced a new concept in metallising compact discs. Equipment that has been available has had problems with reliability, high costs, capacities not matched to the capacities of injection moulders, and difficult automation of disc handling and masking. This system, the *DiscLine-500* is a small, cost-effective metalliser designed to be matched one-for-one with injection moulders. The system eliminates the need for large cleanrooms, simplifies handling and reduces large capital investment. Denton Vacuum's unique and proprietary vacuum seal design allows operation of a vacuum system with no cycling valves and minimal pumps. This differentially pumped system is also claimed to be virtually leak-free.

The system design provides 24 hour, seven day a week operation, is fully automated to reduce labour and to support factory-wide process control. The time the CD spends in vacuum before coating, is maximised to promote adhesion of aluminium.

**The metallising of CDs has been a major problem in CD production. Denton Vacuum believe they have found the answer.**

The system is small enough to allow it to be in immediate proximity to an injection moulder. It has simplified design with minimal internal mechanism, no cycling valves, differential pumping and very low leak rates, which minimises pumps required.

It offers single or multiple positions for loading/unloading CDs, internal masking so no external masking equipment is needed, full computer control including data logging and interfacing with both the factory host computer and the injection moulders. The deliberately simplified modular design provides for rapid change of subsystems. Sputter targets, masks and other components are easily accessible for routine

changing. Throughput is 500/hour, which matches or exceeds state-of-the-art injection moulders.

The machine configuration involves an inverted U-design and takes up very little floor space. The simple mechanics include three air cylinders (two operating in the vacuum section of the machine) one rotary load/unload table and no cycling valves. Substrate carriers are loaded and unloaded with CDs on a rotary table. The table rotates each new carrier with its uncoated CD under a precision tube at the left of the machine. An air cylinder pushes the CD and carrier into the inlet tube. The CD carrier has O-ring seals on its periphery providing an almost perfect seal to the inside of the tube. As the substrate carriers are pushed up into the inlet, a vacuum is pumped through the walls of the tube. The first pumping stage uses a direct drive rotary roughing pump.

As the CDs are pushed further up into the inlet tube, the second stage pumps them into the high vacuum region. The stage two pump is a cryopump to maximise water vapour pumping speed and eliminate any

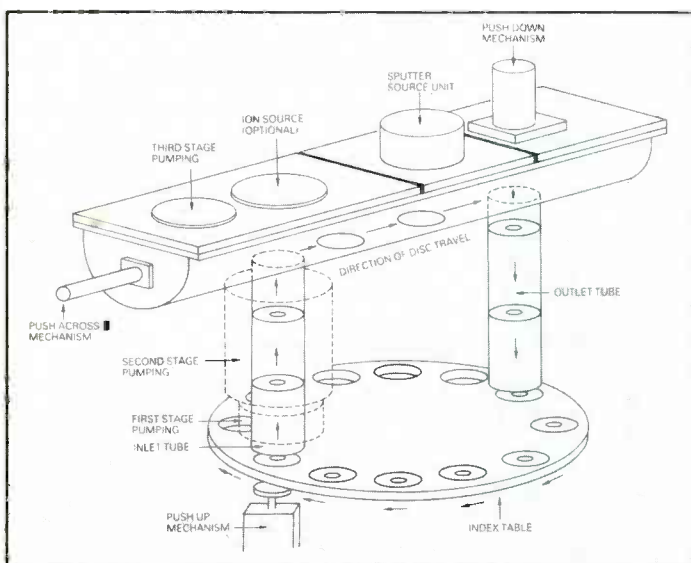

The diagram shows the isometric version of the Denton DiscLine-500 showing the path substrates in their carriers through the system, going from atmosphere to vacuum to atmosphere without passing through doors or valves



The Denton DiscLine-500 Substrate carrier

requirements in the system for liquid nitrogen.

After the CDs come out of the inlet tube into the top sputtering portion of the chamber, they are pushed to the right and under the sputtering cathode. When the CDs are pushed under the sputter cathode, internal masks are lowered over them. The sputter cathode is turned on and the CDs are metallised.

During sputtering, the index table at the bottom is rotated to place a new CD and carrier under the inlet tube. After sputtering is complete, and the index table has been rotated, another carrier and CD are pushed under the sputter cathode and the CD just coated is pushed to the top of the exit tube. Finally, the exit and entrance air cylinders, operating simultaneously, insert a carrier (and CD) into the system and remove a carrier (and coated CD) from the exit tube placing it on the index table.

The sputter target assembly is an 8 in diameter planar magnetron. Targets are bolted on a directly water-cooled backing plate eliminating the need for expensive target bonding. The sputtering assembly includes Denton Vacuum's patented anode grid between the sputter plasma and CDs. This prevents over 90% of the secondary electrons emitted from the plasma from reaching the compact disc, and minimises

heating of the CDs. The anode grid is mounted on a circumferential water-cooled anode that prevents any slow increase in system temperature with continuous production. Typically 80,000 to 100,000 CDs can be coated in one week before target change is necessary.

Another unique feature of the *DiscLine-500* is the use of a switching power supply to drive the sputter plasma. This power supply is ramped off and on between each coating cycle. Since the power supply is only coating when the CD and masks are in place, the substrate carriers are never metallised with aluminium, reducing particulate contamination.

The design concept of the *DiscLine-500* claims to provide a number of key process advantages. The CDs are in vacuum for 3 min before being coated and are pumped to a vacuum of  $10^{-3}$  torr, or less, during this time. CDs are therefore outgassed to a much greater extent than in higher throughput machines. Because of the high water vapour pumping speeds of the cryopumps used and the length of time the CDs are in vacuum, no glow discharge or sputter etch cleaning is required. Cryopumps also eliminate the cost of liquid nitrogen (or mechanical refrigeration systems) to pump water vapour.

Denton Vacuum also has the patented CC-102 cold cathode ion cleaning systems

available as a sputter etch cleaning device but to date no need for this has been found.

The system is completely automated with an IBM PC computer. The computer includes a 20 Mbyte hard disk for automatic data logging. All key process parameters are available to the computer such as pressure, sputter power, time between cryopump regeneration, number of CDs coated per cathode, etc. A capacitance manometer and mass flow control system maintain consistent sputtering pressure. The system is designed with interfaces to allow it to be controlled by an injection moulder, external load/unload robots or a factory host computer.

Other Denton Vacuum systems include the *DV-CDM*, full automatic system for coating CD masters with a deposit of silver or nickel. The *DV-CDM* is made for single operator use, has reprogrammable process controls and is cryopumped for rapid recycling and the elimination of liquid nitrogen requirements.

A quality control testing unit, the *DV-502/QC* is also part of the group. It is used for quick aluminisation of the first few discs produced at the start-up of the injection moulding machine.

Finally, Denton can also offer the *DV-504/CD* batch coating unit. Its capacity, based on the user's disc handling system, varies from 400 to 700 CDs an hour, with 60 to 80 discs per batch and 5 to 10 min air-to-air cycle. ■

## AUDIOPTIC XAV LASER DISK ..... NICKEL ELECTROFORMING SYSTEM



Equipment that is consistently producing precision fathers, mothers and stampers of the highest quality, cycle after cycle, for leaders in optical disk manufacture and research around the world.

We also provide complete electroforming services on the same equipment in our own clean room.

### **Audio Matrix, Inc.**

400 Madison Avenue, New York, NY 10017  
Milton B. Gelfand, president  
(212) 308-6888 Telex: 12-6419  
Fax: (212) 308-5817

**WORTH ITS WEIGHT IN GOLD**

# The GOLD BOOK

**ONE TO ONE**

**FOR PROFESSIONALS IN MASTERING, PRESSING & DUPLICATING**

Traditionally the industry has been serviced by a network of local suppliers but now with changing consumer demand and the introduction of new technologies, sources for products and services often extend well beyond national barriers.

With the GOLD BOOK you will be able to quickly identify who's providing what services in which sector of the market, in which geographical areas.

Equally you will be able to see at a glance what products are available – be it a major piece of equipment or a small 'throw-away' item.

With thousands of listings covering the many areas of Mastering, Pressing and Duplicating.

The GOLD BOOK will be sectionalised into three main headings:

VINYL – MAGNETIC – OPTICAL

The GOLD BOOK will be published in an A5 format, so it will never be far away from your side.

If you're involved in the many areas of Mastering, Pressing and Duplicating and you want a book just for you – then just look no further than the order form.

Professional Publications Group,

Link House Magazines Ltd, Dingwall Avenue, Croydon CR9 2TA, United Kingdom.



Cover price £30 (UK) \$50 (USA)

Please send me ..... copies of the GOLD BOOK. £31: (UK) £32: Europe \$57: USA Airmail £35: World Airmail includes postage and packaging.

I enclose a cheque/postal order/International money order payable to **Link House Magazines** for the amount \_\_\_\_\_

Or debit my credit card



☐ Credit card holders can order by simply ringing 01-686 2599 ext163, quoting credit card No

Credit card No.

Signed \_\_\_\_\_

Name \_\_\_\_\_ (please print)

Address \_\_\_\_\_

Please return the completed order form enclosing full remittance (including delivery) or giving your credit card number to **Professional Publications Group, Link House Magazines Ltd, Dingwall Avenue, Croydon, CR9 2TA, United Kingdom.**

Please allow 28 days delivery in Britain, extra overseas depending on country and delivery method



# Index

## Address changes

1987	
Disctronics	6/5
HHB Hire & Sales	20/2
International Audio and Music Association	8/7
JRF/Magnetic Sciences Inc	8/7
Tape Automation	10/9

## Agencies

1986	
Electro Sound to distribute TTL	10/10
Stanley distributes Transco	12/10
1987	
Elliott Bros Distribute NTP	10/9
European distribution for Compusonics	10/9
Douglas appoints representatives	12/9

## Authors

### Janet Angus

1986	
CBS Records — UK Vinyl	12/6
Mastering for CD	21/6
Frazer Peacock In Depth Video	30/10
1987	
ITD Duplicating	32/2
Adrenalin Pumps Life into Record Pressing Plant	26/5
Staying Ahead in Data Duplication	66/5
If Lacquers Could Speak, What Stories They'd Tell	38/7
Small Spells Success	26/9

### John Atkinson

1986	
Vinyl Master	25/6



**A three-year guide to One to One's news, features etc, from our first issue to September 1987. The right hand column indicates page number/issue.**

### Hans Beekhuizen

1986	
RBS Real Time Copying	36/6
PolyGram International Quality Control	36/10

### Brian Bonner

1986	
Everything had to be Delivered Yesterday	42/10

### Graham Boswell

1987	
The Neve Digital Transfer Console — Part I	54/5
The Neve Digital Transfer Console — Part II	34/7

### Sean Davies

1986	
Back Catalogue: Who Cares?	58/2

### Val Falloon

1987	
CD Video — The Music Industry View	38/5

### Jack Field

1987	
Swarf McGoo's Greatest Cut	26/12

### John Fisher

1985	
Improving Cassette Quality	10/12
1986	
Tape Saturation and Improving Raw Materials	26/10
1987	
Kiss-print in Loopbin Duplicating Applications for Dolby SR	38/2 28/7

### Bill Foster

1985	
EQ Copies and the Master Tape	22/12
1986	
Raw Deal for Disc Cutters	35/6
F1 — Digital Bliss, Mastering Headache	24/10
1987	
Digital Options	22/2
DAT Goes Pro	42/7
All Taped Up	66/9

### Barry Fox

1985	
Are The Record Companies Trying to Kill Off CD?	14/12
1986	
Growing CD Production	29/6
CD Production at EMI	22/10
R-DAT Further Background	34/10

### 1987

Alternative CD Formats	46/2
CD Video — The Technology	28/5
Laser Rot: The Story So Far	16/7
Anti-copying: Past and Present	40/9

### Peter Herring

1986	
Production Options — Part 1 In Praise of Vinyl	40/10
1987	
Commitment to CD	42/2
Production Options Pt 2: the Case for Cassettes	42/5
Production Options Pt 3: Mid-Priced Expansion of the CD Market	48/7
DAT's the Way it is, say Nimbus	38/9
Records are Forever	46/9

### Chris Hollebone

1987	
Analogue to Digital Conversion	57/2

### Ann Horan

1987	
Stuck on You	56/9

### Scott Hull

1987	
User's Guide to the Sony DAE-1100 Editor	60/9

### Mike Jones

1985	
New Developments in Duplicating	24/12
The Long and Winding Road	34/12
1986	
Developents in Duplicating	18/6
Duplicating in the 80s	18/10



# REFERENCE

<p><b>Ken Kessler</b> 1987 Maine Event 32/9</p> <p><b>Tim Leigh-Smith</b> 1985 PR Records: Vinyl Pressing and CD Expansion 18/12</p> <p>1987 A Flexible Approach to Pressing 24/7 Reader's Digest Music: Investing in Quality 43/2 Duplicating from a Distance 46/5 At the Centre of the Industry 50/9</p> <p><b>Pedro Leonarz</b> 1987 Toolex Alpha: Manufacturing CDs 50/5</p> <p><b>Bob Ludwig</b> 1986 Letter from New York 46/10</p> <p>1987 US Digital vs Analogue 50/2 User's Guide to the Sony DAE-1100 Editor 60/9</p> <p><b>John Matarazzo</b> 1987 Effective Quality Assurance 32/6</p> <p><b>Clark McCoy</b> 1987 Tape Manufacturers' Specification Sheets 58/5</p> <p><b>Susan Nunziata</b> 1987 ITA How and Why Seminar 21/7 US Report 23/9 Duplication's Diverse Markets 68/9</p> <p><b>Carl M Rodia</b> 1985 CD Manufacturing Trials and Tribulations 28/12</p> <p><b>Randy Savicky</b> 1986 Prospering in a Technology Driven Industry 16/6</p> <p>1987 US Mastering Houses meet the Challenge 60/2 New Formats, New Marketing for the 80s 20/5 US Report 45/7</p> <p><b>John Seabury</b> 1987 CD Video — Report from PDO Blackburn Plant 32/5</p> <p><b>Chris Sidall</b> 1987 Maintaining CD Quality 62/5</p> <p><b>Carl A Snape</b> 1985 Voices in the wilderness? 5/12</p> <p>1986 R-DAT: A New Standard? 38/6 Getting it in writing 5/6 Profit or loss 5/10</p> <p>1987 Teldec Direct Metal Mastering for Compact Disc 24/2 Here today, gone tomorrow? 5/2 Rights and wrongs 5/5 Copyright Reform in the UK 53/9 JVC Disc Cutting 64/5</p> <p><b>Tony Spath</b> 1987</p>	<p>Applications for Dolby SR 28/7</p> <p><b>A A Tripp</b> 1987 Disctronics, Australia's First 16/9</p> <p><b>Stan White</b> 1986 A New Boom for CD 44/10</p> <p><b>Terry Yeadon</b> 1985 Cassette Mastering and Chrome Duplication 32/12</p> <p><b>Data sheet</b> 1985 Cassette tape lengths — number of cassettes per pancake 36/12</p> <p><b>Editorials</b> 1985 Voices in the wilderness? 5/12</p> <p>1986 Getting it in writing 5/6 Profit or loss 5/10</p> <p>1987 Here today, gone tomorrow? 5/2 Rights and wrongs 5/5 Looking down the thin edge of a very long wedge 5/7 Another one of those days? 5/9</p> <p><b>Equipment</b> 1985 AGE Telefunken calibration system for high speed duplication equipment 8/12 Concept Design 1 in loop bin 9/12 Kenneth A Bacon Associates real-time cassette duplication 9/12 Magnefax 7000 series high speed duplicators 8/12 Recortec super high speed cassette duplicator 8/12 Polyform precision electroforming equipment 8/12 Telex 6120 High speed duplication system 8/12 TracSystems CD201 high speed duplication 8/12</p> <p>1986 Aerosonic 8 mm pancake tester 6/10 Ampex 467 digital cassettes 10/6 Avis-Asona electronic update 10/6 Avis-Asona 2015 winder 6/10 Electro Sound 4800 duplicating system 9/6 GEM high-speed copiers 10/6 Investment Technology L-2 auto labeller 9/6 Kopex Cablejacket anchor 6/10 Seidel SST labelling unit 10/6 Souriau 8526 connector 10/6 Tascam 112R cassette recorder 6/10 Thermographic Measurement micro labels 6/10</p> <p>1987 Agfa cassette tape improvements 6/2 Ampex 467 update 6/2 Apex scrubber 16/5 Apogee 944 filters 18/5 Audico label sheets 8/2 Audio Matrix Audioptic XAV system 14/7 BASF LHD improvements 8/2 BASF Studio Master cassettes 13/9 Brady magnetic tape marker 8/2 Datakey process control 13/9 DISC SP-1 CD stamper analyser 14/7 Douglas Readyseal feedthrus 12/7 Ferrograph optical disk recorder 13/9 Fuji DAT tape 13/9 Fuji M401 MII video tape 8/2 Fulmer abrasive monitor 14/9 Future Productions QCMC-1 14/9 Heyna CDP 3500 CD analyser 14/9</p>	<p>High Vacuum CDC-1000 coater 6/2 Howe Audio Model 2300 phase chaser 6/2 Intelair compressed air products 8/2 JVC BR-7000UR VHS hi-fi duplicator 18/5 KABA portable duplicator 6/2 Kenwood DAT test equipment 18/5 King model 2500 video loader 16/5 Machines Dubuit silk screen printers 12/7 Magnefax 3800 series duplicators 14/9 Maxell new tapes 14/7 Otari T-303 VHS loader 14/7 Philips LHH 3050 PQ editor 17/5 Shape compact disc analyser 16/5 Sick scan system 13/9 Sony DAT duplicating system 17/5 Sony digital products: DM-U30, DAL-1000 12/7 Sony DMC-1200 CD master code cutter 6/2 Sony PCM-1630 delay board 18/5 Sony PCM-2500 DAT recorder 14/9 Tape Automation X-L minor 17/5 Tapex plate maker 16/5 tec electronic equaliser/spectrum analyser 12/7 TDK DA digital audio tape 12/7 TDT pinchroller kit 14/7 Teac LV-200A videodisc recorder 14/9 Telex 6120XLP duplicator 8/2 Vanwell 60 tape cleaning unit 18/5</p> <p><b>Features</b> 1985 Are the Record Companies Trying to Kill off CD? 14/12 Cassette Mastering and Chrome Duplication 32/12 CD Manufacturing Trials and Tribulations 28/12 Computerised Quality Control 37/12 EQ Copies and the Master Tape 22/12 Improving cassette quality 10/12 New Developments in Duplicating 24/12 PR Records: Vinyl Pressing and CD Expansion 18/12 Raw Deal for Disc Cutters? 35/6 Swarf McGoo's Greatest Cut 26/12 The Long and Winding Road 34/12</p> <p>1986 A New Boom for CD? 44/10 CBS Records — UK Vinyl 12/6 Developments in Duplicating 18/6 Duplicating in the 80s 18/10 Effective Quality Assurance 32/6 Everything had to be Delivered Yesterday 42/10</p>
---	---	---

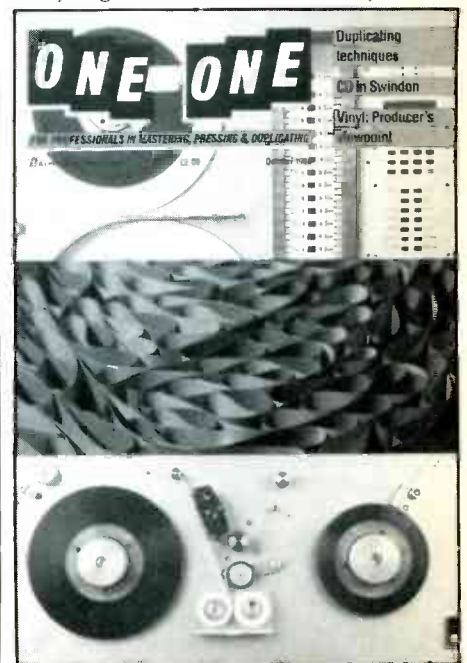

Fl—Digital Bliss, Mastering Headache?	24/10
Frazer Peacock In Depth Video	30/10
Letter from New York	46/10
PolyGram International Quality Control	36/10
Production Options — Part One In Praise of Vinyl	40/10
FBS Real Time Copying	36/6
R-DAT: A New Standard?	38/6
R-DAT Further Background	34/10
Tape Saturation and Improving Raw Materials	26/10
UK record industry back to steady growth	46/10
Vinyl Master	25/6
<b>1987</b>	
Adrenalin Pumps Life into Record Pressing Plant	26/5
A Flexible Approach to Pressing	24/7
All Taped Up	66/9
Alternative CD Formats	46/2
Analogue to Digital Conversion	57/2
Anti-copying: Past and Present	40/9
Applications for Dolby SR	28/7
At the Centre of the Industry	50/9



Back Catalogue: Who Cares?	58/2
CD Production at EMI	22/10
CD Video — The Technology	28/5
CD Video — Report from PDO Blackburn Plant	32/5
CD Video — The Music Industry View	38/5
Commitment to CD	42/2
Copyright Reform in the UK	53/9
DAT Goes Pro	42/7
DAT's the Way it is, say Nimbus	38/9
Digital Options	22/2
Disctronics, Australia's First	16/9
Duplicating from a Distance	46/5
Duplication's Diverse Markets	68/9
Growing CD Production	29/6
If Lacquers Could Speak, What Stories They'd Tell	38/7
ITD Duplicating	32/2
JVC Disc Cutting	64/5
Kiss-print in Loopbin Duplicating	38/2
Laser Rot: The Story So Far	16/7
Maine Event	32/9
Maintaining CD Quality	62/5
Mastering for CD	21/6
Production Options — Part Two: The Case for Cassettes	42/5
Expansion of the CD Market	48/7
Reader's Digest Music: Investing in Quality	53/2
Records are Forever	46/9
Small Spells Success	26/9
Staying Ahead in Data Duplication	66/5
Stuck on You	56/9
Tape Manufacturers' Specification Sheets	58/5
Teldec Direct Metal Mastering for Compact Disc	24/2
The Neve Digital Transfer Console Part 1	54/5
The Neve Digital Transfer Console Part 2	34/7
Toolex Alpha: Manufacturing CDs	50/5
US Digital vs Analogue	50/2
US Mastering Houses meet the Challenge	60/2
User's Guide to the Sony DAE-1100 Editor	60/9
You want to release a CD — Which tape should be sent?	22/6

### Pre-emphasis

<b>1985</b>	
CBS mastering business up	6/12
CBS/Fox video	6/12
Graff and the Koran in Tunisia	6/12
Musitech turnkey packages for CD manufacturers	6/12
New CD plant goes into production	5/12
New Vice-president at Electro Sound	5/12
New sources of chrome duplicating tape	6/12
Philips/DuPont optical storage	6/12
Tapetek speed up service	5/12
TracSystems buyout	6/12
USA sales manager appointment at ICM	5/12
USA tests to improve pre-recorded audio cassette quality	5/12
US Lyrec distributor	6/12
<b>1986</b>	
Adrenalin buy Linguaphone plant	8/10
Anti-piracy in the UK	9/10
APRS: new labels	14/10
Asona news	8/10
Audio Matrix CD electroforming plant	7/6
Awards for Philips CD scientists	10/10
BBC Records distribution deal	7/6
BIPI 1985 figures	8/6
BPI First quarter figures	8/6
Burlington distribute IPS	9/10
Clone: Realtime at loopbin costs	9/10
COPS: Need a Production Manager?	5/6
Digital Audio Disc Corporation targets higher capacity	6/6
Digital Information Exchange '86	8/10
Disc cutting courses	10/10

Distance teaching	12/10
DMM processing at PR Records	8/10
Do they know something we don't?	9/10
Eldoret acquires cassette duplicator	10/10
Electro Sound to distribute TTL	10/10
EMI Music/Capitol in China deal	6/6
Gauss sells to China	5/6
Koch CD plant on stream	8/10
KIPM go DMM	9/10
Luwa wins Nimbus contract	7/6
Maxell optical disks	5/6
MJA launch Monitor by Mail Service	13/10
Nightingale shift to high tech duplication	7/6
Philips/Sony announce CD-1	7/6
Philips/Sony CD-1 specifications	13/10
SHAPE Otimedia move into CDs	7/6
Shape Optimedia moves CD production	12/10
Shape Video expansion	12/10
Sony 1630 acceptance	6/6
Stanley distributes Transco	12/10
Studio 301 suspends custom pressing	9/10
Tam disc-cutting equipment	6/6
Tape levy illegal	8/6
James Yorke custom duplication	8/6

<b>1987</b>	
All Digital CDs	8/9
Ampex Care and Handling Guide	12/9
Arista join chrome 'family'	21/2
Asona news — custom Revox B77	14/2
Barone — new appointment?	10/9
BASF Studio Master cassettes	13/9
Blue Cross/Blue Shield sign with ORC	21/2
BPI — new yearbook	10/9
Budget CDs	12/5
CD-ROM from Discovery	6/5
Cetec Gauss promotion	12/9
Chinese made easy	12/9
Cinderella won't play ball — 3M price increase	14/2
Computer giant moves into music	11/7
Counterfeiters caught	14/2
DAT legislation moves forward	10/9
DAT provision approved	12/5
Davkore news	7/5
Dick Clark's first compact discs	18/2
Digital Audio Disc Corp mastering	16/2
Digital Information Exchange '87	11/7
Disc Mastering all digital CDs	8/9
Discovery Systems open LA office	8/9
Disctronics buys Disctec	6/7
DIY CD plant to order	20/2
Dolby SR for digital mastering	21/2
Electro Sound change of course	16/2
Elliott Bros Distribute NTP	10/9
EMI America + Manhattan	10/9
EMI CD expansion	8/7
EMI new international manager	7/5
Entrepreneurs of the Year Award (Shape)	18/2
European cassette quality control	12/2
Forward Technology buys Fraser Peacock	14/2
Fraser Peacock Christmas rush	18/2
Fraser with an 's'	11/7
Fuji: new technical manager	8/5
Gauss expand in Europe	12/5
Gauss promotion for Williams	18/2
Graff overseas sales	16/2
GTS step up cassette production	8/5
IFPI 1986 Review	14/2
Independent Duplicators push up hardware sales	8/7
Kodak manufacture optical disks	8/5
Kurzeder, Alf-Obituary	18/2
Lathe nods from TAM	11/5
Lunatic at large	8/9
Mastered on Compusonics	8/9
Mastertronic — computer giant moves into music	11/7
Meiki win award	11/5

## REFERENCE

Midem '88	8/9
Neve appointments — Roger Clemo	8/5
New manufacturing facility for Ampex	12/2
Otari plans move to new US headquarters	8/9
PDO buys Ampex VTRs	8/9
Playback go digital	11/7
Pop pirate jailed	12/9
Praxis to increase production	12/5
Precision Lacquer order DTC-1	16/2
Quality priority at WCI	12/9
Queen's Award for Nimbus	11/7
RIAA reports CD growth	8/9
Shape appoints Mort Fuji	16/2
Shape unveils new CD packaging	6/7
Silverplatter CD-ROMs new distribution	8/5
Singapore relapping service	16/2
Softstrip International Paper data	12/5
Sonic Solutions new noise reduction system	8/7
Sony extends PCM-1630 format	6/7
Sony promotions following digital success	18/2
Sony Tape Division — new structure	11/5
Soul pirates scuppered	8/5
Spoken word goes stereo	8/7
Syco appointments — Jon Ridel	8/5
Tape Automation sell to Japan	8/7
Tape pirate gets jail sentence	11/7
Teac open UK office	10/9
Technology and Marketing Seminar	18/2
TDK 8 mm duplicator cassettes	16/2
3M storage system	14/2
UK trade deliveries July-Sept 86	12/2
UK total trade deliveries: 1986	6/5
UK trade deliveries April-June 1987	12/9
US royalty review	11/5
US trade deliveries: Jan-July 86	7/5
Versadyne International appointments	18/2
Versadyne improved quality	8/5

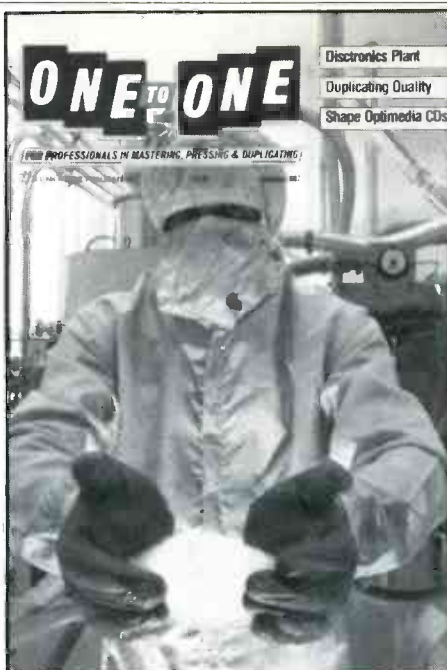

Videoprint choose Q. Lock 21/2  
James Yorke buy British 8/7

### Publications

1986	
Making Europe's Music — the role of the recording industry	8/6
Inside the Recording Industry: An Introduction to America's Music Business	8/6

### US Report

1986	
CBS to manufacture CDs	16/10
DAT technology group proposed	16/10
Neve releases DTC-1	16/10
New CD plant in Dallas	16/10
Sax appointed to advisory board	16/10
1986	
AEG adding TTL	22/9
Agfa opens headquarters	45/7
Alarm & RIAA	22/9
Arrest in counterfeit tapes	46/7
B&L goes Sony	46/7
Bubble cushion mailers available	46/7
DADC appoints Bartlett	46/7
DAT Act acknowledges duplicators	15/5
DAT now 'On Air'	22/9
DeWolfe goes CD	24/9
Editel/New York masters CDV	46/7
EIAJ, EPI and RIAA fail to agree	10/2
Engineers reject Copycode concept	24/9
Growth in spoken word	10/2
Irangate videos	24/9
ITA releases report	22/9
LaserActive '87	45/7
LaserVideo and Dainippon Link	45/7
New York Copycode demo	24/9
Otari available again	46/7
Sanyo moves into US	24/9
Shape stresses services	15/5
Solid state duplicating	22/9
Studer delivers digital deck	45/7
Telex duplicator	45/7
US CD manufacturing system	15/5
US Congress still debates DAT Bill	46/7

# Adrenalin

offer the best in analogue pressings,  
in black, colour and picture discs, and

We offer a full custom service for sleeves, labels,  
pressings, cassettes and C.D.'s. For our full  
price brochure call or write to:

Adrenalin Records Ltd.,  
252/253 Argyll Avenue, Trading Estate, Slough, Berks SL1 4HA  
Tel: Slough (0753) 23200/31837  
Fax: (0753) 692243

# Adrenalin

# SERVICES

Advertisements for classified lineage must be pre-paid. The rate is 45p per word, minimum £9.00. Box Nos £4.00 extra + 15% VAT (UK only). Semi-display rates on application. Copy and remittance for advertisements in January issue must reach these offices by 14th December addressed to: The Advertisement Manager, One to One, Link House, Dingwall Avenue, Croydon CR9 2TA. Cheques made payable to Link House Publications (Croydon) Ltd. **Note:** Advertisement copy must be clearly printed in block capitals or typewritten. Replies to Box Nos. should be addressed to the Advertisement Manager, One to One, Link House, Dingwall Avenue, Croydon CR9 2TA, and the Box No. quoted on the outside of the envelope. The district after Box No. indicates its locality.

The attention of advertisers is drawn to "The Business Advertisements (Disclosure) Order 1977", which requires that, from 1st January 1978, all advertisements by persons who seek to sell goods in the course of business must make that fact clear. From the above date consumers therefore should know whether an advertisement relates to a sale by a trader or a private seller.

For details ring  
Adrian Tippin on 01-686 2599

Rates £11 per single  
column centimetre

One to One  
Link House Magazines  
Dingwall Avenue  
Croydon, Surrey

**jbs records**  
**MUSIC-SPEECH-DATA**  
REAL TIME/HIGHER-SPEED Quality Cassette  
Duplication and Blanks from 1-10000 Computer printed  
Labels. Solo, 1st real, Sony Betamax recording.  
Fast Security Delivery service.  
FILTERBOND LTD, jbs records div. FREEPOST  
19 SADLERS WAY, HERTFORD SG14 2BR. 0992-500101

**REAL TIME CASSETTE DUPLICATION**  
**TAPELINE**  
**061-336 5438**

**Channel 5 Audio**  
High Quality, Real time cassette duplication.  
Printed inlay cards and side labels.  
Custom wound blank cassettes  
**Tel: 01-803 9036**

TO ADVERTISE IN THIS  
SPACE IT COULD COST  
YOU AS LITTLE AS  
£35.00 INCLUDING VAT

**Angel Talk Limited**  
AUDIO CASSETTE  
DUPLICATION TO THE  
HIGHEST STANDARD  
IN REAL TIME  
RAPID SERVICE STEREO FORMAT FROM  
PCM FILE/BETAMAX DIGITAL MASTERS, MASTERS 1 1/4"  
3 3/4" 7 1/2" I.P.S. N.A.B. OR 1 1/2" I.P.S. N.A.B. OR I.E.C.  
OR CASSETTE OR OPEN REEL MASTERS 1 1/4" 3 3/4" 7 1/2"  
I.P.S. N.A.B. I.E.C. 30-1000 DUPLICATES PER MASTER  
ALSO AND DIGITAL OPT. REEL DUPLICATION  
**RING BRACKNELL (0344) 425200 ANYTIME**  
6 ABBEY CLOSE, HARMANS WATER, BRACKNELL RG12 3NX

**CASSETTE  
DUPLICATORS**  
The specialist in the supply and service  
of cassette duplicating equipment, bulk  
custom wound cassettes, and  
accessories.  
**GRAFF SONY TELEX WOLLENSAK**  
Main Dealers UK and Export  
**SOUND CASSETTE SERVICES LIMITED**  
BODEN STREET, CHARD, SOMERSET  
**0460 67237**  
**NATIONWIDE**

**CASSETTE PRODUCTION**  
For a complete service designed to give you the best results at competitive prices  
★ REAL TIME DUPLICATION  
★ HIGH SPEED LOOP BIN DUPLICATION  
★ INLAY CARDS and SIDE LABELS  
★ CUSTOM WOUND CASSETTES  
**THE ANSWER IS**  
**Tel: (048 92) 6527**  
**GET SOLD ON**  
**BARGATE RADIOTRAX CASSETTES!**

**REAL RECORDINGS**  
THE CASSETTE DUPLICATING SPECIALISTS  
Real time & high speed loop bin duplication,  
printing & packaging. Blanks wound to length.  
**TEL: 061-973 1884**

**STATETUNE LIMITED**  
Quality Custom  
Record Pressings  
Specialists in short and medium runs,  
both 7" and 12", from master tape to  
finished disc. Regular deliveries to London and  
throughout the country.  
Factory:  
**Grant Road, Wellingborough,**  
**Northants NN8 1EF.**  
Telephone: Wellingborough (0933) 77442.

**CASSETTE DUPLICATION**  
Quality Cassette Duplication, High-Speed (Loop Bin) and Real  
Time. From 1/4" PCM-FI or Cassette Masters. Overwrapping. Custom  
wound blank cassettes, labels and inlays.  
Tel. Leicester (0533) 602064  
**ACCURATE SOUND LIMITED**  
QUENIBOROUGH (Ind. Est.) MELTON ROAD  
QUENIBOROUGH, LEICESTER LE7 8FP

**EXCELLENCE** is the result of *uncompromising* dedication  
to quality and service.  
JRF is proud of its reputation as a leader in the field of magnetic heads.  
Our technical and engineering staff is committed to providing the finest  
products and services:  
• Magnetic Head Refurbishing  
• Optical/Digital Assembly  
Alignment  
• Full line of replacement heads  
IN STOCK  
• MCI/Sony parts dealer  
• 3M parts dealer  
• Technical Assistance  
• Fast, reliable service that's  
unmatched for quality  
Responsive to the needs of the recording  
industry, we at JRF feel there can  
be no substitute for **EXCELLENCE**  
**JRF**  
MAGNETIC SCIENCES  
Kennedy Road • P.O. Box 121 • Greendell, NJ 07839  
Tel: (201) 579-5773 • Fax (201) 579-6021 • Telex 325-449

# SERVICES

## THE COMPLETE SERVICE includes:

BLANK CASSETTES (C1-C100 incl. Chrome)  
HIGH-SPEED LOOP BIN CASSETTE COPYING  
OPEN-REEL COPYING  
CASSETTE LABELS & INLAY CARDS  
EMPTY TAPE SPOOLS & TAPE BOXES  
LEADER TAPE & SPLICING TAPE  
AMPEX MAGNETIC TAPE.

and is available from —  
MEDIATAPE LIMITED

The Courtyard, 152-154 Ewell Road, 01-399  
Surbiton, Surrey KT6 6HE, England. 2476-7

## OUR 10TH ANNIVERSARY

IF YOU ARE LOOKING FOR A RELIABLE  
ENDLESS CASSETTE, YOU'VE FOUND IT...  
YOUR ENDLESS SEARCH IS OVER.

UP TO 120,000+ PASSES, HEAVY DUTY SELF-  
CLEANING TAPE SOUNDS BETTER LONGER

PLAYS VERTICALLY OR HORIZONTALLY —  
WILL NOT LOOP OUT OR SPILL TAPE WHEN  
HIGH SPEED DUPLICATED.

ALSO HEAVY DUTY ENDLESS PLAYER WITH  
MOTOR RATED AT 10,000 HOURS  
CONTINUOUS — OUR COMBINATION  
ENDLESS CASSETTE AND PLAYER WILL NOT  
PERFORM AUTO REVERSE MACHINE. WE  
INVITE COMPARISON. NOW BEING USED FOR  
LOW POWER RADIO TRANSMITTERS, POINT  
OF PURCHASE AND ON HOLD MUSIC/INFO  
MESSAGES. ASK ABOUT 8TR CTG CLOSE OUT @ \$1.00 EACH



Write or call for prices

MANN ENDLESS CASSETTE INDUSTRIES, P.O. Box 1347 San Francisco, CA 94101, (415) 221-2000 EXT 2

## ONE TO ONE

FOR PROFESSIONALS IN MASTERING, PRESSING & DUPLICATING

## CLASSIFIED ADVERTISEMENTS ORDER FORM

Please use this coupon for all your sales and wants.

Rates: 45p per word. Min £9.00. Box Nos. £4.00 extra. + 15% VAT

\$1.00 per word. Min \$20. Box Nos. \$10.00 extra.

PLEASE PRINT IN BLOCK CAPITALS

To: One to One, please publish the above advertisement for ..... insertions under the heading  
..... Cheque/P.O to be made payable to LINK HOUSE PUBLICATIONS LTD,  
LINK HOUSE, DINGWALL AVENUE, CROYDON CR9 2TA.

Is a Box No. required Yes/No. If no, please include remittance to cover name and address and/or tel. no.

Name ..... Address .....

## ADVERTISERS INDEX

Adrenalin Records.....	52	Kabo Research & Dev.....	31
Alfa Sound Ltd.....	7	Lyrec UK Ltd.....	21
Arkal.....	6	Mann Endless Cassette Ind.....	54
Audio Matrix Inc.....	47	Mayking Records Ltd.....	37
Auvis Asona.....	9	Midem.....	39
Avac.....	43	Music Box Spa.....	7
Avcom Systems Ltd.....	9	Neve Electronics Int.....	25
Capitol Magnetics.....	33	Philips & Dupont.....	12, 13
CBS Precision Mouldings.....	20	P & J Sibert & Co.....	40
Denton Vacuum Inc.....	41	Reflex Audio Ltd.....	6
Digipro International.....	IFC	Shape.....	29
Dolby Labs.....	44	Tape Automation.....	15
Greencorp Magnetics.....	6	Tapematic.....	7
High Vacuum Equipment Corp.....	OBC	Teldec Schallplatten GmbH.....	16, 17
ICM Ltd.....	4	Unimagnetic PTE Ltd.....	9
JLR Associates.....	23	White Knight Products Ltd.....	11

# Precision equipment for the audio and video recording industries is only part of the story

---

The Musitech Group – specialists in the design and manufacture of precision machinery for the audio and video recording industries.

Our engineers combine a wealth of experience with state-of-the-art technology.

Our consultants will advise on all aspects of compact disc, record and tape manufacture.

Our designers offer a service ranging from special purpose machines to the production line lay-out of a complete factory.

Our products include fully automated compact disc production lines, matrix systems for masters, mothers and stampers, optical and other test equipment.



A unique British company  
serving the World of Sound.

Tel: High Wycombe (0494) 464488 (3 lines)  
Telex: 838825 MUSTEC G Fax: (0494) 462743

11-13 Temple End, High Wycombe, Bucks HP13 5DM

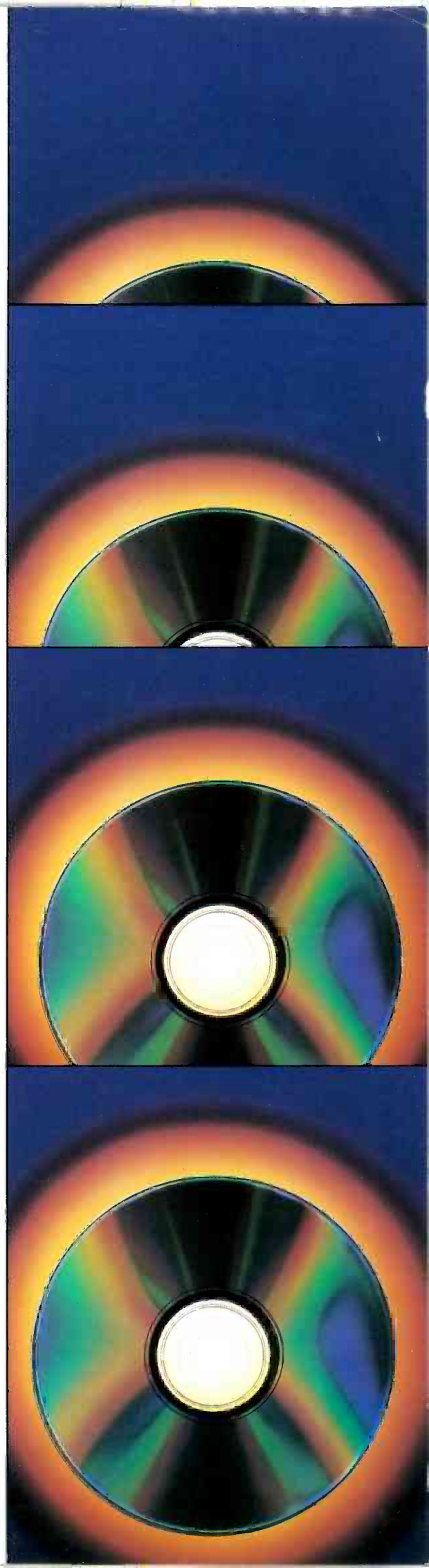

# CDC-1000

## Compact Disc Metallizer

Designed for use as a stand alone or integrated into 3rd generation, in-line production modules.

- Up to 1000 discs/hour throughput (stand alone); reduced throughput for integrated 3rd generation.
- Limited clean room area required.
- Unique design features for optimum reliability.
- Total system manufactured in the United States.

Write or call for detailed descriptions and specifications.



### High Vacuum Equipment Corp.

110 Industrial Park Road  
Hingham, MA 02043  
Telephone: 617-749-9000  
TWX: 710-348-0160  
Fax No: 617-749-5749

