

Special  
5th  
Anniversary Issue!

ICD 08560  
\$1.75

# MODERN RECORDING & MUSIC

VOL. 6 NO. 1  
OCTOBER 1980

## CHICK COREA "LIVE!"

**PROFILE:** Bassist  
Alphonso Johnson

**Building A "Hot  
Springs" Reverb**

**LAB REPORTS:**  
Audiovisual Systems  
Patch Bay

Lux M-4000A  
Power Amplifier

Nakamichi High-Com II  
Noise Reduction System

**HANDS-ON REPORT:**  
Furman TX  
Electronic Crossover

**NOTES:** The Fender  
Twin Reverb Amplifier

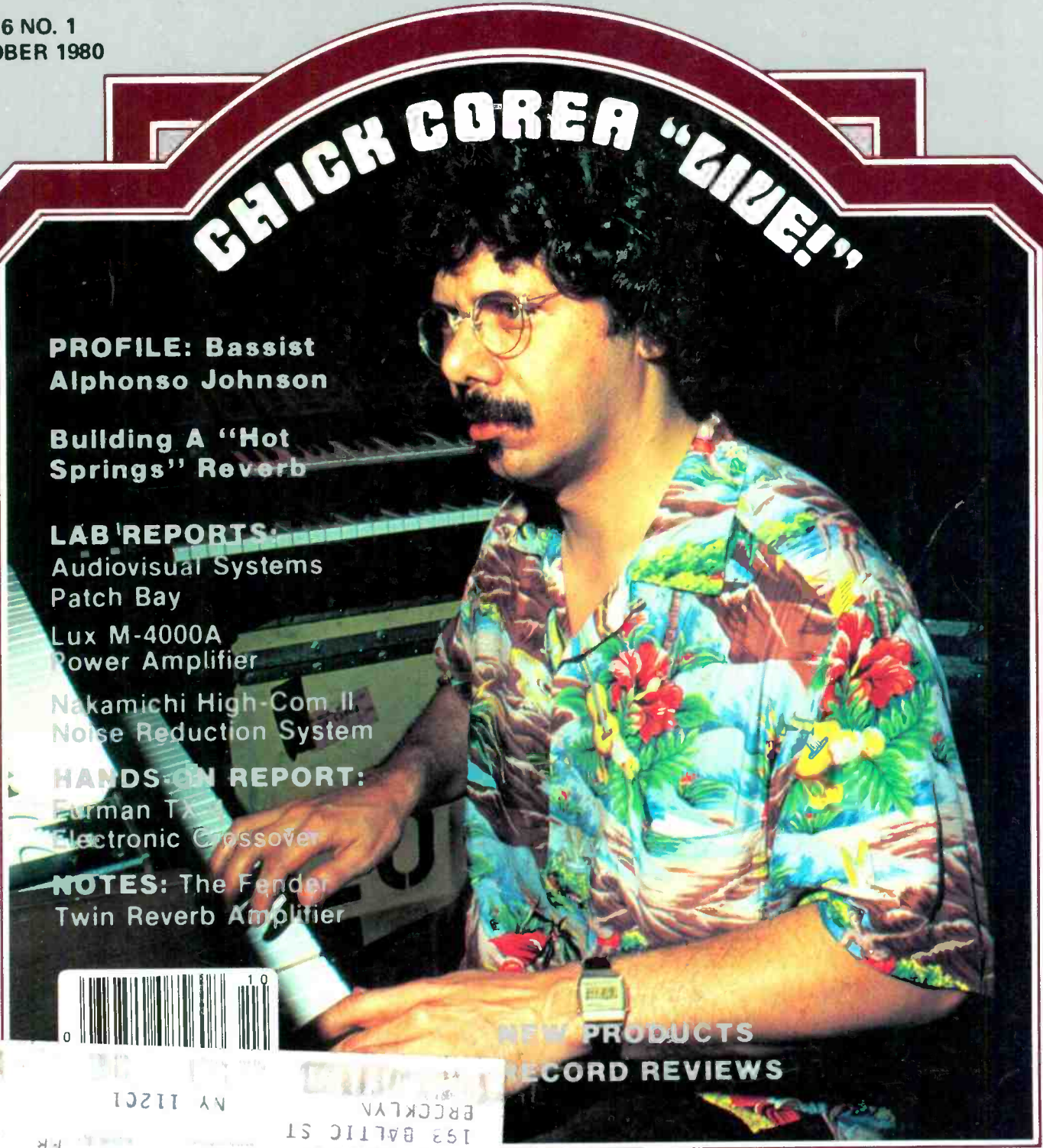

NEW PRODUCTS  
RECORD REVIEWS

APGMD193BAL95  
C. POWERS  
193 BAL TIC ST  
BRCKLYN  
NY 11201  
81/04 10



# How serious are you about a synthesizer?



Even if you don't have an unlimited budget, you still want virtually unlimited expression from your synthesizer. Yamaha knows this. We also know what kinds of features and functions give you this expression. The musicians who evaluated our prototypes told us. And we listened. The result is a new line of affordable synthesizers from Yamaha built especially for live performances. They are capable of many of the sounds of our larger, costlier models, and have all of the quality and reliability.

**CS-40M.** Duophonic, programmable and highly portable describes this top model in the new line. It has four VCO's, two VCF's and two VCA's plus a Ring Modulator, an Attack/Decay EG for the LFO and Ring Modulator, and a unison mode which converts the unit to mono operation by doubling up the VCO's for richer sound. The keyboard has 44 keys.

The CS-40M can store and recall, at the push of a button, up to 20 sounds that you've created, even after the power is shut off. Interface with a tape recorder requires just two patch cords.

**CS-20M.** Up to 8 voices can be stored and recalled in this model. The CS-20M has two VCO's, an LFO, a noise generator, a mixer (for the VCO's and the noise), a 3-way VCF and a VCA. It is a monophonic instrument with a 37-note keyboard.

Both models have keyboard trigger in/out jacks and control voltage in/out jacks for convenient use with a sequencer. Rear panel jacks are provided for ON-OFF foot switching of Sustain and Portamento/ Glissando effects, and for foot-pedal control of the filter and volume.

**CS-15.** This compact, very affordable synthesizer has two VCO's, two VCF's, two VCA's, two EG's and one LFO. One-touch knobs and switches free you from complicated patch work. Sawtooth wave, square wave, white noise, and triangle wave give unique tonal characteristics.

MODEL	KEYS	VCO	VCF	EG	NOTES	DIGITAL MEMORIES
CS-5	37	1	1	1	1	N/A
CS-15	37	2	2	2	1	N/A
CS-20M	37	2	1	2	1	8
CS-40M	44	4	2	2	2	20



**CS-5.** This is our most compact monophonic synthesizer. It has 37 keys, but with the 6-setting Feet selector switch, the instrument's range is extended to a full 8 octaves. A Sample and Hold circuit allows you to automatically play a continuous random pattern. There are many other features that make this model's very affordable price even more attractive.

For more information on the full line, write: Yamaha, Box 6600, Buena Park, CA 90622. (In Canada, write: 135 Milner Ave., Scarb., Ont. M1S 3R1.) Or better yet, visit your Yamaha dealer for a demonstration of the synthesizers that take both your creative desires and your budget considerations seriously.

Because you're serious.



CIRCLE 99 ON READER SERVICE CARD

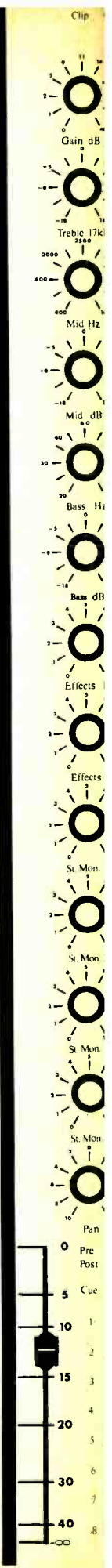
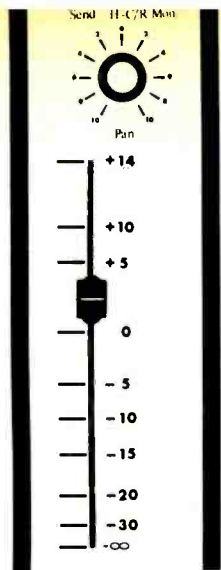
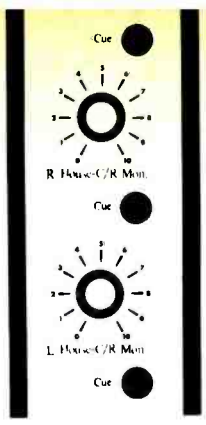
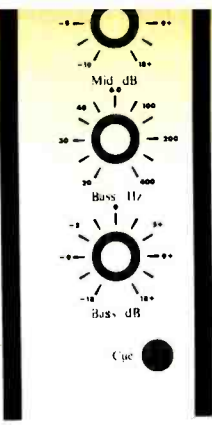

# The Totally Modular Mixer

# Studiomixer

## A Logical Choice

*Totally Modular* is our way of saying something exciting to the recording & sound reinforcement industry. We can finally help every mixing console buyer overcome the greatest obstacles faced in selecting a new console . . . the problems of obsolescence, non-versatility, after sales service, and initial expense. If you are one of those potential buyers, you should read about **Studiomixer** and see if you don't agree that *Totally Modular* is the *Logical Choice*.

To say that we have engineered obsolescence out of the **Studiomixer** is a considerable understatement. Through our *Totally Modular* concept, **Studiomixer** owners are protected from outgrowing their original mixer purchases because **Studiomixers** constantly grow to meet the needs of the group or studio. Let's start at the beginning.

*Totally Modular* means that we have assigned a separate plug-in module for each mixing console function. You can decide what features you want on your mixer . . . and can then *custom* make it at your dealer's *the same day*. For example, if you want a mixer with 6 input channels and two output channels, that is what you get. As you need additional input channels later, you can simply purchase them one at-a-time from your dealer. And, if your requirements change from a two channel output to a four-out (as used with a 4-track tape recorder) configuration, just add two more output channels. And for eight-out, add four more. That's right, our mixer expands both *in and out*. Doesn't this sound logical?

We mentioned versatility. Let's expand on that a bit. **Studiomixer** is designed for recording or sound reinforcement applications. In addition to 2 effects sends, every mixer from 2X2 to larger sizes has *four* independent stage (or studio) monitor sends per input channel, sending to 4 master monitor sends, so you can accomplish a 4-way monitor mix from the console. You can even select either equalized or non eq'd monitor sends, should you desire an outboard eq system. Each mixing console also has a stereo submaster section, making the smallest **Studiomixer** 2X2X4.

With concept engineering this sophisticated, you would expect that our audio performance specifications are excellent . . . and you are correct. We will be glad to provide you with full specifications on your written request.

**Studiomixer** has a breathtakingly low residual output noise level, incredible headroom, and a slew rate so fast that our printed specifications and independent test results will make you check your data book to see if it is current! And no **Studiomixers** leave our factory until they have gone through over 36 hours of gruelling audio and vibration testing.

Forgive us for dwelling (or bragging) on the *Totally Modular* concept, but we feel that the obvious advantages in serviceability should also be pointed out. If anything fails on your mixer, the product can be fixed the same day at any of our dealers. Simply take the mixer to him and he will replace the plug-in module with one from his stock . . . input, output, or any other . . . absolutely free for two full years. Can you remember how long it took you to get your present mixer fixed the last time? You might even be afraid to take it in for service because of the costly time you will lose. Our warranty card gives you our toll-free service number so that we can give you service instructions anywhere in the U.S. in case you're on the road, too. Now stop us if we're not being logical.

We said that our price was right and we meant it. If you have taken note of our features and of the quality we represent, and you have looked at mixers in this class, you are undoubtedly expecting a price tag of \$10,000 to \$15,000 or more. In fact, the only other mixer we know of that expands both *in and out* costs 3 times as much as ours. So what does \$4750 sound like for a 16X8X4X2 mixing console? No, it is not a misprint. \$4750 buys 16 channels in, 8 tape channels out, 4 monitor channels out, 2 effects channels out, and a stereo mix. You also get 15 VU meters to tell you the levels on each of the fourteen output channels and the cue level, a built-in pink noise generator for room equalization, in-out channel patching, 5-way eq per input channel, and a list of additional features too lengthy to print here.

So why not write to us now for a brochure describing how **Studiomixer** works, a list of performance specifications and for the name of your closest dealer for a demonstration. You will probably agree with us that *Totally Modular* is the only logical choice.

For the name of your closest **Studiomixer** dealer, or for descriptive literature and specifications on our products, please write to Craig Bullington, National Sales Manager, Amerimex Co., Inc., PO Box 55, Atwood, California, 92601.

CIRCLE 83 ON READER SERVICE CARD





## Silence. The Step Beyond.

Even more important than what an effect adds to your performance is what it doesn't add. Noise—pops, clicks, and hiss can make a good effect virtually unusable in a performance. That's where BOSS effects are different, and it's a difference you'll notice from the moment you turn them on.

You see, all the different effects on the market share the same noisy problem—they all use the same kind of mechanical footswitch, and no matter who makes it, it still has the same problem—it makes an audible "click." That can be a pain in the studio where you have live mikes, but even worse is that a mechanical switch is prone to make popping noises in the signal when it's engaged, and that's a real problem no matter where you are.

BOSS effects have been designed differently. We incorporate what is called F.E.T. switching. This means that there are no mechanical contacts in the signal system, so it won't make an audible click—and it can't make a pop. The switching is done totally electronically and cleanly.

But that's only the beginning of the beauty of BOSS pedals. You'll find a host of other features the competition has yet to catch up with. Features like battery eliminator jacks on every pedal, skid pads that work, and a unique design that allows you to change the battery without exposing the circuit board. And, back on the subject of silence, you'll find BOSS pedals to be the quietest pedals on the market with signal to noise ratio consistently better than 80 dB.

You'll find a BOSS pedal to fit any need—from phasers to flangers, to equalizers to compressors to the new CE-2 Chorus Ensemble, a compact version of our legendary CE-1.

None of the BOSS pedals make noise. No clicks, no pops, no hiss. And that's pretty important. Cause if you're serious about your music you know that what you leave out is as important as what you put in.

BOSS products are designed and manufactured by Roland, 2401 Saybrook Ave., Los Angeles, CA 90040. (213) 685-5141.

 **BOSS**

CIRCLE 71 ON READER SERVICE CARD

[www.americanradiohistory.com](http://www.americanradiohistory.com)



# MODERN RECORDING & MUSIC

OCTOBER 1980

VOL. 6 NO. 1

## THE FEATURES

### THE TEN COMMANDMENTS OF TAPE RECORDING

By James F. Rupert **32**  
Our own "Moses" Rupert offers some advice from the big studio upstairs.

### BUILDING A "HOT SPRINGS" REVERB **38**

By Craig Anderton  
No, the design doesn't involve Perrier at room temperature, but does result in a spring reverb that offers low cost, high performance and amazingly good sound!

### SPECIAL FIFTH ANNIVERSARY RETROSPECTIVE **50**

On the eve of our sixth publication year, Art Director Bill Travis selects what he feels were our most outstanding issues. We think he did a simply great job of charting our growth in this industry, as reflected on "Cover 1."

### CHICK COREA "LIVE!" **52**

By Jeff Tamarkin  
From his start with jazz greats Woody Shaw and Miles Davis, Chick Corea has proved himself a jazz keyboardist par excellence. Recently, he and soundman Bernie Kirsh discussed their artistry with MR&M.

### PROFILE: BASSIST ALPHONSO JOHNSON **58**

By Steve Caraway  
Woody Herman's early recognition of his talent marked Alphonso Johnson as someone special. His work since then has proved Herman's prediction an accurate one.

#### COMING NEXT ISSUE!

*A Session with Edgar Winter  
The Electric Primer—Part IX  
Plus much more!*

## THE STAPLES

LETTERS TO THE EDITOR **4**

TALKBACK **16**  
The technical Q & A scene.

THE PRODUCT SCENE **24**  
By Norman Eisenberg  
The notable and the new, with a comment on the best digital offering to date.

MUSICAL NEWSICALS **28**  
By Fred Ridder  
New products for the musician.

NOTES **64**  
By Brian Roth  
MR&M looks at the Fender Twin Reverb amplifier.

AMBIENT SOUND **68**  
By Len Feldman  
A look at the past and present of noise reduction.

LAB REPORT **72**  
By Norman Eisenberg  
and Len Feldman  
Audiovisual Systems PB-289G Patch Bay  
Lux M-4000A Power Amplifier  
Nakamichi High-Com II Noise Reduction System

HANDS-ON REPORT **80**  
By Jim Ford and John Murphy  
Furman Sound TX-4 Crossover

GROOVE VIEWS **78**  
Reviews of albums by Spider, Dirk Hamilton, The New York All Stars, Jimmy Rushing, Edith Wilson and PDQ Bach.

ADVERTISER'S INDEX **100**

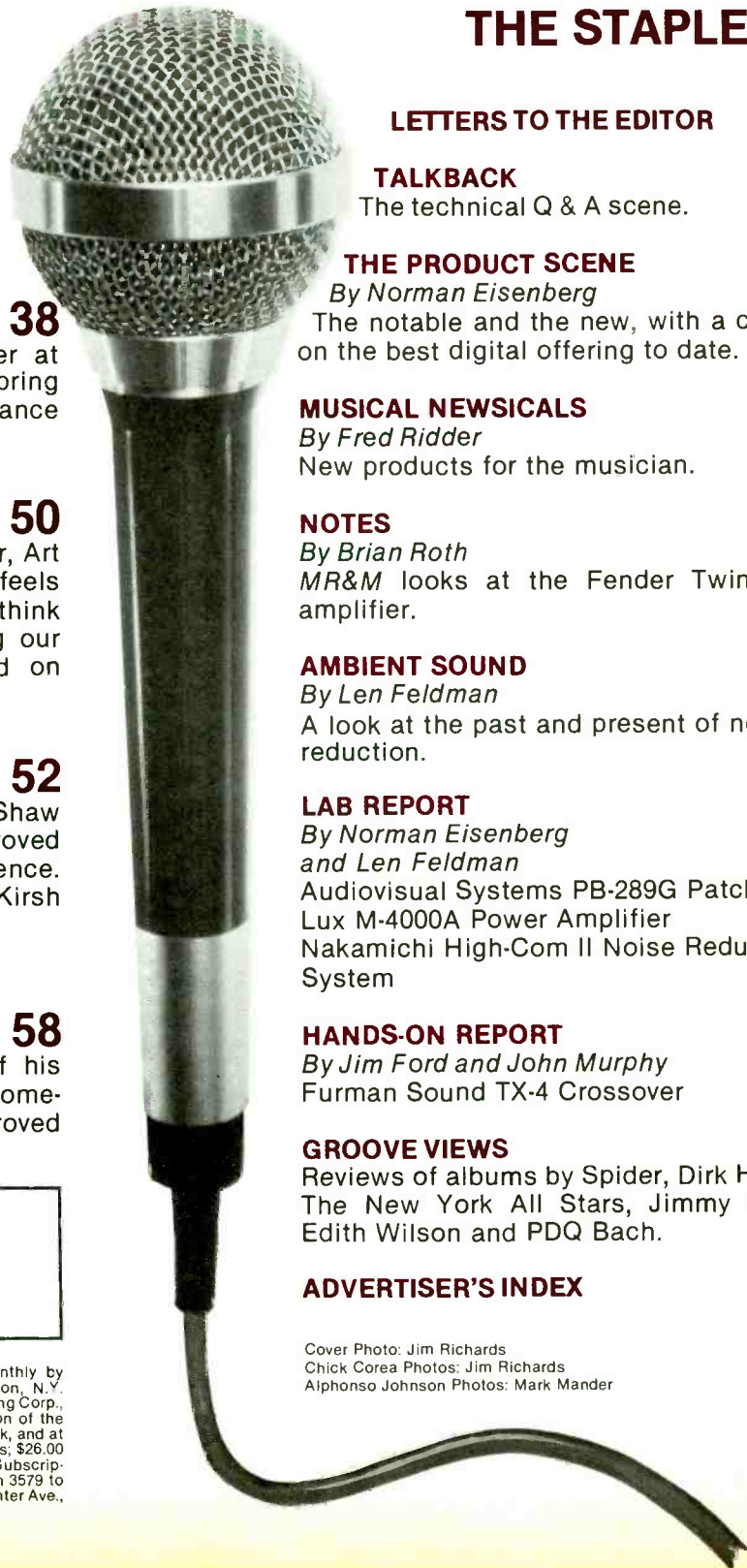

Cover Photo: Jim Richards  
Chick Corea Photos: Jim Richards  
Alphonso Johnson Photos: Mark Mander

Modern Recording & Music (ISSN 0361-0004) is published monthly by Cowan Publishing Corp., 14 Vandeventer Ave., Port Washington, N.Y. 11050. Design and contents are copyright 1980 by Cowan Publishing Corp., and must not be reproduced in any manner except by permission of the publisher. Second class postage paid at Port Washington, New York, and at additional mailing offices. Subscription rates: \$14.00 for 12 issues; \$26.00 for 24 issues. Add \$3.00 per year for subscriptions outside of U.S. Subscriptions must be paid in American currency. Postmaster: Send Form 3579 to Modern Recording & Music, Cowan Publishing Corp., 14 Vandeventer Ave., Port Washington, N.Y. 11050.

**H.G. La TORRE**  
Editor/Publisher

**PAM HIGHTON**  
Managing Editor

**GENE SCARAMELLINO**  
Assistant Editor

**NORMAN EISENBERG**  
**LEONARD FELDMAN**

**JIM FORD**  
**JOHN MURPHY**  
**BRIAN ROTH**  
Technical Editors

**CRAIG ANDERTON**  
**ROBERT ANGUS**  
**NAT HENTOFF**  
**DAVID MOYSSIADIS**  
**FRED RIDDER**  
**PETER WEISS**

Contributing Editors

**MIKE DEREVLANY**  
**ROBERT HENSCHEN**

**JOE KLEE**  
**ALLAN KOZINN**  
**STEVE ROW**

**RUSSELL SHAW**  
**JEFF TAMARKIN**  
Music Reviewers

**LORI RESSA**  
Production Supervisor

**DENISE MAZUR**  
Production Assistant

**BILL TRAVIS**  
Art Director

**KAREN JENSEN-RICHARDS**  
Associate Art Director

**ELIZABETH BAILE**  
Designer

**JANET KURTZ**  
Circulation Manager

**EILEEN NOFI**  
Advertising Assistant

**BILL SLAPIN**  
West Coast  
Advertising Representative

**MYLES GROSSMAN**  
Associate Publisher  
Advertising Director

Editorial and Executive Offices  
Modern Recording & Music  
14 Vanderventer Ave.  
Port Washington, N.Y. 11050  
516-883-5705

Cowan Publishing Corp.: Richard A. Cowan, Chairman of the Board & President; Cary L. Cowan, Vice President; Jack N. Schneider, Vice President, Marketing; Marc L. Gilman, Credit Manager; Amy C. Gilman, Secretary/Treasurer; Sanford R. Cowan, Founder & President Emeritus.

Editorial contributions should be addressed to The Editor, Modern Recording & Music, 14 Vanderventer Ave., Port Washington, N.Y. 11050. Unsolicited manuscripts will be treated with care and must be accompanied by return postage.

# LETTERS TO THE EDITOR

## Delay Without Delay

Receive my congratulations for such a magisterial magazine. About a year ago, I wrote to you asking for advice on P.A. systems. A few months later, you published my letter together with your answer, but that took too much time and I had started to think you had never received my letter.

This time, I have another question to formulate, but I will be very grateful to receive a prompt answer and if later on you want to publish the letter, it will be okay, for I know other persons may have the same questions.

What does a digital delay defer to an analog delay unit? This question seems vague, but my special interest is in their performance quality, for I have been told that the analog type produces a lot of noise when used in P.A. systems and that its reverb quality, flanging, chorusing, etc., are poor, no matter how expensive the unit can be.

By mistake, my father purchased a Yamaha analog delay model E1005 for me in Miami. After testing it, I found it difficult to operate because of its two different effects outputs and its sound quality was rather muddy.

Would you suggest its use in a P.A. system, or would you suggest changing to a Yamaha E1010 or digital delay type unit? Also, would you use a Roland Space-Echo 301 in a P.A. system, or do you think it's noise?

Please, please mail the letter with the answer to the questions as soon as possible. Thank you very much.

—Ian Achong, Jr.  
Caracas, Venezuela

*Something we sorely regret is that we are at an utter loss when it comes to answering readers personally, whether they've sent a stamped and self-addressed envelope, or not. Perhaps it's time to update our past monition: Forgive us when we don't answer you personally. It doesn't mean we didn't get your letter (of course, we wouldn't know if we didn't get a letter from you; we're not Mom) and it doesn't mean we don't care. We do. But we can only ask that you not send stamped envelopes—we will do our best to answer your question, and as speedily as possible, but we cannot answer you individually. We simply haven't the time. True, the request is often for a simple address or the like, but more often it is for answers to questions of this nature—and for that matter, questions regarding product evaluation and choice are things we avoid like the bubonic. But we must admit we always melt when we get a letter from someone across the ocean seas, the language barrier, or from the otherwise exotic.*

*So, here, Ian, a personal reply from John Murphy: We'll post the answer to you immediately.*

For a discussion of the differences between analog and digital delay techniques I suggest you see the "Hands-On Report" titled "An Overview of Echo, Reverberation, and Other Time Delay Effects" in the May 1980 issue of *MR&M*.

You seem concerned about the noise from your analog delay unit (Yamaha E1005). This surprises me because I've observed the Yamaha analog delay units to be very quiet (due, no doubt,



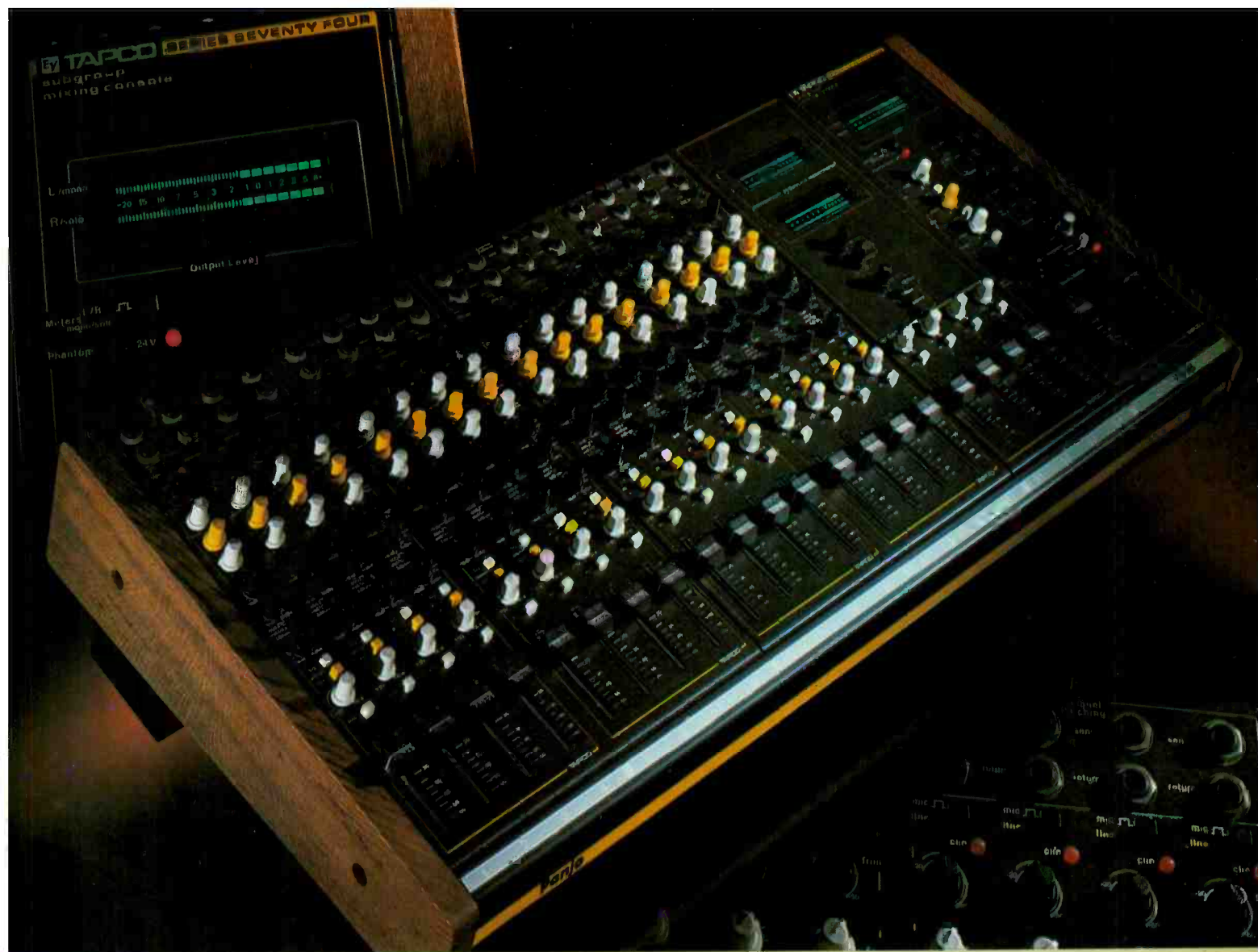

**To sound the best,  
use the best.**

## **TAPCO-leader in Music Electronics.**

We have a reputation for providing the right product, at the right time and at the right price. This reputation began almost a decade ago when TAPCO offered the first affordable full-featured mixer. The reputation continued when TAPCO first introduced the working band and soundman to the benefits of subgroup mixing with the C-12 mixing console.

With the introduction of the new Series 72 and 74 mixing consoles, we have reinforced our position as the leader in the music electronics industry — a position that only comes from being sensitive and responsive to real needs.

You can't go wrong when you use the best. See our full line of mixers, equalizers, reverberation units and amplifiers at your TAPCO dealer.



**TAPCO**  
3810 148th Ave. N.E.  
Redmond, WA 98052  
(206) 883-3510  
TWX/910-449-2594

**In Canada:**  
Gulton Industries, Ltd.  
Box 520, 345 Herbert Street  
Gananoque, Ontario  
Canada K7G 2V1

**In Europe:**  
EVSA  
Romerstrasse 3  
2560 Nidau  
Switzerland

**In Australia:**  
Electro-Voice Australia PTY-LTD  
174 Taren Point Road  
Taren Point, Australia 2229

CIRCLE 77 ON READER SERVICE CARD

to the use of an internal compressor/expander noise reduction system). Indeed, Yamaha specifies the noise for the E1005 as “-80 dB,” which is quite low. Only the best digital delay units can provide this kind of low noise performance. In any event, upgrading from the E1005 to the E1010 would result in somewhat lower noise (“-87 dB”), but either unit should provide good performance in a P.A. system.

—John Murphy  
Physicist/Audio Engineer  
Ford Audio & Acoustics, Inc.  
Oklahoma City, Oklahoma

### Other People's Mail

I have recently had the opportunity to work with two of the finest people in the recording business. Not only professionally but personally also. Jim Rupert and Doug Dickeson gave me a chance to learn and experience a business that's pretty hard to get into (expletive deleted).

This is a fan letter for Doug and Jim, for if it weren't for the two of them I would still be ignorant of the recording world today.

After Jim gave me this job I soon realized that I was a very lucky person. The only things I did know about recording were picked up from your fine magazine. But first hand experience is vastly important. Please print this to show Jim and Doug my appreciation. And also to show other budding recordists that there's always a chance.

—Warren F. Schwindt  
Lincoln, Neb.

*Jim Rupert, in case readers haven't been paying attention, is our writer with a studio base in Nebraska. Jim (also known as James F.) recently wrote of his near-mythic experience of recording Godzilla in Japan. We're not exactly sure who Doug Dickeson is.*

### Request

I just opened a small, commercially run studio outside of Atlanta in Carrollton, Georgia. (Tascam Series.) For my board I have cascaded two model 5Bs. The studio sounds good, but flexibility is worrying me. I know the two model 5Bs are capable of more than

what I have in my head. I would like to hear from other small owners and operators using Tascam equipment.

—Phil Cohey  
Carrollton, Georgia

*Perhaps you could write to TEAC/Tascam, at 7733 Telegraph Rd., Montebello, Ca. 90640, or visit a local professional or Tascam dealer. You may also obtain some information by visiting a sophisticated professional studio in Manhattan, if possible. Let's hear from other small studio owners who could be of assistance with some ideas.*

### When Webster's Just Won't Do

Could you recommend a handbook that would explain studio language—what's used for what? I've done studio work, but I'm sure there's more to become acquainted with.

—Joey Nelson  
Atlanta, Georgia

*Try the Cameo Dictionary of Creative Audio Terms. It's published by: Creative Audio and Music Electronics*



**MODERN RECORDING MODERN RECORDING**

**Sharing our first five years together.**



sound workshop

Sound Workshop Professional Audio Products, Inc.  
1324 Motor Parkway, Hauppauge, New York 11787  
(516) 582-6210 Telex 649230



# If you play guitar...



Suggested List Price: \$550.

## that's not all you can play.

### YOU CAN GET OVER 2000 NEW SOUNDS WITH YOUR GUITAR USING THE NEW KORG X-911 GUITAR SYNTHESIZER

Imagine creating today's incredible synthesizer effects with your guitar. Or turning your guitar into a totally different instrument (for example, a flute, fuzz guitar, electric bass, violin, tuba or trumpet.)

The X-911 Guitar Synthesizer is designed specifically as a *performance* instrument—to enhance, not interfere with your playing style. Just plug in your guitar, (no special pick-ups or drilling required) and with the touch of a button, you can select from a wide range of separately adjustable instrument and synthesizer sounds, or *mix* them together *instantly*.

Even if you thought you could make a guitar do "anything"—with the X-911, you can make it do a whole lot more!

Send \$1.00 for Demo Tape to:  
Unicord 89 FROST STREET, WESTBURY, N.Y. 11590

# KORG

**puts synthesizers within reach.**

CIRCLE 111 ON READER SERVICE CARD

# The augmented cord.

If you think you still have to choose between either a straight cord or a coiled cord, think again. Because now the best of both is wrapped into one... the Constrictor by Whirlwind.

Constrictor's revolutionary, versatile design combines almost two feet of retractile cord (extending up to 10 feet) with an additional 10 feet of basic straight cord. So you have freedom of movement on stage when you need it... and a compact, organized cord when you don't.

Made from rugged, cured neoprene cable by Belden, the Constrictor passes signal quietly, with exceptional fidelity. Like all Whirlwind precision products, the Constrictor is backed by a two-year guarantee.

So when you need a straight cord as much as you need a coiled cord, plug into the Constrictor... the augmented cord.

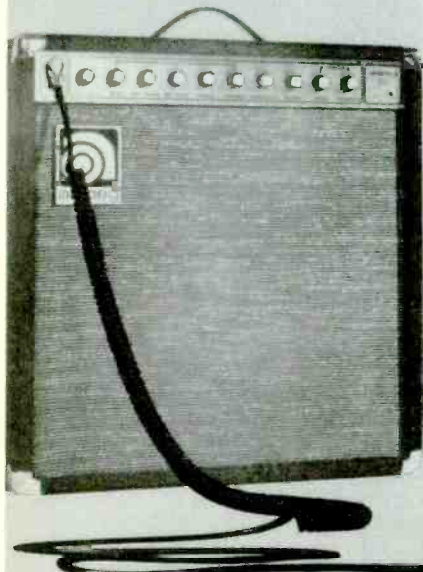

**whirlwind**

Whirlwind Music, Inc.  
P.O. Box 1075  
Rochester, New York 14603  
(716) 663-8820

CIRCLE 110 ON READER SERVICE CARD

Organization, 10 Delmar Avenue, Framingham, Massachusetts, 01701. It's written and edited by Gary Davis and Associates, Topanga, California, and it was published in 1979.

## Not for Sale

I was very interested in the article you published about Journey in April, 1980, particularly the "big paper system" referred to by Kevin Elson on page 54. He said it was manufactured in Canada. Could you print the name of the firm so that I could contact them?

—Kjell Lundstrom  
Tulsa, Oklahoma 74105

*Sandy Einstein of Nightmare Management, who handles Journey, told us that the speaker system you asked about is manufactured by Audio Analysts, 943 Montee de Liesse, St. Laurent, Quebec, Canada, H4T1R2. Their phone number is 514-735-5557, and they said they'd welcome hearing from you. Audio Analysts also mentioned to us that they are one of the only two companies "in the world" who manufacture the S4—the system you referred to. The other is Clair Brothers, P.O. Box 396, Lititz, Pennsylvania 17543. (Phone: 717-733-1211.) Neither manufacturer, though, sells the system. They produce and rent them. Audio Analysts told us that the S4 will next be travelling with Jackson Browne.*

## Hard to Get

I am a professional musician studying electronics. The only projects I have been able to find are geared toward the "hobbyist" except those occasionally published in your magazine. In an article titled "Building a Dual Limiter" by Craig Anderton in the above November, 1979 issue he mentions he has a book called *Electronics Projects For Musicians*. I wish to purchase a copy of this publication, but have been unable to locate it in this area. Can you please supply me with the information I need to acquire a copy? Thank you for your time and consideration in this matter.

—Steven J. Busman  
Guitarist  
Merritt Island, Florida

*We managed to get Craig to reveal his source. (But will your copy arrive in a plain brown wrapper? That is the question.) The publisher of Electronics Pro-*



# SYNERGY

## "On the Road"

### With DeltaLab!

*Sonically Accurate & "Built to Take It"...The DL-2 Acousticcomputer®*

LARRY FAST / SYNERGY  
electronic music production  
box 362 south plainfield, n.j. 07080

June 10, 1980

DeltaLab Research, Inc.  
27 Industrial Avenue  
Chelmsford, MA 01824

I have found my DeltaLab DL-2 to be an excellent sounding and versatile digital delay system. In the growing field of ambience synthesis, the DL-2's range of electronically derived acoustic "environments" has become an important part of my programming of electronic sounds. The wide signal to noise ratio and broad bandwidth have never failed to impress engineers at studios where I have brought the DL-2 as part of my synthesizer equipment.

The unit's rugged design has also made it a valuable part of my road equipment. Months of touring have already been logged without a hint of trouble. If all future DeltaLab products are built to these standards I'm sure that they will also become exciting and useful creative tools.



*Larry Fast*  
Larry Fast/Synergy



**DeltaLab**

**DeltaLab Research, Inc.**

27 Industrial Avenue, Chelmsford, MA 01824 (617) 256-9034 - Telex # 951205

Canadian Distributer: Heini Audio Developments, Inc., Markham, Ontario, Canada (416) 495-0688

CIRCLE 114 ON READER SERVICE CARD

[www.americanradiohistory.com](http://www.americanradiohistory.com)

jects For Musicians is *Music Sales* at 33 West 60th St., N.Y., NY 10013. You can either order it through a store or directly by mail.

### Distinctive Extinction

I have an old receiver (1940's or 1950's) that still kicks. It is a West German Korting Dynamic 1050 with AM, FM, LW, SW, phono and tape capabilities. However, I would like to use the phono and tape inputs, but I don't have the correct plugs. The phono uses two banana type plugs and one other type plug. The tape input is an odd four-pronged Switchcraft-type plug. I am presently at a loss as to where I can obtain these parts. Could you give me some insight as to possible places to find the parts, or supply me with some addresses?

—Joe Summers  
Rockford, Illinois

*We spoke to people at German Hi-Fi, and they think they have the piece you want. First of all, what you describe as*

*a four-pronged plug is, they say, actually a three-pronged plug, the fourth "prong" being a slide guide. They say you need a banana plug, not a DIN plug. (If the receiver were any newer they would have recommended a DIN plug.) If you would like to write to German Hi-Fi, their address is: 1574 Third Avenue, New York, N.Y. 10028. Their phone number is (212) 369-3366. (One good plug deserves another.) Perhaps, too, you could facilitate the process of determining that they actually do have what you need by sending any kind of imprint of the indentation for the plugs—either wax, foil, or a pencilled tracing—to them. (This was their suggestion, not some crazy whim of ours!)*

### Prize Review

The following letter is directed to Jim Farber.

If they gave "Grammy" awards for L.P. reviews, your July issue (1980) Marianne Faithful "Broken English"

review was fantastic. A wonderful piece of word-magic. It deserves a "Grammy." May you have continued success.

—Jess Rand  
Personnel manager  
Beverly Hills, CA

### Johnson & Johnson— Cuts and Bruises

On the cover of the August, 1980 issue of MR&M appears a photograph of the Brothers Johnson. It was brought to our attention that the Brothers, in the photo, are using the A&M Recording Studio A, while the cover story explained that they had actually used Kendun's Studio D for their album, *Light Up the Night*, which was recorded on the A&M label. Well, perhaps you were misled. The studio pictured is A&M's Studio A, and the mixing board they are using in the photograph is a 40 in, 32 out Trident console. Yes, that's it. Unless... those were the Brothers Johnson, weren't they?... yeah, had to be...



The Orban 111B Dual Spring Reverb is ideal for small studios, because it offers the ideal combination of fully professional sound and affordable price: \$799. (suggested list). Orban's unique signal processing, flexible equalization, low noise, and heavy-duty construction make the difference. Unlike cheaper reverbs, the 111B is a reverb you'll want to live with after the honeymoon's over.

Judge for yourself. If you test the 111B the *right* way — in a *real* mixdown situation (*not* listening to the echo return *only*) — you'll find that the 111B's bright, clean sound *complements* the music, instead of muddying it as even higher-priced reverbs can do.

There are cheaper reverbs — with noise, flutter, "twang" sounds on transients, and questionable construction. There are more expensive reverbs — some of which are disappointing in "real world" situations. And there is the proven 111B — the right sound at the right price for the professional on a buç'get.

**orban** Orban Associates Inc., 645 Bryant St., San Francisco, CA 94105 (415) 957-1067

CIRCLE 100 ON READER SERVICE CARD



# "Listening tests confirmed what the excellent measurements implied: the Eumig FL-1000 is a superb performer."

JULIAN HIRSCH—STEREO REVIEW, APRIL 1980

What you are about to read is Julian Hirsch's unedited conclusion in his review of the Eumig FL-1000.

"Listening tests confirmed what the excellent measurements implied: the Eumig FL-1000 is a superb performer. Dubbing from FM or phono discs revealed no audible differences between the original and the copy, and even FM interstation noise—our most severe test—could be recorded and played flawlessly up to levels of approximately -5 dB. The Computest adjustment for different brands of tape was not only accurate but contains a built-in rewind mechanism that returns the tape to the precise point where you began your adjustment. The counter was the most accurate we have ever used. And for people who are "into" computers, the one-of-a-kind (so far) Eumig FL-1000 cassette deck opens up endless possibilities."

We couldn't have said it better. We wouldn't even try. For the complete text of the review, write to us. Or, better yet, visit your nearest Eumig dealer and find out for yourself what it takes to make a reviewer rave

**eumig**<sup>®</sup>

Eumig (JSA) Inc., Lake Success Business Park,  
222 Community Drive, Great Neck,  
New York 11020, (516) 466-6533



CIRCLE 149 ON READER SERVICE CARD



# PATCHWORK PAYS OFF.



When you start working with an 8-track recorder, there's a great temptation to rush out and buy a so-called "8-track" board. Forget it. You don't need the fat price tag. Because what you're really looking for is 8-buss operation.

That's why we've put together a systematic approach to 8-buss

operation built around our new Model 5B. You get control over all your tracks.

Total access to the signal flow. The ability to adapt quickly to each new session. And a rather large savings in cash outlay.



It starts with our new Model 5B. Eight-in/four-out. Expandable to 20x4. Color-coded controls get you where you're going faster, with fewer miscues. And new ICs have been incorporated throughout its circuitry. The slew rate has been improved by a factor of four. The result: better transient response. Tighter, sharper, cleaner sound.



Now add the Model 1. It gives you an independent 8x2 mix anywhere, anytime you need it. During basic tracks and overdubs, it's your monitor mixer. During final mixdown, it's ready for stereo echo. Any time you need another 8x2 mix, it's right there.

Our MB-20 lets you meter any line level signal you want. That's handy when you're using one mic or one instrument per track and driving your 8-track with the Model 5B's direct outputs.



There's also some extra mixing flexibility in the MB-20. You get Buss/Tape selectors and an independent 4x2 monitor mixer.

Holding the system together is our PB-64 patch bay.

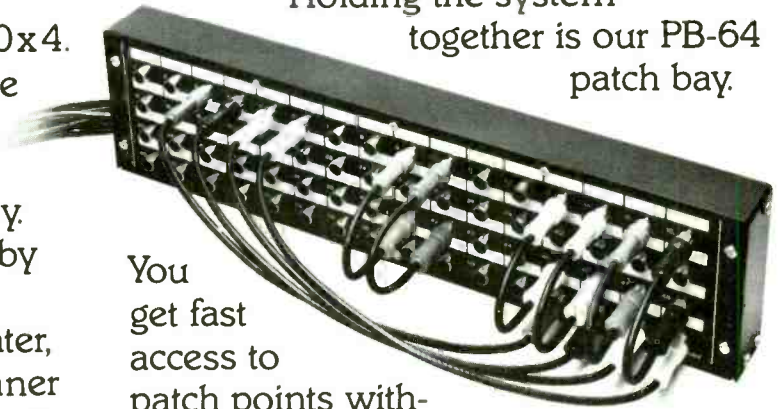

You get fast access to patch points without crawling behind and under your rig. You use jumper cables like push-buttons to route signals. And you don't get trapped into one hard-wired configuration. You can grow, change or completely re-arrange your set-up without throwing out the gear you've already invested in.

That's the Tascam concept of modularity. One that's paid off for recording artists for more than seven years.

See your Tascam Series dealer or write us for a free copy of our operations/hook-up bulletin, "8-Buss Operation With The Model 5." You'll see the functions you need. At a price you can afford. Because patchwork does pay off.

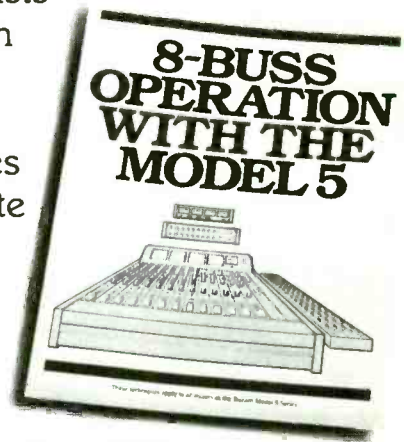

**TASCAM SERIES**  
TEAC Professional Products Group

©1979 TEAC Corporation of America, 7733 Telegraph Road, Montebello, CA 90640.

# TALK BACK

"Talkback" questions are answered by professional engineers, many of whose names you have probably seen listed on the credits of major pop albums. Their techniques are their own and might very well differ from another's. Thus, an answer in "Talkback" is certainly not necessarily the last word.

We welcome all questions on the subject of recording, although the large volume of questions received precludes our being able to answer them all. If you feel that we are skirting any issues, fire a letter off to the editor right away. "Talkback" is the Modern Recording reader's technical forum.

## Phantom Powering a Fantasy No More

*Our request satisfied, our faith in our readers reinforced, we present two additional methods of making the phantom power conversion to a Teac Model 5 board as requested by Ed Perrone in his letter to Talkback which appeared in our June '80 column. (Ed, isn't this response great? Ed, are you listening? Put down the soldering iron, and read this, Ed...)*

—Ed.

Having found ourselves in the situation of needing a portable phantom power supply for condenser mics, our studio has designed, built, and used the following unit with complete success and satisfaction.

The accompanying schematic and parts list are fairly self-explanatory, but a few construction hints will prove to be helpful for first-time builders.

First, in the power supply section: A diode bridge can be substituted for the individual diodes. Just be sure it is rated 24 vdc, 50 piv, 1 amp min. Also, be sure to observe polarities.

Regarding the jack panel: Up to six

inputs and outputs may be used, without any possibility of overloading the power supply. Also, before soldering any resistors to the input jacks, use an ohmmeter to obtain as close a reading as possible for each pair. After they are soldered to the input jacks, connect them both to the buss wire originating at the "plus" side of the power supply.

In order to prevent any ground loops, connect all the #1 pins of the input jacks to the shield buss; but, connect the #1 pin of the first output jack only, to the shield buss. (See note 1 on the schematic.) The remaining output jacks will have their shields carried through at the mixer.

As for enclosing the project, I mounted all the power supply components except the transformer onto a PC board, and hand wired them. A small metal shield should be placed around the transformer, as to eliminate any 60 cycle hum pick up. The jacks

were all mounted on the removable top cover of a metal box measuring 12"L x 5½"W x 4½"D. The on/off switch and pilot light were also mounted on the cover of the box.

Before plugging in any mics, make sure to test the unit by inserting the probes of a DC voltmeter into pins/holes 2 and 3 of each jack. You should obtain a 24 vdc reading.

If any problems are encountered locating parts or building the project itself, help is but a phone call away at (502) 968-8757.

Good luck and happy powering.

—Carl Sandler

Sunshine Sound Recording Studio  
Louisville, Ky.

We found modifying a Teac Model 5 console to power low-voltage microphones to be very easy. Here's what worked successfully for us:

Buy sixteen resistors, 3000 ohm 1/4

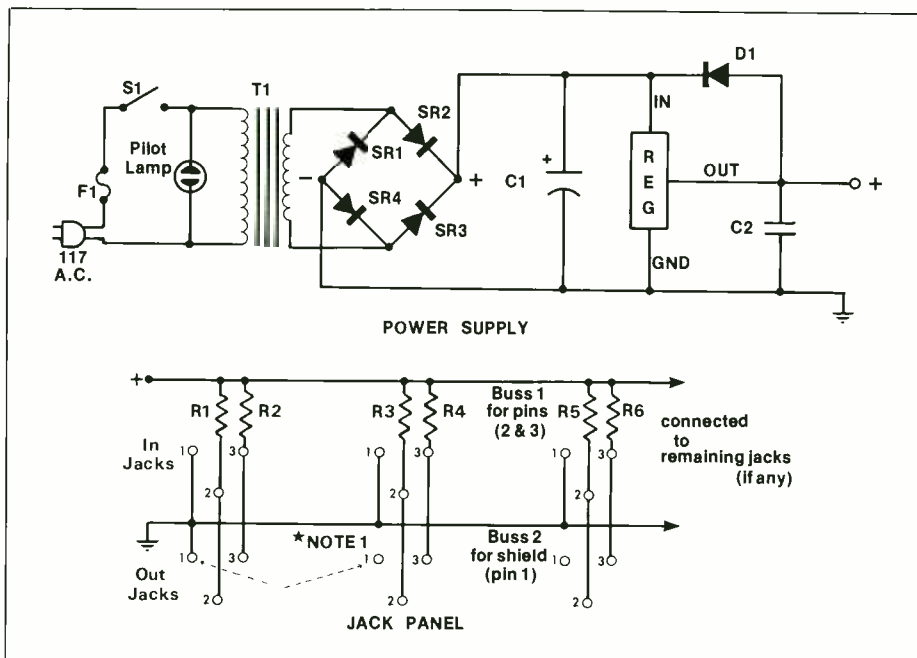

\*Note 1: Connect buss 2 to jack 1 only on output side to prevent ground loops.



#### Power Supply Parts:

F1 - Fuse, ½ amp  
S1 - Switch on/off  
Neon pilot light  
T1 Power transformer (Triad # F-117X)  
117 vac pri. 24 vdc C.T. 400 ma  
SR1—SR4 - 24 vdc 50 piv 1 amp  
C1 - Electrolytic 1000 mfd 50 vdc  
REG - 24 vdc (Motorola part # 7925)  
C2 - .1 mfd ceramic disc 50 vdc  
D1 - IN4001

#### Jack Panel Parts:

Input jacks - Switchcraft D3F  
Output jacks - Switchcraft D3M  
R1—R6 - 1500 ohm ¼ watt 10%  
Solid buss wire

watt 1% (2700 ohm 5% will do in a pinch).

Turn the mixer around and remove the screws holding the back panel on. The panel will be restrained by the wiring but you can tilt it out enough to work on it (be gentle with the wiring).

Solder one end of one resistor to each pin number two of each mic input connector. Solder one end of another resistor to each pin number three of each mic input connector. Solder the free ends of the pair of resistors on each connector together. You have now created the equivalent of a 1500 ohm resistor connected to the center tap of the mic input transformer.

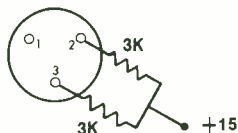

With hook up wire, connect each "center tap" to the next and run a wire from the end of the string to the power supply unit or a point on the motherboard where the regulated +15 V power is available.

I've found AKG C-451E mics to be excellent companions for my Model 5. Their extra-hot output overcomes the input noise of the console in distant miking of acoustical instruments and classical ensembles. With dbx on my recorder I've been able to make really nice, really *quiet* classical recordings with 451's and my Model 5.

—Dan Dugan

Dan Dugan Sound Design  
San Francisco, Ca.

## If we'd introduced the new ARP8 Performance Series Mixer five years ago, you probably couldn't have afforded it.



## Today you probably can.

It's strange, but true. The more sophisticated technology becomes, the cheaper it gets. That's why ARP can now introduce a better mixer at, believe it or not, a better price.

The ARP8 Performance Series Mixer is designed for professional musicians. It has all the live-performance features you need to make your music sound the way you want, no matter where you play. Built-in analog delay for the echo effect you want. 3-bands of equalizers on each channel for a

balanced sound from each instrument. Two 7-band equalizers — one stereo for program left and right, one mono for the monitor submix — for the balance you like among all the instruments you play.

All for a price that's more than up-to-date. About two-thirds what you'd pay for a competitor's comparable mixer.

You can try out the new ARP8 Performance Series Mixer now at selected ARP dealers.

For further information and the names of selected ARP Mixer dealers in your area, write:



ARP Mixer  
45 Hartwell Avenue  
Lexington, MA 02173  
Or call:  
(617) 861-6000

© 1980 ARP Instruments, Inc.

CIRCLE 143 ON READER SERVICE CARD

## Rounding Out Your Recordings

I've got a simple, 4-channel; set up (a Teac 3440 and a Teac Model 2 mixer) which I use primarily to do vocal work. The problem is that my recordings sound flat because I use close-miking techniques and therefore lose the natural sound of the room. The flat sound is okay for me, because I'm concentrating more on the music I'm recording, but to others the recording sounds amateurish because it sounds unnatural. Overdubbing doesn't help—it only sounds like more voices in a flat room.

I've been thinking of adding some artificial reverb. You've had some excellent articles on reverb, as well as some reports on reverb units, but I need to know where the budget-minded guy fits in. Is there hope for the little guy who would like a good quality reverb? (I would like to be able to use it on an unaccompanied, solo voice but can't afford more than \$1,000 and would prefer something under \$700.) My budget is tight but I won't tolerate something that sounds like the inside of an electronic bucket. In my price range, are

spring reverbs more likely to be found than digitals? Can you "fix" a cheap reverb with EQ?

—Gary M. Ericson  
Sunnyvale, Ca.

*We have always advocated doing it right from the start, not trying to fix it in the mix. Effects such as echo, reverb, etc., should be viewed as additions to your music to be made for their own sake or artistic merit, not as means of fixing a poor recording. Since the music you are recording is so important to you, we are a bit perplexed by your seeming acceptance of an inferior recording, unless you are making them purely for reference purposes. The type of music you are recording must effect the miking techniques you use. We are not saying, however, that your close-miking techniques are at fault here. This method is, in fact, the technique used by the majority of professional recording engineers, especially in rock music, where leakage is a problem. We do suggest that you consider the addition of a room or ambience*

*mic to your present set up. By mixing this track in with your others, you will achieve a more natural sounding recording without sacrificing any of the "close up" quality that you desire.*

*To find out exactly where the "budget minded guy" fits in on the special effects scene, we perused the "Echo, Reverb and Delay" category of our 1980 Buyer's Guide, and found quite a sampling of reverb devices that are within your monetary guidelines. We suggest that you do the same: acquire a copy by any means (as long as they're nice and they're legal) possible and select some models that fit your specifications. Then turn to your local audio dealers for their feedback. Based on what you tell them and their past experience with various manufacturers, they will be able to help you narrow your list to the most suitable pieces.*

*You will find in the course of your research that spring reverbs are more prevalent in your price range than the more sophisticated digital models. In fact, since you are considering the pur-*

# Soundcraftsmen

## GUARANTEED SPECS and FEATURES

The 750 watts at 8-ohms output of the RA7501 is rated 20-20KHz at less than 0.09% THD in the bridged mono mode, 375 w/p/c at 4-ohms and 250 w/p/c at 8-ohms in the dual-channel mode. While all performance data is at the STATE-OF-THE-ART level, the new Amp's physical construction was specifically designed to enable its use by TOURING GROUPS or PROFESSIONALS under EXTREMELY ADVERSE conditions. A new "RUGGEDIZED" chassis utilizes a 16-gauge steel main-frame structure, with MODULARIZED construction throughout for EASY ACCESS to all component parts. STEREO or MONO operation are rear-panel selectable, with either BALANCED or UNBALANCED inputs.

Specifications: • THD <0.02% • SLEW RATE >50 • IM <0.05% • DYNAMIC HEADROOM measured >2dB • Signal-to-noise >105dB • Damping >150. The CLASS "H" circuitry features LOW OPERATION WATTAGES for ENERGY CONSERVATION and to allow use WITHOUT A FAN under all normal operating conditions. A completely new PATENT-PENDING AUTO-BUFFER electronic switching circuit has been designed to provide automatic internal electronic compensation to allow CONTINUOUS 2-OHM OPERATION without actuating any of the protective circuitry. PROTECTIVE CIRCUITRY IS FOUR-WAY. Short circuit protection is provided by an exclusive-design dual-purpose AUTO-CROWBAR circuit with AUTOMATIC RE-SET and front-panel LED indicator, also provided is Thermal sensing with AUTOMATIC RE-SET and front-panel indicator, as well as EXTERNAL FUSING protection.

The new Amp uses 1/2 inch PHONE JACK INPUTS for BALANCED or UNBALANCED operation in EITHER the STEREO or BRIDGED MONO mode. Outputs are 5-way binding post (banana plug) type. Front panel includes a SEPARATE LEVEL CONTROL for each channel as well as fast-attack LED CLIPPING INDICATORS and a DELAY TURN-ON power switch. The 1/2 inch aluminum front panel is 19 inch rack mountable, and the massive handles are bolted through the front panel into the 16-gauge steel main-frame. An individually serialized Lab-measured TEST DATA CERTIFICATE is provided with each unit showing LAB MEASUREMENTS of that unit and signed by the Final Inspector. Size is 7 in. x 19 in. x 15 in. deep, weight is 56 lbs.

OUR NEW CLASS "H" PRO AMPLIFIER IS A REAL WORK-HORSE, WITH ONE FULL HORSEPOWER OUTPUT (750 WATTS) @ 8 OHMS, <0.09% THD 20Hz-20KHz, IN BRIDGED MONO MODE. \$799.00



Made in U.S.A. by SOUNDCRAFTSMEN • Santa Ana, CA 92705 • CANADA, E.S. GOULD LTD. • Montreal, Quebec, H4T 1S9

FREE!! circle READER CARD # for 16-page FULL-COLOR BROCHURE

CIRCLE 130 ON READER SERVICE CARD



# IF THERE'S A MAXELL CASSETTE IN THIS CAR AND IT DOESN'T WORK, WE'LL REPLACE IT.

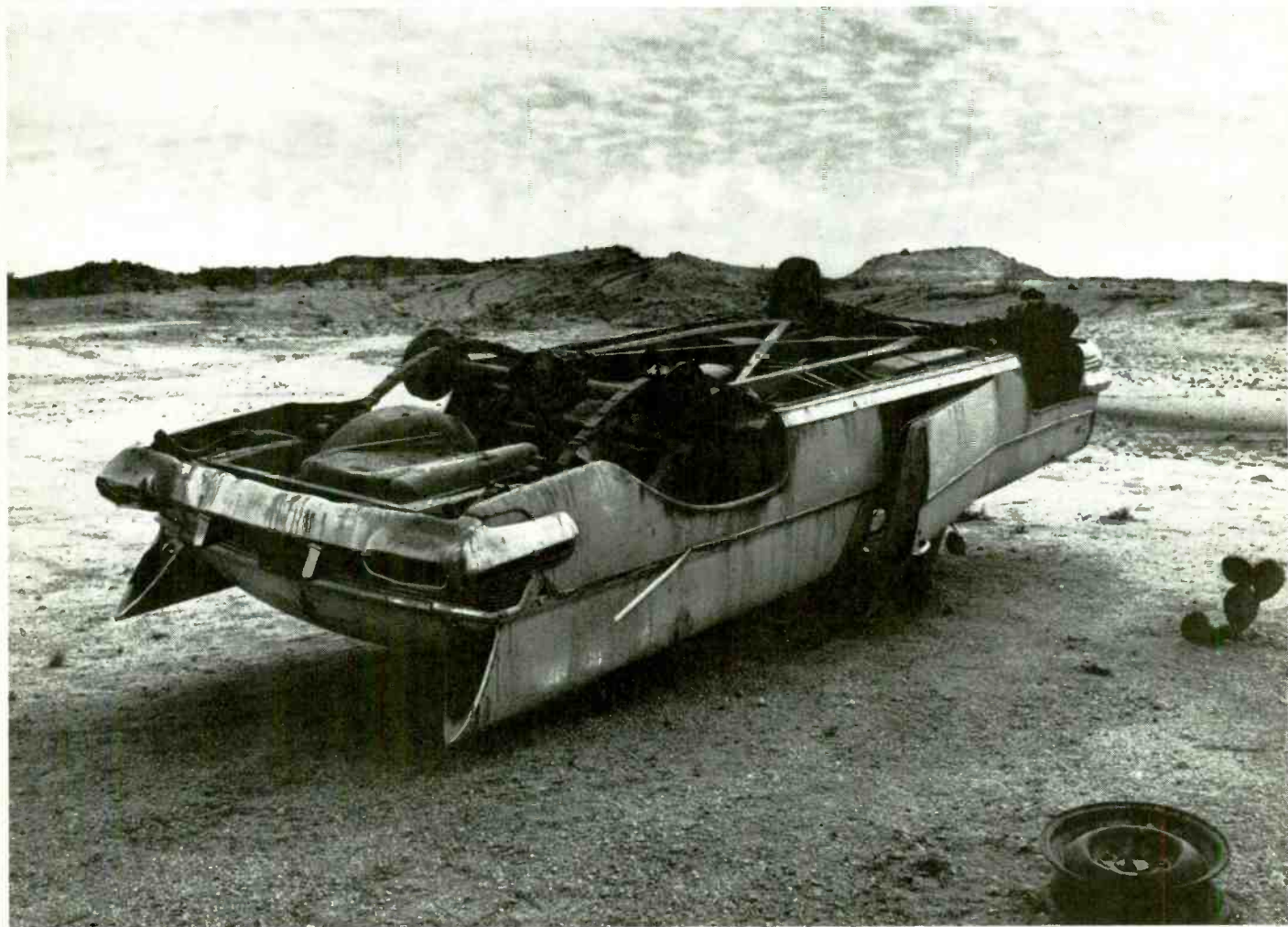

If you own a car stereo, you've probably already discovered that many cassette tapes don't last as long in your car as they do in your living room.

Conditions like heat, cold, humidity, and even potholes can contribute to a cassette's premature demise.

At Maxell, our cassette shells are built to standards that are as much as 60% higher than the industry calls for. Which is why we can offer you the best guarantee in the industry. An unconditional lifetime warranty.

So if you'd like better mileage out of your cassette tape, try Maxell. Even after 100,000 miles on the road, it'll run like new.

If only they made cars this well.



## IT'S WORTH IT.



## ASHLY HAS A LIMITER FOR YOU



For loudness enhancement, clipping prevention, speaker protection, control of vocal levels, elimination of overmodulation, musical instrument sustain . . . Whatever your limiter application, check out the Ashly SC-50 (mono) or SC-55 (stereo) Peak Limiter-Compressors. You'll find incredible versatility, super packaging, and state-of-the-art design. You'll be amazed at the freedom from noise and distortion and the clean, transparent sound. Features like balanced inputs, stereo-tie connections, detector patch point, and high-current output stage are all standard. All this at a cost low enough to embarrass a lot of high-priced competition. Ashly limiters . . . clean, quiet, powerful control designed and built by people who still care about quality and reliability.

For more information see your Ashly dealer or  
Call or write:

**ASHLY** Ashly Audio Inc.  
Customer Service  
100 Fernwood Ave. • Rochester, N.Y. 14621  
(716) 544-5191 • Toll Free (800) 828-6308 (except N.Y.S.)

CIRCLE 84 ON READER SERVICE CARD

chase of a spring, you might want to flip to page 38 of this issue and read Craig Anderton's "build it yourself" article: "Hot Springs" reverb. If you are up to this sort of project, Craig's innovative design should be the answer to your problems, both artistic and financial.

We got in touch with Craig to answer your last question and he informed us that EQ cannot be used to fix a poor reverb, but it certainly can enhance a good one. He went on to recommend that whether you build the "Hot Springs" or purchase another reverb, and bring it in under your limit, you should seriously consider the purchase of a delay line. Craig tells us that the professionals put them in line before the reverb for a 50-100 ms delay and that this technique can really snap up your recordings.

Whatever method you try to improve your recordings, it all goes to prove our original assessment: there is no right or wrong in this business, just room for constant growth.

### Hum . . . Click . . . Pop

**Congratulations on a fine publication.** I am an amateur songwriter and I record my own demos at home on a basic 4-track set-up. Can you give me any ideas on how to effectively shield the electronics of my 1979 Fender Strat? I am experiencing a lot of hum, clicks and pops that are unacceptable for quality demos. I have no incandescent lights nor am I near any overhead power lines or other sources of interference. The electrical system in my home is well-grounded to a cold water pipe and my guitar amp has a three-prong outlet plug. Any suggestions on how to get rid of this noise will be appreciated.

—Lee S. Martel  
Whittier, Ca.

The problem you describe is known as EMI, or electromagnetic interference. Basically, EMI is unwanted interference from electromagnetic energy. It is present even in remote areas, but your Southern California home studio is in one of the world's worst locations in terms of high ambient EMI levels.

This problem is compounded by the fact that a guitar pickup is essentially an antenna for the electromagnetic energy transmitted by a vibrating magnetized guitar string. Since a guitar pickup cannot distinguish between wanted or unwanted electromag-

**We asked:  
Are  
Noise Gates  
Obsolete?**

**You answered:  
Yes.**

To the thousands of people who have purchased or heard our Noise Fader the difference is like night and day. To date no one has claimed that any noise gate can meet, let alone better the performance of our Noise Fader.

Those of you who have noise problems (and who doesn't?) will also love our low noise FET Pre-amp, which has a small fraction of the noise of other floor-box pre-amps. You will really hear your instrument for the first time.



**CARROTRON**  
2934 Shasta Road  
Berkeley, California 94708  
Dealer & CEM inquiries invited

CIRCLE 108 ON READER SERVICE CARD



# UNEQUALIZED RESPONSE

The state-of-the-art in compression drivers has reached a new high.

**Pure Beryllium Diaphragms** and surrounds that are extremely lightweight and rigid result in unsurpassed high frequency response and sensitivity. They are bonded to edgewound voice coils capable of withstanding temperatures of up to 400° C (752° F).

Computer-Aided Design and Laser Holographic Analysis have provided the flattest response and phase uniformity, giving the TD-4001 unprecedented intelligibility.

**Precision Machining and Assembly** of the highest quality materials result in dependable, predictable performance.

The TD-4001 driver meets the requirements of the uncompromising professional. For additional information, contact:

**TAD** Technical Audio Devices

A division of U.S. Pioneer Electronics Corp.  
142 Redneck Ave., Moonachie, N.J. 07074  
(201) 440-8234 - Telex: 133484 PIONERUSA MOON

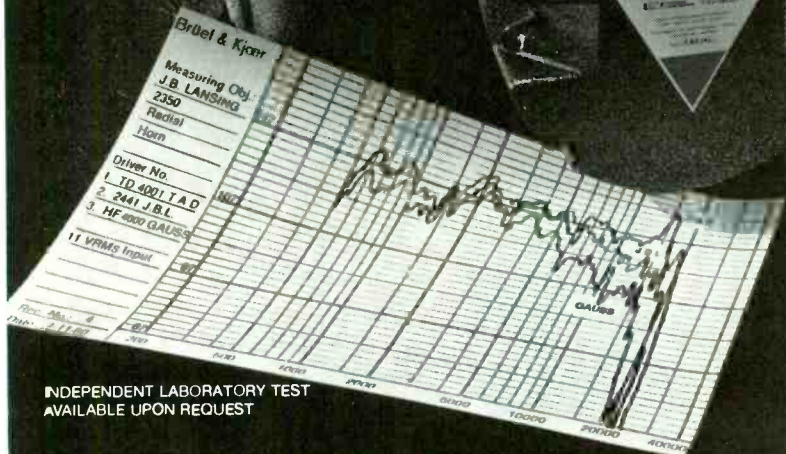

CIRCLE 93 ON READER SERVICE CARD

netic energy, the result is that both your music and too much noise end up on your tapes. Fortunately, there are several things you can do to improve matters.

Since guitar pickups are directional in nature, experiment with your physical location in your studio. Often a simple relocation of a guitarist's chair can make a significant difference in noise levels. You may discover that your guitar amplifier or even your own recording and playback equipment are strong EMI emitters.

Don't be afraid to equalize to eliminate hum. EMI at 60 Hz can be significantly reduced by judicious use of a third-octave or parametric equalizer. Since the lowest fundamental normally produced by a guitar is E - 82.407 Hz, the need for sharp rolloff attenuation should be obvious.

Try recording at odd hours. Much EMI is generated by industrial sources, and urban areas become electromagnetically "quieter" after dark. It's no surprise that the midnight to six a.m. hours are so heavily booked in major studios; superior recordings can

be made during these hours due to reduced EMI levels.

If all else fails, shield your guitar's circuit. Shielding merely reflects EMI emissions away from your instrument, or absorbs some frequencies and channels these to ground. Don't expect a shielded guitar to completely reject EMI; to do so, it would also have to reject its own musical signals. Any competent repair shop will shield your Strat, or a do-it-yourself kit is available from Stars Guitars, 818 Folsom Street, San Francisco, CA 94107.

—Gregg Wilson

Manager, Guitar Design  
Research & Development  
Fender Musical Instruments

## A "Smear Proof" Scheme

I have an old speaker cabinet that I wish to remodel with four small piezo-electric disco tweeters (each rated at 50 watts) to use with my Kenwood KA-600, which is rated at 50 watts per channel.

My plan is to put the four tweeters in that single cabinet: two tweeters for

the right channel, two tweeters for the left channel. They will be hooked up to the "B" terminals of the amp. I'll hook up my regular speakers to the "A" terminals so when the equipment is being used, the speakers will work simultaneously in the A + B position. However, I need to know how to actually hook the tweeters up in the cabinet and in the amp. Would I use a 70-volt distribution line, or a 2-way crossover each for the two tweeters?

—Thomas W. Faulkner  
New York, N.Y.

If you put both channels of tweeters in one box, as in a center channel, you may "smear" the stereo image. A separate box for each channel with tweeters at 15° angles for better dispersion might be better. Some older transistor amplifiers put the A and B sets of speakers in series, the Kenwood KA-600 may be one of them, and the tweeters should be wired in parallel.

While the piezo tweeter can operate without damage without a crossover, there is less distortion when one is used. A 70 volt distribution line is not



# mix and patch like the professionals

Russound's QT-1 control center and patchbay accommodates up to four tape recorders of mono, stereo or four-channel, plus noise reduction, equalizers, compressor/limiters and other signal processing. Connect all to phono jacks on rear panel (72 available) and switch and program them from the front panel.

Record, monitor, playback, mixdown and make dupes at the flip of a switch. Patch cords (12 furnished, extras available) permit convenient sound-on-sound, overdubs, channel interchanging, and insertion of equalization and noise reduction anywhere in the component chain.

QT-1 delivers studio quality and flexibility at an audiophile price of \$289.95 and is available in either cabinet version shown or rack mount. For complete information and list of demonstrating dealers, contact Russound/FMP, Inc., Box 2369, Woburn, Massachusetts 01888 (617) 935-3625.

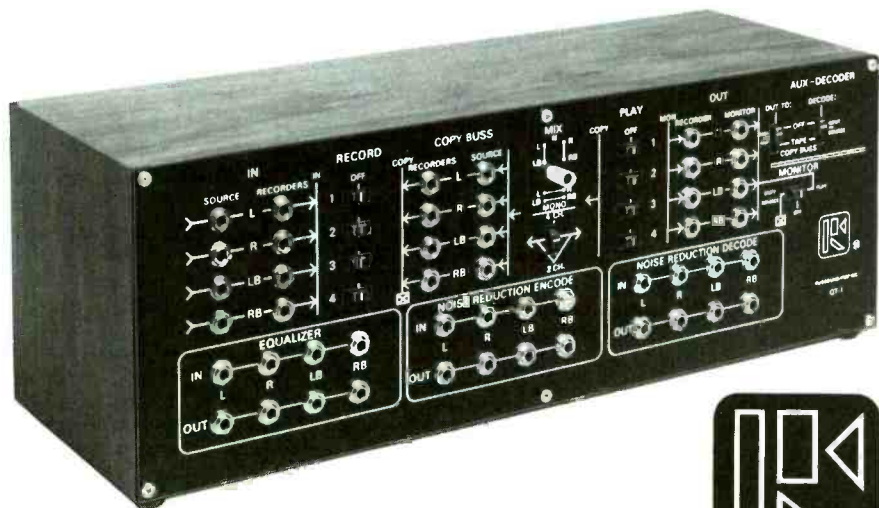

Russound/FMP, Inc.  
Box 2369  
Woburn, Massachusetts 01888

CIRCLE 152 ON READER SERVICE CARD

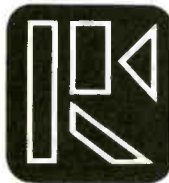

appropriate here.

For a 5000 kHz crossover, the following schematic from Motorola's application notes are suggested:

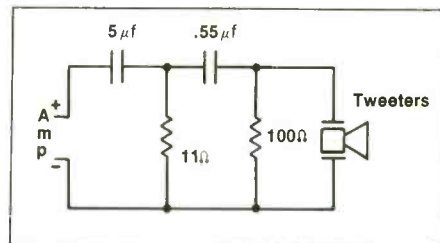

By wiring two tweeters in parallel, output is increased 3 dB over a single tweeter. If the two tweeters are wired in series, output is decreased 3 dB from a single tweeter (6 dB from paralleled tweeters).

—Mike Klasco

Director, Research and Development  
Integrated Sound Systems, Inc.  
Long Island City, N.Y.

## Speaker Design Dilemma

I have become very interested in speaker design for hi-fi and pro sound use, and have come across a design problem that I cannot solve.

Most raw drivers have a sensitivity specified (i.e., 90 dB SPL 1 watt at 1 meter). What will happen when this driver is in a bass reflex or acoustic suspension enclosure? Will sensitivity rise or fall or stay the same? What if two or more drivers are installed in the same cabinet? If the low-frequency SPL increases, what will happen to the midrange—will it increase as the lows increase? Any—and I do mean *any*—information on this subject will be appreciated!

—Dan Wilczek  
Auburn, N.Y.

A speaker driver's sensitivity is measured by placing the speaker in either a large flat baffle or a large enclosure (10 cu. ft.) in a free space and measuring the maximum on-axis sound pressure level at 1 meter at 1 watt. Tuning an enclosure (bass reflex) generally goes not change the sensitivity of the speaker but reinforces the low frequencies for a wider bandwidth. If one tuned the enclosure to the maximum sensitivity point, then the sensitivity would increase but this would give a very peaky response which is generally undesirable for hi-fi use.

Placing two speakers in a box has the same effect as placing one speaker

**OCT. 30 IS AUDIO RECORDING CONFERENCE III DON'T MISS IT!**

BUSINESS PERSPECTIVE / 10 AM - 1 PM  
STUDIO MARKETING TECHNIQUES  
TECHNICAL PERSPECTIVE / 2 - 5 PM  
DOWNTIME / THE INVISIBLE THIEF  
ENGINEERING PERSPECTIVE / 7 - 10 PM  
UNVEILING THE SPARS STUDY OF RECOMMENDED AUDIO RECORDING PRACTICES

**SPARS**  
SOCIETY OF PROFESSIONAL  
AUDIO RECORDING STUDIOS

for reservations & further information write or call  
**(215) 735-9666**

CONFERENCE TO TAKE PLACE IN  
NEW YORK CITY AT THE DORAL INN  
\$150 full conference or \$75 seminar.  
Students & faculty \$75 full conference  
Door registration \$10 additional.

WRITE FOR INFORMATION TO SPARS  
215 S. Broad Street, 7th Floor  
Philadelphia, PA 19107

CIRCLE 151 ON READER SERVICE CARD



# UNEQUALED PERFORMANCE

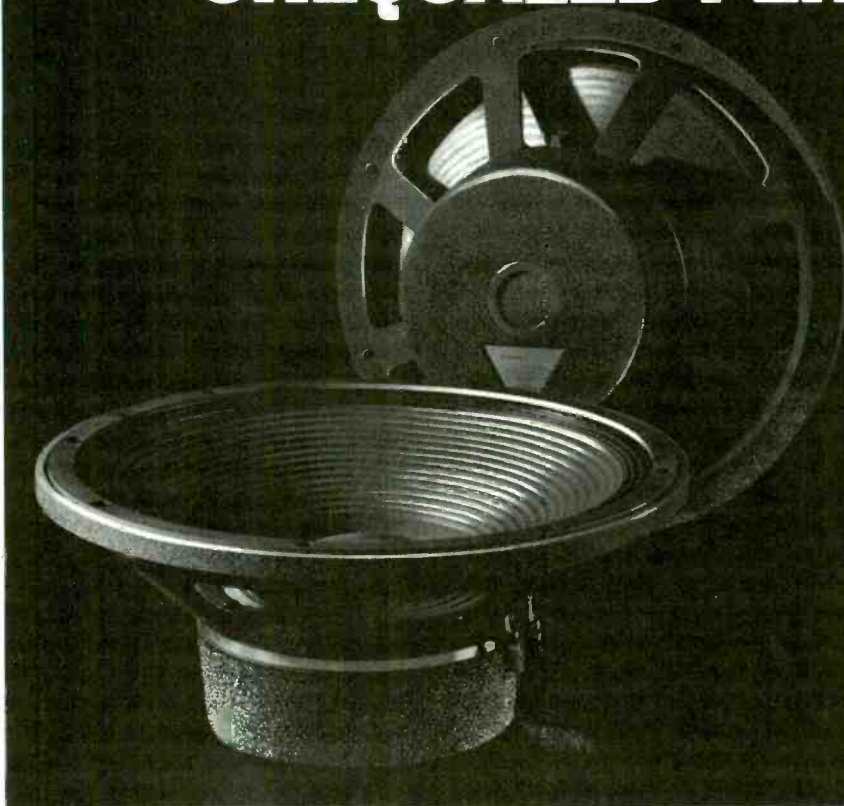

**Powerful Alnico Ring Magnets;** select high purity materials and precise machining tolerances produce the strong linear fields necessary for demanding applications.

**Computer-Aided Design and Laser Holographic Analysis** enabled the production of true linear piston motion assuring low distortion and controlled response. The resulting sound is smooth and uncolored at levels in excess of 120dB at one meter.

**High Power Voice Coils** edgewound on four inch heat resistant glass fiber bobbins assure long-term dependability.

Model TL-1601 is recommended where high level, low frequency sound is required.

Model TL-1602 offers a carbon fiber blended cone and a wide 21 to 2000Hz bandwidth.

The TAD 15 INCH loudspeaker meets the requirements of the uncompromising professional. For additional information, contact:

**TAD Technical Audio Devices**

A division of U.S. Pioneer Electronics Corp.  
142 Redneck Ave., Moonachie, N.J. 07074  
(201) 440-8234 - Telex: 133484 PIONERUSA MOCN

CIRCLE 93 ON READER SERVICE CARD

in a box with one half the volume. That's if both speakers have the same characteristics. The smaller effective volume will raise the resonance frequency of the speaker which has the effect of rolling off the low frequencies sooner. If the box is very large, then the frequency effect will be small. For a more definitive analysis of speaker and enclosure performance, you should read A.N. Thiele's "Loudspeakers in Vented Boxes," Journal of the Audio Engineering Society, Part I, Volume 19, May 1971, Pages 382-391 and Part II, Volume 19, June 1971, Pages 471-483.

—John Meyer  
President  
Meyer Sound Laboratories  
San Leandro, Ca.

## Frankly Speaking

My question concerns the concept of "0 dB." I've acquired all sorts of information (much of it from *MR&M*) regarding dBm, dBV, +4 dBm, 1.25 volts, etc., but still do not know how to adjust for it on my board for accuracy. To

be quite frank, I'm not even sure what difference it would make because my amps need 1.75 volts +2%. Does this linear need become 0 dB? Do I need to back up and learn something? Just what exactly does 0 dB have to do with accurate metering and proper adjustments?

—Kenny Flame  
Lake Charles, La.

*May we speak frankly, Kenny? You've really opened a theoretical can of worms here, and we simply don't have the space in this column to untangle the little buggers. However, Peter Weiss, never one to quibble about pages, has tackled just this topic in Part IX of "The Electric Primer," so our suggestion is that you bite the educational bullet just one more time and we are quite sure Peter will once and for all answer your questions on ratio, levels, measurements, etc.*

## On the Lookout for Outputs

I have seen combined echo/reverb units. I would like one with at least two

outputs for stereo work; the ones I have seen have only one output. A local vendor has told me that is all they make, but I find that rather hard to believe. Any light you could shed on this subject would be appreciated.

Steve Lloyd  
Syracuse, N.Y.

*Although your question is a bit too vague to answer in great detail, we will attempt to give you some vague reassurance! We're assuming that by "combined echo/reverb units" you're referring to a tape loop/spring reverb unit. If we are right in this interpretation, we will go even further and state that these units are available with more than one, or "stereo," outputs. A word of warning at this juncture: these outputs do not always work in a "stereo" fashion, so don't let a multi-output unit deceive you. It still might not suit your purposes. A sensible course of action would be to "shop" our annual Buyer's Guide and, armed with your selections, visit another "vendor" that might have more positive answers for you.*

# THE **PRODUCT** SCENE

By Norman Eisenberg

## DYNAMIC PROCESSORS



RG Dynamics is offering the new RG X-15, and an updated version of its RG Pro-20, dynamic signal processors. The company emphasizes that its models are processors, not merely dynamic range expanders, because of their ability to restore musical transients (peak unlimiting) and their spatial-imagery features. The RG X-15, which offers 15 dB expansion at full setting, is the firm's lowest-priced unit and is said to be among the easiest to use of any on the market. It employs a four-position expansion setting, including a position for "optimal tape recording." Record and playback are possible with or without processing. The device is pre-set adjusted for incoming signal levels. In common with costlier RG units, the RG X-15 employs a harmonic analyzer for each channel to automatically guide range expansion; it offers independent left and right channel processing instead of a compromise signal for both channels; it has an image-control circuit said to enhance left-to-right and front-to-back imaging for a "fuller, more three-dimensional effect." Price is \$255.

The new version of the RG Pro-20 offers 20 dB of processing. A new circuit feature, called "programmed attack," is described as a "multi-stage logic circuit that programs the amount of dynamic range expansion to preserve and enhance the delicate, subtle dynamic shadings that characterize the best recordings, especially the classics." Price is \$419, or \$399 for a rack-mount version.

CIRCLE 2 ON READER SERVICE CARD

## 24-TRACK, 2-INCH RECORDER

Otari advises that it has started shipping its new 24-track, 2-inch recorder, the MTR-90. According to a company spokesman, "The first units have been very well accepted by studios . . . we've decided to dub the recorder 'The New Workhorse' since we anticipate that it will become a new production standard in the industry." The MTR-90 with remote session controller is priced at \$34,050 in the 24-track version, while a 16-track version costs \$23,500.

CIRCLE 3 ON READER SERVICE CARD

## NEW BEYER MICROPHONES

Said to offer a specially-shaped frequency response that is optimized for lavalier position is the new M-112 omnidirectional dynamic lavalier microphone from Beyer. It is described as a twin to the Beyer M-111, but without the chest filter. Range is given as 60 Hz to 15 kHz. Price is \$145 (including clamp, cord and case).

Another recent Beyer mic is the DT-109, a moving-coil microphone/headphone combination designed for pro use in "live" remote broadcasting, studio, film, TV, disc jockey and language lab applications. Left and right channels may be independently wired so that one channel can be used for studio talk-back and the other for program monitoring. The ear cushions attenuate external sounds, but they can be removed from one or both sides if background ambience is required. The microphone is highly directional, and is said to withstand levels beyond 120 dB/SPL. Price is \$106.

Beyer also is offering its DT-444S, a cordless stereo headphone that uses infrared electronics to eliminate the need for a signal cable. The headphone operates on built-in rechargeable NiCad batteries. Price is \$225.

CIRCLE 4 ON READER SERVICE CARD



## AUTO BIASING FOR AMPEX RECORDER

Ampex's model ATR-124 multi-channel tape recorder now can be fitted with an accessory that automatically sets correct bias for any tape used. The plug-in accessory generates test signals internally and adjusts the bias for the machine's three speeds. Once bias is set for a single channel it automatically becomes a ganged setting for other selected channels. Overbias is selectable from 1 to 6¾ dB in ¼-dB steps. Storage of the selected level is permanent, even in the event of power failure or accidental shutoff. Typical processing time for the auto bias operation is 10 seconds. Manual bias levels, set by the operator on trim pots, remain accessible at the press of the manual switch.

CIRCLE 5 ON READER SERVICE CARD

## UPDATING THE NAKAMICHI 1000

Latest version of the well-known model 1000 cassette deck from Nakamichi is the 1000ZXL which features a built-in "A.B.L.E." (standing for azimuth, bias, level and equalization) computer that adjusts the deck's recording characteristics to suit any tape used. The A.B.L.E. data may be stored in the computer for instant recall. The deck also contains a RAMM (random access music memory) system for locating up to fifteen separate programs on a recorded cassette. Up to thirty commands will be accepted by the computer which then finds and plays the selections in any desired sequence. The code also enables the deck to automatically set playback equalization and noise-reduction circuitry. Response of the 1000ZXL is rated within ±3 dB from 10 Hz to 25 kHz. Price is \$3,800.



CIRCLE 6 ON READER SERVICE CARD

## AKAI ENTERS EQ PRODUCT AREA

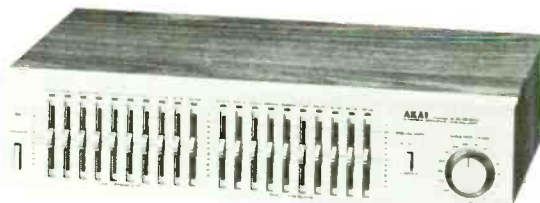

Known mainly up to now for its tape decks (although it has offered a relatively full line of products for some time), Akai has introduced its first graphic equalizers. The model EA-G80 offers ten bands on each of two stereo channels. Center frequencies, starting at 31.5 Hz, are an octave apart. Variable range for each CF is ±10 dB. The unit weighs 15 pounds and is priced at \$339.95.



The EQ-27 is a 27-band equalizer with center frequencies spaced ⅓ octave apart across the audio range. Each band has its own slider with center dB. Both versions have an EQ-defeat switch and a built-in relay muting circuit for connection to DC amplifiers.

CIRCLE 7 ON READER SERVICE CARD

## TAPCO UPDATES MIXING SYSTEM

Tapco's C-12/Series Two Mixing System updates the previous C-12 with new packaging and added features. The system's sub-grouping feature has been refined to allow the routing of input channels directly to sub-groups 1, 2, 3 and/or 4, as well as the direct assignment to the main outputs, bypassing the sub-groups. An added mute switch for each channel allows defeating of all but the pre-fader and solo functions. Other improvements include the addition of pan pots and solo capability on the sub-masters. With Tapco's C-8E/Series Two Expander, the mixing system is available in 12, 20, 28, 36 and 44 input channel versions.

CIRCLE 8 ON READER SERVICE CARD



## FIRST AMPLIFIER FROM UREI

UREI, a company known up to now for its signal processing equipment and studio monitors, has announced its first power amplifier. It's the model 6500, a stereo unit in which each channel is totally independent of the other, including its own power supply and its own continuously variable cooling fan. Circuitry boasts the use of a new system called "Conductor Compensation" by means of which the feedback loop is extended to the speaker terminals rather than to the speaker outputs on the amplifier. The result, claims UREI, is an extremely high damping factor and "near-perfect transient response." The new amp is rated for 275 watts RMS per channel into 8-ohm loads with 0.1 percent THD. In mono mode at 4 ohms, power rating is 1200 watts.



CIRCLE 9 ON READER SERVICE CARD

## TDK SHOWS NEW TAPE

TDK, which is credited with having introduced the first non-chrome high-bias audio tape (SA) in 1975, has announced a dual-layered version of Super-Avilyn known as SA-X. The bottom layer is said to make for improved low and middle frequencies; the top layer, better highs. The tape also employs a new binder for strength and long-term stability. Says TDK, "low- and mid-range frequency sensitivity is a full 1 dB higher than the SA audio cassette when measured at 333 Hz. High-frequency sensitivity is 1.0 to 1.5 dB higher than SA when measured at 10 kHz and 16 kHz. In addition, the maximum output level of SA-X is 1 dB higher than SA throughout the frequency range." TDK further points out that SA-X offers "ideal compatibility" with existing decks. The C-90 size is priced at \$6.99; the C-60, at \$4.99.

CIRCLE 10 ON READER SERVICE CARD

## YAMAHA PRO OFFERINGS

Included in Yamaha's latest pro audio products are mixing consoles, signal processors and sound-reinforcement speaker systems and enclosures. The M series mixing consoles come in 8, 12 or 16 channel versions, priced, respectively, at \$1,500, \$2,000 and \$4,700. Processors include a 1/3-octave graphic equalizer, the Q-1027, priced at \$895; and the model F-1040 four-way frequency dividing network at \$725. Speaker products include various drivers and enclosures for sound-reinforcement and stage monitor applications. Yamaha also has an analog delay device, the model E-1010, for use in recording or at "live" concerts.

CIRCLE 11 ON READER SERVICE CARD

## ECHO AND DELAY DEVICES

Newest addition to Korg's line of professional echo devices is the model SD200 which uses a compander noise-reduction circuit for "almost noise free operation." With a delay range of 30 to 400 milliseconds, the device produces effects such as doubling, hard reverb and long repeat echoes. A tone control handles only the echoed signal so that the user may tailor the tone of the delayed signal to personal taste. Other features include a two-channel mixer with input and output attenuators; effect/direct output for mono; effect-out only for P.A. and stereo operation; on/off footswitch jack; and nine LEDs (six green, three red) for headroom and overload indication.

The model SD400 is a new Korg analog delay system with a variable range of 25 to 400 milliseconds, plus an automatic double tracking effect, an effect ordinarily created by recording the same vocal or instrumental part two or more times on extra tracks. A "doubling" effect is created that makes the original track sound "thicker."



CIRCLE 12 ON READER SERVICE CARD



## MXR PREAMP

In addition to standard function select controls, the new Linear Preamp from MXR Innovations, Inc. features a subsonic filter, two tape or processor loops, and left-right mono/reverse capabilities. A gain switch offers 20 dB of additional gain when needed for optimizing signal-to-noise. The unit occupies 1 3/4 inches of rack space (optional rack ears are available).



CIRCLE 13 ON READER SERVICE CARD

## SAE's "01" AMPLIFIERS

The "01" concept in SAE's new line of power amps is based on the notion that conventional distortion tests do not give an accurate indication of an amplifier's ability to function outside of a laboratory environment. According to SAE, its research has documented "vast differences between an amplifier's ability to drive a single symmetrical wave into an 8-ohm resistor (as in conventional distortion tests) and its ability to drive complex musical waveforms into the dynamic, ever-changing load of an active loudspeaker."

The model 2401 amplifier, says SAE, incorporates ten times the amount of power necessary to meet its rated power at 8 ohms. This reserve is claimed to lend the amplifier the ability to drive the most complicated reactive loudspeaker loads even below 2 ohms. The 2401 is rated for 250 watts per channel; the 2301 for 150 watts per channel; the 2201 for 100 watts per channel. Prices were not available at press time.

CIRCLE 14 ON READER SERVICE CARD

## DIGITAL'S BEST TO DATE

What sounds to me like the best digitally processed disc yet released is the recent version of the Saint-Saens Symphony No. 3 "Organ," performed by young organist Michael Murray with the Philadelphia Orchestra conducted by Eugene Ormandy (Telarc Stereo 10051; distributed by Audio-Technica). The eloquence and musical mastery of the performance combine with unexcelled sound to

make for a really exciting listening experience. I wouldn't be surprised if this album earns some kind of recording award; it certainly would be my nomination for the year so far.

Beyond that, the release demonstrates some important things about today's recording techniques. For one, it is possible to get a sense of air or ambience into a stereo recording that was done originally as a digital tape. This point is worth making since several critics, while acknowledging the superior dynamic range of digital, have also complained that the digital discs tend to sound like "two mono tracks" rather than like the solid sound of stereo. Related to this there have been remarks about the "dry" acoustic quality of such recordings that detracted from their other audio virtues.

Valid or not, such criticism cannot be made of this recording. In addition to awesome dynamics and utterly clean sound across the audio range, this release does have a built-in ambience and a feeling of "space" that add to its grandeur.

Which brings me to point no. 2. And that is, simply, that the modern recordist—using digital or whatever—should recognize that more than hardware, no matter how ingeniously designed, is required to produce a great recording. Assuming of course a given level of musical talent to begin with, the recordist must pay rigorous attention to the recording environment and how it is likely to interact with his efforts. In the case of this Telarc production, the taping was done in the St. Francis de Sales Church in Philadelphia. A cursory glance at its interior would convince any soundman that this is a great place for organ recording. But there also was the fact of some 100 musicians, not to mention the battery of microphones, mixers, cables and the Soundstream Digital recording system itself.

To accommodate all this, a large section of the church's pews was removed, extra circuits were installed, the organ pipes were modified in pitch and—believe it or not—during the recording, nearby streets were closed to traffic.

Admittedly, that all took a lot of time, effort and influence with the authorities. For most recording personnel, that kind of all-out effort is a dream-goal rather than a realizable practicality. But it did, apparently, pay off in terms of the recorded sound. It also should stop the carpings about digital's being "limited" in its inherent ability to capture "musical realism."



# MUSICAL

# NEWSICALS

## SYNTHESIZERS AND ACCESSORIES

One of the most popular polyphonic synthesizers for recording and "live" applications has been the Prophet 5 from Sequential Circuits. After 2½ years on the market, the manufacturer has announced a totally revised and redesigned version of the Prophet 5 which offers several new functions in addition to generally simplified circuit design for improved reliability and roadworthiness. Among the new features of the improved Prophet 5 is a cassette interface which allows the transfer to and from cassette of a complete set of forty synthesizer programs; this function allows the user to store any special or unusual programs for later reloading into his own or any other Prophet 5. The cassette interface does not include the recorder itself which may be anything from a portable to a top-quality component unit. A new, improved edit function has been incorporated in the Prophet to facilitate real-time modification of any program by simply turning a knob or moving a switch without having to enter a special edit mode. The program created by such a modification can be permanently stored or the original pro-

gram can be recalled. A unique feature of the Prophet 5 is its ability to change the tempering of the keyboard to play in alternate scales such as Pythagorean or mean tone. In the variable scale mode each of the twelve notes in an octave can be varied over a range of approximately  $\pm\frac{1}{2}$  semitone from its equal tempered value. Each different tuning can then be programmed into memory for instant switching from one scale to another, and once in memory it is of course possible to dump the programs for alternate tunings onto cassette for later reloading. An additional feature of the improved Prophet is a voice defeat function which allows any voice to be conveniently disabled if it should become defective. In the event that some part of the circuitry should fail, servicing should be readily available to the user thanks to the establishment of service centers in eight major cities with more locations to follow.

CIRCLE 18 ON READER SERVICE CARD

One possible direction for the future of music synthesis may be exemplified in the Fairlight Computer Musical Instrument (CMI for short). The Fairlight CMI is primarily the invention of

a young Australian named Peter Vogel, and Vogel's design is worthy of our attention despite the fact that the system's \$36,000 price tag puts the Fairlight far beyond most musicians' reach. The Fairlight CMI is a completely digital synthesizer system which can create literally *any* sound, and not just the ones which can be produced with conventional analog oscillators and filters. The system comprises three basic units: a central processing unit, which houses the actual computer and its two floppy disc memories; a graphics monitor, which is basically a cathode ray tube (CRT) computer terminal complete with light pen for two-way graphic communications with the computer; and a piano-style keyboard with velocity sensitive keys which can be augmented by as many as seven slave keyboards. Several modes of operation are possible with the Fairlight CMI, but in the basic mode the desired waveform is drawn in on the CRT screen with the light pen and then manipulated until the desired sound is produced; manipulation can be accomplished by modifying the CRT display with the light pen or by entering computer commands with the light pen and an alphanumeric keyboard display on the CRT. In another basic operating mode, an existing sound is fed into the unit via a microphone, analyzed by the computer and made available for transposition up or down in pitch simply by pressing a key on the keyboard; with one input note it is thus possible to recreate an entire range of notes far beyond the limits of the original sound source. The system will analyze up to a one-second segment of source sound, and once the sound has been analyzed it may be manipulated in the same manner as any other waveform in the computer. An optional Music Composition





Language software package is available which allows musical data to be entered without necessarily using the music keyboard. Well-heeled synthesists should contact International Sound (1610 Butler Avenue, West Los Angeles, Ca. 90025), the North American distributor for system availability information and/or utilize the Reader Service Number card for more information.

CIRCLE 19 ON READER SERVICE CARD

A unique new product is the English-made Clap Trap, a handclap synthesizer made by the same people who make the Simmons Drum Synthesizer. The Clap Trap generates its synthetic handclaps (or footstomps depending on pitch) from a mixture of a percussive waveform (Ensemble Clap) and a noise signal (Hiss) which are triggered from one of several trigger sources. The unit may be triggered manually by tapping a switch pad on the unit or a plug-in footswitch, or automatically from a built-in oscillator for metronome-like operation or an external audio signal or trigger signal as from a synthesizer. Controls are provided for auto trigger rate, external trigger sensitivity, clap/hiss balance, level and pitch and time spread for both clap and hiss signals.

CIRCLE 20 ON READER SERVICE CARD

## MUSICAL INSTRUMENT ACCESSORIES

Carrotron is a Berkeley, California audio consulting firm which is now manufacturing three interesting professional signal processors. The first of these is the C821B1 preamplifier. This unit is a flat frequency response preamp with variable gain for 0-20X (26 dB), very high (5 Megohm) input impedance for use with any signal source to a maximum level of +8 dBV. The noise level of the unit is very low thanks to discrete FET and transistor circuitry rather than the more typical IC op-amp circuits. The Carrotron C900B1 is a noise filter designed primarily for electric guitar and piano. As a note from one of these instruments decays, the higher harmonics of the note die out first leaving a low to mid frequency signal and hiss at the higher frequencies. The Carrotron Noise Filter uses a low-pass filter controlled by the input signal level to progressively roll off the high frequencies as the note decays below an adjustable

threshold where noise would be objectionable. The result is a significant improvement in the "background noise" of the musician's sound without any noticeable tonal coloration, and without the distortion and false triggering of conventional noise gates. The Carrotron C610B1 Isolator is an interesting product for musicians concerned about shock hazards on stage. The Isolator provides total electrical isolation from input to output by use of an electro-optical isolator which transmits the signal in the form of a modulated light beam with no electrical connection from one side to the other. All three Carrotron units use FET input circuitry for low distortion and noise and high input impedance, and all are powered by a 9-volt battery and housed in a die-cast aluminum enclosure.

CIRCLE 21 ON READER SERVICE CARD

Multivox has announced the introduction of a complete new line of electronic effects pedals carrying the name "Big Jam." Each of the units is battery powered (AC adapter available) and housed in a color-coded steel



case with non-skid rubber sole. FET switching eliminates annoying clicks and virtually eliminates breakdowns. The Big Jam effects line includes: a distortion unit; a compressor; a flanging+distortion unit called a Jazz Flanger; a phaser; a dual phaser; a flanger; an analog echo + reverb unit; an envelope filter; an octave device; and a graphic equalizer.

CIRCLE 22 ON READER SERVICE CARD

A multi-channel volume control is the latest new product from Morley. The Morley MCV is a master pedal

which simultaneously controls the volume of up to five separate inputs. The five inputs are not combined in the unit; each of the five inputs has its own isolated output. Typical applications might include simultaneous control of a keyboardist's instruments before the mixer or amplifier, or control of an entire group's volume level.

CIRCLE 23 ON READER SERVICE CARD

DOD Electronics has announced that its popular model 640 Flanger has been discontinued and replaced by a new, improved unit, the model 670. The DOD Flanger 670 features controls for manual and automatic sweep, sweep width and speed and regeneration. The unit incorporates several innovative features including an active bypass footswitch for silent switching, an LED status indicator which blinks at the sweep rate and, most importantly, a compression/expansion system for dramatically improved signal-to-noise ratio through the active circuitry of the flanger.

CIRCLE 24 ON READER SERVICE CARD

Range Leather Products introduced an innovative guitar strap called the Slinger in 1979, and has now followed up the basic design with the Flashback series of ornamented straps. The Flashback straps are the same extra-comfortable, 3-piece contoured design as the Slinger and feature the same Velcro adjustments front and back for guitar height and angle, but feature ornamental cutouts of diffraction grating material which produces jewel-like patterns of ever-changing iridescence. Two models of Flashback straps are available, the Standard with a sunburst design on the shoulder section of the strap only and the Deluxe with the sunburst plus an alternating pattern of diamonds and circles along the length of the front and back sections of the strap. Both models are available in black leather lined with non-slip suede with a choice of silver, amber or red diffraction gratings to complement the guitar's color scheme. Also available from Ranger Leather are five models of Flashback buckle-less belts so that guitarists can hold up their pants without the danger of scratching their instrument with a metal buckle. The Ranger Flashback belts are fastened with Velcro and are designed to complement the Flashback guitar straps.

CIRCLE 25 ON READER SERVICE CARD

FX Labs, Inc. is a small company run by two experienced roadies/technicians whose recent credits include work for Peter Frampton, Jan Hammer and Bill Graham's FM Productions. FX Labs is now manufacturing a device known as the FX Switcheroo which is an outgrowth of the stage electronics system they designed for Frampton. The Switcheroo is a rack-mount switching unit with remote control footpedal which allows either four or eight effects units to be connected and preset and then switched in or out of the circuit remotely. The Switcheroo is particularly useful with studio signal processors such as delay lines, limiters and equalizers since such studio units usually do not have provision for in/out

access lines which allow the connection of wah-wah or volume pedals at the footswitch pedal rather than having to run extra lines between the switcher unit and the effect pedal.

CIRCLE 26 ON READER SERVICE CARD

For the past few years brass hardware has been all the rage among America's guitarists for a number of good reasons including improved sustain and sound quality as well as the beauty of the metal itself. Eastman Manufacturing Co. makes a very wide range of brass replacement parts for various guitars under the trademark Guitar Man. Eastman points out in its literature that all Guitar Man parts such as bridges, tailpieces, pickup

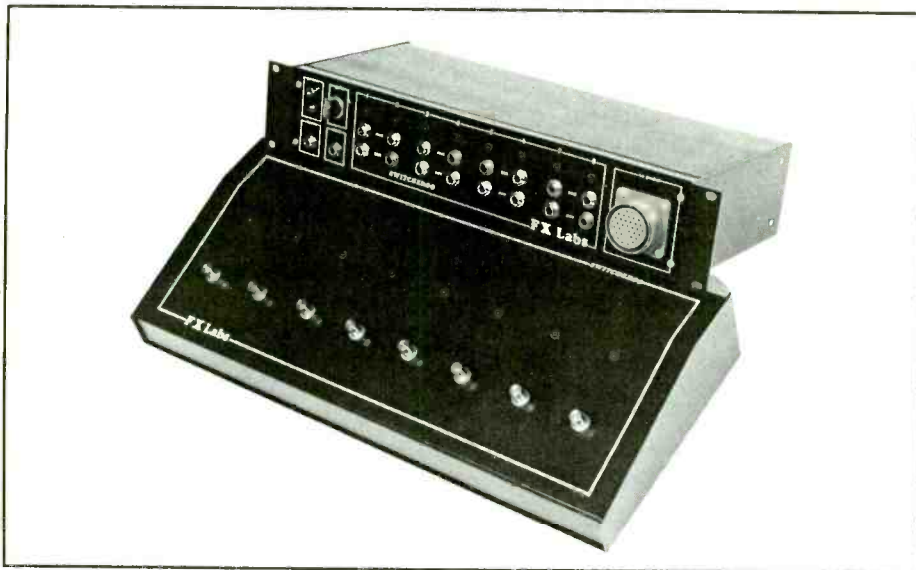

switching on their own. Additionally, such studio effects may be rack-mounted and pre-wired in the same amp rack as the Switcheroo for a completely self-contained setup. In operation, the various effects units are connected to the Switcheroo and set for the desired effect and left switched on. Then when any of the footswitches on the Switcheroo's remote footpedal is pressed, the signal will be routed to the corresponding effect device and LED indicators will light up on the pedal unit and on the switcher unit. The send and return jacks on the switcher unit are normalled so that the signal will not be interrupted if a channel is selected which does not have a device connected; this use of normalling contacts also allows the musician to use the Switcheroo to switch between amplifier chains as well as controlling effects processing. Also the system includes

covers, etc., are machined from solid brass bar stock rather than being fabricated from stamped and bent sheet brass as are many other brass parts on the market. To preserve the beauty of the highly polished brass, all Guitar Man parts are protected from oxidation and corrosion by a baked-on clear finish. Parts ranging from bridges and tremolo assemblies to knobs, pick guards and strap buttons are available for various Fender and Gibson guitar styles.

CIRCLE 27 ON READER SERVICE CARD

Nearly all musicians rely on connecting cables whenever they play, but guitarists seem to be the most demanding users of cables because they are physically the hardest on them and because their high gain amplifiers are least tolerant of cable-related noise problems. Hot Wires, from The Music

People, Inc., is the latest entry in the premium cable field. Hot Wires starts with a ten-strand conductor, insulated with Cortex, a high-strength polyethylene type material, shielded with braided copper and jacketed with a very flexible high polymer vinyl. Terminations on Hot Wires is via machined solid brass plugs with knurled grips and brass-plated strain relief springs. An additional feature is the anti-pop switch integrated in the plugs which shorts the cable until the jack is fully plugged into the instrument. Hot Wires are offered in a variety of lengths including 1-foot and 3-foot patch cords, 20- and 25-foot straight cords and a 20-foot coiled cord.

CIRCLE 29 ON READER SERVICE CARD

Kaman Musical String Corp. has announced the introduction of a new line of strings for acoustic and acoustic-electric guitars. Adamas strings are said to embody several important new techniques in the design and manufacture of strings. The wound strings use a hexagonal core of Swedish steel wrapped with phosphor bronze, but unlike most strings which have a thick core and fine wrap wire, Adamas strings use core and wrap of exactly the same diameter for a sharper, more precise tone. All Adamas strings are wound on exclusive computer-controlled winding equipment for precision and consistency not possible by conventional means. The second and third strings of an Adamas set have also been redesigned to smooth the typical frequency response peak of the second string when playing amplified and to lessen the tension on the third string for easier playing and less breakage. Adamas strings may be recognized by their distinctive solid brass knobs.

CIRCLE 30 ON READER SERVICE CARD

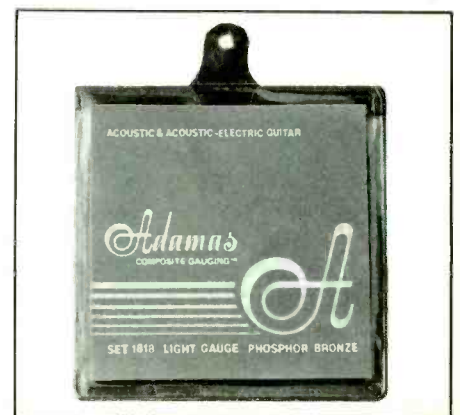



# THE RADICAL RADIAL

In response to the demands of the sound professional we present a totally new kind of radial horn—the **Community Super90**.

**OUR BEST YET.** This horn is by far the most well behaved ninety degree radial horn we've made—and we've designed a few winners. Super90's are highly efficient; exhibiting smooth axial directivity with no vanes, obstructions or diffraction effects in the critical throat area. The result? A smoother, cleaner sound, but with a new dimension added.

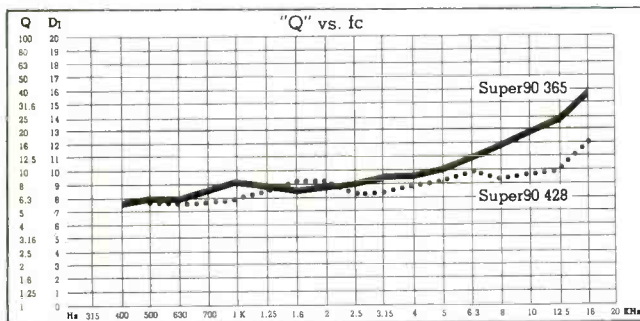

**A NEW DIMENSION? Yes. It's flat.** The front of this superb horn doesn't curve back in the familiar arc, it's flat, with straight, rectangular sides that make box mounting a snap and set-ups a breeze.

**It's compact**—measuring at least 7" less in depth from driver mount to the front of the horn.

**It's stronger**—greater structural rigidity means even less resonance than that of our standard radial designs.

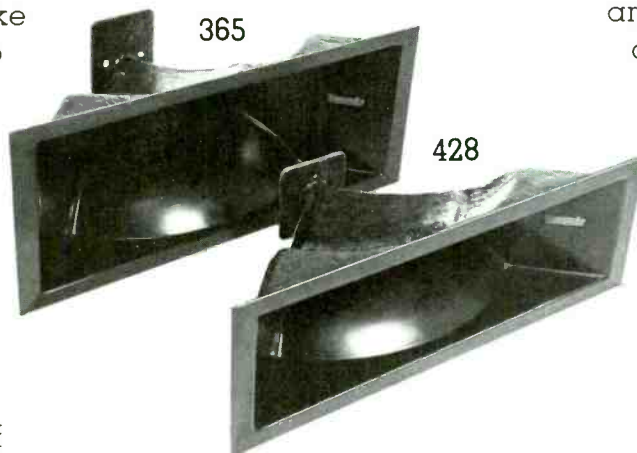

## Community

We have two **Community Super90** horn designs available—the **Super90/365** (flare rate 365Hz, operating range from 600Hz and up, for 2" exit compression drivers) and the **Super90/428** (flare rate 428Hz, operating range 800Hz and up) which accepts 1" exit loudspeakers.

THE REGULAR RADIAL

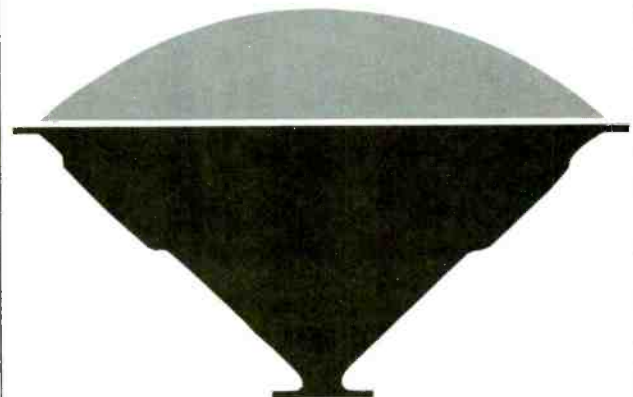

THE RADICAL RADIAL

**Community Super90's** are the correct choice wherever a predictable, compact 90° radial is needed. Flush-mounted system installation is greatly simplified with the use of Super90's. In tour applications these horns are easily mounted in multiples and are the ideal solution for quick, hassle-free set-ups.

**Community Super90's** provide you with the best of both worlds—radial horn performance superbly coupled with the packaging convenience of a straight horn.

**From Community.  
The best there is.**

# The Ten Commandments of Tape Recording

By James F. Rupert

Dear Readers:

The following is a little hazy for me to try and recall, being as dream-like an experience as it was. Whether it was real or just the product of too many baloney and swiss cheese sandwiches immediately prior to retiring, I'll never know. But here it is for your approval nonetheless, as well as I can remember. Be it authentic or merely gastrointestinal high jinks, it seems as if the advice given still remains "sound." (No pun intended.) We'll just have to let history be the judge. Till then may I most cordially remain . . .

Yours,



James F. Rupert



"Wake Up, James Rupert!"

"Mmmph. G'way."

"Rise and wake, Rupert. I bring you news from the world beyond."

"Jus' five more minutes, Mom. Then I'll geddup for school."

"I said awaken, James Rupert!"

"Wha . . . whozzit? Who's there?!"

"Rise and stand before the god of recording arts, mortal!"

"You mean George Martin, here? Where?"

"Forget Martin! I'm getting tired of that guy stealing my thunder. It's getting so you can't trust any mortal with an Audio Cyclopedia and a dictionary."

"Wait a minute, lemme get my glasses."

"I'm standing here being ethereal, and you're fumbling for your spectacles!"

"Okay I got 'em. Now who is this really?"

"I'm telling you Rupert, this is the god of recording arts, and I'm here to bring you cosmic truth."

"Listen if this is about the studio rent payment, I can explain."

"Rent, schment! Will you just listen for five minutes?"

"Sorry. Go ahead."

"You have been selected, James Rupert, to receive a directive from the powers above, regarding the recording studios of your world."

"I have?!"

"Yes, you have. Personally I would have chosen your competition down the block, but my boss happens to think you're funny."

"Your boss? You mean . . ."

"No, I don't mean George Martin. Listen, do you want to receive this directive or not?"

"Okay, okay. Let me have it."

"Keep your shirt on; it doesn't work that fast. First we need a mountain and a coupla stone tablets."

"There aren't any mountains around this part of the country, and the only tablets I've got have Aspirin written on them. I don't suppose they'd work, would they?"

"Nope, no good. How about if my flaming finger would just etch the words on this wall over here?"

"Hey, no dice! I rent this place and I'd lose my security deposit. How about some nice stationery? I got some nice stationery, you know? How about some nice stationery?"

"How's it going to look using my flaming finger to etch words on 'nice stationery,' answer me that?"

"Why don't you just tell me what you want me to know, and I'll write it all down, okay?"

"Well . . . it's not as impressive as what I had in mind."

"I'll still be impressed, no kidding."

"You're sure?"

"Scout's honor."

"So be it mortal. Then prepare yourself to receive . . ."

## the Ten Commandments of Tape Recording!

"WOW! How do you talk in Old English script like that?"

"Sorry, trade secret. Where was I? Oh yes,

### Commandment Number One

*Thou shalt not engineer  
and produce simultaneously*

"That's a good start."

"I thought so. To elaborate a smidgeon, there are times when perhaps the studio client will specifically request you to handle engineering and producing chores. You will have to handle this in whatever way you see fit. But any experienced studio veteran knows the differences between the two jobs, and how each must command full attentions and individualized talents. Combining them means cutting corners and non-delivery of full potentials. This isn't just my rule by the way, this is straight from one of the giants in our industry."

"Ah, then of course this time you must mean . . ."

"No, I mean Phil Spector. Lissen Rupert, you try to bring up Martin's name one more time, I'm warning you I can still make it to your competitor's place and give the rest of this to him!"

"My lips are zipped."

"See that they are. One more time and I'm going to tell the world what the 'F' in James F. Rupert really means!"

"Don't do that! I'll be good!"

"Alright,

### Commandment Number Two

*Thou shalt give all clients  
instructions in advance*

"Could you elaborate on that one please?"

"Surely. All the ground rules for a good session should be lain down *before* the clock starts. Tell the musicians to change their strings and drum heads two or three days before the session to allow for stretching. Stress the importance of having their material down absolutely pat before they walk in your building. Any advice, tips or instructions should be given previous to the studio appointment so everybody involved knows most of what to expect

from the word go. This commandment alone can save you a lot of agony and frustration. You can tell the client it can save him a lot of money."

"I'm hep. What's next?"

### Commandment Number Three

*Thou shalt contract all studio work*

"You mean like writing?"

"Exactly. All rates, times, appointments and costs should be down in black and white. Agreements are tough to reach, so reach them on paper once everyone agrees. After that everybody signs it and everybody gets a copy. If you're working with a band, get all band members' signatures. Sign all copies in front of each other, so all are witnesses to each other. List how long the customer has to pay the bill. Tell him in the contract that he does not receive the finished tape or any dubs or rough mixes until the bill is paid. Whatever is agreed to, get that contract as a written commitment."

"I know what you mean. I had a full head of hair before I went into this business."

### Commandment Number Four

"Are these commandments in any particular order?"

"No, I'm going to wing part of this. It's been a long day."

"Okay, go ahead."

### Commandment Number Four

*Thou shalt keep and maintain paperwork on everything*

"What kind of paperwork?"

"Every kind. Track sheets, maintenance reports, contract copies, scripts, purchase orders, studio schedules, work orders, equipment use schedules—the works. You all have a

pencil in your studio, and you all want to keep your sanity. So use it before you lose it."

"What kind of information should be included on the track sheets you're talking about?"

"I'm going to touch on that briefly in some of the upcoming Commandments, but to go into that in depth somebody is going to have to maybe do a special article just on the different forms that should be used in studio work. Know anybody who might want to write that one?"

"Yeah, it just so happens the guy I shave in the mirror every morning is planning just such an article."

"I thought he might. Anyhow, let's go on to:

### Commandment Number Five

*Thou shalt not get wasted until the session is over*

"I hear you."

"Lots of guys think they're laying down gold until they hear it the next morning straight and discover they were really trowelling poop. Whatever stimulant or depressant you choose to use, wait until you are on your own time. You've got to be able to walk in straight and give your customers the best of your abilities before you space warp out to the planet Zotar."

"I read you there fly-boy. I got blitzed just once and made a fool out of myself by trying to take my underwear off over my head . . . in public."

"Anything that affects your judgment and capacity to make decisions is something that should be considered. A fight with your girlfriend, a family problem, fatigue, illness. These are all reasons to ask yourself if you can handle the session with objectivity, complete attention and professionalism."

"That makes sense. Okay, what's next?"

### Commandment Number Six

*Thou shalt develop a track assign system for standardizing channel assigns*

"Once again, I need more details."

"This means to determine where you are going to assign the different instruments and vocalists on the tracks of your tape machine and consistently stick to those same channel assignments. Drums on Channels one and two, Bass or Rhythm Guitar on three and so on. There will be some variations from group to group with different instrumentation, but the philosophy will remain the same. You might even mark the input faders with masking tape or press-apply lettering for quick reference as to what instrument the input is standardized for. You can also find optimum EQ settings for whatever instrument is being run through that module and leave them set in that position. This can be a big time saver, but isn't something that can't be changed and adapted to different situations. Are you getting all this, Rupert?"

"I'm writing, I'm writing . . . okay, I got it."

"This'll slingshot us right into:

### Commandment Number Seven

*Thou shalt not position the most important tracks on the outside tracks of the tape*

"High frequency loss, right?"

"Right, at least the possibility of high frequency loss. Repeated playing and high-speed reversing and forwarding of the tape can result in the possibility of damage to the edge of the tape. Consider any head misalignment and the reasons become clearer and clearer. Stick any vocals or other tracks dependent upon inherent high frequency response in the safer middle tape track positions. This is especially important when using limited tape





0.00% switching distortion. 0.00% FM drift.  
Two reasons Technics has a lot to say about nothing.

Technics SU-V8 amplifier with New Class A circuitry eliminates switching distortion. The ST-S7 quartz synthesizer tuner eliminates FM drift. And as you'll discover, the more we eliminate, the more we add.

Take the SU-V8. You won't hear any switching distortion because, unlike most of today's amplifiers, its output transistors don't switch on and off as the input waveform goes from positive to negative. The reason: Technics synchro-bias circuitry. What it does is employ high-speed diodes that constantly send minute amounts of current to the transistor not in use. And since the transistors are always on, switching distortion is eliminated.

And there's nothing minute about the SU-V8's power

output: 110 watts per channel from 20 Hz to 20 kHz into 8 ohms with no more than 0.005% THD. The results: Music that's rich, crisp and bursting with dynamic range.

In concert with the SU-V8 is the ST-S7. With its quartz-crystal oscillator, only the broadcast frequencies you select can be received. And since both frequencies are quartz-synthesized, the tuner can't drift. That means any station you tune is perfectly in tune.

And the ST-S7's microprocessor allows you to preset eight AM and eight FM stations and even turn the power on and tune three stations all by itself.

Discover Technics new amps and tuners. When it comes to New Class A and quartz, Technics gets an A plus.

**Technics**  
The science of sound

CIRCLE 98 ON READER SERVICE CARD

width formats such as ½" eight track or 1" sixteen track machines."

"What about the edges of a tape being uneven right out of the box?"

"It's rare, but it can happen. It's just one more reason to play it safe and put a little thought into track assignment. That forethought can save you a lot of apologizing and excuse-making later on in the session. Can you dig it?"

"You bet."

"I knew that you could. Let's not stop; I'm on a roll."

### Commandment Number Eight

*Thou shalt establish and commit to tape a tuning reference for each recording*

"So the tuning is constant throughout the recording, is that it?"

"Give that mortal a cigar! Whether you're using a piano, an organ, a pre-tuned guitar or some form of signal generator, record those reference tones and verbally label them at the beginning of each multi-track mother tape. If returning has to be done, go back and use the reference tones. Also, use a metronome or some sort of rhythm machine to establish a tempo for each song. Record about ten to fifteen seconds of this before each song to use as a speed reference, and mark the metronome setting on the track sheet for future help. That way if the final tape is to be mixed or mastered on a different machine, slight mechanical speed variations can be compensated for. In addition, if tracks are to be added to the unfinished tape at another studio, they then have both a speed and tuning reference standard to achieve the best recording possible without trial and error takes. Are you beginning to see how all these little things add up?"

"More by the minute. What else?"

### Commandment Number Nine

*Thou shalt slate every take recorded*

"What if I own an auto-locator? Should I still slate each take?"

"It would still be a good idea. Slate each try with the title, the take number and a slate tone if you have one. You might wish to tap the slate tone switch as many times as the number of take it is. For example, 'Take Three' would have three short tone bursts after the verbal slate section. Then be sure to list the final 'keeper' take on the track sheet. If you have kept a counter reading, also list the counter number position on the track sheet with the rest of the information. That way you won't have to be searching back and forth for the final version for editing and mixdown. It's a small enough thing but it certainly can help make things simple, simple, simple."

"I see, see, see. What's next, next, next?"

### Commandment Number Ten

*Thou shalt have maintenance, repair and instruction manuals for all studio equipment, and have them close at hand*

"What if a piece of gear doesn't come with a service manual?"

"It might be necessary to special order it from the manufacturer. Much of the equipment available today, especially the semi-pro gear, does not come with any service manuals. But two o'clock in the morning is a bad time to realize there aren't any service shops open when you have a breakdown in the middle of a big money session. It naturally follows that if you are going to have service and maintenance manuals available for use, you better have some idea how to use them. Otherwise you are just draining the alligator swamp wearing only Bermuda shorts. You aren't ready for anything that might go wrong."

"That's a good line, could I steal it?"

"As long as you quote me and not George what's-his-name."

"Guaranteed."

"Any questions for me before I go?"

"Well, it just seems to me like these Commandments all seem to have to do with procedure that should take place before the session begins. Are there any more Commandments for intra- and post-session work?"

"Yes, but not now. I've got a dental appointment."

Okay, I'll wait 'til next time."

"One thing to remember, mortal, is that lo, you will be amazed unto thyself at how many people who hear these laws will consider themselves to be the exceptions to the rules. They will go on with sloppy preparation, time consuming tape searches and no solid plan as to how to conduct their studio time."

"I think you could be right."

"And now it is your duty, Rupert, to spread the holy word of these Commandments unto the audio conscious of the world you reside in. Are you ready to accept the responsibility placed upon you?"

"You bet your halo. I needed to get an article into *Modern Recording & Music* by Tuesday anyhow."

"Ah yes! 'Tis the holy book indeed, spoken of in praised whispers in the halls of audio on high."

"Yeah, I kinda like it too."

"And with that, I must depart."

"Wow, lissen, I can't thank you enough for all this great stuff. I wish I could do something to repay you for all your time and effort in giving it to me."

"Well... perhaps there is just one small favor you might perform for me."

"Sure, what is it?"

"It's such a minor thing..."

"Just name it."

"Could you get me George Martin's autograph? For a friend, I mean..."





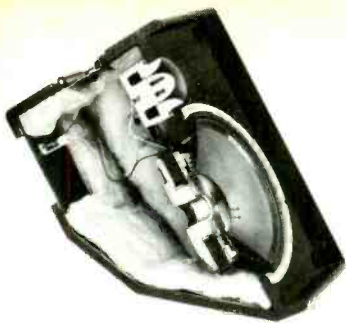

## 4602 Cabaret Stage Monitor.

It performs as well as you do.



Here's the best way to keep in touch with yourself when you're performing.

The JBL Cabaret Stage Monitor.

It cuts through the sound on stage... at concert halls or clubs... to give you an accurate picture of what you're playing.

The 4602 is a powerful, efficient and indispensable tool for the working artist. It can handle 150 watts continuous sine wave power. It puts out a lot of dBs with a lot less watts. And it can direct the sound to you at either 30° or 60° angles.

That's only half the 4602 story. Turn it around, stand it upright, and use it as a reinforcement system for vocals or instruments.

The Cabaret Stage Monitor is designed with the ruggedness, portability and flexibility of the other professional products in the JBL Cabaret Series. It's made of multilaminated, cross-grained hardwood which is far superior to pine plywood, other softwoods or particle board. And, unlike other monitors, it serves as its own road case—complete with flush-fitting cover. The exterior is finished with a triple coat of highly durable black polyurethane.

Inside its tough, roadworthy acoustic enclosure is an advanced JBL E Series transducer with a Symmetrical Field Geometry magnetic structure. JBL's SFG technology lets this speaker perform at the lowest magnetic circuit distortion level of *any* known speaker made today. In addition to the 12" SFG full-range loudspeaker, there's a high-frequency ring radiator and a specially designed crossover network. For extra low end boost, the enclosure is vented.

JBL's 4602: the one stage monitor that's up to your standard of performance. On stage. And off stage. It delivers that trusted JBL sound, quality and reliability.

Hear the Cabaret Stage Monitor soon. It's like listening to... yourself. Handcrafted in the USA by JBL in our Northridge, California facility.

James B. Lansing Sound, Inc.,  
8500 Balboa Boulevard,  
Northridge, CA 91329.

Model	Frequency Range	Power Capacity		Sensitivity (1W @ 1m)	Crossover Frequency	Enclosure Volume
		Continuous Sine Wave	Continuous Program			
4602	50 Hz - 15 kHz	150 W	300 W	103 dB SPL	3 kHz	42 litres 1.5 ft <sup>3</sup>

**JBL** First with the pros.

CIRCLE 140 ON READER SERVICE CARD

© 1980 James B. Lansing Sound, Inc.

# Building A

# HOT SPRINGS

# Reverb

By Craig Anderton

**WAIT!** Don't turn the page. I know that simple spring reverb systems may not have the greatest reputation in the world, but this version uses a truly novel design technique. The result is a reverb system that offers an attractive combination of low cost and high performance.

You don't have to take my word for it, though. An engineer for a well-known manufacturer of effects boxes recently developed an all-electronic reverb system; part of his market research involved checking out the reverb market to see how his design compared to other currently available models. Since I felt he could be a little more objective about the "Hot Springs" reverb than I could be, I asked him to give it a listen. He was absolutely floored, and said it sounded better than anything else he had heard during his months of testing! I think you'll probably feel the same way after hearing it... but before we get into building, we need to examine just why the "Hot Springs" reverb (or "HS" reverb for short) is so different from the norm.

## How Spring Reverbs Work

Let's begin by refreshing our memory as to how spring reverbs work in general (see Figure 1). The spring connects to two transducers, one at the input and one at the output. Signals appearing at the output of the drive amp couple into the input transducer, which then takes this signal and couples it to a long spring; the signal is delayed as it travels down the spring. The output transducer picks up this delayed sound, and feeds it to a recovery amp which takes the extremely weak output of the reverb spring and amplifies it to a useable listening level.

So far, what we have described would only give a single "slapback"

type of echo if it weren't for one very important fact: once the signal has reached the end of the spring, it bounces back along the spring towards the input, then reverses direction and bounces back towards the output again (contributing another echo), returns again towards the input, and so on until it eventually fades out. This creates the effect of multiple echoes and reflected sounds—just like you get in a large room. Also, there are several mechanical resonances in the spring itself that add peaks and dips in the response. This helps to simulate even more closely the properties of "real-world" reverb.

However, there are some problems (aren't there always!). The first is that

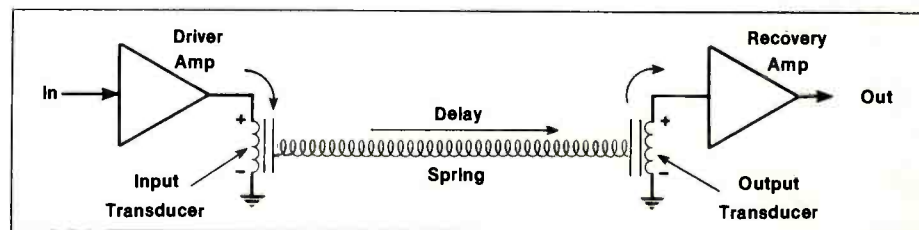

Figure 1



the motion of the spring itself adds a certain type of sound to the audio signal, which produces the characteristic "boing" and "twang" of spring reverbs. The second problem is that if you just listen to the reverb output, you'll hear a mushy version of the "dry" sound along with the sounds created by the multiple reflections and echoes we mentioned earlier. The third problem is that the spring output is in the millivolt range, which is exceedingly weak. As a result, the recovery amp must run at a very high gain to bring this signal up to a useable level, and this contributes noise to the system. The final problem we'll discuss is that springs have an inherent bandwidth limitation, which means that there is no significant audio energy above approximately 5 kHz. This is why springs often sound bassy and boomy compared to a good, crisp plate system.

### Solving these Problems

The HS design uses "hot rod" guitar pickup technology to overcome the above-mentioned problems. This is one of those situations where the solution seems so obvious you wonder why no one has thought of it before; but to the best of my knowledge, and several other people, the following represents a totally original approach... so MR&M readers, you heard it first.

The basic principle is to take two springs and connect the input and output transducers in a special way, as shown in Figure 2. The input transducers are connected in series and *out-of-phase*; the output transducers are connected in series but *in-phase*. As a result of the out-of-phase input connection, the original audio signal—as well as the "sproings" and "boings"—cancel each other out at the output, leaving mostly the multiple echoes and reflections. This neatly solves problems 1 and 2, and gives a very rich reverb sound. Additionally, the input transducers are driven by a constant-current source that provides equal drive for high and low frequencies. This gives the bright high end associated with plate systems, while de-emphasizing the muddy, bassy sound often encountered with some spring reverb designs. Finally, by connecting the output coils in phase and in series, we double the overall output level. This means that the recovery amp doesn't have to provide quite as

much gain, thereby giving an improved signal-to-noise ratio.

You might wonder why the cancellation effect discussed above doesn't cancel the *entire* reverb signal. Luckily, although reverb springs are matched closely enough so that the "boings" and dry signal are mostly cancelled, there are enough differences in response (particularly in the high frequency regions) so that the subtler reverb sounds are left pretty much unaffected.

Musically speaking, we traditionally think of reverb as trying to simulate the sound someone sitting in the audience would hear at a concert. However, anyone who has played on the stage of a 2000 to 10,000 seat venue knows that reverb sounds quite different from the performer's perspective; it is this sound which the HS reverb simulates. Instead of hearing an ill-defined reverb mix of dry signal and hall acoustics (as you do in the audience), from center stage you hear the reverb coming back at you without any discernible dry signal. What this means in the studio is that the HS reverb sound never "steps on" the signal being reverberated, since it contains the multiple reflections and echoes associated with a good reverb sound *while excluding virtually any trace of the original signal*. This is highly desirable, since in practice the reverb signal is mixed in at a low level compared to the signal being reverberated. By cancelling the muddy sounding version of the dry signal that comes out of most spring reverbs, the overall sound is clean, crisp and well-defined instead of being boomy and sproingy. Vague terms, to be sure, but if you've worked with inexpensive

spring reverb systems in the past I'm sure that all the above expressions will sound familiar.

### Controls and Options

Actually, the only control for the reverb unit is a level-matching trim pot. At maximum sensitivity, signals greater than -10 dB will overload the driver amp. At minimum sensitivity, clipping does not occur until the input reaches +15 dB or greater. There is an additional clipping indicator LED that lets you know when the driver amp is being overloaded. Due to the high-frequency boosting action of this stage, clipping will occur sooner at higher frequencies than at lower frequencies.

### Finding Parts

As mentioned in the last D.I.Y. ("do-it-yourself") Limiter article [*Modern Recording & Music, November 1979*], whenever possible I try to line up a parts source that stocks all of the parts necessary to build a given circuit, as well as provide a repair service for wiring jobs that go astray. For this project, PAIA Electronics (1020 W. Wilshire Blvd., Oklahoma City, OK. 73116) is again providing this service—particularly because they stock the Accutronics model #1FB2B1D reverb springs which are used in this project. These springs were chosen for their low cost, small physical size, sound quality and ready availability from PAIA. As a result, all circuit components were selected with these springs in mind. While other springs may be used with this project, I cannot guarantee the quality of performance if substitutions are made. All other parts are commonly available and shouldn't be hard to find at all. If you decide to build the

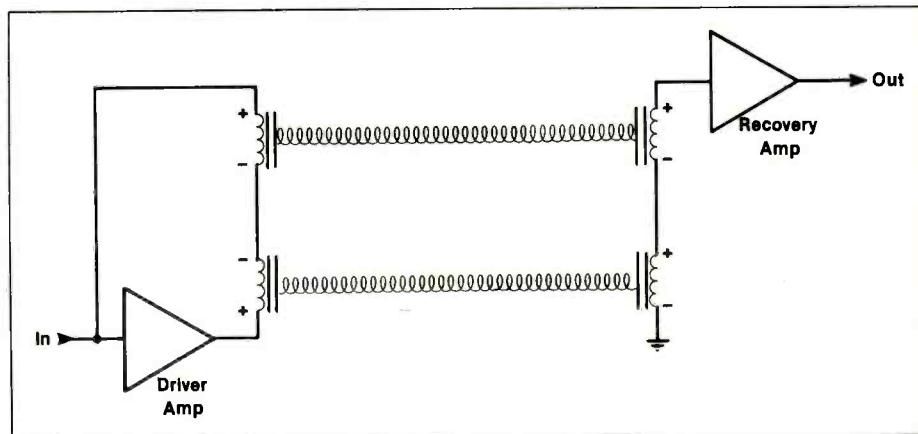

Figure 2

project from scratch, however, I highly recommend that you follow the circuit board layout as closely as possible to prevent ground loops, hums, oscillations and other potential problems.

### Preliminaries

While this is a fairly simple project, some aspects of it (such as modifying the reverb springs) require a bit of skill. So, I wouldn't recommend that beginners undertake this project unless they have successfully completed similar projects in the past. On the other hand, I said the same thing about the D.I.Y. Limiter and several beginners built it with no trouble at all. You are probably the best judge of your capabilities. However, there are some basics which *must* be observed, namely:

- Use a low wattage (40 watts or less) soldering iron. *Do not use soldering guns!*

- Use only rosin core solder designed for electronic work. Any kind of acid core solder, or use of flux, will ruin an otherwise good circuit board and some of the parts as well. Use the solder sparingly; don't blob it all over a connection, since that can cause shorts between adjacent circuit board traces.

- The amount of heat used in soldering is very important. Too little heat can cause "cold" joints, where the solder's rosin is not sufficiently melted; this causes a high-resistance connection. On the other hand, too much heat will damage parts. I'd suggest holding the iron tip against the

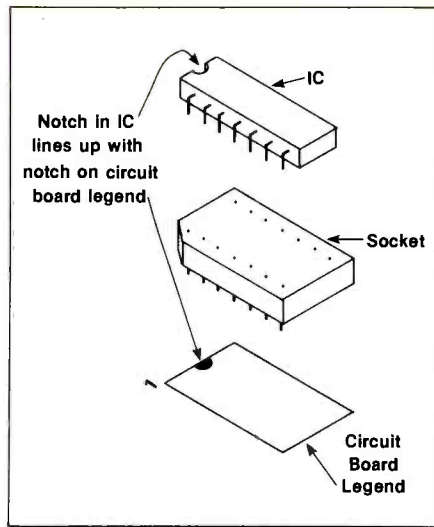

Figure 3a

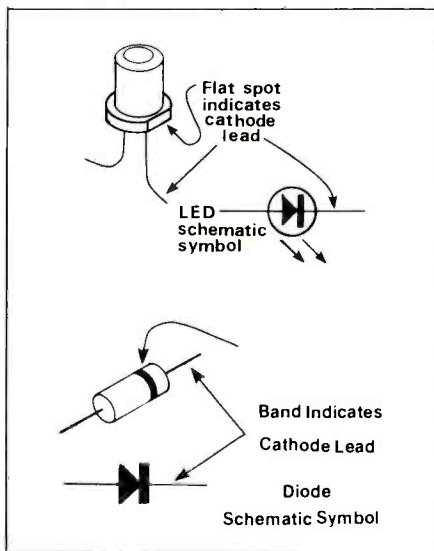

Figure 3b

connection to be soldered for a few seconds, then feeding in a little bit of solder and continuing to apply heat until the solder flows freely over the connection. If the solder balls up around the connection, reheat it and feed in a little more solder.

- Use an IC socket. This simplifies replacement should the IC ever fail; also, you don't have to worry about frying the part through incorrect soldering techniques (see Figure 3a).

- Clean the copper side of the circuit board with steel wool to remove oxidation. A bright and shiny board contributes to successful soldering.

- Note that electrolytic and tantalum capacitors are "polarized" components and have (+) and (-) marks, just like a battery. Like a battery, if you don't hook these parts up right the circuit won't function; so, the circuit board legend has a (+) symbol near the hold where the capacitor's (+) lead must go. LEDs and diodes are also polarized. Referring to Figure 3b, the LED symbol is an arrow pointing towards a bar. Generally, the bar (or cathode) end of the LED is designated with either a flat indentation in the case or a dot of paint. Diodes have a similar schematic symbol, and the bar end of the diode corresponds to a band painted on the diode itself.

- Take your time and work carefully. Impatience is one of the biggest reasons why do-it-yourself projects fail.

- No power supply is shown in the schematic. If you built the Limiter,

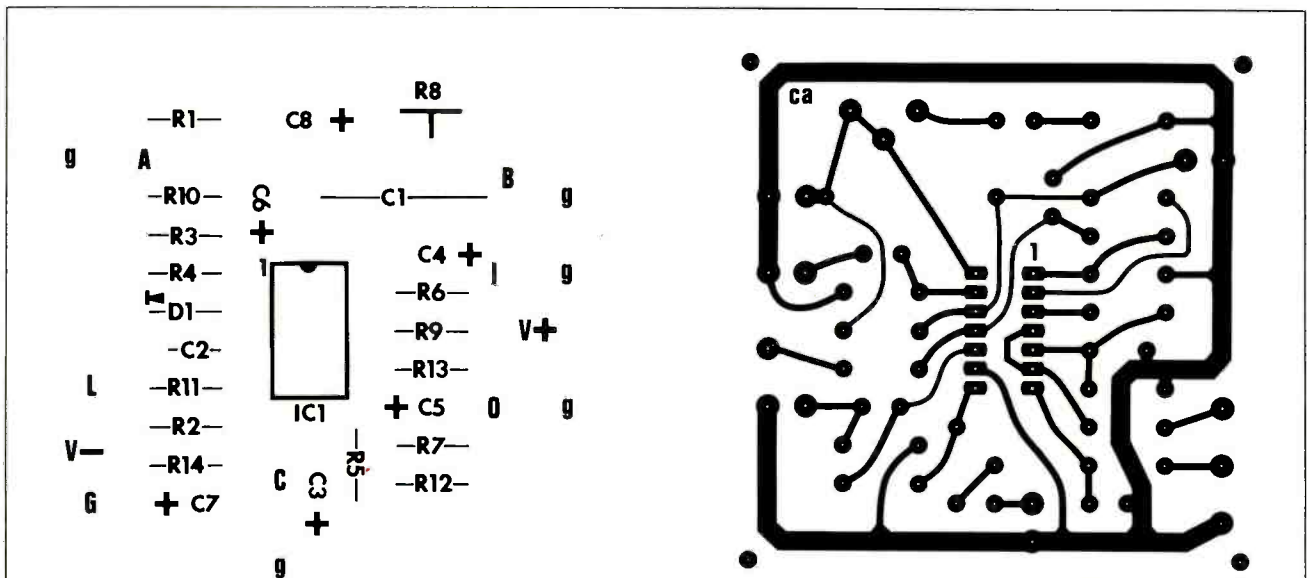

Figure 4





AUDIOARTS ENGINEERING 4000 Mixing System



### A SYSTEMS APPROACH

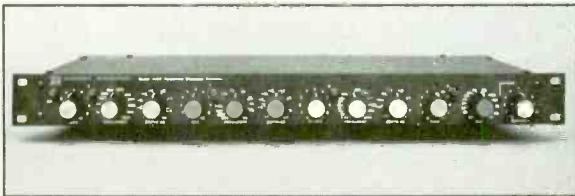

Model 1400 Parametric Electronic Crossover



Model 1500 Feedback Suppressor



Model 2100A Tuneable Electronic Crossover

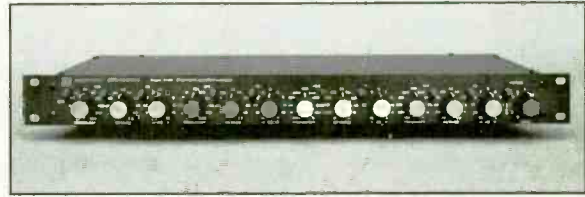

Model 4100 Parametric Equalizer - Preamp



Model 5200A Stereo Mixer/Preamplifier

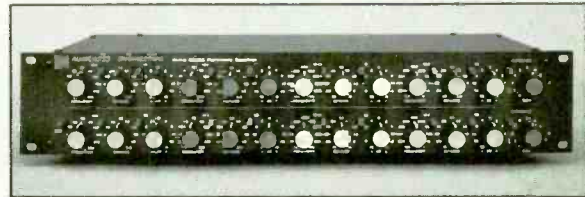

Model 4200A Parametric Equalizer



AUDIOARTS® ENGINEERING

286 DOWNS ROAD, BETHANY, CT. 06525 • 203-393-0887

you can use the same power supply; simply tap off another set of connections for the reverb unit and you're ready to go. Otherwise, you can use any  $\pm 15$  V bipolar supply such as the PAIA #4771 or the HK-116 from Bill Godbout Electronics (P.O. Box 2355, Oakland Airport, CA. 94614).

Space prohibits us from going into all possible aspects of electronic construction. If you'd like to find out more about this topic, refer to my *Electronic Projects for Musicians* book (published by Music Sales, 33 West 60th Street, NY, NY 10023) [Craig... is this a blatant plug for your book!?!—Ed.]. It contains complete information on finding parts, soldering, packaging projects, labelling, etc.

**CONSTRUCTION:** There are four distinct phases to construction: 1) loading and soldering the circuit board; 2) modifying the reverb springs; 3) packaging the springs and circuit board in a suitable chassis; and 4) connecting the circuit board to the power supply and springs. We will deal with each one in order.

**SOLDERING the CIRCUIT BOARD:** Referring to Figure 4 (the component side of the board) and the parts list, solder the various components in place. Start with the resistors first, then the IC socket, capacitors and trimpot. Check that all solder connections are well made, then proceed to the next section.

**MODIFYING the REVERB SPRINGS:** In order to do the various in-phase and out-of-phase tricks mentioned in the beginning, we have to modify the wiring of the two reverb springs. This is probably the most complex part of the

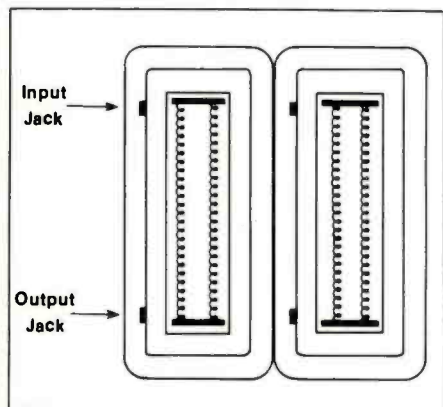

Figure 5

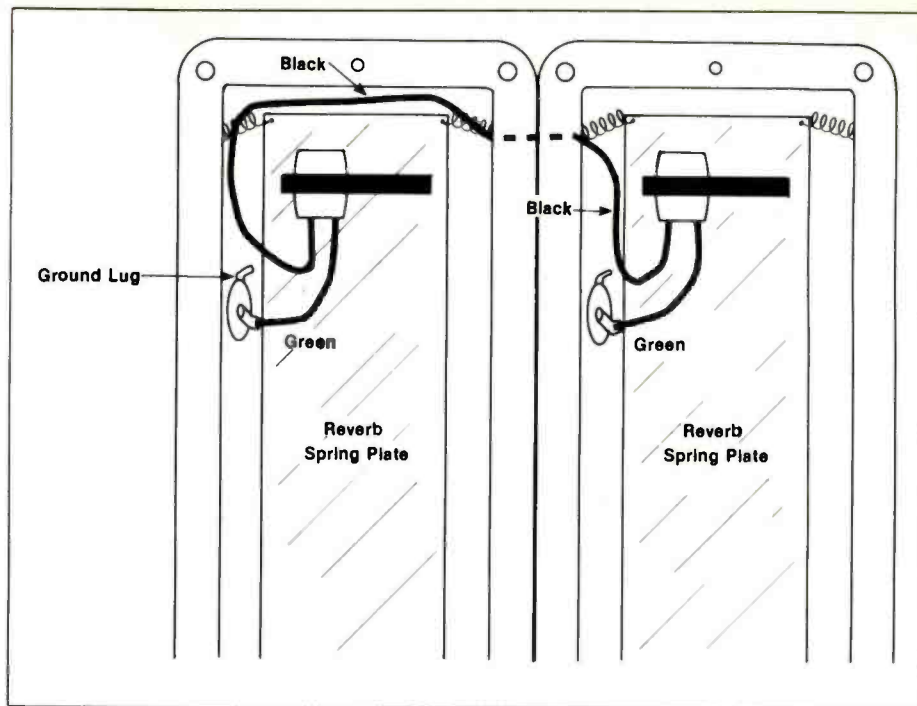

Figure 6

project, so pay careful attention to the following instructions.

Begin by placing the two reverb units side-by-side with the springs facing up, as shown in Figure 5; note that the two jacks are facing to the left. The input jacks are towards the top of this figure, and the output jacks towards the bottom. Since the input jacks are easiest to wire up, we'll do them first.

Referring to Figure 6 (which shows

the modified wiring), disconnect the black wire attached to each reverb spring's input transducer from the associated ground lug of the input jack. Next, note that there are some little springs that hold the spring plate to the case, and that these springs hook on to a hole in the side of the reverb spring case. Now connect a small piece of thin gauge insulated wire to the black lead of the left-most reverb unit,

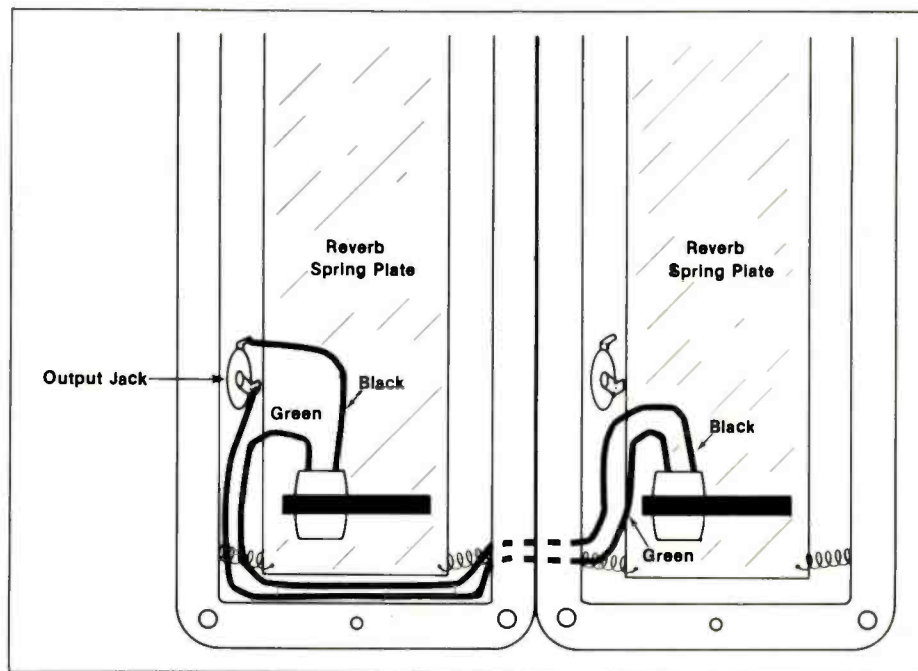

Figure 7



# The continuing story of TDK sound achievement.

## Part Four.



In previous chapters we've told you about the technological breakthroughs that make TDK tape so outstanding. We've shown you how TDK tape is wound on a perfect y circular hub/clamp assembly for the smoothest possible flow of sound. But the perfection of the first two phases would be wasted effort if tape travel were inconsistent or slowed down by excess friction. *Part Four*, the TDK bubble slip sheet, is one of our unique answers to reducing friction. On it rests TDK's reputation for smooth-running sound.

TDK engineers painstakingly studied tape travel. They found the edge of the tape comes into direct contact with the cassette at several points. At any of those critical spots, the tape can be slowed down, tilted away from the parallel, side-tracked or damaged. The need to reduce friction was evident. And it had to begin where the tape edge makes contact with the shell.

The TDK slip sheet first came into existence as a flat piece of paper. Our engineers knew it had to do more than reduce friction. It also had to maintain constant tape speed and perfect tape winding. Two formulations met the exacting TDK standards. Ultra-thin paper coated with silicone. And teflon

coated with a fine layer of graphite. To further diminish the area of contact between tape and slip sheet, our engineers created the bubble concept.

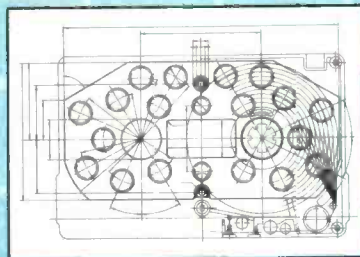

Running analysis of TDK bubble slip sheet.

Each TDK bubble slip sheet is computer-designed with twenty bubbles of varying diameters. Each bubble slip sheet is manufactured to micron tolerances to guarantee uniformity in height. In operation, the TDK bubble slip sheet maintains a constant running angle for the tape, minimizing friction. Tape winding is even and consistent. Your music is recorded and played back in a safe, reliable environment. Music is what it all

comes back to. That's why TDK considers all parts in a cassette equally important. And why every effort is made to achieve a perfect interplay between them. It's an achievement you'll hear every time you play your favorite music on TDK. Music is the sum of its parts.



**TDK**  
The Amazing Music Machine.



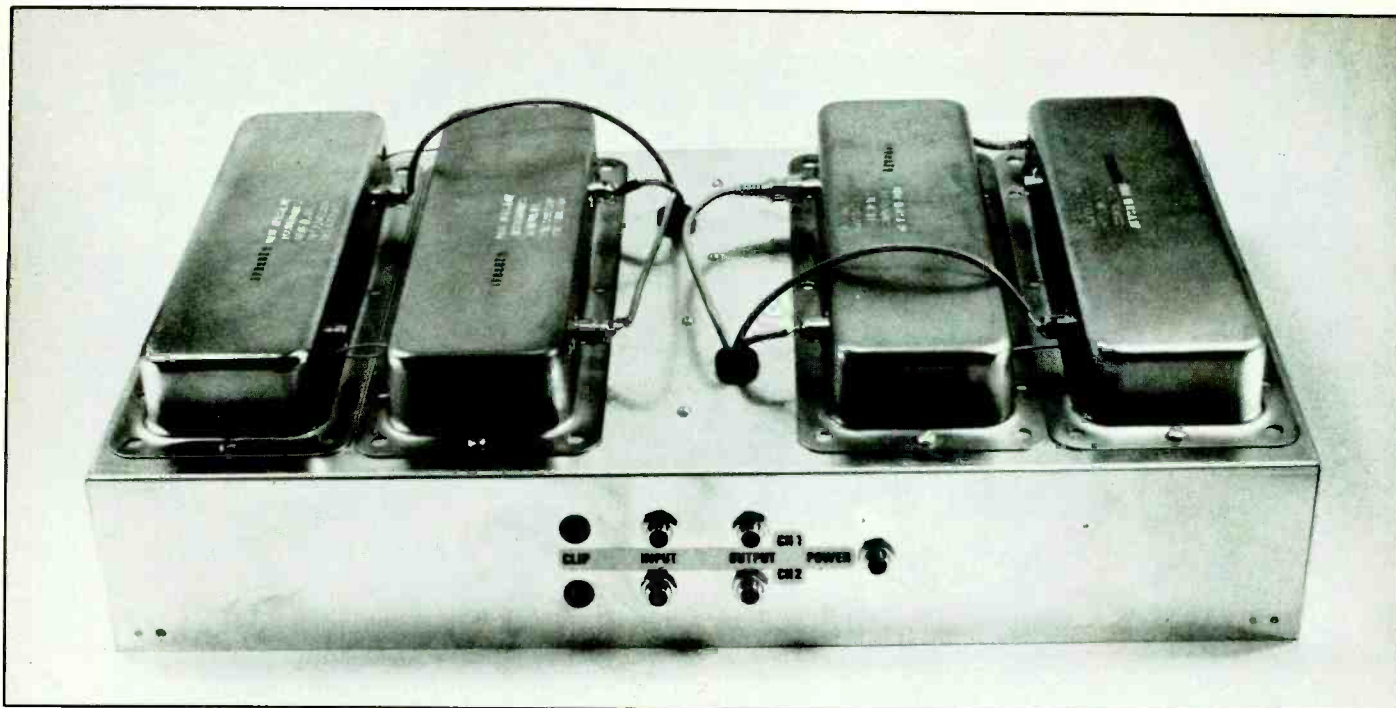

Figure 8

run it around the inside of the case as shown, and run it through the holes in both cases where the little springs hook in. Then, after you've gotten this wire inside the reverb unit on the right, connect it to the black wire coming from the remaining transducer. Finally, use a thin piece of electrician's tape to insulate the connection between the transducer leads and the added "jumper" lead. Check with *Figure 6* again to make sure everything is connected correctly, and that the extra length of wire does not interfere with the free motion of the reverb spring plate.

*Figure 7* shows a detail of the modified output jack wiring. In this case, disconnect the green wire from the left transducer and the black and green wires from the right transducer from their associated phono jacks. Connect the green wire from the left transducer to a short length of thin gauge insulated wire, and run this into the right reverb case through the case holes (like the ones mentioned above). This wire should then connect to the black wire from the right transducer. Finally, the green wire from the right transducer should connect to a wire that again runs through the two holes used for routing the last wire, and ends up connecting to the "hot" terminal of the output jack mounted on the left reverb unit. Look carefully at *Figure 7*

to check that all is well. It is important that the wires not interfere with the motion of the springs or the plate to which they connect. Make a mark on the case near the output jack so that you don't forget which one is wired to the springs.

(If you feel ambitious, the two wires connected to the output transducers can be shielded. However, you'll have a hard time finding shielded wire that's skinny enough to be comfortably routed as shown in the diagram—luckily shielding isn't absolutely necessary.)

Now that the springs have been modified, it's time to find a suitable enclosure to hold the springs and circuit board. *Figure 8* is a photo of the case I used, which is a general purpose aluminum chassis sold by electronics supply houses. Since I wanted stereo reverb, I used four springs (two for each channel). These springs should be mounted as shown; do not mount them

upside down or sideways, as they don't sound right that way. In my particular case, I mounted the two circuit boards for the two channels inside the box, and ran the connections from the boards to the springs through a few holes drilled in the chassis. The input/output jacks and LEDs mount on the front of the box as shown.

### Connecting It All Together

Now we come to the last stage. Run a shielded cable from pad I on the board to the input jack; connect the shield at the board end only. Note that there is a pad next to pad I (pad "g") where you can connect the shield. Next, run a shielded cable from pad O to the output jack; again, connect the shield at the board end to the pad "g" next to pad O. All future steps involving shielded cable should have the shields connect to the nearest pad "g" on the board. Do not confuse these with point "G," whose use will be covered later.

Now connect a length of shielded cable to point A, and terminate it in an RCA phono jack. This wire should be long enough to reach either reverb spring input jack. The shield should *not* connect to the plug's ground, but just to pad "g" on the board. Plug this ungrounded phono jack into the reverb spring input. Then, in a similar fashion, connect a piece of shielded cable to point B, with its shield con-

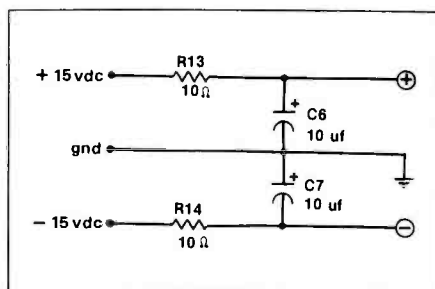

Power supply connection



 SHURE

StarMaker  
SERIES



SM77•SM78

cardioid dynamic microphones



### a new look for the 80's

There's so much new about these professional microphones we can only touch the highlights. Exclusive "picture perfect" SUEDECOAT™ Tan or Ebony matte finish looks great—*permanently*. Significantly smaller, exceptionally light in weight; yet so extraordinarily rugged and reliable we call them the "Light Heavyweights." They feature the crisp sound that makes Shure the world's most widely used professional performer microphones.

 **GENUINE**  
 **SHURE**

For more information write:

Shure Brothers Inc., 222 Hartrey Ave.,  
Evanston, IL 60204

In Canada: A. C. Simmonds & Sons Limited  
Manufacturers of high fidelity components, microphones,  
sound systems and related circuitry.

CIRCLE 118 ON READER SERVICE CARD

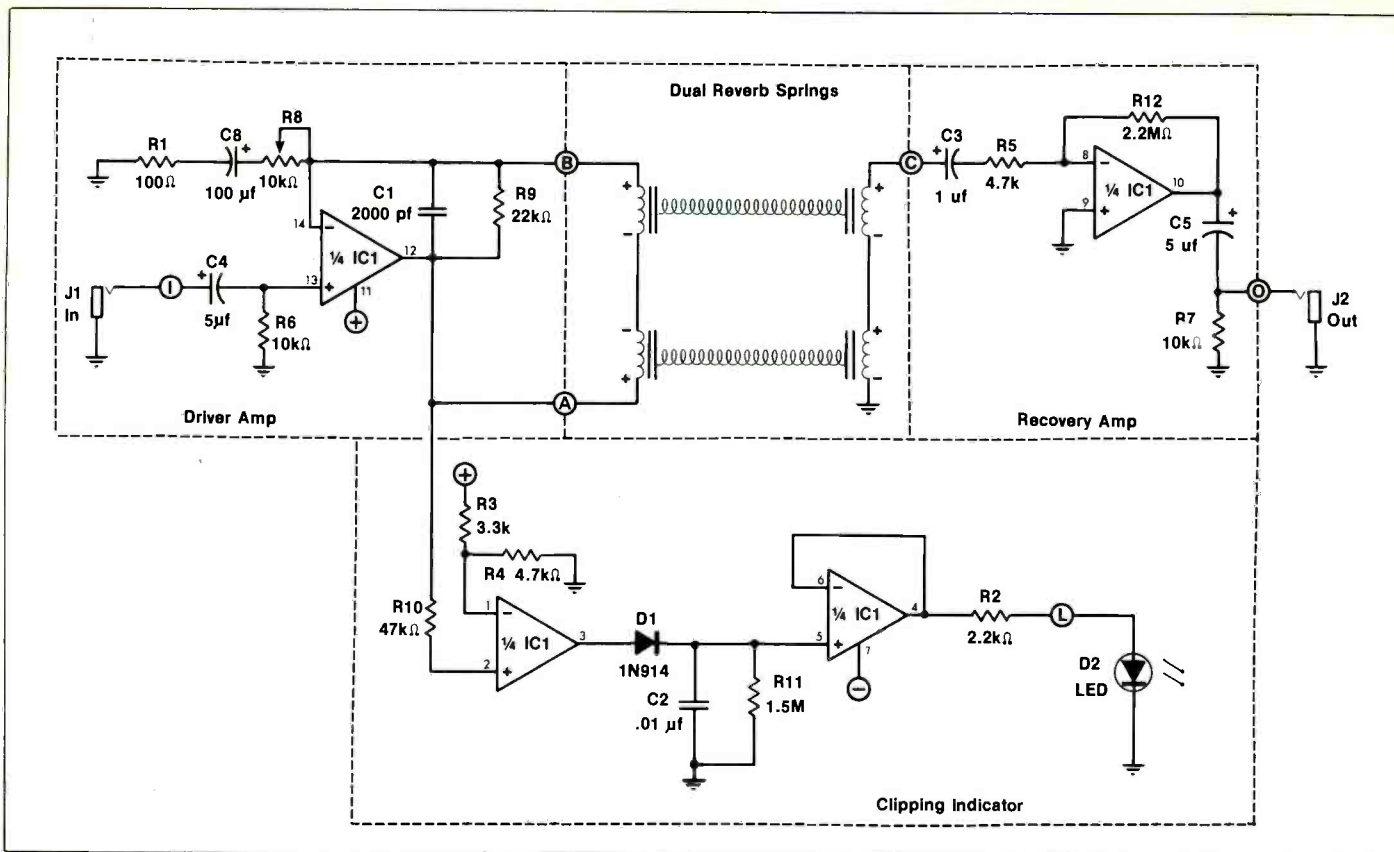

Figure 9

nected to the "g" pad near B. Again, check that the shield does *not* connect to the plug's ground. The ungrounded phono plug connected to this wire should plug into the remaining reverb spring input.

Our final piece of shielded cable connects to point C, with (you guessed it)

**SPECIFICATIONS**

Maximum input before clipping: - 10 dB (maximum sensitivity), + 15 dB (minimum sensitivity)

Input impedance: 10 k (may be changed to 100 k by replacing R6 with a 100 k resistor and C4 with a .22 uF capacitor)

Output impedance: Less than 1 k

Current consumption: + 7 mA, - 7 mA

Signal-to-noise ratio (peak output compared to residual noise): greater than 63 dB

Frequency response of reverb signal: (please note, due to the various resonances and uneven response desirable in a reverb unit, it is difficult to give accurate response figures. The Figure 10 graph is an attempt to average the response to give a meaningful composite figure).

the ground connecting to the nearest point "g." This wire should terminate in an RCA phono plug; *but this time, make sure that you do connect the shield to the plug's ground*, then plug into the reverb spring output jack you marked in an earlier step.

O.K., now we've connected the springs to the circuit board and the circuit board to the input and output jacks. Our final task is to hookup the LED and power connections. Run a

wire from pad L to the anode of the indicator LED; run a wire from the cathode of the LED to a convenient ground point, such as the ground tab of the output jack. For power, connect the +15 V line from your power supply to pad V+, the -15 V line from your supply to pad V- and the ground line from your supply to the chassis ground or input jack ground tab. In my version, I used a stereo jack

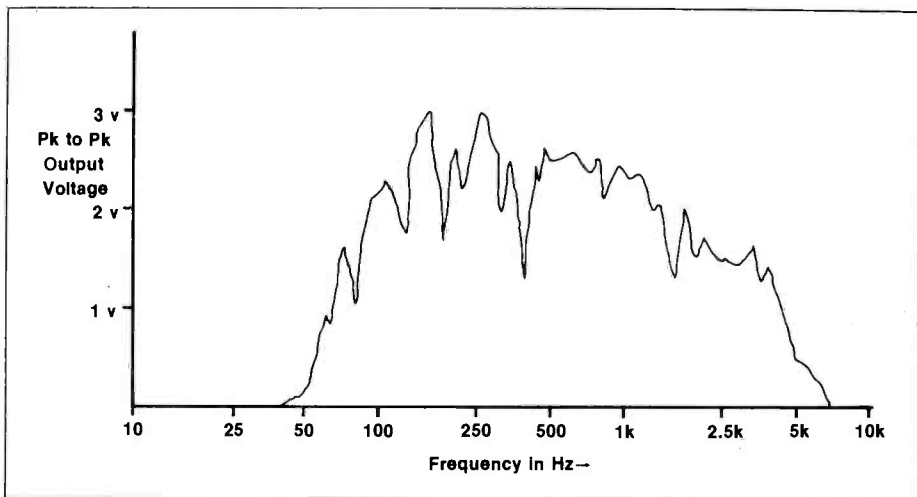

Figure 10



# CHORUS

**Chorus / kōr-əs / n**

Something sung or uttered simultaneously by a number of persons or instruments.



DOD has redefined the chorus for musicians. The 21 millisecond delay gives effective doubling and the internal oscillators bend the pitch just enough to provide realistic multiple voices. We have included a compandor for whisper quiet operation even at line levels, and the effect foot switch is active so it switches

quietly. There are two switchable speed controls that can speed up and slow down like a rotating speaker. However, the most dramatic feature is the synthesized stereo outputs. Go to your DOD dealer, plug in two amplifiers, a guitar and listen to the fullest stereo guitar sound you've ever heard.



Electronics Corp., 242 W. 2950 So.,  
Salt Lake City, Utah 84115, Telephone (801) 485-8534

CIRCLE 106 ON READER SERVICE CARD

## "HOT SPRINGS" REVERB PARTS LIST

### Resistors

All resistors are ¼-watt, 10% tolerance unless noted. 5% tolerance resistors are preferred.

R1	100 Ohms
R2	2.2 k (2 k 2 metric)
R3	3.3 k (3 k 3 metric)
R4, R5	4.7 k (4 k 7 metric)
R6, R7	10 k
R8	10 k trim pot
R9	22 k
R10	47 k
R11	1.5 M (1 M 5 metric)
R12	2.2 M (2 M 2 metric)
R13, R14	10 Ohms

### Capacitors

All capacitors are rated at 15 or more working volts.

C1	2000 pF or 2200 pF (2 nF metric) polystyrene
C2	.01 uF (10 nF metric) disc ceramic
C3	1 uF electrolytic or tantalum
C4, C5	5 uF electrolytic or tantalum
C6, C7	5 to 50 uF electrolytic or tantalum
C8	100 uF electrolytic or tantalum

### Semiconductors

D1	1N914 or equivalent silicon diode
D2	Red LED
IC1	RC4136 (Raytheon) or XR4136 (Exar) quad op-amp

### Other Parts

J1, J2	Open circuit ¼-inch phone jacks or RCA phono jacks (depends on your particular setup)
Misc.	14 pin, IC socket, Accutronics #1FB2B1D reverb spring, circuit board, solder, case, wire, etc.

(Note: a parts kit containing the above mentioned items, less case and solder, is available from PAIA Electronics for \$59.95; specify #6740-K. The circuit board is available for \$7.95; specify #6740-PC. The reverb springs are also available for \$22.95 each. All prices are postpaid in the USA.)

on the front for my power supply wiring; this enables me to use a stereo cord to plug the reverb unit into a multiple-outlet power supply.

One more thing: If for some reason you mount the reverb springs on a non-conductive material (e.g., plastic), run a wire from each reverb spring case to ground. It is important that the spring cases be grounded to keep hum to a minimum.

### Testing Time

Connect the output of the reverb system to a suitable monitor amp (with

the volume turned down!), then patch an instrument, tape track, or similar signal source into the reverb input and apply power. Turn up the monitor; you should hear the reverberated sound. Now observe the indicator LED. If it doesn't glow very much, *increase* the sensitivity trim pot so that it flashes on signal peaks in order to avoid excessive noise. If, on the other hand, the LED flashes a lot, *decrease* the sensitivity to avoid distortion. The setting of this trim pot is rather important, so don't be afraid to experiment. If you find that the reverb output is too

noisy, make sure that the sensitivity control is set properly in order to give the maximum possible level to the springs short of distortion.

### How It Works

Referring to the schematic (Figure 9), IC1A is the driver amp. Capacitor C1 tunes the reverb for a response peak at about 5 kHz, while R9 sets a ceiling on the maximum amount of gain generated by this stage. IC1C and IC1D tap off the output of this stage and comprise a simple clipping indicator. If the signal appearing at IC1's output exceeds the threshold set by R3/R4, then IC1C turns on and charges C2 through D1. C2 acts as a pulse stretcher to catch short duration transients, with the decay time being set by R11. IC1D simply buffers this cap and drives the clipping indicator LED.

Signals appearing at the spring output drive IC1B, the high-gain recovery amp stage. The 2.2 M feedback resistor is kind of extreme, but of all the configurations tested this one gave the lowest overall noise figure. R5 is a low enough value to load down the springs just a tiny bit, which reduces excessive high frequency response that would otherwise add a kind of "tinniness" to the sound. You can substitute a 10 k resistor for R5 if you'd like to trade off more noise for extended bandwidth, but I think 4.7 k gives the best overall results.

By the way, if the reverb unit has poor lead layout or ground loop problems (which it shouldn't if you followed the instructions carefully), it's possible that IC1B will oscillate. To avoid starting over from scratch, you can fix the problem by adding a 10 to 20 pF capacitor in parallel with R12. However, this should not be necessary if you grounded your shielded cables correctly and used the circuit board layout shown in Figure 4.

### In Conclusion

I hope you get as excited about this reverb unit as I am; I think it sounds real good, and am happy to be able to share it with the recording fans who devour *MR&M* each month. If you have any questions about the reverb's operation, or run into difficulty, be sure to write so that we can cover any problems in future issues of *MR&M*.

Copyright (C) 1980 by Craig Anderton





# **FINALLY!**

# **THE PHASE LINEAR PROFESSIONAL SERIES**

*Phase Linear's dedication to audio excellence has just taken another leap forward. Introducing the Phase Linear Professional Series, designed specifically for the professional.*

*Despite our objections in the past, many of our audio components designed solely for consumer use were repeatedly (and successfully) used by professional performers of all sizes, complexity and notoriety.*

*Now, after years of exhaustive field testing, Phase Linear has developed an unprecedented line of components representing the optimum in reliability and performance for the most demanding applications.*

*Contact your Phase Linear distributor or write: Phase Linear Professional Series, 20121 48th Avenue West, Lynnwood, Washington, 98036.*

**PHASE LINEAR  
PROFESSIONAL SERIES**  
*Optimum performance for the professional.*

# 5<sup>TH</sup> ANNIVERSARY ISSUE

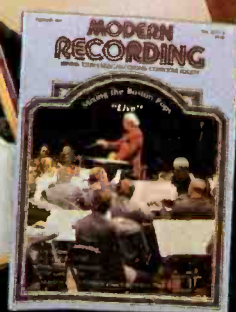
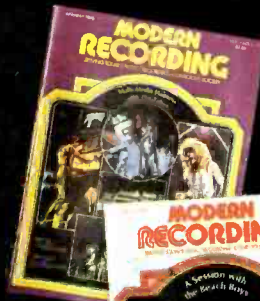
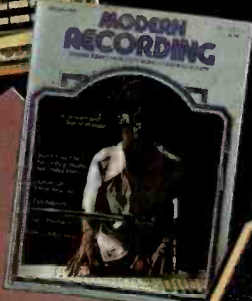
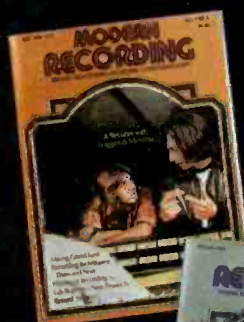







# CHICK COREA



By Jeff Tamarkin

*When you speak of jazz keyboard playing, you speak of Chick Corea. Since the 1960s, Corea has been a fixture in the jazz world. He has played (in his early years) with such luminaries as Miles Davis, Woody Shaw, Joe Farrell and Anthony Braxton, and in 1972 he formed the first of a number of aggregations going under the name of Return To Forever.*

*With such jazz giants as Stanley Clarke, Airto Moreira, Al Di Meola, Flora Purim and Lenny White taking part in the group at one point or another, RTF revolutionized jazz, becoming the most successful fusion outfit of its time and spawning countless other groups which, in turn, broadened the scope of jazz. Corea eventually disbanded the group to*



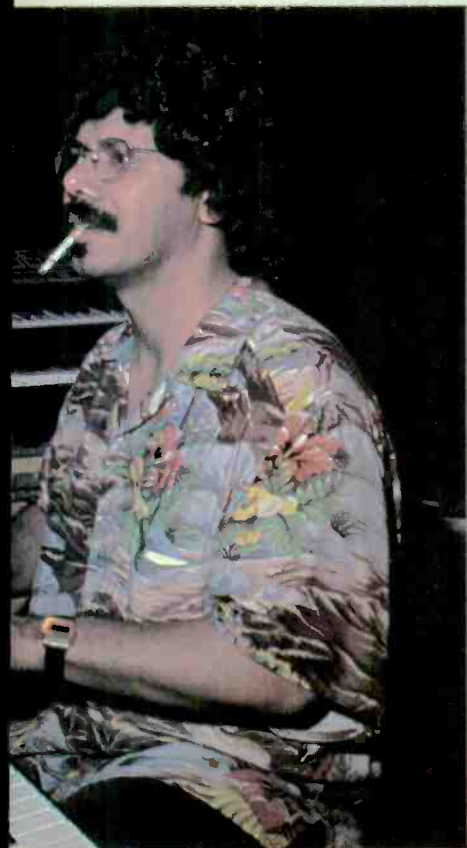

**LIVE!**

KJR

concentrate on solo and duet work, and recorded albums with pianist Herbie Hancock and vibist Gary Burton.

Early this year, Corea got back into ensemble work and released *Tap Step*, an ambitious recording on Warner Brothers Records. Produced by Corea, the album was engineered by Bernie Kirsh, who has served as Corea's

studio engineer since 1975. In 1977, Kirsh went out on the road with Corea and the last formation of *Return To Forever*, to serve as the group's sound mixer. Kirsh has traveled with Corea ever since, and the pair came to New York in early June for a three-night series of concerts at the *Bottom Line*, one of the most popular showcase clubs in New York City.



The date posed certain problems for Corea and Kirsh, as the band included seven musicians in addition to Corea, and the small stage was barely enough to contain everyone. The group—bassist Bunny Brunel, drummer Tom Brechtlein, vocalist Gayle Moran, trumpeter Al Vizzutti, sax and flute player Steve Kujala and percussionists Don Alias and Laudir

Oliveira—proved to be musically dazzling, and if there were any problems playing on the small stage in an intimate club, they overcame them without arousing any suspicions. Modern Recording & Music's Jeff Tamarkin spoke with Corea and Kirsh at the Bottom Line the day after the triumphant opening night.

**Modern Recording & Music:** What is the first thing you do when you come into a club like the Bottom Line? Where do you begin when you have an empty stage and an empty room?

**Bernie Kirsh:** We have a sound company we're working with called McCune. There's a fellow with the company named John Rusko. He's actually responsible for the set-up of the P.A.

and the other things. Mick Erickson is in charge of the stage. He's the road manager and he takes care of Chick's keyboards.

**MR&M:** Do you have other people working with the rest of the equipment, then?

**BK:** Basically, Mick is working with keyboards and Duncan Aldrich does the bass and drums set-up. Usually, by

the time we get in, it's forming on stage. We look at the room, look at the speaker placements... it's a fairly standard procedure for us.

**MR&M:** What is the step-by-step procedure in setting up?

**BK:** The piano goes on stage first, then the bass equipment. It is all wired and tested through the P.A. Then the rest goes on.

**MR&M:** The stage at the Bottom Line is fairly small for a group the size of this one; what are some of the problems with a stage that is barely large enough to hold the musicians and their equipment?

**BK:** The main problem is playing space for the musicians, elbow room. From a sound point of view, a problem is a lot of stage sound getting into the house [mix]. The other problem is a leakage problem from the monitors into the microphones. That has to be taken into consideration in getting the house mix.

**MR&M:** Still, you have to have a certain amount of sound coming from the stage. For example, when the conga player soloed last night, he did some very quiet things, and for that to come across, you had to have his volume turned up rather high...

**BK:** That may be true in some places, but in this place that stuff carries very well.

**MR&M:** Can you give a rundown of all the equipment that the band uses, starting with Chick's keyboards?

**BK:** We have a Steinway acoustic grand piano. There's a Fender Rhodes 88. On top of that is a Mini-Moog. In the normal set-up, we have a Yamaha CP 70. And there's a clavinet (Duo) and an Oberheim OBX. There's not enough room on stage for the Yamaha.

**MR&M:** Obviously, Chick could fill any hall in New York. So, what is the advantage of playing a club such as the Bottom Line?

**BK:** It's more fun sometimes. You're closer to the people and get to play more than one show. They can stretch out a little bit, and it's not quite as formal. There's a great deal more audience participation.

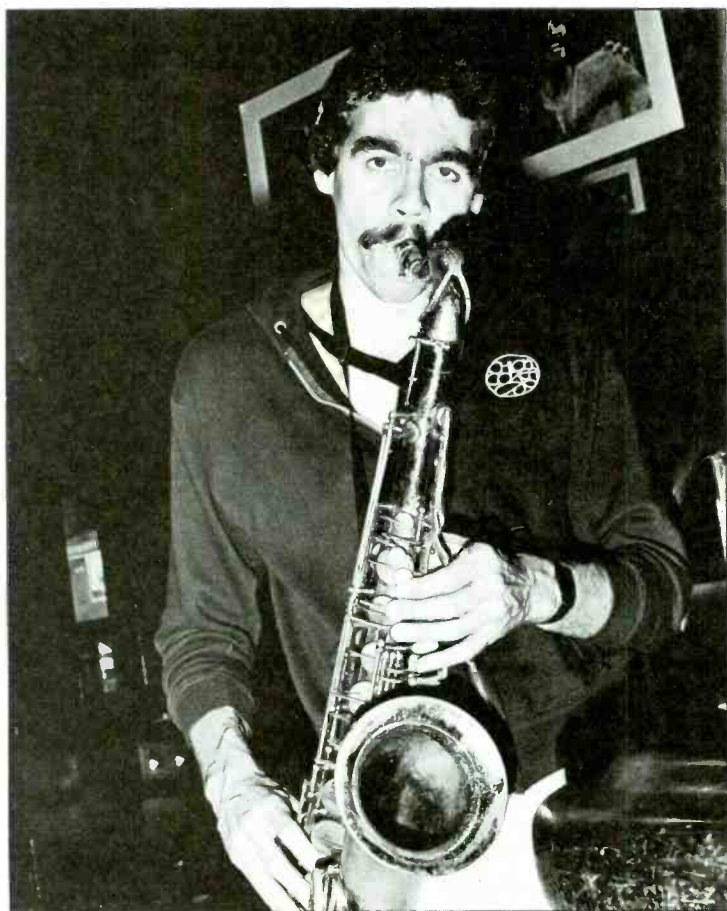

**Ensemble member Steve Kujala, who plays both sax and flute.**



**MR&M:** How is Chick's equipment miked?

**BK:** It's all direct, except for the acoustic piano. There are two Sony mics on the piano—two electret condensers.

**MR&M:** How about the bass?

**BK:** The bass is direct as well. There are two feeds from the bass. One is the direct sound and the other is an effects sender. Bunny Brunel plays a Framus bass.

**MR&M:** What does the drummer use?

**BK:** The drums are Gretsch. The cymbals are Paiste. The horns and congas I'm not sure about.

**MR&M:** What mics do you use?

**BK:** There's nothing special being used. I use Sennheiser 421s, [Shure] SM57s and SM 58s, Sony 33s. That's basically it.

**MR&M:** Would you use the same equipment in a larger hall, let's say in a theater?

**BK:** Yeah. I might use different microphones, but this is the set-up we're using on this tour.

**MR&M:** What amps are being used?

**BK:** Crown amps.

**MR&M:** What about the effects on the keyboards and bass?

**BK:** There's an MXR digital delay and phaser on the keyboards. On the bass, there's an MXR delay. The pedals are his [Brunel's] own concoction. It's all custom.

**MR&M:** Is any of Chick's equipment custom?

**BK:** No, it's all standard.

**MR&M:** Are any limiters used?

**BK:** None. There's actually no need for limiting. The system we're using has a built-in limiter for the speakers. But it doesn't limit the audio, it limits the current, so the audio doesn't suffer. You don't hear a squashed sound, just less volume.

**MR&M:** During the concert, the band went through many changes in dynamics. How much of the differences in volume are controlled by you from the board, if any?

**BK:** The musicians govern dynamics. Because I'm balancing, I may at times pull something back when it gets loud.

**MR&M:** Let's say, when the horns come in, do you have to adjust the volume of the rest of the band to compensate for the added volume of the horns?

**BK:** Sure, I'll ride them.



## Sound mixer Bernie Kirsh chats with John Rusko of McCune Sound.

**MR&M:** I noticed another sound man at the side of the stage; what does he do?

**BK:** He's running the floor monitors in front of Gayle and the horn players.

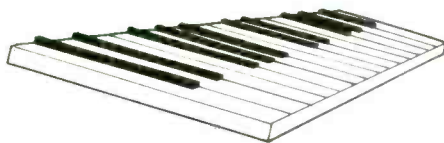

**MR&M:** You worked with Chick when he played the duet concerts with Herbie Hancock in 1978 (captured on two albums—one on Columbia and one on Polydor). What are the major differences between working a show with just two acoustic pianos and a show with a full band set-up like this one?

**BK:** The two pianos are much simpler. The halls in which we played those concerts were more concert hall-like. So, we were using the natural sounds of the room, which are designed for acoustic instruments.

**MR&M:** During much of last night's concert, Chick's keyboards were under-emphasized and other members of the band seemed louder. Of course, when Chick soloed, he was loud and clear. But during the group improvisations, was it intentional that Chick was often

not as loud as the others, or was there a problem in the mix?

**BK:** This is an ensemble, so we like to have everybody heard. If a soloist wants to solo, he'll make sure that he's heard. But last night there was a problem. Where the mixing console is located, I'm hearing a slightly different balance than people located in the center. It was compensated for during the second show.

**MR&M:** Steve Kujala plays both sax and flute. What adjustments do you have to make when he switches from one to the other?

**BK:** None, really. I actually use two different mics. One is an SM 57 for the sax, and the flute is an SM 58.

**MR&M:** Do any of the instruments present any particular problems to you?

**BK:** The one that causes the most problems is the acoustic piano. It's open and often is close to the P.A. So, to generate some volume, we have to do some playing with it.

**MR&M:** How much communication goes on between Chick and you once he takes the stage?

**BK:** He leaves the mixing up to me. We've been working long enough so that that's O.K. We keep good eye con-



tact when we can see each other—which we can here. And we like to keep the lights up so that we can see the audience.

**MR&M:** Is this tour being recorded?

**BK:** I record every concert for our “archives.” This one isn’t being recorded for an album, but just on cassette.

**MR&M:** Does Chick do much overdubbing in the studio on the “live” albums?

**BK:** Well, we did an album with the nine-piece Return To Forever, that was a four-album set and there was no overdubbing on that.

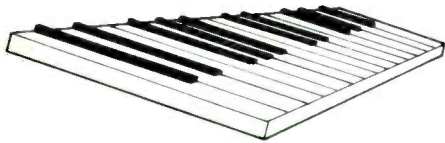

*At this point in the interview, Chick Corea came by to sit and talk. So, we turned our questions towards Chick and discussed more of the performing aspects of the date.*

**MR&M:** Let’s start with the members of the band. Where did you find all of these great musicians?

**Chick Corea:** Each one’s a different

story. Gayle and I have been together since ’75 or ’76. Her way of singing is a great instrument for me to use as a composer. Tom, the drummer, I found on Long Island. It was one of the first times I ever auditioned a musician. I just ran out of drummers and a friend of mine had him as a pupil. I loved the spirit of what he did. We’ve been together for a few tours. Bunny, the bassist, I first saw in London. I remembered his playing. A couple of months later I was doing the *Secret Agent* record, and there he was. Vizzutti, the trumpet player, I found when I recorded a piece I wrote for Woody Herman called “Suite For Heart Band.” I rehearsed the piece with Woody in Boston at the Berklee School and Vizzutti impressed me. He was just leaving Woody’s band, so I asked him if he wanted a gig. Kujala is another story, too. Joe Farrell started out on this tour for a few weeks and he needed to do some solo work. Vizzutti recommended Kujala, and based on that and his work with a group called Auracle, I chose him. And within a few days, he played the music just great. Don Alias is an old friend of mine from the 50s in Boston.



**Percussionist Don Alias  
at the congas.**

**MR&M:** I’m curious why you chose not to have a guitar player in the band.

**CC:** There’s no reason except that in addition to playing as a soloist on the Mini-Moog and the Fender piano, I love the art of accompaniment. The guitar tends to fill in the role of that sometimes. It gives me more space as a keyboard player.

**MR&M:** Do you prefer to work with a band with this instrumentation, or a band like Return To Forever, or, say, just with another pianist like Herbie Hancock?

**CC:** My taste is very catholic—musically, I like a lot of different playgrounds and games and ways of doing music. This [type of band] is one of the things I really like and have been meaning to do for a while. I haven’t had a band in a couple of years and this is a perfect rhythm, cook-on-out band.

**MR&M:** Do you use everything you have on stage during all of the shows you’re playing at this club?

**CC:** To varying degrees. I’m least familiar with the [Oberheim] OBX, only because it just arrived about a week before I made my recording (*Tap Step*). I didn’t have time to study it. The clavinet, the Hohner Duo, I’m pretty familiar with. I like to do various things with it. It’s there as a sound I can rely on all the time. It’s a touch-feel instrument and is not far away from the [acoustic] piano and the electric piano.

**MR&M:** I asked Bernie this question before, but I’d also like to ask you. When you’re on stage playing, do you try to keep up with what Bernie is doing, or do you like to leave all the mixing to him and just play?

**CC:** My ideal is not to worry about any technical aspects. In fact, a weird thought came into my mind today. I was thinking about the Mini-Moog and something I might do, and I recognized that for weeks I hadn’t touched a knob on the Mini-Moog. Occasionally I touch the tuning knob, but even that doesn’t drift anymore. Really, I walk in and start playing the damn instrument. I have one filter setting on it. When I was using the Vocoder, I would change the octave. But I love it as one single voice.

When I’m playing, I don’t like to be thinking about changing this, or changing patches. The more familiar I get with an instrument, the more simple it becomes to just work it around. Bernie and I talk things through and



we both know what we're going for. Our biggest problem is to find a way to get the best sounds in the incredible, diverse environments we play in. Bernie's on the side of making it sound good out front, and I'm on the side of making it feel comfortable on stage. We play off one another.

**MR&M:** What are some of the problems that occur when you're doing a series of one-nighters in different cities, playing different kinds of halls each night?

**CC:** Those are mostly the musicians' problems. The whole technical hookup has gotten so standard and simple. That just gets plugged in and done. We have each instrument play for a few minutes and Bernie does some EQing for each instrument. The most difficult thing is getting the musicians to utilize the acoustic environment they are in, which is different from the one they were in last night. The only answers I've even found to that are—one's a spiritual one and one's a mechanical one—to learn to listen and recognize the sound to be what it is at that instant. You have to be able to know how to define the acoustics of a place and know what works and what doesn't. The mechanical end of that is to play softer, with less sound pressure level.

**MR&M:** What are some of the specific problems, if any, you have with this club?

**CC:** It's a funny situation. On stage, it's one of the most comfortable places to play. The sound on stage is great. For instance, the congas, which have no monitoring on stage, are very present. The stage is so tiny and squashed that we can hear each other's sounds very easily. But it's a different perspective from out front.

**MR&M:** Do you like having the small stage, or would you rather have more room to stretch out?

**CC:** I enjoy it. It forces us to be close and it physically forces us to listen better. Every time we come from playing a place like this, I encourage everyone to set up closer, even if we're playing on a larger stage. The tendency is to spread out, but I like to play close. But in places where it gets so small that you literally can't fit the body, that's no good. What I did here was to eliminate the Yamaha electric piano. That gave Bunny some elbow room.

**MR&M:** Do you like playing concert halls or would you rather try to stick to clubs?

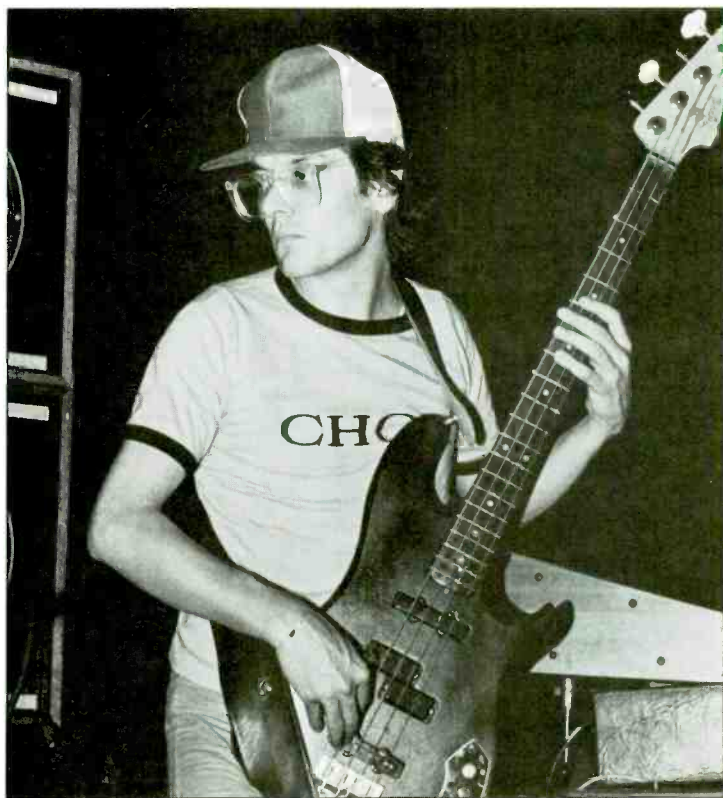

**Bassist Bunny Brunel during the sound check at the Bottom Line.**

**CC:** It depends. I like a range of moods. In some ways I can express a wider range of moods in a concert hall. Because of its atmosphere and the intention of its building, the concert hall lends itself to subtler playing and quieter playing.

**MR&M:** Really! I would have guessed that you can play more intimately in a club situation.

**CC:** No, because in a bar you have people always moving, waitresses moving; it's more informal. There are conversations going on, you're eating and drinking. In a concert hall, all the attention is on the stage, so you can create very subtle feelings. But if I did concert halls all the time, I would get bored, too. Sometimes I like to play large, outdoor environments. But I definitely couldn't do that all the time either.

**MR&M:** At a lot of jazz concerts it seems as though the musicians are on-

ly playing for themselves, and are oblivious to the audience. Your approach seems to be the opposite. You seem to really enjoy playing to people.

**CC:** I'm kind of a traditionalist as far as life in general goes. I like the realities of touch and feel and sense. As far as making music goes, the reality of it for me is playing it for people. That's the most enjoyable experience I know of. Recording is a very secondary thing to me. Recording is more the fun of doing it, and the toys of the technology, than getting off on having one record go all over the world.

**MR&M:** One last question. On a night such as this, when you're playing two shows, for a total of nearly five hours, what do you feel like after it's over?

**CC:** Totally exhilarated. It's hard to get to sleep. I've been going back to the hotel, turning on the T.V. and getting glued to the most horrible movies!



# BASSIST...

PROFILE

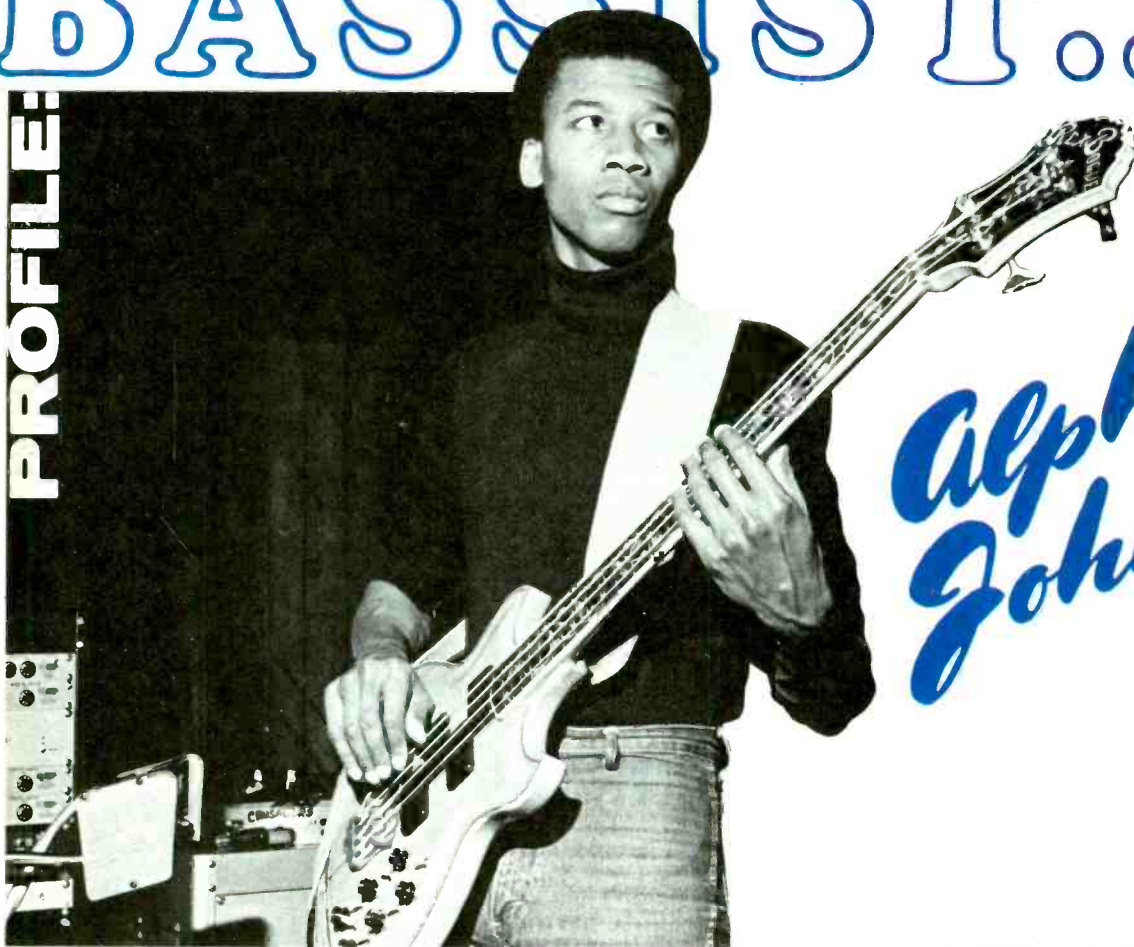

Alphonso  
Johnson

By Steve Caraway

*At the ripe "old age" of 29, Philadelphia born Alphonso Johnson has already recorded two solo albums, done extensive studio session work and played bass with some of contemporary music's most respected groups. Having been introduced to the professional ranks through Woody Herman's band, Alphonso has done residency with Chuck Mangione,*

*Weather Report, The Crusaders, The George Duke/Billy Cobham Group and Tom Scott.*

*Upon completing sessions with his new group, Los Angeles-based Johnson took a breather in San Francisco. While in the city-by-the-bay Modern Recording & Music met with Alphonso to discuss his musical past, present and future directions.*

**Modern Recording & Music:** Did your parents encourage you to take up music?

**Alphonso Johnson:** Yes and no. Coming from a large family I think my parents were more interested in my academic achievements. They looked at music as a hobby. They wanted me to go to college and be a doctor or some kind of professional. At the same time, they didn't discourage me either; they were very supportive. But they had an ultimate goal for me and they were a little disappointed when I went into music as a career.

**MR&M:** What are some of your early musical experiences that you can remember?

**AJ:** Well, before I played any instrument I sang. When I was in elementary school I sang in the All-City choir. Upon leaving elementary school I began playing the upright bass and I started training classically. I played acoustic bass through junior high school, and when I got to high school, they didn't have a band so I played trombone for about a year and a half.

After I got out of high school was when I first heard of a "Fender Bass," and I thought it was a bass shaped like a car fender. *[laughs]* I had never even heard of an electric bass before, but when I first heard one, it was so different. You know, it looked really good! The thing about the upright bass

is that it is an awkward instrument to play, to hold and to look at. It's uncomfortable! After playing the upright a while you develop this "mother-son" relationship with it, as my teacher used to put it; you learn to caress the instrument and to hold it in a warm way. But the Fender Bass, "Hey I am liberated—like a guitar player, I can move around out front!"

**MR&M:** With all the studying you must have been able to sight read early on in your life.

**AJ:** Oh yeah, I took ear training, orchestration, theory and harmony, all the courses.

**MR&M:** Were you a music major?

**AJ:** No! To satisfy my parents I



followed in the footsteps of my older brothers and pursued a career in carpentry and cabinet making. I really majored in that for about six years. Three years in junior high school and three years in high school.

**MR&M:** Who were you listening to in your musical formative years?

**AJ:** Groups like the Shirelles, Martha and the Vandellas, most of what would become the Motown groups. They were all on obscure labels back then. My brothers and sisters used to always listen to those groups 'cause they used to go out and dance. I'd just pick up on the groups that they were listening to. The first song I figured out on electric bass was "Summertime" by Billy Stewart. I must have worn that record out; I played it over and over so much! That made me feel real good because I could finally *play a song*. I went to a place called the Uptown Theatre in Philadelphia where all the groups used to play when they came to town and Billy Stewart was playing! I sat there in the theatre while he did "Summertime" and *sang* the bass part! While I sang the bass part, the bass player was improvising on the bass part, and I thought, "Wow, that's really nice!" I thought that what he was doing was on the record but a little different! That's when I got really interested in improvising and adding my own thing!

**MR&M:** Whom do you listen to now?

**AJ:** I listen to Journey, Earth, Wind and Fire; I listen to a lot of George Duke and Genesis. I listen to a lot of different people. I love [Antonio Carlos] Jobim; my tastes in music vary. I'll go to the store one week and I'll buy a few rock albums and check them out for a while and then I'll go out and do the same with some jazz albums or Brazilian music, or whatever. I am really interested in a lot of different kinds of music.

**MR&M:** When you were growing up did you play in bands with friends?

**AJ:** Yeah, we had the neighborhood guys and we would play during the days and at night we'd sing on the street corner. We'd just sing all the songs that we liked. We used to go over to somebody's basement and jam on our instruments and talk about it in the afternoon, go home and cleanup, then meet back out on the street corner at night and sing. It was sort of a gang, but it was a nice gang!

**MR&M:** You mentioned various in-

struments. What types of instruments are you playing these days?

**AJ:** The artillery consists of one fretless bass built by Charles LoBue, one fretted stereo bass built by Rex Bogue, an eight-string built by Ibanez, an Ibanez Roadster, Emmette Chapman's "Electric Stick" and a 6- and a 12-string acoustic. The 6-string is a Spanish classical guitar and the 12-string is a Woodburn, a company in Canada.

**MR&M:** As you grew up, was there a point where you realized you were going to be a professional musician?

**AJ:** I always think about that. The funny part is, never in my wildest dreams did I think that I would be a musician. Music was always considered a hobby. The carpentry was going to be the thing that I was going to develop and would be my mainstay. I was a straight A/B student in carpentry and I loved it. I love the smell of sawdust, you know? I was addicted to it! The music thing developed because I liked it and it gave me an opportunity to share a creative thing among a lot of people. Not just me working on a specific thing, as in cabinet making. The other part of it was that it was a great way to be popular in the neighborhood. You'd go out and play, make \$15 and have your pick of the ladies.

Another thing that kept me in there was the challenge. I've been fortunate because I have always played with musicians who are older than me and people who were *that* much better than me. I have always been in a situation where I was learning, where I was always kicked in the ass because I was the least knowledgeable, and I always had to struggle to keep up. I was the musical director for this vocal group called the Majestics in 1968. The musicians in the band, some of them were in their 30s and had been around—they knew all Bird's [Charlie Parker] stuff; and here I was, a kid, telling them what to do.

**MR&M:** How did the professional angle of it come about?

**AJ:** It just sort of evolved. The word spread that I was a young and up-and-coming bass player. I got a call to work with this band—Sherman Ferguson and Catalyst—in Philadelphia. After working with them a while I got a call from the late Gregory Herbert, who was a saxophonist with Woody Herman's band. He had heard of me because he and Sherman worked together, and he

told me that there was an opening for a bass player in Woody Herman's band. I had never, *never* thought that I could work with someone like Woody Herman. The gig opened up and I went there; scared shitless to say the least. *[laughs]* Woody called me back, and at first I said no because it meant leaving Catalyst hung up for a bass player. Then Gregory called back and I said yeah. When I said no, I felt real good because I was being loyal to the band [Catalyst]. But then I felt that it was an opportunity of a lifetime. The second time I said, "Yeah, I'll do it!"

The first gig we did was a dance, and Gregory was up in his dressing room going over all the charts with me, and then we went downstairs an *hour* late. Gregory was always late! From Woody Herman I went to Chuck Mangione after he had heard me. From Chuck I went to Weather Report and from Weather Report to Billy Cobham and George Duke. From there, Billy and I formed a band with Tom Scott and Steve Khan and Mark Soskin, and after that, here I am with my new group!

**MR&M:** How different was it working with Weather Report than with Duke/Cobham?

**AJ:** With Weather Report there wasn't as much organization. It was, "Hey in two weeks we're going out and do this and do that." Or, "Hey let's talk about concept; what are we going to play?" And, "How are we going to feel the audience out?" "What are we going out to do?" With Weather Report it was, "Hey how ya doin', let's go out and play!" We'd go up on stage and jam. We would jam off of themes, but that was basically the extent of it.

With the Cobham/Duke situation, we pretty much sat down and talked about what *exactly* we wanted to do. We wanted to improvise, but more towards a rock format, a little heavier. We wanted to play loud. We wanted to do it with lyrics and vocals. We wanted to make a "cross-over" attempt! The concepts of the groups were different.

**MR&M:** How about the work you're doing with the Crusaders?

**AJ:** That is another situation where it is like a dream come true! I had admired those guys for a long time and I grew up listening to their music. The thing that was nice about it was I got to work with them at a time when they really needed a bass player and it was great for me. so I was not only honored

## “... never in my wildest dreams did I think that I would be a musician.”

but I felt *needed*. They didn't treat me like a sideman. They've really got a format down and a direction, they basically need someone to just keep up with them and give them a little challenge when they play. When Wilton Felder told me that he hadn't practiced for 12 years, and he said that when we went out and played together it was the first time he felt like pickin' up his horn before the gig and gettin' into it. He knew it was going to be a fun evening, and that made me feel great!

**MR&M:** Can you give me a line-up of your new band and tell me what we can expect?

**AJ:** Basically, it consists of a lead vocalist, guitar, bass, drums and keyboards. The band was really put together as a concept about three years ago. It's really a takeoff from my last album *Spellbound* on Epic, where I tried to do everything: sing, write and arrange and play all the instruments. I wanted to do the same kind of thing but I wanted to hire other people to fill the certain roles. This would free me up to be more creative on my end. It's different from what I am used to doing. It is definitely more rock oriented. It was great because while working with them, it was like I was a sideman. I didn't have all the pressures that I had before. Yet I still had the responsibility to make sure it was happening, and I had to pull it all together.

**MR&M:** Can you run down the personnel for us?

**AJ:** Joe Turano is the lead vocalist, Mitch Brownstein is an 18 year-old lead guitarist from Fort Lauderdale. Mitch is amazing. He has the potential to become a monster guitar player! On keyboards we have Jesse Harms and Vinnie Appice on drums.

**MR&M:** You were one of the first well-known artists who has incorporated Emmette Chapman's Electric Stick into your music. How did you get introduced to that truly amazing instrument?

**AJ:** I went to an Indian restaurant in West Los Angeles with a friend of mine. There was this tabla player and this other guy—Emmette Chapman—on Electric Stick. I didn't think about it much, in fact I was a bit annoyed because I had to *listen* to this in-

teresting music while I ate. I remember liking the tabla player and the music, but it didn't hit me right away. Then Joe Zawinul, who had contacted Emmette early on about The Stick, got one and started practicing. I thought, "Well, if he's going to play it, I am going to play it!" So I picked it up. Joe was really the one that got me into playing it. When he had The Stick, I used to go over to his house and mess around on it. He had it on the road and I'd pick it up and practice some stuff. I was fascinated by it. I was fascinated by the fact that you could play percussively with *both* hands. I started doing that a little bit on bass, with a left hand pizzicato (plucking the string with the left hand). But I never really developed it.

There is a bass player in New York named Tony Levin who used to do some things with his left hand where he'd hold the bass note and then play a two note chord, a root and a third, and it sounded really good! so when I saw The Stick I said, "Yeah, that's it! I gotta play it!" I started playing it in 1975 and I took some lessons from Emmette. As a matter of fact, I've composed two songs for an upcoming album on The Stick. One of the songs called "Looks Can Kill" was composed specifically on The Stick! I took the melody to the band and then Joe, Jesse and I collaborated on the lyric. I am not really the hot soloist on this new instrument; mainly I use it for composing songs. It was always a struggle for me to play piano, at the same time it was easier for me to learn to play guitar. I think that made it easier for me to adapt to The Stick as opposed to the piano.

**MR&M:** What type of gear did you use on your recent sessions?

**AJ:** I used most of my instruments really. I used my Moog Taurus bass pedals on a song called "Time Capsules." I used my B.A.S.T.A.R.D., which stands for Bass Amplification System Through Added Regenerated Devices. The B.A.S.T.A.R.D. is a series of outboard gear rack-mounted and hooked up to give me the ability to set up all my gear, as far as volumes and tones of each instrument, and leave it set up so that I can play through effects without having to go

back and constantly readjust settings. It took a long time to develop the system.

This company in Boulder, Colorado, called Backstage, was made up of a couple of guys, Tom Beamen and John Herchinder, who originally were with Malatchi. They built the B.A.S.T.A.R.D. and they used some Malatchi mixers in it. What the system is, is that I have eight channels of instruments and eight separate channels of effects, which I can blend together and have come out of a stereo system. All of the effects are foot controlled so I don't have to worry about turning things off and on. It's really nice; it's a Godsend!

**MR&M:** What are some of the devices that are mounted in the B.A.S.T.A.R.D.?

**AJ:** There's an Eventide Harmonizer H910, a Lexicon Prime Time, four Allison Kepexes, two Allison Gain Brains, a Backstage custom-made Bi-Phase and also an instrument patch bay. I'm using four Malatchi mixers. The top one, the master or PM 54E, has four channels and also two overall master volume controls, left and right. The other three mixers, each having four volume controls are PE 54Cs. On all of the mixers, each channel has a volume, EQ with a 20 dB boost either way, an effects send and a pan pot. The effects send determines how much of that signal gets sent to any given effect in the chain. Then I have an effects return which effects the masters, so I can control it through the master channel. For example, if I decide that I want to sing, play my stereo bass and play the Moog Taurus pedals simultaneously, while at the same time I want to have Harmonizer on my voice, have a delay repeating on the bass, and have a slight delay on the Taurus pedals, I can do that with little trouble. Before, if you tried to send all that through one amplifier, it would be a mess. When I first took the system out with the CBS All-Star tour in 1977, I had a few problems, but since then we've installed some limiters and the system is very clean now.

**MR&M:** Any other problems alleviated by your B.A.S.T.A.R.D. system?

**AJ:** The biggest problem I ran into on the road was that if you're in an



# THE NEW 900 SERIES MODULAR SIGNAL PROCESSING SYSTEM. IT'S COMPACT. IT'S FLEXIBLE. IT'S dbx.

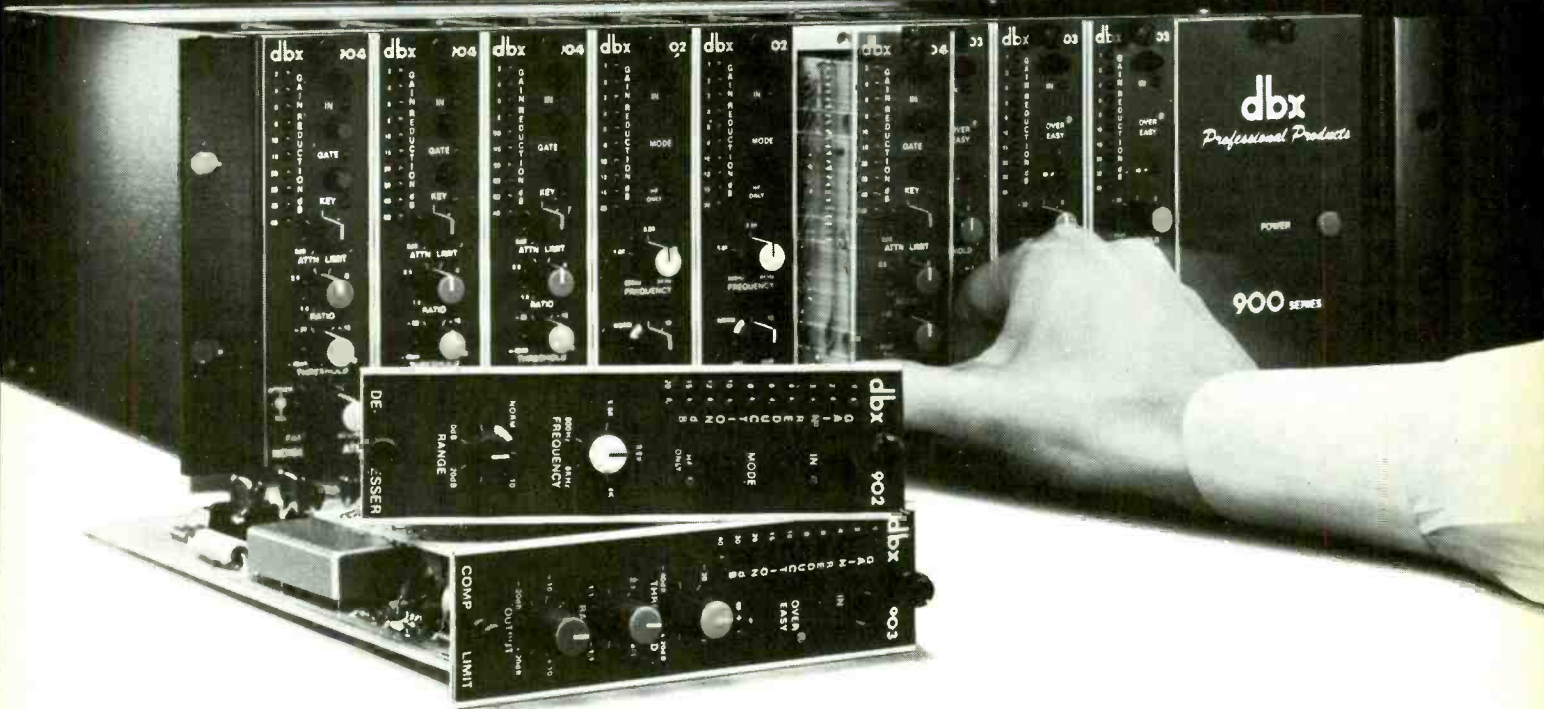

With rack space at a premium, you want to save space anywhere you can. That's why dbx is introducing the new 900 Series Modular Signal Processing System.

You start with a single, easy-to-install 5¼" x 19" rack with built-in power supply. Then just slip in the modules you need. Up to 8 dbx signal processors, with storage for a ninth.

But the modules themselves are the real stars.

Our Model 902 is the only de-esser that continuously analyzes the input signal spectrum, providing the exact amount of de-essing you want regardless of signal level. And the 902 can be used broadband or on high frequencies only.

The 903 Compressor offers a special negative compression feature. In use, it actually begins to attenuate at the threshold, which gives the signal a new sense of punch. Of course the 903 also features our Over Easy compression as well as true RMS level detection.

Our 904 Noise Gate features adjustable attack and release rates, Over Easy downward expansion, a special key input that allows you to gate one instrument by another, and a unique "gate" mode which eliminates the need to gain ride solos during multi-track mixdown.

The 900 frame accommodates dbx noise reduction modules as well.

And this is just the beginning of our signal-processing system. Soon we'll be offering an equalizer, a flanger, and more.

So now you've got a signal processing system that's everything you want.

It's compact. It's flexible. Best of all, it's dbx.

dbx, Incorporated, 71 Chapel St., Newton, MA 02195. 617/964-3210.

**dbx**<sup>®</sup>

CIRCLE 92 ON READER SERVICE CARD



You've already purchased the equipment . . .

Now, how are you going to mount it?

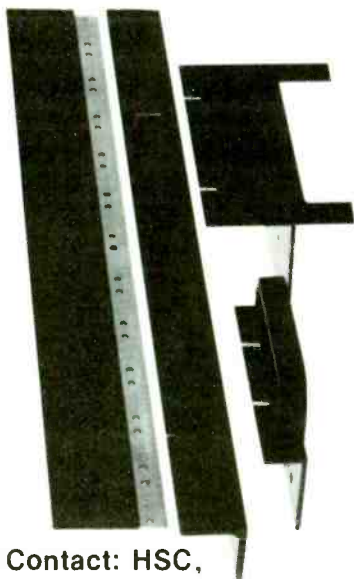

Contact: HSC,

- we are the only manufacturer and distributor of custom mounts
- we offer, in stock, mounting hardware for all audio and video equipment



**Special!**  
**Teac and Tascam rack mounts \$35.00 a pair this month**



Now that you've purchased the equipment... contact HSC to mount it!



PHONE NO. 312-452-5551

CIRCLE 41 ON READER SERVICE CARD

#### SELECTED DISCOGRAPHY

<i>Catalyst</i> , Catalyst	(1972)	Cobblestone
<i>The Land of Make Believe</i> , Chuck Mangione	(1973)	Mercury
<i>Mysterious Traveller</i> , Weather Report	(1974)	Columbia
<i>Sunburst</i> , Eddie Henderson	(1975)	United Artists
<i>Tale Spinnin'</i> , Weather Report	(1975)	Columbia
<i>Moonshadows</i> , Alphonso Johnson	(1976)	Epic
<i>I Heard That</i> , Quincy Jones	(1976)	A&M
<i>Yesterday's Dreams</i> , Alphonso Johnson	(1976)	Epic
<i>Heavy Weather</i> , Weather Report	(1976)	Columbia
<i>Capt. Fingers</i> , Lee Ritenour	(1977)	Epic
<i>Spellbound</i> , Alphonso Johnson	(1977)	Epic
<i>Everyday, Everynight</i> , Flora Purim	(1978)	Warner Bros.
<i>Moving Home</i> , Rod Argent	(1978)	MCA
<i>Electric Guitarist</i> , John McLaughlin	(1978)	Columbia
<i>Touching You, Touching Me</i> , Airto	(1979)	Warner Bros.
<i>Street Life</i> , The Crusaders	(1979)	MCA
<i>Rhapsody In Blues</i> , The Crusaders	(1980)	MCA

opening act situation, and if you're lucky enough to get a sound check, you've got very little time to make sure everything is hooked up right and working correctly. Then the thing is they have to strike (break down) everything, and then set you back up again and nothing is ever the same. With the B.A.S.T.A.R.D., I don't have to worry about changing the settings, once I get it set up, it's set.

**MR&M:** What kind of amplification are you using with this set-up?

**A.J.:** I have been using Phase Linear amps. I have a Phase Linear 700 for the low end and I have two cabinets with two 15-inch Gauss speakers. The cabinets were custom made by a company located in L.A. called Pirate Sound in 1976.

I also have some 12-inch cabinets that were built by a friend of mine who worked at JBL. They are designed according to the Bose speaker design of the angled front. I have two 12-inch speakers in each cabinet and I have two cabinets and they're powered by a Phase Linear 400. All of my equipment was designed to do a specific thing. I got sick and tired of doing an album with all these great effects, and then going "live" and not having those effects at my disposal. A classic example was that I went to see Grover Washington after the *Mister Magic* album came out, and he didn't have the guitar player. I mean it was the guitar player who made that song happen for me. It was great when Grover Washington played the tune, but it was missing *it*, you know? I said to myself, "There is no reason that should happen." I wanted to get to the point where I could represent myself "live" with the same quality as on record.

When I had my fretless bass built, I had Charlie LoBue incorporate certain things. For instance, the angle of the headstock is, to me, one of the most important considerations when building a quality instrument. It determines the tension of the strings and it can make the difference between a note jumping out or just sounding flabby. The wood used for the fingerboard, the type of wood used for the neck and the body, how dense the body is, they all enter into the overall sound the instrument produces. When I ran into Rex Bogue and heard his pickups and hot preamps, that's what I wanted to hear. I wanted to hear the real high end of the bass as well as the real low sound characteristics. That's part of my sound and I couldn't get it with the traditional instrument.

**MR&M:** How do you like performing "live?"

**AJ:** I am really into creating a mood. I am not into lasers and smoke bombs, but I like a situation where people can come and feel that they really got something for their money. Those people should be *thoroughly* entertained and they should get off on the whole effect. I think that's what is needed these days because audiences are very sophisticated; they really appreciate fine lighting and sound.

**MR&M:** What projects are you going to be working on in the near future?

**AJ:** Well, I just talked to Phil Collins [Genesis] and he's got a solo album that I am probably going to be playing on. There is a tour of Japan coming up as part of the Aurex Jazz Festival. I am going back to L.A. and will write some more . . . so I'll be staying pretty busy with the band and all. I am a workaholic, and I prefer staying busy.



MODERN RECORDING & MUSIC

If You Haven't Purchased The Equipment Yet, Contact HSC. We Sell All Major Brands.

P.O. BOX 155  
RIVER GROVE, ILLINOIS 60171



If you could hear this ad,  
we wouldn't have to write it.



Visit a Bose® Professional Products Dealer  
and listen to the Bose 802.

Bose Corporation, Dept. MR  
100 The Mountain Rd.  
Framingham, MA 01701

Please send me a copy of the Bose Professional  
Products Catalog and a complete dealer list.

Name: \_\_\_\_\_

Address: \_\_\_\_\_

City: \_\_\_\_\_

State: \_\_\_\_\_ Zip: \_\_\_\_\_

Tel. (     ) \_\_\_\_\_

Covered by patent rights issued and/or pending.  
© Copyright 1980 Bose Corporation

**BOSE**®

Better sound through research.



## Fender Twin Reverb Amplifier

By Brian A. Roth

**EDITOR'S NOTE:** *This review is the first in a staggered series of musical instrument amplifier evaluations. We decided to test the Fender Twin Reverb for this initial amplifier appraisal because it is a very popular, widely used amplifier. Thus, the descriptions and measurements can be used by the reader as an initial reference point for comparisons when future amplifier reviews are published.*

*For those who regularly read the "Lab Report" and "Hands-On Report" columns in MR&M, the bench measurements of the Fender Twin may look rather poor; after all, modern power amplifiers exhibit ruler-flat frequency response and total harmonic distortion (THD) figures of .01% or less. Keep in mind, however, that instrument amplifiers are generally not designed for high fidelity reproduction, but rather for the initial signal "generation." Consequently, a non-flat frequency response or a high amount of distortion can be thought of as a type of signal enhancement.*

*We are anxious to hear readers' comments concerning our coverage of this amplifier so that we can evolve as complete an evaluation format as possible.*



**WHAT IS IT?** The Fender Twin Reverb is a self-contained musical instrument (amplifier chassis and loudspeakers are in one cabinet) amplifier of tube-type design with two input channels. The first "Normal" channel has two ¼-inch phone jacks for instrument interface, and

volume, bass, middle and treble controls. A slide switch provides an additional treble boost function. The second "Vibrato" channel has these same features in addition to vibrato speed and depth controls and a reverb intensity control. To the far right end of the front panel is a master volume control which affects both input channels, and will allow the input preamplifiers to be overdriven to generate more distortion while keeping the acoustical output level in the playing environment at a reasonable level. A pilot light is also included on the front panel.

Found on the rear of the amplifier chassis are the AC power on/off switch, a "standby" switch which keeps the tube filaments warm while deactivating the audio output and a three-position ground switch to minimize hum and buzz. Standard ¼-inch phone jacks are provided for the two internal 12-inch "Fender design" loudspeakers as well as an external loudspeaker if so desired. The footswitch which activates the vibrato and reverb effects connects via RCA phono jacks mounted on the chassis rear, as do the reverb tank input and output lines.

Physically, the Twin is a relatively compact unit that is covered with a black, pebble finished vinyl. The review sample was fitted with casters to allow the amplifier to be rolled around, although a plastic handle was mounted on the top of the unit as well.

The steel amplifier chassis is mounted to the top of the cabinet, with the tubes "hanging" upside down from the chassis; metal tube shields secure the small preamplifier tubes, while metal clips hold the larger power output tubes in place.



The loudspeakers are mounted from the rear of the open-back cabinet, so replacement of the loudspeakers would be quite simple if that should ever be required. The reverb spring "tank" is mounted inside the cabinet on the bottom panel.

The amplifier chassis can be extracted from the rear of the cabinet after removing four long screws from the top of the cabinet and a small vinyl covered wooden plate located at the cabinet rear. The electronic components inside the chassis appeared to be of good quality, and service access was excellent.

Fender supplied a small, but thorough, owner's manual and a schematic diagram.

**PERFORMANCE EVALUATION:** We secured the services of two guitarists and proceeded to experiment with this latest edition of the Twin. Fender and Gibson guitars were used during the course of the evaluation.

The two input channels each exhibited a slightly different tonal characteristic, even with identical tone control settings, which gave a wider variety of sonic possibilities. The tone controls themselves had a sufficient amount of variability to suit the tastes of the musicians. An interesting characteristic of the Fender tone control circuit would cause the audio output to be almost completely attenuated when all three potentiometers were turned fully counter-clockwise to the "zero" setting.

The vibrato circuit actually produced a tremolo effect; vibrato is basically defined as a periodic fluctuation of pitch while tremolo is a fluctuation of volume. The range of speed and depth was more than adequate, although both guitarists expressed little interest in using the effect, apparently due to the changes in guitar styles that have evolved over the years, and not due to any deficiency in the effect itself.

We did notice a soft thumping sound that varied in speed in response to the vibrato speed control; this minor aberration was more apparent at high volume settings, but did not create any real problems.

We experimented with the reverb, and found it to be typical of most "built-in" reverb effects. When picking the guitar strings sharply, the spring unit would generate a slapping "boink" that is characteristic of this type. At low to moderate reverb mix settings, the "twang" was acceptably low, and the overall reverb sound quality was adequate for the purpose.



We next experimented with the master volume control. With the input volume controls turned "up" and the master volume pot set at a lower level, it was possible to create a "dirty" sound quality without extreme sound pressure levels in the room. The opposite combination of settings created a cleaner and louder (and the Twin can get loud!) output. We did note that the type of distortion generated by overdriving the preamplifier (i.e., master turned down and input turned up) was not the same as merely "cranking up" all the volume controls. One of the guitarists described the sound as "mushy," and this can be attributed to the distortion characteristics of the

preamplifier as compared to the power output stage. Nevertheless, the ability to generate controlled distortion at lower sound pressure levels was a useful feature, and through judicious setting of the controls a most acceptable distortion was produced.

Fender has an additional feature in the master volume control circuitry. By pulling the master knob, a switch activates an additional overdrive effect that increases the distortion as well as apparent volume and sustain. Again, this type of distortion does not sound quite the same as playing at a loud level. It did offer a wider variety of possible distortion characteristics, and consequently was judged to be quite useful.

Because the tonal quality of an instrument amp is almost strictly a matter of taste, it is impossible to make specific comments. Suffice it to say that both guitarists were quite pleased with the results they achieved while experimenting with the Twin.

We noticed that the treble control on the vibrato channel was noisy when rotated, but this seemed to clear up after working the control back and forth several times. Overall, the Twin was a *most* satisfactory performer.

**BENCH TESTS:** We first measured the power output, and observed that it met or exceeded the Fender specification. Just before amplifier "clipping" or overload, the Twin produced 108 watts RMS (or average, if you prefer) of output at 1 kHz, and an even 100 watts at 100 Hz and 5 kHz. These tests were conducted with the amplifier's output driving a 4-ohm load resistor, as recommended by Fender. Distortion characteristics varied depending upon input level and power output, but with 30 millivolts input (fairly typical of a moderately low output guitar) and 100 watts output THD measured 2.9% at 1 kHz and approximately 3.3% at 100 Hz and 5 kHz. With a 25 millivolt input and a 50-watt output level, the THD figure dropped slightly to 2.5% at all three frequencies, and with 5 millivolts input and 10 watts output level, THD measured about 1.8% at





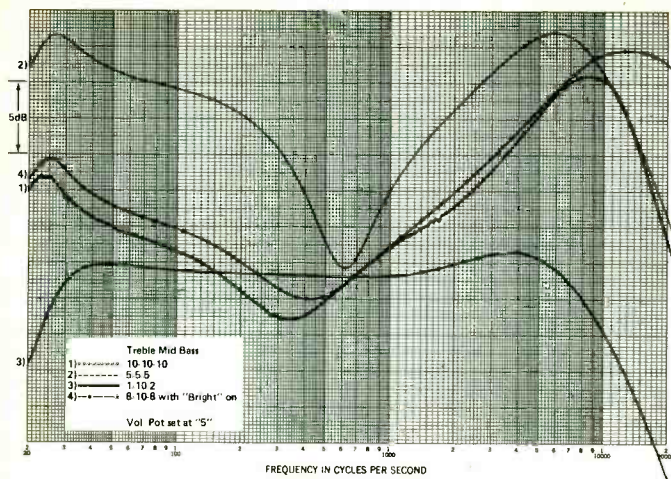

**Fender Twin Reverb: Frequency responses for the "Vibrato" channel. Again each curve has different settings for treble, mid and bass controls, and fourth curve has "Bright" switch on, volume pot at "5."**

the three test frequencies. Distortion components were mostly second, third and fourth harmonics, although at the 100 watt output some additional higher odd-numbered harmonics were observed.

When driven into clipping, the waveform observed on the oscilloscope was quite symmetrical, except in cases when the preamplifier rather than the power amplifier was overdriven. In this case, the clipping was very "soft" and non-symmetrical, which would account for the differences we heard when experimenting with the master and input volume controls during our earlier listening tests.

We conducted SMPTE intermodulation (IM) measurements (this consists of driving the input of the amplifier with two tones, one at 60 Hz and the second at 7 kHz mixed 4:1) and observed similar distortion figures at the three different power output levels used for the THD test, and the average level was just under 4%.

Next, we measured the frequency response of the Twin with various tone control settings. Due to the interaction of one control with another, it was impossible to generate curves for all the combinations. However, we plotted four different curves for both of the input channels. There was no absolutely "flat" setting, although we sure looked for one. Curve 3 was the closest that we could achieve. Naturally, a totally flat setting is not necessary in a musical instrument amp.

The general curve was what some people call the "California Curve," which is a healthy boost at low and high frequencies. This curve is quite typical in this application, and produces the familiar electric guitar sound quality; a totally "flat" response would sound lifeless since we are all used to hearing the results of that particular type of frequency response.

An interesting characteristic of the "bright" switches was observed. Electrically speaking, the switches bypass high frequency signals around the volume control. Consequently, the frequency response of the amp when the bright switch is activated will vary depending upon the input volume control setting. When the volume pot is "wide open," the switch has no effect. At lower settings, the tre-

ble boost is more pronounced. Curve number 4 was generated with the volume control set to "5." We should also point out that the four curves generated by the plotter are at a relative level from one to another since we had to keep readjusting volume controls to eliminate clipping and to keep the plotter's pen from running off the paper.



We next checked to see how high an input signal level the Twin would accept before overloading the preamplifier stages. Due to the wide variability of the tone controls, the maximum input level prior to overload would also vary greatly. However, when we reduced the input volume control to a very low setting we observed that approximately 250 millivolts at 1 kHz was required to "clip" the input preamplifier stage. This figure dropped with higher volume control and with various tone control settings since the stages after the volume and tone controls would go into an overload condition.

Because the Twin is a tube-type design, the input impedance was very high—well over 1 megohm—which should preclude excessive "loading," and hence tonal alteration, of the musical instrument's audio output.

**CONCLUSIONS:** The Fender Twin Reverb amplifier has been in production, with various minor design changes, for probably two decades. That should demonstrate the high degree of acceptance of this amp with musicians. The Twin can be considered as a classic design with sturdy, intelligent packaging. It is sized just right for easy transportation, and yet can produce very high sound pressure levels.

Some people may argue the merits of "pre-CBS" and "post-CBS" versions, but little has been altered in the basic design over the years. We hope Fender will continue to keep the Twin in its product line for at least another two decades.

CIRCLE 1 ON READER SERVICE CARD

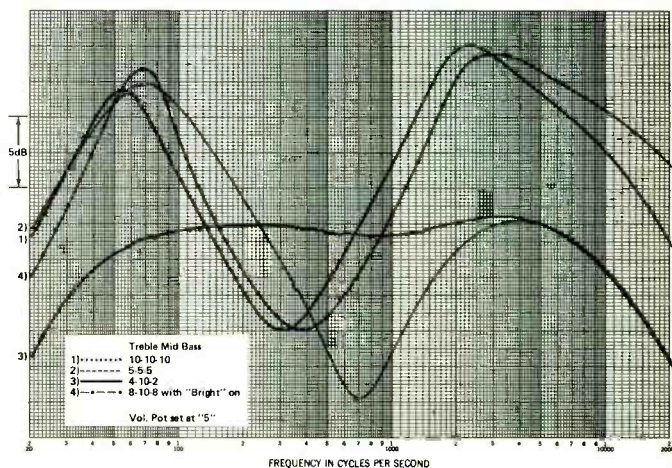

**Fender Twin Reverb: Four frequency response curves plotted at different settings for treble, mid and bass controls. Fourth setting was with volume pot set at "5"; "Bright" switch on the above is for the "Normal" channel input.**



# You can tri ours with a lot less... than you can bi theirs.

Bi-amping and tri-amping (electronically dividing the frequency spectrum into low-high/low-mid-high bands and amplifying them separately) are quickly becoming the expected methods for insuring the low levels of intermodulation and harmonic distortion so necessary for clean, accurate reproduction of today's music. Unfortunately, this involves the use of multiple power amplifiers and electronic crossover networks — usually a substantial financial burden for the average musician or sound engineer.

To help ease that burden, we have incorporated circuitry for **two** separate and

independent electronic crossover networks into our CS Series stereo power amplifiers. Bi-amp operation is enabled by merely selecting and plugging in the appropriate crossover module. Utilizing an additional power amp makes tri-amp operation possible. In addition, we have included our unique DDT® compression

circuitry to virtually eliminate amplifier clipping and the associated headroom problems, transformer balanced input capability, and two-speed forced air cooling.

There are many good power amplifiers on the market today, but not one can match the quality, versatility, performance, and, most importantly, the

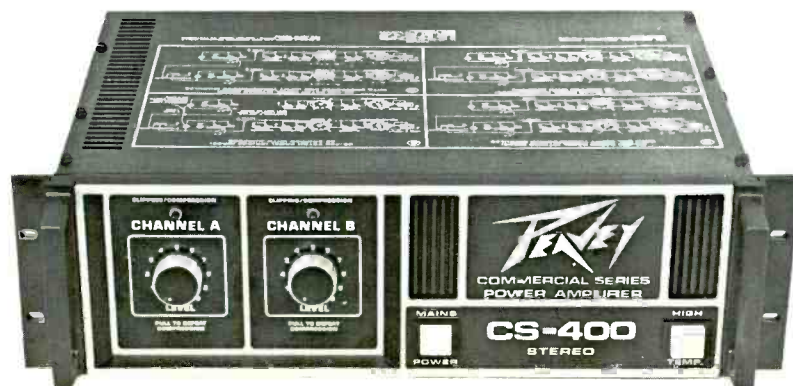

incredible dollar value offered by our CS Series. We invite you to compare specs, features **and** prices. You'll see why so many are choosing Peavey.



**PEAVEY ELECTRONICS CORP.**  
711 A St./Meridian, MS 39301  
© 1980

*"Peavey makes it possible"*

CIRCLE 89 ON READER SERVICE CARD

# Ambient Sound

BY LEN FELDMAN

## All That Noise . . .

No matter what sort of program source you have to deal with in the electronic reproduction of music, you are faced with an unwanted signal component called noise. Though some of us may describe some of the program material we have to deal with as noise, the real definition of noise is any signal that is not part of the original program being recorded or reproduced. Generally, noise means random noise, such as tape hiss or record surface noise, but it can also be used to describe such unwanted signals as power supply hum or buzz, where frequencies are defined and not random.

Ever since the beginnings of electronic sound reproduction, scientists and engineers have been fighting noise. You've probably heard about new digital recordings (so far limited to tape) which have banished noise "completely." Well, that's not quite true. There is still some measurable noise even on digital audio tapes; it's just so low in amplitude compared with the signal (signal-to-noise ratio) that you can't hear it during normal playing conditions.

Since digital discs or, for that matter, home digital tape decks are still a ways off, I thought it might be a good idea to review some of the basics of noise reduction circuitry: when these noise reduction systems should be used (and when not), what the differences are between the more popular N/R systems and what the trade-offs are when using noise reduction in the first place.

## Dolby Is Still Number One!

Despite the recent proliferation of noise reduction systems, Dolby B noise reduction is still number one as far as home audio recording is concerned. So, let's talk about Dolby—or, more specifically, Dolby B. The reason the "B" is in the title is because Dolby A, the first noise reduction system developed by Dr. Ray Dolby, is strictly for pro equipment. Dolby B operates only at high audio frequencies (where the tape hiss is) while Dolby A works on mid-frequencies as well as highs. Dolby B is, first of all, a two-part system. For it

to work properly, music must be recorded with Dolby B *encoding* and must be played back with a proper Dolby B decoder turned on. During encoding, low-level, high-frequency program content is *boosted* (to get it up and over the noise floor), but high-level highs remain essentially unaltered in amplitude. During playback, the reverse takes place, with low-level highs cut, much as they would be with a tone control turned counter-clockwise. Treble cutting in this way, on a dynamic basis (depending upon *level* of highs) restores everything to flat response while at the same time attenuating any tape hiss that would have been added to the program by the recording electronics or the tape itself.

There are several key points to remember about Dolby B. For the system to work properly, record calibration must track perfectly with playback calibration of the tape deck. More often than not, this is a factory adjustment, but if front or rear panel controls are available on your deck for Dolby calibration, make sure you follow the instructions regarding this important calibration procedure carefully. If playback decode does not track properly with record encode, not only will the system fail to produce desired noise-reduction results but response will no longer be "flat" at all playback levels of the recorded program. Another point to bear in mind is that Dolby B can do nothing for program material that already has noise content. In other words, if you want to dub or copy a tape that is not Dolby encoded and that sounds "hissy" during playback, the copy will be just as hissy even if Dolby is turned on for the tape dubbing on the deck that is making the copy. If you think about it, that makes sense, because the noise you hear is, for all intents and purposes, part of the "program" and therefore cannot be sliced away from it during the dubbing or copying process. There are dynamic filters which can help such tapes, but they are not true closed-loop noise reduction systems like the ones we are discussing here. Finally, if you want to copy a Dolby-encoded tape onto another



machine, the best way to do that is to leave the Dolby switch *off* on both machines while the copying process is going on. The tape original is already Dolby-encoded, so all you need to do is transfer exactly what's on the tape to the dub without any further encoding. When you want to play back the copy, however, you would of course turn *on* the Dolby circuit to get proper decoding and noise reduction.

### The dbx Approach

Whereas Dolby B (and several other NR systems) process only one portion of the audio spectrum (the highs) during the encode and decode phases of noise reduction, the dbx approach deals with the entire program content, regardless of frequency, and is called linear companding. Here's how it works: for every two dB of level change in program content, the linear compression circuitry of the dbx system turns out a signal with a 1 dB level change. Thus, if the loudest and softest moments of a given program to be recorded have a difference in level of 80 dB, for example, this will come out of the dbx encoder as a maximum difference in level of only 40 dB. A big advantage of this approach (and one not directly related to noise reduction) is the fact that this sort of compression makes it possible to "fit" wide dynamic range programs onto recording media such as cassette tapes that would not otherwise accommodate such wide swings of loudness. If the compression that takes place were all in one direction, (louds getting softer), the dbx system would offer improved dynamic range but no noticeable noise reduction. In fact, compression takes place in *both* directions. Louds are made softer (downward compression) while the very softest sounds in the program are compressed *upwards* (made louder) during the encoding or recording half of the process. As a result, during playback, when the softs are now expanded downward (made even softer, or returned to their true relative levels), any tape noise, which might be regarded as a form of ~~quite~~ **sound**, is also pushed **downward in level**—by as much as 30 to 35 dB.

A great advantage of the dbx system is that it does not require critical calibration. Since the compression is *linear*, the system will track well from encode to decode at just about any level you choose for a reference level. A disadvantage lies in the fact that the encoding is so extreme that it is almost useless to try to play back a dbx-encoded tape unless you own a dbx encoder. (That's not true of Dolby, where, if a Dolby tape is played back on non-Dolby equipment, it is still fairly acceptable, even if not perfect in response at all levels). The one thing that's true about both of these systems, though, is that neither of them can remove noise from a program source that is already laden with it.

### Two-Band Noise Reduction Systems

As we mentioned earlier, Dolby B deals only with high frequencies. While it is true that most of the ob-

jectionable noise we hear on tape is in the form of hiss (high frequencies), there is also noise in other parts of the audio spectrum. As for the dbx companding system, while it deals with all frequencies, it does so by considering all tones to be part of a single band. Professional noise reduction systems split the audio spectrum up into two or more bands to minimize so-called "breathing" or "pumping" effects (perception of the action of the noise reduction electronics as an audible effect apart from the music itself). Recently, a couple of manufacturers have introduced consumer noise reduction systems which divide the spectrum into more than one frequency band. The first of these to gain recognition is the High-Com II system developed jointly by Nakamichi and Telefunken (see test report in this issue of *MR&M*). In principle, the High-Com II system works very much like Dolby, except that encoding and decoding occurs in two frequency bands and in different amounts for each band. As a result, the High-Com II system is able to provide more than 20 dB of noise reduction, as opposed to the 10 dB (above 5 kHz) offered by Dolby B. Incidentally, aside from the already stated reason of compatibility which prompted Dolby to limit his noise reduction improvement to only 10 dB, another good reason was his desire to minimize any audible side-effects when the system is used. The more extreme the noise reduction, the greater the side effects ("breathing or pumping") are likely to be in a one-band system such as Dolby. Thus far, the High-Com II system has been marketed only by Nakamichi in this country, and at that, it is offered as an add-on device rather than as a built-in feature on any of their cassette decks.

Another two-band noise reduction system was recently introduced by Sanyo and is called Super-D. We reported on this add-on noise reduction device in the July issue of *MR&M* and, basically, the Super-D system seems to combine some of the virtues of the High-Com II with those of dbx companding in that it offers two-to-one (dB) companding in a two-frequency-band configuration.

In discussing frequency-selective noise reduction systems such as Dolby B, we must also mention JVC's noise reduction system which they call ANRS (Automatic Noise Reduction System). Originally, the working parameters and calibration of the ANRS system were not compatible with Dolby B, but from everything we are able to determine, in more recent embodiments of the ANRS system, you could take a tape encoded using ANRS and play it quite successfully on a deck having Dolby B decoding and vice versa and would barely notice any difference.

### At the Other End of the Dynamic Range Scale

Some years ago, JVC improved upon their ANRS by coming up with "Super-ANRS." And, because they chose to use the same initials, many mistook the new





'58 was a  
very good year...

**The '80's will be even better!**



The PL80 is going to be the hottest vocal microphone of the '80's. It is the microphone every vocalist wants because it has the sound every vocalist wants. The sound of the PL80 results not only from extensive user field testing with rock superstars like Steve Perry of Journey, but also from side-by-side product comparisons and interviews with many of the most highly respected sound men in the business. Most of all, the PL80 is the result of an entirely new application of computer-design technology called "fast Fourier transform" that allows the design engineer to predict, as it's being designed, precisely how a microphone will sound in use, not just in a sterile test environment. The

PL80 is a performing vocalist's microphone that has been called the best new microphone design in years.

The Electro-Voice PL80 not only gives you the exact sound you want, it does a whole lot more. The PL80 tops the competition in just about every performance category. Its style sets it apart from any other mike. Its sensitivity is higher than the current best-selling microphone, and when it comes to gain before feedback, the monitor speakers are likely to give out before the PL80 will.

Even the "feel" of the PL80 is impressive! It has the weight and the "heft" to give you confidence. The new snow-gray finish and contrasting charcoal gray grille screen make a striking impression on stage, but the colors are subtle enough not to detract from your performance. E-V's exclusive Memraflex grille

material resists the dents and knocks common to other microphones. This will keep the PL80 looking like new for years while other mikes look old after one or two accidental drops.

Use the PL80 at your Electro-Voice PL Microphone Dealer. Test it against any other mike. If you want your sound to be the sound of the '80's, the PL80 — the "Sound of the '80's" — is the only mike you'll buy.



600 Cecil Street, Buchanan, Michigan 49107

In Canada:  
Electro-Voice, Div. of Gulton Industries (Canada) Ltd.,  
345 Herbert St., Gananoque, Ontario K7G 2V1.

CIRCLE 82 ON READER SERVICE CARD

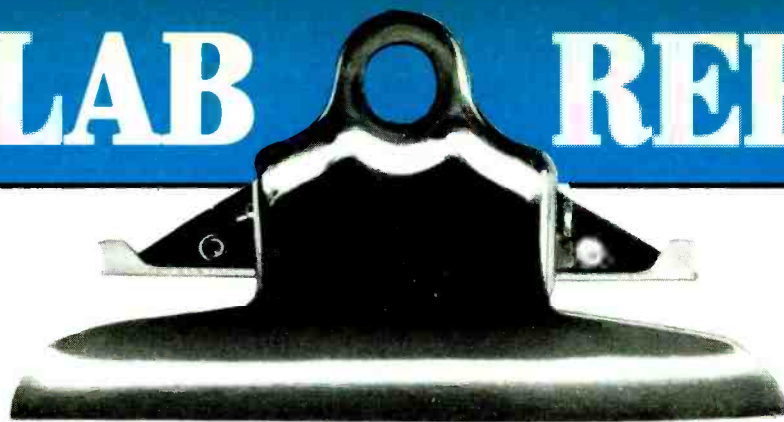

NORMAN EISENBERG AND LEN FELDMAN

## Lux M-4000A Power Amplifier



**General Description:** The Luxman M-4000A is a two-channel (stereo) power amplifier using direct-coupling and Lux's newly developed duo-beta circuitry, which refers to two feedback networks ("beta" is the engineering term that describes the magnitude of feedback in an amplifier). Conservatively rated for 180 watts minimum continuous output power per channel, the M-4000A incorporates both speaker and amplifier protection features.

The front panel has two large average signal level meters calibrated from  $-30$  to  $+3$  dB. Under each meter is an additional LED scale showing peak levels. Separate switches over at the right activate the meters and peak indicators, and may also be used to change their sensitivity so that both indicators will operate at low output levels. Centered between the peak indicators is a standby lamp that blinks when power is initially turned on and goes out in about 8 seconds to indicate that the amplifier circuitry is ready for operation. The meter lamp comes on at that time too. The standby lamp also will blink should one of the protection cir-

cuits begin to operate.

Also on the panel are two input level controls, and the amplifier's power off/on switch.

Inputs at the rear are phono-tip types; speaker outputs are XLR connectors. Pre-wired adapter plugs are supplied for those users who prefer not to use the three-pin connectors. On the top of the chassis, between the two massive heatsinks, is a subsonic filter switch for use with certain types of loads, as explained in the owner's manual.

An all-DC design, the circuit in the Lux M-4000A uses MOS-FET output devices. The use of two feedback systems (duo-beta) is based, explains the manufacturer, on the idea that too much negative feedback in the audio range, while it can reduce static forms of distortion such as THD and SMPTE-IM, will in turn introduce other forms of distortion (such as TIM) which are audible during music listening. However, in order to lower overall feedback amounts, it is necessary first to design an amplifier that has wide bandwidth and low distortion before any feedback is applied. Still,



lowered feedback in the subsonic region can have undesirable results—specifically, damping factor is poorer which means that speaker cones are free to wobble widely in the presence of warp frequencies caused by warped records used as program sources. Lowered feedback in this region also means that a DC amplifier becomes more subject to DC drift. Enter the second feedback network whose effect is introduced below about 5 Hz, serving to stabilize the amplifier's DC operating points and to act as an ultra-subsonic filter. The result, claims Lux, is tighter overall bass, negligible IM products introduced within the audible range and a "warmer" more accurate sound in the mid- and high-frequency portions of the range.

**Test Results:** In our lab tests, the Lux M-4000A met or exceeded its published specifications and generally shaped up as one of the finest power amplifiers we have yet encountered. Actual output power per channel went well beyond the 180-watt level, and all distortion measurements proved significantly lower than claimed. (Incidentally, our reading of 0.0007 percent for THD was so low that it could be obtained only by using an indirect method involving the lab's spectrum analyzer.) The test data, listed in the accompanying "Vital Statistics" table, add up to a superior, well-designed amplifier.

Structurally, the M-4000A is both handsome and rugged. The unit is supplied in a rosewood-finished case and presents a stylist appearance. More important, examination of the innards reveals superior construction and layout of parts. A view of the inside is

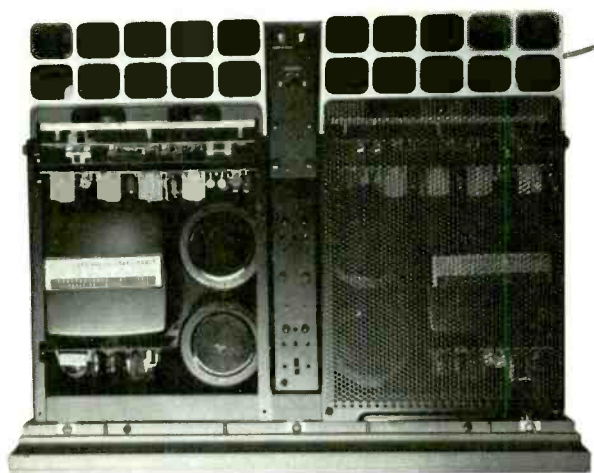

**Lux M-4000A: Internal view of the power amp. Note heatsinks and subsonic filter switch.**

shown in the internal photo of the unit. With the cabinet removed, there is a protective screen over the circuit parts. In our photo, the screen over the right half of the amplifier has been removed for a clearer view of the circuit board and power supply. We note that separate power supplies are used for each channel. The subsonic filter switch (which changes the DC coupled input to AC input) may be seen between the "chimney" heatsinks.

**General Info:** Dimensions are 19 $\frac{3}{32}$  inches wide; 15 $\frac{1}{2}$  inches deep; 6 $\frac{1}{8}$  inches high. Weight is 66 pounds. Price is \$1495.

**Individual Comment by L.F.:** The Luxman M-4000A looks much like that company's earlier model 4000 amplifier introduced about five years ago. To my view that is both fortunate and unfortunate. Fortunate from an aesthetic viewpoint since the original 4000 (and its successor the 4000A) impressed me as an elegant amplifier with its sculptured, three-dimensional front panel fairly spelling out the ruggedness and quality that lay behind it, and its "chimney" heatsinks at the rear instilling total confidence that here was an amplifier that would never have a heat problem. The wood surround further gave me the impression that just because an amplifier is capable of delivering high audio power levels doesn't mean it has to look like a piece of industrial machinery.

The "unfortunate" aspect of the physical resemblance between the old M-4000 and the new M-4000A is that perhaps unsuspecting potential buyers might assume that the model change—designated only by the added letter A—is nothing more than superficial differences from the earlier design. Nothing could be farther from the truth, as I learned from examining the newer amplifier which is a totally redesigned amplifier, from the power supply on up. In fact, the resemblance to the older model is purely cosmetic—and even here, some subtle refinements are evident. For example, the illuminated power meters which, on the older model, were slow-acting meters with essentially VU ballistics, are now quasi-peak indicators. And where the LED peak power indicator banks on the older model 4000 were conventional round lights, the newer model uses rectangular LEDs—a small matter, perhaps, but one that makes the unit more attractive to look at.

The more important differences, of course, are hidden inside the unit, including the DC circuitry and the use of MOS-FET output devices in place of the earlier bi-polar output transistors. The duo-beta feedback system does what Lux claims for it, according to our test measurements and to my own listening tests. I





# Nakamichi High-Com II Noise Reduction System



**General Description:** Nakamichi's High-Com II noise-reduction system, developed jointly with Telefunken, is a two-band compander (hence the II in the name). Simply stated, in any compander the dynamic range (difference between softest and loudest signals) is compressed so as to fit "comfortably" within the limitations of a storage or transmission medium, such as tape. The weakest signals are thus amplified and recorded at a level above the inherent noise of the tape. At the same time, the strongest signals are recorded below the level of severe distortion. On playback, the signal is expanded so that weak signals are made weaker (to compensate for the extra gain they received during compression). The noise level, which is weaker yet, is thereby reduced to inaudible levels. The strong signals, on the other hand, are amplified to compensate for the compression they underwent earlier.

Nakamichi's High-Com II is designed to perform in this manner, but with the added benefits of preserving transients, and without the side effect known as "breathing." Low distortion, and no introduction of sonic coloration also were design goals in this project. High-frequency transients require that a signal processor have a fast "attack time" to recognize an abrupt change in signal level. Too fast an attack time, however, can cause the device to respond unduly to low-frequency signals and thereby introduce bass distortion.

Nakamichi's solution to this problem has been to divide the musical spectrum into two ranges, so that highs and lows are processed separately through their own circuits. This technique has been in professional-grade noise reduction systems but has never before been offered in a format and at a price that would appeal to a larger market of audiophiles and "semi-pro" recordists. (The original Dolby system, using four frequency ranges, costs thousands of dollars; the Dolby-B, widely used in cassette decks, confines its action to only one frequency range, above 5 kHz). High-Com II is rated to provide 20 dB of noise reduction through the entire audio band. The reduced tape distortion is said

to make for 5 dB more of headroom, so that the total improvement in dynamic range comes to 25 dB.

The product that embodies this design concept is styled in typical Nakamichi fashion, with black matte panel and neat, though legible, control markings. Of rack-mount width and fitted with handles, the front panel has two peak-level signal meters (one per channel) calibrated from -40 to +10. To their right are two rotary switches, followed by four knobs and the device's AC power off/on button.

The first rotary switch is a mode selector with positions for calibrate, record, pass and play. In "calibrate," a built-in 400-Hz tone generator supplies a test signal for calibrating levels. The actual controls for level adjustment in this process are at the rear, and the meters provide readout for the process. The meters also are used as guides when recording.

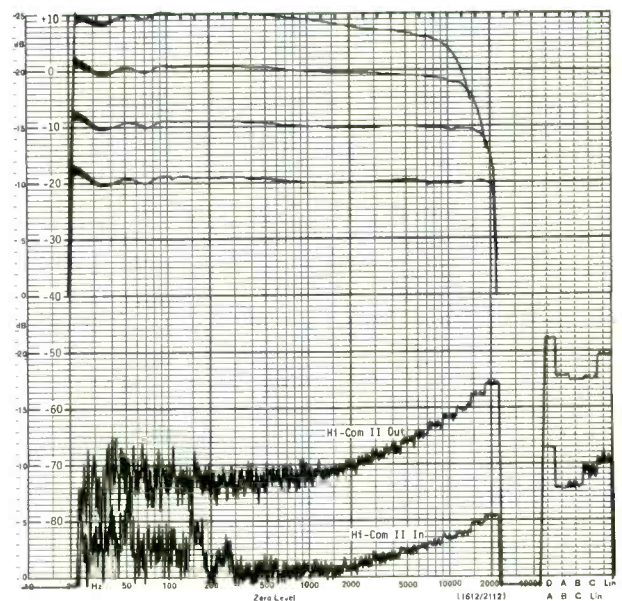
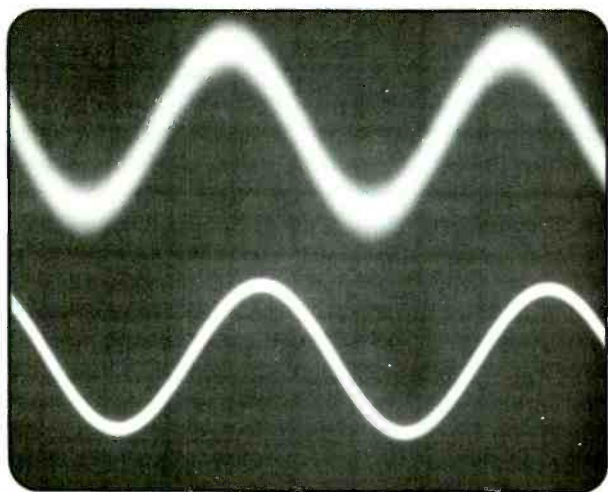

**Fig. 1: Nakamichi High-Com II: Frequency response and noise analysis with and without High-Com II.**

The next rotary switch handles a built-in filtering system for subsonic, off, multiplex and multiplex with subsonic filtering. The four knobs are for output (playback or monitor) level, left- and right-channel recording level and a master input level.

The High Com-II is patched into a sound system via the pin-jacks at its rear. The normal interfacing is between the tape connections of an amplifier and the line connections of a tape deck. There are consequently stereo pairs of jacks for line in, line out, record out and play in. Associated with the last two pairs of jacks are the individual channel calibration level adjustments, small knobs near the jacks.

**Test Results:** In lab tests and in use- and-listening sessions the Nakamichi High-Com II acquitted itself admirably. Bench test results confirmed or exceeded published specifications. Hands-on use tests confirmed the device's effectiveness in operating "as claimed"



**Fig. 2: Nakamichi High-Com II: Playback of 400 Hz signal recorded at -40 dB without High-Com II (upper trace) and with High-Com II in-circuit (lower trace).**

with an absence of coloration, breathing and an ability to preserve the crispness and impact of transients.

In a technical paper that introduced High-Com II, Nakamichi published a plot of frequency response and noise analysis, with and without High-Com II in the circuit. The deck used was Nakamichi's own model 680, and the tape was Nakamichi's metal-particle ZX. We offer this material in *Fig. 1*. Normally we would *not* publish a manufacturer's test results, but in this case our lab owns the same deck and so we were, in fact, able to repeat Nakamichi's tests. Our results, though not plotted on the same type of chart recorder used by Nakamichi, were virtually identical to those shown in *Fig. 1*. The pen traces on the lower right-hand corner of the graph paper show overall wideband noise levels with various weighting curves or filters. With "A" weighting, the noise reduction is exactly 20 dB. The

overall increase in dynamic range is actually a bit better than 20 dB because the High-Com II continues its companding action beyond "0 dB." With the equipment used in these tests, the 3-percent THD level occurs at a true recording level of +6 dB (where "0 dB" equals 200 nWb/m). With High-Com II in the circuit, its 2:1 compression ratio raises the 3-percent THD point to +12 dB. Since "A" weighted noise (with High-Com II "on") is 74 dB below 0 dB, that makes the total dynamic range referenced to 3-percent THD a total of 12 plus 74, or 86 dB.

If graphs and weighted noise curves are not your dish, *Fig. 2* may be simpler to understand. Here, the upper sine wave seen on the 'scope is a playback of a 1-kHz signal that was recorded (without High-Com II) at a very low -40 dB level. The lower trace shows the same signal, this time played back after having been recorded with High-Com II in the circuit. The noise reduction is quite apparent.

**General Info:** Dimensions are 18<sup>31</sup>/<sub>32</sub> inches wide; 3<sup>1</sup>/<sub>2</sub> inches high; 10<sup>1</sup>/<sub>8</sub> inches deep. Weight is 11 pounds. Price is \$420.

**Joint Comment by L.F. and N.E.:** The Dolby-B noise reduction system is generally acknowledged to be a major reason why cassette tape recording has achieved the popularity it has in recent years. We all tend to accept Dolby-B as a rather obvious concept in noise reduction. Yet, if you analyze the choices made by Dr. Ray Dolby when he developed his consumer version (the professional Dolby 4-band system, of course, predates the Dolby-B), you might discern that a great deal of brilliance went into the making of those choices.

For example, Dolby could have easily improved his signal-to-noise gain had he chosen to do so. But in the relatively simply, low-cost single band Dolby-B system, that improvement would have led to audible breathing and pumping effects. Moreover, such a large reduction in noise (and the encoding required for it) would have made Dolbyized tapes sound rather odd when played back on a deck that was not equipped with a Dolby decoder (as most decks were not when Dolby-B was first introduced). Accordingly, Dolby had to concern himself with the important question of compatibility. That is, Dolby-processed tapes had to sound reasonably (if not perfectly) satisfactory when played on non-Dolby Machines.

More than ten years have passed since Dolby-B was incorporated into consumer tape decks, and a lot has happened in terms of dynamic range of other program sources (e.g., digitally mastered discs, and direct-to-disc recordings). A lot also has happened in terms of the basic capabilities of cassette decks and the new cassette tape formulations. Nakamichi, in presenting High-Com II, apparently feels that while Dolby-B is, more or less, accepted as a world standard, it is time for a "better" noise-reduction system to be made available to those audio recordists who feel that Dolby-B is no



longer adequate, but who are hardly prepared to go all out for the original Dolby-A. The system thus is offered as an add-on product rather than being incorporated into a new cassette deck. Actually, the High-Com II can be used with any cassette deck or, for that matter, with any open-reel machine. And it does its job in exactly the way it is supposed to; this we both can confirm on the basis of individual and separate tests.

Do we believe that High-Com II will someday replace Dolby-B. No, we do not. The dbx noise-reduction system has been available for five or so years, and while it is an excellent noise-reduction system and dynamic range enhancer, its use is still limited to those

recordists who have a need for the extreme dynamic range it can provide. What may be significant about Nakamichi's High-Com II is its achievement of a higher degree of noise reduction with virtually no side effects at a price that is far lower than one would have to pay for some of the professional noise reduction systems that provide the same benefits. For the serious recordist who owns a good open-reel, cassette deck and some mixing equipment and microphones, an investment in High-Com II does not represent a monumental increase in capital equipment expenditure, and as such it may be very worthwhile in cases where Dolby-B just hasn't been up to the job.

#### NAKAMICHI HIGH-COM II: Vital Statistics

PERFORMANCE CHARACTERISTIC	MANUFACTURER'S SPEC	LAB MEASUREMENT
Harmonic distortion at reference level	< 0.2%	0.08%
Noise reduction	20 to 25 dB	20 to 25 dB
Frequency response	± 1 dB, 20 Hz to 20 kHz	± 1 dB, 10 Hz to 22 kHz
Compression ratio: Encoding	1:2	Confirmed
Decoding	2:1	Confirmed
Line input level	60 mV	60 mV
Line output level	600 mV	600 mV
Playback level from tape deck	200 mV	210 mV
Output level to tape deck	300 mV	300 mV
Power consumption	10 watts	8 watts

CIRCLE 16 ON READER SERVICE CARD

## Audiovisual Systems PB-289G Patch Bay System

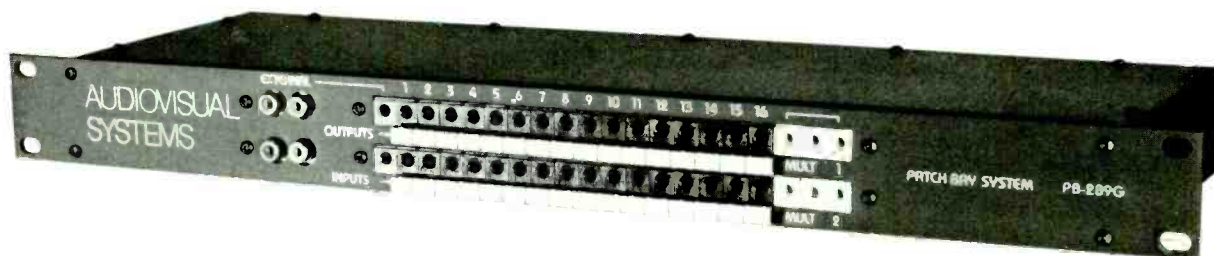

**General Description:** The model PB-289G from Audiovisual Systems is a rack-mountable signal patch bay of unusual flexibility. The essential difference between it and other patching systems is that all circuits connected to the PG-289G may be "normalled." That is, the patch bay can be programmed by means of its slide switches (located beneath the top cover) to internally connect all external signal components in their normal operating modes without the need to use external patch cords. "Isolated" circuits also may be selected on any of the lines. Thus, equipment normally patched in, and additional equipment, may be intermixed and readily changed.

The way this is done may be understood by studying the wiring diagram. When a given circuit's "normal"

switch is set to the "in" position, stereo input jacks from component outputs connected to the lower L and R jacks in the diagram are internally connected to the upper L and R output jacks of the patch bay. This means the latter jacks can be connected via rear-panel audio cables to the next component in the line.

Conversely, when the "normal" switch is in the "out" position, the rear-panel jacks are connected only to their corresponding front-panel jacks and not to each other. This arrangement provides the option for installing any units that may not be used often, but which should be readily accessible for occasional use, such as a spare tape deck, test instruments, special filters and so on.

Patch cords are used only to assign signals to places

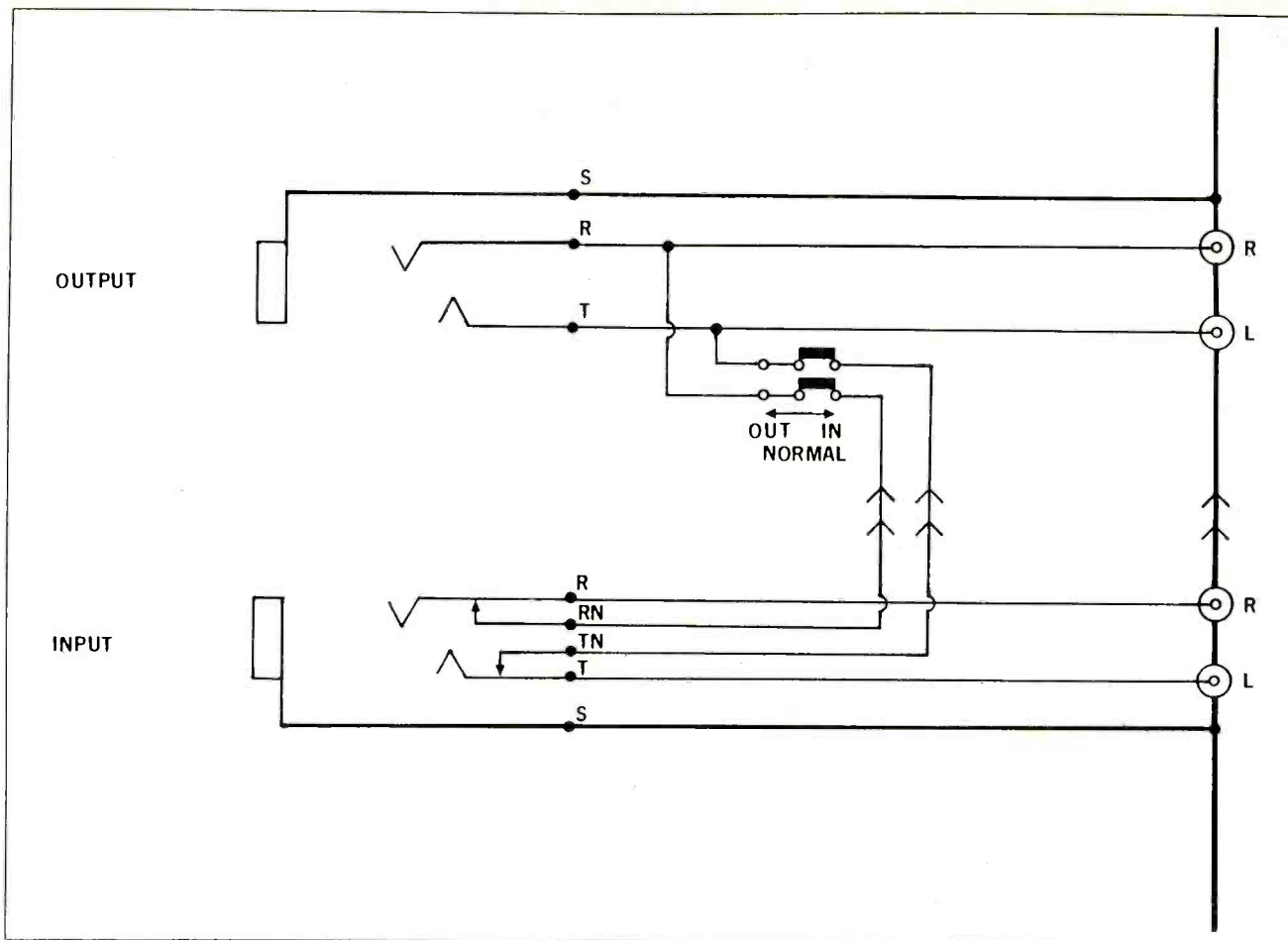

**Audiovisual Systems PB-289G: Wiring diagram of input/output/normalling on the system.**

other than their "normal" destinations, or to insert components or test equipment into the system. For any numbered input/output group having its switch in the "normal" position, plugging a patch cord into an output jack splits the output, providing an additional source of that signal. Plugging a patch cord into an input jack, on the other hand, isolates the input, breaking the "normal" connection and substituting the output selected.

While the patch bay is designed for stereo or two-channel unbalanced signals, it also may be used for single-channel balanced lines with suitable adaptors. A balanced bridging box (model PBX 22), available from Audiovisual Systems, may be used to connect high level (+4 dBm) balanced outputs to low level (-10 dBm) stereo inputs.

The rear of the device contains sixteen pairs of gold-plated pin-jacks for stereo in and out (sixty-four jacks

in all), clearly numbered and color-coded for channel identity. The front panel contains sixteen patch-cord inputs and sixteen outputs, plus additional patch-cord jacks and an extra stereo pair of pin-jacks for "external" use. The extra jacks are provided so that additional temporary equipment may be added to any point in the system without requiring access to the rear panel, in the event, for instance, that the device has been rack- or wall-mounted. These external jacks are not "normalled" and may be used either as inputs or outputs. Each is connected only to its corresponding jack on the front panel.

Additional patch-cord jacks to the right of the front panel, labeled "mult 1" and "mult 2" may be used for multiple patches since the three jacks in this group are connected only to each other. They thus may be used to provide multiple feeds of an output to several inputs, thereby eliminating the need for "Y" cords.

**Test Results:** Since this device is passive, no lab measurements were involved. In our "Vital Statistics" table the descriptive claims of features and hardware, as listed by the manufacturer, are shown. Our examination and use-tests of the device verified and confirmed all claims.



**Audiovisual Systems PB-289G: Rear panel contains sixty-four gold-plated phono tip jacks.**



**General Info:** Unit occupies 1 1/4 inches of standard rack space, as is 5 1/4 inches deep. It weights five pounds. Price is \$650. Supplied with two 18-inch patch cords. Additional cords, \$12 each. PBX-22 balanced stereo transformer, \$275. Other cord lengths and terminations available.

**Individual Comment by L.F.:** The PB-289G seemed at first glance to be a basic kind of passive interconnection device, but after removing the top cover and reading the instructions for the unit I realized how truly flexible this system is. In my opinion, it is nicely engineered and well thought out, carefully assembled and neatly packaged. If the price of \$650 seems a bit high, even in these inflated times, keep in mind that even plating sixty-four phono jacks uses up a fair amount of gold—and we all know what's happened to the price of gold, right?

**Individual Comment by N.E.:** This is a very sophisticated version of what used to be called a "gozinta" box (derived from "goes into" and possibly

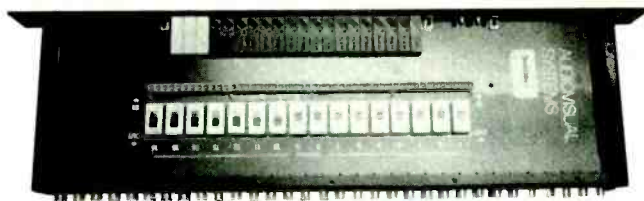

**Audiovisual Systems PB-289G: Internal view of unit reveals sixteen individual "normalling" switches for signal routing and programming.**

also from the expression "Gesundheit" which means "to your health" and would apply in this instance to the well-being of one's sound system not to mention your own well-being when involved in the complexities of interfacing and switching of signal lines). A very nice and useful job all told, although I don't think the amount of gold used for plating the phono jacks is responsible for the cost of the unit. One thought: couldn't the top lid have been hinged so that you would not have to remove and reinsert nine Phillips-head screws to gain access to the switches?

**AUDIOVISUAL SYSTEMS PB-289G PATCH BAY SYSTEM: Vital Statistics**

PERFORMANCE CHARACTERISTIC	MANUFACTURER'S SPEC	LAB MEASUREMENT
Inputs:	16 2-channel inputs (32 phono jacks) on rear panel, 1 2-channel input on front panel.	No measurements: see explanation in text of report.
Outputs:	16 2-channel outputs (32 channel jacks) on rear panel, 1 2-channel output on front panel.	
Multiples:	2 provided, 3 jacks each.	
Normals:	16 provided—splitting on outputs, isolating on inputs by insertion of Patch Cord or Dummy Plug. Normals may be opened via internal switches.	
Patch jacks:	ADC BANTAM® printed circuit jacks mate with standard .175 inch BANTAM® or T-T® 3-circuit plugs. Contact Resistance: 30 milliohms maximum. Insulation Resistance: 10,000 megohms minimum. Insertion Loss: less than 0.01 dB/600 ohms. Life Expectancy: 10,000 cycles minimum.	
Patch cords:	ADC BANTAM® molded patch cords—3 conductor cord: 2 stranded copper conductors, shielded, vinyl jacket plug: conductor parts brass, soldered, molded nylon insulation.	
Contacts:	All internal contacts are gold-plated to prevent corrosion, signal loss, or RFI detection.	
Enclosure:	Welded steel chassis, double-anodized aluminum front panel, 19" L x 1.719" H x 5.5" D to EIA rack standards.	

CIRCLE 17 ON READER SERVICE CARD



# Furman Sound TX-4 Crossover

By John Murphy and Jim Ford

We begin our series of crossover reviews this month with the TX-4 electronic crossover from Furman Sound. The TX-4 provides electronic crossover filtering for stereo 3-way loudspeaker systems or can be switched to provide appropriate filtering for a mono 5-way system. The TX-4 features front panel control over crossover frequency selection as well as both input and output signal levels. It employs 12 dB/octave Butterworth filters and is packaged in a double width rack-mounting steel chassis with a black anodized aluminum front panel. The price of the TX-4 is \$415.

**General Description:** As with all electronic crossovers, the TX-4 is intended to be used as a component of a multi-driver loudspeaker system which uses a separate power amplifier for the drivers covering each separate frequency range. This approach to loudspeaker systems is referred to as "bi-amplification," or "tri-amplification" for two-way or three-way systems, respectively, or more generally, "multi-amplification." The alternative to multi-amplification is to use a passive crossover between a single power amplifier and the individual loudspeaker drivers. Although multi-amplification has been gaining in popularity, as listeners demand more accurate sound reproduction, its use continues to be concentrated most in sound reinforcement systems and critical monitoring applications.

In order to use the TX-4 in a multi-amplified loudspeaker system the full frequency range signal to be reproduced is routed to the input of the crossover. For a two-channel (stereo) system the TX-4 will divide each of the input signals into three frequency bands. These are labeled: "Lo," "Mid" and "Hi." A slide switch on the rear panel can be used to reconfigure the unit to divide a single channel (mono) signal into five frequency bands: "Lo," "Lo-Mid," "Mid-Mid," "Hi-Mid" and "Hi." The overlap frequencies or "crossover frequencies" of the TX-4 are determined by the settings of the front panel controls. Each crossover point can be set independently to any frequency over the 20 to 20 kHz audio spectrum. In the case of a stereo three-way system the TX-4 provides three output signals for each channel. These signals are routed to the appropriate power amplifier inputs; the power amp output signals are then applied to the appropriate low-, mid- and high-frequency loudspeaker drivers. (It's



quite important when interfacing the components of a multi-amplified system to be sure that the correct frequency band is applied to each driver as many horns and high-frequency transducers are easily damaged by low frequency signals.)

The front panel controls of the TX-4 are organized as two horizontal rows with channels one and two across the upper and lower halves of the panel, respectively. With the unit set in the stereo mode, the controls for the two channels act in an identical fashion as indicated by the white control legends. When the crossover is switched to the five-way mono configuration the action of the controls is modified as indicated by the red legends in parenthesis. Now let's go over the controls in more detail.

At the far left of the front panel is a rotary input level control. The settings of this control are clearly labeled from "0" to "10" with a setting of about "7" corresponding to unity gain. A maximum setting of this control provides a signal gain of 6 dB. In the mono mode only the upper input level control is used as the input level control for channel 2 is defeated.

To the right of the input level control is a set of three interlocking pushbuttons for selecting the frequency range of the first (lower) crossover frequency. These buttons are labeled "X1," "X10" and "X100" and act in conjunction with the rotary crossover frequency control located to the right of the buttons. The crossover frequency control is labeled from 20 to 200 with ten other frequencies identified in between. With the "X1" frequency range button depressed the crossover frequency is adjustable over the range 20 to 200 Hz. Depressing the "X10" button changes the frequency range to 200 to 2000 Hz. Likewise, with the "X100" button depressed the range of the crossover frequency control is 2 K to 20 kHz. The combination of the three





“frequency range” settings and the continuously variable crossover frequency control therefore allow the crossover frequency to be easily varied anywhere from 20 Hz to 20 kHz.

This same set of crossover frequency controls is duplicated to the right of the first set for the second (upper) crossover point. Since the two channels of the unit are identical, there are two more sets of crossover controls located directly below those for the first channel. When the TX-4 is operated in the five-way mono mode the crossover controls for the second channel are



used to establish the third and fourth crossover frequencies (i.e., the upper two crossover frequencies).

At the far right of the front panel there are six output level controls, three for each channel. In the stereo mode these controls serve to attenuate the “Lo,” “Mid” and “Hi” output signals for each of the channels. In the five-way mode the Hi output level control for channel one is not used. Instead, the other five controls are used to adjust the levels of the five output signals as indicated by the red legends in parenthesis under each control.

The appropriate settings of the output level controls will depend on the input sensitivities of the power amps and the relative sensitivities of the different loudspeaker drivers. Since the output level control settings determine the relative loudness of each frequency band, the final adjustment of these controls should be made with the aid of a real-time spectrum analyzer if at all possible.

The last item on the front panel of the TX-4 is a small red LED pilot light located just to the right of the output level controls. There is no power on/off switch; the unit is simply powered on whenever it is plugged into an AC power outlet.

All of the input and output connections to the TX-4 are made at the rear panel by way of ¼-inch phone jacks. These input and output signals are all single sided (i.e., two conductors). As an option, the TX-4 can be purchased with balanced inputs on 3-pin XLR-type connectors in addition to the ¼-inch phone inputs. The rear panel also contains a small slide switch for selecting between the stereo 3-way and mono 5-way modes of operation. In the 5-way mode neither the high output from channel one nor the input to channel two is used.

**Listening Test:** In order to evaluate the audio quality of the TX-4 we configured the crossover in such a way that we could conveniently insert it into our listening chain and alternately listen through it and bypass it in an A/B fashion. In order to do this it was necessary to sum the separate output signals before returning the signal to our preamp. This was accomplished with a summing amplifier designed specifically for evaluating crossovers. Because of the nature of 12-dB-per-octave Butterworth filter pairs (as used in the TX-4), accurate summing of the outputs results in a deep notch in the summed frequency response at each crossover point. This notch was readily audible in our listening test. Since the preferred method of using 12-dB-per-octave, 3-way crossovers is to invert the polarity of the mid-frequency signal (see the August & September 1980 “Hands-On Reports”), we reconfigured our summing amp to invert the polarity of the mid-frequency band before summing. The results were precisely as expected. The deep notches at the crossover points became rather gentle 3 dB peaks at each crossover point. This resulted in a vastly more accurate frequency response even though the peaks at crossover were clearly audible. We tried listening for any other sonic problem that might exist with the TX-4 but found that in the A/B test the frequency response peaks readily masked any other subtle problems which may have been present.

Be aware that electronic summing is an extremely rigorous test of a crossover. In practice, the summed responses we’ve described will be observed only with very high-quality loudspeaker drivers employed in a very conservatively designed system. By this we mean a loudspeaker system designed with drivers having accurate amplitude and phase characteristics for more than an octave or two past the crossover frequency. Also, such high accuracy systems would have drivers spaced apart by only a fraction of a wavelength of the



crossover frequency between them to assure accurate acoustic summing. Since very few P.A. systems are designed according to such criteria it is reasonably safe to say that the summing problems of the TX-4 (and other 12 dB/octave-type crossovers) are unlikely to degrade the performance of today's typical P.A. systems. However, with high resolution loudspeaker systems (such as those appropriate for critical monitoring) crossover summing problems will be audible to the extent that the remainder of the system is accurate. Ideally, it shouldn't be necessary to depend on the flaws of the rest of the loudspeaker system to mask the summing problems of the crossover.

**Lab Test:** When we took the TX-4 to the lab we measured the usual parameters and also took some seldom reported crossover parameters: the summed response characteristics. For details of the lab test results see the "Lab Test Summary" below.

The input stage of the TX-4 is preceded by an attenuator in the form of the input level control. As a result, input signals can be attenuated to an appropriate drive level, thereby making it possible for the unit to handle even the hottest of input signals. The maximum output level before clipping was  $\pm 21.5$  dBV or about 12.5 volts peak. This should be more than enough to drive any power amplifier to full output.

The noise at the output varied from about  $-70$  to  $-75$  dBV depending on the output, crossover frequency settings and the level control settings. The total harmonic distortion (THD) plus noise was measured at a drive level of  $\pm 10$  dBV. Low- and mid-frequency distortion was quite low but the distortion increased rapidly at high frequencies as slew limiting was approached. The 20 kHz THD test may seem a bit curious at first considering that the distortion components of a 20 kHz tone would all be above 20 kHz and therefore be inaudible. However, a recent comparison of distortion measurement methods<sup>1</sup> has shown the 20 kHz THD test to be highly sensitive to a

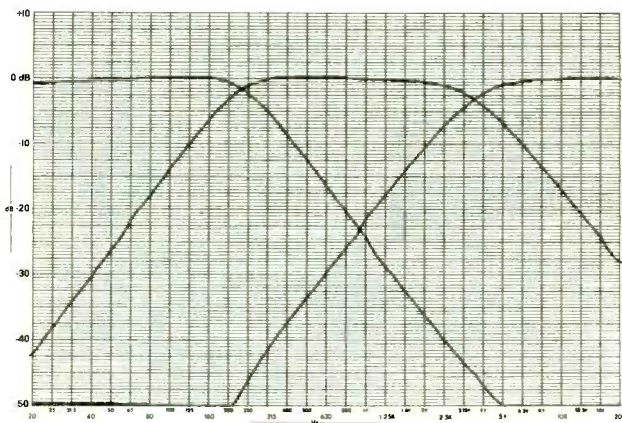

**Fig. 1: Furman Sound TX-4: Amplitude response of the low, mid and high outputs of the unit for crossover points of 250 Hz and 4 kHz.**

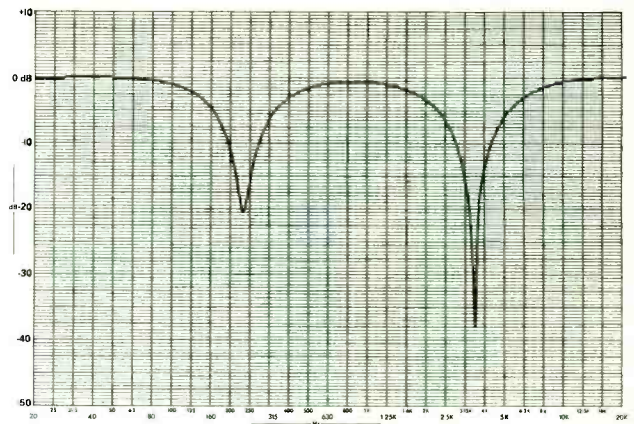

**Fig. 2a: Furman Sound TX-4: Amplitude response of the summed outputs (no polarity inversions).**

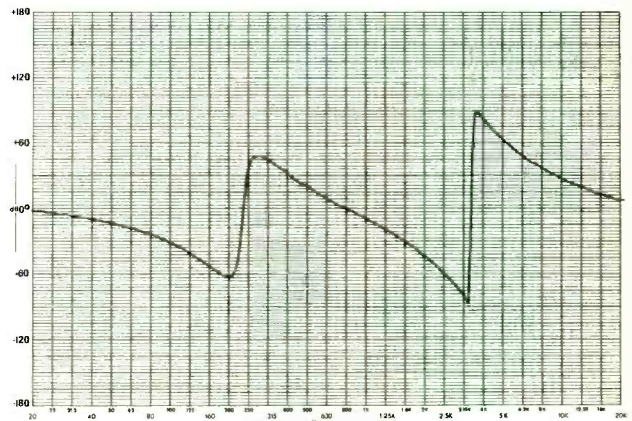

**Fig. 2b: Furman Sound: TX-4 Phase response of the summed outputs (no polarity inversions).**

wide variety of distortion mechanisms including slew induced distortion.

The power bandwidth of the TX-4 was observed to be about 16 kHz. Above this frequency the TX-4 rapidly transforms a full power sine wave into a triangle wave. This indicates "hard slew limiting." The small signal bandwidth of the unit was observed to extend from below 1 Hz to beyond 1 MHz (yes, one mega Hz). The slew rate limit of the unit was observed to be 1.2 volts per microsecond. Dividing the slew rate by the maximum peak output voltage of 12.5 volts gives a "normalized" slew rate limit (we've previously referred to this as a "slew rate ratio") of .096 volts per microsecond per volt. This is considerably less than the minimum recommended for freedom from slewing induced distortion<sup>2</sup> (0.5 to 1.0 volts per microsecond per volt).

The amplitude response for the three output signals of the TX-4 in the stereo mode is shown in *Figure 1*. Summing the three outputs of the TX-4 results in the frequency and phase characteristics shown in *Figures 2a and 2b*, respectively. The notches at the crossover points are characteristic of the 12-dB-per-octave



# BREAKING THE SOUND BARRIER

The new SD12-2 finally bridges the gap between price and professionalism which has prevented groups attaining high quality PA and demo recording sound. We supply complete studio systems to bands like Genesis, Thin Lizzy and Queen so you have assurance of quality and reliability. Why accept anything less.



- ★ Separate line inputs and direct recording outputs.
- ★ 4 way stereo monitor with powerful headphone amp
- ★ Separate foldback eq for control of stage sound

- ★ Now long travel faders
- ★ Larger illuminated VU meters
- ★ Padded front arm rest
- ★ Fully balanced XLR mic inputs

## EAST COAST

AUDIOMARKETING LTD.  
652 Glenbrook Road  
Stamford, Connecticut 06906  
Toll Free: (800) 243-2598

# AHB

ALLEN AND HEATH BRENNELL LTD.  
Pembroke House, Campsbourne Rd.  
London N.8., England  
Tel: 01-340-3291

## WEST COAST

CARA PACIFIC SALES CO.  
P.O. Box 9339, Marina Del Ray  
California 90291  
Tel: (213) 821-7898

CIRCLE 141 ON READER SERVICE CARD

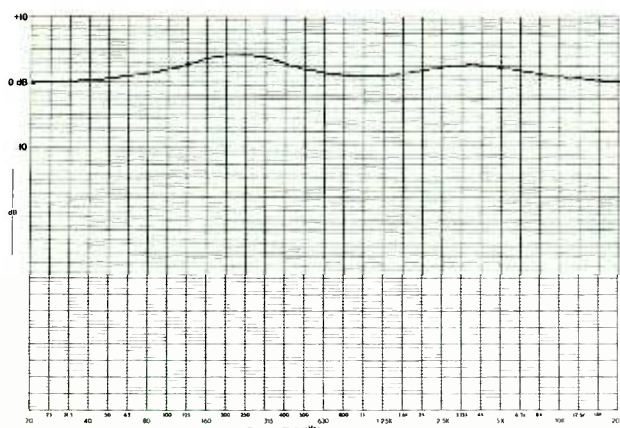

**Fig. 3a: Furman Sound TX-4: Amplitude response of the summed outputs (polarity of the "mid" output inverted).**

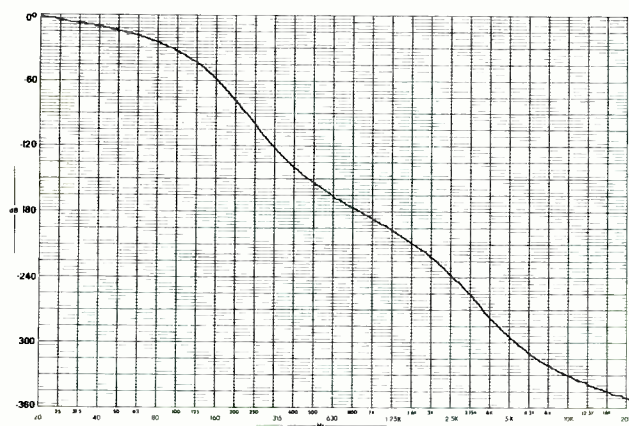

**Fig. 3b: Furman Sound TX-4: Phase response of the summed outputs (polarity of the "mid" output inverted).**

Butterworth filter pair employed in the TX-4. The shallower notch at 250 Hz is the result of slight filter mismatching as seen in *Figure 1* where the response at the 250 Hz crossover is  $-1.5$  dB rather than  $-3$  dB as at 4 kHz. When the polarity of the "mid" frequency band is inverted before summing, the amplitude and phase characteristics are as shown in *Figures 3a and 3b*, respectively. The notches in response have been replaced by peaks of 4 dB at 250 Hz, and 3 dB at 4 kHz. Note also the much smoother phase characteristic. The significance of the phase response curve is its relationship to the time delay the signal encounters on passing through the unit, the smoother curve implying less "time smear."

Clearly, the preferred configuration for operating the TX-4 is with a "mid" output polarity inversion. In practice this can be most easily accomplished by wiring the "mid" frequency drivers of the loudspeaker system in reverse polarity with respect to the "lo" and "hi" frequency drivers. In the case of a five-way system the "lo-mid" and "hi-mid" drivers should be wired in

reverse phase with respect to the "lo," "mid-mid" and "hi" drivers.

We found the instruction manual supplied with the TX-4 to be adequate to allow most users to understand the operation of the unit and satisfactorily employ it in a multi-amplified loudspeaker system. There is an interesting section describing the use of the TX-4 as a tunable bandpass filter for studio effects.

**Conclusion:** The TX-4 crossover from Furman Sound was found to be a highly flexible filter set appropriate for use with multi-amplified P.A. loudspeaker systems. However, in our opinion, the unit's 12-dB-per-octave Butterworth filters make it inappropriate for use in *critical monitoring systems* because of the inaccurate summed response.

#### REFERENCES:

- <sup>1</sup>Richard C. Cabot, "A Comparison of Nonlinear Distortion Measurement Methods," Audio Engineering Society reprint no. 1638 (May 1980).
- <sup>2</sup>J. G. Jung, M. L. Stephens, C. C. Todd, "An Overview of SID and TIM. Part II-Testing," *Audio*, LXIII (July 1979), 38-47.

#### LAB TEST SUMMARY

(Note: 0 dBV is referenced to .775 Vrms)

##### Input/Output Levels

Maximum input level before clipping: Depends on setting of the input level control  
 Maximum output level before clipping: +21.5 dBV

##### Noise Performance

(20 kHz filter, unweighted; crossover points at 250 Hz & 4 kHz; output level controls at maximum)  
 Noise at the "Hi" output =  $-74.8$  dBV  
 Noise at the "Mid" output =  $-70.9$  dBV  
 Noise at the "Lo" output =  $-70.2$  dBV

##### THD Performance

(+10 dBV output level)

Frequency	THD & Noise
100 Hz	.0065% (at "Lo" output)
1 kHz	.003% (at "Mid" output)
10 kHz	.022% (at "Hi" output)
20 kHz	.101% (at "Hi" output)
Small signal bandwidth: Less than 1 Hz to beyond 1 mega Hz	
Power bandwidth: 16 kHz	
Slew rate limit: 1.2 volts per microsecond	
Normalized slew rate (see text): .096 volts per microsecond per volt	

CIRCLE 37 ON READER SERVICE CARD





# Introducing the Crown PZM,<sup>TM</sup> the second major advance in microphones in 100 years.

In 1876, Bell invented the first microphone.

Crown now announces the second microphone – the PZM.<sup>TM</sup>

During the last century, microphones have been much improved, but they still employ Bell's basic concept: a movable diaphragm connected to a transducer, the whole assembly intended to be stuck out in the air somewhere near the sound source.

Comb filtering is a side effect of that design that cannot be eliminated.

Every Bell-design microphone demonstrates frequency response anomalies because of an inability to satisfactorily combine direct and reflected signals. Phase-induced amplitude cancellation and reinforcement are the inevitable result.

Crown PZM microphones eliminate comb filtering from the primary boundary because they detect sound according to a new principle, the Pressure Recording Process.<sup>TM</sup> As a sound wave approaches a boundary (wall, table, floor) a pressure field four or five millimeters deep forms at the boundary, within which the direct signal and its reflection from the boundary add coherently and remain in phase.

The Crown PZM<sup>TM</sup> places a small pressure transducer into the primary boundary pressure zone, eliminating the possibility of phase-induced interference. The PZM concept thus provides a significant improvement in signal quality. Its small profile also improves microphone aesthetics.

The PZM pickup pattern is hemispherical, with no "off-axis" position.



Singers and speakers can move more freely around the PZM. Gain related to distance will change, but not tonal quality.

The PZM responds accurately to SPL up to 150dB. You can put it right inside a drum, a bass fiddle, or a piano. The PZM hears whispered conversations in an ordinary room at thirty feet. In certain situations where undesired ambient noise can't be eliminated, or in halls with poor acoustics, the PZM probably should not be used – it will pick up everything.

Singers, orchestra conductors, pianists, percussionists, broadcasters have all tried – and praised – the PZM.

Recording engineers find that the PZM suggests new miking techniques. For small groups it now seems that the best place for a PZM is on the floor! Recording and reinforcement may well require fewer PZM mikes.

Several PZM models are now available, including a clip-on and recessed model for permanent installation.

The PZM is changing ideas about how a microphone ought to sound, look and be used. Find out for yourself how it might improve your own recording or reinforcement systems.

*Write for information on the PZM.  
Or call us at 219/294-5571.*

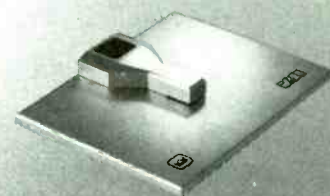

© Crown International, 1980



1718 W. Mishawaka Road, Elkhart, Indiana 46517

*Innovation. High Technology. American. That's Crown.*

PZM, PZMicrophone and Pressure Zone Microphone are trademarks of Crown International.

#### CROWN INTERNATIONAL

1718 W. Mishawaka Road, Elkhart, IN 46517

(Mail this coupon to Crown.) Send PZM info. Hurry!

Name \_\_\_\_\_  
Company \_\_\_\_\_  
Address \_\_\_\_\_  
City \_\_\_\_\_ State \_\_\_\_\_ Zip \_\_\_\_\_  
Phone \_\_\_\_\_

CIRCLE 104 ON READER SERVICE CARD

# GROOVE VIEWS

Reviewed By:  
MIKE DEREVLANY  
ROBERT HENSCHEN  
NAT HENTOFF  
JOE KLEE  
STAN SOOCHER

## POPULAR

**SPIDER: *Spider*.** [Peter Coleman, producer; Doug Schwartz, engineer; recorded October 20 to November 27, 1979 at MCA Whitney Studios, Glendale, Ca.] Dreamland Records DL-1-5000.

Performance: **Big Mac attack**  
Recording: **Rough but ready**

It's more than just a fetish, this fascination with New Wave girl groups. For instance Spider, led by Amanda Blue and Holly Knight, plays some of the best New Rock of 1980. Without overt pop pretensions, the ten tunes here often function beyond stylistic barriers. And the ladies play integral roles.

The opening cut, "New Romance (It's A Mystery)," has all the makings of a huge hit in today's New Wavish marketplace. A simple but infectious big beat, and a correspondingly engaging melody hook, make for a tune as hot as anything Blondie has done. Ms. Blue's lead vocals are immediately noteworthy.

Subsequent cuts on side one resist the New Wave tag and go in more conventional hard rock directions. With Knight on keyboards, Blue on lead vocals, Keith Lentin on guitar, and a hot two-man rhythm section, it's not difficult to see the Fleetwood Mac formula at work in Spider. Ms. Blue's voice, in fact, has the dusky quality of a Chris McVie ("Everything Is Alright") or better yet, Sandy Denny ("Shady Love"). And when the band

plays hard rock, as on the smoking "Crossfire," they release an energy equal to anything the Mac or Heart has done.

Side two's opener "Little Darlin'" gets back into a semi-New Rock groove, with compelling pop hit potential provided by tough guitar tempos and an upbeat chorus as accessible as ABBA. It is this unlikely combination of streetwise attitude and sweet disposition that works best for Spider. Harder cuts like "Brotherly Love" and "Zero" pack a punch, but don't have quite the freshness of "What's Going On," "New Romance," and the other elementary rockers. "Don't Waste Your Time," appearing near the end of this disc, is a contrastingly sumptuous ballad also deserving of airplay.

Three members of this racially in-



**SPIDER: Functioning beyond stylistic barriers without pop pretensions.**

tegrated group originally hail from South Africa, but New York City is their stomping ground and you can hear the sharp edge of East Coast club bands in their ability to sizzle. Managed by Bill Aucoin of Kiss fame, Spider caught the ear of Mike Chapman (The Knack, Blondie) and his partner Nicky Chinn who put them on Dreamland, their new label out of L.A. Producer Peter Coleman (Pat Benatar, Nick Gilder) used no frills to capture the sheer energy of this group. *Spider* is a sizzling debut from a band that should definitely break through at the national level. R.H.

**DIRK HAMILTON: *Thug of Love*.** [Dirk Hamilton and Don Evans, producers; Richard Digby Smith, engineer; recorded at United Western Studios, Hollywood, Ca.] Elektra 6E-249.

Performance: **Unexpectedly impressive**  
Recording: **Superbly tailored**

*Thug of Love* is certainly an unusual name for an album, especially one that does not claim to be punk-new wave. But then Dirk Hamilton is not your typical artist. He has a most unusual and distinctive voice which he uses quite skillfully, putting it through its full range of capabilities. Facilitating this, of course, is the fact that he wrote all the songs and co-produced the album. With that sort of control, no artist is going to show too many weaknesses.

Side one starts out with "Out to Unroll the Wheel World," a cut with a crisp, trebly sound that brings out the full, bright guitar work. This upbeat



# BRUTE FORCE

## Low Frequency...Loud and Clear

Introducing the newest additions to the Sunn Professional Line: the Sunn low frequency loudspeakers. These heavy-weight performers are the result of over a year and a half of intensive engineering effort. They offer the professional a rugged, high quality loudspeaker that is capable of incredibly accurate, high level bass reproduction.

High power handling, over 400 W program, is assured through the use of vented aluminum voice coils, high temperature adhesives and massive 96 oz. vented magnets. The cast aluminum frames and heavy suspension components allow long, linear excursion and extended service life without fatigue. Improved magnetic field symmetry and rigid cone assemblies guarantee high level, low distortion performance.

The Sunn SPL low frequency loudspeaker...newcomers you'll be hearing a lot more from...loud and clear.

sunn 

*Capture the Energy*

Sunn Musical Equipment Company  
A Hartzell Corporation Company  
Amburn Industrial Park  
Tualatin, Oregon 97062

CIRCLE 76 ON READER SERVICE CARD

[www.americanradiohistory.com](http://www.americanradiohistory.com)



**SOUND BOX  
SELLS ONLY THE  
REAL THING  
IN  
PROFESSIONAL  
AUDIO GEAR  
AT  
DON'T PANIC  
PRICES**

**Order Your Free  
1981 Catalog  
Call Toll Free For  
Orders and Info**

**1-800-638-6050**

MD RESIDENTS (301) 881-2663



PHONE ORDERS  
ACCEPTED

**GOULD BOOK**

P.O. BOX 2094  
ROCKVILLE, MD 20852

CIRCLE 59 ON READER SERVICE CARD

**Professional Grade  
Recording  
Tape**

Stocked for Immediate Shipment

1/4" & 1/2"

**Audio  
Tape  
ALL TYPES**

AMPEX  
3M  
TDK

CASSETTES  
ACCESSORIES

ASK FOR OUR CATALOG  
OF PROFESSIONAL  
RECORDING SUPPLIES

**Polyline  
Corp.**

1233 Rand Rd. Des Plaines, IL 60016

312/298-5300

25

CIRCLE 126 ON READER SERVICE CARD

tune has a noticeable amount of high-end emphasis. "Turn Off the T.V." is slower and more somber, but retains the same production features: clear, bright guitar work and lots of high end. The guitars are also altered in various creative ways but always in such a manner to complement the tune.

The emphasis on the high end seems to have an important function, namely, to support Hamilton's high, easily muddled tenor voice. The fact that it never does become truly muddled is testimony to the effectiveness of Hamilton's production techniques. Although Hamilton exhibits a fair variety of styles on the rest of the side, the production methods that are used don't vary greatly from the basic recipe. This is evident on tones like "Moses and Me," which finds Hamilton backed by Ron Fransen on piano and the unmistakable Garth Hudson on accordian. Side two also follows the basic format.

Dirk Hamilton has put together a most intense album. The only problem with it is that while everything sounds good, nothing sounds great; there's no particularly striking cut. And yet, as an entire album, it's an outstanding accomplishment. Thug of love indeed.

M.D.

**RICHIE FURAY: *I Still Have Dreams.***

[Val Garay, producer; Val Garay with George Ybarra and Niko Bolas, engineers; recorded at The Sound Factory, Los Angeles, Ca.] Asylum 6E-231.

Performance: **Typically boisterous  
Furay**

Recording: **Most cohesive of the three  
solo Furay albums**

Richie Furay—entangled in one of rock's epic uphill battles for more than a decade now, through the bad blood of the Buffalo Springfield, the failure of early Poco to outdistance the Eagles, the indifference of Souther, Hillman, and Furay, and as a self-doubting solo act—would seem to have found his Holy Grail in *I Still Have Dreams*.

Bringing in producer Val Garay, who engineers for Linda Ronstadt and James Taylor, along with assorted session players of the Ronstadt/Taylor axis, Richie has decided to drop the country rock posture he's adopted since the Springfield's "A Child's Claim To Fame," opting instead for streamlined, melodic rock and roll,

much like the current line-up of Poco has done with *Legend*. The strings and horns of Furay's last two albums, the confessional *I've Got A Reason* and pop-inspired *Dance A Little Light*, have been replaced by the distortion-sharp guitars of Dan Dugmore and Waddy Wachtel (comparing favorably with Wachtel's work on Warren Zevon's *Excitable Boy*). On songs like "Island Love" and the young Rascals' soul-rock classic "Lonely Too Long," Richie's alto-tenor voice cleverly stretches unsuspecting melodic lines through some surprising twists and turns. Randy Meisner and Timothy Schmit's backup vocals on four songs, plus those of Rosemary Butler and Vanetta Fields, create striking choral counterpoints that underscore lyrics about the religious/romantic pursuit of a musical vision as a lover. On "Oooh Child" Richie sings: "Baby all my life I have been waiting/I see you in my dreams each night." He later adds on another song: "Baby let me say to you/I'm satisfied."

The problem here, however, is that Furay has become a free agent without a recording contract since the release of this record. It is, therefore, all the more ironic that on *I Still Have Dreams* Richie Furay has come as close as he ever has to musically satisfying his audience and himself. S.S.

**SCOTT JARRETT: *Without Rhyme or Reason.***

[Dave Grusin and Larry Rosen, producers; Larry Rosen, Ollie Cotton, Frank Laico and Ted Brosnan, engineers; recorded at A & R Studios and CBS 30th Street Studios, New York, N.Y., October and November, 1979 and January, 1980.] Arista/GRP 5007.

Performance: **Plenty of reason for  
these rhymes**

Recording: **Digital—what else could  
you ask?**

Many years ago, when Keith Jarrett was playing piano with Miles Davis' group, I interviewed him for *Down Beat Magazine*. Asked if there were any other musicians in his family, he replied that he had a younger brother who plays guitar and piano and sings and writes pop songs. I'd almost forgotten about it until this new album by Keith's kid brother, Scott Jarrett, crossed my path. Knowing what a consummate artist the elder Jarrett sibil-



"Lexicon Prime Times  
aren't just an effect for me ...  
... they're an integral  
part of my sound."

Fat Metheny

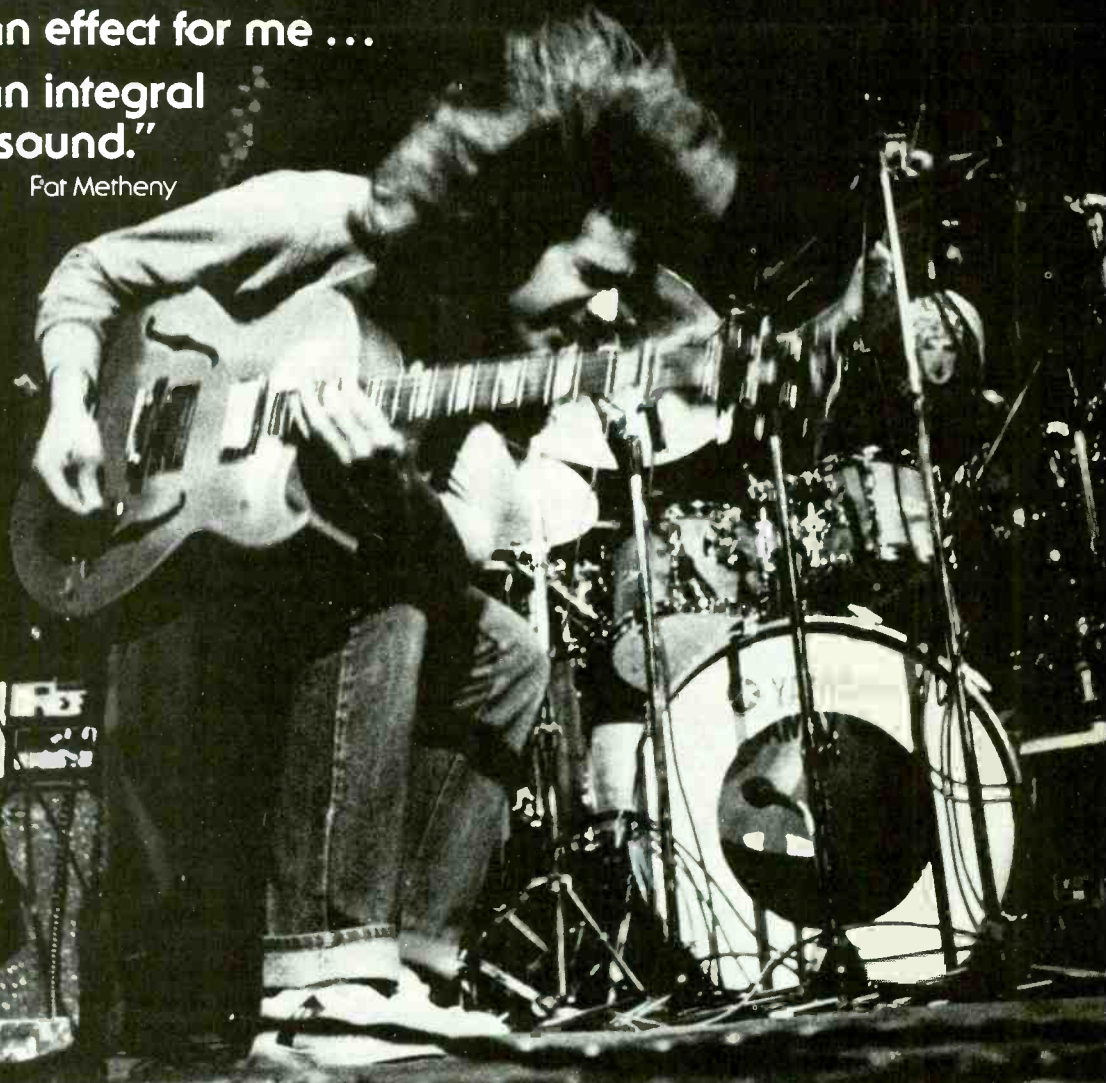

Pat Metheny records for ECM Records.

"I felt I needed a bigger guitar sound, and the sound engineer at Talent Studios in Oslo where I was recording told me to wait while he plugged in a box. What came over the monitor was the greatest guitar sound I'd ever heard, something I'd been seeking for many years. The box was a Lexicon digital delay."

"I'm amazed at the guitar sound I get from Prime Time. No other delay has its warmth. Prime Time creates a space around the sound which in a lot of ways is as important as the sound itself. Knowledgeable listeners say our concerts sound like our records. Much of that can be attributed to the Lexicon Prime Time."

"Today, I use five Lexicon systems on a typical concert, of which I do about 300 a year. On stage at my right hand is a Prime Time; another Prime Time is at the board that mixes the drums and piano. A third Prime Time is used on the PA line. We also use a Model 92 and the new 224 digital reverb."

If you'd like to experience the sound enhancement that's made Lexicon's Prime Time the favorite of Pat Metheny and dozens of top touring and recording groups, circle reader service number or write to us. We'll arrange to get you into Prime Time.



**lexicon**

Lexicon, Inc., 60 Turner Street, Waltham, MA 02154 • (617) 891-6790/TELEX 923468

Export: Gotham Export Corporation, New York, NY 10014

CIRCLE 122 ON READER SERVICE CARD



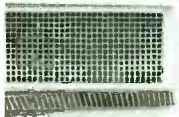

**mikes  
by mail?  
for less?  
why not!™  
and much  
more!**

Now, we're offering mixers, reverbs, sound reinforcement systems™, amps, DDL's and much more.

And, because we maintain a mail-order only policy, we haven't the high overhead, no store-front, no salesmen... that means lower prices to you.

Write or call us for a prompt price quote or for our price sheet.

The Mike Shop™... mikes and audio equipment by mail, for less... Why not!

**The Mike Shop™**  
PO Box 366V,  
Elmont NY 11003  
516/437-7925  
A Division of Omnisound Ltd.

CIRCLE 136 ON READER SERVICE CARD

## Get A GNOME

the original micro-synthesizer

Every day more people discover that PAIA's GNOME is the most versatile, cost effective special effects device on the market today.

John Simonton's time-proven design provides two envelope generators, VCA, VCO and VCF in a low cost, easy to use package. Use alone with it's built in ribbon controller or modify to use with guitar, electronic piano, polytonic keyboards, etc.

The perfect introduction to electronic music and best of all, the Gnome is only \$59.95 in easy to assemble kit form. Is it any wonder why we've sold thousands?



PAIA 1020 W. Wilshire Blvd. Oklahoma City, OK 73116

- Send GNOME MICRO-SYNTHESIZER Kit (\$59.95 plus \$2.00 postage)
- GNOME MICRO-SYNTHESIZER (Fully Assembled) \$100.00 plus \$2 postage
- Send FREE CATALOG

name \_\_\_\_\_

address \_\_\_\_\_

city \_\_\_\_\_ state \_\_\_\_\_ zip \_\_\_\_\_

visa \_\_\_\_\_ m.c. \_\_\_\_\_ card no. \_\_\_\_\_

PAIA Dept. 10M (405) 843-9626  
1020 W. Wilshire Blvd. Oklahoma City, OK 73116

CIRCLE 60 ON READER SERVICE CARD

ing is, I ought not to be surprised at what a fine album this is and, frankly, I'm not. Knowing Keith and his music and his high standards of excellence, I'm certain that if Scott had been just another rock-n-roller Keith wouldn't even have mentioned it.

I'm not normally moved by a rock or pop performer but here is the same type of clarity and honesty and simplicity that I've admired in Paul Simon and, a generation earlier, in the Beatles. Here's a contemporary songwriter who writes emotionally in an uncluttered style and performs the same way. Nothing is superfluous. Everything has a reason for being there. I guess producers Dave Grusin and Larry Rosen deserve as much credit for that as anyone. That goes for the clean, un gimmicky digital recording as well.

Actually, this debut recording is long overdue. It would have happened years ago but Scott Jarrett was busy running away from opportunities to make it as Keith Jarrett's brother. Keith is on two cuts here ("Never My Fault" and "Pictures") and, if they stand out above the others, it has more to do with Keith Jarrett's superb ability as an accompanying pianist than whom he's related to. There are other instrumental highlights as well, not the least of which is Scott Jarrett's harmonica on "I Was A Fool."

The influences aren't hard to trace. I hear a lot of Paul Simon in the compositions, the singer and the vocal arranging which was all done by Scott Jarrett. In the lyrics one finds a sense of poetry which occasionally surfaced in the days of the early pre-electrock Bob Dylan but here one finds it with a consistency that was missing even in Dylan's best work.

At the risk of bringing in big brother's name one more time, I'd like to point out that among the other things that Keith Jarrett pointed out to me as I interviewed him in the empty Gaslight A Go Go on Blecker Street a decade ago was that people who buy records and go to concerts expect the artist to just dump the music in their lap without them having to make any effort to understand or get involved with the creative process. The shame is that when something gets dropped in your lap, the minute you get up from your chair, it all spills out. Something you must search under the surface for will give more lasting

enjoyment and enlightenment.

Scott Jarrett says it another way . . . to quote from his "On Looking Back":

"Everybody's got something to give you.

Everybody's got something he needs.

You can't collect the harvest, Til you've given to the seeds."

Amen.

J.K.



**THE NEW YORK ALL STARS: *New York, New York, Sounds of the Apple.*** [Bernard Brightman, producer; Les Paul, Jr., engineer; recorded in New York City.] Stash ST 204.

Performance: **Big Apple appealing**  
Recording: **Superlative**

In my admittedly limited travels, I have been in three major cities in my life—London, Paris and New York. The rest, including the one I grew up in, were small towns—some with delusions of grandeur, but small nonetheless.

For some reason songwriters seem to favor New York, with Paris running a close second, as settings for pop tunes. Herein you'll find nine of the best, going all the way from Rodgers' and Hart's classic "Manhattan" to such current examples of the new music as Billy Joel's "New York State of Mind." This isn't the first time it's been done. Ronnie Whyte's recent album on Monmouth-Evergreen comes most immediately to mind, but it is the first time to my knowledge that an album of New York songs has been done by a band that plays what I consider New York Jazz.

Historically, the music made by Red Nichols and Miff Mole and the Dorsey Brothers in the 1920s was called New York Jazz but I never agreed with that term. Nichols, Mole and Dorsey were playing the logical extension of what happened when Chicago Style Jazz was fused with the pop dance band music, as top Broadway show bands like Roger Wolf Kahn's and Paul Whiteman's took on the best of the hot players as featured soloists. Today, I do believe there is a real New York style. It's being made in the studios and on record dates by most of the players who play on this





# Carvin The "GUITARIST" SUPER MARKET

These top musicians use Carvin M22 PICKUPS and PARTS for their superior performance.

RODGER WATERS (PINK FLOYD)  
SNOWY WHITE (THIN LIZZY)  
JOHN CIPOLLINA

LARRY CORYELL  
DEEP PURPLE  
WA WA WATSON

THE KNACK  
GREY STAR  
PETER D'OH

## CARVIN M22 HUMBUCKER

BEND YOUR STRINGS WITH INCREASED SUSTAIN & NO POWER LOSS  
SPECIAL DESIGNED NON-ROCKING BEZEL  
DROP-REPLACEMENT FOR ALL GIBSON HUMBUCKING PICKUPS

The M22 is more than just a hot pickup with lots of power, it's a super sounding pickup that has clarity and definition. Many pickups on the market today have good output but their sounds are over distorted and muddy.

Now You can bend your strings without sustain loss! The ultimate design of the M22 features 22 poles which can be adjusted for string differences without power loss between poles.

Give the M22's a try and hear the improvement. It's the best sounding pickup yet! (If you're not satisfied after using them for 10 days, we'll buy them back).

Available in 4 Models

**M22 w Cream or Black Bezel**  
**M22B for Bass Guitar w Cream or Black Bezel**

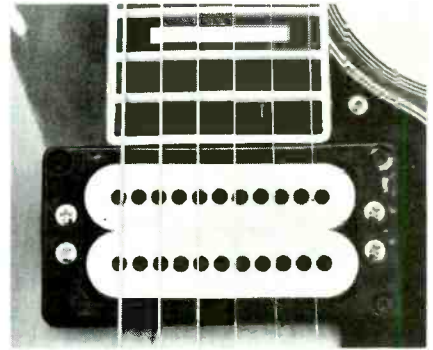

The M22's are now selling for \$44.95 (Direct Only) List \$85. If you do not wish the 4 wire output for Dual-to-Single Coil & Phase Switching, you may deduct \$5.00 (\$39.95) and specify M22-S. All M22's feature a built-in copper shield to prevent R.F. and Hum interference.

## PRECISION BRASS BRIDGE ASSEMBLES



The TB6 CARVIN Tune-O-Matic Bridge is made from heavy solid brass for richer, greater sustain capabilities. Each string insert is locked in place to minimize intonation error. Direct replacement for Gibson Tune-O-Matic.

TB6-Chrome Your Price \$24.95 list \$54.95  
TB6-Gold \$35.00 \$74.95



The N6 CARVIN Tail Piece is made from heavy solid brass and features precision milled slots designed to stop uncontrolled resonances caused by poor string coupling to the guitar body.

N6-Chrome Your Price \$14.95 list \$29.95  
N6-Gold \$19.95 \$39.95



The TB8 CARVIN Bass Tail Piece & Bridge is made from heavy solid brass which eliminates bridge flexing and adds to the overall rich tone quality of the guitar. Precision milled slots couple the strings securely to the body. Precision string saddles are fully adjustable for both height & intonation. Fits guitars with 2 1/8" space between saddles centers.

TB8-Chrome Your Price \$34.95 list \$79.95  
TB8-Gold \$49.95 \$98.95

SCHALLER, the world's finest Machine Heads, M6, M6-Mini, M6L-Mini, M4S-Bass, M4SL-Bass. All Models in CHROME at Your Price of \$36.95 ea. set. List \$64.95. GOLD also available in M6 model at Your Price of \$49.95. List \$94.95.



## GUITAR COMPONENTS

(All Components Pictured Left to Right)

P1	500K VOLUME Potentiometer w smooth action 6mm shaft	\$ 3.50
P2	500K TONE Potentiometer w smooth action 6mm shaft	\$ 3.50
L11	Switchcraft Input JACK (open circuit)	\$ 1.00
12A	Switchcraft Input JACK (closed circuit)	\$ 1.00
E2	Strap Button machine out of brass & nickel plated	\$ 1.50
S3	Sub-miniature DPDT SWITCH (for phase switching)	\$ 4.00
S4	Sub-miniature SPST SWITCH (for dual to single coil)	\$ 3.00
S1	Switchcraft LEVER SWITCH (for pickup selection)	\$ 6.75
C1	.022 Mylar CAPACITOR for guitar tone circuits	\$ 1.00
C2	.047 Mylar CAPACITOR for Bass Guitar tone	\$ 1.00
JP1	Mono JACK PLATE made from brass & chrome plated	\$ 4.00
JP2	Stereo JACK PLATE made from brass & chrome plated	\$ 4.00
K1	KNOB w 6mm shaft, 1 1/8" Dia with Numerals	\$ 2.00
BN6	Brass NUT measures 1 3/4" L x 3/16" W x 5/16" H	\$ 3.00
WS1	Wiring & Shielding Kit which includes 3 mill adhesive copper tape w wire and solder for superior shielding	\$ 12.00

SAVE \$25.20 on a complete GUITAR KIT-10 which includes (2) M22 Pickups, (2) P1 Controls, (2) P2 Controls (1) S1 Switch, (1) S3 Switch, (2) S4 Switches, (1) L11 Jack, (1) 12A Jack for stereo wiring, (2) C1 Capacitor, (4) K1 Knobs, & (1) WS1 Wiring & Shielding Kit. PRICED SEPARATELY \$145.15 #KIT-10 PRICE \$119.95.

## HEAVY-DUTY REPLACEMENT SPEAKERS & HORNS

Model	Description	Imp.	DIRECT	list
1021	10" MagnaLab 50W Guitar Spk	8	\$29	\$45
1224	12" MagnaLab 80W Guitar Spk	16	\$39	\$65
1588	15" MagnaLab 100W Bass Spk	8	\$49	\$85
G12	12" Celestion 30W Guitar	16	\$59	\$89
4224	12" Super Duty Eminence 125W	8	\$68	\$95
4828	15" Super Duty Eminence 150W	8	\$79	\$110
E120	12" JBL 150W (Full Range)	8	\$139	\$159
E130	15" JBL 150W (Full Range)	8	\$145	\$165
E140	15" JBL 200W (Bass)	8	\$149	\$168
440	800Hz Heppner 40W Horn (16KHz)	16	\$49	\$79
6016	Piezo Super Tweeter 100w		\$11	\$19
2461	JBL 16 Ohm 50W Horn Driver	16	\$199	\$222
SSD1800-16	Renkus-Heinz 40W Driver	16	\$159	\$195
XC1200	Fused 2Way 1200 Hz Crossover 100W		\$37	\$65
XC806	Fused 2Way 800 Hz Crossover 150W		\$58	\$90
R500	Professional 90° Fiberglass Radial Horn for JBL & Renkus-Heinz Drivers. 22" W x 8" H x 16" D		\$129	\$210

All spks include 1 yr warranty against factory defects (5 yrs on JBL spks.)

4 SPEAKER ENCLOSURE PLANS AVAILABLE. Entire Set \$400.

## CABINET HARDWARE & GRILL CLOTH.

(A) Rap-around corner (set of 4)	\$3.50
(B) Tri Corner (set of 4)	\$3.50
(C) Edge Corner (set of 4)	\$3.50
Heavy Duty Cover Latch (set of 4)	\$8.00
Steel Bumper Feet (set of 4)	\$2.50
Rubber Bumper Feet (set of 4)	\$2.50
Cabinet Handle (Chrome strap type)	\$3.95
Cabinet Handle (large recessed type)	\$10.00
Black Vinyl Grill Cloth 46" x 58"	\$19.50
Black TOLEX Covering 54" x 72"	\$21.50
3M Spray Adhesive for above TOLEX size	\$5.95

## PRO MONITOR AND P.A. CABINETS



#620M 2-Way Hi-Powered Monitor complete with 1224 & 6016 components with Fused Input in a Monitor TOLEX Covered Plywood Enclosure. Imp. - 16 Ohms RMS. Size 25" W x 18" D x 15" H. DIRECT \$119. List \$209.

#840M 3-Way Hi-Powered P.A. Speaker complete with 1588, 440, 6016, & XC-1200 components mounted in a tune-ported TOLEX Covered Plywood Enclosure. Imp. 8 Ohms 100W RMS. Size 20" W x 12" D x 25" H. DIRECT \$198. List \$295.

## SHURE'S FINEST MICROPHONES PRE-WIRED w XLR CONNECTORS

	Your Price	List
588 SB-CN	\$69.00	\$123.00
565 SD-CN	\$99.00	\$205.00
SM57-CN	\$105.00	\$210.00
SM58-CN	\$135.00	\$235.00

## HEAVY DUTY MIC. & SPEAKER CABLES w SWITCHCRAFT STEEL CONNECTORS

15' 2 cond. shielded cable w steel phone plugs	#PH-15 \$12.00
50' 2 cond. #16 spk cable w steel phone plugs	#PH-50 \$23.00
25' 3 cond. Bal shielded cable w XLR connectors	#XLR-25 \$22.00
50' 3 cond. Bal shielded cable w XLR connectors	#XLR-50 \$30.00

## PREMIUM G.E. PRE-TESTED TUBES

6L6GC	\$6.95 ea.
12AT7	\$3.75 ea.
12AX7A	\$3.95 ea.

## TO ORDER

CALL TOLL-FREE 800-854-2255 in Calif. Call 800-542-6070

A 24 HOUR Answering Service will be happy to take your order every day except Sunday. CARVIN'S SHOW ROOMS & OFFICES are open 8:00am to 5:00pm Monday thru Friday for Direct Phone Orders & Technical Assistance.

We accept MASTER CHARGE, VISA on both Phone & Mail Orders. (Give us your credit card number & expiration date, plus the code #R50 when ordering). Send Cashiers Checks or Money Orders for Mail Orders not using charge cards. Phone COD Orders will be accepted for Guitar & Hardware Parts Only (10 lb. max.) Canada & Foreign orders must be paid in full in US dollars.

## SHIPPING INFORMATION & RATES

All merchandise will be shipped as soon as possible by UPS (United Parcel Service) to your door. For HANDLING & SHIPPING add the below charges to your order. For Foreign orders, add \$10 to the below shipping charge.

ORDER AMOUNT	ADD SHIPPING CHARGE
\$10.00	Minimum Order
\$10.00 to \$50.00	\$2.00
\$50.00 to \$99.00	\$3.00
\$100.00 to \$200.00	\$4.00
\$200.00 & over	\$5.00

DO NOT USE THE ABOVE CHART for Speakers & Mics. Just add the following amounts for Shipping & Handling. For speakers add \$2.50 ea. (except 8016 piezo). For JBL, Eminence Speakers & Radial Horn, add \$7.00 ea. For all Mics, add \$2.50 ea. For 620M System add \$10 & for 840M System add \$15 ea. Speakers & Mics, not shipped to Foreign Countries. ONLY California residents add current state tax to their order.

FOR YOUR FREE CATALOG OR TO MAIL YOUR ORDER SEND TO CARVIN PARTS, Dept. MR50, 1155 Industrial Ave., Escondido, CA 92025

**CARVIN**  
1980 Pro-Line Guide  
**FREE!**  
Send for a comprehensive 64 pg. color guide to all Carvin Pro-Line equipment including illustrations, technical information and specifications with Special Direct Prices.

--- CARVIN FREE CATALOG ---

Name \_\_\_\_\_  
Address \_\_\_\_\_  
City \_\_\_\_\_  
State \_\_\_\_\_ Zip \_\_\_\_\_ MR50

CIRCLE 85 ON READER SERVICE CARD

www.americanradiohistory.com



LP. Guys like Marky Markowitz and Phil Bodner are heard outside the studios only at the occasional jams such as the ones that Jack Kleinsinger puts on at N.Y.U. It's not the hell-for-leather unrestrained push music of the Chicago style nor the ultra-laid-back and relaxed music of the cool school. If a word must be found to describe the New York style of jazz, it would be *professional*. All these players—from well-known veterans like Slam Stewart to those like Bodner, who are seldom heard outside

of the studios—are thorough professionals who know the job and how to get it done. Some, like Slam Stewart, are also virtuosos who evolved out of the era of jazz stars into what is now a more leisurely life that includes, in this case, teaching in upstate New York. Dardelle also had her shot at stardom with a couple of records on the Victor label back in the '40s. One of them, "After You Get What You Want You Don't Want It" was a hit of minor proportions and probably would have gotten her big

name status but this was the era of the male crooner and Frank Sinatra and Dick Haymes got all the airplay. If John Bunch, for example, doesn't make the sparks fly off the piano the way Dave Brubeck does, he does a very professional job in the rhythm section and his solos, while not the kind you're going to call up all your friends and tell them "wait 'til you hear this," are respectable and tasty.

The star here is Phil Bodner, who is best known for his Benny Goodman styled clarinet work. I don't know where he's been hiding his tenor sax playing because I find it more to my taste than his clarinet. He plays here with the drive and the verve and the booting sound that I've heard from few tenor saxophone players since my main man, the late Chuck Berry.

The only track about which I have real reservations is Grady Tate's laid back singing of "Autumn In New York." I prefer the more impassioned approach of a Frank Sinatra on this sort of ballad. Otherwise everyone plays well, sings well (even Slam on a wonderful "Side-walks Of New York") and the engineering is a model of getting it all down, but then the name of Les Paul, Jr. is enough to assure that.

J.K.

**EDITH WILSON:** *He May Be Your Man But He Comes To See Me Sometimes.* [Robert Koester, producer; no engineer listed; recorded at Stu Black Sound Studios, Chicago, Ill., between 1974 and 1976.] Delmark DS-637.

Performance: **Masterful blues**  
Recording: **Serviceable, if not spectacular**

Edith Wilson had been a name in history books and discographies until that evening when Eubie Blake very gallantly introduced her and enticed her out of the audience at Carnegie Hall to join him in a few selections. She, in turn, was not as gallant as Eubie. Edith Wilson proceeded to steal the show away from the stars Eubie Blake, Joan Morris and William Bolcom with her heartfelt blues and ballads. That night I became aware of Edith Wilson as more than just a name and I've gone out of my way to seek out her recordings and her infrequent New York engagements since that time.

This is one record which eluded me until producer Bob Koester called it to my attention some four to six years



**REAL TIME ANALYZER—ASA-10**

- Quickly analyze and balance any room
- Reduce feedback while increasing the gain
- Improve sound quality for P.A. systems
- Position speakers for maximum effect
- With REAL TIME ANALYSIS your equalizer will deliver its full potential

Suggested ASA-10 resale . . . . \$239.95  
Pink/White Noise Generator . . . \$59.95

WRITE: BOX 115, WEST REDDING, CONN. 06896  
TELEPHONE: (203) 938-2588

**GOLD LINE**

CIRCLE 87 ON READER SERVICE CARD

**CALL FREE  
800-446-8000  
LOOK AROUND!**



**...THEN  
CALL  
A, L & N**

You'll find straight information and super equipment selection from a friendly team of musicians and creative technicians. You'll get fast delivery and great services because, for us, that's what being a **PRO** is all about.

VISA and Master Charge orders accepted  
Virginia Residents (804) 583-1894  
AUDIO, LIGHT and MUSICAL • 7461 TIDEWATER DRIVE • NORFOLK, VA. 23505

CIRCLE 62 ON READER SERVICE CARD



# GO AHEAD. STOMP YOUR FEET!



## You've got an ATM Instrument Microphone System.

 You're on stage to make music, not noise. But most microphones will respond to everything that hits them. Including noise coming through the mike stand. Except these new ATM microphone systems. Because each of these specially-designed instrument mikes includes a *very* effective shock mount and a windscreen.

Even if you're on a "bouncy" stage, you needn't tiptoe when an ATM microphone system is at work. Distracting noises are reduced... not amplified. Including floor resonances from speakers nearby. Or the clunks when you raise or lower the mike. All the audience hears is your chops.

But a great microphone system is not just a shock mount or a piece of foam. At the heart of our systems are

three superb studio-quality microphones: a unidirectional dynamic, a unidirectional condenser and an omni condenser. Road tough? Of course. But with response specially tailored with uncanny accuracy for instrument reproduction.

With these ATM microphones a trumpet is bright, not strident. Trombone is dark but not murky. Reeds are full but not thick. And drums are crisp and clean, not fuzzy or thumpy. For two important reasons.

First, frequency response is smooth and peak-free and extends well beyond the limits of your instrument. So the balance between overtones and fundamental isn't distorted. And one part of your range isn't favored over another.

Second, and equally important is our wide dynamic range... designed

to capture and amplify all of yours. It's almost impossible to overblow our ATM dynamic, for instance. And our electrets will handle up to 130 dB with ease. So your *fff* crescendo won't come out just *ff*.

Great sound and no distractions. The best possible way to start your sound system working *for* you. ATM Instrument Microphone Systems are waiting for you at leading pro music dealers everywhere. Kick up your heels! AUDIO-TECHNICA U.S., INC., 1221 Commerce Drive, Dept. 100MR, Stow, Ohio 44224. In Canada: Audio Specialists, Inc., Montreal, P. Q.

## audio-technica®

Great sound right from the start!



Model ATM10SM  
Omnidirectional  
Fixed-Charge  
Condenser



Model ATM11SM  
Unidirectional  
Fixed-Charge  
Condenser



Model ATM21SM  
Unidirectional  
Moving Coil  
Dynamic



All systems include  
microphone, stand mount,  
shock mount, foam windscreen,  
and carrying case.

# We've got it.

The Belden 42 Pair Cable. Ends multiple wiring problems in the studio and on stage. Available in bulk or with custom plug configurations.



## whirlwind

**Whirlwind Music Inc.**  
P.O. Box 1075  
Rochester, New York 14603  
(716) 663-8820

CIRCLE 65 ON READER SERVICE CARD

**WOW!!**

AUDIO TRANSFORMERS

114 Different Types!  
In Stock!  
And Priced Right Too!

World Famous Sescom "MI-Series" Transformers  
for Professional Audio Applications

**Send for your FREE 1980 Catalog**

**SESCOM, INC.** (702)384-0993  
Professional Sound Division (800) 634-3457  
1111 Las Vegas Blvd. North, Box 910-397-6996  
Las Vegas, NV 89101 U.S.A.

CIRCLE 116 ON READER SERVICE CARD

## ROOTS and SOURCES: from Jimmy Rushing to Mingus's Children

By Nat Hentoff

Hosannas are due Columbia Records for issuing the two-volume *Jimmy* as part of its Contemporary Masters Series. Though Jimmy Rushing's high spirits and deeply affecting lyricism are cherished by jazz musicians and those listeners who followed him with the Count Basie band and then through his years as a single in diverse contexts, his recordings these days are not going to sell in large quantities. But Columbia recognizes how valuable and vital an element Jimmy Rushing was in this singing country's cultural heritage.

He was a very large man, but he was quick to distill and hold a mood, and he swung—always—with mellow grace. In this kaleidoscope of some of his post-Basie performances, Rushing is joined by such swing-era titans as Coleman Hawkins, Ben Webster, Jo Jones, Dickie Wells, and Vic Dickenson. And there are other tracks with Dave Brubeck-Paul Desmond and Benny Goodman. Whatever the setting, Rushing shaped it to his subtly enlivening expressive needs. There are blues, ballads, and a sinuous song that Jimmy used to sing only for close friends before finally recording it—"Trix Ain't Walkin' No More," a courtesan's letter of resignation.

Four of the tracks have not been released before, and on all, the sound is that spacious, very "live" but not at all overheated ambience that characterized Columbia's jazz recordings in the 1950s.

Rushing's musical foundation was laid in Kansas City, and so he was an expert in the blues and in the preaching sounds that preceded them. Going back even farther, while simultaneously involving some of the musicians on jazz's newest frontiers, is *From The Root*

to the Source. In this exuberant, driving, plunging gospel set, the singing is by Martha and Fontella Bass, along with David Peaston. But what makes the proceedings singularly revealing is the presence of younger musicians Amina Claudine Myers (organ, piano), Phillip Wilson (drums), and Malachi Favors Maghostus, bassist with the Art Ensemble of Chicago. They all fit together with commanding ease—showing how deep are the roots of current jazz improvisers.

On the same label—Black Saint/Soulnote, distributed in America by Rounder Records—Dannie Richmond, Charles Mingus's indispensable drummer, has created, in *Ode to Mingus*, an affectionate and accurate tribute to the hugely protean bassist-composer-leader. With the continually stimulating Richmond are tenor saxophonist Bill Saxton, pianist Danny Mixon, and Mike Richmond, a bassist with a fullness of sound and range of ideas that Mingus himself would have highly approved.

The recorded sound is crisp, full-bodied, and abounds with presence. Throughout, the musicians remember one of Mingus's key commands—do not lose or abuse the melody!

**JIMMY RUSHING:** *Jimmy*. [Irving Townsend, Teo Macero, producers; Russ Payne, re-issue engineer.] Columbia C2 36419.

**MARTHA BASS, FONTELLA BASS, ETC.:** *From The Root to the Source*. [Giovanni Bonandrini, producer; Giancarlo Barigozzi, engineer.] Black Saint/Soul Note SN 1006.

**DANNIE RICHMOND:** *Ode to Mingus*. [Giovanni Bonandrini, producer; Giancarlo Barigozzi, engineer.] Black Saint/Soul Note SN 1005.



after the fact. It pairs Edith Wilson with blues pioneer Little Brother Montgomery and blues and jazz veterans Oliver Alcorn, Franz Jackson and Preston Jackson. Also on hand is historic banjo virtuoso, Ikey Robinson, who was on the Jabbo Smith sides for Brunswick records. Unfortunately, Ikey has added the electric guitar to his original instrument, the banjo, but that's the price you pay for what they call progress. This album is heavy on the blues, and includes such fine gems as W.C. Handy's little known "Hesitation Blues" and Eubie's "My Handy Man Ain't Handy No More," in addition to the title tune, a double entendre blues by Lemuel Fowler which has long been one of Edith's specialties.

The problem is that a release on a small label like Delmark can be lost in the shuffle. The big publicity guns of the major companies can make everyone aware of what is available from them but a small outfit like Delmark has considerably more trouble keeping the public abreast of what they're up to. That's where we reviewers can help by calling attention to recordings of unusual merit and it is my privilege to do so here. The band is a little rough and scruggily sometimes, but that just adds to the old-timey blues feel. Actually, while it's good to have recordings by such greats as Preston Jackson around, the band isn't what it's all about. Edith singing the blues and Little Brother backing her sensitively on piano is quite enough for an evening's pleasure. In their recent engagement at Tramp's in New York City that's exactly what they did — just Brother and Edith and it was just fine.

This, however, is only half of the Edith Wilson story. She does sing good blues. She also does fine show tunes, having been in the cast of such Broadway extravaganzas as *Hot Chocolates* and Lew Leslie's *Blackbirds*.

For those of you who savor chronological data, keeping in mind Koester's reluctance to list recording dates (fearing that customers sometimes shy away from all but the latest recordings), I think I'm safe in saying that the first recordings had to be made no later than 1974, which is when Leon Scott, who plays trumpet on seven of these selections, passed away. Since the copyright date is 1976, one can assume that they were finished before the end of that year. It really isn't important when Edith Wilson made these recordings because she's as good today as she ever was. . . What is important is that she get back into a studio again soon. J.K.

## INSTITUTE OF AUDIO/VIDEO ENGINEERING

OFFERING DIPLOMA PROGRAMS IN:

- RECORDING ENGINEERING
- VIDEO ENGINEERING
- CONCERT SOUND REINFORCEMENT AND MAINTENANCE
- RECORD PRODUCTION

Two In-House State-Of-The-Art  
24-Track Recording Studios

Faculty Members Are Leading  
Recording Industry Professionals

Internship/Placement Assistance

Professional Working Environment

Write or Call for Brochure

INSTITUTE OF AUDIO/VIDEO ENGINEERING  
1831 Hyperion Ave.  
Hollywood, California, U.S.A. 90027  
(213) 666-3003



CIRCLE 150 ON READER SERVICE CARD

## NOISE GATE GT-4

The remarkably simple optical noise gate that contributes no noise or distortion to your signal, occupies only 1 3/4" of rack space and costs only \$395.00 for four channels.

To get the full story and a list of dealers call or write

OMNI CRAFT INC.  
RT. 4 BOX 40  
LOCKPORT, IL.  
60441  
815-838-1285



CIRCLE 64 ON READER SERVICE CARD

## Vortec For Those Who Care



Integrated Sound Systems' Vortec Sound Reinforcement Series has been developed to provide touring bands with the insurance they so desperately need to protect themselves against inevitable speaker mishaps on the road. These highly efficient enclosures have been specially designed to offer cool-operating, high-definition performance at the highest output. Vortec Sound Reinforcement Series speaker enclosures are equipped with rugged Vortec Industrial Series drivers. Innovative speaker cone and ring diaphragm designs allow long linear excursions and ultra-high frequency extensions without

distortion or break-up. These high-quality enclosures are vented, Theile-aligned, and constructed of heavy-duty plywood. They can be employed individually or in multiple speaker configurations. All high-frequency components in the Vortec Sound Reinforcement Series are field replaceable.



INTEGRATED SOUND SYSTEMS, INC.  
29-50 Northern Boulevard  
Long Island City, NY 11101 U.S.A.  
(212) 729-8400

CIRCLE 134 ON READER SERVICE CARD

# DON'T MISS OUT on back issues of MR&M!



Just send \$2.00 plus \$.50 for postage and handling per issue to:

Modern Recording & Music  
Back Issues Dept.  
14 Vanderventer Avenue  
Port Washington, N.Y. 11050

**Check Box:**

- Jan. 1980       July 1980  
 Feb. 1980       Aug. 1980  
 May 1980       Sept. 1980

*Sorry! All other back issues are out of print.*

Name \_\_\_\_\_

Address \_\_\_\_\_

City \_\_\_\_\_

State \_\_\_\_\_ Zip \_\_\_\_\_

SUBSCRIBER SERVICE

## CHANGE OF ADDRESS

Planning to move? Please let us know six weeks in advance so you won't miss a single issue of MODERN RECORDING & MUSIC. Attach old label and print new address in space provided. Also include your mailing label whenever you write concerning your subscription to insure prompt service on your inquiry.

<p>Name _____</p> <p>Address _____</p> <p>City _____</p> <p>State _____</p> <p>Date _____</p> <p>Zip _____</p>	<p>▶ New Address Here ▶</p>	<p>Attach Label Here</p>	<p>▶ Please print ▶</p>
--	-----------------------------	--------------------------	-------------------------

Modern Recording & Music Magazine  
14 Vanderventer Ave • Port Washington, N.Y. 11050

# CLASSICAL

**THE CANADIAN BRASS: *Royal Fanfare*.** [Eleanor Sniderman, producer; David Green, engineer; recorded at Manta Sound, Toronto, Canada, December 1973. Original recording released by Boot Records, Ltd., Canada.] Vanguard SD 71254.

Performance: **A fanfare for the Brass**  
Recording: **Clean, crisp, the Brass ring**

Anyone who has studied one of the brass instruments knows that compared to the availability of music for stringed instruments, keyboards or voice, brass literature is in a state of poverty. Even when you get to the level of virtuoso performing units like the Canadian Brass there isn't that much for brass groups. That's why so many of these selections are arranged for the Canadian Brass by arrangers running the gamut from members of the Canadian Brass to John Glasel who used to play cornet in Bob Wilber's Wildcats (a dixieland ensemble out of Scarsdale, N.Y., circa 1947). Composers range from the well-known J.S. Bach to such relative unknowns as Anthony Holborne and as far apart in time as the fifteenth-century Josquin des Prez whose "Royal Fanfare" gives the album its title to the contemporary William McCauley whose "Miniature Overture" was commissioned by the ensemble.

Brass recording seems to demand, or at least call for, a livelier sound and a crisper attack than most other recording situations. Engineer Green has given the Canadian Brass exactly the kind of sound that serves them best.

This leaves one with the gaping question of what would Bach think if he knew that somewhere, someone was reorchestrating his "Little Fugue in G Minor" for brass quintet??? Actually this bothered me a lot more when I read it on paper than it did after I heard it on disc. The Canadian Brass do no violence to Bach's music and if one decides, after hearing this, that one likes it better on pipe organ, one can always go back.

If I have any criticism at all of this record, it would have to be that this is lightweight music. It's too bad that Bach, Beethoven and Brahms didn't write full-length brass quintets or concertos for brass instruments. That fact, how-

ever, shouldn't stop contemporary composers like McCauley from doing full length works that would give us an idea of how brass ensembles would work in the concert medium. Meanwhile this program of miniatures is a pleasant one and it certainly shows off the virtuosity of our northern neighbors. J.K.

**P.D.Q. BACH: *Black Forest Bluegrass*.** [Maynard Solomon, Seymour Solomon, Peter Schickele and William Crawford, producers; Tom Lazarus, engineer; recorded in New York City; no dates given.] Vanguard VSD 79427.

Performance: **Prof. Schickele puts us on again.**

Recording: **Excruciatingly clear**

**PETER SCHICKELE: *The Music of Peter Schickele*.** [Seymour Solomon, Peter Schickele and William Crawford, producers; Tom Lazarus, engineer; recorded in New York City; no dates given.] Vanguard VSD 71269.

Performance: **The composer's conception**

Recording: **Okay, but it could be a little more intimate for chamber music**

I don't know whether Peter Schickele's split personality is the cause of his music or the result of it. That the same man can give us the self-kidding atrocities of P.D.Q. Bach and such penetrating, searching chamber music as the "Elegies for Clarinet and Piano" can only be explained away by asking what else could one expect from a composer who espouses, as his two major musical influences, Igor Stravinsky and Spike Jones. This is not to say that the classicists were humorless, but their humor was of a more subtle variety. Wolfgang Amadeus Mozart kidded himself mercilessly in his "Musical Joke," K. 522. But Mozart's jokes were so subtle you were never quite sure whether he meant them as jokes or not. P.D.Q. Bach leaves no question. These are jokes and they're anything but subtle. Actually the jokes of Professor Schickele's which work best are not the auditory jokes but such written puns as his reference to a bargain counter tenor, Enrico Caruso or his reference to P.D.Q. as a son-of-a-Bach. It makes hilarious reading. The listening is not as amusing—blending cliches of bluegrass



music, for example, with quotations from Bach's *Brandenburg Concerti*. It reminds me of an acquaintance who as a party stunt used to play "Three Blind Mice" on the piano in the style of Mozart, Beethoven and Gershwin by the simple expedient of weaving bits of their greatest hits into the tune of the nursery rhyme. It was fun the first time you heard it, but not the second. I'm afraid that's the way I feel about P.D.Q.'s "Blaves Grass Cantata." I find far more enjoyable the selections on side B: "No No Nonette" a fine update of the "Toy Symphony" originally attributed to Haydn but currently thought to be the work of Leopold Mozart, Wolfgang's father—and the baroque equivalent of a singing commercial, "Hear Me Through."

Writing under his own name, Schickele has had some success, although, to be sure, the clown opened the door for the serious composer. His "Songs," composed as incidental music for the Beaumont and Fletcher play, *The Knight of the Burning Pestle*, is certainly music worth hearing although I hear reminiscences of Stravinsky in it (I seem to hear Stravinsky in most contemporary music.) Unlike the "Blaves Grass Cantata," I find myself enjoying it more with repeated exposure. However, again the gems are on side B. In the "Elegies For Clarinet and Piano," warmly and superbly played by Richard Stolzman and the composer, and in the "Summer Trio", played with sensitivity and style by the Walden Trio, we find that Peter Schickele can compose serious music which, while it may show the roots of Stravinsky (and didn't Beethoven build on Mozart and Brahms on Beethoven), compares favorably with any contemporary chamber music.

I suspect that all the cuts on both of these recordings were made in the same studio. While the spacious sound of the studio, which I presume to be Vanguard's own 23rd Street facility, is fine for the medium-sized consorted material on the P.D.Q. Bach record and for *The Knight of the Burning Pestle* excerpts, it lacks the intimacy that would have made Schickele's chamber music all the more charming.

The danger of a split personality for the composer shows up at several points during *The Knight of the Burning Pestle* excerpts. There are times when the listener asks himself—is this Schickele or P.D.Q. Bach? I suspect there are times the composer may well have asked himself the same question.

J.K.

## A SINGER'S DREAM!



### REMOVES VOCAL FROM MOST STEREO DISCS

The Thompson Vocal Eliminator can actually remove most or virtually all of a solo vocalist from a standard stereo record and yet leave most of the background music untouched! Not an equalizer! We can prove it works over the phone. Write for a brochure and demo record below. COST: \$249.00

## YOU SHOULD SEE US

- Studio Echo/Reverb
- Tape Noise Reduction
- For: • Parametric Equalization
- Electronic Crossovers
- Comp/Limiters

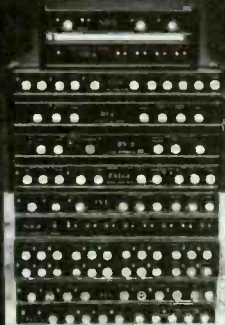

We manufacture a full line of high quality audio and recording equipment. You will probably have to pay twice as much elsewhere to obtain comparable quality. Only Direct Sales make our prices and quality possible. Send \$1 for a 20 page brochure and 20 minute demonstration record.

Write to: **LT Sound**, Dept. MR, P.O. Box 729, Decatur, GA 30031. (404) 284-5155

## GUARANTEED FIVE YEARS



### TYPE 85 FET DIRECT BOX

If it fails or you manage to break it within five years of the date of original purchase, we will fix or replace it no questions asked. That says a lot about the way we build them.

**COUNTRYMAN ASSOCIATES INC.**  
424 STANFORD AVE.-REDWOOD CITY, CA. 94063

CIRCLE 61 ON READER SERVICE CARD

# Sam Ash

ONE OF THE WORLD'S LARGEST DEALERS

## PRO AUDIO

BGW • JBL • YAMAHA • CETEC-GAUSS • ALTEC • ROLAND  
TANGENT • EMILAR • KELSEY • TAPCO • ELECTRO-VOICE  
PEAVEY • QSC • SHURE • MXR • BIAMP • ASHLY • KUSTOM  
BOSE • ANVIL • BEYER • SENNHEISER • IBANEZ • FURMAN  
EDCOR • SESCOM • WHIRLWIND • SUPERMUSICAL • ATLAS  
AKG • ACOUSTIC • CALZONE • LEXICON • DOD • ASHFORD  
DELTALABS • ADVANCED AUDIO • McCAULEY • EVENTIDE

WHY WAIT? CALL US NOW—WE PROBABLY HAVE IT IN STOCK.

FAMOUS  
LOW  
PRICES

**SAM ASH HOT LINE**  
**800-645-3518**

IN NEW YORK STATE CALL 212-347-7757

SINCE 1924  
**Sam Ash** MUSIC STORES

301 PENINSULA BLVD. HEMPSTEAD, N.Y. 11550



CIRCLE 124 ON READER SERVICE CARD

## Advertiser's Index

R.S. #	Page #
141	Allen & Heath..... 83
84	Ashly Audio.....20
47	Audioarts Engineering.....41
62	Audio Light & Musical.....94
102	Audio Technica.....95
143	Arp Instruments.....17
No#	Bose.....63
108	Carrotron.....20
85	Carvin.....93
59	CMG.....88
53	Community Light and Sound 31
61	Countryman.....99
104	Crown.....85
92	dbx.....61
114	DeltaLab.....11
106	DOD Electronics.....47
82	Electro-Voice.....71
149	Eumig.....13
87	Gold Line.....94
41	HSC.....62
150	Institute of Audio/Video Engineering.....97
140	JBL.....37
122	Lexicon.....89
No #	LT Sound.....99
79	Maxell.....19
136	Mike Shop.....90
No #	MXR.....Cover 4
64	Omni Craft.....97
100	Orban.....12
No #	Otari.....Cover 3
60	PAIA.....90
89	Peavey.....67
153	Phase Linear.....49
126	Polyline.....88
71	RolandCorp US.....2
152	Russound.....22
124	Sam Ash.....99
116	Sescom.....96
118	Shure.....45
59	Soundbox.....88
130	Soundcraftsmen.....18
No #	Sound Workshop.....6
151	SPARS.....22
83	Studiomaster.....1
76	Sunn.....87
93	TAD.....21
93	TAD.....23
77	Tapco.....5
67	TDK.....43
125	TEAC.....14, 15
98	Technics.....35
111	Unicord.....7
134	Vortec.....97
65	Whirlwind.....96
110	Whirlwind.....8
99	Yamaha.....Cover 2

# CLASSIFIED ADS

**BROADCASTING CAREER!** Free information. Six month Radio/TV Broadcasting course at major studio. Accredited, Veterans. School of Communication Arts. Division Communication Arts, Inc., 2526R 27th Avenue South, Minneapolis, MN 55406.

**JBL AND GAUSS SPEAKER WARRANTY CENTER.** Fast emergency service. Speaker Reconing and Repair. Compression driver diaphragms for immediate shipment. **NEWCOME SOUND**, 4684 Indianola Avenue, Columbus, OH 43214. (614) 268-5605.

**101 RECORDING SECRETS MOST ENGINEERS WON'T TELL**, \$7.95 Tunetronics, P.O. Box 55, Edgewater, NJ 07020.

**THE MUSIC BUSINESS INSTITUTE** offers a Professional Music Marketing Program: Recording & Studio Production; Artist Representation; Concert Production; Video Production; Retailing & Wholesaling; Record Promotion; Copyright Law; Songwriting and More. Call or write for free brochure: Buckhead Tower, Suite 400, 2970 Peachtree Rd. NW, Dept. MR, Atlanta, GA 30305. (404) 231-3303.

**SWITCHCRAFT PATCH BAY SPECIAL:** Model 1789, 96 jacks, rack mount; List: \$340.00, Sell: \$150.00. While supply lasts. 1-614-387-6632.

dbx 155, 4 channel noise reduction. Dbx 162 stereo compressor limiter. Dbx 110 Boom Box. Orban 516 desser. (303) 741-4746.

**SPECIAL EFFECTS!** We have anything you can imagine for intros, breaks, transitions, beds, or logos. Spice up the performance or demo! Write for very reasonable quote. Satisfaction guaranteed. Creative Rediffusions, 7019 Big Daddy Drive, Panama City Beach, FL 32407.

For Sale New: JBL 2482's \$250, JBL 2220J's \$110, JBL 2203A's \$100, JBL 4602 Stage monitors \$350, Ashly crossovers: SC-22 \$190, SC-77 \$260, SC-80 \$215, SC-66A stereo parametric \$365, TAPCO C-201 stereo equalizer \$230, dbx 500 \$175, dbx 505 \$329. Barney O'Kelly (614) 268-5643.

Tascam 80-8 with or without DX8. Tascam 70-4 in console 1/2" tape. Dbx 155, Teac 2A mixer, Orban 516 desser, EV RE16 mic, Beyer M500, Tascam model 10 12x4, Teac 3300-2T, Tascam 35-2, Pioneer 1050 all 2Tk 7 1/2-15. (303) 741-4746.

**ECOPLATE 11**, the most innovative plate reverb breakthrough for the semi-pro studio. Enhancing the music not cluttering it. In stock for immediate shipment. Trade in's welcome. We buy used semi-pro gear. Audio House, 4675 S. Yosemite Unit 203, Denver CO 80237. (303) 741-4746.

**SPEAKER BUILDER**, the new quarterly can save you one-third on your audio system: build ribbon tweeters, Thiele aligned reflexes, a wall of electrostatics, update cheap bookshelves, giant sub woofers. You'll find it all in Speaker Builder. \$10/four issues, \$18 for eight. Box 494M1, Peterborough, NH 03458. MC/Visa orders (603) 924-6526.

**3M 4 channel deck b/o over \$3,000.** 80 microphones, accessories—extensive list. Martin Gasman, 779 Worcester Street, Wellesley, MA 02181. (617) CELTICS.

**STEINWAY MODEL S 1940. ORIGINAL OWNER.** In prime, professional condition. Irreplaceable quality for \$5,000. (516) 883-8410 eve/weekend.

**WOULD YOU LIKE TO LEARN THE GUITAR** from the most respected teachers and performers playing today? Folk, Blues, Jazz, Bluegrass and many other styles are taught on cassette taped lessons. The teachers include John Renbourn, Stefan Grossman, Duck Baker, Dick Fegy and Eric Thompson. For your free catalog please write to Stefan Grossman's Guitar Workshop, Box 804, Cooper Station, NY 10003.

**Use**  
**MODERN**  
**RECORDING**  
**& MUSIC**

**Classified Ads-**  
**They Get**  
**Results!**

**IMPROVE THE SOUND OF YOUR TAPES.** New detailed manual explains the how and why of proven studio miking techniques. Many illustrations. Send \$5.25 to "Techniques," Box 6736, Louisville, KY 40207.

**AUDIO, VIDEO, ELECTRONIC PRODUCTS.** BEST pricing! Prompt delivery! SONY, dbx, TEAC, TASCAM, ONKYO, SOUND WORKSHOP, MAXELL, MOBILE FIDELITY RECORDS, others. SOUND IDEAS, Dept. MR, P.O. Box 340, Cary, NC 27511. 1-800-334-2483 (NC 919-467-8462).

**PROFESSIONAL AUDIO EQUIPMENT.** Shop for pro audio from N.Y.'s leader, no matter where you live! Use the Harvey Pro Hot-Line 800-223-2642 (except NY, AK, HI). Expert advice, broadcast selection such as: Otari, EXR, Ampex, Tascam and more. Write or call for price or product info: Harvey Professional Products Division, 2 W. 45th Street, New York, NY 10036 (212) 921-5920.





# The New Workhorse

Quietly, you have made the OTARI tape machine a standard for reliability and performance in literally hundreds of stations and thousands of production studios—worldwide! The legendary 5050 series were the first compact professional recorders accepted by the industry and remain, dollars for dB's, the best tape recorders made. Whether moving 1/4" or 1/2" tape, these SMPTE adaptable machines are complete with every necessary production feature.

Our ARS Series Reproducers have been accepted by the most prestigious automation manufacturers in the business. These people must have a reliable product before they put their name on it. Our MX-7800 1" transport production machine remains the most functional eight track on the market.

The OTARI pre-eminence in engineering is more than fifteen years old and encompasses tape formats from full track to twenty-four track and tape speeds from 3 3/4 to 240 ips. To the broadcaster, OTARI has earned its envied reputation for reliability with technological leadership and 100% pre-shipment check-out.

Behind our product is a further commitment: factory support with a large domestic parts inventory, thorough documentation and communicative personnel. A qualified and dedicated dealer network is the final link in OTARI's comprehensive approach to the broadcaster.

You have made OTARI—*The New Workhorse*. We have made them the most comprehensive line of tape machines in the world.

Call or write today for your nearest dealership. They will be happy to put you on top with an OTARI.

## **OTARI**®

Otari Corporation  
1559 Industrial Road  
San Carlos, CA 94070  
(415) 592-8311

In Canada:  
BSR (Canada, Ltd.)  
P.O. 7003 Sta. B  
Rexdale, Ontario M9V 4B3

Models 5050B & Mark II-4 shown in optional cabinets available from the Rus Lang Corporation, Bridgeport, Conn. (203) 384-1266

# Two delays, one price.

Since flanging and doubling are important effects derived from time delay, we put them both in a single, cost-effective unit and called it the Flanger/Doubler.

As a flanger, the MXR Flanger/Doubler can add a variety of tonal colors and vibratos, from the subtle to the bizarre. As a doubler, it can thicken textures, broaden stereo images, make a single instrument or voice sound like many, and create spatial illusions.

Many time delay devices offer a time delay range that is enormous but impractical for certain applications. You end up paying for effects that are either inaudible, distorted, or extremely difficult to manage in performance.

By incorporating a concentrated time delay range of .25 to 5 milliseconds in its flanging mode and 17.5 to 70 milliseconds in its doubling mode, and by providing a variable sweep speed of .03 to 20 Hz, we've enabled the Flanger/Doubler to offer, without unnecessary expense, a tremendous range of time delay effects that are clean, musical, and expressive.

With the MXR Flanger/Doubler, you can create everything from fast frenetic quivers to slow pulsating throbs, including hard reverb and numerous chorus sounds, *without sacrificing sonic integrity.*

The Flanger/Doubler switches easily between flanging and doubling modes and provides pre-setting and LED monitoring of sweep speed and range, so musicians no longer have to hunt for correct flanging and doubling settings during performance. And the MXR Flanger/Doubler is an economical and effective way for engineers to free other delay devices (such as a Digital Delay) for longer time delay functions.

The Flanger/Doubler is designed for use in the studio and on stage, with line or instrument levels. Rugged construction and an optional road case enable it to readily handle the punishments of the road.

Like all MXR products, the Flanger/Doubler has been designed as a practical tool for both musicians and engineers. It has been built with the highest-quality materials and the most advanced American musical technology in order to provide creative artists with the freedom to make original and imaginative statements in today's electronic music. See your MXR dealer.

**MXR Innovations, Inc.**, 740 Driving Park Ave.,  
Rochester, New York 14613. (716) 254-2910

**MXR** Professional  
Products Group

