

# HIGH FIDELITY

OCTOBER 1978 \$1.25

ICD 08398

## Focus on Speakers

The New Vented Systems - "Boom Boxes" Transformed

HF BCHS HOODL DO398CT 78 1 03  
DAVID S BUCHANAN  
APT 26 UNIV APTS  
HOODLAND AVE  
ASHLAND KY  
41101

ensive  
bles:  
orth It?

### Lab/Listening Tests

Got 7 Grand for a Speaker System? Maybe the Beveridge 2SW-1 Is for You... Plus five more speaker tests:

- \* Acoustic Research Model 9
- \* Barcus-Berry AudioPlate
- \* Fried Model Q
- \* Infinity Qe
- \* Realistic Optimus-10



For years, Nakamichi has enjoyed a reputation for building the world's finest cassette deck.

Now Pioneer is introducing something Nakamichi won't enjoy at all: the Pioneer CT-F1000.

A cassette deck that offers all the features and performance of Nakamichi's best cassette deck, at less than half the price.

### **PIONEER VS. NAKAMICHI: THE HEAD TO HEAD COMPETITION.**

The \$1,650\* Nakamichi 1000II and the \$600\* Pioneer CT-F1000 are both honest three headed cassette decks that let you monitor right off the tape as you record.

Both have separate Dolby systems for the playback and recording heads. So when you're making a recording with the Dolby on, you can monitor it exactly the same way.

Both have two motors to insure accurate tape speed.

Both feature solenoid logic controls that let you go from fast forward to reverse, or from play to record without punching the stop button, and without jamming the tape.

And both are filled with convenient items like automatic memories for going back to a selected spot on a tape, multiplex filters for making cleaner FM recordings, separate bias and equalization switches for getting the most out of different kinds of tape, and even a pitch control adjustment that lets you match the pitch of a cassette to the tuning of your guitar or piano.

### **A \$1,000 GAP IN PRICE; NO GAP IN SOUND.**

When we built the CT-F1000, however, we did more than match the Nakamichi's renowned features. We also matched its renowned performance.

Both machines boast totally inaudible total harmonic distortion levels of less than 1.5%.

Both have all but conquered the problem of wow and flutter. (An identical 0.05% for each machine.)

Both offer similarly impressive signal to noise ratios: 64 decibels Pioneer, 65 decibels Nakamichi. (At these levels

# It's value.

we dare you to hear any noise at all, let alone any difference.)

And finally, where the CT-F1000 delivers a frequency

response of 30 to 17,000

hertz, the Nakamichi

deck goes from 35 to

20,000 hertz. (We offer a little more at the

bottom; they offer a little more at the top.

Either way, the specifications are close enough to be called virtually identical.)

### **A FEW PIONEER ADVANTAGES THAT AREN'T MONETARY.**

To prevent you from making distorted tapes, the CT-F1000 has a peak limiter that the Nakamichi machine lacks.

Our tape heads are made out of a special single crystal ferrite material that's been proven to last longer than the Nakamichi's permalloy variety.

And our Dolby system can be calibrated by hand while the Nakamichi 1000II requires a screwdriver.

Admittedly, the Nakamichi 1000II does feature a fancy azimuth control for aligning your heads before every recording session. But we've developed a more accurate way to mount the heads in the first place. So you can spend your time recording, instead of aligning.

### **A FEW CONCESSIONS TO NAKAMICHI.**

Obviously, at almost \$1,000 more, the Nakamichi 1000II must offer some advantages over the CT-F1000.

And we'd be remiss if we didn't point out that their VU meters extend slightly higher than ours.

And that they have extra input for premixed program sources.

And although their signal to noise ratio is hardly different than ours, the Nakamichi 1000II does feature an extra Nakamichi-invented noise reduction system.

Considering the slimness of these advantages, the choice is clear-cut:

You can buy a Nakamichi 1000II and get an incredibly expensive cassette deck.

Or you can buy a CT-F1000. And get one that's simply incredible.

 **PIONEER®**  
We bring it back alive.



The Pioneer CT-F1000: \$600\*

The big  
difference  
between this  
cassette deck  
and Pioneer's new  
CTFF1000  
isn't sound.



The Nakamichi D2001: \$1,650

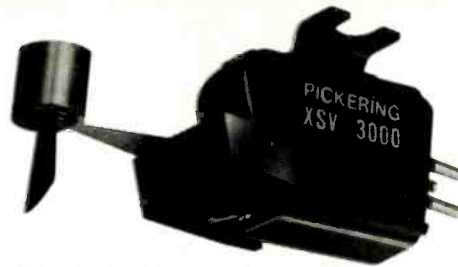

# The XSV/3000 is the source of perfection in stereo sound!

Four big features ... all Pickering innovations over the past 20 years ... have made it happen.

**1976: Stereohedron®** This patented Stylus tip assures super traceAbility™, and its larger bearing radius offers the least record wear and longest stylus life so far achievable.

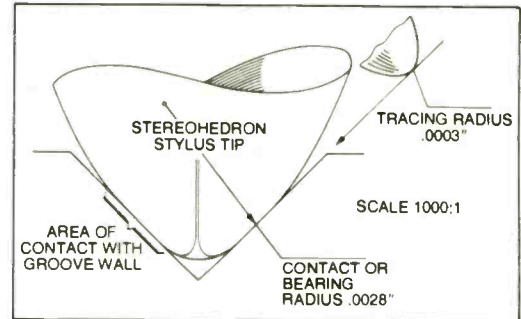

1. Technical drawing of the Stereohedron shape.

**1975: High Energy Rare Earth Magnet**

Another Pickering innovation, enabling complete miniaturization of the stylus assembly and tip mass through utilization of this type of magnet.

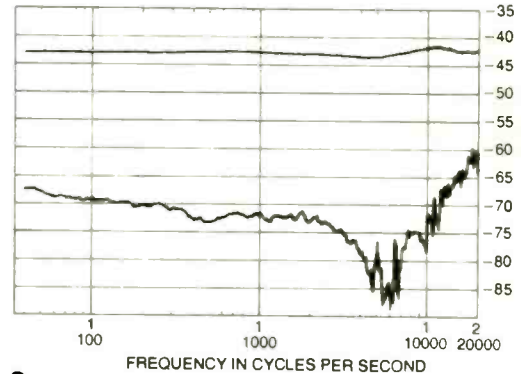

2. Typical frequency response and channel separation curves of the XSV/3000.

**1968: Dustamatic® Brush**

This Pickering patented invention dynamically stabilizes the cartridge-arm system by damping low frequency resonance. It improves low frequency tracking while playing irregular or warped records. Best of all, it provides record protection by cleaning in front of the stylus.

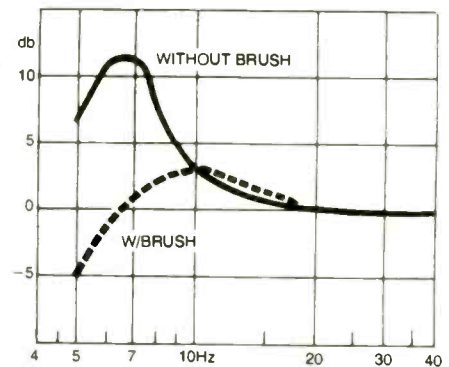

3. Damping effect on tonearm resonance.



**1959: Record Static Neutralizer**

The patented V-Guard Record Static Neutralizer has been a feature of all Pickering cartridges since 1959. It eliminates electrostatic dust attraction at the stylus and discharges record static harmlessly into the grounded playback system.



4. V-Guard Static Neutralizer, "Where the Stylus meets the groove."



For further information write to Pickering & Co., Inc., Dept. HF, 101 Sunnyside Blvd., Plainview, N.Y. 11803

# HIGH FIDELITY

OCTOBER 1978 VOLUME 28, NUMBER 10

## MUSIC AND MUSICIANS

- 22 **Music U.S.A.: The Drug Connection**  
*Gene Lees*
- 29 **High Fidelity Collector's Bookshelf**  
*David Hamilton*
- 32 **Recordings '79: A Coda**
- 82 **On Conducting** *Bernard Jacobson*
- 88 **Koussevitzky's "Grandchildren"**  
*A musical genealogy*
- 93 **Toward a "Complete" Caruso** *David Hamilton*  
*RCA's presentation is welcome, but is it enough?*
- 98 **A Clear Winner for Mendelssohn's Symphonies**  
*Karen Monson*  
*Masur/Leipzig lead the way again*

## AUDIO AND VIDEO

- 50 **News and Views**
- 52 **Equipment in the News**
- 58 **Too Hot to Handle**
- 63 **Equipment Reports**  
*AR-9 loudspeaker system*  
*Barcus-Berry Model 36 AudioPlate add-on tweeter*  
*Beveridge 2SW-1 loudspeaker system*  
*Fried Model Q loudspeaker system*  
*Infinity Qe loudspeaker system*  
*Realistic Optimus-10 loudspeaker system*
- 76 **The Reduction of the Bass Reflex**  
*David Weems*
- 80 **Exotic Speaker Cables: Cure with No Disease?**  
*Harold A. Rodgers*

## REVIEWS

- 93 **Featured Recordings**  
*Enrico Caruso*  *Mendelssohn symphonies*
- 101 **Classical Records**  
*Czech marches*  *Falla's Atlántida*  *Mikrokosmos*
- 110 **Critics' Choice**
- 144 **Theater and Film**  
*Scorpio*  *The Gauntlet*
- 146 **The Tape Deck** *R. D. Darrell*

## BACKBEAT

- 151 **Boston's Return: More Than a Followup?**  
*Toby Goldstein*
- 155 **Bob James in the Studio** *Fred Miller*
- 160 **What Is Funk?** *Michael Rozek*
- 163 **Input Output**
- 164 **Talking Heads** *Ken Tucker*
- 164 **Records**  
*Jimi Hendrix*  *Colin Blunstone*  *Tammy Wynette*
- 170 **Jazz Specialty Discs** *Don Heckman*
- 172 **Spinoffs: New Acts** *Jim Melanson*
- 177 **Spinoffs: R&B** *John Storm Roberts*
- 180 **Folios**  
*Aerosmith*  *Barry Manilow*  *Queen*

## ET CETERA

- 11 **Letters**
- 60 **HiFi-Croctic** *William Petersen*
- 149 **Reader-Service Cards**
- 180 **Advertising Index**



# Fine tune your living room.

Drapes  
muffle lows.

Rugs  
soak up lows.

Wood floors  
bounce highs.

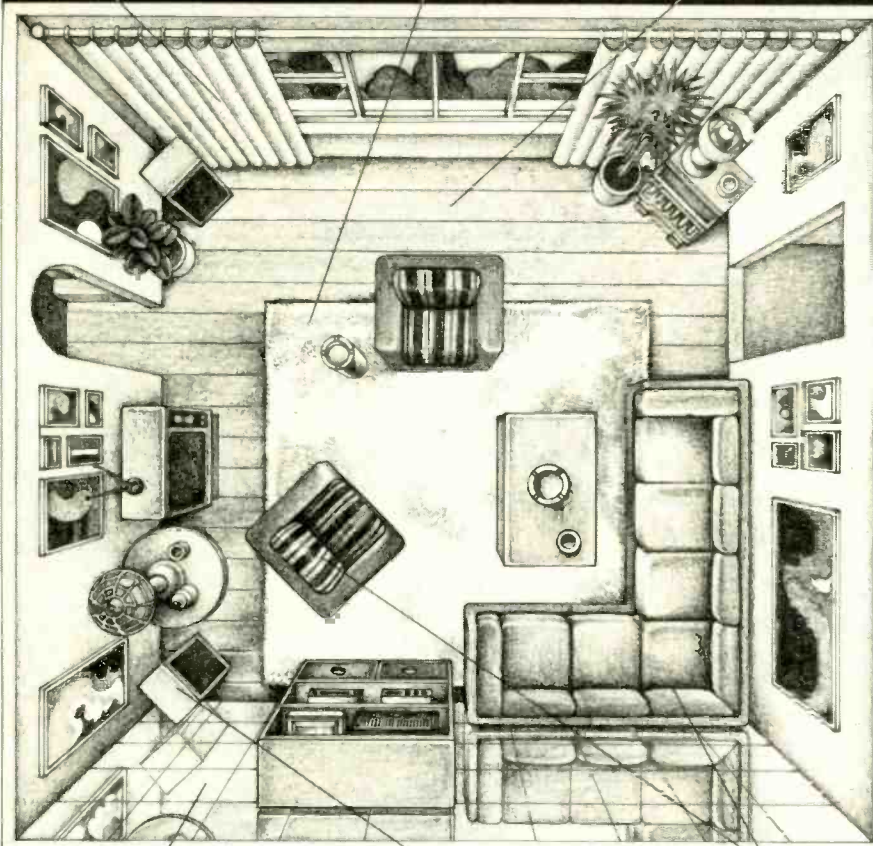

Mirrors  
reflect highs.

Poorly placed speakers,  
poor sound.

Upholstery  
soaks up lows.

Your stereo probably doesn't have the sound you thought you bought. Because you first heard it in a sound room. Unfortunately, most stereos are set up in rooms designed for living. Not listening.

That's why you need a Sound Shaper® One or Two. The frequency equalizers that re-shape music to fit your ears. And your living room.

Sound Shaper One has ten frequency controls, five for each stereo channel. And beautiful styling. But if your system is more sophisticated, you'll want Sound Shaper Two Mk1 with twenty-four frequency controls (twelve for each stereo channel). Plus, internal switching and monitoring. So highlight the vocal. Suppress the bass. Wipe out the flute entirely. And if you want the professional touch, get the new SLM-2 Sound Level Meter. With it, sound levels can be read directly on the Sound Shaper Two, so no longer will you have to run back and forth between the listening area and the equalizer.

Without redesigning your living room, turn it into a listening room.

## Sound Shaper® One and Two



ADC PROFESSIONAL PRODUCTS  
A Division of BSR Consumer Products Group  
Route 303, Blauvelt, N.Y. 10913  
A BSR COMPANY

Distributed in Canada by BSR (Canada) Ltd., Rexdale, Ont. • \*Sound Shaper is a registered trademark of Audio Dynamics Corp. on.

CIRCLE 4 ON PAGE 149

## HIGH FIDELITY



Cover: Roy Lindstrom

LEONARD MARCUS  
Editor

ROBERT S. CLARK  
Editorial Director

KENNETH FURIE  
Music Editor

ROBERT LONG  
Audio-Video Editor

HAROLD A. RODGERS  
Associate Audio-Video Editor

SHIRLEY FLEMING  
Editor, Musical America

SUSAN ELLIOTT  
Popular Music Editor

WAYNE ARMENTROUT  
Director of Production

REBECCA ABBOTT  
Copy Editor

LYNDA CARLOTTA  
CYNTHIA PEASE  
Assistant Editors

ROY LINDSTROM  
Graphics Director

EDWARD J. FOSTER  
Consulting Editor

EDWARD GREENFIELD  
European Editor

ROYAL S. BROWN  
JOHN CULSHAW  
R. D. DARRELL  
ALFRED FRANKENSTEIN  
HARRIS GOLDSMITH  
DAVID HAMILTON  
DALE HARRIS  
PAUL HENRY LANG  
GENE LEES  
IRVING LOWENS  
ROBERT C. MARSH  
FRED MILLER  
H. C. ROBBINS LONDON  
Contributing Editors

DAVID LEE  
Circulation Director

JOHN D. KALLMANN  
Circulation Manager

WARREN B. SYER  
Publisher



Up to now you had to choose between the turntable you wanted and the turntable you could afford.



Technics MKII Series. The SL-1300 MKII automatic, the SL-1400 MKII semi-automatic and the SL-1500 MKII manual.

You expect a quartz turntable to give unparalleled speed accuracy. And these do. What you didn't expect were all the other advantages Technics totally quartz-controlled direct-drive system gives you.

Like torque that cuts buildup time to an incredible 0.7 seconds. And at the same time maintains 0% speed fluctuations with loads up to 300 gms. That's equivalent to 150 tonearms tracking at 2 gms. each.

And that's not all. Technics MKII Series adds quartz accuracy to whatever pitch variation you desire. In exact 0.1% increments. At the touch of a button. And instantaneously

displayed by the front-panel LEDs.

And to take advantage of all that accuracy, Technics has a low-mass S-shaped universal tonearm that's so accurate, friction is down to 7 mg. (vertical and horizontal).

Technics MKII Series. Compare specifications. Compare quartz. And you'll realize there's really no comparison.

MOTOR: Brushless DC motor, quartz-controlled phase-locked servo circuit. SPEED: 33 $\frac{1}{3}$  and 45 RPM. STARTING TORQUE: 1.5 kg. per cm. BUILDUP TIME: 0.7 seconds (= 90° rotation) to 33 $\frac{1}{3}$  RPM. SPEED DRIFT: Within  $\pm 0.002\%$ . WOW & FLUTTER: 0.025%. WRMS. RUMBLE: -78 dB. PITCH VARIATION:  $\pm 9.9\%$ .

Technics MKII Series. A rare combination of audio technology. A new standard of audio excellence.

**Technics**  
Professional Series

# Q • Where should you start in your search for better sound?

## A • At the beginning. With a new Audio-Technica Dual Magnet™ stereo phono cartridge.

Our AT12XE, for instance. Tracking smoothly at 1 to 1-3/4 grams, depending on your record player. Delivers smooth, peak-free response from 15 Hz to 28,000 Hz (better than most speakers available). With a minimum 24 dB of honest stereo separation at important mid frequencies, and 18 dB minimum separation even at the standard high-frequency 10 kHz test point. At just \$65 suggested list price, it's an outstanding value in these days of inflated prices.

Audio-Technica cartridges have been widely-acclaimed for their great sound, and for good reason. Our unique, patented\* Dual Magnet construction provides a *separate* magnetic system for *each* stereo channel. A concept that insures excellent stereo separation, while lowering magnet mass. And the AT12XE features a tiny 0.3 x 0.7-mil nude-mounted elliptical diamond stylus on a thin-wall cantilever to further reduce moving mass where it counts. Each cartridge is individually

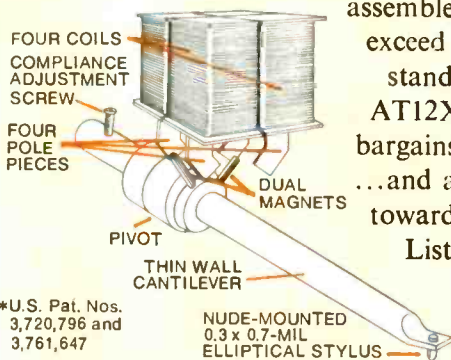
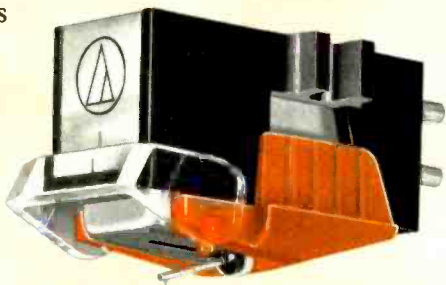

assembled and tested to meet or exceed our rigid performance standards. As a result, the AT12XE is one of the great bargains of modern technology ...and a significant head start toward more beautiful sound.

Listen carefully at your Audio-Technica dealer's today.

\*U.S. Pat. Nos.  
3,720,796 and  
3,761,647



**audio-technica**  
INNOVATION □ PRECISION □ INTEGRITY

AUDIO-TECHNICA U.S., INC., Dept. 108H, 33 Shawassee Avenue, Fairlawn, Ohio 44313  
In Canada: Superior Electronics, Inc.

CIRCLE 9 ON PAGE 149

### COMING NEXT MONTH

No doubt about it, the glamor product on the home entertainment vista these days is the video-cassette recorder, and the important manufacturers are crowding into an already well-stocked field. For November we assembled some representative current models, asked CBS Technology Center to measure their video and audio performance, and conducted critical viewing/listening tests for **VCRs: Five Models Meet Head On**. We mark the sesquicentennial of Franz Schubert's death with David Hamilton's probing look at the complex universe of one of the master's songs, *Im Frühling*, in **The Secret Life of a Song**. And Nancy Pope Mayorga—known to friends and family as "**Ma Sheffield**"—wryly discloses the unorthodox ways a small audiophile record company becomes a national institution. In **BACK-BEAT**, Sam Graham examines the phenomenon that is **Crystal Gayle**, Todd Everett busts open **The Great Radio Ratings Race**, and there are reviews of new albums by the **Beach Boys**, the **Who**, and **Hall and Oates**.

### SOLUTION TO HIFI-CROSTIC NO. 38

CHARLES ROSEN: *Arnold Schoenberg*

In Schoenberg's music before serialism, the relation of dissonance and consonance had so weakened as to be concentrated in the motif. Serialism allowed an almost unlimited source of motivic variation with an assurance of unity of all developments from the same series.

### ADVERTISING

**Main Office:** Robert J. Ur Sr., Director of Advertising Sales, The Publishing House, Great Barrington, Mass. 01230. Telephone: 413-528-1300.

**New York:** ABC Leisure Magazines, Inc., 130 E. 59th St., 15th floor, New York, N.Y. 10022. Seymour Resnick, National Advertising Manager, 212-826-8381. George Dickey, 212-826-8383. Classified Advertising Department, 212-826-8394.

**Midwest:** ABC Leisure Magazines, Inc., 190 N. State St., Room 632, Chicago, Ill. 60601. Telephone: 312-782-1173. William P. Gordon, Midwest Advertising Manager.

**Los Angeles:** ABC Leisure Magazines, Inc., 2020 Avenue of the Stars, Suite 245, Century City, Calif. 90067. Telephone: 213-553-2000. Andrew Spanberger, Western Advertising Manager; Janet Endrijonas, Associate Western Advertising Manager.

**Tokyo:** Japan Advertising Communications, Inc., New Ginza Bldg., 7-3-13 Ginza, Chuo-ku, Tokyo 104, Japan. Telephone: (03) 571-8748. Shigeru Kobayashi, President.

**High Fidelity** and **High Fidelity/Musical America** are published monthly by ABC Leisure Magazines, Inc., a subsidiary of American Broadcasting Companies, Inc. Warren B. Syer, President; Herbert Kessler, Vice President; Photographic Publishing Division, Leonard Levine, Vice President; Advertising, Warren Tuohy, Vice President; Finance, Cathleen Alois; Assistant to the President, Member Audit Bureau of Circulation. Indexed in Reader's Guide to Periodical Literature. Current and back copies of **High Fidelity** and **High Fidelity/Musical America** are available on microfilm from University Microfilms, Ann Arbor, Mich. 48106. Microfiche copies of these magazines (1973 forward) are available through Bell & Howell Micro Photo Division, Old Mansfield Road, Worcester, O. 44691.

**Editorial correspondence** should be addressed to The Editor, **High Fidelity**, Great Barrington, Mass. 01230. Editorial contributions will be welcomed, and payment for articles accepted will be arranged prior to publication. Unsolicited manuscripts should be accompanied by return postage.

# THE JVC RECEIVER.

Every bit as revolutionary as they look, and then some.

In our case, looks are never deceiving. Because all our new DC integrated stereo receivers combine unprecedented, revolutionary styling with unique electronic design features that reflect JVC's more than 50 years' experience in audio development and innovation.

## DC Power Amplifier Design

All four new JVC receivers feature DC amplifier circuitry. They offer virtually distortion-free performance (0.03% THD) throughout the entire audible spectrum. As a result, the sound you hear is clearer, cleaner and crisper. In addition, your speakers are protected with the Triple Power Protection circuit and you can monitor output wattage with dual power meters. Choose from 120, 85, 60 and 35 watts/channel.\*

## SEA all the way

All four receivers offer JVC's exclusive built-in SEA five-zone graphic equalizer for more complete control of

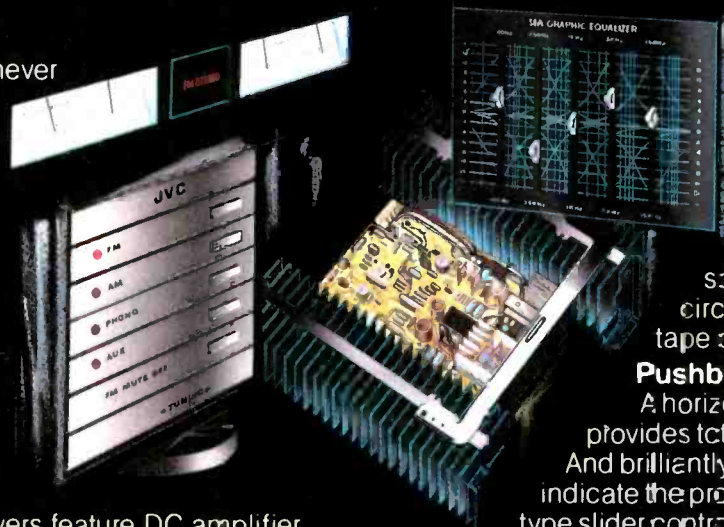

the music spectrum than conventional tone controls. You can attenuate or accentuate any of five separate musical bands, and as an added feature, we've incorporated a special button so that the SEA circuit can be switched to your tape deck.

## Pushbutton Source Selectors

A horizontal panel of pushbuttons provides total control over all functions. And brilliantly illuminated LEDs instantly indicate the program source. Professional-type slider controls set volume and balance. Combine all these exclusive features with high sensitivity and tuning precision thumb control tuning wheel and accurate dual-metering and you'll see just how revolutionary the new JVC DC integrated stereo receivers are. Play one at your JVC dealer soon. JVC

High Fidelity Division, US  
JVC Corp., 58-75 Queens  
Midtown Expressway,  
Masereth, NY 11378. In  
Canada: JVC Electronics  
of Canada, Ltd., Ont.



JR-S 401 (top), JR-S 201 (bottom left) & JR-S 301 (bottom right).

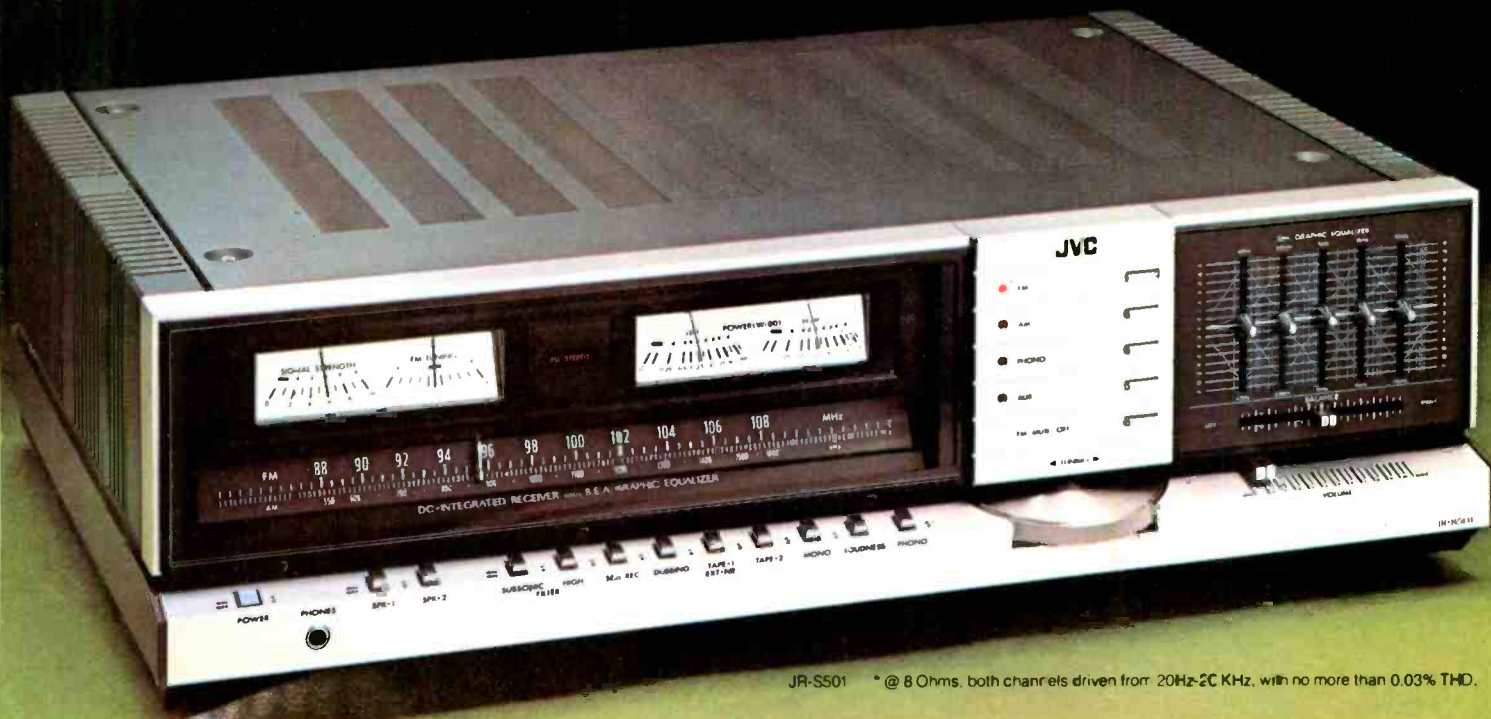

# JVC

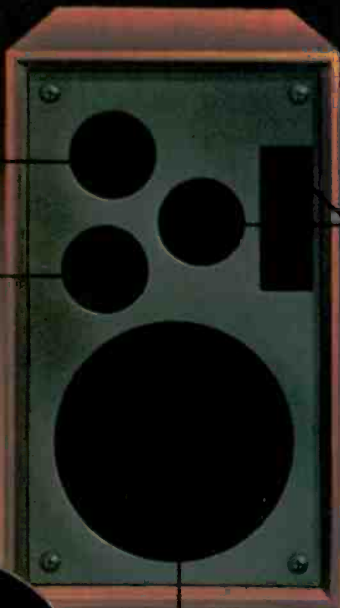

1½" Mylar® dome tweeter for extra-wide 170° high frequency dispersion.



High and mid frequency controls are continuously variable to adjust response to suit any room, program material or individual taste.



Two 3½" midranges with individual tuned isolation chambers.



Low frequency driver with specially treated polyurethane foam suspension for lower distortion, free cone movement, and smoother response.

# An inside look at Jensen's Total Energy Response.

You're looking at the heart of one of the most uniformly accurate sound reproducers made today.

Jensen Lifestyle speakers present a faithful reproduction of music, with all its complexities and tonal balances. They accurately distribute this sound throughout your listening room. Which is what Total Energy Response is all about. It's the uniform radiation of sound throughout the entire listening area... at all frequencies.

Unlike many speakers that require special on-axis listening positions—or others that bounce the sound all over your room—Lifestyle is engineered to deliver a wide spectrum of musical information through-

out the listening area. In proper perspective. With all the depth and imaging your source material is capable of. And at real-life volume levels.

## How does Jensen achieve Total Energy Response?

With a series of drivers and crossover components designed for wide dispersion and engineered to work in total unison with each other for proper stereo imaging.

In fact, for perfectly integrated speaker systems and total quality

control, we make every element that goes into the manufacture of our Lifestyle speakers. From the heavy duty magnets to our hand-wound, high power voice coils. Even the computer-designed crossover network.

At Jensen we take pride—and extra care—in producing the specially designed Mylar dome tweeters that provide 170° high frequency radiation. The same goes for the polyurethane foam cone suspension woofers. And the critical midrange units with tuned isolation chambers.

But please, give a critical listen to these speakers in person. We think you'll agree, a notably superior design concept has resulted in audibly superior sound reproduction.

### The Jensen dome tweeter.

A significant factor in Jensen's Total Energy Response.

High frequency sound waves travel in a straight line. But the rounded shape of this element creates a sound wavefront pattern of the same shape. Thus, as these rounded sound waves travel outward from the dome, they fill the entire listening area.

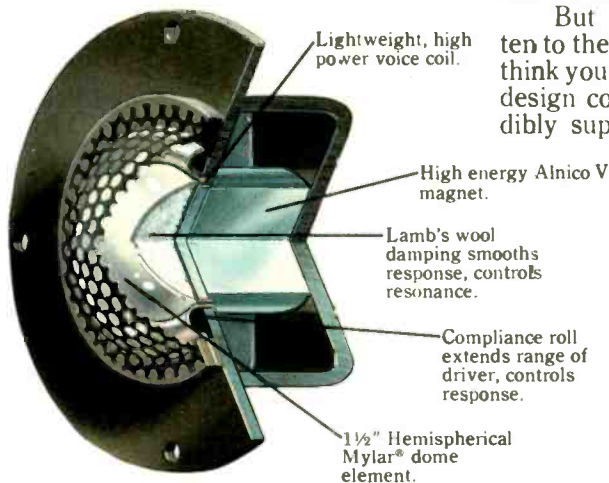

# JENSEN

LIFESTYLE SPEAKER SYSTEMS

Division of Pemcor, Inc.  
Schiller Park, Illinois 60176

# FISHER INTRODUCES THE RECEIVERS THAT LISTEN TO YOU.

Ever since 1937, when Fisher introduced the world to the first high fidelity system, we've been constantly looking for ways to make sound even better.

One of our biggest improvements came in 1959 with the world's first stereo receiver — the famous Fisher 500.

Now, we proudly announce our latest major advance: the all-new RS2000 Studio Standard series — *the receivers that listen to you.*

**Sound the way you like it.** With the RS2000 series, you're not limited to only simple bass and treble controls like other receivers. Instead, you tell the receiver exactly how you want the sound tailored by setting its built-in graphic equalizer's slide controls. By boosting or cutting each of the five equalizer controls, you can transform ho-hum sound into the most exciting you've ever heard. You get sound that exactly matches your taste, your moods, and your environment.

Say you want to really *feel* the drums on a disco record. Just push up the 50 Hz (low bass) slider, and you get just the effect you want — without disturbing the tonal color of voices and other instruments. Want to really bring a vocalist "up front"? Add a little 1 kHz (midrange) boost. And so on. In a few seconds, you can make such a dramatic improvement in the sound of all your records, tapes, and FM broadcasts that you won't want a receiver without this fabulous built-in feature.

**There's logic to our front panel.** Most sophisticated receivers keep you guessing when it comes to operating the controls. Not the Fisher RS2000 series. We've engineered a unique "Panel Logic" system with an illuminated, computer-like display that tells you at a glance what the receiver is set up to do.

The RS2010, below, has great performance specs like superb 1.7  $\mu$ V (9.8 dBf) FM sensitivity, and plenty of power (100 watts min. RMS per channel, into 8 ohms, 20-20,000 Hz, with no more than 0.09% total harmonic distortion). Other models are available from 45 to 150 watts per channel.

Listen to the Fisher RS2000 series receivers. Once you do, you'll never be satisfied with the sound of a receiver without an equalizer.

Available at selected audio dealers or the audio department of your favorite department store. For the name of your nearest dealer, call toll-free in the continental U.S.: 1-800-528-6050, ext. 871 (in Arizona, 1-955-9710, ext. 871). For a copy of the new Fisher guide to high fidelity, send your name and address and \$2 to: Fisher Corporation, 21314 Lassen St., Chatsworth, CA 91311.

 **FISHER**

The first name in high fidelity.



# Letters

## “The Responses Were Amazing...”

As regular readers will recall, we devoted the January 1977 issue of HIGH FIDELITY to the centennial of the invention of the phonograph. Among our celebrations was an article on Thomas Edison as a record producer, by Bridget Paolucci, and among the people she wrote of was Edison's favorite trumpet soloist, Edna White (Chandler). Miss White sent us a letter recently to tell us how the article has affected her life.

During the course of one's career comes a time of frustration and loss of stature when the road ahead bends and the vista beyond is unknown. I had considered myself an utterly forgotten classical trumpeter and had retired in 1968 to the small, lovely town of Greenfield, Massachusetts. Nobody here knew of my former musical experience, and I informed no one of it though I joined a local theater group and played several roles.

In 1972, I received a letter from Leah Burt, assistant archivist of the Edison Historical Site in West Orange, New Jersey, inviting me to attend the annual fall meeting and to speak about my experiences as an Edison artist. I was quite elated to attend that first meeting, and I have done so each year since. That occasion marked the beginning of a new life for me. Ambition blazed once again, and since then I have made a hectic effort to put some creative enterprise on the map. At this late date it is difficult, to say the least, I have outlived a majority of the influential people who would once have befriended me. Not only have the young people of this day and age never heard of me, but their taste in public performers has undergone a radical change. And yet these young people are interested in knowing about the styles of former musicians, such as myself.

The responses to your article were amazing in both origin and content. I had not known that the influence of this excellent magazine would extend so far. Letters came

from all over the U.S.: orders for tapes came to me from Australia and South Africa!

One of the fan letters came from Beth Baker, a high school student in Bemidji, Minnesota. She wrote about her school band activities, and we established a steady correspondence. Since then Beth has won awards and her school band has been selected for state honors, and I am looking forward to having her visit me in the near future for a program I am planning.

Another response came from the daughter of Elizabeth Barry, my former trombonist, to tell me that her daughter, Valerie, was studying the trumpet at Hartt College of Music in Connecticut. I invited Valerie to visit me and let me hear her play. She proved to be exceptional, and I am trying to help her get appearances on television and as a soloist with several orchestras.

I also met Dr. Walter Chesnut, director of the brass instrument section at the University of Massachusetts, and heard his student Steven Schaffner play at his senior recital. This young man is a magnificent trumpet virtuoso.

The most wonderful result of your article came from a telephone call right here in Greenfield. My second cousin, Jean MacDonald, and I lost touch when very young. She read the article and traced me here, her own hometown. Jean is a violinist, and her daughter Anne is working hard to become a classical trumpeter. It was a joyful reunion!

There were many letters, too numerous to write about. It is thrilling to know that there is such interest in the noble classical trumpet.

It is too early to announce the projects I am working on and planning, but I think it is wonderful that they all stem from HIGH FIDELITY. I owe you very much happiness, as I do Leah Burt and the Edison Site. It has been a royally beautiful trip through Memory Land.

Edna White

### Repeat Performance

With reference to Harris Goldsmith's review of the Budapest Quartet's EMI recordings [May], the otherwise superlative performance of the Brahms B flat Quartet is, for me, marred unaccountably by the failure of the players to observe the repeats at measures 121 and 149 of the last movement. This is not just another pedantic assertion on that tiresome topic of observance of repeats: with all the repeats, the structure of this movement, with its relation to the first movement, is one of the most astounding achievements in musical architecture. Their omission in this performance renders the *doppio movimento* section a mere ap-

pendage, at best an extended coda. That this was not Brahms's intention was apparently recognized by the Budapest Quartet, for in its later recording of this work, made in the 1950s, all the repeats in the last movement were observed.

Burton Rothleder  
Silver Spring, Md.

### Correction: Spatial Preamp

Thank you very much for "Ever Heard of 'Noise Intermodulation?'" ["News and Views," August], previewing our first product, the Spatial Coherence Preamp Model TVA-1. We would like to point out to your readers that the \$800 price quoted for



It sounds like music

An incredibly solid 30 Hz low end gives you bass response not found in any other speaker of this size. This is clean bass. It isn't phony. There is no "hump" around 80 Hz to give the impression of bass when there really isn't any. What's on your source material is what you're going to hear - accurately.

There is no sacrifice at the high end either. Both front and rear-firing tweeters give you the uniform total acoustic power output that takes you into a "live-music" environment.

When you buy your next pair of speakers, do yourself a favor - audition the Interface:B's. If your criteria is musical accuracy, the Interface:B's are what you'll buy.



Electro-Voice®

a gulton company  
600 Cecil Street  
Buchanan, Michigan 49107

# Interface: B

# ASK ANY AUDIOPHILE ABOUT PHILIPS' REVOLUTIONARY PROJECT 7 SERIES.

## HE KNOWS.

	AF 877	AF 867	AF 777
Wow & Flutter	0.03% (WRMS)	0.05% (WRMS)	0.05% (WRMS)
Rumble	-70dB (DIN B)	-65dB (DIN B)	-65dB (DIN B)
Price	Under \$240**	Under \$200**	Under \$180**

\*\*Suggested retail prices optional with dealers.





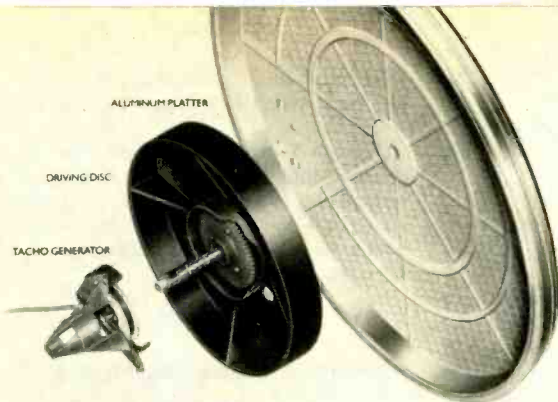

### The World's First No-Compromise Turntables.

These are the turntables audiophiles have been waiting for. The world's first turntables to combine the specs and performance of direct drive with the proven advantages and value of belt drive. That's right – the Philips Project 7 Series turntables have wow & flutter and rumble specs as good as the most expensive direct drive systems. And the acoustic and mechanical isolation of a belt drive. Philips even designed two new tonearms to be perfectly compatible with the new drive system.

The Project 7 Series opens up a new era in turntable performance – the no-compromise era. Because Project 7 turntables compromise on nothing. And because of the incredible Project 7 prices, you won't have to compromise, either.

### Did Philips Compromise on Performance? No!

The heart of the Project 7 revolution is a 160 pole tacho generator that electronically monitors and controls the speed of the platter at the driving disc. Actually putting the driving disc right into the electronic feedback loop. This unique electronic Direct Control system means that variations in line voltage and frequency, variations in pressure on the platter, variations in temperature, even belt slippage – all have virtually no effect on platter speed. All Project 7 turntables maintain constant, accurate speeds – automatically and electronically.

### Did Philips Compromise on Specs? No!

The wow and flutter on the Philips AF 877, for example, is a remarkable 0.05% (DIN) and 0.03% (WRMS). With a rumble figure of better than -70dB. No compromise there.



### Did Philips Compromise on Construction? No!

The aluminum platter and the specially designed straight, low-mass, tubular tonearm are mounted on a separate, shock-proof, free-floating sub-chassis – which is suspended from the main chassis by three nickel chromium leaf springs with butyl-rubber dampers. And that mouthful translates into superb acoustic and mechanical isolation, excellent tracking characteristics, and exceptional stylus and record protection.

### Did Philips Compromise on Controls? No!

Project 7 Series turntables are all-electronic, all the way. On the Philips AF 877, for example, four reliable electronic touch controls provide quiet, convenient, vibration-free operation. There are separate touch controls for starting, stopping, reject and speed selection – all with LED indicators. One touch is all it takes. And when the record is completed, you don't have to touch anything at all. Because electronic (not mechanical) controls lift the tonearm and return it to its rest.



Nine LED indicators also monitor platter speed – and help you vary pitch – with pinpoint electronic accuracy. No more cumbersome checking of the strobe rings on the platter.

And a convenient, built-in, accurate direct read-out stylus gauge makes stylus force adjustment as easy as turning the de-coupled adjustable weight on the tonearm. No extra gauges, gadgets, or paraphernalia needed.

### Philips Won't Compromise. Neither Should You.

Four years ago Philips set out to build the best-performing, best-looking, best-priced turntables in the business. The Project 7 Series turntables more than meet all those goals. With no compromises.

And we don't want you to compromise, either. That's why we've prepared a new, fact-filled 36-page brochure "Ask Us About High Fidelity. We Know." It's filled with dozens of tough questions and honest answers about everything from turntables and tape decks to amps, preamps, tuners and speakers. And it's yours, free. Just call us, toll-free, at **800-243-5000\*** and we'll send you a copy. It can help you find the high fidelity equipment you're looking for. With no compromises. (In Conn.: 1-800-882-6500)

**EVERYONE WHO KNOWS, KNOWS**

# PHILIPS

High Fidelity Laboratories, Ltd.

CIRCLE 39 ON PAGE 149

## SONUS SERIES II.

THE BEST  
KEEPS GETTING  
BETTER.

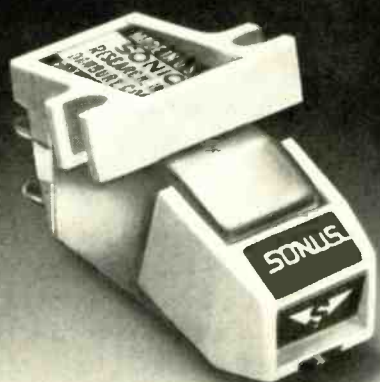

The original Sonus cartridge established a new standard in high definition phonograph reproduction. Yet we believe there is even further room for improvement in this often-overlooked area of high fidelity. So we have taken the original Sonus cartridges and refined their designs, taking full advantage of the latest in materials and techniques. Sonus Series II cartridges are the result of these new design developments.

The new Sonus Gold consists of three models with identical bodies and stylus assemblies, differing only in the form of their diamond tips. The new Sonus Silver comes in two stylus types, and shares all the qualities of their more costly counterparts, yet still can offer a dramatic improvement in sound reproduction overall. Both series employ a transducer system characterized by reproduction of exceptional accuracy, clarity and definition. For full details and a recommendation of which model is correct for your particular system, we suggest a visit to the Sonus dealer nearest you, or write us.

SONIC RESEARCH, INC., Sugar Hollow Rd.  
Danbury, Conn. 06810

# SONUS

High Definition Phono Cartridges

the preamp was in error; the suggested retail price is \$1.195.

William A. Hutchison  
Vice President, Marketing  
Spatial, Inc.  
Long Beach, Calif.

### Wrong the First Time

I wish to bring to your attention an error in "Brisbane's Recording Studio: Right the First Time" by John Culshaw [April]. Mr. Culshaw called me the acoustic consultant to the Sydney Opera House. In fact, the consultant was Dr. V. L. Jordan of Denmark, and I worked as his assistant on the design stages. My involvement in the Brisbane Ferry Road studio was as the acoustic designer advising the construction authority for the Australian Broadcasting Commission.

Peter R. Knowland  
Peter R. Knowland and Associates  
Milsons Point, Australia

### Ersatz Vivaldi?

I would like to make two observations on the interesting and thoughtful article by Paul Henry Lang, "In Defense of Antonio Vivaldi" [March]. First, the six Op. 13 sonatas, *Il Pastor fido*, are to my mind falsely attributed to Vivaldi. Walter Upmeyer, in the Hortus Musicus edition, concedes that the only attribution to Vivaldi is in a printed version of 1737 by a Paris publisher, Boivin. This same publisher four years later printed a set of flute duets by one Johann Schultze that he fraudulently claimed were by Handel. (An earlier edition had credited the correct composer.) Obviously, Boivin is not a publisher to be trusted. Although the ear may deceive, in my opinion, these works are what they sound like: the compositions of some minor French composer of the period.

Second, today we accord nineteenth- and twentieth-century composers the courtesy of acknowledging their unpublished compositions as being distinct from their published ones, recognizing the composer's right to his own evaluation of his work, if not to the privacy he sought. Strangely, eighteenth-century composers like Vivaldi are not given this courtesy. Yet, it is clear that Vivaldi's published compositions are generally far superior to his unpublished ones, and the compositions that are most often criticized as routine are the ones he did not see fit to publish. If he were given the same courtesy as composers of later generations, I believe that critical opinion of his oeuvre would be much higher.

W. Rothstein  
Baltimore, Md.

### Open-Reel Fan

It was good to see the mentions in recent months of Barclay-Crocker in R. D. Darrell's "Tape Deck." For readers who are convinced that impeccable fidelity is obtained only via open reel, there has been no other company—dealing in records or tapes—that in my experience can approach B-C for personal attention, courtesy, promptness in correspondence and handling orders, and complete accountability!

What other retailer would issue critical reservations, when deserved, of the products it sells?

Though I understand there is a resurgence of interest in open reel, perhaps it is not enough to justify Darrell's giving more space to it. But I, for one, appreciate whatever news or comments I can find about this very best of sound media.

G. W. Handy  
Cummerquid, Mass.

### More on Karajan and Masur

I was completely bowled over by the vicious attack by Laurance Maney ["Letters," May] on Herbert von Karajan's conducting genius. To judge this great conductor solely in terms of "women, sports cars, planes," and the like is the height of idiocy. And to compare Karajan with Kurt Masur, a provincial conductor, borders on the ludicrous.

If Maney wasn't impressed with Karajan's new Beethoven symphony cycle for Deutsche Grammophon, he'll never be satisfied. Has he heard Karajan's gorgeous Strauss *Don Quixote* on Angel, his tremendously exciting *Ein Heldenleben*, his magnificent *Symphonie fantastique*, his Bruckner Seventh and Eighth Symphonies? What about the marvelous remakes of the Tchaikovsky Fourth, Fifth, and Sixth?

Ted Meyer  
Coronado, Calif.

The Masur cycle is scheduled for release on Varèse Sarabande.

The mention of the Kurt Masur Beethoven symphony cycle in reader Maney's letter prompted me to write. Although, as your editorial note said, the set is no longer available in this country through regular channels, it is readily available from England. It was released there in September 1975 (Philips 6747 135) in stereo.

Competitive with any integral Beethoven set on the market at any price (indeed, it is my favorite of the six I own), Masur's has the additional advantages of being offered at a budget price—approximately \$30 list—and including the complete overtures.

Scott K. Colebank  
Lawrence, Kan.

### In Defense of Gene Lees

I have found Gene Lees's attempts, through his "Music U.S.A." columns, to generalize about the contributions of various nationalities to the arts very intelligent and enlightening.

The characteristics of the environment into which each of us is born seem to determine the shape our creative expression will take, and the great wealth of words in the English language is no doubt the cause for England's staggering contribution in the field of letters. Compare the English vocabulary of 120,000 words with the French of 60,000. Mr. Lees's English education taught him, better than most Americans know, the sources of these words: Celtic, until 55 A.D. brought a 400-year occupation by Latin-speaking Romans; then Danes, Angles, Saxons, and Jutes brought 500 years of Teutonic languages, until 1066, when the

# the unreel deck



**The AIWA AD-6900U. Super specs and sound quality we defy any reel-to-reel to beat. Plus a lot of extras.**

For openers, the AD-6900U delivers a frequency response of 20 to 20,000 Hz and an S/N Ratio of 68 dB using FeCr tape with Dolby\* on. And only 0.04% WOW and FLUTTER (WRMS). Great numbers, but there's more.

**The exclusive AIWA Flat Response Tuning System (FRTS) gets sensational sound out of any kind of tape on the market.**

With just the push of a button, FRTS will use its own circuitry to measure the precise bias level of any kind of tape and adjust for the flattest possible response. And with the built-

in 400 Hz and 8 kHz oscillators, the AD-6900U offers the most precise test recording possible, so you know exactly what to expect before you record. Coupled with AIWA's exclusive combination 3-head V-cut design, you can expect absolute optimum results in recording, playback and test.



Exclusive AIWA 3 head V-cut design

**The AD-6900U features Full Logic operation and exclusive Double Needle Meters.**

Full logic feather-touch push button controls and dual motor operation make the going easy, and the feather-touch operation with Cue and Review can't be found on any other cassette deck. And no other reel-to-reel or cassette deck offers Double Needle Meters that combine both VU and Peak functions on each meter.

**Plus a full array of extras, including AIWA's exclusive SYNCHRO-RECORD.**

When you use the AD-6900U with AIWA's AP-2200 turntable, Synchro-Record activates recording automatically when the record is cued, and stops when the tone arm lifts. Mic/line mixing, oil-damped cassette ejection, Double-Dolby Noise Reduction with fully adjustable calibration, optional RC-10 remote con-



RC-10 Remote Control

trol, low profile design and your choice of rich wood side panels or tough rack-mount handles make this deck an unparalleled value.

The AD-6900U is the absolute deck. When you hear it, when you use it, you'll agree it's UNREEL.

## AIWA®

Distributed in the U.S. by: **AIWA AMERICA INC.**, 35 Oxford Drive, Moonachie, New Jersey 07074 • Distributed in Canada by: **SBRIRO (CANADA) LTD.**  
\*Dolby is a trademark of Dolby Laboratories, Inc.

The Ditton 44 by Celestion. An hermetically sealed three-way system employing a 1" dome super tweeter functioning from the 5 kHz crossover point to well beyond audibility, a 6" cone midrange that functions down to 500 Hz and a 12" bass transducer that is operational down to 30 Hz. Overall frequency response is 30 Hz to 40 kHz. Available in walnut or teak finish. 30" h x 14½" w x 10" d.



**We're not certain  
you'll prefer the Ditton 44  
over other \$300 speaker systems.**

**Just reasonably confident.**

We not only know how to make speakers, we know how difficult it is to evaluate them. Especially at dealers, because speakers that you love in the showroom have a habit of sounding different at home.

At Celestion, we make all our own crossovers and crossover networks (as we've been doing in England for more than fifty years). So we are reasonably confident of the outcome whenever and wherever our speakers are auditioned and compared with others.

That's why, when we entered the U.S. market in mid-1977, each of our models was introduced together with a select list of competitive systems we considered good values. And also worth your consideration.

Of course, not everyone who made the comparisons chose ours, but enough did to make us feel we were doing the right thing. There are obviously many music lovers who prefer a traditionally-made speaker that produces untraditionally clean, uncolored sound that is as close to the original as we know how to make it.

We don't know how pleased you will be with other speakers when you get home. But from what Celestion owners tell us, ours continue to be satisfying to live with long after the honeymoon is over.

**Celestion**  
Loudspeakers for the perfectionist



Celestion Industries, Inc., Kuniham Drive, Holliston, MA 01746  
In Canada: ROCELCO Inc., Downsview M3J2J7

Normans forced the French tongue upon the land. All of this has given English-speaking peoples four, five, and even six words with which to express the various nuances of feeling in one situation. No other language is so rich. With this incredible array of words to express their feelings and ideas, it seems little wonder that the English were not foremost among those who needed to express themselves in music.

Mr. Lees has offered many reasonable and intriguing reasons for England's relatively limited contribution in music creation, but he barely touches upon the linguistic point. I hope he finds my thoughts as provocative as I found his.

Emelie Ruth Dodge  
Scarsdale, N.Y.

### Trittico Reissue

I was pleased to read that Angel has reissued its recordings of Puccini's *Trittico* in their entirety [reviewed by Dale Harris, April] but also disappointed that it has chosen not to re-release any of the individual operas separately, especially *Suor Angelica*. Although, as Harris pointed out, there may indeed be "benefits to be derived from hearing all three operas together," some may find only one of these operas to their liking.

I feel that the De los Angeles/Serafin *Angelica* comes as close as possible to being a definitive recording of this superb Puccini work. I was horrified at the decision to rechannel it for simulated stereo and think a separate reissue of it in the original mono format would be very well received by the opera public in general and Puccini admirers in particular.

Allen Jones  
Port Arthur, Tex.

### Opera Rara

I thought your readers would be interested in a layman's point of view on the Opera Rara Record Club of London, which has reached fruition with the first recording of Donizetti's *Ugo, conte di Parigi*. Any apprehension I may have entertained concerning the quality of the Opera Rara products vanished with the first playing of this set. I was singularly enthralled by the vigorous performance of the relatively unknown soloists (which indicates to me that you do not necessarily need superstars to make a good operatic recording) and, moreover, assuaged by the superb quality of the clean pressings, the equal of any commercially produced recordings without the commonplace flaws. The handsome boxed set of three records contains a libretto and an entertaining booklet filled with enlightening information on Donizetti, his era, and this opera. Opera Rara's *Ugo, conte di Parigi* is a triumph.

James A. Lewis  
Oakland, Calif.

Our October 1977 "Behind the Scenes" column introduced Opera Rara to our readers. Those interested may write to the Opera Rara Record Club, 8 Haverstock St., London N1 2DL, England.

# Free for 10 days: von Karajan conducts Beethoven

To introduce the ultimate Beethoven Collection:  
all 9 symphonies plus 9 overtures including Leonore  
and Coriolan...50 piano, violin and cello sonatas...  
7 concertos...66 folk songs...18 string quartets...  
41 dances...6 bagatelles...7 marches...9 arias...41 lieder...  
Missa Solemnis...Fidelio...and much more!

Time-Life Records invites you to a perfect marriage of the arts of composing and performing great music: Beethoven's symphonies conducted by Herbert von Karajan.

Beethoven, the arch-romantic—his music (like his tortured soul) surging with fiery emotion. von Karajan, called "the space-age maestro"—cool, precise, methodical, whether on the podium or at the controls of his private jet.

Two more different geniuses are hard to imagine. Yet the product of their "collaboration" is sheer magic—as you can now discover in a free audition of Volume I of the Beethoven Bicentennial Collection.

## Hear von Karajan and the Berlin Philharmonic play the first 6 symphonies—free for 10 days.

In this elegant boxed set of five 12" LP stereo discs, recorded in Europe by the famous Deutsche Grammophon, you will hear the stirring Leonore Overture No. 3, as well as six complete symphonies, among them:

**SYMPHONY NO. 3 ("Eroica").** A heroic struggle waged in sound—described by one critic as "the greatest single step by an individual composer in the history of music."

**SYMPHONY NO. 5.** The wild jubilant conclusion is all the more electrifying because of the brooding drum taps and weeping violins preceding.

**SYMPHONY NO. 6 ("Pastoral").** An image-filled trip to the country—complete with nightingale (flute), cuckoo (clarinet) and quail (oboe).

And this is only the beginning. If you decide to subscribe, you will enjoy free auditions of further volumes in this definitive Beethoven collection. They include the remaining symphonies, Nos. 6-9, again by von Karajan... the celebrated "Moonlight" and turbulent "Apassionata" piano sonatas... the fascinating "Triple Concerto" for piano, violin and cello...

In all: 17 elegant boxed sets, 85 LP 12" records, over 325 different works—virtually every major composition the master ever wrote!

## No risk or obligation

If you are as delighted with the first six symphonies as we think you'll be, you may own them for only \$19.95 plus shipping and handling. Mail the attached card today (no postage required). Or, if card is gone, send coupon at right to TIME-LIFE RECORDS, Time & Life Building, Chicago, Ill. 60611

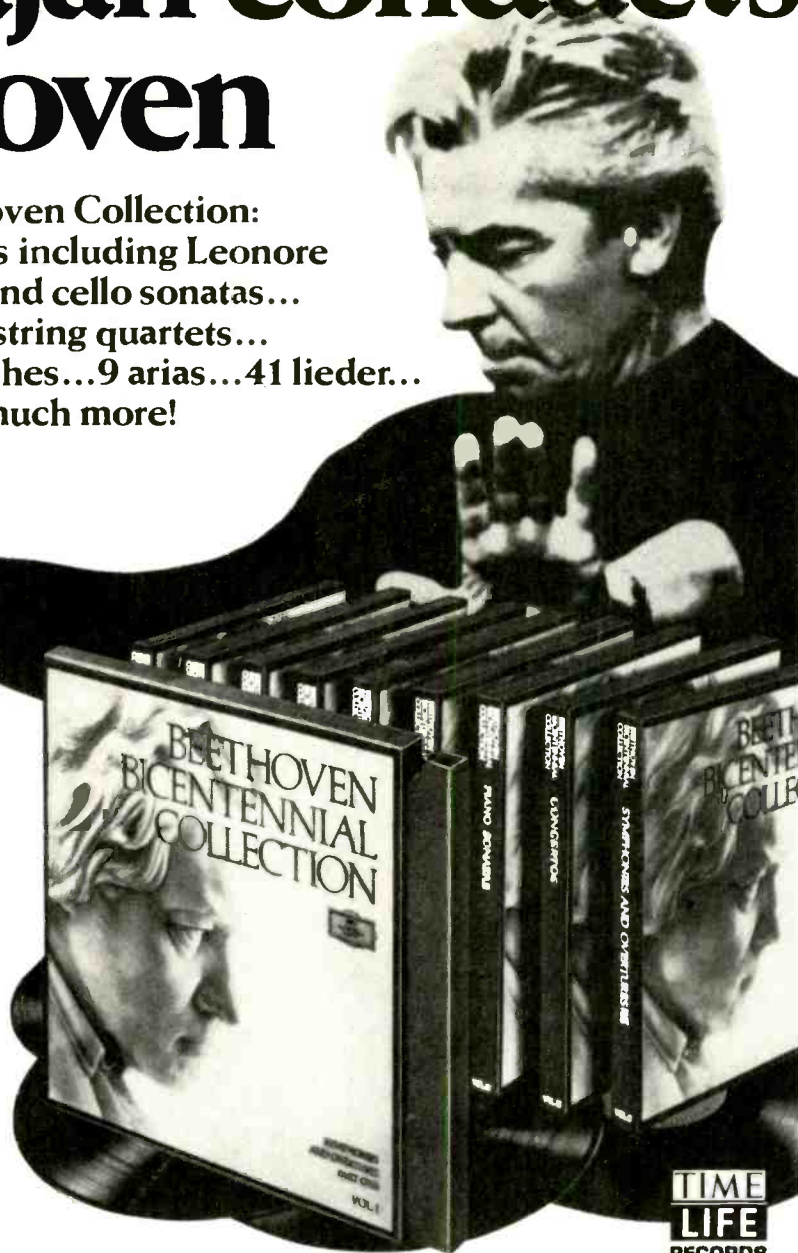

Every major work Beethoven ever wrote, performed by leading virtuosos: Menuhin, Nilsson, Kempff, Fournier, Fischer-Dieskau, The Amadeus Quartet

TIME-LIFE RECORDS, TIME & LIFE BUILDING, Chicago, Ill. 60611.

Yes, I would like to examine the first album of the *Beethoven Bicentennial Collection*. Please send it to me—for 10 days' free examination and enter my subscription to the *Beethoven Bicentennial Collection*. If I decide to keep the first album, I will pay \$19.95 plus shipping and handling. I then will receive future albums in the *Beethoven Bicentennial Collection*, shipped an album at a time approximately every other month. Each is \$19.95 plus shipping and handling and comes on a 10-day free-examination basis. There is no minimum number of albums that I must buy, and I may cancel my subscription at any time simply by notifying you.

If I do not choose to keep the first album, I will return the album within 10 days, my subscription for future albums will be canceled and I will not be under any further obligation.

RBBHX2

Name \_\_\_\_\_

Address \_\_\_\_\_ Apt. No. \_\_\_\_\_

City \_\_\_\_\_ State \_\_\_\_\_ Zip \_\_\_\_\_  
(or Prov.) (or Code)

# Unboxed sound.



# Introducing minimum diffraction loudspeakers by Avid.™

In the quest for accuracy, cabinet loudspeakers, regardless of price, still generally suffer from a common failure — they still sound like loudspeakers, or more precisely their sound obviously comes from a box.

## Your brain hears the box.

Without going too deeply into psycho-acoustics, cabinet speakers tell us their sound is emanating from a box because the brain has been conditioned to recognize the characteristics... size, shape, etc.... of any sound source.

What creates the boxy effect? Diffracted or reradiated sound waves, those that bounce off the sharp edges of the speaker and grille assembly, are the clues interpreted by the brain as "box-like."

## No diffraction, no box.

The problem is graphically illustrated in the drawings. By eliminating sharp cabinet edges and grille panel obstructions, you reduce diffraction effects... which means you eliminate the boxiness of the sound. And that's exactly what we've done with our new line of Avid Minimum Diffraction Loudspeakers™.

## To open the box, we closed the cover.

The solution was deceptively simple.

By engineering the drivers, cabinet enclosure and, importantly, the grille assembly, to create a totally integrated acoustic system, we eliminated cabinet diffraction and the boxy sound quality inherent in typical cabinet loudspeakers.

Our new tweeter and midrange drivers have specially engineered coupling devices (we call them Optimum Dispersion Couplers™) which transmit sound waves with minimum diffraction.

"Solid front" grille panels perfectly mate with each coupler eliminating grille panel diffraction. And, the grille panels have rounded edges creating a smooth, gradual transition from the grille to the cabinet, significantly reducing cabinet edge diffraction — a major cause of boxy sound.

These three simple, but audibly significant, features, coupled with Avid's critically acclaimed accuracy, assure you a new level of performance and sense of reality.

Of course there's a lot more to the Avid story — like our new drivers and Q-Span testing. Write us for literature and a full description. We invite your comparison.



Unwanted cabinet/grille diffraction effects (B) give listener clue as to the size/shape of sound source — in this case a box. First arrival signals (A) locate source, while brain uses delayed room reflections (C) to identify listening environment.

## The Problem

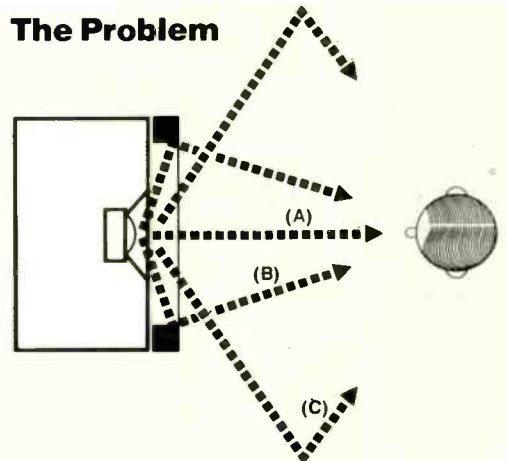

## The Solution

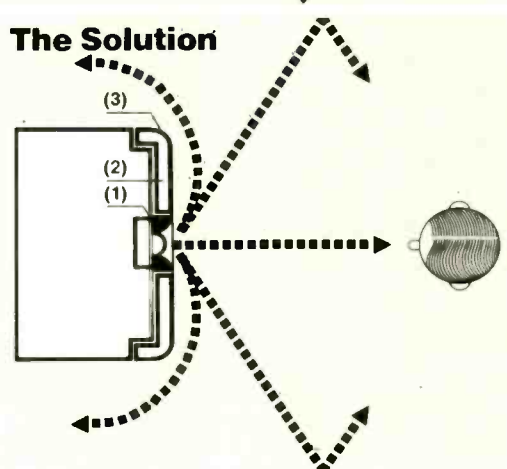

The careful integration of special engineered Optimum Dispersion Couplers™ (1), and solid front grille panels (2) with rolled edge design (3), significantly reduces the unwanted cabinet diffraction effects — a principal contributor to "boxy" sound. These design principals are incorporated in all Avid Minimum Diffraction Loudspeakers™.

**AVID**

10 Tripps Lane, East Providence,  
R.I. 02914



STAN KENTON said once, "There has always been an affinity between jazz and booze." In fact, there has always been something of an affinity between art of all kinds and drugs of all kinds. Baudelaire used hashish. The nineteenth-century English essayist Thomas de Quincey described his drug experience in "Confessions of an English Opium-Eater," and so did Aldous Huxley in "The Doors of Perception." The reason artists are drawn to drugs is obvious, really: the hunger to perceive more deeply, the desperate conviction, born of yearning, that there *must* be more to life than its paltry visible manifestations. That and the fear of not having a vision of life sufficiently unusual to continue making a living as an artist.

Marijuana was, and still is, the drug of preference for jazz musicians. There was a ghastly period in the 1950s and '60s when heroin became commonplace among them, but their addiction rate is comparatively low today. Of those who used it in the so-called bebop era, almost none use it now. They either have quit (and the number who successfully withdrew is remarkable and at odds with the gloomy statistics of recidivism among heroin users in general) or have long since gone to cemeteries.

In the early 1940s, Mezz Mezzrow, a clarinetist who lived his life in imitative awe of Sidney Bechet, stated in his book *Really the Blues* that marijuana had been made illegal under the Harrison Act at the behest of the liquor lobby in order to remove an inexpensive competitor from the market. Whether this is true or not (and no one will ever know now) the book had a considerable influence on young jazz fans, many of whom later became musicians. At least as far back as 1945, marijuana use was almost universal

## 19. The Drug Connection

by Gene Lees

among jazz musicians—but they remained very discreet about it.

The original lyric to "St. James Infirmary Blues" contains a reference to Cokey Joe, a cocaine user, and the original (and unpublished) lyric to "Goodnight, Irene" has the protagonist saying that he is going to take morphine and die. There are drug references in Cab Calloway's "Chinatown, My Chinatown" and "Minnie the Moocher." Both Calloway and the late Fats Waller made joking allusions in songs to "vipers," a 1930s term for potheads. In "I Get a Kick out of You," Cole Porter wrote, "I get no kick from cocaine." He had to alter it for recorded performances to, "Some go for perfumes from Spain." The entire lyric of "You're Getting to Be a Habit with Me," written in 1932 by Harry Warren and Al Dubin, is an allegory of drug use: "Oh, I can't break away, I must have you every day, as regularly as coffee or tea." At that time, "tea" was a euphemism for marijuana.

The references to drugs were obscured by slang and little understood by the public—by the white public, at least. And jazz musicians were content to smoke their joints behind dance halls or in parked cars and keep it all an ingroup secret. ("Ah, those were the days when pot was pot," one of them said recently, recalling a time before demand lowered quality.) The jazzmen, and even the popular songs

that made mention of drugs, made no attempt to convert the public to their use. In the 1960s that changed: The rock singers did precisely that. Code was still used, but it was a lingua franca of both performers and audiences, meant to be understood by the young people, but not by their parents.

In 1966 the show business trade paper *Variety* carried a story, headlined "Pop Music's 'Moral Crisis,'" that said, "A recent wave of pop songs contains references to getting high on dope or liquor, suicide, prostitution, and sundry other way-out, offbeat, and taboo subjects." The paper cited the song "Eight Miles High" by the Byrds and Bob Dylan's "Rainy Day Women" as examples. Many people, it said, had taken Dylan's "Tambourine Man" as "an explicit paean to the connection or pusher." The propaganda for drug use was just getting under way, and it was necessary for *Variety* to explain the term "connection."

Soon *Time* magazine, pointing out that many of the rock lyrics had a slippery ambiguity, cited "Straight Shooter"—slang for a mainliner—and "You've Got Me High" as examples of songs about dope use, or at least containing double entendres permitting that interpretation. *Time* also said the Beatles' "Norwegian Wood" was about a man trying to seduce a lesbian. In fact, "Norwegian Wood" was a British term for marijuana. The song's last line, "Isn't it good, Norwegian wood?", was forthright advocacy of the drug's use.

A young woman who graduated from high school in 1967 observed a decade later, "I was the last of the beer generation. All those songs were coming out, and the drugs were just starting to be used in my class. The kids who came right behind us were



# IN MUSIC, FORM FOLLOWS FUNCTION.

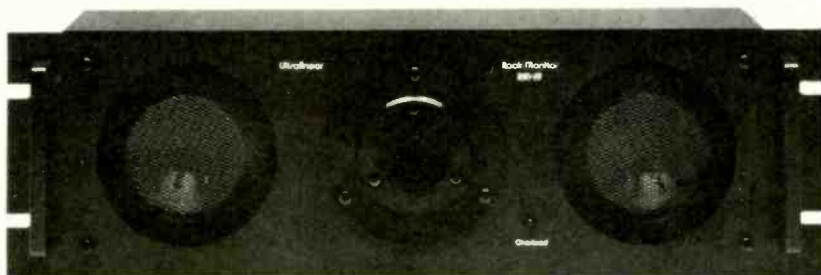

The trombone and the violin look and sound nothing alike. That's because they were designed to perform different musical functions. The trombone's long tubular curves were meant to produce a deep bass sound very different from the high pitched resonant tones of the violin.

Ultralinear's revolutionary new Rack Monitor-19 loudspeaker system is also a fine musical instrument. Our only objective was to develop a loudspeaker that would defy all performance standards for systems of this size. What you see is what we got... the totally functional RM-19. Here's why it sounds better.

**The Componentry** The RM-19 features dual 4½" air suspension low/mid frequency drivers each with a 1½ lb. magnetic assembly, and a 1" soft dome high frequency radiator. These components are strategically aligned in the speaker enclosure to produce sound quality normally associated with 10" and 12" systems. The RM-19 also has an exceptional power handling capacity from 6 watts (min) to 70 watts (max) RMS continuous. To help guard against power overload the system incorporates built-in circuit breaker protection and a miniature Light Emitting Diode (LED) indicator that warns when excessive power levels are being reached.

**The Cabinet** The unique size and shape of the RM-19's enclosure is specially constructed and acoustically matched to the speakers for optimum air suspension performance. These versatile speakers easily adapt to studio type rack mount or shelf mount applications. The functional handles help make the RM-19 a truly portable unit that complements today's professional look

in receivers and amplifiers.

**The Sound** With Sound Pressure Levels (SPL) exceeding 90 decibels this amazing unit is capable of translating modest amplifier output into room expanding sound. On a response curve the RM-19 delivers near linear performance, with overall frequency response within  $\pm 3$  decibels; the minimum coloration level discernable by the human ear.

Anyway you look at it, Ultralinear's RM-19 is a classic example of functional design and engineering. But sound is what really counts, so the only way for you to truly appreciate the RM-19 is to hear it. For the Ultralinear dealer nearest you **call toll free, 1-800-325-8383**. In Missouri call **1-800-392-0900**. The revolutionary RM-19, the latest in Ultralinear's full line of quality built loudspeaker systems for the home and auto.

## Ultralinear®

©Ultralinear Loudspeakers,  
a Division of Solar Audio Products, Inc., 1978  
3228 Eas 50th St  
Los Angeles, CA 90058



# McIntosh

## "A Technological Masterpiece..."



McIntosh C 32

### "More Than a Preamplifier"

McIntosh has received peerless acclaim from prominent product testing laboratories and outstanding international recognition! You can learn why the "more than a preamplifier" C 32 has been selected for these unique honors.

Send us your name and address and we'll send you the complete product reviews and data on all McIntosh products, copies of the international awards, and a North American FM directory. You will understand why McIntosh product research and development always has the appearance and technological look to the future.

Keep up to date.  
Send now - - -

McIntosh Laboratory Inc.  
Box 96 East Side Station  
Binghamton, NY 13904

Name \_\_\_\_\_

Address \_\_\_\_\_

City \_\_\_\_\_ State \_\_\_\_\_ Zip \_\_\_\_\_

If you are in a hurry for your catalog please send the coupon to McIntosh. For non-rush service send the Reader Service Card to the magazine.

CIRCLE 33 ON PAGE 149

all into drugs. A lot of them—and I mean a lot—are dead now. Of course the music was responsible."

Interestingly, many of the rock groups popular in the U.S. were also popular in France, but a drug problem comparable to ours did not develop there. Why? "It's simple," said a Frenchman now living in the U.S. "We didn't understand the lyrics"—or at least the code words.

Not all the lyrics were ambiguous. "Rainy Day Women" refers to marijuana joints, and the last line of that song, "Everybody must get stoned," could not be clearer in meaning. Another of Dylan's songs, "Like a Rolling Stone," concerns a woman of former respectability who becomes a junkie and prostitute. In spite of Dylan's cult reputation for humanism, it seems to express a vicious, perverse pleasure in a woman's degradation.

The late Richard Farina's "Mainline Prosperity Blues" begins, "Good mornin', teaspoon . . . teaspoon, give me back my brain." Reference to the heroin addict's cooking spoon also could be found in the very name of one group, the Lovin' Spoonful. A song called simply "Heroin" contains the line, "I'm married to my vein."

"Eight Miles High" was published by the Richmond Organization, one of the larger publishers. Asked about the company's sense of responsibility, or lack of it, in handling such material, Al Brackman, who was in charge of Richmond's folk and rock music, said, "All these songs are a reflection of our times." This sort of hypocrisy was repeated endlessly in the next decade by record companies, television networks, and movie producers to disclaim any responsibility for the effect of their products on society.

One of the most successful groups of the period, the Jefferson Airplane, frankly admitted there were drug references in its music. Lead singer Marty Balin, who was twenty-three at the time, told a Time reporter that "Running Around the World," a trip song, celebrated the "fantastic experience of making love while under LSD."

Balin's candor sent RCA executives into a dither, but when the weeks passed without the sky falling in, they let the Jefferson Airplane do as it pleased. Later, the group made a record protesting government attempts to halt importation of marijuana from Mexico, and the company put out a 45-rpm single whose cover design consisted entirely of a picture of packed marijuana.

For a time in the '60s record companies tried to pretend that they did

not understand the drug-oriented lyrics, that the various groups had slipped something past them. To the contrary, they all knew what the songs meant, and—at least in the case of RCA—the decision to record them was consciously and deliberately taken. Because arch-competitor Columbia was stealing a march on them with the Dylan drug songs, some of the RCA producers began demanding that they be allowed to make similar records. At first the company held off, but finally the a&r department got the go-ahead and soon thereafter Jefferson Airplane was given a free hand. Before long, the record companies abandoned the pose of innocence and referred in publicity to "acid rock" and "psychedelic" art.

Paul G. Marshall, a New York attorney specializing in the record industry and counsel for the Woodstock Festival in 1969, said "Acapulco Gold" and "Lucy in the Sky with Diamonds," among others, "have made vast fortunes for companies, which accept the money and deny the responsibility. Would one turn out phonograph records extolling the virtues of forcible rape, armed robbery, or kidnapping? The answer, I think, for many companies is yes—as long as there is money in it and they don't go to jail. Several executives have said, 'We're not judges and are only giving the kids what they want.' It is the same argument one occasionally hears used in the courts of New York to defend narcotics pushers."

Marshall's comments were more than a little prophetic. Soon the Beatles put out an album whose cover showed the foursome sitting blood-spattered among pieces of slaughterhouse meat mixed with the arms and legs of dismembered dolls. Capitol—evidently surprised by the intensity of public reaction—quickly withdrew it from the market. Then Alice Cooper simulated a hanging on-stage, and a boy in western Canada died trying to reproduce the trick.

Steve Paley, a Columbia a&r man, once said, "This business is amoral. If Hitler put together a combo, all the top executives would catch the next plane to Argentina to sign him up." This, too, was prophetic. After the arrest of Charles Manson for the Sharon Tate murders, one record company announced it would release an album of his songs.

The music business' propensity to cash in on catastrophe is nowhere more blatantly illustrated than in its war songs and antiwar songs. I will begin a consideration of this topic next month. 

# Technics

by Panasonic

Introducing Technics Linear Phase bookshelf speaker series. Each with staggered speakers, a wide Frequency response and flat amplitude. It may sound complicated, but it made Technics Linear Phase our biggest idea in speakers.

And now with the 3-way SB-X50 and SB-X30 plus the 2-way SB-X10, our biggest idea is small enough for shelf mounting. Like our other Technics Linear Phase Speakers, they all have the ability to reproduce a musical waveform that's virtually a mirror image of the original. Our engineers call it waveform fidelity.

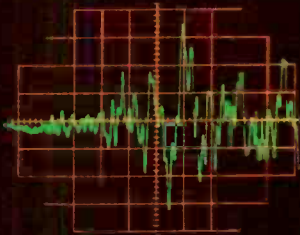

Piano Waveform.

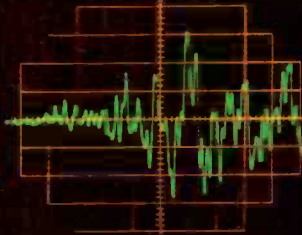

Piano Waveform reproduced by SB-X50.

Look at the waveforms. If seeing is believing, you've just become a believer in Technics Linear Phase. Because that's accuracy that sounds better than good. It sounds live.

How we got that much accuracy into such small enclosures was extremely complicated. But our engineers found the key. A straight horn on a dome tweeter. It not only improved high frequency dispersion, it also gave us the unconventional staggered speaker configuration we wanted, in the conventional enclosure you want.

But what's more important is what Technics Linear Phase bookshelf series does for your hi-fi. For the first time you can have the accuracy of Technics Linear Phase in a speaker system small enough for shelf mounting.

## How Technics made their biggest idea in speakers, smaller.



SB-X50



SB-X10



# The perfect pair.

## The new Koss CM/530 bookshelf speakers with the perfect mirror-image sound.

Here is truly a remarkable achievement in loudspeaker design and performance. The Koss CM/530 bookshelf loudspeaker sets an entirely new standard in extended bandwidth response, high efficiency, low distortion and perfect mirror-image for speakers in its size and price range and within today's technological capabilities.

By designing a left and a right channel configuration for the passive radiator, the woofer and the tweeter, Koss engineers created a perfectly matched set of bookshelf speakers that can be placed horizontally or vertically without losing perfect right

to left or left to right imaging, an incredible degree of dispersion and the beautiful Sound of Koss.

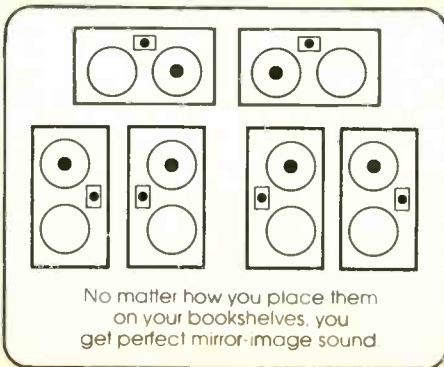

Once you've heard the CM/530 you'll be amazed at its breathtaking depth and clarity and incredible low distortion properties. By utilizing an 8-inch passive radiator to radiate the sound energy over the lower two octaves, Koss engineers were able to use an 8-inch woofer to reproduce the critical sounds in the midrange up to 3,000 Hz. Thus the CM/530 is able to reproduce a maximal flat frequency response from an  $f_3$  (3 dB down point) of 36 Hz on upward. In addition, the CM/530's 1-inch dome tweeter produces an exceptionally flat energy output and unusually low distortion

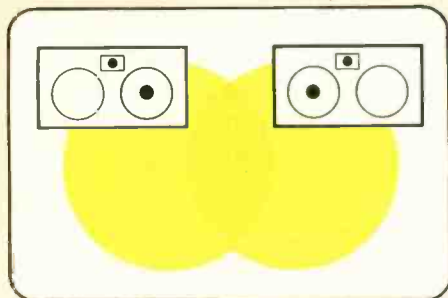

that gives your music a liveliness and transparency not found in competitive speakers.

But what really puts the CM/530 speakers in a class by themselves is their perfect mirror-image sound. By creating a right and left channel configuration, the sound from the left and right speakers comes to the listener with the same musical balance.

So, no matter whether you're sitting in your favorite easy chair or walking around your room, you'll always hear a perfectly balanced, full-bandwidth sound.

The Koss CM/530's also offer an unmatched increase in dynamic range over competitive bookshelf speakers. Due to the CM/530's higher efficiency and lower distortion, you can hear the higher sound pressure levels without clipping and also hear the lowest bass with a dramatic clarity as well. And to help you shape the extra sound you'll hear, there's a 3-position Tweeter Level Control switch on each speaker that allows you to alter the tweeter



frequency spectrum from a flat response to  $\pm 3$  dB.

Ask your Audio Dealer to give you a live demonstration of a matched pair of CM/530 bookshelf speakers. You'll be amazed at their perfect mirror-image sound. And while you're at it, try the perfect answer to private listening: Koss Stereophones. But by all means write, c/o Virginia Lamm for our full-color speaker and stereo-

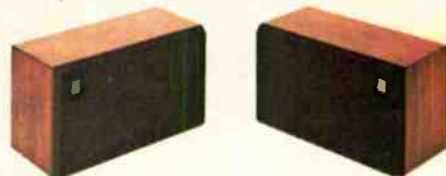

phone catalogs. The Sound of Koss will do great things for your records and tapes... and your image.

# **KOSS**® CM/530 BOOKSHELF SPEAKERS hearing is believing™

**If the bass isn't as clean as you'd like...**

## **The problem may be your tonearm. Not your amplifier or speakers.**

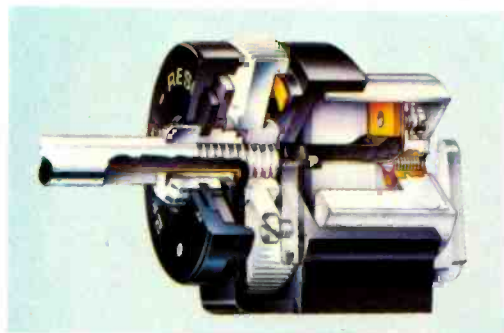

Cutaway view of anti-resonance counterbalance.  
(A feature of Dual models 604, 621, 721 and 1246)

Solid lines show effectiveness of anti-resonance filters in damping resonant amplitudes of three different cartridges (compliance 15, 25 and 43 x 10<sup>-6</sup> cm/dyne). Broken lines show higher resonant amplitudes with conventional counterbalance.

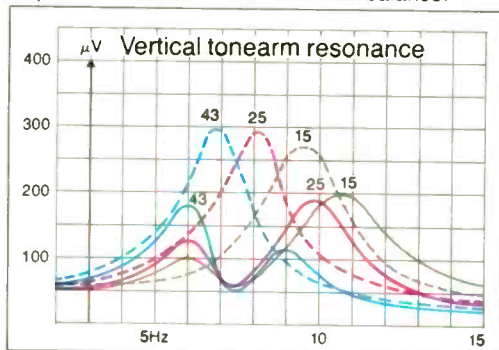

These are specially tuned to damp resonant energy in the tonearm/cartridge system and chassis.

The startling effectiveness of these filters in lowering the resonant amplitude of three cartridges having different compliances can be seen in the graph. Whether the improvement in the bass is subtle or obvious to you depends on the other components and your listening environment.

We've prepared a technical paper on this subject which we'll send to you if you write us directly. You may discover that you don't have to replace your amplifier or speakers after all.

If you've been wondering why your high-powered amplifier and great speaker system don't deliver deep bass as cleanly as you'd like—especially at high listening levels—the problem may well be the effects of resonance on the stylus.

Ideally, the stylus should move only in response to the contours of the record groove. But in reality, the stylus tip also responds to various resonances: its own (with the stylus shank) and the combined resonance of the tonearm/cartridge system.

These subsonic frequencies, though inaudible in themselves, can have very audible effects. Especially with warped records. They can drain amplifier power and cause excessive movements of the low frequency driver. They can cause the tonearm to vibrate and even to momentarily leave the groove. All of which results in audible distortion.

Competent tonearm designers know all this and do their best with materials, masses and compliances to establish the inevitable resonances at the least harmful frequencies (usually between 8 and 10 Hz) and with the lowest possible amplitudes.

Dual's tonearm designers have taken a significant step beyond this.

The unique counterbalances of our direct-drive models (604, 621 and 721) and our top belt-drive multiple-play model (1246) contain two mechanical anti-resonance filters.



**Dual**

**For the life of your records**

United Audio, 120 So. Columbus Ave., Mt. Vernon, NY 10553

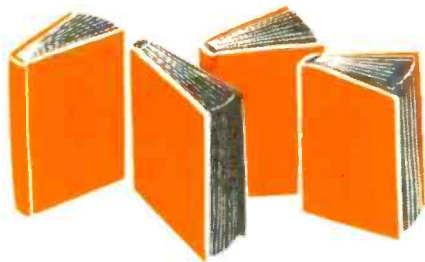

# Beyond Schwann: A Guide to Discographies

by David Hamilton

SOME OF US are content to listen to our records. Others want to know more about the music they contain—and for that we can turn to scores, reference books, biographies, and monographs. Still others also want to know about the recordings themselves—where, when, how they were made. Or even to know about recordings we don't have: What other recordings are there of this composer's music or of that person performing? When these questions reach beyond what can be answered from the latest SCHWANN catalogs, we must turn to the increasingly scholarly discipline known as "discography."

Discography is to records what bibliography is to books. Both terms have been applied rather freely to a variety of things, ranging from simple lists of currently available items to book-length, precisely documented enumerations and detailed descriptions of all traceable material in a chosen category. The subject of a discography may be a performer, a composer, a record company, a type of music. It may include evaluations (as do HIGH FIDELITY's frequent surveys of individual composers), or it may focus entirely on description: circumstances of recording, matrix, take, and issue numbers, couplings, labels, playing speeds, and the like. It may appear in a magazine article, as an appendix to a book, or as an independent monograph.

Just how extensive a field this has become emerges from an invaluable new book, the first of a series entitled *Bibliography of Discographies*, compiled by Michael H. Gray and Gerald D. Gibson (R. R. Bowker, \$19.95). The initial volume, devoted to "Classical Music, 1925-1975," contains 3,307 entries, classified by subject (from Abbado to Zukerman—who was "discographed" by the time he was twenty-five!) and cross-indexed by authors and compilers. Further volumes are planned to cover jazz, popular music, ethnic and folk music, and general discographies (including label numerical lists and the like). Gray and Gibson don't evaluate the quality or comprehensiveness of what they list, but a system of coded symbols indicates certain special features (whether a

discography includes noncommercial recordings, matrix and take numbers, release dates, recording dates), so you can tell whether a particular discography will include the kind of information you need. No such book is perfect, of course, but I have found precious few errors or omissions in this one, which is certainly the most valuable tool we now have for access to discographies. Even if you don't expect to consult it almost daily (and I do), make sure that your local library has a copy.

What are the other basic books in this area? First of all, Clough and Cuming's *World's Encyclopædia of Recorded Music*, the basic general discography of classical recordings from 1925 to 1955, recently reprinted by Greenwood Press (\$87.50, three volumes) and familiarly known as WERM. The first *Gramophone Shop Encyclopedia* of 1936, compiled by R. D. Darrell, is also essential, for Clough and Cuming regarded their work as a supplement to Darrell's and consequently gave less thorough treatment to pre-1936 recordings (they list acoustics only in special cases, when a work wasn't re-recorded electrically or when the recording had special authority, as in the case of performances by composers). The later editions of the *Gramophone Shop Encyclopedia* (1942 and 1948) are in large part superseded by WERM, but can sometimes be useful; secondhand copies of all three are not too hard to find, but this series should certainly be reprinted soon. From 1955 on, you're on your own; nobody has felt up to the challenge of coping with the flood of modern recordings.

If WERM leaves loopholes here and there in its coverage of electrical recordings, they are as nothing compared to the lacunae in the literature on acoustics. One basic work, Roberto Bauer's *New Catalogue of Historical Recordings (1898-1908/9)*, first published in 1947 and reprinted most recently by Greenwood (\$19.50), covers only lateral-cut recordings; though a noble piece of work for its day, Bauer badly needs revision. Julian Morton Moses' *Collectors' Guide to American Recordings 1895-1925* (reprinted last year by Dover, \$3.50, pa-

perback) lists recordings made by artists for the major American companies, also mentioning some of their European recordings. Girard and Barnes's *Vertical Cut Cylinders and Discs*, published by the British Institute of Recorded Sound (see below), does an admirable job on "hill-and-dale" recordings. Naturally the bulk of the listings in these books are of vocal records, but they don't shirk the few instrumentals that were made.

Nor, despite its title, does the very important series called *Voices of the Past*, issued by the Oakwood Press in England. Here we are down to the nitty-gritty of discography, based on the principle that the best way to make sure you have traced all recordings is to reconstruct the numerical series of the various manufacturers. Moses followed that procedure in his *Collectors' Guide*, which includes a numerical list of Victor Red Seals up to 1925, and *Voices of the Past* has been steadily working away at the important European labels; a new series is devoted to the mono LP number sequences of EMI, but most of the volumes deal with 78s. These volumes are all indexed by artist, although not by composer or title.

A good source for these books—and for other European books having to do with recordings—is The Record Collector Shop, 17 St. Nicholas St., Ipswich, Suffolk, England, whence also emanates one of the more valuable record periodicals, with a primary focus on vocal recordings: *The Record Collector* (\$9.00 per year). More catholic in its coverage is *Recorded Sound*, the journal of the British Institute of Recorded Sound (\$12 per year; 29 Exhibition Rd., London S.W. 7, England). And of course there's the *Journal* of our own Association for Recorded Sound Collections (\$10 per year, from James B. Wright, Fine Arts Library, University of New Mexico, Albuquerque, N.M. 87131). Not only do these periodicals include important discographical work; they review and list other publications, helping you keep abreast of the field.

Editor's note: WERM is available to readers through HF's Music Listeners' Book Service. See page 118 for details.

What do you get when you put

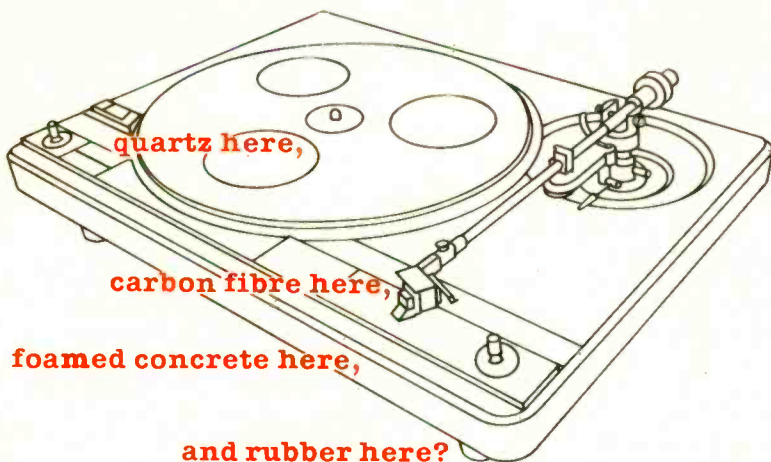

# ADC THE FIRST LOW-MASS TURNTABLE.

ADC is in the business of building breakthroughs.

First, we brought you the innovation of the low mass cartridge. Then the remarkable computerized Accutrac® turntables. Next, the State-of-the-Art Low Mass tonearms.

And now, our engineers have combined the latest advancements of tonearm technology and turntable construction to reduce mass and resonance to new lows.

Result: new benchmarks of high performance.

Finally, the integration of a carbon fibre design tonearm. The famous LMF Carbon Fibre tonearm was the model for the tonearm found on the ADC 1700DD.

In fact, until now you had to make a separate investment in an ADC tonearm to achieve this level of performance.

A level of performance never before available on an integrated turntable.

The mass is lowered by the development of a tapered profile. It is statically balanced with a lead-filled decoupled counterweight, and the headshell is molded carbon fibre, long known for its low mass to high tensile strength ratio.

Furthermore, the headshell is connected to the arm with gold plated computer terminal pins. And the main bearing cradle is made of sintered aluminum. The pivot system utilizes micron polished instrument bearings which are hand picked and matched perfectly to both the inner and outer races, for virtually frictionless movement.

The viscous cueing is a gentle 4mm/sec., and the tempered spring anti-skate adjustment is infinitely variable to 3.5 grams.

The design, the materials and the details interact to provide incomparable performance for a tonearm on an integrated turntable system.

In fact, the tonearm alone is worth the price of an ADC 1700DD.

Finally, resonance conquered. The technical know-how that conquered the problems of the tonearm mass, also conquered the problems of turntable resonance.

The ADC 1700DD reduces resonance to levels so negligible they are virtually nonexistent.

The achievement lies in the innovative construction formula for the turntable base that incorporates the latest advancements from European engineers.

The base is constructed with two dissimilar materials that are resonance-cancelling. First, the outer frame of the base is molded, and then a composition of foamed concrete is injected to absorb and neutralize resonance and feedback.



# LOW RESONANCE

Beyond even this foamed concrete anti-resonance breakthrough, the base is isolated by energy absorbing, resonance-tuned, rubber suspension feet.

This is as close as technology has ever come to defying the physical laws of resonance.

The motor in the ADC 1700DD is also present standard of excellence: Direct Drive Quartz Phase-Locked Loop. The quartz is used in the reference oscillator of the motor.

An electronic phase comparator constantly monitors any variance in the speed, making instantaneous corrections. Even when out of the Quartz-Locked mode, the optical scanning system keeps drift at below 0.2%.

In fact, to check the speed at a glance, we've engineered the 1700DD with a pulsed LED strobe display for your convenience.

Low-mass. Low-resonance. High performance.

What is the result of all these breakthroughs? Pure pleasure.

The pleasure of enjoying your favorite music with less distortion and coloration than you may have ever experienced before. Now you can truly appreciate the integrity of the original recording.

Our engineers have reduced record wear and music distortion to a point where rumble is -70dB Din B, and Wow and flutter less than .03% WRMS.

In the history of audio technology, significant breakthroughs have been made over the past four years with the development of Quartz Lock Direct Drive, carbon fibre tonearms, foamed concrete anti-resonance construction. And now, ADC is the first to bring them all together in the 1700DD. We invite you to a demonstration of this and the other remarkable ADC turntables at your nearest franchised ADC dealer.

Or, if you'd like, write for further information to: ADC Professional Products, a division of BSR Consumer Products Group, Route 303, Blauvelt, N.Y. 10913.

Low-mass. Low-resonance.  
We think you'll be highly interested.

Distributed in Canada by BSR (Canada) Ltd., Rexdale, Ont.  
\*Accutrac is a registered trademark of Accutrac Ltd.



# Preview of the Forthcoming Year's Recordings

HERE IS THE COMPLETION of this year's preview of forthcoming recordings, begun in the September issue. Reissues are indicated •; orchestra names are abbreviated with P (Philharmonic), R (Radio), S (Symphony), and C (Chamber) in appropriate combination with O.

## GERMAN NEWS CO.

Distributes various labels. German News Co., 218 E. 86th St., New York, N.Y. 10028.

## QUALITON RECORDS

Distributes various labels. Qualiton Records, 65-37 Austin St., Rego Park, N.Y. 11374.

## Acanta

(distributed by German News Co.)

- Beethoven: *Fidelio* (without dialogue). H. Konetzni, Ralf Schoeffler, Alsen Seefried, Klein, Neralic; Vienna State Opera, Böhm (1944; two discs).
- Leoncavallo: *I Pagliacci excerpts* (in German). Scheppan, Roswaenge, Schmitt-Walter, Hann, Wessely; Berlin Radio, Rother.
- Rossini: *Barbiere di Siviglia excerpts* (in German). Reichelt, Fehenberger, Schellenberg, Frick, Böhme, Maier, Zimmermann; Dresden State Opera, Striegler.
- Wagner: *Die Walküre excerpts*. Reining, Ringer, Krauss, Rode, Manowarda; Stuttgart Radio, Leonhardt; Königsberg Opera, Brückner (two discs).
- Als Orpheus wieder sang*. Recordings relating to Berlin State Opera premieres, 1945-48.
- Singer Portraits: Hans Hopf, Gunther Trep-tow, Josef Herrmann, Josef Greindl* (two discs each).
- Sternstunden der Musik: I. Die Oper*. Sampler of operatic excerpts from Acanta's historical series.

## Chalfont

- Brahms: *Serenade No. 2*. London PO, W. Jackson.
- Chopin: *The Romantic Chopin*. Wibaut; Cathedral Strings, Kilbey.
- Vaughan Williams: *The House of Life: Songs of Travel*. A. R. Johnson, Willison.
- Williamson: *Symphony for Organ; Vision of Christ-Phoenix*. Wicks.
- English Folksongs*. Wessex Singers.

*French Organ Music from York Minster Cathedral*. F. Jackson.

*Music of Christmas*. Combined London choral societies.

Chalfont Records, Box 11101, Green Lantern Station, Montgomery, Ala. 36111.

## Consortium Recordings

### LAUREL

Baker: *Concerto for Two Pianos, Jazz Band, Strings, and Percussion*. Webb, Hornbrook; Baker, cond. *Singers of Songs/Weavers of Dreams*. Starker, cello; Gaber, percussion.

Baker: *Concerto for Violin and Jazz Band*. Getzoff; Dragon, cond. Bloch: *Violin Sonata No. 2*. Getzoff, Dieterow.

Bernstein, C.H.: *Les Trois Jonas; Rhapsodic Outline and Drawings*. Brennand, cello. Bloch: *Four Episodes for Small Orchestra*. Creston: *Two Choric Dances*. Muczynski: *Dance Movements; A Serenade for Summer*. Arizona CO, Hull.

Bloch: *String Quartets Nos. 1-2*. Los Angeles Qt.

Western Arts Trio, Vol. 3. Works by Manziarly, Mendelssohn, Turina.

### LAUREL-PROTONE

Bach: *Keyboard Works*. Keene, piano. Chopin: *Preludes (26)*. Keene.

### PROTONE

Irma Rogell: *Harpichord Sounds of Celebration*. Baroque and Renaissance music plus folk music from 12 countries.

### GSC RECORDINGS

Paul Hindemith Anthology, Vols. 8-11: Vol. 8: *Concert Piece for Two Alto Saxophones*. Pittel, Rotter. *Trombone Sonata*. Peebles. Carno. *Oboe Sonata*. Ellis, Carno. *Eight Pieces for Flute*. Stokes.

Vols. 9-11: *String Quartets Nos. 1-2, 3-4, 5-6*. Los Angeles Qt.

### SEP-INTERNATIONAL

Bach: *Goldberg Variations*. Hayden.

Consortium Recordings, 2451 Nichols Canyon, Los Angeles, Calif. 90046.

### Crystal

Hindemith: *Oboe Sonata*. Messiaen: *Le*

*Merle noir*. Vivaldi: *Trio Sonata*. Bordeaux: *Premier Solo*. D., D., and A. Weiss.

Mendelssohn, Fanny: *Piano Trio*. Saint-Saëns: *Tarantelle (plus Paganiniana)*. Camerata Canada.

Annapolis Brass Quintet. Works by Tche-repnin, Cabus, Stein, Molineux, Pilss, Pauer.

Roger Bobo: *Botuba* (works by Reynolds, Stevens, Wilder, Lazarof, Kraft, Spillman). With Stevens, trumpet; brass ensemble.

Brian Bowman: *Euphonium Recital*. Works by Adler, Boda, Ross, Capuzzi.

James Campbell: *Clarinet Recital*. Works by Weber, Wellesz, Martinâ, Arnold, Lefebvre.

Peter Christ: *Works with Oboe*. By Persichetti, Still, Schmidt, Thompson.

Dallas Brass Quintet. Works by Haines, Childs, Hovhanness, Persichetti, Reynolds.

Fine Arts Brass Quintet. Works by Linn, Michalski, Plog, Dahl.

Daniel Perantoni: *Works with Tuba* (by Hackbarth, M. Powell). Contemporary Chamber Players.

Harvey Pittel, Westwood Wind Quintet: *Sextets with Saxophone*. By Milhaud, Dubois, Heiden.

Ralph Sauer: *Trombone Recital*. Works by Telemann, Haydn, Borden, Serocki, Larsson.

David Shostac: *Flute Recital*. Works by Kosins, et al.

Soni Ventorum. Works by Taffanel, Martignon, Arrieu.

Mark Watters: *Baritone-Saxophone Recital*. Works by Linn, Pelusi, Bonneau, Boismortier.

Crystal Record Co., Box 65661, Los Angeles, Calif. 90065.

## Denon

Beethoven: *Piano Trios*. Suk Trio (continuation of series).

Beethoven: *String Quartets Nos. 3, 6, 7*. Smetana Qt.

Brahms: *String Quartets (3)*. Wolf: *Italian Serenade*. Prague Qt.

Bruch: *Violin Concerto No. 1*. Mendelssohn: *Violin Concerto in E minor*. Kantorow; Lille PO, J.-C. Casadesus.

Dvořák: *Dumky Trio*. Suk: *Elegy*. Suk Trio. Mozart: *Violin Sonatas*, Vols. 5-6. Kantorow, Planes.

Scarlatti: *Harpichord Sonatas*. Dreyfus. Schubert: *Symphony No. 9*. Berlin RSO, Rögner.

Tchaikovsky: *Symphony No. 4*. Berlin SO, Sanderling.

Telemann: *Chamber Works*, Vol. 1. Hansen, harpsichord; Societas Musica members.

*Japanese Favorite Melodies on Baroque* (arr. Hayakawa). Toyama, violin; Tokyo Vivaldi Ensemble, Hayakawa.

Charley Olsen: *Lüneburg Organ Concert*. Charley Olsen: *Organ Concert at Our Savior's Church*.

All releases are digitally recorded; distributed by Discwasher, 1407 N. Providence Rd., Columbia, Mo. 65201.

# Nikko. Deadly Accurate for Live Sound.



All audio equipment is simply a means to an end — the accurate recreation of music.

These three components from Nikko Audio's professional series incorporate a level of technology that truly puts the "high" into that "end" of accurate music reproduction.

## Gamma V Synthesized Digital Tuner

Nikko's Gamma V FM stereo tuner has PLL twin-stage synthesized tuning circuitry. When the LED readout shows 100.3 MHz, for instance, you've got 100.3 MHz on the button. You can tune to the station automatically or manually, and then set it (and five others) into the memory bank for instant recall. Accuracy plus convenience!

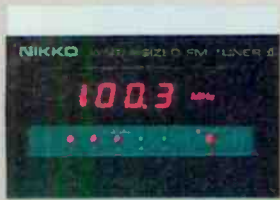

Gamma V Digital Readout

## Alpha III Power MOS-FET DC Amplifier

The Alpha III power MOS-FET DC amplifier oozes accuracy. The power MOS-FET circuitry assures ultra wide frequency response at rated output, while the continuous DC operation from input to output stages assures absolute stability.



Alpha III LED Display

An LED power level display provides a direct reading of the power output of each channel. And (here comes the best part) THD is one of the lowest in the industry — 0.006% (80

watts RMS per channel, both channels driven into 8 ohms, 20Hz to 20kHz). Unheard-of-accuracy!

## EQ 1 Graphic Equalizer

For situations where room acoustics



EQ 1 Gain Control

interfere with faithful music reproduction, Nikko's EQ 1 is the solution. With 10 bands per channel providing  $\pm 12\text{dB}$  boost or cut, you can adjust your system to precisely recreate the live performance. Accrive accuracy.

Nikko works hard to stay ahead in technological excellence. But we never forget what it's all about — accurate musical sound for ultimate musical enjoyment. If this is what you want too, call this toll-free number for the name of your nearest Nikko dealer: (1) 800 423-2994.

# Nikko Audio

For Those Who Take Their Stereo Seriously

Nikko Electric Corp. of America  
 16270 Raymer St., Van Nuys, Calif. 91406 (213) 988-0105  
 218 Sherwood Ave., Farmingdale, N.Y. 11735 (516) 293-2906  
 In Canada: Superior Electronics, Inc. ©Nikko Audio 1978

## Entr'acte

- Amfiteatrof: *Cello-Piano Works*. Strassner, Mayorga.
- Chavez: *Toccata for Percussion*. Schifrin: *Journeys*. Ken Watson Percussion Ensemble.
- Dvořák: *Symphony No. 9*. New Philharmonia O. Handley.
- Friedhofer: *The Best Years of Our Lives* (film score). London PO, E. Newman.
- Herrmann: *Echoes*. Schifrin: *Canons*. Los Angeles Qt.
- Herrmann: *It's Alive!; The Night Digger* (film-score suites). Herrmann, cond.
- Newman: *Hunchback of Notre Dame; Gunga Din* (film-score suites). London PO.
- Thompson: *Testament of Freedom*. Stothart: *Voices of Liberation*.
- Walton: *Symphony No. 1*. Royal Liverpool PO, Handley.
- Waxman: *The Paradine Case* (plus film concertos by Herrmann, Steiner, Webb). Various performers.
- 20th-Century Music for Solo Instruments. By Stevens, Rózsa, Raksin, Waxman, Schifrin.
- Entr'acte Recording Society, Box 2319, Chicago, Ill. 60690.

## Eurodisc

(distributed by German News Co.)

- Bach: *Suites*. Lucerne Festival Strings.
- Brahms: *Piano Works*. Demus.
- Chopin: *Piano Concerto*. Sokolov.
- Flotow: *Martha*. Popp, Jerusalem, Riederbusch: *Bavarian RSO*, Wallberg.
- Haydn: *Cello Concertos*. Geringas.
- Mozart: *Piano Concertos*. Schmidt; Dresden PO, Masur (continuation of series).
- Schubert: *Trout Quintet*. Sawallisch, et al. *Christmas with René Kollo*.
- Erika Köth: *Song Recital*. Songs by Mozart, Schubert, Brahms, R. Strauss.
- Lucerne Festival Strings: *Gala Concert*.
- Lucerne Festival Strings. Works by Dvořák, Grieg.
- Chantal Mathieu: *Magic of the Harp*.
- Romantic Cello Music. Geringas.
- A recording of Mozart's *Entführung aus dem Serail* is planned.

## Everest

- Beethoven: *Piano Concerto No. 5; Rondo in B flat*. Blumenthal; Innsbruck SO, Wagner.
  - Brahms: *Horn Trio*. Mozart: *Horn Quintet*. Marais: *Le Basque*. D. Brain, et al.
  - Britten: *Simple Symphony*. Tchaikovsky: *Serenade for Strings*. Vivaldi: *Concerto Op. 3, No. 11*. Solisti di Zagreb.
  - Castelnuovo-Tedesco, Vivaldi: *Guitar Concertos*. Cubedo; Barcelona SO, Barcons.
  - Mozart, Benda, Corrette: *Flute Concertos*. Rampal.
  - Schubert: *Symphony No. 8*. Haydn: *Symphony No. 100*. Vienna PO, Walter.
  - Sibelius: *Symphony No. 1; Karelia Suite*. *Symphony No. 2*. London SO, Kajanus.
- Chinese Classical Music. From the Tang, Sung, Yuan, and Ming dynasties, 600-1600.

- Classical Guitar and Strings. São Marcos: Solisti di Zagreb.
- English Medieval Carols and Christmas Music. New York Pro Musica.
- English Sacred Music of the 16th Century. Oxford and Cambridge choirs.
- Gregorian Chant, Vol. 3. Benedictine Monks of St. Wandrille de Fontenelle.
- Everest Record Group, 10920 Wilshire Blvd., Los Angeles, Calif. 90024.

## Golden Age Recording

- Babadjanian: *Andante and Suite*. Beethoven: *Piano Sonata No. 23*. Liszt: *Mephisto Waltz*. Tanyel.
- Duke: *Songs (17)*. Boothman, Duke.
- Duruflé: *Requiem* (plus American choral works). Augustana Church Choir, Wagner.
- Komitas: *Sacred Works*. Jamgochian, Hearn. *Secular Choral Works*. Jamgochian Chorale; Huddleston, piano.
- Mozart: *Mass in C minor, K. 427; Kyrie; Et incarnatus est* (plus contemporary American art songs). Anders (s).
- Onslow: *Sonata, Op. 7; Saint-Saëns: Carnival of the Animals*. Joseph, Ross.
- Armenian Love and Patriotic Songs. Jamgochian Chorale; Huddleston, piano.
- Armenian Mass and Folksongs. Jamgochian Chorale; Schrock, organ; Huddleston, piano.
- Armenian Popular Songs. Jamgochian; Armenia's Folk Instrumental Ensemble, Anasian.
- Renata Babak (ms): *Operatic Arias and Ukrainian Songs*. With Hrynkiw.
- Jean Carrington Cook: *Piano Recital*. Works by Chopin, Liszt, Powell, Scriabin.
- Dicran Jamgochian: *Aria Recital*. Armenian SO, Mangasarian.
- Levon Katerjian: *Armenian Folksongs*. With orchestra.
- Glenn Sales: *Piano Recital*. Works by Bach, Beethoven, Chopin, Liszt.
- Golden Age Recording, 5347 28th St., N.W., Washington, D.C. 20015.

## Grenadilla

- Amram, Feldman, Partos: *Works for Piano Quartet*. Orgad: *Shaar Shaar*. Bonazzi (in Orgad); Cantilena Chamber Players.
- Colgrass: *New People*. Bonazzi, Schulman, Basquin, Richter: *Piano Sonata*. Basquin.
- Dello Joio, J.: *String Quartet*. Loeb: *Quartets Nos. 4, 8*. Primavera Qt.
- Husa: *Piano Sonata*. Basquin, Dahl: *Clarinet Sonata*. Sobol, Basquin, Diamond: *Vocalises*. Shelton, Schulman.
- Husa: *Violin Sonata*. Layman: *Gravitation I*. Oliveira, Oei.
- Kaufman: *In Time Past; Time Remembered*. MacDowell: *Three Pieces for Clarinet and Piano*. Long Island Chamber Ensemble.
- Orgad: *Dialogues on the First Scroll*. Gilboa: *Beth Alpha Mosaic*. Contemporary Chamber Players, Shapey.
- Rochberg: *Carnival Music*. Mandel. *Nach Bach*. Kipnis. *Black Sounds*. Oberlin Wind Ensemble.
- Roem: *Serenade on Five English Poems*.

- Starer: *Piano Quartet*. Bonazzi; Cantilena Chamber Players.
- Sydeaman: *Trio Montagnana*. Millburn: *Soli III*. Montagnana Trio.
- Tal: *Shape*. Barolsky: *Cries and Whispers*. Contemporary Chamber Players, Shapey.
- Brass Arts Quintet. Works by Sydeaman, Levy, Hindemith, Poulenc.
- Brass Guild. Works by Amram, Hovhannes, Kaufman, Calvert, Lieb, Hermann, Chase, Kraft.
- Contemporary Works for Solo Instrument and Percussion (by Dahl, Frazeur, Tanner). Frazeur, percussion.
- Lark Woodwind Quintet. Works by Sydeaman, Reif.
- Gregg Smith Singers: *Art of the Round*.
- Gregg Smith Singers: *Contemporary Chamber Theater*. Works by Reif, Roxbury.
- Gregg Smith Singers: *Contemporary Madrigals and Airs*.
- Martin Walker: *Contemporary Clarinet Works* (by Dawson, Cox, Kuhlman, Fox). With Hatt.
- Grenadilla Records, 345 Park Ave., S., New York, N.Y. 10010.

## Klavier

- Bach: *Well-Tempered Clavier, Book II*. Oberacker, piano.
- Harold Bauer Plays Beethoven, Brahms, Liszt. From piano rolls.
- Catch the Brass Ring, Vol. 2. Band organ music from a carousel (popular and show tunes).
- Masters of Flute and Harp, Vol. 2 (works by Lauber, Persichetti, Badings). Di Tullio, McDonald.
- Paderewski Plays Liszt, Chopin, Schubert. From piano rolls.
- Klavier also offers a limited series of DBX-encoded discs, for playback with the noise-reduction unit made by DBX, Inc. New releases (already available in normal stereo editions) are: "Ten-String Guitar Interprets French Classics" (Macaluso), "España for Two" (N. and S. Gordon, duo-pianists), "Virtuoso Guitar, Vol. 1" (Vick).
- Klavier Records, 10520 Burbank Blvd., North Hollywood, Calif. 91601.

## Mark Levinson Acoustic Recordings

- Vol. 6: *Eliot Fisk: Guitar Recital*. Works by Bach, D. Scarlatti (arr. Fisk).
- Vol. 7: *Jazz at Long Wharf* (original compositions for piano, acoustic string bass, and drums). D. Levinson, M. Levinson, Elgart.
- Note: These releases, which are recorded at 45 rpm, "represent the maximum efforts of the chiefs of staff at C.I.D.I.S., manufacturers of Philips and DG records in France, who claim that the technical quality of these discs greatly surpasses the normal quality of the finest European pressings."
- Mark Levinson Acoustic Recordings, 55 Circular Ave., Hamden, Conn. 06514.

**If Your Records Are Valuable**

# LOOK FOR THE RED BOTTLE

## Why?

**General Need:** Tests by the Discwasher Labs show that fingerprints are absolutely not totally removed by "dry cleaning" in any form, either brush or adhesive rollers.

Long term record care requires the complex integration of micro-dust pick-up (not spreading around), with removal of chemical contamination such as fingerprints; plus an in-process reduction of static charge so that dust particles are not immediately sucked back onto the surface. And all of this must be done without leaving a residue.

D3 fluid, used with the Discwasher System for capillary removal of fluid/contamination achieves the results required for record survival. But the hidden requirements of a record cleaner are much more complex than integrated function alone.

**Chemical Integrity:** The trick is not to simply clean—but to clean with vinyl safety and extremely low "solute load" or fluid content. D3 is a solution that typically has half the dry weight residue of tap water and about one-fifth the median for other "record cleaners". D3 typically has the dry weight residue of distilled water sold in drug stores—and yet D3 has an activity in surface tension reduction/fingerprint removal that is greater than any fluid with twice the solute load of D3.

D3 fluid contains a complex blend of buffered surfactants conjugated in the labs of Discwasher, Inc. These provide cleaning "activity" against real-world record contamination, like fingerprints and airborne oils. But not against artificial "test conditions" of mineral oils and sheep wax (lanolin). Because if D3 removed waxes and oils of this nature, then D3 would also begin to soften critical vinyl stabilizers which are essential for record survival under the incredible heat and pressure of a tracking audio stylus. Alcohols and many cleaners pull stabilizers and age vinyl.

Some cleaning fluids contain large molecules of fatty acids to "float" dirt—but these "molecules" positively stick to vinyl and are literally a dust trap.

D3 fluid does not dramatically reduce static charge forever. The only liquid that can is one which leaves a coating. But D3 does reduce static charge during cleaning (using 3 drops on the Discwasher brush), and actual static voltage is reduced during playback to about one-half the normal levels.

**The Discwasher "Systems Approach":** Any cleaning fluid, when left on the record, only spreads out contamination. With three drops of D3 on the special directional micro-fibers of the Discwasher brush, dust is lifted out of the grooves, without "follow up" or adhesive oxide removal of the vinyl.

In addition, the Discwasher System wicks up D3 fluid plus suspended contamination. The fluid is drawn deep into the absorbent backing of the Discwasher brush. No liquid, dust or contamination "dries back" when the system is properly used. The "systems approach" of Discwasher includes a hand-rubbed, milled walnut handle. Something to outlast plastic wonders and out-perform everything else. Your records can't do better than the Red Bottle inside the "system".



# The Bose® Model 301 bookshelf speaker. Is it the best-selling, or just the best?

Small size, small price, big performance. That potent combination is the reason why over a quarter of a million Model 301 Direct/Reflecting® speakers have been sold since they were first introduced. And that probably makes the Model 301 the best-selling bookshelf speaker in the world.

But we didn't build the Model 301 to win popularity contests. We built it to give you Bose sound...open, spacious, clear, room-filling sound...in a small, economical package.

And to do that required an exceptionally sophisticated design.

The right and left speakers are designed as a mirror-image pair.

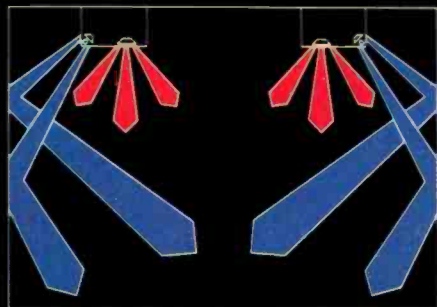

An asymmetrical configuration, with both sides working together to create full, rich, balanced stereo. Throughout your entire room, not just someplace in the center between both speakers.

The extended-range woofer faces forward, but the tweeter is angled sideward to bounce high-frequency sound off side walls. This produces the correct balance of reflected and direct sound that gives Bose Direct/Reflecting® speakers their live-performance quality.

The unique Direct Energy Control, an adjustable vane positioned in front of the tweeter, allows you to shape the sound of the Model 301 to fit the acoustics of your room.

And unlike heavy, oversized, so-called bookshelf speakers, the Model 301 actually fits comfortably on a normal-size bookshelf.

The price? A little over one hundred dollars apiece. With the Model 301, you get a dimension of performance you can't buy in speakers costing twice as much.

The Bose Model 301 bookshelf speaker. Probably the world's best selling. Certainly the world's best sounding.

**BOSE®**

## Marlboro Recording Society

New releases, if any, were to be determined at this summer's Marlboro Festival.

Marlboro Recording Society, 5114 Wisconsin Rd., Washington, D.C. 20016.

## MPS

(distributed by German News Co.)

MPS will be reissuing a large number of recordings previously available on BASF, by such performers as Friedrich Gulda, Rudolf Kempe, the Birnauer Kantorei, Ludwig Hoelscher, Kurt Rapf (including continuation of his series of Reger organ works).

## Musical Heritage Society

Couperin: *Harpichord Works, Book IV*. Gilbert.

Elgar: *Organ Works (complete)*. Robinson. Handel: *Alcina*. Sheppard, Bevan, et al.; Stour Festival, Deller.

Mahler: *Symphony No. 5*. U.S.S.R. SO, Kondrashin.

Mendelssohn: *A Midsummer Night's Dream*. Soloists: London PO. Leppard.

Pfitzner: *Chamber Works (complete)*. Various performers.

- Prokofiev: *Symphonies (7)*. Moscow RSO. Rozhdestvensky.
- Rimsky-Korsakov: *The Golden Cockerel*. Soloists: Moscow Radio, Kovalev.
- Tchaikovsky: *Queen of Spades*. Milashkina, Andzhaparidze, Mazurok, Levko, Arkhipova, Kiselev; Bolshoi Theater, Khaikin.

Plus, of course, some 200 additional releases in the coming year. Musical Heritage Society, 14 Park Rd., Tinton Falls, N.J. 07724.

## Quintessence

- Bach: *Brandenburg Concertos Nos. 1, 2, 6; Nos. 3-5*. Collegium Aureum (separate discs).
- Bach: *Notebook of Anna Magdalena Bach selections*. Ameling, Leonhardt.
- Bach: *Violin Concertos*. Szeryng.
- Beethoven: *Archduke Trio*. Suk Trio.
- Beethoven: *Piano Concertos (5)*. Arrau; Philharmonia O. Galliera (separate discs, with overtures by Berlin PO, Kempe).
- Beethoven: *Piano Sonatas Nos. 8, 14, 26*. Kempff.
- Beethoven: *Symphony No. 3*. Czech PO, Matačić.
- Beethoven: *Symphony No. 5; Fidelio Overture*. Bavarian RSO. Jochum.
- Beethoven: *Symphony No. 6*. Rotterdam PO. Munch.
- Beethoven: *Triple Concerto*. Suk, Chuchro, Panenka; Czech PO. Masur.
- Beethoven: *Violin Concerto*. Szeryng; London SO. Schmidt-Isserstedt.
- Berlioz: *Harold in Italy*. Suk; Czech PO, Fischer-Dieskau.
- Brahms: *Symphony No. 2*. Schumann: *Manfred Overture*. Berlin PO. Kempe (mono).
- Brahms: *Symphony No. 3; Tragic Overture*. Berlin PO. Kempe.

Brahms: *Symphony No. 4*. Czech PO. Fischer-Dieskau.

- Bruch: *Violin Concerto No. 1*. Mendelssohn: *Concerto in E minor*. Suk; Czech PO. Ančerl.

- Handel: *Water Music*. Collegium Aureum.

Liszt: *Piano Works*. Wild.

Mozart: *Divertimento, K. 205; Eine kleine Nachtmusik*. Collegium Aureum.

Mozart: *Piano Concertos Nos. 14, 23*. Moravec; Prague CO.

- Mozart: *Piano Concerto No. 25; Fantasy, K. 425*. Moravec; Czech PO. Vlach.

Mozart: *Symphony No. 35*. Haydn: *Symphony No. 104*. Royal PO, Krips.

- Mozart: *Symphonies Nos. 39, 41*. London

SO. Schmidt-Isserstedt.

- Schubert: *Songs; Piano Works*. Ameling, Demus.

- Schubert: *Symphony No. 9*. Bavarian RSO. Jochum.

- Schubert: *Trout Quintet*. Panenka, Suk, et al.

Smetana: *Má Vlast*. Czech PO. Ančerl.

- Tchaikovsky: *Symphony No. 6*. Czech PO. Matačić.

Vivaldi: *Four Seasons*. Schröder; Concerto Amsterdam.

- *Dance Music of the Renaissance*. Collegium Aureum.

Released by Pickwick International, 135 Crossways Park Dr., Woodbury, N.Y. 11797.

# The Video Center beats the system...

Video Cassette Recorders		Projection Systems	
<input type="checkbox"/> Sony SL-8200 (Beta)	\$995	<input type="checkbox"/> World's largest Advent dealer, also Panasonic, Mitsubishi, G.E., Sony	CALL
<input type="checkbox"/> (1 hr. 2 hr) Limited Supply			
<input type="checkbox"/> Magnavox 2000 (VHS)	799		
<input type="checkbox"/> JVC HR 3600 (VHS)	1049		
<input type="checkbox"/> Sanyo B-Cord (Beta)	749		
<input type="checkbox"/> RCA VCT 200 (VHS)	849		
<input type="checkbox"/> Hitachi VT 3000 (VHS)	749		
<input type="checkbox"/> JVC, Panasonic, G.E., Mitsubishi, Zenith	CALL		
 <b>Wireless Remote</b>			
Up to 50 ft. away! Available for all above recorders	CALL		
<input type="checkbox"/> <b>Color Cameras</b>			
From \$999 and up	CALL		
<input type="checkbox"/> <b>B &amp; W Cameras</b>			
From \$199 and up	CALL		
<input type="checkbox"/> <b>Pre-recorded Movies</b>			
Sports World Cinema, Adult films and others. Send for literature	Many Titles		
		<b>Video Games</b>	
		<input type="checkbox"/> Atari CX 2600	\$159.95
		<input type="checkbox"/> Carts: Street Racer, Video Olympics, Surround, Air Sea Battle, Black Jack	\$16.75
		<b>Video Tapes</b>	
		<input type="checkbox"/> The Video Center KCA 60	\$18.95
		<input type="checkbox"/> Memorex UCA 60	22.95
		<input type="checkbox"/> Hitachi T120 (VHS)	19.50
		<input type="checkbox"/> JVC T 120 (VHS)	19.95
		<input type="checkbox"/> RCA VK 125 (VHS)	15.95
		<input type="checkbox"/> RCA VK 250 (VHS)	20.95
		<input type="checkbox"/> Sony L 500 (Beta)	13.95
		<input type="checkbox"/> Sony L 750 (Beta)	19.95
		<input type="checkbox"/> Sanyo V-Cord (V-120)	17.50
		<input type="checkbox"/> Sanyo L-500 (Beta)	13.75
		<input type="checkbox"/> Sanyo L-250 (Beta)	10.75

**and how!** The Video Center is the first and the largest "complete systems" video supplier to, you the consumer, and industry. This depth of experience and our tremendous buying power are what makes the selection and pricing of this ad possible. The answers to the "right equipment" at the right price... are here!

### ALL NEW BUYER'S GUIDE

The most complete guide to video products ever. A complete understanding of what is available, what to buy and how to use it. Jam-packed with helpful hints, charts, photos and video technology. A \$4.95 value FREE!!!

### Special of the Month!

A Video Center Exclusive

**SANYO V-Cord II ONLY**  
The only home VCR with freeze frame! **\$599.**

The Timer, only \$50.  
Wireless Remote Pause: \$90.

Call for similar savings on other equipment!! (213) 479-8547.

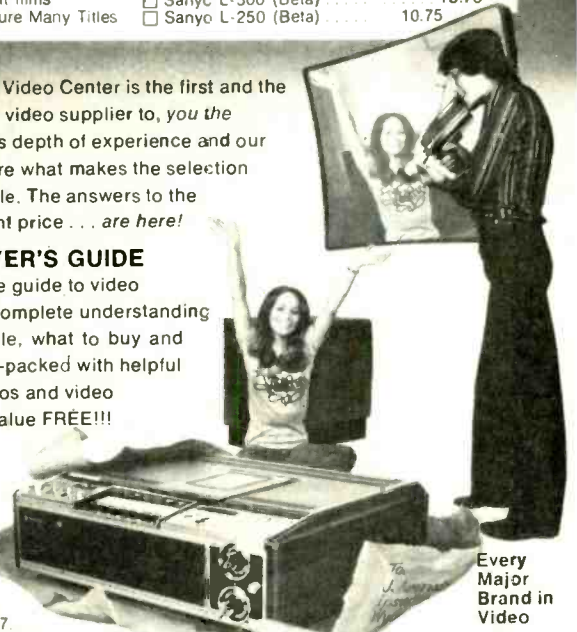

Every Major Brand in Video



2311 Pontius Avenue  
Los Angeles, CA 90064  
(213) 479-8547

Please send me your catalog. Enclosed is \$1. for postage and handling.

I can't beat your prices anywhere! I've checked what I want and my remittance is attached.

Name \_\_\_\_\_

Address \_\_\_\_\_

City \_\_\_\_\_ State / Zip \_\_\_\_\_

Signature \_\_\_\_\_

Card # \_\_\_\_\_ Exp \_\_\_\_\_

**IMPORTANT:** Money Order, Cashiers Check, Visa or Master Charge (fill out coupon) \*California residents add 6% Sales Tax  
**NOTE:** Ad (prices) valid during this issue date only. Includes manufacturer's guarantee. Minimum order \$50. All orders under \$100, include \$4. shipping and handling charge. No return without prior approval. Prices valid for mail order only and subject to change/F.O.B. Los Angeles, Calif.

# Take a close look at a better record cleaner. Audio-Technica AT6002

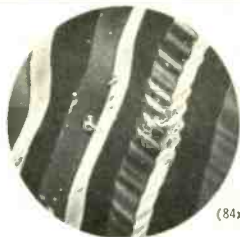

(84x enlargement)

This is an A-T scanning electron microscope photo of the dirt that must be removed if your records are to sound clean. It's dirt that is falling on your records even as you listen.



(169x enlargement)

Our unique carbon fiber brush sweeps each groove literally hundreds of times as the record plays, just before the stylus touches the groove. The carbon fiber brush helps conduct static charges away, making groove cleaning easier. And the incredibly small 6 micron diameter reaches deep into the groove for the smallest particles.



(844x enlargement)

Immediately behind the brush, our velvet pad captures and holds dust particles as you play. And moisture released from an inner reservoir helps to dissolve stubborn deposits to prevent static build-up.

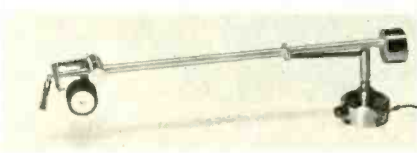

This 4-way attack on dirt (brush, pad, liquid, and conductive path to ground) is uniquely effective. For proof, clean a record with any other system. Then "play" it with the AT6002. You'll find dirt removed by the AT6002 that was left behind by other cleaners. Try it today. Just \$12.95 at all Audio-Technica dealers.



**audio-technica**  
INNOVATION □ PRECISION □ INTEGRITY

AUDIO-TECHNICA U.S., INC.  
Dept. 108H, 33 Shawnee Avenue  
Fairlawn, Ohio 44313  
In Canada: Superior Electronics, Inc.

## Varèse Sarabande

Auric: *Les Fâcheux*. Milhaud: *Le Train bleu*. Satie: *Jack in the Box*. Monte Carlo National Opera O, Markevitch.

- Barber: *Cello Concerto*. Britten: *Serenade for Tenor, Horn, and Strings*. Garbousova, Bressler, Froelich: *Musica Aeterna*. Waldman.

Beethoven: *Symphonies Nos. 2, 9*. Tomova-Sintov, Burmeister, Schreier, Adam: *Leipzig and Berlin Radio Chorus, Leipzig Gewandhaus O, Masur*.

- Beethoven: *Symphony No. 3*. Vienna Tonkünstler O, Busch.

- Copland: *Piano Concerto*. Smit; Rome RSO. Copland: *Danzón Cubano*. Smit, Copland. *Our Town Suite*. Smit.

- Dawson: *Negro Folk Symphony*. American SO, Stokowski.

- Gillis: *Tulsa*. Rudhyar: *Sinfonietta*. Glanville-Hicks: *Gymnopedie*. Freeman: *String Quartet*. Various performers.

Hindemith: *Harp-Woodwinds Concerto; Trumpet-Bassoon Concerto; Kammermusik, Op. 24, No. 1*. Adams, Haug, Ojeda: *San Francisco Little SO, Millar*.

Holdridge: *Scenes of Summer; Ballet Fantasy; Grand Waltz for Strings*. London SO and Los Angeles String O, Holdridge.

- Kay: *Concerto for Orchestra*. Brant: *Alto-Saxophone Concerto (original version)*. Lockwood: *Concerto for Organ and Brasses*. Rascher, Mason: various orchestras.

Poulenc: *Les Biches*. Sauguet: *La Chatte*. Monte Carlo National Opera O, Markevitch.

Schumann: *Symphony No. 3*. S. German RSO, Schuricht.

Sibelius: *Symphony No. 2*. Berlin RSO, Jalas.

- Sibelius: *Symphony No. 5*. Berlin RSO, Jalas. *Finlandia*. Vienna Tonkünstler O, Wöss.

Skalkottas: *Greek Dances (12)*. San Francisco Little SO, Millar.

Stockhausen: *Kontakte; Refrain*. Aloys Kontarsky, Caskel, Stockhausen.

- Villa-Lobos: *Choros No. 6; Bachianas brasileiras No. 7*. Berlin RSO, Villa-Lobos.

Simon Barere: *Legendary Pianist II*. Works by Liszt, Chopin, Weber, etc.

Electronic Music; *Musique Concrète*. Works by Carlos, Cage, Berio, et al.

Severino Gazzelloni: *Strange Flute*. With piano, cello, and koto accompaniment.

New Works for Alto and Tenor Trombone (by Bazelon, Lewis, Packer, Kellaway). Rankin.

Varèse International, 6404 Wilshire Blvd., Suite 1127, Los Angeles, Calif. 90048.

## Wergo

(distributed by German News Co.)

Ligeti: *String Quartet*. Arditti Qt.

Cologne Philharmonic Cellists.

Sonja Kehler Sings Dessau, Eisler, Weill. Poems by Brecht.

Dickie Landry: *Fifteen Saxophones*.

## Tandberg's New TD 20 A With The Exclusive ACTILINEAR Recording System

Tape recorders can no longer be looked upon as independent units in today's extremely sophisticated sound systems, but rather as components within a total system with performance capability as technically advanced as all other components of that system.

Drawing upon its unequalled 30 year tradition in magnetic recording technology, Tandberg has met this challenge by developing a completely new concept in tape recording known as ACTILINEAR Recording (Patent pending) for their new, advanced open reel and cassette machines.

In conventional recording systems, the summation of record & bias currents in the recording head is done through passive components, leading to inherent compromise solutions. The new ACTILINEAR Recording System is totally free of these compromises, as the passive components have been replaced with an active Transconductance amplifier developed by Tandberg. Just a couple of its many benefits are: up to 20 dB more headroom over any recording system currently available, and the ability to handle the new high coercivity tapes.

In fact, Tandberg's new ACTILINEAR Recording System, when used in conjunction with the soon-to-be-available metal particle tapes now under intense development in the U.S., Japan and Germany, offers performance parameters approaching those of experimental Pulse Code Modulation (PCM) technology, yet is fully compatible for playback on all existing tape recorders. It is literally a machine for the future, with no obsolescence factor, as it can be used with any type of recording tape, available now or in years to come.

Tandberg engineers have mated this new recording system to a logic-controlled, four-motor, solenoidless tape transport of advanced design, which, like the ACTILINEAR concept, is totally unique on the market today.

Other superior features of the TD 20 A include: built-in Sel. Sync. • front panel bias adjustment • front panel 2-position microphone sensitivity switch • frequency-corrected, peak-reading VU meters, with new graphics designed for improved readability • four line inputs + master gain control • a "free" mode + Edit/Cue facilities for easier editing • LED mode indicators • separate power supplies for operational functions and audio functions • rack mount capability • optional wireless, PCM infrared remote control.

Visit your authorized Tandberg dealer for a demonstration of the new TD 20 A deck, and discover how tape recording will be done in the years to come. For your nearest dealer, write: Tandberg of America, Inc., Labriola Court, Armonk, N.Y. 10504.

# TANDBERG



# Tandberg Presents the Next Generation





## Moore Succeeds Bauer at CBS

*Dr. Benjamin Bauer*

August 1 marked the changing of the guard at the CBS Technology Center. On that date, J. Kenneth Moore was appointed the laboratories' vice president and general manager, replacing Dr. Benjamin Bauer.

As regular readers of this magazine may be aware, Ben

Bauer was instrumental in setting up our equipment testing program at the Center and has been a long-time friend and associate of ours. He joined what was then CBS Laboratories in 1957 and was appointed vice president in charge of acoustics and magnetics the following year. He held that position until his elevation to general manager in 1975. He has also been president of the Audio Engineering Society.

Holder of over 100 patents, Bauer developed the single-transducer, unidirectional microphone that became the basis for similar devices manufactured first by Shure Bros. where, for many years, he was chief engineer. Also during his tenure with Shure he invented the moving-magnet phono pickup. His most recent major invention was the quadriphonic SQ system, which he had been spending the past several years promoting—ironically with less success at CBS than at other record companies around the world. With his wife, Ida, he has now set up a consulting firm, Audio-Metric Laboratories, and he will continue as a consultant at CBS.

Unlike Bauer, Moore comes from the video end of the communications field. He became head of the Center's Advanced Television Technology Department under Bauer in 1975 and has been a pioneer in digital video techniques for broadcasting. One of his most recent patents has been for a digital noise reducer for color TV.

## What's in a Name?

You still have time to win a superpower amplifier and a new preamp worth more than \$1,000, plus a trip to New York to pick up the prize, by naming the brand for the products of Bob Carver's new company. The deadline for entries—and you may enter as many times as you wish—is November 30.

Carver, the founder and former president of Phase Linear Corporation, designed and produced the Phase Linear 700, whose 350 watts per channel gave it the highest power of any amplifier available to the consumer when it was introduced in 1971. Now enshrined in audio folklore is the fact that Carver's first prototype of the 700 was built in a coffee can, since a conventional metal chassis was then beyond his means. His latest superpower amp is said to be highly efficient and extremely light in weight (less than 12 pounds) and is expected to sell for less than \$1.00 per watt.

To enter the contest, send your brand-name suggestions printed on a postcard along with your name, address, and telephone number to Bob Carver, c/o HIGH FIDELITY, The Publishing House, Great Barrington, Mass. 01230.

### Also . . .

- Bennett Sound Corporation, a marketing organization of Kinergetics, Inc., expects to enter the home high fidelity market soon. Kinergetics, which supplies equipment to the commercial diving industry, has conducted research on scrambling the speech of divers in a helium atmosphere (a

kind of Donald Duck effect) and has come up with a hitherto neglected distortion factor that, it says, affects all speech and music reproduction systems. Kinergetics claims to be able to eliminate this factor with analog computer techniques now being demonstrated to companies that manufacture loudspeakers and electronics.

- The High Fidelity Music Show, Inc., directed by M. Robert and Teresa Rogers, is scheduled for New York this month, October 5 through 8.
- The day when stereo sound emerges from your TV set may be inching closer. The Public Broadcasting Service has completed the first stage of upgrading its sound by means of DATE—a digital system that places four audio channels alongside the video—and the engineers are investigating the other technical problems inherent in providing additional audio channels. Emergence of a second channel would not necessarily be used only for stereo: an audio track in a second language is an interesting and viable alternative.
- BASF may be preparing to enter the metal-particle-tape field, but, consistent with its position to date, the company hopes also to foster an international standard for the tape's physical makeup. In a meeting with Japanese tape and tape-hardware manufacturers early last summer, BASF provided samples with coercivities of 950 and 1,100 oersteds while recommending that the standard for audio application be not more than 1,000 oersteds. The company claims that "theoretical advantages of higher coercivities do not show up in practice."

# HOW MUCH OF THE MUSIC DO YOU WANT TO HEAR?

Today's professional musicians are putting more into their music than ever before.

A whole new generation of recording equipment allows them to pack a tape or fill a record's grooves with musical shadings and textures and subtleties that simply went unrecorded a few years ago.

JBL is part of that process.

In fact, according to a recent national survey by Billboard Magazine, JBL is the most widely

used loudspeaker in professional recording studios. There's a reason:

JBL delivers all the music, all the time. And it does it with flawless accuracy and attention to detail that professionals can't afford to be without.

If you want to get all the music out of your records and tapes, get the loudspeaker the pros used to put it there: JBL.

**JBL**

GET IT ALL.

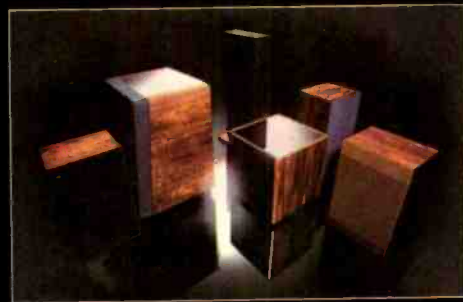

You don't have to be a professional to own JBL loudspeakers. The same sound is available in a wide variety of home systems, priced from \$150 to over \$3,500.

Cherokee Recording Studios, Los Angeles, California.

James B. Lansing Sound Inc., 8500 Balboa Blvd., Northridge, Ca. 91329

As the number one professional speaker company, we have to satisfy the most discriminating ears. Recording engineers and artists. What they're listening for is faithful sound reproduction of a live performance. And for over forty years, that's exactly what we've been able to deliver.

The same professionalism pays off for you when Altec Lansing leaves the studio and gets down to some serious playing at home.

The patented Altec "Tangerine™" radial phase plug, for example, is one of our most recent breakthroughs, and it's built right into the compression drivers on our Models 15 and 19. Unlike old circumferential phase plugs, our new radial design actually widens your high-frequency bandwidth. So now you



can get super-high efficiency and a range of highs you've never heard from a compression driver.

At the same time, we've also enhanced low-frequency response.

Our new computer-designed, tuned and vented enclosure gives you the best ratio of lower limit vs. sensitivity.

Finally, we improved the dividing network with a new frequency-selective, dual-range equalizer. You'll get smooth transitions without the roughness and distortion associated with ordinary crossover designs.

So listen to our speakers and hear how our work for professionals comes into play. For the name of your local dealer and a full line catalog, just write us: Altec Lansing International, 1515 S. Manchester Ave., Anaheim, CA 92803, (714) 774-2900.



## THE NO.1 PROFESSIONAL SPEAKER

AT WORK. AND PLAY.



## Uni-Sync's versatile mixing desk

The Trouper I Live Music Mixing system, designed by Uni-Sync for concert or club sound reinforcement, offers a versatile ensemble. Each of eight inputs has an XLR balanced microphone input, line input, 20 dB of mike attenuation, monitor send, echo send, a three-band graphic equalizer, a solo switch, and an individual mix fader. The output section features separate house and monitor controls, master pots for echo send and return, a headphone jack, and an LED VU indicator. Trouper I sells for \$749; a companion expander module, at \$698, adds ten more channels.

CIRCLE 140 ON PAGE 149



## Disco Film peels it off

New in Empire's Audio Groome line is Disco Film, a record-cleaning preparation that is water-soluble. The solution is spread over the record surface with a built-in applicator to form a flexible film that, when dry, can be peeled off with Scotch tape, taking dust and other debris with it. Disco Film is not for use on shellac records. One container, said to clean up to 70 LP record sides, costs \$29.95.

CIRCLE 141 ON PAGE 149

## NAD bows with receiver line

NAD (New Acoustic Dimensions) makes its U.S. market debut with a line of stereo receivers. All of the models share some characteristics, such as a switchable infrasonic filter, and may be used with any commonly available speaker, regardless of impedance. The top-of-the-line Model 7080 is rated to deliver 180 watts (22½ dBW) into 2 ohms. Among its features are turnover switches for bass (500/250 Hz) and treble (2.5/5 kHz) controls, an FM de-emphasis switch, high and low filters, and an ambience output for a second pair of speakers. The Model 7080 is priced at \$535.

CIRCLE 142 ON PAGE 149



## A speaker kit from Acusta Craft

The Power Tower speaker from Acusta Craft incorporates Electro-Voice's SP12-C woofer, 8HD and 1823M midrange and compression drivers, and T-350 tweeter. The rated impedance of this system is 8 ohms; crossovers occur at 800 Hz and 3.6 kHz. Recommended amplifier power range is 10 to 200 watts (10 to 23 dBW). The Power Tower comes in three forms: The fully assembled PT-A costs \$445, the PT-WK kit is \$385, and the speaker components and crossover may be purchased separately for \$268.

CIRCLE 143 ON PAGE 149

## Switchcraft makes room for the Big Ugly

The new entry in Switchcraft's two-conductor phone-plug line is called the Big Ugly—not because its appearance suffers by comparison with other guitar plugs, but because it is somewhat larger, for easier solder connections. The manufacturer claims it will withstand 20 pounds of pull, due in part to a strain-relief clamp and additional internal threading. The plug has a brass frame and tapered cable entry to cut down on cable wear at the connector. The Big Ugly can be purchased at music-supply stores for \$4.15.

CIRCLE 144 ON PAGE 149



## Fulmer's boost for the auto audiophile

New in the auto-sound department is Arthur Fulmer's Model 15-0730 graphic-equalizer/power-booster, providing boost or cut of up to 12 dB at seven frequencies from 60 Hz to 15 kHz. Rated power is 20 watts (13 dBW) per channel with no more than 10% total harmonic distortion. A front/rear fader, when used with the left/right balance control on any car tape deck, gives four-speaker control. The 15-0730, designed for under-dash installation, costs \$99.95.

CIRCLE 145 ON PAGE 149

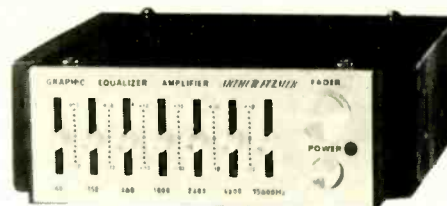

## Lectrotech offers power indicator

Lectrotech announces the PPI-400 peak power indicator, with LEDs calibrated in eight steps from 0 to -30 dB monitor power levels. The 0-dB reference can be matched to the maximum power outputs between 2 and 1,200 watts (3 and 30¾ dBW). A six-position switch selects eighteen combinations of power levels and speaker impedances, and a seventh position allows custom setting through the use of external resistors. The PPI-400 costs \$129.95. An optional walnut case (LWC-1) is available for \$24.95.

CIRCLE 146 ON PAGE 149

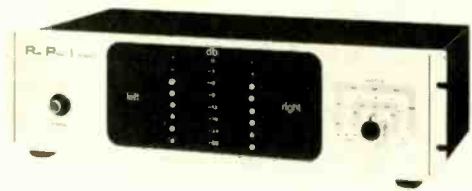

## Speck console has parametric equalizer

Speck Electronics' Model SP-610 is a 10-in./8-out board designed for medium-sized studios. The input module contains a three-band, six-knob parametric equalizer, mike/line switch, input attenuators (0/-10/-20 dB), echo and monitor send pots, and two cue sends, as well as the 8-channel output-assignment section. Mixdown is via pan pots on each fader and board master fader. The Model SP-610 claims 16 dB of headroom and a signal-to-noise ratio of 72 dB. The price of this console is \$4,120.

CIRCLE 147 ON PAGE 149

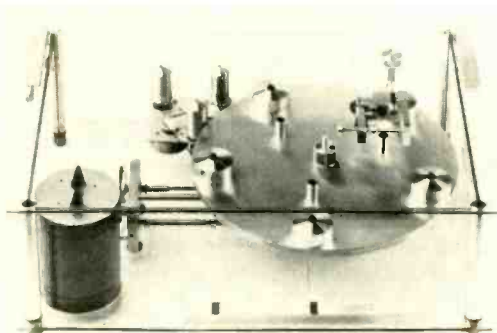
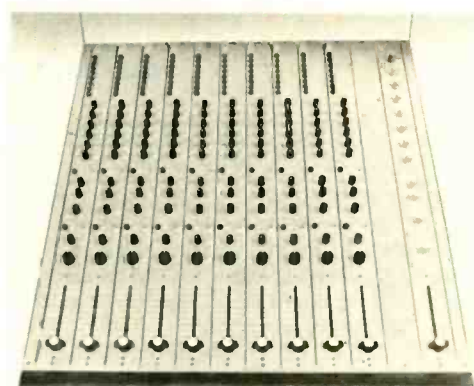

## A tangent-tracking Transcriptor turntable

The Microtracer is the second of Transcriptor's turntables to be distributed in the U.S. Designed in glass and stainless steel, it has a platter that moves horizontally while the tone arm remains stationary. Like more conventional tangent-trackers (in which the arm moves rather than the platter), it therefore eliminates lateral tracking-angle error and skating force. The Microtracer comes with an Ortofon VMS-20ED Mk. II cartridge and sells for \$690.

CIRCLE 148 ON PAGE 149

## AST electronic crossover network

AST is offering three new electronic crossover networks to accommodate a variety of biamping and triamping situations. The basic model is the XO-2, a stereo version with the crossover points continuously variable from 250 Hz to 7 kHz. This rack-mountable device features line switch, power LED, and fuse access on the front panel. It claims a frequency response of  $\pm 1/2$  dB from 10 Hz to 40 kHz; filter slopes are 12 dB per octave. Output impedance is 600 ohms unbalanced. The Model XO-2 costs \$298.

CIRCLE 149 ON PAGE 149



## How to recognize the 5 most perplexing problems in high fidelity speakers:

It is not the purchase price that gives value to an audiophile quality speaker but its ability to overcome the major problems inherent in reproducing sound. Recognize these problems, and the solution to determining a speaker's worth becomes readily apparent.

**One. Coloration:** Speakers should be seen and not heard. Speaker cabinets and components can "color"—add their own tones—to a musical piece.

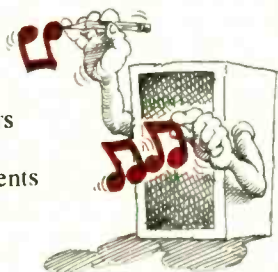

**Two. Sonic instability:** Standard alignments of woofer, midrange and tweeter can cause orchestral musicians to seem out of place. Piano and violin solos often seem to be played by two or more instruments.

**Three. Vocal passivity:** No instrument is more expressive than the human voice. And none is more difficult to reproduce.



**Four. Volume distortion:** If it cannot reproduce music faithfully with the volume adjusted either up or down, a speaker cannot offer audiophile responsiveness.



**Five. Unnatural nature:** The sounds of creation are also music to the ear. A warbling bird, babbling brook or clapping hands that do not express immediacy take the very life from nature.

## How to eliminate the 5 most perplexing problems in high fidelity speakers:

The solution is RTR's new D-Series speakers. From the Corinthian columned 600D and 300D to the curvilinear 100D and 75D bookshelves, every component is RTR designed, manufactured and assembled for problem-free performance.



True clarity and natural warmth so apparent in the D-Series start with RTR's new 1.5 inch soft dome midrange. This break-through system offers optimal midrange response and broad dispersion while eliminating crossovers in the critical 1500-3000 Hz range. Nothing enhances, colors or subtracts from programmed material.

This same devotion to musical purity extends to the performance of the newly-stated RTR woofers and articulate dome tweeters. Throughout the system, reproduction is faithful to the human voice, musical instruments and natural sounds.

As a final triumph for the D-Series, RTR incorporates "resolved point source radiation field"—achieved by uniquely repositioning woofers, drivers and tweeters to create an almost unbelievably stable sonic image. Instruments and voices remain positioned as they were live.



Audition the 100D, 300D and 600D at your RTR dealer soon. And ask why RTR not only designs and assembles all of its components but manufactures each as well. That's "Total Capability"—the big difference between RTR and other makers of audiophile-quality speakers. At RTR we don't just build speakers, we build solutions.

RTR Industries, 8116 Deering Ave.,  
Canoga Park, CA 91304

CIRCLE 66 ON PAGE 149



**Listen...  
you'll be hearing  
more from RTR.**



## Too Hot to Handle

In 1964 I purchased an H. H. Scott Model 299C tubed stereo amplifier. The pertinent specifications on the unit are: 35 watts [15½ dBW] per channel at 4 ohms, less than 0.5% THD, and less than 0.5% IM distortion at rated output. The transient response characteristics of the amplifier are unknown. I coupled this with a Garrard Type A automatic turntable and Empire 880 cartridge, plus a pair of inexpensive Knight two-way speakers. Recently I purchased a set of Acoustic Research AR-12 three-way speakers and a Pickering 625E cartridge. I was limited in my selection of a cartridge as the Garrard automatic trip mechanism would not cycle with a vertical tracking force below 2 grams.

Am I getting the full potential from the AR-12s using the system I now have? Is the transient response of a good tube amplifier (I felt that the 299C was a good one when I bought it) comparable to a good current solid-state unit? Would the difference in sound reproduction as heard from the speakers (especially on classical music) justify the \$400 or so that a new amplifier would cost?—James J. McConnell, Bloomfield, N.J.

It is undoubtedly true that the specifications on present-day solid-state amplifiers are better than those of your Scott. More important, it is very unlikely (unless you have had the amp tested recently) that it is still delivering factory-new specs after all this time. Getting the full potential (assuming that you mean the widest dynamic range) from the ARs will require about 150 watts (22 dBW) per channel. On the other hand, if transient response is your main concern and you're not looking for high sound pressure levels, the Scott might be perfectly adequate for your needs. You might ask a dealer to demonstrate AR-12s driven with a high-power amp or try to borrow such an amp on a trial basis. But the basic rule is: If you are unsatisfied by what you hear, look for gear that will improve on the point of dissatisfaction. If you are satisfied with your present system, we see no valid reason for spending money to upgrade it.

Some time ago I read that the sound quality of recorded tapes decreases considerably after only 20 to 30 plays. The same article pointed out that this deterioration would not occur with Maxell UDXL, due to a special coating process that permanently fixes the magnetic particles to the tape. With this in mind, I wish to take steps to insure longevity of my recordings.

I have recorded a number of cassettes, mostly on Maxell UD C-90s. I have not played them too much, so they should be in good condition. I want to purchase an open-reel deck and dub the cassettes onto Maxell UDXL

reels. Will the results be worth my time, effort, and money? If so, I'm open to suggestions on how to get the best possible results.—Jim George, Altoona, Pa.

The sound quality of a recorded tape should be maintained for many more than 20 or 30 plays provided that the tape is properly handled and stored. That means the tape should be kept clean and free of fingerprints, stored in an atmosphere that is relatively cool and dry, and kept away from magnetic fields such as those near transformers and motors. The heads on the deck should be inspected regularly for wear and cleaned or replaced as necessary. They should also be demagnetized periodically.

With the exception of some early cobalt-doped tapes—not to be confused with modern ferricobalts—actual playing under proper conditions doesn't materially diminish the fidelity. Of course, accidents can happen and a "vault copy" of a cherished irreplaceable recording is the best backup. Whether your recordings warrant such immortality, we'll leave to you to decide. But outside of a possible lowering of print-through in long-term storage, we see no real advantage in reel copies—which will perforce pick up some distortion in the copying.

**Surrounded by national forest and thus having no neighbors, I am in the fortunate position of being able to play music outdoors (in the dry part of the year) as loudly as I wish to. I am using two Advent speakers per channel and intend to upgrade my power amplification. With enough power, could the Advents handle the 10-dB bass boost of the Cerwin-Vega Bass Excavator and produce sufficient sound pressure levels to realistically reproduce a symphony orchestra as it would sound outdoors from 50 feet away? Each speaker is supposed to handle brief peaks up to 400 watts [26 dBW].—Caleb Layton, Springville, Calif.**

A symphony orchestra is subject to the laws of acoustics just as much as a loudspeaker is and, without a bandshell or similar reflecting surface, would produce a sound severely lacking in bass. Assuming that you do not intend to sit 50 feet away from the speakers but at a distance more like 3 to 4 feet, you have a chance to improve on reality a little. A power amp rated at 200 watts [23 dBW] or better will probably be needed and should be rated for 4-ohm loads, since you will want to connect a parallel pair of speakers to each channel. For the continued health of your speakers, each of them should have a 1-ampere, slow-blow fuse connected between it and the amplifier.

The use of 10 dB of bass boost is some-

what problematical, however. If, indeed, you find it called for, the safest course is to begin at fairly conservative sound pressure levels, turning the volume up only when you are sure that the woofer is not pushed to the limits of its cone excursion.

I own twelve aquariums, each of which is equipped with a heater controlled by a thermostat sufficiently sensitive to switch on and off about ten times per minute. My FM tuner produces a very obtrusive "pop" each time a thermostat switches. In your July 1977 issue ["Get the Noise out of Your System"], you wrote of the SAE 5000, which is capable of removing such noises from phonograph records. Would it reduce the noise from my tuner? If not, is there something else I might try?—Donald A. Seese, Littleton, Colo.

The SAE is specifically designed for use with phonograph records. A better cure for your problem would stop the interference at its source. One possible solution would be to use a power-line interference filter to isolate the thermostats from the AC supply. Such devices are made by Cornell-Dubulier and Corcom and are available from large electronics distributors. Even with a filter in place, it is possible for noise to be radiated from the line cords to the thermostats and picked up by your FM antenna. Therefore keep these cords as short as you can.

I am in the process of researching possible designs for speakers I plan to build for my home system. I have read a number of impressive reports of systems employing passive radiators, but I have been unable to find any adequate explanation of how a passive radiator works or how it should be matched with the woofer and the enclosure. Could you kindly suggest a source of information on this subject?—Richard F. Blake, Niles, Ill.

We'd recommend the *Loudspeaker Design Cookbook* published by SRA, 3959 S.E. Hawthorne, Portland, Ore. 97214.

I am currently using a JVC CD-1920 cassette deck to record local band and orchestra concerts for the school district. The 1920, which has response of 30 Hz to 16 kHz, has ANRS noise reduction. Using a DBX dynamic range enhancer (128) with both DBX and ANRS on, will this deck outperform a Teac A-3300SX-2T open-reel machine in terms of sound reproduction and quality? (The DBX noise reduction would be used on the scene.)—Karl Seuring, Freeport, Ill.

For recording a large orchestra or band we would prefer the extra-high-frequency headroom to be found in the open-reel machine, but it is possible for a cassette deck to do quite a good job nonetheless. We don't recommend that ANRS and DBX be used together; try each separately and see which gives the best results. (Even pros have to try out their recording setups at rehearsals before they know what works best.) The DBX, of course, can be applied to any tape deck, cassette or open-reel.

*We regret that, due to the volume of reader mail we get, we cannot give individual answers to all questions.*





Kenwood KX-C30

Akai GXC-5700II

Hitachi E-900

# You paid a lot for good specs. Now spend a little more and hear them.

Just because you put a great deal of money into your tape deck, it doesn't necessarily mean you'll get a great deal of sound out of it.

Unless of course, you're using the tape that's engineered to get the most out of high-performance equipment. Maxell.

Maxell is specifically designed to give you extended frequency response, the highest possible signal-to-noise ratio and the lowest distortion of any tape in its price range.

Which is why people who own the finest tape decks use Maxell more than any other brand.

Of course, there are other reasons. Like the fact that every Maxell tape has a unique non-abrasive head cleaner. And a full warranty that covers the one thing other manufacturers don't cover. Everything.

Try Maxell.

It's sure to make the sound that comes out of your tape deck worth every penny you put into it.



**maxell**

K	1	A	2	F	3	X	4	R	5	C	6	P	7	M	8	Z	9	V	10		B	11	F	12	J	13	L	14	O	15		
P	16			C	17	S	18	G	19	A	20			M	21	R	22	K	23	O	24	F	25	H	26	S	27	T	28			
C	29	Y	30			F	31	M	32	O	33	D	34			K	35	S	36	E	37	A	38	W	39			N	40	U	41	
Z	42	F	43	G	44	Y	45	X	46			L	47	P	48	Z	49	K	50			M	51	F	52	T	53	V	54	B	55	
A	56			O	57	G	58			W	59	S	60	D	61	O	62	I	63	A	64	K	65	E	66	M	67	C	68	F	69	
		P	70			I	71	X	72	F	73	N	74	M	75	J	76	S	77	C	78			R	79	V	80	K	81			
M	82	Z	83	J	84	A	85	W	86	C	87			F	88	B	89	L	90	Y	91	E	92			I	93	S	94	O	95	
		G	96	P	97	C	98			W	99	B	100	X	101	Z	102	M	103	V	104			H	105	T	106			Y	107	
F	108	G	109	S	110	C	111	A	112	R	113	L	114	K	115	M	116	I	117	H	118			F	119	O	120	Z	121	C	122	
		S	123	O	124			R	125	L	126	Z	127	K	128			N	129	M	130			F	131	U	132	C	133	X	134	
V	135			L	136	B	137			A	138	C	139			D	140	U	141	K	142	R	143			Z	144	G	145			
V	146	M	147	X	148	C	149	O	150			F	151			J	152	K	153	N	154	S	155			P	156	E	157	F	158	
L	159			Z	160	V	161	R	162	L	163	B	164	K	165	O	166			I	167	X	168	G	169			D	170	F	171	
H	172	E	173	A	174	C	175	Y	176	S	177			P	178	M	179			B	180	I	181	H	182	X	183	M	184			
F	185	W	186																													

**DIRECTIONS**

To solve these puzzles—and they aren't as tough as they first seem — supply as many of the Output words as you can in the numbered dashes following the Input. Unless otherwise specified in the Input, the Output consists of one English word. "Comp." means compound, or hyphenated, word.

Transfer each letter to the square in the diagram that bears the corresponding number. After only a few correct guesses you should begin to see words and phrases emerging in the diagram, which when filled in will contain a quotation related to music, recordings, or audio.

The words in the quotation are separated by darkened squares and do not necessarily end at the end of a row.

Try to guess at these words and transfer each newly decoded letter back to its appropriate dash in the Output. This will supply you with further clues.

A final clue: The source of the quotation — the author and his work — will be spelled out by the first letters in Output, reading down.

The answer to HiFi-Crostic No. 39 will appear in next month's issue of HIGH FIDELITY.

**INPUT**

**OUTPUT**

A. Singing societies (2 wds.)	64	38	20	2	112	85	174	138
								56
B. American pianist, won the International Chopin Competition, 1970	164	100	55	180	11	137	89	
C. Former conductor of the Louisville Orchestra (full name)	175	6	98	139	78	149	17	68
				111	29	133	122	87
D. Record reviewer Harris	34	140	61	170				
E. An alternative version	157	92	173	37	66			
F. Noah Greenberg's group (4 wds.)	43	3	131	69	185	171	88	158
		31	52	73	108	119	25	12
								151
G. American choreographer	96	145	58	109	19	44	169	
H. _____ Simon, pianist, many recordings on Turnabout	172	105	26	182	118			
I. The _____ of Baghdad, opera by Boieldieu	71	167	117	63	181	93		
J. Lubberly persons	13	84	152	76				
K. Berlin-born conductor (1876-1962), champion of Mahler (full name)	1	65	165	115	81	35	153	142
						128	50	23
L. Peter _____, music critic for the London Observer	163	114	159	47	90	14	136	126

**INPUT**

**OUTPUT**

M. Former conductor of Los Angeles Philharmonic (1885-1973) (full name)	75	116	21	179	184	103	8	51			
							67	32	82	130	147
N. Percussion instrument	40	129	154	74							
O. Of music performed at a banquet (Ger.)	166	33	124	150	62						
P. Intervals with the most perfect consonance	97	156	178	70	7	48	16				
Q. Rakes	24	57	120	15	95						
R. Benjamin Britten's biographer (initials, last name)	143	125	79	5	113	162	22				
S. Richard Strauss symphonic poem (3 wds.)	60	36	77	155	123	177	27	94			
									110	18	
T. One of several English rivers	53	28	106								
U. Song paradigm	132	141	41								
V. Allvén's _____ Rhapsody	135	146	54	104	161	10	80				
W. Treble, alto, tenor, et al.	59	86	39	186	99						
X. Persistently repeated phrase	72	46	4	148	168	183	134	101			
Y. Barbara _____, popular record reviewer for the New York Times	45	30	91	176	107						
Z. Schoenberg stage piece for one character (Ger.)	83	121	160	127	49	144	102	9			

Solution to last month's HiFi-Crostic appears on page 6.

# "State-of-the-art Fever."

The peculiar disease that has made Infinity what it is today.

(And what it will be tomorrow.)

It's chronic and incurable — our need to reach for state-of-the-art perfection; our obsession with absolute accuracy of musical reproduction.

Certainly Infinity isn't the first speaker company to create exotic technology. But when you look around and start counting, you'll discover that we're the *only* major American speaker company involved with state-of-the-art technology — year in and year out. Chronic.

**It's people like you who spread the disease.**

Of course, speakers speak, and more than one Infinity speaker has sold itself. But the Infinity success story is due in no small part to knowledgeable audiophiles and music lovers — people like you — who, having heard Infinity speakers, spread the word.

In fact, the widest dispersion in stereo is the sound of friends telling friends about Infinity speakers.

And we thank you.

**Our object all sublime.**

First, we'll continue to develop the most advanced speaker technology in the world. Second, we'll continue to put as much as possible of that technology into speakers at *all* prices.

**A case in point: EMIT™**

We believe our Electromagnetic Induction Tweeter to be the most advanced tweeter in the world of audio.

An etched "voice coil" on an extremely low-mass diaphragm is driven by magnets of rare-earth Samarium Cobalt — the most powerful magnetic substance known. The

resulting output shares an electrostatic's delicacy of sound. But is better than electrostatics, cones and dome tweeters in power-handling capacity, transient response and horizontal dispersion.

Every speaker in the Infinity Quantum and Q lines — all the way down to our \$109\* bookshelf Qe — has one or more EMITs. Which is one reason they also have a clarity, a transparency and a smoothness of response superior to that of any other speaker in each price range.

**The formidable QRS and the more modest Quantum 5**

To the rare listener who needs to consider neither speaker size nor price, our Quantum Reference Standard — at \$6500\* for the complete speakers-and-equalization system — offers tremendous energy handling capacity, accuracy of response, and a seldom heard warmth and reality.

Quantum 5 — at \$355 each — utilizes much of the same unique Infinity technology on a smaller scale, and still produces a level of accuracy that would be a revelation from speakers of any size.

**No one ever wrote a hit musical called "The Sound of Speakers."**

We're convinced that, in the long run, speaker buyers will prefer to hear *music the way the musicians intended it*, and not the way a

speaker designer intended it. Thus our continuing obsession with accuracy.

We're making progress. Five years ago only hard-core audiophiles ever heard of Infinity. Today

we're one of the three largest speaker companies in America.

But we're not discouraged. We'll keep on trying.



 **Infinity™**

We get you back to what it's all about. Music.

\*Manufacturer's suggested retail price, optional with dealers. West of the Mississippi, the suggested price for a Qe is \$105; for a Quantum 5, \$340. Speaker Stand optional.

© 1978, Infinity Systems, Inc., 7930 Deering Avenue, Canoga Park, California 91304. (213) 883-4800 • TWX 910-494-4919. For information, call toll-free (800) 423-5244 (In California; (800) 382-3372).



## No matter what system you own there's an Empire Phono Cartridge designed to attain optimum performance.

Detail, brilliance, depth.

This is the promise of each Empire Phono Cartridge and although there are many Empire models, each designed to meet specific turntable performance characteristics, every Empire cartridge contains the following features:

Features	Details	Benefits
Unique Fixed Unidirectional Three-Magnet Structure	Every Empire cartridge uses 3 high energy ferrite magnets in the cartridge body to provide a high level of unidirectional flux.	Higher and more linear output signal, immunity to bi-directional magnetic distortion, and improved hum and microphonic rejection.
Molded Four-Pole Magnetic Assembly	Every Empire cartridge employs a four-pole magnetic assembly that is precisely aligned and locked in place by a high pressure injection molding process... providing a uniform and orthogonal magnetic field.	Improved crosstalk and reduced distortion that is insensitive to tracking force.
Tubular moving Iron Design	By using a tubular high magnetic saturation iron armature we obtain an optimum ratio of output level to effective tip mass.	Improved tracking ability and widened frequency response.
Four Coil Hum Bucking Assembly Plus Electromagnetic Shielding	Using custom designed computer controlled machines, a precision drawn copper wire (thinner than human hair and longer than a football field) is wound onto a symmetrical 4 bobbin structure. By using 2 coils per channel a symmetrical electrical circuit is formed.	Improved rejection of hum and stray noise fields.
Aluminum Alloy Cantilever	The Empire computer designed tubular cantilever provides optimum coupling of the diamond tip to the moving magnetic system resulting in minimum effective stylus tip mass.	Superb low level tracking, reduced tracking distortion... plus enhanced wideband separation characteristics.
Precision Ground Oriented Diamond Tips	Empire diamonds are precision ground, polished and inspected in house, using sophisticated television cameras and powerful microscopes to ensure accurate angular orientation.	Reduced tracing phase distortion, together with reduced wear of both the record and the diamond tip.

For the full story on Empire cartridges we suggest you "test-listen" to one at your local Empire dealer, and for information on our full line of cartridges, write for our brochure "How to Get the Most Out of Your Records": **Empire Scientific Corp.**, Garden City, N.Y. 11530

# EMPIRE

**A CONSUMER'S GUIDE**

# New Equipment Reports

Preparation supervised by  
Robert Long, Harold A. Rodgers,  
and Edward J. Foster  
Laboratory data (unless otherwise noted)  
supplied by CBS Technology Center

## AR's Best Speaker Yet

**AR-9**, a floor-standing loudspeaker system in wood veneer enclosure. Dimensions: 15 $\frac{3}{4}$  by 52 $\frac{1}{2}$  inches (front), 16 inches deep. Price: \$750. Warranty: "full," five years parts and labor. Manufacturer: Acoustic Research, 10 American Dr., Norwood, Mass. 02062.

One of the more elusive ingredients in designing a loudspeaker is retaining control of how it will sound in real life, as opposed to the laboratory. That the room has a major influence on the tonal quality of a speaker is by now widely accepted, but relatively few manufacturers have met head on the matter of interfacing the two; more often than not, a particular design will give performance that ranges from good to poor depending on where it is installed and how. Anechoic measurements may tell a good deal about a speaker, but not necessarily how it will sound in a real room. And, of course, no two rooms are alike—a fact that has led many companies to consider the whole matter insoluble and proceed on conventional rules of thumb.

In the last few years research has shown that the major ways in which the acoustic properties of rooms affect loudspeaker performance can be quantified and predicted—and allowed for in the design of speaker systems. Thus, while it is unlikely that a speaker can be made to sound exactly the same in two different rooms, gross anomalies can be avoided. And a small but growing number of manufacturers has demonstrated this point with their products. An earlier example of this type of speaker from Acoustic Research was the AR-10 $\pi$  (see HF, July 1977). The AR-9, a large floor-standing system that divides the audio spectrum into four bands and uses tandem woofers for the low bass, carries the room-matching effort a step further and introduces some new refinements.

To a large degree, nondiscriminatory radiation of bass frequencies requires that the reflective image the woofer produces by its sound bouncing off the room boundaries coincide with the real woofer as closely as possible. AR has seen to this by locating the woofers near the floor and on the sides rather than on the front, so that when the speaker is placed with its back to a wall (as recommended) the woofers are close to that boundary as well. The fact that the woofers face in opposite directions helps to prevent imbalance in the stereo image that might result from the low crossover (200 Hz) being above the point where bass frequencies are completely nondirectional. Complete coincidence of images is not achieved, but any frequency cancellations that occur are above the 200-Hz crossover. The midbass/low-midrange driver is located conven-

tionally on the front of the cabinet, but any cancellation its position might cause falls below the crossover.

Another interesting feature of the AR-9 is that the drivers on the front panel are surrounded by a heavy felt blanket. This absorbs energy that would otherwise be radiated directly to the sides, where diffraction effects at the cabinet edges would tend to create frequency-response errors and false stereo imaging.

The lab's data indicate values that are well contained over the frequency range and a nominal rating of 3.5 ohms, reasonably close to the 4 ohms given by the manufacturer. The lowest actual impedance is 3.2 ohms, reached in the region between 2 and 3 kHz. Despite the unrealistically cautious advice given by most amplifier manufacturers concerning loads below 4 ohms, the AR-9 should be an acceptable load for a good quality amplifier, even though a good deal of musical en-



---

**REPORT POLICY** Equipment reports are based on laboratory measurements and controlled listening tests. Unless otherwise noted, test data and measurements are obtained by CBS Technology Center, Stamford, Connecticut, a division of Columbia Broadcasting System, Inc., one of the nation's leading research organizations. The choice of equipment to be tested rests with the editors of HIGH FIDELITY. Samples normally are supplied on loan from the manufacturer. Manufacturers are not permitted to read reports in advance of publication, and no report, or portion thereof, may be reproduced for any purpose or in any form without written permission of the publisher. All reports should be construed as applying to the specific samples tested; neither HIGH FIDELITY nor CBS Technology Center assumes responsibility for product performance or quality.

---

ergy occurs around the impedance minimum. But a set of ARs will keep an amp quite busy—extension speakers in simultaneous operation are not recommended.

One of the tasks allotted to the amp, of course, will be to supply prodigious gobs of current (and thus power) to the speakers because, true to its heritage, this model is not notable for efficiency. The pink-noise test at 0 dBW (1 watt) produces an average sound pressure level of just over 80 dB at 1 meter in the anechoic chamber. A continuous drive at 20 dBW (100 watts) at 300 Hz elicits an on-axis SPL of 107 dB and no signs of distress from the speaker. Fed with high-level, short-duration pulses at the same frequency, the AR-9 can accept the full peak output of the test amp—somewhat over 4 kilowatts!—and produces a shattering peak SPL of 123 dB without visible distortion of the output waveform.

Steady-state distortion measures very low. At a 0-dBW drive level, second harmonic distortion for the most part remains below 0.6% from 40 Hz to 10 kHz, and in the critical region from 200 Hz to 6 kHz it is below 0.3%. Raising the drive to a voltage equivalent to 100 dB output at 300 Hz raises the level of the second harmonic somewhat, but even then an upper limit of 1.0% is rarely breached between 40 Hz and 10 kHz. Levels of the third harmonic are generally comparable with those of the second except for the region between 200 Hz and 1.2 kHz, where they run somewhat higher at the low-power drive. When the drive increases, the second and third harmonics become substantially equal, although the third rises faster as extremes of frequency (particularly in the bass) are approached. Photographs of the speaker's pulse output show very good transient response, with rapid startup and decay, negligible undershoot and overshoot, and good suppression of ringing.

Interpretation of the anechoic frequency response requires care, since the woofer appears to be 6 dB less efficient when deprived of room boundary reflections. If the average omnidirectional response is corrected for this effect by raising levels below 200 Hz by 6 dB, it remains between  $\pm 5$  dB re 80 dB SPL from 30 Hz to about 12.5 kHz. Looked at another way, the corrected curve peaks at 100 Hz and rolls off gradually by 8 dB as frequency moves toward 12.5 kHz. A similar, faster rolloff occurs between 100 and 30 Hz. The on-axis and front-hemisphere curves generally parallel the omnidirectional, indicating good dispersion and an absence of on-axis "hot spots."

Audition of the AR-9s showed that best results are achieved with the recommended placement—with backs to a wall and several feet away from any corners. But the placement requirements are not, in fact, all that rigid: The excessive bass generated by placing the units too close to a corner is easily cut down to size by a normal bass control, which can also compensate for the loss caused by positioning the speakers away from walls. If the latter placement is used, one caveat is in or-

der: The minimum distance from any wall should be about 5 feet.

In listening to the speakers, one is not struck by any particular feature except, possibly, the excellent and natural solidity and clarity of the bass. Switched attenuators for the upper drivers can reduce the output of each by about 3 or 6 dB in the middle of their respective ranges. We liked the sound best with full output from all drivers. Dynamic range is wide, and transient response is such that instrumental attacks, as well as spoken and sung consonants and vowel glides, seem natural without drawing attention to themselves.

While characteristics such as these may suggest some bland, lackluster speakers, the AR is not that way at all. Rather, it is exceedingly well balanced. Its transparency strikes us as second to none; in fact, its chief limitation in comparison with far more expensive and exotic speakers is, it seems to us, that the optimum reproduction is found only in a somewhat restricted area—within 40 degrees or so of the axis of both of the speakers and at roughly ear height for a seated person. But within this region, the stereo image is very precise and detailed, with a good sense of depth and unusually generous sense of ambience. A pair of AR-9s represent a considerable investment, and top performance from them requires that they be connected to a capable and hefty power amp—also not a cheap item. But when we listen to the sound we get from this setup, the cost seems quite reasonable—perhaps even a little like a bargain.

CIRCLE 136 ON PAGE 149

## AR-9 Loudspeaker System

Average omnidirectional output, 250 Hz to 6 kHz	80½ dB SPL for 0 dBW (1 watt) input
Continuous on-axis output at 300 Hz	107 dB SPL for 20 dBW (100 watts) input
Pulsed output at 300 Hz	123 dB SPL for 36¼ dBW (4,114 watts) peak
"Nominal" impedance	3.5 ohms at 60 Hz
Approximate LOWER MIDRANGE control range (re "flat")	-2½ & -5 dB, 250 Hz to 1 kHz
Approximate UPPER MIDRANGE control range (re "flat")	-2½ & -5 dB, 1.5 to 7 kHz
Approximate HIGH RANGE control range (re "flat")	-2½ & -5 dB, 10 to 20 kHz

### Akai's Head Warranty

In our August issue, we closed our report on the Technics RS-631 cassette deck with the words, "And where else does one find a ten-year head warranty?" Well, the answer is, with another of the cassette decks we reported upon in that issue: the Akai GXC 750D. The company warrants all its glass-and-crystal heads for 150,000 hours—the equivalent of playing the machine 24 hours a day for more than 17 years! (Installation labor is covered only during the first year.) We regret the oversight.

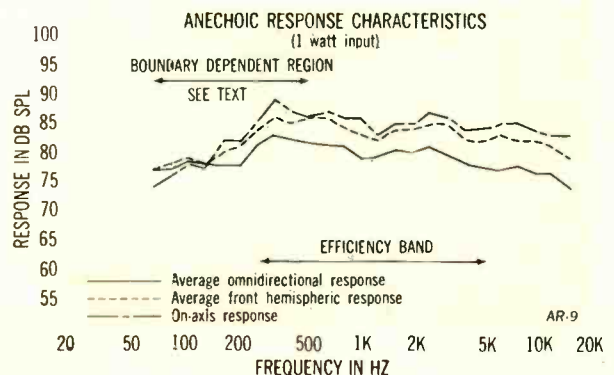

## Barcus-Berry's Provocative Plate

**Barcus-Berry Model 36 AudioPlate** add-on tweeter. Dimensions: 7 by 7 inches (front), 3½ inches deep. Price: \$200 per pair. Warranty: "limited," two years parts and labor. Manufacturer: Barcus-Berry Sales Corp., 15461 Springdale St., Huntington Beach, Calif. 92649.

A plate-glass speaker? "You must be kidding!" was the typical reaction from the high fidelity cognoscenti (ourselves included) when Barcus-Berry, a West Coast company heretofore specializing in products for the music-making (as opposed to music-reproduction) market, announced the AudioPlate. Our skepticism was hardly assuaged when the inventors admitted they weren't sure how the thing worked. But that aroused our curiosity even further. The AudioPlate appears to be a piece of ordinary ¼-inch plate glass to which a transducer is bonded. Though there is no compliance in the plate's mounting (preventing it from moving like the conventional diaphragm), the device definitely works: It does create sound. Yet it can't be felt to vibrate, and touching it doesn't seem to affect its sonic output.

In its present form, it is available as a separate add-on tweeter. It forms the front surface of a small wooden box that sits on your speaker. Connections from the amplifier are made to color-coded spring-loaded binding posts. A short length of lamp ("zip") cord, terminated on one end by a phone plug, connects the AudioPlate to the speaker it's helping. Its two mating phone jacks provide connecting options: One of them simply connects the main speaker in parallel with the tweeter, and the other feeds the main speaker via a crossover so that at high frequencies the AudioPlate flies solo. A level control is provided to match its sensitivity to that of the existing system.

CBS had to modify its speaker-measurement techniques somewhat to fit the peculiarities of a separate tweeter. The impedance of the AudioPlate is very high at low frequencies (about 125 ohms at 100 Hz), so it doesn't affect the speaker or amplifier operating conditions in that region. The impedance falls at 6 dB per octave, reaching a low of 6⅔ ohms at 1.5 kHz, then rises to 22½ ohms at 5 kHz, and droops to 3 ohms at 20 kHz (with a few peculiarities in the octave above 10 kHz). CBS considered the speaker's "nominal" impedance to be 13½ ohms (at 10 kHz) and based the other measurements on that rating. We would think that the AudioPlate, connected in parallel with virtually any main speaker, should produce no problem for an amplifier.

The anechoic response curves (which begin at 2 kHz, the rated bottom of the driver's bandpass, below which response drops off rapidly) show very smooth on-axis response (within ±2 dB from 2.5 to 16 kHz); front-hemisphere and average omnidirectional response is less noteworthy (the latter being within ±5 dB over the same range), probably due to the dispersion properties of the AudioPlate, which is rather large with respect to the wavelengths involved. Off axis, it has a definite preference for the octave between 5.5 and 11 kHz or so. Distortion is predominantly of the second order and averages about 1¼% at the 1-watt level. At the 100-dB sound pressure level, the distortion reaches 3%. Tone-burst photos at 3 kHz

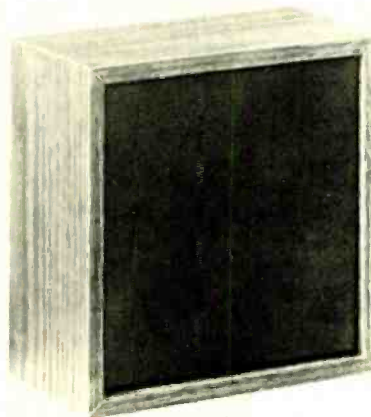

reveal a fair amount of envelope distortion and some ringing; both properties become more exaggerated at 10 kHz. Some of the pulse hangover (and some of the oddities in polar response) may, in fact, be due to near reflections and/or resonances; the supposedly omnidirectional AudioPlate might conceivably be more effective in an enclosure of less conventional design.

Diversified Science Laboratories determined that the low-pass filter used to roll off the highs to the main speaker consists of a series inductor of 890 microhenries. The resistance of the coil is about 0.8 ohm—a value precariously high if good damping is to be preserved in the associated woofer. When feeding an 8-ohm speaker, such a network rolls off at 6 dB per octave, with a crossover frequency of about 1.5 kHz. Regardless of the amplifier, the maximum damping factor would be only 10. (With a 4-ohm speaker, not only would the damping factor be worse—5 at best—but the crossover frequency would drop to about 850 Hz.) While it is virtually impossible to design an add-on tweeter to cross over in an optimum fashion to every loudspeaker on the market, we're surprised that Barcus-Berry chose so low a frequency here in view of the depressed response of the AudioPlate below 2.5 kHz.

We listened to the AudioPlate in conjunction with a high-quality 8-ohm speaker system. When we used the ROLLOFF connection, it quickly became apparent that the crossover frequency was too low for smooth upper-midrange response. The fundamentals in the upper register of the piano were weak while the overtones (handled by the AudioPlate) were there in full force. The result was a bell-like quality—not unpleasant but not faithful to the original either. A similar effect was apparent on violins—an undue emphasis on the upper partials and a weakness in certain registers. No adjustment of the level control could eliminate the condition.

When we tried the PARALLEL connection and turned the tweeter control of our main speaker down as far as it would go (the system we were using, like most of today's models, would not permit us to turn the tweeter off completely), the tonal balance was better, although some roughness could still be noted in certain registers. The bass response was audibly tighter, undoubtedly due to the better damping afforded by connecting the woofer directly to the amplifier.

How well the AudioPlate will work with a speaker will depend as much on the characteristics of that system as on the AudioPlate itself. When it gets a piece of the action, the results can be startling. Cymbals, for example, are shattering in their brilliance. So are the percussive attacks of the xylophone—a sharpness honed to a razor's edge. We found the direct-to-

disc "Nexus Ragtime Concert" (Umbrella UMB DD2) particularly good in showing off what the tweeter can do.

A clear distinction should be made between the AudioPlate as a generic idea and the Model 36 tweeter we tested. In the first place, any add-on tweeter results in a speaker system that is not through-engineered; an integrated system (or, at minimum, a bramped add-on) would automatically remove some of our reservations about this model. Then there's the question of its propagation behavior and how any enclosure might influence its unique properties, were they understood in detail—as, it appears, they are not. So while the present product has salient limitations, they need not necessarily apply to other applications of the principle. For the present, the Model 36 may prove useful in ameliorating top-end deficiencies in some speaker systems. For the future, who knows?

CIRCLE 135 ON PAGE 149

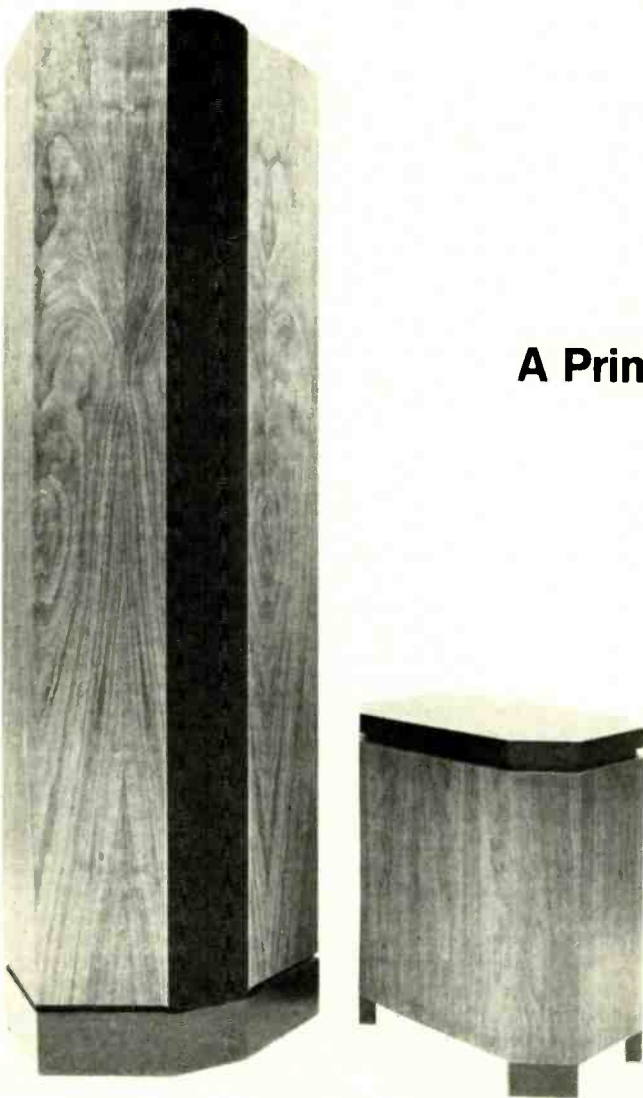
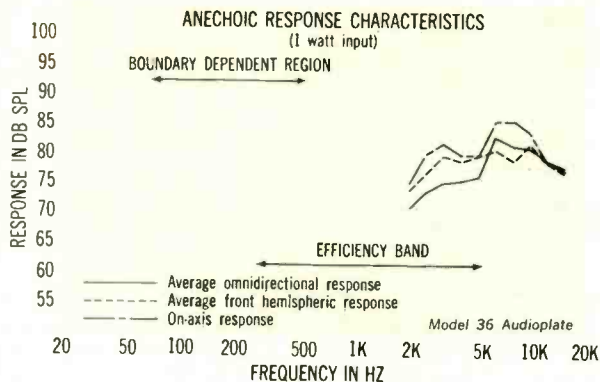

## A Prime Contender for the World's Best Speaker

**Beveridge 2SW-1** floor-standing loudspeaker system, in walnut enclosures. Dimensions: 24 by 16 inches, 79 inches high (electrostatic units); 15¾ by 22 inches, 26 inches high (subwoofers). Price: \$6,995 for complete stereo system. Warranty: "limited," no formal time limit on parts, five years on labor. Manufacturer: Harold Beveridge, Inc., 422 N. Milpas St., Santa Barbara, Calif. 93103.

What can you expect when you go to an audio salon and plunk down almost \$7,000 for a loudspeaker system? First of all, you get two electrostatic modules that stand close to seven feet tall when on their bases; then you get a dynamic subwoofer for each channel, to prevent heavy bass transients from straining the electrostatics' power-handling capability and, at the same time, to extend low-frequency response. You also get the welcome news that each base actually is a "power module" (amplifier) designed especially to meet the requirements of the system (the output devices, for example, are vacuum tubes), saving the lengthy search for an amp capable of driving the kind of reactive load a speaker of this type represents. But, most of all, you get the sophisticated and imaginative engineering that makes this an extraordinary product.

Even for an electrostatic, the design of the Beveridge 2SW-1





XL-55 Pro with cartridge-head shell integration

# Command Performance.

A new Sony cartridge designed for the ultimate in sound.

In a high performance sound system, the single most important element between your record and your ears is the cartridge.

That's why Sony went to a lot of trouble to create a highly original MC (Moving Coil) cartridge so superbly sensitive, the sound hardly seems to be coming from the record at all.

It uses a unique, simple figure-8 coil generating mechanism newly developed by Sony. To minimize resonance, it adopts an extremely intricate carbon-clad

cantilever, etc. The result—almost incredible sound transparency.

And that's only the beginning of the sophisticated technology and loving care Sony has lavished on the astounding XL-55 Pro.

We're convinced it was worth the extra effort. And we can back our claim with some pretty impressive statistics. But why read statistics when you can listen to the real thing?

Hearing is believing.

# SONY

is unusual. The planar radiator is enclosed in a specially shaped chamber that opens to the outside environment through a slot that runs from top to bottom of the panel. The enclosure makes the electrostatic unit function as a line radiator and produce a cylindrical wave front with the slot as its axis. Literature supplied by the company says that in a sound field of this type the sound pressure level falls off inversely with distance from the source—rather than inversely with the square of the distance from the source, as it does with “spherical” radiation patterns. (We made no attempt to verify or disprove this claim in the lab.) Other claimed advantages are, in a nutshell, very wide horizontal dispersion with uniform frequency response, reduced early reflections from floor and ceiling, and a relatively orderly pattern of images resulting from sidewall reflections.

Like any speaker meant to interact with a real room in a predictable way, the Beveridge insists on proper placement. The restrictions are not severe, however, and we would expect that any room that can tolerate the fairly prodigious size of the system could accommodate it correctly without too much trouble. And anyone who buys a speaker this expensive owes it to his investment to get the best sound it can offer.

The room-oriented design of the 2SW-1 makes measurements taken in the anechoic chamber (which is barely large enough to admit the system) particularly difficult to interpret. Since the speaker is self-powered, its impedance is of concern only in terms of the preamp used to drive it. The required input is 1 volt into 47,000 ohms, which should be within the capabilities of any good-quality preamp. (A cautious person, considering that there is the added capacitance of a good many feet of shielded cable to be driven, might want to be sure that the preamp's output impedance is 1,000 ohms or less.) In the sensitivity test, the system blew fuses when fed a pink-noise signal of 0.25 volt, necessitating that this (and the other tests) be carried out at a lower level. The chosen level was 0.1 volt, which produced an average level of about 74¼ dB SPL (250 to 6,000 Hz) around a semicircle 2 meters in radius in the plane cutting horizontally through the unit, half-way up. Measured on-axis over the same range, the average is 78¾ dB. These results suggest a limited dynamic range. In a listening room of roughly 6,500 cubic feet, however, we were able to produce musical peaks in the range of 106 dB at a distance of about 3 meters. Such peaks blew no fuses, and our ears backed up the opinion of the sound level meter, in that this was as loud as we wished; listeners' opinions were divided on audible evidence of overdrive at this level (the subwoofer's output to the room structure raised questions of possible acoustic feedback), but the lab's pulse photos at roughly the same level (2 volts peak to peak) do show evidence of waveform distortion.

In the distortion tests themselves, made at 0.1 volt, second and third harmonics remain below 1% from 100 Hz to 10 kHz except for a few minor prominences in the region of 3 to 7 kHz. Between 100 and 1,000 Hz, 0.3% represents the upper limit for gratuitous second and third harmonics. The subwoofer, operating from 100 Hz down, produces levels of each of the harmonics measuring around 2% regardless of frequency, with occasional sallies into less favorable territory. This is good performance from a subwoofer, although not quite up to the level of the panels.

Transient response is a forte of the Beveridge. In the 300-Hz pulse test, the output waveform from the speaker could almost be mistaken for the one fed to the amp input. The 3-kHz pulse excites a small amount of ringing that dies out very quickly. Anechoic response slopes off by about 8 dB between approximately 80 Hz and 10 kHz, with minor variations, along with an additional broad dip of 3 to 4 dB centered around 4 kHz. Below 80 Hz (and above 15 kHz or so) response falls off

rapidly, though the position of the subwoofer near the floor boosts the low end considerably when the system is used in a normal room. The frontal response and on-axis response track each other well across the frequency spectrum, tending to support the claim of a cylindrical radiation pattern.

When we set up a pair of the Beveridge 2SW-1s and listened, we found this as transparent a system as we have ever heard. The speakers do their job so well that after a few minutes they seem to fade into the background, leaving only the music. We repeatedly had to remind ourselves that we were auditioning a loudspeaker, for fine points of musical performance and interpretation—and recording technique—were so stunningly revealed that they tended to dominate our attention.

Save for a slight heaviness in the lower bass (tamable to a degree via the tone controls) we found nothing audible to complain of in the frequency response. Some purists might prefer a flatter top end and, in particular, might take exception to the dip in the 4-kHz region. We find these departures innocuous, but they are smooth enough to yield to an equalizer should one wish to remove them.

In its transient response, the system virtually vindicates the promise of the lab data; compared with the midrange and high-frequency transients of the Beveridge, “clean as a whistle” seems dirty. The subwoofer, which strikes us as the weak link in the total system, begins to show signs of breathlessness in trying to match the standard set by its more agile working partner.

Stereo imaging is dependent on proper room placement, but when this is achieved the results are superb—and at almost any point in the listening room. The one peculiarity of the image is that, apparently because of the cylindrical radiation pattern, the virtual sound sources can seem larger (taller, especially) than life, particularly if one listens from a standing position. In just about every other way, the stereo image is stable, vivid, plausible, and possessed of good depth.

Can a speaker such as this be said to justify its price? If we use prosaic standards such as price-to-performance ratio, the answer is that this is hardly your “basic best buy.” But this speaker design demands other criteria: It must be evaluated in terms of the uncompromising attitude that must have motivated its designer. If this kind of technological quest moves you, go listen to a 2SW-1 and phone your accountant.

We would hesitate to call any speaker “the best,” but the Beveridge is surely at least one of the prime contenders. If you are fortunate enough to be seeking a system in this champion class, you would be derelict to pass over it. You may not decide to take it home with you, but we'll bet you won't regret the time you spent in auditioning it.

CIRCLE 131 ON PAGE 149

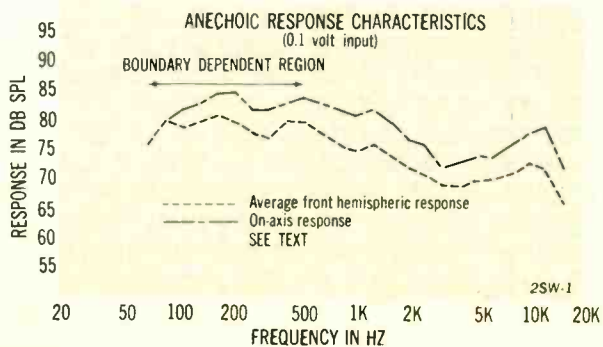

# HITACHI

## The New Leader In Audio Technology



...introduces the world's most powerful 50 watt receiver.

The new Hitachi SR 804 stereo receiver has the revolutionary Class G amp that instantly doubles its rated power from 50 to 100 watts to prevent clipping distortion during those demanding musical peaks (note the clipped and unclipped waves in the symbolic graph above). The SR 804 is conservatively rated at 50 watts RMS, 20-20,000 Hz into 8 ohms with only 0.1% THD.

Class G is just one example of Hitachi's leadership in audio technology. Power MOS/FET amplifiers, R&P 3-head system cassette decks, Uni-torque turntable motors, and gathered-edge metal cone speakers are just some of the others. There's a lot more. Ask your Hitachi dealer.



**HITACHI**

When a company cares,  
it shows.



You know us best for our reputation in audio. In fact, it's audiophiles like you who have made TDK SA the best-selling High bias cassette in America today. But here's something you may not know: the same Super Avilyn engineering principle that revolutionized audio cassettes is in TDK's equally revolutionary new Super Avilyn video cassettes.

No wonder that TDK Super Avilyn is the first 4-hour capability video cassette to be quality approved by the people who know: video cassette recorder engineers. And even less wonder that Super Avilyn makes possible an image so stunning, you will feel as though you are sitting in the broadcast studio.

What's more, TDK's strict quality control works to give you low wear on delicate video heads, virtually non-existent oxide shedding, and no problems with tape stretching, even with repeated playback.

That's because TDK Super Avilyn video cassettes are an actual component of the system, not just an accessory. Our tape is housed in a precision, jam-resistant mechanism, for years of consistent high quality video reproduction. And TDK Super Avilyn VHS video cassettes are compatible with all VHS machines, both those with short-play (2-hour) capability and those with short and long-play (4-hour) options.

TDK Super Avilyn VHS video cassettes: model VA-T60, for one and two-hour recording; model VA-T120, for two and four hour recording. If you like things to look as good as you like them to sound, take a look.

TDK Electronics Corp., Garden City, NY 11530. In Canada: Superior Electronics Ind., Ltd.

 **TDK**<sup>®</sup>  
The Machine for your Machine.™

# What TDK did for your ears, it now does for your eyes.

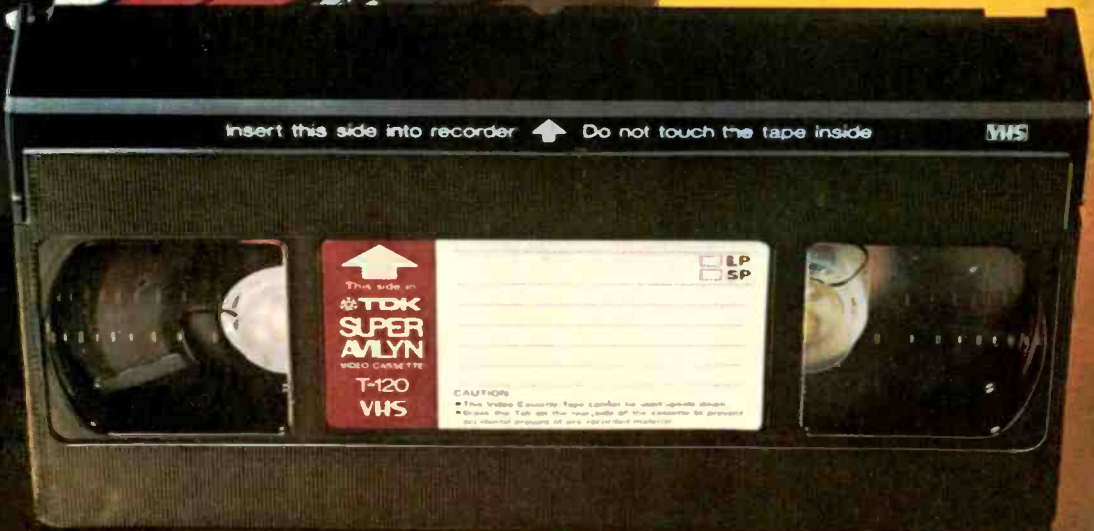
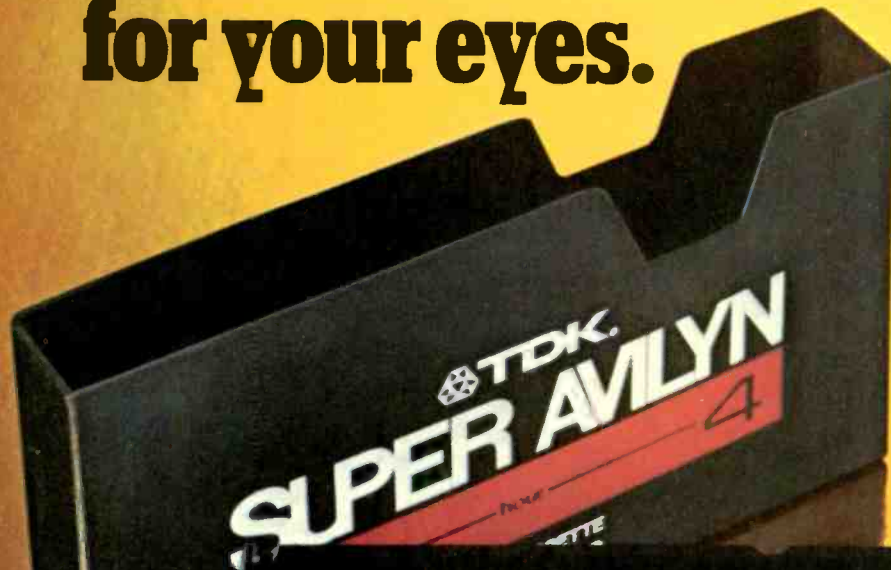

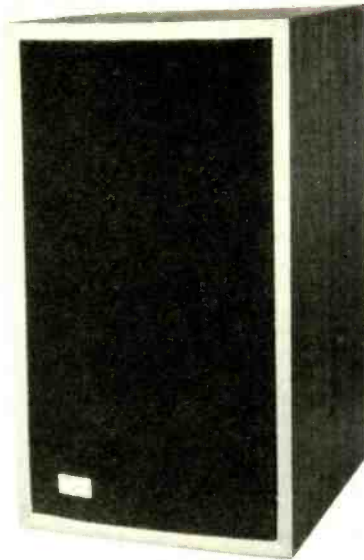

## A Speaker that Maintains Neutrality

**Fried Model Q** loudspeaker system, in walnut-grain vinyl cabinet. Dimensions: 11½ by 19¾ inches (front), 10 inches deep. Price: \$140. Warranty: "limited," two years parts and labor. Manufacturer: Fried Products Co., 7616 City Line Ave., Philadelphia, Pa. 19151.

Of the various types of loudspeaker systems possible, one of the least understood is the transmission line. Usually large and relatively inefficient, it trades both size and efficiency for tight bass. And, in the mind of Irving M. Fried—long a champion of this type of design—the tradeoff is well worthwhile. The Fried Model Q is a variation on the classic transmission line, and it is an example of what can be done with this technique in a small, relatively inexpensive package.

A true transmission line absorbs and dissipates the rear radiation of the woofer without allowing any of it to reflect back; the expected benefit is an improvement in transient response and bass that is less muddy than that of the average resonant enclosure. The Model Q is a two-way system in a foam-grilled enclosure small enough to fit on a bookshelf. Connection to a power source is made via color-coded three-way binding posts, and three-position IMPULSE control sets the tweeter efficiency. Fried calls the bass loading of the Model Q's enclosure a "line tunnel" and describes it as a duct into which critical foam damping is inserted. The damping adjusts the acoustic impedance for efficient power transfer in the bass; it provides an auxiliary source of very low bass (the end of the tunnel is open); and it permits the driver to respond more rapidly on steep wave fronts than is possible in sealed enclosures.

Judging from the impedance curve, the Model Q has accomplished its goals. It is an essentially nonresonant loudspeaker system in a small enclosure. The low-frequency impedance is 6½ ohms and rises to just 6¾ ohms at 75 Hz, the only sign of any resonance. Nominal impedance measures 5 ohms, and the maximum impedance is about 14 ohms—at 1.6 and 20 kHz.

Characteristically for a transmission-line system, the Model Q has a much lower than average efficiency. Given sufficient drive power, however, it will deliver a peak sound pressure level up to 119 dB for brief periods before its protective fuse blows. But these levels took peak powers of 34½ dBW (almost

3,000 watts)! The speaker easily handles the continuous 20-dBW (100-watt) 300-Hz test signal.

The pulse photos taken at the lab suggest that the Model Q also has the excellent bass transient response claimed for transmission-line systems. The on-axis frequency response shows a slight rise at 100 Hz and a dip at 200 Hz. We suspect these minor anomalies are related to the relative reinforce-

### Fried Model Q Loudspeaker System

Average omnidirectional output, 250 Hz to 6 kHz  
77¼ dB SPL for 0 dBW (1 watt) input

Continuous on-axis output at 300 Hz  
104 dB SPL for 20 dBW (100 watts) input

Pulsed output at 300 Hz  
119 dB SPL for 34½ dBW (2,880 watts) peak

"Nominal" impedance 5 ohms at 120 Hz

Approximate IMPULSE (tweeter) control range (re "flat")  
+ 1, -1½ dB, 2 to 15 kHz  
+ 1½, -2 dB, 3.5 to 7 kHz

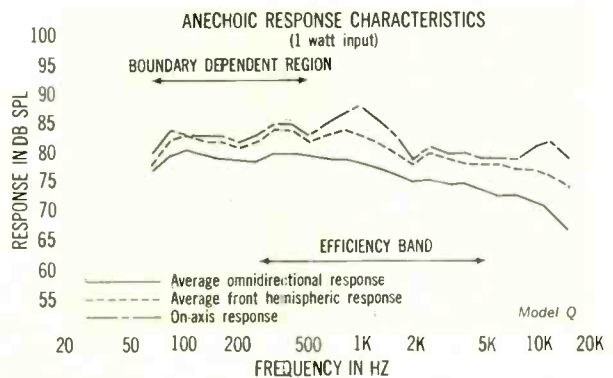

ment and cancellation afforded by the open-ended duct. The integrated power output in the bass region is exceptionally smooth, however. The average omnidirectional response is within  $\pm 1$  dB from 80 Hz to 1 kHz and within  $\pm 2$  dB from 60 Hz to 1.6 kHz. The on-axis response of the tweeter is also very smooth—within  $\pm 1\frac{1}{2}$  dB from 2 to 16 kHz—but at a level about 5 dB below that of the woofer, which the limited range of the IMPULSE control does little to reduce. The tweeter exhibits some directionality above 8 kHz, and overall the integrated output is within  $\pm 5$  dB from 50 Hz to 12.5 kHz.

At the 0-dBW (1-watt) level, the THD is reasonably good (no greater than  $\frac{3}{4}\%$ ) at frequencies of 100 Hz and above. At the lower frequencies, distortion is composed predominantly of the more benign second harmonic; at the higher frequencies, the second and third harmonics jostle for prominence. In the lower-bass region, the distortion increases rapidly ( $1\frac{1}{2}\%$  at 70 Hz,  $5\frac{1}{2}\%$  at 50 Hz, and more than 10% at 30 Hz). Higher sound pressure levels also raise the THD, but, again, it is mostly second harmonic. At approximately the 100 dB sound pressure level, the THD averages about  $1\frac{1}{2}\%$  or less from 200 Hz to 7 kHz and rises to  $4\frac{1}{2}\%$  at 100 Hz and  $2\frac{1}{2}\%$  at 10 kHz.

The Fried Model Qs give the best bass response when set at bookshelf level and removed from the corners of the room.

And, subjectively, that response is surprisingly good, especially for so small a speaker. Its tightness in the bass could well be the envy of many more efficient systems. We prefer the sound with the tweeter (IMPULSE) switch at maximum. Even so, the upper midrange and treble are not quite the peers of the rich bass, which leaves the sonic impression of added distance. The sound is smooth and sweet but with a trace of hollowness. While the transient response is very quick on the attack, the speakers never become brash or edgy—nor do they call attention to themselves or add anything to the music. The stereo image has good lateral extent and a solid center.

Given sufficient power—at least 20 dBW (100 watts) per channel—a pair of these speakers has good dynamic range. Some distortion is audible when the Model Qs are driven hard, but the sound is not raucous; they will handle a surfeit of power more comfortably than an insufficiency. They should appeal to the mature music lover who is no longer subject to the allure of tinsel and glitter—one who can appreciate the tight, extended bass response of this small system and does not demand the most brilliant sound on the block. If he is willing to feed the Model Qs sufficient amplifier power to satisfy their appetite, they will reward him accordingly.

CIRCLE 134 ON PAGE 149

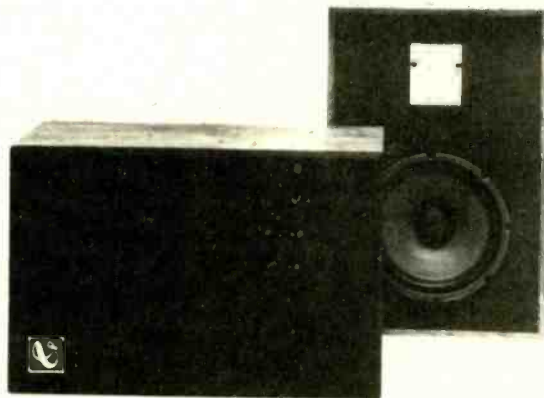

## A Fine Budget Speaker—and From Infinity

**Infinity Model Qe** loudspeaker system, in wood cabinet. Dimensions: 18 by 12 inches (front),  $10\frac{1}{4}$  inches deep; tweeter is rotatable for either vertical or horizontal placement. Price: \$105. Warranty: "limited," five years parts and labor. Manufacturer: Infinity Systems, Inc., 7930 Deering Ave., Canoga Park, Calif. 91304.

Infinity Systems is a company whose reputation up to now has rested largely on its expensive, high-performance systems incorporating design features that can be called unusual, even exotic. Electrostatic drivers, line radiators, and dual-voice-coil woofers have all had their places in Infinity loudspeakers. More recently, the company has begun to introduce spinoffs of its high-technology items at lower prices. The pleasant surprise is that enough spinning has taken place to reach the price point of the Qe. And while designing a no-compromise loudspeaker is an engineering feat of a kind, making a model that delivers good sound at a low price can be just as difficult if not more so.

This is a small two-way system using the same type of Emit (for Electromagnetic Induction Tweeter) tweeter that appears elsewhere in the Infinity line, and in this model the tweeter can be rotated 90 degrees so that its dispersion characteristics suit either horizontal or vertical placement of the speaker. Frequencies from the 2.5-kHz crossover downward are radiated from an 8-inch woofer housed in a sealed enclosure.

Unlike many budget speakers that take back most of what they offer in cost savings by demanding a high-powered amplifier, the Qe is somewhat above average in efficiency. The 96 dB measured at 300 Hz, for a steady 9-dBW (8-watt) input, is prodigious for so compact a speaker. Actually, the system will put out more than this at 300 Hz, but the fact that 9 dBW pushes it over the distortion limit at a nearby frequency (250 Hz) led the lab to confine its testing to this level. On short-duration pulses, however, it will produce peaks at an astounding 116 dB SPL. But two notes of caution are in order. First of all, the test conditions represent extreme stress to the speaker itself. Second, the unit dips below its nominal impedance to a

level close to 2.5 ohms at 5 kHz and above; trying to deliver current to a load such as this at high levels could easily give many amps a severe pain in the output stage. (Similarly, paralleled pairs are likely to overload most amps even at more reasonable listening levels, so we advise against driving more than a single pair with the same amp.)

As for distortion, except for a few brief sallies into unfavorable territory, the Qe can produce a steady 96 dB SPL from 100 Hz to 10 kHz with second harmonic distortion mostly below 3%. The more troublesome third harmonic distortion at this power level follows a similar profile but is better suppressed, remaining below 3% down to 60 Hz. Lowering the input drive to 0 dBW generally reduces distortion; the third harmonic, which is lower to begin with, shrinks less than the second. A few distortion peaks, seemingly independent of level, that appear near the crossover (between 2 and 5 kHz) are almost certainly artifacts resulting from cancellations at the on-axis microphone position.

Measured in the anechoic chamber, the average omnidirectional frequency response is exceedingly flat and extended, remaining within  $\pm 2\frac{1}{2}$  dB from 60 Hz to 8 kHz. The high-end rolloff begins near 4 kHz and continues at a rough average of 5 dB per octave until 16 kHz, the upper testing limit. The average front hemisphere response parallels the omnidirectional closely, indicating that the system has good dispersion. On-axis "hot spots" are rare; the only one of any consequence lies near the crossover frequency.

In the transient response testing, the Qe comes off rather well. Pulses at 300 and 3,000 Hz are cleanly reproduced with excellent suppression of ringing and near reflections. Though at the lower frequency there is some evidence of noise produced by the cone itself, it does not come even close to being prominent.

With our listening setup matching the manufacturer's instructions (7 to 10 feet apart and at least 18 inches off the floor), a pair of these speakers give an excellent account of themselves. The instructions suggest placing each near the front of a bookshelf as far from the wall as possible. We get best results by going a step further and locating the speakers on stands at least 18 inches from the walls. Under these conditions, bass remains relatively free of boom and tubbiness. Instrumental tone colors are well reproduced, although the minor anomalies of the crossover region can be heard, adding some zing to instruments such as the oboe that have formants there and some hardness to those that, like the

strings, do not. Voices generally sound realistic, despite an occasional trace of edginess. Midbass reproduction is clear, and although extremely low fundamentals are largely a matter of psychoacoustic illusion with this system, the trick is pulled off so gracefully that the speaker is not embarrassed in an A/B comparison with a large floor-standing model that sells for many times more.

Stereo imaging of the Qe is particularly good, with better than adequate depth and location and a nearly uncanny stability as the listener changes position. Overall, we would say that this speaker leaves the artistic and emotional values of the music it reproduces intact. Obviously, Infinity has done what it set out to do—and well: The Qe can do a great job of making you lose sight of how little you paid for it.

CIRCLE 132 ON PAGE 149

## Infinity Qe Loudspeaker System

Average omnidirectional output, 250 Hz to 6 kHz  
83 dB SPL for 0 dBW (1 watt) input

Continuous on-axis output at 250 Hz<sup>2</sup>  
96 dB SPL for 9 dBW (8 watts) input

Pulsed output at 300 Hz  
116 dB SPL for 29¼ dBW (837 watts) peak

"Nominal" impedance 4.3 ohms at 160 Hz

<sup>2</sup>see text

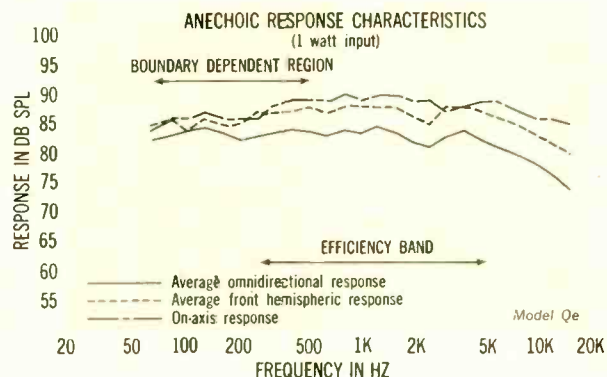

## Big Sound for a Small Price

**Realistic Optimus-10** floor-standing loudspeaker system, in walnut-veneer cabinet. Dimensions: 15½ by 25¼ inches (front), 10¾ inches deep. Price: \$139.95. Warranty: "limited," five years parts and labor. Manufacturer: Radio Shack, Div. of Tandy Corp., 1400 One Tandy Center, Fort Worth, Tex. 76102.

The floor-standing Optimus-10 is a new two-way system with a passive-radiator vent. Clad in real oiled-walnut veneer rather

than the vinyl ersatz common in low-priced systems, it offers surprising gratification to the eye and touch. Ambitious goals appear to have been set for the Optimus-10 electroacoustically as well, for efficient floor-standing systems are not common at this price point.

The active 8-inch woofer/midrange driver operates up to 2.5 kHz and is allowed to roll off naturally above that frequency, where a 3½-inch tweeter with a 1-inch voice coil takes over. Crossover to the tweeter is by way of a simple network



that includes a BRILLIANCE control to match the levels at the two ends of the spectrum. A 10-inch passive radiator is rated to extend the bass down to 45 Hz. Both screw terminals and an RCA phono jack are provided to make connection to the system.

Although the nominal impedance of the Optimus-10 measures 5.8 ohms, we see no problem in connecting parallel pairs of these speakers to the average amplifier. The nominal impedance is also the minimum, and over most of the band the speaker presents a load of 8 ohms or more.

The pure-tone on-axis response in the anechoic chamber reveals some irregularities in the upper part of the woofer's range—due, presumably, to cone breakup. Average omnidirectional response, a more important measurement, shows very smooth woofer/midrange power response: within  $\pm 1\frac{1}{2}$  dB from 100 Hz to 2 kHz. The tweeter's response is equally well contained between 2.5 and 8 kHz. On average, the tweeter response is about  $5\frac{1}{2}$  dB below that of the woofer, but much of that can be made up with the BRILLIANCE control.

Except for the upper reaches of each driver's range—say, 2 and 10 kHz, respectively, where the THD reaches  $1\frac{1}{4}\%$ —the distortion at the 1-watt level remains below  $\frac{3}{4}\%$  at frequencies of 100 Hz and above. The distortion increases to  $1\frac{1}{2}\%$  at 70 Hz and  $1\frac{3}{4}\%$  at 50 Hz. At 30 Hz, it exceeds 10%. At an input equivalent to a 100-dB sound pressure level at 300 Hz, the distortion is under  $2\frac{1}{4}\%$  at 100 Hz and above, averaging 1% over much of that range. THD at 50 Hz approaches 6%. In the low-frequency region (at the 1-watt level), and throughout the band at higher power levels, the distortion is predominantly second harmonic, rather than the more annoying third.

Efficiency is greater than average. The dynamic range is excellent: The Optimus-10 will deliver 112 dB SPL continuously with a 20-dBW (100-watt) input, and pulses into the kilowatt range can be accommodated. Low-frequency tone-burst response is very good, but hangover can be found in the reproduction of 3-kHz bursts.

In listening tests, we found that—despite the owner's manual suggestion that the Optimus-10s be placed flush against the wall—the stereo imaging could be improved greatly by pulling them away from the wall and turning them slightly in toward the listening area. This also tightens bass response.

Piano recordings are well handled, with a rich, resonant bass leading to a smooth midrange; the treble, however, is slightly hollow and somewhat brittle. Reproduction of cymbals

is quite good, but some distortion appears in the middle-high region of the brass. Transient response is more resonant than sharp. Voices reproduce fairly well with just a slight edge in the tenor range and a bit of hiss on the sopranos. Choral works have reasonable definition, and low string tones are reproduced with better clarity than are the upper ones.

Considering the modest price of these speakers, we'd say they acquit themselves very well indeed, both in the lab and in the listening room. There is a natural tendency to compare them with their look-alikes—speakers of considerably greater cost. Even so, they need not blush in the limelight.

CIRCLE 133 ON PAGE 149

### Realistic Optimus-10 Loudspeaker System

Average omnidirectional output, 250 Hz to 6 kHz  
86 dB SPL for 0 dBW (1 watt) input

Continuous on-axis output at 300 Hz  
112 dB SPL for 20 dBW (100 watts) input

Pulsed output at 300 Hz  
125 dB SPL for 33 dBW (2,000 watts) peak

"Nominal" impedance 5.8 ohms at 190 Hz

Approximate BRILLIANCE control range (re "flat")  
+3, -2 dB above 3 kHz

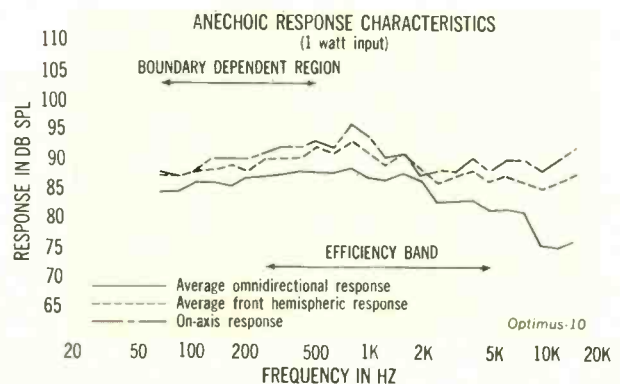



It's midnight. You're losing, and your roll is critical. Click. The music stops and so does your concentration.

**Introducing the you-don't-have-to-stop-what-you're-doing switch.**

No matter what you're doing, it has to be more interesting than getting up to turn over a cassette. So now you don't have to. The tape will automatically reverse itself and play side two, then shut off. In Auto-Repeat mode, the tape plays until tomorrow, or whenever you turn it off.

**Read this if you can't live without knowing how we combine quality and convenience.**

Some people just want to listen to good sounds. But if you're

interested in how it happens, a specifically designed TEAC transport mechanism makes the auto-reverse and auto-repeat functions work with incredible precision. Independent capstans pull the tape in either direction. And our newly-designed head-shift mechanism has solved a problem that's plagued the industry for over a decade: how to achieve reversing convenience without sacrificing channel crosstalk. Now, with the A-601R, you can get one-way sound performance from a two-way machine. What's more, we've further improved sound quality by utilizing our new "Sendust" head which combines the permeability of metal with the wear factor of ferrite.

**There's a single simple source of information.**

All function indicators, including direction lights, are located on a central panel which also includes a solenoid-controlled direction switch. So one glance tells you what's happening. And then there's Memory Stop, Mic/Line Mixing, 3-Stage Eias and Equalization Selections, Precision VU Meters, a Timer Switch and all the other reliable features you've come to expect from TEAC. TEAC tape decks are first. Because they last.

# TEAC

First. Because they last.  
TEAC Corporation of America  
7733 Telegraph Road  
Montebello, CA 90640

## The A-601R can play longer than you can. Automatically.

Wow & Flutter: 0.07%  
Signal to noise ratio: 65dB with Dolby  
Frequency Response: 30-16,000 Hz (CROz/FeCr)  
30-14,000 Hz (Normal)





**HIGH  
FIDELITY**

# The Reduction

of  
the  
**Bass  
Reflex**

by David Weems

**re·duce** (re·dūs), v.t. . . . 1. To bring back, as to mind, from error. . . . 2. To draw together; now, to diminish, esp. in bulk. . . . 4. To bring to terms; humble; conquer; subdue; as to *reduce* a fort or a person to submission. 5. To bring into a certain order, arrangement, classification, etc.; as, to *reduce* language to rules. . . .

WITH THOSE DEFINITIONS, my old Webster's *Collegiate Dictionary* aptly describes some developments in speaker systems—particularly bass-reflex speakers—that, in the last few years, have transformed the ported enclosure from the status of near-outcast (in an acoustic-suspension world) to that of technological and social triumph.

The first clues to the trend are new buzzwords, such as "Butterworth tuning" and "Chebychev response," but the long-term implications of contemporary thinking reach beyond the speaker system itself—to amplifier design. One possibility: amplifiers with built-in bass equalizers that can be tuned to match any speaker. Such amplifiers could increase a speaker's low-frequency range and power-handling ability while reducing distortion. If this sounds too utopian, note this: The technology for these benefits has been around for several years.

My view of the former state of bass-reflex theory was formed a decade ago during research for a "how to" speaker article. Speaker builders, amateurs and professionals alike, shared the assumption that bass-reflex design was a cut-and-dried process that could be followed like a cake recipe. After all, the thinking was, resonators have been understood since 1863, when Hermann von Helmholtz published *On the Sensations of Tone*. Any simple enclosure with a port in it is a Helmholtz resonator in which the air in the port vibrates and alternately compresses and expands the air trapped inside. This produces a well-defined resonance whose frequency can be tuned by varying the area or depth of the port (the mass of the vibrating air) or the size of the enclosure (the compliance of the trapped air).

So far so good. But when you put a loudspeaker into such a box, matters get much more complicated. One striking effect occurs at the frequency of the port resonance, where the vibrating air compresses the air in the box in phase with the speaker-cone movement, damping the cone itself so that it hardly moves. Low cone movement generally means low distortion, so some engineers have tended to favor reflex enclosures.

In 1968 the various companies that produced ported-box speakers agreed, naturally, that low distortion was a goal worthy of any general bass-reflex theory, but when the discussion shifted to design procedure, consensus fell apart. Some engineers, for example, thought the drivers should

have high magnetic damping (low Q), while others worried that too much damping could cut bass response. The range of recommended damping ran from high to moderate (Q from about 0.3 to 0.62).

Sometimes systems from different manufacturers had drivers with the same resonance frequency and identical cone size but with box volumes varying by as much as 100%—and with no precise explanation for that difference. And how should the box be tuned? "Tune to free-air resonance," one engineer would say. "Free-air resonance means nothing," another said. Chaos.

G. A. Briggs summed it up in 1968, when he wrote, "Frankly speaking, I do not think it is a practical proposition for anybody to build a reflex cabinet at home and insert a speaker in accordance with theory." Or, one might be tempted to add, for anybody in a laboratory to do so either. With about \$25,000 worth of anechoic-chamber and test equipment, he might match a specific woofer to a box—but by theory?

Briggs went on: "Turning now to commercial models, there has recently been quite a move in the direction of total enclosures [that is, without ports] . . . . Incidentally, all the latest models produced by Rank Wharfedale are of the infinite baffle or total-enclosure type." And Wharfedale had been a traditional champion of the ported box. This showed just how far the high fidelity world had moved toward universal acceptance of Briggs's "total enclosure."

There were many reasons for the popularity of the closed box, but its predictability and simplicity were certainly major advantages. The reflex promised some tantalizing advantages itself, low distortion among them, but in the hands of most builders it failed to deliver. Too often it earned its early nickname—boom box—yet certain factory-built reflex speaker systems performed satisfactorily even though they were built by people who disagreed on how to design them. One audiophile, an electrical engineer working for a space program contractor, noted that there was obviously more than one way to design a ported-box system. Unfortunately when a builder tried to apply someone's theory to his own speaker, he usually produced a boom box. Some experimenters muted the boom by stuffing the box with damping material, usually choking off the low bass and ending up with a system whose low-frequency performance was inferior to a simple closed box.

### Other Voices, Other Boxes

While engineers disagreed on theory and hobbyists argued about the merits of glass fiber vs. Dacron batting, several workers had, unnoticed, analyzed and tamed the ported box. James F. Novak, now vice president of engineering at Jensen

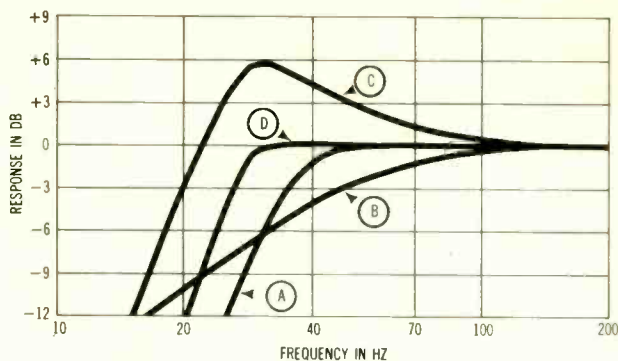

## HOW AN "ASSISTED" BASS ALIGNMENT WORKS

**Curve A** represents the response of a theoretical speaker system in an enclosure optimized for flattest bass response, without assistance, for the given driver and cabinet size.

**Curve B** shows what the response of the same system might be with the port altered to produce a resonance a half-octave lower than that in A. Note that though response is a bit less weak below 30 Hz, it begins rolling off at a much higher frequency and, without assistance, would produce unacceptably weak bass.

**Curve C** represents an equalizer designed to complement the system response of Curve B.

**Curve D** is the sum of Curves B and C—that is, the response of System B with the equalizer "assisting" its bass response. Now the total response is flat down to almost 30 Hz and the "3 dB down" point has been moved about a half-octave lower with neither the drooping response nor the susceptibility to warp information below the operating range that the unassisted system would suffer.

Sound Laboratories, made one of the first steps toward the reduction of the bass reflex in 1959, when he published a paper comparing the performance of a high-compliance speaker in a closed box to that in a ported box. He showed that the ported box produced lower distortion if the design was right. Novak's design matched a highly damped woofer ( $Q$  between 0.3 and 0.4) with a box volume small enough for the compliance of the air inside to be lower than that of the cone's suspension. He specified that the best ratio of speaker compliance to box compliance was 0.707. His suggestion that there is an optimum volume for each speaker was contrary to an old rule of thumb for bass-reflex enclosures that said, "The bigger, the better."

About the same time Novak was developing his optimum-volume concept, Australian electrical engineer A. N. Thiele was assigned a speaker-design problem: specifically, to match a certain speaker to a dictated ported-box volume. Thiele wasn't satisfied with the performance he got from the combination, so as his deadline approached he finally did what many other engineers were doing—gave up on the ported enclosure and put the speaker into a closed box. But he continued to ponder why the reflex system hadn't worked right.

Later Thiele read Novak's paper, which included a mechanical equivalent circuit for a ported box with a speaker in it. Thiele, who had been designing filters for television systems, saw that Novak's equivalent circuit was identical in form to that of an electrical high-pass filter. He then applied network theory to the bass reflex and came up with a slightly different optimum enclosure volume. His analysis predicted that the ratio of speaker-to-box compliance should indeed be 0.707—but only when the driver  $Q$  is precisely 0.383. Then he developed a series of ported-box designs—which, borrowing a term from filter theory, he called "alignments"—each one requiring a different speaker  $Q$ . He showed that a highly damped driver should be used in boxes that are relatively small, while a less damped driver requires a much larger enclosure—larger at least in the acoustical sense: in compliance. (Enclosure compliance varies inversely with the square of cone area as well as directly with box volume.) Thiele named his various alignments after electrical filters whose low-end response characteristics they matched—filters named after those who formulated them: Butterworth and Chebyshev.

Thiele's data consist of twenty-eight separate alignments specifying a range of box volumes inconceivable for experimenters used to the older rules of thumb. The first nine alignments are simple speaker-in-a-box setups. These nine alone show box sizes that vary as much as 2,000%, even for speakers with identical cone area and compliance but different magnetic damping. A relatively minor increase in  $Q$ , say from 0.30 to 0.38, can double the required cubic volume.

Looking over a chart of Thiele alignments, it's easy to see why loudspeaker engineers of the 1960s disagreed about ported-box-speaker design. People who worked with systems of different  $Q$ s were groping at diverse parts of the reflex problem. With so many variables—driver cone area, compliance, and magnet size—there was no chance of a consensus without a set of general design principles.

Thiele published his paper on ported loudspeaker enclosures in Australia in 1962. It went virtually unnoticed until it was republished in an American technical journal about ten years later. Further work by Richard Small, Ray Newman (senior systems engineer at Electro-Voice), and D. B. Keele Jr. (then also at Electro-Voice) has added to the original information and made it more accessible. The net effect of this work is predictability. An engineer can change drivers and quickly calculate performance with the same certainty that one has about the French fries at a new McDonald's. If he wants to determine the effects of making the box smaller, he does it with a computer. The printout can tell him how much bass

range will be sacrificed along with the frequency and magnitude of the bass peak in the smaller-than-optimum box. This predictive function of the new approach is another sign that the ported box has been mastered—brought to order, reduced.

### Smaller Can Be Better

Thiele's work has permitted a reduction in the more usual sense of the word too. Early experience showed that the sound quality of large boxes was more acceptable than that of small ones. Experimenters found that making the box bigger was one way to load the dice—even if the design process was still a gamble. Now an engineer can turn the traditional procedure on its head: choose a box size that meets the demands of the market and then design (or select) a driver to give optimum performance in that box. Or, by using an auxiliary circuit, he can extend the range of his driver and at the same time compensate for one of the inherent weaknesses of the reflex, its habit of unloading the speaker at the lowest frequencies.

This could be the *pièce de résistance* of Thiele's contribution. The earliest bass-reflex drivers had relatively stiff cones, but as looser suspensions were used to lower the frequency of resonance—and with the development of more powerful amplifiers—speaker damage became a hazard. In a reflex system, the air in the port goes out of phase with the cone below the resonance frequency, moving in when the cone moves out. The air load on the cone is less than it would be in a sealed box at these frequencies, so any signal (such as turntable rumble) below resonance can drive the cone to incredible excursions. Some amplifier manufacturers try to protect the speaker by adding a low-frequency (often infrasonic) filter. If the cut-off frequency is suitably low (at, say, 20 Hz), it can insulate the speaker from infrasonic pulses without the loss of useful audio frequencies. Such filters can enable both the amplifier and speaker to perform at higher power with reduced distortion.

The Thiele approach is to use an equalizer that does this more effectively and does much more than protect the speaker. Equalizers are specified for Thiele alignments Nos. 10 to 28—alignments that produce speakers with dips or peaks in their response. In rough terms, the design procedure is to take one of the first nine alignments and tune the box about a half-octave below the normal optimum, producing a drooping bass response. Next, add an equalizer that boosts the curve down to the tuned frequency, flattening the response, and then cuts off sharply. Because the bass boost is applied in the frequency band where the port controls the cone, distortion is low. This combination can give solid bass with almost no cone surging. And it saves space.

A parallel development that can be used—with or without the equalized-bass approach—to keep enclosure sizes small without compromising bass response is what might be called artificially loaded ports. In exploring the various options open to him in tuning the woofer's properties and those of the enclosure to each other, the designer may find that, to encompass a sufficient mass of air, the port would need to be excessively large. Obviously it would not make much sense to whittle the box down to "bookshelf" size if the port requires a duct several yards long to tune it correctly.

The compliant mass at the port need not be all air, however. The alternative is to use what often is called a passive radiator—essentially an undriven speaker cone, often with considerable mass added to the diaphragm so that the total moving mass is equivalent to that of a much greater volume of air. It is perhaps unfortunate that such loading devices have been dubbed with exceedingly abstruse-sounding tradenames; there is nothing very mysterious about them, though they certainly have contributed materially to the "miracle" of good sound from small, well-engineered enclosures.

Some engineers and technicians still are skeptical of the Thiele data. They say that speakers are too complex and variable to be tied down by theory and mathematical formulas. The "too variable" objection can be met with careful quality control. If a cone suspension isn't dimensionally accurate, the voice coil may rest out of the region of maximum flux density—or far enough from the center of the field that it can be driven out. Such a speaker would have less magnetic damping—a higher *Q*—than was designed into it. It not only would have more distortion than expected, but would boom in the ported box that was designed for it. Yet if a closed-box speaker has a higher *Q* than that specified by the designer, it too can boom.

The thousands of engineers, technicians, and hobbyists who grappled for years with boom boxes can appreciate the contributions of Thiele, Small, Novak, Newman, Keele, and others to the understanding of the bass reflex. Some of them will surely feel—with Helmholtz—that "I was like a mountaineer who, not knowing his path, must climb slowly and laboriously, if forced to turn back frequently because his way is blocked. . . . Finally, when he reaches his goal, he finds to his embarrassment a royal road that would have permitted him easy access . . . if he had been clever enough to find the proper start." Now, more than a century after Helmholtz described his resonators and a half century after they were first used for a loudspeaker, engineers seem to have found the proper start. The potential advantages that vented systems have in efficiency, compactness, and, perhaps, cost are at last being realized. ●

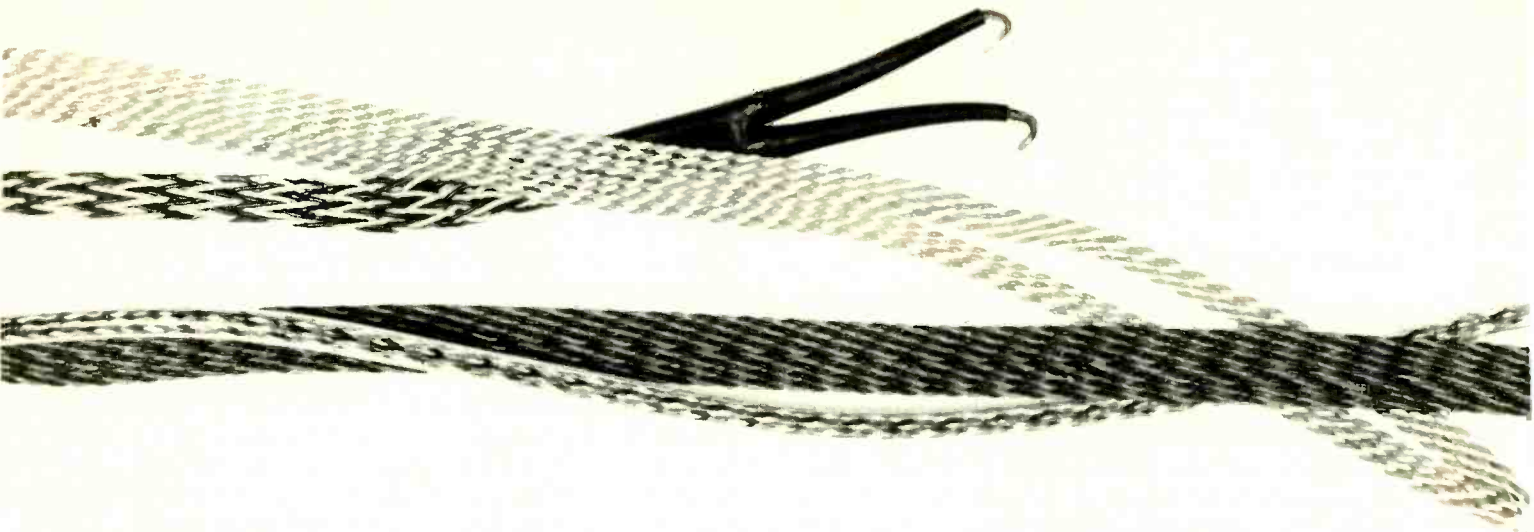

**O**NCE UPON A TIME "loudspeaker wire" meant plastic-jacketed two-conductor copper cable, 20 or 22 gauge, with one side marked to provide polarity identification. This cable has its advantages: It is cheap (dealers have been known to throw it in as a "freebie" if you buy a system), and it is relatively easy to conceal in a home installation. But it soon became apparent that wire this small with its total ("there and back") resistance of almost 0.1 ohm per meter could cause audible degradation of the sound coming from the speaker.

One way this tiny wire misbehaves is in reducing the damping factor of amplifiers appreciably. For example, an amplifier with a damping factor of 50 for an 8-ohm load would have an output impedance of 0.16 ohm. That means, electrically, that the output of the amp looks like a "perfect" generator feeding the loudspeaker through a 0.16-ohm impedance, which we will assume is a resistor. If the amp is connected to the speaker by 3 meters (a little over 9 feet) of 22-gauge cable, the resistance between the two is increased by 0.29 ohms, bringing the total to 0.45 ohm. The damping factor reduces to less than 18 and is now marginal, particularly since the designer of the speaker probably assumed an amplifier with an infinite damping factor (0 output impedance) in order to simplify his calculations. If the impedance of the amplifier output plus that of the cables exceeds this ideal by too much, the frequency response and transient response of the speaker may be adversely affected.

Another problem is that some power from the amplifier gets used up heating the cable rather than driving the speaker. Using the same 3-meter cable run, an amplifier driven hard enough to develop 100 watts—into an 8-ohm speaker with a direct connection—will deliver a hair less than 90 watts at the speaker end of the cable, for a loss of about 1 dB. This does not seem like a horrendous loss, and it is not. But if you were willing to put up

with it, you could have used a cheaper amp and better speaker cable and have the same power at lower overall cost—and with better speaker damping. Note that in our examples we are assuming a cable run of less than 10 feet, which is unrealistically short.

The obvious way to escape these difficulties is to use a heavier wire (that is, one with a lower gauge number), which offers inherently lower resistance. Accordingly, 16-gauge lamp cord—also known as "zip cord"—on the order of 0.024 ohm per meter (0.072 ohm for the 3-meter example we have been using), has come into general use. This wire size generally has been found to work very well for all but very long runs; for them, 14-gauge or even 12-gauge wire is preferable. The point is to keep the total resistance of the wire so low that the speaker won't notice.

That was the state of the art in wire until recently, when a few companies began to look at the effects of energy stored in the magnetic field surrounding the current-carrying conductors (their inductance) and the charge stored in the insulating material of the cable (its capacitance). Reasoning that the inductance, which is a form of impedance that increases in magnitude with frequency, might cause losses at the upper extremes of the audio range, manufacturers have set about reducing it. They purport to have done this by using cables specially designed for lower inductance and resistance, but at the expense of higher capacitance. In some cases, it has been suggested that these cables operate as transmission lines, much the way a length of 300-ohm antenna cable does—that is, a constant-impedance system that matches its termination impedance and will carry signals over long distances with minimum losses and reflections. The fact that a loudspeaker is a load whose impedance varies widely with frequency and therefore is an exceedingly poor termination for such a line is only one of the reasons

# Exotic Speaker Cables: Cure with No Disease?

by Harold A. Rodgers



we find this idea naive. But whatever the theory underlying their operation, these new "supercables" have attracted a good deal of attention—and our curiosity.

We arranged for Diversified Science Laboratories to conduct a four-way supercable shootout among three of the new "high performance" types and plain old 16-gauge wire. Each was measured for resistance, inductance, and capacitance. Then each was used to feed a high-frequency square wave to an 8-ohm resistor and later to a loudspeaker. In addition, each cable was judged for listening quality with a set of speakers.

The measurement data show that, if reduction of inductance is a goal for any of these cables, none has succeeded. The inductance per unit of length falls within a few percent for two of the special wires and the 16-gauge cable: the figure for the remaining high-performance type is roughly double those for the other three. In resistance per unit of length, two measured lower than 16-gauge cable (one being very close), and one much higher than the other three. One cable showed an extremely high capacitance, two of them moderate amounts: 16-gauge wire was, as expected, the lowest by far.

Feeding an 8-ohm resistor and driven by a 10-kHz square wave, all of the test cables except one showed some ringing, but this was determined to be at a frequency in the region of 5 MHz. Delivering the same signal to a loudspeaker, all four showed an output with a slight saddleback appearance. When the test signal was changed to music and was evaluated by listening, there was no discernible difference among the four.

Using the measured data, the lab calculated characteristic impedance as a double check on the possibility of transmission-line operation. Three of the cables, including the 16-gauge wire, were completely out of the ballpark. The fourth was not too far off, but as we pointed out earlier, any real

loudspeaker is virtually certain to mismatch it over most of the audio band. Besides that, the wavelength of a 20-kHz tone is about 15 kilometers (say, 9½ miles); the length of any credible run of speaker leads is negligible by comparison, making the use of a true transmission line a waste of time.

Yet that is what these high-performance cables are, in our opinion. What one accomplishes by using them, essentially, is to load the amplifier with additional capacitance—a factor that may be problematic, since specific amounts of capacitance applied to power-amp outputs have been known to cause instability and oscillation. Dire happenings are not too likely, but there are recorded cases of amplifiers self-destructing while connected to exotic wires such as these.

The lab suggests that, if there are any points of superiority among the special cables, they are of use only if you can hear 100 kHz or so and want it reproduced cleanly, in which case, finding program material will be a problem. But more important, to our way of thinking, the tests have vindicated the lowly two-conductor zip cord that has served so well and seems capable of continuing to do so. If you want to spend money on your system—the exotic cables go for up to \$1.00 or \$1.25 per foot—you will do best to put it where it can be heard. Garden-variety speaker wire at 8 to 15 cents per foot seems as good as any you can get—as long as it is heavy enough.

How heavy is heavy enough? Assuming an amplifier damping factor of 40 for an 8-ohm load, an 8-ohm speaker could be connected at the end of a 25-foot run of 16 gauge, a 40-foot run of 14 gauge, or a 60-foot run of 12 gauge with good results. Using an amplifier with a damping factor of 100 or better would double the permissible distances: using a 4-ohm speaker would cut them in half. With these figures in mind, you can easily decide what gauge best suits your system and the dimensions of your room or residence. ●

# Bernard Jacobson On Conducting



Felix Weingartner conducting the Vienna Philharmonic Orchestra

Bernard Jacobson, a former *HF* contributing editor, has completed a book of interviews, *Conductors on Conducting*, scheduled for publication by Columbia Publishing Company, Inc., early next year. This article is an adaptation of the introduction to that book.

SINCE ITS SHADY ORIGINS about 700 years ago, the history of conducting falls into three periods. The first and third of these, though utterly different in spirit for reasons we will consider in a moment, are linked by the common presence of the man waving the little stick, or something like it—or, at the very least, his hand. In between, from some time in the seventeenth century until the early part of the nineteenth, came an interregnum when the baton-wielder handed his coordinating function over to a keyboard player (the *Kapellmeister* or *maestro al cembale*), to a string player (most commonly the first violinist, or concertmaster), or more usually to a kind of freely interacting committee of the two.

Between the thirteenth century, when writers like Elias Salomonis (in his *Scientia artis musicae*) set down the earliest accounts of conducting practice, and the seventeenth the human voice played a central—often the central—role in musical life. So it is not surprising

that Salomonis and other theorists of the time always specified or assumed that the conducting would be done by one of the singers. In Salomonis' description, the conductor "beats time on the book with his hand and gives the cues and rests to the singers. If one of them sings incorrectly, he whispers in his ear, 'You are too loud, too soft, your tones are wrong,' as the case may be, but so that the others do not hear it. Sometimes he must support them with his own voice if he observes that they are lost."

However it was done, time-beating was certainly regarded as a normal practice before the fifteenth century was out. Contemporary pictures and written accounts attest to the frequent use of a stick or a roll of paper, called a "sol-fa." Often, as even the earliest pictures show, the baton became quite a formidable affair. To make things easier for his players and singers, the conductor could use a long stick to render his beat audible as well as visible. The disadvantages of this practice came drastically home to Lully in 1687: Thumping his stick on the floor during the performance of a *Te Deum* to celebrate Louis XIV's recovery from illness, the celebrated composer/conductor accidentally hit his foot, and the abscess that resulted led first to gangrene and then to his death. Less dramatically, Jean-Jacques

Copyright © 1978 by Bernard Jacobson. Adapted by permission of the book publisher.



Rousseau in his 1767 *Dictionnaire de musique* complained still about the "insufferable noise" made by conductors in banging the baton against a desk.

But more than 100 years before that, changes were already on the way. As Renaissance styles had given way to baroque, instruments took on a new independence, and musical texture came to be dominated by the thorough bass, or *basso continuo*—essentially a form of shorthand that enabled a keyboard instrument to extemporize inner parts from a text that showed only the bottom line. At the same time the coordinating role passed naturally enough to the new breed of player: to the virtuoso violinist/composers of the late seventeenth century, like Biber in Austria and Corelli in Italy, and their successors (above all, Vivaldi) or to the keyboard players, among them Handel and Bach, who presided at a harpsichord placed at the physical center of the ensemble.

It was still the rule, we must remember, for composers to be involved in most performances themselves. Taste had not yet turned its back on the contemporary, and the bulk of the music to be heard was new. But whatever eminence and authority either a violinist or a harpsichordist might possess, he would still normally divide the responsibility of preparing and guiding the performance with his colleague. As late as the 1790s, Haydn, seated at one of those newfangled pianos that were all the rage in England, shared the direction of his famous London concerts with Johann Peter Salomon, the enterprising violinist and impresario who had invited him to the city and thus provided him with the stimulus to compose the twelve great "London" symphonies.

What is perhaps surprising musically—though not psychologically, since power is something few like to give up once they possess it—is that the practice of divided leadership hung on as long as it did. During the second half of the eighteenth century, as the orchestra moved toward a more standardized makeup in which rapidly improving wind instruments played an increasingly integral part, composers took to writing their music down with all the harmonies complete instead of leaving much of the texture to the performers' inspiration of the moment. The continuo, in consequence, became unnecessary. It is hard to imagine what Haydn's harpsichord or piano could usefully have added to his supremely finished orchestral scores of the 1780s and 1790s, and only the most self-consciously stylish of modern performances use a keyboard instrument for these works—yet Haydn went on leading that way. Johann Forkel relates in the 1789 volume of his *Musikalischer Almanach für Deutschland* that the previous year there was a Viennese performance of a cantata by C. P. E. Bach in which "Kapellmeister Herr Mozart beat time and had the score." (The far more common practice, surviving into the nineteenth century, was for conducting to be done from either the bass or the violin part.) But on this occasion there was still another Kapellmeister, Umlauf, making his own contribution from the keyboard. Two decades into the nineteenth century, in the time of Beethoven's late maturity, there were still keyboard conductors around to provoke complaints of impracticality and anachronism from Spohr and Moscheles.

Nor did the violinists yield their prerogatives without a struggle. In 1847, after the first London performance of Mendelssohn's *Elijah*, which the composer himself con-

ducted with a baton, the critic for the *London Times* complained of a concertmaster who "was constantly beating time with his fiddlestick in such a manner as to obstruct the view of the Conductor and to confuse the attention of the instrumentalists." And away from the major musical centers the practice was even longer in dying, as witness the Leeds organist William Spark's memoirs of the city's musical life as late as the 1880s.

Though they could still precipitate an occasional skirmish, the instrumentalists were losing the battle against the baton. In Berlin in 1776, when he took over the post of Kapellmeister to Frederick the Great, Johann Friedrich Reichardt dispensed with the conventional keyboard and led his ensemble from a separate desk that served purely for conducting. Several contemporary accounts afford a vivid picture of Beethoven standing at a similar desk, almost disappearing beneath it when he wanted to coax a pianissimo from the players and leaping in the air for a forte. Gasparo Spontini, nearly forgotten today as a composer, set a new level of discipline and vigor with the comprehensiveness of his one-man rule as a conductor of opera (mainly Italian) in Berlin between 1820 and 1841, and François Antoine Habeneck, more by dint of conscientious rehearsal than through the possession of any remarkable flair, made a comparable contribution in the orchestral sphere with the concert society he founded at the Paris Conservatoire in 1828 and led for twenty years.

Being essentially an interpretive musician, and only in a very minor way a composer, Habeneck pointed some way into the future. Conductors up to his time had always been distinguished composers too. Besides Beethoven, the most recent instance had been Weber, whose contribution to the conducting of opera was almost as important as that to its composition. For several years more, the central figures in the development of the art were four of the leading composers of the period: Berlioz, Mendelssohn, Liszt, and Wagner.

Mendelssohn, noted by his contemporaries for the polish of his performances as well as for his penchant for fast tempos, brought a new care and balance to the often neglected art of program-building. He took particular trouble to seek out neglected works, giving the first "modern" performance of Bach's *St. Matthew Passion* in 1829 and, ten years later, the first performance ever of Schubert's Ninth Symphony. It was Mendelssohn, too, whose conductorship of the Leipzig Gewandhaus con-



J. B. Lully wielding the lethal stick



Berlioz leading his forces

certs from 1835 on gave Germany its first orchestra to rival the standards of performance for which Habeneck had made Paris famous.

Berlioz and Wagner seem to have been the two most magnetic and exciting conductors of their age. The effect of their writings has also been deep and long-lasting. Berlioz' essay on conducting at the end of his still-used orchestration manual codified the physical specifics of the conductor's beat with unprecedented clarity and common sense, going on to offer suggestions for subdividing the beat and admirably practical hints on many problems of performance. Wagner's main theoretical contributions lay in his exposition of two principles that, as a practical conductor, he shared with Liszt: the need to derive the beat not from the mathematical divisions of the measure, but from the melos—the line of the music considered in all its aspects; and the importance of allowing tempo to respond to the changing expressive modes of the composition.

It was with the next two generations that the purely executant conductor in the Habeneck mold came into his own. From Hans von Bülow, who was born in 1830, by way of Hermann Levi, Hans Richter, and Anton Seidl to Felix Mottl, born in 1856, many leaders of the new school were Wagner disciples. Others—like the German-born Theodore Thomas, who did much to educate American musical taste and who founded the Chicago Symphony Orchestra in 1891, and the Hungarian Arthur Nikisch—developed far from Bayreuth but did pioneering work in the performance of Wagner's music. With Karl Muck, born in Darmstadt in 1859 and conductor of the Boston Symphony Orchestra between 1906 and 1918, and Felix Weingartner, born in the Dalmatian town of Zara in 1863 and a dominant figure in Europe for half a century, came a strong and often conscious reaction against the "excesses" of the Wagnerian school of tempo modification.

Weingartner, like his German successors Otto Klemperer and Wilhelm Furtwängler, regarded himself as composer first and conductor second. With only two clear exceptions, Mahler and Richard Strauss, and a handful of in-between ones like Antal Dorati, Jean Martinon, Leonard Bernstein, Bruno Maderna, Pierre Boulez, and André Previn (and, one is tempted to add, Leopold Stokowski), most conductors since then, of whatever interpretive school, have concentrated on performing to the virtual exclusion of composing.

The change from all-rounder to specialist performer followed naturally and necessarily from nineteenth-century developments in musical language and practice. For one thing, the performing apparatus was becoming so large and scores were correspondingly so complex that their mastery called for long and rigorous application of the conductor's mind—and often, for the sort of mind not necessarily well adapted to the more directly creative process of composition. But the shift was not only in scale: It was a transformation also of attitude and atmosphere. With the Romantic movement, the picture of the artist as someone doing, like anyone else, useful work for society gave way to the image of the lonely creator in his (preferably squalid) garret, fated to be understood only by posterity. The purely personal results of this change, embryonic in the more self-absorbed moments of a man like Beethoven, reached probably their highest point of unpleasantness in the egocentricity of Wagner. But there were consequences on the musical side too. Composers gradually narrowed the area of creative responsibility they shared with performers and sought instead to be ever more specific in fixing their detailed intentions on the written page, to the point where, as James Levine put it, a Mahler score becomes "a conductor's road map."

Though a great deal of conducting was done before the days of Berlioz and Wagner, there are important senses in which Serge Koussevitzky's assertion that "orchestral conducting was born at the end of the nineteenth century and really flourished only in our time" is true. Technically, musicians before the nineteenth century, disposing of less complicated performing forces and of instruments and instrumental techniques that had a much narrower expressive range, were (like their audiences) far less demanding in the matter of precision. It is true that Lully, lordling it over the French musical establishment of the mid-seventeenth century, and Gluck, in the Paris of 100 years later, were prototypes of the latter-day martinet conductor. But outside Paris, and at various times perhaps two or three other centers, the standards of orchestral execution and ensemble demanded by such men were unknown. Recordings and radio did not yet exist to disseminate these exceptional values far from the centers where they were pursued, and even for a well-schooled musician, finding himself for the first time in, say, late-eighteenth-century Mannheim, the experience of hearing an orchestra play really brilliantly, responsively, and together must have been a revelation—as, indeed, the thoroughly knowledgeable Charles Burney's account of his visit there in 1772 shows that it was.

The general feeling of technical *laissez-faire* depended, moreover, on something deeper. In an interpretive sense, while autocratic composer/conductors like Gluck did exercise a "minute care and solicitude for the utmost faithfulness to the original score" beside which, as Paul Henry Lang puts it in *Music in Western*

Civilization, "the legends that circulate about the tyrannical requirements of Toscanini pale." Gluck and his kind were exceptional as much in what they wanted as in their ability to get it. The notion of an ideal interpretation, which is never possible to reach, but which is somehow always in mind, was essentially a nineteenth-century innovation. Paradoxically, it follows that any conscious modern approach to a genuine baroque (or earlier) style—whether along the consciously empirical, eclectic lines represented by a gifted individualist like Charles Mackerras, or through efforts like those of Nikolaus Harnoncourt to re-create the original sound as nearly as possible—is itself bound, in essence, to be inauthentic. Even if we leave aside the red, if tasty, herrings of commentators like Donald Tovey (who slyly observed that a *truly* authentic performance of a Bach cantata would have to be marked by consistently bad intonation and followed by beating the choirboys), there can be little doubt that the very concept of "fidelity to the composer's intentions" was foreign to most eighteenth-century musical minds, and that the related impulse to "re-create" the conditions of a past musical age would have been greeted by them with a similarly robust incomprehension.

But if performers and composers before the nineteenth century were largely innocent of the notion of authenticity, at least two awkward questions face the interpreter in our own time. One of them extends the paradox implicit in the conscious imposition of *laissez-faire* to the musical practice of all periods: Performance practice can be judged by the criterion of taste—but how is taste itself to be evaluated? After all, in Mozart's day, or Rameau's, or Handel's, audiences talked a good deal, and composers were unsurprised, and often unbothered, by the habit. Does this mean that, in essaying the "faithful" presentation of their music, we must rush about our concert halls enjoining inattention—for all the world like Erik Satie crying, "*Parlez, parlez!*", in his Parisian theater lobby when the public frustrated the very purpose of his *musique d'ameublement* ("furniture music") by politely listening instead of talking through it, as was the usual practice? Or more self-confidently, should we conclude that, in this matter, at any rate, we have reached a loftier stage of musical culture and act on the conclusion? There is evidence that, for all or most of the nineteenth century, second and third presentations of the same thematic material were taken progressively faster than its initial statement. Does this mean that we must follow a practice that may well seem to us haphazard and disruptive, or should we, again,

fearlessly adopt a different—and, in twentieth-century eyes, "higher"—principle of formal unity?

Authenticity is, indeed, a complex concept, and the saddest aspect of most contemporary critical comment on the supposed dichotomy between "subjective" and "objective" styles of interpretation is its failure to grapple with—or even apparently to notice—the paradox. This is most damagingly the case in much discussion of nineteenth-century music in twentieth-century performance. For the other difficult question a modern conductor has to tackle is: How far must the old *laissez-faire* approach be discounted in performing music of the nineteenth century and later? In this area, it seems to me, justice has seldom or never been rendered to the evidence.

Granted the important qualification about the "ideal" interpretation kept always in the composer's and performer's minds, contemporary accounts overwhelmingly discredit the view that, as the eighteenth century passed into the nineteenth, a long-established tradition of interpretive freedom suddenly disappeared. Certainly performers were increasingly seen as servants of the newly exigent composers' ideas. But a servant is not a slave, and almost all nineteenth-century comment suggests that a composer of the period would have been profoundly dissatisfied with a performance that did not give some rein to the interpreter's feelings, judgment, and taste.

The opposite view does occasionally surface, as in one or two descriptions of Berlioz' conducting and in Verdi's tart remark, "I do not allow either singers or conductors to *create*." However, most of the exceptions are no more than apparent. Weingartner and, in his later years, Richard Strauss are commonly represented as apostles of the "objective" school, especially in regard to their supposed rejection of tempo modification along Wagnerian lines. Yet the very words Weingartner used to castigate the Wagner school as Bülow personified it—"Where a modification of the tempo was necessary to get expressive phrasing, it happened that, in order to make this modification quite clear to his hearers, he *exaggerated* it"—show that he rejected not the principle of modification, but only its injudicious application. The same is true of Strauss's recommendation: "Any modification of tempo made necessary by the character of the piece should be carried out imperceptibly, so that the unity of tempo remains intact."

The emphasis differs. But the assumption underlying these words in no way contradicts Weber's formulation of the point: "There is no slow tempo without passages



Mahler on the podium

The Bettmann Archive



Culver Pictures



The Toscanini technique

that demand a quicker motion to avoid any impression of dragging. And there is no presto that does not demand, in contrast, a quieter delivery of certain parts, so as not to impede the means of expression with too much zeal." Beethoven, even in providing a metronome marking for his song "Nord oder Süd," immediately qualified it—"But this must be applicable only to the first measures. for feeling also has its tempo, and this cannot be entirely expressed in this figure." And his pupil Anton Schindler's description of a rehearsal of the Second Symphony, where Beethoven required eight "bendings" of tempo within twenty measures of the slow movement, is one of several accounts that confirm the composer/performer's extreme elasticity of time. Where Weingartner and Strauss are concerned, we possess still more concrete evidence, in the shape of old recordings, to explode any remaining notion that these conductors eschewed modification of tempo.

The amusing—or, depending on one's viewpoint, reassuring—thing is that, even when they think they are being most strict, consciously "objective" conductors with true musical gifts cannot help yielding in some degree to the urge toward expressive freedom they theoretically disapprove of. Bernard Shore, leader of the orchestral violas when Arturo Toscanini rehearsed and performed Beethoven's *Pastoral* Symphony in London during the 1930s, relates in his book *Sixteen Symphonies* how the conductor insisted at the start of the first movement: "The violins, in time, no *ritenuto*, no *ritenuto* to the pause!" Yet, on disc (and he recorded the work more than once), Toscanini never succeeded in giving that opening phrase without a breath of tempo relaxation in the third measure. Try as he thought he should, he was unable to deny the music's nature—and his own. Fortunately for those of us whose delight it is to hear them at work, if conductors are not slaves, they are not machines either. The tension between Toscanini's dogmatic opinions about music and his ultimately uncrushable feeling for it may or may not lead to certain conclusions about the total artistic value of his work.

But what is more relevant here is the evident parallel between that tension, in the interpretive sphere, and the contradiction between the theory and the practice of a

composer like Stravinsky: If music is, as he claimed, "by its very nature, powerless to express anything at all, whether a feeling, an attitude of mind, a psychological mood, a phenomenon of nature, etc.," then what is the direction *espressivo* doing in his scores? And it was the prescriptive Stravinsky who observed, "The metronome mark's only a beginning," just as the more "romantically" oriented Sibelius remarked to Sir Adrian Boult, "If ever your musical instinct wants you to do something different from my markings, please obey your instinct."

These points all illustrate the thorny, treacherous nature of any judgments about the opposition of objective and subjective approaches. No facile distinction can be drawn between the two. Everywhere, paradox lies in wait to trip the unwary critic. Almost all composers have plainly taken it for granted that the score can never fully represent the work—"the most important element in music," as Mahler put it, "is not to be found in the notes"—and that some creative contribution must accordingly be made by the performer, even if that contribution amounts to no more than an attempt to bridge the gap between cold print and the original inspiration. In that context, what the "objectivists" have forgotten is that an attempt to render the score, and no more than the score, implies a subtraction from the composer's idea that can be just as damaging as any so-called subjective addition. George Szell, as quoted by Harold Schonberg in his book *The Great Conductors*, observed that Toscanini "wiped out the arbitrariness of the post-Romantic interpreters" and "did away with the meretricious tricks and the thick encrustation of the interpretive nuances that had been piling up for decades." No doubt meretriciousness was obtruding in some quarters, and it may well have been time for a swing of the pendulum.

In recent years, after a few decades dominated by the Toscanini approach, a new generation of conductors has begun to explore again the difficult but rewarding ground of interpretive flexibility. In particular, Daniel Barenboim, a self-avowed disciple of Furtwängler's, has turned to fresh and powerful effect the re-evaluated principles of modification and of a rhythmic treatment

that emphasizes the broader melos rather than the individual beat. In some recent recordings, he has also reintroduced string portamento—that expressive glide usually up to a note, which was an accepted interpretive resource during the nineteenth century. It is entertaining to observe the mental gymnastics of critics unable to deny the musical conviction of the results, as they strive to reconcile their satisfaction with years of adherence to the school of strict tempo and no portamento.

Cutting and retouching are two other areas of conductorial activity where categorical judgment is elusive. Among composers, Schoenberg put the case against cutting as well as it ever has been in a letter written in 1918 to Alexander von Zemlinsky: "Brevity and succinctness are a matter of exposition. . . . A work that has been shortened by cutting may very well give the impression of being an excessively long work (because of the exposition) that is too short in various places (where it has been cut)." A century earlier, Berlioz castigated Habeneck for "correcting Beethoven by suppressing an entire repeat" in the finale of the Fifth Symphony, thus throwing baleful light on the view held by many performers today that by Beethoven's time, let alone Berlioz', repeats were merely a matter of convention whose observation was happily left to the interpreter's discretion.

Yet here again we must tread carefully. The purist view is fairly held, provided we admit once more that holding it is a partly subjective decision. For practice has always varied on such points. Berlioz did not hesitate to conduct programs that included isolated movements from the same Beethoven symphony—and, indeed, from his own works. The famous story about the 1806 premiere of Beethoven's Violin Concerto, in which the soloist, Franz Clement, is said to have played a piece of his own (with the violin upside down!) between movements, may be apocryphal. But it is clear that, at the time, the integrity of the work as a whole was a novel and still fragile concept. Interpolations were no less common than omissions in Mozart's time, as they had been in Handel's. Bülow regarded Wagner's wholesale revamping of Mozart's *Don Giovanni* not as desecration, but as the sincere practical expression of one master's admiration for another's work. As for abbreviations of the more conventional and less ambitious kind, the supposed literalist Weingartner considered "judicious cutting an artistic duty that greatly enhances the aesthetic pleasure to be obtained."

At least as far as their own work is concerned, composers since the middle of the nineteenth century have been more or less unanimous in deploring cuts. But whatever we consider ought to happen, it would be a mistake to believe that cutting is unknown in contemporary practice. Another literalist, Szell, used inferior (and cut) editions of Bruckner symphonies on the explicit ground that Bruckner was a composer of less than infallible judgment who needed help, and he cut a substantial passage in the finale of Bartók's *Concerto for Orchestra* with the somewhat sketchy justification that the composer had asked his advice on the scoring. Twentieth-century French conductors traditionally make a small cut in the Berlioz Requiem. Jean Martinon used to excise several pages from the slow movement of the *Symphonie fantastique*. Asked about this cut after a Chicago performance in the late 1960s, he conceded that he had accepted it without question from Charles Munch, and by the time he recorded the work

near the end of his life he had restored the disputed passage. Sir Thomas Beecham, admired Mozartean as he was, inflicted cuts of the most arbitrary kind even on such a masterpiece as the *Sinfonia Concertante*, K. 364.

Beecham again comes readily to mind on the still more difficult question of retouched orchestration. "The entire work has been reorchestrated by me," was his bland and unblushing final thrust in introducing the recording he made, late in life, of something resembling Handel's *Solomon*. (The same performance caused last-minute problems for the record company concerned; it was discovered only a week or two before its release that the scene chosen for illustration on the front of the box had been omitted in Beecham's romp through the work, and a hasty substitution had to be made.) But Beecham's thorough transformation of Handel's orchestral sound does not differ in attitude—though it may in subtlety of execution—from Mozart's in composing new accompaniments for *Messiah* to suit the taste and conventions of his own time.

What makes the question of retouching a more equivocal problem than that of cutting is that, instead of the potentially fixed element of a work's composed proportions, we are here dealing with aspects of performance that are subject to inevitable change. Instruments themselves change. So do playing techniques, and so, for that matter, do halls, which are almost all bigger now than they were before 1800. To some extent it is possible to reverse those changes, and groups like Harnoncourt's Vienna Concentus Musicus have demonstrated vividly that a return to old instruments, old playing techniques, and old pitch—for eighteenth-century music, often a semitone or more below standard modern pitch—can have a revelatory effect in the performance of music written before 1850.

At the same time it is wise to remember, again, that changes of instrumentation were not even considered matter for comment before the classical period. The celebrated Concerto in A minor for four harpsichords attributed to Bach is not his at all, but simply an arrangement of Vivaldi's B minor Concerto, Op. 3, No. 10, for four violins. And when we come to Beethoven, and a problem passage like the transition phrase in the first movement of the Fifth Symphony (which, heard first on horns in the exposition, sounds almost comically absurd transferred to bassoons in the recapitulation), the conclusion of the retouchers may well be the one more truly faithful to the spirit of the work. We can be reasonably sure that Beethoven would have written the passage for horns again on its second appearance if they had been able to play it; thus, now that horns have valves that enable them to play in all keys, the sensible course is to transfer the recapitulation's phrase to them and avoid bathos. At any rate, conductors of all schools—those associated with interpretive freedom, like Wagner, Mahler, Nikisch, and Furtwängler, and those more literally inclined, like Weingartner, Toscanini, Ernest Ansermet, and Colin Davis—have at various times either declared themselves in favor of the principle of limited retouching or, in their performances, acted on it.

In truth, there are no simple answers to the stylistic problems of conducting. Whether the question is one of tempo, phrasing, instrumental execution, orchestration, or fidelity to form, individual judgments always have to be made. What they must rest on is knowledge of the style of a period and of the composer in question. ●

# Koussevitzky's "Grandchildren"



Seiji Ozawa

"IT HAS OFTEN OCCURRED to me how much all of us conductors are like the mentors to whom we were apprenticed. Ideas, methods, and podium manner so reflect those of our masters that one shudders to think how much we are like our *masters' masters*." Thus wrote one conductor to us as we were preparing this feature. And whatever form a mentor's influence on his student takes—reflection of or reaction against—no one has had a greater impact on the current international crop of conductors than Serge Koussevitzky (1874–1951), music director of the Boston Symphony from 1924 to 1949.

Through Tanglewood—and by this we mean the Berkshire Music Center, the school Koussevitzky founded in 1940 and to which he was zealously devoted, rather than the Berkshire Music Festival—his influence has spread worldwide. Koussevitzky's "children," as he liked to call his students, and now his "grandchildren" (and even some "great-grandchildren") direct ensembles from Australia to Wales, from three of the "Big Five" U.S. orchestras to Europe's most revered opera house.

The accompanying musical genealogy stems

Nilsson



Koussevitzky with his conducting student Eleazar de Carvalho in 1948. At right, two other "children" prepare for a 1944 performance of Ravel's Piano Concerto at New York's Lewisohn Stadium: soloist Leonard Bernstein and conductor Lukas Foss.



Lorin Maazel



Claudio Abbado



Zubin Mehta



Christoph von Dohnányi



Edo de Waart

from replies to questionnaires we sent to all the conductors listed in the MUSICAL AMERICA DIRECTORY OF THE PERFORMING ARTS, from an examination of the class lists at the BMC during the eras in which Koussevitzky or his protégés taught conducting, and from a list of New York Philharmonic assistants to Leonard Bernstein, Koussevitzky's most prominent pupil.

In the summers of 1940 and 1941, Koussevitzky worked with a handful of students at Tanglewood, while a larger class of "auditors" studied with other teachers. The BMC was active in 1942, but without a conducting class, and it closed down completely during the remaining war years. In the summer of 1946 the school began operations again, now with the "active" conducting students generally limited to three and the auditors under the guidance of Bernstein, one of the prewar actives. After Koussevitzky's death just before the 1951 season, Bernstein took over the entire program for the next five years (except for a leave of absence in 1954), assisted by such other Koussevitzky disciples as Seymour Lipkin and Eleazar de Carvalho. In 1956, Carvalho became head of the conducting department and served until 1963. That summer, the new BSO conductor, Erich Leinsdorf, decided to teach the class himself (something his predecessor, Charles Munch, like the incumbent, Seiji Ozawa, forbore to do), and the immediate Koussevitzky era at Tanglewood came to a close. After a year's absence, however, Bernstein began to return for part of almost every summer, and while he was there he held classes for the conducting students.

We have therefore limited the genealogy to the prewar active conducting students, the postwar active and auditor conducting students through 1962, omitting 1954, and those conducting students who attended Bernstein's classes since 1964. We omitted those conductors who, in the questionnaires they returned, acknowledged Koussevitzky as a major professional influence solely on the

basis of having performed in orchestras under him or his pupils.

We did, however, include assistant conductors, most prominently all those apprentices whom Bernstein accepted—generally three per year—from 1959 through 1971 (except for a 1964 sabbatical) when he was with the New York Philharmonic. Beginning in 1963, Bernstein's assistants were winners of the Dimitri Mitropoulos Competition, sponsored by the Federation of Jewish Philanthropies, and worked with Bernstein in a relationship similar to his own with Koussevitzky. For example, Ozawa, who actually studied under Carvalho at Tanglewood but was a Philharmonic assistant in 1961, was quoted by Herbert Kupferberg, in his book *Tanglewood*, as saying that "Koussevitzky was big poppa to Lenny, and Lenny was big poppa to me."

For reasons of simplicity, and because the chart is intended to show merely the Koussevitzky relationship, only one master-disciple connection is indicated, the teacher-pupil relationship (a solid line) usually taking precedence over the conductor-assistant relationship (a dotted line). That is why, for instance, Ozawa appears only as a pupil of Carvalho's and not as an assistant to Bernstein. (Some of the relationships are quite complex: Lipkin, besides being a Koussevitzky student, was a Philharmonic assistant under Bernstein and taught some of the same students as Bernstein and Carvalho, a few of whom later became assistants to still other conductors on the chart.)

In this age of jet-assisted multiple positions, many conductors have responsibilities with musical organizations around the world. We have generally noted extra positions only where the Koussevitzky influence is thereby shown to be at work in an additional geographic area. And, finally, we have limited the list to those conductors who either direct their own orchestras, who have made notable recordings, or who have otherwise come prominently to our attention.

(overleaf)

# The Koussevitzky Genealogy

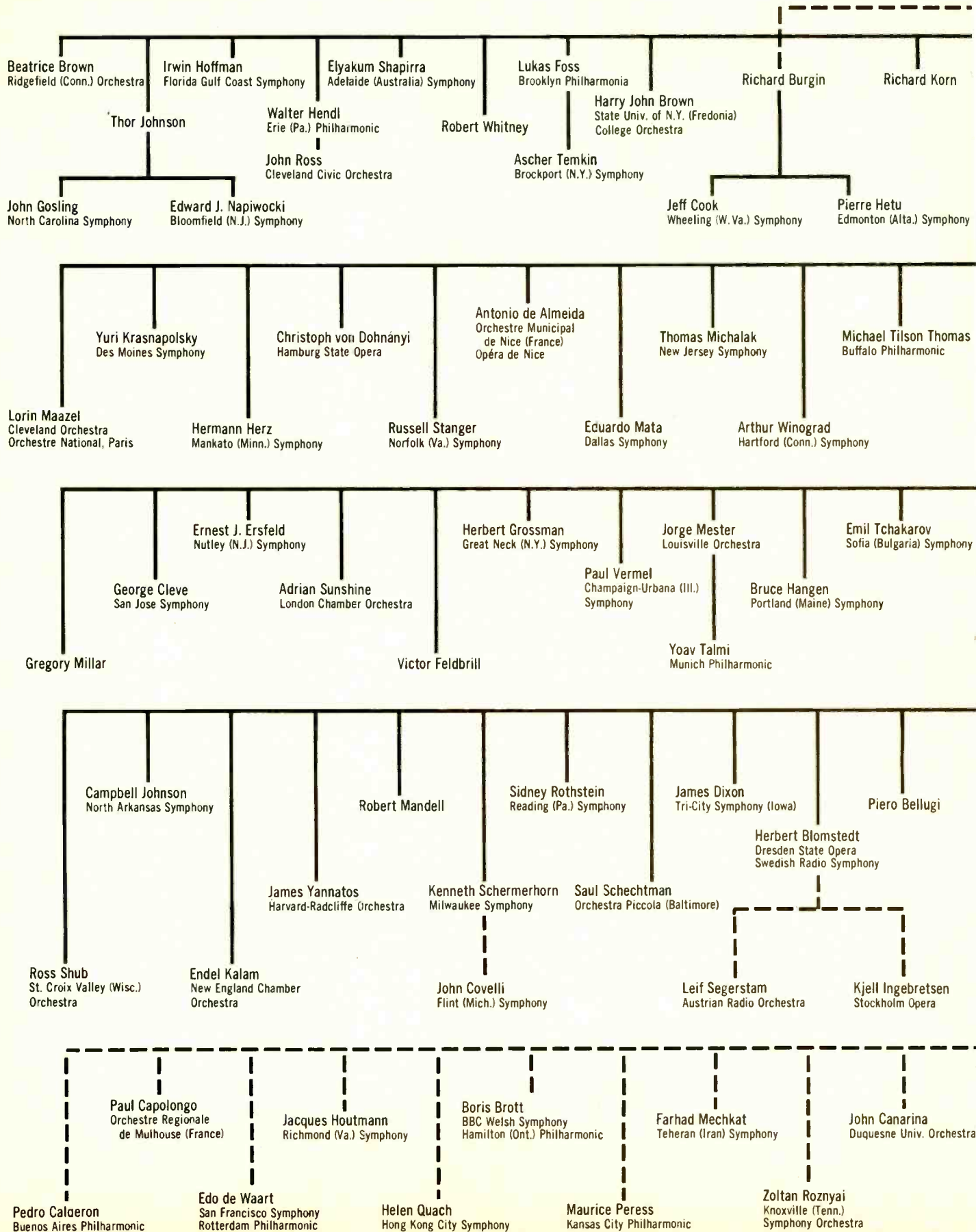



Prepared by Jean E. Mercier

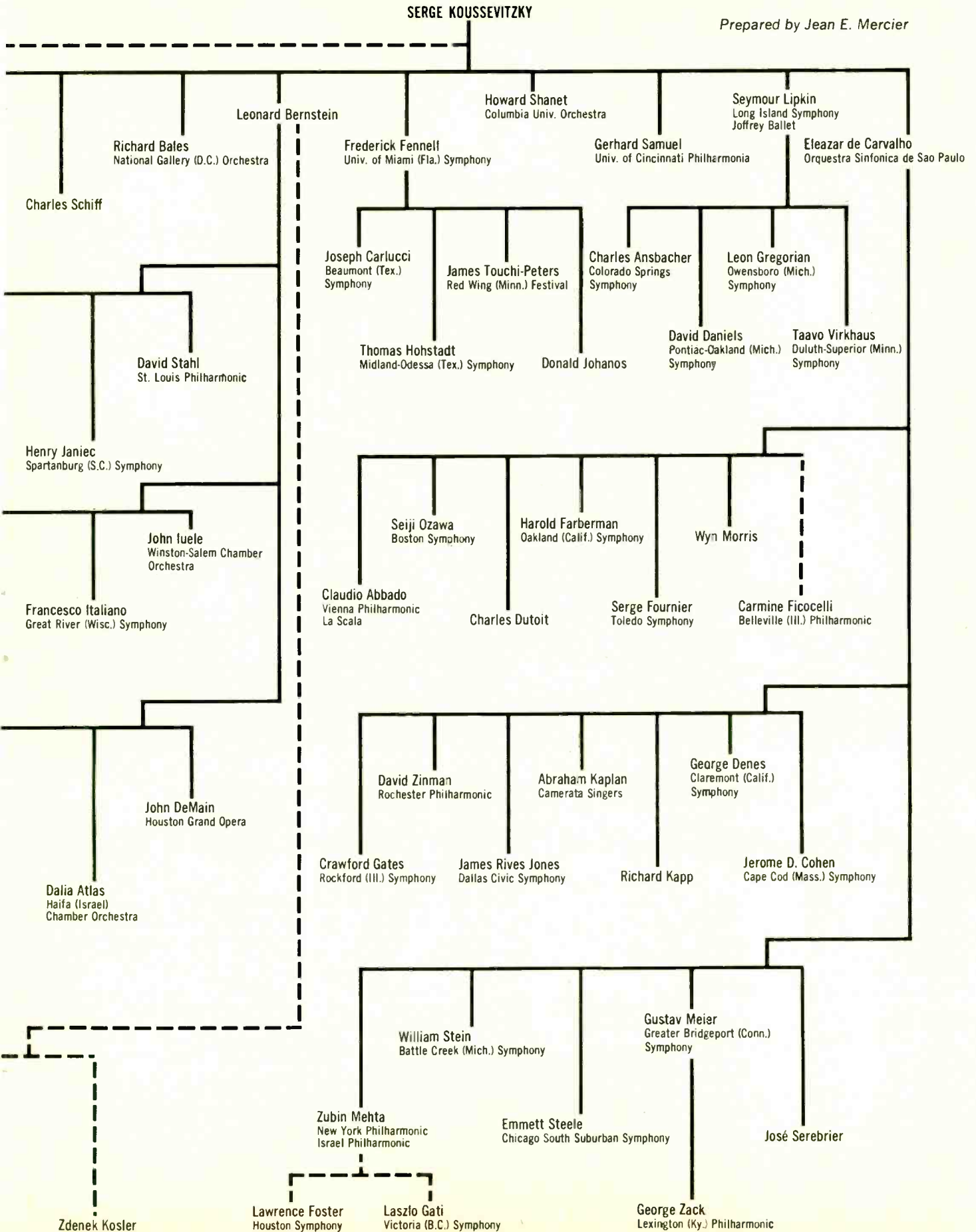



# With BASF you can fill a room with sounds you never heard before.

## **Sensitive Sound.**

Using an anechoic chamber, the finest sound equipment available, and the most sensitive tape ever made, we were able to capture the sound of the wingbeats of a butterfly in flight... a sound similar to that of a great bird of prey.

## **More sensitivity for more music.**

It is a startling demonstration of the sensitivity of our New Professional Series Cassettes. You get more headroom, greater dynamic range, a better signal-to-noise ratio and unheard of sensitivity. And that's why you hear music the way you have never heard it before on cassette.

## **Sounds of other worlds.**

Visit your BASF dealer soon and ask him about the New Professional Series, including Professional I, our new ferric formulation, Professional II, our new second generation chrome formulation, and Professional III, our new ferrichrome formulation that is ideal for auto cassette players.

If you would like to discover the sounds of an ant in distress, an eye winking, a butterfly in flight, and other never-before-recorded sounds, send \$3.50 to BASF OTHER WORLDS, Box 18367, Boston, Mass. 02118.

We will send you a \$4.99 Professional II C-90 cassette with these sounds. This offer will be available while supplies last. Please allow 4 weeks for delivery.



Sensitive Sound. From The People Who Invented Magnetic Tape.

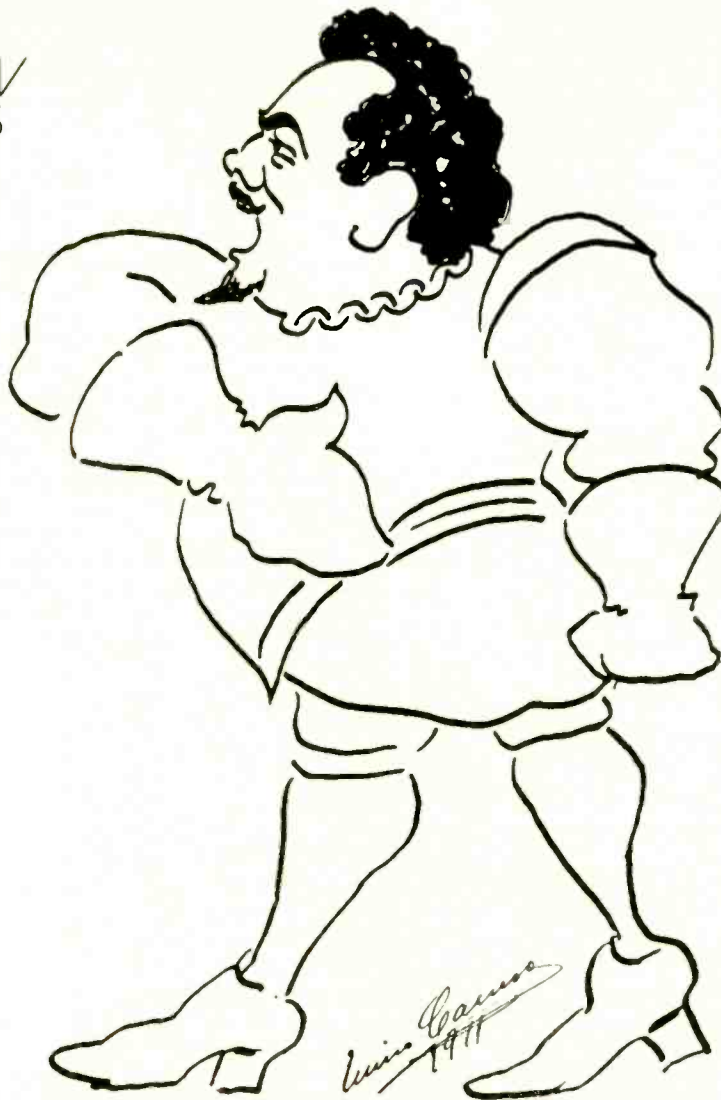

*The first issues in RCA's new Soundstream presentation of the Caruso recordings raise some basic questions about how to publish a collected edition.*

**by David Hamilton**

ENRICO CARUSO'S recorded legacy is significant in many ways. Edison may have invented the phonograph; Caruso made it a socially acceptable musical instrument. He also made the fortunes of the Victor Talking Machine Company, establishing it as by far the most prestigious and successful American enterprise of its kind (in the process eclipsing Edison's own recording operation). Beyond that, the Caruso recordings are prime documents in the history of musical performance—not only for what they tell us about Caruso's own singing, but also because that singing, disseminated throughout the world by the recordings, enormously influenced what came after. Finally, and not least, Caruso's records can still be a source of substantial musical and human pleasure.

For all these reasons, a "Complete Caruso," prepared from the best available source material, handsomely packaged, comprehensively documented, would seem an obvious undertaking for the proprietors of the bulk of that heritage. Ideally, this would be done simply because it ought to be done, because virtue is its own reward. Just as the works of great writers and composers are carefully gathered, edited, and printed in first-class collected editions, so the recordings of great musicians of the past should be accorded systematic and painstaking republication.

Besides, it ought to make good commercial sense. The older record companies have ever-growing archives that represent a potential source of income if public interest in historical recordings can be stimulated. Superior "complete editions" would enhance the visibility and prestige of the recordings and the performers; such editions, beautifully produced, informatively and literately annotated, would increase listeners' enjoyment and interest, and whet their appetites for more. Such editions would tangibly assert that records are more than mere ephemeral entertainment goods, would offer them as objects of importance and permanence.

American record companies have been slow to exert themselves in this direction. Abroad, Philips and Deutsche Grammophon have shown how mammoth collections of the works of great composers can be assembled and marketed, while here mail-order entrepreneurs such as Time-Life Records have achieved striking success with their elaborate repackagings of London's Ring and DG's Beethoven series. In the historical field, RCA's Rachmaninoff and Heifetz collections represent an enterprising start, but fall short of what EMI has done with Elgar's recordings, for example, or with Melba's English recordings. (We hear of great things from Japan as well, though few of us are in a position to evaluate the literary presentation of the few historical issues that have crept across the Pacific.)

Let me describe what the "Complete Caruso" would involve if I were publishing it. Obviously, all the surviving recordings, in scrupulous, perfectly pitched, carefully engineered transfers, presented in the order in which Caruso recorded them, pressed on highest-quality silent-surfaced discs.

The associated material would be—well, voluminous. Technical information is a must: What kind of source material was used, how were the transfers to tape made? A full chronological discography, based on the Victor files, would list all the recordings Caruso made, whether they survive or not, with indications of status: Approved? Published? Held for possible later use? Rejected? Was the master destroyed at the time, or lost later? Do test pressings survive? And so on. (If material not approved by the artist for publication is to be included for historical reasons—and there are ample precedents in many fields for doing this—there still remains an ethical obligation to label this material clearly and to specify, if known, the reasons for its nonpublication: Artistic? Technical? Commercial?) The keys and vocal ranges of all the musical selections would be indicated, with specifics of transpositions and of the playing speeds used for the transfers.

That's all essential, but actually subsidiary to the main thrust, which is to help the listener get the most out of the recordings. At one level, there would be texts and translations for all the selections (with information

on the dramatic situation in which operatic excerpts occur), as well as information about obscure works and composers. A biographical study would place particular emphasis on the relationship of the recordings to Caruso's stage career, and include a narrative of his contracts and other dealings with the recording companies, not to mention any information that can still be scraped up about the sessions themselves. His collaborators in duets and ensembles would be identified, their roles in his career described.

Most important, there would be a serious critical essay on Caruso as a singer—not a puff piece, but a hard-nosed, well-informed evaluation: the technical characteristics of his voice; the difficulties he encountered at various times as well as the evident mastery; the historical role of his methods and mannerisms in the contexts of the repertory he sang and of the styles of his predecessors and successors. I don't believe you need to whitewash recordings such as these. They are obviously not all perfect, and some we will want to hear more frequently than others. Taken in toto, however, they tell an important story—not only an essential piece of the history of singing, but also a human story, of the most universally acclaimed singer of all time achieving that height and then struggling against the inevitable ravages of age.

The "Complete Caruso" ought frankly to help the listener hear that story, for its own sake and for the light it casts on the careers of other singers past and present. It may be a glamorous profession, but it's also bloody hard work, especially at the top, and that fact should emerge vividly from these records. This human dimension would surely be enhanced by pictures: photos candid and posed, documents, and as many as possible of the inimitable Caruso drawings, full of lively, touching insights into the man's sensitivity and humor.

What I'm asking is that the companies raise their sights beyond merely throwing records onto the market; they must also exert themselves to help people hear what's on the records. Caruso's recordings do constitute the raw materials of a "biography in sound," but only the most informed specialist listeners come to them with the background knowledge and directed aural skills to assemble those raw materials into a coherent story. Make that knowledge and skill available to every purchaser, and I warrant the project will interest and excite many more than just the antiquarians and opera buffs.

So much for what I'd like to see. The first two releases, comprising Vols. 4 and 5, in what RCA describes as "The Complete Caruso" are at hand, and they fall a good deal short of my specifications. No doubt I should be grateful for this much, for previously RCA's treatment of the Caruso legacy on LP has been pretty dismal. In the early 1950s it began issuing single-disc collections, and later a couple of sets. Not until 1973—in a centennial box that arrived belatedly, some ten months after the anniversary it was supposed to have celebrated—was the last of the RCA Caruso material released in the new format, along with a small number of sides that had never before circulated in any form.

By this time, many of the earlier reissues had vanished from the catalog—and, one is tempted to add, small loss, for the technical work had been pretty erratic: The question of correct playing speeds was often ignored, and the sonic "rehabilitation," with filters and

added resonance, frequently travestied the original sound. (Some sort of low point in this respect was reached during the centennial year, in two singles entitled "The Greatest Hits of Enrico Caruso," ARM 1-0278 and 1-0279; though correct in pitch, these transfers were brassily exaggerated and subjected to clouds of trailing resonance. On the other hand, the clumsy electrically recorded accompaniments superimposed on some of the best-selling titles in the 1930s were at least consigned to the scrap heap after the earliest LP reissues.) What is more, many of the RCA Caruso singles and sets mutually duplicated each other in part.

In 1976, a new element came into the picture: Dr. Thomas Stockham's Soundstream process for computer restoration of acoustic recordings. When RCA floated a trial balloon (CRM 1-1749) containing a selection of Caruso's most famous recordings refurbished by Stockham, I found the results striking and remarkably convincing, and ended my November 1976 review with the following thought: "Since the boys at RCA are such past masters at the art of selling the same thing over and over again: If the Soundstream reprocessings become generally accepted and they undertake to sell us all of Caruso all over again, let us hope they will do it this time in an orderly and systematic way, not in another quarter-century of dribs and overlapping drabs."

Well, it appears that the minimal desire I expressed then is to be granted, more or less. That first Soundstream release having presumably found sufficient market acceptance, we will now get "all the known recordings" of Caruso, in Soundstream reprocessings, on a series of single discs to be published over the next several years; as I've said, I should be grateful, and I am—moderately. Leaving aside for a moment the Soundstream process itself, these are good transfers. All the selections on the two discs are in pitch. There are no traces of artificial echo. Some noisy patches (e.g., a grinding at the beginning of the *Forza* duet) seem to be common to all RCA transfers of the same material since 1950, so they are probably long-standing flaws in the matrices. I'd like to think that the best available material was submitted to Stockham; I'd feel more confident about this had RCA seen fit to boast about it, instead of offering us a mere paragraph of boilerplate about the Soundstream process.

The next point in my more exigent list of desiderata is one with which RCA evidently agrees: "The records will be chronological, as the tenor recorded them," says the preliminary press release. But they aren't. True, the recording sessions are presented in chronological order, but within each session the sequence of selections follows the order of Victor's issue numbers (assigned after the sessions) rather than that of the matrix numbers (which in most cases indicate the actual order of recording). As Dale Harris pointed out in these pages (February 1974), the same problem afflicted the short-lived (and incomplete) Murray Hill "Complete Caruso," because its editors were following the order of Aida Favia-Artsay's *Caruso on Record*—and I surmise, for this reason and another that will emerge shortly, that the boys at RCA are doing the same thing.

Now I'm full of admiration for Mrs. Favia-Artsay's painstaking work on the pitch of the Caruso recordings, but her book isn't a good authority for chronological ordering. Perhaps this strikes you as a quibble: However, having the recordings in exact sequence is conceivably

of value to close students of the voice's workings—and since they have to be in some order, why not the right one? What's more, it's disturbing to find that the producers haven't gone back to their own, more authoritative source material in preparing this important project.

Reliance on this particular secondary source, I believe, is to blame for a more serious consequence: The "Complete Caruso" isn't complete. As we learned from that "bottom-of-the-barrel" RCA centennial box, of the *Rigoletto* quartet with Marcella Sembrich there survives not only the published Take 3, recorded on February 7, 1907, but also an unpublished Take 2, recorded four days earlier with Josephine Jacoby instead of Gina Severina as Maddalena—apparently the only surviving Caruso recording from that session. Since Mrs. Favia-Artsay, writing in 1965, confined herself to published recordings and those few "unpublished" ones that had circulated among collectors in private dubbings, she didn't list that Take 2. And, because someone at RCA didn't do his homework properly, Take 2 isn't here where it should be, even though it was made public five years ago, by RCA itself.

Now, one might well argue that such "outtakes" ought to be relegated to an appendix, outside the primary sequence of the recordings Caruso is known to have approved as representing his singing. But that clearly isn't RCA's policy here, for the unissued 1906 "*Celeste Aida*" and the flawed second take of the *Don Sebastiano* aria are both here in sequence. Instead of an appendix of outtakes, this series looks as if it will need one entitled "Things We Forgot."

As far as literary matter is concerned, to describe what is not included here would entail a substantial *da capo* of the first part of this review; it will be simpler to tell you what is included. For documentation: matrix and take numbers, and recording dates. For reading matter: two unrelated essays, of which that for Vol. 4 is pleasantly anecdotal; that for Vol. 5, slightly more critical in tone, does make some attempt to relate the record-

---

### Corrections

A particularly embarrassing gaffe—one of those that makes superficial wacky sense and so can be read straight by the unwary—occurred on page 95 of our September issue. In his review of the Peters International album "Edith Piaf at Carnegie Hall," Gene Lees wrote, "The irony in her songs was about as close as she could come to humor in her public guise." A printer's error changed "humor" to "human," creating a non sequitur and, worse, an unintentional insult to the artist. We apologize to Mr. Lees, to Peters, and to the shade of Miss Piaf.

And while we're at it, on page 112 of that issue, in the penultimate paragraph of David Hamilton's review of EMI's abridged *Tannhäuser* recording, another printer's error rendered obscure the references to the Wagnerian baritone Friedrich Schorr. In an inventory of possible Wagner reissues from the Electrola vaults, Mr. Hamilton wrote, "Then there are the extensive excerpts from *Die Meistersinger*, recorded at a Berlin performance in 1928, with Schorr [not Schoff, as printed] as Sachs."

---

ings to Caruso's career, and particularly to his vocal crisis and operation of 1909. If you want to know what he's singing about—or even such a basic bit of information as how old he was when he made these recordings—you will have to search elsewhere. And you will have some difficulty reading what is here, for a Caruso caricature has been tastelessly superimposed on the type.

Presumably because the European recordings and the piano-accompanied American ones of 1904–5 present special difficulties in processing, the project is being launched with Caruso's first orchestrally accompanied session, in February 1906. To my mind, the piano-accompanied Victors are, as a group, Caruso's finest

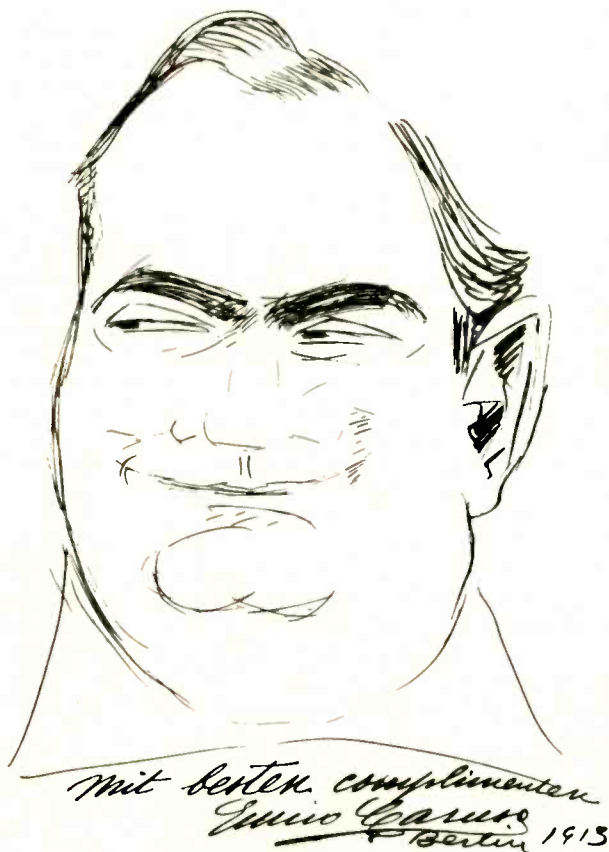

Above and on opening page:  
two caricatures of Caruso  
by his own hand

recordings; the present selection, from the immediately following years, is also pretty remarkable. A few, such as the "*Di quella pira*" that opens Vol. 4, are slightly stodgy, undercommitted rhythmically though fervent enough tonally. More are distinguished by a marvelous amplitude of phrase, carrying the line forward in powerful arches: "*M'appari*," "*Spirto gentil*," "*O paradiso*," "*Ah, si, ben mio*," and of course "*Vesti la giubba*."

The *Forza* duet with Antonio Scotti is deservedly famous for the matching of vocal color; don't overlook Caruso's phrasing, or the extra weight he brings to bear on the phrase "*al cor mio*" the second time around. There are lyrical moments, too, such as the gentle singing in the *Bohème* quartet, though in "*O soave fanciulla*" not even Caruso can defrost Melba. In general, however, the predominant impression is one of controlled power, the most successful dramatic posture one of stoic, dolorous nobility (the *Favorita* aria, the slow aria and the duet from *Trovatore*).

Comparisons with earlier and later versions should doubtless wait until the series is complete; even so, one cannot help noting that by 1908 the voice and production are becoming unwieldy for parts like the Duke of Mantua, whose arias are delivered with a vivid but strenuous brio. The songs don't come off well; several of them are undistinguished to begin with, while the Tosti morsels, more skillfully made, are too much of the salon to respond comfortably to this voice's primary orientation—Caruso's "*Ideale*" can hardly compare, in tonal or verbal imagination, to the one Luciano Pavarotti sang at his Met recital last winter. (There will be many more songs in the later volumes, for after 1912 Caruso recorded less and less operatic material.)

Even these two volumes alone begin to suggest some of the interesting points in the total Caruso legacy. The 1906 "*Celeste Aida*" is but one of a series of Enrican experiments with the phrasing of that difficult piece—an eccentric one that must have been quickly recognized as unsuccessful, and the disc withheld: the 1908 recording is entirely conventional in this respect, though a few of the 1906 oddities were to turn up once again in the better-known 1911 remake. (There are three pre-1906 versions still to come.) Also worth noting is the easy, casual insertion of extra graces, even in the then very recent works such as *Bohème* and *Pagliacci*. Naturally, the fact that many of these recordings stem from quite soon after the introduction of the operas gives them added historical interest.

I've held off discussing the Soundstream reprocessing so far. It doesn't really affect the musical characteristics of the performances, though a few flaws spring to the ear more readily than before. (I had not particularly noted, previously, the ill-focused final note of "*Questa o quella*," and the "bubbles" that afflict the final notes of the 1906 "*Celeste Aida*" and the "*O paradiso*" are certainly more obvious now, as well as the multitudinous clinkers in the accompaniments.) Soundstream's success in neutralizing the resonances of the recording horn is amply evident, and very satisfying to the ears.

On these discs we hear for the first time female voices Soundstreamed. As one might have predicted, the process cannot (nor was it intended to) overcome the frequency limitations of the original material: Since women's voices lie an octave higher than men's, the acoustic system transmits them with an octave fewer partials, and of course their generally lesser volume

meant that they had less impact on the cutting stylus. Geraldine Farrar evidently took fairly well to the horn. Sembrich did not—and their relative effectiveness is unchanged by Soundstream. The lower male voices, on the other hand, do come through more clearly in the ensembles, especially Marcel Journet and Scotti in the *Lucia* sextet, and the latter in the first *Rigoletto* quartet, with the inadequate Bessie Abbott; he's not so clear in the later one with Sembrich, though, which seems to be the result of Caruso hogging the horn on that occasion.

How is one to test these recordings for verisimilitude? The favorable testimonials from those who worked with the singer, quoted in James A. Drake's article (*HIGH FIDELITY*, October 1976), probably deserve some weight, especially since they are made against a background of more than fifty years during which recollection might well have been colored by the sound of the pre-Soundstream recordings.

On the part of those of us who didn't hear Caruso in the flesh, what surely is not germane is unfavorable comparison with the original recordings, for those are, after all, the result of sending the true "original" (that is, Caruso's voice) through a distinctly nonlinear mechanical filtering system (the combined result of the nonlinearities of the recording horn, diaphragm, and cutting mechanism). Though Soundstream does not attempt to restore the frequencies that were completely eliminated by that "filtering system," it does aspire to correct the imbalances within the transmitted frequency range, and it does this in an enormously more refined and objective way than any previous attempts at rehabilitation.

Let me emphasize that. This is a fundamentally different kind of "sonic refurbishment" from that done on a subjective, empirical basis by an engineer adjusting filters and similar gadgets to "make it sound better"—a process that can be carried out with more or less discrimination but remains always basically a matter of altering the sound to match some ideal in the engineer's mind. The Soundstream technique is an objective, impersonal transformation, consistently applied throughout the recording on the basis of an equally impersonal and exhaustive analysis of the recording's sonic character and comparison with modern recordings of the same music.

Thus, arguments about Soundstream's Caruso have to be made in a different context from arguments about other transmutations of the originals, such as those RCA has offered in the past. Then it was essentially your taste against the engineer's, your guess about what Caruso sounded like against his—but Stockham and his colleagues have applied science, rather than taste, to the problem. Some of their process is based on assumptions rather than facts—necessarily so, since some of the facts are lost, along with those missing high and low frequencies—but that doesn't of itself invalidate the results. You may dislike these transformations, but you cannot do so on the grounds that they don't sound like the original recordings—they're not supposed to; you'll have to disagree with the scientific principles and procedures involved in the transformation.

Or because you perceive some unwanted side effects. One such possibility was raised by John Steane in *Gramophone*, when reviewing the first Soundstream Caruso record: "I had always thought of Caruso as a singer whose intonation was naturally and more or less

invariably correct. Yet here one was, finding it not infrequently, albeit very briefly, wrong." I wish he had cited some specific cases; I have noticed some instances (the aforementioned final note of "*Questa o quella*," at "il creato a bear" in the *Pearl Fishers* duet, and on the line "*in te rapito*" in "*O paradiso*," for example), and then found, on checking dubbings of the originals, that the flaw was always there. The reason may simply be that the strikingly "new" presence of the voice on the re-recordings makes us aware afresh of things that were always there but remained (or became) obscured by the effort of listening through surface noise and horn distortion.

And yet there is perhaps something more: a fugitive sense that the pitch stability of the recordings may have been slightly undermined, perhaps in the analog-to-digital (or vice versa) conversion, or merely in one or another transfer along the way. (I should not think the Soundstream filtering to blame, for digital recordings ought to be rock-solid—but maybe I'm wrong about that.) It's one of those now-you-hear-it, now-you-don't phenomena, slightly troublesome on some hearings, not at all on others, but it's something I've never experienced with the originals or reasonably competent transfers thereof.

That marginal and, I hope, ephemeral, reservation aside, this is to my ears a more convincing Caruso—and an easier one to listen to—than what we've heard before. It certainly isn't all of him, nor is it claimed to be (at least by Stockham and his colleagues; I can't vouch for RCA's publicity). It's not a "high fidelity Caruso," merely a much clearer view of the old "low fidelity" one. For the moment, it's the best science can do.

It isn't the best that record publishing can do, however. My suggestions above are offered in a constructive spirit; if RCA doesn't feel able to follow through along those lines, perhaps some imaginative book publisher would like to undertake "*The Complete Caruso Book*," and then perhaps Time-Life, the Metropolitan Opera Guild, or some similarly enterprising operation might arrange to package the whole business—records, book, and perhaps Mrs. Caruso's partisan but genuine and touching memoir of her husband (but not, please, the recent Stanley Jackson biography, sloppy and inaccurate)—for mail-order distribution. That would bring us closer to the ideal.

**H ENRICO CARUSO:** *The Complete Caruso*, Vols. 4–5. Enrico Caruso, tenor; orchestral accompaniment. RCA RED SEAL ARM 1-2766 and 1-2767. \$7.98 each (mono) [from VICTOR originals, 1906–9].

Vol. 4: **VERDI:** *Il Trovatore*: Di quella pira (2/11/06). **FLÓTW:** *Martha*: M'appari (2/11/06). **PUCCINI:** *La Bohème*: Che gelida manina (2/11/06). **GOUNOD:** *Faust*: Salut, demeure (2/11/06). **DONIZETTI:** *La Favorita*: Spirto gentili (2/11/06). **VERDI:** *Aida*: Celeste Aida (3/13/06). *La Forza del destino*: Solenne in quest'ora (with Antonio Scotti, baritone; 3/13/06). **BARTHÉLEMY:** *Triste ritorno* (12/30/06). **TOSTI:** *Ideale* (12/30/06). **MEYERBEER:** *L'Africaine*: Mi batte il cor... O paradiso (2/20/07). **VERDI:** *Rigoletto*: Bella figlia dell'amore (with Bessie Abbott, soprano; Louise Homer, alto; Scotti; 2/20/07). **GIORDANO:** *Andrea Chénier*: Un di all'azzurro spazio (3/17/07). **LEONCAVALLO:** *I Pagliacci*: Recitar!... Vesti la giubba (3/17/07). **PUCCINI:** *La Bohème*: O Mimì, tu più non torni (with Scotti; 3/17/07). **BIZET:** *Les Pêcheurs de perles*: Dal tempio al limitar (with Mario Ancona, baritone; 3/24/07). **PUCCINI:** *La Bohème*: O soave fanciulla (with Nellie Melba, soprano; 3/24/07).

Vol. 5: **DONIZETTI:** *Don Sebastien*: Deserto in terra (two versions; 1/10/08). **BARTHÉLEMY:** *Adorables tourments* (1/10/08). **VERDI:** *Rigoletto*: Bella figlia dell'amore (with Marcella Sembrich, soprano; Gina Severina, mezzo-soprano; Scotti; 2/7/08). **DONIZETTI:** *Lucia di Lammermoor*: Chi mi frena (with Sembrich; Severina; Francesco Daddi, tenor; Scotti; Marcel Journet, bass; 2/7/08). **PUCCINI:** *Madama Butterfly*: Un po' di vero c'è (with Geraldine Farrar, soprano; 3/10/08). *La Bohème*: Addio, dolce svegliare (with Farrar; Gina Vlahora, mezzo-soprano; Scotti; 3/10/08). **VERDI:** *Rigoletto*: La donna è mobile; *Questa o quella* (3/16/08). *Il Trovatore*: Ah, si, ben mio (3/16/08). *Se m'ami ancor... Al nostrl monti* (with Homer; 3/17/08). *Aida*: Celeste Aida (3/29/08). **TOSTI:** *Pour un baiser* (11/6/09). **PUCCINI:** *Tosca*: Recondita armonia; *E lucevan le stelle* (11/6/09).

# For Mendelssohn's Symphonies, a Clear Winner

*As in last month's Schumann symphony roundup, Kurt Masur and the Leipzig Gewandhaus Orchestra sweep the Mendelssohn field.*

by Karen Monson

LAST MONTH, surveying a recent crop of Schumann symphony recordings, I gave an enthusiastic recommendation to Kurt Masur's performances with the Leipzig Gewandhaus Orchestra, released domestically by Musical Heritage Society. This month it's Mendelssohn's turn, with a Masur/Gewandhaus cycle once again included, and the decision is even simpler: If you have any interest at all in Mendelssohn's symphonies—and sometimes, when I'm not under their spell, I do wonder why anyone would be interested—get the Masur set on Vanguard Cardinal.

If these four discs were sold at full price, they'd still be a musical bargain. At the Vanguard Cardinal price, however, they're the proverbial steal. Beyond that, \$15.92 plus tax gives you plasticized proof that Mendelssohn didn't write only his Third, Fourth, and Fifth Symphonies. A First and Second are also on the books—not to mention at least twelve string symphonies, but the story of the familiar works is complicated enough without throwing anything else in.

Issue No. 1 regarding the group of five symphonies for full orchestra is that they were not written in anything approaching the order suggested by their numbers. Most record jackets will confuse you with all the relevant dates; the only important thing to remember is that the order of composition was not 1, 2, 3, 4, 5, but rather 1, 5, 4, 2, 3. Unless you know this, don't try to argue that Mendelssohn lost his touch of genius when he reached maturity, since only the First Symphony is a work of his youth. (He wrote it at the age of fifteen.)

Issue No. 2 is that they're deceptively difficult, not to play, but to present. Mendelssohn seems to have tightened up at the thought of symphonic stature. As opposed to the octet, the incidental music to *A Midsummer Night's Dream*, and the violin concerto, to list only three of the best and best-known pieces, the symphonies share a certain tendency to act uppity and inspire conductors to behave the same way. To be sure, the music is on the snobbish side—very, very upper-crust. But more than that, it's elegant, graceful, and rich, and it doesn't work its magic unless all of these qualities are present in careful proportion.

Masur is so good at finding and holding this balance that anyone might suspect he was around the Gewandhaus when Mendelssohn was conducting there in the late 1830s. It's also tempting to credit the Leipzig orchestra's 235-year-old tradition for part of the beauty of these performances. Obviously, though, there's credit to be served only to the conductor, who is in his tenth year at the Gewandhaus; to the youthful sound of the oldest German concert orchestra; and to the engineers of East Germany's VEB Deutsche Schallplatten, who had the good taste to make themselves inconspicuous.

The first impression is that Masur *cares*—cares enough, for instance, about the opening of the most popular symphony, the *Italian* (No. 4), not to bump the C sharps in the opening theme, but just to let them open out gently and naturally. He also cares enough about the *Reformation* (No. 5) to tone it down from the usual hellfire-and-brimstone bombast. You have neither to convert nor to confess to listen to this performance of the symphony, and the recurring Dresden amen sounds nowhere near as artificial and gratuitous as it does in the more common roof-raising renditions.

The only cycle that can reasonably be compared to this one is Deutsche Grammophon's (2720 068), with Herbert von Karajan conducting the Berlin Philharmonic. And though that orchestra may be somewhat superior to the Gewandhaus, the Masur set is still fresher, lighter, and more elegant.

Finally, the virtue of completeness counts in favor of the Vanguard package, setting it off from the *Italian/Scotch/Reformation* duets or trios that have become the norm. The First Symphony has all the virtues of the Fourth; why these two works haven't been given equal rights in the repertory is a mystery. And the Second, the difficult *Lobgesang Symphony—Cantata on Words of Holy Writ for Solo Voices, Chorus, and Orchestra*, Op. 52, is a fascinating combination of Mendelssohn at his best and worst. Robert Schumann, in his capacity as critic, refused to call the work either a symphony or a cantata; Mendelssohn himself didn't think of it as a symphony—and certainly not as his Second.

But whatever we call it, *Lobgesang* is worth more attention than it has received over the past 135 years. The symphony that opens it is a charmer, and the long cantata (taking two of the three recorded sides) has enough worthy and sophisticated passages to attract fine soloists. Masur is joined in this performance by sopranos Celestina Casapietra and Adele Stolte, tenor Peter Schreier, and the Leipzig Radio Chorus. The effect is gala and exciting.

The availability of the Vanguard Cardinal set considerably diminishes my interest in the other recent Mendelssohn, except perhaps for Raymond Leppard's Erato/RCA coupling of the *Italian* and *Reformation*. The English Chamber Orchestra's participation is promising in prospect, since Mendelssohn himself, during the years he conducted at the Gewandhaus, was lucky if he could talk the management into assembling fifty players, and it's too bad that these performances so rarely have a convincing chamber-orchestra sound. At points in the *Italian*, though, Leppard does get a shiny, bright tone from the group, with a good one-to-one balance between strings and winds. The third movement of the *Reformation* is especially attractive. But be warned:



Every now and then, for no apparent reason, a note comes flying forth—not accented, not stressed, but indecorously goosed.

Riccardo Muti's *Angel Italian*, backed by Schumann's Fourth (noted last month), is a good example of full, rich Mendelssohn, if that's to your taste. Leopold Stokowski's *Italian* on Columbia is so full and fat that it wants to fall asleep; as dessert, this disc includes a charmless reading of Bizet's Symphony in C. Both works are badly delivered by London's National Philharmonic. Problems of balance and intonation also afflict the Royal Philharmonic as Hans Vonk conducts two "greatest hits": the *Italian* Symphony and the Overture, Scherzo, Nocturne, and Wedding March from *A Midsummer Night's Dream*.

The *Italian* fares better with Sergiu Comissiona conducting the Baltimore Symphony on Vox's Turnabout label, where it's paired with the *Reformation*; the *Scotch* and the *Hebrides Overture* are available on a companion record. All of these performances are adequate; they do credit to the city of Baltimore, and they're certainly preferable to many others by richer, better-known ensembles. But neither Comissiona nor the Baltimore Symphony nor the engineering here impresses as being of world class.

**B** **MENDELSSOHN:** Symphonies (5). Leipzig Gewandhaus Orchestra, Kurt Masur, cond. VANGUARD CARDINAL VCS 10133/6, \$15.92 (four discs, manual sequence).

Symphonies: No. 1, in C minor, Op. 11; No. 2, in B flat, Op. 52 (*Lobgesang*; with Celestina Casapietra and Adele Stolte, sopranos; Peter Schreier, tenor; Leipzig Radio Chorus); No. 3, in A minor, Op. 56 (*Scotch*); No. 4, in A, Op. 90 (*Italian*); No. 5, in D, Op. 107 (*Reformation*).

**MENDELSSOHN:** Symphonies: No. 4, in A, Op. 90 (*Italian*); No. 5, in D minor, Op. 107 (*Reformation*). English Chamber Orchestra, Raymond Leppard, cond. RCA RED SEAL ARL 1-2632, \$7.98. Tape: ■ ARK 1-2632, \$7.98; ● ARS 1-2632, \$7.98.

**MENDELSSOHN:** Symphony No. 4, in A, Op. 90 (*Italian*). **SCHUMANN:** Symphony No. 4, in D minor, Op. 120. New Philharmonia Orchestra, Riccardo Muti, cond. [John Mordler, prod.] ANGEL S 37412, \$7.98 (SQ-encoded disc). Tape: ■ 4XS 37412, \$7.98.

**MENDELSSOHN:** Symphony No. 4, in A, Op. 90 (*Italian*). **BIZET:** Symphony in C. National Philharmonic Orchestra, Leopold Stokowski, cond. [Roy Emerson, prod.] COLUMBIA M 34567, \$7.98.

**MENDELSSOHN:** Symphony No. 4, in A, Op. 90 (*Italian*). *A Midsummer Night's Dream*, Opp. 21/61: Overture; Scherzo; Nocturne; Wedding March. Royal Philharmonic Orchestra, Hans Vonk, cond. [Raymond Few, prod.] LONDON PHASE-4 SPC 21145, \$7.98. Tape: ■ SPC5 21145, \$7.95.

**B** **MENDELSSOHN:** Symphonies: No. 3, in A minor, Op. 56 (*Scotch*)\*; No. 4, in A, Op. 90 (*Italian*)\*; No. 5, in D minor, Op. 107 (*Reformation*)\*. Hebrides Overture, Op. 26.\* Baltimore Symphony Orchestra, Sergiu Comissiona, cond. [Marc Aubort and Joanna Nickrenz, prod.] TURNABOUT QTV 34604\* and 34643\*, \$3.98 each QS-encoded disc. Tape: ■ CT 2135\*, \$6.95.



# POUND FOR POUND DOLLAR FOR DOLLAR THE BEST SPEAKER IN THE WORLD.



THE INCOMPARABLE AR11. IT CAN BRING YOU MUSIC FROM YOUR OWN RECORDS YOU MAY NEVER HAVE HEARD BEFORE. TO LEARN SOME OF THE ENGINEERING REASONS. GET OUR FULL COLOR BOOKLETS FROM YOUR AR DEALER OR WRITE TO US AT THE ADDRESS BELOW.

AR doesn't build the biggest speakers in the world. Or the most expensive.

All we say is this.

If you're going to pay between \$70 and \$750 apiece for speakers, you must compare AR with anything else you're considering.

They just plain sound better — because of the way they're designed and because of the way they're built.

You do the comparing. You'll be able to hear the difference.

Compare low end response. Pick a record with heavy drum work or long

organ passages. You'll hear chest-thumping bass from the AR. But none of the 'boom,' or bass coloration many other speakers have.

Walk around the speakers and listen for mid- and high-range passages. Vocals particularly. With AR the sound will be evenly dispersed around the room. No bursts or dead spots.

Listen carefully for smooth response. It's hard to discern because it's characterized by nothing happening. No frequencies overshadowing others. Nothing shouting at you.

Pick a record with cymbals, triangles or the like, to check the high end. The AR will produce them more crisply, more clearly, without the bright, brittle sound some other speakers have.

Then, when you like what you've heard and learned, ask your dealer to show you the AR full 5-year warranty. Among other things it promises your speakers will perform to factory specs for 5 years from the day you buy.

They're not the "brassiest" speakers you'll hear.

But if you want to know the difference between the sound of a \$2 fiddle and a Stradivarius you want AR.



Truth In Listening

**TELEDYNE ACOUSTIC RESEARCH**  
10 AMERICAN DRIVE, NORWOOD, MASSACHUSETTS 02062  
IN CANADA: A.C. SIMMONDS & SONS LTD. ©1978

# Classical

reviewed by ROYAL S. BROWN  
SCOTT CANTRELL  
ABRAM CHIPMAN  
R. D. DARRELL  
PETER G. DAVIS  
ROBERT FIEDEL  
SHIRLEY FLEMING  
ALFRED FRANKENSTEIN  
KENNETH FURIE  
HARRIS GOLDSMITH  
DAVID HAMILTON  
DALE S. HARRIS  
PHILIP HART  
PAUL HENRY LANG  
IRVING LOWENS  
ROBERT C. MARSH  
ROBERT P. MORGAN  
JEREMY NOBLE  
CONRAD L. OSBORNE  
ANDREW PORTER  
H. C. ROBBINS LONDON  
PATRICK J. SMITH  
SUSAN THIEMANN SOMMER

**BACH:** Chorale Preludes, S. 651-68. Daniel Chorzempa, organ of the Lebunuskerk, Deventer (the Netherlands). PHILIPS 6700 114, \$17.96 (two discs, manual sequence).

Although I enjoyed Daniel Chorzempa's first Bach disc (Philips 6500 214, July 1972), I was rather disappointed with his subsequent recording of the trio sonatas (6700 059, November 1973). The latter performances struck me as dull and even labored—just the impression one doesn't want in such disarming music—and I'm sorry that I must register the same complaint with this new recording of the eighteen "Leipzig" chorales.

In the first place, tempos are often too slow to give any real feeling of drive, of dynamic motion. The opening fantasia on "Komm, heiliger Geist" lacks exuberance, the second "Allein Gott" setting plods along interminably, and the first "Nun komm' der Heiden Heiland" is absolutely ponderous. We do get some agreeably brisk tempos in the trio settings of "Herr Jesu Christ, dich zu uns wend'" and "Allein Gott in der Höh' sei Ehr,'" but even here one feels the lack of what is perhaps the most important attribute of sensitive organ-playing: rhythmic inflection. Almost nowhere is there any perceptible shaping of phrases, any caressing of agogic accents, or any space for life-giving breath: phrases are devoid of contour, sentences of punctuation. I was surprised, moreover, to find Chorzempa repeatedly committing a perverse stylistic faux pas—playing written-out trill terminations exactly as noted, rather than (properly) at the speed of the trill.

Quite honestly, I don't sense any real stylistic affinity here—or, for that matter, a particularly compelling musical personality—and I can't help wondering why Philips is pushing Chorzempa while withholding American distribution of Wolfgang Rubsam's absolutely stunning Bach recordings (now available in Europe). The only things Chorzempa has going for him here are a gorgeous instrument (recently restored by Flentrop) and exemplary recorded sound. For a truly satisfying performance of the "eighteen," we will do well for now to stick with Anton Heiller (Vanguard Cardinal VCS 10039/40) or Peter Hurford (Argo ZRG 843/4). S.C.

**BACH:** Sonatas and Partitas for Solo Violin (6), S. 1001-6. Sándor Végh, violin. TELEFUNKEN 36.35344, \$23.94 (three discs, manual sequence).

Sonatas: No. 1, in G minor, S. 1001; No. 2, in A minor, S. 1003; No. 3, in C, S. 1005. Partitas: No. 1, in B minor, S. 1002; No. 2, in D minor, S. 1004; No. 3, in E, S. 1006.

**Comparisons:**  
Szerjng Odys. 32 36 0013, DG 2709 028  
Mistein DG 2709 047  
Menuhin Ang. SC 3817

Add another very good solo Bach to the shelves. The Hungarian violinist Sándor Végh, founder of the Végh String Quartet, is an immensely serious and intelligent artist, and while he doesn't invest the sonatas and partitas with the nuance of tone and scintillation of spirit of Szerjng or Milstein, or

## Explanation of symbols

### Classical:

- B** Budget
- H** Historical
- R** Reissue

### Recorded tape:

- Open Reel
- ◐◑ 8-Track Cartridge
- Cassette

Sándor Végh—intelligent solo Bach



Béla Bartók—a twentieth-century phenomenon

with the individuality and thrust of Menuhin, he knows what these works are about and delves into them searchingly.

At times—in the slower, elaborately ornamented movements like the Adagio of Sonata No. 1 or the Grave of Sonata No. 2—Végh can sound a bit laborious, and the listener may begin to have that fatal feeling that one listens to the music because it is “good for you.” And in the Sarabande of Partita No. 1 his somewhat deliberate approach carries the music a long way from its original character (the sarabande was, after all, a dance of “sensuous grace,” in the words of Grove’s).

But in his stubborn solidity, Végh builds up a kind of monumentality—particularly in the Chaconne—that in most cases does the music justice. The Chaconne, in fact, brings forth some of his most interesting ideas: He plays the first arpeggio section so softly that it achieves a gossamer effect without ever losing the underpinning line,

and in the double-stop climax of the sixteenth-note section after the key change to D major, his delicate staccato is wonderfully telling. The fugue movements never attain quite the life-giving pulse of Szeryng’s, but they are precise and poised nonetheless.

In short, a substantial contribution to the catalog. S.F.

**BARTÓK:** *Mikrokosmos*. Dezső Ránki, piano. TELEFUNKEN 36.35369, \$23.94 (three discs, manual sequence).

Bartók was a phenomenon in twentieth-century music, for aside from being one of the outstanding composers of the century, he was a fine pianist, a pathbreaking scholar who organized folkloristic research along scientific lines, and an educator in the noblest sense of the word. He abhorred the so-called teaching materials provided by

piano pedagogues, the junk fed to children, knowing that until the Romantic era fledgling musicians were given live music, not educational concoctions. By live music I mean music of the day, by professional composers, which provides the only means of keeping up with changing art. The great expert on folk music and on the close connections between speech rhythm and musical convolutions found that it was not even enough to give children good music especially intended for them—Bach’s various *Notenbüchlein* or Schumann’s delightful pieces for children. What they needed at the beginning was music using the rhythmic, melodic, and tonal qualities of genuine folksong, which was as immediately and instinctively absorbed as the mother tongue.

This was the origin of *Mikrokosmos*, and the man who undertook this task was not a young idealist, but a seasoned musician and teacher. Bartók worked at it for years, adding, exchanging, and correcting until the fateful year of 1939. But this collection is far more than a piano method; it is also a graded introduction to music in general and to twentieth-century music in particular. Children brought up on this fare proceed from simple pentatonic and modal tunes with implied harmony, to the intricacies of modern harmony; to them there are no “difficult” scales or harmonies, and polytonality holds no terrors. They also learn phrasing and articulation, rhythm from the simplest patterns to the most complicated compound variety (notably in the six Bulgarian dances). Then the novices are gradually introduced to counterpoint and the fine points of part-writing, while throughout Bartók makes them conscious of good sound and varied color. Today the sounds and rhythms of Eastern European music are no longer distant and wildly exotic to Americans as they were when Bartók and Stravinsky first invaded with their “barbarous” rhythms and sounds the enervated music of the West, and *Mikrokosmos* should be readily accessible, especially to young musicians. But this is also great music, piano literature of the first water far exceeding its pedagogical aims.

Dezső Ránki, the young pianist whom I admired in his recording of Haydn’s late piano works (Hungaroton SLPX 11625/7, October 1977) and, more recently, in Bartók’s *For Children* (Telefunken 26.35338, August 1978), grew up in the spirit represented by *Mikrokosmos*, in the legacy that Bartók left at the Academy of Music in Budapest. We take it for granted that a pianist who has been collecting a number of “firsts” in prize competitions all over Europe will possess a finished technique, especially needed in the virtuosic pieces toward the end of the collection; but listen to the “naked” pieces in the first volume, where one misplaced accent or inflection would stand out like a tall tree in a meadow.

Ránki’s remarkable musicianship and taste and his finely nuanced touch bring out all the beauty, the hidden elemental power and millennial ancestry of these pieces. He plays the early numbers with wonderful simplicity and can create an attractive split sonority between melody and accom-

# Loudspeakers: Then And Now.

There was a time when it took a big speaker to get full, rich high fidelity sound.

It's not true anymore.

Now Visonik has developed a series of ultra-compact high fidelity loudspeakers that are heard but hardly seen.

This remarkable accomplishment is the DAVID® line of five speakers. Each is an ideal combination of maximum sound and minimum size.

To achieve the sound of a large, well-engineered speaker from a speaker the size of the DAVIDS® is no small accomplishment.

Visonik blends equal parts of technology, precision German engineering, and careful craftsmanship to arrive at this mini miracle.

The result is a speaker small enough to fit in the palm of your

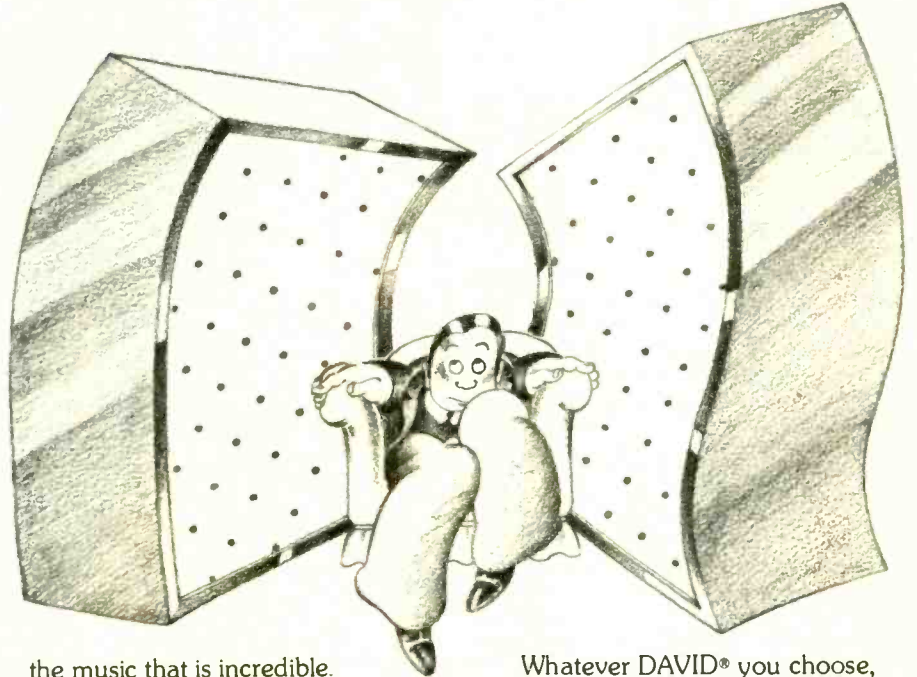

hand, with the sound of a speaker you could barely lift off the floor. And with dispersion and imaging of

the music that is incredible.

The smallest of the DAVIDS® are the two-way D-302 and D-502, perfectly made for easy placement within your home, or even in a car or van (in an MO version with mounting bracket).

While identical in size to the D-302, the two-way D-502 has more power handling capacity and deeper bass response. Commensurately fuller sound and greater power handling capacity are achieved with the D-602, D-702, and three-way D-803.

With the exception of the D-302, the DAVIDS® have an LED overload indicator to signal overload risk to the tweeters.

The D-602, 702, and 803 come in a choice of a walnut wood veneer cabinet for a touch of visual warmth, or the standard black finish cabinet.

Whatever DAVID® you choose, whether the tiny D-302 or its big



(but still relatively small) brother, the D-803, you can be sure you will own a loudspeaker whose size makes it possible to have the best sound wherever you want it.

See and hear today's concept in loudspeakers at your Visonik dealer. Write us or call this toll-free number for the name of your nearest dealer. (1) 800 423-2355, extension 606. In California, call (1) 800 232-2175, extension 606.

## VISONIK® HIFI

You'll hear more from us!™

Visonik of America, Inc./1177 65th Street/Oakland, CA 94608

\*Registered Trademark. Visonik K. G.™ © 1978. Visonik of America, Inc.

paniment, but he can also unleash all the virtuosity needed for the elaborate pieces with their tricky rhythm and meter. Yet everything remains clear and spontaneous. All of Side 6 is really spectacular, particularly the uncanny fast leggieros played pianissimo.

This is a distinguished achievement, and the album is graced by excellent and informative notes by Peter Cahn. P.H.L.

**BEETHOVEN: Late Quartets.** LaSalle Quartet. [Rainer Brock, prod.] DEUTSCHE GRAMMOPHON 2711 018, \$35.92 (four discs, manual sequence).

Quartets for Strings: No. 12, in E flat, Op. 127; No. 13, in B flat, Op. 130 (original version, with Grosse Fuge, Op. 133) [from 2530 351, 1973]; No. 13: second finale, No. 14, in C sharp minor, Op. 131; No. 15, in A minor, Op. 132 [from 2530 728, 1976]; No. 16, in F, Op. 135.

**Comparisons:**

Yale Qt  
Végh Qt  
Budapest Qt (1961)

Van. Card. VCS 10101/4  
Tel. 46.35040  
Col. M55677

Late Beethoven always poses tremendous problems for interpreters: Although its outward appearance suggests formal and aesthetic involution almost to the point where structure and rhythm—in the classical sense of Haydn, Mozart, and earlier Beethoven—dissolve in a sea of cryptic contrasts and figurations, a difficult balance must be maintained between granitic firmness and spiritual “free association” that will suggest the elusive basic architecture without stifling the moments of quirky, rapturous lyricism. In a sense, “just playing what Beethoven wrote” works well here; the major problem is that the more one delves into the texts, the more problematic—even contradictory—they become.

For example, I have heard the direction *L'istesso tempo* (“the same tempo”) for the trio of Op. 132’s second movement interpreted antithetically, referring to either individual notes or entire measures; which is right? Since the composer didn’t specify, both readings can be justified as a “literal” reading of the score. Then, what exactly did Beethoven mean by those echo notes at the start of the *Grosse Fuge* (he asks for a similar effect in the recitativo of the Op. 110 Piano Sonata)? Are those second notes actually to be played, as Broadus Erle did in the Yale Quartet recording, or are these long notes to be tied in the usual manner, as the LaSalle Quartet reads them?

And what about those places where Beethoven challenges the established realm of possibility? In many of the late piano works (e.g., the final bagatelle of Op. 126) he asks for a crescendo *after* a note has been struck—which keyboard scientists, but not poets, will dismiss out of hand—and there are times (as in the variations of the Op. 111 Piano Sonata) when the indicated bar lines enclose more notes than are mathematically allowable (again poets will try to make these spots work by reading in them a message that transcends mathematics). The more one studies the music, the more evident it becomes that Beethoven’s markings, so much more copious and detailed than in his earlier music, contain far more implication than simple direction.



Underwood/DG

The LaSalle Quartet—fastidious Beethoven

I was not fond of the Op. 130/133 and Op. 132 in the LaSalle’s earlier single-disc issues. (I steadfastly refuse to second-guess Beethoven by accepting the restoration of the *Grosse Fuge* to its original position as the finale of Op. 130.) Hearing them in the larger context of the complete late quartets, I find my antipathy somewhat modified. The rather unrhymic playing in the first five movements of Op. 130 still bothers me, but it proves somewhat atypical of the group’s overall approach, and the *Grosse Fuge*, taken on its own, is sonorous and broadly scanned—more lustrous in sound and less rigidly emphatic in phrasing than much of the LaSalle’s playing. It is worth noting that both of the earlier performances were taped before Lee Fiser replaced cellist Jack Kirstein. (Fiser thus plays in the proper finale of Op. 130, which is here banished to the disc containing Op. 127 and 135.)

DG’s accompanying booklet tells us that the LaSalle meticulously researches every aspect of the source materials before even beginning to study the music, and one can hear evidence of that scrupulousness in some rigorously moderate tempos (for example, the very slow second scherzo of Op. 131; I much prefer the Yale’s dangerous precipitousness, even if it does threaten to come apart at the seams) and in some downright perverse textual choices (in Op. 131 the LaSalle second violinist pedant-

ically omits his B natural in the fifth bar of the third movement, thus preserving a clear misprint of the original Breitkopf edition—a variant also heard in both Juilliard recordings).

My main problem with these literal, extroverted, well-intentioned, and fastidious interpretations is reconciling the lightly objective, all-on-top-of-the-music phrasing with the rather opaque sound the LaSalle normally produces. The Yale readings are similarly keen and symmetrical (and indeed more consistently so, as in such movements as the aforementioned second scherzo of Op. 131), but that approach sounds more appropriate when stated with the Yale’s pulsating tone. The darker sound of the Végh and 1961 Budapest sets—which is in any case much purer than that of the LaSalle, whose violins tend to whine in moments of stress—is allied to a far more ruminative approach. The LaSalle’s narrow outlook is least limiting in Op. 127, Op. 135, and most of Op. 131; the severest casualties are Op. 132, with its warmly effusive writing, and most of the slow movements, whose scope is most shrunken. (The variation movements of Op. 127 and 131, however, keep their shape admirably.)

The realism of DG’s reproduction (with smooth disc surfaces) lets one hear a great deal of resin on string, and there is a fine solidity of bass, even if these players—who

# The Dahlquist DQ-10. Time...and Time again.

Critics and audiophiles agree — the listening quality of the DQ-10 is unexcelled. What accounts for its superb performance?

## Time

Much credit for its smooth coherence must be given to the precisely matched transient characteristics of the five drivers. And, a good deal has been written about the DQ-10 and its extraordinary solution to the problems of time delay or phase distortion. It is not surprising that other high quality speaker designers have followed suit in offering their versions of time delay correction.

## ...and Time Again

The real "secret" to the unprecedented performance of the DQ-10 lies in Jon Dahlquist's patented method for reducing *diffraction*, a more audible and destructive form of *time distortion*. The separate baffle plate on which each driver

is mounted is dimensioned to minimize diffraction in the frequency band in which it operates. Thus, the effect of the sound we hear is that of a driver mounted in free space, without obstructions or surfaces to distort the original sound source.

It can be said that the DQ-10 eliminates inaccurate reproduction caused by time elements — inertial time delay, and diffraction time delay — distortions that limit the performance of conventional speaker systems.

That's why the more critical listener will select the DQ-10. Time and time again.



**DAHLQUIST**

27 Hanse Ave., Freeport, N.Y. 11520



**"The 'State of The Art' loudspeaker should be so focused, clear and transparent that electronics and speakers disappear, leaving only the music . . . The Art."**

**Harold N. Beveridge**

No one's speaker is perfect, including our own. We're still trying to achieve perfection. However, we believe our 2SW-1 achieves this on an order of magnitude better than any other speaker system in the world.

The Beveridge Electrostatic System 2SW-1 is the most expensive production speaker in the world today. We invite music lovers with the dedication and funds to enjoy the best with us. Thank you.

## The Beveridge Electrostatic System 2SW-1

Two full range electrostatic line sources, two direct drive tube amplifiers for electrostatics, two solid state amplifiers for subwoofers, two electronic crossovers, (18 db per octave, 100 hz), two HD subwoofers and the CM-1 Control Module. Warranty: No time limit parts (1 year tubes) 5 years labor. About \$7,000.

## Redefining The Art



**Harold Beveridge Inc**

505 East Montecito Street  
Santa Barbara, California 93103

CIRCLE 11 ON PAGE 149



Neumeister / DG

Peter Schreier—completing his Beethoven song survey

tend to subordinate all to the first fiddle—don't always ideally clarify what Beethoven does down there.

H.G.

**BEETHOVEN:** Songs, Vols. 2–3. Peter Schreier, tenor; Walter Olbertz, piano. TELEFUNKEN 6.42082 and 6.42130, \$7.98 each.

**Vol. 2:** An die Hoffnung, Op. 32; Das Glück der Freundschaft, Op. 88; An die Hoffnung, Op. 94; An die ferne Geliebte, Op. 98; Klage, WoO. 113; Selbstgespräch, WoO. 114; Gedenke mein, WoO. 130; Der Jungling in der Fremde, WoO. 138; Der Liebende, WoO. 139; An die Geliebte, WoO. 140 (two settings); Ruf vom Berge, WoO. 147.  
**Vol. 3:** Adelaide, Op. 46; Der Zufriedene, Op. 75, No. 6; Dimmi, ben mio, Op. 82, No. 1; T'intendo, si, mio cor, Op. 82, No. 2; L'Amante impaziente, Op. 82, No. 3; Trinklied, WoO. 109; Punschlied, Op. 111; An Laura, WoO. 112; Zärtliche Liebe, WoO. 123; La Partenza, WoO. 124; Der Kuss, WoO. 128; Der Wachtelschlag, WoO. 129; In questa tomba oscura, WoO. 133; Andenken, WoO. 136; Lied aus der Ferne, WoO. 137; Sehnsucht, WoO. 146; Resignation, WoO. 149; Abendlied unterm gestirnten Himmel, WoO. 150.

**BEETHOVEN:** Songs. Martyn Hill, tenor; Christopher Hogwood, fortepiano. [Peter Wadland, prod.] OISEAU-LYRE DSLO 535, \$7.98.

An die Hoffnung, Op. 32; Adelaide, Op. 46; Märlied, Op. 52, No. 4; Marmotte, Op. 52, No. 7; Neue Liebe, neues Leben, Op. 75, No. 2; Wonne der Wehmut, Op. 83, No. 1; Sehnsucht, Op. 83, No. 2; Mit einem gemalten Bande, Op. 83, No. 3; Das Glück der Freundschaft, Op. 88; An die ferne Geliebte, Op. 98; Zärtliche Liebe, WoO. 123; Der Kuss, WoO. 128; Der Liebende, WoO. 139; Des Kriegers Abschied, WoO. 143.

The completion of Peter Schreier's Beethoven song survey (Vol. 1, Telefunken

6.41997, was reviewed in November 1977) means that the bulk of this literature is once again available on records, as it has not been since the deletion of Fischer-Dieskau's bicentennial survey.

Schreier has the advantages of a lighter touch, a cleaner command of the occasional fioritura, and the range of the original keys. Now and again his baritone colleague's more portentous manner made more effective points (e.g., the opening recitative of the second setting of Tiedge's "An die Hoffnung"). At all times, Schreier's singing is accurate and musical, and he is admirably supported by Walter Olbertz' fluent, rhythmically lively playing. I was less troubled on these two discs by the obtrusive sibilants that occasionally cropped up in the first volume. There is no improvement, however, in Telefunken's presentation—no dates or other historical information, original texts only (printed in run-on format, the type dropped out against a dark background and very hard to read).

For all his reliability, Schreier is somewhat short on charm and personality, and this is one of the welcome aspects of Martyn Hill's record, part of Oiseau-Lyre's Florelegium series, devoted to performances on period instruments. Hill's is a lighter voice than Schreier's, and a shorter one—the few high A's that turn up in these songs are taken in near-falsetto. I don't find this

Discwasher, Inc., is currently offering limited-edition 23- by 15½-inch reproductions on high-grade textured paper of the series of four original paintings by Jim Jonson commemorating "100 Years of Recording." The series, which appeared in HIGH FIDELITY in 1977, the phonograph's centenary year, is accompanied by detailed historical notes, on separate sheets, by HF's Audio-

Video Editor Robert Long. The paintings illustrate four periods in recording history: "The Cylinder Era," "The Acoustic Era," "The Electrical Era," and "The Microgroove Era." Prominent persons and significant innovations in each period are depicted. The set costs \$20 and may be ordered from Discwasher, Inc., 1407 N. Providence Rd., Columbia, Mo. 65201.



# Before Sound Guard<sup>®</sup>, you only played a record in mint condition once.



Unprotected

Magnification shows the record vinyl wearing away.



With Sound Guard

Same magnification shows no record wear.

methods, removes all common record contaminants—from dust particles to oily fingerprints.

And whether your records need a light cleaning to remove surface dust or a thorough cleaning to remove deep-seated contaminants, Sound Guard record cleaner does both.

**2. Sound Guard<sup>™</sup> Total Record Care System** puts Sound Guard record preservative and Sound Guard record cleaner in one package—for the best possible total care for all of your records.

Available in audio and record outlets.

\*Tests available on request.

You can see how the picture has changed.

Independent tests\* show that records treated regularly with Sound Guard preservative keep the same full amplitude at all frequencies, the same absence of surface noise and harmonic distortion as records played just once in mint condition.

With its patented dry-lubricant film, Sound Guard

preservative maintains sound fidelity by reducing record wear. And with its built-in, permanent anti-static property, it resists dust accumulation.

## And now, two new Sound Guard products:

**1. Sound Guard<sup>™</sup> record cleaner**, developed from extensive research into record cleaning problems and



## Sound Guard<sup>®</sup> keeps your good sounds sounding good.

 Sound Guard preservative—Sound Guard cleaner—Sound Guard Total Record Care System  
Sound Guard is Ball Corporation's registered trademark. Copyright © Ball Corporation, 1977. Muncie, IN 47302

# THE STORY OF DC

**A** year ago Sansui introduced the AU-line of DC integrated amplifiers. Other manufacturers followed.

Six months ago Sansui introduced a complete line of DC receivers, the G-series, with a patent pending on our DC amplifier circuitry. Today there are a few lines of DC

amplifiers and receivers on the market. Comparison between one company's DC line and another's is not always easy. There are significant differences, and many of the measurement techniques are entirely new. But since DC is an improvement that's here to stay, we at Sansui believe that these differences should be clarified.



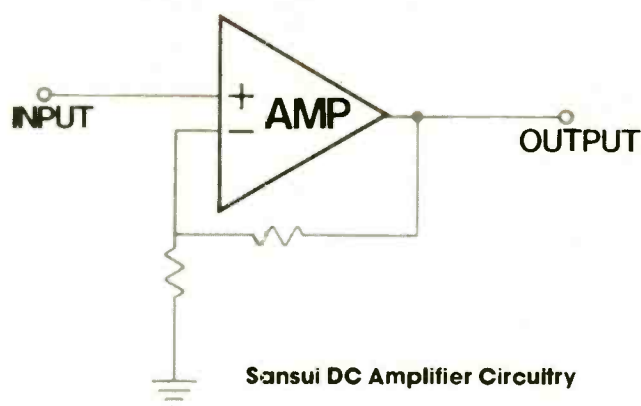
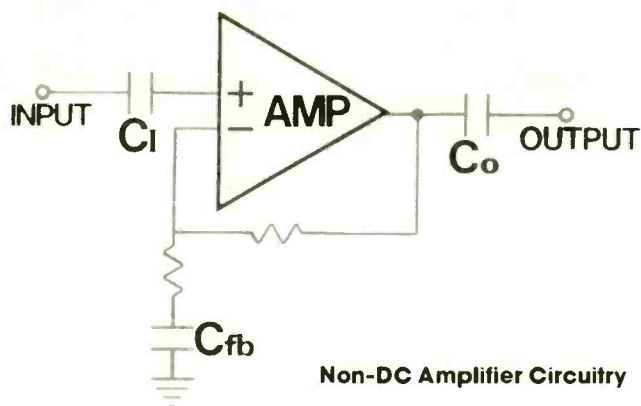

True DC components are Direct Coupled, and also Direct Current. The best DC components also offer extremely wide frequency response and very high slew rate.

Direct Coupling means basically that capacitors, which create delays in the signal path and therefore cause phase distortion, have been eliminated. But not all DC components are fully Direct Coupled. Only a very few manufacturers have eliminated their input stage capacitors, for example.

#### FREQUENCY RESPONSE

By eliminating the input capacitor, Direct Current, with a "frequency response" down to zero Hz (DC) is achieved. The frequency response of all Sansui DC components does go all the way down to zero Hz (from main-in). Other manufacturers cut off at 5 or 10 Hz. With Sansui DC response you get the best possible low frequency performance.

Sansui DC components respond all the way up to 200,000Hz in order to achieve incredibly good transient response. This requires a correspondingly fast rise time. The frequency response of many other DC components reaches only 100,000Hz or 150,000Hz.

#### HIGH FREQUENCY RESPONSE



non-DC

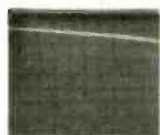

other DC

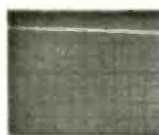

Sansui DC

#### SLEW RATE & RISE TIME

High slew rate is equally important for the quality of musical reproduction. It means simply that the amplifier will respond

fully and virtually instantaneously to high-level, high-frequency musical transients.

The slew rate and rise time measurements of Sansui DC components are far superior to those of all other competitive models.



Rise Time  
non-DC



Rise Time  
other DC



Rise Time  
Sansui DC

#### TRANSIENT INTERMODULATION DISTORTION (TIM)

Both total harmonic distortion and transient intermodulation distortion (TIM) have been dramatically reduced in Sansui DC amplifiers. This has been achieved primarily by an exclusive two-pole compensation circuit. In Sansui DC components, TIM is virtually non-existent.



non-DC



other DC

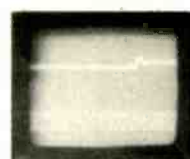

Sansui DC

When you compare overall, the specifications of the Sansui G-receivers with other DC receivers, you will understand why our line is today's best value. The Sansui G-receivers sound better because they are designed better. After all, "sound" is what it's all about.

See the complete line of Sansui DC receivers at your franchised Sansui dealer today. From the powerful top-of-the-line G-33,000 to the moderately priced G-5,000 every Sansui DC receiver delivers brilliantly clean and true-to-life music reproduction. When you listen to a Sansui G-receiver, you will never want to listen to another receiver again.



SANSUI ELECTRONICS CORP.

Woodside, New York 11377 • Gardena, California 90247 • SANSUI ELECTRIC CO., LTD., Tokyo, Japan  
SANSUI AUDIO EUROPE S.A., Antwerp, Belgium • In Canada: Electronic Distributors

CIRCLE 44 ON PAGE 149

Callas • Rostropovich  
 Perlman • Weissenberg  
 Darenboim • Tennstedt  
 Karajan • Berman

New Recordings

# A Celebration of Angel Artistry

Eloquent, distinguished.

**VIEUXTEMPS**  
**VIOLIN CONCERTOS**  
 No. 4 in D minor • No. 5 in A minor  
 PERLMAN 5-37557



5-37484

Intent, electrifying.

Authoritatively glorious.

**TCHAIKOVSKY**  
**ROMEO AND JULIET, Fantasy Overture**  
**FRANCESCA DA RIMINI, Fantasy Op. 32**  
 London Symphony Orchestra  
 ROSTROPOLICH 5-37508



5-37528

Noble and exemplary.

Ovation worthy.

**SCHUBERT**  
**SONATA IN B FLAT**  
 Op. Post. D.960  
**LAZAR BERMAN** 5D-3854 (4 LPs)



5-37495

Stunning.



unattractive, and the singing has a fresh, boyish character that sits well with the basically folklike character of the songs Hill has chosen. (An exception is "Wonne der Wehmut," which demands a more complex emotional aura than provided by this rather casual performance.) Technically, it's very accomplished singing within the limitations of such an essentially natural, "un-schooled" kind of sound, quite able to encompass the expressive range of "An die ferne Geliebte," from the nesting birds to the vision of twilight in the final song.

This latter moment is a high point, not only for Hill's rapt singing, but for the total sound picture, for the piano is a contemporary one, an Andreas Stein from the early years of the nineteenth century, and those deep chords sound with exemplary transparency. Throughout, the weight of piano and vocal sound is wonderfully matched, figurations and voice-leading in the accompaniments are crystal clear, and piano ornamentation is winningly fluent—so much so that I fear Christopher Hogwood occasionally tends to run away out of sheer exuberance with the instrument's facility. That is worth bearing, I think, for the fresh light

that these performances cast on the songs, most of which are sentimental rather than profound and thus do not gain from the heavier emotional weight of larger, more "expressive" voices. I would be very happy to hear Hill and Hogwood turn their attention to Schubert. Oiseau-Lyre gives full texts and translations, plus a sound historical note.

Beethoven song fanciers may also wish to know—or be warned—about a two-disc set emanating from Bellaphon/Acanta, the successors to the BASF historical catalog (DE 23 038). Drawn from wartime German broadcasts of variable sound quality, it includes *An die ferne Geliebte* (a shaky and ponderous performance by Karl Schmitt-Walter), some of the standard songs sung by a variety of singers, and a selection of the folksong arrangements performed in German translation. Of the whole lot, I found only Maria Müller's "Die Trommel gerühret" (from *Egmont*) really first-rate—and the piano accompaniment rather lacks the impact of Beethoven's martial orchestrations. Hans Hotter sings the fine late "Abendlied unterm gestirnten Himmel" smoothly but without much lift, and there

## Critics' Choice

The most noteworthy releases reviewed recently

- BACH:** Cantatas, Vol. 18. Harnoncourt. TELEFUNKEN 26.35340 (2), Aug.  
**BARTÓK:** For Children. Ránki. TELEFUNKEN 26.35338 (2), Aug.  
**BEETHOVEN:** Diabelli Variations. Rosen. PETERS INTERNATIONAL PLE 042, Sept.  
**BEETHOVEN:** Symphony No. 5; Fidelio Overture. Jochum. ANGEL S 37463, Aug.  
**BLOCH:** Piano Quintet No. 1. New London Quintet. HNH 4063, Aug.  
**BRAHMS:** Symphony No. 4. Levine. RCA ARL 1-2624, July.  
**BUXTEHUDE:** Organ Works, Vols. 1–2. Chapuis. TELEFUNKEN 6.42001 and 26.35307 (2). Organ Works. Lagacé. TITANIC Ti 11, Aug.  
**CHOPIN:** Ballades; Fantasy. Arrau. PHILIPS 9500 393, Sept.  
**CHOPIN:** Late Piano Works. Ashkenazy. LONDON CS7022, Aug.  
**DEBUSSY:** La Mer; Après-midi d'un faune; et al. Haitink. Philips 9500 359, July.  
**DVOŘÁK:** Symphony No. 9 (*From the New World*). Giulini. DG 2530 881, July.  
**HAYDN:** Middle Piano Trios. Vienna Haydn Trio. TELEFUNKEN 46.35332 (4), July.  
**LISZT:** Piano Sonata et al. Fialkowska. RCA FRL 1-0142, July.  
**MOZART:** Quartets Nos. 20–23. Alban Berg Qt. TELEFUNKEN 6.41999, 6.42042, July.  
**NIELSEN:** Maskarade. Brodersen, Landy, Hansen, Frandsen. UNICORN UN3 75006 (3), July.  
**PROKOFIEV:** Ivan the Terrible. Arhipova, Mokrenko, Muti. ANGEL SB 3851 (2), Aug.  
**ROSSINI** (arr. Sedlak): Operatic excerpts. Netherlands Wind Ensemble. PHILIPS 9500 395, Aug.  
**SCHUBERT:** Songs. Ameling, Baldwin. PHILIPS 9500 169, Sept.  
**SCHUMANN:** Piano Concerto. **FRANCK:** Symphonic Variations. Moravec, Neumann. SUPRAPHON 4 10 2073, Aug.  
**SHOSTAKOVICH:** Symphony No. 10. Haitink. LONDON CS 7061, July.  
**STRAUSS, R.:** Aus Italien. Kempe. SERAPHIM S 60301, Aug.  
**VARÈSE:** Amériques; Arcana; Ionisation. Boulez. COLUMBIA M 34552, July.  
**VIVALDI:** Concertos, Op. 8. Harnoncourt. TELEFUNKEN 26.35386 (2), Sept.  
**VIVALDI:** Kyrie; Gloria. Regensburg soloists, Schneidt. ARCHIV 2533 362, July.  
**VIVALDI:** Wind Concertos. Marriner. ARGO ZRG 839, Aug.  
**GEORGE THALBEN-BALL:** Organ Recital. VISTA VPS 1046, Aug.  
**GALINA VISHNEVSKAYA:** Russian Vocal Works with Orchestra. ANGEL S 37403, Aug.  
**FREUD; MACARTHUR; COMA.** Original film soundtrack recordings. CITADEL CT 6019, MCA 2287, and MGM MG 1-5403, Aug.  
**THE FURY.** Original film soundtrack recordings. ARISTA AB 4175, Aug.

*(The SoundSpace™ Control by Advent.)*



## Another Step Closer To Hearing It All.

Music sounds best in a space very unlike the usual listening room at home—a good-sized space where there is room for sound to expand and reverberate, and where the right proportions and right combination of sound-reflection and sound-absorption produce rich, warm and clear acoustics.

Advent's SoundSpace™ control, a new electronic product that uses the most sophisticated technology ever developed for home audio

required enough power to light up a city block.) It digitally processes signals from a preamp, integrated amplifier or receiver, and adds time delays that are multiply mixed and recirculated to model the ways in which sound is delayed, reflected and absorbed in good public listening spaces. The delayed sounds it creates—from standard stereo recordings and broadcasts—are meant to be fed to a second amplifier (which needs no controls) and heard over a second set of two or more speakers placed at the sides and/or rear of a home listening room.

With two simple basic controls, the SoundSpace control lets you choose how big a listening space you want to create and how reverberant you want it to be. (A digital "Size Index" display lets you see as well as hear how big a space you are creating.) As you make your choices, the SoundSpace control automatically puts you in the theoretical "best seat" of any space you create, and chooses a "stage depth" appropriate for the size of the space.

The effectiveness, simplicity, and sound quality of the SoundSpace control are far beyond those of any previous time-delay or other device for creating listening space. With very low noise and distortion (less than 0.1%), 80 dB of dynamic range, and tremen-

dous flexibility, it does what's really needed to create not just acoustic space but a whole series of *good-sounding* spaces in your living room.

Advent's SoundSpace control makes a far greater and more realistic difference in the way music sounds at home than anything you can experience by changing or improving conventional stereo components. It provides a three-dimensional "presence" that can't be achieved with tone controls, equalizers, reflective speakers or added amplifier power.

It enlivens the sound of *all* music—including the many rock and other recordings where the only original listening space is the one in the heads of the musicians, producer, and engineers.

The suggested price of the SoundSpace control is \$595.\* For more information and a list of dealers, please send us the coupon.

Thank you.

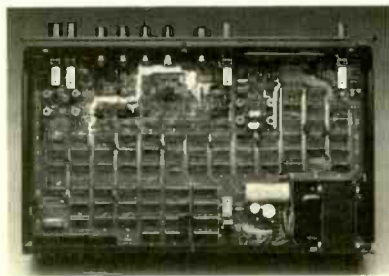

*The computer-grade construction of the SoundSpace control.*

equipment, brings home the acoustic experience of good public listening spaces. It lets you hear music much as you would in good-sounding concert halls, cathedrals, night clubs, theaters, and auditoriums.

The SoundSpace control is a 32,000-bit computer—using the equivalent of more than 43,000 transistors. (In the days of vacuum tubes, its hardware would have filled an auditorium—and

HF-10/78

To: Advent Corporation,  
195 Albany Street,  
Cambridge, MA 02139

Please send me information on  
Advent's SoundSpace™ control  
and a list of your dealers.

Name \_\_\_\_\_  
Address \_\_\_\_\_  
City \_\_\_\_\_  
State \_\_\_\_\_ Zip \_\_\_\_\_

\*Subject to change without notice.

**Advent Corporation, 195 Albany Street, Cambridge, Massachusetts 02139.**

# VIVAT PRAGA



## ...and *ave atque vale*, Rudolf Urbanec

by R. D. Darrell

**CZECHOSLOVAK MILITARY BAND:** Vivat Praga (Famous Czech Marches). Czechoslovak Military Band, Rudolf Urbanec, cond. [Jindřich Bauer, prod.] SUPRAPHON 1 14 2014, \$7.98.

are two pleasant Peter Anders tracks ("Adelaide" and "Lied aus der Ferne"). From there the level sinks to some precarious efforts by the aged Emmi Leisner—one of them, "Nur wer die Sehnsucht kennt," not even any of Beethoven's four settings of that celebrated poem, but actually Schumann's! D.H.

[At presstime the Oiseau-Lyre disc has not been scheduled for U.S. release but may be found in some import stores.]

**BIZET:** Symphony in C—See Mendelssohn: Symphonies.

**BOCCHERINI:** Quintets for Strings (6), Op. 29. Sigiswald Kuijken and Alda Stuurop, violins; Lucy van Dael, viola; Anner Bylsma and Wieland Kuijken, cellos. ABC CLASSICS/SEON AX 57022/2, \$15.96 (two discs, manual sequence).

**BOCCHERINI:** Quintets for Strings: in F, G. 279; in C. G. 324 (*La Musica notturna delle strade di Madrid*); in D. G. 341 (with Pastorale from Quintet in D, G. 270). Quinteto Boccherini. HNH RECORDS 4048, \$8.98.

Luigi Boccherini (1743–1805) was one of the most admired musicians in the latter part of the eighteenth century. As well as being a great virtuoso on the cello, he was an extremely prolific composer whose music was

liked not only by the public, but by virtually all his fellow composers. It is well demonstrated that Mozart patterned his Violin Concerto, K. 211, after Boccherini's in the same key of D.

Yet this charming, honest, sincere, and naive idealist, who loved beauty but avoided the expression of the bitter things in life, died in misery and was forgotten, save for one famous minuet. The Romantics did not know how to take his music, which is full of delicate lyric moods, delightful melodies that he liked to veil by displaced accents and syncopations, creating a soft evanescent flow. Boccherini was not troubled by the *Sturm und Drang*, did not belong to any school, and in turn created none. Even the most modern reference books say little about him, because the nineteenth century and the early part of ours did not like music free of problems and symbolism; they preferred demonic power and bottomless depth. Fétis, who is often unreliable, declared that Boccherini "knew no other music than his own," but that must be an exaggeration. As a virtuoso he traveled a great deal and must have heard the works of the Mannheimers at the Concert Spirituel; he was acquainted personally with Sammartini and Tartini; and it is recorded that he sent his compliments to Haydn via his publisher.

Nevertheless, he arrived at the string quartet and quintet independently and before knowing Haydn's work, by stabilizing

In most ways the latest addition to Supraphon's Czechoslovak Military Band series is typical: played with crisp authority, cleanly recorded in bright if somewhat lightweight (by American standards) sonics. Programmatically, it's wholly nationalistic, with only one (Julius Fučík) of the composers represented likely to be known even by name to non-Czech listeners. It is musically novel only for its several examples of so-called fanfare marches (by Fučík, Jan Fadrhons, František Zita, Jaroslav Labský, and Jaroslav Pasovský), which stem from Austro-Hungarian empire days before territorial infantry regiments were given full-sized bands to supplant makeshift ensembles of trumpeters or buglers. It might also be noted that two of the present selections embody national folk tunes in their trio sections.

What gives this disc exceptional—and intensely poignant—significance for band-music aficionados all over the world is that it is dedicated to the memory of its conductor, one of the most personally esteemed as well as professionally respected bandmasters of recent years: Rudolf Urbanec, who died in Prague on December 28, 1976. His recorded legacy includes at least seven other entries in the current Supraphon catalog of discs distributed in this country by Qualiton. Among them, American listeners are sure to find uncommon interest in the all-Sousa and all-Fučík march programs (respectively on 1 14 0586, also on cassette, and 4 14 1714, SQ-encoded) as well as in an already famous historical anthology of "Old Austrian Military Marches" (1 14 1020, also on cassette).

the preclassic gropings toward a chamber music style apart from the baroque heritage; this gentle dreamer had a very original turn of mind. Boccherini was a finished craftsman with a most sensitive ear for instrumental color. He knew his counterpoint and, above all, had a charming and inexhaustible melodic invention. True, there are few dramatic accents in his music, no rhetoric, and no confrontations, but there are plenty of beguiling ideas, a never-failing elegance of texture, and an unmistakable pleasure in creating these pleasant works. What is wrong with music that aims to entertain, in the best sense of the word? Why can't we enjoy and value works that are not weighted with *Weltanschauung*?

The Op. 29 quintets are chamber music at its attractive best. No. 2 has a robust first movement with rich sonorities, the Largo's melodies are dark yet warm, and the finale is a spanking good fugue devised for just such an ensemble. (It would not be accepted by the likes of Ebenezer Prout.) A string quintet is not, of course, simply a quartet with an extra viola or cello; it is much richer in sound, and the pivotal use of the fifth voice permits fully harmonized antiphony of three vs. three. Mozart used a second viola in his quintets, but Boccherini preferred two cellos, partly because he liked the color combination, partly because he usually played the first cello, and partly because many of these works were written for the Prussian king, Frederick William II,

# OUR NEW CASSETTE DECK WOULD BE DAZZLING EVEN WITHOUT THE COMPUTER.

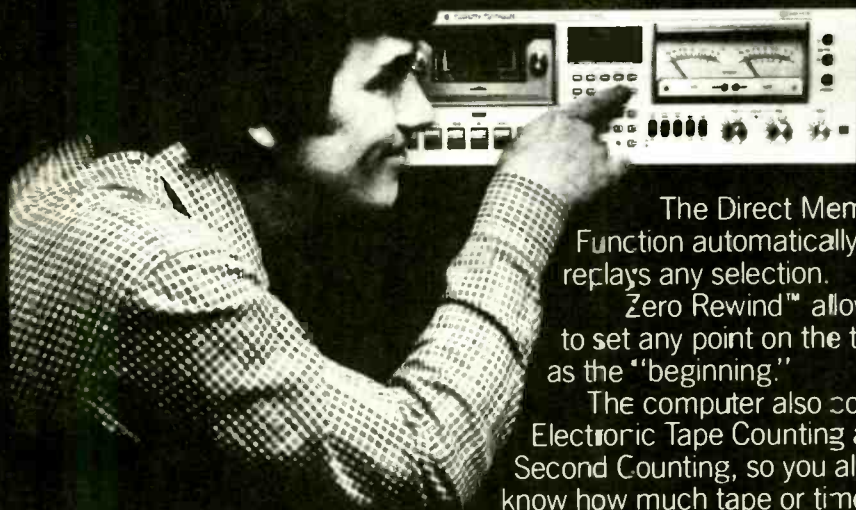

The first cassette deck controlled by computer—a micro-processor with no fewer than five memories—would be enough to dazzle anybody.

You merely program the computer: tell it how and when you want to listen to which song.

It controls Sharp's exclusive Auto Program Locate Device. This unique feature skips ahead or back to any song you select (up to 19 songs) and plays it automatically.

The Direct Memory Function automatically replays any selection.

Zero Rewind™ allows you to set any point on the tape as the "beginning."

The computer also controls Electronic Tape Counting and Second Counting, so you always know how much tape or time you have left.

A Liquid Crystal Display shows you current mode and function.

The built-in digital quartz clock acts as a timing device; it displays timed-programming operations, so you can actually program your RT-3388 to record automatically from a radio or TV at any pre-selected time and then switch itself off.

But what really makes the RT-3388 so special is that the musical performance of the deck is

every bit as dazzling as the electronic performance of the computer.

Just a few specs tell the story: S/N ratio; 64dB with Dolby.\* Wow and flutter a minimal 0.06%. Frequency response, 30-16,000 Hz ( $\pm 3dB$  for FeCr).

Without the computer, the RT-3388 would merely be one of the best engineered cassette decks you could find.

But how nice that you can have the deck with your own private computer to run it. (The RT-3388 is just one of a complete line of Sharp® cassette decks with the unique ability to find and play your music for you.)

When your Sharp dealer shows you the RT-3388, we suggest that you ask to hear some music first.

Then go ahead and let the computer dazzle you.

Sharp Electronics Corp.  
10 Keystone Place  
Paramus, N.J. 07652

**SHARP**

**SHARP'S RT-3388.**  
**THE FIRST COMPUTER THAT PLAYS MUSIC.**



Only good music. Music without distortion. If your turntable is a BSR Quartz® turntable, you see, with the introduction of the Quanta models 600, 700 and 800, BSR has created a turntable base with virtually no resonance.

# NO MORE BAD VIBRATIONS.

Other turntables reduce resonance with concrete and foam. Low-frequency absorbing foamed concrete inside high-frequency absorbing foam.

Not one little vibration thanks to the isolation of the resonance-tuned suspension feet.

No acoustical feedback. Just beautiful sound. And that's only the beginning.

On every BSR Quanta turntable is an S-shaped statically balanced tonearm. Viscous damped cueing for perfectly smooth arm movement. Arc on the Quanta 800 is the most accurate Quartz Phase-Locked Loop direct drive motor in existence. The quartz generated pulsed LED strobe display provides visual monitoring of the speed.

BSR Quanta turntables. Non-resonating. Not bad.

**BSR**

QUANTA®

**THE NON-RESONATING  
TURNABLES.**



a capable cellist for whom Mozart composed three quartets with elaborate cello parts.

No. 3, in F, has an energetic Allegro of symphonic élan but is still altogether within chamber music boundaries. Here, as well as in No. 5, we observe Boccherini's most endearing quality, the constantly changing little mood pictures that he manages even in the minuets, notably the one in No. 4. However tightly constructed a fast movement may be, he usually smuggles in one or two fine little melodies with their slightly melancholy undertone. No. 5 is an intimate, predominantly lyric work with a refined dynamic scheme. No. 6, in G minor, is elegiac, with a sepulchro-like Preludio leading to a cheerful rondo. Throughout these works the colors constantly change with the moods, and there is a mixture of the galant with virtuoso configurations, which is a personal mark of Boccherini's style.

The ABC/Seon performers are all able instrumentalists, but they form an ad hoc ensemble, not a group that plays together day in and out. They master their respective parts and stay nicely together, but only in No. 5 do we perceive that unanimous spirit that is the essence of chamber music. Sigiswald Kuijken, the first violinist, presses in the higher regions, and the sound becomes metallic. (We hope he does not perchance stoop to using a wire E string; that would be inexcusable for such a stalwart history-conscious artist!) I suspect that poor monitoring contributes to this occasional harshness. The attacks are good in the fortes and in the fast movements, but a bit spineless elsewhere, and there is not enough finesse in the dynamic scheme, which merely undulates. Still, the performance is good enough for us to enjoy this unknown music.

With the HNH disc, the first thing we notice after half a dozen measures is that the Quinteto Boccherini (the spelling is Spanish, although most of the players have Italian names) has a settled ensemble spirit as well as technique. The playing is superior, the precision admirable; all the strings have a warm and nicely equalized tone. The first violin leads with authority (there is daylight between the notes even in the very fast passages), and the balances are superb.

The F major Quintet, G. 279 (we shall not discuss here the garbled chronology and numbering of Boccherini's works), offers particularly smooth and elegant part-writing; the Largo sings with abandon, while the Presto is a tour de force both as composition and as performance. The D major Quintet, G. 341, has a remarkably extended minuet, then a slow introduction leads to a splendid fandango. Boccherini having lived from 1768 onward in Spain, the exotic rhythms of that country are often present in his music.

He very rarely indulged in program or descriptive music, but the final composition on this disc, entitled "The nocturnal music of the streets of Madrid," is one such instance. In a letter to his publisher in Paris, Boccherini said that "this piece is absolutely useless and even ridiculous outside



# The most powerful argument for our new receiver is not just power.



True, it's tempting to be swept up by our power.

150 watts per channel minimum RMS at 8 ohms, from 20Hz to 20kHz, with no more than 0.07% Total Harmonic Distortion, is nothing to sneeze at.

But raw power means nothing. What's important is how that power is delivered. In the case of the STR-V7, it's brought to you by Sony in a very classy package.

You get a combination of features and controls that are impressive on their own—but almost unheard of in a single machine.

To start with, we've built in a Dolby system, for decoding Dolbyized FM broadcasts.

The advantages of our tuner,

though need no decoding. They include a normal and narrow FM IF bandwidth selector. It makes life simple for people in areas where their signals are crowded together elbow to elbow.

In our preamp section, the V7 comes equipped with a special phono EQ circuitry. Thanks to Sony's high IQ, it allows for direct connection of a low-output, moving-coil cartridge phono source. Without calling for an external step-up transformer or pre-preamp.

When you're gifted with as much power as the V7, you need a way to keep track of it. This receiver keeps tabs with two power-output meters, monitoring the power being fed to the speakers. So overload can't result from oversight.

And all that power comes from our direct coupled DC power amp. And our power is stable, thanks to a high-efficiency, high regulation toroidal-coil transformer.

There's a lot more to the STR-V7 than power. This receiver takes the best that contemporary technology has to offer, and offers it in a single machine.

Other manufacturers may have the power to bring you power. But only Sony has the power to bring you more than just power.

# SONY<sup>®</sup> AUDIO

# KEEP ROCK



# CLEAN

Dirty, fuzzy high frequency sound is great when a rock artist plays it. But not so great when your cassette adds it. Unfortunately, most cassettes, no matter how costly, do just that. Fortunately, our premium AD cassette cleans up that act, and without cleaning out your wallet. A unique ultra-sensitive formulation gives it a hot high end. So you don't have to set those high notes on the back burner—they can cook right up front—loud, clear, and distinct. And AD is ideal for any noise reduction system. AD, like all TDK cassettes, is backed by a full lifetime warranty. \*TDK Electronics Corp., Garden City, N. Y. 11530.



Wait till you hear  
what you've been missing.

\*In the unlikely event that any TDK cassette ever fails to perform due to a defect in materials or workmanship, simply return it to your local dealer or to TDK for a free replacement.

CIRCLE 57 ON PAGE 149

## Handbook of Multichannel Recording

Here is very possibly the single most important book on sound recording for the layman or professional who wants to make quality recordings of musical groups. For the first time, here's a book that covers it all—dubbing, special effects, mixing, reverb, echo, synthesis—for both stereo and four-channel recording. Simply circle No. 781 on the coupon.

"Handbook of Multichannel Recording" is only one of a wide selection of carefully chosen audio books made available to HIGH FIDELITY readers through Music Listeners' Book Service. (Many of the selections are not readily available in bookstores.) Choose your books from the list, circle the numbers on the coupon, and enclose your check or money order. That's all there is to it.



No. 781 HANDBOOK OF MULTICHANNEL RECORDING. F. Aiton Everest.

A comprehensive volume of 322 pages, with 201 illustrations, covering all aspects of live recording in both stereo and four-channel formats. Paperbound: \$7.95. Hardbound: \$10.95.

No. 603 DURABLE PLEASURES, A Practical Guide to Better Tape Recording. Hans Fantel.

Written in nontechnical language by one of the most respected writers in the field, this illustrated volume is a "must" for all tape recordists, whether beginners or old hands. \$8.95.

No. 756 FOUR-CHANNEL STEREO FROM SOURCE TO SOUND. 2nd Edition (1974). Ken W. Sessions, Jr.

Complete technical and nontechnical information on all approaches to four-channel sound, both discrete and matrix. Paperbound: \$4.95. Hardbound: \$7.95.

No. 640 SELECTING AND IMPROVING YOUR HI-FI SYSTEM. (1973) Harvey Swearer.

A handy guide to what to look for, what to expect and what to avoid in setting up or expanding your home audio system. Paperbound: \$4.95. Hardbound: \$7.95.

Check or money order must accompany your order.  
No cash or C.O.D. s, please.  
Allow 60 days for delivery.

HIGH FIDELITY  
MUSIC LISTENERS' BOOK SERVICE  
Dept HW  
P.O. Box 550  
Great Barrington, MA 01230

Here's my check for \$ \_\_\_\_\_ Please send  
me, postpaid, the books I've circled below.

781 603 756 640

Name \_\_\_\_\_

Address \_\_\_\_\_

City, State, & Zip \_\_\_\_\_

of Spain." Well, it is perhaps a little strange, but what delectable rhythms and colors! A brief plaintive ritornel, almost like psalmody, separates the full-voiced "couplets," with some eerie pizzicatos interspersed. The thing is bizarre but also haunting, and perfectly enjoyable even outside of Spain, especially when so well performed.

P.H.L.

**BRITTEN:** Peter Grimes: Sea Interludes and Passacaglia—See Vaughan Williams: Fantasia on a Theme by Tallis.

**CHOPIN:** Scherzos (4); Impromptu (4). Roberto Szidon, piano. [Wolfgang Mittlehner and Rainer Brock, prod.] DEUTSCHE GRAMMOPHON 2536 378, \$8.98.

**Comparisons—scherzos:**  
Rubinstein RCA LSC 2368  
Barbosa Conn. Soc. CSO 2071  
**Comparison—impromptus:**  
Vasáry DG 136 455

Roberto Szidon's recording of the Liszt Hungarian Rhapsodies (DG 2709 044, May 1974) seemed to me full of pianistic dazzle and wanting in musical characterization. The dazzle remains, and I can't say that I am happy with his musical progress.

I am all in favor of freewheeling abandon and interpretive innovation provided that the liberties grow out of deep conviction and result in some clarification of the work's content. And certainly at least three of the Chopin scherzos have explosive ardor among their ingredients. But Szidon's playing often has little more meaning than idle graffiti, and I simply cannot fathom his apparent inability to resist tasteless nuances and garish dynamic contrasts, his insipid diddling with tempo and phrasing. Lyrical sections are generally protracted, while rapid passages are frequently fragmented, italicized, and toyed with self-indulgently.

DG has captured Szidon's bright, cutting sonority well, although the large quantity of music squeezed on the disc results in a low recording level and uncomfortably brief pauses between selections. For the scherzos, Rubinstein's RCA disc is still my first recommendation, with Connoisseur Society's Antonio Barbosa approximating his robust readings surprisingly closely. For the impromptus, Tamás Vásáry's older DG disc (with the four ballades) represents a far superior order of artistry. H.G.

**COPLAND:** Piano Works. Joan Singer, piano. GOLDEN AGE GAR 1008/9, \$13.98 postpaid (two discs; Golden Age Recording, 5347 28th St., N.W., Washington, D.C. 20015).

The Cat and the Mouse (1920). Passacaglia (1922). Sentimental Melody (1926). Piano Variations (1930). Two Children's Pieces: Sunday Afternoon Music; The Young Pioneers (1936). Sonata (1941). Four Piano Blues (1926/48). Piano Fantasy (1957). Down a Country Lane (1962). In Evening Air (1966). Night Thoughts (1972).

**COPLAND:** Piano Works. Charles Fierro, piano. [Heidi Lesemann, prod.] DELOS DEL 25436, \$7.98.

Passacaglia; Piano Variations; Piano Fantasy; Night Thoughts.

# SLICK

Most advertising is. Clever headline (like this one), sharp photo, slick copy.

Happiness, they tell us, is smelling like Joe Namath, eating an Egg McSomething or wearing shirts without ring around the collar. So we buy and nothing magical happens.

Our advice: clip the ad if you like it. Be much more cautious before *buying* a product.

About turntables. With 48 manufacturers competing for your attention and dollars, claims can get pretty wild. They keep telling us why this year's wonder is so much better than last year's miracle.

At Garrard, we know that the only way to stay ahead of the competition is to upgrade technology and features — not claims. That's how we've stayed at the top for over 50 years.

We believe our new GT turntables are the finest and most dependable Garrard has ever produced (they're warranted for 3 years)\* Now that's a strong claim and we've just suggested that advertising claims are self-serving. So here's what *others* say about our turntables.

**High Fidelity on the GT35:** "...Its... tonearm... one of the lowest in mass of this general type that we have ever encountered..."

**Audio on the GT35:** "...should give years of trouble-free service..."

**Stereo on the GT35:** "...worked perfectly, and with impressive silence and smoothness..."

**Popular Electronics on the GT25:** "...cannot be dismissed as just another record player... the tonearm is compatible with any cartridge presently manufactured, no matter how compliant it may be... an excellent medium-priced record player."

**Radio Electronics on the Delglide Automatic System (in all GT models):** "...the pick-up arm is handled more gently than could be done by the steadiest of hands..."

There it is. With such reviews, you can see why we don't have to claim instant happiness. Our turn-

tables will merely change the way you listen to music. Not a bad place to start.

\*Limited warranty.



## Garrard

More than ever.

For a free brochure, write:  
Garrard, Division of Plessey Consumer Products, Dept. B  
100 Commercial Street, Plainview, N.Y. 11803.

The Golden Age set—accurately if not very stylishly entitled "All the Piano Music by Aaron Copland"—is well intentioned but little else. Joan Singer can cope reasonably well with the smaller works on the program but is technically out of her depth in the bigger ones. True, some of these short pieces don't seem to be recorded otherwise, but this is an expensive way to acquire them—and a noisy one too, for the surface roar on these discs surpasses anything this reviewer has encountered on any commer-

cial record pressed west of Budapest in the last two decades (a compound of ground gravel and library paste, I would guess). In addition, the piano sound is dull and limited, several tape burbles have crept in, and the splice-editing is not well done.

Charles Fierro's disc is altogether more distinguished, and includes the only recording (aside from Singer's) of the brief but eloquent *Night Thoughts*. This is well done, though the piano tone is a shade pallid and unseductive in the gentle closing measures. The other pieces come up against stiffer competition, and, although Fierro's playing is shapely and often well characterized

(particularly in the early parts of the Piano Variations), it's short on tension. This is particularly damaging in the lengthy and problematic *Fantasy*, which really needs the greater dynamic range and energy of William Masselos' performance on *Odyssey*, a disc that also contains the best recording of the Variations. D.H.

**B** **DEBUSSY:** Quartet for Strings, in G minor, Op. 10. **RAVEL:** Quartet for Strings, in F. Orford Quartet. LONDON TREASURY STS 15440, \$3.98.

Comparison—same coupling: LaSalle Qt

DG 2530 235

The Orford Quartet—violinists Andrew Dawes and Kenneth Perkins, violist Terence Helmer, and cellist Marcel St. Cyr—was founded in 1965 and now enjoys some repute in Canada. Its first recording to reach these parts is of "acid test" repertoire for any such group, made more beguiling by the absence in SCHWANN-1 of a rival budget version of this perennial pairing.

Clearly, the Orford knows how to breathe and mold and sway with this idiom. Its rubato is intuitively convincing, and overall tempo choices make sense. Internal balance is evenhanded, thanks in part, no doubt, to the Decca/London recording team. Indeed, the candor of the recorded sound points up some problems: rather gluey tone from the violist and cellist, and intonation that becomes a liability in the Ravel quartet—note the closing bars of the first movement and the opening of the third.

My recommendation for this coupling remains the magical interpretation of the LaSalle Quartet. A.C.

**DVOŘÁK:** Concerto for Cello and Orchestra, in B minor, Op. 104. **SAINT-SAËNS:** Concerto for Cello and Orchestra, No. 1, in A minor, Op. 33. Mstislav Rostropovich, cello; London Philharmonic Orchestra, Carlo Maria Giulini, cond. [David Mottley, prod.] ANGEL S 37457, \$7.98 (SQ-encoded disc). Tape: ♣ 4XS 37457, \$7.98.

**R** **DVOŘÁK:** Concerto for Cello and Orchestra, in B minor, Op. 104\*; *Othello Overture*, Op. 93. Mstislav Rostropovich, cello\*; Czech Philharmonic Orchestra, Václav Talich, cond. REDIFFUSION HERITAGE COLLECTION HCN 8004, \$7.98 (mono) [from SUPRAPHON originals, 1952 and 1951] (distributed by Qualiton Records).

Comparisons—*Dvořák concerto:* Rostropovich, Khaikin/Moscow Radio Sym. West. WGM 8245, Mon. MCS 2090 Rostropovich, Boult/Royal Phil. Sera. S 60136 Rostropovich, Karajan/Berlin Phil. DG 139 044

Allowing for the possibility—nay, the probability—of an additional Soviet version or two, I count six Rostropovich recordings of the Dvořák B minor Cello Concerto, ranging in time from the youthful 78-rpm efforts with Rakhlin and Talich to the new collaboration with Giulini.

The new performance and the Rediffusion reissue provide a fascinating comparison. While the great cellist has had his rec-

## High Fidelity's Music Listener's Book Service offers the reprint edition of Clough and Cuming's **The World's Encyclopaedia of Recorded Music**

The most comprehensive reference work on classical recordings of the electrical and early microgroove eras from 1925 through 1955, this 3-volume set (commonly called "Werm") is the ultimate addition to the record collector's library shelf. For years unavailable except through the catalogs of out-of-print booksellers, now the complete original text is yours in sturdy, library-bound Greenwood reprint editions. Over 1,700 pages of information, some only available from this source.

- Basic Volume (1925-1950) Including; First Supplement (1950-51). xviii, 890 pages.
- Second Supplement (1951-52). xxii, 262 pages.
- Third Supplement (1953-55). xxvi, 564 pages.

All three volumes \$87.50, plus \$2.75 shipping.



MAIL TO: Music Listener's Book Service High Fidelity Magazine, Great Barrington, MA 01230

Yes! Please send \_\_\_\_\_ set(s) of Clough and Cuming's *The World's Encyclopaedia of Recorded Music* for \$87.50 per set plus \$2.75 for shipping.

I enclose \$\_\_\_\_\_ (Residents of Ohio, N.Y. and Mass. add applicable sales tax.)

Charge to  Master Charge  BankAmericard/Visa

My credit card number is

Master Charge Interbank number  Card expires \_\_\_\_\_ Signature \_\_\_\_\_

Name \_\_\_\_\_

Address \_\_\_\_\_

City \_\_\_\_\_ State \_\_\_\_\_ Zip \_\_\_\_\_

Allow 4 to 6 weeks for delivery

## THE INSIDE STORY ON AKAI'S GREAT PERFORMANCE.

### AKAI GXC-730D

Wow and Flutter:  
less than 0.08% WRMS

Frequency Response:  
30 to 17,000 Hz ( $\pm 3$  dB using FeCr tape)

Distortion:  
less than 1.5% (1,000 Hz, "O" VU)

Signal-to-Noise Ratio:  
better than 60 dB using LN tape with Dolby on (measured via tape with peak recording level of +3 VU)

Bias Frequency:  
100 kHz

Heads:  
(3) one GX recording/playback head for forward and reverse direction; two erase heads.

Motor:  
4-pole hysteresis synchronous motor

Dimensions:  
17.3"W x  
6.9"H x  
11.9"D

Weight:  
27 lbs.

### GREAT PERFORMANCE FEATURES:

Automatic stop or stop and play mode from fast forward or rewind with "memory wind". Soft touch solenoid AKAI's Automatic Distortion Reduction System, limiter circuit to cut distortion microphone or line input selector, peak level indicator and reverse selector.



## DON'T INTERRUPT LIFE'S GREAT PERFORMANCES.

With the new AKAI GXC-730D, great moments in music aren't shattered by those not-so-great moments in cassette rewinding and flipping.

Instead, a bi-directional GX record/playback head allows you to play both sides continuously. Automatically. And you can play or record both sides without ever having to stop and physically turn the cassette over.

The fact that the 730D is the most versatile front-loading cassette deck on the market is just the beginning. It's also loaded with some pretty fantastic features.

Like Dolby\* and AKAI's exclusive

Automatic Distortion Reduction System (ADRS). Memory rewind. Pause control. Separate right and left channel record level controls. Soft touch, direct function operating controls. Peak level indicator. Illuminated VU meters. A great-looking walnut-grained vinyl cover. And all the specs you'd expect an AKAI top performer to deliver.

Hear it at your dealer's.

The AKAI GXC-730D. Dedicated to the proposition that some of your performances are just too good to interrupt.

\*Dolby Labs, Ltd.

# AKAI

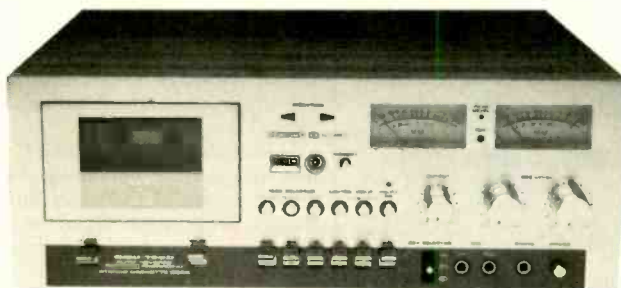

### ART COLLECTORS:

For an 18" x 24" reproduction of this Charles Bragg etching suitable for framing, send \$2 to AKAI, Dept. HF, P.O. Box 6010, Compton, CA 90224, ATTN: Lovers.

# An open and shut case for buying Maxell LN tape.

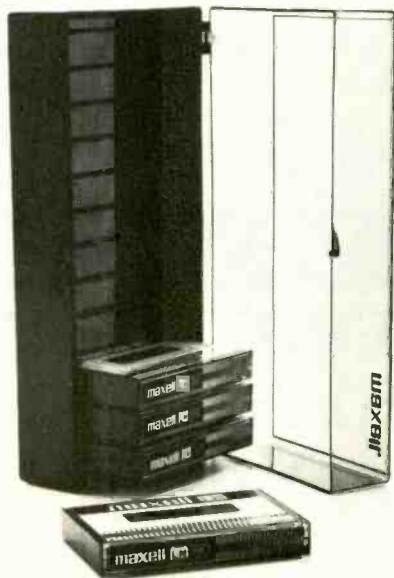

The case in point is this twelve slot cassette storage file.

It's free when you buy this special package of four Maxell Ultra Low-Noise cassettes. Some of the world's finest all purpose tape.

That way you'll not only have recordings that are free of dropouts and noise, you'll have a great place to keep your tapes safe and sound.

Case closed.

**maxell** 

\*Available at participating dealers.



Mstislav Rostropovich—competing against himself in Dvořák

ognizable, individualistic interpretation from the start, it can be much modified according to the occasion and conductor. Thus the c. 1958 reading with Boult on Seraphim takes on an almost aggressive militancy, perhaps influenced by Sir Adrian's brusque, no-nonsense tempos, while that with Boris Khaikin (on both Westminster Gold and Monitor)—with its saxophonelike horns and segmented orchestral framework—has rather clipped, italicized phrasing in the solo part. I was rather vehement in my dislike for the late-Sixties DG account with Karajan, but, rehearing that beautifully reproduced disc, I am impelled to modify my views. To be sure, there is a certain Teutonic sentimentality—a feeling of excessive luxuriance and slick sophistication that clashes with the folk elements in the music—but such marvelously drawn gradations of tone and subtly gauged precision cannot be completely disparaged.

Rostropovich also seems to have modified his views. His performance with Giulini closely resembles that with Karajan, but his sensuality is now a bit more low-key and less insistent. Giulini himself might have conducted a very different sort of framework had he recorded this concerto in the late Fifties, when he was still a hard-driving maestro in the Toscanini-Cantelli-Galliera tradition. My chief complaint with the present-day version is that Giulini's slowish tempos are sometimes a trifle fancy, lacking directness and vitality—as illustrated by the protracted ritard on the first movement's final measures. Even so, his ear for detail is extraordinary (and felicitous details abound in this marvelously crafted score).

In the Saint-Saëns A minor Concerto, the new partnership combines the easy melodic lyricism of the older Rostropovich/Sargent (RCA, deleted) and the galvanic, ultra-clear, but rather stiff-jointed Starker/Giulini (Angel, deleted) with a refined elegance surpassing either of those fine editions. If there is a more lovely or loving ac-

count of this charming, lightweight concerto, I have not heard it.

But my long-held opinion that the 1952 Rostropovich/Talich Dvořák is one of the all-time great concerto recordings is triumphantly renewed by Rediffusion's reissue in excellent mono sound. Rostropovich, then in his mid-twenties, plays with a combination of rhapsodic verve and irresistible lyricism. His intonation may not quite be what it became later (a few spots in high position sound a bit suspect in the first movement, particularly when playing against woodwind chords), but by any reasonable standards his technical ability is in the highest echelon.

What for me makes this the greatest of Rostropovich's Dvořák recordings is the sublimely idiomatic playing of the Czech Philharmonic under Talich (who was a teenager when the concerto had its premiere and undoubtedly knew the composer well). His reading is full of heartwarming sentiment but is free of sentimentality. Tempos are spaciously inflected but at the same time brisk and firm. Talich knew how to draw a broad, compassionate sonority from his players but maintained a Toscanini-like concision, a crispness of attack and release that energizes Dvořák's invigorating patterns.

And how his players respond! The slight tinge of vibrato in the oboes, the pastoral flutes, the reedy clarinets, and the mellifluous, transparent horns stand out in refreshing relief against the crisp, songful strings and punctilious timpani. Supraphon's quarter-century-old sound wears its years with honor: There is liveness, presence, and impact aplenty, and one can almost listen to the performance as if it were a modern recording. This reading is unique, in its way, as was the equally magnificent prewar account by Casals and Szell with the same great orchestra (Seraphim 60240).

Talich's *Othello Overture*, recorded a year before the concerto, is of a piece interpretively and sonically. H.G.

# The new Yamaha Separate.

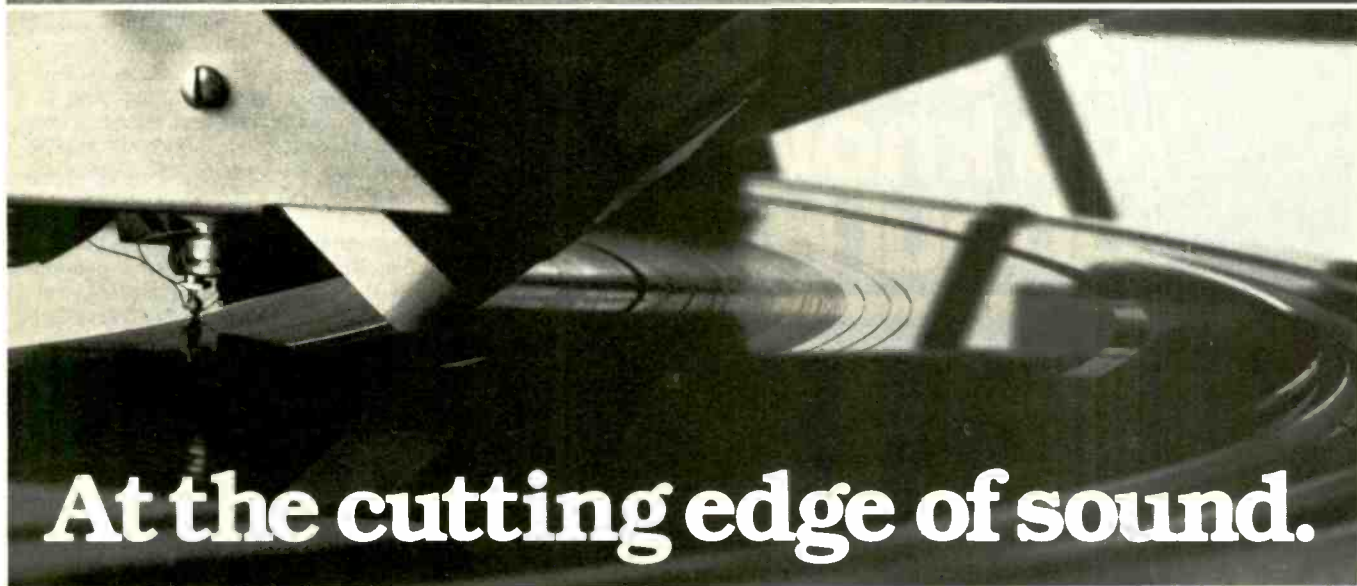
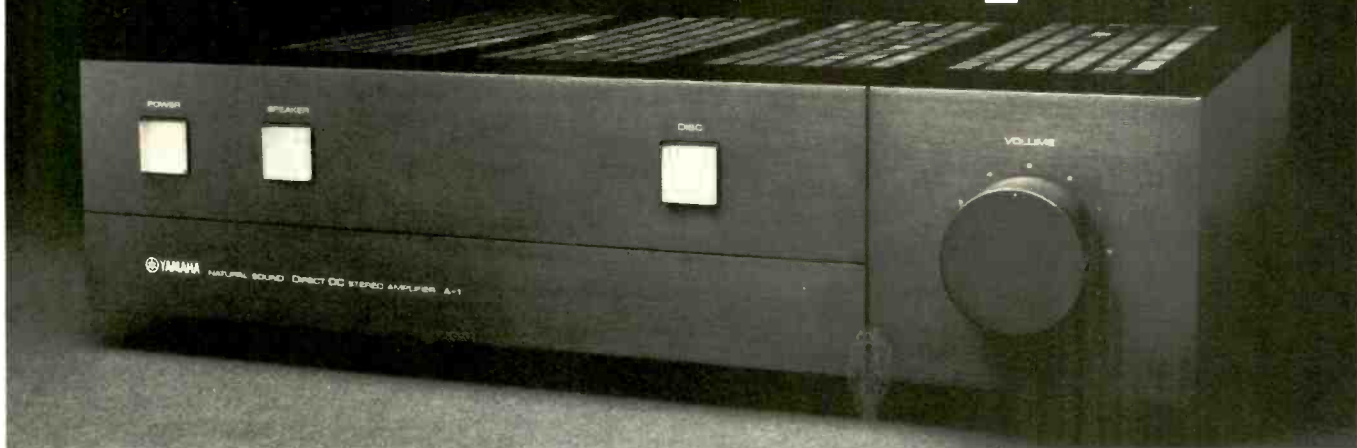

## At the cutting edge of sound.

At the very edge of audio technology is exactly where the new Yamaha A-1 Amplification System stands.

Our engineers got there by cutting out excess circuitry and components through innovative configurations that reduced the very number and possibilities for noise and distortion to occur. It's as close as you can get to the proverbial straight wire with gain.

For a key example, note the computer-grade DISC switch on the right front panel. Engage it and you virtually direct-couple the phono cartridge to the output power amp. When disengaged, the tone control circuit is inserted between the DC phono equalizer and the DC amplifier. Sleekly positioned behind the bottom front panel, these precision tone controls can be used to enhance any signal source.

There's even a built-in MC Head Amp so

you can enjoy the transparent highs and extended frequency response of a moving coil phono cartridge.

In short, precision sound has never been achieved so cleanly and simply in look and function. So go for the cutting edge. Listen to the new A-1 Amplification System and its companion, the new T-1 Tuner, at your Audio Specialty Dealer.

For his name, check the Yellow Pages, or write Yamaha.



 **YAMAHA**

Audio Division, P.O. Box 6600, Buena Park, CA 90622

**DVOŘÁK:** Overtures: My Home, Op. 62; In Nature's Realm, Op. 91; Carnival, Op. 92; Othello, Op. 93. Prague Radio Symphony Orchestra, Jaroslav Krombholc, cond. [Pavel Kühn and Jan Vrána, prod.] SUPRAPHON 4 10 1990, \$7.98 (SQ-encoded disc).

Comparison—Opp. 91–93:  
Kubelik/Bavarian Radio Sym.

DG 2530 785

Krombholc's firm, straightforward, relatively neutral approach works for *My Home*, which sounds like a better piece than it does when more individual conductors overburden its tentative structure with lyrical effusion or rhetoric.

This approach serves the Opp. 91–93 overture cycle less well. *In Nature's Realm* would benefit from more poetic sensitivity; *Othello* needs more somber power; and the familiar *Carnival* could do with a mite more color and dash. All of these were provided by Rafael Kubelik in his recent DG recording (reviewed in February), which is filled out with the *Husitská* overture, a more distinguished work than *My Home*. Kubelik's Bavarian Radio Symphony also plays with more warmth than the slightly undernourished, though capable enough, Prague Radio Symphony.

Both DG and Supraphon provide fine en-

gineering, if less distinctive than London's for István Kertész (CS 6574) or Philips' for Witold Rowicki (issued as fillers with his Dvořák symphonies). A.C.

**DVOŘÁK:** Serenade for Strings—See Vaughan-Williams: Fantasia on a Theme by Tallis.

**FALLA-HALFFTER:** *Atlántida*.

Queen Isabella  
A Lady of the Court  
Queen Pyrene  
The Pleiades

Enriqueta Tarres (s)  
Paloma Pérez-Iñigo (s)  
Ann Ricci (ms)  
Paloma Pérez-Iñigo (s)  
Young-Hee Kim Lee (s)  
Julia Casamayor (s)  
Maravillas Losada (ms)  
Maria del Carmen Torrico (ms)  
Maria Luisa Castellanos (a)  
Terry Ann Hughes (s)  
Evelia Marcote (a)  
Eduardo Giménez (t)  
Vicente Sardinero (b)  
Gregorio Oreja Armendariz (t)  
José Gabriel Vivas Sayas (t)  
Jesus Sanz Remiro (bs)

Archangel  
Narrator  
Geryon

Children's Chorus of Our Lady of Remembrance, Spanish National Chorus and Orchestra, Rafael Frühbeck de Burgos, cond. [Suvi Raj Grubb, prod.] ANGEL SBLX 3852, \$16.98 (two SQ-encoded discs, automatic sequence).

Though *Atlántida* is in many ways the most nationalistic of Falla's works, it contains none of the local color and dancelike brio that have helped to make *The Three-Cornered Hat* and *El Amor Brujo* so widely popular. *Atlántida*, for all that it was left incomplete at the composer's death, brings to a climax the tendencies evident in his later music, especially the haunting concerto for harpsichord and chamber orchestra of 1923, by which date extroversion had given way to contemplation and nostalgia. Not that the concerto is any less Spanish in character than the earlier works: The difference is that its animating spirit is no longer place, but history.

In this allusive work Falla meditates upon the musical achievements, ranging from the popular to the solemn, of his native land during the past several centuries and, out of the juxtapositions and confrontations to which he subjects his material, finds solace and a sense of cultural stability. Here he is more directly and expansively concerned with his cultural heritage, the subject of this huge and quasi-dramatic work being not music, but the divinely appointed destiny of Spain to spread the word of God, through the agency of Christopher Columbus, to the unknown lands across the Atlantic.

The poem by the nineteenth-century Catalan priest Jacinto Verdaguer on which most of *Atlántida* is based (the text of one brief section was provided, at Falla's request, by a contemporary Catalanian poet and playwright) is a latter-day epic, a commingling of local history and eternal myth for the ends of universal spiritual enrichment. In *Atlántida* the geological creation of the Iberian Peninsula is coupled with the cataclysm through which God submerged Atlantis beneath the waves as punishment for its inhabitants' impious attempt to rival His power.

If you know  
about ROTEL  
You know  
about Hi-Fi



Quality. Uncompromised.

**ROTEL**

ROTEL OF AMERICA, INC.

1055 SAW MILL RIVER ROAD, AROSLEY, NEW YORK 10502 (in Canada—NORESCO, Downsview, Ontario)

CIRCLE 70 ON PAGE 149



# HEAR AT LAST. ACUTEX, THE WORLD'S BEST SOUNDING CARTRIDGE.



You won't need a golden ear to hear the difference between a good stereo cartridge and the best stereo cartridge you can get — Acutex.

The Acutex sound is richer, clearer, more three-dimensional. Because Acutex separates your stereo's left channel signal from its right better than any other cartridge you can get. At any price. And we've got the specs to prove it.

**"ACUTEX CLAIMS (OF) IMPROVED SEPARATION ARE NO IDLE BOAST."\***

But separation is just the beginning. Acutex sensitivity picks up more of what your records have to give.

And Acutex cuts down on the hiss and scratch of surface noise. So you hear more of what you do want to hear, and less of what you don't.

**"FREQUENCY RESPONSE WAS ABOUT RULER FLAT."\***

How does Acutex do it? With a new tri-ple

induced-magnet design. This unique, patented design not only minimizes channel "crosstalk" and enhances separation, it also delivers superior trackability.

**"THE CARTRIDGE AGAINST WHICH ALL OTHERS WILL BE MEASURED."\*\***

Relax, the world's best sounding cartridge is not the world's most expensive. Our bottom of the line beats our competition's top of the line. And our top of the line costs less. You can choose from six Acutex models, and pay as little as \$45 to \$175.

So try an Acutex cartridge on your stereo system. And hear your stereo at its best. At last.

And stay tuned to Acutex for speakers that look and sound like no other speakers for the money.

\*Audio

\*\*Complete Buyer's Guide to Stereo



**ACUTEX**  
THE WORLD'S BEST SOUNDING CARTRIDGE.

# Introducing THE BOOM BOX.

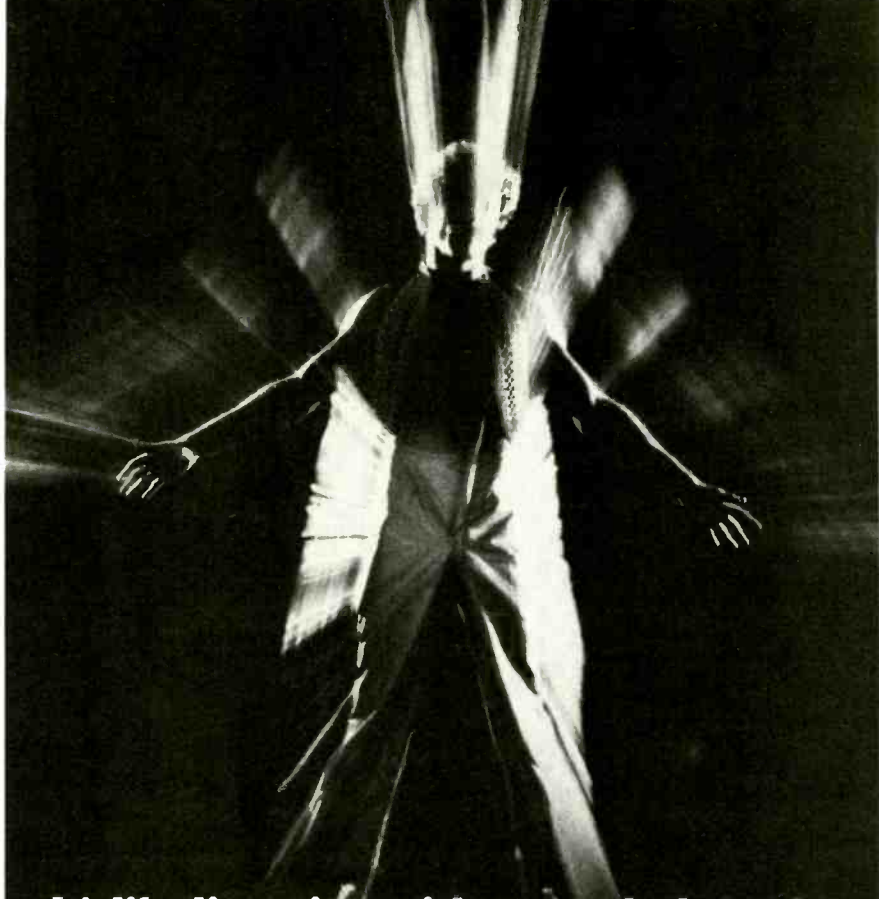

## It's like listening with your whole body.

You know how good a live bass feels. It talks to you through your chest.

So you know how tough it is to get that sound — and that feeling — when you're listening to records.

But now, you can get fast, fast relief from pale bass. Just hook up one dbx Boom Box. And stand back.

In just milli-seconds the Boom Box goes to work so you can feel all the vibrant, low frequency energy of live bass. Because the Boom Box recreates the low frequency sound that's often deliberately

left out in the recording studio.

You actually feel the blast of air a real bass note produces.

The Boom Box does this by seizing the lowest notes, instantly creating new notes an octave lower, and then realistically putting them back into your music. Low frequency notes surge through your hi fi system.

The Boom Box works on any music system that has a tape monitor switch. And it not only makes modest systems sound expensive, it makes expensive systems sound unbelievably real.

Hear the Boom Box. Feel the Boom Box. At your dbx dealer. You'll experience an all-time "low" in musical enjoyment.



# dbx

dbx, incorporated  
71 Chapel Street  
Newton, MA 02195  
617/964-3210

Falla was drawn to Verdaguer's poem by his shared belief in the mystical origins of civilization, though unlike the priest he seems to have found it impossible to sustain his faith in a beneficent Providence without a certain amount of difficulty. From the end of 1928 until his death in 1946, Falla struggled unavailingly with the problems posed by *Atlántida*. Among the reasons for his failure to bring the piece to a conclusion must be numbered the long political agony of Spain during the 1930s and the destructive world war that followed.

That we are in possession of a performable score is due solely to the dedication of Ernesto Halffter, Falla's pupil, colleague, and friend/ who after much labor has imposed coherence of a sort on what appears to have been left by the composer as a series of unintegrated fragments, some of them unorchestrated. What Falla would have achieved himself if granted a longer life is beside the point: For whatever reason, he could not fully realize his intentions—that is, give them their definitive and inevitable shape. During the course of nearly twenty years, all he could achieve was the musical material from which a finished work might be put together.

What we have here is both frustrating and fascinating, though there is no question for me that fascination wins out over frustration. The quality of Falla's musical sensibility, fundamentally conservative but impressively individual, gives the entire work a poetical character hard to forget. Eclectic and syncretic as he was, he brought together in *Atlántida* a whole conspectus of Spanish music, including popular and folk melody, modal polyphony from the great age of Spanish religious music, and courtly dance forms of the Renaissance, yet as with the harpsichord concerto the results are, imaginatively speaking, richly reverberative and at the same time coherent. The extensive choral music, in particular, is a unifying element. Though strikingly varied in character, it clearly derives from a single comprehensive creative vision.

That Falla's viewpoint was only partly dramatic does not in my opinion account for the work's ultimate inability to match the aspirations of his original conception. No less contemplative than the rest of his later output, *Atlántida*, for all its epic sweep, is essentially a narrative, not a dramatic representation. More than even scenic cantata, the term by which it is often designated, it is oratorio. As his three-voiced depiction of Geryon, the triple-headed monster, vividly attests, Falla did not lack the gift of musical characterization. On this occasion, however, he simply found himself more interested in the iterations of ritual than in the dynamics of theater. Thus there are no characters in the operatic sense to be involved with here, only agents and representatives of cosmic and mystical forces. *Atlántida*, I would say, is a dreamlike meditation on eternal truths, not a failed opera. Where it falters is in consistency of inspiration. Above all, the final section, where Halffter's help seems to have been most needed, fails to provide the kind

# MUTT & JEFF. TWO OF THE MOST AMAZING AR SPEAKERS EVER.

Here you have two of the newest additions to the AR range.

The little fellow (AR18) sells for about \$70.

The big guy (AR9) is approximately \$750.

Each, in its own way, is formidable.

If you're ready to spend over \$1000 for a pair of speakers you'll be 'demo-ing' some pretty exotic hardware. Even so, the AR9 is practically guaranteed to boggle your mind. Stuff that costs a lot more won't sound as clean and strong, and give you such an impeccable stereo image.

And the AR18 will prove equally startling. Especially if you compare it with speakers around twice its size and price. People who've made this little comparison blindfolded are amazed. How can a little character like the AR18 sound so big, bold, and accurate?

That's the AR secret. One standard for all speakers.

Truth in listening.

So, while the big guy will handle up to 400 watts per channel, vs 100 watts for the small one (both driven to clipping 10% of the time and using normal source material)...and while there's a difference in the sound levels and the bass, both have the same flat response and satisfying sound.

It means that no matter how big your room or your bank account, you don't have to settle for less than the highest quality speaker delivering high quality sound.

With AR you pay your money. But you don't take any chances.



Reprinted with permission of AEdita S. de Beaumont and McNaught Syndicate Inc. ©1978



Truth In Listening

LEARN MORE. READ OUR FULL COLOR BOOKLETS WHICH DESCRIBE THE AR SPEAKER LINE. PICK THEM UP FROM YOUR AR DEALER OR WRITE TO US. ALL AR SPEAKERS ARE COVERED BY A FULL 5-YEAR WARRANTY WHICH YOUR AR DEALER WILL SHOW YOU.

**TELEDYNE ACOUSTIC RESEARCH**  
10 AMERICAN DRIVE, NORWOOD, MASSACHUSETTS 02062  
IN CANADA: A.C. SIMMONDS & SONS LTD. ©1978

of spiritual ecstasy that would make believable the re-establishment of universal order through Columbus' voyage to the Indies.

The performance under Rafael Frühbeck de Burgos' fervent leadership has about it an utterly convincing sense of occasion. Both adult and children's choruses are, if not perfect, at one with their tasks. So is the orchestra. Vicente Sardinero is a compelling narrator. Eduardo Giménez an unearthly Archangel. Anna Ricci is moving, if slightly awkward, in the death scene of Queen Pyrene. Only in the case of Enriqueta Tarrés does technical insecurity (especially in the upper part of her voice) interfere with expressivity. The recording quality is fittingly large-scaled. Angel's pressings are better than in the past. Text and translation. Helpful notes. D.S.H.

**HANDEL:** Nine German Arias. Catarina Ligendza, soprano; Karlheinz Zöller, flute; Peter Ligendza, oboe; Thomas Brandis, violin; Colin Tilney, harpsichord; Hans Lemke, bassoon; Ottomar Borwitzky, cello; Rainer Zepperitz, double bass. [Gerd Ploebusch, prod.] DEUTSCHE GRAMMOPHON 2536 380, \$8.98.

Handel, whom the Germans still consider a genuine and uncorrupted German composer and always pair with Bach, never composed anything for the Lutheran lit-

urgy. As a matter of fact, aside from an insignificant youthful setting of the Passion, he set his mother tongue only twice more, in a second Passion and in the songs recorded here.

Why he should have composed these German arias—by that time he was thoroughly Anglicized—is not clear. He never again used a German text; even his correspondence with his German colleagues was in French! But perhaps the poet of the song texts, the same who supplied him with the second Passion libretto, had something to do with it. Barthold Heinrich Brockes (1680-1747), senator, poet, lawyer, diplomat, and magistrate, was a famous and influential man; his Passion text was read in almost every German Protestant home, translated into foreign languages, and set by practically every noted composer in the homeland. Bach, who was his own librettist for the *St. John* Passion, also used portions of the Brockes Passion.

The wretched poetry with its pietistic wallowing could have appealed to the straightforward Handel for only one reason: Brockes, translator of Thomson's *Seasons*, introduced the contemplation of nature into German literature, and Handel, who absorbed the old English love of nature with ardor, used every opportunity to testify to his almost pantheistic faith. The songs are fine, well worth possessing, but the recording does not do justice to them.

In the first place, Catarina Ligendza is miscast. The soprano's intonation is correct but not positive enough because of a vibrato, she does not color her voice, and her diction is poor. The vocalises, which are not of the bravura type, do not flow smoothly because a crescendo escapes her every time the melismas take an upward swing, and she has no trill. She is obviously a dramatic soprano, not properly coached for this engagement, and falls into the heroic idiom of the seria when she should be intimate and delicate. No matter how crude the poetry, all that Handel needed for creating a mood were four or five words, as for instance, "The shimmering light of the tumbling waves," or, "Red-glowing rose, you queen of all flowers" (in Nos. 2 and 9)—the music immediately flows with a warm bucolic charm that requires subtlety and intimacy rather than the full operatic treatment.

The style is wrong, and this is the responsibility of the producer, Dr. Gerd Ploebusch, who seems to be also the house musicologist. The designation "German arias" has been taken too literally, for these pieces are more songs than arias. The delivery is metronomic, the da capos are not prepared, the middle sections are sung at the same pace and tone as the rest, and the continuo is overdone. Besides the harpsichord, it is loaded down with cello, bassoon, and double bass. This is musicological overkill;



**new!**

## fact: the Shure/SME Series III is the state of the art in tone arms.

### Breakthroughs & Improvements.

The Series III is the culmination of research and development extending over more than seven years. It embodies a number of significant breakthroughs as well as evolutionary improvements over its distinguished Shure/SME predecessor.

Notable among these is an exotic nitrogen-hardened titanium tubing arm (with wall thickness only twice the diameter of the average human hair) providing a previously unattainable strength-to-weight ratio. The arm has a soft core annular cross-section with an internal fibrous lining which results in an efficient, natural damping of the vibration fed into the arm by the cartridge.

### Cartridge Carrier.

The Series III "cartridge carrier," a combination tone arm and shell in one piece, is removable and interchangeable for multi-cartridge use. Coupling is close to the fulcrum so the carrying arm makes a minimum contribution to the Series III total effective mass (only 5.05 grams measured at 9 inch radius!).

### Fluid Damper.

A built-in highly efficient F.D. 200 Fluid Damper gently but effectively resists spurious or potentially damaging stylus forces in both planes, yet does not interfere with normal arm motion.



**Incomparable High Fidelity Performance!**

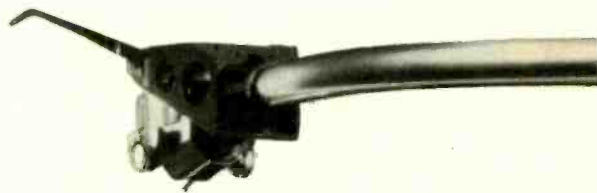

"The best pickup arm in the world."

### THE SME SERIES III PRECISION PICKUP ARM WITH THE NEW SHURE V15 TYPE IV CARTRIDGE

The combination of the Shure V15 Type IV cartridge and the SME Series III tone arm transcends previous tone arm-cartridge system performance, and sets dramatic new standards in connoisseur-class high fidelity reproduction.

such an elaborate continuo is for large-scale works, like oratorios. For the songs, harpsichord and a discreet cello would have been sufficient.

Fortunately, the players show good musical common sense and keep down the volume. The three concertante parts—violin, flute, and oboe, respectively—are well executed. P.H.L.

**HOLST:** Choral Works. St. Paul's Cathedral Choir, London Symphony Chorus, London Philharmonic Orchestra, Charles Groves, cond. [John Willan, prod.] ANGEL S 37455, \$7.98 (SQ-encoded disc).

Choral Hymns from the Rig-Veda, Op. 26. Group 2. The Hymn of Jesus, Op. 37. Ode to Death, Op. 38. Short Festival Te Deum.

The juxtaposition of compositions on this record affords an astonishing reminder of the wide range of intellectual stimuli to which Holst was capable of responding. The Apocryphal Acts of St. John, the Rig-Veda, the Book of Common Prayer, Whitman's *Leaves of Grass*—each of these somehow sparked his imagination, and in the first two cases he even went so far as to study the languages of the originals (Greek and Sanskrit, respectively) in order to produce more precise English translations.

The *Hymn of Jesus*, completed in 1918, is the longest of the four works recorded here,

and arguably the most original. Holst, as his daughter Imogen has pointedly noted, "was unencumbered by any notion of routine piety, and his idea of Christ included the fierce unexpectedness of the Byzantine mosaics." To an English audience in 1920, the *Hymn* must have been unexpected indeed—it is worlds removed from Elgar and the like—and the piece has lost little of its startling freshness in the intervening years. Sir Adrian Boult recorded it for London in the early Sixties, but since that very fine performance has been unavailable for several years this new recording is particularly welcome. Boult was perhaps marginally better at sustaining a sense of urgency, but Groves proves to be a sympathetic and capable Holstian himself, and his version has a gratifying illusion of depth largely missing from its predecessor. Unfortunately, the sound of the chorus in the Angel edition is a bit cloudy, and both sides of my copy are afflicted with considerable surface noise.

The disc's real "sleeper" is the little-known *Ode to Death*, a setting of words from Whitman's *When lilacs last in the dooryard bloom'd*. Here Holst deploys both choral and orchestral sounds in the most magical ways—just what one would expect of a man who had completed *The Planets* only two years before—and in its quiet ecstasy the piece is profoundly moving. The same, alas, cannot be said of the *Short Festival Te Deum*, much of which seems to me

the very personification of a "tempest in a teapot." S.C.

**LISZT:** Sonata for Piano, in B minor. **SCHUMANN:** Fantasy in C, Op. 17. Alicia de Larrocha, piano. [Michael Woolcock, prod.] LONDON CS 6989, \$7.98. Tape: ●● CS5 6989, \$7.95.

All praise to De Larrocha and London for this coupling. The juxtaposition of these two ardent, large-scale piano works, each dedicated to the other composer, has such obvious validity that it is incomprehensible that no one has done it before.

Having heard De Larrocha perform the Liszt sonata at Hunter College a decade or so ago, I was slightly surprised by her recording. I recall the earlier account as being somewhat lighter and more flowing; the new interpretation is very rhetorical, with a weighty, bronzelike massiveness in the grandioso passages and lots of pedal for sustained emphasis. Nor does she strive particularly for filigreed contrasts in the more lightly scored passages, as do some artists. Some will find her reading ultracapricious, and it would be folly to suggest that it has the textual validity of those of, say, Claudio Arrau, Clifford Curzon, and Sviatoslav Richter, but this is nonetheless a statement of a very strong executant who has lived with the work a long time and re-

### ...other features of the unique SHURE/SME Series III precision pickup arm:

- Unique balance system enables cartridges weighing 0 to 12 grams to be operated under conditions of minimum inertia.
- Interchangeable integral carrying arm replaces conventional tone arm and shell.
- Positive rack and pinion overhang adjustment.
- Main pillar hardened and ground.
- Low friction pivots, vertical axis: high precision fully protected ball races. Horizontal axis: knife edges. Less than .02 gram applied at the stylus will deflect the arm!
- Vertical and horizontal bearing axes intersect at stylus level for minimum warp-wow.
- Precise tracking force up to 2.5 grams can be applied without a tracking force gauge.

- Bias (antiskating) with fine adjustment.
- Longitudinal and lateral balance with fine adjustment.
- Ultra low-distortion geometry.
- Fluid-damped lowering and raising control.
- All electrical contacts heavily gold-plated.
- Superb camera finish throughout.
- 1978 Design Award from the British Design Council.



Send for complete brochure AL579.

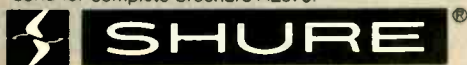

Shure Brothers Inc., 222 Hartrey Ave., Evanston, IL 60204 In Canada: A. C. Simmonds & Sons Limited  
Manufacturers of high fidelity components, microphones, sound systems and related circuitry.

CIRCLE 48 ON PAGE 149

# ONE TOUCH



One light touch.  
No dials to turn.  
No weights to adjust.  
No lifting.  
No cueing.

Nothing but one touch and music. The Beogram 2400 turntable. It does everything for you, and does it exceedingly well.

Write for literature.

# BANG & OLUFSEN

BANG & OLUFSEN OF AMERICA, DEPT. 11, 515 BUSSE ROAD, ELK GROVE VILLAGE, ILL. 60007

CIRCLE 65 ON PAGE 149

"...it is hard to imagine a headphone sounding better than these, or being more comfortable to wear..."

Stereo Review August 1978  
Julian D. Hirsch

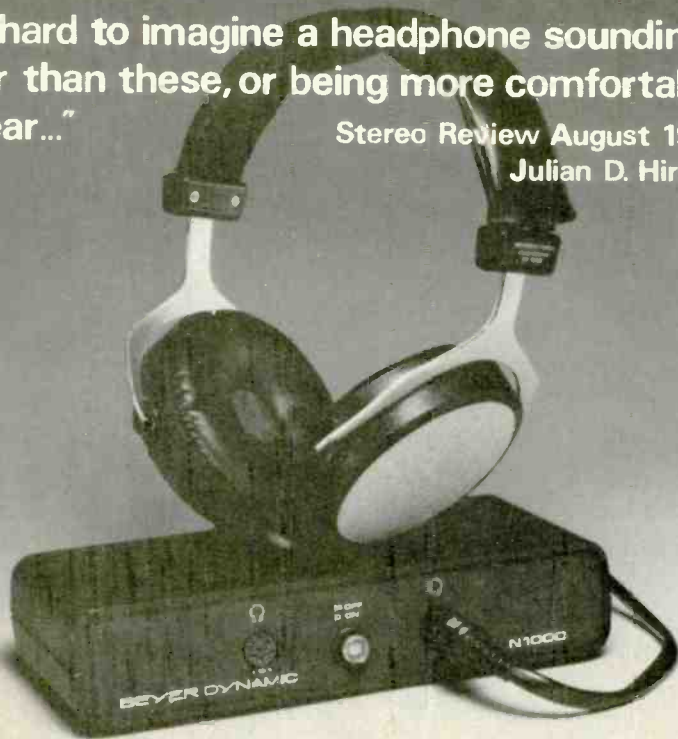

the superlative Beyer ET1000 critical listening system,  
available at the most discriminating dealers

Hammond Industries Inc, 155 Michael Drive, Syosset, New York 11791  
Telephone (516)364-1900 West Coast (213)846-0500 Canada(416)677-0545

**HII**

CIRCLE 71 ON PAGE 149

flected on it in great detail.

As much could be said for the Schumann Fantasy, which gets the same sort of monumental statement in the central march and an eruptive, highly contrasted alternation of *Sturm und Drang* and ruminative lyricism in the outer movements. London's piano reproduction is resonant but less gimmicky than is sometimes the case. H.G.

**MENDELSSOHN:** Symphonies (5). For a feature review, see page 98.

**B** **MOZART:** Sonatas for Violin and Piano. Oscar Shumsky, violin; Artur Balsam, piano. MUSICAL HERITAGE SOCIETY MHS 3475/80, \$29.70 (\$22.50 to members; six discs). Tape: MHC 5475/80, \$41.70 (\$29.70 to members). (Add \$1.25 postage; Musical Heritage Society, 14 Park Rd., Tinton Falls, N.J. 07724.)

Sonatas: in C, K. 296; in G, K. 301; in E flat, K. 302; in C, K. 303; in E minor, K. 304; in A, K. 305; in D, K. 306; in B flat, K. 372; in F, K. 376; in F, K. 377; in B flat, K. 378; in G, K. 379; in E flat, K. 380; in A, K. 402; in C, K. 403; in B flat, K. 454; in E flat, K. 481; in A, K. 526; in F, K. 547. Variations: on "La Bergere Celimene," K. 359; on "Helas, j'ai perdu mon amant," K. 360. Andante and Allegretto, in C, K. 404.

Oscar Shumsky and Artur Balsam contribute a good and durable set of the Mozart violin sonatas. Shumsky is an utterly dependable violinist whose strength stems from a firm, declarative, forthright kind of playing that wears well and never short-changes the music. His tone is warm in the upper register and robust in the lower, and he maintains a sense of presence and a degree of urgency in this Mozart that keep the listener tuned in. Balsam is musical and businesslike.

If this general description of the duo sounds somewhat earthbound, it is because this collaboration falls somewhere between the very distinctive ones of Henryk Szeryng and Ingrid Haebler (Philips—only three of the six discs available domestically) and Szymon Goldberg and Radu Lupu (London). Szeryng's is a hard production for anybody to compete with: The elegance of his playing and the ability to create nuance within a phrase remain unmatched in this repertory, and Haebler is an admirable partner. The Goldberg is a quite different affair—rather too retiring on the violinist's part but soaring in pianistic terms. Shumsky is a more assertive and overt performer than Goldberg, and the immediacy of his playing is welcome here. He does not, however, reach the poetry of Szeryng. Nor does Balsam project the sweep and exhilaration of Lupu; he is more akin to Haebler, though his skillful work does not allow much scope for the lift and pearly surfaces she achieves. (In the extraordinary fifth variation of the finale of K. 481, for example, he does not capture the surge and flow of either Haebler or Lupu.)

But such negatives should not obscure the pleasures of this set, which offers clean, expressive, disciplined, and sensitive performances, attractively priced. S.F.

**MUSSORGSKY:** Pictures at an Exhibition (arr.

# THE DREAM COMPONENTS



**A tape deck that thinks, a turntable steady as a rock, a receiver that protects itself, and more.**

In your dream you hear beautiful music coming from a high fidelity system. All the components have the same name on them.

Impossible? Only if you believe there's one "best" maker for each type of component. Once, perhaps. But today no one has a monopoly on technological excellence. You'll find the Optonica® name on entire systems of the world's most advanced components, with innovations—our own

new circuits and features—you might expect to find only in a dream.

In a dream you might own the amazing Optonica cassette deck that contains a small computer. You can program it to control endless recording and playback functions. It would be a fantastic deck even without its own computer.

In the same dream you could have the Optonica turntable with a beautiful base that looks and feels

just like granite. It is, in fact, mikage granite, which will transmit exactly the correct amount of vibration to the tone arm: *none*.

You might furnish your dream with a new Optonica receiver or separates, the only ones in the world built with aircheck calibration, Opto-lock tuning, triple power supply designs, and three protection circuits.

Now the same source also produces some of the most accurate speaker systems in

history. Optonica CP-5151's incorporate a unique new tweeter. It weighs just about 1/50th as much as a comparable "dome"-type tweeter, and its sound is incomparable.

Listen to a system with one name: a dream system, only at an Optonica dealer.

**OPTONICA**

THE OPTIMUM.

10 Keystone Place, Paramus, N.J. 07652

**NATIONAL RECORD PLAN**  
44 W. 18th St., N.Y., N.Y. 10011

**FALL DISCOUNT SALE**  
**AT UP TO 50% OFF**

**All Records**—Classical,  
Opera, Pop, Rock, Folk,  
Jazz, Shows, Int'l, Country.

List Per LP	Sale Price Per LP
\$3.98	\$2.39
4.98	2.49
6.98	3.99
7.98	4.89
8.98	5.79

For multiple sets, multiply sale price per LP by number of LP's in set. All other List Prices, your discount is 35%.

NEED CATALOG? Send \$1 for Schwann (plus 50c for postage and handling.) If you order catalog, we extend sale ending date to give you more time to order.

**ALL PRE-RECORDED**  
**8-TRACK CARTRIDGES**  
**AND CASSETTES**

List Price Per Tape	Sale Price Per Tape
\$7.98	\$4.99
8.98	5.79

All other List prices, your discount is 35%.

**SPECIALS OF THE MONTH**

All Angel (LP, Tape)	\$4.79
Everest	1.99
London (LP, Tape)	4.79

**SPECIAL—SPECIAL**

Arrau Plays Beethoven's Piano Conc. No. 5—Haitnik cond. Phil. 839600—\$3.99 LP only;

Elvis Presley—Tonite Is So Right For Love—European Import—RCA 6886—\$3.99 LP only

**GUARANTEE**

Cash refund if we can't deliver. Record or tape replaced at no charge after one play if defective.

**ORDER NOW**  
**SALE ENDS OCT. 31, 1978**

List items wanted on separate sheet of paper. State whether LP or Tape. Add 95c for first LP or Tape, 25c each additional LP or Tape, plus 40c for insurance for entire order. UPS Shipments if desired, add \$1.00.

VISA, Master Charge, Am. Exp. accepted.

**NATIONAL RECORD PLAN,**  
**DEPT. HF8, 44 West 18th St.,**  
**New York, N.Y. 10011**



Igor Markevitch—as distinctive a Pictures as you can find

Browning); Piano Works. John Browning, piano. [Heidi Lesemann and Amelia S. Haygood, prod.] DELOS DEL 25430, \$7.98.

Piano Works: Sonata for Four-Hand Piano, in C; Impromptu passionné; Hopak (original version); Hopak (arr. Rachmaninoff).

**B** **MUSSORGSKY:** Pictures at an Exhibition (orch. Ravel); A Night on Bare Mountain (arr. Rimsky-Korsakov). Leipzig Gewandhaus Orchestra, Igor Markevitch, cond. MUSICAL HERITAGE MHS 3650, \$4.95 (\$3.75 to members). Tape: ♡ MHC 5650, \$6.95 (\$4.95 to members). (Add \$1.25 postage; Musical Heritage Society, 14 Park Rd., Tinton Falls, N.J. 07724.)

For some reason Mussorgsky has always been considered fair game for other people's "improvements." Ravel's masterly orchestration of *Pictures at an Exhibition* is, of course, a special case: That transformation is an example of rarefied genius in its own right. One could also argue that Rimsky-Korsakov's *Night on Bare Mountain* rambles less than the more primitively barbaric original.

Among pianists there has been a widespread feeling—encouraged by such titans as Bauer and Horowitz—that the piano original of *Pictures* is ineptly written for the instrument. John Browning concedes that the urtext *Pictures* has its points but says, "Mr. Horowitz' unpublished reworking of the original remained indelibly engraved in my mind. . . . Try as I may, after much thought and work, I am unable to play the original without reservations." The pianist fails to persuade me that his innovations are an improvement. As I hear them, the fancy octave adjustments, the figurations made more intricate, the incursions of a graceful, Lisztian glitter into Mussorgsky's purposefully stark blocks of sound produce a slight but pronounced jarring effect: it is something like introducing steel-point engraving techniques into wood carving.

When Mussorgsky's original tremolos and linear part-writing are performed by a consummate craftsman (Browning certainly would qualify), they can have an almost Schubertian transparency that gets lost in this garish, albeit self-effacing, arrangement. If one must sin in this work, Horowitz' grand-scale villainy is at least more interesting than Browning's petty misdeemeanor.

In some of his recent concerts, I have much appreciated Browning's thoughtful approach: He has phrased some Mozart works with carefully chiseled lines and tastefully concise rubatos. To Mussorgsky, however, he brings an inappropriately finicky, cut-and-dried salon approach. Rubato is contrived rather than intuitive, and I miss weight and coloration in the bigger climaxes. Since the recorded sound seems fairly spacious, I am inclined to blame the pianist rather than the engineers.

The shorter works are more gratifying. The *Hopak* is played both in the original and in the better-known Rachmaninoff arrangement, and there is less contrast than I might have imagined. The other pieces—a two-movement sonata for piano four hands and the *Impromptu passionné*, both early works—show the composer's humble origins. (Browning partners himself in the sonata, via overdubbing.)

One of the most interesting recordings of the Ravel *Pictures* in pre-stereo days was Igor Markevitch's with the Berlin Philharmonic (a Deutsche Grammophon production issued here by Decca). Now Markevitch has done it again with equally felicitous results. In his early days he conducted for Diaghilev's Ballet Russe, and much of his work reflects that heritage with finely sprung rhythms, lavishly characterized—but aristocratically tasteful—phrasing, and a stylized manner that breathes and flows. The sonorities he draws from the fine Leipzig Gewandhaus Orchestra are



# Finally. Video technology comes to audiotape.

One of these cassettes can reproduce up to 4,000,000 hertz with extreme linearity. Its tape surface is mirror-smooth because the slightest variation would severely limit its remarkable response and dramatically increase noise. The millions of magnetic particles on its surface are incredibly uniform in size, orientation and distribution. To increase output and dynamic range. Minimize distortion. And reduce noise even further.

The result is our highly-acclaimed Beridox videocassettes, which utilize a special magnetic particle that provides great stability and significantly lower print-through. And set new performance

standards in 3/4" and 1/2" video reproduction. Just as Fuji two-inch videotapes have done in network broadcasting.

Now, with high-bias Fuji FX-II, our engineers have brought the benefits of Beridox video technology to audiocassettes. Delivering linear response, low noise and wide dynamic range to fully utilize all the performance built into today's cassette tape equipment.

Audition an FX-II cassette at your Fuji dealer today. And hear a breakthrough in video become a new milestone in audio.

## FUJI

Magnetic Tape Division of Fuji Photo-Film U.S.A., Inc.  
350 Fifth Avenue, New York, New York 10001



**TOLL FREE 800-356-9514**

**KENWOOD**



DC Stereo Integrated Amplifier  
**KA-7100**

**Dual**



Direct Drive Single Play Semi-Automatic  
**DUAL 604**

**TEAC**



Front Load Cassette Deck  
**A-105**

- Home and Car Stereo
- Over 60 Brands Stocked and Discounted
- Write for Free Price Sheet
- All Equipment in Factory Sealed Cartons
- MASTER CHARGE and VISA Accepted by Phone

**WDS**  
WISCONSIN DISCOUNT  
**STEREO**

For The Lowest Prices  
Call Toll Free

800-356-9514  
608-271-6889

2517 whalen lane madison, wisconsin 53713

CIRCLE 64 ON PAGE 149

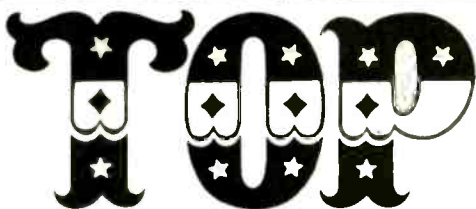

**DISCOUNT  
AUDIO**

1150 N. Powis Rd.  
West Chicago, IL 60185

**YOUR NATIONAL HEADQUARTERS FOR  
NAME BRAND ELECTRONICS BY MAIL**

**MULTI-  
MILLION  
\$\$\$  
INVENTORY**

**FULL  
MANUFACTURER  
GUARANTEE  
APPLIES  
TO ALL SALES!**

**ALL ORDERS  
Shipped In  
Factory-Sealed  
Cartons—  
Most Within  
24 Hours!**

**TOP DISCOUNT  
AUDIO**

1150 N. Powis Rd.  
West Chicago, IL 60185  
(312) 293-1825

We Honor VISA and  
MASTERCARD  
By Phone or Mail

Send catalog

MR.  
MS.

(First) (Initial) (Last) (Date)

(Number and Street)

(City) (State) (Zip code)

Call or Write for the **LOWEST PRICES** Anywhere!

• RECEIVERS • SPEAKERS • COMPACTS

• TUNERS • AMPLIFIERS • AUTOMOTIVE

• TAPE DECKS • CHANGERS • CARTRIDGES • HEADPHONES

CIRCLE 61 ON PAGE 149

somewhat mercurial and scaled down (even the broadly paced "Bydlo" has a spring in its step, as if its heavy wheels were turning on padded cobblestones), but the instrumental contributions are full of personality. I particularly admire the delicious patina of the oboe, the wide, insinuating vibrato of the trumpet solos, and the contained fervor of the strings. And I like the way lower brass dominates without coarsely overpowering in the more ram-bunctious tableaux. As before, Markevitch's severe pointing presses forward and even runs some usually paused-over endings into successive episodes without letting up.

This MHS offering, licensed from East Germany's VEB Deutsche Schallplatten by way of Japan (arrangements were made through Tokuma Musical Industries), is an impressive bargain. In fact, this is as distinctive a *Pictures* as you will find in the catalog, fully comparable to the recent full-priced Giulini/Chicago edition (DG 2530 783, July 1977) for consummate tone painting. The recorded sound, while not especially impactful, has more vivid definition than the recent norm from Leipzig (e.g., Kurt Masur's Schumann symphonies, also available from MHS). Markevitch's impetuous *Night on Bare Mountain* is similarly a notable addition to the list, although it doesn't quite, for me, erase memory of the astonishing ferocity of the deleted Giulini/Philharmonia Angel recording, made when that now gently lyrical maestro was a firebrand.

Markevitch is one of today's finest orchestral stylists, and his neglect by managements and record companies is totally inexplicable. Let us hope for more releases from him. H.G.

**Puccini: Suor Angelica.**

Suor Angelica Katia Ricciarelli (s)  
Suor Genovietta, A Novice Rosanna Lippi (s)  
Suor Dolcina, First Lay Sister Miwako Kuo Matsumoto (s)  
Suor Osmina, First Alms Collector Margherita Benetti (s)  
La Zia Principessa Fiorenza Cossotto (ms)  
Mother Superior, Mistress of Novices:  
Second Lay Sister Maria Grazia Allegri (ms)  
Sister Monitor, Nursing Sister, Second Alms Collector  
Anna di Staslo (ms)

Rome Polyphonic Chorus, Orchestra of the Accademia di Santa Cecilia, Bruno Bartoletti, cond. RCA RED SEAL ARL 1-2712, \$7.98. Tape: •• ARK 1-2712, \$7.98.

Comparison:  
Scotto, Horne, Maazel/New Phil. Col. M34505

RCA's belated issue of a performance available for some years in Europe does nothing to change the situation with respect to recordings of *Suor Angelica*: Columbia's remains for me the best, Renata Scotto's clear superiority over her competitors in the title role outweighing all other considerations.

One feature of the new recording is worth attention: Fiorenza Cossotto's Principessa—stern, inflexible, dedicated to recititude and duty, yet far from a monster, as she tends to become in Marilyn Horne's portrayal on Columbia. Though Cossotto properly makes the character unsympathetic, she remains, for all that, a human being, someone with motives one can at

# THE NEXT BEST THING TO ORIGINAL SOUND.



Klipsch® loudspeakers are a temptation. Once you've heard them, the world of music will never be the same.

No valid test has ever shown any other speaker to be better. Or as good.

Overall performance tests of the Klipschorn® show the lowest distortion of any speaker ever tested in our laboratories—and we test them. Klipsch loudspeakers are the ultimate in sound.

But we can't tell you the difference in Klipsch loudspeakers. We can't even show you. After you've read all the specs and heard all the theories, listen. Listen and compare.

Only then will you know what it's like to be bitten by the next best thing to original sound.

**klipsch**®

Please send me your FREE color brochure on the full line of Klipsch loudspeaker systems, along with a list of Klipsch dealers.

Name \_\_\_\_\_

Address \_\_\_\_\_

City \_\_\_\_\_

State \_\_\_\_\_ Zip \_\_\_\_\_

**klipsch**®

P.O. Box 688 H10  
Hope, Arkansas 71801

In Canada: Superior Electronics, Inc.

Made from selected hardwood veneers.

Order Toll Free! Except N.Y., Alas., Hawaii

SCA 800-221-0974

FOR ORDERS ONLY!  
Mon-Thurs 9AM-9PM, Fri-Sat 9AM-5PM, N.Y. Time

STEREO  
**HOT-LINE**

AKAI Technics

CHECK US OUT!

- ✓ Our prices are the lowest.
- ✓ Discounts on over 60 major brands.
- ✓ Reliability: one of the oldest audio mail-order houses in the U.S.A.
- ✓ Rated #1: by a leading trade publication.
- ✓ Large inventory: we buy in volume getting the best deals from the manufacturers you get the best deal from us.

GIVE US THE OPPORTUNITY TO BEAT THE BEST DEAL YOU'VE BEEN ABLE TO FIND.

— QUOTES AND INFORMATION —  
(212) 253-8888, 9AM-5PM, MON.-SAT., N.Y. TIME

Write or Call us now for the lowest price quotes and a Free price flyer.

**STEREO CORPORATION OF AMERICA**  
HF-1629 Flatbush Ave.  
Brooklyn, New York 11210

CIRCLE 53 ON PAGE 149

**J&R** BLANK TAPES & ACCESSORIES AT WHOLESALE PRICES!

**BLANK TAPES**

**CASSETTE TAPES**

AmpeX Grand Master I C-90	\$2.14
AmpeX Grand Master II C-90	\$2.79
BASF Studio C-90	\$2.69
BASF Professional I or II C-90	\$2.99
Maxell UD C-90	\$1.83
Maxell UD XL I or II C-90	\$2.84
Maxell UD XL I or II C-90	\$3.47
Scotch low noise C-90 / 3 pk.	\$4.99 for 3
Scotch Master I C-90	\$2.84
Scotch Master II or III C-90	\$3.29
Sony Ferrichrome C-90	\$3.58

Minimum Order 12 Tapes — 100% Guaranteed.

**CARTRIDGES** audio-technica

AT-20 SLA	\$118.00
AT-18 SA	\$82.50
AT-14 SA	\$46.50
AT-12 SA	\$34.90
AT-10	\$12.00

**STANTON**

8815	72.50
681EE S	33.50
681EE E	42.50
680EE	20.80
500EE	14.40

**EMPIRE**

2000Z	\$59.90
2000T	\$31.50
2000E III	\$19.50
4000D	\$29.90

**HEADPHONES**

**PIONEER**

SE-205	\$19.95
SE-605	\$46.70
SE-4	\$33.50
SE-500	\$39.95
SE-700	\$59.95

**SIEMENS**

HD-400	\$24.99
HD-414	\$35.97
HD-424	\$59.95

**SHURE**

V15 TYPE IV	\$89.90
V15 TYPE III	\$63.50
M5E D	\$26.50
M5E D	\$21.00
M24H (QUAD)	\$36.50
M70E J	\$9.90

**PICKERING**

XUV/45000 (QUAD)	\$66.00
XSV/3000	\$46.95
XV15/750E	\$30.00
XV18/625E	\$20.98
XV15/400E	\$17.95

**HOW TO ORDER:** For shipment within 48 hours, send money order or certified check. Two weeks delay on personal checks. Please add \$3.50 per order for shipping & handling. (\$5.50 for orders outside U.S.). N.Y.S. residents add tax. No C.O.D.'s. All merchandise 100% guaranteed, brand new & factory fresh.

**J&R MUSIC WORLD**  
33 Park Row, Dept. HF, N.Y.C. 10038 (212) 732-8600  
WRITE FOR FREE CATALOG

CIRCLE 27 ON PAGE 149



Fiorenza Cossotto  
*Puccini's Principessa convincingly done*

least understand. Moreover, the midrange tessitura of the role perfectly suits her current vocal estate; operating well within her vocal powers, she gives what I would call the most effectively sung as well as convincingly characterized account of the part on disc.

Katia Ricciarelli, on the other hand, is surely the least effective Angelica available, sounding only too precisely what she was when this record was made: a fledgling performer with a beautiful voice and hardly any idea of how to bring a role to life. Or even how to register a sudden change of feeling. One wonders, for example, how she can react so blandly to the news of her sister's impending marriage when Puccini has written Angelica's surprise into the score with such care. Above all, it is hard to believe in a character who suffers, takes poison, and then repents with hardly a trace of emotional disequilibrium. Part of the problem here is technical: At this stage of her career Ricciarelli clearly had not learned how to handle consonants as well as the smooth emission of tone, and, rather than disturb the vocal line, she preferred to suppress the consonants wherever possible. Some of Angelica's most affecting lines are thus converted into little more than a blur of vowels, with the inevitable result that the drama is nullified. Only in the lyrically expansive passages, where the beauty of her voice can, as it were, make its effect in the abstract, does Ricciarelli shine.

The rest of the cast is adequate enough. Bruno Bartoletti's conducting, however, is damagingly undervalitized. There are times—as in the Principessa's long discourse on Angelica's mother—when the opera seems to come to a complete halt. The recording, too, is poor, especially in quiet passages, where the sound is often infirm. Libretto and translation. D.S.H.

**RAVEL:** Quartet for Strings—See Debussy: Quartet.

**SAINT-SAËNS:** Concerto for Cello and Orchestra, No. 1—See Dvořák: Concerto.

**SCHUBERT:** Symphony No. 9, in C, D. 944. Israel Philharmonic Orchestra, Zubin Mehta, cond. [Ray Minshull, prod.] LONDON CS 6948, \$7.98. Tape: CS5 6948, \$7.95.

Comparisons:  
Karajan/Berlin Phil. DG 139 043  
Toscanini/Philadelphia (1941) in RCA CRM 5-1900  
Toscanini/NBC Sym. (1953) RCA (Germany) AT 151  
Giulini/Chicago Sym. DG 2530 882

Mehta discloses a basically tough approach to the symphony from the outset, with a swiftly flowing and rhythmically pulsating account of the introduction. Like Karajan and Toscanini, he almost imperceptibly quickens the pace as he approaches the Allegro of the first movement proper, thus avoiding the tension-dissipating rigidity of Giulini, who maintains an exact correspondence of note values between the introduction and the Allegro. Mehta is the first conductor of my experience to take the first-movement repeat (although it is also observed by John Pritchard in his recent English Classics for Pleasure recording, which I have not heard); it alters the proportions less than I would have expected. Mehta does not make the second-movement repeat—wisely, I think (it is made by Giulini and a few others); neither he nor anyone else I know of takes the repeat in the finale.

Nothing that Mehta does with this problematical work could be called eccentric (though he does draw out the final notes of the first movement a bit pompously and opts for a slowish tempo for the second). Yet as the performance unfolds I find myself increasingly dissatisfied by the beefiness of the playing—its lack of tonal variety and a scintillating pianissimo—and by a slight doggedness of phrasing that fails to relate to a larger rhythmic scheme. One has only to compare the grandeur and exhilarating sense of climax of Karajan and Toscanini or, for that matter, Giulini, whose version remains a distinguished one despite all its idiosyncrasies. H.G.

**SCHUMANN:** Fantasy in C—See Liszt: Sonata for Piano, in B minor.

**STAMITZ, C.:** Concertos for Clarinet and Orchestra: No. 1, in F; No. 3, in B flat. Lawrence Sobol, clarinet; Rome Chamber Orchestra, Nicolas Flagello, cond. [Jeffrey Kaufman, prod.] PETERS INTERNATIONAL PLE 033, \$7.98. Tape: PCE 033, \$7.98.

This disc is billed implausibly as part of Peters' "Library of Baroque Masterpieces," although Carl Stamitz, son of the great Johann, was born thirteen years after Haydn and died ten years after Mozart! The annotator is even more anachronistic, giving

# IF YOU OWN A TV AND A HI FI, YOU'D BE FOOLISH NOT TO OWN THIS COMPONENT.



Television has always been fun to look at.

But compared to your hi fi, it's an absolute disaster to listen to.

Where your hi fi provides you with rich, undistorted sound, the average TV sounds no better than a cheap kitchen radio.

And how can you seriously expect to experience something like the "thrill of victory" (or even the agony of defeat) through a 3" TV speaker?

As the world's leading audio company, we at Pioneer have long felt obligated to do something about the quality of TV sound.

Which is why we created the TVX-9500.

It's the first TV audio tuner. A high quality audio component that attaches to your receiver or amplifier like a cassette deck, and provides you with rich, clean, clear TV sound. Through your hi fi system, instead of the TV. (When you use the TVX-9500, you turn your TV sound off.)

But the TVX-9500 does more than just make TV sound better.

It makes TV an entirely different experience.

When you watch a football game, you feel more like a participant than a spectator. You hear the signals. Feel the

snap. And almost wince at the tackle.

Movies begin to feel as if you're sitting in the theatre, instead of your living room. Characters like Brando's Godfather remain just as menacing in 19" as they were in Panavision. Musicals like "The Sound of Music" don't end up featuring "the sound of distortion." And for the first time, someone like King Kong will also sound larger than life.

Then there's TV music.

With the TVX-9500, live concerts will, at last, sound that way.

Symphonies will finally be as much fun to listen to as they are to watch. (Which is the whole idea of watching them in the first place.)

And when you view something like "Gone With The Wind," you'll actually be able to hear Atlanta burning.

Admittedly, even the great sound the TVX-9500 offers won't make up for bad TV programming.

But then our advice would be to do what you'd do to a bad TV show anyway:

Turn the set off.

And enjoy your hi fi.

**PIONEER®**  
We bring it back alive.

U.S. Pioneer Electronics Corp., 85 Oxford Drive,  
Moonachie, N.J. 07074.

# SAVE!

MONEY • TIME • FREIGHT

QUALITY STEREO EQUIPMENT AT LOWEST PRICES.

YOUR REQUEST FOR QUOTATION RETURNED SAME DAY.

FACTORY SEALED CARTONS—GUARANTEED AND INSURED.

SAVE ON NAME BRANDS LIKE:

AKAI	PIONEER
B.I.C.	SANSUI
DUAL	SHERWOOD
KENWOOD	TEAC
MARANTZ	TECHNICS

AND MORE THAN 50 OTHERS

BUY THE MODERN WAY

BY MAIL—FROM

## illinois audio

12 E. Delaware Place  
Chicago, Illinois 60611  
312-664-0020

CIRCLE 25 ON PAGE 149

## FREE

 details...  
**A DIFFERENT KIND OF RECORD CLUB**

### TREMENDOUS SAVINGS

on every record and tape in print—  
no "agree-to-purchase" obligations of any kind.  
**DISCOUNTS OF 43% TO 73%**  
off mfg. suggested list... special catalog  
features hundreds of titles and artists.

### ALL LABELS AVAILABLE

including most imports through special custom  
ordering service—guarantees satisfaction.

### SCHWANN CATALOG

lists thousands of titles:  
classical, pop, jazz, country, etc.

### DISCOUNT DIVIDEND CERTIFICATES

Dividend Gifts—certificates  
redeemable immediately for extra discounts.

### NEWSLETTERS

informational news and happenings in the  
world of music... special super-sale listings.

### DISCOUNT ACCESSORY GUIDE

Diamond needles, cloths, tape cleaners, etc.

### QUICK SERVICE

same day shipping on many orders...  
rarely later than the next several days.

### 100% IRON-CLAD GUARANTEES

on all products and services—your total  
satisfaction is unconditionally guaranteed.

Discount Music Club is a no-obligation membership club  
that guarantees tremendous discounts on all stereo  
records and tapes and lets you buy what you want... when  
you want... or not at all if you choose.

These are just a few of the money-saving reasons to write  
for free details. You can't lose so why not fill out and  
mail the coupon below for immediate information.

**dmc** DISCOUNT MUSIC CLUB, INC. DEPT. 8-1078  
650 Main Street, New Rochelle, N.Y. 10801

Name \_\_\_\_\_  
Address \_\_\_\_\_  
City \_\_\_\_\_  
State \_\_\_\_\_ Zip \_\_\_\_\_

CIRCLE 15 ON PAGE 149



Adrian Sgei

Eugene Ormandy—a grandiose Tallis Fantasia

the reader, besides some vital statistics culled from Grove's, some vital historical mistakes.

This is run-of-the-mill music in the late Mannheim *symphonie concertante* style, and Stamitz' mill was a very large one that must have worked day and night. But as early as 1811, Spohr called him "very dated," so imagine how he sounds today. The music is mellifluous yet without a shred of individuality; Stamitz must have been a man who had begun to reminisce at the age of ten. Every cliché of the classic era is spliced together—with good workmanship, it is true, and with the knowledge of one who grew up in the orchestra, but there is not a single original idea. Carl cannot hold a candle to his distinguished father.

Clarinetist Lawrence Sobol plays well, but his tone is occasionally a little raw in the highest register and his trills are not very elegant. The orchestra is so-so, the conductor does his job, and the sound is indifferent—there is a disturbing echo in the *tuttis*. P.H.L.

**VAUGHAN WILLIAMS:** Fantasia on a Theme by Tallis.\* **BRITTEN:** Peter Grimes: Sea Interludes and Passacaglia, Op. 33 a, b.\* Philadelphia Orchestra. Eugene Ormandy, cond. [Peter Dellheim\* and Jay David Saks\*, prod.] RCA ARL 1-2744, \$7.98. Tape: \*\* ARK 1-2744, \$7.98.

**VAUGHAN WILLIAMS:** Fantasia on a Theme by Tallis. **DVOŘÁK:** Serenade for Strings, in E, Op. 22. **PURCELL:** Dido and Aeneas: When I am laid in earth (arr. Stokowski). Royal Philharmonic Orchestra, Leopold Stokowski, cond. [Antony Hodgson, prod.] **DESMAR** DSM 1011, \$8.98. Tape: \*\* **ADVENT E** 1047, \$8.95.

**R** **VAUGHAN WILLIAMS:** Fantasia on a Theme by Tallis; Fantasia on "Greensleeves"; English Folk Song Suite (orch. Jacobs). **COATES:** London Every Day. Orchestra, Morton Gould, cond. **QUINTESSENCE** PMC 7049, \$3.98 [from **RCA LSC** 2719, 1964].

**B** Comparison—Vaughan Williams: Marriner/St. Martin's Academy Argo ZRG 696  
Comparison—Britten: Britten/Covent Garden Lon. CS 6179

Although the magnificent *Tallis Fantasia* is an international favorite (surely one of the finest string-orchestra works of any age, not just ours), its near-exclusive ownership long has been staked out on records by English conductors, Sir Adrian Boult and Sir John Barbirolli in particular. So it's always interesting to see whether foreigners (or an expatriate, in the special case of Stokowski) can invade this territory as successfully as they have the similarly exclusive domain of Elgar's *Enigma Variations*. You have to judge the Vaughan Williams results for yourself, but I'll stick with the Englishmen.

Ormandy's new RCA *Tallis Fantasia* is—like his 1963 Columbia one (M 31074), still in print—formidably impressive both for the incomparably sumptuous Philadelphia string sonorities and for the recording's tremendous sonic weight and breadth. But did the composer have such grandiosities in mind? I'd guess that the chamber-scaled—and far more personally heartfelt—Marriner version is closest to Vaughan Williams' intentions, although many aficionados are sure to prefer the eloquently expansive Boult and Barbirolli approach. Ormandy's treatment has its own fascinations, however, not least for audiophiles.

Overside, Britten's *Peter Grimes* excerpts present the Philadelphians with, if not a

The Realistic SCT-30 tells it like it is:

# Why 3 heads are better than 2. Why 2 capstans are better than 1. Why double Dolby\* is better than single.

## 3 Heads.

Two independent record and play heads eliminate the compromises of one combined r/p head, and the head assembly is integrated to eliminate azimuth error. The result: cleaner sound. The third head lets you monitor

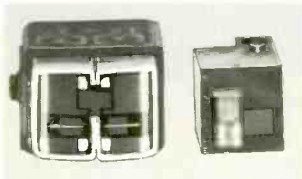

your recording an instant after it's made, without interrupting the program. SCT-30 has 3 heads!



## 2 Capstans.

Dual capstans (instead of the usual 1) reduce wow and flutter to an inaudible 0.06% WRMS or less, and extend the audio frequency response. SCT-30 has dual capstans!

## Double Dolby.

You know the single Dolby system cuts noise and adds dynamic range. But let's examine double Dolby. You get Dolby on both record and monitor so you know exactly what your tape will sound like.

You get a decoder for recording superb Dolby FM stereo. And you get simultaneous listening enjoyment of the decoded broadcast on receivers with tape monitoring. The Realistic SCT-30 has double Dolby! About \$380.



## P.S. - Supertape® Gold.

To go with 3 heads, 2 capstans and double Dolby, you need a cassette tape that will enhance — not degrade — performance. That's why we design and manufac-

ture Supertape Gold in our own Fort Worth factory. Like SCT-30, it's a playmate you can believe in at a price you can afford.

## Why Realistic®?

Because Radio Shack has delivered quality audio at sensible prices since 1921, its Realistic tape and recorder line can point to over 5,000,000 customers as living proof of these claims. Add after-sale service that isn't lip service. Add in-house engineering and manufacturing of much of the Realistic line. And add the convenience of neighborhood shopping where you get "sound talk" from a specialist. That's Realistic!

\*TM Dolby Laboratories, Inc.



**Radio Shack®**  
The nationwide supermarket of sound™.

Radio Shack is a Division of Tandy Corporation, Fort Worth, TX 76102. Over 7000 locations in nine countries.

# SPEAKER INFORMATION KIT.



Get 70 pages of speaker facts in three fact-packed publications.

Speakerlab's Speaker Operating Manual covers everything you need to know to get the best performance out of any loudspeaker, including placement, wire gauges and allowable lengths, amp overloads, room acoustics, L-pad adjustments and impedances.

Our 54-page color catalog covers enclosures, designing your own speakers and driver principles as well as our line of nine easy-to-build speaker kits ranging from a miniature two-way system only ten inches high to a massive all-horn corner system.

"How To Hook Up Your System" spends twelve pages of text and diagrams really explaining system hookup. From where to place your electronics for maximum cooling to the intricacies of installing a cartridge, from eliminating hum to proper record care.

Get all three for just a dollar from the folks who take speaker information seriously...



Dept. HF-O, 735 N. Northlake Way  
Seattle, Washington 98103

Here's a buck! I can really use 70 pages of speaker information from the world's largest manufacturer of speaker kits. Dept. HF-O

name \_\_\_\_\_

address \_\_\_\_\_

city \_\_\_\_\_

state \_\_\_\_\_

zip \_\_\_\_\_



## QUALITY SOUND DIRECT

ALL the quality, mid and high end HI-FI, and VIDEO equipment you want at low direct prices you would not believe in an ad. . . . So send for our fall catalog with the coupon below, or call for immediate action!

SAVE NOW! . . .

(Please Print)

send me your Fall catalog NOW!

Name \_\_\_\_\_

Street \_\_\_\_\_

Town \_\_\_\_\_

State, Zip \_\_\_\_\_

QSD • Box 185, Villanova, Pa. 19085  
(215) 544-2277



Columbia

Leopold Stokowski—fervent and restrained

foreign language, at least a largely unintelligible dialect, which they seem to be reading with painstaking literalness and little if any comprehension. Here more transparent and vivid recording (the two sides are credited to different producer/engineer teams) has captured exceptionally beautiful orchestral tonal qualities. For the magical evocation of Britten's somber, salt-sprayed seascapes, one must go back to the composer's own 1960 versions (originally in his London recording of the complete opera), although more recently André Previn has done well with them and is strikingly well recorded by Angel (S 37142, January 1977).

Stokowski's stereo *Tallis Fantasia* (he first recorded the work in mono many years ago), released first on cassette (I commented on the technically superb Advent edition in the April 1977 "Tape Deck"), is now available in an imported disc edition pressed by Teldec in West Germany. The generally romantic treatment is of course no surprise, but what is less expected is Stokowski's restraint. Not at all "English" in feeling, this is a persuasively fervent reading in endearingly lucid and warm recording. It's only in the coupled transcription of "Dido's Lament" that the old Stokowskian emotionalism is given free expression. And while the Old Sorcerer's first-ever recording of the Dvořák String Serenade (probably one of the most irresistibly appealing works ever written) undoubtedly will delight the conductor's devotees, it gives scant inkling of the serenade's essential folkishness.

Morton Gould's *Tallis Fantasia* is, for all its earnestness, too careful, even constrained, to compete with the best versions,

and his *Greensleeves Fantasia* lacks lilt and grace. The still surprisingly strong, close-up recording, originally on RCA, is shown to better effect overside in the delectably breezy *English Folksong Suite* and in that unjustly neglected symphonic-pops favorite of yesteryear, Eric Coates's sparkling *London Every Day*—in what seems to be its only available recorded version. R.D.D.

**H WAGNER: Parsifal: Prelude; Act III.**  
Kundry Elsa Larčen (s)  
Parsifal Carl Hartmann (t)  
Amfortas Hans Reinmar (b)  
Gurnemanz Ludwig Weber (bs)

Chorus and Orchestra of the Deutsche Oper Berlin, Hans Knappertsbusch, cond. ACANTA DE 23 036, \$17.96 (two discs, mono, manual sequence) [recorded from broadcast, 1942-43] (distributed by German News Co.).

Acanta has inherited the rights to the former BASF historical series, and it has retained the old format, complete with cover illustrations in children's-book style. Presumably there is a good deal of Nazi-period broadcast material still to be tapped, and this is one of the more promising items to come along from such sources in quite a while. I don't know if the whole opera was broadcast (the Prelude ends with the operatic conclusion, not the concert ending, which may or may not be significant); at least we are given the entire third act, not (as suggested by the front liner) merely a scattering of "Hohepunkte." The outside and inside liners can't seem to agree whether the performance took place in 1942 or 1943, but I don't suppose that matters much. I'm surprised that this recording ex-



# Onkyo TA-630D Cassette Deck with the Exclusive Accu-Bias System.

The reason  
you waited  
to buy one.

With cassette hardware and software changing constantly, a lot of you have been waiting. Holding off for top technology.

You've got it.

Onkyo's TA-630D with our exclusive Accu-Bias is here. And it's the only cassette deck with

adjustable bias in a two-head configuration. Which right there offers lower distortion, better low frequency response and little or no crosstalk. That's a lot, but there's more.

You know how important it is to have optimum bias when you record. Too low a bias signal and you have distortion. Too high a bias signal and you lose high frequency response.

Other cassette decks have adjustable bias and equalization, set at the factory for average conditions. Onkyo doesn't believe in playing averages. And gives you Accu-Bias.



Accu-Bias is Onkyo's exclusive system. It works with a pair of reference signal generators built into the TA-630D. Feed these signals to your tape, and read the reproduction signal on the meters. If bias is off for that cassette tape, you compensate with continuous, variable settings until you get an absolutely flat frequency response. It's that simple...and you get the best high frequency response, least distortion and lowest signal to noise ratio.

You get all that because the bias signal primes your tape as the recording is made, and every manufacturer's tape is different. Even when equalization is correct, if the bias is incorrect, it results in producing peak or losing the high frequency characteristic. Again, this depends on the tape used...all of which respond differently.

*Does it work?*

After all the effort Onkyo's gone to so you can have the only two-head continuously variable bias control you might expect fantastic sound.

You've got it.

You've got frequency response of 20-15,000 Hz on normal tape; 20-18,000 Hz with FeCr and CrO<sub>2</sub>.

S/N ratio with FeCr is 58dB, goes up to 68dB with built-in Dolby<sup>®</sup> NR System. Wow and Flutter are negligible at 0.055% WRMS by use of a DC servo motor for constant speed.

There's still more, but you'll have to find out from your Onkyo dealer. Be prepared for a stunning cassette listening experience and features found only in higher-priced decks. Listen for the difference Accu-Bias makes and find out what keeps Onkyo a step ahead of state-of-the-art.

\*Dolby is a trademark of Dolby Laboratories, Inc.



ARTISTRY IN SOUND

## ONKYO<sup>®</sup>

Eastern Office: 42-07 20th Ave., Long Island City, NY 11105 (212) 728-4639

Midwest Office: 935 Sivert Drive, Wood Dale, ILL. 60191 (312) 595 2970

West Coast Distribution Center: Damark Industries, Inc. 20600 Nordhoff Street, Chatsworth, CA 91311 (213) 998-6501

Canada: Sole Distributor, Tri-Tel Associates, Ltd., Willowdale, Ontario Canada M2H 2S5

# The stereo catalog with a guarantee



Dixie Hi Fi guarantees that you'll find in our free catalog the lowest prices on the highest quality brand name stereo and TV. We carry everything in stereo components, and the latest in TV technology, all with brand names like Pioneer, Technics, Altec, Kenwood, Maxell, Sansui, Teac, Shure and many more.

TO ORDER MERCHANDISE  
Call TOLL FREE: **800-446-7925**  
(Within Va. . . Dial 804-257-4241)  
OR WRITE FOR OUR FREE CATALOG



## LOW PRICES & RELIABILITY

### DISCOUNT HI-FI STEREO COMPONENTS

- RECEIVERS • SPEAKERS • TURNTABLES
- CARTRIDGES • TAPE RECORDERS

#### Technics

SU8600  
STEREO  
INTEGRATED  
AMPLIFIER

73 Watts Minimum RMS per channel at 8 ohms from 20-20,000 Hz with no more than 0.08% total harmonic distortion.



#### Sansui

SANSUI-AU717  
STEREO

INTEGRATED AMPLIFIER 85 w/ch.RMS into 8 ohms over 20-20,000 Hz with 0.025% total harmonic distortion



Get our low prices on these and hundreds of other components listed in our new FREE catalog



SEND FOR  
CATALOG  
TODAY!

**District Sound Inc.**

2316 RHODE ISLAND AVENUE, N.E.  
Washington, D.C. 20018  
(202)832-1900

CIRCLE 16 ON PAGE 149



Ludwig Weber  
In wonderful form as Gurnemanz

ists at all, for Knappertsbusch had little patience with the Nazis and would seem to have been an unlikely candidate for the favor of a broadcast performance.

In the event, the recording has one really strong point: the Gurnemanz of Ludwig Weber, then in his early forties rather than his early fifties, as represented by the 1951 Bayreuth recording. Gurnemanzes do tend to be on the elder side (Hans Hotter was fifty-three when he recorded the part, and Gottlob Frick sixty-three), but there is a tangibly greater vocal mastery in this younger incarnation of the performance we know and love. None of the notes are any problem, the voice moves easily and smoothly throughout the range, and the lines are delivered with warmth and authority. A fine singer, in wonderful form.

Hans Reinmar's brief appearance is also of interest; though his pitch is sometimes suspect, there is a good feeling of destination as he makes his way through Amfortas' tortuous lines. Decidedly less memorable (except in the wrong sense) is the Parsifal of Carl Hartmann, who had a brief Met career filling in for Lauritz Melchior; he's a dull singer, both in tonal quality and musical intelligence, and sings flat quite a lot. Kundry has but two words to utter in this act, so the qualities of Elsa Larçen (a singer otherwise unknown to me, and not further identified in the notes) are hardly revealed.

The chorus seems to be suffering from wartime decimation, and it pokes out its lines in painful fashion. The orchestra is rather better, but there are badly balanced patches in the woodwinds and woolly moments from the horns. The sound, about average for this sort of material, manifests a few slight dropouts, some stretches of burbly tape, irregularly distorted high frequencies, and a weak bass line.

Listening "through" this, as it were, with all the sympathy in the world, I can't say that Knappertsbusch is having one of his better days. The Prelude lumbers along as if up and down a gently rolling hill. The last act, though sensitively paced through the Good Friday music, never gets off the

ground in the Transformation or the final scene. In short, this is a recording for fans of Gurnemanz's music and admirers of Ludwig Weber: if you want a great Act III, try Karl Muck's (Preisler LV 100).

No text; the historical note (in German and English) makes both Hartmann and Reinmar ten years older than they were (both were born in 1895, not 1885). D.H.

## Recitals and Miscellany

**ENRICO CARUSO:** The Complete Caruso, Vols. 4-5. For a feature review, see page 93.

**CZECHOSLOVAK MILITARY BAND:** Vivat Praga. For a review, see page 112.

**JESSYE NORMAN:** French Song Recital. Jessye Norman, soprano; Dalton Baldwin, piano. PHILIPS 9500 356, \$8.98.

**DUPARC:** La Vie antérieure, Phidylé; Chanson triste, L'Invitation au voyage. **POULENC:** Voyage à Paris; Montparnasse; La Grenouillère; Les Chemins de l'amour. **RAVEL:** L'Enigme éternelle; Kaddisch. **SATIE:** La Statue de bronze; Daphnéo; Le Chapelier, Je te veux.

This recital could serve as a textbook example of the insufficiency of beautiful sound in the performance of art songs. Not that Jessye Norman is unaware of the problems. Throughout the program one hears her making an effort to interpret as well as produce mellifluous tone, adjusting her dynamics in accordance with the meaning of the words, using different kinds of rhythmic emphasis, trying to vary the color of her voice. Conscientiousness, however, is not enough: The songs remain inert, undifferentiated, inexpressive. Norman's performances, I fear, lack imagination, the ability to express the essential poetic character of this diverse (yet similar) material.

To hear Maggie Teyte (or Claire Croiza or Charles Panzéra or Pierre Bernac) articulate the refrain of Duparc's "L'Invitation au voyage" ("Là, tout n'est qu'ordre et beauté./Luxe, calme et volupté"—"There, all is order and beauty./Richness, tranquility, and delight") is to experience a world of meaning not hinted at in Norman's art. Similar comparisons reveal her lack of success in all the other selections: The vividness that a singer like Bernac (or Jane Bathori or Mady Mesplé) brings to Satie's "Le Chapelier," a song about the Mad Hatter from Alice in Wonderland, is simply not within her grasp. Neither is the sophisticated use of the operette idiom in Poulenc's waltz "Les Chemins de l'amour," originally written for Jean Anouilh's play *Léocadia*, starring Yvonne Printemps and Pierre Fresnay. The former's performance (available on an imported Voix de son Maître disc, 2C 064 10811), with its air of melancholy reflectiveness (and its irresist-

# Fill out this coupon and save the children

Complete this simple questionnaire, and befriend a needy child through Save the Children. For only fifty-two cents a day, your money, combined with that of other sponsors, can breathe new life into an impoverished village... help hardworking people in their fight for dignity... turn despair into hope for a child who has known only disaster. Fifty-two cents may not buy much where you live. But for the poorest of the poor where the need is so desperate, it can work miracles.

HF 8/8

My Name Is \_\_\_\_\_ (please print)

Address \_\_\_\_\_

City \_\_\_\_\_ State \_\_\_\_\_ Zip \_\_\_\_\_

**Tell us how you want to help, by answering these questions:**

**1. What kind of child would you like to help?**

- Boy     Girl     No preference

**2. What geographical area are you interested in?**

Urgent need exists in all the areas listed below, especially overseas. If you have a strong preference for a particular location, check the area of your choice. If not, won't you please let us assign a child where the need is greatest?

**Certainly. Choose a child for me in an area of greatest need.**

**I strongly prefer:**

- |  |   |  |
|--|---|--|
| <input type="checkbox"/> Appalachia (U.S.) | <input type="checkbox"/> Dominican Republic     | <input type="checkbox"/> Inner Cities (U.S.) |
| <input type="checkbox"/> Bangladesh        | <input type="checkbox"/> Honduras               | <input type="checkbox"/> Israel              |
| <input type="checkbox"/> Chicano (U.S.)    | <input type="checkbox"/> Indian (Latin America) | <input type="checkbox"/> Korea               |
| <input type="checkbox"/> Colombia          | <input type="checkbox"/> Indian (U.S.)          | <input type="checkbox"/> Lebanon             |
|  | <input type="checkbox"/> Indonesia              | <input type="checkbox"/> Mexico              |
|  |   | <input type="checkbox"/> Rural South (U.S.)  |
|  |   | <input type="checkbox"/> Upper Volta         |

**3. Would you like a picture of your sponsored child?**

Shortly after we select a child for you, we can send you a photograph and brief personal history, if you desire.

- Yes     No

**4. Would you like to exchange correspondence?**

If desired, correspondence can build a meaningful one-to-one relationship and provide a unique educational experience for the sponsored child. In areas where illiteracy is high, a village representative will keep you informed of the progress your child is making. Translations, where necessary, are supplied by Save the Children.

- Yes     No

**5. Would you like information about the child's community?**

Several times a year you can receive detailed reports on the activities and projects being undertaken in the community to benefit your sponsored child. These community reports show how your money is being used most effectively for permanent improvements to the child's environment—for health care, education, food production, nutrition, and community training. Would you like to receive such information?

- Yes     No

**6. How do you wish to send your sponsorship contribution?**

Enclosed is my check for \$ \_\_\_\_\_

- Monthly, \$16     Semi-annually, \$96  
 Quarterly, \$48     Annually, \$192

**7. Do you wish verification of Save the Children credentials?**

Save the Children is indeed proud of the handling of its funds. Based on last year's audit, an exceptionally large percentage (77.3%) of each dollar spent was used for program services and direct aid to children and their communities. Due to volunteered labor and materials, your donation provides your sponsored child with benefits worth many times your total gift. Would you like to receive an informative Annual Report (including a summary financial statement)?

- Yes     No

(A complete audit statement is available upon request.)

**8. Would you rather make a contribution than become a sponsor of an individual child at this time?**

- Yes, enclosed is my contribution of \$ \_\_\_\_\_  
 Check here for general information about our unique programs for aiding impoverished children.



Mail to:  
 David L. Guyer, President

**Save the Children®**

50 Wilton Road, Westport, Connecticut 06880

YOUR SPONSORSHIP PAYMENTS AND CONTRIBUTIONS ARE U.S. INCOME TAX DEDUCTIBLE

Established 1932. The original U.S. child sponsorship agency. Member of the American Council of Voluntary Agencies for Foreign Service.

photo: Bentley Kassal

ible use of portamento), is unforgettably personal. Norman's is hardly separable from the rest of this bland recital.

Dalton Baldwin, an excellent pianist, does some delicate playing here (e.g., in the second half of "L'Invitation au voyage") but on the whole is uncharacteristically featureless. Philips' recording is close. Sometimes Norman's voice takes on a disconcerting fuzziness of tone, as when she sings out at the end of Duparc's "Phidyle" (for a memorable account of which one can turn to British EMI's Teyte set, RLS 716). The record surfaces, as usual with Philips,

are noiseless. Texts are supplied (though not in the order of performance) but, unaccountably, no translations. D.S.H.

**GILLIAN WEIR:** The Organ at Hexham Abbey. Gillian Weir, organ of Hexham Abbey, England. [Chris Hazell, prod.] ARGO ZRG 864, \$7.98.

**WIDOR:** Symphony No. 6. Allegro. **VIERNE:** Impromptu, Op. 54, No. 2. **BULL:** Dr. Bull's My Selfe; Dr. Bull's Jewell. **GRIGNY:** Tierce en taille. **MULET:** Toccata "Tu es Petrus." **DAQUIN:** Noel suisse. **DUPRE:** La Fileuse. **LANGLAIS:** Dialogue sur les mixtures. **TOMKINS:** Worster Brawles. **SWEELINCK:** Variations on "Mein junges Leben hat ein End." **DUBOIS:** Toccata.

Perhaps I should confess at the outset that "bits and pieces" anthologies of this sort do not often strike me as very satisfying, and when the order of the pieces is as inscrutable as that on this recording the effect can be disconcerting indeed. Somehow I can't help thinking it a bit tasteless to follow, as Gillian Weir does here, a Grigny Tierce en taille with Mulet's Tu es Petrus, or Sweelinck's "Mein junges Leben" variations with a tempest-in-a-teapot toccata by Théodore Dubois. The aim, obviously, has been to demonstrate the versatility of both performer and instrument—and in this respect both get high marks—but surely a more careful arrangement of the selections would have provided a more pleasing musical experience.

As in her recent "French Virtuoso Organ Music" album (Prelude PRS 2507, January), Weir proves that her virtuosity is second to none, and her sense of style in this wide-ranging program is generally quite secure. She has, in addition, a marvelous way with rhythmic nuances—rubato and agogic accents—and the musical impact can be quite powerful.

Unfortunately, they are not always applied as consistently or as discreetly as one might have wished. In the Sweelinck, for example, each phrase of the opening cantus firmus statement is quite sensitively shaped, but we sometimes search in vain for parallel treatment in the ensuing variations; part of the problem is that Weir keeps speeding up the basic pulse, and as each variation gets just a bit faster than its predecessor the margin of acceptable rhythmic give-and-take becomes smaller. I have some reservations, too, with her performance of the Widor, for while the exaggerated agogic accents provide undeniable excitement they are hardly consonant with the rather strict performance style of the Lemmens-Widor-Guilman-Dupré school. It is interesting in this connection to compare Marcel Dupré's noble performance of the piece, recorded by Mercury in New York's St. Thomas Church in 1957, which I hope will someday reappear in the Golden Imports series.

The organ that Weir plays here was designed and built a couple of years ago by her husband, Lawrence Phelps. It is a mechanical-action instrument with thirty-four speaking stops on two manuals and pedal; its tonal design is basically a modern synthesis—a rather well-conceived one, too—with something of a French accent. As is typical of Phelps's instruments, though, the actual sounds are sometimes less than genuinely beautiful, and the somewhat aggressive "chiff" soon becomes wearying. It is an instrument to admire but not, perhaps, to love.

The sound of the organ has been vividly captured, and the bass has impressive solidity. The record sleeve includes a complete specification of the instrument and the performer is given a substantial panegyric, but the music is largely left to speak for itself: The pieces are only sketchily identified, and Basil Ramsey's superficial annotations are an insult. S.C.

# The New York Philharmonic Guide to the Symphony

by Edward Downes

All in one 1,058-page volume, "the most comprehensive English-language reference work on the present-day symphonic repertory."

- Three centuries of music from C.P.E. Bach to Bernd Alois Zimmermann, arranged by composer and by work with descriptive analysis of each orchestral composition.
- Over 450 works, over 400 musical examples, numerous photographs and portraits of composers.
- Includes symphonies, concertos, symphonic poems, suites, overtures, ballet music and incidental pieces, plus the texts of vocal works.
- Provides rich and pertinent historical background, including quotations from composers' letters, the circumstances in which the work was written, interesting stories behind the compositions and related biographical material.

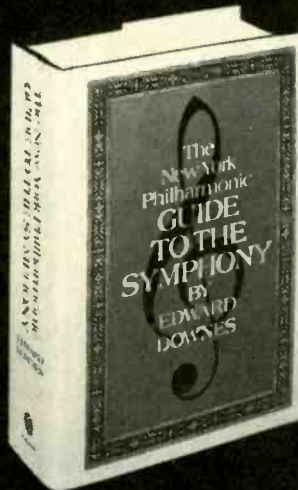

**MAIL TO:**  
Music Listener's Book Service  
High Fidelity Magazine, Great Barrington, MA 01230

- Yes! Please send \_\_\_\_\_ copy(ies) of Edward Downes' *The New York Philharmonic Guide to the Symphony* for 15-days trial examination. If dissatisfied in any way, I may return my order for a full refund or credit within 15 days. I pay only \$25.00 per book plus \$1.00 for shipping.
- I enclose \$\_\_\_\_\_ (Residents of Ohio, N.Y. and Mass. add applicable sales tax.)

Charge to  Master Charge  BankAmericard

My credit card number is

Master Charge Interbank number

Card expires \_\_\_\_\_ Signature \_\_\_\_\_

Name \_\_\_\_\_

Address \_\_\_\_\_

City \_\_\_\_\_ State \_\_\_\_\_ Zip \_\_\_\_\_

Allow 4 to 6 weeks for delivery

**fact:**  
**the IV does more... *much more!***

**new!**

Shure V15 Type IV  
**SUPER TRACK IV™**  
 Stereo Dynetic® Phono Cartridge

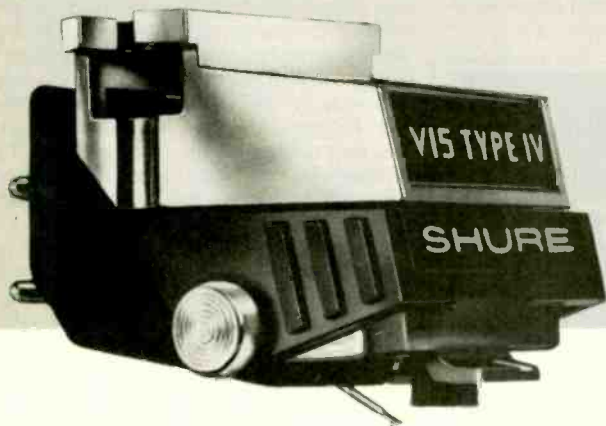

The creation of the new V15 Type IV is a tour de force in innovative engineering. The challenge was to design a cartridge that would transcend all existing cartridges in musical transparency, technical excellence, and uniformity. The unprecedented research and design disciplines that were brought to bear on this challenge over a period of several years have resulted in an altogether new pickup system that exceeds previous performance levels by a significant degree—not merely in one parameter, but in totality.

In fact, this pickup system has prevailed simultaneously over several extremely difficult music re-creation problems which, until now, have defied practical solutions. Most of all, this is an eminently musical cartridge which is a delight to the critical ear, regardless of program material or the rigorous demands of today's most technically advanced recordings.

**THE V15 TYPE IV OFFERS:**

- Demonstrably improved trackability across the entire audible spectrum—especially in the critical mid- and high-frequency areas.

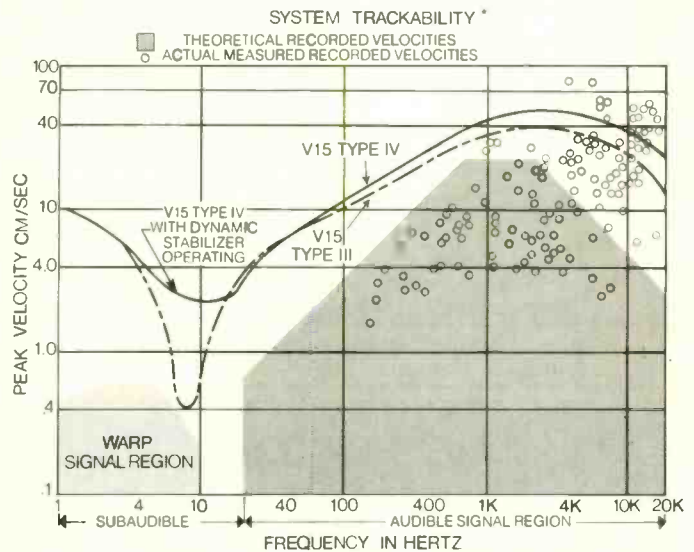

\*Cartridge-tone arm system trackability as mounted in SME 3009 tone arm at 1 gram tracking force.

- Dynamically stabilized tracking overcomes record-warp caused problems, such as fluctuating tracking force, varying tracking angle and wow.
- Electrostatic neutralization of the record surface minimizes three separate problems: static discharge; electrostatic attraction of the cartridge to the record; and attraction of dust to the record.
- An effective dust and lint removal system.
- A Hyperelliptical stylus tip configuration dramatically reduces both harmonic and intermodulation distortion.
- Ultra-flat response—individually tested to within  $\pm 1$  dB.
- Lowered effective mass of moving system results in reduced dynamic mechanical impedance for superb performance at ultra-light tracking forces.

For more information on this remarkable new cartridge, write for the V15 Type IV Product Brochure (ask for AL569), and read for yourself how far Shure research and development has advanced the state of the art.



Shure Brothers Inc., 222 Hartrey Ave., Evanston, IL 60204 In Canada: A. C. Simmonds & Sons Limited  
 Manufacturers of high fidelity components, microphones, sound systems and related circuitry.

# Buy direct by phone by catalog that's free

We sell top name brands of Hi-Fi equipment, accessories, records, and tapes at incredibly discounted prices. Our catalog contains 48 pages of select quality products and its FREE.

Order one now, or call TOLL FREE.  
1-800-638-3920

NAME \_\_\_\_\_  
ADDRESS \_\_\_\_\_  
CITY \_\_\_\_\_  
STATE \_\_\_\_\_ ZIP \_\_\_\_\_

**STEREO DISCOUNTERS**  
6730 Santa Barbara Court  
Baltimore, Maryland 21227

## Theater and Film

**SCORPIO.** Original film soundtrack recording. Composed and conducted by Jerry Fielding. [Jerry Fielding, prod.] FILM MUSIC COLLECTION Album 11, \$8.00 plus 60¢ handling, to members only (annual membership \$5.00; Elmer Bernstein's Film Music Collection, Box 25198, Los Angeles, Calif. 90025).

**THE GAUNTLET.** Original film soundtrack recording. Composed and conducted by Jerry Fielding. WARNER BROS. BSK 3144, \$6.98. Tape: ● M 53144, \$7.97; ● M 83144, \$7.97.

The Film Music Collection release of the Jerry Fielding score for Michael Winner's 1973 *Scorpio* represents that organization's first non-homegrown venture. While all of its earlier discs (some of which are now being issued by Warner Bros.) were newly recorded by founder/president Elmer Bern-

stein, the *Scorpio* album is taken from the well-recorded original music tracks conducted by the composer.

I know of few film scores that have the mixed-bag effect of this one. Starting with a theme that evokes France through a Francis Lai type of moodiness and the use of a musette, Fielding breaks into a big swell of strings for the opening titles that is pure old-fashioned Hollywood. The next band includes a violin duet that flirts with atonality over sustained cluster chords in the strings, and many of the other cuts maintain this level of musical sophistication. An impressive dirge for strings adds a dimension of great poignancy to the film's conclusion; the de rigueur action ostinatos of modern film music are replaced here by an ingeniously conceived bolero rhythm; classical and jazz devices are brought together for some of the other action sequences; and along the way Fielding turns to predecessors from Johann Strauss to Serge Prokofiev.

The record also has two bands of near Muzak (especially the interminable "On the Plane from Paris" cut) and another in which an old man croaks out a Spanish Civil War song, all of which I could have done without. And although Jay Alan Quantrell makes some good points in the liner notes, including the parallels between doubled instruments and the story line, he needs a refresher course in musical terminology. He also implies that the CIA termed the film to be "little known" in this country, even though it received a substantial first run, was re-released on a double bill with Winner's *The Mechanic* (which has another outstanding Fielding score), and has been shown on television.

But it would be easy to put up with a good deal more to get the first-rate Fielding that is on the disc, and I hope more is forthcoming. Certainly, the teaming of Fielding with director Sam Peckinpah has been an important film collaboration, and I would love to see an album containing music from *Straw Dogs* and *The Killer Elite*. And a recording of at least some of his music for the much underrated *Demon Seed* is a must.

Those who, like me, find Fielding's "classical" style to their taste may be initially disappointed with the mainly jazz-oriented score for Clint Eastwood's *The Gauntlet*, since there is little in it one can readily associate with the composer. But as a jazz score—and how many films use jazz scores these days?—it works beautifully. In addition to the main theme, a lazy "travelin' blues" kind of piece featuring a stunning trumpet solo by Jon Faddis, *The Gauntlet* uses a number of big-band sounds somewhat reminiscent of Maynard Ferguson.

The Fielding touch still stands out strongly here and there, most particularly, perhaps, in some of the breathtaking rhythmic figures. In the "Exit Tunnel. Roaring!" cut, for instance, the listener is treated to a dazzling multiple-battery display instead of the standard snare-drum beat. *The Gauntlet*, judged on its own considerable merits, is a very impressive album. R.S.B.

## THE CASE OF THE MISSING CELLIST.

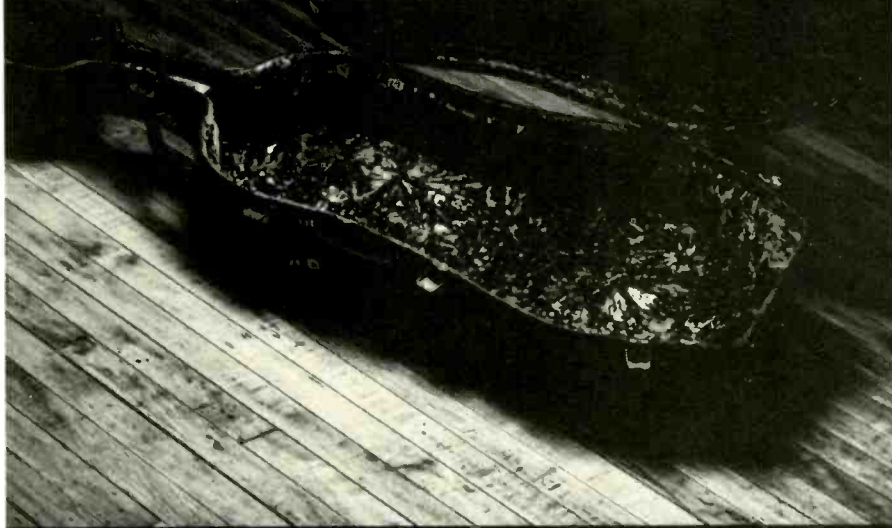

Here one second, gone the next. This is clearly a case of brutality by a low definition cartridge. But an ADC cartridge can rescue him.

The ZLM and its unique ALIPTIC® stylus, combines exciting sound reproduction with less wear to your records and flawless stereo imaging.

Fact is, it has an ultra linear frequency response of ± 1dB 10Hz to 20kHz and ± 1½ dB to 26kHz, and tracks at ½ to 1¼ grams.

So bring back the cellist and other musicians. Invest in something that understands them, and protects them. An ADC cartridge.



Audio Dynamics Corp., Pickett District Rd., New Milford, CN 06776 • Distributed in Canada by BSR (Canada) Ltd. Rexdale, Ont.  
Please circle our reader service number and we'll send you a free record care gift.

CIRCLE 8 ON PAGE 149

# Here It Is! 1978 Edition High Fidelity's Test Reports

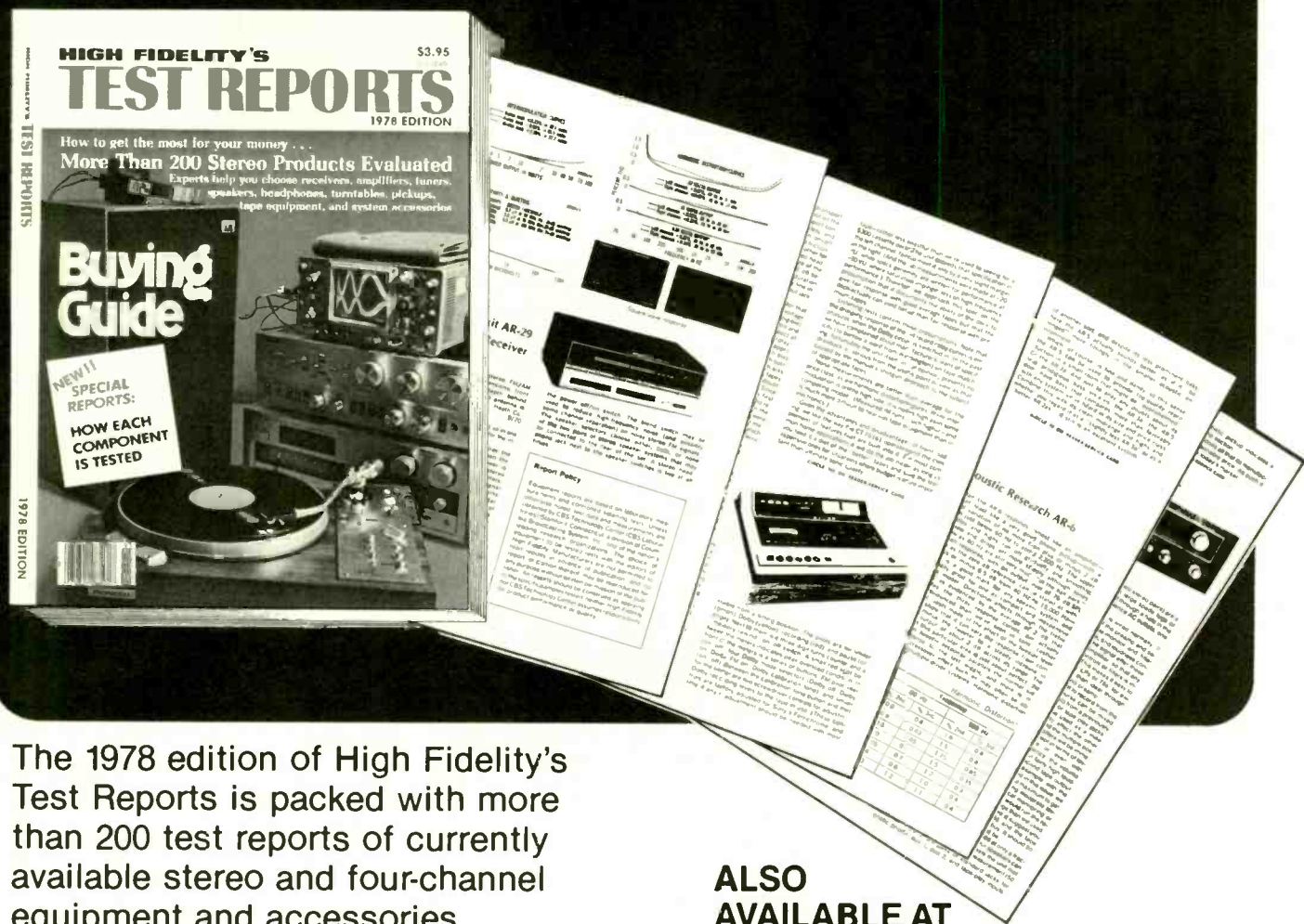

The 1978 edition of High Fidelity's Test Reports is packed with more than 200 test reports of currently available stereo and four-channel equipment and accessories, including:

**ALSO  
AVAILABLE AT  
YOUR LOCAL NEWSSTAND.**

**Receivers • Headphones • Amplifiers • Tape Equipment  
Turntables & Pickups • Speakers • Tuners . . . and more!**

This new book is bigger and better than ever before! 330 pages of in-depth analyses with charts, tables, pictures and prices, plus a guide to technical audio terms. Order now. Send in the coupon or circle number 161 on the Readers' Service Card in the back of this magazine. Be sure to enclose cash with order.

**High Fidelity's Test Reports  
1978 Edition  
1 Sound Avenue, Marion, Ohio 43302**

Please send me \_\_\_\_\_ copies of the 1978 High Fidelity's Test Reports at \$3.95 each, plus \$.50 postage and handling, total \$4.45.

Name \_\_\_\_\_

Address \_\_\_\_\_

City \_\_\_\_\_

State \_\_\_\_\_

Zip \_\_\_\_\_

(add tax where applicable)

DB55A

RCA too, with Gold Seal vintage. It's beginning to seem monotonous: This is the sixth of my 1978 columns to announce a music cassette-series debut. Nine labels are represented so far, and I'm not counting Angel's long-promised Seraphims, which have yet to find their way to my listening room. Many of us have wondered how long RCA's treasure-rich Gold Seal catalog could delay cassette challenges to the competitively priced (\$4.98) Odysseys and eventually Seraphims, but we weren't left long in doubt. Still busy listening to the twenty-program Gold Seal debut list, I've learned that thirty more releases will follow within a few months. Needless to say, they are all Dolby-encoded. Sadly needful to say, they, like all major American manufacturers' cassettes, lack any program notes.

Summarizing the first batch: There are four Erich Leinsdorf programs; three each by Arthur Fiedler and Charles Munch; two each by Morton Gould, Pierre Monteux, André Previn, and Fritz Reiner; one each by Zubin Mehta and Leopold Stokowski. With only two exceptions, they have been available at one time or another in the regular RCA disc catalog; many have been previously available on open-reel tape or non-Dolby cassettes/cassettes.

In general, the processing of the \$4.98 Gold Seals ranges, like that of full-price Red Seal cassettes, from fair to quite good. And both series demonstrate that Dolby-silencing techniques are not yet fully mastered—more excusable here, perhaps, since the original recordings range from the mid-'50s to the '60s. But even the oldest one (from 1954), the second Fiedler/Pops Offenbach-Rosenthal *Gaîté parisienne*, proves that this sonic champagne ages without any loss of sparkle. So too its AGK 1-2701 filler, the 1957 Rossini-Respighi *Boutique fantasque*, another example of the most delectable ballet music on record. And I'm delighted to hail the return of a less widely appreciated Fiedler masterpiece, his extended Tchaikovsky *Swan Lake* excerpts (AGK 1-2121), exceptionally well recorded by 1963 standards—or any other, for that matter.

Not everything wears as well, of course: Stokowski's notoriously inflated Handel, the *Royal Fireworks Music* (with fireworks) and eight *Water Music* excerpts (AGK 1-2704), now seems intolerably boomy sonically as well as an interpretative travesty.

by R. D. Darrell

## The Tape Deck

And Sviatoslav Richter's American record debut, with Leinsdorf and the Chicago Symphony in the Brahms Second Piano Concerto (AGK 1-1267), still sounds mannered and uncoordinated despite some lovely lyrical moments. On the other hand, the technically outstanding 1965 Leinsdorf/Boston Stravinsky *Firebird* and Rimsky-Korsakov *Coq d'Or Suites* (AGK 1-1528) are still kaleidoscopic demonstration recordings; the long-definitive 1960 Monteux/Boston Stravinsky *Petrushka* (AGK 1-1272) is still as fine an all-round version of the complete ballet as can be found anywhere; and if the 1958 Monteux/Boston Tchaikovsky Fifth Symphony (AGK 1-1264) still will be far too straightforward for impassioned Tchaikovskians, it's a matchlessly lucid delight.

Yet all these and other treasurable Gold Seal programs are outshone by two of Reiner's supreme achievements. His Wagner *Meistersinger* and *Götterdämmerung* excerpts with the Chicagoans (AGK 1-1278) are incomparably eloquent readings embodied in grandly dramatic sonics that today's youngsters probably never will be convinced date back to 1959. His Brahms Fourth, made with the Royal Philharmonic for Reader's Digest only a few months before his death in November 1963, is new to me, as probably to many others. But once it has been heard (now as AGK 1-1961), none of us is likely to dispute the dying conductor's belief that "this is the most beautiful record I have ever made."

**Sine Qua Non upgradings.** SQN cassettes are not newcomers, but they now are arrestingly processed, still in Dolby of course, on TDK high-energy low-noise base tape with head-cleaning leaders. And they include program notes, yet are budget-priced at \$4.98 each. As before, the repertory includes both current recordings and reissues of much older ones to which SQN has obtained reprint rights.

Two current programs feature the virtuoso Empire Brass Quintet, first in

the fascinating Victor Ewald program (SQN C 2012), which I praised so enthusiastically in its disc edition (April), but which is even better processed on tape. Then, the quintet plus "friends" offer "The American Brass Band Journal Revisited" (SQN C 2017), which is of comparable exuberant and technological excellence and of novel programmatic interest for its now mostly forgotten small-town summer-bandstand favorites. But its prime appeal is that the thirteen-man brass and percussion ensemble is led—after far too many years away from records—by the incomparable Frederick Fennell. Welcome back!

**Offbeat prestige boxes.** Leery as I normally am of reissue anthologies, I'm bewitched by the Neville Marriner/St. Martin's Academy "Baroque Festival" of fourteen widely varied concertos, many of which helped to establish the artists' international fame. There are four by Vivaldi, three by Handel, two each by Bach and Telemann, one each by Arne, Corelli, and Fasch. The originals date from 1964 through 1977, yet are miraculously uniform in sonic clarity and vitality, while the infectiously delectable performances are a consistent delight (Argo K69K 33, three cassettes, \$26.94).

The first-ever tape version of Liszt's singular *Faust* Symphony is appropriately by one of its longtime exponents, Leonard Bernstein, here with the Boston Symphony, Tanglewood Chorus, and tenor Kenneth Riegel (Deutsche Grammophon 3370 022, two cassettes, \$17.96). The recording is unexpectedly restrained and unmanipulated—as is Bernstein's devilishly suave reading, one that almost persuades us to suspend disbelief. The filler, the Prologue to Boito's *Mefistofele*, with Bernstein leading soloist Nicolai Ghiaurov and Viennese choruses and orchestra, is more spectacular sonically.

Although I'd never heard Verdi's early opera *I due Foscari* until its first complete recording came along, I'm immediately convinced that whatever "story" handicaps it may have on the stage, its music ranks with the composer's pre-*Rigoletto* best. Top honors go to conductor Lamberto Gardelli, who (with the Austrian Radio Chorus and Orchestra) makes the most of the highly imaginative scoring (Philips 7699 057, two cassettes, \$17.95).





## THE TUNE UP KIT FOR YOUR CAR STEREO. IT'LL GIVE YOU A BETTER HIGH END.

With a Scotch® Master III™ Cassette and a minor change in your recording routine, you can noticeably boost the highs you get from your car stereo.

You see, our Master III Cassette was engineered for use with the ferri-chrome switch position on your cassette recorder. Normally, you'd record and play back in this position, enjoying strong response across the entire frequency spectrum.

But most hi-fi buffs seem to agree it's the high frequency response in particular that adds the details to your sound and makes high fidelity truly high. And this high frequency response is especially critical in car cassette players.

You can boost those highs simply by recording on a Master III ferri-chrome cassette in the normal switch position. Master III records with more highs than standard tapes, so you'll be getting stronger highs on playback

than were really there to begin with.

Give it a try. You might just get hooked on the highs you get with a Master III Cassette.



**SCOTCH RECORDING TAPE.  
THE TRUTH COMES OUT.**

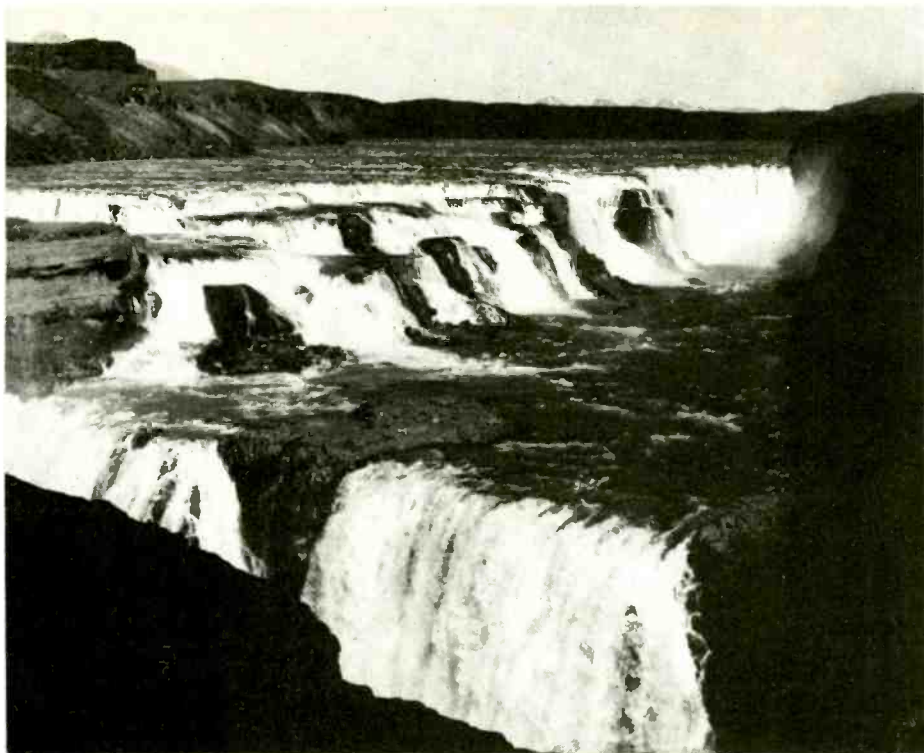

Next time you plan a trip to Europe, make sure you visit the unique country.

Where can you find: Europe's largest waterfalls?  
 Europe's blondest blondes?  
 Europe's highest geysers?  
 Europe's greatest glaciers?

And where can you find moonlike craters where the astronauts trained? More volcanos than anywhere else on earth? Historic landmarks of the world's oldest continuous parliament? Celebrations marking Europe's youngest republic?

The answer to all of these questions is—ICELAND. Next time you plan a trip to Europe, make sure you visit Iceland.

The only thing it may cost you is time well spent. Because you'll save enough money on Icelandic's lowest jet fares to Luxembourg to pay for your stopover in Iceland. Or, you can hop over from New York or Chicago for longer tours. See an erupting volcano. Take a cross-country pony trek.

Next time you plan a trip to Europe, ask your travel agent about Icelandic Airlines. Or phone Icelandic Airlines, for folders about Iceland and lowest jet fares to Europe. In New York State, phone (212) 757-8585. Elsewhere in U.S., phone (800) 555-1212 for local toll free number.

CIRCLE 24 ON PAGE 149

## Moving?

Be sure and send us your new address 8 weeks before you move so you won't miss any copies of HIGH FIDELITY. And please include an old mailing label from our magazine when writing us about your subscription.

Write to:

**HIGH FIDELITY,**  
 1 Sound Avenue, Marion, Ohio 43302

- Change of address.  
 Enter new subscription. 1 year \$9.95  
 payment enclosed  bill me

AFFIX LABEL

If you have no label handy, print OLD address here

name \_\_\_\_\_ please print  
 address \_\_\_\_\_  
 city \_\_\_\_\_  
 state \_\_\_\_\_ zip code \_\_\_\_\_

New Address

name \_\_\_\_\_  
 address \_\_\_\_\_ please print  
 city \_\_\_\_\_  
 state \_\_\_\_\_ zip code \_\_\_\_\_

Add'l postage: \$3 per year outside U.S., if possible.

## High Fidelity's Free Armchair Shopping Service

- On the card opposite, circle the number indicated at the bottom of the ad or at the end of the editorial mention of the product you're interested in. (Key numbers for advertised products also appear in the Advertising Index.)
- Type or print your name, address, and zip code on the card. Postage is prepaid.
- Mail the card today. You'll soon receive free product literature and specifications from manufacturers.



## MAIL ORDER BUYER'S SERVICE

Use the Mail Order Buyer's Service card on opposite page to order:

### BUYING GUIDE

- High Fidelity's Test Reports 1978
- High Fidelity's Buying Guide to Stereo Components 1979
- High Fidelity's Buying Guide to Speaker Systems 1979

### SUBSCRIPTIONS

- High Fidelity Magazine
- High Fidelity/Musical America edition

Mail card along with payment to:

**High Fidelity**  
 1 Sound Avenue  
 Marion, Ohio 43302

# Back Beat



Photos by Ron Pownall

*Tom Scholz, Fran Sheehan, Barry Goudreau, Brad Delp, Sib Hashian*

## Boston's Return: More than a Followup?

by Toby Goldstein

**I**n the cramped basement of a small neat house in one of Boston's outermost suburbs, the leader of a six-million-dollar band is trying to finish a second album. Tom Scholz—chief songwriter, lead guitarist, arranger, producer, and engineer for the group—has spent most of his daylight hours during the past year here in his hand-built studio, listening, adjusting, in-

venting, and perfecting. Considering his six-foot, five-inch frame, it's surprising that he has not gone totally berserk in the claustrophobic surroundings. Yet he says that the two-room space (smaller than the average city crackerbox apartment) is positively huge compared to that in which Boston's stellar debut recording was produced. "The last one had a control



Scholz, Delp, Goudreau, Sheehan: back on stage at last

room in a closet. It was essentially a room about six by eight." Yet somehow he managed to spend six painstaking years there, emerging with the nucleus of an album that—initially—nobody wanted.

"I never set out to create anything new. I just wanted to make a record I could stand to listen to all the way through," Scholz says. "It's amazing we got across to anybody. Who'd have guessed, after being rejected so completely for seven years, that anyone out-

---

**"More than a Feeling never sold a million copies; it sold six million albums, though."**

---

side of me and a few musicians would have thought it was real good? 'Cause we aren't a new band, and this isn't new music.

"I'm really surprised that—after all that rejection from people in control of the industry—when we did find somebody who was willing to put out the record, a whole bunch of *real* people liked it. Which leads me to believe that all the record companies should unload their entire a&r staffs and hire high school and college kids."

Boston's story—the lengthy struggle to secure a contract and the unprecedented explosion that followed the first album's release—is the stuff of which music-biz legends are made. Only three years ago, thirty-year-old Scholz and fellow New Englanders

Bradley Delp, Barry Goudreau, Fran Sheehan, and Sib Hashian were just another struggling rock band playing hit-single covers at fraternity parties and local bars. To support their musical habit, they took day jobs ranging from Brad's work on a factory line to Scholz's weighty position as a creative brain for Polaroid—a post he didn't leave until the album's sales began to skyrocket.

Scholz still remembers all the producers, managers, and booking agents who weren't interested in the band's unrevolutionary melodies, harmonies, and clean guitar sound. "There was a guy I ran into while we were on tour last year; he was working for an agency. We had put *Smokin', Foreplay/Long Time*, and a couple of the other tunes on a demo, and it wasn't a bad demo—maybe a little crude—and he had said back then, 'Don't call us, we'll call you.'" He was about ready to pack in the music business when he made one final trip to New York and the CBS megastore. Epic took a shot on releasing the record, expressing confidence in its precise vocal overlays and memorable, soaring guitars. It was shipped, with little advertising, to radio programmers, who soon discovered that increasing numbers of listeners wanted to hear *More than a Feeling*.

"You mean our nongold hit single?" asks Scholz. "*More than a Feeling* never sold a million copies; it sold six million albums, though." He breaks into a hearty laugh. *More than a Feeling* became synonymous with the Boston album. Like Bruce

Springsteen's *Born to Run* and the Sex Pistols' *Anarchy in the U.K.*, the song will stand as one of this decade's anthems. Yet Scholz is unperturbed at its under-a-million sales. "If I did have a smash hit single, one that I wrote, it might be the sign of a weak album. Because if you have a strong album to go along with the song that's getting a lot of airplay, other songs will be getting a lot of airplay. People will, instead of paying a buck for the single, shell out the money for the album. But maybe I'm full of it. All I do is just stumble down here in the morning, turn on the machines, and hope everything goes well. I liked *Peace of Mind* more than *More than a Feeling* anyway."

Whatever the ultimate cause, millions of listeners heard in Boston a sound they wanted to own and hear again. But there were also plenty of disparagers—from envious groups who labeled them one-hit wonders to critics who called their well-organized songs sterile and labeled them "the bionic band." The furor they created was so widespread that a national magazine reporter seriously claimed their songs had been written by a computer.

Scholz looks back at the rush to pigeonhole them with an ironic detachment, born of his lengthy efforts to get noticed in the first place. He's particularly amused by the notion that Boston's success story has now become part of hype phraseology—managers hasten to call their new darlings "the new Boston." "I think that's real funny. It's the old story. It used to be the hype that everybody was the new Beatles. But they really didn't break that fast; Chicago broke much faster than they did. So now they have a real hype for

breaking new bands. I think it's a terrible move on the part of managers or the record companies. Frankly, I wouldn't want to be the new *anybody*. It seems like the kiss of death."

Meanwhile, as Foreigner, Heart, Fotomaker, et al. have been slotted into the newcomer sweepstakes, Boston's players are back home in New England resuming their almost anonymous lives, having completed a full year of cross-country touring in their personally logoed Viscount jet. Several of the boys splurged on new homes and "star car" vehicles, but nobody seriously overindulged.

The image that sticks, from my travels with Boston, is of Tom Scholz on the plane stretched out in T-shirt, jeans, athletic socks, and eye glasses, reading *Scientific American*. He and his wife Cindy have bought a new car, but the battered Pinto still sits in the driveway. Cindy has continued her horticultural studies over the past year and wants to run a greenhouse. There is not the slightest clue that behind the sunny, white exterior is a \$100,000 studio in which Scholz has been creating Boston's second album, one song and one instrument at a time.

"This is not an expensive studio," he says. "Most cost well in excess of a million, even two million. Some of this gear has nothing to do with record production per se. Some of it's educational." He points to a mysterious looking gadget that resembles an oscilloscope. "That thing"—a real-time analyzer—"has taught me more about music in the last six months than I've learned in the last six years of working in studios. It's been available for a while—we used them at Polar-

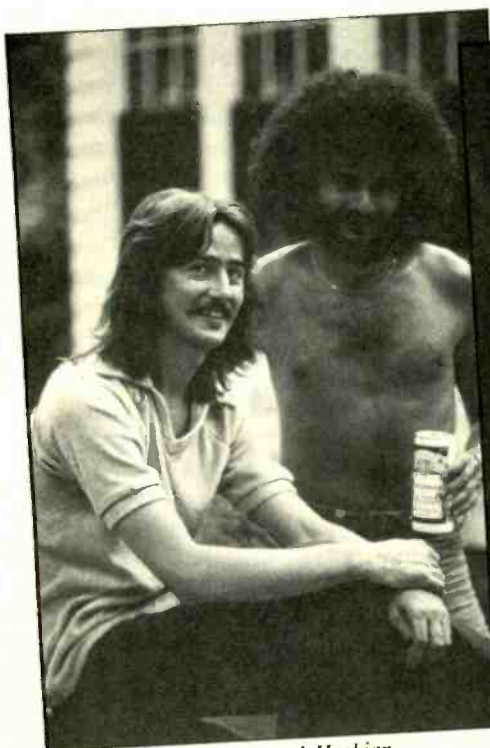

Goudreau and Hashian



Delp

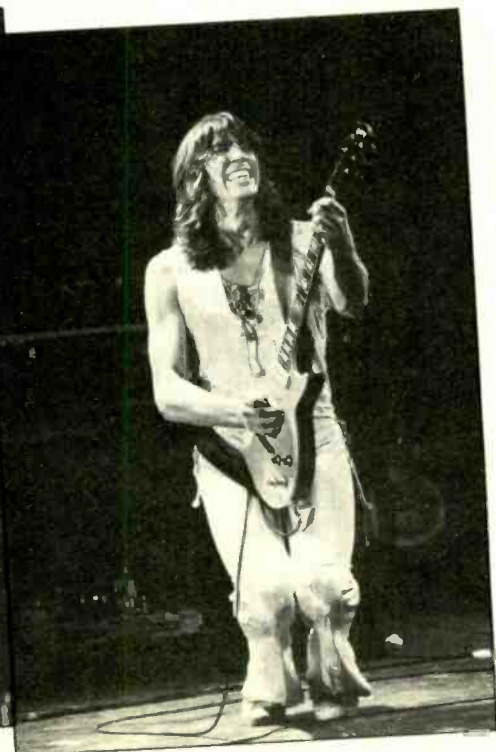

Scholz

oid—but for some reason, nobody uses it in the recording studio. You can get an exact picture of what the sound level looks like at all frequencies. All the things I could never figure out about how to make an instrument sound punchier, crisper, or all of a sudden become clean. I can now re-create. I really like to see what I'm doing. Every time I come up with some mystery, or I don't understand why a thing doesn't sound right or it does sound right, now I can find out. It takes out the guesswork."

Such a fearsome piece of equipment might reopen Boston to charges of "better music through chemistry," but Scholz is ready on the defense. "There was no truth to the rumor that technology had anything to do with our *music*. I think songwriting, arranging, and playing should be strictly organic. I don't even use synthesizers. They don't sound natural—they sound bionic. But I do think recording and record production should be scientific. It better be. We're past the days of somebody singing into a big horn and that going onto a disc. If people were willing to pay six bucks for that, it'd be fine. But they expect something really nice—like you'd get on a very fine recording of a symphonic piece. Unfortunately, we're not dealing with symphonic instruments. Electronic instruments have a lot of problems, and they all have to be dealt with."

Scholz appears to be dealing with them very well, particularly in light of his double-edged responsibility for both the technical and creative aspects of the new LP. He's been working on it since May of 1977, and both he and Cindy have long been waiting for the moment when it would be finished and he could get back onstage. So has Epic. ("They've been a little anxious," he laughs.) But Scholz says that some of the numerous release-date postponements were unavoidable (like when some of the completed masters were "accidentally erased" in April.) He is an unapologetic perfectionist, which is understandable in light of his experience with the first go-round. Besides, the second album was bound to have enough trouble simply matching both the public's and the band's high expectations.

"Don't Look Back," their appropriately titled second album and current single, finally rolled into record stores in August, and early reactions ought to allay Scholz's anxieties. The distinctive buzzing guitars and vocal harmonies on the title track create an atmosphere described as "majestic" by exuberant disc jockeys. However, even if the eight-cut LP comes close to the sales levels reached by "Boston," the group has a good deal of financial catching up to do.

"This adventure in recording has cost us an incredible amount of money. We've missed so many live dates. In the spring of '77, after we ended our tour, we had a few outdoor date offers totaling more money than we'd made in six months on the road. And we had to pass them up because we wanted to get started on this album. And we missed them again last spring.

The amount of money lost because I was taking my time with this album is really staggering. Much, much more than the album is worth." (To recoup a part of those lost potential earnings, Boston went back on tour as soon as "Don't Look Back" was delivered to CBS. Scheduled concerts will take them from New York to Seattle, from Canada to Texas.)

"It was a question of cashing in and trying to make as much money as possible, or maintaining the image of the group with the standards it was able to reach. My personal feelings were, I was so amazed at what happened and really proud of being a part of it, that I much preferred to lose the money and have the image stay the same. It would've been nice to go



*The basement studio with platinum potential*

around and play the stadiums—we'd all be fabulously wealthy. But it's more a matter of pride now than anything else. It's like being on a winning basketball team. You don't care if you're making the top dollar as long as you go on being the best."

Instead of more dollars, it's been two years of semi-solitude. Scholz has left the house infrequently. (Once it was to see a concert by Cheap Trick, who opened many of Boston's tour dates. He couldn't catch their sets then, because he warms up in his dressing room for up to two hours.) He played eight or nine cuts from the new album to friends who aren't wild about rock & roll and was thrilled when somebody told him, "Gee, that sounds like Boston."

"My outlook on the whole thing was, I'd like to make an album the public felt was as good as the first. That was my goal. The record company—I think they'll consider anything a success that sells over three million copies. I think they'd consider it a turkey if it only sells a million. I figured that when we put out this album, there'd be a whole lot of critics lying in wait.

"The only thing I want to do is come out with an album that's good enough that a lot of them who are ready to pounce on us will pick it up and have to say, 'Jesus Christ, they came out with another good album!'" His wide grin fills the little rooms as he indulges himself for a rare moment, imagining how this very likely situation would feel.

(For a review of "Don't Look Back" see page 165.)

## Bob James Records Bob James: The Producer Takes on the Purist

by Fred Miller

In the control room of CBS Records' Studio B in New York, a cheerful maintenance engineer named Harold checks the cable connections, while the tape operator cues up a reel of blank tape. Engineer/associate producer Joe Jorgensen is seated behind the console, getting ready for another day of rhythm tracks on Bob James's latest record. It's 10:15 a.m., and none of the musicians has arrived yet (though the session was called for 10), so I check out the microphone setups, the patch bay, and the custom-built console. Bassist Garry King is the first to drift in, sporting denim cutoffs and a huge friendly grin. He's followed by guitarist Hiram Bullock, saxophonist David Sanborn, and James, who arrives with pencil in teeth finishing up the song they're about to record. Then Steve Gadd enters, with cymbals, drumsticks, and a copy of *Screw* magazine. After several cups of coffee and a brief thumbing of the available reading material, the musicians repair to the studio to run down the form of Bob's new song, tentatively titled 6/7—this is the sixth Bob James record and the seventh song to be recorded.

\* \* \* \* \*

Jorgensen started his engineering career as an assistant to Phil Ramone at the original A&R Studios on West Forty-eighth Street. After Army service, he went to National Recording, still one of New York's biggest jingle studios, and then to MediaSound when it opened as a two-room, 12-track studio in 1969. He stayed on as staff engineer for several years, recording everything that came through the door, from Italian opera to Maynard Ferguson. It was on Maynard's



Photos by Howard Millard

Keyboardist/composer/producer Bob James

1976 "Primal Scream" album that Jorgensen first worked with James, an association that has ultimately led to a partnership with producer Jay Chattaway in the newly formed Columbia-distributed Tappan Zee label.

James's move to the forefront of progressive jazz started in the mid-Sixties when he worked as Sarah Vaughan's musical director. Subsequent work as an arranger on the albums of Dionne Warwick, Roberta Flack, and Aretha Franklin led to a contract with CTI records, where as a keyboardist/composer he made four of his own albums ("One," "Two," "Three," and "Four") and arranged and produced for the likes of Grover Washington, Hubert Laws, and Ferguson in association with producer/owner Creed Taylor and engineer Rudy van Gelder. Washington's "Mister Magic" went gold in 1976, and, as the jazz fusion movement began to take hold everywhere, CBS Records hired James as director of progressive a&r. He continued to take outside assignments, writing the charts for Paul Simon's *Still Crazy after All These Years* and Neil Diamond's "Beautiful Noise," and arranging and producing Kenny Loggins' "Celebrate Me Home."

His own jazz records were also doing well in the marketplace, and all signs pointed to James's having

"Our jazz . . . is the jazz of the '70s. To refer to other kinds as being the 'real' or 'pure' jazz is just not accurate."

found the "something" that the public wanted to hear. What is that something? I guess it can best be categorized as commercial—and very structured—instrumental music. Perhaps jazz/rock. He describes the larger part of his audience as rock post graduates: "After growing up on vocal-oriented pop and rock, people get hungry for more abstract instrumental music and somewhat more depth and adventurousness than they've been accustomed to hearing with Top 40. We also have some jazz fans who are turned on at least somewhat more to our music than they would be to

#### MICROPHONES

<i>Electric piano</i>	<i>Direct</i>
<i>Electric guitar</i>	<i>Electro-Voice RE-16</i>
<i>Electric bass</i>	<i>Direct</i>
<i>Alto saxophone</i>	<i>Neuman U-67</i>
<i>Bass drum</i>	<i>Electro-Voice RE-20</i>
<i>Snare drum</i>	<i>AKG 452, -20dB pad</i>
<i>High hat</i>	<i>Electro-Voice RE-11</i>
<i>Tom-toms</i>	<i>Electro-Voice RE-20s (inside)</i>
<i>Overhead</i>	<i>Neuman U-67 (2)</i>



James does an overdub on the Oberheim in the control room

rock. And then we have a whole *new* audience of people who've become jazz fans in the '70s—since the jazz/rock thing started to happen. I don't know if I'm going too far out on a limb, but I've felt for some time that this music is our jazz. It is the jazz of the '70s. To refer to other kinds as being the 'real' or 'pure' jazz is just not accurate."

CBS is apparently willing to share his limb, as evidenced by the rather happy nature of the company's distribution agreement with Tappan Zee—now just a year old. James can sign artists of his choice, produce their recordings, even decide on cover art, and continue to make his own records; CBS is responsible for the promotion and publicity budgets of those records and sees to their worldwide distribution. So far Tappan Zee has released LPs by guitarist Steve Khan, saxophonist Marc Colby, a "Montreux Summit" two-record set (with George Duke, Billy Cobham, Stan Getz, and lots of others), and James's "Heads." Future plans include an album by pianist Richard Tee, a favorite New York studiomaniac, and another James record (tentatively titled "Sixth Sense"), the basic tracks of which are currently in progress.

\* \* \* \* \*

In the studio, James is seated at the Fender



Rhodes, still working on that song. Gadd is in front of the huge double-glass window of the control room, with baffles around his drum kit. Hiram is to his right, the Fender Twin guitar amp not even visible behind the gobos, and King is directly across from him. Hiram's bass is taken direct to the mix console as well as through a microphone on the amp. Sanborn is totally isolated in a booth in the corner. James is at the center of the group, and everyone can see everyone else. His Rhodes is taken direct from its two line output jacks, allowing for stereo vibrato effects, and the internal speakers have been disabled to prevent leakage into open microphones. (Incidentally, Tappan Zee uses its own drum set, pianos, and amps.) Each musician also has a "talk" mike since isolation makes it impossible for them to communicate without electronic amplification. Jorgensen adjusts the cue mix (only one is used, and it is mono) in the headphones according to each player's needs.

With Bob in the studio, Joe not only is responsible for the engineering, but also acts as associate producer. It's the combined artistic, technical, and production strengths of their partnership as well as the assurance of knowing each other's capabilities that make the whole atmosphere seem so relaxed, yet thoroughly under control. "Joe knows exactly what we're looking for," says James. "I would never be able to produce my own record if it weren't for this kind of relationship."

While they're playing through in the studio, Jorgensen checks each of the input positions to make sure they're functioning as they should and makes a note to adjust one of the drum overhead and sax mikes before recording. He selects his mikes from CBS' almost limitless array, and although I saw Neumann U-49s, Telefunken 251s, and Schoeps on stands off to the



Joe Jorgensen (foreground) and Jay Chattaway at the board



The Tappan Zee brass in conference

side, Joe stayed with the more familiar types. (See microphone selection box). Instrument baffling was less severe than I've seen, though isolation seemed quite adequate. The house gobos were four feet high by about two feet wide, and almost a foot thick.

I asked Joe about the outboard signal-processing devices. "We're not using much. I put limiters on all the toms. There's so much low frequency that you wind up getting no level on tape, so I limit them a lot, especially the floor tom." (Low-frequency information "fools the meter," so that it may show full modulation at the console though not enough upper harmonics of the tom-tom are being recorded to get a good sound.) In addition, Joe uses a Urei 1176 limiter on the bass direct, an LA-3A limiter and ITI parametric equalizer on the bass drum, and another parametric by Orban on the snare drum to get its snap.

The MCI 24-track recorder is running at 30 ips with Dolby noise reduction. The tape type is 3M's 256. Another tape machine and EMT reverberation plates are used for "tape slap," a fairly common technique that enhances the depth of the sound and creates a larger-seeming listening room in the ear.

Studio B has Big Red monitor speakers—which are Altec 604 Es with Mastering Lab crossover networks in ducted-port bass-reflex cabinets painted red. Joe also had his own pair of Big Reds set up directly in front of the console. "I use them up close so that I'm not hearing the room itself," he says. "Since I work in so many different rooms, I like to have the same kind of speaker wherever I go. I use the Big Reds because I don't think you can mix on sensational sounding speakers. You have to work a little harder on these to make your record sound good."

In fact the audio quality on a Jorgensen/James record is one of the outstanding features. Joe gets an unusual clarity on all the instruments, and Bob's writing style is naturally uncluttered. Even though there might be a six-piece rhythm section, eight horns, sixteen strings, overdubs, vocals, and a few synthesizer lines on a given cut, the listener is able to hear everything that's going on and even point to its location in the stereo spectrum.

The musicians are now ready for a take. Jorgensen asks Gadd to hit each tom-tom individually as he balances them between the monitors and make last-minute equalization and limiting adjustments. Steve hears something he doesn't like and takes a moment to retune one drum. Joe mentions that the snare sounds "flabby," and Gadd tightens it. All the mikes have been adjusted during the run-throughs, so everything is ready to go.

Take 1 lasts more than nine minutes, and the playback in the control room persuades everyone to go out and try another. There is a good deal of navigating to be done on 6/7, and until the musicians get used to "add two bars here, play letter D, go back to letter B, and play the figure until Dave's solo." the feel of the tune suffers. But by the end of the third go-round the feel is definitely there, and everyone agrees to use Take 2. King allows that he'd like to punch in one section of his bass part, and James suggests they use the original track for punching rather than record-

### James can best be described as a bebop wolf in sheep's clothing.

ing on a separate track and bouncing later. In this case, the pressure of working with the original is a plus and the punch comes out right the first time. Gary is in and out of the studio in a very few minutes. It is time for a breather and a chance to talk a bit.

\* \* \* \* \*

James can best be described as a bebop wolf in sheep's clothing. While his studio methods are more in keeping with the way a commercial pop record is produced than a jazz record, he says that his "goal as a writer in the jazz area is to have something natural and simple that'll act as a catalyst for making us want to play." He'll start a tune—like 6/7—with a two-line sketch, "a suggestion of a bass part and chord symbols, and I'll usually have some kind of figure we can all lock into, some rhythmic arrival points." Then, for his own records, he'll write the string and horn arrangements to suit the subtleties of that rhythm part once it's recorded. The horns, for instance, will actually play off a figure introduced by the drummer.

Yet James maintains that "the most difficult part of the recording process is to make everything feel like it was played live." So one gets the feeling that he may be a purist at heart but is unable to get away from his producer's need for control and his arranger's need for structure. There was even talk in the control room that this would be a small-group record, without his usual sweetening and lush arrangements. "I had a concept for this record—I wanted to make it simpler and more acoustic with more live improvisation. Yet the whole procedure of overdubbing and reacting to rhythm tapes over a period of weeks has become so much a part of my musical personality that I just don't feel

right about not having the arranger element in it. I love the process of having those 24 tracks and being able to juggle them around and say, 'these sixteen bars

### "My thought on current jazz records is that after one or two listenings, the dull, uninspired moments become intolerable."

are a little too bare—they need another element'. All of those manipulations done afterward are really the most fun part of recording."

Perhaps, as the head of a record label, he's simply playing it safe. "My thought on current jazz records is that after one or two listenings, the dull, uninspired moments become intolerable." Those moments, he feels, often come up during a solo—which is why he isolates a soloist, so he can punch in, alter, or redo it at a later date.

"We're searching," he adds, "both for fire and for a solo that will hold up over one hundred listenings, a solo that has melodic content, not just an indulgent technique thing that doesn't hold up."

\* \* \* \* \*

How does he achieve this? In the studio Sanborn is ready to try another crack at his sax solo. The original is saved on Track 14 and removed from the cue and monitor mix, so that Sanborn, James, and Jorgensen won't hear it on the rhythm track while they're overdubbing. Jorgensen locates the starting point and cues Dave in the booth. There are a few false starts before an entire solo is laid down on Track 13. During playback James points out that about midway through there is conflict with what Gadd is playing. Could Dave try it once more? Sanborn, as flexible as he is musical, obliges with another, this one on Track 15. Ultimately, there are five complete tracks of sax solos, and James assures Sanborn that one of them, or perhaps a composite, will fit the bill. After an hour of playing the same section and five hours of playing the same song, even the indefatigable Dave seems pleased that it is over.

\* \* \* \* \*

While it is clear from talking to him that James has a deep respect for improvised jazz, it becomes clearer from watching sessions such as this one that structure and modern recording technique are of utmost importance to him. Though they may appear to be incompatible with pure music—particularly to the ear of the jazz purist—James doesn't think so, and neither does the record-buying public. ●

The illustration that accompanied Don Heckman's article on backup singers (September, page 120) should have been credited to Leavenworth Jackson.

# Ohm's Law 8:

**Make loudspeakers with great pride,  
and they will get great reviews.**

Ohm defies the laws of modern loudspeaker production.

We don't mass-produce our speakers in huge quantities. Most of the elements that go into Ohm loudspeakers are so intricate, they must be made by hand.



The result is pride-of-craftsmanship you can hear.

Audio critics have heard it. As you're about to read...

#### **Complete Buyer's Guide to Stereo/Hifi:**

"The Ohm C2 is a high efficiency speaker with ruler-flat response to 37 Hz., high power-handling capability, very smooth



treble response, and excellent dispersion. Considering the size of the box, performance, and the price, the Ohm C2 must be reckoned with as one of the better speaker values available...Ohm speakers are very well made, and we recommend this model highly."

#### **Stereo Review:**

"Our standard live-room integrated frequency response measurement of the Ohm F produced one of the flattest extended curves we have ever seen from a loudspeaker...It should be apparent from the foregoing that we include the Ohm F among



those few speakers we have tested that achieves state-of-the-art performance." (Copyright 1973 by the Ziff-Davis Publishing Company. Reprinted from *Stereo Review*, October, 1973, by permission. All rights reserved.)

#### **Canadian Stereo Guide:**

"The Ohm E is just an ordinary speaker to look at.



But when you fire it up, it's something else again. Sound quality within the limits of its capability was well defined and well controlled, with no indication of mushiness even at the outer fringes of the spectrum. The Ohm E speaker system has an excellent dispersion pattern over its entire operating frequency range..."

#### **Complete Buyer's Guide to Stereo/Hifi:**

"The Ohm H manages to get prodigious bass response out of a small box without sacrificing efficiency. The high end is handled by conventional drivers and is everything one might ask from a speaker. Dispersion is excellent, and the overall sound quality is exemplary."

#### **Stereo Review:**

"In the simulated live-vs.-recorded test, the Ohm L proved to be a highly accurate reproducer of music...Its highs were strong, and even in our well damped listening room the

crispness imparted to vocal sibilants and instrumental sounds such as wire brushes and triangles could be plainly heard... The upper mid-range and high frequencies were virtually perfect." (Copyright 1977 by the Ziff-Davis Publishing Company. Reprinted from *Stereo Review*, June, 1977, by permission. All rights reserved.)

#### **Complete Buyer's Guide to Stereo/Hifi:**

"The Ohm F is an extraordinary loudspeaker. The coherent sound produced by this speaker is clear, full, and undistorted. It may well be the finest speaker on the market, and is certainly without a doubt among the top few."



For 13 complete reviews, and full specifications, please write us at: Ohm Acoustics Corp., 241 Taaffe Place, Brooklyn, N.Y. 11205.



**We make loudspeakers correctly.**

## What Is

# FUNK?

by Michael Rozek



Clinton's funk: earth shoes and the Upper East Side?

I once used the word "funk" seven times during the course of a 250-word record review. But, as a friend pointed out later, I never once defined it. So I decided to ask some musicians. "What is funk?"

"Funk," says Boz Scaggs, "is never having to say you're sorry." "Funk," says singer Eddie Kendricks, "is any music of worth." "How," poses an outraged Ernie Isley of the famed brothers, "can you define something you can only feel? You either feel funk or you don't."

Drummer Roy Haynes, when he thinks of funk, thinks of "the sound of a bass drum, padded with sandbags." Joey Ramone says, "Funk is toejam. . . . It's hot and homely. When I think of funk I think of earth shoes, the Upper East Side, and jazz; the Latin hustle, southern fried chicken and corn fritters, and red metalflake convertibles with raccoon tails." Continuing in Ramone's gastronomic vein, jazz organist Jimmy Smith feels funk is "some fried cornbread with collard greens and okra mixed with red hot chili peppers, peach cobbler, and a broad with a fine body to have sex with afterwards." Bob Parissi of Wild Cherry (*Play That Funky Music, White Boy*) figures, "When you hear funk, you want to get up and move." And finally, drummer Lenny White insists that "you shouldn't analyze funk. There's nothing clinical about it. If it's clinical, it ain't funky." Thanks, fellas.

Then I asked a few nonmusical friends and relatives for some synonyms of "funky." Their replies: "ugly," "dishonest," "complicated," "ill-lit," "disco," "black," and "relaxed."

So then I decided to do some research. Most of funk's fifteen dictionary definitions relate to "paralyzing fear or extreme depression" (*Webster's Seventh New Collegiate*), as in "blue funk"; or, a "strong smell or stink." This last, notes the 1933 *Oxford English Dictionary*, is funk's oldest English meaning, possibly stemming from German or Flemish. The *O.E.D.* quotes a W. Capps from 1623: "Betwixt decks there can hardlie a man catch his breathe by reason there ariseth such a funke in the night that it causes putrefaction of blood." Almost three hundred years later, this meaning was

*The author writes on the subject of jazz and fusion music for the Village Voice, Downbeat, and Rolling Stone.*

still in use, primarily among blacks and usually expressed in adjectival form. Johnny Winter remembers that when he "was thirteen or fourteen, black people told me that 'funky' meant the smell of a woman. ... It was like a secret word among blacks, a joke that whites didn't catch. Even now, I don't use the word very much. I mean, a situation's gotta be really severe for me to say it."

Eventually, however, blacks came to use the word to describe bluesy, "dirty" music. Producer Jerry Wexler tells me that in turn-of-the-century New Orleans, black jazz trumpeter Buddy Bolden played and sang a gutsy blues called *Funky Butt*. The song had a line that went something like this: "Funky butt, funky butt/Take that thing away." In that context, Wexler says with some delicacy, funky still referred to "an un-

jorette boots. Funk, si; bad taste, no." Designer Norma Kamala explains: "Funk in fashion is doing the unexpected and making it part of you ... like wearing cowboys boots with an evening gown." So in his essay, *Funky Chic*, Tom Wolfe depicts a restaurant full of "leather jerkins, Hindu tunics, buckskin shirts, deerslayer boots, dueling shirts, bandanas knotted at the Adam's apple ... antifashion itself became the most raving fashion imaginable ... known as Funky Chic."

Which brings us to the present, where, as a combination of all its past connotations, "funk" lies somewhere between the informal and, as writer Roy Blount Jr. figures, the "blue, smelly, and chugging." I was almost ready to leave it at that, too. But in that record review I wrote, I was vaguely using "funk" to de-



James Brown—funk of the '60s



Clinton: "P-funk opens up people for other experiences"

similarly told me: "In funk, a group LOCKS INTO a heavy rhythmic pulse. ... The bass, drums, guitar, and keyboards LOCK INTO a common element, and this generates a PROPULSIVE, forward-moving kind of pattern." Then in *The Rolling Stone Illustrated History of Rock & Roll*, I discovered critic Robert Palmer describing James Brown's '60s gestalt as a "push-pull." Exactly. That's what my body used to do. Finally, Joe McEwen of *The Boston Phoenix* told me, "You ought to listen to Parliament and Bootsy Collins. A lot of the guys in both bands used to play with James Brown. In fact, Bootsy was the bass player on *Sex Machine*."

So, I listened to Parliament's album "P-Funk Earth Tour." There's a tune called *Mothership Connection (Star Child)*, which is a self-contained aural definition of funk. Start on the down-

washed posterior," and it wasn't until the 1950s that the scatological connotation of the double entendre began to fade. Jazz pianist Horace Silver, who played bop with an earthy, bluesy touch during that time, titled one of his songs *Opus de Funk*. Critics followed suit by describing his music as "funky," and the word began to catch on among white and black jazz fans. Still, Silver recalls that his father, for example, "was insulted when he first read that my music was 'funky.' ... I had to explain that the word just came as a compliment from older musicians who liked my playing, and that's why I used it in song titles."

In the late Sixties, funk's meaning blurred from "dirty" to "informal," describing fashion and decor that achieved elegance by being mismatched. In Cyra McFadden's recent saga of Marin County, *The Serial*, a character cogently notes, "Nobody in Lagunitas wears ma-

scribe a sound I'd heard in the 1960s. Most simply, the sound of James Brown. And how his songs, like *Papa's Got a Brand New Bag* (1965), *There Was a Time* (1968), and especially *Get Up, I Feel like a Sex Machine* (1971), made me act. I'd jerk my head slightly, sway a bit, squint, and GRUNT. Nothing too wild, because the beat was LOCKED INTO itself, easily PROPULSIVE, like horses' legs in a perfect trot. Not high-stepping or galloping like disco: more subtle—chunky, blocky, even meaty. Ten years later, I somehow knew intuitively that all of that was funk.

So I checked with other musicians and music critics for reinforcement. And slowly a pattern developed. After some prodding, Lenny White admitted that "real funk relies on a PROPULSIVE thing, through the bass and the drums being LOCKED IN, playing a regular pattern in unison." And percussionist Ray Barretto



Joey Ramone: "Funk is toejam"

beat, count a slow 1-2-3-4, and you'll notice how the band always rolls to meet on 1, usually with a cymbal crash. After several repetitions, the 1-2-3-4s start to LOCK IN together, and the feeling is infectiously PROPULSIVE. This easy pace (again in contrast to disco, where the pulse surges ahead double-time and is wildly syncopated) gives you room to nod your head and sway slightly, squint, and GRUNT. And, I guess when you get to the level of grunting, you get to the bottom of "funk." To continue: The propulsion and emphatic state make the music funkier than funky. And now, back to the 1. As you listen—2, 3, your head moves slightly, your feet move slightly,



Bootsy: "Funk is a way of life"

and your hips move slightly, and then 4 stretchhess to ONE!—that cymbal crashes, and you feel that rush of release, and you regroup and start counting again. This pattern, though not present in all Parliament or Bootsy Collins songs, is in all of both musicians' phraseology. It is the P-funk, the pure funk, the uncut funk, music in which "Everything is on the 1."

But what makes this P-funk worth special discussion? Simple. It is unlike any other pop music you hear today—with very few, and then only relative, exceptions. P-funk is even funkier than Brown's classic *Get Up... Sex Machine*, which takes everything on the 2 and thus feels much faster and less gutsy. As Parliament leader George Clinton likes to say, most other "funky" bands "fake the funk." (Though he and Bootsy have lately praised keyboardist George Duke's efforts in a similiar direction.) And, in truth, no one else makes a practice of putting everything on the 1. For example, Sly Stone's rhythmic patterns are much more complicated. As mentioned, the snappy pulse of disco (and of much '70s soul) is much faster than P-funk. Sometimes horn bands, like Tower of Power or the Dallas-based Pyramid, put horn riffs on the 1. Otherwise, the power of real funk has only been approached by Herbie Hancock and two bands from New Orleans, the Meters and the Neville Brothers. With the latter two, you still move at least four parts of your body, but a little faster and on the 2, and hence not as emotionally. Herbie's music is slower than the Meters', though often similarly syncopated, but usually too complex to dance to.



Kendricks: "Funk is any music of worth"

P-funk's proponents, Clinton and Collins, even equate it with a certain spirituality. As Clinton recently said "[P-funk] opens up people for other experiences. They're able to think, they're able to see, and they're able to feel new things for themselves." Similarly, Bootsy tells me that funk, more than anything, is "a way of life. . . . When you consider that people and music have gotten so complex, P-funk is the first step toward opening both up again."

Cynics and rationalists may be scoffing by now, but every time I listen to Bootsy or Parliament play P-funk, I open up. Why? Because it's funky—a subjective quality that can be defined only by the aural experience of it. If you haven't heard *Star Child*, check it out. Beyond that, I can only suggest a visit to the Pyramids.



The Isley Brothers: "You either feel funk or you don't"

# Input Output

Instruments and  
Accessories

**Polytone Teeny-Brute.** When we reviewed the Polytone Mini-Brute II amplifier in this column about a year ago (April 1977, to be exact), we were pleased at how good it sounded, especially considering its diminutive size. This year's entry in Polytone's "less is more" campaign is the Teeny-Brute, and it is every bit as good as its big brother. Even smaller (would you believe 13½ by 13 by 10 inches?) than the Mini, it packs 60 watts continuous into its built-in 5-ohm speaker—a 10-inch full-range unit that absolutely refuses to sound small.

The control panel is marvelously simple, sporting a power switch (on/off/reverse polarity) with a status light, a volume control, bass and treble controls, and a three-position BRIGHT switch. There are two standard ¼-inch phone jacks for HI- and LOW-level inputs; the latter is suggested for instruments with high-level outputs, such as synthesizers. On the back panel there are two more jacks: PREAMP-OUT and SPEAKER-OUT. The first feeds the preamp signal to any

external device, such as a mixing console; the second can drive an additional speaker system. Neither interrupts the original signal to the internal power amp and speaker. The tone controls offer a range of ±20 dB in both bass and treble sections, and BRIGHT adds or subtracts 10 dB in the higher frequencies. That means a wide range of color possibilities.

The Teeny-Brute does not have reverb, separate preamp gain control, fuzz, or distortion controls. This is a simple, straightforward amplification system for instruments (or for voice, if you don't need the reverb), and it just cannot be beat. Though its new fabric covering feels like your old Teddy bear, Polytone says it is fireproof, waterproof, Scotch-guarded, and tougher than the old vinyl finish. For recording, playing clubs, practicing, or anything short of vibrating the paint off your walls, the Teeny-Brute is a mighty handful of good sound. At 20 pounds and \$275 list, it lets you breathe easy in more ways than one.

CIRCLE 121 ON PAGE 149



Polytone Teeny-Brute

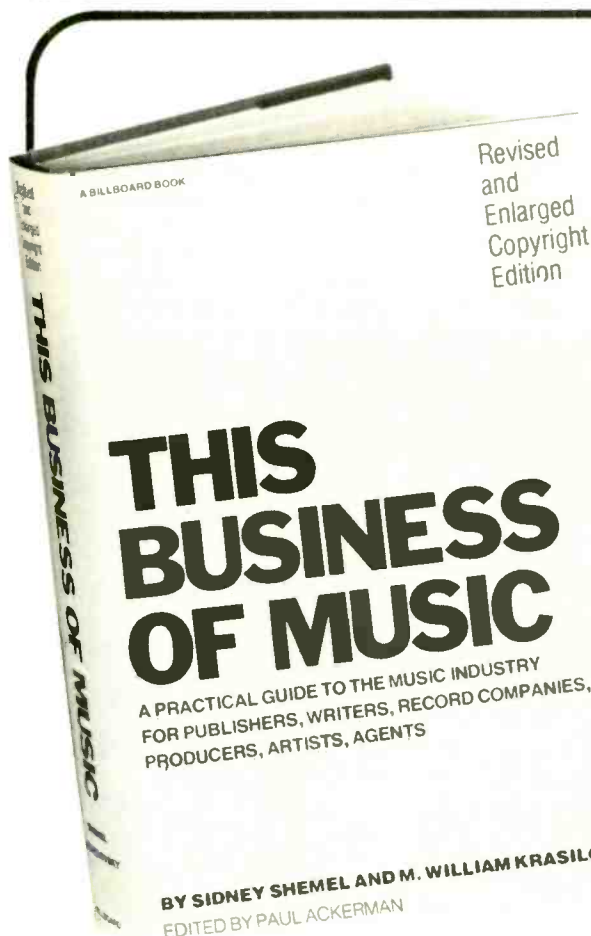

New, updated edition —

## THIS BUSINESS OF MUSIC:

Revised and Enlarged  
Copyright Edition

By Sidney Shemel and M. William Krasilovsky  
Edited by Paul Ackerman

- An essential desk reference for music publishers, writers, musicians, artists and recording companies, this 612-page volume explains the legal, practical and procedural problems encountered by every practicing music person.
- 38 Chapters — two completely new, all substantially revised — and more than 200 pages of laws, regulations, forms, licenses, and contracts.
- Readable and detailed explanation of the new Copyright Act of 1976.

No. 287

High Fidelity  
Music Listener's Book Service  
Dept. HW,  
2160 Patterson St., Cincinnati, Ohio 45214

Please send me \_\_\_\_\_ copy(ies) of THIS  
BUSINESS OF MUSIC @ 16.95 each postpaid.  
Here's my check for \$ \_\_\_\_\_

Name \_\_\_\_\_

Address \_\_\_\_\_

City \_\_\_\_\_

State & Zip \_\_\_\_\_

# Records

SUSAN ELLIOTT  
TODD EVERETT  
TOBY GOLDSTEIN  
SAM GRAHAM  
DON HECKMAN  
LEN LYONS

JOHN STORM ROBERTS  
SAM SUTHERLAND  
KENNETH J. TERRY  
NICK TOSCHES  
KEN TUCKER  
JOHN S. WILSON

## Buildings, Food, Clothes, Landscapes, and Talking Heads

by Ken Tucker

**Talking Heads: More Songs about Buildings and Food.** Brian Eno and Talking Heads, producers. *Sire SRK 6058*. \$7.98. *Tape: ● M5 6058, ● M8 6058*. \$7.98.

Aside from containing some of the most fascinating meditation/dance music of the year, "More Songs about Buildings and Food" accomplishes exactly what the second album from an idiosyncratic New York band should: It integrates those idiosyncrasies, and proves that its startling music can move beyond novelty to thrive and mature. It synthesizes Talking Heads' unique brand of art rock with a commercial mainstream of chunky lead guitar and a kinetic rhythm section. "More Songs" is both more experimental and funnier than the debut LP, "Talking Heads '77," and the two expanding musical directions make the band all the more seductive and entertaining.

Coproducer Brian Eno brings an exalted dreaminess to the Heads' sound, one that displays head David Byrne's willfully banal lyrics to best effect. Byrne's turkey-gobble voice holds notes longer now (even genius turkeys enjoy singing lessons) and quivers all the more oddly within Eno's stark, hollow arrangements.

It is this interplay of peculiarities that makes Talking Heads so attractive. The catchy herky-jerk of Byrne's lead guitar repeats a few furious, key riffs in each song; the rhythm section of Tina Weymouth's bass and Chris Frantz's drums keep Byrne snugly within a tight, at times nearly disco-ish, beat. And Jerry Harrison's keyboards alternately provide wry punctuation and witty echoes of

the lead guitar riffs. Thus a song like *Warning Sign* commences with a long, spacy guitar vamp that inveigles the listener long before Byrne's modulated squawk snakes in to mutter a simile about admonitory billboards and romance. The Heads' slash-and-freeze pace exposes the ominous underbelly of Al Green's *Take Me to the River*, laying bare the dangerous, thrilling side of a religious experience. And on one of the band's oldest songs, *The Girls Want to Be with the Girls*, a new bridge has been inserted: Tough, punchy, and curt, it complicates the tone of this happy songsong considerably, implying that maybe the girls will have to *fight* the boys to stay with the girls.

*Girls*, with its unstated but inevitable

political implications, is exceptional to the Heads' style, which most often piles up vapid declarative sentences with idiot's repetition. But set within the context of the glowingly astute music, the repetition becomes everything *but* idiotic: the multiply allusive words serve both as hooks and quietly ironic jokes. So it is with the very title of the album. As the lyricist of most of the band's material, Byrne uses as models not other rock & rollers (though Jonathan Richman and Lou Reed have occasionally employed similar strategies), but the young poets loosely referred to as the New York School—Tom Clark, Ron Padgett, and Anne Waldman. Byrne, an ex-art student and Lower East Side veteran, shares with them an aesthetic/geographic sensibility in which New York is the locus of a cool, distanced, but funny approach to art. (He has designed both of his group's album covers—calm, gorgeous visions—and his exemplars in painting are similarly New York-ish.)

For these poets, the banality of an accumulation of quotidian comments becomes, at its best, whimsically witty; at its worst, it becomes merely coy and cute. For the Heads the banal is kept on its toes since it must compete with the beat. This is certainly true of Byrne's masterpiece *The Big Country*, in which a startling bit of detail is added here and there or a deadpan zinger is tacked onto the end of a verse.

This grounding in the everyday, the placid ordinariness of the words and Byrne's voice, keeps the Heads honest, even earthy. Its commonplace obsessions—buildings, food, clothes, landscapes—never allow the music to float off into Television-ite improvisations. (That would be fatal if only because the Heads



Talking Heads: Tina Weymouth, Jerry Harrison, David Byrne, Chris Frantz



never traffic in Tom Verlaine's saving romanticism.) The band's music finds coherence and shape in the limitations of its vocalist and in its own admirable insistence on concision and hooks. "More Songs" achieves a rock & roll rarity: It is gentle-spirited but never sentimental—a delicate, precise record that rocks hard.

**Mike Auldridge & (Old Dog).** Mike Auldridge, producer. *Flying Fish FF 054*, \$7.98.

Mike Auldridge and Josh Graves are generally known as the two best full-time Dobro players around. Auldridge is indisputably a master of that resonator guitar, and his albums—both solo and with his band, the Seldom Scene—are joyous excursions into the world of tradi-



Mike Auldridge

tional country music and what has come to be called "newgrass."

This album falls into the latter category, sporting acoustic instruments like banjo and mandolin, three-part harmony, no drums, and repertoire stretching from standards to idiomatic new material. The New Haven group Old Dog sounds very much like the Seldom Scene. In fact its lead vocalist, Phil Rosenthal, has joined the Scene maintaining two separate yet intertwined (his wife is Old Dog's bassist) careers. His voice is strong and flexible, and on *Cold December* he even manages to sound eerily like Glenn Yarbrough, who originally recorded that song.

The musicians are plenty fluent, but there's never any doubt that this is Auldridge's album. Familiar tunes include *Sweet Georgia Brown*, Jim Croce's *Age*, and Gordon Lightfoot's *That Same Old Obsession*. The band also gallops through two favorite steel guitar numbers—*Bud's Bounce* and *Steel Guitar Rag*—as well as the Osborne Brothers' *Stedd Ridin'* and a couple of adequate originals.

T.E.

**Boston: Don't Look Back.** Tom Scholz, producer. *Epic FE 35050*, \$8.98. *Tape: ●● FET 35050, ●● FEA 35050*, \$8.98.

Boston's second album, "Don't Look Back," has been in the making for more than two years. Leader Tom Scholz wanted to produce a seamless, flawless record, and he has certainly succeeded. In fact, his production perfectionism and relentless guitar and vocal choir wall building could make him the Phil Spector of the '80s.

Having created an atmospheric "Boston guitar" sound on the last album, Scholz here solidifies his group's uniqueness with deftly timed buzzing guitars. But though the temptation to do so must have been alluring, he resists duplicating the first LP's riffs. The title cut, which is also the first single, carries its own instantly recognizable guitar-sequence hook. On *Man I'll Never Be*, the first ballad Boston has attempted, Brad Delp's vocal sticks in the mind as much as Scholz's instrumentation, countering two years of silence with a voice so powerful it punches.

Indeed, "Don't Look Back" merits much attention, as Scholz brings each note, word, and instrument right out front to be heard, examined, and understood. But perhaps that very dedication to the separate parts of the whole is the album's most serious problem. As the saying goes, this LP is about ninety per cent perspiration and only ten per cent inspiration, which would have been fine had Boston not made *More Than a Feeling* two years ago. But they did, so it isn't. Nowhere on "Don't Look Back" does Scholz live dangerously, challenging us on that precarious edge between excitement and disaster. While nothing here repeats what we've heard before, neither is anything totally new or untamed.

Maybe it's unfair to expect another cliffhanger from a group that has already given us one of the '70s' major rock anthems. And "Don't Look Back" does offer a perfectly agreeable group of songs, brilliantly executed and recorded, that will give Boston fans an appealing hour of party music. But the group is capable of delivering more. Why couldn't they have traded a little of that perfectionism for a few jolts of high tension?

T.G.



Brad Delp—a voice that punches

**Colin Blunstone: Never Even Thought.** Bill Schnee, producer. *Rocket BXL 1-2903*, \$7.98. *Tape: ●● BXX 1-2903, ●● BXS 1-2903*, \$7.98.

This album is pleasant proof that all records with a soft heart do not necessarily have a rotten center. Colin Blunstone's singular breathy voice, which hovered like ether above his hits with the Zombies, skillfully handles both uptempo numbers and tender ballads backed by full instrumentation. This is because he and producer Bill Schnee appear to understand the need for treading a fine line with his vocal sensitivity. Too many violins would turn Blunstone songs like *Lovelight* or *Touch and Go* into pure corn; too heavy an emphasis on guitars would overwhelm the delicacy of Murray Head's *Never Even Thought* or the album's introduction, *I'll Never Forget You*. Fortunately, seasoned session players like drummer Jeff Porcaro, keyboardist James Newton Howard, and former Elton John band member Davey Johnstone lock into a level that spotlights Blunstone rather than drowns him.

The charm of "Never Even Thought" lies more in the complete package than in any particular song. While each is interesting enough as a framework for Blunstone's sensual tenor, none is going to strike bells fifteen minutes after the album has ended. Scattered throughout the LP's strongest message—the romantic interlude—are flashes of a country picking style, apparently tossed in to make things sound a bit different. No matter that the songs might otherwise grow monotonous; one's focus ultimately returns to Blunstone's voice, as tempting as the serpent in the garden.

At the risk of being condemned by gender-conscious readers, I would call "Never Even Thought" a "woman's al-



Blunstone—a woman's album

bum." It reminds me of one of those gothic novels whose cover depicts an imperiled young lass, hair trailing in the wind. Or perhaps a TV soap, where the heartbreaks of love are whitewashed with a sheen of unreality. Like both those media, the sexual promise Blunstone offers is an almost palpable presence, yet one that is not specific enough to demand censorship. And like those other "women's" pastimes, "Never Even Thought" ultimately should attract male audiences as well. I rate it two hankies and a box of chocolates. T.G.

**Elkie Brooks: Shooting Star.** David Kershbaum, producer. *A&M SP 4695*, \$7.98. *Tape: CS 4695, 8T 4695*, \$7.98.

**Lori Lieberman: Letting Go.** Paul Leka, producer. *Millennium MNLP 8005*, \$7.98. *Tape: 5 8005, 8 8005*, \$7.98.

These two album titles should be reversed: Lori Lieberman is the shooting star; letting go describes what has happened to Elkie Brooks. Two often greatly underappreciated women have made drastic career moves, with decidedly mixed results.

Brooks has been recording for more than a decade, first with rock bands Dada and Vinegar Joe, later, in the 1970s, as a solo artist. Her voice is robust, boisterous, and friendly, the kind of full-bodied style that challenges the listener to guess whether she is black or a soulful white (she's the latter). She rarely writes her own material—she has made her mark as an interpreter of everyone from Gene Pitney to Jerry Leiber and Mike Stoller. In fact, it was on her last album, "Two Days Away," produced by Leiber and Stoller, that Brooks exhibited her voice at its most emotionally convincing. Her reading of Ellie Greenwich's *Sunshine after the Rain*, a lush tearjerker of a ballad, even won her a British Top 10 hit.

If any hits are born off "Shooting Star," they will be less the result of Elkie's vocal gifts than of the current disco craze. To open an album with a noncaring, dance-beat version of Neil Young's heartrending *Only Love Can Break Your Heart* cheapens the singer more than the song. She similarly cavorts through one of Peter Frampton's more genuine songs, *Putting My Heart on the Line*, and softens where she should toughen up on Stevie Wonder's *As*. Only when she falls into appropriate tenderness performing Ned Doheny's *Learn to Love* does she sound at all comfortable on this record. But once she hooks into that lovey-dovey mood, she's not inclined to let go, sounding rather alike on her own *Too Precious* and *Just an Excuse*. Sometime in the past



Brooks—what happened?



Lieberman—free at last

year the rhythm & blues foundation that underscored Brooks has gone astray. She has indeed let go—of the essence of herself.

At the other end of the spectrum, mild-mannered Lori Lieberman has finally found the courage to kick her mismanagers Norman Gimbel and Charles Fox out of her life. Ever since she first attracted attention with her painfully serious *Killing Me Softly with His Song* back in 1971, the terrible twosome has written her material, produced her records, and practically reduced her to a cipher. Since 1974, she has had no label but has been building up plenty of her own thoughts. They form the core of "Letting Go."

Lieberman still sounds as if every word she sings is gospel, her low voice as honest as a basset hound's eyes. But she slices accurate humor into the love songs that dominate the album, offering mor-

dant comments on the way she spent those years when no one was waving a contract. As a writer she still has her self-doubts, but they work well for her:

"'Come on' I said, you can do it after all—  
You've got records in the stores  
and you've sung at Albert Hall  
Well okay, so you never got  
that big hit single  
But you can try out  
for a Burger King jingle. . . ."

Lieberman has never won the chance to be a fast-food huckster; what she has fed upon instead are events a lot more satisfying and long lasting. She's finally realized that she can "have it her way." T.G.

**Marshall Chapman: Jaded Virgin.** Al Kooper, producer. *Epic JE 35341*, \$7.98. *Tape: JET 35341, JEA 35341*, \$7.98.

"Jaded Virgin," Marshall Chapman's second album, matches her live-performance reputation for loose, hard country/rock, wittily sung and passionately played. Where her misguided debut record last year floundered in folk sentiment and a Waylon Jennings-ish waltz pace, "Virgin" is all guitars (Chapman's, prominently) and laser-sharp singing. Under the sure hand of master eccentric Al Kooper, production is tricky and effective—a combination Kooper can pull off more frequently than most. There are times, as on *The Island Song* and *I Walk the Line* (yep, the Johnny Cash chestnut) when Chapman's deep voice electronically reverberates into a parody of your standard macho country artist. The effect transcends trickery, since Chapman imbues her performances with sly sincerity.

"Jaded Virgin" still retains vestiges of the singer's weakness for the soppy, as in



Chapman—total confidence

You're the One for Me and a stunningly banal Bob Seger number. *Turn the Page*. But it also gives full vent to her feminism, both obliquely (her aggressive amorousness on *I Forgot to Put the Music On*) and overtly (*Why Can't I Be like Other Girls?*). A large part of Chapman's charm is her modesty and affable casualness, characteristics founded on utter self-confidence and a knowledge that she can rock with the best country players. But there is also an intelligent self-consciousness. On *Why Can't I Be like Other Girls?* this enables her to turn what would appear to be a hackneyed disgruntled-tomboy romp into a poignant, pensive brawl with the music biz and sexual prejudice. And in co-lyricist Dave Hickey, once and future great rock critic, Chapman has found a comrade in battle. His precise wordplay makes *A Thank-You Note*, their tribute to Hank Williams—that subject of approximately 2,748 doleful elegies—both touching and rousing.

K.T.

**C. J. & Co.: Deadeye Dick.** Mike Theodore & Dennis Coffey, producers. *Westbound* WT 6104, \$7.98. Tape: CS 6104, TP 6104, \$7.98.

If every other track on "Deadeye Dick" were trash, the first cut on Side 2, *Big City Sidewalk*, would be worth the LP's full list price. From its eight-to-the-bar rhythm and portentous bass-trombone riffs on, this is the most distinguished potential hit single I've heard all year. The hook clamps onto you like barnacles, the tenor and baritone vocalists (no credits of attribution are printed) contrast and blend perfectly, and singers and instruments come together with a driving cohesion that used to be called Swing but these days can only be called a miracle.

Far from being trash, most of the other tracks make your average, super-hyped r&b sound like last week's omelet. Four marvelous singers—two male, two female—and superb arrangements by Mike Theodore and Dennis Coffey give C. J. & Co. more than ample musical nourishment for the six long tracks. *Burning Drums of Fire* exemplifies the group's relentless energy with its driving Afro-Latin funk rhythm, moving brass and string riff, haunting backup melody, clean tenor and contrasting gravelly baritone, and edge of manic humor.

More of that humor echoes through *Deadeye Dick*, the widescreen saga of a Desperado with a capital D, and *Beware the Stranger*, a tongue-in-cheek creepy about a menace closer to home. Whether such sophistication ever created a gold record is moot. The ballads, which plunge so many groups into bathos, even work. The midpaced *Hear Say* builds

# Not Only Does It Come Alive, It Jumps Out at You!



It jumps out at you because it's recorded "direct-to-disc" on Century Records. You'll hear it for the first time, the way it was played the first time. The closest thing in hearing an artist's live performance.

Century Records is the leader in the direct-to-disc recording industry with the

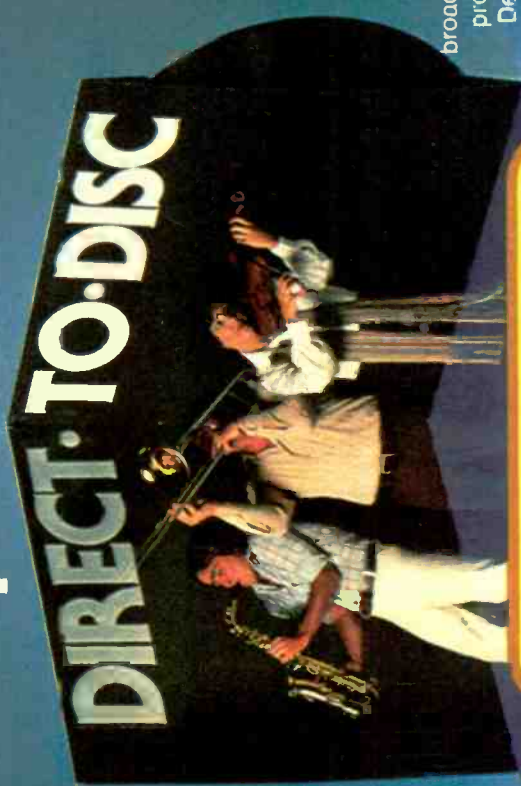

## DIRECT-TO-DISC

**CENTURY RECORDS**

6550 Sunset Blvd., Hollywood, CA 90028 (213) 464-3250 TELEX 67 7230

Available in Canada through **GRAY** Acoustics Ltd.

broadest line of artists and largest catalogue of product available. Soon to be released will be Denise McCann, Benny Goodman and Chick, Donald, Walter & Woodrow.

Available at all within 1000 retail and record shops everywhere.



C.J. & Co.: Clark, Sandra Cooper, Brown, Sanders, Jean Cooper

through rich yet plaintive female vocals to a riveting dialectic made up of lilting women and a preaching male lead. And *You're Still the Sweetest Thing in My Life*—the most conventional track—opens boldly with a swift steal from *Peer Gynt*. Unless the next quarter turns up more miracles, "Deadeye Dick" looks like the r&b album of the year. J.S.R.

**Burton Cummings: Dream of a Child.**

Burton Cummings, producer. *Portrait JR 35481, \$7.98. Tape: JRT 35481, JRA 35481, \$7.98.*

This is pianist/composer/singer Burton Cummings' third album since leaving the Guess Who, and he has arrived at a formula that shows off all of his talents, though not necessarily simultaneously. A decent composer in his own right, he has the good sense to go outside for changes of pace and insights into his own influences. This time around, the oldies include Percy Sledge's *When a Man Loves a Woman*, Sam & Dave's *Hold On, I'm Comin'* (with Steve Cropper, who produced and played on the original, guesting on guitar), and an obscure Bobby Darin foot-tapper, *Wait by the Water*. Cummings' proficiency on the acoustic (hooray!) piano is evident throughout but gets its greatest workout on Jon Hendricks' revamping of the Count Basie swinger, *Shiny Stockings*.

Cummings the writer donates a couple of decent, if not spectacular, tunes. The fact that he was apparently suffering some romantic difficulties while putting the album together gives an occasional nasty edge to songs like *Roll with the Punches* and his not-so-cryptic album dedication, "Dream of a Child" is the thoughtful, mature work of a person who's obviously intelligent, talented, and a natural-born rocker. It's music for adults from somebody who has grown up during some musically interesting decades and listened well. T.E.

\* \* \* \* \*

**Burton Cummings: Dream of a Child.**  
Burton Cummings, producer.

Burton Cummings' third solo album doesn't quite live up to the promise of his first two. Without any of the melodic subtlety that marked several cuts on his debut or the rock & roll energy that lifted "My Way to Rock" off the ground, "Dream of a Child" betrays a curious lack of direction for the former lead singer of the Guess Who.

Skipping around between m.o.r., r&b, country, rock, and Broadway, Cummings serves up a farrago of his own and others' songs. The superiority of the latter is painfully evident: His *I Will Play a Rhapsody*, a slick piece of m.o.r. fluff, simply doesn't hold up alongside Sam & Dave's *Hold On, I'm Comin'*, or Percy Sledge's *When a Man Loves a Woman*. His *Break It to Them Gently* tries to portray the regrets of a fugitive from justice with wallpaper music that effects little more than muddy nostalgia. And the finger-popping tune of *Guns, Guns, Guns* destroys whatever chance its socially conscious lyrics might have had to mean something.

What's worse is that the outside material is usually not suited to Cummings'



Cummings—the critics disagree

talents. His imitation of Sledge has everything except the down-deep soul feeling of the original: his version of *Hold On* only points up the fact that he is not a soul shouter. And although the easy-listening title track is more suited to his voice, the song itself (by David Forman) is about as exciting as a dentist's waiting room. A sharp contrast is his r&b-oriented reading of Bobby Darin's *Wait by the Water*, where the gospel-styled chorus and tasty saxophone licks complement his singing perfectly. So do the breezy musical comedy lyrics of Foster and Hendricks' *Shiny Stockings*.

Cummings' backup band is excellent. Besides Randy Bachman, with whom he wrote the Guess Who's biggest hits, it includes Doobie Brothers guitarist Jeff "Skunk" Baxter, drummer Jeff Porcaro, and guitarist Steve Cooper.

This is his first self-produced album, and he does come up with tasteful arrangements. But he could use some outside help in choosing material. Even if he can't pen another song like *These Eyes*, *Laughing*, or *Stand Tall*, he could still create some new standards with the right material. K.J.T.

**The Dictators: Bloodbrothers.** Murray Krugman & Sandy Pearlman, producers. *Asylum 6E 147, \$7.98. Tape: TC 5 147, ET 8 147, \$7.98.*

The Dictators' third album is in one way a debut: For the first time, the band makes a concerted effort not to play for laughs. Repressed are the comic vignettes of Middle American teen consumer life. No more do the Dictators celebrate the sort of nihilist capitalism that allied them with the early writing of R. Meltzer. Gone is the go-for-deafness volume favored by early Blue Oyster Cult and producers Murray Krugman and Sandy Pearlman. "Bloodbrothers" might have been titled, "The Dictators Go Idea-Crazy."

The ideas are an extension of their earlier ones in that songwriter Adny Shernoff continues to sketch and defend the Average Kid Who Loves Rock & Roll. This is inextricable in the innocently macho clannishness of his songs. As the band pounds out street anthems like *I Stand Tall*, *Faster and Louder*, and *Slow Death*, lead singer Handsome Dick Manitoba's ragged, surly, but passionately enunciated singing appropriately lends conviction and wit to the imagery. His bellow also helps to rush much of Shernoff's bathos past us before it begins to annoy.

Producers Krugman and Pearlman take essentially the same approach they have with the Blue Oyster Cult of late, thickening the guitars into great lumps



*The Dictators—taking themselves too seriously*

of rhythm and pushing Ritchie Teeter's drums to the front of the mix. This unfortunately tends to bury Shernoff's keyboards, which can often supply an appropriate melodramatic touch where his lyrics are awkward.

Nearly all of the urban fraternalism that "Bloodbrothers" celebrates has been done better elsewhere, especially in movies and the novels of a few young writers. The best of those is Richard Price, an old school pal of at least one of the Dictators, and the obvious inspiration of much of this album's stance. (He has written a novel with the same title.) The Dictators are best here when they have the least to talk about, as on *Faster and Louder* and *What It Is*. If anything, the band takes itself *too* seriously on "Bloodbrothers." K.T.

**Peter Frampton/The Bee Gees: Sgt. Pepper's Lonely Hearts Club Band.** George Martin, Maurice White, & Jack Douglas, producers. *RSO RS 2-4100*, \$15.98 (two discs). *Tape: ●● CT 2-4100*, ●● 8T 2-4100, \$15.98.

Maybe it's just my nerves, but somehow my pretensions to critical objectivity dissolve the second I listen to the new, souped-up version of "Sgt. Pepper's Lonely Hearts Club Band." Snide clichés like "I can't believe I listened to the whole thing," or "just when you thought it was safe to go back into the record store" keep coming to mind.

Nobody likes cheap shots, whether from critics cracking wise or artists aiming low, but since the musicians (and, more prominently, the business interests) behind this widescreen, all-star movie and soundtrack are so transparently guilty of the latter, they may just deserve the former. This four-sided extravaganza contains several rooms full of recognized rock stars performing the material from the original "Sgt. Pepper" LP, along with additional Beatles songs. And, whether or not one still accepts the exalted niche of the real McCoy in both

the Beatles' recorded oeuvre and '60s pop in general, it does so without improving or even reinterpreting the original. If anything, the added music and changed cast bury the underlying coherence of its model. A conceptually resonant song cycle that once masqueraded as an album has been transformed into a rambling pastiche masquerading as a concept. And if that sounds confusing, wait till you hear the record.

Robert Stigwood, scion of the formidable RSO media empire (*Grease*, *Saturday Night Fever*, and now *Pepper*) and the Bee Gees's mentor since their first crack at blatant Beatisms over a decade ago, has allowed an oddly schizoid view of both the Beatles and their most-lionized album. On the one hand, the new fantasy plot (which provides the onscreen logic for the extra songs, if only in the minds of Stigwood and screenwriter Henry Edwards) and the multiplicity of narrators force some perplexing shifts in sense. The allusive, open-ended original lyrics are mated to more specific meanings that don't necessarily survive on record. In particular, a new strain of cynicism manifests itself on songs like *I Want You (She's So Heavy)*, and once double-edged works like *She's Leaving Home*, *Getting Better*, and *When I'm Sixty-Four* are reduced to the single romantic dimension of Broadway workhorses in a high school revival.

On the other hand, Stigwood has convinced the producer of the first "Pepper," George Martin, to arrange and produce the album, leading to a frequent reverence for the musical framework's source. Asked in 1973 whether more sophisticated production techniques and the lessons of hindsight could improve "Pepper," Martin told me such tools were less important than the original vision. His work here proves how right he was. Unable or unwilling to devise dramatic musical changes, Martin has tried to integrate the most distinctive elements of the original arrangements into these new recordings. But whether recapturing a brass fanfare or the pedal note of a

droning sitar, he ends up with bloodless Xeroxes. Ironically, two of the most likely stinkers—Aerosmith performing *Come Together* from "Abbey Road," and Earth, Wind & Fire playing *Got to Get You Into My Life*—end up being high points. This is because each was produced by the respective artists, not Martin, so each risks bold revisions of style—especially Earth, Wind & Fire with its sassy horn charts.

Less fortunate are Peter Frampton, the Bee Gees, Steve Martin, newcomer Sandy Farina, Paul Nicholas, and the other recording artists (well-known and otherwise) who submit to the project's master plan. Beatle fans with a taste for the bizarre may get a chuckle out of hearing British character actor Donald Pleasance intone his own sinister spoken reading of *I Want You*. But at something over ten bucks after discounting, such pleasures are far too infrequent.

Finally, the commercial test for the new "Sgt. Pepper" will be Capitol's understandable eagerness to direct attention to the original with a major sales campaign. Those fans who started with the Bee Gees and are just learning about the Beatles will have a chance to compare the two readings. But I'm convinced that even newcomers will hear how much creativity has been lost in the retelling. S.S.

**The Essential Jimi Hendrix.** Jimi Hendrix, Charles Chandler, Mitch Mitchell, Eddie Kramer, Eddie Mitchell, & John Jensen, producers. *Reprise 2 RS 2245*, \$12.98 (two discs). *Tape: ●● 2R5 2245*, ●● 2R8 2245, \$12.98.

Jimi Hendrix' impact has been so profound and his influence so pervasive that it's hard to imagine his tenure in the limelight was just a little more than three years. He was an anomaly: a black leader in what had become a very white rock & roll world and a far better guitarist than most of his peers—both in originality of inspiration and technical ability. He also had a vision that those who attempt to carry on his legacy today can barely even approximate. For the generation that knows him only through the likes of Robin Trower and Mahogany Rush's Frank Marino, "The Essential Jimi Hendrix" will be a revelation. For everyone else, it will be a reaffirmation of Jimi's brilliance.

Care has been taken to include not only the obvious classics, but also material that is representative of Hendrix' versatility. The sides that he (or his "discoverer"/manager, Charles Chandler) produced have been left untouched, and even 1978's jaded ears will admit that he

Continued on page 174

---

# Digital and Direct-to-Disc Come to Jazz

by Don Heckman

---

**Diahann Carroll with the Duke Ellington Orchestra under the direction of Mercer Ellington: A Tribute to Ethel Waters.**

Michael Robert Phillips, producer. *Orinda Records ORC 400*, \$12.95 (*Orinda Recording Corporation, 23 Altavinda Road, Orinda, Calif. 94536*).

**The New Brubeck Quartet: A Cut Above!** Tom Semmes, producer. *Direct-Disk Labs DD 106*, \$22.95 (two discs; *Direct-Disk Labs, 16 Music Circle South, Nashville, Tenn. 37203*).

**Barry Miles: Fusion Is . . . Barry Miles.** Norman Schwartz, producer. *Century Records CRDD 1070*, \$13.95 (*Century Records, 6550 Sunset Boulevard, Hollywood, Calif. 90028*).

**Phil Woods: Song for Sisyphus.** Norman Schwartz, producer. *Century Records CRDD 1050*, \$13.95.

**Woody Herman: Road Father.** Woody Herman & Glen Glancy, producers. *Century Records CRDD 1080*, \$13.95.

The two recording processes represented here—digital mastering and direct-to-disc cutting—are particularly valuable for the documentation of jazz. By its very nature, improvisational music adapts easily to the one-take-only methodology of direct-to-disc, and digital mastering provides the kind of clear, accurate reproduction that brings out the subtle qualities of timbre and precise rhythmic inflections so vital to the best jazz. Neither of these methods eliminates the need for traditional studio preparation. In fact proper mixing, balancing, equalization, and signal processing are probably more important than in the case of the standard analog tape-to-disc process. Digital recording, in particular, is easy prey to improper balancing and mixing, since its remarkable clarity exposes every voice—inner and outer—to merciless examination.

The Diahann Carroll LP is one of the first digital jazz-style recordings, and its sound—technically speaking—is a marvel. It quite literally seems to emerge from total silence. The other four releases were all produced using direct-to-

disc, whose aural advantage—though less immediately obvious—is nonetheless significant. Clearly, the fact that the disc must be cut in one continuous performance, or set of performances, takes considerable musicianship. But it does not automatically make for better sound reproduction or better music.

While I marvel at the sound quality of the Carroll recording, I am less enthusiastic about its musical value. The Ellington Orchestra is buried beneath the turgid orchestrations by Bruce W. Miller, and its tart energies—diluted though they have been since the deaths of the Duke and many of his key sidemen—are virtually nowhere to be heard. A few excellent improvisations from an alto saxophonist and a pianist go uncredited in the self-congratulatory liner notes, and on *Sweet Georgia Brown* and *St. Louis Blues* the band momentarily gets loose, giving us a glimpse of its creativity and sparkle. More often it drifts in the background, working its way through charts that would be more appropriate on a Las



Duke and Mercer Ellington in 1968

Vegas stage.

The same can be said for Miss Carroll, who has never really delivered on the promise of her first, remarkable performance in the original company of *House of Flowers*. She manages effective



Ethel Waters performing with Count Basie's band in 1943

imitations of—appropriately—Ethel Waters on some tunes, Lena Horne on others, and, most blatantly, Fran Warren on *Happiness Is a Thing Called Joe*. But somewhere along the way, the Waters tribute became little more than another show-time set for Carroll.

The direct-to-disc recordings, as a group, are impressive. The two-disc Brubeck set features the collegiate jazz star of the Fifties in what must have been an ego-gratifying performance, since the ensemble consists entirely of his three sons. The material is mostly new versions of his past hits, including Paul Desmond's *Take Five*, Brubeck's *Blue Rondo à la Turk*, his superb ballad *The Duke*, and a lengthy excerpt from one of his oratorios. Brubeck's flaws have long been obvious: He is not a strong rhythmic player, he has too strong an affection for ostinatos and for sequential melodic passages, and, perhaps most important, he lacks a sense of pacing in his improvisations, usually falling into an emotional bell-curve. Unfortunately, his offspring either have inherited his tendencies or lack the self-direction to push things any other way. They play well enough, if not as well as the accompanists the elder Brubeck has worked with in the past. This is, for the most part, a recording for already-sold Brubeck fans: I doubt that it will win many new ones.

Producer Semmes has come up with admirable sound, clearly enhanced by the direct-to-disc process. I have reservations about some of his mixes, since Brubeck is usually well up front even when he is playing accompaniment rhythms, but the production is generally solid and professional.



Dave Brubeck

The Barry Miles disc has even better sound, producer Norman Schwartz managing to blend the sometimes complex layers of electronics convincingly. The same cannot be said for the performances, which are never more than acceptable mainstream fusion (if there is such a thing). Miles is a phenomenal keyboard technician, and guitarist Vic Juris only a shade less so. The group sounds best when that technique is brought to bear, as on *Routes* and *Country Miles*. But for the most part they seem to simply meander in vague, directionless pieces that are all method and no content.

Phil Woods is, sad to say, even further from his peak. He is one of the last surviving beboppers and one of the very best. But he seems intimidated by the demands of direct-to-disc, and the quality of his improvisations varies wildly from very good to little more than running the changes. (Curiously, one of his least effective efforts is on the bebop classic *Shaw Nuff*.) Woods's group—which can sound excellent in live performance—lacks point and thrust. Guitarist Harry Leahey and pianist Mike Melillo make very little of their two solo spots—*Nuages* and *Summer Afternoon*. The production,



Barry Miles

again by Schwartz, is workmanlike and unobtrusive, if not likely to win any awards for inventiveness.

I've saved the best for last: Woody Herman's "Road Father." The recording combines the best qualities of direct-to-disc with the extraordinary tonal variations and improvisational range of this best of Woody's recent bands. The group plays so well, and the solos are so consistently inventive that it's difficult to believe they were recorded under one-take-only circumstances. Glen Glancy's



Woody Herman

engineering team deserves special credit for the colorful, true to life but not hokey sound they have captured.

Among the best moments are Allen Vizzutti's brilliant trumpet work on his piece *Fire Dance*; Woody's always sensual alto sax playing on *Duke Ellington's Sound of Love*; Bruce Johnstone's bright, bouncy *Sunrise Lady*; Gary Anderson's lovely arrangement of Fauré's *Pavane* (with an astonishing bass clarinet solo by Johnstone); and the crisp, contemporary ensemble playing on Stevie Wonder's *Isn't She Lovely*. There are also a few problems: Woody really shouldn't have re-recorded *I've Got News for You* (the classic recording by his Second Herd simply can't be touched), and the underlying rock rhythms on *Isn't She Lovely* are unnecessary and detract from the horn playing.

But don't get me wrong: All in all these discs are an impressive group of performances, the recording processes aside. A few bad moments, to be sure, but plenty of good ones—even on the Carroll-Ellington collaboration. But don't expect to get the most out of any of these recordings without equally good equipment. If the new era of technical reproduction continues to produce jazz of this quality, we all have a great deal to look forward to. ■

# New Acts

BY JIM MELANSON

**Bim: Thistles.** Emitt Rhodes, producer. *Elektra 6E132*, \$7.98. *Tape: ●● TC5 132, ●● FT8 132, \$7.98.*



Canadian artist Bim, also known as R. Forbes, has an odd-sounding voice—sort of a squeaky Paul Williams. While it's effective on uptempo numbers such as *Shell of a Life*, it's downright distracting on the more laidback cuts. He will attract a following, though just how big is hard to say.

**British Lions.** British Lions, producers. *RSO RS 1-3032*, \$7.98. *Tape: ●● CT 1-3032, ●● 8T 1-3032, \$7.98.*

Ex-Mott the Hoople players Ray Major, Terry Buffin, Morgan Fisher, and Overend Watts take in Medicine Head vet John Fiddler to round out a highly polished new band in the so-very-British hard and heavy rock tradition. The material is good and nicely varied. But didn't we hear the same sound more than a few years ago?

**Brotherhood.** Dwight White, producer. *MCA 2373*, \$7.98. *Tape: ●● MCAC 2373, ●● MCAT 2373, \$7.98.*

Group leader/producer White is quoted as saying that he and his three brothers and the three other members of Brotherhood make "music that can represent all people, 'cause that's the only way that you win Grammys." A better way for the group to win listeners would be to expand on the funky feel of the cut *Funk Footin'* and forget about the rest—a predictable mixture of disco/soul, r&b, and rock.

**The Michael Johnson Album.** Steve Gibson & Brent Mather, producers. *EMI America SW 17002*, \$7.98. *Tape: ●● 4XW 17002, ●● 8XW 17002, \$7.98.*

Johnson, a member of the Chad Mitchell Trio back in its John Denver days, falls in the rock-crooner category. The cut *Bluer than Blue*, a heroic rock & roll lament, has already more than dented the easy-listening charts. But my guess is

that that will be the extent of it. Johnson has a good voice, but after several cuts it becomes as tedious as the material.

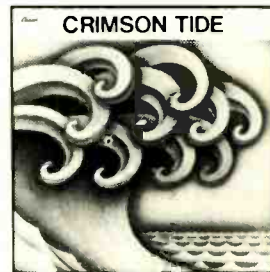

**Crimson Tide.** Carter & Richard Landis, producers. *Capitol SW 11806*, \$7.98. *Tape: ●● 4XW 11806, ●● 8XW 11806, \$7.98.*

The University of Alabama football team, nicknamed the Crimson Tide, shouldn't be too upset over this rock group's appropriation of its name:

Leader Wayne Perkins apprenticed at the Fame Studios in Muscle Shoals back in 1969. The band, hard-driving and capable of delivering a basically clean sound, will probably become a hard-working road act—the likes of Black Oak Arkansas.

**Joanne Mackell.** Joe Falsia, producer. *United Artists UALA 878H*, \$7.98. *Tape: ●● CA 878H, ●● EA 878H, \$7.98.*

During the first listen, and maybe even the second, you'll be wondering whether it's a male or a female rock singer that you're hearing. A combination of an m.o.r. Rod Stewart and a Melanie-ized Janis Joplin, Mackell has her writing and performing moments. Unfortunately, they come neither often enough nor in a grand enough way to warrant a large following.

**Moon Martin: Shots from a Cold Nightmare.** Craig Leon, producer. *Capitol SW 11787*, \$7.98. *Tape: ●● 4XW 11787, ●● 8XW 11787, \$7.98.*

John Martin—who is a sideman, an ex-lead guitarist for Southwind, and a songwriter (among his credits is Mink DeVille's *Cadillac Walk*)—goes solo here with a healthy array of stylized rock material. Most of it sounds firmly rooted in the tradition of classic late-Fifties/early-Sixties rock & roll. Mass appeal is out, but expect a strong cult following.

**Werewolves.** Andrew Loog Oldham, producer. *RCA AFL 1-2746*, \$7.98. *Tape: ●● AFK 1-2746, ●● AFS 1-2746, \$7.98.*

Here's another group to add to the list of southern rockers. To the band's credit, though, British rock influences are interspersed with homegrown boogie styles, making for an interesting mix. Expect to see the Werewolves move into the national spotlight after they get another LP or two under their belts. Their connection with producer Oldham, known for his work with such artists as the Rolling Stones, Rod Stewart, and Humble Pie, is sure to help matters.



# Scott puts out.



188T

Pro 100B

196W

176B

Scott's unique gold warranty card. Individualized with your warranty, model and serial numbers, and expiration date. Scott's fully transferable, five-year parts and labor-limited warranty is your assurance of lasting pleasure.

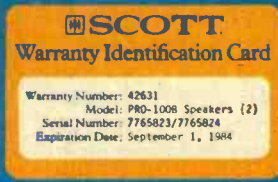

A Scott exclusive. By carefully controlling the variation of impedance over the entire listening range, Scott speakers give you maximum amplifier power output and minimum speaker distortion.



# Because Scott puts more in.

Deeper, richer lows. Crisper, clearer highs. And an accuracy across the entire tonal spectrum that's second to none. That's what you get with Scott Controlled Impedance speakers.

No matter what your listening preference, Scott speakers will make your whole sound system sound better.

At Scott, there's no such thing as an "off-the-shelf" component. Unlike many other makers, Scott custom designs and acoustically aligns every speaker component to give you accurate frequency response, high efficiency, and extra power handling capacity. After all, the sound you get out depends on what we put in.

But listen for yourself. And you'll hear just how much Scott speakers really put out.

For more information on Scott speakers, or on our entire audio line, see your nearest Scott dealer or write H.H. Scott, Inc., Corporate Headquarters, 20 Commerce Way, Dept. IS, Woburn, Massachusetts 01801. In Canada: Paco Electronics, Ltd., Quebec, Canada.

**SCOTT**  
The Name to listen to.  
Makers of high quality high fidelity equipment since 1947.

Continued from page 169

knew his way around a studio. From the first album come *Are You Experienced*, *Purple Haze*, and *Third Stone from the Sun*. Five songs are from the second LP, "Axis: Bold as Love," the best (and best known) of which are the raunchy, defiant *If 6 Was 9* and the compact, exquisite *Little Wing*.

"Electric Ladyland," Hendrix' third and last LP, was his finest work and it's treated accordingly. Fully seven tracks are taken from it, including the entire fourth side (in a curiously rearranged order): *Still Raining, Still Dreaming*, *House Burning Down*, *All Along the Watchtower*, and *Voodoo Chile (Slight Return)*. This classic quartet reveals every facet of Hendrix's genius—his arranging skill, his wailing mastery of old blues and r&b—in all, the utter unity of song, voice, guitar, and execution that made him unique. *Watchtower* alone may be the greatest guitar exhibition rock music has ever known.

Material from three posthumous LPs fills out the rest of the anthology. The three selections from "The Cry of Love" have a finished quality to them because that album was nearly completed when Hendrix died in 1970. The other tracks are raw but not without power—their inclusion is instructive, at the very least. The complete lack of live takes is the only serious flaw, but if a second compilation is released as planned, that and any other gaps will be filled. S.G.

**George Jones: Bartender's Blues.** Billy Sherrill, producer. *Epic KE 35414*, \$7.98. *Tape: ●● KET 35414, ●● KEA 35414*, \$7.98.

I take it as an indication of George Jones's (or producer Billy Sherrill's) intelligence and gall that they raced to cover James Taylor's homage to Jones, *Bartender's Blues*, and made a big hit of it. It's nice when the Greatest Voice in Country Music is also such an opportunistic cuss. Certainly *Bartender's Blues* deserves success, with its combination of hefty dollops of self-pity and sparks of sorrowful wrath. And George, you know, is all heart—he even lets Taylor sing the chorus with him.

The rest of the album is almost as good as its title song, and it's Jones's best work since the cathartic "Alone Again." For once he says a few good words about romance (*I Gave It All Up for You*), and makes them convincing, even though those words are, of course, outnumbered by a slew of "I loved you, you left me" sagas. The best of these have corny yet incisive twists and titles created from non sequitur parenthetical modifiers, like (*When Your Phone Don't*

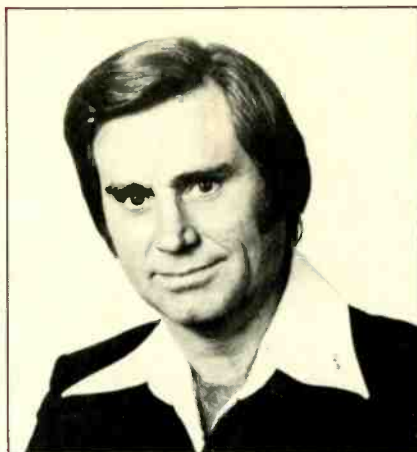

Jones—he's all heart

*Ring*) *It'll Be Me* and *If You Loved a Liar (You'd Hug My Neck)*, both of which Jones lifts into discomforting passion. And a potentially ridiculous lyric like that of *I Don't Want No Stranger Sleepin' in My Bed* is made convincing by the obsessed specificity of its unifying metaphor—Jones describes in minute detail his wife's lover creasing the sheets of the Jones bed.

Throughout, Sherrill's production is typically anonymous (who plays that sly but powerful guitar line in *Leaving Love All over the Place?*) and atypically subtle. The strings don't swell, and the drums are prominent but muted; all of our attention is directed toward Jones's eloquent moan.

In place of the one novelty tune Jones has long included in each of his releases comes a jaunty number with a highly danceable beat. *I Ain't Got No Business Doin' Business Today*. Oh hell, I'll come out and say it: This is a *disco* tune, pure and unsimple. A monumentally atypical female backup group coos behind George's snapping of the title phrase, the bass thumps Parliafunkadelicementally, and, by God, the whole thing works. George Jones goes disco, and the tough, honorably dishonorable old coot goes out triumphantly. K.T.

**Gerry Rafferty and Joe Egan/Stealers Wheel: Stuck in the Middle with You.** Leiber/Stoller & Mentor Williams, producers. *A&M SP 4708*, \$7.98. *Tape: ●● CS 4708, ●● 8T 4708*, \$7.98.

**Gerry Rafferty: Can I Have My Money Back?** Hugh Murphy, producer. *ABC BA 6031*, \$7.98. *Tape: ●● 5 6031 BA, ●● 8 6031 BA*, \$7.98.

For those listeners introduced to Gerry Rafferty through his recent "City to City" album and its hit single, *Baker Street*, these records should provide a satisfying summary of his earlier work

While both reissues appear somewhat flawed when compared to the artist's current solo excursions, on balance they merit the renewed attention. They also at least partially explain the complaint by Rafferty's American labels that this solitary Scot undercuts his own popularity by his hermetic distance from the public.

The tracks comprising "Stuck in the Middle with You" are likely to be most familiar, despite the slight confusion of the twin artist listing. Stealers Wheel began as a largely self-contained band led by Rafferty and songwriting partner Joe Egan. Internal problems led to its reduction to just Rafferty and Egan, who compensated by relying on outside musicians. But the best tracks are those cut by the original band.

On songs like the title tune (their only hit) and *Late Again*, both from the group's first album, producers Jerry Leiber and Mike Stoller focused on a lean, evocative sound that peaked with those songs' moody shuffle and ironic vocal style. By the time they recorded material like *Who Cares* and *Star* (both from "Ferguslie Park," the next album), or the sweeping *Benediction* (from the final LP, "Right or Wrong"), the musical scale had swollen to more problematic dimensions.

Even so, Rafferty and Egan shared a ruefully disenchanted view of pop and rock that imbued their singing and writing with a world-weary loveliness. That vantage point was clearly a long-standing one for Rafferty. On his first solo album, "Can I Have My Money Back?" the title song is a neatly drawn folk parable about naiveté. But the rest find Rafferty darkening his bright pop touches with dispiriting conclusions. *New Street Blues* is a sadder-but-wiser vignette of the urban hustle, while *Mr. Universe* and *Sign on the Dotted Line* assess fame in different guises, the former somewhat obscurely (veddy English), the latter brilliantly. Rafferty's lush melodic sense is also very much in evidence on *Sign* and on the one comparatively direct romantic ballad, *The Long Way Round*.

In some respects, "Can I Have My Money Back?" is closer to "City to City" in its arranging and production styles, due no doubt to Hugh Murphy, who rejoined Rafferty last year as coproducer. All three LPs, however, cover common ground in their thematic concerns and Rafferty's (and Egan's, for that matter) folk-inflected roots. My only complaint is that of a true fan: Why does the A&M anthology include the second version of *Everything Will Turn out Fine?* Cut by the full band, and produced as the followup single for *Stuck in the Middle*, the original version tapped much of its

predecessor's brooding power. In the alternate format that eventually showed up on "Ferguslie Park," Leiber and Stoller tidied up the proceedings, goosed the tempo a bit, and added a number of crisp but unnecessary instrumental flourishes that only sapped the song's mordant wit. Perhaps this remake sounds closer to the production polish that dominated the later work, but its muddier original was far more affecting. s.s.

**Thin Lizzy: Live and Dangerous.** Thin Lizzy & Tony Visconti, producers. Warner Bros. 2BS 3213, \$9.98 (two discs). Tape: ● L5 3213, ● L8 3213, \$9.98.

It's rather unusual for a band to kick off their association with a new label by releasing live tracks instead of new material. But "Live and Dangerous," Thin Lizzy's first LP for Warner Bros., is a far cry from being a collection of in-concert muddled-sounding rehashes. Three out of its four sides show the band at its most exciting and original, effectively blending leader Phil Lynott's two chief influences—Van Morrison and Jimi Hendrix. Lynott, surely one of the few black Irishmen who plays rock & roll, soothingly sings the role of the romantic lover in *Dancing in the Moonlight* and *Cowboy Song*. Yet he's equally effective as the sexual streetfighter with his bass slung low across his black leather trousers, sneaking through *Jailbreak*, and declaring his prowess as *Warrior* and *The Rocker*. The crowded concert ambience gives Lynott's personalities more of an opportunity to flourish than on Lizzy's many studio albums.

Lead guitarists Scott Gorham and Brian Robertson blossom on their many solos without exhibiting egotism. The few times they blatantly call up Hendrix (particularly on *Still in Love with You*) are easily outweighed by leads that owe strong debts to their many years on the road. And the band's paean to Ireland, *Emerald*, sounds high-spirited and irresistible, as if performed on a night of many drinks down at the local pub.

Only on Side 4 of "Live and Dangerous" does the record fall into the very trap that threatens Thin Lizzy's credibility onstage. Here, far too often Lynott's sensuous vocals are overwhelmed by a glut of noise, capped by a drum solo. Unlike the entrapped audience, listeners have the option of skipping Brian Downey's solo on *Sha-La-La*, or Side 4 altogether. Yet they will not feel cheated, for "Live and Dangerous" is a healthy cross-section of the band's best recent tunes, played well and ebulliently by all, and tightly framed by well-defined production. T.G.



Wynette—a talent for suffering

**Tammy Wynette: Womanhood.** Billy Sherrill, producer. Epic KE 35442, \$7.98. Tape: ● KET 35442, ● KEA 35442, \$7.98.

There are female country singers, and then there is Tammy Wynette. Not only is her voice stronger and surer than anyone's in the neighborhood, but she packs enough emotion into her readings to put her right up there with Aretha Franklin and Ray Charles. She's one of the few artists in any genre who can cover songs that have already been hits for another (as with Barbara Mandrell's *That's What Friends Are For*), and do so with such a sense of rightness that the original rendition simply doesn't matter anymore. So emotion-drenched is her voice that she can make the fluff that comprises a good third of all her albums sound important. There's none like her; and thank God she shows no desire to sell out or cross over.

Billy Sherrill, who produced Wynette's first single in 1966 and every record since, stopped making mistakes (save for the predictable lapse into weak material) long ago. His last was to have Tammy record *The Happiest Girl in the Whole U.S.A.*, a concept that—though we all wish her well—her fans would never believe. For Tammy is a long-sufferer, a Nashville Piaf.

She suffers a lot here. Her best friend takes over her love life, someone else wrote the song she'd always wanted to write, and, curse it all, *Love Doesn't Always Come (on the Night It's Needed)*. There's also a novelty song—*I'd Like to See Jesus (on the Midnight Special)*. The idea is that, if Jesus were to land a spot on that show, he could sing everybody's favorite hymns and we'd all become born-again Christians. It's cute and funny and probably wasn't meant to be taken too seriously. But Wynette is so

convincing that she makes it sound like the Second Coming is both necessary and imminent: we find ourselves right in there with her, hoping that Jesus can sing in English so that we'll be able to join in. Now that's art. T.E.

## JAZZ

**Bill Evans: New Conversations.** Helen Keane, producer. Warner Bros. BSK 3177, \$7.98. Tape: ● M5 3177, ● M8 3177, \$7.98.

Bill Evans' first work for Warner Bros. is a solo album of overdubbed acoustic and electric pianos, and every track save one is a gem. Its concept began auspiciously in 1963 with his Grammy winner, "Conversations with Myself," and its sequel, "Further Conversations with Myself"—both recorded on the Verve label. Those LPs are now out of print, and anyway they aren't nearly as mature, witty, or powerful as "New Conversations."

During the Seventies, Evans' playing took a giant step forward. Melodic lines were suddenly sharper and more clearly defined; rhythms were snappier. It just wasn't the same brooding, analytical mind. That vivacity endures: With two and sometimes three pianos at work, he manages a veritable feat in retaining a pristine clarity through his dense, rich harmonies. Though *Song for Helen* (inspired by Helen Keane, his producer/manager of sixteen years) is based on a three-note theme, the harmonic variety is stunning.

His use of the electric piano is intriguing. Purists who favor the acoustic instrument often complain that its electric counterpart sounds the same no matter who plays it. But in Evans' case it



The new Bill Evans

sounds different from one track to the next. He doubles the melody with it on two tracks. In the introduction to *Maxine* (his stepdaughter) he uses heavy vibrato—a bit too heavy, in fact. On *Nobody Else but Me*, the hottest cut, he uses it to provide a bass line and punch out chords in accompaniment of his acoustic improvisation. There are also a couple of ascending glissandos on a track that will remain unnamed because they should come as a surprise—something like being goosed (though not quite so unnerving).

The cut that does not succeed contains no overdubs. *Reflections in D*, an obscure Ellington composition, is pensive and spacious. It is the old Bill Evans. I prefer the new. L.L.

**Egberto Gismonti: Sol do Meio Dia.**

Manfred Eicher, producer. *ECM 1-1116*, \$7.98. *Tape: ●● M5 E 1-1116, ●● M8 E 1-1116*, \$7.98.

Egberto Gismonti is one of a remarkable generation of Brazilian composer/performers that includes Aírto Moreira (main catalyst in the 1970s U.S. percussion revolution) and keyboardist Hermeto Pascoal. To an even greater extent than they, Gismonti blends his reverence for Brazilian forms with a cross-culture musical understanding.

Far-reaching though it is, "Sol do Meio Dia" is much more cohesive than most internationalist-eclectic music. Its Brazilian ingredients are quite strong, but in no markedly identifiable ways. The exceptions to this include an enchanting wordless vocal in *Kalimba* that sounds rather like Aírto's evocations, and a brief passage on the title piece of hocketed (each person in a group sings or plays one note) vocal and wood pipe based on Xingu Indian music.

But for the most part, guitar and piano phrasings and percussion patterns melt from one musical area to another. In one number, *Raga*, Collin Walcott's tabla playing sets up an essentially Indian mood. But Gismonti's acoustic guitar only flirts with Oriental-tradition ragas, and intersperses them with Brazilian, conservatory, and jazz phrasings.

Another piece with strongly non-Western implications is *Kalimba*, named after the African finger piano. But Gismonti's concern is not with African music as such; he seems to have selected the kalimba largely because it blends tonally with the Afro-Brazilian *berimbau*, a musical bow. While percussionist Nana Vasconcelos plays *berimbau* in fairly traditional Brazilian patterns, Gismonti uses the finger piano for sets of purely personal improvisations.

The jazz element is very European sounding—particularly in Jan Garba-

rek's soprano sax solo on *Café*—with a plaintive lyricism in place of the outraged anguish of much black American free jazz. And then there is the conservatory element. Gismonti plays piano on a couple of cuts, but his major instrument is an eight-string acoustic guitar. On this, his tradition—worn as a very loose garment—is the conservatory music of Spain and Portugal. His piano playing, too, reflects a European impressionism, though he has personalized it. All this makes a very invigorating brew. It would be sad if it were avoided on the basis of being inaccessible. For though Gismonti's music is experimental, it is also enriching and quite irresistible listening. J.S.R.

**Max Kaminsky: When Summer Is Gone.**

Hank O'Neal, producer. *Chiaroscuro CR 176*, \$7.98.

Although Max Kaminsky was an outstanding trumpet player with the Tommy Dorsey and Artie Shaw bands in the late '30s and early '40s, he has been heard primarily as a Dixieland cornetist for the past thirty-five years. For more than a decade, he has been playing at Jimmy Ryan's in New York, locking into endless renditions of *Muskrat Rambler* and *Original Dixieland One-Step*.

This record not only gets him away from those Dixieland wallows, but shows a totally different side of his playing. His low register on ballads is dark and throaty (somewhat like the Ruby Braff approach), and when he swings it's with punched phrases. Unfortunately that happens only twice; indeed, the overabundance of slow ballads eventually dilutes the set's initial promise.

Still, it's a pleasure to hear the lyrical Max in the enlivening company of pianist John Bunch, guitarist Bucky Pizzarelli, bassist George Duvivier, and drummer Ronnie Traxler. And the repertory is certainly adventurous for a jazz band. The way Kaminsky plays the four Noel Cōward songs harks back to the pioneering jazz Gershwin album that he made with Pee Wee Russell, Fats Waller, and others forty years ago. Also included are the haunting but rarely heard *Blame It on My Youth* by Edward Heyman and Oscar Levant, five virtually unknown ballads including a gorgeous treatment of *From Here to Eternity* (which Frank Sinatra recorded in 1953), and a series of swinging solos for the whole group. The last features an entire Bunch chorus that echoes *Song of India*.

From its title, one gathers that *Is That What You Wanted* is an answer to the producer's plea for something up and swinging. Not only did the set need more of that, it also needed better liner notes than those provided by John de Vries.

Though Kaminsky is quoted as insisting, "Don't forget to tell about the songs," there is not a word of background on any of the fresh material he has dug up. Nor is there anything on singer Mary Eiland, unknown to this listener, whose two appearances indicate that she has good ideas but is not yet in full control of them. J.S.W.

**Donald Lambert: Harlem Stride Classics. Pumpkin 104, \$7.98 (Pumpkin Productions, Inc., P.O. Box 7963, Ludlum Branch, Miami, Fla. 33155).**

Dick Wellstood has written some illuminating and provocative notes for this collection of piano solos by Donald Lambert. Not only does he describe the piano techniques involved in stride piano, but he offers the thought that "Lambert was, to my mind, perhaps the single most exciting stride pianist. His only rivals would be Fats, or James P. in his younger days."

The fact that Lambert, who died in 1962, is a virtual unknown may seem odd—particularly since he is held in such high esteem by as knowledgeable a stride pianist as Wellstood. But he was one of those eccentrics who dot the history of jazz; he spent virtually his entire career playing in bars in New Jersey. At his only session for a major label—Bluebird in 1941—he recorded four stride treatments of classical numbers that Brian Rust describes in his discography as "an apparent attempt to bridge the aesthetic gap between jazz and the classics—their appeal to the jazz collector is bound to be somewhat limited." In 1949 and again in 1961, he did two sessions for Circle Records, much of which has not been released.

This collection, recorded between 1959 and 1962 in an unnamed room in Warren, New Jersey, does not exactly make it easy to appreciate Lambert. The pianos he plays range from adequate to terrible, the recording from thin to heavy. But through it all there are some fine moments that back up Wellstood's assessment: *I'm Just Wild about Harry* is a remarkable performance, with Lambert topping himself on chorus after chorus; *When Dreams Come True* builds and rollicks; *Russian Lullaby* is dashing and driving. That they are not all of a piece is at least partly because he suffered a stroke, apparently in 1961, and five of the selections were recorded when his right hand was not as reliable as it once was. Despite this, despite the sound, despite the pianos, Lambert left so little evidence of his talent that this record should be treasured for its insight into how a masterly stride pianist could play. J.S.W.

# R&B

BY JOHN STORM ROBERTS

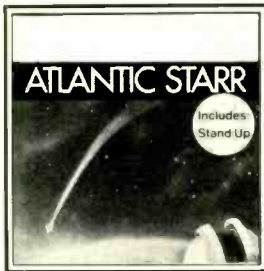

**Atlantic Starr.** Bobby Eli, producer. *A&M SP 4711*, \$7.98. *Tape: CS 4711, 8T 4711*, \$7.98.

Just now and again, a piece of music leaps right out of the stereo and into the head, the heart, and the feet. Atlantic Starr's superlative *Visions* does just that, and part of its originality

is the strong Arab twist to its riffs. The rest of the album bursts with the joie de vivre that belongs only to the very best of new bands. Atlantic Starr is this month's proof that there's more out there than comput-a-pop.

**Gato Barbieri: Tropico.** David Rubinson, producer. *A&M SP 4710*, \$7.98. *Tape: CS 4710, 8T 4710*, \$7.98.

Gato Barbieri, like most romantic geniuses, has spent most of his career being misunderstood. Though he's a gorgeous player with the edge to make romanticism work, his previous work for Flying Dutchman and ABC/Impulse represented the most consistently original body of Latin-jazz experimentation on disc. Still, even with the easy-listening trappings that surround him here, originality keeps flashing through.

**Gary Bartz: Love Affair.** Gary Bartz, producer. *Capitol SW 11789*, \$7.98. *Tape: 4XW 11789, 8XW 11789*, \$7.98.

A lean and sinewy alto saxophonist, Bartz makes a good case for eclecticism with jazz-oriented solos, r&b, pop, party-party, a bunch of nursery rhymes, a lot of taste, and a sense of humor. And it works at a level much more interesting than your average Lush Listening. Really.

**Grace Jones: Fame.** Tom Moulton, producer. *Island ILPS 9525*, \$7.98. *Tape: ZC 19525, Y81 9525*, \$7.98.

While it's true that careers have been made by some pretty invisible talents, there's no way I can call this album's title prophetic. Ms. Jones can sometimes carry a tune for a measure or two. But her performance is dull, her interpretation nonexistent, and her version of *Autumn Leaves* an outrage. Hope cometh in the morning: Her contract has to run out someday.

**Professor Longhair: Live on the Queen Mary.** Tom Wilson, producer. *Harvest SW 11790*, \$7.98. *Tape: 4XW 11790, 8XW 11790*, \$7.98.

Professor Longhair is one of those shadowy influences on black music—the probable progenitor of the rumba-inflected New Orleans r&b sound that Fats Domino first made famous. *Tell Me Pretty Baby* and *Mardi Gras in New Orleans* have that mellow throb; the rest don't match their flair.

**Howard Kenney: Superstar.** Larry Blackmon, John Pate, & Howard Kenney, producers. *Warner Bros. BSK 3220*, \$7.98. *Tape: M5 3220, M8 3220*, \$7.98.

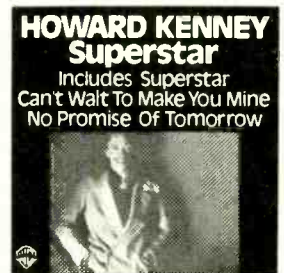

Despite vapid ballads and predictable pieces of whatsapppin trendiness, this first album by Howard Kenney has more than passing flashes of originality—particularly on the cut *Superstar*. His métier is the rock/r&b blend that's producing some of the most interesting young black sounds today.

**Wilbert Longmire: Sunny Side Up.** Bob James & Jay Chattaway, producers. *Tappan Zee JC 35365*, \$7.98. *Tape: JCT 35365, JCA 35365*, \$7.98.

Whether or not the title is a crafty way of hinting that somebody laid an egg, the presence of so many high priests of the New Muzak pretty much guarantees instant amnesia. Inside sources inform me that Wilbert Longmire is not the name of a CBS computer, but I'm still suspicious.



**Johnny Mathis & Deniece Williams: That's What Friends Are For.** Jack Gold, producer. *Columbia JC 35435*. *Tape: JCT 35435, JCA 35435*, \$7.98.

In my book, making an entire album of remorselessly bland love songs is *not* what friends—or above average vocal cords—are for. This is the kind of stuff millions hear and nobody listens to.

**Ms. (Sharon) Ridley: Full Moon.** Jerry Peters, producer. *Tabu JZ 35377*, \$7.98. *Tape: JZT 35377, JZA 35377*, \$7.98.

Ms. Ridley wrote six out of the nine songs on her album, and they are the most memorable. Strictly clichéd arrangements sometimes swamp her better-than-average ballad singing, but her individual melodic sense manages to shine through.

# HIGH FIDELITY CLASSIFIED

130 East 59th St., New York, NY 10022. Phone: 212-826-8393/4

GENERAL: All copy subject to publisher approval. First line caps. Users of P.O. Box MUST supply permanent address and telephone number before ad can run. CLOSING DATE: 1st of second month preceding cover date.

CLASSIFIED RATES: Per word: 1x—\$1.60; 6x—\$1.50; 12x—\$1.40. MINIMUM 15 words. Words in caps—10¢ extra each. Box numbers: \$2.00 additional per insertion to cover cost of handling and postage. Display: 1 inch—\$275; 2 inch—\$550; 3 inch—\$825. Also 6 and 12 consecutive issue discount rate.

PAYMENT WITH ORDER: Send check, M.O., MASTERCHARGE or VISA No. and expiration date to: Classified Dept., HIGH FIDELITY, 130 E. 59th St., New York, NY 10022.

## for sale

3600" New L/N Scotch or Ampex tape. 10 1/2" metal reel. 5 for \$38.00. 24 page booklet on tape editing 80¢. Soundd POB 338, Dunwoody, Ga. 30338.

PERFECTIONISTS PREFER "DYNAKITS. BEFORE Purchase You Owe Yourself Our Quote. MAINLINE III, 971 Fronheiser, Johnstown, Pa. 15902.

## SPEAKER INFORMATION KIT.

Get 70 pages of speaker facts, specs, construction tips plus info on our raw speakers, crossovers and a line of nine quality hi-fi speaker system kits. We'll send you our full-color catalog; plus

**How To Hook Up Your System**, an exhaustive step-by-step treatise on hi-fi system installation; and our Speaker Owner's Manual, chock-full of facts on how to get the most from any speaker system, for only \$1.00. Send to:

Speakerlab, Dept. HF-1  
735 N. Northlake Way, Seattle, WA 98103

AUDIOPHILES WANTED!! Put your knowledge to use, earn an excellent spare time income. We need campus Dealers to sell name brand stereo equipment at substantial discounts in your area. No investment necessary. For information and application please write: ABCO, Dept. CR, 1201 East Main Street, Meriden, Conn. 06450. Call (203) 238-7979.

STEREO REPRESENTATIVES NEEDED!!! LOWEST POSSIBLE PRICES!!! OVER 100 BRANDS!!! KRASCO Rep., 998 Orange Ave., West Haven, Conn. 06516.

HI-FI ENTHUSIASTS WANTED!! Earn more than just spare money in your spare time. We need campus representatives to sell name brand stereo components at discount prices in your area. No investment required. Serious inquiries only, please. Contact: Mail Order Dept. K&L Sound Services Co., 75 No. Beacon St., Watertown, Mass. 02172. (617) 926-6100.

STEREOS, UP TO 40% SAVINGS, FOR PRICE QUOTE OR CATALOG. CORATHERS, 169 S. St. John = 249, Pasadena, CA 91123.

PROTECT YOUR LPs POLY SLEEVES 9¢ ROUND BOTTOM INNER SLEEVES 8¢ SQUARE BOTTOM 6¢ POLY LINED PAPER 15¢ WHITE JACKETS 35¢ POSTAGE \$1.50 RECORD HOUSE, HILLBURN, NEW YORK 10931.

SAVE up to 80% BY MAIL on: SCOTCH, TDK, BASF, MAXELL, MEMOREX, CAPITOL MUSIC TAPE, CERTRON (over 180 different reel & cassette tapes to choose from); top brand recorders; America's largest collection of taping accessories, too. Same day service. **FREE catalog.**

America's Recording Tape Specialists

**SAXITONE TAPE SALES**

1776 Columbia Rd., Washington, D.C. 20009  
(202) 462-0800

BUY FROM MANUFACTURER. Send US \$10 for ten Chromium Dioxide C-60 cassettes. PolyArt Company, P.O. Box 5170, Tsimshatsui Hongkong.

COLLEGE DEALERS—Write for Details on College Program. Fast shipments, low prices, excellent profit. Sound Reproduction, 460 Central Avenue, East Orange, New Jersey 07018.

REPRESENTATIVES increase your profits! DEUTSCHE Radiowerke offers high quality IMPORTED headphones, SPEAKERS, microphones, 6311 Yucca Street, Los Angeles, California 90028.

DYNAKITS low prices, fast service. DEW Audio (formerly Underground Hi Fi), #4 Pinewood, Hampstead, N.H. 03841 603-329-5403.

DIRECT-TO-DISC RECORDINGS: All labels. Send \$2.00 for descriptive catalog—Free Newsletter DISConnection, P.O. Box 10705, Tampa, Fla. 33679.

QUALITY SPEAKER CABLES, 25 Ft.—\$24.95. Send check: "Snake Cables," P.O. Box 242, Littlerock, Cal. 93543.

## A SINGER'S DREAM!



**REMOVES VOCAL FROM MOST STEREO DISCS**  
The Thompson Vocal Eliminator can actually remove most or all of a solo vocalist from a standard stereo record and yet leave the background music virtually untouched! Not an equalizer! We can prove it works over the phone. Write for a brochure and demo record below. COST: \$195.00

## ECHO Ambiance

We do it BETTER for LESS  
Whether your interest is in using Ambiance for a concert hall effect or as an echo chamber for studio recording use, we manufacture a broad line of sophisticated analog delay Echo and Reverberation devices at prices which only direct sales make possible. Prices range from \$159 to \$495.  
Write for a brochure and demo record. Include \$1 to cover costs (refundable with order.)  
Write to: **LT Sound**, Dept. HF, P.O. Box 1061, Decatur, GA 30031 (404) 284-5155

AT LAST! THE ULTIMATE CABINET DESIGN FOR HOUSING STEREO COMPONENTS—THE CUSTOM SOUND MODULAR EQUIPMENT CABINET. NEARLY TWO YEARS IN DEVELOPMENT FEATURING: Flexible modular design expandable to suit any size installation; Accommodates any size components including the largest; Totally enclosed design with locks prevents dust buildup, tampering, or theft; Bottom casters for mobility and rear door for easy rear access; High grade furniture design and construction; Very attractively priced. BEFORE YOU INVEST IN A RACK, CALL OR WRITE FOR OUR FREE ILLUSTRATED INFORMATION. WRITE: CUSTOM SOUND, ALGONAC, MICHIGAN 48001 (313) 794-5400.

PROFESSIONAL HI-FI Home study course available—Instructors include Len Feldman, Julian Hirsch, Larry Klein, Larry Zide. Send \$2.00 for full color AUDIO PRIMER and information on joining Society Audio Consultants (SAC), 19 W. 34th St., Room 1208, Dept. HF NYC, NY 10001.

DON'T WASTE MONEY!! MANUFACTURER'S PRICE LISTS on the equipment you want—plus unbiased recommendations. \$4.95 to Audio Shoppers Service, Box 707, Amherst, Mass. 01002.

STEREO REPS NEEDED!! SELL BETTER EQUIPMENT For less and make more money. We're better than the rest. Are you? Contact Wholesale Audio Distributors, Box 707, Dept. M4, Amherst, Mass. 01002.

HORNS-WOOFERS-MIDS-TWEETERS at tremendous OEM savings Altec, Electro-Voice, Pioneer, Peerless, Polydax and many others. Dozens of hard to find items used in major manufacturers most expensive systems. Huge selection of crossover network components, automobile systems, and musical instruments loudspeakers. Send for FREE CATALOG. Sherman Research Corp., Audio Sales Div. Dept. HF, 9144 King Arthur Dr., Dallas, Tx. 75247.

AUDIOPHILES' HIGH FIDELITY COMPONENTS. OVER 100 DOMESTIC AND FOREIGN BRANDS. LOW PRICES! EFFICIENT, PERSONALIZED SERVICE BUY WITH CONFIDENCE! AUDIO AMERICA, BOX 445H, LEXINGTON PARK, MARYLAND 20653. (301) 862-3088, 5-9PM. WEEKDAYS: 9AM-9PM, SATURDAYS AND SUNDAYS.

Don't Buy MAXELL-UDXL or TDK-SA CASSETTES. Now Get Superb Quality, Low Cost Equivalents. C-60, \$1.50. A. Blank, Box 621, Forest Hills, N.Y. 11375.

## TAPE Cassette Sale!



**TDK CASSETTES**



TDK-DC-45	1.09	TDK-SAC-80	1.99
TDK-DC-60	1.29	TDK-SAC-90	2.99
TDK-DC-90	1.69	TDK-ADC-60	1.79
TDK-DC-180	2.99	TDK-ADC-90	2.89

### 8-TRACK

TDK-45 D 8tr	1.59	TDK-45 AD 8tr	2.29
TDK-90 D 8tr	1.99	TDK-90 AD 8tr	2.99

LIFETIME PRODUCT GUARANTEE! ORDER NOW!

Minimum order 10 tapes

Orders shipped within 1-3 days. Please add \$2.00 for shipping and handling per order. N.Y.S. Res. add sales tax. NO C.O.D.'s FREE CATALOG!

## CONSUMERS CO.

P.O. Box 550 Dept. HF-10

Mt. Vernon, N.Y. 10551 Phone: (914) 664-2909

## miscellaneous

DIAMOND NEEDLES and Stereo Cartridges at Discount prices for Shure, Pickering, Stanton, Empire, Grado and ADC. Send for free catalog. All merchandise brand new and factory sealed. LYLE CARTRIDGES, Dept. H, Box 69, Kensington Station, Brooklyn, New York 11218. For Fast Service, call TOLL FREE 800-221-0906.

PROTECT YOUR ALBUMS. WHITE CARDBOARD REPLACEMENT JACKETS 35¢. PLASTIC LINED INNER SLEEVES 15¢. POSTAGE \$1.25. OPERA BOXES, 78 SLEEVES AVAILABLE. FREE CATALOG. CABCO 301-3, BOX 8212, COLUMBUS, OHIO 43201.

The Best New Stereo Systems Deserve The Best New Stereo Records (Tapes too!) You need the Monthly SCHWANN RECORD CATALOG available from record shops everywhere or, for a sample copy PP, Send \$2.50 to: ABC-SCHWANN, Single Copy Sales Dept., 2160 Patterson St., Cincinnati, Ohio 45214.

COLLEGIATE RESEARCH PAPERS. All subjects. 10,250 on file. IMPROVE YOUR GRADES! Send \$1.00 today for 256-page catalog. Rapid Delivery. Box 25916-RR, Los Angeles, Calif. 90025, (213) 477-8226.

## new equipment for sale

DON'T BE FOOLISH!!! WE CAN SAVE YOU MONEY! THE best prices on all audio/video equipment—cars, home or mobile. Write for quotes and specials. New England Audio Wholesale, Box 707, Amherst, Mass. 01002.

## Buy with confidence

Send for Quotes & Price List on JVC & Over 60 Other Famous Brands

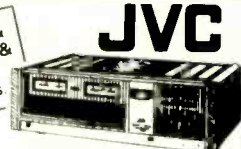

JVC JR-S300 II STEREO RECEIVER WITH 5-BAND GRAPHIC EQUALIZER - 50 watts per channel, min. cont. power, into 8 ohms, from 20Hz to 20kHz, with no more than 0.1% T.H.D.

**ARSTON** Sales

Mon.-Fri. 9:00-5:30  
Sat. 9:00-3:00

146 Old Brookfield Road, Danbury, Conn. 06810  
(203) 744-6421 (212) EN3-6212

BRITISH AND EUROPEAN EQUIPMENT DIRECT TO YOU. Most quality makes of equipment available at advantageous prices. Price list and price quotes send International Reply Coupon. For specific brochures send \$2.00 bills. Audio T, Dept A, 190 West End Lane, London NW6, phone 01-794 7848. Visitors welcome.

SANSUI and PICKERING! BELOW mall order prices! Send to: GSH Super Savings, P.O. Box 86, Eden, N.C. 27288 (919) 627-1919.

BARCLAY RECORDING & ELECTRONICS—Send \$2 for equipment catalog and component evaluation manual. 233 East Lancaster Avenue, Wynnnewood, Pa. 19096, (215) 667-3048 or 649-2965.

CONNECT your TELEVISION to your STEREO system in minutes! Record your favorite shows too. Free details. JMC, 491 South Wyckles, Decatur, Illinois 62522.

DISCO MIX MASTER IV The Best Mixer For Phono. Tape, Microphone Disco Use. Only \$189.00. Berkshire Audio, P.O. Box 35, Great Neck, N.Y. 11021. Dealer inquiries invited.

**tapes & records**

**NOTICE:  
Record Raters  
Wanted**

(No experience required) Each month you will receive nationally released albums to rate. **There is no extra charge for the LP's you receive** — all you pay is a small membership fee which covers all costs of the LP's including postage and handling. In return for your opinion you will build a substantial album collection - "first come basis." For application write:

**E.A.R.S. INC.**  
Box 10245 Dept. HF  
5521 Center St., Milwaukee WI 53210  
"Guaranteed" © 1975 E.A.R.S. INC.

RARE OPERA, SYMPHONIC MUSIC ON OPEN REEL TAPE. Historic performances. EUROPEAN, DOMESTIC. Free Catalogue. Underhill, Box "U," Bellport, NY 11713.

"SOUNDTRACKS, SHOW, NOSTALGIA & JAZZ—FREE Catalog & Offering List—A-1 Record Finders, P.O. Box 75071-H, L.A. CAL. 90075."

SCOTCH RECORDING TAPE, LOWEST PRICES. TAPE CENTER, Box 4305C, Washington, D.C. 20012.

CUT-OUT RECORDS. HUGE STOCK. ALL NEW. No catalog, Cohn, 2205 Marylane, Broomall, Pa. 19008.

RAREST CLASSICAL, SOUNDTRACKS, SHOWS, PERSONALITY LPs. Huge catalog 50c. Grammy's Attic, Box 181, Bluffton, SC 29910.

"HISTORICAL OPERA DISC & TAPE—Magnificent quality, speedy service. Greatest live performances of past 50 years. Reel, cassette, disc. Free Catalog. Historical Recording Enterprises, Box 12, Kew Gardens, N.Y. 11415."

"LIVE OPERA TAPES. Reels—Cassettes. Unbelievable treasures since 1926. Over 5,000 selections. Free DELUX Catalog. MR. TAPE. Box 138, Murray Hill Station, NYC 10016."

SOUSA RECORDS. Free catalog upon request. Stafford, Box 36163, Grosse Pointe, Mich. 48236. Dealer inquiries invited.

TDK, MAXELL, MEMOREX, CASSETTES, REELS, 8-Track Free Catalog, New Guaranteed. S&S AUDIO, P.O. BOX 94485, Schaumburg, IL 60194.

SEARCHING? WRITE DISContinued RECORDS, 444 South Victory, Burbank, California 91502.

SHOW ALBUMS—Rare, out-of-print lps. 64-page list \$1.00. Bakers Wife cast LP \$9.95. Broadway-Hollywood Recordings, Georgetown, CT. 06829.

EVERYTHING ON OPEN REEL! Classical, Popular, Dolby, Quadraphonic. Latest releases. For catalog, send \$1.00. Barclay-Crocker, Room 1470H, 11 Broadway, New York 10004.

RECORDING TAPE—OUTSTANDING VALUES! Cassettes, 8-tracks, open reels, video, data tapes, bulk cassettes, accessories. New. Fully guaranteed. Free catalog. Write: Magne House, 2015-D, 17th Street, San Francisco, CA 94103.

1930-1962 RADIO PROGRAMS. INFORMATIVE 200 page catalog, \$1.25. AM TREASURES, Box 192HF, Babylon, NY 11702.

LIVE OPERA TAPES, CASSETTES. Incredible selection. Performances since 1930's. Personal, quick service guaranteed. Free bonuses. Magnificent free catalogue. Live Opera, Box 3141, Steinway Station, L.I.C., N.Y. 11103.

CLASSICAL RECORDINGS FOR COLLECTORS. BI-MONTHLY LISTS. SEND \$1.00. ARS MUSICA, 13 Dante St., Larchmont, N.Y. 10438.

VIENNESE LIGHT MUSIC SOCIETY—Strauss, Lanner, etc. on Dolby Cassettes, KC Company, Box 793, Augusta, Maine 04330.

RARE RECORD/TAPE COLLECTOR'S DIRECTORY. New enlarged treasury of over 250 addresses. Annotated. All categories. Send \$4.95. DIRECTORY, Dept. H, 550 East Rustic Road, Santa Monica, Calif. 90402.

GOLDEN AGE RADIO—YOUR BEST SOURCE for radio tapes. Free catalog. Box 25215-JA, Portland, Oregon 97225.

RARE OUT-OF-PRINT LPs. Factory Sealed—99c to \$3.99 ea. Over 25,000 in stock. List-\$1.00 Record Warehouse, Box 4617, Rochester, New York 14613.

BASF TAPE: Largest discounts, fastest service. All tapes guaranteed! INTERGALACTIC ENTERPRISES, 1043 Kirts, Troy, Michigan 48084.

BARGAINS! RECORDS, TAPES: blank, prerecorded. CLOSEOUT PRICES! Catalog \$1.00 (refundable). Tower, Box 12, Lewes, Del. 19958.

CASSETTE SAVINGS\$ BREAKTHROUGH!!! PROVEN BEST OR YOUR-MONEY-BACK. No minimum. Free same-day shipping. Sample \$1.00—Facts free. LARKSONG, Box 469B10, Point Arena, CA 95468.

CLASSICAL CASSETTES, STEREO-DOLBY, FREE CATALOG QUALITY GUARANTEED, DISCOUNTED, CREDIT CARDS ACCEPTED. EKR CLASSICS, GPO BOX 1977 HI, NEW YORK, N.Y. 10001.

HAVING TROUBLES FINDING DIRECT-TO-DISC AND SOTA RECORDINGS? WE HAVE THEM ALL. SEND FOR FREE CATALOGUE. KNOT SO CHEAP RECORDS, 7505 BIG BEND, DEPT. HF11, WEBSTER GROVES, MO. 63119.

LIVE PERFORMANCE TAPES OPERA, CONDUCTORS, INSTRUMENTALISTS. Open reel only. Emphasis on superior sound. Good Sound Associates, POB 263, Planetarium Station, New York, N.Y. 10024.

DIRECT-TO-DISC, SUPER-DISC AND FILM MUSIC recordings. Comprehensive, free catalog. COSMIC CHORDS, P.O. Box 4873, Boulder, Colo. 80302.

Symphonic rarities on Reels and Cassettes. Stereo and mono. Custom service. Catalog \$1.00 (refundable). Michael Herman, 170-21 Dreiser, Bronx, NY 10475.

CASSETTE SAMPLER SPECIALS (Dolby) Piano Concerti: Mozart No. 21, Beethoven No. 2. \$2.49 each. Both \$3.98. Free catalog. Musical Concepts, Box 53H, Cedarhurst, NY 11516.

**BLANK TAPE SALE**

MAXELL RECORDING PRODUCTS: We carry the complete line of Maxell's products. Write or call for prices.

TDK SA-C50	\$1.97	Ampez: Grandmaster C50	\$2.29
TDK SA-C90	2.87	Ampez: Grandmaster C90	2.75
TDK AD-C90	2.39	BASF: Studio or CR7-C90	2.49
Scotch Master I-C90	2.79	BASF: Prof. I-C90	2.69
Scotch Master II or III-C90	3.24	BASF: Prof. II or III-C90	2.79

Minimum order 12 pieces. All tapes can be assorted. PA add sales tax. Shipping \$2.50 per order. Or write for complete catalog. 412-283-8621.

Tape World, 220 Spring St., Butler, PA 16001.

RARE RECORDING: Phyllis Curtin singing Hymns and Dr. Donald Paterson accompanying on the historic Roosevelt organ. Five organ Solos plus ten Hymns. Limited edition at \$7.95 postpaid from First Congregational Church, Box H, Great Barrington, MA 01230

**business opportunities**

CABLE FM BROADCASTING: Unique no investment/experience business. Home operation possible. Excellent income. "CAFM," Box 130-D-10, Paradise, CA 94596.

**wanted to buy**

BROADCASTS, LIVE CONCERTS featuring cellist Gregor PIATIGORSKY for family's archive. Terry King, 927 High St., Grinnell, IA 50112.

**quad**

ENJOY THE ULTIMATE IN 4-CHANNEL SOUND. Add a Vista QS-100 or SQ-400A Quadriphonic Decoder. Brochure 25c. Photolume Corporation, 118 East 28th Street, New York, N.Y. 10016.

**publications**

YELLOW PAGES OF AUDIO—\$3.95 Sourcebook to 1,100 periodicals, 250 books, 7,500 products! Future Publications, 137 Valley Park South, Bethlehem, PA 18018.

DON'T FUMBLE WITH THAT DIAL looking for your favorite music! Take the guesswork out of FM listening with the FM Atlas and Station Directory. \$3.95. "FM Atlas," Adolph, Minnesota 55701.

**accessories**

STEREO CARTRIDGES AND STYLI are our specialty; also phono accessories, direct-disc records. All major brands and many hard-to-find replacements. Free catalog. Needle in a Haystack, Dept. H, P.O. Box 17436, Washington, DC 20041.

**electronics**

ELECTRONICS SURPLUS, CLOSEOUTS, LIQUIDATIONS! Parts, audio equipment, stereo, industrial, educational. Amazing values! Fascinating items unavailable in stores or catalogs anywhere. Unusual FREE catalog. ETCO-017, Box 762, Plattsburgh, N.Y. 12901.

**employment**

RADIO-TV JOBS... Stations hiring nationwide! Free details: "Job Leads," 1680-GW Vine, Hollywood, CA 90028.

Classified Dept., HIGH FIDELITY,  
130 East 59th Street, New York, NY 10022  
Telephone: 212-826-8393/4

Name \_\_\_\_\_

Address \_\_\_\_\_

City \_\_\_\_\_ State \_\_\_\_\_ Zip \_\_\_\_\_

Telephone \_\_\_\_\_

Payment enclosed \$ \_\_\_\_\_ for \_\_\_\_\_ issues,  Check  M.O.

MASTERCHARGE  VISA Card # \_\_\_\_\_ Expiration \_\_\_\_\_

Bank # \_\_\_\_\_ Signature \_\_\_\_\_

Please run following ad copy for \_\_\_\_\_ issues starting next available

issue: \_\_\_\_\_

## ADVERTISING INDEX

For free product literature, use the reader service card on page 149

Key No.		Page No.
1	Acoustic Research	100
2	Acoustic Research	125
3	Acutex U.S.A. International	123
4	ADC Professional Products, a Div. of BSR Consumer Products Group	4
5	ADC Professional Products, a Div. of BSR Consumer Products Group	30, 31
	Advent Corp.	111
6	AIWA	15
	Akai America Ltd.	119
68	Altec	54
7	Angel Records	110
8	Audio Dynamics Corp.	144
9	Audio Technica U.S. Inc.	6
	Audio Technica U.S. Inc.	48
10	Avid Corp.	20, 21
65	Bang & Olufsen of America	128
	BASF Audio	92
11	Beveridge	106
	Bose Corp.	46
67	BSR Consumer Products Group	114
12	Celestion Industries	16
13	Century Records	167
	Classified Ads	178, 179
14	Dahlquist	105
69	DBX, Inc.	124
15	Discount Music Club	136
	Discwasher Inc.	35-45
16	District Sound	140
	Dixie Hi Fi	140
17	Dual	28
18	Electro Voice, Inc.	11
19	Empire Scientific Corp.	62
20	Fisher Corp.	10
21	Fujil Photo Film U.S.A. Inc., Magnetic Tape Division	131
22	Garrard	117
71	Hammond Industries	128
	High Fidelity's Test Reports	145
23	Hitachi Sales Corp.	69
24	Icelandic Airlines	148
25	Illinois Audio	136
26	Infinity Systems, Inc.	61
	Jensen Sound Laboratories	8, 9, 181
27	J & R Music World	134
28	JVC America, Inc.	7
	Kenwood	Cover IV
29	Klipsch & Assoc.	133
30	Koss Corp.	26, 27
	Lansing, James B., Sound Co., Inc.	51
	Marantz Co., Inc.	182, Cover III
31	Maxell Corp.	59
32	Maxell Corp.	120
33	McIntosh Laboratory	24
	Music Listeners' Book Service	116, 118, 142, 163
35	National Record Plan	130
	Nikko	33
36	Ohm Acoustics	159
37	Onkyo	139
38	Optonica Electronics	129
39	Philips High Fidelity Labs., Ltd.	12, 13
40	Pickering & Co., Inc.	2
41	Pioneer High Fidelity	Cover II, 1
42	Pioneer High Fidelity	135
43	QSD	138
	Radio Shack	137
70	Rotel of America Inc.	122
66	RTR Industries	57
44	Sansui Electronics Corp.	108, 109
	Save The Children	141
45	Scott, H.H., Inc.	173
46	Sharp Electronics, Inc.	113
47	Shure Brothers, Inc.	143
48	Shure Brothers, Inc.	126, 127
	Sonic Research, Inc.	14
50	Sony	67
51	Sony Corp. of America	134
52	Sound Guard	107
	Speakerlab	138
53	Stereo Corp. of America	144
	Stereo Discounters	144
54	Tandberg of America	48, 49
55	TDK Electronics Corp.	53
56	TDK Electronics Corp.	70
57	TDK Electronics Corp.	116
58	Teac Corp. of America	75
59	Technics by Panasonic	5
60	Technics by Panasonic	25
	3M Company	147
	Time-Life Records	17-19
61	Top Discount Audio	132
	Ultralinear	23
17	United Audio Products	28
62	Video Center, The	47
63	Visonik of America	103
64	Wisconsin Discount Stereo	132
	Yamaha Audio	121

# Folios

## Music in Print

**Aerosmith: Draw the Line.** *WBP, 9 songs, \$6.95.*

I've never figured out how the members of Aerosmith manage to applaud themselves and play their instruments at the same time. I'm sure they're nice kids and good to their mothers, but they're also very long on effrontery.

**The Gregg Allman Band: Playin' Up a Storm.** *WBP, 8 songs, \$4.95.*

Allman supporters may want to purchase this folio, but there's really very little here to sink the fingers into. The music is juiceless, and the emaciated lyrics lean toward rhyming "mind" with "mine" when they rhyme at all. The band merits listening to, but you won't find good nutrition on the printed page.

**Kansas: Point of Know Return.** *WBP, 10 songs, \$5.95.*

This group takes itself oh, so seriously. Whatever happened to rock music designed for pleasure rather than penance? Since I'm not into masochism this month, I declined to suffer along with rifts notated—however brilliantly—in consecutive measures of 10/16, 12/16, 11/16 (*The Spider*), et al. It's not that I'm chicken, but this kind of music, when printed, just doesn't hold up.

**Barry Manilow: Even Now.** *Kamakazi & Big 3, 12 songs, \$6.95.*

You will find no fewer than fourteen photos of the appealing Mr. Manilow in this folio, but you don't have to settle for just that. These twelve ballads by various young writers (some of whom collaborate with the artist) are audience pleasers, lyrically and melodically shaped for those who accept love (or the lack of it) as a motivating force in life. Knowing the reluctance of publishers to credit any of the industry's artisans by name, I am happy to report that the excellent piano-vocal transcriptions were done by Frank Metis.

**#1 Songs of the Seventies.** *WBP, 58 songs, \$6.95.*

For the beginning collector, or those

who aspire to be the life of a not-too-avant-garde party, this mélange should be just the thing. Every one of these songs has been No. 1 on either the *Billboard* or *Cashbox* pop singles chart, and every one is linked, in the table of contents, with the name of a prominent recording artist. *Southern Nights* is attributed to Glen Cambell (*sic*) and Steve Miller's hook lyric, "Keep on a-rockin', rockin' me baby" is titled as *Rock 'n Me*—a very different connotation. Despite these lapses in literacy and/or proofreading, this collection is an excellent value. Included are six hot items by the Bee Gees, two by America, three by the Eagles, some by Neil Sedaka, Carly Simon, Elton John, Fleetwood Mac, and Abba, to name but a few.

**Queen: Anthology.** *Big 3, 31 songs, \$8.95.*

English group Queen has been releasing one album a year since signing with Elektra and this folio contains selected excerpts from 1973's "Queen," '74's "Sheer Heart Attack," '75's "A Night at the Opera," and '76's "A Day at the Races." We are warned by the publisher that "copying of the photographs ... herein contained is prohibited," but curiously there are no photographs at all. This is a serious omission, for the group uses its self-penned material as a vehicle for some entertaining performances.

**Top Country Hits of 1977.** *Big 3, 87 songs, \$7.95.*

**Don Williams Songbook.** *Big 3, 30 songs, \$5.95.*

"Top Country Hits" delivers exactly what it promises, and you won't be disappointed even if you consider yourself a city slicker. During the last twenty years, country writers have been quietly laying it on the line about husbands, wives, and honky-tonk angels. As evidenced here, today's country music—part naturalism, part melodrama—is cleverly constructed and often quite sophisticated. Three of those "Top Hits" are also singing acquaintances of performer/writer Don Williams, so the better value is the more expensive collection, though both are pleasantly playable.

ELISE BRETTON





1½" Mylar® dome tweeter for extrawide 170° high frequency dispersion.

Two 3½" midranges with individual tuned isolation chambers.

High and mid frequency controls are continuously variable to adjust response to suit any room, program material or individual taste.

Low frequency driver with specially treated polyurethane foam suspension for lower distortion, free cone movement, and smoother response.

# An inside look at Jensen's Total Energy Response.

You're looking at the heart of one of the most uniformly accurate sound reproducers made today. A Jensen Lifestyle Speaker.

Unlike many speakers that require special on-axis listening positions—or others that bounce the sound all over your room—Lifestyle is engineered to deliver a wide spectrum of musical information throughout the listening area. In proper perspective. With all the depth and imaging your source material is

capable of. And at real-life volume levels. That's what Total Energy Response is all about.

In fact, for perfectly integrated speaker systems and total quality control, we make every element that

**JENSEN**  
LIFESTYLE SPEAKER SYSTEMS

Division of Pemcor, Inc.  
Schiller Park, Illinois 60176

goes into the manufacture of our Lifestyle speakers. From the heavy duty magnets to our handwound, high power voice coils. Even the computer-designed crossover network. And of course, all of our precision woofers, midrange drivers and 170° dispersion dome tweeters.

But please, give a critical listen to these speakers in person. We think you'll agree, a notably superior design concept has resulted in audibly superior sound reproduction.



# TRY THE MARANTZ P WILL NEVER KNOW OUR

By using a simple test you can prove to yourself that Marantz loudspeakers deliver the same brilliant sound separation over the widest possible listening area:

Here's the test:

Have your Marantz dealer place any pair of Marantz floor standing loudspeakers in a normal listening position. Now, listen as your selection of dynamic music is played through the Marantz loudspeakers. Notice the three dimensional quality of the sound. Now close your eyes and have two people slowly turn the Marantz loudspeakers until they're actually *facing each other*.

Did the sound change?

In almost every case we've found the listener cannot hear a change in the sound... because there isn't any! Even with the loudspeakers facing each other. Incredible!

But if you try the same test with most conventional loudspeakers you'll notice a striking difference. The sound literally falls apart. You'll hear a loss of overtones—sparkle and brilliance—all the qualities that make music open and spacious disappear.

## WHY MARANTZ PASSED THE TEST WHILE OTHERS FAIL.

In a nutshell: Constant Radiated Power (CRP)—180 degrees dispersion regardless of frequency. To achieve CRP we consider both the frequency response and dispersion characteristics of each individual transducer in the system; woofer, midrange and tweeter. The result is a unique design approach incorporating three important performance parameters:

1. We know that dispersion is determined by the diameter of the radiating surface—the speaker cone—and the frequency being reproduced. So we pick the precise frequency at which each individual driver radiates 180 degrees and use this as the crossover point.

But many manufacturers often crossover at a frequency where, for example, the woofer's dispersion has already started to beam. Why? They may be trying to save money by using cheaper transducers and crossover networks. Or, perhaps they consider CRP to be unimportant. But you won't!

2. Our transducers are positioned on the baffle to ensure the best possible dispersion.

Other manufacturers may position their driver for eye-appeal, but that's not good enough for Marantz.

3. To control transition between our drivers, we use the most sophisticated, best thought-out crossover networks ever developed.

As you can see from the illustration below (Fig. A), wherever you are in the room you hear the same ideal stereo separation and 180 degrees dispersion pattern. Notice how the other speaker

"beams" certain frequencies in a narrow corridor (Fig. B). Unless you sit directly in front of those speakers, you lose part of the music.

## TRANSDUCERS YOU'D EXPECT FROM A WINNER.

Wide sound dispersion alone doesn't guarantee sonic accuracy. You also

### Tone burst test demonstrates superior low stored energy characteristics of Marantz loudspeakers.

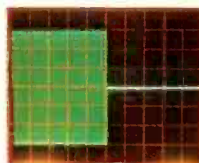

Original signal. Note instant start/instant stop of trace.

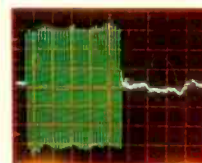

Marantz loudspeaker. Note close similarity to original signal.

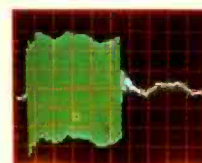

Competitor. Note overhang caused by inability of cone to stop vibrating.

need transducers that exhibit low distortion and low stored energy.

Stored energy is the continued vibration of a loudspeaker's radiating element after the driving force has stopped. It can exist in any loudspeaker; woofer, midrange or tweeter, and is heard as a smearing or running together of the individual instruments.

To assure Low Stored Energy, Marantz uses extremely rigid cones and domes tightly coupled to the voice coil to create a homogeneous rigid structure. Accurate control of this structure is then assured by an extremely powerful magnetic motor assembly. The result is that Marantz transducers move as a unit in a smooth, piston-like motion without the slightest hint of cone break-up or flexing—even under the most rapid acceleration and deceleration! You hear precise, sharp instrument definition—the truest musical sound possible—wherever you are in the room!

Your Marantz dealer has the full line of Marantz speaker systems. If you truly want the best—and are willing to spend a little more to get it—then go for it. Go for Marantz.



25<sup>th</sup> Anniversary **marantz**®

# ***DO NOT TEST YOUR EARS LOUDSPEAKERS MOVED.***

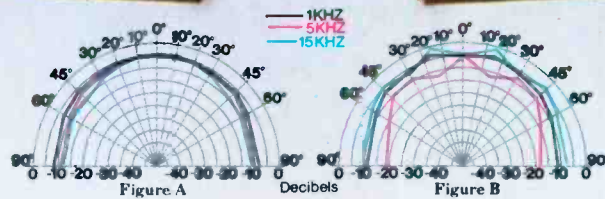

The Marantz speaker disperses all the frequencies 180 degrees. Conventional speakers tend to narrow certain frequencies.

In actual test, speakers should be placed the same distance apart as you are away from them.



# The single biggest mistake you can make.

From the outside, all speakers look pretty much the same. But buying an off-brand, bargain speaker can be a very big mistake.

Since speakers are the only components that actually produce sound, when you compromise your speakers you compromise your entire music system.

Fortunately, there's one way to make sure you wind up with a speaker that sounds as good as it looks: Buy a speaker with a name as good as the rest of your components.

At Kenwood, we didn't just start with a bunch of commercially available speaker parts. We started with a goal: *To deliver a crisp, clean sound that accurately reproduces the original music.*

To begin with, we create each raw frame speaker.

For the tweeter and the midrange, we used a computer to design light-weight, extra-rigid cones. And by properly designing the weight of the voice-coil with the cone assembly in the woofer, we have eliminated the crossover-coil: One of the major causes of speaker distortion.

We mount our speakers on a lumber-core baffle board made of special anti-resonant material. And design the enclosure to assure an acoustic match between cabinet and components.

Though you can't see all that by just looking at a Kenwood speaker, you'll know it the first time you listen.

Next time you're at your Kenwood dealer, compare our \$180.00\*, 3-way LS-407B with any off-brand speaker. Or, for that matter, with any speaker at all.

You'll save yourself from making a big mistake.

**Your speakers' reputation should be as good as your receiver's.**



 **KENWOOD®**

For the dealer nearest you, see your Yellow Pages, or write Kenwood, P.O. Box 6213, Carson, CA 90749.

\*Nationally advertised value. Actual prices are established by Kenwood dealers. Walnut grain vinyl finished cabinet. In Canada: Magnasonic Canada, Ltd.