

JUNE 1977 \$1.00

# HIGH FIDELITY

ICD © 08398

Focus on

## Speakers

### Lab/Listening Reports

- Bertagni Model D-120
- Cizek
- Jennings Vector One
- Koss Model 2
- Phase Linear Model III

### How to Shop for Speakers

Electrostatics,  
Planar Magnetics,  
Quasi-Panels

**Those Flat-Panel  
Speakers:  
A Challenge  
to the Box**





# G LIKE THIS.



incredible tolerances. Which give the 9191 the kind of wow and flutter figures that no deck in our price range can match.

Of course, having a great tape transport system means nothing if you don't have great electronics to back it up. We do.

The 9191 comes with an advanced three stage direct coupled amplifier that extends high frequency response and minimizes distortion. The built-in Dolby system can reduce tape hiss by as much as 10 decibels in high frequencies.

Our multiplex filter lets you record FM broadcasts without picking up a lot of unwanted noise, or the multiplex signal every FM stereo station sends out.

Even our ferrite solid tape head offers the

best combination of accuracy and long life you can get in a cassette head.

There's also a peak limiter that lets you cram as much onto a cassette as possible without distortion. Large VU meters and a peak indicator light that let you know if you do begin to oversaturate the tape and distort. Plus separate bias and equalization switches that let you get the most out of different brands of tape. And an automatic CrO<sub>2</sub> selector.

If all this isn't enough, you'll find that the 9191 comes with a memory that lets you go back to a favorite spot on the tape automatically. And electronic solenoid controls for going from play to rewind, or from rewind to fast forward, without hitting the stop button. And without jamming the tape.

There's also the convenience of front loading. A door over the cassette compartment to help keep the tape heads clean. And a light behind the cassette that lets you see where you are on the tape.

Go slip a cassette into a Pioneer 9191 at your local Pioneer dealer.

You'll find it hard to believe such a little thing could come out sounding so big.

#### CT-F9191 Specifications:

**Frequency Response:** Standard, LH tape: 25-16,000 Hz (35-13,000 Hz  $\pm$ 3dB); CrO<sub>2</sub> tape: 20-17,000 Hz (30-14,000 Hz  $\pm$ 3dB)

**Signal-to-Noise Ratio:** Dolby OFF: More than 52dB. Dolby ON: More than 62dB (Over 5,000 Hz, Standard and LH tapes/When chromium dioxide tape is used, signal-to-noise ratio is further improved by 4.5dB over 5k Hz)

**Harmonic Distortion:** No more than 1.7% (0dB)

**Wow and Flutter:** No more than 0.07% (WRMS)

**Motor:** Electronically-controlled DC motor (built-in generator) x 1; (4.8cm/s speed drive), DC torque motor x 1; (Fast forward and rewind drive)

## PIONEER

U.S. Pioneer Electronics Corp., 75 Oxford Drive, Moonachie, New Jersey 07074

© U.S. PIONEER ELECTRONICS CORP. 1977

CIRCLE 29 ON READER-SERVICE CARD



# A BEAUTIFUL BIG THIN



The recording tape in a cassette is only an eighth of an inch wide.

Crammed into that eighth of an inch may be as many as 64 original tracks mixed down to two. A hundred musicians. Countless overdubbings. Not to mention the entire audible frequency range.

Any cassette deck can reproduce part of what's been put down on that eighth of an inch.

The Pioneer 9191 was designed to reproduce all of it. Superlatively. Without dropouts,

unacceptable tape hiss, or noticeable wow and flutter.

Take our tape transport system.

Since the tape in a cassette moves at only 1-7/8 inches per second, even the most minute variation in tape speed will make a major variation in sound. To guard against this, when most cassette decks give you one motor, the 9191 comes with two. The first is used only for fast forward and rewind, so the second can be designed exclusively for maintaining a constant speed for play and record.

All of our tape drive components—the capstan, belt, and flywheel—are finished to

**WHAT DOES IT TAKE  
TO GET THE MOST  
BEAUTIFUL MUSIC OUT  
OF A LITTLE THING  
LIKE THIS?**





# The source of perfection in stereo sound... Pickering's new XSV/3000

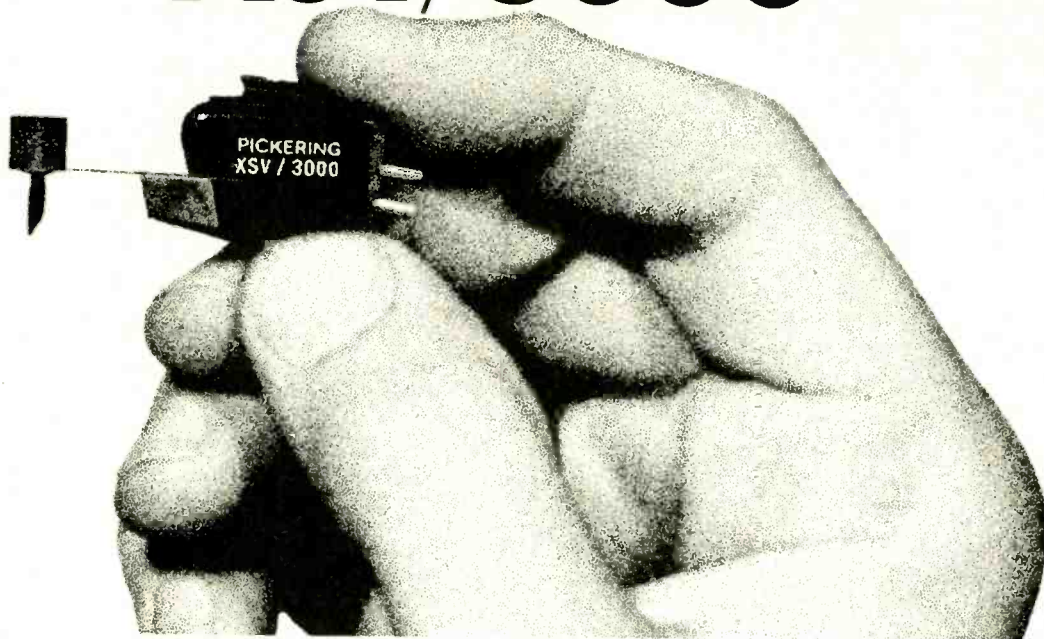

## The reviewers applaud as never before!

"... we don't see how you can do better at any price."

Hirsch-Houck Laboratories. Stereo Review. February 1977

"The new unit offers the stereo performance of the XUV/4500Q (or perhaps a little better than that) at a lower price. It seems hard to go wrong with such a combination."

CBS Technology Center. High Fidelity. February 1977

"Congratulations to all concerned on a fine contender amongst the world's best stereo pick-ups."

John Borwick. Gramophone. United Kingdom 1977

Pickering's new XSV/3000 is a remarkable development. It possesses a totally new and different design that makes it the precursor of a whole new generation of sophisticated, advanced stereo cartridges.

This has been made possible by technological advances in two areas. **First**, it has an unusually tiny, samarium cobalt (rare earth) magnet of remarkably high power that

permits extremely low mass, and also offers high output. **Second**, this cartridge features the new Stereohedron™ stylus tip, a Pickering first! This extraordinary shape has a far larger bearing radius, which provides increased contact area in the record groove. This assures gentler treatment of the record groove, longer record life, and also, far longer stylus life.

This cartridge provides remarkably smooth and flat frequency response; its channel separation is exceptional, its transient response possesses superb definition.

Truly, Pickering's XSV/3000 represents a whole new concept of excellence in stereo cartridges... the true **Source** of perfection in stereo sound.

For further information write to  
Pickering & Co., Inc. Dept. HF  
101 Sunnyside Blvd., Plainview,  
New York 11803



"for those who can hear the difference"

PICKERING & CO., INC., COPYRIGHT 1977

CIRCLE 34 ON READER-SERVICE CARD



# HIGH FIDELITY

JUNE 1977 VOLUME 27, NUMBER 6

## MUSIC AND MUSICIANS

- 14 **Scala's Televised Norma—Ouch!** *John Culshaw*
- 19 **Music U.S.A.: Jazz—Music of Exile** *Gene Lees*
- 58 **Richard Rodney Bennett: An Interview** *John Caps*
- 63 **The New Copyright Law in Outline** *Leonard Feist*
- 68 **Behind the Scenes**
- 71 **Shostakovich's 14th: A New View** *Royal S. Brown*
- 72 **Operatic Scarlatti** *Andrew Porter*
- 74 **Chaucer in Search of a Voice** *Alan T. Gaylord*
- 107 **Peter Asher: Producer Power** *Sam Sutherland*
- 111 **Making It in the Musicbiz** *John Storm Roberts*

## EQUIPMENT AND INSTRUMENTS

- 22 **Too Hot to Handle**
- 24 **News and Views**
- 24 **Equipment in the News**
- 37 **Equipment Reports**
  - Cizek Speaker
  - Jennings Vector I loudspeaker
  - Bertagni Model D-120 loudspeaker
  - Koss Model Two loudspeaker
  - Phase Linear Model III loudspeaker
- 46 **Interpreting Loudspeaker Tests** *Edward J. Foster*  
How reports can help in buying

- 50 **Loudspeakers Without Boxes** *Peter W. Mitchell*
- 115 **Instruments and Accessories**

## REVIEWS

- 71 **Essays**
  - Shostakovich's 14th  A Scarlatti opera  Chaucer
- 79 **Classical Records**
  - Three Iberias  Rubinstein's Brahms
- 80 **Critics' Choice**
- 103 **The Tape Deck** *R. D. Darrell*
- 118 **Backbeat Records**
  - Van Morrison  Bonnie Raitt
- 137 **Books**
  - John Coltrane  Backstage Passes

## ET CETERA

- 6 **Letters**
- 33 **HiFi-Croctic** *William Petersen*
- 104 **Advertising Index**
- 105 **Reader-Service Cards**

**BACKBEAT** begins on page 107



High Fidelity is published monthly by ABC Leisure Magazines, Inc., The Publishing House, Great Barrington, Mass. 01230, a subsidiary of American Broadcasting Companies, Inc. Copyright © 1977 by ABC Leisure Magazines, Inc. The design and contents are fully protected by copyright and must not be reproduced in any manner. Second-class postage paid at New York, New York, and at additional mailing offices. Authorized as second-class mail by the Post Office Department, Ottawa, and for payment of postage in cash. Yearly subscription in U.S.A. and possessions, \$6.95; Canada, \$10.95; elsewhere \$11.95. Single copies \$1.00. Subscribers: Send subscriptions, inquiries, and address changes to High Fidelity, 1 Sound Ave., Marion, Ohio 43302. Change of address: Give old and new addresses, including ZIP code. Enclose address label from last issue and allow five weeks for change to become effective. Postmaster: Send Form 3579 to High Fidelity, 1 Sound Ave., Marion, Ohio 43302.

# If your cartridge is more than three years old, don't replace your stylus!

Don't get us wrong. There is nothing worse than playing your records with a worn stylus. And no better way to restore your old unit to its original glory than a new diamond.

But frankly, there have been significant strides made recently in the phono cartridge field. And the new cartridges of today stand head and shoulders above even the finest of a few short years ago.

Here's the choice: Get fresh—but outdated—performance with a replacement stylus, or enjoy all the benefits of modern cartridge research and development for just a few dollars more. You'll find that you can update your system for far less than you might imagine. It's probably the most dramatic single improvement you can make.

For instance, Audio-Technica offers Universal™ cartridges equipped with a genuine Shibata stylus and our uniquely effective Dual Magnet™ system beginning at just \$75.00 list. Or you can replace your present cartridge with a fresh new Audio-Technica cartridge with highly-polished elliptical tip for as little as \$45.00 list.



AT11E	AT12Sa	AT13Ea	AT15Sa
\$45.00	\$75.00	\$65.00	\$125.00

Are these new models worth the difference? Absolutely! You'll be amazed at what you hear from today's generation of phono cartridges. Improved frequency response. Lower distortion. Better separation. Less record wear. Truly better sound.

A new Audio-Technica cartridge.  
Your best value in hi-fi.



**audio-technica**  
INNOVATION □ PRECISION □ INTEGRITY

AUDIO-TECHNICA U.S., INC., Dept. 67H, 33 Sylvania Avenue, Fairlawn, Ohio 44313  
Available in Canada from Superior Electronics, Inc.

IN THIS ISSUE: MAKING IT IN MUSIC: RITZ MYTH & REALITY

## HIGH FIDELITY

### Speakers

#### Lab/Listening Reports

- Harman Model D-120
- JBL Model 309
- Klipsch Model 2
- Pioneer Model Model 01

#### How to Shop for Speakers

- Characteristics
- Room Response
- Drive Power
- Those Flat-Panel Speakers: A Challenge to the Box



Cover photo: Daniel McCoy

LEONARD MARCUS  
Editor

ROBERT S. CLARK  
Executive Editor

KENNETH FURIE  
Music Editor

ROBERT LONG  
Audio-Video Editor

HAROLD A. RODGERS  
Associate Audio-Video Editor

SHIRLEY FLEMING  
Editor, Musical America

SUSAN ELLIOTT  
Popular Music Editor

WAYNE ARMENTROUT  
Director of Production

REBECCA ABBOTT  
Copy Editor

LYNDA CARLOTTA  
CYNTHIA PEASE  
Assistant Editors

GAIL KOOKOOLIS  
Editorial Assistant

ROY LINDSTROM  
Graphics Director

EDWARD GREENFIELD  
European Editor

ROYAL S. BROWN  
JOHN CULSHAW

R. D. DARRELL

NORMAN EISENBERG

EDWARD J. FOSTER

ALFRED FRANKENSTEIN

HARRIS GOLDSMITH

DAVID HAMILTON

DALE HARRIS

PAUL HENRY LANG

GENE LEES

IRVING LOWENS

ROBERT C. MARSH

H. C. ROBBINS LONDON

Contributing Editors

DAVID LEE

Circulation Director

PETER MICHAELSON

Circulation Manager

WARREN B. SYER

Publisher



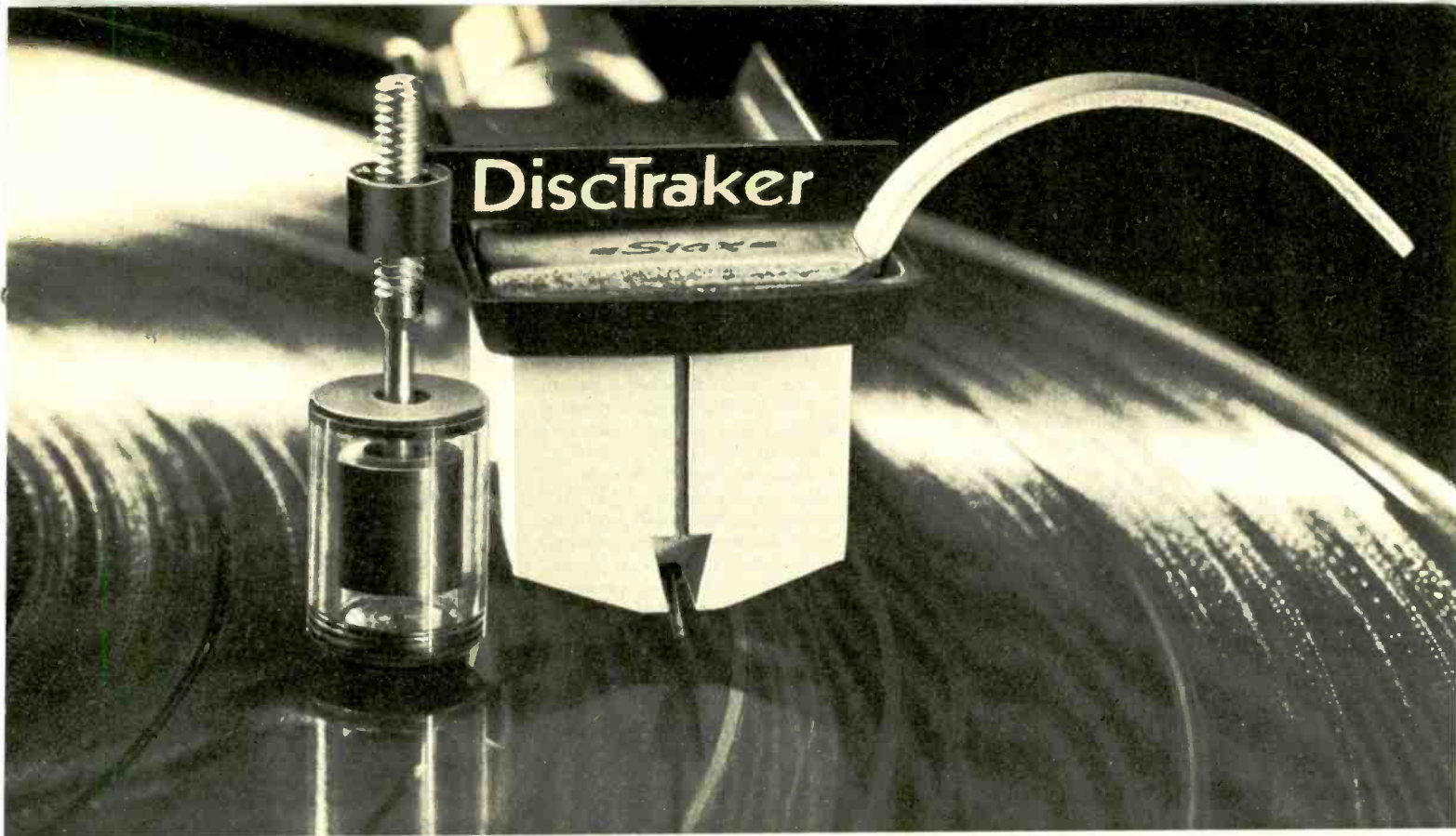

# THE NEW REVOLUTION FROM DISCWASHER.

DiscTraker is a revolutionary pneumatic damping device that provides a critical protective cushion so badly needed with state-of-the-art tonearms and cartridges.

- effectively reduces tonearm/cartridge resonance at low frequencies.
- drastically and listenably reduces record-warp resonance (woofer flutter).
- allows badly warped records to be played with fidelity and without record wear or stylus damage.
- applicable to any tonearm.
- patented in all industrialized countries.

DiscTraker greatly enhances the performance of fine record playback systems; another example of Discwasher's leadership and innovative technology.



## DiscTraker™



**discwasher® inc.**

1407 N. Providence Rd.  
Columbia, Missouri 65201

## COMING NEXT MONTH

With windows open in July, you hear the cries and commotion of the neighborhood kids' street games; with them closed, you have to put up with the air-conditioner's dull roar. So who needs noise intruding on your pleasure when you finally retreat to your listening room for some Beethoven or Bonnie Raitt? Next month our audio editors bring you an update on noise-reduction devices—**De-Hissers and De-Clickers**. We continue our recording-centennial celebrations with R. D. Darrell's **The Electrical Era**, Jim Johnson's color acrylic rendering of the period (third in the series "100 Years of Recording"), and W. R. Moran on **Nellie Melba's Farewell Concert**. Farflung correspondent John Culshaw reports on "Bali Hoo!", Gene Lees on another ethnic strand in "Music U.S.A." Plus **BACKBEAT**, five test reports, and more.

## SOLUTION TO HIFI-CROSTIC NO. 24

LESLIE BAILY: *Gilbert and Sullivan's Their Lives and Times*

In America pirates were making fortunes from *Pinafores* of infinite variety. One interpolated a song about a new fashion in trousers, another the Hallelujah Chorus. Characters were interpreted with un-Gilbertian freedom, as when Little Buttercup was played by a man seven feet tall.

## ADVERTISING

**Main Office:** Ramon Rustia, Director of Advertising Sales, Leonard Levine, Advertising Promotion Manager, The Publishing House, Great Barrington, Mass. 01230. Telephone: 413-528-1300.

**New York:** ABC Leisure Magazines, Inc., 130 E. 59th St., 15th floor, New York, N.Y. 10022. Telephone: 212-826-8381. Seymour Resnick, National Advertising Manager.

**New England:** The Publishing House, Great Barrington, Mass. 01230. Telephone: 413-528-1300. Myles Grossman.

**Midwest:** ABC Leisure Magazines, Inc., The Publishing House, Great Barrington, Mass. 01230. Telephone: 413-528-1300. Leonard Levine, Midwest Advertising Manager.

**Los Angeles:** ABC Leisure Magazines, Inc., ABC Entertainment Center, 2040 Avenue of the Stars, Suite 270, Century City, Calif. 90067. Telephone: 213-553-2000. Andrew Spanberger, Western Advertising Manager. Janet Endrijonas.

**Tokyo:** Japan Advertising Communications, Inc., New Ginza Bldg., 7-3-13 Ginza, Chuo-ku, Tokyo 104, Japan. Telephone: (03) 571-8748. Shigeru Kobayashi, President.

**High Fidelity and High Fidelity/Musical America** are published monthly by ABC Leisure Magazines, Inc., a subsidiary of American Broadcasting Companies, Inc. Warren B. Syer, President, Herbert Kaplan, Vice President, Photographic Publishing Division, Warren Tuohy, Vice President, Finance, Cathleen Aloisi, Assistant to the President, Member Audit Bureau of Circulation. Indexed in Reader's Guide to Periodical Literature. Current and back copies of High Fidelity and High Fidelity/Musical America are available on microfilm from University Microfilms, Ann Arbor, Mich. 48106. Microfiche copies of these magazines (1973 forward) are available through Bell & Howell Micro Photo Division, Old Mansfield Road, Wooster, O. 44691.

**Editorial correspondence** should be addressed to The Editor, High Fidelity, Great Barrington, Mass. 01230. Editorial contributions will be welcomed, and payment for articles accepted will be arranged prior to publication. Unsolicited manuscripts should be accompanied by return postage.

# Letters

## Boston Broadcaster

"Boston: Hub City of American Audio" by Michael Riggs [March] was really informative and well organized. But Riggs somehow missed one name that has come to symbolize the best in FM programming for some 250,000 music-loving listeners throughout New England.

Robert J. Luritsema has worked seven days a week for seven years now at WGBH to make his *Morning Pro Musica* a living model of what FM broadcasting can and should be: a carefully planned, warmly human, wonderfully imaginative presentation—from 7:00 a.m. to noon daily—of the best recorded and live music available. The fact that his efforts are largely supported by voluntary contributions from people of all ages, occupations, and income levels is solid evidence of today's demand for quality on the air.

Edward E. Androvette  
Pembroke, N.H.

## Edison Labs

I want to thank you for "The Life and Labs of Thomas A. Edison" [January]. The National Historic Site is indeed an interesting place: I've had the privilege of visiting there for a couple of the annual programs held in October. I understand that you had the assistance of Mrs. Wallace Burt in gathering the materials for the Edison article.

John A. Potty  
Rutherfordton, N.C.

*We are glad you called attention to our oversight in not mentioning Leah Burt's part in the preparation of our January issue. We take this opportunity to give her the credit she deserves. If all that depended on her participation were to be removed from that issue, the remainder would be sparse indeed.*

## Choosing Components Revisited

The letter from Thom Jakowczyk [March] flaying the experts on their component choices in your December 1976 issue is typical of certain audio dealers I have met. They would apparently rather score a put-down of a prospective customer than make a sale.

First, Mr. Jakowczyk dismisses a list of reputable components as "pure garbage" and delivers gratuitous slurs on specific products from Sony, Bose, Marantz, and Kenwood. Second, he assaults the intelligence of "anyone who is still fooling around with four-channel systems"—idiots, to him. Another expert, he says, "has chosen in an asinine way" and is by implication "deaf as a doorknob."

I wonder how Mr. Jakowczyk behaves toward the abundance of audio customers who cannot afford the luxury of \$3,000 to

\$5,000 systems and who must perforce be content with modest equipment that nevertheless will give the majority of music lovers an experience of reproduced music unequalled in any earlier generation. Few persons, regardless of their musical sophistication, can afford the kind of price-is-no-object installations that many audio dealers would like to sell them. On second thought, I don't think prospective customers in that category would like the put-down either.

As for me, I am using a four-channel system with great pleasure.

Clyde D. Williams  
Baltimore, Md.

I pity the customers of Thom Jakowczyk. Perhaps I live in a benighted area, but I thought the day of the know-it-all audio dealer had passed. My only response to one who would toss around terms like "pure garbage," "utter idiot," "total junk," and "asinine" in talking about reputable equipment and audiophiles would be that audio needs him like it needs power shortages.

I thought the December article on choosing components was fascinating. Some of the experts I agreed with, some I didn't, and some made me rethink the decisions I have made. I'm not going to trade in my equipment, because my needs and preferences are not the same as those expressed in the article. But the experts did have their points.

Walter C. Crawford  
Walnut Creek, Calif.

## Maestro Tennstedt

Once again we are observing here in Boston that the work of all the great conductors is not available on recordings. I am referring to maestro Klaus Tennstedt, whose debut with the Boston Symphony in 1974 con-

## Record-Playing Buyer's Guide: Addenda and Corrigenda

We regret very much that Stanton Magnetics' cartridge line was unintentionally omitted from the "Directory of Turntables, Tone Arms, and Cartridges" in our April issue. Stanton's elliptical-stylus 680EL (\$90) is recommended for disco use and comes with an extra stylus. Other elliptical-styli models include the 680EE (\$62.50), 681EE (\$78), and 681EEE (\$90). Stanton's discrete four-channel cartridge, with a "special" stylus, is the 780/4DQ (\$125).

In the turntable section of the guide, we identified two JVC turntables, Model JL-F35 and Model JL-F45, as changers. They both, in fact, are automatic single-play units.



# The Precision Decision. We made it. Now it's your turn.



QL-7



JL-F50

We believe that precision is the most important factor in turntable design and performance. Which is why we've built such a high degree of precision into our advanced new line of turntables. So you'll need a whole new set of reasons to choose the one that's right for you. And when it comes to value, all seven will play second to none.

Take our new QL-7 Quartz-Locked and JL-F50 Fully Automatic direct drive, shown above. They're both unusually close when it comes to some important specs, but what will surprise you most is that they're also both in the same price range.

For instance, the JL-F50 checks in with 0.03% wow and flutter (WRMS); 70dB signal-to-noise ratio (DIN B). And it offers a host of convenience features as well, with most controls up front so you can operate them without lifting the dust cover. Its fully automatic operation gentles your favorite records, and lets you repeat them from one to six times, or infinitely. A built-in strobe makes speed adjustments easy and accurate. And the JL-F50's looks are in keeping with its precision design

The QL-7's looks are equally great. And in its electronic heart, it's a tiger. All business, with the incredible accuracy only a Quartz-Locked machine can boast. Truly for a perfectionist, the QL-7's wow and flutter measures only 0.025% (WRMS); S/N is more than 74dB (DIN B). Figures that no other QL turntable we've seen in its category can touch. It's totally manual, with strobe speed indicator, and priced less than any other QL machine on the market.

The way we see it, you're left with a superb decision: our JL-F50 at less than \$250\*, with all the convenience and performance most people could ever want, or our QL-7, the finest under \$300\* turntable available today for the discriminating audiophile.

Either JVC you choose, you'll

have made the right decision.

JVC America Company,  
Division of US JVC Corp., 58-75  
Queens Midtown Expressway,  
Maspeth, N.Y. 11378 (212)  
476-8300. Canada: JVC Electronics  
of Canada, Ltd., Scarborough, Ont.

For your nearest JVC dealer, call  
toll-free (outside N.Y.) 800-221-7502

Approximate retail value.

# JVC

We build in what the others  
leave out.



# The Beauty



AIWA's AD-1250 is so beautifully built it makes the other decks look flat. Its new ultra-modern slant backed deck with its 20° angle stands out in a crowd. And up. So you can see what you're doing. And of course underneath all this streamlined beauty, lies the pride and joy of our AIWA engineers. The technical genius that has made AIWA famous for quality worldwide. Our built-in Dolby\* and interlocked Dolby-MPX filter switch have a 60dB S/N ratio. The 30Hz to 16kHz (Fe-Cr tape) fre-

quency response insures vividness and clarity of sound. The oil-dampened cassette elevation and ejection feature, pioneered by AIWA, handles your cassettes with kid gloves. The AIWA AD-1250. The body beautiful.

\*Dolby is a Trademark of Dolby Laboratories, Inc.

ducting a Brahms program and a glorious Bruckner Eighth has been followed by two summers of magnificent Tanglewood programs and a return to Symphony Hall this year in renewed triumph. Tennstedt is quite simply the greatest conductor we have today of the Viennese classics.

A native of East Germany, he escaped from that country in 1971 and is now musical director in the city of Kiel, Germany. This year he will be conducting many of the major American orchestras. Let us hope that the wide exposure his work is getting on the radio broadcasts from Boston (and from Chicago, New York, and Philadelphia too) will prompt the record companies to make a move in his direction.

Tennstedt's recent Schubert Ninth Symphony performances in Boston match the high standard set by Toscanini's Philadelphia Orchestra version and, indeed, surpass it in some particulars. Such miracles should not be lost to the wider public, which does not have access to concert halls of the major music centers.

Arthur S. Leonard  
Cambridge, Mass.

Tennstedt is scheduled to record with the London Philharmonic this summer for EMI.

## Croctic Fans

Imagine five or six college music majors all sitting in a dormitory room around a table. With them are a set of Grove's, Harvard, and Webster's dictionaries. No, they are not working on a term paper: they are all work-

ing on the monthly HiFi-Croctic puzzles.

This actually occurs when each new issue is sent to us. The puzzles are challenging, informative, and even fun. Keep them coming!

Kevin Dirth  
Ithaca, N.Y.

*We had, as a matter of fact, been wondering just how many of our readers enjoy solving the HiFi-Croctics and would appreciate your letting us know. Frankly, we had been considering dropping them, but we won't if enough of you respond.*

## Abravanel's Posthorn

Abram Chipman's review of James Levine's recording of the Mahler Third Symphony [March] contained the statement, "The Abravanel recording claims to use a posthorn, but to my ears it sounds like a trumpet." To conclude the lengthy paragraph (eighteen lines) devoted to the issue of posthorn vs. flugelhorn and trumpet in this symphony, Mr. Chipman says, "Levine-like Haitink and Bernstein, among others—does use a trumpet, and it's certainly effective enough."

We did use a posthorn. As soon as I alerted our principal trumpet player, William Sullivan, he went to great lengths to find the proper instrument. Thanks to the help of the highly respected principal trumpet player of the Chicago Symphony, Adolph S. Herseth, he located a posthorn—an instrument built like a French horn but smaller—got used to a different mouthpiece,

and became so thoroughly familiar with the instrument that he could play the solo, I believe, in the way Mahler had in mind.

Jack Diether is absolutely right: The solos that Mahler gave to the posthorn could not be played on the Mozart posthorn. I also doubt that there was a posthorn with valves at the time of the premiere, but obviously an enterprising and dedicated instrument builder in Bohemia (how's that for authenticity?) did build one. Anybody who, like me, wants to play the Third with the posthorn indicated by Mahler can get this instrument from Reinold Schilke, 529 S. Wabash Ave., Chicago, Ill. 60605.

Maurice Abravanel  
Conductor  
Utah Symphony  
Salt Lake City, Utah

## Text Case

In his excellent review of José Carreras' aria album [March], Dale S. Harris states that Philips provided no texts. This appears to be an isolated oversight: Texts were included in the commercial album I bought. Furthermore, they were printed on heavy glazed paper that should far outlast the cheap paper on which such texts are often printed.

John Clarke Adams  
Syracuse, N.Y.

## Edison Discs

In Dale S. Harris' review of the Claudia Muzio reissue [March], he refers to the orig-

HIGH FIDELITY MAGAZINE



# & The Best



AIWA's AD-1800 is the cassette deck that other machines are trying to measure up to. Check our extra large flywheel which no other deck this size has, and our special oil-dampened cassette elevation and ejection feature. Along with our Solid Stabilized Transport System (SST) and AC hysteresis synchronous motor, the wow and flutter is kept

inaudible at only .05% WRMS. Our biggest competitor can only claim a .07% wow and flutter level. Our built-in Dolby\* and DNL noise reduction systems have a better than -65dB S/N ratio. The 30Hz to 18kHz (Fe-Cr tape) frequency response insures that the multitude of sound colors reproduced are kept vivid and alive. Every sound, from a violin to a drum roll is definitive. The AIWA AD-1800. The superior one

# AIWA

Distributed in the U.S. by MERTON ELECTRONICS INC., 35 Oxford Drive, Moonachie, N.J. 07074 - Distributed in Canada by SHIRO (CANADA) LTD.

CIRCLE 3 ON READER-SERVICE CARD

inals as 78s, which certainly suffices as a generic reference. To set the record straight, however, the Edison discs were recorded at 80 rpm and so played on Edison phonographs.

Authority? In the mid-Twenties, I worked during my college vacations at a rather large record store that sold Edisons, among others.

The Edison company, by the way, didn't spare the horses when it came to quality. The Chippendale model (top of the line) would run idle for 32 minutes on one winding and drag the needle for 27 before deceleration set in.

Carlton C. Porter  
Wiscasset, Maine

## The First Ionisation

Robert P. Morgan's discography of Edgard Varese's music [February] fails to mention the very first recording of *Ionisation* (Orion 7150), made under the direction of Nicolas Slonimsky. Personnel in the orchestra included Henry Cowell, Paul Creston, Roy Harris, Wallingford Riegger, Carlos Salzedo, and William Schuman. As Maestro Slonimsky put it: "Only an orchestra of composers could understand the music."

Gideon Cornfield  
Orion Master Recordings, Inc.  
Malibu, Calif.

The discography was confined to stereo discs. The recording Mr. Cornfield cites was, however, mentioned by Louise Varèse in her reminiscence of the composer in the same issue.

JUNE 1977

## Prophète's Missing Minutes

I'm pleased to report to your readers that, after I wrote to Angel that my set of *Rienzi* had an incomplete Side 8, I received a copy of the corrected disc within two weeks. But twelve missing measures on Angel are nothing compared to thirty minutes of music missing from Columbia's new *Prophète* (M434340). Sides 1 and 2 correspond to Acts I and II of the opera, respectively, and Side 3 supposedly contains the beginning of Act III. On my copy of the set the disc labeled Side 3 is an instant replay of Side 2. The odd thing is that the flip side of this record, labeled Side 6, really is Side 6. The stamper numbers on this schizoid disc are AL 34343-1K on Side 3 and BL 34343-1J on Side 6.

Imagine the fun the clerk in the record store and I had opening four more identical copies of this album. Since none of the reviews of the recording I have seen have mentioned any such problem, I assume that only one stamper was involved and that the mistake in sequence was caught and corrected after the first couple of hundred pressings. (I took a credit slip for the album—and I'm still waiting.)

Brad Deamer  
Buffalo, N.Y.

Fortunately, the *Prophète* problem seems far more localized than the editing error in Angel's *Rienzi*, which occurred in the disc mastering process. The New York Columbia office reports no previous encounter with the doubled Side 2 in *Prophète*, which suggests that the defect was confined to some part of a pressrun at one plant. Still,

prospective purchasers are hereby warned: anyone who encounters a defective set should report it to Columbia Masterworks, 51 W. 52nd St., New York, N.Y. 10019.

## Omni Interface

I was most impressed by the quality and extent of your editorial coverage of musical instruments and equipment accessory devices in BACKBEAT [February].

One note on your review of our Omni synthesizer: It interfaces with the Axxe, Odyssey, and 2600 synthesizers as well as the Arp Sequencer, but does not, in fact, interface with the Pro Soloist or Pro/DGX. The Pro's circuitry is totally digital, while the Omni's is not, so the interface of the two instruments is impossible. They are, however, an excellent combination, since the Omni provides the symphonic accompaniment to the Pro's melody lines.

Bob Hoffman  
Arp Instruments, Inc.  
Newton, Mass.

## Art Gone Astray?

Who is this unhappy Gene Lees? Is he having problems because he is so poorly informed, or is he just always depressed?

I am not a musician, but I can name performers and composers here in New York City who are generating music that is truly exciting. A man who writes comment on the scene should know hundreds, but he writes about a disappointed Cuban composer, Chico O'Farrill [February], as though he is the whole music world. Following is a





**Now  
you can help  
your music  
for a song.**

As an imaginative tool for overdub sessions, for demos and for experimentation, the TEAC A-3340S is the most popular multi-track tape recorder in the world.

Since it was designed to expand your imagination, imagine this: participating TEAC dealers are having a special sale on the A-3340S.

So for everyone who's ever dreamed of owning an A-3340S, it's now priced lower than you ever dreamed possible. But you have to hurry. You have to get into your TEAC dealer before he's out of the A-3340S.

And while you're there, check his prices on the Model 2 Mixer and other multitrack studio accessories.

**THE  
FIRST & ONLY  
A-3340S SALE!**

**TEAC®**

The leader. Always has been.

TEAC Corporation of America  
7733 Telegraph Road  
Montebello, California 90640

In Canada TEAC is distributed by White  
Electronic Development Corporation (1966) Ltd.

©TEAC 1977

MB-20



Model 2



short list of composers who have not given up on music: Phil Glass, Charles "Bobo" Shaw, Julius Hemphill, Oliver Lake, Steve Reich, Richard Landry. Send Gene to see them: he has been listening to too much music in elevators.

Fred Krughoff  
New York, N.Y.

### Horenstein Discography

As an adjunct to the Jascha Horenstein discography compiled by Jack Diether and published in HIGH FIDELITY [October 1973], the Beecham Society has recently published a listing of noncommercial recordings by the late conductor, together with appreciatory articles. Interested readers may wish to contact the editor of the Society's organ "Le Grand Baton," Box 6361, Cleveland, Ohio 44101. (A \$2.00 contribution to the Beecham Society is requested to offset costs of printing, postage, and handling.)

Peter Horenstein  
South Hempstead, N.Y.

### "The Medieval Sound"

Pursuant to Susan Sommer's review of recordings by David Munrow [February], it might be of interest to readers to know that Munrow's Oryx recording "The Medieval Sound" has been available domestically as MHS 1454 through Musical Heritage Society, and at half the cost. Also, for early music lovers, MHS has begun releasing some of the Clemencic Consort's Harmonia Mundi recordings, including Vol. 1 of its *Carmina Burana*.

Not only are they fine recordings, but the Society's pressings have been consistently among the best of any label, imported or domestic.

Rudy Ising  
Chicago, Ill.

### One Lump or More?

As a singer in the Lancaster Opera Workshop's recent production of Britten's *Noye's Fludde*, I read with particular understanding John Culshaw's "Lump in the Throat" [March]. Can he imagine how many lumps resulted from attendance at many rehearsals? And, true, the audience's singing produced greater lumps—and even chills—and was exceeded only by the glories of the Tallis canon.

I appreciated especially Mr. Culshaw's suggestion that a hymn or chorale can form a metaphysical underpinning and stabilizing force "in a world of seemingly endless violence and cruelty and ugliness."

Phyllis Goodman  
Lancaster, Pa.

### Musical Pen Pal

I am a collector of LP records, magazines, and posters. I would be interested in exchanging these items with a pen pal abroad. Those who might wish to do so can write me at: J. Krala 1276, Puchov 02001, Czechoslovakia.

Miroslav Dzima  
Puchov, Czechoslovakia

# What you don't know about effective tip mass won't hurt you, just your records.



You can find out what you don't know by contacting us for our comprehensive cartridge brochure.

## Bang & Olufsen

Bang & Olufsen of America, Inc., Dept. 11G  
515 Busse Road, Elk Grove Village 60007

CIRCLE 6 ON READER-SERVICE CARD

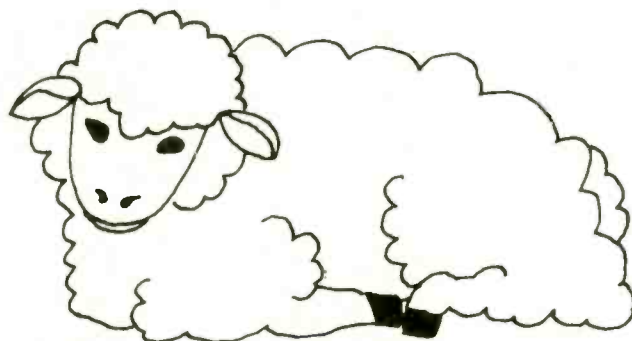

## What has this Animal to do with Cambridge/Cybervox Speakers?

Everything! Science tells us that one of the best damping materials in the world is teased lamb's wool. So we lined a 7 foot tapered duct with teased lamb's wool in increasing density along the length of it.

The transmission line loaded speaker is just the beginning of the careful engineering in the TL200. There is no equal to the neutral uncolored, high definition sound achieved by it.

Four closely matched drive units, and precision closely toleranced crossover elements, enables a very wide smooth response.

You can own a British made Cambridge/Cybervox TL200 with the full knowledge that you're ecological—the lamb grows the wool back again!

Cambridge  
CYBERVOX

Cambridge/Cybervox A Div. of Hammond Industries Inc.  
155 Michael Drive, Syosset, NY 11791 (516) 364-1900

CIRCLE 15 ON READER-SERVICE CARD



# Technics knows there's more to Linear Phase than staggered speakers.

If staggered speakers were all it took to achieve phase linearity, other staggered speaker systems would sound like ours. But Technics knows it takes more. Much more. Like a phase-controlled crossover network that takes into account the phase characteristics of each driver. Like extremely wide-range drivers, each with a frequency response that's as flat as it is wide. And finally, aligning the acoustic center of each for the optimum acoustic position.

But just as important, Technics knows that to achieve phase linearity as well as a wide and flat frequency response is also to achieve the ultimate in high fidelity: waveform fidelity. With it the output waveform of any component or speaker will be a mirror image of the waveform put into it. And that sounds better than good. It sounds live.

And if seeing is believing, look at the waveforms. On top is the oscilloscope reading (the fingerprint) of a live piano waveform. The other, the piano as reproduced by Technics Linear Phase SB-7000A. That's waveform fidelity you can see, as well as hear.

How did we do it? By designing a crossover network that would provide an overall linear phase characteristic for the entire

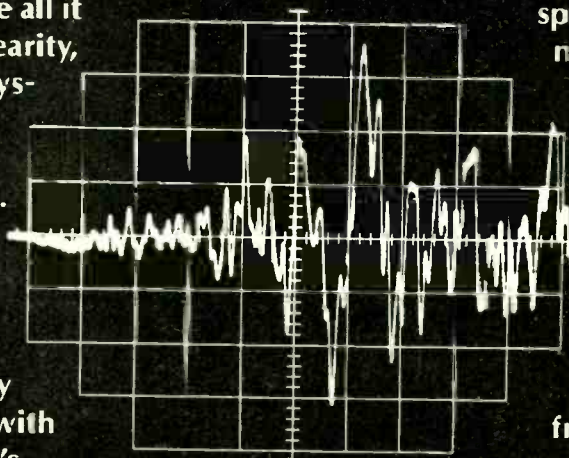

Live Piano Waveform.

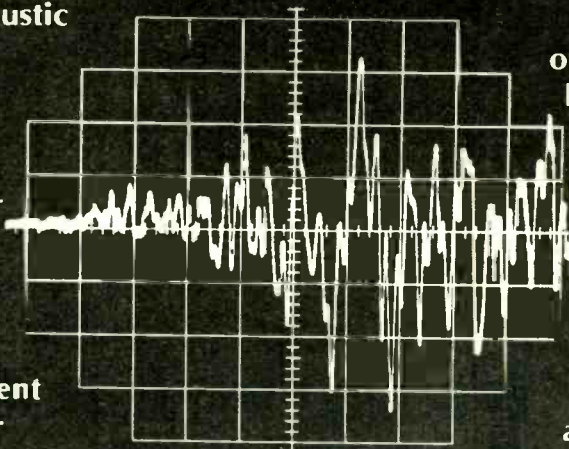

Piano Waveform  
Reproduced by SB-7000A.

speaker system, while simultaneously compensating for the different acoustic pressures of the individual drivers.

When we finished we ended up with a unique phase-controlled crossover network consisting of 6 dB and 18 dB/octave cut-off slopes. It not only eliminates "audible dip" at the crossover frequencies, but also assures excellent localization of the original sound source within the acoustic field.

But as important as the crossover network is in achieving linear phase, so are the individual driver units. That's why we designed and manufactured the speaker drivers with the flattest amplitude, widest frequency response and lowest distortion possible. A goal we achieved only after exhaustive amplitude and phase studies in anechoic chambers.

Our final step was aligning the acoustic center of each driver in precisely the same vertical plane. But it took more than anechoic chambers. Technics had to develop a new time-delay system using BBD (Bucket Brigade Device).

Only then could we locate the optimum acoustic position for each driver. In addition, each unit is positioned vertically for the best horizontal dispersion and then spaced as



# Much more.

closely as possible for the best vertical dispersion of all audio frequencies. What's more, after alignment each unit is fine-tuned to assure precise linearity.

The result, with the SB-7000A for example, is an overall phase response, linear between  $0^\circ \pm 45^\circ$  between 100Hz and 15kHz. A figure that's virtually flat and definitely unsurpassed by any other multi-range speaker system.

As the graphs prove, even staggered speaker systems with seemingly "linear phase" characteristics show moderate to

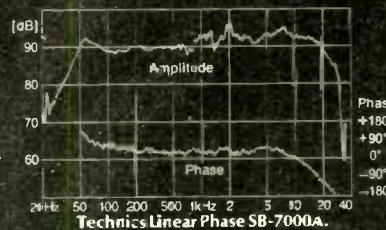
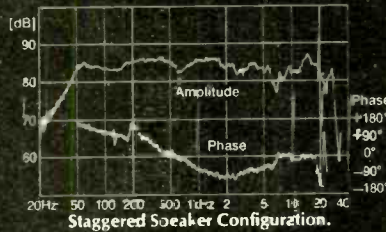

severe phase shifts at different frequencies. But as you can see, the Technics SB-7000A has an unprecedented flat amplitude/frequency response and linear phase response.

But we don't expect you to buy any speaker system based on how good it sounds on paper. Audition the world's most linear phase speaker systems: the Technics SB-7000A, SB-6000A, SB-5000A. You'll find out just how much more there is to Technics

Linear Phase than staggered speakers.

# Technics

by Panasonic



SB-6000A

SB-7000A

SB-5000A



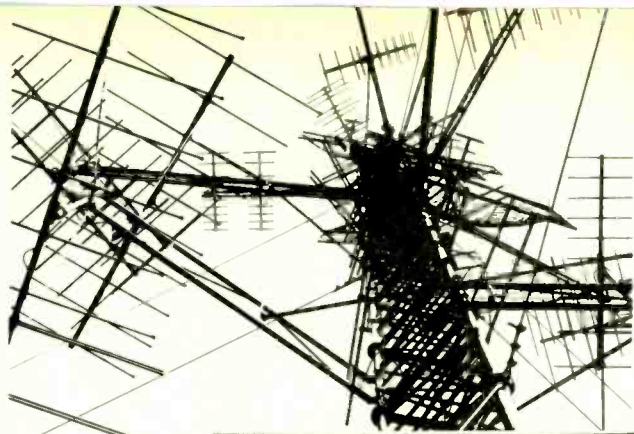

Culshaw  
at Large



## The Scala *Norma*: Televised Opera's Self-Inflicted Wound

by John Culshaw

MILAN—Some little time ago, the La Scala production of *Norma* was televised live from the stage and, according to the handout, was seen simultaneously by viewers in twenty-four countries. In terms of technical ingenuity and coordination it was quite a feat; but it was also an artistic disaster on such a scale that I think it has set back the cause of opera on television by twenty years. For those who like opera it must have been infuriating, while for those who switched on out of curiosity it must have been at best a bewilderment and at worst a bore.

I wonder why *Norma* was chosen in the first place, and especially in this static, stylized production. Then it has to be said that Montserrat Caballé is not the most televisual of personalities, and on this occasion she was not in her best vocal form. The rest of the cast was adequate: the conducting by Gianandrea Gavazzeni was mostly dull. Thus, from the musical and scenic aspects, this *Norma* was hardly the ideal visiting card for La Scala to present to twenty-four countries, but the way in which it was presented just about eliminates all other considerations.

First of all, there was the word—a single word in huge carved letters mounted on the footlights immedi-

ately opposite the conductor. It said: N O R M A. Now since the opera had been carefully introduced before it began, the sign served no purpose at all and brought to mind the irresistible thought that it was there to remind the conductor which work he was performing, lest—perhaps at “*Guerra, Guerra!*”—he should think he was leading *Aida* by mistake. From the television aspect it was a dreadful eyesore, because it commanded the screen in every wide shot taken from the front of the house.

The television direction was by Mauro Bolognini, who had also been responsible for the stage production. Superficially that sounds like a good idea, because there are stage producers—Zeffirelli is an obvious example—who can direct brilliantly for television; but that it is not always so was devastatingly demonstrated by Signor Bolognini. He was wary about close-ups, no doubt on the grounds that singers in full voice are often not a pretty sight at close range. Television is, however, a close-up medium, and it's impossible to sustain dramatic interest when all you can see is a vast stage on which a few midgets appear to be standing about. The issue simply cannot be dodged, and if the idea of a singer in close-up is considered inad-

missible, then so too is the whole concept of televising opera from the stage.

There was one exception. The close-up that appealed very strongly to Signor Bolognini was of the conductor. There is nothing new in that, of course: it is a fairly standard practice to show the conductor during any overture. But once the curtain is up and the action has started, it is intolerable to cut back to the conductor, as Bolognini did time and time again, when there was a short orchestral phrase with no vocal line. It was doubly unfortunate because on most such occasions Maestro Gavazzeni was not so much conducting as mopping his brow.

Yet there was an even worse idea in store. Every now and then the director superimposed a close-up of the conductor over a wide-angle shot of the stage. This produced one of two results: It was either grotesque or hilarious. Into the latter category came the moment when *Norma* and Pollione were standing at opposite extremes of the stage, which, in terms of a wide-shot television picture, put one of them on the right edge and the other on the left. A subtitle reading “Something has come between us!” came up on the bottom of the screen—and at that very moment there appeared, right between them, a superimposed Gavazzeni, who was of course mopping his brow again.

I would not pretend for a moment that it is easy to televise opera from the stage, or that it can ever aspire to be more than good reportage of a worthwhile event. Over the years it has been done very skillfully by the BBC, and I have seen some interesting experimental tapings made at the Metropolitan. But it is reportage, in the sense that a ball game on television is reportage, which can be either well directed or not. The object of the exercise is simply to relay, as clearly as possible, an event that is taking place before a few thousand people to a potential audience of millions, and not pretend that it is anything other than it actually is.

A day or two ago I heard that it is unlikely that *Norma* will be screened in the U.S.A., and I hope that information was accurate. It is hard enough to promote opera on television without self-inflicted wounds like *Norma*. RAI (Italian television), La Scala, and Eurovision, whose joint effort it was, should think a long time before their next attempt; and they should hire a director who knows the difference between a relay and a specially mounted production in an electronic studio. That's where you start. ●



**Dymistatic by RTR Introduces  
the Direct Drive Electrostatic DR-1.**

Never have you experienced a speaker like the DR-1. Nothing is comparable.

Consider the patented elemental systems—electrostatic, amplifier, woofer. Direct-drive, cylindrical electrostatics mate with a dual tandem-driven, three woofer system. A true cylinder, the electrostatics are capable of perfect dispersion over a full 360 degrees. This complex array is driven by a full-range internal amplifier which controls both audio output and vertical dispersion. Designed into an exclusive negative enclosure, the woofers are a sonic match to the ultra-fast electrostatic.

All impedance matching components in the internal amp are contained within the feedback loop—cancelling their distortion-producing effects. For the first time you hear only the electrostatics.

In all respects an impeccable system incorporating the most advanced Dymistatic technology. The DR-1 is available now for audition at prime dealers. Write for specifications and a dealer list.



RTR Industries, Dept. HF,  
8116 Deering Ave.  
Canoga Park, CA 91304



Now...nothing stands between  
you and the music.



# It's time for everybody else to

From the very beginning, Yamaha receivers have set new laboratory standards. Our achievements in low distortion engineering, superb signal-to-noise, as well as high sensitivity and selectivity throughout the line have yet to be duplicated by any other manufacturer.

Now we've raised our standards even higher, beyond the laboratory and into the home. The result is the CR-2020: the pinnacle of a new line of advanced performance Yamaha receivers, rated to meet the more critical demands of real life.

**Real Life Rated™** While traditional laboratory measurements provide a good relative indication of receiver performance, they simply don't tell you how a receiver will sound in your living room in actual operation.

For example, in the lab, each receiver component is tested separately. At home, you hear them together as a single unit.

In the lab, distortion is measured at full-rated amplifier output. At home, you rarely, if ever, use the amplifier's full-rated power.

In the lab, power and distortion measurements are made with the volume control at maximum. At home, maximum volume would be painfully loud to listen to.

In the lab, noise and distortion are measured separately. At home, you hear them together.

Clearly a new standard is needed for evaluating overall receiver performance under real life conditions. Yamaha's new standard is called **Noise-Distortion Clearance Range (NDCR)**. No other manufacturer specifies anything like it, because no other manufacturer can measure up to it.

We connect our test equipment to the phono input and speaker output terminals, so we can measure the performance of the entire receiver. We set the volume control at -20dB, a level you're more likely to listen to than full volume. We measure noise and distortion together, the way you hear them.

On each of our new receivers, Yamaha's Noise-Distortion Clearance Range assures no more than a mere 0.1% combined noise and distortion from 20Hz to 20kHz at any power output from 1/10th watt to full-rated power.

**Component-by-Component Excellence.** By all conventional laboratory standards, as well as Yamaha's more stringent standards, the CR-2020 offers a new level of receiver performance.

At full-rated output, the 100 watt-per-channel power amplifier reduces total harmonic and intermodulation distortion to a new absolute low—a mere .05% from 20Hz to 20kHz into 8 ohms.

The CR-2020's exceptionally fine preamplifier is largely responsible for an incredible -95dB signal-to-noise ratio, from moving magnet phono input to speaker output.

The CR-2020's tuner makes FM reception up to 18kHz possible for the first time with unique negative feedback and pilot signal cancellation circuits (patents pending).

What's more, Yamaha's patented use of special ceramic and LC filters (developed for our revolutionary CT-7000 tuner) provide the highest selectivity and lowest distortion available.

**Built-In Moving Coil Head Amp.** Today, more and more people are discovering the superior performance of the moving coil phono cartridge. While

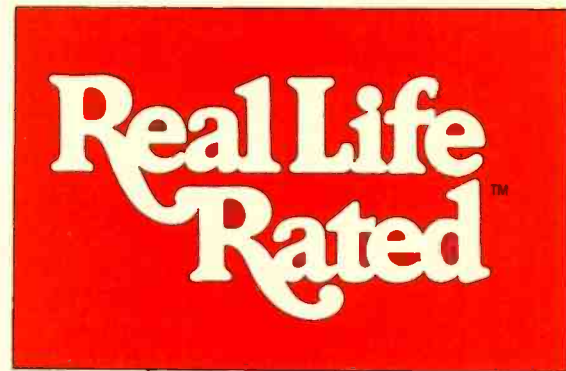

**.05%**

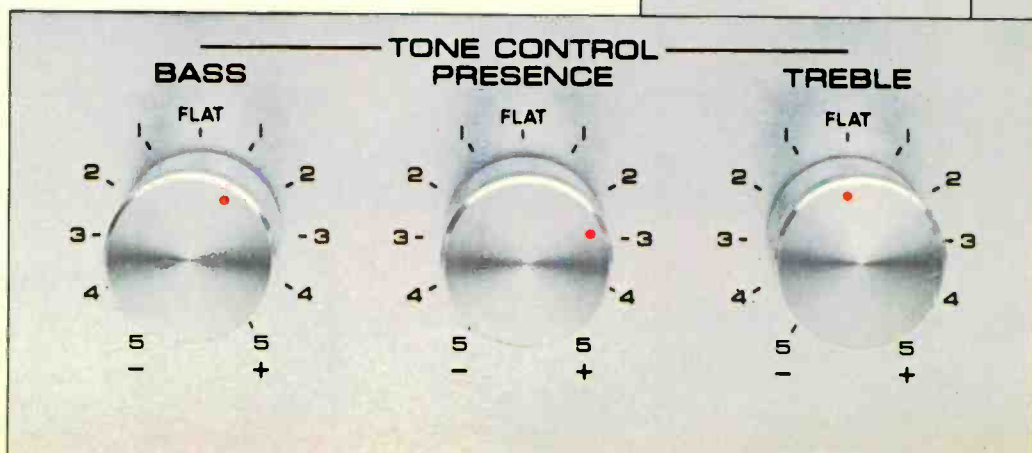
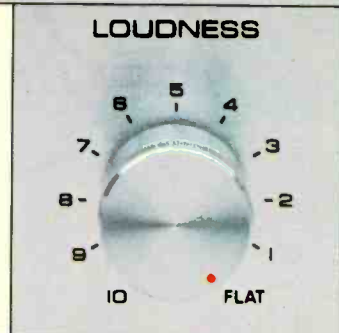
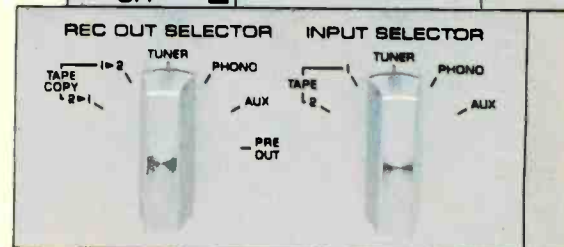
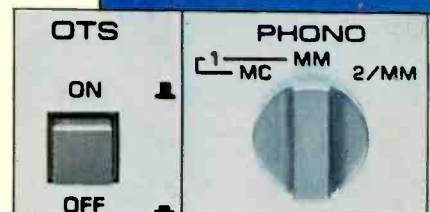



# start playing catch-up. Again.

other receivers require an expensive preamplifier or step-up transformer, which can compromise sound quality, the CR-200 already provides for it—the same solid-state device first developed for our superlative C-2 preamplifier.

**Input/Rec Output/Pre Out Selectors.** Here's extra convenience for tape recording enthusiasts. Record any source while listening to another. For example, copy a tape or disc at the same time you're enjoying an FM program. When you're in the mood to play recording engineer, you can use all the tone controls and filters to compensate for poor quality sound sources.

**Fast Rise, Slow Decay Power Meters.** The CR-200's large, accurately calibrated power meters, with fast rise, slow decay characteristics, make accurate readings possible from 1/10th watt to 200 watt peaks without switching ranges.

**Multi-Function Signal Quality Meter.** When tuning, the right channel power meter automatically converts to a signal quality/strength meter. Needle oscillation indicates the degree of multipath present, while the meter calibrations indicate the strength of the signal. After tuning, the needle automatically reverts to power reading.

**Optimum Tuning System.** Yamaha takes the problem of inaccurate tuning out of human hands. After you manually locate the desired station, OTS automatically fine tunes it to the single point that gives maximum stereo separation and minimum distortion. A defeat switch is provided for special applications.

**Built-In Equalizer.** Think of the CR-200's tone control circuitry as a small multi-band equalizer. Feedback bass and treble controls have selectable turnover frequencies. A midrange presence control adds more flexibility. Two-position low and high filters have 12dB/octave slopes. For the purist, a defeat switch removes the effect of the tone control circuitry entirely.

**The Best Is Yet To Come.** Now that you know about Real Life Rated, you'll want to hear a real life performance. At your Yamaha Audio Specialty Dealer, you'll find uncommon dedication to faithful music reproduction and genuine customer service.

If your Yamaha Audio Specialty Dealer is not listed in the local Yellow Pages, just drop us a line. Along with his name, you'll get complete details about this unprecedented receiver.

© 1977 YAMAHA INTERNATIONAL CORP.



# YAMAHA

Audio Division, P.O. Box 6600, Buena Park, CA 90622

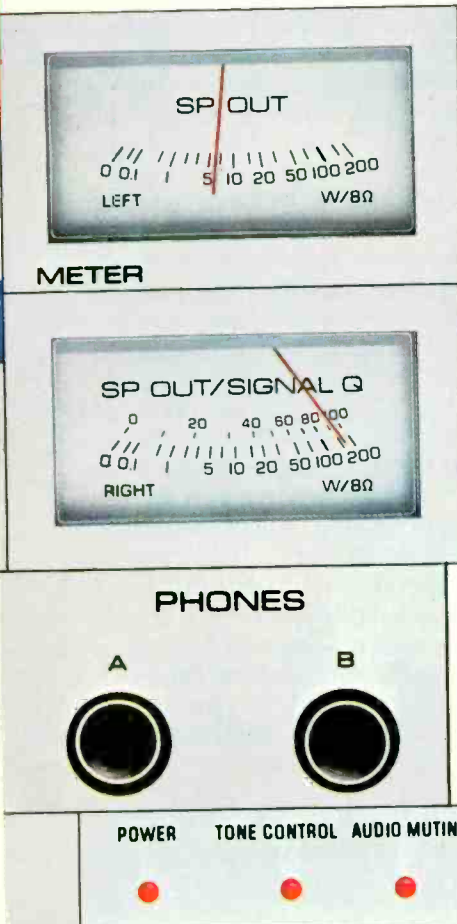

# Tannoy

## INTEGRATED SPEAKER SYSTEMS

At first glance, the Tannoy appears to be a loudspeaker. *It is more.* It is in fact a completely integrated loudspeaker system. Sound is reproduced, phase coherent throughout the entire audio range, from one transducer matrix. The high frequency (HF) tweeter and low frequency (LF) woofer are combined within a single, powerful magnetic structure. Sound is collected by a unique multi-throated phase compensating unit and fed into a short exponential horn. The curvilinear LF diaphragm ensures wide dispersion of high frequencies and an unbroken audio spectrum.

□ The LF diaphragm acts as a true piston from the lowest bass up to 1kHz. The tweeter handles frequencies from 1kHz to beyond 20kHz. The crossover network ensures smooth transition between the woofer and horn-loaded tweeter. A superb, level response curve is achieved throughout the low, mid-range and high frequencies by an ingenious combination of the extended LF direct radiator, crossover network and wide range HF driver. A dynamic balance and roll-off control is incorporated for adjustments to personal taste or room acoustics. The Tannoy is exceptionally efficient. It can handle high powered amplifiers with ease, yet can be driven to high levels by moderately powered units. Equally important, music can be played at low volume without any compromise of musical quality.

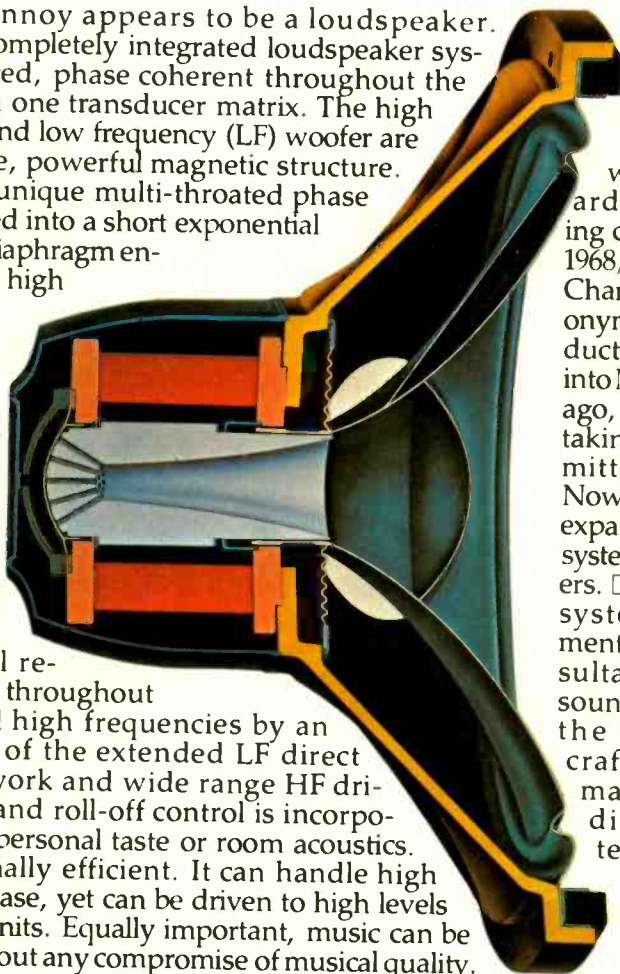

Tannoy has been engaged in continuous research and production of high quality transducers for half a century. From the outset, its products were adopted as a listening standard by broadcasting and recording companies all over the world. By 1968, the term, "Tannoy" was in the Chambers English Dictionary as synonymous with the art of sound reproduction. □ Tannoy was introduced into North America more than 26 years ago, but modest facilities and painstaking standards of production permitted only limited distribution. Now...new techniques, materials and expanded facilities have made Tannoy systems available to many more listeners. □ The Tannoy integrated speaker system is the crowning achievement of generations of acoustic consultants, researchers, designers, sound engineers, and produced in the best traditions of British craftsmanship. The hand of the master cabinetmaker is immediately apparent in the system's exquisitely finished enclosure. The Tannoy will provide the maximum quality your electronic equipment is capable of delivering.

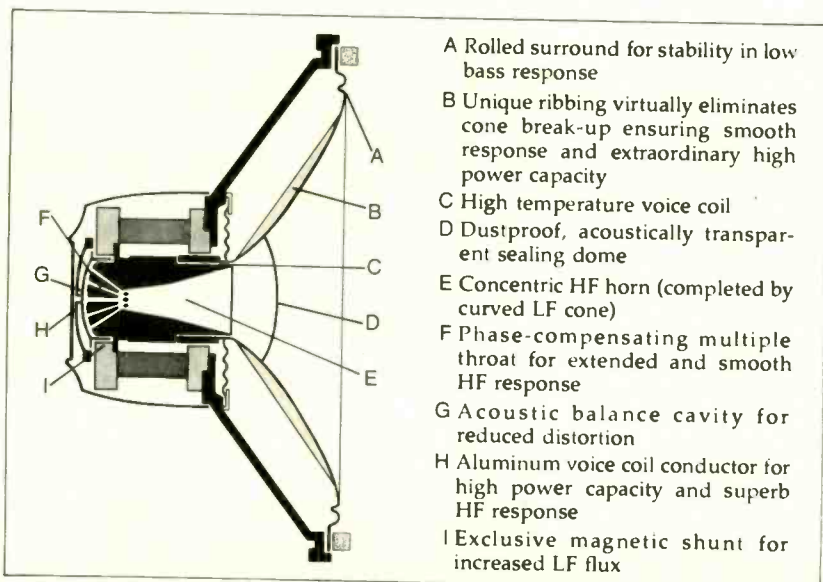

For additional information:

# TANNOY®

122 Dupont Street, Plainview, N.Y. 11803



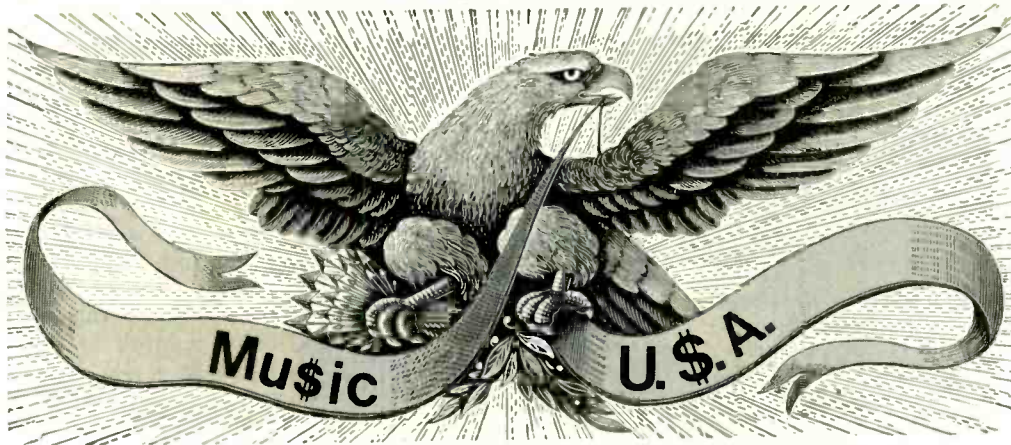

ON NOVEMBER 22, 1963, Woody Herman and his orchestra were recording an album for Philips at the old A&R recording studio on West Forty-eighth Street. When I arrived, the expressions on the faces of the musicians, the engineer, and Woody himself told me they had heard the news that John F. Kennedy had been shot.

Woody listened to a playback of a take, decided he did not like it, and ordered another. The band reassembled and played the arrangement, an instrumental treatment of "A Taste of Honey." When it was completed, he said it was futile under the circumstances to continue.

That last performance of "A Taste of Honey" was included in the album that Philips eventually issued. There is something in that recording that is missing from any of the band's live performances of that arrangement: an overwhelming melancholy, a mournful, ineffable despair that makes the track one of the most moving—and also disturbing—experiences I have had in music. It is in the tone, the sound, the phrasing of the band. What the musicians felt that day went into the music.

Jazz, in common with other popular music, can respond to emotional and social stimuli with an immediacy and fervency not possible to the same extent in classical music. Aaron Copland says that he has spent about six months writing a symphony, which does not seem an unreasonable length of time. When a classical composer is moved to express in music an intense personal experience, as in the case of Fauré's poignant Requiem, written after the death of his father, the work is likely to take considerable time. Get-

## 5. Jazz: Music of Exile

by Gene Lees

ting a commitment from an orchestra to perform it takes more time, as do the copying and rehearsal of the music. When Bill Evans composed a memorial on the death of his father, he performed it a matter of days later in Town Hall, and Verve recorded and issued it shortly thereafter.

The social conditions in which black Americans have had to live have been documented or portrayed in news reports, articles, histories, novels, and movies. What is little realized by the average white American is that the average black American has lived all his life on the periphery of violence and in the fear of it. Blacks are the primary victims of crime, and they are aware that all too many law enforcement officers take the attitude, "Let them kill each other off, who cares?" An old black taxi driver in New York, having said that he kept a .38 under the seat, added: "I'd rather the cops caught me with it than they caught me without it." This hovering presence of violence is something that affects the musician as deeply and constantly as any other black. It is the reason some of the musicians, particularly the older generation, carry switchblade knives: not to commit crime, but to protect themselves from it.

Clark Terry, one of the towering figures in American music, related that he and a friend were chased through the streets of Jacksonville, Florida. They ran onto the construction site of what would later be the Duval Building and lay in a trench of mud and rainwater until their pursuers grew tired of the sport and gave up the hunt. Dizzy Gillespie told me of dragging his friend Charlie Parker from a nightclub after a group of whites had set upon him and smashed him over the head with a bottle. That Terry, Gillespie, and other black musicians (and, for that matter, nonmusicians) are able to be civil to whites, much less maintain close friendships with whites (which both men do), is an achievement in tolerance that few whites could emulate.

But the feelings generated by such experiences inevitably get into the black jazzman's music, as emotion gets into handwriting in ways that the trained graphologist can detect.

Not that the expression of these feelings is intentional (it may be occasionally, as in the music of Charles Mingus). On the contrary, it is because the musician is revealing emotions that he might consciously wish to conceal that the work of black musicians has been socially so prophetic. To anyone who heard jazz sensitively in the late 1950s and early 1960s, the Watts, Harlem, Detroit, and other riots came as no surprise.

One could hear accumulating anger even in musicians whose civility inhibited them from expressing it in words. One could hear it in the playing of the late Cannonball Adderley, the late John Coltrane, Wayne Shorter, Sonny Rollins, Junior Cook,

**The \$395 Dahlquist and  
the \$1100 Infinity use  
this midrange driver.**

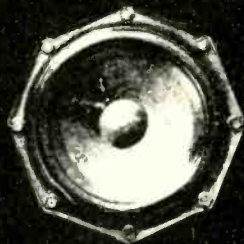

**So does our \$200 Phase II.**

**Acousti-phase**  
*A Tribute to Sound*

CIRCLE 1 ON READER-SERVICE CARD

**FREE**

**McIntosh CATALOG  
and FM DIRECTORY**

Get all the newest and latest information on the new McIntosh Solid State equipment in the McIntosh catalog. In addition you will receive an FM station directory that covers all of North America.



**MX 113**

**FM/FM STEREO - AM TUNER AND PREAMPLIFIER**

**SEND  
TODAY!**

McIntosh Laboratory, Inc.  
East Side Station P.O. Box 96  
Binghamton, N.Y. 13904

NAME \_\_\_\_\_  
ADDRESS \_\_\_\_\_  
CITY \_\_\_\_\_ STATE \_\_\_\_\_ ZIP \_\_\_\_\_

If you are in a hurry for your catalog please send the coupon to McIntosh.  
For non rush service send the *Reader Service Card* to the magazine.

CIRCLE 24 ON READER-SERVICE CARD

the late Eric Dolphy, and many more. Since some of them were in all ways gentlemen, their largely unintended revelation of deep private emotions was the more arresting.

This anger, in the cases of the aforementioned musicians (all saxophonists, by the way), emerged as a hard, strong tone and a generally fierce approach to musical phrases. It was the essence of what the critics called the "hard bop" school of playing. For many critics, indeed, this was the *only* sound, and they dismissed as inferior the work of white musicians who did not have—and had no experiential reason to have—the same emotions as their black colleagues. When Adderley wanted to hire pianist Victor Feldman for his quintet, he first played a recording by Feldman for the other black members of the group. Only when they all said they would be delighted to have such a player join them did Adderley tell them that he was white. And English, at that. And Jewish.

This division, polarized (inaccurately) as the East Coast or hard-bop and West Coast or "cool" jazz, was exacerbated by the jazz critical establishment. Some critics—the Frenchman André Hodeir, for one—went so far as to suggest that no white musician ever contributed anything of importance or originality to jazz. This is in contradiction of Lester Young's statement that he was influenced by Frank Trumbauer; of Miles Davis' statement to me that he had listened a lot to Bobby Hackett, who in turn had listened a lot to Bix Beiderbecke; of Jack Teagarden's pioneer work in developing a high-speed trumpetlike trombone technique that became the norm among trombonists after the 1940s bebop revolution; and of the fact that almost every fine jazz pianist in the U.S. today has been influenced by Bill Evans, who was influenced by Sonny Clarke, Nat Cole, Bud Powell, the twentieth-century French composers, and even Scriabin.

Nonetheless, the strongest impetus in the creation of jazz came from the blacks. Jazz is the triumphant achievement of a people living in a form of exile, under ghastly conditions, that is as much due to their ordeal as in spite of it.

It is the minorities that make American music so incredibly rich. Although black Americans have claimed credit for their great musical contribution, the Jews have been conspicuously reticent about theirs. But in both popular and classical music, their contribution has been one of the most brilliant and important, and this I will discuss in the next issue. ●



# THE OPTIMUM.



## The first turntable that's as steady as a rock.

Turntables shouldn't cause howling and screeching through the night. But that's exactly what happens, thanks to mechanical and acoustic feedback caused by loudspeakers vibrating an insecure turntable.

Since most turntable bases have been made of laminated plywood, beech, die-casting or plastic, howling has been a problem that just wouldn't go away.

Until today, that is.

Announcing the Optonica RP-3636 Direct Drive Turntable. We built the ideal turntable, literally as solid as a rock because it's built on 15.8 pounds of Mikage granite stone. Which means that vibrations from the speakers are absorbed, reducing acoustical feedback and

maintaining maximum signal to noise ratio.

The Optonica RP-3636 also features a highly sensitive S-shaped tonearm. Which means that the stylus will pick up subtle sound signals as accurately as the cutter stylus that recorded them. And an oil-damped cueing control that gently lifts and lowers the tonearm so your records will be protected from damage.

We invite you to test the Optimum turntable at one of the select audio dealers now carrying the full line of Optonica stereo compo-

nents. Call toll-free 800-447-4700 day or night (In Illinois dial 1-800-322-4400), for the name and address of your nearest Optonica showroom, where you can see the complete Optonica line and pick up your free copy of our catalog. Or for further information, write Optonica, Dept. T6B, 10 Keystone Place, Paramus, New Jersey 07652.

From our unique turntable built as steady as a rock to our cassette deck that automatically finds your selections, find out why throughout Europe and Japan, Optonica is one of the fastest selling lines of stereo components on the market today.

**OPTONICA** THE OPTIMUM.





## Too Hot to Handle

At the moment I have a four-channel system that I am planning to modify into something better. The problem is what I should use for a preamp—the market in quad preamps seems quite limited. I am considering the Bose 4401. The phono overload is specified at 70 millivolts, which seems a bit low. Would I have any problems on phono overload using an Audio-Technica VM-35F cartridge?—Charles K. Taylor, Viernheim, W. Germany.

We doubt that you will have any difficulty in using the Bose 4401 preamp with an Audio-Technica VM-35F. The 70-millivolt figure is lower than some but should be adequate. To set your mind at ease, why not ask the dealer to demonstrate the combination for you?

I have been looking at the Akai GX-630DB automatic-reverse cassette deck and the Pioneer RT-1011 and RT-1020 decks. There is only a very small difference (less than \$50) in the prices I have been quoted. The Akai seems to have more features for the money, but I have heard that automatic-reversing machines have an inherent problem with increased distortion as a result of the tape traveling in two directions and head alignment. Which in your opinion is the best value in terms of quality, reliability, and faithfulness of sound reproduction?—Dan Rankin, Chester, S.C.

In auto-reversing decks with fixed, four-gap stereo heads, the performance loss is most likely to be in crosstalk (not distortion as such): in two-gap moving heads, or in transports that reposition the cassette with respect to the head for the second direction, alignment tends to be the problem—particularly when the deck no longer is new and critical parts are becoming worn. These problems are not insuperable, but they cannot be solved without incurring higher costs than are to be expected in a comparable monodirectional model. There has been an unfortunate tendency to cut corners in bidirectional decks to make up for this added cost. Since we have tested none of the decks about which you inquire, we can't tell whether they suffer from this approach or not.

In your test report of the Advent 300 [March] you mentioned that the receiver's phono preamp section has minimal impedance interaction with cartridges, resulting in cleaner sound. Can you tell me of any other preamps or integrated amps that have this type of phono section? I would be specifically interested in the Dynaco PAT-5 since I am considering purchasing it.—Michael S. Lasky, Kansas City, Kan.

The Advent design is proprietary. The best thing to do is to try the Dynaco with one or more of your favorite cartridges.

I have a mechanical feedback problem with my Dual 1229 turntable. I have tried changing the positions of my wall-mounted speakers, and I've installed low-capacitance cables. (The latter move helped the most.) Is there anything else I can do? Would a new turntable work any better? Turning down the bass helps control the feedback, but it ruins the sonic balance.—Kenneth Balog, Tarentum, Pa.

We are curious about your comment on low-capacitance cables, for there is no reason why they would help a mechanical feedback problem. What you need is a means of decoupling the turntable from the speakers. If all are mounted on the same wall, the wall itself doubtless is the coupling medium. Try putting the turntable elsewhere in the room. Isolating mechanisms of various kinds are available: We reported on the Audio-Technica Insulators in an April test report and on the Kenwood "stone"-based turntable in May. It is hard to predict which measures will prove most effective in individual cases, but the cheaper alternatives you might want to try first are the Audio-Technica and Neutronics products for isolating turntables and/or speakers.

I have been a tape enthusiast for many years and have a sizable collection of recorded cassettes, many containing chromium-dioxide tape. My present deck, purchased not long ago, is a Nakamichi 600. I have heard that Nakamichi recommends against the use of chromium-dioxide tape because its abrasiveness causes excessive wear of permalloy heads. This makes a large part of my tape library virtually useless. Is there anything I can do?—Michael Dalton, Eugene, Ore.

We have good news for you: Nakamichi has revised its position with respect to chrome tape, having found that head-wear characteristics are about the same with either chrome or premium ferric-oxide formulations. Du Pont, which developed chromium dioxide, has conducted tests in which a ferric-based tape was found to cause more wear than chrome—though in our experience the results of such tests depend more on the precise manner in which they are conducted than on the oxide used. In any event, don't worry about playing your chrome tapes.

I have acquired an SME tone arm (at a bargain price). In looking about for a suitable turntable that won't cost an arm and a leg, I find the Thorens TD-160 with an SME cutout (at about \$150) a good buy. But my local dealer (who wants to sell me a Technics SL-110A at twice the price) says the Thorens isn't worthy of my arm. What do you say?

Also, the stylus of my Ortofon VMS-20E

cartridge is due for replacement. Would I be better off to apply that \$30 to the purchase of a new Shure V-15 Type III, Pickering XSV-3000, or equivalent cartridge?—Klaus J. Hansen, Kingston, Ont.

Even without considering the merits of the two turntables, we would say that your dealer is giving you the hard sell. There could be perfectly legitimate factors that make the Technics the better buy for you; but if your dealer has some legitimate idea of that sort in mind, he evidently has done a poor job of expressing it. The Thorens at half the price sounds like a good deal to us.

If your question concerning the Ortofon VMS-20E means that you have doubts about it or are dissatisfied, auditioning new cartridges is certainly in order, and those you mention are good candidates. If you're not dissatisfied with the Ortofon, we see no reason to switch.

I recently bought a Teac A-400 cassette deck. With the new Maxell UDXL-II cassette, the manual says to set the bias and equalization switches to Position 1 (high-level bias, 70-microsecond equalization). When I play back the recorded tape, however, and A/B it with the original, eq. Position 1 sounds a bit too dull, and Position 2 sounds better but a bit too bright. Is this an incompatibility between the tape and deck, or is the deck malfunctioning? Is there really any difference in recordings made on this deck with Maxell UD, UDXL-I, and UDXL-II? I can't detect any.—David Foss, Pawtucket, R.I.

We have repeatedly mentioned the minor Dolby-tracking problems that can occur when a "chrome-compatible" ferricobalt tape is used with CrO<sub>2</sub> settings of bias and equalization and no adjustment is made for the extra sensitivity of these tapes. Since the symptoms described for Position 1 are just the opposite of what such mistracking would cause, we suspect that your deck is malfunctioning. (We would have considered dirty heads as a possible cause except that Maxell cassette leaders are designed to clean the heads automatically—as long as you let them run past the head in the PLAY mode.) It would be a good idea to have the deck checked—and, while you're at it, adjusted for the tape you intend to use. When all three Maxell tapes are used correctly, you should find that you can cram a little more level onto UDXL-I than onto UD before encountering audible signs of overload, while UDXL-II will have audibly less hiss than the other two because of the 70-microsecond equalization that it is designed to accommodate.

I have a Pioneer TX-9500 tuner with a test tone for FM recording. My cassette deck (a Technics) has a Dolby-FM mode, and I'd like to record Dolby-FM broadcasts directly—without decoding and re-encoding. Where should I set up the test tone on the deck's meters?—Mario G. Donetti, New York, N.Y.

Our advice is that you're better off decoding and re-encoding. The Dolby reference level for FM broadcasting is defined as 50% modulation—that is, 6 dB below maximum allowable modulation. Unless the station is tossing away some 6 dB of its dynamic range (which would mean that the broadcast is noisier than necessary), the peaks may overload your tape. By decoding, then adjusting gain, and re-encoding, you can set the levels for optimum dynamic range and distortion.



# ARE YOU BLAMING YOUR TAPE RECORDER FOR PROBLEMS CAUSED BY YOUR TAPES?

Every day people all over the country go into hi fi dealers with complaints about their tape recorders.

When in reality what they should be complaining about is their tapes.

Because the fact is, a lot of the problems that plague tape recorders can be attributed to bad tape.

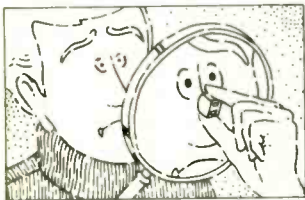

**HEAD WEAR IS CAUSED BY YOUR RECORDER. OR IS IT?**

If you have to clean your tape heads more than usual, for example, it could be your tape doesn't have a special nonabrasive head cleaner.

Maxell has one.

If your recorder jams, it can be any number of things. Maxell does something to prevent all of them.

We make our cassette shells of high impact polystyrene. And then so they won't crack

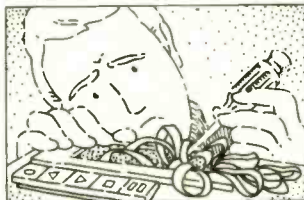

**JAMMING IS CAUSED BY YOUR RECORDER. OR IS IT?**

even after years of use, we finish them to tolerances as much as 60% higher than industry standards.

Inside, we use free rolling Delrin rollers so the tape doesn't stick.

And finally, we screw instead of weld everything together because screws make

for stronger cassettes.

If your recorder frequently suffers lapses in sound, it could be the tape is of inferior quality. And nobody's bothered testing the tape for dropouts before it leaves the factory.



**DROPOUTS ARE CAUSED BY YOUR RECORDER. OR ARE THEY?**

Maxell tape is made of only the finest polyesters. And then every



**POOR TRACKING IS CAUSED BY YOUR RECORDER. OR IS IT?**

step of the way it's checked for even the slightest inconsistencies.

So if you're having problems with your recorder, try a Maxell cassette, 8-track or reel-to-reel tape.

You might find there's really nothing wrong with your tape recorder, just with your tape.



**MAXELL. THE TAPE THAT'S TOO GOOD FOR MOST EQUIPMENT.**

Maxell Corporation of America, 130 West Commercial Ave., Moonachie, New Jersey 07074

## News and Views

### Striking Back at CB Interference

If your music system is bringing you "good buddies" with your Brahms or reports of Smokey Bear with your Miles Davis, you need not sit by in helpless frustration. The abuse of the airwaves by some CBers has prompted the Federal Communications Commission to beef up its enforcement activities, and it is possible that you can help to silence the offenders—who are subject, incidentally, to fines and imprisonment in addition to confiscation of illegal gear.

Many of the instances of interference with other equipment by CB radios stem from the use of transmitting power exceeding the legal maximum—chiefly the addition of so-called linear amplifiers to transmitters' output stages. (The FCC is studying a proposed ban on the manufacture of linear amplifiers that can be used with CB.) It is possible, however, for legally operated equipment to cause interference too, so your complaint will be most useful if you can give information that will help both in pinpointing the source of the interference and in determining the likelihood of legal operation at that source.

First, if you have any idea whose transmission you are unintentionally receiving, try to contact him directly. Some operators will cooperate with you in trying to alleviate the problem (although those transmitting illegally probably will not). Second, note carefully which pieces of your equipment are affected and how they are affected. In particular, see if reception on television Channels 2, 5, and possibly 9 is impaired at the same time as interference appears in your audio, since the harmonics of the CB frequencies fall within these channels. Then send the information to this address: Federal Communications Commission, 1919 M St. N.W., Washington, D.C. 20554. Att: Field Operations Bureau.

A little bit of work on your own behalf may make it possible for you to listen to music undisturbed. It may also help to head off legislation that could require audio equipment to contain bypasses and other RF suppression devices that might limit its basic performance. Indeed past experience with the FTC's notorious "warmup" rule suggests that such legislated solutions probably would inhibit designers to the point of compromising performance.

### Of Shakespeare, Valves, and Audio Hot Rods

The worst thing about *Tu-be or Not Tu-be, a Modification Manual for Vacuum-Tube Electronics*, is the title—that and the price (\$25). But once you get by those, the book is chock full of goodies, particularly if you are into state-of-the-art tubed circuitry. H. L. Eisenson and the staff of Audio Dimensions, Inc., present an in-depth look into the hows and whys of vacuum-tube amps and preamps, mostly in clear language that ordinary people—not just engineers—can understand. Included are step-by-step instructions for upgrading and customizing such veterans as the Dynaco PAS and Citation I, as well as some circuit variations that are scheduled to appear in Audio Dimensions products.

But if you're convinced that solid-state is the way to go, there is a lot of interesting philosophy and many suggestions as to how an already fine system can be fine-tuned for even better performance. This is a provocative book that should delight the advanced audiophile, even though he may take heated difference with some of its more opinionated statements. Audio Dimensions is located at 8898K Clairemont Mesa Blvd., San Diego, Calif. 92123.

### Audio in the Classroom

We are often asked by young readers how to go about getting started on a career in audio and recording technology. Adding to the items we have already published in these pages on the subject, a new source of information has come to our attention. The Journalism Communication Department of the University of Bridgeport is now offering a minor in audio studies. The 21-credit program includes courses in audio techniques, audio production and direction, field sound recording studio technology, and audio engineering practices. A nine-week summer session is also offered, to be held in a professional recording studio. Interested readers should contact Dr. Howard B. Jacobson, Department of Journalism, North Hall 214, University of Bridgeport, Bridgeport, Conn. 06602.

We are planning fuller treatment on degree programs and courses in audio engineering for our BACKBEAT section in a forthcoming issue.

## Equipment in the News

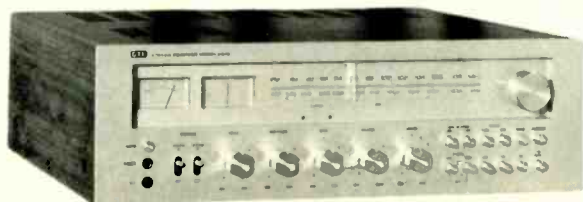

### Feature-laden receiver from GTE

GTE Sylvania's Model 2600 stereo receiver features built-in Phase Q4 matrix for simulated four-channel ambience, tape-monitor switching for two decks, three-way (bass, midrange, treble) tone controls, and two-stage FM muting employing a noise amplifier that is said to kill interstation noise without affecting FM sensitivity. Diode indicators on the front panel light when the amplifier section is driven into clipping. Continuous power output is rated at 80 watts (19 dBW) minimum per channel into 8 ohms from 20 Hz to 20 kHz with no more than 0.1% total harmonic distortion. The price of the Model 2600 is \$599.95.

CIRCLE 136 ON READER-SERVICE CARD



# Only Hitachi's SR/903 Receiver has Class G, "the very newest class in amplifier operation."

Stereo Review  
January, 1977



Stereo Review went on to explain that this exclusive circuitry "uses... a low power and a high power output stage operating together... At low signal levels the lower power stage drives the speakers. The transition to the more powerful output transistors... takes place smoothly at the point where it becomes advantageous to do so."

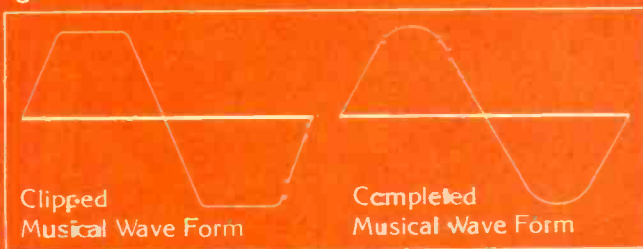

The point they're talking about, of course, is where certain portions of the music you listen to demand more than the rated output to sound like they should. (Rated output on the Hitachi SR/903 is 75 watts continuous power per channel, both channels driven into an 8 ohm load, 20 to 20,000 Hz with no more than 0.1%

total harmonic distortion.) So when your music really gets thrilling, Class G cuts into a standby amplifier. Then, for just a moment, the SR/903 can pump out a lusty 150 watts per channel—without clipping.

One look at comparison wave forms will show you what we mean. See how the sound from the conventional amplifier has the top of its natural arc clipped off. That's

when you'd get clipping distortion. But the same musical peak graphed on the Hitachi SR/903 is complete. So the sound you'd hear would be clean and crisp.

As a wrap-up, Stereo Review said Class G delivers "much higher overall efficiency than a conventional device, and this brings immediate dividends... in reduced weight size and power consumption."

All they neglected to mention was that Class G doesn't cost you any more.

## Hitachi SR/903 Typical Specifications

Amplifier	Rating
Power, minimum RMS, at 8 ohms, 20 to 20 000 Hz	75 watts
Total harmonic distortion at rated power output	0.1%
FM Tuner	Rating
Usable sensitivity (IHF) 300 OHMS	1.6 $\mu$ V (9.3 dBf)
50 dB quieting sensitivity	3.1 $\mu$ V (15 dBf)
Signal/noise ratio 100% mod	74 dB



**HITACHI**  
When a company cares,  
it shows.





# LOUD. SPEAKER.

The Cerwin-Vega S1 is the most elegant and exotic shelf speaker currently available. The rare Yucatan rosewood<sup>1</sup> facade only hints at the marvels inside. A sophisticated sixth order Butterworth vent tuning, integrated with an active equalizer filter, increases the effective bass performance to surpass much larger enclosures. The wave of the future in quality shelf speakers surely will be such a system.

Even this is not good enough for the S1.

We have developed an elegantly simple improvement in bass enclosure technology; we call it Thermo-Vapor Suspension.<sup>2</sup> By filling the S1 cabinet with a soft, inert gas which is more

compressible than air, a lower system response and more controlled damping is achieved.

The drivers are precision aligned die-cast units having the highest magnetic motor drive efficiencies in the industry. The low crossover of 300 Hz to a 6" midrange driver assures low intermodulation at loud levels. A damped dhorm, high frequency unit (moving mass, .1 gram), operates at a low pressure density extending response to 20 kHz with vanishing coloration.

The S1 has impeccable technical credentials too numerous to detail here so write Cerwin-Vega for full performance specifications or see it, hear it, Feel it, at a selected dealer.



**Cerwin-Vega!**

Cerwin-Vega! 12250 Montague Street, Arleta, California 91331, 213/896-0777  
In Canada: Cerwin-Vega Canada Ltd., 19 Malley Road, Scarborough, Ontario, 416/752-7530

<sup>1</sup>Walnut is standard  
<sup>2</sup>Patent Pending



## Titan-ic speaker introduced

One of the new speakers in Kustom Acoustics' line is the Titan Labyrinth. This enormous (each speaker weighs 325 pounds) three-way system employs two 12-inch woofers, two 5-inch midrange drivers, and two 1-inch tweeters. The Titan, whose power-handling capacity is rated at 350 watts (25 dBW), can be biamped or triamped. Frequency response is rated at 24 Hz to 18 kHz,  $\pm 2\frac{1}{2}$  dB. Impedance, at 4 ohms, is said to be very linear because of the tapered acoustical-line design of the crossover. The manufacturer states that harmonic and IM distortion are both 0.5% at 1 watt (0 dBW) from 50 Hz up. Housed in a mirror-matched veneer cabinet, the Titan Labyrinth sells for \$1,295.

CIRCLE 137 ON READER-SERVICE CARD

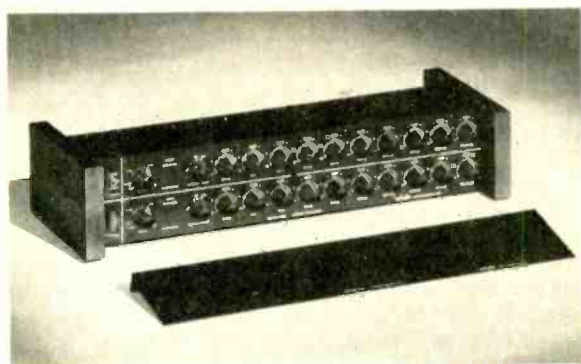

## White Instruments' new equalizer

Each channel of White Instruments' Model 4100 stereo equalizer has ten bands on octave centers from 31.5 Hz to 16 kHz. Continuously variable controls provide 10 dB of boost or cut. Front-panel features include input level attenuators and overload indicators. Input impedance is rated at 40,000 ohms and output impedance at 100 ohms. The output circuits are said to drive loads as low as 600 ohms. A rear-panel accessory socket makes possible the use of low-level crossover networks for biamp systems. The Model 4100, which is furnished with a security cover and is available in a rack-mount model, costs \$599.

CIRCLE 138 ON READER-SERVICE CARD

## Modest power, price in Kenwood receiver

The Kenwood KR-3600 stereo receiver uses direct-coupled complementary circuitry at every stage in the amp section and a single in-line integrated circuit in the preamp section. The tuner section includes a junction-type FET in the front end; the FM multiplex demodulator is said to deliver 40 dB of stereo separation at 1 kHz. Power is rated at 22 watts (13 dBW) into 8 ohms, 20 Hz to 20 kHz, with no more than 0.8% distortion. Inputs are provided for two pairs of stereo speakers as well as for headphones. Negative feedback, high filter, and loudness compensation controls add to the unit's flexibility. The KR-3600 costs \$250.

CIRCLE 139 ON READER-SERVICE CARD

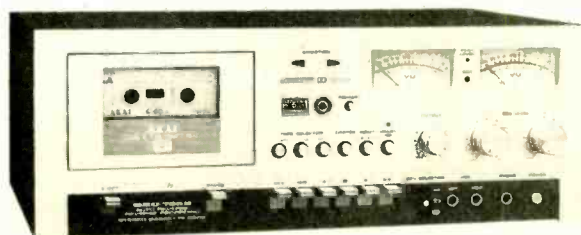

## Bidirectional cassette deck from Akai

Akai is marketing a bidirectional cassette deck, Model GXC-730D. This front-load design has three heads that permit bidirectional recording as well as playback. A reverse selector switch on the front panel allows three operating modes: one-way, out-and-back, and continuous play. Other features are Dolby circuitry, memory wind, and Akai's Automatic Distortion Reduction system. Front-panel tape bias and equalization switches (low-noise ferric, chrome, ferrichrome) can be fine-tuned for special tapes via rear-panel recording-level adjustments. A peak level indicator supplements the meters. The GXC-730D costs \$500.

CIRCLE 140 ON READER-SERVICE CARD

## Transmission-line speaker from Innotech

Innotech's Model D-22 is a three-way speaker that combines a 5-inch cone woofer, 1-inch soft-dome tweeter, and 1-inch dome supertweeter. The plastic cone of the transmission-line design is said to give lower coloration because of its acoustically dead properties. The clustered drivers are front-mounted; the crossover has air-core inductors designed to prevent phase cancellation while minimizing transient distortion. Frequency response is rated from below 30 Hz to beyond 35 kHz. An externally connected subsonic filter, the SF-2, is said to roll off frequency response below 20 Hz by 12 dB per octave. The D-22 comes in an oiled-walnut veneer cabinet and costs \$975 per pair.

CIRCLE 141 ON READER-SERVICE CARD

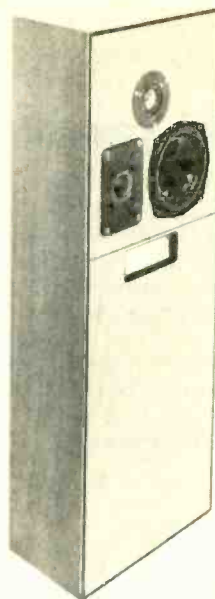

## RAM Audio designs new amplifier

RAM Audio Systems is marketing a newly designed power amplifier, the RAM-512. This amplifier is rated at 180 watts (22½ dBW) per channel into 8 ohms, frequency response at ±0.1 dB, 20 Hz to 20 kHz, with IM and total harmonic distortion of 0.08% at rated output. The 5-inch power level meters cover a 43-dB range. Front-panel diodes indicate peak responses. The unit has no current limiters, and the propagation delay time is said to be less than 0.2 microseconds. The RAM-512 is priced at \$1,150.

CIRCLE 142 ON READER-SERVICE CARD

## Craig produces a receiver

The Craig Model 5503 stereo receiver can handle three pairs of speakers and has two tape-monitor channels. Turnover frequencies are selectable: 250 and 500 Hz in the bass, and 5 and 2.5 kHz in the treble. Speaker selection and five other modes are controlled by pushbuttons. A variable-bandwidth filter and tone defeat are provided. The receiver has a power rating of 50 watts (17 dBW) per channel into 8 ohms, 20 Hz to 20 kHz, with 0.1% maximum total harmonic distortion. Model 5503 comes in a walnut-veneer enclosure and costs \$369.95.

CIRCLE 143 ON READER-SERVICE CARD

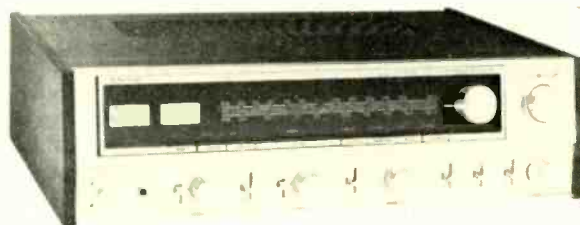

## SAS speaker line makes its debut

The Spectrum I is a middle-of-the-line speaker from SAS Electronics. The bass-reflex system has a 10-inch woofer, 5-inch midrange driver, and 1¾-inch tweeter. The crossovers occur at 1.8 and 5 kHz. Maximum power-handling capacity of the Spectrum I is rated at 55 watts (17½ dBW); SAS says it can be driven successfully with less than 10 dBW (10 watts) because of its high efficiency. The speaker is protected by self-resetting thermal breakers. The enclosure is of walnut-grain vinyl, and the system costs \$175.

CIRCLE 144 ON READER-SERVICE CARD

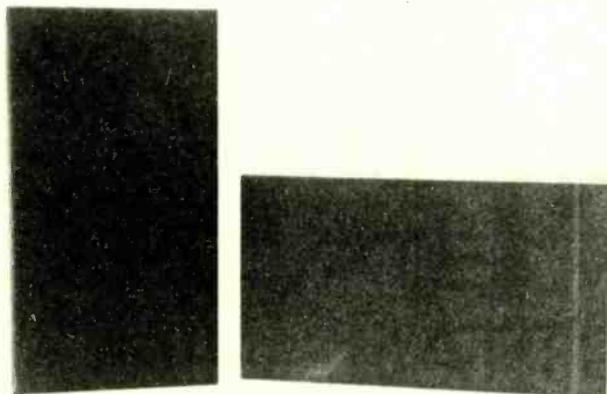





# Accutrac. The turntable with eyes.

What's more, it can do this by cordless remote control, even from across the room.

### The arm your fingers never have to touch.

Since Accutrac's tonearm is electronically directed to the record, you never risk dropping the tonearm accidentally and scratching a record, or damaging a stylus.

And, since it cues electronically, too, you can interrupt your listening and then pick it up again in the same groove, within a fraction of a revolution. Even the best damped cue lever can't provide such accuracy. Or safety.

### What you hear is as incredible as what you see.

Because the Accutrac servo-motor which drives the tonearm is decoupled the instant the stylus goes into play, both horizontal and vertical friction are virtually eliminated. That means you get the most accurate tracking possible and the most faithful reproduction.

You also get wow and flutter at a completely inaudible 0.03% WRMS. Rumble at -70 dB (DIN B). A tracking force of a mere 3/4 gram. And tonearm resonance at the ideal 8-10 Hz.

The Accutrac 4000 system. When you see and hear what it can do, you'll never be satisfied owning anything else.

**Its father was a turntable.  
Its mother was a computer.**

## The Accutrac™ 4000



ADC Professional Products Group, A Division of BSR (USA) Ltd, Route 303, Blauvelt, N.Y. 10913



**Introducing Accutrac.**  
The only turntable in the world that lets you tell an LP which selections you want to hear, the order you want to hear them in, even how many times you want to hear each one.

Sounds like something out of the 21st century, doesn't it? Well, as a result of Accutrac's electro-optics, computer programming and direct drive capabilities, you can have it today.



Just imagine you want to hear cuts 5, 3 and 7 in that order. Maybe you even want to hear cut 3 twice, because it's an old favorite. Simply press buttons 5, 3, 3 again, then 7. Accutrac's unique infra-red beam, located in the tonearm head, scans the record surface. Over the recorded portion the beam scatters but over the smooth surface between selections the infra-red light is reflected back to the tonearm, directing it to follow your instructions.

## Onkyo's solid-state integrated amp

Onkyo's A-7 integrated amplifier features a bus feeder ground and especially large capacitors, which are said to bring the equivalent series resistance as close to the zero-point as possible. With Class A circuitry for low distortion, the A-7 is rated at 70 watts (18½ dBW) per channel into 4 ohms from 20 Hz to 20 kHz with no more than 0.1% total harmonic distortion. Frequency response is rated  $\pm 1$  dB from 2 Hz to 80 kHz. The design offers tape dubbing and monitoring, bass and treble defeat, and subsonic filter at a cost of \$370.

CIRCLE 145 ON READER-SERVICE CARD

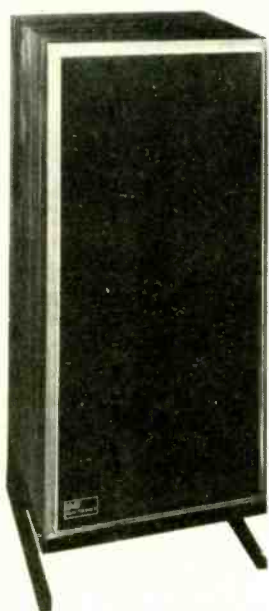
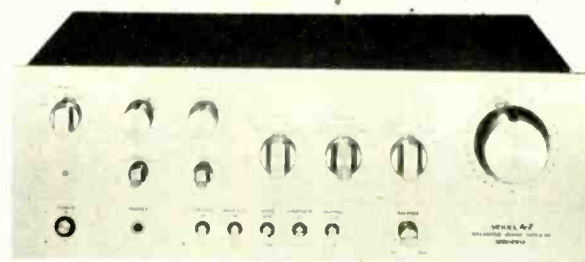

## IMF's Monitor loudspeaker

IMF International has introduced a smaller version of its Reference Standard Mk. IV speaker. Designated the Monitor TLS 80 Mk. II, the new speaker has three drivers and transmission-line loading to simulate concert hall listening. A TILT control is provided to modify energy response. Supplied stands hold the speakers off the floor and angle their radiating surface upward. The power-requirement range is rated at 40 to 100 watts (16 to 20 dBW), and frequency range is at 20 Hz to beyond audibility. Crossovers occur at 350 Hz, 3 kHz, and 13 kHz. The Monitor TLS 80 Mk. IIs come in mirror-image pairs and cost \$850 apiece.

CIRCLE 146 ON READER-SERVICE CARD

## Audionics' Class A preamp

The RIAA input circuitry of the BT-2 preamp is said to isolate interactions between the phono cartridge and the electronics. Audionics claims that its BT-2 will drive loads as low as 250 ohms. Equalization accuracy is rated at  $\pm 1/2$  dB, 20 Hz to 20 kHz; load impedance is 500 ohms. The unit can be rack-mounted and is available in either black-anodized or wood (rosewood or teak) cases, costing \$350 and \$399, respectively.

CIRCLE 147 ON READER-SERVICE CARD



## Got your ears on?

For audiophiles who are being driven up the wall by interrupted FM reception, Electronics Specialists, Inc., has introduced an FM Interference Filter. The company claims that this filter will eliminate or greatly reduce CB, ham, or computer interference entering through the FM antenna. (For more on CB interference, see "News and Views" in this issue.) Sure to be welcomed by listeners who can't handle the handles any more, the compact FM Interference Filter costs \$8.50.

CIRCLE 148 ON READER-SERVICE CARD



# Who said you can't see the quality of a speaker? Look closely at the Sansui SP series.

5 speakers, 4-way L/C crossover  
130 watt peak handling capacity  
98 dB/W efficiency  
16" woofer



SP-7500X

5 speakers, 4-way L/C crossover  
120 watt peak handling capacity  
98 dB/W efficiency  
15" woofer



SP-5500X

5 speakers, 3-way L/C crossover  
100 watt peak handling capacity  
98 dB/W efficiency  
12" woofer



SP-2500X

3 speakers, 3-way L/C crossover  
70 watt peak handling capacity  
93 dB/W efficiency  
10" woofer



SP-1500X

## The SP-7500X

In a great speaker, quality can be seen as well as heard. When you look at the Sansui SP series — you'll see what we mean.

Go to your Sansui franchised dealer and ask for the SP-7500X.

Let your salesman remove the handsome, hand-carved Kumiko grille. The size of the woofer is impressive — a massive 15" — for a rich and full bass. And for clean, transparent super-highs the SP-7500X speaker system features three tweeters — two 2" "super-tweeters" and an additional horn tweeter. Notice the unusually large 8" cone mic-range driver which adds a sense of presence and creates a smooth transition between the highs and lows. The four-way crossover network is built around a ferrite-core inductor with high-voltage capacitors to keep distortion way down over the entire audio range.

Now listen to the SP-7500X. Turn up the power. This speaker can handle lots of it. (130 watts peak). And always with unusually high efficiency.

The Sansui SP series is available in four models. One will certainly be ideal for your own budget and listening preferences.

All speakers simulated walnut grain enclosure.

**A whole new world of beautiful sound**

**SANSUI ELECTRONICS CORP.**

Woodside, New York 11377 • Gardena, California 90247 • SANSUI ELECTRIC CO., LTD., Tokyo, Japan  
SANSUI AUDIO EUROPE S.A., Antwerp, Belgium • In Canada: Electronic Distributors

*Sansui*



You may have noticed that few turntable manufacturers call your attention to the critical role of the tonearm in record playback. Dual is an exception.

Whatever the shape, materials or mechanics of a tonearm, the goal is always the same: to maintain the cartridge in the correct geometric relationship to the groove, and to permit the stylus to follow the contours of the groove

# Why we want you to know more about tonearms. And why others may not.

walls freely and accurately. Whenever the stylus cannot follow the groove undulations, it will gouge its own way. And as we have frequently reminded you, there is no way to repair a damaged record. Every tonearm designer should consider

geometry, mass, balance, resonance, bearing friction, and the accuracy and stability of settings for stylus force and anti-skating. However, despite the simple fact that the shortest distance between two points is a straight line, some designers are more concerned with appearance. Hence, the curved tonearm, whose deviations between pivot and stylus simply add mass, reduce rigidity and increase the likelihood of resonance.

Dual engineers have always designed for optimum performance. The essential differences in approach and results are indicated below. You might keep all this in mind when you are considering your next turntable. Chances are you'll want it to be a Dual.

**Dual**

**United Audio Products**, 120 So. Columbus Ave., Mt. Vernon, N.Y. 10553  
Exclusive U.S. Distribution Agency for Dual

The curved tonearm may appear larger than the Dual tonearm, but both actually have the identical effective length and horizontal tracking angle.

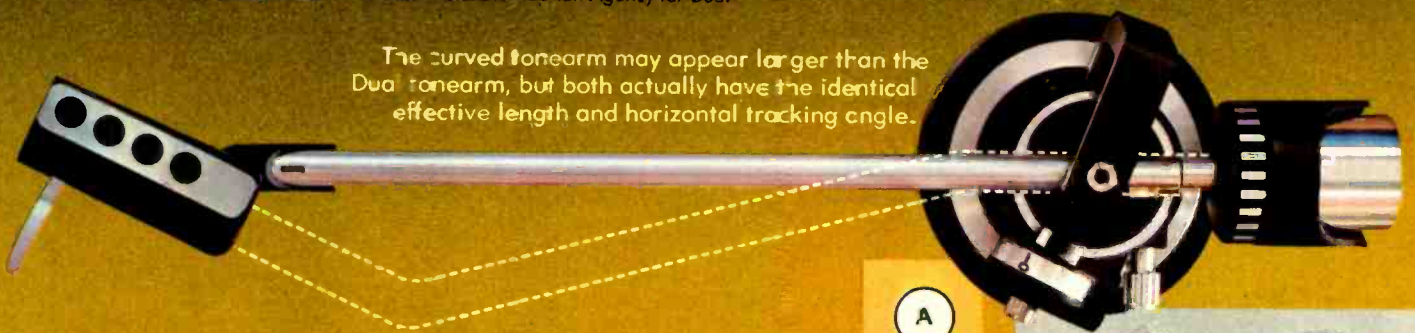

Actual size of Dual tube (A) and typical curved tonearm (B). For the same effective length, straight Dual tonearm has lower mass and resonance, yet greater rigidity.

**Dual 1249.** Single-play/multi-play. Belt-drive. Fully automatic start and stop, plus continuous repeat. Mode Selector parallels tonearm to record in single-play; 6% pitch control; illuminated strobe; cue-control viscous-damped in both directions; multi-calibrated anti-skating. Less than \$280.

**Dual 510.** Similar except semi-automatic. Lead-in groove sensor. Tonearm lifts automatically at end of play and motor shuts off. Less than \$200.

**Dual 502.** Semi-automatic. Less sensor, strobe and pitch-control. Less than \$160.

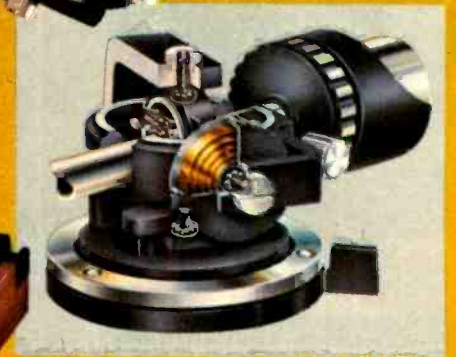

Gimbal-mounted Dual tonearms pivot horizontally and vertically on identical sets of pivot points and high-precision low-friction bearings. Bearing friction: vertical, <0.007 gram; horizontal, <0.015 gram.

Stylus force, applied by long coiled spring around vertical pivot, remains perpendicular to record even if turntable is not level.

**Specifications (DIN B):** Rumble, >€6d3; Wow and flutter, <±0.05%.



C	1	J	2		O	3	D	4	W	5	L	6	K	7	Z	8	X	9		J	10	G	11	D	12	H	13	U	14	
	L	15	Y	16	P	17	N	18		C	19	M	20	J	21	O	22	H	23	I	24	L	25	Y	26	X	27			
C	28	D	29		W	30	H	31	Q	32	J	33	S	34	P	35	G	36	M	37		S	38	X	39	A	40	K	41	
H	42	N	43		U	44	D	45	X	46	V	47	C	48	H	49	Q	50		L	51	X	52	J	53	I	54	A	55	
E	56	N	57		Y	58	M	59	A	60	C	61	J	62	W	63	L	64	V	65	O	66	G	67		X	68	H	69	
D	70	L	71	C	72	T	73	Y	74	K	75	Z	76		V	77	X	78	A	79		W	80	O	81	H	82	C	83	
L	84		O	85	F	86	J	87	Y	88	U	89	V	90		C	91	Y	92		J	93	X	94	K	95	P	96		
T	97	E	98	G	99	V	100		Q	101	O	102	C	103	J	104	U	105	E	106	H	107		N	108	Q	109	X	110	
	M	111	D	112	F	113	J	114		V	115	B	116	G	117	C	118	R	119	L	120	Y	121		Z	122	O	123		
A	124	J	125	F	126	H	127	D	128	P	129		W	130	X	131	R	132	K	133		M	134	J	135	T	136	V	137	
Y	138	O	139	B	140		X	141	CC	142	G	143		Q	144	K	145	J	146		A	147	F	148	S	149	G	150		
X	151		Q	152	A	153	O	154	L	155	Z	156	W	157	J	158	P	159	E	160		X	161	F	162		G	163		
J	164	I	165	C	166		J	167	X	168	H	169		A	170	N	171	V	172	R	173	P	174	X	175	H	176			
J	177	C	178	W	179		X	180	S	181	B	182	K	183		R	184	F	185		C	186		X	187	J	188			
U	189	M	190	D	191	T	192	N	193		A	194	C	195	K	196	H	197	O	198	U	199	M	200	W	201	B	202		
X	203	A	204	V	205	E	206	I	207	L	208	H	209	Y	210		Z	211	S	212	M	213	T	214	L	215	C	216	V	217
H	218	J	219																											

### DIRECTIONS

To solve these puzzles—and they aren't as tough as they first seem—supply as many of the Output words as you can in the numbered dashes following the Input. Unless otherwise specified in the Input, the Output consists of one English word. "Comp." means compound, or hyphenated, word.

Transfer each letter to the square in the diagram that bears the corresponding number. After only a few correct guesses you should begin to see words and phrases emerging in the diagram, which when filled in will contain a quotation related to music, recordings, or audio.

The words in the quotation are separated by darkened squares and do not necessarily end at the end of a row.

Try to guess at these words and transfer each newly decoded letter back to its appropriate dash in the Output. This will supply you with further clues.

A final clue: The source of the quotation—the author and his work—will be spelled out by the first letters in Output, reading down.

The answer to HiFi-Croctic No. 25 will appear in next month's issue of HIGH FIDELITY.

INPUT	OUTPUT	INPUT	OUTPUT
A. French composer of operettas (1848-1903): <i>Les Cloches de Corneville</i>	204 55 153 40 170 60 124 194 147 79	M. American composer of hymns, anthems, and "fuguing tunes" (1746-1800)	111 190 59 20 200 213 37 134
B. Alberich's creation	182 116 202 140	N. Foremost Dutch composer of the 16th century	193 108 57 18 171 43
C. Oratorio by Haydn (4 lt. wds.)	48 178 216 28 61 91 195 142 72 118 103 1 166 19 83 186	O. Popular ensemble, recorded "Blue Pine Trees" on Capitol	102 139 198 3 81 154 66
D. Songs of a trouvère	191 45 112 128 12 4 70 29	P. See Word E.	159 96 174 35 17 129
E. With Word P., English-German musicologist (1874-1925), authority on musical instruments	56 106 206 160 98	Q. Note sounded by organist to give congregation the correct pitch	101 32 144 152 22 85 123 109 50
F. American violin prodigy Zina, once Heifetz's youngest pupil	113 126 86 148 162 185	R. Tremolo effect on a drum	173 184 132 119
G. Making a dull sound	163 150 11 117 143 99 36 67	S. Variations for piano by Schumann, Op. 1	181 38 212 149 34
H. Norwegian conductor/composer (1886-1959): <i>The Skald of Norway; The Tides</i> (full name)	42 82 218 31 127 209 169 13 49 23 107 176 69 197	T. Slope; bias	97 73 192 136 214
I. Fruit peel	24 165 207 54	U. Characteristic specimen	189 44 105 199 14 89
J. Japanese composer (b. 1907), adapted 12-tone techniques to popular Japanese modes (full name)	87 2 164 135 62 114 188 33 146 10 177 104 219 21 53 167 158 125 93	V. Canticle of the Virgin	90 205 137 47 217 115 65 100 172 77
K. German musicographer (1813-69): four-volume biography of Mozart (full name)	95 183 7 133 41 196 145 75	W. Tenor saxophone player/band leader (b. 1926): <i>Twilight Time</i>	5 130 80 63 179 30 201 157
L. With Word Z., marching band (3 wds.)	15 208 51 120 25 6 71 84 64 215 155	X. Richard Strauss's celebration of married life (2 Lat. wds.)	203 9 187 180 78 131 168 52 39 110 161 68 175 27 151 46 94 141
		Y. German music scholar and composer (1823-94): songs, ballads, choral works (initials and last name)	138 210 92 58 16 74 121 26 88
		Z. See Word L.	211 156 8 122 76

Solution to last month's HiFi-Croctic appears on page 6.

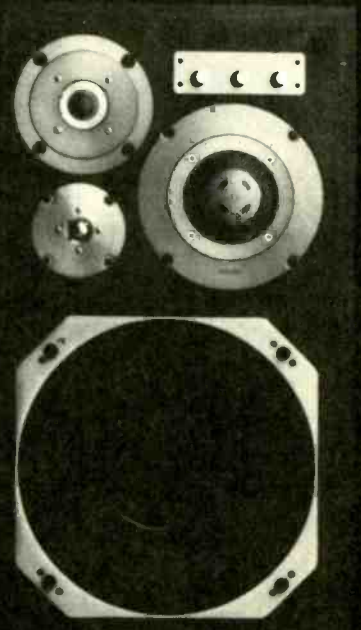
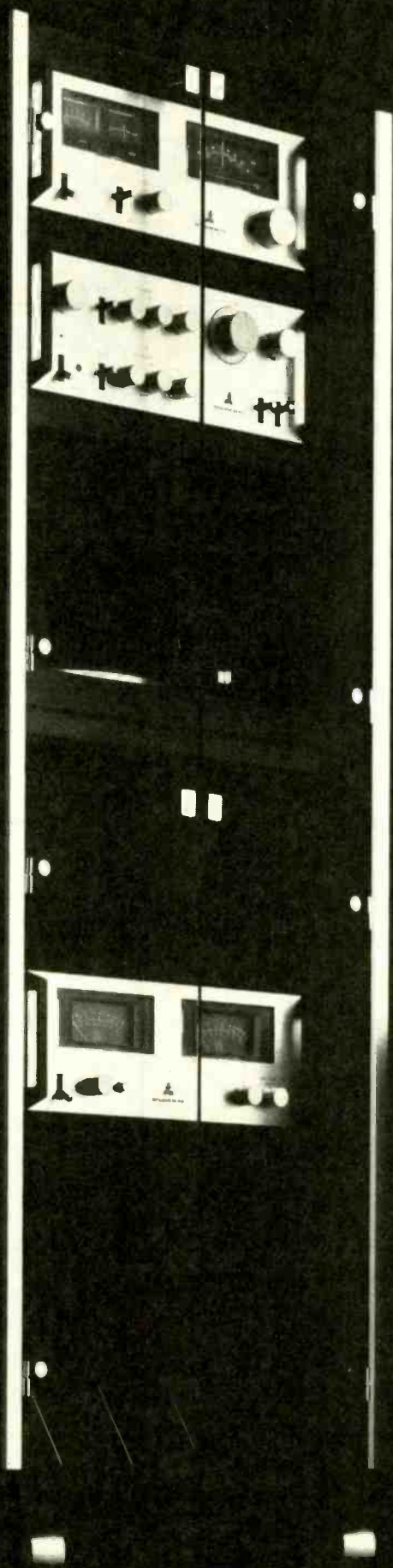



# You can't beat The System. You can only change it.

The System, from Mitsubishi.

The only one-name, one-look, high-performance system with speakers as good as the amplifier. An amplifier as good as the pre-amp. A pre-amp as good as the turntable. A turntable as good as the tuner. A tuner as good as the speakers.

And no weak links.

So, no matter how much you care to spend on alternatives, you simply cannot improve The System. You can only make it different.

Consider the loudspeakers, for example. You could substitute other legendary names in the speaker business. But none are so legendary as Mitsubishi, whose speakers are noted for superb design, meticulous construction and testing, and absolutely faultless response.

Or amplifiers. You could substitute others. But none would give you the 80dB inter-channel separation of the Mitsubishi dual-monaural amplifier in The System.

Or turntables. You could substitute something else. But something else wouldn't give you the benefit of our 3 years' exhaustive testing — covering all aspects of performance — that gave our Mitsubishi Logic Control Turntable its superb audio

quality and foolproof operation.

So, what all other names do for music, the one Mitsubishi name does for music. Without the time and trouble of collecting 7 different components from 7 different manufacturers with 7 different warranties to confuse you.

And since The System comes from one company, with one design philosophy and one standard of quality — it has to look better than any diverse assembly of components. (One Mitsubishi equipment rack is worth a thousand words.)

Still, The System isn't inflexible. You can tailor one to your needs, and your available funds. At prices ranging from about \$1,600 to about \$3,000.

Your audio dealer will be happy to audition all the possibilities for you.

All-Mitsubishi.

Or partly Mitsubishi, and partly alternatives.

And we think you'll agree. There aren't really any alternatives.



For more information write Melco Sales, Inc., Dept. H, 3030  
East Victoria Street, Compton, California 90221.



# It's the real thing $\pm 1$ dB.

"Phono-cartridge performance has come a long way in recent years, as can be judged from the 2000Z's measured frequency response. Including the effect of arm resonance in a typical tone arm, and combining the measurements from a couple of records, the response could honestly be described as  $\pm 1$  dB from 15 to 20,000 Hz. This is comparable to the flatness of most amplifiers, especially if the tone controls cannot be bypassed."

**Stereo Review**

"Finally the light dawned: This is a neutral cartridge — it's supposed to sound that way. The highs are not subdued; they are just smooth, rather than peaky and shrill. Instrumental timbres are reproduced in fine detail, but without being artificially pointed up. Thus one is able to hear soft inner voices and pastel shadings that are all but obscured by the bravura of some of the competition."

"The Empire 2000Z is truly impressive. It is well worth auditioning, even though that can't be done in a hurry if you are to hear — and savor — its quality."

**HIGH FIDELITY**

"The Empire 2000Z offers extremely smooth response in the audible range and, even at the light tracking force (1.0 grams) at which our listening tests were conducted, never failed to track the grooves of even our most dynamically recorded musical test passages. Highs were silky smooth, never 'edgy' or raspy and there was not even a hint of 'peakiness' in the important 12,000 to 16,000 Hz range where so many other pickups often add distinct and easily identifiable coloration."

**Radio-Electronics**

"Frequency response was among the smoothest we have ever recorded for a stereo cartridge and actually did not deviate more than the plus or minus 1 dB specified over the entire audio spectrum. Resonance has been pushed way out beyond the audio range and we suspect that some of the stylus engineering developed for Empire's CD-4 (4000 series) cartridges has been brought to bear in this design to accomplish that feat."

**audio trade news**

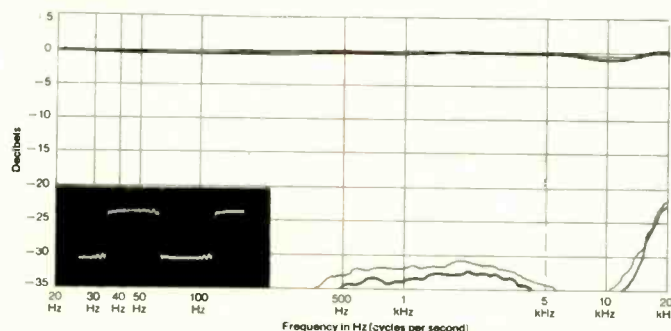

*In the graph frequency response was measured using the CBS 100 Test Record, which sweeps from 20-20,000 Hz. The vertical tracking force was set at one gram. Nominal system capacitance was calibrated to be 300 picofarads and the standard 47K ohm resistance was maintained throughout testing. The upper curves represent the frequency response of the right (black) and left (grey) channels. The distance between the upper and lower curves represents separation between the channels in decibels. The inset oscilloscope photo exhibits the cartridge's response to a recorded 1000 Hz square wave indicating its resonant and transient response.*

For more information on the Empire 2000Z, and our free brochure "How to Get the Most Out of Your Records," write: Empire Scientific Corp., Department  $\pm 1$  dB, 1055 Stewart Avenue, Garden City, N.Y. 11530.

**EMPIRE**

CIRCLE 14 ON READER-SERVICE CARD



**A CONSUMER'S GUIDE**

# New Equipment Reports

Preparation supervised by  
Robert Long, Harold A. Rodgers,  
and Edward J. Foster  
Laboratory data (unless otherwise noted)  
supplied by CBS Technology Center

## Cizek: A New—and Welcome—Name in Speakers

**The Equipment:** Cizek Speaker, a loudspeaker system in wood enclosure. Dimensions: 25 by 15½ by 9½ inches deep. Price: \$198. Warranty: "full," five years parts and labor (includes shipping carton). Manufacturer: Cizek Audio Systems, Inc., 149 California St., Newton, Mass. 02158.

**Comment:** At a time when many loudspeaker designers are using vented "Thiele-alignment" systems, Cizek's new two-way acoustic-suspension system seems to be looking slightly backward. Tradition is not the font of all knowledge, surely, but it usually has something to offer. In this case, the sealed box limits the excursions of the woofer cone on subsonic signals, an advantage not shared by vented systems. Furthermore, the trapped air provides a more linear restoring force for the cone than does a mechanical suspension—and that usually means cleaner bass.

The crossover network, which is innovative, uses an unusual configuration that Cizek claims combines the advantages of a first-order constant-voltage-transfer network with those of higher-order networks. On that we can't comment, but we can point to the exceptional flexibility of the crossover controls located behind the removable grille. Besides a more or less conventional HIGH FREQUENCY LEVEL CONTROL that raises and lowers the entire response of the tweeter with respect to the woofer, there is a five-position HIGH FREQUENCY CONTOUR CONTROL that introduces a gently sloping characteristic above 2, 3, 4, or 6 kHz. The fifth position produces nominally flat response. Finally, a two-position toggle switch sets the Q (a measure of the damping) of the woofer/enclosure system to either 1.0 or 0.6. In the latter position, the woofer is damped for best transient response at the expense of some low bass response.

Lab data taken at CBS Technology Center indicate an extremely smooth impedance curve, suggesting excellent power-transfer characteristics. The minimum impedance—our nominal rating—is 4 ohms at 115 Hz. A single pair of Cizeks should be easy to drive from any amp. (These data, and all CBS data, were taken with a Q of 0.6 and with the HFL and HFC controls in their FLAT positions. According to the manufacturer, the system impedance with a Q of 1 is 7¼ ohms.)

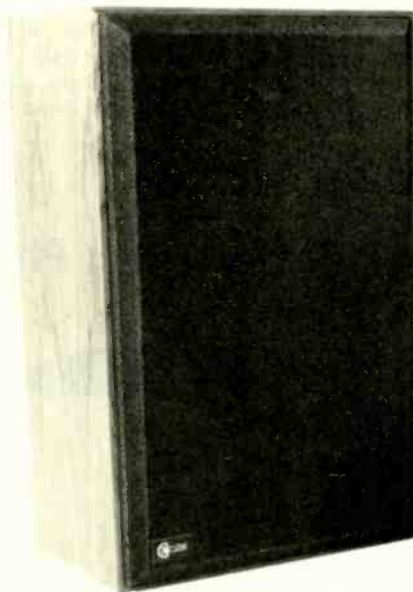

The efficiency is just a shade below average. A 0-dBW (1-watt) input of pink noise between 250 Hz and 6 kHz produces a sound pressure level of 86¼ dB at 1 meter. CBS achieved an SPL of 107 dB at 1 meter, more than adequate for listening, with a 20-dBW (100-watt) continuous sine-wave input at 300 Hz. The distortion at this level is 2.8%. On 300-Hz pulses, the speaker shows no clipping at maximum amplifier power (29½ dBW, or 900 watts, peak), for a peak SPL of 116½ dB.

At more realistic levels, the harmonic distortion is very low, about ⅓% or better at 85 dB SPL with either 80- or 300-Hz signals. At 90 dB SPL, the 80-Hz distortion is a bit over ½%, and some buzzing was noted at the 95-dB level. At 300 Hz, an SPL of 95 dB is achieved at less than ⅓% distortion, while at 100 dB SPL the THD still is under 1¼%.

Measurements taken in the anechoic chamber indicate that the HFL control reduces on-axis response at frequencies above 2 kHz by up to 3 dB. Going from FLAT to the C<sub>4</sub> position of the HFC turns the response at 15 kHz downward by about 4½ dB.

The Q switch affects the bass response in the region be-

---

**REPORT POLICY** Equipment reports are based on laboratory measurements and controlled listening tests. Unless otherwise noted, test data and measurements are obtained by CBS Technology Center, Stamford, Connecticut, a division of Columbia Broadcasting System, Inc., one of the nation's leading research organizations. The choice of equipment to be tested rests with the editors of HIGH FIDELITY. Manufacturers are not permitted to read reports in advance of publication, and no report, or portion thereof, may be reproduced for any purpose or in any form without written permission of the publisher. All reports should be construed as applying to the specific samples tested; neither HIGH FIDELITY nor CBS Technology Center assumes responsibility for product performance or quality.

---

low 100 Hz. In the 1.0 position, the response between 33 and 100 Hz peaks relative to that in the 0.6 position by a maximum of about 1 dB at 50 Hz. Below 33 Hz, the higher-Q system rolls off faster, as is to be expected.

The on-axis response shows a dip of about 6 dB in the crossover region (just above 1 kHz), indicating some phase cancellation between the drivers. The average front hemisphere response curve has a much smaller dip, and there is essentially none in the average omnidirectional curve. The latter, which we believe is more indicative of the overall response of a speaker, is very smooth ( $\pm 3\frac{1}{2}$  dB from 40 Hz to 16 kHz), especially so for a two-way system. With the exception of the dip near 1 kHz and a less significant one at 6 kHz, the three curves track well, indicating good dispersion.

For our listening tests, we placed the speakers with their backs against the wall, several feet above the floor and well away from the corners of the room. While the lab data showed that the controls have only a gentle effect on the

response, we could hear definite differences in the music—and we had our preferences. For example, the tighter bass with Q set to 0.6. For pop and jazz, we liked the  $C_2$  position of the HFC switch with the HFL set at -2; for classical music, we turned up the controls to  $C_1$  and -1, respectively.

The transient response of the Cizeks is exceptionally good. The stereo imaging, though a bit lacking in depth, also is very good. The over-all listening-room response is strikingly wide, as indicated by vivid reproduction of brushed cymbals and well-defined (if slightly heavy) bass. We did note a certain harshness in the flute and piccolo as well as on violins in the upper register. This may be due to the dip in response at the crossover or perhaps to some distortion when the tweeter is driven hard in its lowest octave—a common characteristic of two-way systems.

And though the quality of its sound may lead us to forget the fact, the Cizek is a two-way system. In that league it rates high indeed. It's one of the best we've heard.

CIRCLE 131 ON READER-SERVICE CARD

## Jennings Vector I: Phasing Virtues and a Foam Halo

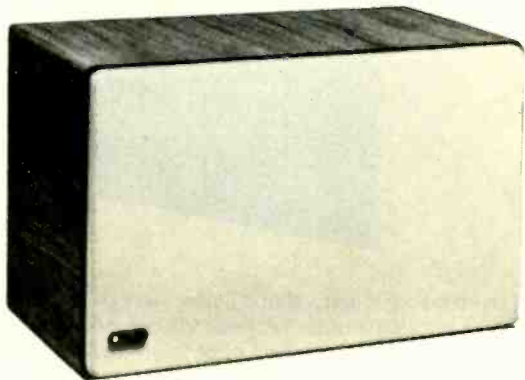

**The Equipment:** Jennings Contrara Vector I loudspeaker system in wood-veneer enclosure. Dimensions: 23 by 14 by 10 $\frac{3}{4}$  inches. Price: \$170; optional V-base tilted stands, \$50 per pair. Warranty: "limited," five years parts and labor. Manufacturer: Jennings Research, Inc., 28-11 Cahuenga Blvd. West, Los Angeles, Calif. 90068.

**Comment:** For years, the drivers of most loudspeaker systems have been mounted flush with the front surface of the enclosure. Not much thought was given to the fact that the woofer cone is relatively large and deep while the tweeter is small and shallow, which gives rise to a time discrepancy between the radiation from each if they are mounted on a common surface. This lack of time synchronization or phase coherence affects the transient response and clarity of the sound—or, at least, so the argument goes.

The importance of phase coherence in a live listening room is still the subject of technical debate and is likely to remain so for some time. We have heard demonstrations that purport to show the importance of acoustic phase coherence and, indeed, a distinctive change in sound character was discernible as the system was switched to and from its phase-coherent mode. In principle, it appears to us that assuring phase coherence at the loudspeaker itself is a step in the right direction, regardless of what happens af-

ter the sound is reflected from the walls of the room, since the direct sound field—that which reaches your ears before any reflections occur—plays a major role in establishing stereo imaging and transient characteristics.

In any event, phase coherence seems to be the "in" thing in 1977 and has given rise to some pretty wild-looking loudspeakers: front-projecting woofers with midranges and tweeters staggered backward to line up the "plane of radiation" of the different drivers. The Jennings Vector I accomplishes the same result in a more conventional enclosure. The 8-inch woofer is mounted flush with the front surface, but the tweeter is recessed behind the surface. To avoid the diffraction effect of sharp edges near the tweeter, an "integrated acoustic foam cone" surrounds the tweeter like a gray halo, absorbing any reflected radiation.

The Vector I is a two-way system with a 1,750-Hz crossover. A two-position switch behind the removable grille sets the tweeter/woofer balance. A rear-mounted 8-inch passive radiator tunes the enclosure to extend the bass response. There is no protective grille over the rear-mounted radiator, and it might be very easy to damage the cone if suitable precautions aren't taken. That aside, the cabinet is above average in construction and nicely finished on four sides in oiled-walnut veneer.

The data taken at CBS Technology Center were, for the most part, accumulated with the tweeter switch in the INCREASE position. The nominal impedance is 4.4 ohms (at around 130 Hz), somewhat below the manufacturer's 6-ohm rating. Above this minimum, the impedance rises quite smoothly to a maximum of 16 ohms at 20 kHz, so the average probably is 6 ohms or more. Nonetheless, some care should be taken in paralleling the Vector I with other speakers. (Even if we accept Jennings' 6-ohm rating for the Vector I, two in parallel would present a 3-ohm nominal load—below the 4-ohm minimum recommended for most solid-state amps.) The upper resonant point of the vented woofer system occurs at 60 Hz (for a 16-ohm impedance), while the lower occurs below 20 Hz.

The system's efficiency is a shade higher than average.



A sound pressure level of 88½ dB was measured at 1 meter with a 0-dBW (1-watt) input. The maximum output level of the Vector I, both with continuous and with pulsed 300-Hz tones, also is a bit above average—quite an achievement for a system of this physical size. A continuous sound pressure level of 107 dB was achieved at 1 meter with an input of 18 dBW (64 watts), for a distortion of less than 6¼%; above 107 dB, the results were inconsistent. The lab measured 114½ dB SPL with pulses having a peak power of 25½ dBW (363 watts) before exceeding the excursion limits of the driver. At more reasonable sound levels, the THD of the Vector I is lower than average except for an increase in 80-Hz second-harmonic content at relatively low test levels (75 dB SPL).

With the tweeter sensitivity at NORMAL, the on-axis response measurement exhibits substantial dips in the crossover region (1,750 Hz) and again around 4,600 Hz. Curiously, the dips fill in quite well (to about a 5-dB hole) when the tweeter switch is set to INCREASE. Elsewhere, there is about 4 dB of change in high-frequency level depending on the switch position. The front hemisphere and omnidirectional response curves, which are more representative of perceived sound, do not exhibit this anomalous behavior. In fact, the omnidirectional response is quite smooth: within 4 dB of nominal (85 dB SPL) from about 45 Hz to 16 kHz.

## Bertagni's Biggest "Geostatic"

**The Equipment:** Bertagni Geostatic D-120 speaker system. Dimensions: 52½ by 20 by 3¾ inches; base: 17¾ by 14½ inches. Price: \$549. Warranty: "limited," three years parts and labor. Manufacturer: Bertagni Electroacoustic Systems, Inc., 345 Fischer St., Costa Mesa, Calif. 92626.

**Comment:** For good or ill, Professor Bertagni's fame and that of his speakers has preceded his product, making it unusually difficult to approach with an open mind. We find that listeners' opinions are easily colored by the innovative principles of the drivers themselves (see Peter W. Mitchell's article in this issue), by the Geostatic name and the resemblance of the D-120 to an electrostatic panel, and by the lackluster sound of plastic-foam panel speakers previously available on the American market. After extensive listening, we have come to the conclusion that, while there may be a modicum of meaning in all of these associations, each is more misleading than it is informative.

The panels are panels and therefore share with electrostatics some propagation properties. Since they deliver as much sound to the back as they do head-on, positioning takes some care if the back wave is not to be swallowed up by overly absorbent materials behind the speaker or, conversely, reflected in such a way as to roughen response (usually caused by the panel's being too close to, and parallel with, the wall behind it). Barring obviously poor positioning choices, however, we did not find the D-120 to be particularly fussy; many changes produced little or no audible alteration in the sound.

Connections (via bared wires) are made at the back of the base, to spring-loaded, color-coded posts. Next to them are a circuit-breaker reset button and two rotary controls: for midrange and highs respectively. (Identify which is which while you're tightening the two screws that hold the "foot" plate in place; with the speaker in working posi-

To get the best performance from the Vector I, we'd strongly recommend a good subsonic filter in the record-playing chain. The system is tuned to a very low frequency, and the small woofer goes through some wild excursions without a filter—even when playing relatively unwarped discs. With the filter switched in, the woofer and drone cones calm down, and the sound is much cleaner. We'd also suggest that you experiment with placement. Stood on the floor, perhaps 10 inches out from the wall and well away from the room corners, the Vector I's produced a prodigious bass output—too much for our tastes, so we preferred them raised several feet above the floor and moved out into the room. This reduced the apparent bass but provided better balance in our listening room. (Our test samples did not have the optional tilting bases.) We definitely prefer the tweeter switch in the INCREASE position, with a slight treble cut in the preamp to avoid excessive brightness.

Set up as we describe, the sound character of the Vector I is very satisfying. Definition is good, and the stereo imaging is exceptional in both width and depth. Whether this can definitely be ascribed to the "linear phase coherent" design we can't say, but we can attest to the superior performance of the Vector I in this regard; more likely than not, LPC has a lot to do with it.

CIRCLE 134 ON READER-SERVICE CARD



tion, we had to lie flat on the floor to read the identifications.)

The CBS measurements show that the MID gives a total adjustment range of approximately 6 dB between about 1 and 6 kHz. The HIGH knob has most effect above about 8 kHz, where the adjustment range is similar. The instructions suggest experimentation (always a good idea), starting with the maximum position of the MID control and halfway for HIGH. At the end of the experimentation we found ourselves back at ground zero and left the controls at these recommended positions for most of our listening. Bertagni also suggests corner placement if you like emphasized bass. Our experiments in this direction led us to concede that the bass is most natural (if not super-deep) when the speakers are kept out of the corners.

The efficiency is relatively low—approximately that of a typical acoustic-suspension system; an input of 0 dBW (1 watt) in the band between 250 Hz and 6 kHz produces a sound pressure level of 83¾ dB at 1 meter on axis in the anechoic chamber. Of course since dispersion is nearly omnidirectional in all planes (omnipolar, as Bertagni calls it) for most frequencies at which this test is made, more off-axis energy is “lost” than is the case with typical bookshelf designs, so the relative in-the-room efficiency of the Bertagni is somewhat higher than a comparison of efficiency numbers might suggest. But it is not high. Bertagni recommends 250 watts (24 dBW) per channel to drive the D-120s. While this may lean a little to the other extreme—offering more power than most home users will actually need—it is by no means an unreasonable suggestion.

The speaker is rated for 20 dBW (100 watts) continuous input at 400 Hz; sure enough, at 20 dBW—and an acoustic output of 105 dB—the circuit breaker tripped in the 300-Hz test. Up to that point, 300-Hz distortion is very well controlled; above it, the lab was able to feed 300-Hz pulses into the D-120 until the test amplifier ran out of power at more than 28 dBW (630 watts) peak, for an output of 113 dB SPL, without untoward behavior from the speaker. At 80 Hz, with continuous tones, the distortion proves somewhat higher though still essentially well controlled, to above 95 dB SPL before buzzing begins. All this translates to excellent dynamic range for all purposes short of discotheque levels in large rooms.

Impedance, response, and dispersion—all of which are related, of course—are somewhat difficult to characterize because all are nonstandard with respect to conventional drivers. The swings of the impedance curve all are well within the range between 4 and 16 ohms, for an exceptionally flat over-all characteristic. (Bertagni rates the D-120 at 4 ohms; the rating point measures 5.5 ohms, giving some safety margin but requiring that the speaker be treated as a 4-ohm model.) The impedance curve contains an unusual number of small peaks and dips, however—presumably reflecting the unusual modal behavior and consequent mechanical impedance of the diaphragms.

Nor is the response—whether considered on axis or “omnidirectionally”—particularly free of peaks and dips. Most speakers are relatively omnidirectional in the bass and become progressively beamy as frequency rises. Not

so the D-120. At the sides there is the noticeable null to be expected at high frequencies in panel speakers; at other positions and frequencies the relationship between dispersion and response—that is, between seating position and coloration—is unusually complex. Again, we take this to be, at least in part, a concomitant of the diaphragm behavior inherent in the design.

Fortunately, most of the discernible coloration is minor. Probably the most noticeable is a tendency for female voices to thicken toward the top of their range—say, around 1 kHz. This appears to be related to the rapidly falling response in the overtone range for these notes (approximately 1.5 to 3 kHz), the lower “wall” of a broad dip in the lower treble. The effect is more difficult—and often impossible—to spot with instrumental music. It is difficult to characterize the dip involved because the dispersion characteristics and the action of the controls both are so complex. The fairest statement we can make about omnidirectional anechoic response is that it appears to be within  $\pm 5\frac{1}{2}$  dB from the bottom limit of reliability in such tests (say, about 40 Hz) to beyond audibility, representing uncommonly broad, but not uncommonly flat, response.

The stereo imaging of the D-120 is excellent. Typically, for an omnidirectional radiator that depends heavily on room reflections, the image is big. With good program material it also can offer startling depth and the illusion that the music is being performed right in the listening room. This sometimes uncanny verisimilitude was judged by some listeners to be the most attractive feature of the system.

Again, this is not a speaker about which it is easy to keep an open mind. While our listeners—like our readers—are always enjoined to do so, we are all subject to our own predilections. There is enough difference between the propagation principles of the D-120 and those of other speakers that we would expect considerable differences of opinion about their merits, and we found them. But if you're at all interested in panel speakers, this is a model that you owe it to yourself to hear. It also is available in smaller, less costly versions (which we have not auditioned). It proves unequivocally that plastic-panel drivers have come a very long way since the last time we tested any, but it is not a speaker that will please everyone.

CIRCLE 132 ON READER-SERVICE CARD

## Manufacturers' Comment

**We invite rebuttal from those who produce the equipment we review. The comments printed here are culled from those responses.**

**Bang & Olufsen Beomaster 1900 receiver (March 1977):** You state erroneously that the Beomaster 1900 is rated for an 8-ohm load. The specified load is, in fact, 4 ohms.

Your comments about the imbalance between phono and FM are well taken. In searching for the cause of this 8- to 10-dB difference between FM and phono outputs, we discovered that no such imbalance exists in Europe. This led us to a comparison of FM transmission there and in the U.S. As you know, 75 kHz is the maximum swing; most U.S. transmitters operate near this limit, however in Europe most transmitters modulate with a swing of approximately 25 kHz. This would seem to be the major cause for the difference.

As an immediate solution, phono output has been increased 3 dB and FM reduced 3 dB, which results in a difference of 3 dB or less. All servicing dealers and service stations are capable of modifying receivers already in the field should this imbalance prove to be annoying to the owner.

HARRY HORNING  
Director of Training  
Bang & Olufsen of America, Inc.

**HF replies:** We stand corrected on the matter of rated load impedance. We note, however, that the unit makes rated power at low distortion into an 8-ohm load, exactly as stated in the report—which is more to the point when considering the Beomaster 1900 as a separate receiver. B&O uses the 4-ohm rating because that is the impedance of the speakers supplied with the receiver in the Beosystem 1900.



## Koss Model Two

### Turns the Tables

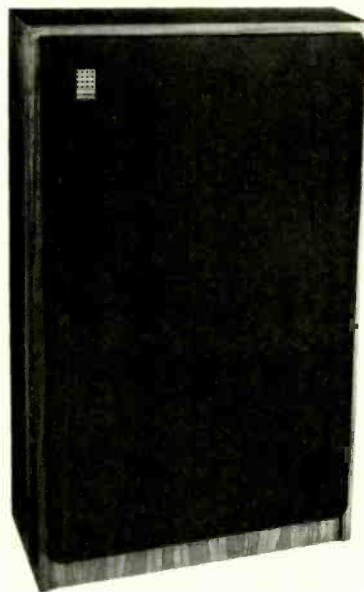

**The Equipment:** Koss Model Two electrostatic speaker system. Dimensions: 41 by 24 inches; 11½ inches deep at bottom, 6½ inches deep at top. Price: \$650. Warranty: "limited," one year parts and labor, shipping included. Manufacturer: Koss Corp., 4129 N. Port Washington Ave., Milwaukee, Wis. 53212.

**Comment:** Traditionally, the vulnerable point of electrostatic loudspeakers has been in low bass response. The problem, while not of dimensions that would earn it the sobriquet "Achilles heel," has led many a designer to elicit aid from the dynamic camp in the form of a large woofer with which to underpin his electrostatic creation. But the Koss Model Two has changed all that, standing the conventional wisdom of loudspeaker design on its head in the process. This is a speaker with an electrostatic woofer and midrange driver topped off by a dynamic tweeter—and, if anything, it may have a bit too much bass for some tastes.

Rated by the manufacturer at an impedance of no less than 4 ohms from 10 Hz to 50 kHz, the Model Two shows a nominal impedance of 5.5 ohms at 200 Hz. The curve is somewhat peaky and rises twice into the neighborhood of 16 ohms, although it remains well above 4 ohms in the audio bandpass. The data (and our experience) suggest that a single pair of these speakers is a safe load for a solid-state stereo amp.

Testing by CBS labs indicates that the Koss, as might be expected on the basis of its design, is notably inefficient, producing an average sound pressure level of just under 79 dB when driven with a 0-dBW (1-watt) pink-noise input bounded by 250 Hz and 6 kHz. Power handling capability is such, however, as to allow plenty of dynamic range; a continuous 300-Hz input at a level of 20 dBW (100 watts) is accepted without objectionable distortion and results in an output level of 105 dB SPL at 1 meter on axis. A pulsed input at the same frequency using a peak power of 28 dBW (654 watts) results in a peak output of 113 dB with clipping just evident. At 80 Hz, distortion becomes apparent at lower power and sound pressure levels, although—probably because it consists chiefly of low-order harmonics—it is difficult to perceive when listening to music.

Installation of a pair of Model Twos should pose no great problem. Koss has provided clear suggestions as to placement, and hookup (via terminals that accept bared wires) is straightforward. Access to an AC power line (for the bias supply) is necessary at the speaker positions. The tweeter level control, which can shift the output of that driver 2 to 3 dB up or down with respect to the median setting, is effective between 2.5 and 19 kHz. Koss's diagram indicates a somewhat restricted preferred listening area, but the high frequency dispersion of the cone tweeter preserves acceptable listening quality somewhat beyond the recommended region.

The sound of a pair of these speakers is solid, clear, and—due to its hefty output in the midbass region—just a trifle somber. Generally the Koss seems happiest with orchestral music, which is especially well served by the life-size and detailed stereo image. Voices are very plausibly reproduced but tend to sound just a bit distant. To our ears, the best sound comes when the bass is rolled off a few dB via the tone control (although in another environment, the extra bass might prove welcome). The highs are all there, if a trifle hard-edged at times, and transient response is acceptably clear without being clinical. Over-all average omnidirectional frequency response, measured in the anechoic chamber, is  $\pm 3\frac{3}{4}$  dB (re 77 dB SPL) 45 Hz to 15 kHz.

What is uncanny about the Model Two, however, is its ability to suggest that there is space around the various instruments or voices and that they have particular locations in that space. The stereo image has an excellent sense of depth, rivaling at times the vividness of quadraphonic reproduction. And sound pressure levels approaching muscle à la disco are produced with no sense of strain.

We would expect that someone considering an investment equal to the price of two of these speakers will move cautiously and already have developed tastes in audio equipment. The Koss has a definite personality that may not suit everyone, but the personality is most engaging and gets along very nicely with music. So, fussy and perfectionistic though you may be, you will probably find that the time it takes to audition a pair of these "upside-down" electrostatics is time well spent.

CIRCLE 133 ON READER-SERVICE CARD

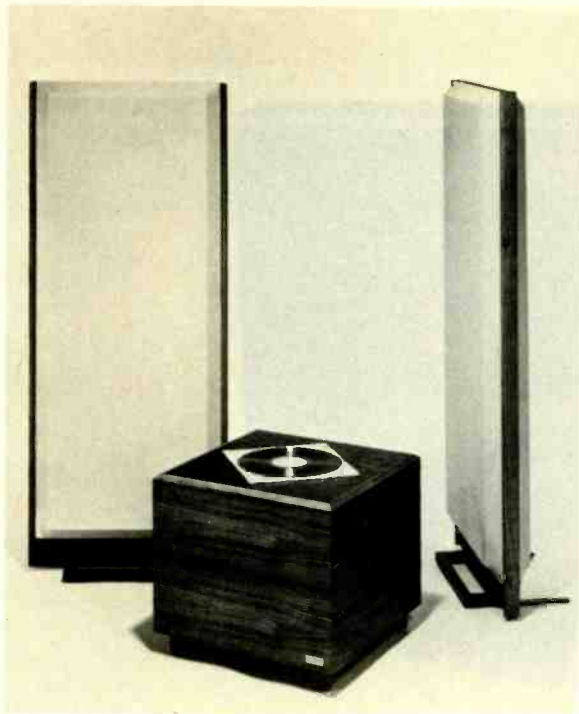

## Phase Linear's Master Illusionist

**The Equipment:** Phase Linear Model III loudspeaker system. Dimensions: 24 by 63 inches, 5 inches deep (panel); 22 by 22 inches, 18½ inches high (commode). Price: \$1,185 per pair. Warranty: "limited," three years parts and labor. Manufacturer: Phase Linear Corp., P.O. Box 1335, Lynnwood, Wash. 98036.

**Comment:** A single look at the Phase Linear Model III loudspeaker system makes clear that it is unique, but that look will give little clue to the extent of that uniqueness or to the sophisticated laws of design that govern the interaction of the twenty drivers that make up the two-channel system. It is, fittingly, the ear that first perceives that some electronic wizardry is afoot; the sonic impact of the Model III is simply amazing.

The system consists of four parts: two free-standing panels, a single bass commode containing subwoofers for both channels, and an Electronic Motion Control Module—a box that connects between preamp and power amp (or in a tape-monitor loop) and contains variable equalization and some other circuitry. The panels each contain five tweeters, two midrange drivers, and two woofers, and are crossed over to the commode at about 140 Hz, where sound propagation is essentially omnidirectional. The placement of the commode, therefore, is not critical. The design of the panels, with conical reflectors provided for the upward-firing tweeters, is aimed at omnidirectional dispersion—which, judged audibly, is very nearly achieved. Only at locations in and very near the actual plane of the panels are there any irregularities in the distribution of the middles and highs.

The on-axis sweep-frequency response measured by CBS from about 2.5 to 19 kHz would ordinarily be regarded as shockingly ragged, but (surprisingly) the succession of sharp peaks and dips that are in evidence are there by design. Phase Linear calls the effect "bounded

ripple" or a "comb filter" and finds it useful in reproducing ambience, provided that the peaks and dips (which have a smooth envelope) are at different frequencies in the two channels. Actually, unusual effort has been expended on ambience recovery; the control module has a knob that can increase the level of out-of-phase information (derived from the program material by a special circuit) routed to the speakers, and the placement instructions suggest that the panels be set up where the back wave will reach the listener after a delay of 14 to 28 milliseconds. The effect of the control depends heavily on the room, the arrangement of the panels, and the program material. In our listening sessions (much of which were performed with the speakers further from the rear wall than suggested), we found the ambience unusually opulent—and convincing.

To the ear, the transient response of the Model III is extraordinarily fast and clean—and well damped to boot. The conflicting requirements of heavy damping and quick response are met in a new and ingenious way: by using a relatively slow and massive tweeter and "speeding up" the signal—via circuits in the control module—so that the tweeter output arrives on time.

The impedance curve of the system is smooth and without extreme peaks or dips. The nominal impedance is 5 ohms, but there is a broad trough between about 200 and 700 Hz, where the impedance falls below 4 ohms and could give some solid-state amps a problem. Actually, because of the extremely low efficiency of the system—a 0-dBW (1-watt) pink-noise signal, 250 to 6,000 Hz, produces a sound-pressure level of 74 dB at 1 meter on axis—we would suggest that an amp in the upper part of the range recommended by the manufacturer (17 to 25½ dBW, or 50 to 350 watts) be used. Most amps in this category will tolerate the impedance dip.

When sufficient power is available the dynamic range of the Model III is vast. A steady SPL of 98 dB is produced by an input of 20 dBW (100 watts) at 300 Hz with no sign of strain from the speakers; both the lab measurements and our extended listening tests suggest that higher SPLs are easily within reach. Similarly, the 105-dB peak SPL produced by a pulsed input at the same frequency exhausted the test amp, which had delivered a peak output of 27¼ dBW (520 watts).

Quite frankly, the Phase Linear Model III is so special a loudspeaker that we find ourselves at something of a loss in trying to relate its frequency response to its performance. The total omnidirectional, anechoic curve is extended and reasonably smooth, but does not suggest the beautifully balanced sound of which the unit is capable. The 3-step equalization controls affect the bass (below 250 Hz), midrange (100 Hz to about 1 kHz), and highs (above 1 kHz) in steps of about 2 dB. Distortion is certainly low, right down to low frequencies, and this contributes to realism through a sense of utter ease. But if the Model III has any particular strong point, it is the spectacular stereo image—life-size, vivid, and with lots of depth. The system makes it seem as if the end of the listening room is open and abuts a concert hall, and when two more high-quality speakers are added to make a quadraphonic array, the effect is stunning.

We are quite certain that this loudspeaker system rates a place in the forefront of state-of-the-art design; we are equally certain that we did not get the best out of it—simply because we lacked the time to experiment at length with placement and, possibly, equalization. So novel a speaker takes time to reveal its personality, engaging as it is on first acquaintance. Its price is rather high, but when have superstars been cheap?

CIRCLE 135 ON READER-SERVICE CARD



# Advance- Meant...



To create a full featured cassette recorder at an affordable price. Well, our engineers out did themselves. To them, advance meant creating our Exclusive Biaset feature. A continuously adjustable recording bias control that lets you set the bias best suited for the formulation of any cassette tape. From normal to chrome and ferrichrome tapes. As a matter of fact, Dokorder engineers built into this Biaset feature a setting for tapes that haven't even been produced yet!

The MK-630 also has 3-position Dolby Noise Reduction selector, a newly engineered DC servomotor system, mic/line mixing and more.

This is what advance meant to us. Investigate the Dokorder MK-630 Cassette Tape Deck... and it will mean the same to you.

SUGGESTED RETAIL PRICE  
MK-630... \$379.95

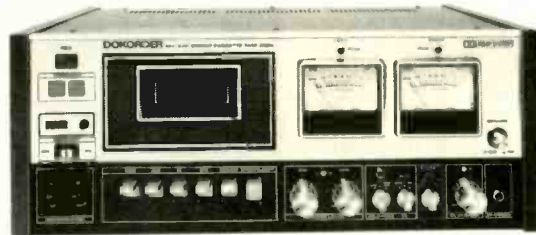

Telling it like it is.

## DOKORDER

5430 Rosecrans Avenue, Lawndale, CA 90260 U.S.A.

CIRCLE 13 ON READER-SERVICE CARD

*A New Version of This Country's Most Popular  
And Most Imitated Speaker System.*

# The New Advent Loudspeaker.

Over the past few years, the Advent Loudspeaker has gone into more people's homes in the United States than any other speaker system. It has been imitated over and over, and has been used consistently as a standard of performance (even by salesmen and companies trying to sell other speakers). It has also prompted an almost incredible number of unsolicited praise letters from satisfied owners.

The new Advent Loudspeaker sounds very much like the original. It should, since the frequency balance, clarity, and neutral, "open" quality that contribute to the sound-character of a really excellent speaker shouldn't need much alteration—and shouldn't be subject to change for the sake of change.

But the New Advent Loudspeaker is audibly different at the high end of the frequency range. The change has been made possible, and worth making, by improvements in the high-frequency capabilities of tapes, broadcasts, and—most of all—records.

## **About Speaker Design.**

Despite all the advertising to the contrary, it is not hard to design a good loudspeaker. The necessary knowledge and materials have been available for quite a while, and any of many design concepts can produce excellent sound.

But the trick, to our way of thinking, is to produce a balanced product. One that doesn't lead the customer to pay unnecessarily for an overelaborate design concept, or for a "solution" to a nonexistent problem. And one that sounds good not just under "ideal" conditions or in an artificial laboratory environment, but under the widest range of actual conditions in people's homes.

Knowing that complexity has often been a substitute for good design in speakers, and that a great deal of speaker design doesn't have all that much to do with the requirements for *home* listening, we designed the original Advent Loudspeaker to fit at the lowest possible cost into the "best" category in speaker performance in a home. Its success has been underlined for us not just by the number of original

Advents sold (half a million), but by the *kind* of satisfaction people have continually reported—to us, and to their friends.

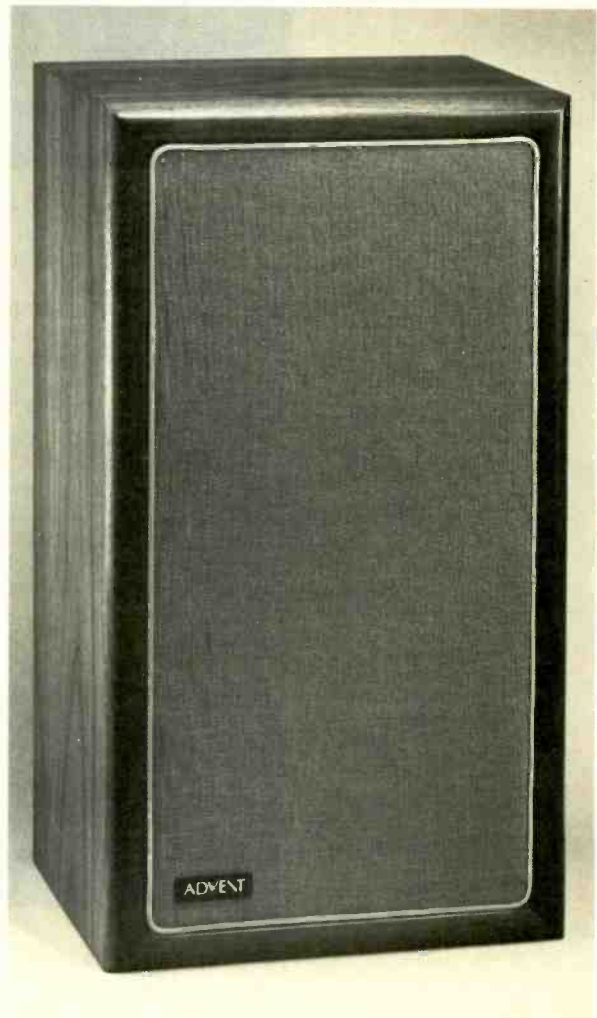



## The Difference And How It Came About.

A vital part of designing a speaker for use in the real world is to consider the capabilities and limitations of recording and broadcasting processes at a given moment. For most of the high-fidelity era, the most important limitation on actual usable performance in a speaker has been the high-frequency limits of recordings.

Almost twenty years ago, for instance, some of us now at Advent were involved in a live-vs-recorded test of an "ideal" tweeter design that could, and did, sound identical to the live source. But this same tweeter was absolutely unlistenable for playback of recordings, particularly for LP records. It mercilessly revealed the tremendous residual noise and distortion (from tape hiss, cutter limitations, vinyl imperfections, and other sources) present on records at high frequencies.

By the time we designed the original Advent Loudspeaker in 1969, tremendous improvements had been made in recordings and broadcasts. But there were still important limitations, and the total high-frequency energy output of the Advent was balanced to suit that reality and match well with the mixture of new, not-so-new and old LP's in most people's record collections.

In the 1970's, however, two very important improvements have been made in the high-frequency capabilities of recordings and broadcasts:

■ The almost universal adoption of the Dolby® system and other noise reduction measures for recordings has reduced background tape hiss and residual "hash" at high frequencies by a tremendous amount. The entry of the Dolby system into FM broadcasting is also beginning to be felt.

■ A new generation of record-cutting equipment has made it possible to put more essentially undistorted output onto records in the 10,000 Hz region. And a new generation of phono cartridges has been designed to take advantage of the opening for cleaner high-frequency response.

These factors add up to more *recoverable, usable* high-frequency content in source material than ever before—more clean sound above the noise and distortion in the recording process.

With these improvements, and influenced by the fact that most people's record and tape collections now date mainly from the early 1970's onward, we decided to change the high-frequency capabilities of the Advent Loudspeaker. Also involved in the decision was the knowledge that we could make use of developments like ferro-fluid damping for the tweeter to come up with a higher-output design of very high reliability at very little added cost.

The New Advent Loudspeaker, then, can radiate significantly more energy at 10,000 Hz than our original design—more than enough to reveal the cleaner high-frequency output on records. The audible difference is subtle on most recordings (a slightly more open and defined quality) and most noticeable on recordings that have a heavy content of brass, snares,

cymbals, and other demanding high-frequency material.

We don't believe that the difference is great enough to make more than a tiny percentage of present Advent Loudspeaker owners want to trade in their speakers. (We don't design any of our speakers, including the least expensive, to make people want to trade them in after the honeymoon, however long, is over.) But the change is the kind we think should be made in a speaker designed to compete in the "best" category without compromise. And we think it will be appreciated by today's and tomorrow's speaker and record buyers.

## What Stays The Same.

Like the original Advent, the New Advent Loudspeaker is the best answer we know how to make to two fundamental questions:

■ What is the highest level of performance that has real meaning for the great majority of truly critical, demanding listeners?

■ How do you get that performance at a cost low enough to make it available to the widest number of people who would like it?

We realize that it is hard to believe, especially when speaker advertising consistently suggests that more dollars and more complexity and more novelty are the key to speaker performance, that a relatively simple two-way speaker system can really fit into the very highest performance category. Especially a speaker that costs only \$129 to \$159\* (depending on cabinet finish and how far we have shipped it).

But it can and does.

The New Advent Loudspeaker has a useful frequency range as wide as that of any speaker at any price. Its bass response is approached by few speakers at any price. It will fill a large living room with a satisfying amount of undistorted sound. And it doesn't require a super-power amplifier or receiver.

It also has an all-important octave-to-octave tonal balance that's based on long experience with the performance both of equipment and of recordings in the real world. We don't have enough room left here to explain the full implications of that statement, and to explore the design of the New Advent Loudspeaker in full detail. But if you will send us the coupon, we will be happy to provide full information on what the New Advent Loudspeaker is and how it does what it does.

Thank you.

■ To: Advent Corporation, 195 Albany Street,  
Cambridge, Massachusetts 02139

■ Please send full information on the New Advent  
Loudspeaker, and a list of your dealers.

■ Name \_\_\_\_\_

■ Address \_\_\_\_\_

■ City \_\_\_\_\_

■ State \_\_\_\_\_ Zip \_\_\_\_\_

\*Suggested price, subject to change without notice.  
"Dolby" is a trademark of Dolby Laboratories Inc.

**Advent Corporation, 195 Albany Street, Cambridge, Massachusetts 02139.**

©Advent Corporation 1977

by Edward J. Foster

Making buying decisions  
with the aid of our test reports

## How to Interpret Loudspeaker Tests

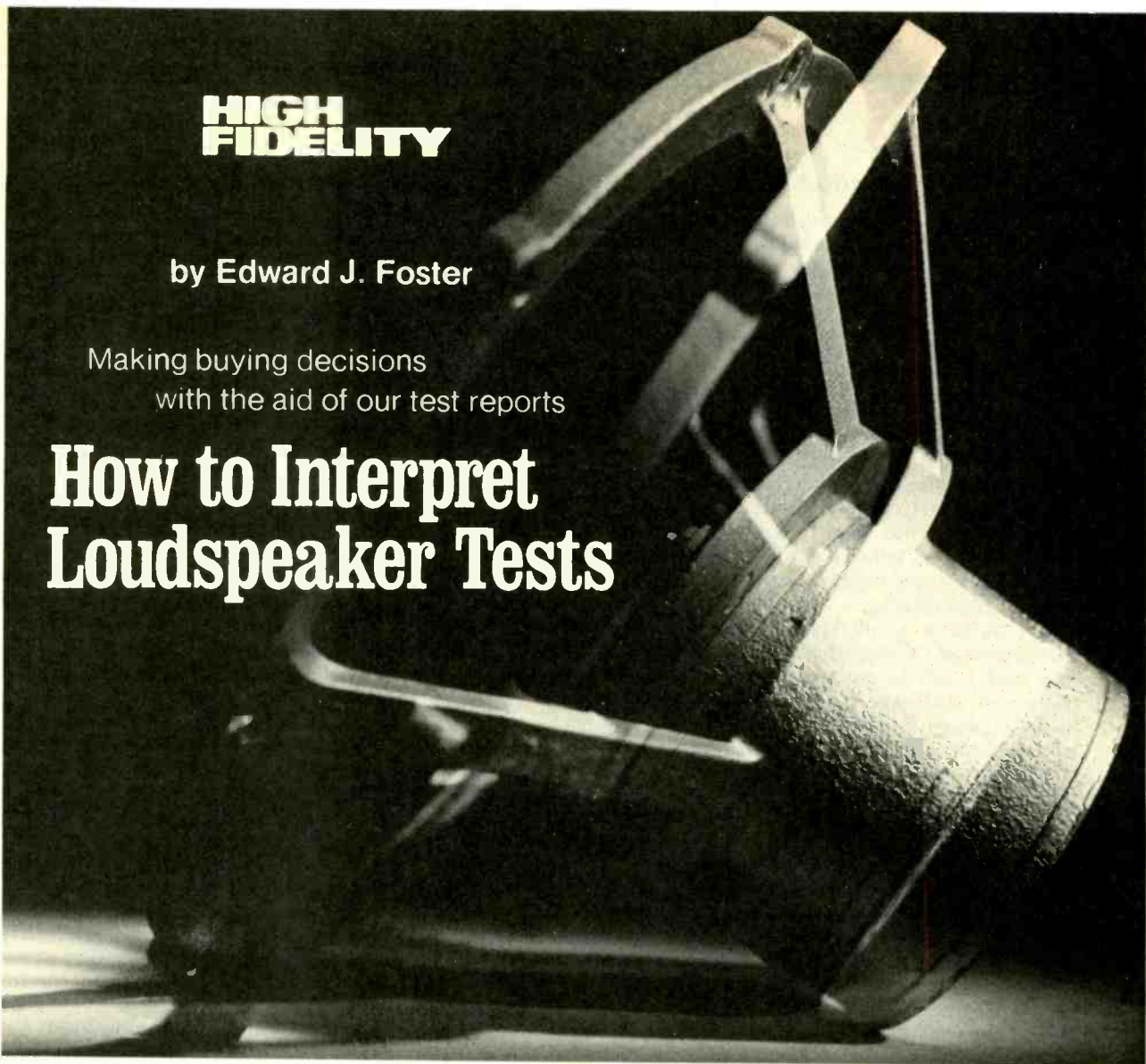

OVER THE YEARS, standards have been established for testing just about all of the common high fidelity components. Of course, the standards may change from time to time as the state of the art advances—witness the recently updated FM tuner standard—and since multiple standards frequently exist (IHF, NAB, DIN, JIS, etc.), manufacturers and equipment reviewers may opt for one or another of them. And standards committees, moving as cautiously as they do, may not promulgate an updated version rapidly enough to suit the needs of, say, a reviewer. (For this reason, HIGH FIDELITY took the initiative in introducing the dBW concept of amplifier specification.) Nonetheless, standards do exist for most products so that communication among manufacturer, reviewer, and consumer can take place.

When it comes to loudspeaker measurements, there is little agreement among the engineering fraternity—and hence no standard. For many years, HF based its reports strictly on extensive listening tests, but in 1970 CBS Technology Center (then called CBS Laboratories) devised a set of

measurements, and the methods for taking them, that serve to help us in our evaluation. Since then, we have used the data from CBS as the underpinning of our reviews. Manufacturers—and indeed other reviewers—employ different techniques. Thus our test data do not necessarily agree with theirs. (That is what happens when no standard exists.)

Our speaker measurements are made in an anechoic chamber in order to simulate a “free field” environment that avoids the reflections created at the boundaries of a “real” room—reflections that might color the measurements. While introducing certain limitations of its own, the anechoic chamber provides a common test situs. The loudspeaker’s impedance, frequency response, distortion, power handling capability, and sensitivity all are measured in these tests.

The loudspeaker’s impedance is a measure of the “load” it presents to the amplifier that is driving it. Although impedance is measured in ohms (like a resistor), the impedance of a loudspeaker system generally varies with frequency (that of an



ideal resistor does not). Since the power capability of an amplifier typically is measured with a resistive load, it is important to know the effective impedance of the loudspeaker at different frequencies. The higher the impedance, the less power will be drawn from the amplifier. This is usually of no concern. But, at frequencies where the impedance is low, the speaker will draw relatively large amounts of current from the amp—possibly, at high volume settings, more than the amplifier can deliver safely. The automatic current-limiting protective circuitry that is built into many amps can, in this event, be triggered, creating distortion. Under extreme circumstances, the amplifier conceivably might be damaged.

Most amplifiers are rated to operate into load impedances down to 4 ohms, some into impedances even lower. But a loudspeaker rated at 4 ohms may actually exhibit less than a 4-ohm impedance over portions of the frequency band. Similarly, "8-ohm" loudspeakers often measure less than 8 ohms over much of the band. As long as they don't drop much below 4 ohms, you're safe in driving one set of them with an amp rated for 4 ohms. Many audiophiles hook up two sets of speakers, however, and are encouraged to do so by the speaker-selector switches built into their equipment. When both sets of speakers are driven simultaneously in parallel, the load on the amp drops further. If both sets of speakers are identical, the net load impedance is *half* that of a single set. Obviously, operating two sets of 4-ohm speakers is a bad idea with any amplifier not rated for a 2-ohm load. But pairs of 8-ohm speakers can also be a problem for many amps if their true impedance falls significantly below 8 ohms over much of the frequency range.

Impedance dips confined to narrow regions where little music power occurs are relatively unimportant, but if the impedance falls below about 6 ohms in the high power region (250 Hz to 6 kHz), it's reason for concern. Our reviews warn of this when appropriate.

Besides commenting on the suitability of operating parallel pairs of speakers, our review will tell you what the nominal impedance of the system is. We define the nominal impedance as the *minimum* impedance reached just above the system resonance. Typically, the impedance curve of a speaker system exhibits a peak at a resonance somewhere in the low bass. (There will usually be two peaks if the system is vented.) Above the system resonance, the impedance will fall to a minimum and then, usually, rise gradually as the test frequency increases. It is a characteristic of the woofer/enclosure combination, since the midrange and tweeter are not active in this region.

The impedance at higher frequencies depends on the midrange and tweeter and the associated crossover networks. The impedance may be

higher or lower than the nominal value. But the nominal impedance *should* agree closely with the manufacturer's rating.

Intuitively, the frequency response of a speaker would be expected to reflect its listening quality strongly, but measuring and evaluating this parameter is not as straightforward as it might at first seem. Loudspeaker systems never have the smooth extended response of, say, an amplifier. Furthermore, the response varies with the position of the test microphone. The lower frequencies are generally propagated more or less uniformly around the speaker (and hence microphone position—at least in an anechoic chamber—is not critical); at higher frequencies, many loudspeakers tend to concentrate or "beam" the sound directly in front of the driver that produces it. With normal stereo placement in your listening room, such a system might change considerably in sound, depending on the listening position.

CBS makes separate frequency response measurements at a number of positions around the loudspeaker. One of these corresponds to an "on axis" measurement, 1 meter in front of the enclosure. ("On axis" here means directly in front of the center of the enclosure, not necessarily directly on the axis of any one driver.) The other measurements correspond to microphone positions equidistant from each other around the "surface" of an imaginary sphere, 1 meter in radius, with the speaker at its center. The data from these various response curves are averaged and normalized by a computer, which generates two curves in addition to that for on-axis response—an "average front hemispheric response" that tells us the average power response of the speaker toward the front, and an "average omnidirectional response" that measures the total power radiated in all directions.

We have found that the omnidirectional curve is the most meaningful in characterizing the frequency balance of a speaker in a listening room. But the comparison of the omnidirectional curve with the other two tells us a lot about the speaker's dispersion qualities. The more nearly parallel the three curves are, the more uniform the dispersion. If, however, the on-axis response curve lies well above the others in the midrange and highs, we can expect a very "beamy" speaker.

The bass response of these curves typically rolls off somewhere near 100 Hz when the speaker is measured in an anechoic chamber, since there are no reinforcements provided by reflections from the room walls and floor. (The reason for anechoic measurements is precisely to avoid room-induced reflections.) The audible bass response in a listening room generally is better than the anechoic curves would suggest. How much better depends upon the room, the speaker, and its location in the room.

What we look for in the frequency response data

is over-all smoothness. Slight dips in the curve are much more readily acceptable than peaks. (Peaks are easily heard in music, while dips often go unnoticed.) Given over-all smoothness of the omnidirectional response and reasonably parallel response curves, we look for the widest response we can get.

With all the hoopla made over cramming a few extra watts of power capability into an amplifier, we're frankly surprised that the industry does not attach the importance to loudspeaker sensitivity (or efficiency, if you will) that it seems to deserve.



## Ten Loudspeaker Shopping Tips

1. In conducting an A/B comparison test of speakers, be sure that both sets are made to play at the same level. Otherwise the louder set usually will sound better regardless of quality.

2. If the speakers you audition are a part of a display in which a great many are stacked against a wall, be sure that the candidates are in reasonably equivalent positions. A speaker at floor level will have a good deal more bass than one that is two feet off the floor.

3. Speakers that are designed to reflect off the walls probably will sound very different in the showroom, as compared with your listening room, especially if the former contains many models. Each speaker in the showroom that is not being driven sucks up acoustic power from those that are being demonstrated.

One reason, surely, is that no standard method of specifying speaker efficiency exists, making this a difficult subject for manufacturers to write about intelligibly. Loudspeaker sensitivities—i.e., the relationship between the sound pressure level produced and the input power that produces it, as measured at a given distance in front of the speaker—easily vary over a 10-dB range. Thus a low-efficiency speaker may require ten times the amplifier power to produce the same sound level as a high-efficiency model.

Our measurements are based upon the average

4. Bring your own records and/or tapes, preferably ones with which you are intimately familiar, to use in auditioning. If your choices are discs and you want to be really fussy, ask the dealer to play them with the cartridge model you have in your home system. An alternative is to use the cartridge model you intend to use with the new speakers.

5. If the speaker manufacturer has made specific recommendations about the positioning and installation of his product, be sure they are observed—both in the showroom and at home.

6. Unless you are sure that an FM station in your area does not limit or otherwise process its signal, avoid using FM for speaker evaluations.

7. When you find a speaker you think you like, listen to it for a fairly long time (half an hour should do) to check for long-term fatigue effects. Better yet, try to arrange for a home trial. The more prestigious audio stores often offer this service.

8. Try to test a prospective speaker with an amplifier at least similar to the one you plan to use. The speaker's performance will avail you little if you cannot supply the power it needs. Damping factor of the test amplifier also should be similar to that with which the speakers will be driven if the test is to be valid.

9. For this reason, demonstration systems that adjust relative levels by way of attenuators between the amplifier's output and the speakers may compromise performance of the more efficient models through loss in effective damping factor. Ask your dealer whether level adjustments are made at the input or output of the amplifier; if the latter—and particularly if you hear any boominess in a relatively efficient speaker system—you may need to hear the speaker driven directly from the amplifier before you can assess it adequately.

10. Listen with an open mind.



efficiency, measured at 1 meter, in the frequency range from 250 Hz to 6 kHz, since that is where the bulk of the power in a normal music spectrum lies. CBS drives the system with a test voltage that would deliver 0 dBW into the *nominal* impedance of the speaker. (To the extent that the true average impedance in the range between 250 and 6,000 Hz is different from the nominal impedance, the measurement will be slightly off.) To get the most sound from the available amplifier power—assuming that you need to do so—you will want efficiency to be as high as possible. The “average” speaker produces a sound pressure level of about 87 dB at 1 meter in this test. A low-efficiency model might come in at 82 dB, while a really hot speaker might do 92 dB.

For high-quality sound reproduction, low distortion is a must. Fortunately, loudspeakers produce mostly “low order” distortion products—predominantly the second and third harmonics. Most listeners can tolerate a reasonable level of this type of distortion. We report on the second and third harmonics, using tones of 80 and 300 Hz at different sound pressure levels. Generally the distortion increases as the frequency goes lower and the sound level goes up.

At relatively low volume levels (75 dB SPL), the average loudspeaker might generate about  $\frac{1}{4}\%$  or less of the second harmonic and a shade more third harmonic—say, under  $\frac{1}{2}\%$ . At these levels, it is the inherent nonlinearity of the speaker that creates the distortion, and there won't be much difference between the 80- and 300-Hz measurement.

As the level increases, the second harmonic distortion predominates, especially at 80 Hz, where the cone moves through a relatively large distance. “Average” figures here might be up to 2% of the second harmonic, plus about  $1\frac{1}{2}\%$  of the third at 80 Hz, and somewhat lower figures (perhaps  $1\frac{1}{4}\%$  second and  $\frac{3}{4}\%$  third) at 300 Hz. When we drive the speaker to 105 dB SPL, the 300-Hz averages might rise to 3% second, plus  $1\frac{1}{2}\%$  third. We find very few speakers that can deliver 105 dB SPL at 80 Hz without distortion in excess of 10%.

The distortion figures all need careful interpretation, however, because driving a speaker in an anechoic chamber is not the same thing as driving it to the same SPL in a room, and the relationship between the two will vary from design to design, particularly at 80 Hz, where room-boundary coupling has a major influence on response. For this reason HF no longer presents the distortion data in tabular form in its reviews.

To see what the limits of the speaker are, CBS measures the maximum continuous sound pressure level that is generated at 1 meter with a 300-Hz input and at a distortion of less than 10%. (If anything starts to buzz, we call it quits right there.) Typical figures might range from 100 dB for a

small bookshelf system to better than 110 dB for a large one. Average is probably 105 to 106 dB.

These are severe tests—done as they are with a continuous-power input. Music is never continuously at levels this high but reaches them only for brief periods. To get an idea of the sort of acoustic levels that can be reached for short periods of time, CBS uses a filtered pulse, with most of the energy concentrated at around 300 Hz. Again the peak sound level is measured at a 1-meter distance. The limiting factor is visible distortion of the reproduced wave—or, as occasionally happens, running out of amplifier power. A good average speaker might deliver 113 dB SPL on this basis, and the lab has measured better than 119 dB.

When reviewing this data, you obviously want the lowest distortion and highest power capability possible. We like to see the low-level (75-dB SPL) figures down below  $\frac{1}{4}\%$ . At 95 dB SPL, we'd hope for perhaps  $1\frac{1}{4}\%$  or less. We especially look at the maximum peak power capability, for this is more indicative of the quality of music reproduction. Most definitely, the more the better, especially if you like to listen to your music loud. Shoot for perhaps 115 dB if you have a reasonably large room. For small rooms or for background music, you can get by with much less.

But whether you will be able to achieve the peak power capability of the speaker will depend upon its efficiency and on the power capability of your amplifier. Go back to the sensitivity figure (say, 90 dB SPL with a 0-dBW input) and add to that the power rating of your amplifier (say, 17 dBW). That will tell you the peak levels you can achieve with the combination (in this case, 107 dB SPL). If the answer equals the peak SPL we achieved with the speaker, you have a match. If it exceeds the peak SPL rating of the speaker, you have more than enough power in the amp to drive the speaker to its limits. (If it greatly exceeds the capability of the speaker—say, by 3 dB or more—you are overpowered and the amp *could* conceivably damage the speaker.) But if the total is *less* than the speaker rating, the speaker could manage a more powerful amplifier, or the amplifier a more efficient speaker with the same power capability.

Our final test is perhaps the most important one: extensive listening by a panel of critical reviewers. This is not to say that the technical measurements are unimportant, but they cannot fully establish the quality of a system as complex as a loudspeaker. Frequently we discern characteristics in our audition that escaped the laboratory measurements, and very often we simply like the sound of a system whose measurements appeared only mediocre. So don't be too surprised if you find a verbal review that does not correspond precisely with the measurements. After all, if it were easy to spec a loudspeaker, standards would have been set long ago. ■

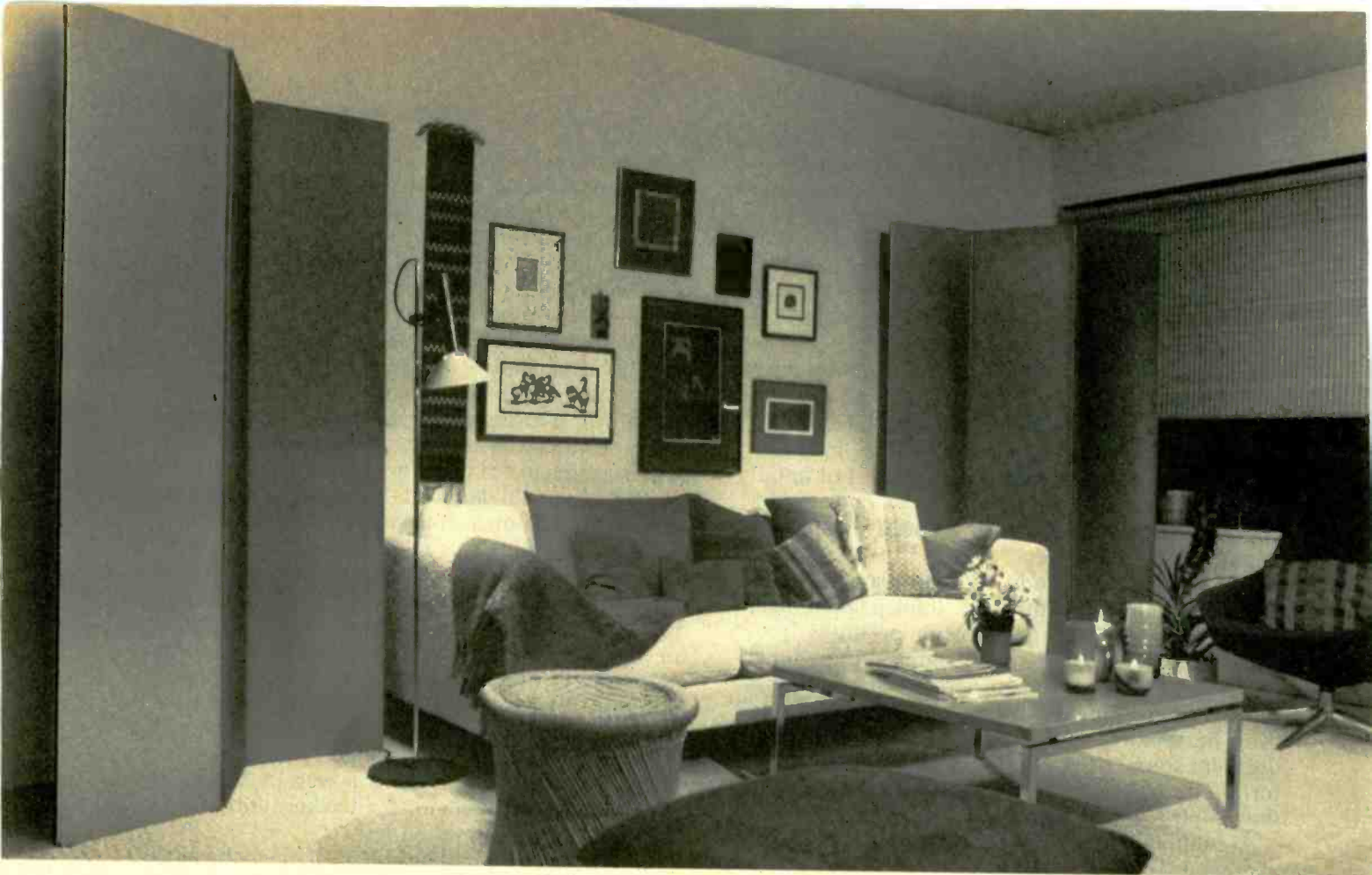

A pair of Audio Research Magneplanar Tympani speakers in camera

## Loudspeakers Without Boxes

*Flat-panel systems find new followers—and new operating principles.*

by Peter W. Mitchell

IN THE FIFTY-TWO YEARS since the design of the conventional electrodynamic loudspeaker was established by Rice and Kellogg at General Electric, it has been a nearly universal practice to mount loudspeaker drive elements in cabinets. In each decade diverse nonboxed speaker systems have been patented and offered for sale, but most have rapidly disappeared. The dominance of the cabinet speaker is such that the average person's mental image of a "loudspeaker" is a rectangular box with a grille on its front—never mind what's inside. Of course, departures from the standard rectangular prism occasionally occur to suit specific purposes; recent examples include the triangular prism (Allison One), pentagonal prism (Bose 901), and dodecahedron (Design Acoustics D-12). But a box still is a box.

Recent years have seen the emergence of an-

*Peter Mitchell, a new contributor to HIGH FIDELITY, is by profession an astrophysicist. He is a stalwart of the Boston Audio Society and a consultant to Audio Pulse, Inc.*

other loudspeaker configuration, not just as an item of transient, esoteric interest, but as a major contender for the buyer's attention. This is the free-standing panel: tall, wide, and thin. One contributor to their appeal, no doubt, is their striking appearance. Another is that many employ novel transducer designs—unusual approaches to the problem of converting electrical energy to sound. More to the point, however, are the sonic and musical advantages that result from the transducer operation and geometry of flat-panel systems.

### The Electrostatic

The classic flat-panel loudspeaker is the electrostatic. Older than most audiophiles realize, it was described in principle a century ago. Arthur Janszen, whose name is immutably linked to the electrostatic tweeter, recalls encountering the Kyle Condenser electrostatic loudspeaker in a Peerless AM radio console in the late 1920s.



Operation of any electrostatic is based on a phenomenon you may have seen demonstrated in high-school physics: Similar electrical charges repel each other, and opposite charges attract. To make use of electrostatic force in a loudspeaker, a lightweight membrane is suspended parallel to and a fraction of an inch away from a large metal plate. An electrical voltage (from a power supply or battery) is used to establish opposite electric charges on the membrane and the plate, producing a uniform attractive force between the two surfaces. When the audio signal voltage (usually stepped up to a higher voltage level by a transformer) is combined with the DC voltage on one of the surfaces, the result is an electrostatic force between them that varies with the applied signal. The force makes the membrane vibrate, producing sound.

This is a "single-ended" electrostatic system. Some designers prefer the "push-pull" electrostatic—two plates driven in opposite polarity by the audio voltage, with the charged membrane suspended between them; the symmetry minimizes even-order harmonic distortion.

The crucial advantage of the electrostatic drive principle is that the membrane moves in response to a force field that acts equally on every part of its surface. The result is sound noted for its purity, uncolored by the myriad small resonances of cone speakers and free of cabinet resonances as well.

Contrast this with a conventional dynamic speaker, in which the audio signal creates magnetic forces that make a voice coil vibrate. The coil is attached to a diaphragm (a cone, or disc, or dome made of treated paper, plastic, or metal), and as it pushes the diaphragm back and forth the diaphragm moves the air to create sound. When the voice coil accelerates too suddenly, those areas of the diaphragm not connected directly to it tend to flex with the air load and their own inertia. Hence these portions of the diaphragm do not accurately follow the motion of the voice coil. This "cone breakup" causes distortion, a ragged response (especially in transients), and audible coloration.

Were their advantages attained easily, electrostatics might have supplanted cone speakers. But, as one expert has said, the history of electrostatic speakers has amounted to an unending search for a truly satisfactory membrane material. Early models used sheet-rubber membranes that tended to dry out and disintegrate, especially in the presence of ozone produced by the high DC polarizing voltage. So when the technology of cone loudspeakers advanced during the 1930s, the unreliable electrostatics were soon abandoned.

During the 1950s the application of modern materials technology began to revive the electrostatic speaker. In England, Peter J. Walker introduced the Quad model, which today is still regarded by British critics as among the most natural-sounding

systems available. Meanwhile, Arthur Janszen was experimenting at Harvard with electrostatics as research tools. This led to the Janszen 130 tweeter, acclaimed in the November 1955 issue of *HIGH FIDELITY* as "possibly the finest tweeter available at any price." This decade also saw the first production, by Acoustic Research, of the acoustic-suspension woofer, so for many audiophiles the ultimate loudspeaker was obtained by combining the AR-1 woofer with the electrostatic tweeter. Janszen, interested in the concept of a full-range electrostatic, sold the manufacturing division of Janszen Labs—which to this day makes systems using electrostatic tweeters and dynamic woofers.

Janszen's first full-range electrostatic made its appearance as the KLH Model Nine—which is still in limited-quantity production. Each Model Nine consists of two panels 6 feet tall, 2 feet wide, and 3 inches thick, bolted together in a shallow V (to improve dispersion). A stereo pair thus contains four of the large (and costly) panels. As a lower-cost alternative, KLH designed the system so that each panel has its own inputs, stepup transformer, and polarizing supply, allowing the two panels of a single Model Nine to operate separately, minus some bass output and volume capability, as a stereo pair. Many audiophiles regard a four-panel stereo pair of Nines as the best system ever devised for reproducing the natural sound of a symphony orchestra.

The KLH Nine soon was followed by Janszen's Acoustech Ten, similar in appearance but with a different tonal balance. Like that of the Model Nine, its bass response was pure, clean, and tight; but even these 6-foot electrostatics lacked the massive bass that many audiophiles prefer. Infinity Systems responded with the Servo-Statik, a stereo



Quad electrostatic

pair of large electrostatic panels with a separate, bi-amplified bass commode containing a dynamic woofer.

Electrostatic panels tend to be limited in acoustic power output, especially at low frequencies, because the vibrating membrane has only a fraction of an inch of clearance from a metal stator plate (or plates). If the membrane approaches a plate too closely, the air gap breaks down under the high voltage and a spark jumps with a crackling sound between the membrane and the plate, usually puncturing the graphite-coated Mylar membrane of modern electrostatics. Repeated

sparking can cause gradual deterioration of the membrane. Trying for disco-sound levels can even propel the membrane into contact with a stator plate, where it may stick and render the speaker useless. (Some are equipped with fuses to prevent such damage.)

An obvious way to increase excursion limits is to start with a greater plate-to-membrane separation. But since the strength of electrostatic forces falls off with the square of the distance, the efficiency of the speaker is reduced. Efficiency can be regained by increasing the DC polarizing voltage, but this reintroduces the problem of arcing. Day-

---

---

## The Consequences of Geometry

Panel speaker systems have two interesting properties that arise directly out of the geometry of their operation.

First, they tend to be fairly phase-coherent, since all of the radiating surfaces typically are in the same plane. In most cabinet loudspeakers, by contrast, the depth of the woofer cone causes the low frequencies to emerge from an acoustic position slightly behind that of the tweeter. The audible significance of such phase aberrations is currently a subject of debate among speaker designers. (It will be discussed in future issues of *HIGH FIDELITY*.)

Second, their sound is less influenced by room acoustics than that of a conventional speaker. A conventional loudspeaker is much smaller than the listening room. If it had very poor dispersion—if it fired much of its sound straight ahead in a narrow beam—then the listener would hear a correct sonic balance only at one spot in the room. Good coverage of a listening area requires that a loudspeaker have wide dispersion. As a consequence, much of the sound strikes the walls, floor, and ceiling and has its frequency content altered by the absorption of each surface it strikes. Furthermore, resonant modes are caused by the room's shape and dimensions. Jointly, these absorptions and resonances color the sound reaching the ear from the speakers.

There is a second way to provide a broad listening area: Select a loudspeaker with a flat radiating surface comparable in size to one of the dimensions of the room, and let the speaker beam its sound directly at you. At frequencies where the radiating surface is larger than the wavelengths of the sound, the sound will project straight ahead, interacting little with room boundaries and so acquiring minimal coloration. A tall, wide radiator minimizes reflective effects and requires aiming for best coverage of the listening area. A tall, narrow one (approximating a vertical line source) is less critical because its radiation pattern is wider, although it interacts with the side walls.

Most panel systems are dipole radiators that fire sound equally to the front and back. This has both good and bad effects. The back radiation, in traveling to the wall behind the speaker and reflecting back toward the listener, mixes with the front radiation after a brief time delay that adds a sense of depth and spaciousness to the sound. But the back wave affects the frequency response and the stereo imaging of the speaker. A 9-millisecond delay (the result of placing the speaker 5 feet from the wall), for instance, would produce a peak at 110 Hz and cancellations at 55 and 165 Hz. Therefore, dipole loudspeakers require careful placement if they are to deliver their best sound.

P.W.M.

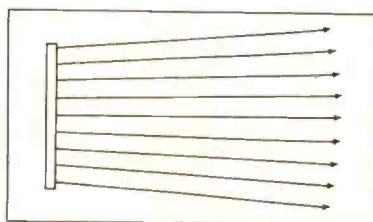
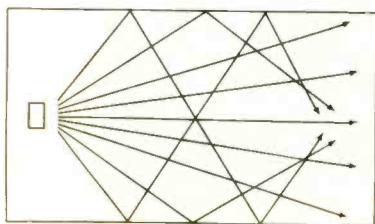

Box loudspeaker (left), a small source with wide dispersion, bounces sound off walls; panel speaker directs sound forward from a large radiating area.





Infinity Servo-Statik electrostatic

ton-Wright succeeded with this approach by sealing the entire loudspeaker in a plastic bag filled with sulfur hexafluoride, an inert gas having a higher breakdown voltage than air. The result is a full-range electrostatic, the XG-8 Mark III, that can safely be driven to high peak levels if your power amp is sufficiently large and stable.

When Acoustech ceased operations it was purchased by Koss, which thus entered the electrostatic domain, first in headphones and later—after extensive development—in full-range speaker systems of its own. Koss handled the problem of excessive membrane motion by noting that the greatest excursion of the membrane occurs when low frequencies are reproduced at high levels. Acoustic output depends on both excursion and diaphragm area, which is why full-range electrostatics tend to be very large. For the Koss Model One electrostatic, a way was found to interleave panel elements so as to pack an effective total diaphragm area of 19 square feet into a system just 2½ feet wide by 4 feet high.

Koss used yet another design innovation to gain

higher peak levels. In conventional two-way designs each stepup transformer handles several octaves (which can result in IM distortion due to core saturation at high levels); each Model One employs four stepup transformers, which also function as crossover elements. Koss also took an unconventional approach to controlling costs. Instead of the common combination of electrostatic tweeters with dynamic woofers, the Koss Model Two contains a dynamic dome tweeter coupled to scaled-down versions of the electrostatic midrange and woofer used in the Model One.

As suggested earlier, many electrostatic speakers demand a hefty and stable amplifier suited to their low efficiency and to the difficult load they present. Many solid-state amps are designed (perhaps optimistically) to function with moderately low resistive loads (4 to 8 ohms). But the impedance of a typical electrostatic is not resistive, and many fall well below 4 ohms. This is because the membrane and stator plates of an electrostatic constitute a large capacitor whose magnitude is multiplied by the stepup transformer at the system's input. The impedance (or reactance) of a capacitor drops as frequency rises, causing electrostatics to draw fairly large currents at 10 kHz and above—just the region where output transistors begin to lose efficiency and develop internal heat. To make matters worse, the current is out of phase with the voltage (due to the reactive nature of the load), a condition that heats the transistors still further. Unless the amplifier designer has allowed for the handling of such difficult loads, the protective circuits may trigger (causing distortion or intermittent operation), or the amp may fail altogether.

Some designers realized that vacuum tubes are



Dayton-Wright XG-8 Mark III electrostatic

Beveridge  
electrostatic

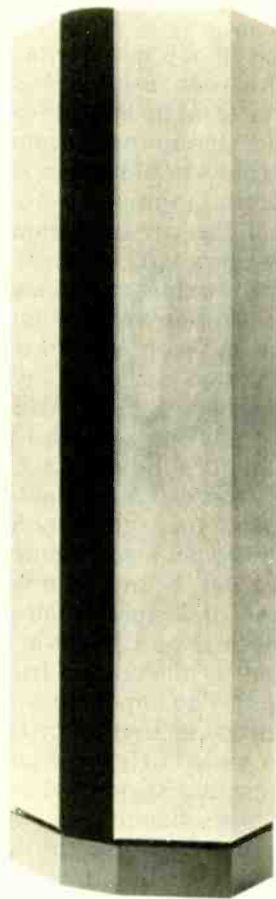

well suited for driving high-voltage electrostatic panels—and without recourse to a stepup transformer. Beveridge and Acoustat have produced full-range electrostatic systems with built-in tubed amplifiers. The Acoustat retains the usual flat-panel design. Beveridge encloses the tall panel in a triangular-prism cabinet with a narrow vertical slot to let the sound escape: this design yields unusually wide and uniform lateral dispersion.

Despite their attractively pure and uncolored sound and their geometric advantages, electrostatics have disadvantages. They are expensive to manufacture: Except for the modest Quad (\$930 for a pair), the cost of stereo with full-range electrostatics generally is between \$2,000 and more than \$4,000. And electrostatics often are neither very reliable nor at all easy to repair when something goes wrong. Arcing due to high-voltage breakdown may become severe in humid weather, and like the static charge on a disc record, the DC polarizing voltage can collect airborne dust, hairs, and smoke.

Of course, not all models are equally prone to these ills, and you can substantially extend the life of even the most vulnerable by careful control of its environment. But many designers have sought a transducer that would provide the essential advantages, but not drawbacks, of electrostatics.

## Planar Magnetics

The planar magnetic combines the geometry of the electrostatic with the operating principle of the conventional dynamic speaker. Like an electrostatic, it contains a membrane of thin Mylar suspended parallel to a large metal plate. A magnetic force field is set up by an array of thin bar-shaped magnets fastened to the plate, and a parallel array of thin wires is bonded to the membrane. When audio-signal current from a power amplifier passes through the wires, they react with the magnetic field, just as the voice coil reacts to a dynamic speaker's permanent-magnetic field.

The input impedance of such a system is principally that of the membrane wires: about 8 ohms and purely resistive, ideal for ordinary solid-state amplifiers. Since the active wires are distributed throughout the surface of the membrane, it is driven nearly as uniformly as that of an electrostatic and should approach the same freedom from resonances and colorations. The elimination of a high-voltage supply should enhance the reliability of the planar magnetic and reduce its cost relative to the electrostatic, although assembly of the panels remains expensive. And, like electrostatics, planar magnetics must be large to have good bass response.

Full-range planar magnetic loudspeaker systems currently available bear two brand names. The Magnepan MG-II is a medium-priced (\$625) pair of panels 6 feet by 2 feet by 2 inches. The Audio Research Magneplanar Tympani series of speakers (so called because the Mylar membranes are stretched taut on the frame like the skin of a drum) are larger multipanel systems producing increased range and bass output, with correspondingly higher price tags.

And like the electrostatic principle, the planar magnetic principle has begun to appear in headphones (the Yamaha HP-1 among others) and in tweeters (the DvR tweeter used in the KLH SCX series and the similar tweeter used in Infinity's Quantum-Line Source).

## The Pulsating Panel

A few years ago a rumor arose that someone in Argentina had developed a new kind of loudspeaker that fit none of the usual classifications. It seemed unlikely; but in 1974 Professor José Bertagni and his colleagues moved from Argentina to California and set up shop making BES Geostatic speakers.

At first glance the drive mechanism in the Bertagni seems almost conventional. The transducer employs voice-coil/magnet assemblies, and the larger systems use a piezoelectric supertweeter. But the voice coil does not simply push a diaphragm back and forth. Instead it presses on a large disc formed of specially formulated and



cured polystyrene foam. The disc is shaped into an asymmetrical diaphragm that tapers from the center to the edge.

The frame of the speaker clamps the diaphragm under tension, so that a low-frequency vibration of the voice coil causes the diaphragm to flex more at the center than near the edge. Meanwhile, mid-range vibrations of the voice coil are conducted laterally through the diaphragm, radiating into the air as they go. In a conventional cone driver we call this cone breakup, but the BES diaphragm minimizes the coloration that might otherwise occur with this mode of vibration. Finally, high-frequency vibrations are conducted through the diaphragm material by alternately compressing and expanding it on a microscopic scale. Thus in no mode of its operation does the flat polystyrene panel vibrate as conventional drivers do; the BES Geostatic is indeed unique.

From the external appearance of the Bertagni, one might expect it to produce a plane-wave radiation pattern. Actually the Geostatic produces a nearly spherical dispersion, except at the extreme ends of the audio spectrum (below 125 Hz and above 10 kHz) where nulls begin to show at the edges of the panel. Since the word "omnidirectional" has been misapplied to speakers that have uniform dispersion only in the horizontal plane, Bertagni describes the Geostatic's spherical radiation pattern as "omnipolar."

### Quasi-Panel Systems

Finally, there are loudspeakers that look like panel systems but actually contain conventional drivers—with their virtues of nonexotic technology, high reliability, economy of production, and sample-to-sample consistency. Perhaps the best known is the Dahlquist DQ-10. In external appearance it resembles the Quad electrostatic, but the grille cloth hides a 10-inch woofer enclosed in its own cabinet, a 5-inch lower-midrange driver, a 2-inch dome for the upper midrange, a ¾-inch dome tweeter, a piezoelectric supertweeter, and an elaborate crossover. The mounting of these drivers, in a staggered fashion rather than in the single-plane baffle board of a typical box, is intended to provide linear phase operation and freedom from edge diffraction. Thus the Dahlquist achieves some of the virtues of panel radiators while retaining conventional drivers and a relatively modest (\$800 per pair) price.

The new Phase Linear Model III resembles a full-range electrostatic or planar magnetic system even more closely. It is supplied as a stereo pair of free-standing panels (5 feet by 2 feet by 5 inches) together with a subwoofer cabinet in the form of a 2-foot cube containing 12-inch woofers for both channels. Each tall panel is a frame on which are mounted two 8-inch woofers, two 4-inch midrange

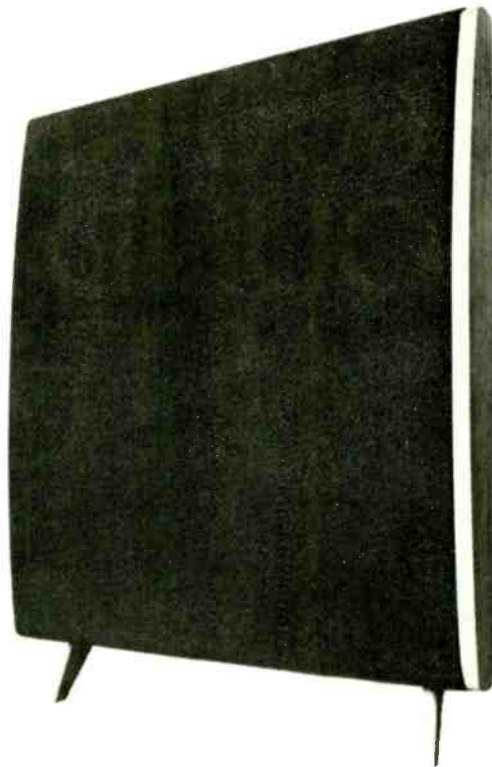

Dahlquist DQ-10 dynamic quasi-panel

units, and five 1-inch cone tweeters. The Model III is not intended to produce plane-wave radiation; rather, its drivers generate a wide-dispersion radiation pattern. The high-frequency dispersion is particularly wide, as each tweeter fires upward into an inverted-horn reflector that provides virtually uniform horizontal radiation. This allows the tweeters to deliver an unusually large amount of high-frequency power to the listening room, providing a sense of "air" in the stereo image, without harshness due to excessive on-axis tweeter output.

### Summing Up

What counts in a loudspeaker is how it sounds, not how it is made. When auditioning a speaker you should consider several questions: Does it sound realistic to you with the type of musical recordings you usually play? Will it play loud enough to satisfy you? Is it compatible with your amplifier? Is it compatible with your room's acoustics, and will your room accommodate its placement demands? Will your dealer let you try it at home for a few days before committing yourself to the purchase? Is it provided with an adequate warranty to protect your investment? And can you afford it?

If your answers lead you to a panel system, you will have joined a growing band of audiophiles. The survey in these pages is not encyclopedic, but it indicates that panel loudspeakers are, today, less than ever a specialized class reserved for a few wealthy or eccentric enthusiasts. ●

**MOST  
\$600 RECEIVERS  
SOUND AS GOOD  
AS THIS ONE.**

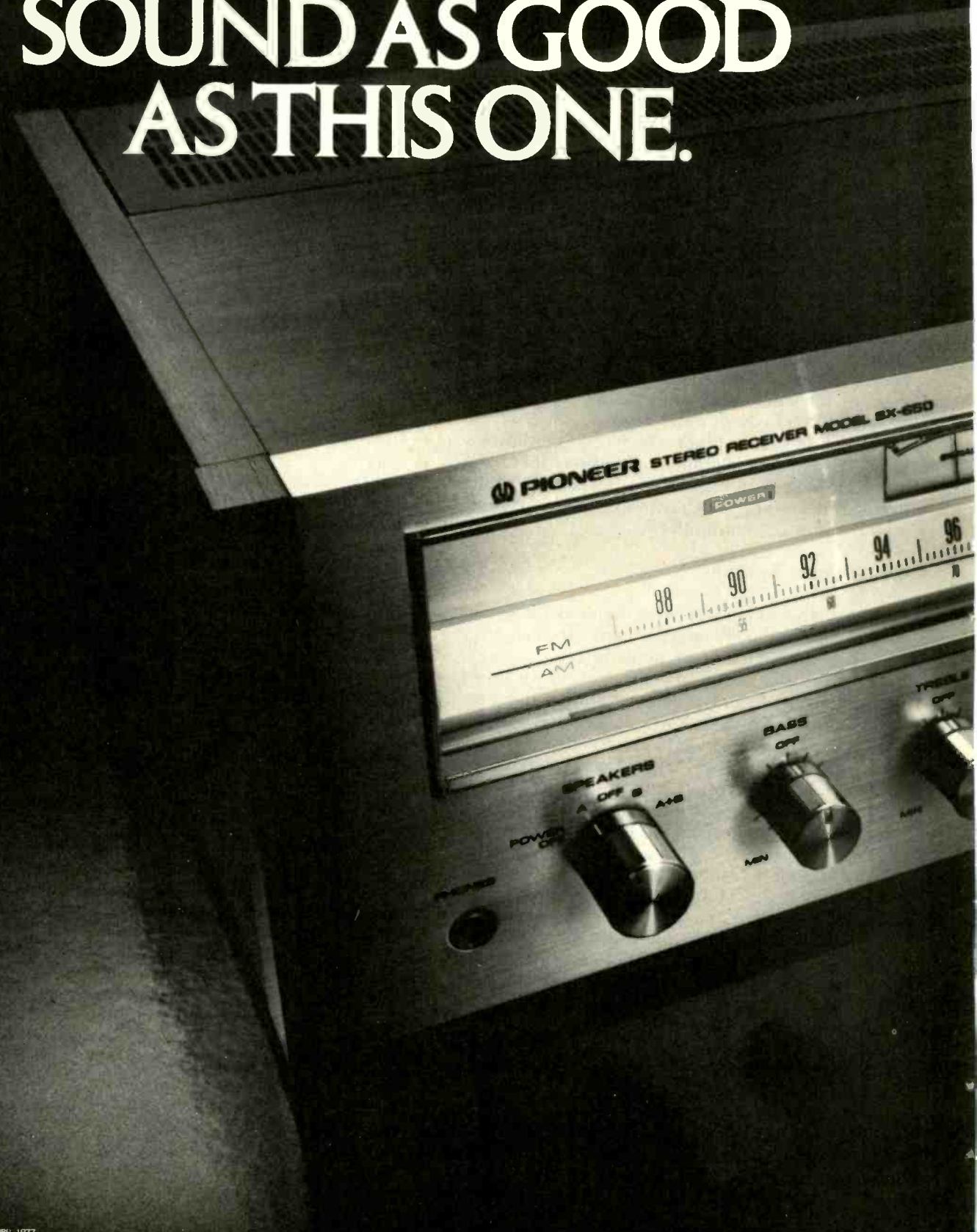



# UNFORTUNATELY FOR THEM, THIS ONE SELLS FOR UNDER \$300.\*

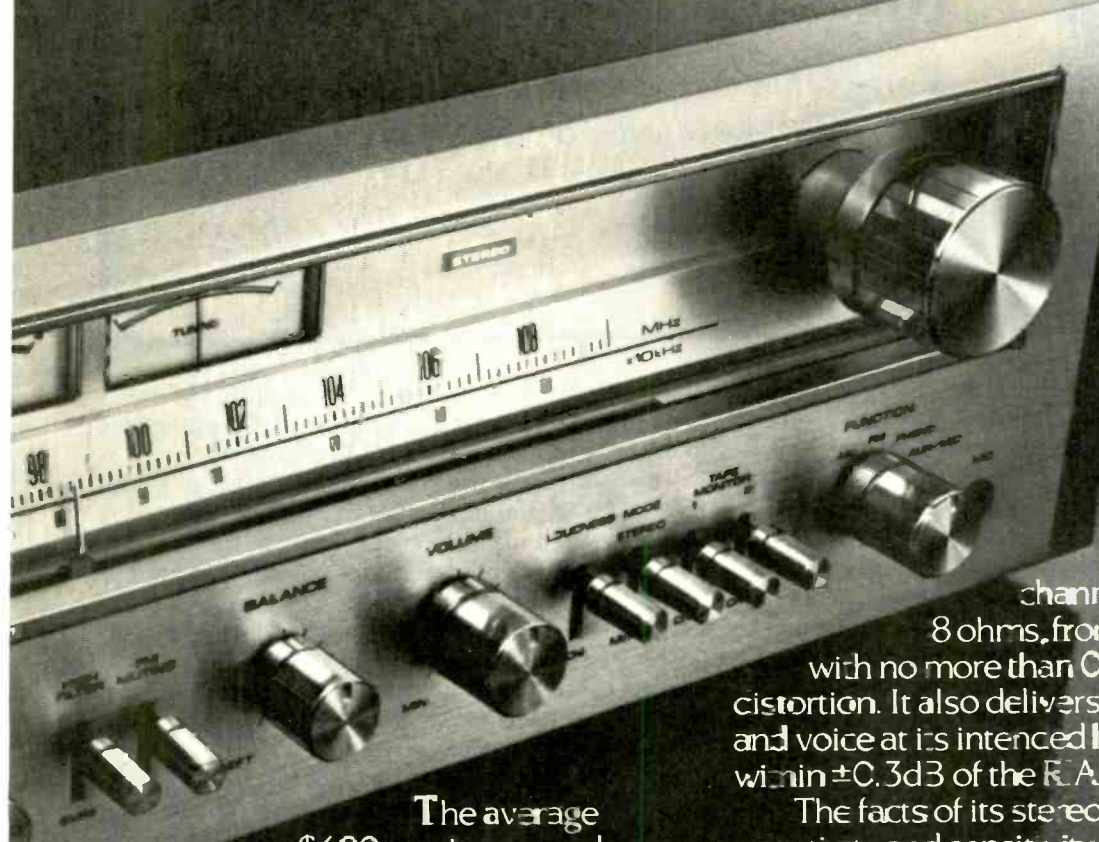

The average \$600 receiver sounds as good as the new Pioneer SX-650 until you start listening to prices.

If \$600 is your kind of price, an SX-650 should qualify as your kind of receiver. Not only will it give you the kind of features and sound quality you'd expect for that kind of money; it'll also leave you with roughly half your receiver budget unexpectedly unspent.

But suppose your idea of a receiver price is somewhere under \$300. The SX-650 will sound better to you than anything you thought you could afford. Because it has more power, a wider frequency range, less distortion, and far greater versatility than most other receivers in that category.

It's a fact that the SX-650 provides a continuous power output of 35 watts per

channel, min. RMS into 8 ohms, from 20 to 20,000 Hz, with no more than 0.3% total harmonic distortion. It also delivers each instrument and voice at its intended level, balanced within  $\pm 0.3$  dB of the RIA curve.

The facts of its stereo separation, selectivity and sensitivity must really be experienced: sometimes only hearing is believing.

You'll also be impressed by what you don't hear from the SX-650. You won't hear the thousand miscellaneous acoustic devils that live in the limbo between FM stations on lesser receivers.

On your next visit to a high fidelity dealer, listen to a Pioneer SX-650 with any reasonably accurate speakers.

You'll find either its price or its performance amazing. Depending on which you hear first.

**PIONEER**

U.S. Pioneer Electronics Corp., 75 Oxford Drive, Moonachie, New Jersey 07074.  
\*The value shown in this ad is for informational purposes only. Actual resale prices will be set by the individual Pioneer dealer at his option.



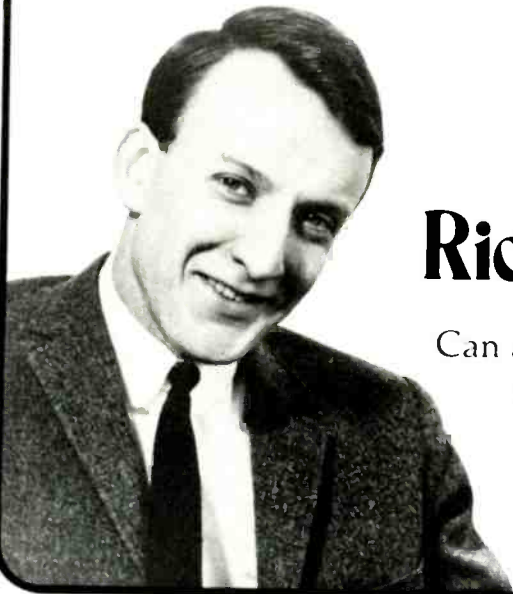

by John Caps

## An Interview with Richard Rodney Bennett

Can a serial composer find happiness writing for films like *Murder on the Orient Express*?

THERE IS A TIME-HONORED standoff between composers for the popular media and those for the concert hall. Each artist disparages the other, one being regarded as shameless because he puts his talents at the service of mere entertainment, the other being looked upon as stuffy and mired in purism. Yet each stands somewhat in awe of the other: Film composers often live like movie stars, making the concert musician envious, while legitimate composers have the respect of the public, colleagues, and perhaps posterity, and the film musician is jealous.

Bridging these two worlds, and successful in both, is Britain's forty-year-old Richard Rodney Bennett. His opera *The Mines of Sulphur*, his symphonies, and his piano works seem to stay around with promising tenacity, and several have been recorded. His scores for *Nicholas and Alexandra*, *Murder on the Orient Express*, and *Far from the Madding Crowd* have won British and American honors. But a lush romantic score for *Lady Caroline Lamb* and a sparse serialist work like the Concerto for Guitar and Orchestra barely seem to have come from the same pen. I asked Bennett in an interview how he sees this apparent contradiction.

**RRB:** I'm a serial composer, and even if I'm doing films I still think in that way—using intervals and building something out of nothing. If you think of Pierre Boulez and the way you can use his pure kind of serial technique but then integrate tonal

harmonies back into it if necessary, then it seems to be an endlessly fruitful thing.

I went through the whole Webern thing in the Fifties. I was Boulez' first pupil, and in those days he was extremely intolerant. I mean, he just saw what was before him, and that was all I wanted to see. I fought him, even so. After all, it was that extreme meticulousness that has killed him as a composer. I remember having fights with him in my lessons even though he was God and I was maybe twenty. He used to be horrified if you had the merest vestige of a tonal chord.

Over the last ten years, particularly while working in opera, I've realized the wealth of harmony I've denied myself because of the Boulezian model. I mean chords that are not exactly tonal chords, but very relaxed chords, diatonic chords. If you start with a serial scale that has very strong tonal elements, then it more or less becomes, well, melodic. I like having those resources at hand, because they suddenly sound new to me again.

**JC:** There are elements in your symphonies that sound almost tonal.

**RRB:** I don't take the academic line: "Here's the serial technique, and let's not even admit any other influences." That's too much technique. Rather, it's the flexibility I spoke of: relaxed sorts of sounds and harmonies that are so free that they can open up to anything. It just comes naturally to me.

**JC:** How did that develop?

*This marks the first appearance in HF of John Caps, a psychology student with a fondness for film music.*



**RRB:** Well, my mother was a pupil of Holst, so that contributed to it, and—well, just the times. At school back then, things were slipshod. It was geared to producing either virtuoso instrumentalists or teachers, and I wasn't either. I was very much involved in contemporary music, which at that time—the Fifties—just wasn't the thing.

There was a lot of growing time there when I really had a chance to look around and practice. I'm glad for it. For example, I know a boy in England whose first performance of a symphony he had written when he was still a teenager was at Festival Hall, and the second performance was at Carnegie Hall! And then what do you do? Now he's perhaps in his early twenties, and he goes around like a grand old man. He's really become shaggy and tweedy and very patronizing. It turns out he's a very good composer, but that's a horrendous way to start.

**JC:** The first real success you had, at least in this country, was *The Mines of Sulphur*, as I recall. When was that?

**RRB:** It was written in 1963 and premiered in the States in '68 at the Juilliard School of Music. I've just attended another production of it in Toronto, by students, and it was done very well. It still works. That's what I noticed most. It really startled me. That sounds naive—all the effort that went into that piece seems so long ago. Now I think of it as my warhorse. I'm very proud of that opera: There's a dark atmosphere to the whole thing, and even the performers are affected by the ghostliness of it.

**JC:** You've used Beverley Cross, the librettist for this gothic thriller, on other projects, haven't you?

**RRB:** She did the libretto for *Victory* and for *All the King's Men*, a children's opera in one scene that runs only forty minutes or so. That work is very lightly and brightly scored, for obvious reasons.

**JC:** On the other hand, your first symphony, premiered by the London Symphony Orchestra and recorded on RCA, is a showpiece for scoring—almost a concerto for orchestra. And yet I detect a certain vocal feeling to it.

**RRB:** Well, of course, opera is my favorite medium and I wouldn't be surprised if much of what I do has a singing quality.

**JC:** But when you play the piano, you seldom do lyrical things in that sense.

**RRB:** Now that's a different thing, you see. I play a great deal, but I have to be careful what I play because I don't have a conventional technique. I don't want to do the classical repertoire because there are millions of people who can do it better than I. I'll play Boulez and all kinds of wild music that doesn't demand a conventional technique. Say you go to Juilliard, that wondrous machine for turning out virtuoso pianists; you're not geared there to play contemporary music at all, unless you're lucky with a particular teacher. In fact, a conventional finger technique can often get in the way because the demands of contemporary music are not the same.

Still, I love to play old Tinpan Alley tunes on the piano. I have a collection of old sheet music of Gershwin, Porter, Arlen, and all those are the epitome of the lyric approach.

**JC:** Would you ever consider writing some songs like those yourself?

**RRB:** I'd quite like to, but I've never met a lyric writer that I wanted to work with. And I'm not a songwriter; they are two different crafts—songs and my kind of composition. Of course, if you happen to do both, as Gershwin could, that's wonderful. Or someone like Steve Sondheim, who is absolutely brilliant. I really worship him. The songs he wrote for the film *Stavisky* have a wonderful atmosphere.

**JC:** Would you ever compose a song cycle, art songs, in this day and age?

**RRB:** Oh, I have done: a sonnet sequence and a piece for tenor and piano, "The Music That Her Echo Is."

**JC:** Do they require a conventional technique to perform?

**RRB:** Singing contemporary music, one is naturally going to use new tools of a sort—not exclusively the classic vocal methods, certainly. But the whole past of vocal music is still there. So many new musicians say that they follow this or that line and that it's the only valid one for them. But it's never a matter of who's "right."

**"Boulez' extreme meticulousness has killed him as a composer."**

**"Working in films is important for me, but the music is not important."**

**JC:** How do you feel about Schoenberg's influence as against, for example, Stravinsky's?

**RRB:** I can't imagine a world without Stravinsky, but I don't know exactly what he led to—except a lot of talented people imitating him. In a sense, he devoured himself as he went along. You know, he was a composer of the most dazzling genius, but he fed off what was around him, and when he died, what did he leave? Yet the Schoenbergian tradition goes on and on.

I could never understand Stravinsky's later music at all. Some pieces like *Threni* or *Canticum Sacrum* and the rhythms in *Rite of Spring*, his instrumentation—it's just the music of a knockout composer. But his later stuff, his serial music, no. On the other hand—maybe I'm just going through something right now—I love Schoenberg's music before he invented the serial technique. *Erwartung*, for example: I'll never know how he did it.

Stravinsky did some things that were terrifyingly new, but I just don't know where it got anybody. He was like a comet that lit up everything and then was gone. At one time, all I wanted to do was take music apart, and Stravinsky looks endlessly interesting when you do that with him. But again, what have you got? A lot of little elements all laid out in front of you, but nothing has been advanced.

**JC:** That's what most people do with film music, for that matter, saying, "Sure, the sum total is not so good, but look at all these marvelous parts!"

**RRB:** Absolutely, absolutely. I'll have to tell you, I'm simply not a film-music buff, though I love the cinema. There are two things that repel me about the worship of film music. First, the moment it approaches the sort of French *Cahiers du Cinéma* attitude, I just shrivel up. I lived with that for so long, because I was a movie nut in Paris, reading all the film magazines, and I really can't stand that *auteur* business now. Second, I think a lot of that film-music worship is a throwback to the Bette Davis/Barbara Stanwyck/George Raft mystique. It's fun, but either it's very trivial or it's inflated.

Working in films is important for me—always has been and always will be. But the music, considered apart, is not very important. That's why I won't take any of my film music out of context.

When I was in Toronto, somebody came dashing up to me, saying, "Please, can I get permission to have the elegy that you wrote for the record album of *Lady Caroline Lamb* done as a ballet by some of the national company here?" And I said, "Absolutely not!" It works well in the context of its film and I'm very pleased with it, but I don't want it done as a ballet—it's really only a kind of high-class schmaltz!

**JC:** What kind of treatment does a legitimate composer receive in Hollywood?

**RRB:** I'm very well received by the composers out there. But I guess they're rather surprised that I've actually wanted to come—and that I'm not Robert Russell Bennett, which everyone always thinks. I was out there recently for the first time, as I usually work in London. The picture I did was a TV movie, which doesn't pay all that much, but I wanted to work there, you see, just to establish the fact that I'm available. Otherwise, there's always somebody nearer at hand, there's always somebody who's hustling harder. Why, I was about to do a very big picture recently for which they had to use an English composer, and I couldn't get to Hollywood two days earlier . . . and so I lost it.

**JC:** Do they worry in Hollywood about the fact that you don't conduct?

**RRB:** Not really. I was at the Royal Academy of Music in London, and if I had stayed on for a fourth year, I could have learned to conduct. But by the third year I was scoring feature films already, and I wasn't about to handle all of it at one time and learn to conduct. It's rather strange—it's like I don't drive a car any more, and now I'm scared of taking it up again. You know, I'm sure if I had learned to conduct when I was nineteen, there'd be no problem now. It's just a psychological thing.

**JC:** What about those Academy days? What did you like then?

**RRB:** We had a new-music society, and we used to give concerts every week of all the current avant-garde stuff. About fifteen or twenty people would turn up, mostly girl friends and so on, and it was





Juilliard

In a student production of *The Mines of Sulphur* staged at the Juilliard School in 1968, soprano Evelyn Mandac (second from right) had the central role.

wonderful. That's the way you learn. You make your mistakes in front of twenty people.

**JC:** Did any of those avant-garde composers try to touch film music at all?

**RRB:** No, they were too pure—though there's something to be said for that. Of course, a good many major composers *have* done films: Prokofiev, Milhaud, Shostakovich, Poulenc, Ireland, Britten, Walton, Hindemith. When film music first developed away from the pit band, it was those composers who did it. The Hollywood composers were much later, in the Forties. You know, the big symphonic thing. But film music began long before Max Steiner and the others.

**JC:** Was it visual music, though? Cinematic music?

**RRB:** I'm sure it was, and I think the composers in those days—particularly in France—had a closer relationship with the film makers too. I think there's a really good generation working in Hollywood at the moment—people like John Williams and Jerry Goldsmith, David Shire and Billy Gold-berg. You could talk to any of these composers about contemporary music, and they'd know what's going on.

**JC:** How about some of your film music now? Is the

theme from *Orient Express* your most-recorded theme so far?

**RRB:** I suppose so.

**JC:** Even more than *Nicholas and Alexandra's* love theme?

**RRB:** Well, that was done in a few film-music albums, but it just had that one pop recording by Engelbert Humperdinck. They took the theme, which was originally very long and had lots of key changes, which was nice to do. They used about eight bars of it and put it all in C major and left it there. Then they wrote a whole new bridge that I had nothing to do with, and they called it "Too Beautiful to Love." I have no control over such things.

The song they made from the *Orient Express* music was turned into a thing called "Silky." The people who prepared the sheet music never looked any further than the main title, where the song is not played completely. It's only later in a dining-car sequence where the tune actually has a climax. So they thought it had no end, and they just repeated the first half and stopped. I was so angry, I went to the head of EMI and made the most colossal scene. I mean, if they can't get out a proper twelve-bar song copy of a tune from a film—!



EMI/Paramount

Bennett's music accompanied the Orient Express on its cinematic sojourn from murderous intent to dazzling detection. Here Albert Finney as Hercule Poirot questions Anthony Perkins. To Perkins' left are Vanessa Redgrave, Sean Connery, Ingrid Bergman, and George Coulouris. Behind Finney are Rachel Roberts, Wendy Hiller, Jean-Pierre Cassel, Michael York, Jacqueline Bisset, Lauren Bacall, and Martin Balsam.

**JC:** You commented in the past that the experience of a motion-picture job changes the way the music comes out. Why is that?

**RRB:** You can go through such traumatic times on films. A director I worked for a while back, for instance, was one who couldn't make up his mind about anything. I could never be sure that my music wasn't going to be all messed about. On the other hand, there was a horror picture called *The Nanny*, which was just a happy experience that worked very well.

**JC:** I heard you had to go out on location for the filming of *Madding Crowd*.

**RRB:** That was a different kind of experience. John Schlesinger, the director, loves everyone to be involved from the word go. I had done *Billy Liar* with him in '63, and I knew him socially before that too. He was terribly anxious, in a very endearing way, that one should be part of his "gang" and really involved in it all.

That's fine in principle, except in actual fact I don't like to do it. There's nothing I can do there. You have to do dumb things like supervising people singing in crowd scenes, such as when they were shooting this sort of harvest supper sequence. That day I just sat in the field feeling terribly out of place and getting appalling hay fever. It was only later that I started working on my music. I can't do anything, you see, until I see that film finished.

**JC:** In your concert music, do you have to make

concessions toward what's expected of you, either by sponsors or by the public?

**RRB:** As a person and as a composer I do try to please a little bit, but I try not to compromise my ideas. Of course, some people would say that it's a compromise already for me to be working in films and not sticking to the "pure" music, but I don't think it is at all—it's just like wearing different hats. Music is music. Some is meant to explore the possibilities of the art, and some is meant just to illustrate the love affair of Caroline Lamb and Lord Byron on screen. Why despair about it?

**JC:** Does working in an entertainment medium affect your musical ideals? Do you have any problems writing music for films?

**RRB:** I do tend to use less and less music in my films—I won't do it unless there's something I can contribute. In *Lady Caroline Lamb*, for example, which has only twenty minutes of music, people noticed the score and I got more mentions in the press for it than ever before. I think to a certain extent it was because each piece of music was so specific.

Film music is an independent art in its own right, but it's a secondary one, a supportive one, because it's not generated by the composer. The spark comes from up there on the screen, not from down here within the music itself. I'm a concert composer first and foremost, but my only musical ideals in any medium are to keep on working and improve—and to feel my music is liked and needed. ●



# Of Copyrights, Creators, and Phonorecords

by Leonard Feist

The new federal copyright law clarifies many  
questions— and raises others.

ON OCTOBER 19, 1976, President Ford signed a new copyright law, culminating a process that had begun twenty-one years before when Congress authorized a series of studies covering the many varied considerations, conflicts, and problems that would be involved in a thorough revision of an outmoded law. The new law will, except for several special provisions, become effective January 1, 1978.

The enactment of the statute of 1909 that has governed the protection of authors' rights and the use of copyrighted materials for almost seventy years took a little over three years from start to finish. In its drafting, the joint congressional committee was faced with the responsibility of dealing with the many technologies that had developed since the previous complete revision in 1870.

Legislators now, as then, are caught up in a tangled web when dealing with copyright, an intangible, subtle, and esoteric form of property. They are confronted with the need to reconcile, if possible, the conflicting interests of authors whose properties are involved, the users of those properties—and the public's interest.

The public interest has historically been a strong determinant of copyright policy. For example, every copyright eventually enters the public domain, at which point anyone is free to use—or misuse—it in any way. The drafters of our Constitution determined that this most personal of all kinds of property, the creation of man's mind and spirit, which exists by reason of law, should be his and his family's for only a limited time.

Under the 1909 law, that limited period was twenty-eight years with a possible extension for

an additional twenty-eight years. The 1976 law provides that all copyrights subsisting on January 1, 1978, shall have a duration of seventy-five years from the date copyright was originally secured. All works created after that date will generally enjoy copyright protection for the life of the author plus fifty years, which is the term long prevailing in most developed countries.

The exclusive rights that the copyright owner will enjoy are enumerated: 1) the right to reproduce the copyrighted work in copies or phonorecords; 2) the right to prepare derivative works based upon the copyrighted work; 3) the right to distribute copies or phonorecords of the copyrighted work to the public by sale or other transfer of ownership, or by rental, lease, or lending; 4) in the case of literary, musical, dramatic, and choreographic works, pantomimes, and motion pictures and other audiovisual works, the right to perform the copyrighted work publicly; and 5) in the case of literary, musical, dramatic, and choreographic works, pantomimes, and pictorial, graphic, or sculptural works, including the individual images of a motion picture or other audiovisual work, the right to display the copyrighted work publicly.

This is followed by various limitations on the



---

*Leonard Feist is president of the National Music Publishers Association, Inc., and a vice president of the Copyright Society of the United States.*

rights. The law giveth, and the law taketh away.

Among these limitations is a carryover from the 1909 law: the provision establishing compulsory license for phonorecords.\* In the middle of the 1906-9 congressional process, the Supreme Court had ruled that the copyright proprietor of a musical work did not have the exclusive right to reproduce that work on recordings because, unlike printed works, the intervention of a machine was necessary before the work embodied in the recording could be "perceived." Therefore, the work was deemed not to be a protectable copy under the copyright law. Piano rolls, discs, and cylinders were becoming increasingly important and more and more of a factor in our musical life. In all equity, Congress had to create a new exclusive right: the right to record.

In anticipation of a favorable Supreme Court decision, one piano-roll company had signed up the recording rights of a large number of music publishers, and there was evidence that a monopoly of copyright music in recordings was quite possible—a music trust. It will be recalled that in the early years of the twentieth century, monopolies were an immediate concern of government. Teddy Roosevelt, the trustbuster, sat in the White House.

To resolve the problem and remove the threat of monopoly, Congress came up with a very interesting innovation—something completely new in copyright legislation anywhere in the world. It invented the compulsory license. Once a copyright owner had recorded a nondramatic musical work himself or permitted someone else to do so, any other person could record the work by complying with certain procedures set down in the law. Since no consent by the copyright proprietor was necessary, this constituted, in fact, the "compulsory" license. The statute of 1909 set the royalty at 2¢ per copy. That rate continues to January 1, when the new law increases it to 2¾¢ per selection (an increase of 37½% after sixty-nine years!) or ½¢ per minute, whichever is larger. Under the new law, payment will be made on phonorecords distributed rather than on those manufactured, as had been previously provided.

The first recording of a work has always required the consent of the copyright owner; but it must be noted that unmodified compulsory licenses are almost never invoked for subsequent recordings, so that the consent of the copyright owner is often obtained in these instances as well. Practically all licenses have been and are negotiated within the framework imposed by the provisions in the law.

Even as the Supreme Court's decision in 1908

\*The phrase used to describe records in the 1909 law is "parts of instruments serving to reproduce mechanically [no infinitives are split in the U.S. law!] the musical work" and "mechanical reproductions." In the new law, the term is "phonorecords" for material objects—the discs or tapes—themselves, and "sound recordings" for the works that result from the fixation of the sounds.

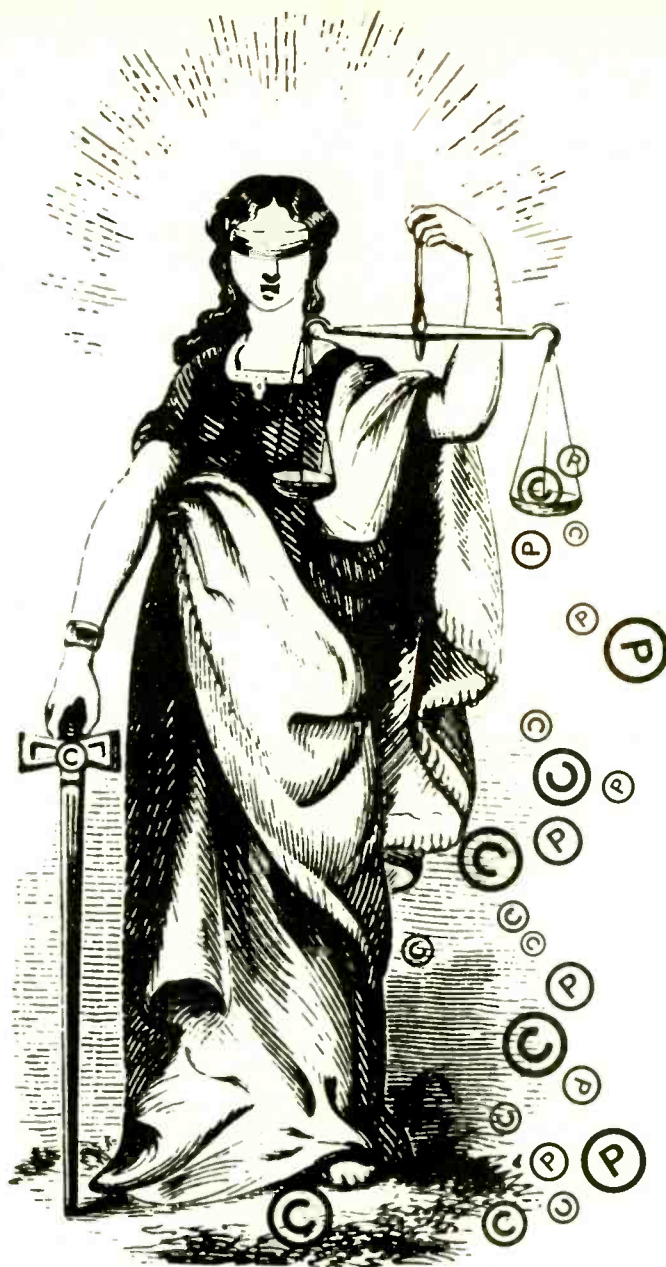

excluding recordings from existing copyright law made it necessary to deal with an unanticipated and thorny problem, so too did a decision concerning cable television during the early legislative stages of the new bill. Just when it seemed that the revision process was proceeding more or less on schedule, the Supreme Court ruled that in some situations transmittal of programs by cable television was not a "performance" under the law and consequently that no copyright liability existed. A subsequent decision went even further, and the problem of cable became one of the chief reasons for the agonizing delay in the enactment of the new law. The conflict between copyright proprietors of motion pictures and TV programs on the one hand and the cable system operators on the other was one of the most bitter of any in the long revision process. The matter was finally resolved by recourse to what has become the all-purpose



compromise solution—a compulsory license! The royalties to be payable by cable television under the compulsory license for their use of programs picked up from regular broadcasts do not look as though they will result in great increases in the monthly charges to the subscribers.

Nor is it likely that the final elimination in the new law of the jukebox exemption will cause any increase in the price per play of the music performed on that device which jukebox operators have labeled “the poor man’s symphony orchestra.” Jukeboxes had been specifically exempt from payment of royalties for performance under the 1909 act. At that time, coin-operated music machines were a novelty in penny arcades. Jukeboxes since have become an industry with an estimated annual income of \$500 million. Again, in the new law, Congress has resolved the conflict between jukebox operators and lyricists, composers, and their publishers by creating still another compulsory license. After January 1, an annual royalty of \$8.00 will have to be paid for each jukebox.

Another performance problem with which Congress had to deal was the “not-for-profit” exemption in the former law. Performance royalties had to be paid for a nondramatic musical work only if the performance was public and for profit. This limitation had long seemed to be inequitable, for often it was only the composers and lyricists who were not compensated, while all others involved in the performances were being paid. The blanket “for profit” exemption has been eliminated in the new law, and in its place there are established certain specific exemptions of performances such as those in connection with classroom teaching activities, of transmissions that are part of a nonprofit institution’s systematic instructional activities, and of performances of religious works in places of worship. Moreover, performances where there is no direct or indirect commercial advantage nor compensation to anyone are not infringing. To be exempt, proceeds from any admission charge covering more than reasonable production costs must be used for educational, religious, or charitable purposes.

Performances on public broadcasting clearly come under the new exemptions only for those programs of a systematic instructional content and purpose. However, in the congressional hearings, public broadcasting spokesmen raised the specter of problems of clearance of copyrights or excessive charges for their use. Yet another compulsory license was created! Payment must be made for copyrighted musical works that public broadcasting entities use. If negotiations on the royalty rates and conditions fail, the Copyright Royalty Tribunal will fix those rates both for performance on public radio and television and for the recording of music in conjunction with filmed public TV programs.

The establishment of the Tribunal is a very interesting and innovative development in the new law. Although in the case of public broadcasting it may set the initial royalty rates, the Tribunal’s prime function is to review periodically the rates set by it and by the law: i.e., royalties for recordings, jukeboxes, and cable television. The Tribunal will determine if the royalty rates should be adjusted. It will also distribute the royalties paid by jukeboxes and cable television and is responsible for resolving any controversies that may arise concerning distribution of royalties among the various parties entitled to share in them.

The Copyright Royalty Tribunal will consist of five members appointed by the President with the advice and consent of the Senate. Their terms of seven years will be staggered. It will have subpoena powers, may require testimony under oath, and in other ways may be better able to demand and get factual information than were the congressional copyright subcommittees in their hearings.

The provisions of the antipiracy law of 1971, which became effective on February 15, 1972, have been incorporated in the new law. The protection of phonorecords from unauthorized duplication has been continued, and the penalties for infringement of this provision of the law are particularly stringent. Since piracy is a willful infringement for commercial gain, the penalty for the first offense can be a fine of \$25,000 or one year in prison or both. For a second or subsequent offense the penalties may be doubled. The antipiracy law, by creating a copyright in the phonorecord itself, did not change or affect any rights in the music content in the phonorecord that had been, as previously noted, established in the 1909 law. In other words, a record manufacturer may own the copyright of his recording, but that does not give him any rights in the music he has recorded.

Although there were several strenuous efforts by record manufacturers, recording artists, and the American Federation of Musicians—with support from some influential individuals in the government—to require payment of royalties whenever a recording was performed, a performing right in recordings was not included in the new law. The law does direct the Register of Copyrights to conduct a study and submit recommendations on this right to the Congress by January 3, 1978.

In 1909 and for many years after, interest in copyright was limited to those who created the works (copyright proprietors) and those who utilized copyrights in the course of their business undertakings: broadcasting, motion pictures, phonorecords, and publishing of all kinds. Assuming public broadcasting is included as a mass consumer, although not specifically a commercial one, all the provisions of the new copyright law thus far

outlined come within the scope of legislative accommodations between these interests—users in a traditional sense—and copyright proprietors.

During the past twenty years, a new interest has appeared—that of the individual user. Because for the first time it has become easy for anyone to copy printed materials and recordings, a broad awareness, if not a comprehension, of copyright has developed. No longer is it necessary to have a sophisticated recording apparatus and a pressing plant to make phonorecords. Since World War II, anyone can have his own recording studio with an inexpensive tape recorder and the presence of music. Anyone can operate his own printing plant to duplicate existing graphic material with a photocopying machine down the hall in the office or, at worst, around the corner in the stationery store. Since so much of what is duplicated or taped is copyrighted, the copyright law now touches millions of people, most of whom may not feel the touch.

In the legislative proceedings, the promise and the problems that are part of these new devices were presented by educators and librarians who saw and, indeed, were enjoying the benefits of instant availability of and access to masses of useful material at no cost beyond that of the photocopying paper.

Over the years, the courts have recognized certain limitations upon the copyright owner's exclusive right by finding "fair use" in specific instances. This judicial doctrine has now been given statutory recognition by its inclusion in the law.

Four criteria have been established for determining whether reproduction in copies or phonorecords for such purposes as "criticism, comment, news reporting, teaching, scholarship, or research" is fair use or infringement. The factors to be considered are: 1) the purpose and character of the use, including whether such use is of a commercial nature or is for nonprofit education purposes; 2) the nature of the copyrighted work; 3) the amount and substantiality of the portion used in relation to the copyrighted work as a whole; and 4) the effect of the use upon the potential market for or value of the copyrighted work.

Subsequently, some educators claimed that even these four criteria were not clear or definitive enough. At the request of the House copyright subcommittee chairman, representatives of book and periodical publishers met with educators' spokesmen, as did representatives of music publishers with music educators' spokesmen. Guidelines were drafted and are included in the legislative history. No guidelines were requested of recording companies, probably because phonorecords had not been a major issue in this long, drawnout controversy. One significant limitation included in the education guidelines on fair use as it applies to music is that no single printed copy—let alone mul-

iple copies—may be made of any work in its entirety or any part of a work that is itself a performable unit, i.e. an aria from an opera, a section of a suite, etc., without permission of the copyright proprietor.

Libraries, in addition to the exception under fair use, have other exemptions. Under certain circumstances, they may reproduce single copies of literary works or phonorecords of literary works without permission if there is no commercial advantage of any kind. These exemptions are spelled out in detail in the law, as are their limitations. The library's rights of reproduction and distribution, however, do not apply to the duplication of copyrighted musical works, with certain very limited exceptions for out-of-print materials.

Many feel that these special provisions—fair use and reproduction by libraries and for certain educational or nonprofit purposes—are the only provisions in the new law that, provided the requirements of such provisions are met, would permit the use of photocopying devices and tape recorders to reproduce copyrighted works. In other words, they believe that the limitations set down in the new law on the exclusive right to reproduce a work are specific as to the use and the user and are not applicable to the general public.

At the moment, the question of private copying or recording has come into focus, not primarily because of the new law, but because of a new lawsuit brought under the old law [see "MCA vs. Sony," HF, April 1977]. MCA, owner of Universal Pictures, and Walt Disney Productions have instituted a suit against the Sony Corporation and others. The suit challenges the legality of home videotaping by Sony's Betamax device. The action claims as copyright infringement both advertising that proposes the use of the device to record TV programming for later viewing and the actual recording of TV programs by Betamax. The eventual outcome of this interesting case may have some bearing on the extent to which taping of copyrighted music from copyrighted phonorecords, or advertising of devices that can be used for that purpose, may be permitted.

Perhaps to emphasize that this exposition on the new copyright law is a mere outline will suggest the true complexity of the subject. The new law probably satisfies no interested party completely, although it includes some concession for almost everyone. The Betamax case may be a preview of things to come. It could be that in creating a new law, new controversies and legal questions have also been created. Still, the long years of wondering and waiting are over, and some answers are clear on many questions that have perplexed and plagued us for a number of years. Other answers are less clear but, be that as it may, come January 1 there will be a new copyright law in the land. Happy New Law. ●



# Some \$5 blank cassettes have the nerve to tinker with Beethoven. We think it's outrageous.

**B**eethoven, even when he was deaf, knew exactly how a piccolo sounded in relation to the rest of the orchestra. Some cassette manufacturers would just as soon forget. Their cassettes give the piccolo and other high frequency sounds a distorted prominence. They appear to do this deliberately, regarding absolutely natural sound as raw material to be improved upon.

At BASF, we think this is an abomination. We're purists; we stake everything on total accuracy of sound reproduction. You will never encounter artificially enhanced high frequencies in our cassettes. We believe that if you care enough to buy an expensive audio system, the last thing you need is a cassette that imposes its own dubious tastes upon your sensitive ears.

Faithful reproduction entails more than miracle ingredients and fanciful initials on a cassette label. At BASF, we begin with the best quality ferric oxide. We mill it by a patented process to

achieve maximum packing density and uniformity of coating. We use an exclusive chemically cross-linked polymer binding which will never deteriorate and cause head-related frictional noise or wow and flutter.

We use a unique multi-stage polishing process, and our slitting technique results in an edge that's clean even when viewed under a microscope. Even our cassette case is different, incorporating our patented Special Mechanism, designed to assure smooth tape feed for years of dependable performance.

Is completely natural sound worth that kind of effort? To people who know the difference, it is.

At BASF, we're purists. We've been obsessed with total accuracy since we invented magnetic tape back in 1932. There are no shortcuts to perfection. But you knew that when you planned your own audio system. We'll give you no reason to compromise when you buy our cassettes.



 **BASF The Purist**

Our Promise: the purest, most accurate sound that tape can reproduce.

**Chicago returns home.** The revival of Orchestra Hall as a recording site made the Chicago Symphony's sessions for Deutsche Grammophon in February especially pleasant—and perhaps a portent for the orchestra's recording future, according to contributing editor Robert C. Marsh. In 1968, after a remodeling job had rendered the hall less suitable for recording, Leopold Stokowski abandoned it in favor of Medinah Temple, which has presented problems of its own. The musicians hated the move north and have made it plain that they prefer to work at home: engineers have found it difficult to work there as well.

Orchestra Hall has too little resonance; Medinah Temple has too much. DG's producers decided that the former problem would be easier to overcome than the latter. To increase the amount of resonance, platforms were used to nearly double the size of the stage and main-floor seats were covered with heavy plastic to reflect sound upward.

Producer Rainer Brock, guest conductor Claudio Abbado, and all others concerned seem to agree that the orchestra's distinctive sound—brilliance combined with unusual warmth and depth of tone—has been captured on the two discs that came out of these sessions. The recordings contain Bartók's Piano Concertos Nos. 1 and 2, with Maurizio Pollini as soloist, and Prokofiev's *Scythian and Lt. Kije Suites*.

DG was scheduled to record with two more guest conductors, Daniel Barenboim and Carlo Maria Giulini, at Orchestra Hall. It remains to be seen whether the other labels that record the Chicago Symphony—RCA, London, and Angel—will follow DG's lead.

**Fanciulla in London.** DG plans a recording of Puccini's *Fanciulla del West* based on the new production at Covent Garden, featuring Carol Neblett (Minnie), Plácido Domingo (Dick Johnson), and Ingvar Wixell (Jack Rance), with Zubin Mehta conducting.

**The Rostropoviches in Paris.** Mstislav Rostropovich has conducted his third opera recording, returning to the composer (Tchaikovsky) and site (Paris) of his first, but under quite different circumstances.

When EMI recorded Yevgeny Olegovich, Rostropovich and his wife, Galina Vishnevskaya (the Tatiana), were in Paris as part of a tour by the Bolshoi Opera. Now that they are living in the West, their ties with the Bolshoi have of course lapsed—a particularly pain-

## Behind The Scenes

ful separation for Vishnevskaya, who was a member of the company for twenty-one years. (Rostropovich recently told Gramophone's Alan Blyth that the omission of her name from the Bolshoi's 200th-anniversary celebrations in 1976 "hurt us greatly.") So when, in January, the couple arrived in Paris to record *Queen of Spades* (which they have performed together in San Francisco and will do next season at the Paris Opera), it was under the auspices of Deutsche Grammophon, for which company they had previously recorded *Tosca*. The Ghermann is the Bulgarian tenor Peter Gougaloff.

**Pianistic Bartók.** Pascal Rogé has recorded Bartók's three piano concertos and Op. 1 Rhapsody for Decca/London, with Walter Weller conducting the London Symphony. Meanwhile, the young Hungarian pianist Dezső Ránki, who will soon be heard in the final volume of Hungaroton's *intégrale* of Haydn's keyboard works, has signed a contract with Telefunken, which begins with a complete recording of *Mikrokosmos*.

**Katya in Vienna.** Decca/London has recorded Jánáček's *Katya Kabanova* with Elisabeth Söderström in the title role and a mainly Czech supporting cast. The Vienna Philharmonic is conducted by Charles Mackerras, who also conducted an enthusiastically received revival of the English National Opera's production.

**Handel in Paris.** The first opera that Handel wrote after he arrived in England, *Rinaldo*, is being recorded by CBS, but not in England. The site is the Eglise du Liban in Paris, which the company has been using increasingly. The cast includes Ileana Cotrubas (Armida), Carolyn Watkinson (Rinaldo), Jeanette Scovotti (Almirena), Paul Esswood (Goffredo), Charles Brett (Eustazio), and Ulrik Cold (Argante). The conductor is Jean-Claude Malgoire.

**Italian quartets.** For Telefunken the Quartetto Esterházy has recorded

Boccherini's Op. 3 string quartets, while the Quartetto Italiano has been working on Cherubini quartets for Philips.

**Schumann from St. Louis.** Under music director Jerzy Semkow, whose contract has been extended through the 1979-80 season, the St. Louis Symphony has recorded the four Schumann symphonies for Vox.

**Dotted-Line Department.** Neville Marriner and the Academy of St. Martin-in-the-Fields—who, separately and together, have become something of a record industry unto themselves—have now signed on exclusively with Philips (though the contracts, we are told, provide for some outside activity). . . . Beverly Sills has extended her association with EMI, signing a new contract directly with Capitol Records, the U.S. EMI affiliate. . . . Andres Segovia must be pleased with his recent RCA records, for he has signed an exclusive contract with that company. . . . EMI has contracted to record the National Iranian Radio and Television Chamber Orchestra in works by Purcell, Vivaldi, and Shostakovich; the four-year-old orchestra's director, Scherezade Afshar, is the wife of the NIRT's director-general.

**Composers competition.** To celebrate its seventy-fifth anniversary, the Minnesota Orchestra invites U.S. composers to enter its composers competition. A distinguished jury of composers and conductors, headed by music director Stanislaw Skrowaczewski, will consider new (i.e., not yet published or publicly performed) works lasting up to thirty minutes for an award of \$3,000 plus performance by the orchestra. All entrants must register by October 1 and submit the completed work by January 1, 1978; the jury's decision will be announced in April. Detailed information and registration forms are available from the Minnesota Orchestra Composers Competition, Orchestra Hall, 1111 Nicollet Mall, Minneapolis, Minn. 55403.

**Lincoln memorial.** The Reading Symphony Orchestra is offering a recording of a Lincoln's Birthday concert given in Washington's Ford's Theater under music director Louis Vyner on February 9, 1975. The all-American program features André Watts narrating Copland's *Lincoln Portrait* and playing MacDowell's *Second Piano Concerto*. The two-disc set is available with a (tax-deductible) contribution of \$50 or more to the Reading Symphony Orchestra, 219 N. Fifth St., Reading, Pa. 19601. ■





## Nikko's dedication and your patience are now rewarded.

The people at Nikko have a very unique philosophy about the way they produce and market audio products.

It starts with producing only state-of-the-art components, the testing of every unit before you buy it, a three-year parts and labor warranty\* and conservatively rating every specification. Only in this way do you reap the benefits of true performance. Nikko now presents its finest discrete matched components: the Alpha-1 dual channel power amplifier has a three-stage Darlington direct-coupled OCL pure comple-

mentary circuit, large electrolytic capacitors (33,000 mF), and a rack mount design with optional side panels.

A matching Beta-1 "FET" preamplifier features high-voltage FET circuitry, three-stage direct coupled with two-stage differential amplifier, and a number of useful features, including a phono impedance selector and tape monitor (play 1, play 2, dubbing 1 to 2, dubbing 2 to 1). Beta-1 is also provided in a rack mount design (shown stacked atop Alpha-1).

### Alpha-1 specifications

**Continuous power output of 220 watts per channel, both channels driven from 20 to 20kHz into 8 ohms with no more than 0.08% total harmonic distortion.**

Intermodulation distortion	no more than 0.08% (at rated output)
Frequency response:	10 Hz-100kHz -0dB 1dB
Input sensitivity/impedance:	1V/50Kohms
Signal-to-noise ratio (I.H.F.):	100 dB
Dimensions:	7" high, 11 1/2" deep, 19" wide
Price:	\$599.95

*Specifications subject to change without notice.*

### Beta-1 specifications

Input Sensitivity:	Phono 1 & 2 2mV Tuner 100mV Aux 100mV
Input Impedance:	Phono 1 & 2 22K/47K/100Kohm Aux Tuner 50Kohm
Total Harmonic Distortion:	no more than 0.015% (at rated output)
Signal-to-noise ratio (I.H.F.):	Phono 1 & 2 72dB Aux 100dB
Frequency Response:	Phono 1 & 2 30-15kHz ±0.2dB (RIAA equalization) Aux Tuner 20-20kHz ±0.1dB
Phono Overload Level:	400mV RMS @ 1kHz
Output:	1V rated, 10V max
Power Consumption:	120V 25VA 50/60 Hz
Dimensions:	2 1/2" high, 11 1/2" deep, 19" wide
Price:	\$299.95



Nikko Electric Corp. of America  
16270 Raymer St., Van Nuys, Calif. 91406  
In Canada:  
Superior Electronics, Inc., Montreal

*\* See the warranty card with the product for full details*

*The above prices are shown for informational purposes only. Actual retail price will be set by the individual Nikko dealer at his option.*

**CIRCLE 27 ON READER-SERVICE CARD**

# A significant step backward.

**It's shaped this way to correct a problem – time/phase distortion.** In conventionally shaped loudspeakers, the voice coils of the high and low frequency drivers are not vertically aligned. The sounds you hear from each driver must travel unequal lengths to reach your ear and the result is time/phase distortion. You don't hear the music reproduced in the same order it went into the speaker.

**The step back design is a definite step forward in making the music you hear, clear.** Ultralinear's Synchronic Time Array ST550 corrects time/phase distortion by positioning the low and high frequency drivers in the proper vertical alignment and fine-tuning the frequency-dividing network with intricate

circuitry refinements. Music fundamentals and overtones reach your ear in the proper order, sharply defined, spacious and faithful to the original.

**This three-way system is also three-way tuneable.** Most quality loudspeakers provide mid and high frequency level adjustments, but the Ultralinear ST550 goes one step further with Dual Tuned Ports. Each port is fitted with a removable aluminum blocking plate, allowing you to adjust bass output to your own musical preferences or room acoustics. With ports open, bass response is optimized, complementing today's now sounds.

Closing the ports creates a tighter, more controlled bass, often preferred for classical listening.

The Ultralinear ST550; a dynamic musical step forward.



## Ultralinear®

For a dealer list plus color brochure, write Ultralinear, 3228 East 50th Street, Los Angeles, California 90058

Synchronic Time Array and Ultralinear are trademarks of Ultralinear Loudspeakers, a division of Solar Audio Products, Inc.



## The New Releases

ONE MIGHT NOT THINK that a work as gloomy, as tragic, as angry, as bitter, as sardonic, as terrifying, and ultimately as thoroughly pessimistic as Shostakovich's Fourteenth Symphony could at the same time be called "beautiful." Yet in spite of the brittleness of the strings-and-percussion orchestration; in spite of the coldness of the often chromatic melodic lines and the frequent open-interval chord structures; in spite of the nonmelodic, recitativelike setting of most of the texts sung by the bass and soprano in this eleven-movement symphony/song cycle; and in spite of the shock effects, ranging from lugubrious glissandos in the low basses and cellos to violins screeching in their highest registers, the symphony draws the listener so totally into its communicative fabric that the over-all aesthetic experience is at least as strong as in any work of art, musical or otherwise, I know of.

The recording newly released by Columbia (it was issued earlier by the French, German, and English Melodiya affiliates) is the work's third, and the second to come from the Soviet Union, which in itself is a bit of a surprise. For if the Soviets no longer find advanced musical devices seditious (unappreciated new works are simply shunted aside after one or two performances, as they are in any country), their reactions to even mildly negative spoken or written words generally remain swift and predictable. Yet, as I noted in my February 1971 review of Barshai's premiere recording, not only are the texts—by Garcia Lorca, Apollinaire, Küchelbecker, and Rilke—strong outcries in themselves, but they are ordered in such a way as to suggest an invective autoportrait of the thorny career of this Soviet composer, with the shadow of death, in its various forms, pervading everything else. And the way in which Shostakovich has combined words and music (note the snarling tone of the "Zaporozh'ye Cossack" movement, for instance), seems to make his intentions unmistakable.

At any rate, neither of the previous recordings, both excellent in their own ways, communicates Shostakovich's stark vision with quite the directness or force of the new one. To begin with, the chamberlike nature of the scoring invites the up-close, fairly nonreverberant sound obtained by the Soviet producers. The sonic impact, both in its realism and in its capturing of the verbal and instrumental detail, is simply overwhelming.

Equally impressive is the taut, energetic shaping of the musical flow by conductor Mstislav Rostropo-



## A New View of Shostakovich's Somber Fourteenth

*Rostropovich's uniquely impassioned conducting of Shostakovich's gloomy and sardonic masterpiece is ably seconded by his singers.*

by Royal S. Brown

vich, who was one of the late composer's closest friends. There are those who may find that Rostropovich burns himself out too quickly with the almost frenzied way he plunges into the "Malaguena" second movement and the opening of the third ("Die Lorelei"). To me, however, the individual movements are linked to each other in a rather cubistic manner, so that the content of each definitely bears full coloration, as opposed to the progressive shadings favored by Ormandy.

Rostropovich also elicits a particularly gripping *sostenuto* quality from both singers and instrumentalists in the slow sections; and throughout, he perfectly maintains the instrumental and instrumental-vocal tensions that help make the music so gripping. He turns the *col legno* nightmare strings in the middle of the "Santé Jail" seventh movement into a disquieting, almost static *grotesquerie*. Only in the ninth movement ("O Delvig, Delvig") does Rostropovich falter somewhat, failing fully to bring out the string-quartet intimacy at the opening and not completely identifying, it seems to me, with the fatalistic sadness of the general tone.

Rostropovich's soloists, soprano Galina Vishnevskaya and bass Mark Reshetin, sang in the work's first Moscow performance, on October 6, 1969. (The actual premiere had taken place in Leningrad on September 29; the bass of that production, Yevgeny Vladimirov, took part in the Barshai recording.) The

sopranos of both earlier recordings—Margarita Miroshnikova and Phyllis Curtin—gave excellent, sensitive performances. However, I know of no soprano who can impart quite so much depth of meaning to Russian texts as Vishnevskaya. Her vocal expressivity ranges from a vibratoless, very Slavic melancholia to full-voiced, impassioned outbursts, with everything so perfectly related to words and music that one hardly notices the occasional straining. For the male part a genuine Russian basso is definitely needed. Reshetin supplies the rich, dark hues called for better than Ormandy's Simon Estes, and I also prefer him somewhat to Vladimirov.

The Shostakovich Fourteenth is a masterpiece that certainly merits more than one recording, and it has fared especially well with the discs devoted to it so far. If a choice must be made, then the vitality of Rostropovich's interpretation, the outstanding vocal performances, and the brilliant sonic presence of this Columbia/Melodiya release elevate it to a strong first place.

**SHOSTAKOVICH:** Symphony No. 14, Op. 135. Galina Vishnevskaya, soprano; Mark Reshetin, bass; Moscow Philharmonic Orchestra, Mstislav Rostropovich, cond. [V. Antonenko, prod.] COLUMBIA/MELODIYA M 34507, \$6.98.

*Comparisons:*

Miroshnikova, Vladimirov, Barshai/Moscow Chamber Orch.

Curtin, Estes, Ormandy/Philadelphia Orch. Mel./Ang. SR 40147  
RCA LSC 3206 or CRL 3-1284

by Andrew Porter

## The Operatic Scarlatti

*Cambridge's disc of  
La Griselda excerpts helps  
argue the case for modern  
performances of  
Alessandro Scarlatti's  
stage works.*

ALESSANDRO SCARLATTI'S OPERAS are not well represented on disc; in fact, in the current SCHWANN there is none of them. Stage revivals have become more frequent during the last decade (at least nine of the operas have been done), but the composer has still to take his rightful place in the performed eighteenth-century repertory. The day of his doing so is being brought nearer by Harvard University Press's publication of the operas, under the general editorship of Donald Jay Grout. Three volumes have so far appeared: *Eraclea* (staged at Cornell in 1970), *Marco Attilio Regolo*, and *Griselda* (staged at Berkeley in May last year).

Scarlatti's importance—and the rewards to be found from listening to his operas—can be summed up in two quotations from Edward J. Dent:

Before 1700, he had gathered up all that was best of the tangled materials produced by that age of transition and experiment, the seventeenth century, to form out of them a musical language, vigorous and flexible as Italian itself, which has been the foundation of all music of the classical period.

Thematic development, balance of melodic phrase, chromatic harmony—all the devices which the seventeenth century had tentatively introduced, are by him woven into a smooth and supple texture, which reached its perfection in one who, although he never knew his true master, was yet his best pupil—Mozart.

In his earliest works there are traces of roughness, of "experiment." At the start of the eighteenth century



he unites holdness with easy control. *Mitridate Eupatore* (1707) is both grand and passionate. *Griselda* (1721). Scarlatti's last surviving opera, represents effortless mastery. Nothing now remains to be "solved." Form, harmonic control, balance of melodic periods, and beauty of expressive line conspire; the delicate intimacy of his chamber cantatas and the emotional force of his earlier dramas are united.

I attended most of the Berkeley performances of *Griselda*. There were serious deficiencies—in the staging, the conducting, the playing, and some of the singing—but the show grew on me, night after night, and it was easy to understand how eighteenth-century audiences could happily go repeatedly to the same opera, with the same cast. Because 1) Scarlatti's score does not yield all its secrets at once; 2) one soon discovered favorite moments that one waited for and could not hear too often; 3) the execution steadily improved, and number after number was brought to fuller life during the run; and 4) the singers varied their ornamentation and cadenzas, so that there were always surprising new feats of bravura as well as familiar pleasures to enjoy.

Cambridge's disc of *Griselda* excerpts, though described on the sleeve as "a documentary recording made during . . . performances," was, I believe, recorded about midway during the run, and not during actual performances. I wish it had been made "live." *Griselda* opens Act II with an aria, "Mi rivedi, o selva ombrosa," whose middle section ends with a long-sustained E flat that must be joined seamlessly to a reprise of the first section. Carole Bogard spun the sustained note ever more exquisitely, made the join ever more tenderly, until by the last performance she inspired her listeners to something like rapture. The sound of that moment is a vivid memory, but the execution on the recorded performance is less bewitching.

As a souvenir of the Berkeley production—the sum of those increasingly beautiful performances—I find the disc a shade disappointing. But let me try to review it as it may sound to someone who wasn't there, and as a partial representation of Scarlatti's opera. Nine of the thirty-seven arias are here (twenty-one were sung in the Berkeley edition), and all four of the ensembles (not counting the brief choral moments in that tally). They are not done in order, and therefore the disc is not a fair representation of the dramatic progress.

The libretto is an adaptation of one by Apostolo Zeno. "Patient Grizzel" is a country maiden whose merits were perceived by the king of Sicily, Gualtiero, who married her, and who then treated her most abominably so that her innate virtue would become as apparent to his populace as it was to him. The liner note dates the tale back to Petrarch, and could have taken it back to Boccaccio and the *Decameron*, whence Petrarch translated it.

The outstanding singers are Kari Windingstad, as Costanza, the young and beautiful princess brought to court ostensibly to be Gualtiero's new wife (in fact she is his and *Griselda*'s daughter, believed by *Griselda* to have been executed), and, above all, Daniel Collins, as Gualtiero.

Costanza was composed for the debut of Carestini, later famous as Handel's *primo uomo* in *Arianna*,



*Ariodante*, and *Alcina*. (Being written for Rome, at a time when women did not appear on the operatic stage, *Griselda* had an all-male cast, five castratos and a tenor.) Carestini, then about sixteen, was not yet the deep, noble, heroic mezzo for whom Handel wrote, but still a clear, bright soprano. Windingstad sings the music with clear, bright definition, and she brings much tenderness to the duet in which mother and daughter (identities still unrevealed) embrace, each drawn by instinct to the other. Gualtiero was composed for Bernacchi, Handel's Lotario in 1729, when Mrs. Pendarves said he was "as big as a Spanish friar." He was renowned—and sometimes re-proved—for his positively "instrumental" virtuosity. Collins' virtuoso prowess in divisions and decorations makes him a worthy successor. His manner is incisive and commanding.

These two singers have the sense of line, phrase weight, and rhythm to supply what the conductor, Lawrence Moe, lacks. They take charge of the music and reveal Scarlatti's expressive power. I regret that in the selection Windingstad has been allotted only one aria, and Collins only two. *Griselda* herself has four. It is true that she (in 1721 played by a "he," Farfallino, the "little butterfly") dominates the original score. And in Berkeley, Bogard dominated the performance with her lustrous presence and vivid, appealing manner. But the recording did not catch her at her best. The tone seems narrower than it did in the theater and, though of very agreeable quality, somewhat monochromatic. There is a dramatic aria in which *Griselda*, commanded to choose between embracing the villain and seeing her infant son killed, exclaims "Figlio! Tiranno! O Dio!" As it comes out here, all three exclamations might be addressed

to the same person, rather than in turn to her son, her persecutor, and the deity. There is a "sleep" aria of melting beauty, "*Finirà, barbara sorte,*" which Bogard sings limpidly but with a less certain placing of stress and a less certain moving into the lovely, unexpected extensions of the melody than she showed in the later Berkeley performances. Her attack and definition are not crisp, but she does make attractive sounds.

Judith Nelson as Roberto, Costanza's suitor, is trim, light, and exact. The three women's voices, in various combinations, produce that happy ensemble in which the ingredients do not jar yet keep their distinct characters. Riccardo Cascio, in a single tenor aria, is polite but callow.

The orchestra is carefully identified as "student" on the sleeve, and the instruments used are modern, not those of the Berkeley Collegium. The playing—strings, recorders, horns—is quite acceptable (though

the horns, I believe, are an octave too low). It is the conductor who strikes me as dull. Scarlatti's music, however, is not dull for a moment, but filled with one marvelous invention after another.

In the notes, Bononcini's setting of *Griselda* is dated 1721 instead of 1718 (its London performance was in 1722, not 1721). The third band is not Gualtiero's "*Che bella tirannia,*" as billed, but his "*No, non sospira,*" which Collins sings with uncommon brilliance. The recording is clean and decently balanced; there are moments of pre-echo.

**SCARLATTI, A.: La Griselda (excerpts).**

Griselda	Carole Bogard (s)	Gualtiero	Daniel Collins (ct)
Costanza	Kari Windingstad (s)	Corrado	Riccardo Cascio (t)
Roberto	Judith Nelson (s)		

Bruce Brown, harpsichord; members of the University of California (Berkeley) Orchestra, Lawrence Moe, cond. CAMBRIDGE CRS 2903, \$6.98.

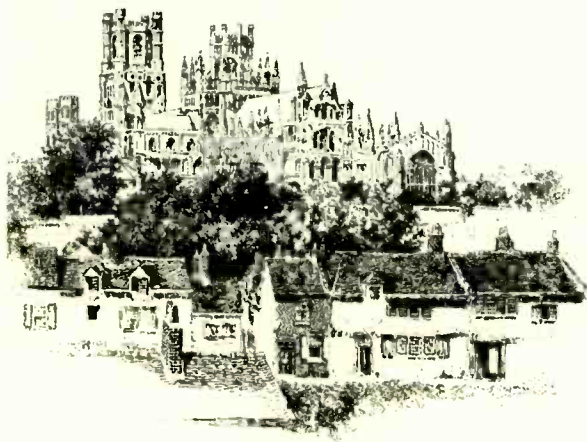

by Alan T. Gaylord

## A Master Storyteller in Search of a Voice

*Argo's "Knight's Tale" and "Pardoner's Tale" have solid merits but leave the dramatic promise of Chaucer on records unfulfilled.*

For readers who wonder how Geoffrey Chaucer has crashed these pages, a few words may be in order. No explanation is needed by those who have heard Alan Gaylord's virtuoso reading of the uproarious "Miller's Tale," an annual event at Dartmouth College, where he is professor of English. What that lucky group knows is that for sheer entertainment value Chaucer's poetry has never been equaled, even for nonspecialist listeners.

The importance of sound in Chaucer's writing makes it an ideal candidate for recording, and the arrival of two new releases prompted me to ask Mr. Gaylord to interrupt work on a variorum edition of "The Knight's Tale" to explore the subject. This review, I'm delighted to report, has in turn inspired a more comprehensive discussion of Chaucer on records, to be published in *College English*, where interested readers can pursue the matter. K.F.

*"Myne handes and my tonge goon so yerne  
That it is joye to se my bisynesse."  
—from "The Pardoner's Tale"*

NO DOUBT ABOUT IT, Chaucer should be heard and not seen. If the printed page is forced to be only a picture of his poetry, rather than a guide to its performance, it will seem too much a curiosity, guarded by teachers and scholars. For in black and white, Chaucer may appear simply quaint—an inconsistent speller, with a penchant for unbroken columns, obvious rhymes, and regular lines, not to mention thick glossaries and stupefying footnotes. But release him from the prison of the page, and he will enchant the ear. Chaucer writes—to be recited—the most accomplished narrative poetry in the English language.

In its new recordings of two of the *Canterbury Tales*, "The Knight's Tale" and "The Pardoner's Tale," Argo has given us a good sample of the range of Chaucer's entertaining art. Although the latter is the more familiar, the former deserves to be heard. And, above all, in Middle English.



That "bisynesse" the Pardoner boasts of was in the language itself. In the fourteenth century, English was collecting honey from all over. Scandinavian, Latin, Flemish, and, most of all, French words were being assimilated and gave Chaucer a copious hoard to dip into. The underlying structure, of course, remained Germanic, with accents strongly placed, consonants generously pronounced, and vowels clearly formed. Although everyone has memorized "Whan that Aprill with his shoures soote," those who recite the opening of the "General Prologue" too sweetly, with a cooing sound, will miss the varied pulse, the walking pace, and the colloquial alertness of this poetry of pilgrimage.

In "The Miller's Tale," a wench is wooed with a series of taste treats: "He sente hire pyment, meeth, and spiced ale, / And wafres, pipynge hoot out of the gleede." i.e., sweet spiced wine, fermented honey, spiced ale, and wafer-cakes, hot from the coals—to me, the passage neatly characterizes the taste of Chaucer's English. The honey is there, but smoothly fermented. It goes to the head.

There is a great deal that is attractive about these recordings. Their jackets are beautifully bright and authentically medieval. Their readers have been well coached by Derek Brewer of Cambridge University, among the best, and certainly the most readable, of Chaucer scholars in England today. (His *Chaucer in His Time* is highly recommended to newcomers.) They pay proper attention to rhyme and rhythm, and to the sounds of Middle English. They are accurate, in that they use the same pamphlet on pronunciation everyone else uses. Helge Kokeritz's *Chaucer's Pronunciation* (Holt, Rinehart, & Winston, 1962), and their clarity is exemplary.

Nevertheless, the Argo productions illustrate critical choices that are eccentric. These, combined with certain artistic deficiencies, leave me moderately pleased but far from satisfied.

"The Knight's Tale," the more heroic of Argo's ventures (it runs to three discs), has not been previously recorded. Although it is the first to be told on the pilgrimage, and is deemed by all to be a "noble storie" worth remembering, most modern readers prefer the "noble tale" the drunken Miller insists on telling next. "The Knight's Tale" is without "likerous" wenches, dandy dudes, cuckolds, surprising kisses, monstrous farts, sizzling bottoms, or all those other good things a fabliau provides. It is, rather, a tale supremely about love and passion, set above and beyond that sexuality the Miller descends to with such gusto. And it is very long—the longest of all the tales.

But a great tale, nevertheless. Chaucer has plundered the new humanism of Italy and found an elaborate romantic epic by Boccaccio. In translating, he multiplies his matter into old English gold.

His hero is the legendary Theseus of Athens, home from the Amazonian wars (Shakespeare will include the character in *Midsummer Night's Dream*, and also collaborate to turn "The Knight's Tale" into *Two Noble Kinsmen*). In disciplining and destroying Thebes, he captures two young knights, Palamon and Arcite, who, while in Theseus' prison, fall deeply in love with a vision of "fresshe" Emelye, the Amazonian ward and sister-in-law of the Athenian lord. Their bitter, if fruitless, rivalry is finally taken in hand by Theseus. He commissions a vast tournament

to settle the issue. Each young knight prays to a god for success. The knight of Mars, Arcite, wins the battle but loses his life. After a reconciling speech on early death and Providence, Theseus allows the knight of Venus, Palamon, to wed Emelye, and brings about a happy conclusion.

"The Knight's Tale" lacks only the music to be called the first English opera. It is filled with emotional arias and extended recitatives. If short on characterization, it is long on effects of language. Its descriptions of states of mind, battles, temples, and funerals are lavish, and its changes of pace are many. In charge of the telling is the character of the Knight, an illustrious old campaigner, full of practical wisdom and not without a sense of humor. The tolerant irony exercised by Duke Theseus is clearly in the image of the Knight.

Since all Argo productions parcel out speeches to separate actors—a choice I call eccentric—one can hardly look to Richard Bebb for a realized version of the Knight; rather, he is the "Narrator" and probably more like "Chaucer" than one of his characters, though a Chaucer more at home at the BBC than in the Tabard. Bebb is genial and unruffled, courteous and not too noisy. He speaks to us as from an adjoining chair, over sherry. For effect he often drops, rather than raises, his voice. Over-all, I fear, he becomes much too deliberate. His style tends to be "descending," in that a line will have both pitch and loudness higher at its start, and then run down. Whereas, as the narrator of a long tale, he needs to be "ascending." He must catch the latent energy in the tale, must move forward, be ready to burst beyond couplets, run beyond lines. This tale may not gallop, but it should stride. Bebb strolls.

Denis McCarthy's bass-baritone conveys quite well the "ire," the "resoun," and the positive lordship of Theseus, although in long passages he can drone. He does better with agitated anger than with that nonsarcastic inclusive irony that expresses the Duke's authority. In the brief role of the malevolent planet god, Saturn, he lacks color and force. Peter Orr, as Palamon, provides a baritone that is clear but much too mature for this proto-Romeo; while the casting of Frank Duncan as Arcite is a mistake. He sounds here like an aggrieved old man, as if Chaucer's Merchant had stumbled into the wrong tale. (He will do much better in the other album as the Pardoner.) Prunella Scales, who is all the women, has a mellow alto almost totally out of character. Reading Emelye's lines as if written by Edna St. Vincent Millay, she conveys lyric bemusement instead of the shallow anguish of a very young girl. Scales is much more suited for Chaucer's Criseyde, an older and more experienced woman, and reads the part well on Argo's recording of Chaucer's *Troilus and Criseyde* (ZPL 1003/4).

It would seem that clarity and deliberateness were basic goals for the Argo cast, as if by not apologizing for the poem but setting it straightforwardly out, they would let it make its own way. Yet their very seriousness becomes a drag upon its progress. And there are other limitations. First, since the whole Chaucer enterprise began with the BBC Third Programme in 1947, Argo's Chaucer has never stopped sounding like a genteel radio talk. Chaucer has thus been "said," rather than declaimed, and his elo-

quence shut up in too small a booth. Many of his tales are literary sermons; many of his characters rant and rave. Chaucer is always rhetorical, implying rousing an audience in a public place, implying vocal virtuosity, implying stylized speech. You could hear him more than one horse back. But Argo is for ambling side by side.

Second, the splitting of a narrator's tale into pseudo-drama is bad application of a Shakespearean principle. Except for the narrator, all characters are assigned only speeches, and they noticeably fall back upon the model of the soliloquy. Orr tries to take a Palamon "compleynte" about Fate to the brink of tragedy, lacking the narrator's leash. It should be the continuous presence of the narrator that provides ironic distancing and control. Narrated, the same speech will betray a certain amount of youthful hyperbole and self-pity.

"The Pardoner's Tale," though the better production, illustrates most vividly the effect of this voice-splitting. For the single disc is so divided that the Pardoner-narrator is the only one who speaks on the first side. The other voices are not heard until the record is half over. And since Frank Duncan does so well in this role, it is the more disappointing to see his effect dissipated, just when it should become concentrated.

We hear him first, telling us how he rings out his "hauteyn speche" from the guest pulpit, how he japes the simple folk by appealing to that same avarice he preaches against, and how he settles old scores as he goes: "thus spitte I out my venym under hewe/Of hoolynesse" (the record omits the "Introduction" to the Prologue, which is understandable in terms of length, but in no other way justifiable). We listen to his model sermon and like it. The sins are interesting and luridly cataloged. The Pardoner's knowledge of the self-indulgent will is devastating.

But when he begins his tavern tale of three louts who go out to find Death and slay him, the Pardoner is reduced to a bit player. His pulpit disappears; his story becomes separated from him. We need to hear the Pardoner go on to impersonate those churls whose black hearts he enters, and we need to hear him become the voice of Death-in-Life, the old man who cannot die but knows a "croked way" to send them down. We need to hear the Pardoner take the louts to a heap of florins under an old oak tree, and then separate them into plots to murder each other to avoid sharing the wealth. Thus, when he returns to point his moral and demand his prize, he will be altogether the athlete who thinks he has run his course and won. Dividing his voice divides him, and prematurely robs him of his prowess.

From this flow two consequences. First, the character of the Pardoner, neutered of its final potency, becomes too Dickensian. He is a rogue and a confidence man but not an impudent villain. There is no venom sprayed, nor does the voice come very close to the goatishness Chaucer ascribes to it. The Pardoner in this version is an eccentric exhibitionist who would please, rather than a lost soul who would dismay. We do not begin to fear this Pardoner, nor wish, somehow, to strike back, to show how we have resisted even as we have nodded under his command. That becomes the act of the Host, Harry Bailly,

whose vehemence when the Pardoner fingers him sounds more like vulgar bad manners than near-hysteria.

Second: like character, like tale. It has been blanded. Its reserve of power is not tapped, and we get sprightliness rather than aggression. "The Pardoner's Tale" is a moral tale, although the Pardoner only uses morality to increase his winnings, but it is also an act of revenge—on the blustering masculinism of Harry, on the condescending members of the pilgrimage, and on all those who seek a good price for the saving of their souls. Of course, the Tale, if spiritual melodrama, is firmly placed within the Chaucerian comedy, which means that the Pardoner is not banished from the company. But he must go a long way into the outer darkness before being brought back—by the Knight—to a kiss of peace.

Anyone who will supplement a reading of the Tale with the excellent essays collected by Dewey Faulkner in *Twentieth-Century Interpretations of "The Pardoner's Tale"* (Prentice-Hall, 1973) will find abundantly demonstrated the complexity of the Pardoner and his recital. It may well be that the Argo version does not aim for such complexity because it does not believe in it. If so, it would not stand alone. Most of the other recordings in print do the same.

Let me be clear, then, as to where we are. I have called these recordings "good." There are few that are better. If I were discussing all other Chaucer records that have been made, I should be just as critical—with the exception of what J. B. Bessinger has done for Caedmon (the "General Prologue" on TC 1151, the "Miller's Tale" and "Reeve's Tale" on TC 1223). Most of them do not rise beyond the quaint, the interesting, or the amusing. They remain sincere, even scholarly, trivializations. They help to maintain an image of "gentle Chaucer" that is miniature and two-dimensional, if in pretty colors.

Even though the recording of Chaucer is a very minor industry, there remain great resources in his art to be developed. Great stories, written by a great storyteller, deserve great performance. A master waits for a voice.

#### CHAUCER: The Knight's Tale.

The Knight	Richard Bebb	Theseus; Saturn	Denis McCarthy
Archie	Frank Duncan	Emelye; Venus; Lady	Prunella Scales
Palamon; Aegesus	Peter Orr	Mercury; Herald	Roy Spencer

Derek Brewer, director. [Harley Usill, prod.] ARGO ZPL 1208/10, \$23.94 (three discs, manual sequence).

#### CHAUCER: The Pardoner's Tale.

The Pardoner	Frank Duncan		
1st Riotour; Narrator	Peter Orr		
2nd Riotour	Denis McCarthy	Boy	Prunella Scales
3rd Riotour;	Taverner; Knight	Old Man; Apothecary; Host	Richard Bebb
	Roy Spencer		

Derek Brewer, director. [Harley Usill, prod.] ARGO ZPL 1211, \$7.98.

[N.B.: No printed texts are included with these recordings. Newcomers to Chaucer may be most comfortable with Robert A. Pratt's edition of just the *Canterbury Tales*, published in paperback with glossary and notes interspersed with text. Confirmed Chaucerians will want F. N. Robinson's more scholarly *Works of Geoffrey Chaucer* (second edition, 1957), which includes *Troilus and Criseyde* and the shorter poetry, along with more elaborate notes and glossary in appendices. Both are published by Houghton-Mifflin.]



If you've been thinking Realistic is great only in the middleweight division, the STA-2000 is going to take you by surprise. We designed and manufactured it in our own factory to deliver quality beyond reproach, and judging from critical acclaim, we succeeded. The fine styling and precision controls are obvious. But the heart of this receiver is in its circuitry ... the extra-low-

noise phono stage ... the sensitive dual-gate MOSFET tuner with PLL. Come by your nearby Radio Shack for a free copy of the reviews. And hear for yourself what all the excitement's about. You'll be amazed at just how far \$499.95\* can go. The Realistic 2000, 75 watts per channel, min. RMS at 8 ohms from 20-20,000 Hz, with no more than 0.25% total harmonic distortion.

"noise figures rivaling those of many a separate (preamp) ... If any part approaches over-achiever status, it is the power amplifier ... The controls are unusually flexible"

High Fidelity Magazine,  
March 1977

"separation at mid-frequencies was an incredibly high 54 dB ... usable (FM stereo) sensitivity point was reached with a signal of only 5.0  $\mu$ V ... excellent basic circuit design"

Audio Magazine,  
March 1977

# The Rave-Reviewed Realistic® 2000

STA-2000 AM/FM STEREO RECEIVER

**REALISTIC**

AM FM PHONO AUX1 AUX2 STEREO

FM 88 90 92 94 96 98 100 102 104 106 108 110

AM 540 550 560 570 580 590 600 610 620 630 640 650

SELECTOR PHONO AUX1 AUX2

TONE TREBLE BALANCE

VOLUME

**NOW PLAYING AT A RADIO SHACK NEAR YOU**

SOLD ONLY WHERE YOU SEE THIS SIGN:

**Radio Shack®**

A TANDY COMPANY • FORT WORTH, TX 76107 • 5800 LOCATIONS IN 9 COUNTRIES

These two credit cards honored at most Radio Shacks.  
\*Price may vary at individual stores and dealers.

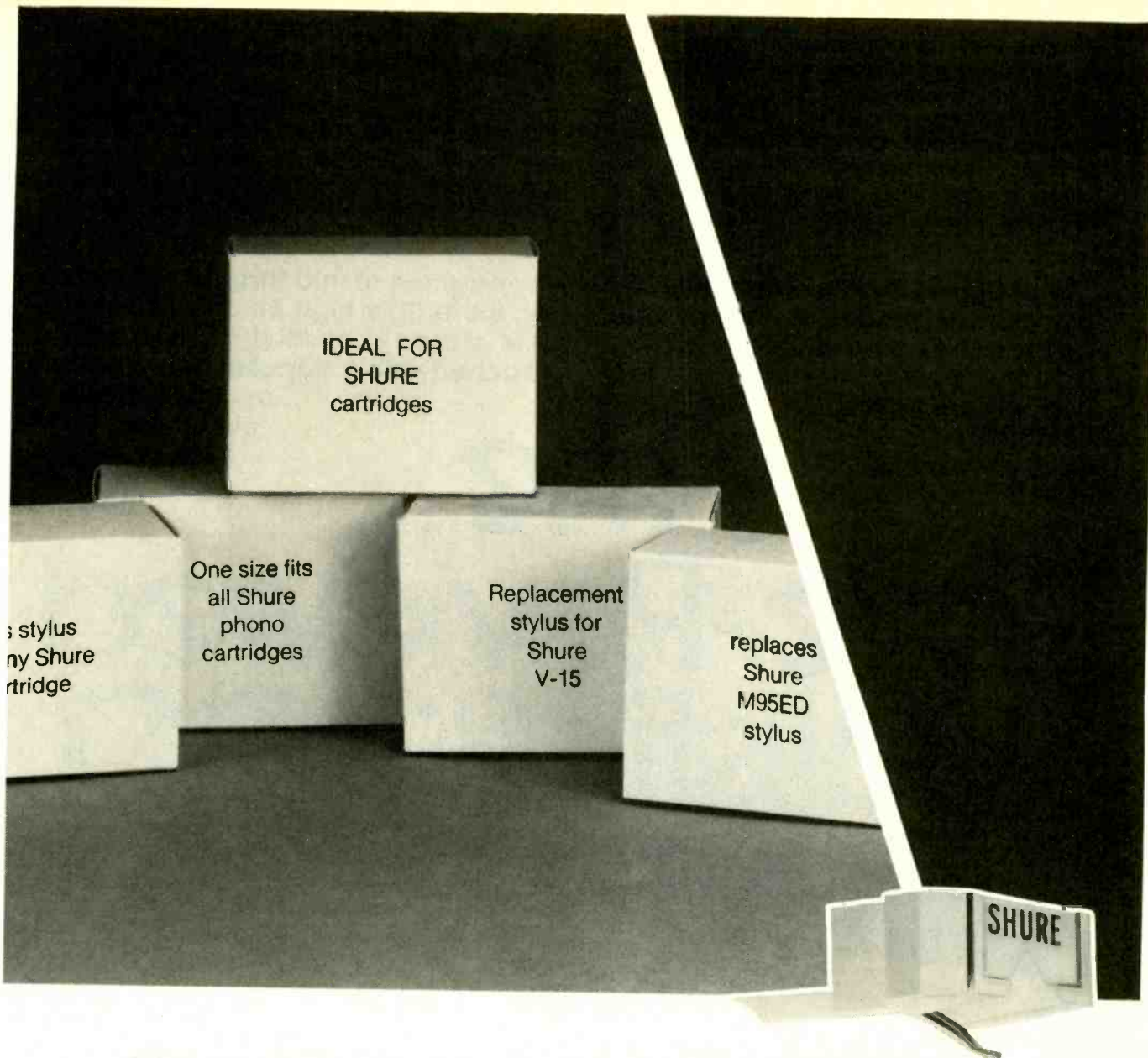

## Needle in the hi-fi haystack.

*Even we were astounded at how difficult it is to find an adequate other-brand replacement stylus for a Shure cartridge. We recently purchased 241 random styli that were not manufactured by Shure, but were being sold as replacements for our cartridges. Only ONE of these 241 styli could pass the same basic production line performance tests that ALL genuine Shure styli must pass. But don't*

*simply accept what we say here. Send for the documented test results we've compiled for you in data booklet #AL548. Insist on a genuine Shure stylus so that your cartridge will retain its original performance capability—and at the same time protect your records.*

Shure Brothers Inc.  
222 Hartrey Ave.,  
Evanston, IL 60204

In Canada:  
A. C. Simmonds & Sons Limited

### TECHNICORNER

The criteria for these tests involved the eight standard production line inspections used for all Shure styli: Visual and mechanical inspection, tip configuration, trackability, vertical drift, 1,000 Hz output level measurement, channel separation at 1,000 Hz, channel separation at 10,000 Hz, and frequency response.

Only genuine Shure styli have the name SHURE on the stylus grip and the words "This Stereo Dynetic® stylus is precision manufactured by Shure Brothers Inc." on the box.



*Manufacturers of high fidelity components, microphones, sound systems and related circuitry.*

CIRCLE 38 ON READER-SERVICE CARD



# Classical

reviewed by ROYAL S. BROWN  
 ABRAM CHIPMAN  
 R. D. DARRELL  
 PETER G. DAVIS  
 SHIRLEY FLEMING  
 ALFRED FRANKENSTEIN  
 KENNETH FURIE  
 HARRIS GOLDSMITH  
 DAVID HAMILTON  
 DALE S. HARRIS  
 PHILIP HART  
 PAUL HENRY LANG  
 IRVING LOWENS  
 ROBERT C. MARSH  
 ROBERT P. MORGAN  
 JEREMY NOBLE  
 CONRAD L. OSBORNE  
 ANDREW PORTER  
 H. C. ROBBINS LONDON  
 PATRICK J. SMITH  
 SUSAN THIEMANN SOMMER

**ALBÉNIZ: Iberia (complete); Navarra.** Michel Block, piano. [Michel Glotz, prod.] CONNOISSEUR SOCIETY CS 2120 and 2121, \$6.98 each.

**B** **ALBÉNIZ: Iberia (complete).** Aldo Ciccolini, piano. SERAPHIM SIB 6091, \$7.96 (two discs, automatic sequence).

**ALBÉNIZ: Iberia (complete). TURINA: Danzas fantásticas, Op. 22.** Blanca Uribe, piano. [Giveon Cornfield, prod.] ORION ORS 75202/3, \$15.96 (two discs, manual sequence).

Until now Alicia de Larrocha has for some twenty years maintained her supremacy in *Iberia* by periodically re-recording Albéniz' demanding suite. Her first recording for Hispavox (issued here as Columbia M2L 268 and currently available, rechanneled, as Musical Heritage MHS 1307/8) was superseded by a stereo edition, also for Hispavox (issued here as Epic BSC 158), and, most recently, by London CSA 2235. In whichever incarnation, her interpretation has unfailingly rebuffed all competition.

Now this three-way challenge has finally produced a recorded *Iberia* that surpasses De Larrocha's wonderfully idiomatic, but slightly overrefined, performance. The new winner is Michel Block, a French-born American citizen who lived for a time in Mexico. Block, a Juilliard graduate and one-time winner in both the Leventritt and Warsaw competitions (he won a special Arthur

Rubinstein prize at the latter at the master's behest), plays these complexly difficult pieces with atmosphere, poetry, and brilliant technical address. His brilliant, red-blooded, magnificently idiomatic and at the same time very personal interpretations benefit from gorgeously vibrant, rich-toned piano reproduction, far and away the best ever heard in this music. Even the London engineering for De Larrocha's latest effort—suave and agreeable—sounds rather artificial by comparison.

Not everyone will agree with every detail of Block's very subjective playing. Some may justifiably feel that he subdues ostinato excessively with his lush pedaling, or that he breaks the line at one or two places in an excessively cubistic manner. But as with Picasso or Arthur Rubinstein, one gratefully accepts the magnificently authoritative playing on its own terms. Indeed, it isn't at all hard to see why Rubinstein was so taken with Block's pianism, which is strikingly reminiscent of Rubinstein's own art at an earlier stage in his career. I was deeply impressed with Block's early concert performances in this country and by the DG disc made at the 1960 Warsaw contest, and frankly astonished that his career never really caught on domestically. Perhaps this superlative recording will put him on another course. His playing here is, beyond a doubt, that of a major international artist.

On the few occasions that I have heard her, the South American-born virtuoso Blanca Uribe has also impressed me as a very special sort of artist, and one who ought to be heard from a great deal more than she is. Uribe is quietly teaching (at Vassar) while pianists many times her inferior are performing frequently. She too brings to *Iberia* a big technique and a superbly idiomatic understanding of the writing. In many ways, her singing tone and completely natural welding of dramatic thrust and yielding lyricism remind me of De Larrocha's earlier performances. Uribe does equally well with the sparer, more modernistic Turina *Danzas fantásticas*.

Unfortunately, Uribe is not helped by her recorded sound—although not actively unpleasant, the piano tone is rather drab, literal, and unalluring. This music needs physical beauty and (real) resonance of tone if it is to weave its spell of ephemeral magic. Furthermore, the review copy had

Michel Block  
*An Iberia that  
 displaces De Larrocha's  
 at the top*

## Explanation of symbols

Disc:

- B** Budget
- H** Historical
- R** Reissue

Recorded tape:

- Open Reel
- 8-Track Cartridge
- Cassette

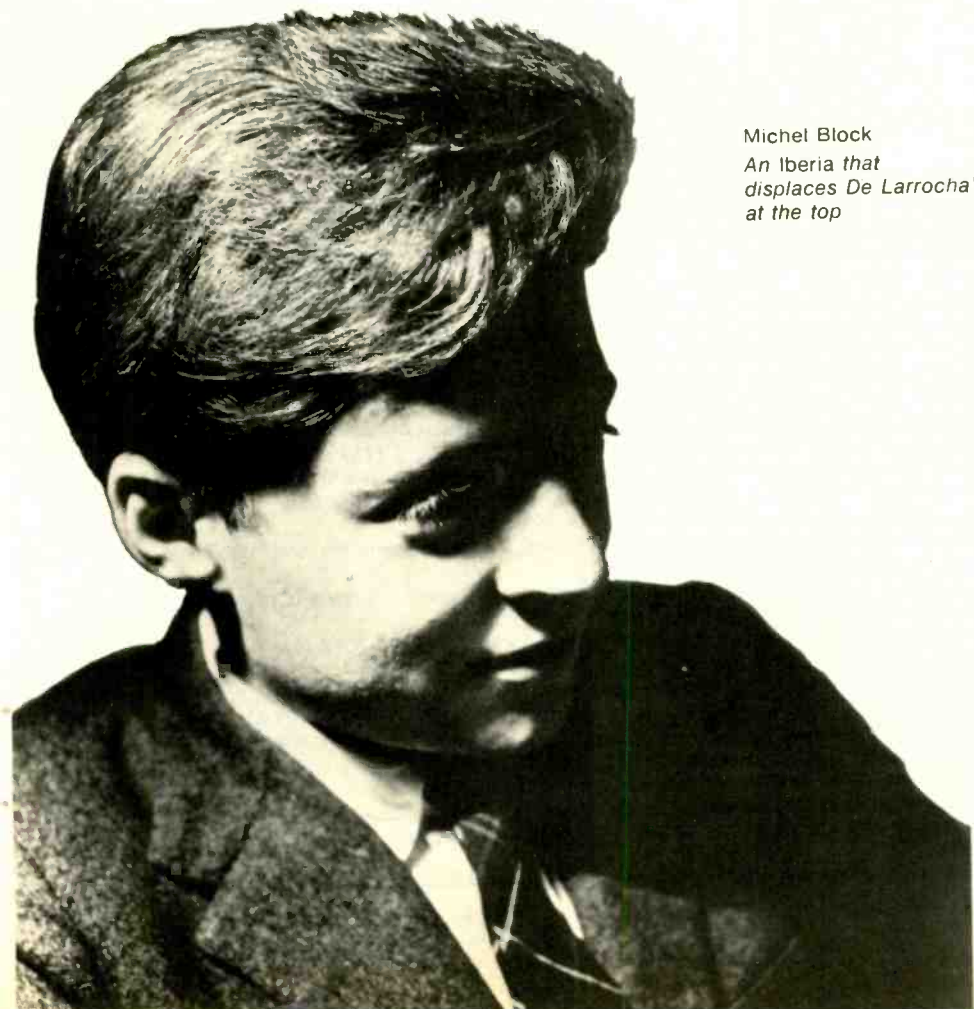

an assortment of pops, swishes, and crackles—hardly conducive to rapturous, sensual listening.

Aldo Ciccolini's *Iberia* is similar to his performance of Granados' *Goyescas* (also on Seraphim, S 60178). His performances are thrusting and full of incisive digital command, but for all their shapeliness and sure-handedness they sound overly dry—a two-dimensional replica of writing that screams for Cinerama (not to mention Technicolor). H.G.

**B** **BACH:** Brandenburg Concertos (6), S. 1046–51. Stuttgart Chamber Orchestra, Karl Münchinger, cond. LONDON TREASURY STS 15366/7, \$7.96 (two discs).

Comparison: Münchinger/Stuttgart Ch. Orch. Lon. CSA 2301

Many collectors of the early LP era were brought up on Münchinger's 1950 *Brandenburgs*, which survived in various formats until the late Sixties. His 1959 remake has in turn proved to be the longest tenured stereo edition in SCHWANN. The marketing problem posed for London by this third version (first released abroad in 1973) has been neatly solved through its issue in the budget Treasury series.

Although all three sets nominally feature the Stuttgart Chamber Orchestra, there in fact has been a complete turnover of solo personnel with each new effort. Consistent stylistic threads have included the use of a small ensemble (though with more than one player to a part) and of modern instruments (harpsichord excepted). Between the first and second sets there are virtually no differences in textual solutions or interpretive approach. Slow movements were rarely terribly broad and faster ones were leisurely. Basically, if you've heard one, you've heard both, although my own sense is of more gentleness and lightness in the 1950 set.

Apparently, however, Münchinger radically rethought his approach during the Sixties. Strangely enough, he seems to be responding to both the baroque-performance reformation and the Romantic revival!

Concerto No. 1 is a clear example of this eclecticism. With superstar Igor Kipnis on hand for the harpsichord part, we hear very nearly a full cadenza around the desolate and stark closing chords of the slow movement. In the finale, instrumentation is varied at the third occurrence of the Minuet. On the other hand, the eye-popping ritard that ends that movement and the rubato-soaked treatment of the Polacca seem straight out of the nineteenth century, certainly a far cry from the *Kapellmeister*-ish world the earlier recordings occasionally inhabited. For consolation, the third movement isn't as poky as of yore. London's annotations fail to identify the violino piccolo player.

Concerto No. 2 has changed less dramatically; Münchinger is just a little more lively than he used to be. His various solo teams have all been a pretty efficient lot. (Bernard Gabel is the trumpeter this time around.) Of No. 3 there are many interpretations more interesting rhythmically and texturally than any of Münchinger's, but now he has joined the "find a slow movement" club. Kipnis' suggestion (from the presumably in-

finite numbers that could be advanced) is the Adagio of Concerto No. 15 in G for solo harpsichord.

One of my favorite individual performances from the original Münchinger set was the pliant, gracious No. 4. That performance was adequately, if somewhat dourly, copied in 1959: the new version seems even more flexible in pulse, which may be partly an illusion produced by the more resonant sonics of the new set. One point I consider nonnegotiable: It was cruel and seemingly unnecessary to put a side break between the second and third movements.

Münchinger still can't seem to muster the crisp accentuation needed for the opening tune of No. 5, nor does he effectively build tension in the long modulating passages of that first movement. There is much to be enjoyed, though, from the superb solo interplay between flutist Aurèle Nicolet and the young Bulgarian violinist Stoika Milanova. Kipnis is disappointing in the cadenza—he is merely crisply efficient, projecting little dramatic ebb and flow. He does, however, inspire his colleagues to join him in ornamenting the middle movement (wherein a solo cello helps to fill out the texture).

I like the first Münchinger version of No. 6, especially for the sweet (and tonally contrasted) viola playing of Heinz Kirchner and Franz Beyer. Both stereo issues are similar in their solid, moderate pacing of the work; I wish the new release credited the viola solos.

In totality, then, there are too many inconsistencies of style (not to mention the

unfortunate disposition of the works across sides) to recommend this album unreservedly. The chug-chug rhythmic stolidity sometimes familiar from Münchinger's work isn't all gone here, though it is—perhaps even more annoyingly—covered over by a gloss of legato and rubato that ill suits it. For various degrees of authenticity of style, period instrumentation, textual innovation, transparency of part-writing, and interpretive eloquence, one can do better elsewhere: Britten (London CSA 2225), Davison (Vanguard Everyman SRV 313/4 SD), Leppard (Philips 6747 166), Marriner (Philips 6700 045), or the Collegium Aureum (Victrola VICS 6023) for starters. A.C.

**B** **BARTON:** *The Disappointment*. Milford Fargo, Arden Hopkin, William Sharp, Joseph Bias, Tony di Paolo, John Malloy, Richard Hudson, Richard Reif, Elaine Bonazzi, and Ruth Denison, vocals; Eastman Philharmonia Chamber Ensemble, Samuel Adler, cond. [Donald Hunsberger, prod.] TURNABOUT TV-S 34650, \$3.98.

The mountain hath labored and brought forth a mouse. This single disc, recorded in March 1976 (some seven months before the work's "first performance" in the Coolidge Auditorium of the Library of Congress), is all that remains of an ambitious collaboration between the Eastman School of Music and the Library of Congress to reconstruct and mount *The Disappointment*, or *The Force of Credulity*, a ballad opera written

---



---

## Critics' Choice

The best classical records reviewed in recent months

- BACH:** Cantatas Nos. 92, 126. Schreier et al., Richter. ARCHIV 2533 312, Apr.  
**BACH:** Goldberg Canons (with Reger). Marlboro soloists. MARLBORO MRS 12, May.  
**BRAHMS:** Violin Sonatas. Grumiaux, Sebok. PHILIPS 9500 108, 161 (2), Apr.  
**CARTER:** Brass Quintet et al. American Brass Quintet. ODYSSEY Y 34137, May.  
**CHOPIN:** Polonaises. Pollini. DG 2530 659, Apr.  
**COUPERIN:** Concerts royaux; Nouveaux concerts. Holliger et al. ARCHIV 2712 003 (4), Apr.  
**CRUMB:** Makrokosmos II. R. Miller. ODYSSEY Y 34135, Apr.  
**DVOŘÁK:** Symphony No. 7. C. Davis. PHILIPS 9500 132, Apr.  
**GOTTSCHALK:** Piano Works. List, Lewis, Werner. VANGUARD VSD 71218, Mar.  
**HANDEL:** Double Concertos; Overtures. Marriner. ANGEL S 37176, May.  
**HINDEMITH:** Brass Sonatas. Various soloists, Gould. COLUMBIA M2 33971 (2), May.  
**MAHLER:** Symphony No. 3. Horne, Levine. RCA RED SEAL ARL 2-1757 (2), Mar.  
**MEYERBEER:** *Le Prophète*. Horne, McCracken, Scotto, Lewis. COLUMBIA M4 34340 (4), Mar.  
**MUSSORGSKY:** Boris Godunov. Reizen, Golovanov. RECITAL RR 440 (3), May.  
**PAGANINI:** Caprices (24). Rabin. SERAPHIM SIB 6096 (2), Apr.  
**SAINT-SAËNS:** Violin Concerto No. 3. **VIEUXTEMPS:** Violin Concerto No. 5. Chung, Foster. LONDON CS 6992, Apr.  
**SCHOENBERG:** Variations, Op. 31 (with Elgar). Solti. LONDON CS 6984. Chamber Symphonies. Inbal. PHILIPS 6500 923, Apr.  
**STRAUSS, R.:** *Ein Heldenleben*. Mengelberg. RCA VICTROLA AVM 1-2019, Apr.  
**TCHAIKOVSKY:** *Swan Lake*. Previn. ANGEL SCLX 3834 (3), Mar.  
**VERDI:** *Macbeth*. Cossotto, Milnes, Carreras, Muti. ANGEL SCLX 3833 (3), May.  
**WEILL:** Vocal and Instrumental Works. London Sinfonietta. DG 2709 064 (3), May.  
**WOLF-FERRARI:** *Segreto di Susanna*. Chiara, Weigl, Gardelli. LONDON OSA 1169, May.  
**JOSÉ CARRERAS:** Operatic Recital. PHILIPS 9500 203, Mar.  
**PAUL JACOBS:** Piano Recital (Etudes). NONESUCH H 71334, May.  
**YOLANDA MARCOULESCOU:** French Songs. ORION ORS 76240, Apr.  
**BIDÚ SAYÃO:** FRENCH ARIAS AND SONGS. ODYSSEY Y 33130, Apr.
- 
-





S. Hurok

Vladimir  
Ashkenazy  
*Growing toward  
Solomon?*

in 1767 in Philadelphia by Andrew Barton (a pseudonym) that was never performed in the eighteenth century.

This was to be a major contribution to the Bicentennial celebration, since *The Disappointment* has long been an intriguing mystery for American music historians. Reconstruction involved the identification "of all 22 ballads whose lyrics are contained in the libretto" by Gerald Graue, chairman of Eastman's musicology department, and their arrangement "for a 13-piece instrumental ensemble by Samuel Adler, chairman of the Eastman composition department, who has also composed an overture and three interludes in the style of the period," according to a joint LC-Eastman press release.

The result of their work was published in a two-volume edition in the "Recent Researches in American Music" series brought out by A-R Editions of Madison, Wisconsin, a highly respected house. The series is under the general editorship of H. Wiley Hitchcock, director of the Institute for Studies in American Music at Brooklyn College, CUNY, and both he and Edward N. Waters, recently retired chief of the music division in the Library of Congress, "have been consultants on the project since its inception."

After the October 30, 1976, Library of Congress premiere, the Eastman School company was supposed to embark on an East Coast tour with the show, and according to the *New York Times* of August 22, 1976, "10 American colleges are already planning to use this version for fall or spring production." However, as the date of the LC production neared it became evident that a minor musicological scandal was agitating the ranks of those interested in the puzzle. To begin with, it turned out that a version of *The Disappointment* reconstructed by Stanley Sonntag of Manhattanville College and Shirlee Emmons of Princeton University had been performed in August under the auspices of the Bi-State Bicentennial Commission at the Open Air

Theater in Washington Crossing State Park, New Jersey; thanks to the researches of Beth Slusser of the New York After Dinner Opera Company it was revealed that the New Jersey production had been based on a 1937 WPA Federal Theater Project reconstruction that played in the Majestic Theater in Brooklyn under the title of *The Treasure Hunt*. In addition, it was disclosed that the LC-Eastman version had relied heavily upon the researches of Judith Layng of Hiram College, and those were demonstrated to have been based on faulty assumptions.

To top it off, the LC-Eastman production turned out to be a crashing bore. By far the most interesting aspect of the show was the music. Many of the popular eighteenth-century airs identified by Graue maintain considerable charm, and Adler did no violence to their spirit in his graceful settings. Thus, the Turnabout disc does preserve the best of the LC-Eastman *Disappointment* in the overture, prologue, eighteen airs, and epilogue. The interminable spoken text would be of interest only to specialists.

Graue's skimpy notes give the listener no conception of the musicological and textual difficulties posed by *The Disappointment*, which (surprisingly enough) reappeared in a second, revised edition in 1796 that also never reached the boards. One of the most tantalizing puzzles about the piece is that it seems to have been in production when the show was called off, according to the *Pennsylvania Gazette* of April 22, 1767, because its "personal reflections" rendered it "unfit for the stage." The text casts no light on these insulting "personal reflections."

The stated reason for the withdrawal is that an epidemic of digging for buried treasure was plaguing the City of Brotherly Love at the time and that, since this was the subject matter of the ballad opera, its caricatures of characters referred to recognizable respectable Philadelphia citizens. This strikes me as a rather lame excuse for killing *The Disappointment*. Another mystery is the 1796 edition, in which the references

to the king and his tax collectors are altered to the president and his minions. Was there also a 1796 epidemic of digging for buried treasure, or was there some other reason why that version never saw the light of day?

It would have been pleasant too to have some authentic information about such fine tunes as "The Bloom of May," "The Bonny Broom," "Shambuy," or "Kitty, the Nonpareil," but Graue supplies us with nothing but the titles.

Those who buy this recording, by the way, hear more music than did those who saw the performance—the record includes instrumental interludes that were omitted at the Library of Congress. And fortunately the Turnabout cast does not sing in the incomprehensible dialect affected by that of the LC-Eastman production cast (they are not identical, and the recording's Trushoop and Hum are not identified at all), but I am at a loss to account for the variation between the sung texts and those printed in 1767.

At least one participant in this musicological comedy comes out of the morass with some credit—arranger/composer Samuel Adler. If you forget all about such things as authenticity and scholarly integrity, you can listen to his sensitive settings and original music with genuine pleasure.

I.L.

**BEETHOVEN:** Sonatas for Piano: No. 2, in A, Op. 2, No. 2; No. 3, in C, Op. 2, No. 3. Vladimir Ashkenazy, piano. [Christopher Raeburn and Richard Beswick, prod.] LONDON CS 7028, \$6.98. Tape: ●● CS5 7028, \$7.95.

Both of these performances are characteristic of Ashkenazy's superlatively poised (but never flashy) pianistic ability, his scrupulousness of detail, and seriousness of musicianship. His readings of these pieces convey that they are, for all their classical antecedents, big sonatas both in scale and in scope. To be sure, unlike some pianists (Arrau, for one), he realizes the graceful elements—rippling arpeggio passagework and the like. Yet for all the swiftness and symmetry, these are not "pretty" interpretations, featuring instead structural design and a kind of swift, brilliant objectivity that lets the music plead its own case.

As far as they go, these are excellent versions. There are others, however, that go even farther. Schnabel's (in Seraphim ID 6063) have an undercurrent of nervous grandeur. His slow movements have a raw eloquence that somehow reveals greater depths of emotional reserve than Ashkenazy can currently muster. Similarly, the scherzo of Op. 2, No. 3, in Schnabel's reading, although taken at practically the identical fast tempo set by Ashkenazy, has a kinetic "swing" that goes beyond Ashkenazy's precise, rather unenlivening rhythm. Of particular relevance is Solomon's No. 3 (recently reissued in England in RLS 722, a seven-disc set gathering all the Beethoven sonatas he recorded), for although the English pianist also favors a rather icily objective piano tone and a similar interpretive scheme, he inflects the phrases with more grandeur and molds the even faster tempos with more of a personal vibrancy. I would



expect Ashkenazy's performances some twenty years hence to resemble Solomon's.

Competition is fierce in this music, and, while I like Ashkenazy's performances very much, along with the Schnabel and Solomon recordings already mentioned I prefer the terse, vehement Hungerford (Vanguard Cardinal VCS 10084) and gracious Kempff (DG, deleted) in Op. 2, No. 2, and the richly inflected accounts of Op. 2, No. 3, by Arrau (Philips 6747 035), Rubinstein (RCA LSC 2812), and Claude Frank (Victrola VICS 9000).

London uses a moderately distant piano sound in an expansively reverberant acoustic (Kingsway Hall, London). The two producers—the record doesn't specify who did which piece—seem to have worked somewhat differently, or is it Ashkenazy himself who favors a warmer, more unruffled sonority in Op. 2, No. 2, and more of a cutting edge in the companion work? H.G.

**BEETHOVEN:** Sonata for Piano, No. 21, in C, Op. 53 (*Waldstein*); Variations and Fugue in E flat, Op. 35 (*Eroica*). Emanuel Ax, piano. [Peter Dellheim, prod.] RCA RED SEAL ARL 1-2083, \$7.98. Tape: ●● ARK 1-2083, \$7.95; ●● ARS 1-2083, \$7.95.

Emanuel Ax's third recording is in many ways his most successful. The playing shows a cultivated grasp of classical proportion and a pellucid, crystalline coloristic sense. He is also gratifyingly scrupulous in following Beethoven's indications, and even when he does depart from them he seems to know what he is doing and why.

In the interview excerpts printed on the jacket, for example, Ax says, "Those octave passages [at the end of the *Waldstein* Sonata] are *not* marked *glissando*. I find that very important. I don't do them *glissando*. I do octaves from the wrist, simply because I like the sound. Beethoven knew the word *glissando* and used it in the First Piano Concerto. Here comes the question of tempo fluctuation. One plays the coda at a break-neck tempo [it is marked *prestissimo*]. It's impossible to play octave passages from the wrist at that same tempo. I personally feel it is acceptable and desirable to slow down and play octaves." Having encountered this rationale before, I think it is important to point up its fallacy: Beethoven may not have used the actual word "glissando," but he *did* indicate that the cited octaves were to be played *legato* and gave a repeated thumb/fifth-finger fingering whose authenticity is beyond dispute. Ax no doubt knows as well as anybody that it is impossible to play octaves *legato* from the wrist with that fingering at any tempo.

On the other hand, he is unexpectedly forthright on another, equally controversial, point: Beethoven's pedaling in the *Waldstein*'s rondo. Most pianists are trained from the cradle to avoid the mixing of tonic and dominant implicit in those markings; I am happy to report that Ax refuses to invoke such excuses as the composer's deafness and the limited sustaining power of the old pianofortes (even so fastidious a musician as the late Bruce Hungerford hedged on this point) and proves triumphantly that careless execution, and not the modern instrument, makes Beetho-



RCA

Emanuel Ax  
*Classical proportion, coloristic delicacy*

ven's pedaling so hard to realize accurately—he achieves a memorable wash of overtones without any harshness whatsoever. He is also to be applauded for choosing the alternating loud-soft dynamics at bars 321-28 of the third movement, as indicated in the manuscript, rather than the less characterful all-soft variant of the first printing (and most subsequent editions).

I must take some important exceptions to both performances: For one thing, Ax does not really sustain the demonic momentum required by the *Waldstein*'s first movement. He goes slack in the chordal second theme, which he phrases in an overly emphatic, sentimental manner. Some of the part-writing (e.g., bars 14-15) becomes a shade generalized and bland in his interpretation of the *Adagio Introduzione*. And there is a careless misreading in the left hand at bar 104 of the first movement: Ax's A flat (instead of B flat) changes the second chord from B flat minor to D flat major!

Ax's performance of the Op. 35 Variations is closer to the theme's graceful *Prometheus* origins than to the overpowering form it took later in the last movement of the *Eroica* Symphony. His interpretation, then, is far closer to Curzon's witty, urbane statement (London CS 6727) than to Schnabel's caustic, swashbuckling account (Seraphim IC 6067) or Arrau's bronzen monumentality (Philips 839 743). As in the *Waldstein*, the failings of Ax's performance relate to insufficient forward momentum and excessive concern for pianism per se.

In their genteel way, both of these readings make musical sense. And in articulation and delicacy they far exceed the capabilities of most young pianists. H.G.

**BEETHOVEN:** Symphony No. 6, in F, Op. 68 (*Pastoral*). BBC Symphony Orchestra, Colin Davis, cond. PHILIPS 6500 463, \$7.98. Tape: ●● 7300 361, \$7.95.

**BEETHOVEN:** Symphony No. 7, in A, Op. 92. London Symphony Orchestra, Colin Davis, cond. PHILIPS 9500 219, \$7.98.

Davis' early-Sixties recording of the Sev-

enth earmarked him as a conductor of substance, but his more recent Beethoven outings have often been disappointing. The new *Pastoral*, for example, seems to me quite "correct" in terms of matters of style and musicianship and yet totally wrong in terms of communicating the pulse and spirit of the score. Unlike so many current Beethoven conductors, Davis maintains tempos soundly, scans rhythms with proper distinction between upbeats and downbeats, accents justly, and secures reasonably clear textures. Yet all the *Pastoral* tempos strike me as too slow, with movement and singing quality further inhibited by his fondness for heavy tenutos, and he tends to neutralize tone color. The result is a performance without bucolic flavor, humor, lyricism, or sharp-edged energy.

In both the *Pastoral* and the new Seventh, Davis takes all repeats, which in the latter, at least, seems to me mere pedantry. Indeed the timings of this Seventh bode ill, being considerably longer than the earlier recording, and the performance begins inauspiciously, with heavy tenutos on the forte chords. Fortunately that opening proves a false omen. Although the full complement of repeats is a bit of a bore, the tempos are wisely chosen, rhythmically well sprung (in happy contrast to the *Pastoral*), and crisply maintained. While that initial heaviness does recur occasionally, at no other point is it really bothersome. If anything, the new recording is even a little tauter than the old one, and the playing has more passion, variety, and breadth. All is not perfect—the *acciacaturas* beginning at measure 29 of the Allegretto are a bit lethargic and the music's demonic thrust is often confined by excessive sobriety. In the main, however, this is a highly acceptable version, with massive, cleanly detailed sound to match.

The Seventh benefits too from a change of orchestra. The London Symphony matches the BBC Symphony (heard in all the previous installments in Davis' Philips Beethoven series) in fastidiousness and surpasses it in cutting edge and sheer virtuosity. H.G.

**BERLIOZ:** *Roméo et Juliette*, Op. 17. Julia Hamari, mezzo-soprano; Jean Dupouy, tenor; José van Dam, bass-baritone; New England Conservatory Chorus, Boston Symphony Orchestra, Seiji Ozawa, cond. [Thomas W. Mowrey, prod.] DEUTSCHE GRAMMOPHON 2707 089, \$15.96 (two discs, manual sequence). Tape: ●● 3370 011, \$15.96.

The sin of omission that besets so much of Seiji Ozawa's work in music of the classic-romantic period is one of rhythmic blandness. He tends to glide across its surface as if all measures, all notes were of equal importance. Points of departure have no special spring, points of destination arrive unheralded. The textural clarity is often remarkable, the playing disciplined, tonal coloring and blending accomplished with considerable skill—yet the result remains flat and inexpressive because the central issue of shaping has been ignored.

And so it is with this recording of Berlioz' *Roméo*. One can admire the work of the



# A Star is Born.

Introducing the world's first computerized tuner.  
From Sherwood Electronic Laboratories. \$2000.\*

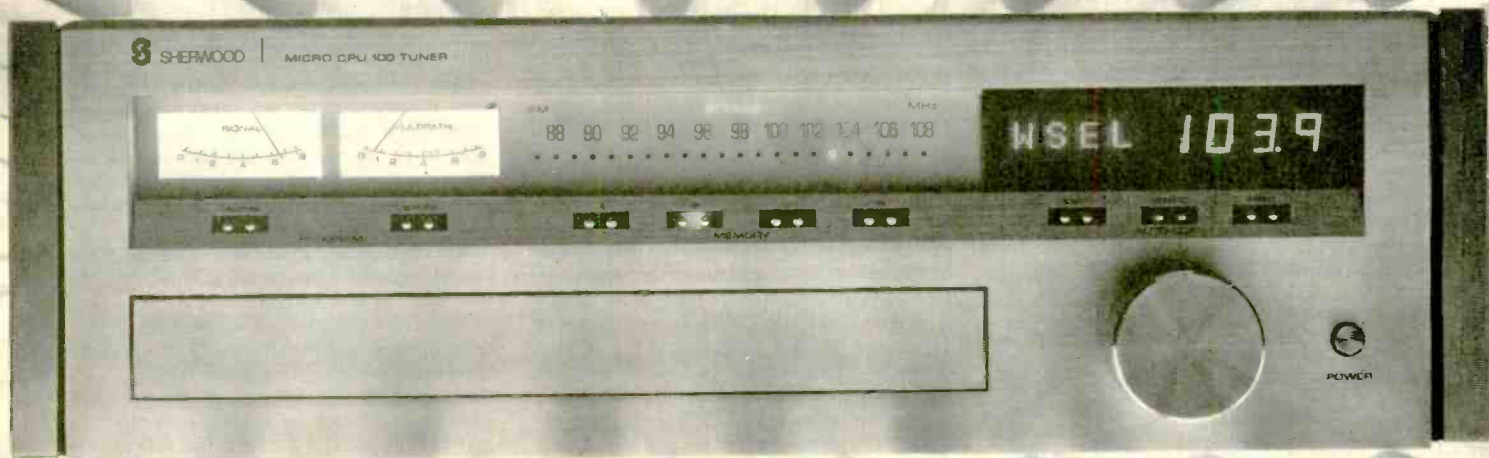

Not since tubes gave way to transistors has consumer electronics reached so dramatic a milestone:

For the first time ever, State-of-the-Art computer technology has been applied to State-of-the-Art audio equipment.

The result is the incredible Sherwood MICRO/CPU 100... the world's first fully computer-controlled stereo tuner.

It introduces a series of features and a level of performance that cannot be attained by means of conventional engineering practices.

Among the breakthroughs:

User-programmable station call-letter LED display. Infrared tuning, with a guaranteed accuracy of .0024%. The most technologically advanced digital detector ever developed. An automatic station scanning function, controlled by right and left touch switches that scan the FM band in either direction.

These are just the bare highlights. For full details and specifications, write to us at the address below. We'll send you a brochure that tells the whole story.

Or see this remarkable instrument at your Sherwood Dealer.

The MICRO/CPU 100. The world's most progressive tuner. New from Sherwood Electronic Laboratories. And made in the U.S.A.

It's lighting the way to the future of tuner technology.

 **SHERWOOD**  
When you're serious about stereo.

Sherwood Electronic Laboratories, Inc.  
4300 N. California Avenue  
Chicago, Illinois 60618

\*Value shown is for informational purposes only. Actual retail price will be set by the individual Sherwood Dealer at his option.

"MICRO/CPU" is a trademark of Draco Laboratories, Inc., U.S.A.

chorus, especially in that little off-stage passage preceding the "Scène d'amour" (admirably handled by the engineers, too). Those ascending series of triplets in the violins near the end of the Capulets' party have an arrestingly abrasive sound. The soloists are capable, and José van Dam more than that—he injects into the final scene precisely the kind of accenting and shading of lines that has been missing heretofore. But the rest is—well, boring, like a speech read phonetically by someone who doesn't understand the language.

The fascinating, subtly irregular violin melody at the start of "Roméo seul" is static, deadpan, when it should bristle with rhythmic ambiguity (is the first note an upbeat or a downbeat?). A bit later, under the great oboe melody, the gentle percussion intrusions are virtually inaudible, their rhythmic conflict with the pizzicato string accompaniment unrealized. The instrumental counterpoints of the "Convoi funèbre" merely gabble, without disclosing either sense or sensitivity. The final chord of the work (as that of the "Fête") seems to have landed on the wrong foot—or is it merely that the performance's general lack of concern about which is the right foot leaves us in ultimate doubt?

On the back of DG's box, some clown has ascribed to Julia Hamari and Jean Dupouy the roles of Roméo and Juliette. Fortunately, they restrict themselves to the assigned solo lines in the Prologue, and do not take voice during the "Scène d'amour." The rest of the presentation is respectable enough, with an intelligent essay by Julian Rushton, texts, and translations. My recommendation would be to stick with the Davis recording (Philips 839 716/7). D.H.

**BRAHMS:** Concerto for Piano and Orchestra, No. 1, in D minor, Op. 15. Arthur Rubinstein, piano; Chicago Symphony Orchestra, Fritz Reiner, cond. [John Pfeiffer, issue prod.] RCA RED SEAL ARL 1-2044, \$7.98 [previously issued only in mono as LM 1831, recorded April 17, 1954]. Tape: ●● ARK 1-2044, \$7.95; ● ARS 1-2044, \$7.95.

This is the first release of an experimental stereo tape made concurrently with (but using different equipment from) the mono recording issued more than two decades ago as LM 1831. Since this version has just been edited for the first time, and from different tapes, it is possible that the mono and stereo performances are not identical. And while sources at RCA assure me that the differences, if any, are minuscule, Rubinstein's first entrance does seem to flow a bit more naturally in the stereo edition. His rubato there is exaggerated almost to the point of caricature in the slower, heavier performance with Mehta and the Israel Philharmonic (London CS 7018, February 1977). Similarly, the pianist's left-hand ostinato in the passage beginning at bar 123 seems more sedate and naturally phrased.

These and other ostensible differences may be largely the result of the sonic superiority of the new version. In the mono original, the rather closely miked piano sounded hard and clangorous, the orchestra edgy and thin. In the stereo version, the piano is placed more discreetly in the total



Arthur Rubinstein and Fritz Reiner—a Brahms First reincarnated in stereo

context and the over-all sound is much richer; although the brass and timpani remain a bit obscure, the woodwind lines—which Reiner shapes as if the entire section were a single suave instrument—have particular luster. Sometimes the reverberation is excessive, but except in the first movement, where the blended, euphonious stereo placement somewhat smooths the cutting ferocity of Reiner's introduction, every sonic advantage is with the stereo edition. Indeed, I expect that some listeners will prefer the big-orchestra approach here to the interpretive and sonic introspection of Rubinstein's 1963 recording with Leinsdorf (LSC 2917 or VCS 7071). I continue to favor the Boston performance, but this reincarnation presents the Chicago one in a much more favorable light.

The best news is that RCA is contemplating release of some other early stereo tapes, including the Munch/BSO *Damnation of Faust* and some portions of Toscanini's final two NBC Symphony concerts. H.G.

**BRAHMS:** Sonatas for Cello and Piano: No. 1, in E minor, Op. 38; No. 2, in F, Op. 99. Gregor Piatigorsky, cello; Arthur Rubinstein, piano. [Max Wilcox, prod.] RCA RED SEAL ARL 1-2085, \$7.98.

A recording of the Brahms E minor Sonata by Piatigorsky and Rubinstein dating from the 1930s was once available on Victor 78s and later in an early microgroove transfer (LCT 1119), both long since deleted. The time was ripe for a reissue of this justly famous collaboration, but what we have here is, in fact, even better: a completely new reunion of two old friends—taped only a few years ago in California, with vastly better sound, of course, and with the F major Sonata thrown in as a (very substantial) bonus.

I certainly hope that the old E minor reappears, for the two performances provide a fascinating contrast. In fact my only regret is that these artists didn't also record both sonatas the first time. The F major makes much greater demands on the cellist,

with far more adventurous use of the different registers and the higher positions. By comparison, the earlier work stays almost doggedly in the "safe" low register, posing fewer technical problems.

The new performance, wonderfully mellow and surprisingly animated, is perhaps a shade more reflective and gently introspective than the old one, but the playing remains suave and refined. The modern engineering makes itself felt in the far greater clarity and impactiveness of the piano, most importantly in the finale, whose fugal ingredients here show their kinship with the Bach gamba sonatas.

There is a dangerous shift near the beginning of the F major Sonata that unwary cellists miss. Piatigorsky is not an unwary cellist, and it sounds as if he made a determined—and successful—attempt to avoid that pitfall. But in other places, his tone turns rather whiny; in intonation, articulation, and sheer energy, he sounds more taxed than in the E minor. Even so, this is the fervent playing of an undisputed master, and Rubinstein's work in both sonatas is the epitome of what a good Brahms ensemble pianist ought to strive for. His solid, bass-oriented sonority is rather akin to Backhaus' (with Fournier, now on Turnabout TV-S 34461, rechanneled), but far more ardent and larger-scaled. Piatigorsky and Rubinstein bring to this music a typically Slavic feel for nuance and freedom of phrasing. Tempos are flexible and varied, but always within an underlying basic pulse.

Save for some crackle throughout the F major Sonata on two review copies, the sound is splendid: full-bodied piano tone that never swamps the cello. Now if only Columbia would counter this wonderful disc with one by Casals and Horszowski—the French radio archives have performances of both sonatas, including several choices for the E minor. H.G.

**BRUCKNER:** Te Deum. **VERDI:** Quattro Pezzi sacri: Te Deum. Uta Sprechelsen, soprano; Heidrun Ankersen, mezzo; Adalbert Kraus,



# Discover music you've never heard before.

## Your own.

The bombardment of brass. Pulsating percussion. Surging crescendos. And strings that caress your innermost senses. The live experience. Lost once the concert ends.

Now, for the first time, you can recapture that live experience from your records, tapes and FM broadcasts with the exciting, new 3BX expander. Now you can breathe new life into your audio system. Life that gives you 50% more dynamic range, while dramatically reducing noise.

But your discovery is not just the sounds you'll hear, but the music you'll see. Visual music that you can control. Divided into 3 separate frequency bands, the unique 30 LED display feature allows you to visualize expansion within each frequency range.

Come hear, and see, the exciting new 3BX perform. Discover music you've never heard before.

Visit the dbxpert at your dealer or write: dbx, Inc., 71 Chapel St., Newton, MA 02195; (617) 964-3210.

# dbx

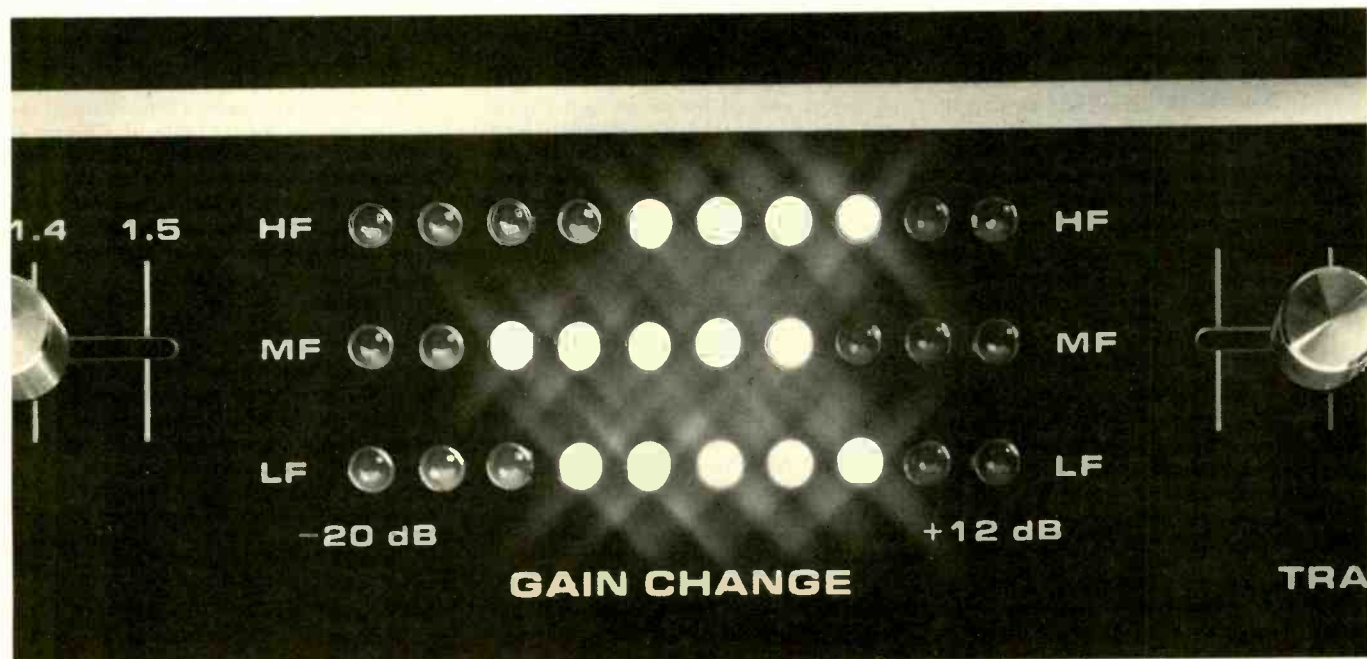

CIRCLE 10 ON READER-SERVICE CARD

tenor; Kurt Moll, bass; Christoph Grohmann, organ; Bielefeld Musikverein Chorus, Philharmonia Hungarica, Martin Stephani, cond. TELEFUNKEN 6.42037, \$7.98.

Some may wonder about the wisdom of recording relatively provincial forces in music already presented on disc by the major Verdian and Brucknerian maestros. Fortunately Martin Stephani proves to be a technically secure conductor with a clear sense of both microcosmic rhythmic patterns and macrocosmic dramatic ones.

His reading of the Verdi *Te Deum* is more pungently outgoing and crisp and less ethereal than any of those in the integral *Four Sacred Pieces* recordings (of which Giulini's, Angel S 36125, is a clear enough top choice). It is even reminiscent, in its tensile strength and forward surge, of the Toscanini *Te Deum* (currently on imported RCA AT 131). The unfortunate brass flubs that plague Toscanini's rendition shortly before the mezzo solo are avoided here, and the Bielefeld chorus is generally smoother than Toscanini's Shaw Chorale. If not nearly as pure and seraphic as Giulini's Pitz-trained Philharmonia Chorus, Stephani does make one textual decision I've not run into elsewhere: The opening measures for tenor and bass are given to soloists, rather than full choir sections.

The Bruckner is similarly successful. Stephani brings lots of excitement to the opening section, and there is abandon and drive aplenty to the "Aeterna fac cum sanctis." Contrasting repose occurs in the following "Salvum fac populum," where Adalbert Kraus's tenor solo is most appealingly plangent. Though the performance as a whole doesn't have the sustained sweep and naturalness of Jochum (DG 2707 024), few will want the erratic three-sided Bruckner Ninth to which that interpretation is currently held in bondage. (Conversely, while I admire Haitink's authoritative Bruckner Seventh, Philips 802 759/60, I find the coupled *Te Deum* rather tentative.)

No prior recording of either work has the fullness and immediacy of Telefunken's sonics, despite the rather modest forces employed and what appears to be a somewhat dry hall acoustic. True, the opening moments of the Bruckner have some misbalancing, with the chorus almost swamped under the weight of orchestral sound. Still, direct comparisons with other editions do leave the competition sounding quite murky, and Telefunken has provided its usual topflight pressing and packaging. A.C.

**CARPENTER:** Sonata for Violin and Piano—See Foote: Sonata in G minor.

**DOHNÁNYI:** Sonata for Violin and Piano, in C sharp minor, Op. 21. **SIBELIUS:** Violin Works. Diana Steiner, violin; David Berfield, piano. [Jamie Wilson and Gideon Cornfield, prod.] ORION ORS 76244, \$7.98.

**SIBELIUS:** Sonata, Op. 80; Devotion, Op. 77, No. 2; Souvenir, Op. 79, No. 1; Berceuse, Op. 79, No. 6.

The pieces heard in this collection, though all twentieth-century in vintage, represent stylistic outgrowths of the post-Romantic epoch. Dohnányi's conservative, well-



Montserrat Caballé and Eve Queler—a rare and splendid Donizetti performance preserved

crafted sonata could almost have come from Brahms's pen: this is a relaxed, tonally rounded, gracious work thoroughly deserving of many more performances than it is granted. Sibelius immediately displays a more acerbic—one might even call it a harshly astringent—personality in the pungent, biting scales and thrusting attacks that begin the neoclassical Op. 80 Sonatina. While it is obviously conceived on a humbler scale, this work has much of the same vaulting edge to be found in the violin concerto. The shorter pieces are relatively more lyrical but are saved from salon banality by the character and quirky humor of Sibelius' style. The *Berceuse*, for instance, is restive rather than reposeful—a kind of more cheerful alternative to the ever-popular *Valse triste*.

The Dohnányi sonata and Sibelius sonatina have been recorded before, although no alternative version of either remains in the domestic catalog. Diana Steiner, a West Coast violinist who studied with Zimbalist and Heifetz, has a vibrant, pulsating G-string sonority free of the sullen, bloated quality so many of her colleagues inflict on lower-register cantabile passages. Her left hand is unfailingly accurate and the bowing mostly assured, but on one or two occasions her playing takes on a slightly forced, astringent quality aggravated by the close microphoning. David Berfield gives keyboard support of real profile and concentration. H.G.

**DONIZETTI: Gemma di Vergy.**

Gemma di Vergy	Montserrat Caballe (s)
Ida	Natalya Chudy (ms)
Tamas	Luis Lima (t)
Count di Vergy	Louis Quilico (b)
Guido	Paul Plishka (bs)
Rolando	Mark Munkittrick (bs)

Schola Cantorum of New York, Opera Orchestra of New York, Eve Queler, cond. [Thomas Frost and Steven Epstein, prod.] COLUMBIA M3 34575, \$20.98 (three discs, automatic sequence) [based on the concert performance of March 14, 1976].

*Gemma di Vergy* (1834) was successful in its day and widely performed. Like *Lucrezia Borgia* and *Maria Stuarda*, which

came just before it, and *Marino Faliero* and *Lucia*, which came just after it, *Gemma* belongs to Donizetti's high romantic period, when he did daring and impressive things with form, with orchestration, and with dramatic turns of melody. It maintains a more consistent level of dramatic invention than *Maria Stuarda*. It has considerable energy—and a not uninteresting plot, based on a play by the elder Dumas.

The baritone, the Count of Vergy, has been ordered to divorce his childless wife, Gemma, and get an heir by another marriage. Gemma, who loves Vergy, alternates between grief and rage. The tenor is a hot-blooded Arab slave, Tamas, who loves his mistress (and is, rather surprisingly, on Christian-name terms with her). The bass, Guido, plays no active role but—like Raimondo in *Lucia*, or Giorgio in *I Puritani*—is ever on hand for sage comfort and counsel. The action is violent: In the course of it, Tamas kills three people (Vergy's squire Rolando, Vergy, and finally himself). Gemma makes two opportune entrances to prevent earlier killings, and Tamas makes one just in time to prevent Gemma from killing her successor, Ida (a small mezzo role).

Not one of the numbers is mechanical or merely conventional. Both of Gemma's solos, her entrance cavatina and an extended finale, have expressive cabalettas at moderate tempo. A duel for husband and rejected wife develops a Rossinian device of exclamations over a line carried by the strings. The soprano/tenor duet unfolds over a ground bass. The buildup of tension in the slow section of the first finale is particularly impressive. There are many unexpected entrances and unexpected structural turns, always for dramatic effect. Although the piece is performed here in an abridged and impure edition by Rubino Profeta, the surprises are authentic Donizetti. The cutting of most cabalettas to a single verse, which deprives them of stature, is not.

*Gemma di Vergy* was revived for Montserrat Caballé in Barcelona and in Naples during the 1975-76 season, and soon after those productions there followed the Carnegie Hall concert performance on



March 14, 1976, given by Eve Queler's Opera Orchestra of New York, which is the basis of this recording. Queler has provided some of the headiest operatic evenings I have had during four seasons in New York, and from its opening bars this set demonstrates her flair for apt tempos, for vivid colors, for encouraging singers to give of their best, for generating excitement.

The first voice heard is Paul Plishka's, and he is in splendid form. He has a kind of double number set into the *introduzione*. Rolando, who has just come from Avignon hearing the Pope's dissolution of the marriage, tells Vergy's men about daring deeds of Joan of Arc, and they reply; against their dashing, almost jaunty dialogue. Guido reflects gravely on Gemma's impending sorrow. Then he continues this reflection in a solo *cavatina*.

Tamas enters. His "*Mi toglieste a un sole ardente*" is a fiery and once-famous piece, with a cry of "*patria, nome, e liberta*" that roused Italian patriots as Verdi's invocations of fatherland and liberty used to do. Luis Lima, a young Argentinian tenor, has the ring of bright metal in his voice, and when that metal is refined and polished he may take his place in the great Spanish tenor line: from Garcia and Gayarré to Kraus, Domingo, Carreras. Already he is a winning performer who puts his heart into the delivery of every phrase and declaims words with ardor.

Next, Gemma. In her entrance aria, Caballé sometimes opens up too violently and exaggerates the dynamic gradients within a phrase. This is perhaps a price that must be paid for "live" performance. As the evening progresses, her singing becomes increasingly beautiful. The final scene is one of the most exquisite things she has put on record, and possibly it is more eloquent, more expressive, than anything that could be achieved in a studio precisely because she is singing to an audience intent, rapt, on each magical phrase. The last fifteen minutes of Side 6 provide an answer to anyone lamenting that the "grand tradition" of operatic singing is dead.

Vergy enters, to sing a duet with Gemma; later, he has two full-scale arias with caballettas. When reviewing Louis Quilico in the concert performance, I said that although he looked like Mr. Pickwick he sounded like a grandee. Listening again, I qualify this only to remark that he, too, takes time to get into his role. At first, he produces fine big tone but is insufficiently graceful or eloquent in his phrasing. Later, he comes to life more fully.

Just how the recording and the live performance overlap, just how much patching and audienceless recording was done, I am unsure. There is very little sound from the audience on the records (a cough near the start of Side 6 is exceptional), and there is none of the applause that greeted every number—usually before the number was quite over—in the live performance, until cheers break in at the very end. There are audible splices. Gemma and Ida, in the scene of their confrontation, sometimes seem to be singing into different acoustics. Moreover the "sound" is not that of Carnegie Hall; I suspect that the singers were closely and directionally miked (Quilico, it seems, with especial closeness) and that—in order to minimize audience noise—hall



## Enjoy Music More

If the recorded music you purchase and listen to is important in the way you enjoy life . . . you ought to know about a goldmine of helpful information for every record collector.

### Schwann Record & Tape Guide

is a compilation of information about records and tapes of many classifications. This wonderfully useful catalog uncovers titles you didn't know were available, helps you select versions by conductors and artists whose work you prefer . . . shows you money-saving reprints on budget labels . . . and much, much more.

More than 65,000 records and 8-track and cassette tapes are listed in the monthly *Schwann-1* and its semi-annual companion, *Schwann-2*. All are available through your record dealer if you ask for them by Schwann title and number. Schwann opens up rich rewards in your record collecting hobby. See your record dealer for latest copies.

**Schwann-1** Monthly. Lists the month's new releases in every category. Also nearly 45,000 available recordings on 702 record labels, 231 tape labels, 82 quadraphonic labels, in classical, recent popular, rock, jazz, musical shows, country, opera, ballet, electronic, etc. \$1.00 at your dealer's.

**Schwann-2** The semi-annual companion catalog for specialized categories: pop more than two years old, classic jazz, classical classics of the pre-stereo era, also the great re-issue catalogs; international pop & folk on domestic labels, spoken, educational, religious, etc. 95c at your dealer's.

#### SPECIAL PRICE SAMPLE OFFER

If your favorite store doesn't carry Schwann, order samples by mail, but please try your dealer first. Prices include postage and handling.

- Latest Schwann-1 (monthly)..... \$1.60
- Latest Schwann-2 (semi-annual)..... \$1.40
- Combination Offer: latest Schwann-1 (monthly) and latest Schwann-2 (semi-annual)..... \$2.75

Basic Record Library booklet.  
Lists 1,000 suggestions in classical music by musical periods for your enjoyment. Send 50c for cost of handling and postage.

I enclose \$..... for the items checked above.

Name \_\_\_\_\_

Address \_\_\_\_\_

City \_\_\_\_\_ State \_\_\_\_\_ Zip \_\_\_\_\_

Dealer's Name & Address \_\_\_\_\_

### Schwann Record & Tape Guide

137 Newbury Street, Boston, Mass. 02116

HF

sound was so far as possible abolished. There seems at times to be some added artificial resonance, not the natural resonance of Carnegie Hall. Balance between singers and orchestra is good.

As in the Columbia *Le Cid* (M3 34211, March 1977), similarly based on a Carnegie Hall live performance by the Opera Orchestra, I am at moments puzzled by the disparity between what I heard a year ago, live, and what I hear now on the records. The latter resembles neither a smooth studio recording nor the familiar "hall sound" as captured by pirates. But then, we are dealing with a novel genre. The custom of preparing a studio recording and a concert performance together, one series of rehearsals serving for both, is sensible and well established. Preparing a broadcast and a recording in tandem also has a long history, from Toscanini to such products of the European Broadcasting Union as the Unicorn album of Carl Nielsen's *Saul and David*. Live recording from the opera house is also familiar. But this kind of—what can one call it: beating the pirates at their own game?—seems to be a new development. I welcome it, for it would be sad if this splendid performance of Gemma had disappeared after a single hearing.

Delta for the cover design. Beta-querminus for the album booklet, which contains some interesting information, some horrid misprints ("Lablanche," "Giuseppini Ronzi," "Mercadente"), a text not quite adjusted to what the singers sing, and a translation often loose and sometimes plain wrong. When Gemma says to Ida, "Do you not know who I am?" ("Me tu ignori?"), her words are rendered, "You ignored me!" A.P.

**DUKAS:** Fanfare pour précéder "La Péri"; *La Péri*. **ROUSSEL:** Symphony No. 3, in G minor, Op. 42. New York Philharmonic, Pierre Boulez, cond. [Andrew Kazdin, prod.] COLUMBIA M 34201, \$6.98 (SQ-encoded disc). Tape: ●● MT 34201, \$7.98.

**DUKAS:** Fanfare pour précéder "La Péri"; *La Péri*; *Polyeucte Overture*; *The Sorcerer's Apprentice*. Czech Philharmonic Orchestra, Antonio de Almeida, cond. [Eduard Herzog, prod.] SUPRAPHON 1 10 1560, \$6.98.

The success Paul Dukas had with fantasy-inspired works becomes particularly apparent when his two orchestral masterpieces, *The Sorcerer's Apprentice* (1897) and the exotic *poème dansé*, *La Péri* (1920), are compared with the ultraserious overture (1891) for Corneille's seventeenth-century heroic tragedy, *Polyeucte*. Although the overture starts off with a striking and very solemn unison theme in the strings, it soon sinks into a kind of Prix de Rome pompousness no doubt suited to Corneille's inflated theatrical language but not very convincing musically. It does have other attractive moments, but the Gounod-cum-Wagner finale ends things on a rather low note.

*La Péri* and *The Sorcerer's Apprentice* are marked by a perfect lightness of touch. *La Péri*, furthermore, intermingles within a beautiful flow several sumptuous melodies, including a strange serpentine invention following the *Sorcerer's Apprentice*-ish opening. Both Pierre Boulez and Antonio de



Paul Dukas

*Péri* times two: one sparkles, one thumps

Almeida perform *La Péri* well. But while the Almeida approach is fairly conventional and recorded in spacious, big-hall sound with a fair amount of thumpy bass and reverberation, Boulez' rendition sparkles with a fairy-tale sheen and with almost excessive brightness of sound. As with several other Boulez recordings, his *La Péri* is a version I would not want to be without because of everything that is suddenly to be heard for the first time. And his disc contains by far the best-played, most stunningly recorded version of the fanfare that precedes *La Péri*.

But I must say I prefer the subtler, less heavy-handed Martinon/ORTF performance of *La Péri* on Musical Heritage (MHS 1467) containing the same fare as the Supraphon. Those who want all three works should probably turn to the Musical Heritage album: those who can do without the *Polyeucte Overture* will probably be satisfied with the Boulez for its sonically brilliant *La Péri* and with the electrifying Weller/London Philharmonic performance of *The Sorcerer's Apprentice* (London CS 6995), which also contains the composer's Symphony in C.

I doubt, however, that Roussel fans will be in any hurry to trade in the Munch/Lamoureux recording of the Third and Fourth Symphonies (Musical Heritage MHS 1879) for Boulez' misconceived Third. Roussel balances his abrasive harmonies and sometimes almost bumptious orchestration with a characteristic rhythmic drive, yet Boulez, particularly in the first movement, heads in one direction while Roussel goes off in another, resulting in a stasis that leaves the music naked and unfairly ugly in spots. He redeems himself here and there, as in the fugal section of the second movement, but for the most part the impression of cross-purposes remains.

R.S.B.

**DVOŘÁK:** *The Golden Spinning Wheel*, Op. 109; *The Wood Dove*, Op. 110. Bavarian Radio Symphony Orchestra, Rafael Kubelík, cond. [Hans Weber and Rudolf Werner,

prod.] DEUTSCHE GRAMMOPHON 2530 713, \$7.98.

**Comparison—Op. 109:**  
Kertész/London Sym.  
**Comparison—Op. 110:**  
Neumann/Czech Phil.

Lon. CS 6721

In Tel. 36.35075

The four programmatic tone poems Dvořák wrote in 1896 to Erben's folk-legend-based verses are sumptuous in melodic invention and use of orchestral imagery. *The Wood Dove* does an altogether splendid job of depicting the events and characters in the story: the violins' imitation of the wicked widow's exaggerated sobbing, the trumpet's bold heralding of her lover's arrival, the brashly defiant wedding music, the harmonically chilling woodwind writing for the denouement with its cooing of the title character. In *The Golden Spinning Wheel*, there are wonderfully swaggering passages portaying the king's arrival at the forest hut of the heroine. The grisly details of the future queen's dismemberment by her stepmother and sisters, however, don't come across in Dvořák's overly benign treatment, nor does the wedding music possess the necessary stark irony to underline the falseness and deception in that situation. Perhaps the atmosphere of cynicism and sadism just wasn't on Dvořák's wavelength. I find too that this work hangs together less tightly than *The Wood Dove*, an opinion apparently shared by Václav Talich, who made sizable cuts in his old Supraphon recording of *The Golden Spinning Wheel*.

In any case, Kubelík's pairing of the two symphonic poems is a logical and welcome one and, taken on its own, quite well done. He makes the most of the dramatic patterning of *The Golden Spinning Wheel*, bringing to bear joviality and open-air vitality when needed without slighting the work's lyricism. He also seems to coalesce the structure of the work nicely at those points where Dvořák's inspiration sags. The rival Kertész/LSO version on London (coupled with the *Symphonic Variations*) is marginally less lovingly shaped, though a trifle neater in execution.

The Bavarian Radio Symphony is more seriously challenged in *The Wood Dove*, where it cannot match the virtuosity, tonal sheen, and expressive understanding of the Czech Philharmonic under Neumann (in the three-disc Telefunken set containing the complete Slavonic Dances and Rhapsodies and the *Czech Suite*). Telefunken's recording, furthermore, has a sense of depth and color lacking in the more cramped and achromatic DG ambience. To balance the scales a bit, there is much to say for Kubelík's lateral division of first and second violins.

DG's spine and jacket front bill this record Dvořák's "Symphonic Poems"; in fact, there is a second disc to come, containing the remaining Erben-based symphonic poems (*The Noonday Witch* and *The Water Goblin*) in addition to the *Symphonic Variations*.

A.C.

**DVOŘÁK:** Trio for Violin, Cello, and Piano, Op. 65—See Recitals & Miscellany: Heifetz-Platigorsky Concerts.

**FOOTE:** Sonata for Violin and Piano, in G minor, Op. 20. **CARPENTER:** Sonata for Vio-



# After people learn what we've done, no one will heckle our speakers.

## We're as close to the impossible as possible.

Our new speakers color sound. Anybody's do.

Should they tell you otherwise, they speak with forked frequency response.

We at Sony developed the SSU-2000 with this grim reality in mind.

Our goal was to create a line of speakers with a minimum of coloration. With a frequency response flat and wide. With low distortion. And with repeatability. Which means each speaker we make will sound like the one before and the one after.

## Searching and researching.

Before you can make a good speaker you have to make a lot of bad ones.

We turned out dozens of prototypes that were made with the same specs, but sound like they weren't.

That's because your ear is more sophisticated than our measurements.

*You can hear how pure water is, for example.*

The purity of the water in which the pulp for the speaker cone is pressed influences the sound.

But it would hardly change the frequency response—or any other measurements.

Now there are dozens and dozens of elements that interact this way.

Changing one changes the other and almost changed our minds about going into the speaker business.

But we stuck it out. Applying the age-old technique of trial and error.

That's why we labored for three years to bring you our speakers. While other manufacturers rushed frantically to market with theirs.

## We keep the whole world in our hands.

Understanding how to control the sound of our speakers, we realized we had to control what went into them.

So we did the only logical thing.

We built a plant. Which does nothing but produce—under outrageously close control—the components for our speakers.

Few companies watch what you hear so carefully.

## Don't judge a bookshelf speaker by its cover.

As you can see, a lot goes into producing a speaker that's not easily seen. (One beauti-



Suggested retail prices: SSU-2000 \$150 each; SSU-1250 \$100 each; SSU-1050 \$130 a pair.

ful exception—the handsome finish on our cabinets.)

That includes the carbon fiber we mix into the speaker cone paper.

Carbon fiber is light and strong. Light, so our speaker needs less power to operate it, and is therefore more efficient.

Strong, so the cone won't bend out of shape in the high frequency range.

Moreover, carbon fiber won't resonate much. It has a low Q, and it took someone with a high IQ to realize it would absorb the unwanted vibration.

Unwanted vibration is also reduced by our cast aluminum basket, which is superior

to a cheap stamped metal one.

We're confident that the results of our three year effort will be clear after three minutes of listening.

At which point, far from heckling our speakers, you'll be tempted to give them a standing ovation.

# SONY®

© 1976 Sony Corp. of America.  
Sony, 9 W. 57 St., N.Y., N.Y. 10019.  
SONY is a trademark of Sony Corp.

CIRCLE 39 ON READER-SERVICE CARD

lin and Piano. Eugene Gratovich, violin; Regis Benoit, piano. [Giveon Cornfield, prod.] ORION ORS 76243, \$7.98.

This recording turns out to be a very pleasant surprise. Not only are violinist Eugene Gratovich and pianist Regis Benoit excellent instrumentalists, but both violin sonatas prove to be well worth hearing.

For me, the Arthur Foote G minor Sonata, published in 1890, is the more fascinating of the two works. First performed by Franz Kneisel (to whom it was dedicated) in Boston, the sonata has a fine, virile opening movement and a strong finale. Were it not for the *alla siciliana* second movement, which has more than a touch of the salon about it, the sonata could easily be mis-

taken for the work of a European *fin de siècle* master.

The John Alden Carpenter sonata, composed in 1911 and first performed by Mischa Elman a year later, is one of the Chicago musician/businessman's earliest works in an extended form. It strongly reflects French influences (César Franck comes immediately to mind), as did most of his later music, but it lacks the virility that makes the Foote sonata memorable.

Nevertheless, both pieces are good enough to deserve an occasional hearing in public concert, and it is good to have them available in strong, well-recorded performances. I.L.

FRANCK: *Psyché*. Belgian Radio Chorus, Or-

chestre de Liège, Paul Strauss, cond. CONNOISSEUR SOCIETY CSQ 2906, \$6.98 (SQ-encoded disc).

The full-length version of *Psyché*, for chorus and orchestra, often sounds as if Franck had simply changed the ripe chromatic progressions of the D minor Symphony around a bit to lead to the same musical conclusions. *Psyché*, however, lacks the symphony's dynamism, and if it compensates somewhat with a warm but rather asexual sensuousness, it does ramble. Nonetheless, this thematically unified work has more than its share of attractive moments, including the limpid theme in the "Psyché and Eros" movement and many of the choral passages.

Performances of the complete *Psyché* have been rare, and this Connoisseur Society/Pathé Marconi release fills a gap in the catalog, though the gap would be better filled by a performance with more richness and contour. The recorded sound, which is rather sheenless, could have been more in tune with the music. An important release, but something of a disappointment on all levels. R.S.B.

**GRIEG:** Concerto for Piano and Orchestra, in A minor, Op. 16. **SCHUMANN:** Concerto for Piano and Orchestra, in A minor, Op. 54. John Ogdon, piano; New Philharmonia Orchestra, Paavo Berglund, cond. [R. Kinloch Anderson, prod.] VANGUARD CARDINAL VCS 10112, \$3.98.

These are thoroughly "traditional" readings in the best sense, with the Grieg concerto benefiting particularly from straightforward phrasing and tempo relationships. Both performances on this EMI-derived disc are rock-solid, unpretentious, admirably forward-thrusting, and perhaps a trifle prosaic in terms of nuance and poetic sensibility. For all that, the essential message of each emerges loud and clear, and the sonics are full of bite, detail, and barbed clarity.

At the price, this is a fine modern counterpart for the classic Lipatti coupling (Odyssey 32 16 0141). Another inexpensive contender, the Fleisher/Szell (Odyssey Y 30668), provides an even more distinctive Schumann concerto, but those artists sound overwrought and stylistically ill at ease in the humbler musical demands of the Grieg. H.G.

**HANDEL:** Organ Concertos (16). Daniel Chorzempa, organ; Amsterdam Concerto, Jaap Schröder, cond. PHILIPS 6709 009, \$39.90 (five discs, manual sequence).

**HANDEL:** Keyboard Concertos (16). Sonata: Il Trionfo del tempo e del disinganno. George Malcolm, organ and harpsichord; Academy of St. Martin-in-the-Fields, Neville Marriner, cond. [Michael Bremner and Chris Hazell, prod.] ARGO D3D 4, \$31.92 (four discs, manual sequence).

Comparison: Rogg, Armand/Toulouse Conn. Soc. CSQ22115/6

Actually hearing these sets, whose imminent arrival I noted in my January review of the Rogg/Armand/Connoisseur Society set, simplifies one's choice determination



Whatever your choice,  
It's on **VANGUARD**  
RECORDINGS FOR THE CONNOISSEUR

## THE INSTRUMENTS OF THE MIDDLE AGES AND RENAISSANCE

Musica Reservata of London

A fascinating analysis of the principal instruments of the years 1400-1600, narrated by Martin Bookspan. Fully illustrated and documented.

VSD 71219/20 (2 discs)

VANGUARD  
**EVERYMAN**  
CLASSICS



### SIR ADRIAN BOULT CONDUCTS BEETHOVEN

Symphonies 3, 5, 6, 7; Overture to *Leonore* No. 3, *Coriolan*, *Fidelio*, *Egmont* Philharmonic Promenade Orch. of London SRV 359/62 (4 discs)

"one has the feeling that one is hearing the music for the first time as Beethoven imagined it . . . Superbly recorded."

— *Records & Recording*

VANGUARD  
**CARDINAL**  
SERIES



### BRAHMS: ORCHESTRAL WORKS

The Four Symphonies; Haydn Variations; *Academic Festival* and *Tragic Overtures*

Utah Symphony/Abravanel VCS 10117/20 (4 discs)

"Maurice Abravanel's conducting is not only elegant and workmanlike, but remarkably sensitive."

— *HiFi/Stereo Review*

### STRAVINSKY: L'HISTOIRE DU SOLDAT

In French Madeleine Milhaud, Martial Singher, Jean Pierre Aumont;

Leopold Stokowski, cond. VCS 10121

"superior in all departments"

— *San Francisco Chronicle*

VANGUARD  
**NOMAD**  
SERIES



### AFRICAN JOURNEY — A SEARCH FOR THE ROOTS OF THE BLUES

Singer/historians from the Gambia, Senegal, Mali; funerals, processions, dances, songs from Ghana, Togo.

SRV 73014/15 (2 discs)

### SWEDISH FIDDLE MUSIC From Boda Village

Folk tunes and dances of an important — and almost lost — art, recorded in the homes of its most famous exponents.

SRV 73016



### ERICH KUNZ: GERMAN UNIVERSITY SONGS

VSD 731/2 (2 discs)

"His extraordinary performances distinguish him once again as one of the finest actor-singers of our time."

— *High Fidelity*

Sugg. list price: SRV and VCS series — \$3.98 per disc

VSD 71219/20 — \$13.96 (2 discs)

VSD 731/2 — \$7.98 (2 discs for the price of 1)

Vanguard Recording Society, Inc., 71 West 23 Street, New York, N.Y. 10010

CIRCLE 44 ON READER-SERVICE CARD





# Sankyo auto-loading

The tape goes in perfectly every time and ends torn tape worries for all time.

This isn't just another deck. It's the Sankyo STD-2000. And for a lot of reasons it's one of a kind.

Reason number one: the automatic front loading system. It practically takes the cassette out of your hand and glides it into the perfect playing position. Torn tapes and damage head problems are now a thing of the past.

Reason number two: our one-year full warranty. It lets you buy with confidence.

Reasons three to six: the STD-2000 has a S/N 66 dB at 5kHz with Dolby. Wow and Flutter at less than 0.65% WRMS. A total harmonic distortion that's less than 1.5%. And a frequency response of 30-17,000 Hz with CrO<sub>2</sub> and FeCr tapes. And there's much more.

All these reasons and a price that's still under \$300 makes the Sankyo STD-2000 truly one of a kind.

Write to Sankyo, Dept. C, for the name of your nearest dealer.



**No other deck offers all these features for under \$300.**

- Dolby noise reduction system with MPX filter switch
- Automatic front loading
- Total automatic shutoff
- 3-digit memory counter
- Separate 3 position bias and equalizer switches
- Peak indicator
- Twin VU meters
- Record, Dolby and tape running indicator
- Permalloy head
- Rich wood cabinetry with chrome accents

If the others had quality like ours, they'd have a Full Warranty like ours.



## Sankyo

The Full Warranty Company

Sankyo Seiki (America) Inc., 149 Fifth Avenue, New York, N.Y. 10010

CIRCLE 49 ON READER-SERVICE CARD

## Buy Hi-Fi. The Modern Way.

Catalog • Mail • Phone

Send today for your FREE copy of our catalog. It's value-packed with:

- Complete Music Systems
- Top Name Brand Components, including many esteem brands
- Unique audio accessories not available in stores

Our prices are the lowest possible.

We are centrally located to serve you fast and keep freight low. Your Master Charge and BankAmericard (Visa) bank cards are welcome.



BOX 567  
1626 Ogden Avenue  
(US 34)  
Downers Grove,  
Illinois 60515  
(312) 852-5885

Wholesale & Mail Order Division

Call us for a quote. Lines open 1-4 p.m. C.T.

Mail this coupon for your FREE catalog.

Mail to: Midwest Hifi, P.O. Box 567, Downers Grove, Ill. 60515

Name \_\_\_\_\_  
Address \_\_\_\_\_  
City/State \_\_\_\_\_ Zip \_\_\_\_\_

## SAVE ON

### Brand Name Audio Components

BY MAIL

Write Today for Our  
FREE Audio Catalog

DIXIE is one of the oldest and largest stereo mail order houses in the country. Our lower prices on brand name components can save you real money. Call us today for a price quote, toll free (800)446-7925. In Virginia call (804) 257-4241. Everything shipped in factory sealed cartons with manufacturer's warranty.

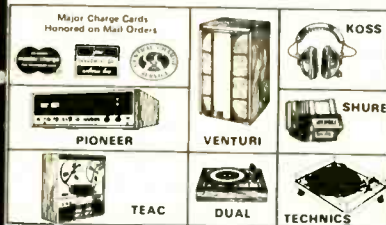

DIXIE HI-FI

P.O. Box 6496  
Richmond, Va. 23230

HF-6

Please rush me your FREE Audio Catalog and complete information. I understand there is no obligation.

Name \_\_\_\_\_  
Address \_\_\_\_\_  
City \_\_\_\_\_ State \_\_\_\_\_ Zip \_\_\_\_\_  
Phone (\_\_\_\_) \_\_\_\_\_  
A.C.

by establishing clear-cut character differentiations. Institutional and historical-specialist collectors who demand all period or replica instruments won't find it difficult to choose between the Chorzewski/Schröder versions and those by Tachezi and Haroncourt for Telefunken (36.35282, March 1976). The former's practical advantages are its inclusion of all sixteen concertos (rather than only the twelve in Opp. 4 and 7) and its more extended use of *organo ad lib* materials mostly drawn from Handel's harpsichord suites and violin sonatas. Its practical disadvantage is that these added materials and the generally slower tempos require five rather than three discs.

The price difference might not be enough to rule the Chorzewski set out of contention—what does so for me is a variety of tonal and executant flaws, none of which is probably the fault of the soloist and the engineers. Chorzewski himself plays well, if without marked personality projection, and his decorative and improvisatory contributions sound appropriate enough. But the Dutch ensemble is too often harsh-sounding in Philips' strong, clean, quite closely miked recording, while Schröder's readings are too often hard-pressed in the faster passages, too stiffly rhythmed and surgily expressive in the slower ones. And what is perhaps the decisive factor is that the organ itself—the c. 1780 Küchel two-manual instrument in the Old Catholic Parish Church of Haarlem, Holland, tuned to a 420-Hz A—lacks, to my ears, either tonal charm or pungency.

In sharp contrast with this mostly constrained approach, that by Malcolm and Marriner is zestfully vivacious and more piquantly varicolored. The soloist is heard on no less than three British organs: The delectable little one in Merton College, Oxford, for Concertos No. 1 and 2 and 4-6; the slightly larger one of St. John the Evangelist, Islington, in Nos. 7-11; and the still larger one of St. Mary, Rotherhithe, in Nos. 13-16 and the sonata *Il Trionfo del tempo e del disinganno*; while in Nos. 3 and 12 he switches from organ to harpsichord (as in the accompaniment the continuo part is switched from harpsichord to organ). Except for the inclusion of the festive sonata, Malcolm is more sparing than any of his competitors—with transcribed or improvised interpolations—and one of my two minor complaints here is that Christopher Hogwood's otherwise informative notes don't specify which of these are Handelian and which Malcolm's own. The other complaint is that in Marriner's admirably pointed, now gracefully lyrical, now invigoratingly majestic accompaniments the spicy oboe timbres aren't always as evident as they might be when they double the violins. In all other respects, though (including bright, crisp, vividly open recorded sonics), this set is a delight throughout and especially delectable in the five concertos featuring the Merton College organ.

Yet all these attractions still must be balanced against the wealth of no less enticing ones of Connoisseur Society's Rogg/Armand version. The merits on each side are so many and so individually differentiated that only a reckless judge could find one "better" than the other. Potential purchasers who can't afford both will have to de-

cide on the basis of their own temperamental affinities—for the generally defter, livelier, more chamber-scaled treatment of Malcolm and Marriner, or for the generally grander, more dramatically ceremonial approach of Rogg and Armand (plus its more thrillingly expansive ambience). For economy-obsessed buyers, the latter set has the advantage of its convenient two-set format for a one-at-a-time list cost outlay. R.D.D.

**LISZT:** *Années de pèlerinage: Sonetti del Petrarca*—See Schumann: *Symphonic Etudes*.

**B LISZT:** *Transcendental Etudes (12)*. \* *Années de pèlerinage: Après une lecture de Dante (Dante Sonata); Les Jeux d'eaux à la Villa d'Este*. Russell Sherman, piano. VANGUARD EVERYMAN SRV 354/5, \$7.96 (two discs, automatic sequence) [\*from ADVENT cassette E 1010, 1974].

One of the reviews reprinted on the back of this double album is the one I wrote for *MUSICAL AMERICA* after Russell Sherman's impressive Tully Hall performance of the complete *Transcendental Etudes*. Unfortunately the recorded version—made some two years before that December 1975 concert and previously issued only as an Advent cassette—for all its undeniable sophistication and intellectual comprehension lacks many of the qualities that had so impressed me.

To begin with, many of the recorded tempos are far more cautious, although in the opening "*Preludio*" and the ensuing "*Molto vivace*" the wealth of detail and the cultivation admirably compensate for the loss of impetus. However, the trouble is compounded when, as in "*Feux follets*" and "*Wilde Jagd*," Sherman takes those "wild liberties" I noted at Tully Hall without at the same time maintaining a sense of line. The abundant detail (or "barbed clarity," as I described it) continues to amaze, but these readings, with their constant stop-go manipulation of motivic content and tortured, faltering rhythmic pulsation, sound very "notey" indeed.

Largely excepted from these reservations are "*Ricordanza*" and "*Harmonies du soir*." The spun-out tessituras of "*Ricordanza*" may not flow as they did in concert (or in Lazar Berman's performances), yet the cantabile filigree is floated with ghostly, haunting, almost sickly reminiscence. And Sherman is also impressive in the way he achieves rich coloristic atmosphere in the strangely admixed opening harmonies of "*Harmonies du soir*." Both of these performances, along with many details in the other works, suggest a more cultured, analytical musical mind than is heard in Berman's recording of the etudes (Columbia/Melodiya M2 33928, May 1976). But for the most part Berman provides a commanding thrust and primitive visceral energy that Sherman had in recital but, alas, not on this recording.

The fourth side, recorded last spring at Vanguard studios expressly for the disc release of the *Transcendental Etudes*, happily captures Sherman in a state of mind closer to that of his concert. The impressive



awareness of the music's every turn and the superbly spiky execution of passagework so often blurred and overpedaled in other performances do wonders for the "Dante Sonata," with its tedious tremolando effects, splashily diminished-seventh chords, and "pianola-in-excelsis" monumentality. In sharpest distinction to that piece's long-windedness, the beautifully fragrant strains of the "Jeux d'eaux à la Villa d'Este" sound positively airborne. Sherman's reading is pretty much on the Arrau level—high praise indeed. Like Arrau, he suggests the often overlooked kinship with Wagner (the "Forest Murmurs" of Siegfried, for instance).

The piano reproduction is quite the finest yet bestowed on the *Transcendental Etudes*, but, ironically, the excitement of the music seems heightened by the clatter of Berman's far inferior-sounding set. H.G.

**MACDOWELL:** Sonata for Piano, No. 1, in G minor, Op. 45 (*Tragica*). **GRIFFES:** The White Peacock. **MEINEKE:** Madam de Neuville's Favourite Waltz, with Variations. Barry Snyder, piano. GOLDEN CREST RE 7063, \$6.98 (SQ-encoded disc).

**MACDOWELL:** Woodland Sketches, Op. 51; Two Fantastic Pieces, Op. 17. **NEVIN:** Piano Works. Paulina Drake, piano. [Robert F. Commagere, prod.] GENESIS GS 1067, \$6.98.

**NEVIN:** Water Scenes, Op. 13. Un Giorno in Venezia, Op. 25. Song arrangements: The Rosary; The Merry, Merry Lark; Oh, That We Two Were Maying.

MacDowell keeps coming on strong. Here is the first recording in some time of his *Sonata Tragica*, Op. 45, and until something much better comes along, this reading by Barry Snyder, who was a triple prizewinner in the 1966 Van Cliburn International Piano Competition and who now teaches at the Eastman School, will hold the field. The sonata has been previously recorded by Perry O'Neil, Vivian Rivkin, and Gary Towlen; but none of them is really in Snyder's class technically, although every now and then Rivkin does catch the *echt* MacDowell spirit. In any case, competition has long since disappeared from SCHWANN.

Regrettably, the work is very distantly miked (the disc, it should be noted, is SQ-encoded), and the necessity to turn the gain way up makes for a certain amount of distortion. Still, it's easily the best *Tragica* (which is not, by the way, the best MacDowell) yet recorded and the only one easily available.

Had it not been for Clive Lythgoe's recent recording of *Woodland Sketches*, Op. 51 (Philips 9500 095, November 1976), Paulina Drake also would have had the field all to herself. The Lythgoe, although not the perfect recording either, does her in. Although Drake has won numerous competitions, she sounds on this disc more like a talented pupil than a finished artist. As a filler she adds the two MacDowell *Fantastic Pieces*, Op. 17, and does rather better with them. The second one, "Witches' Dance," is of course one of MacDowell's best-known genre pieces, but the first, "Legend," here receives its first recording.

Perhaps my impression of Drake's artistry has been somewhat affected by the fact that the flip side is devoted to the effu-

## A World Standard:

# CBS LABS Test Records

For years, the unique, high-precision CBS Laboratories Technical Series Professional Test Records set an industry standard. Now the new series is even better—revised, recut, and expanded.

Each record contains a complete series of easy-to-use tests to help rapidly and accurately evaluate components and systems.

Seven Steps to Better Listening (STR 101)—Only \$6.98. Helps you make sure your equipment functions properly . . . helps tune your system to your ears and your room acoustics. Included is a 16-page booklet by Edward Tatnall Canby explaining how to use the record's "ears-alone" tests for left-right identification, phasing, speaker bal-

ance, tone control setting, buzz and rattle elimination, lateral tracking, and vertical tracking.



**STR-100—Stereophonic Frequency Test Record**—A general purpose record for pickup and system evaluation. Recorded with a constant velocity characteristic below 500 Hz and a constant velocity characteristic above 500 Hz. \$10.00

**STR-130—RIAA Frequency Response Test Record**—Provides spot and sweep frequency measurements for response testing and calibration of professional and consumer record reproduction equipment. \$15.00

**STR-140—RIIA Pink Noise Acoustical Test Record**—By use of bands of noise rather than pure tones, standing waves are minimized, permitting the testing and adjustment of loudspeakers in the room in which they will be used. \$15.00

**SQT-1100—Quadraphonic Test Record**—For the calibration, verification and adjustment of SQ™ decoding equipment. \$15.00

Quantities are limited—order now!

HIGH FIDELITY HF677

Music Listener's Record Service  
Dept. HW  
2160 Patterson Street, Cincinnati, Ohio 45214

Here's my check for \$\_\_\_\_\_ Please send me, postpaid, the records I've circled below.

STR-100    STR-101    STR-130  
STR-140    SQT-1100

NAME \_\_\_\_\_

ADDRESS \_\_\_\_\_

CITY \_\_\_\_\_ STATE \_\_\_\_\_ ZIP \_\_\_\_\_

Check or money order must accompany your order.  
Allow 60 days for delivery.

# TOP Discount AUDIO

*Your* **NATIONAL HEADQUARTERS**  
For Famous Brand Electronics By Mail

1150 N. Powis Rd., West Chicago, Ill. 60185 • (312) 293-1825  
All Orders Shipped In Factory-Sealed Cartons  
Write Or Call For The Lowest Prices Anywhere!

**MILLION \$\$\$ INVENTORY**

**LOWEST PRICES ON**

RECEIVERS	TURNTABLES	TUNERS
SPEAKERS	CHANGERS	CARTRIDGES
TAPE DECKS	AMPLIFIERS	HEADPHONES
CALCULATORS	COMPACTS	CAR AUDIO

Top Discount Audio 1150 N. Powis Rd. West Chicago, Ill. 60185 (312) 293-1825

HF-6 \_\_\_\_\_ Date \_\_\_\_\_  
Please send me a quote on \_\_\_\_\_

MR \_\_\_\_\_  
MS \_\_\_\_\_

CIRCLE 43 ON READER-SERVICE CARD

# SAVE!

**MONEY • TIME • FREIGHT**

- ▶ QUALITY STEREO EQUIPMENT AT LOWEST PRICES.
- ▶ YOUR REQUEST FOR QUOTATION RETURNED SAME DAY.
- ▶ FACTORY SEALED CARTONS—GUARANTEED AND INSURED.
- ▶ SAVE ON NAME BRANDS LIKE:
 

A.D.C.	KLH
A.R.	SHURE
DYNACO	KOSS
FISHER	SONY

**PIONEER**  
AND MORE THAN 50 OTHERS  
BUY THE MODERN WAY  
BY MAIL—FROM

# illinois audio

Department 217H  
12 E. Delaware Place  
Chicago, Illinois 60611  
312-664-0020

CIRCLE 19 ON READER-SERVICE CARD



# In The Company Of Great Conductors

## ANDRÉ PREVIN

S-37260  
His Rachmaninoff is sensuously devastating. For *The Bells* (S-37169)—a '76 Grammy Award. Here, completion of the three unit Symphony Cycle. No other can withstand the comparison.



## RICCARDO MUTI

S-37230  
In two years—he's mastered three complete operas, symphonies by Tchaikovsky, Mozart and Mendelssohn, and the Cherubini Requiem. If you've yet to meet him, let this new issue be your introduction.



## WILLI BOSKOVSKY

S-36826  
Without question, he's champion of the Viennese style. With hands of magic the infectious tunes are made into dazzling delights. Six such Angel albums are now available.

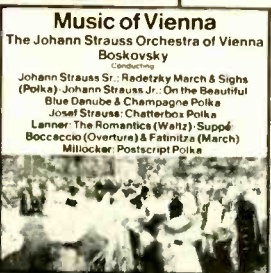

## SIR ADRIAN BOULT

S-37211  
As a Vaughan Williams authority he is unique. At 88, his recordings continue to defy superlatives. "A distinguished release, surely as close as we shall come to a definitive statement of these works." Stereo Review.



## HERBERT VON KARAJAN

SB-3838  
In the art of music-making, he is rivaled by few, perhaps none. Perfection is again his in this winning conjunction of magnificent voices, unparalleled orchestral playing and resplendent sonics.

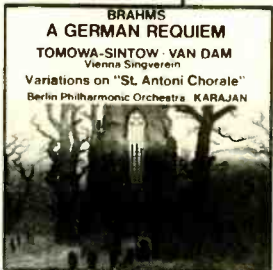

sions of poor Ethelbert Nevin. Nevin once said: "I have a horror of being 'a successful drawing-room songwriter' with nothing else to back it up," and unfortunately that's what "The Rosary" and such salon pieces as "Narcissus" did to him. Drake performs Nevin's *Water Scenes*, Op. 13 (with its ubiquitous "Narcissus" as No. 4), *Un Giorno in Venezia*, Op. 25, which is almost bearable, and three of his songs as arranged for piano solo: "The Rosary" (which sold 2.5 million copies of the sheet music between 1898 and 1928, peaking in 1913 with 287,267), "The Merry, Merry Lark," and "Oh, That We Two Were Maying." The songs are simply wretched—no other word will do. It is difficult to understand why they were, and continue to be, popular. This record, by the way, marks Nevin's triumphant entry into SCHWANN.

In addition to the *Tragica*, Snyder plays a pastel-colored version of Griffes's *The White Peacock* and a nine-minute set of variations published in 1824 by the German-born pianist, organist, and composer Christopher Meineke, who emigrated to America in 1800 and settled in Baltimore, living there until his death in 1850. A very astute real estate operator, he left an estate valued at \$190,000. Meineke is said to have visited Beethoven in Vienna in 1817 and won praise from the master for a concerto he is said to have composed. One would never guess it from his variations on *Madam de Neuville's Favourite Waltz*, which chases its tail rather ungracefully before lapsing into blessed silence. The identity of Madam de Neuville remains a dark secret, but the work was "respectfully dedicated to Mrs. Friese," another unknown female.

Again, I was bothered by the distant mixing and the rather disembodied sound of the piano, but if you must have Meineke, this is the only place you'll find him. LL.

**MOZART:** Sonatas for Violin and Piano, Vols. 1-2. Szymon Goldberg, violin; Radu Lupu, piano [Christopher Raeburn, prod.] LONDON CSA 2243 and 2244, \$13.96 each two-disc set.

Vol. 1: Sonatas: in C, K. 303; in D, K. 306; in F, K. 376; in B flat, K. 454; in E flat, K. 481. Vol. 2: Sonatas: in C, K. 296; in G, K. 301; in E flat, K. 302; in E minor, K. 304; in A, K. 305; in B flat, K. 378; in E flat, K. 380.

**Comparisons:**  
Szeryng, Haebler Phi 6500 055, 6500 143/5  
Szigeti, Horszowski/Szell Van. SRV 265/7, 262/4 SD  
Pauk, Frankl Vox SVBX 546, 547

Haydn has been called the father of the string quartet, but I have never heard Mozart called the father of anything nonbiological. He might well be nominated for the title in relation to the violin/piano sonata, which, when he took it up in the style of Johann Christian Bach, was a one-sided affair, with the piano holding full sway and the violin simply accompanying.

The precocious Mozart spun off eighteen sonatas of that kind (calling them clavichord sonatas with violin *ad libitum*) by the time he was twelve. Then he took ten years' holiday from the medium and returned at twenty-two (in 1778) to write K. 296 for the daughter of his landlord at Mannheim and a set of six sonatas, K. 301-6, for the wife of the Elector of the Palatinate, and he made it clear that he had some fresh ideas on the subject. Although he called the Palatinate

sonatas "*Clavierduetti mit Violin*" there is, in all the sonatas of 1778, substance to the violin part—the dialogues are real, the melodic responsibility is more equally divided, the interplay of instruments is very much part of the scheme.

There are certain hangovers from the older style: All but one of the Palatinate sonatas are in two movements (a pattern stemming from J. C. Bach), and one of the most beautiful and poignant themes to be found among the seven works, the Andante sostenuto of K. 296, is according to Einstein lifted almost verbatim from the London Bach. (Other sources say that Bach may have got the tune from Mozart; in either case, they both recognized its value.) But the violin/piano sonata, whatever its designation, had come to stay, and it continued to develop in Mozart's hands right through a "middle" set of five works in 1781, K. 376-80, up to the final sonatas, K. 454, 481, 526, and 547.

There are wonderful musical peaks along the way: the rondo of surprising solemnity in K. 302, marked "grazioso" but sounding nonetheless quite hymnal; the lovely interweaving of instrumental lines in the Allegro of K. 303 (a sonata that Einstein calls "somewhat strange"); the opening Allegro of K. 304 in E minor, dark and importunate. And so it goes, up to the commanding gestures, exalted lyricism, and searching explorations of K. 454 (and what wide-ranging ideas unfold in the rondo finale!) and the muscular, dramatic statements of the first movement of K. 481, with its slow movement of particular eloquence and a variations finale that allots the piano a special burst of brilliance.

Where does the record buyer stand amidst these riches? The domestic catalog lists four complete or nearly complete recordings of the sixteen "mature" sonatas, including two of extremely high quality. For London, Szymon Goldberg and Radu Lupu offer sensitive, rather intimate, lyrical, and unstressful accounts; twelve sonatas have so far appeared, in two two-disc sets, with Vol. 3 due shortly. For Philips, Henryk Szeryng and Ingrid Haebler perform in a grander, more projecting, more overtly "concert" style; they have recorded all sixteen sonatas and both independent sets of variations (K. 359 and 360), but only four of their six single discs have been released domestically. The stature of the London and Philips teams weighs heavily on the competition, and I for one find that the Vanguard Everyman performances of fifteen sonatas (all save K. 547) by Joseph Szigeti and Mieczyslaw Horszowski (with George Szell taking over at the keyboard in K. 454 and 481) pose too many problems of tone and intonation to be acceptable today except as a matter of historical curiosity. There is, to be sure, an admirable thrust and vigor to Szigeti's approach—his Mozart is no sissy. But the recorded balance as it emerges in the reprocessed stereo (and perhaps in the original, for all I know) favors the violin outrageously, and the ensemble work is not up to the standards of the two new versions. Gyorgy Pauk and Peter Frankl on Vox (all sixteen sonatas, both sets of variations, plus the first of the three unfinished sonatas, K. 402-4) sound demure and polite and, in general, encompass a



*Now we've mastered  
a Scotch® cassette for every switch position.*



**Introducing the Master™ Series.** Three totally different tapes. Each developed to deliver the truest, clearest sound possible at each tape selector switch position.

Our Master I cassette is for normal bias recording. It features an excellent dynamic range, low distortion, uniform high frequency sensitivity and output that's 10 dB more than standard tapes.

Our new Master II replaces chrome cassettes and is designed for use on hi-fi stereo systems with chrome bias (70 microsecond equalization). It features some spectacular performance characteristics, including a special coating that gives it a 3 dB better signal-to-noise ratio at low and high frequencies than chrome cassettes, yet it's less abrasive.

Our new Master III is for the ferri-chrome setting. It's formulated with the most advanced technology available, giving a 3 dB output improvement at low frequencies and 2 dB at high frequencies. And the unique dual layer construction increases both low and high frequency sensitivity over chromium dioxide and ferric oxides.

**All this, plus unique inner workings you can actually see.** Our new Master line has a special bonus feature. A precision molded clear shell that allows you to monitor the inner workings of the cassette. You can actually see the recorder head penetration and the unique roller guides in action. Look closely at the transparent shells above and you'll see the water wheels which were specially designed to move the tape evenly across the head, reducing friction and noise. And two radially creased shims insure smoother wind, improved mechanical reliability and reduced wow and flutter.

Enough said. Now it's time for you to take the true test. Match up the right Master cassette with the bias you prefer. Then just listen.

You'll find that whichever switch position you use, a Scotch Master is the way to get the most out of it.

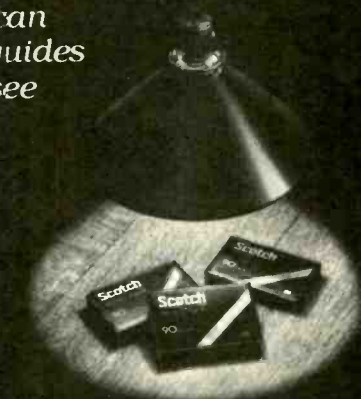

**Scotch Recording Tape.  
The truth comes out.**



much narrower expressive range than their competitors.

It is difficult to compare the violinism of Goldberg and Szeryng without seeming to belittle the former, and this I assuredly do not want to do. While it is true that Goldberg does not command Szeryng's variety of color and the sense of reaching to the back row of the house, his perception of Mozart is balanced and lovingly shaped on its own scale. He may not put as much ginger into the rhythms (as in the Minuet of K. 303), and his tone may be leaner, his profile lower. But he maintains Mozart's momentum unflinching, the lyric lines sing in his hands, and his collaboration with Lupu is deep and instinctive. (Just listen to the balanced interplay in the first movements of K. 454 or 481, for instance.) Lupu's joyous,

flowing grasp of Mozart's occasionally brilliant piano writing illuminates the works throughout. He is, on the whole, a more spontaneous and poetic pianist than Haebler, more given to rhythmic inflection, less to disciplined and slightly stern precision. The London partnership might, in an oversimplified way, be described as a lower-profile violinist and a higher-profile pianist. But it works.

Szeryng, a consummate artist whose tone is warmer than Goldberg's and whose sense of drama is greater, is paired with a pianist who is somewhat austere. And, again, it works. Szeryng's gutsy, accented, crisp-rhythmed playing is anchored by Haebler's articulate and accurate hold on the keyboard part. Together they achieve a kind of monumentality when it is called for, as it is

in the Largo introduction of K. 454, and they, too, interweave marvelously during the seductive elaborations of a movement like the Adagio of K. 481. S.F.

**NEVIN:** Piano Works—See MacDowell: Sonata No. 1.

**OFFENBACH:** La Vie parisienne.

Metella	Regine Crespin (s)
Baroness Gondremarck	Christiane Chateau (s)
Gabrielle	Mady Mesplé (s)
Pauline	Eliane Lublin (s)
Raoul de Gardetueu	Michel Sénéchal (t)
Gontran	Henri Armiel (t)
Bobinet	Michel Trempont (b)
Baron Gondremarck	Luis Masson (b)
The Brazilian; Frick; Prosper	Jean-Christophe Benoit (b)
(plus smaller roles)	

Chorus and Orchestra of the Théâtre du Capitole (Toulouse), Michel Plasson, cond. [Eric Macleod, prod.] ANGEL SBLX 3839, \$15.98 (two SO-encoded discs, automatic sequence).

Offenbach's first attempt to portray, not historical or mythological figures, but his own contemporaries, and thus the manners and follies of his age, has lost none of its power to charm and elate. The element in *La Vie parisienne* of social satire, with its emphasis on such specific concerns of the Second Empire as rank, money, and provincial naiveté, may have been superseded, but there has been no lessening in the work's good humor or its insight into human folly. To this day *La Vie parisienne*, first performed 111 years ago, remains a font of wit, joviality, and delicacy of feeling. The reason, of course, is not so much the libretto of Meilhac and Halévy as the music of Offenbach, a *petit-maitre*, if you like, but a genius in the unerring certainty of his aim and the individuality of his voice.

Given the composer's incomparably greater importance in the continuing artistic value of *La Vie parisienne*, it is unfortunate that his contribution should not be easier to locate on this recording. Though I am glad to have so much of the spoken text, I do not especially want to play it through every time I sit down to listen to this work and I wish that Angel had provided banding so that one could go straight to the music without effort.

The performance itself is wonderfully successful, both well acted and beautifully played. With such talented character singers in the cast as Michel Sénéchal and Jean-Christophe Benoit (who impersonates three figures, each with a radically different temperament and manner of speech), there is no lack of color and vivacity. The "name" singers, too, are equally adept at characterization. Mady Mesplé sounds characteristically narrow in tone but sings with lively assurance. Her easy handling of every mood in the *couplets* in which she impersonates a military widow, "*Je suis la veuve d'un colonel*," is one of the set's highlights. Regine Crespin is less vocally fluent. Though the tessitura is not very demanding, she sounds uneasy and strained, as if battling with recalcitrant vocal cords. She is very expressive in her celebrated letter song, "*Vous souvient-il, ma belle?*," yet it is really only in the spoken dialogue, which she enunciates marvelously, that we catch without impediment her enormous distinction as an artist.

## Children Of The klipschorn® Loudspeaker

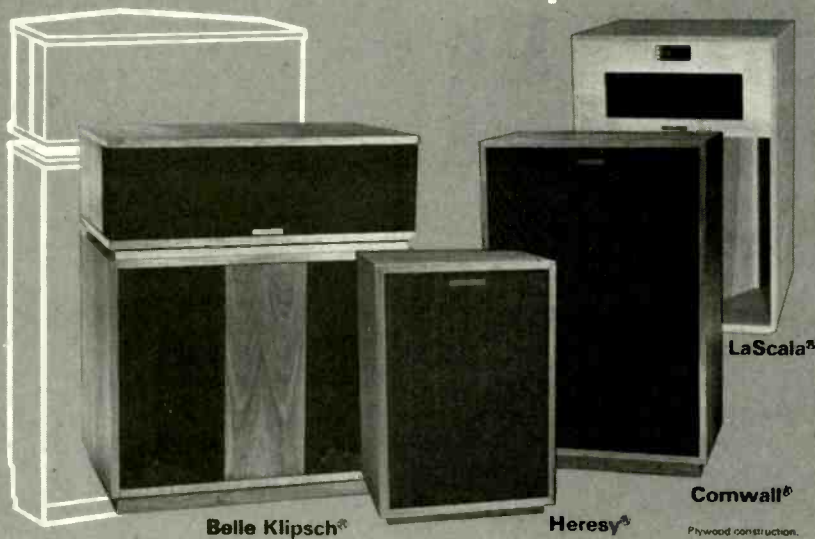

So your listening room won't accommodate a KLIPSCHORN®. Then Klipsch gives you a choice. Large, small, horn-loaded bass, direct radiator bass. All non-corner speakers. Yet all except the HERESY® have the same drive components. Even with it the only difference is a 12" instead of a 15" bass driver. And each Klipsch speaker is individually tested to meet Klipsch standards. Ask your dealer to show you how closely the children approach the father in true sound reproduction. Mail this coupon for information on the complete Klipsch line.

### klipsch

P.O. Box 688 H-6, Hope, Arkansas 71801

Please send me your latest brochure and list of dealers.

Name \_\_\_\_\_

Address \_\_\_\_\_

City \_\_\_\_\_ State \_\_\_\_\_ Zip \_\_\_\_\_

In Canada: Superior Electronics, Inc.



CIRCLE 21 ON READER-SERVICE CARD





Connoisseur Society

Mady Mesplé

Vif characterization in Offenbach's jape

Michel Plasseon conducts his forces with excellent command of rhythm and a fetching lightness of touch that owes a lot to the clarity of his textures. For anyone who is uncertain about the rewards of this work, and thus of the desirability of this recording, I would suggest sampling either "*Je suis la veuve d'un colonel*" or the brilliant mock-elegiac sextet in Act III. "*Votre habit a croqué dans le dos!*" Because of the absence of banding, you will not be able to find them quickly. Even so, they are worth the search. Highly recommended. French-English libretto. D.S.H.

**PROKOFIEV:** Symphonies: No. 1, in D, Op. 25 (*Classical*); No. 7, in C sharp minor, Op. 131. London Symphony Orchestra, Walter Weller, cond. [Michael Woolcock, prod.] LONDON CS 6897, \$6.98.

*Comparison:*  
Rozhdestvensky / Moscow Radio Sym.  
Mel./Ang. SR 40061

The music offered on the London and Melodiya/Angel discs differs in one respect: Rozhdestvensky, like his father, Nicolai Anosov (on a fondly treasured Supraphon/Parliament mono disc, stunningly played by the Czech Philharmonic), uses the original elegiac closing of the Seventh Symphony, while Weller employs the more commonly heard revised version, in which Prokofiev tacked on twenty-three rather trite measures based on the finale's jocular main theme. I rate the quieter ending a definite advantage, and the Russian recording also benefits from Rozhdestvensky's almost manic abandon and drive throughout the Seventh. And the *Classical* is one of the few versions left in captivity to take the opening movement as a "real" allegro and—if my ears deceive me not—to separate first and second violins laterally.

The new release, fortunately, has at least as much going for it. Weller's pacing is broad and steady, his rhythm taut. The Seventh emerges as a somewhat more dignified and subtle work, despite the choice of the less dignified denouement. In the *Classical*, there is a welcome depth and tenderness to the Larghetto, and if I wish he'd get on with the opening movement a bit, I can't complain of any lack of propulsion in the finale.

The LSO is everywhere neater than the Moscow Radio Symphony, its tonal sheen a welcome relief from the raucous playing of the Russian orchestra. Weller passes a rather impressive test in the *Classical*: Among the no less than four LSO versions in London's catalog, his is technically cleaner than both Ashkenazy's (CSA 2314, with the piano concertos and various short works) and the dozen-year-old Sargent (STS 15114, with *Peter and the Wolf*). He evokes as fine playing as did Abbado (CS 6679, with Symphony No. 3), drawing even more pointed phrasing and beauty of woodwind detail. Clearly, Weller has fashioned a *Classical* to rank with Marriner's elegant recording (Argo ZRG 719, with Bizet's Symphony in C) among modern versions.

London's crew has brought out of Kingsway Hall one of the most magnificent-sounding recordings of recent years. The impact and range are of demo caliber (e.g., the bass drum in bar 11 of the Seventh). Everything sounds with clarity and perspective. The image of the orchestra has bite and body, and my copy is flawlessly pressed. A.C.

**PUCCINI: Tosca.**

Floria Tosca  
Shepherd  
Mario Cavaradossi  
Spoletta  
Scarpia  
Sciarrone, Jailer  
Cesare Angelotti  
Sacristan

Montserrat Caballé (s)  
Ann Murray (s)  
Jose Carreras (t)  
Piero de Palma (t)  
Ingvar Wixell (b)  
William Elvin (b)  
Samuel Ramey (bs)  
Domenico Trimarchi (bs)

Chorus and Orchestra of the Royal Opera House, Covent Garden, Colin Davis, cond. PHILIPS 6700 108, \$15.96 (two discs, manual sequence). Tape: ●● 7699 034, \$15.90.

This is not a recording to persuade a skeptic of Tosca's merits. Whether like Joseph Kerman (who states his case brilliantly in *Opera as Drama*) you find Puccini's opera to be "of café-music banality" is beside the point. Much more important, in my opinion, is the fact that this recording fails to make a compelling case for the work. A really first-rate Tosca, it seems to me, should be able to take hold of even the most resistant listener and overwhelm his scruples, indifference, or hostility. Victor de Sabata and his singers (Angel BL 3508) do just that, whereas Colin Davis and his do not.

Davis, of course, is a fine musician, capable of producing really memorable results in the case of certain composers like Berlioz and Mozart. But Puccini is clearly not of their company. There is about this performance a sense of well-mannered inhibition, of caution and judiciousness, that I find fundamentally at odds with the composer's musical personality. Most of the score, in my opinion, is taken too slowly—or, if you like, unurgently—to realize in any convincing way its inherent emotional power. One is not swept along by these events, largely because Davis allows one too much room for reflection.

A clear example is to be found in Act I, where Cavaradossi tries to dispel Tosca's jealousy with an ardor that needs more impulsion from the conductor. Or later in Act I, where Scarpia's colloquy with the Sacristan lacks sufficient tension. Or again in Act III, in the middle of the Tosca/Cava-

"I've got a 60-minute recording studio in my pocket."

It's called the MICROCASSETTE® PearlCorder-S®.



A MICROCASSETTE recorder that's so unique, it's like having your own mini-studio in your pocket with remarkably good fidelity for music as well as voice. It's smaller than a checkbook (5 1/4" from top to bottom, slightly thicker than a pack of cards), and lightweight (12 ounces with batteries), but it's packed with studio precision and professional features:

- 60 minutes recording time.
- Capstan drive for constant tape speed, built-in electret condenser microphone, AC bias, record-warning light.
- All metal construction for years of dependable service.
- One-hand operation; instant loading.
- Fast forward and rapid rewind.
- Automatic level control.
- Connects to your stereo or full-size recorder with a Compaicord, for both recording and playback.

The PearlCorder-S performs beautifully in an office, in your car, even on airplanes; and it's backed by the reputation of the Olympus Optical Co., Ltd., a company famous for fine cameras, medical and other precision scientific instruments.

The PearlCorder-S. Carry one. And have a studio with you.

Available at fine photographic, audio, and A-V dealers everywhere. Or write for our brochure, "Pocket Full of Miracles."

**OLYMPUS CORPORATION OF AMERICA**  
TWO NEVADA DRIVE/NEW HYDE PARK, NEW YORK 11040

60 minutes of sound in this actual-size MICROCASSETTE.®



In Canada: W. Carson Co., Ltd., Ont.

CIRCLE 28 ON READER-SERVICE CARD



**NEW!**

## Two Major Wagner Books!



**Richard Wagner in Bayreuth**  
by Hans Mayer

**Reflections on Wagner's Ring**  
by John Culshaw

**Richard Wagner in Bayreuth is the intimate story of the amoral, hedonistic, arrogant megalomaniac who attained international recognition as a musical genius—and of Bayreuth, the quiet Bavarian town he made famous.**

**Reflections on Wagner's Ring is a compilation of John Culshaw's acclaimed Saturday Metropolitan Opera broadcast intermission talks—a masterpiece that no opera lover (and certainly no student of Wagner) can afford to miss.**

**These are only two of the wide selection of carefully chosen books made available to HIGH FIDELITY readers through Music Listeners' Book Service. Others are listed below.**

**No. 602 RICHARD WAGNER IN BAYREUTH. Hans Mayer.**

An enthralling history of Wagner, his family, and the little Bavarian town he made famous. **\$18.50**

**No. 601 REFLECTIONS ON WAGNER'S RING. John Culshaw.**

An invaluable compilation of information based on Culshaw's Saturday Metropolitan Opera broadcast intermission talks. **\$6.95**

**No. 512 SEASON WITH SOLTI. William Barry Furlong.**

A sustained close-up view of Georg Solti and his Chicago Symphony. Human and readable. **\$12.50**

**No. 600 OUR TWO LIVES. Halina Rodzinski.**

The story of Artur Rodzinski's turbulent career in the world of music, told by the woman who shared it with him. **\$10.95**

**No. 341 THE GLORY OF THE VIOLIN. Joseph Wechsberg. Illustrated.**

A fiddle fancier's delight from the pen of the famed New Yorker author, who delves into all aspects of the violin, including the fascinating business of buying, selling, and cheating. **\$8.95**

Check or money order must accompany your order.  
No cash or C.O.D.'s please.  
Allow 60 Days for Delivery.

HIGH FIDELITY  
MUSIC LISTENERS' BOOK SERVICE

HF677

Dept. HW  
2160 Patterson Street, Cincinnati, Ohio 45214

Here's my check for \$ \_\_\_\_\_ Please  
send me, postpaid, the books I've circled below.

602    601    512    600    341

Name \_\_\_\_\_

Address \_\_\_\_\_

City, State & Zip \_\_\_\_\_

radossi duet, where just before the lovers rouse themselves to action, Puccini, on the phrase "siccome alte sul mare," calls for a rallentando that Davis, because he is already taking the music as slowly as possible, is simply unable to make.

Montserrat Caballe's *Tosca* suffers from a similar failure in coherence. Pleading details abound: The turn of phrase on "Oh! innanzi la Madonna" in Act I, for example, is exquisite, and so is the aside "Dio! m'assisti!" in Act II. Unpleasing details also abound: some strident top notes, especially the Cs, a certain blowsiness of tone in loud passages, an overuse of the glottal stroke. In one difficult phrase in Act III (B flat, A flat, G flat with an upper mordent) she abandons the text altogether and, instead of singing "te vita," simply vocalizes. More serious, however, is the absence of anything like a sustained characterization from Caballe. This *Tosca* reacts to the death of Scarpia without real horror, and in the famous post-mortem summary she makes of the villain, "E avanti a lui tremava tutta Roma," she sounds merely sulky. Her comments during the mock execution are too hysterical, and what should be her whispers to Cavaradossi afterward are hardly confidential. Nothing here quite hangs together. Even "Vissi d'arte" lacks dramatic veracity, a sense of emotional structure.

Cavaradossi is a simpler, less volatile character, and notwithstanding his interpretive imperceptiveness José Carreras thus succeeds better than Caballe. Unlike his compatriot, moreover, he sings throughout with great beauty of tone, and for that alone much can be overlooked. He cannot manage the sweetness or the softness often specified by Puccini, but he always sounds like a convincing lover. I do hope, though, that in time he will learn to follow the composer's expressive markings more closely.

As Scarpia, Ingvar Wixell sings well, if with rather too much vibrato for my taste. But his characterization is not very interesting or very individual—largely because he has only a limited range of vocal colors at his command. The small roles are well done in this recording, and, apart from the closeness to Cavaradossi's place of execution of the shepherd lad (a nice performance from Ann Murray), the recording is excellent. An English-Italian-French-German libretto is included, and Philips' pressings are superb as usual. **D.S.H.**

**RACHMANINOFF:** Concertos for Piano and Orchestra: No. 1, in F sharp minor, Op. 1; No. 2, in C minor, Op. 18. Tamas Vasary, piano; London Symphony Orchestra, Yuri Aronovich, cond. [Cord Garben, prod.] DEUTSCHE GRAMMOPHON 2530 717, \$7.98. Tape: ●● 3300 717, \$7.98.

These fervent, intellectualized, highly subjective interpretations are very different from the composer's own recordings, but I find them totally absorbing—and, in their own way, convincing and valid. Conjecture is always dangerous, but I suspect that they may be rather close to those that Rachmaninoff was giving in the early decades of the century (allowing, of course, for the fact that the "Op. 1" First Concerto was thoroughly revised in 1917). Although the tempos and treatment of detail diverge wildly

from the "official" recordings, the basic style and sound of these new accounts have the ring of conviction. The ripe emotionalism of the orchestral playing, the disciplined, cutting edge of Vasary's pianism, and the penetrating, analytical intellect are all part and parcel of Rachmaninoff's idiom. For all their license, these performances have the ambience of authenticity.

Rachmaninoff, paradoxically, often seemed to take a more literal view, reserving his wildest innovations for the works of others. Vasary and Aronovich, one might say, give Rachmaninoff a dose of his own medicine and, in the process, increase our perceptions of this oft-heard material. Their performance of the First Concerto—solid, emphatic, deliberate, yet very intense—reminds me of the reading that Robert Goldsand gave with Colin Davis and the New York Philharmonic in 1968. In the last movement, the tutti following the opening piano flourish is made to sound akin to portions of the Richard Strauss *Burleske*, which preceded the original version of the First Concerto by only a few years. Toward the end of the Second Concerto, Vasary plays a usually uneventful bridge passage with an accentuation that emphasizes a kinship to the first movement's second theme. Fascinating details keep cropping up in both performances.

There is no dearth of alternative versions to choose from, and traditionalists will probably be happier with, for example, the gorgeous, sleek Second Concerto by Rubinstein and Ormandy (RCA ARL 1-0031). Those in search of a new slant, however, are urged to sample this new disc (incidentally, the first installment in a cycle). The DG reproduction is absolutely first-rate in clarity, impact, and brilliance. **H.G.**

**ROUSSEL:** Symphony No. 3—See Dukas: *Fanfare pour précéder "La Péri."*

**SCARLATTI, A.:** *La Griselda* (excerpts). For an essay review, see page 72.

**SCHUBERT:** Quintet for Piano and Strings, in A, D. 667 (*Trout*). Tashi members (Peter Serkin, piano; Ida Kavafian, viola; Fred Sherry, cello); Joseph Silverstein, violin; Buell Neidlinger, double bass. [Max Wilcox, prod.] RCA RED SEAL ARL1-1882, \$7.98. Tape: ●● ARK 1-1882, \$7.95; ●● ARS 1-1882, \$7.95.

**SCHUBERT:** Quintet for Piano and Strings, in A, D. 667 (*Trout*). Beaux Arts Trio; Samuel Rhodes, viola; Georg Hörtel, double bass. PHILIPS 9500 071, \$7.98. Tape: ●● 7300 481, \$7.95.

**SCHUBERT:** Quintet for Piano and Strings, in A, D. 667 (*Trout*)\*; Quartet for Strings, No. 12, in C minor, D. 703 (*Quartettsatz*). Emil Gilels, piano\*; Amadeus Quartet. [Günther Brest, prod.] DEUTSCHE GRAMMOPHON 2530 646, \$7.98. Tape: ●● 3300 646, \$7.98.

Comparison:

P. Serkin, Schneider, et al.

Van. VSD 71145

It is eleven years since the last really notable *Trout* release—that of Peter Serkin with Schneider, Tree, Soyer, and Levine on Vanguard, which Harris Goldsmith described as unmatched in terms of "tempera-



ment, coloristic detail, and sheer aliveness." Since that 1966 disc we have had clean and serviceable accounts by the Melos Ensemble (Angel) and the Music Group of London (Unicorn) and an indifferent one by the Boston Symphony Chamber Players. Now comes a tripleheader, which adds two more strong contenders to the catalog.

The Amadeus, I am sorry to report, is overshadowed by the Beaux Arts and Tashi: For all Gilels' lovely pianism there is a prevailing overearnestness on the part of the group as a whole and the first violin in particular that repeatedly breaks the pace and flow of the music: the development section of the first movement, for example, is almost halting, and the generally nervous intensity of the first violin tends to lessen the cohesiveness of the textures throughout. (This seems less the case during the stresses and turmoils of the *Quartettssatz*, and the same violinist handles the lyric line quite pleasantly.)

Peter Serkin and Tashi make a fascinating contrast to Peter Serkin and the Schneider group. The irrepressible "temperament" of the older performance has been replaced by a sense of deliberation, a conscious air of taking a hard look at the score and daring to indulge in understatement when it suits. There is a smoothness of ensemble, a fluid, rather serene outlook, a reluctance to dazzle that is quite spellbinding; the second movement gives one the impression of an examination in slow motion, though the tempo isn't actually all that slow. The finale, again, holds back in tempo

and forte/piano contrast. Tashi seems to be saying that it won't be budged from its own search for wisdom in this music and that we must sit still and listen. The approach falls short only in the third movement, where the scherzo (marked presto) is taken at a tempo so relaxed that the lilting meter of the trio doesn't come as much of a contrast.

The Beaux Arts, perhaps less individual than Tashi, nevertheless presents a beautifully wrought performance, full of kinetic energy, sonorous in ensemble tone, occasionally more headlong than Tashi, as in the first variation of the fourth movement. The Beaux Arts adopts faster tempos than Tashi, and is often tighter in rhythm. At the same time, pianist Menahem Pressler takes a more tender view of the piano part in the first movement, giving just a hint of rubato that Serkin eschews. It makes a nice effect.

S.F.

**SCHUMANN:** Concerto for Piano and Orchestra—See Grieg: Concerto.

**SCHUMANN:** Symphonic Etudes, Op. 13.  
**LISZT:** *Années de pèlerinage: Sonetti del Petrarca* (3). Alexis Weissenberg, piano. [Michel Glotz, prod.] CONNOISSEUR SOCIETY CS 2109, \$6.98.

Despite Weissenberg's customary hard, glassy sonority, the Schumann is one of his more successful recordings: big, disciplined, and tautly expansive. (I know that

sounds contradictory, but somehow he achieves both breadth and compression.) Weissenberg includes the five extra etudes from the original 1837 text but wisely opts for the revised version of the finale.

The Liszt *Sonetti del Petrarca* (previously issued in 1967 on Angel S 36383) are less memorable, but here too a certain gaunt intensity makes Weissenberg's tonally threadbare, zombielike detachment feasible, if not exactly a sonic paradise. Timing, articulation, and structure are better than average, and this is a disc worthy of respect. So-so sound. H.G.

**SHOSTAKOVICH:** Symphony No. 10, in E minor, Op. 93. Bournemouth Symphony Orchestra, Paavo Berglund, cond. [David Motley, prod.] ANGEL S 37280, \$7.98 (SQ-encoded disc).

Shostakovich is perhaps best known for the symphonic style that blended large-scale romanticism with neoclassical structure in a context of tragic but nonprogrammatic expressivity. Yet only five of his fifteen symphonies—Nos. 4, 5, 6, 8, and 10—really fall into this category; though I rate the Eighth the finest of the group, for many the Tenth is the outstanding product of this style.

Yet the Tenth is the only one of Shostakovich's symphonies still in need of a really satisfactory recording. Berglund's certainly has more merit than most of the current ones, but, particularly in the climactic passages, one feels a restraint that mutes the

## MUCH ADO ABOUT SOMETHING

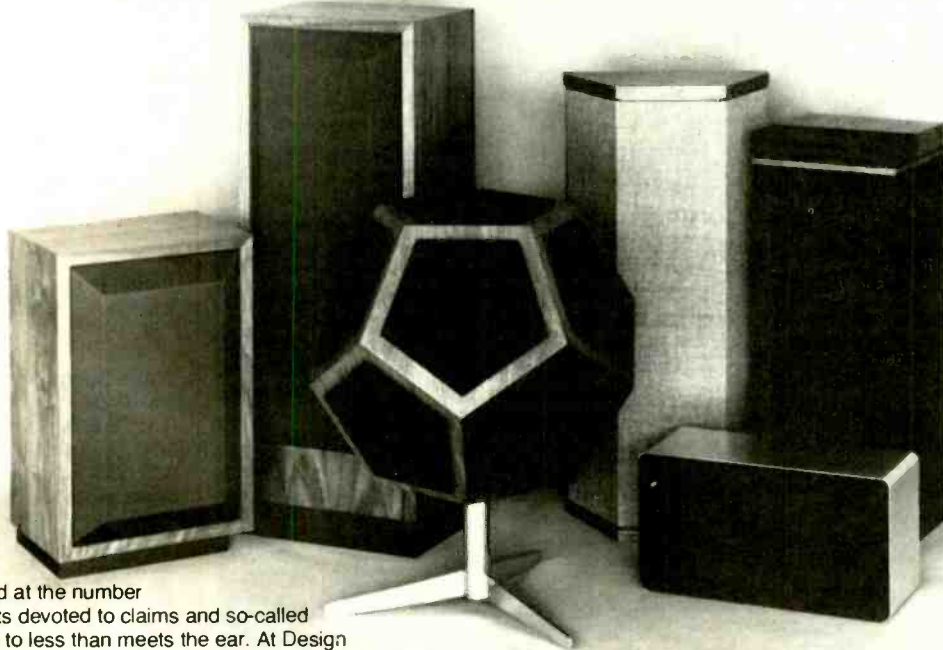

We're continually amazed at the number of speaker advertisements devoted to claims and so-called breakthroughs adding up to less than meets the ear. At Design Acoustics we concentrate on technological advances you can hear. Wide dispersion and flat power response, so the music you get from records and tapes is the music that was put there in the first place.

The fact is, too many aspects of loudspeaker design being bandied about these days add absolutely nothing to a speaker's actual performance. They may make for enticing advertising copy, but isn't that just so much ado about nothing? We'd rather bring you better music.

Design Acoustics, Inc., 2909 Oregon Court,  
Torrance, CA 90503, (213) 320-4981.



Please send brochure and test reports to:

Name \_\_\_\_\_

Address \_\_\_\_\_

City, State, Zip \_\_\_\_\_

HF

full emotional impact. Berglund and his forces still communicate much of the symphony's energy and passion in a performance of exceptionally good balance and flow, although one remains frustrated that that one extra step was never taken. As with Berglund's Fifth (Angel S 37279, April 1977), the English EMI issue (SLS 5044) is the one to get if you are interested. R.S.B.

**SHOSTAKOVICH:** Symphony No. 14. For an essay review, see page 71.

**SIBELIUS:** Symphony No. 1, in E minor, Op. 39; Finlandia, Op. 26. Boston Symphony Or-

chestra, Colin Davis, cond. PHILIPS 9500 140, \$7.98. Tape: ●● 7300 517, \$7.95.

*Comparisons*—Symphony: Barbirolli/Halle Ang. S 36489  
Bernstein/N.Y. Phil. Col. M 30232

There are Sibelius Firsts coming down the pike (Berglund, Stokowski) that are probably worth watching for. There have also been some outstanding ones in the past. Bernstein's impassioned, even demonic, interpretation builds the music in a marvelously frenzied surge from beginning to end, though it has its ensemble problems and the recording has many a flaw (hum, pre-echo, edited-out rests, etc.). Barbirolli's final recording of it (by far the best thing in his

EMI Sibelius cycle, which Angel has only partly issued here) is a deeply felt lyric encounter with the work. It is grand and noble, with surprisingly virtuosic playing and truly enlivening details, such as the switch from staccato to legato and back again in the low strings at letter B of the finale.

Davis' reading, however, is one of absolute and utter probity. Though I prefer more of a stetto in the closing pages of the scherzo, he is right on target about countless details (usually glossed over by other conductors) with regard to sudden and gradual accelerations and decelerations, extreme dynamic changes, accentuation, and the like. Although I've never encountered (nor do I again expect to) an interpretation of such astonishing faithfulness, there is not the least sense of myopic pedantry. Indeed, Davis seems caught up in the great swelling tide of melody and sonority that he and the music generate together. The BSO follows every hairpin, every touch of rubato with uncanny control. Articulation is dazzling, and the pitch is good and true. One can't help singling out Harold Wright's deeply moody delivery of the opening clarinet solo, but special praise should also go to the double basses for their athletic precision in the finale. *Finlandia* comes off with bravura flourish and grim patriotic fervor.

Philips has again provided for these artists sonics of remarkable warmth and depth. The *pppp* bass drum trill before K in the third movement, clarinet clear over these awesomely silent surfaces, is an apt signpost of what we're about, and how far we've come, in this first century of the phonograph. A.C.

**SIBELIUS:** Violin Works—See Dohnányi: Sonata for Violin and Piano.

**TURINA:** Danzas fantásticas—See Albéniz: Iberia.

**VERDI:** Quattro Pezzi sacri: Te Deum—See Bruckner: Te Deum.

**WOLF:** Songs on poems by Goethe, Heine, and Lenau. Dietrich Fischer-Dieskau, baritone; Daniel Barenboim, piano. [Cord Garben, prod.] DEUTSCHE GRAMMOPHON 2709 066, \$23.94 (three discs, manual sequence).

**Goethe songs:** Nos. 1-4, 10-25, 28-36, 38, 39, 42-47, 49-51; *Beherzigung II*; *Wanderers Nachtlid*. **Heine songs:** *Mädchen mit dem roten Mundchen*; *Du bist wie eine Blume*; *Wo wird einst*; *Wenn ich in deine Augen seh'*; *Spätherbstnebel*; *Mit schwarzen Segeln*; *Wie des Mondes Abbild zittert*. **Lenau songs:** *Frage nicht*; *Herbst*; *Abendbilder*; *Herbstentschluss*.

*Comparison*—Goethe songs: Fischer-Dieskau, Moore in EMI 1C 181 01470/6

Fischer-Dieskau's second survey of the Wolf Goethe songs differs in only the smallest respects from his 1960 recording, now available only in a seven-disc Wolf compendium from Germany: No. 37 ("*Sie haben wegen der Trunkenheit*") is omitted, No. 39 ("*Was in der Schenke waren heute*") is added, along with the "*Wanderers Nachtlid*" setting published among the

• The beginning of the end



The Crown IC-150A/D-150A stereo combination pre-amp/amp is a good place to begin building your ultimate system. This Crown approach to the design of an "integrated" amp offers some unusual advantages.

**Power now** 80 watts per channel minimum RMS into 8 ohms, 1 Hz-20 KHz, total harmonic distortion of 0.05%.

**More power later** The D-150A amp converts instantly to mono. Delivers 250 RMS watts into 8 ohms in mono. Two D-150A's could be the way to big power without big instant money.

**Reliability** Drives almost any speaker. Can't be hurt by hookup problems. Three-year full warranty includes round-trip shipping.

**Total control** Eight inputs, switch selectable. Front panel jack. "Panorama" control.

**Future expansion** Add other D-150A's or IC-150A's for more power, for quad, for b-amp.

Start your ultimate system with a good foundation: the Crown IC-150A/D-150A combination. You may never outgrow its specs.

Write. We'll send brochure, specs and test reports. Check it out at your nearest Crown Dealer.



**CROWN**  
Box 100J, Elkhart IN 46514

CIRCLE 9 ON READER-SERVICE CARD



# These new Dahlquist products will greatly improve the performance of your speaker system.

We are pleased to offer you four important new products and accessories that will add considerably to your listening enjoyment. Included are a remarkable subwoofer system and two crossover units, electronic and passive. Also available is an attractive stand for our popular Dahlquist DQ-10 loudspeaker, which will improve both performance and appearance. Ask for a demonstration at your Dahlquist dealer.

**1** **DQ-1W LOW-BASS MODULE.** A superior subwoofer design. Adds an octave or more of extremely tight, well defined low response to most speakers. Propagates considerable acoustic output to 20 Hz and below. Its fast rise/decay times assure excellent coherence with high-definition speakers. Use with either the passive or active Dahlquist crossovers below. High quality 13" driver with heavy cast frame and 12,000 Gauss magnet. Oiled walnut finish with satin aluminum trim.

**2** **DQ-MX1 PASSIVE CROSS-OVER.** For connecting any 8 ohm center-channel subwoofer without requiring another amplifier. Features: 3-position bass level switch; phase switch; frequency selector for 60 or 80 Hz crossover.

**3** **DQ-LP1 ELECTRONIC LOW-PASS FILTER.** For optimum results as a no-compromise,

bi-amplified system. Features: continuously variable crossover settings from 40 to 400 Hz, @ 18dB/octave; bass level adjustments with up to 15dB gain; 0 to +5dB equalization at 20 Hz; bypass switches silence subwoofer and restore full-range response to main speakers; separate outputs for stereo and mixed-center-channel subwoofers; A unique combination of active low-pass and passive high-pass sections prevents any degradation of high frequency performance quality.

**4** **ST-10 OPTIONAL STANDS.** For owners of our Dahlquist DQ-10 speakers. Improve radiation characteristics, especially noticeable in the lower-midrange/upper-bass regions. Packed two to a carton. Assembles with six screws.

**DAHLQUIST**  
27 Hanse Ave., Freeport, N. Y. 11520

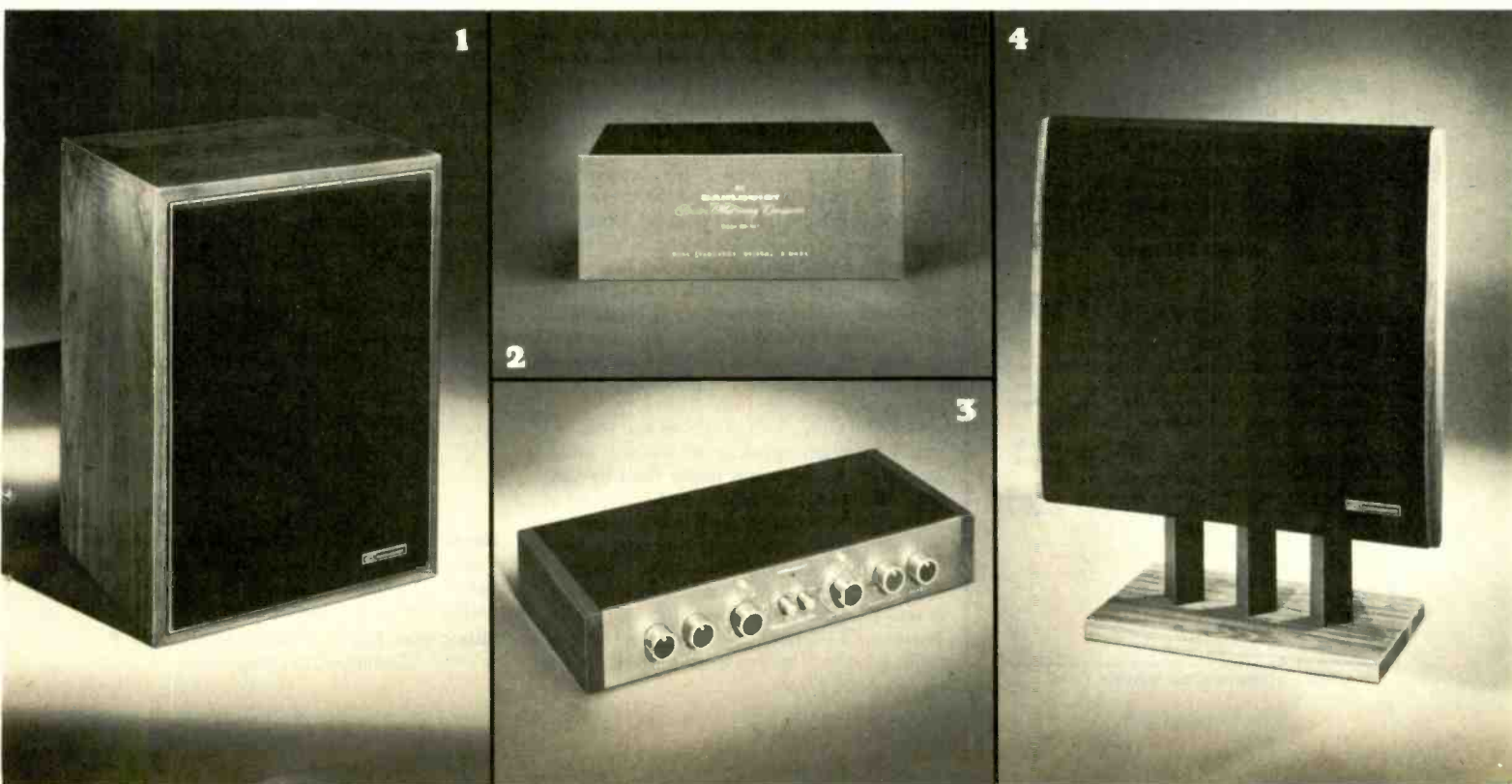

# PRICE WAR

AMERICA'S #1 VALUE LEADER  
STEREO CORPORATION OF AMERICA

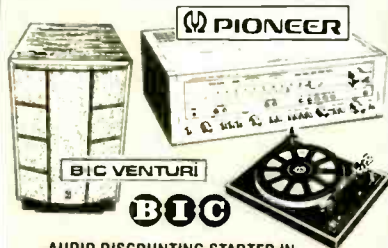

AUDIO DISCOUNTING STARTED IN NEW YORK & NOW WITH THE END OF FAIR-TRADE WE ARE SURE THAT NO ONE CAN BEAT OUR PRICES:

- WE DISCOUNT OVER 60 MAJOR BRANDS
- OVER 10 YEARS OF RELIABLE SERVICE IN THE MAIL ORDER FIELD.
- LARGEST INVENTORY/LOWEST PRICES! WE GET THE BEST DEALS FROM THE MANUFACTURERS; YOU GET THE BEST DEAL FROM US. DON'T DELAY!!!

WRITE US NOW FOR LOWEST PRICE QUOTE

WRITE OR CALL FOR FREE STEREO PRICE CATALOG

SHOP BY PHONE!  
(212) 253-8888

N.Y. TIME  
9-5 MON. THRU SAT.  
Mastercharge/BankAmericard

STEREO CORPORATION OF AMERICA

M-F 1629 Flatbush Ave.,  
Brooklyn, New York 11210

CIRCLE 12 ON READER-SERVICE CARD

**FREE** details.  
A DIFFERENT KIND OF RECORD CLUB

### TREMENDOUS SAVINGS

on every record and tape in print—no obligation to purchase obligations of any kind

**DISCOUNTS OF 43% TO 73%**

off mfg. suggested list special catalog features hundreds of titles and artists

### ALL LABELS AVAILABLE

including most imports through special custom ordering service—guarantees satisfaction

### SCHWANN CATALOG

lists thousands of titles classical, pop, jazz, country, etc.

### DISCOUNT DIVIDEND CERTIFICATES

Dividend Gifts—certificates redeemable immediately for extra discounts.

### NEWSLETTERS

informational news and happenings in the world of music—special super-sale listings

### DISCOUNT ACCESSORY GUIDE

Diamond needles, cloths, tape cleaners, etc.

### QUICK SERVICE

same day shipping on many orders rarely later than the next several days

### 100% IRON-CLAD GUARANTEES

on all products and services—your total satisfaction is unconditionally guaranteed

Discount Music Club is a no-obligation membership club that guarantees tremendous discounts on all stereo records and tapes and lets you buy what you want... when you want... or not at all if you choose.

These are just a few of the money-saving reasons to write for free details. You can't lose so why not fill out and mail the coupon below for immediate information.

DISCOUNT MUSIC CLUB, INC. DEPT. 08-0677  
650 Main Street, New Rochelle, N.Y. 10801

Name \_\_\_\_\_

Address \_\_\_\_\_

City \_\_\_\_\_

State \_\_\_\_\_

Zip \_\_\_\_\_

CIRCLE 41 ON READER-SERVICE CARD

Songs on *Various Poets*. And the set is filled out with settings of Heine and Lenau, only one of which ("Wo wird einst," also among the *Songs on Various Poets*) was published during the composer's lifetime; the others are all early songs, written between 1876 and 1880. All of these modifications are to the good, save for the omission of that one song from among the *Schenkenbuch* group—a nuisance, because it has otherwise been recorded only once, by Raymond Gilvan on a Da Camera record that I've never come across. The other missing songs are all unsuitable for male voice, and were all recorded at one time or another by Elisabeth Schwarzkopf, on discs no longer available; some are also included in current discs by other female singers—but very few.

Nor is there much competition for the songs Dieskau sings, except that provided by his earlier self, Hotter in "Prometheus" (Seraphim IC 6051) and Kipnis in "Cophitisches Lied I" and "Grenzen der Menschheit" (Seraphim 60163) ought to be in every collection, but other classic performances from this literature by Janssen, Hüscher, and Hotter have been long unavailable—some of them never on LP at all. And the comparative merits of Dieskau's two versions are by no means subject to simple generalization. Not surprisingly, the new set is better recorded—not only is the piano sound firmer and clearer, it is also more forward, an equal presence with the voice (as it certainly should be in these songs).

The sounds that piano makes are, for the most part, also finer. As in the preceding set of Morike songs (DG 2709 053, May 1975), Daniel Barenboim's control and coloristic sense prove admirably attuned to Wolf's writing; even such a detail as the bard's prefatory harp strumming in "Der Sanger" is ravishingly shaded, the riotous rhythms of the *Schenkenbuch* songs have splendid bounce and clarity, the *Rattenfänger's* postlude dances him out of town on an enchanting decrescendo that never slackens its pace (as, unfortunately, did Moore's performance in the older set).

The singing is, almost inevitably, less consistent than before; the passing of some fifteen years has taken a toll on the voice, leaving a markedly less full sound that can more easily grow raw under forcing and overemphasis. Some of the fast songs, such as "Der Rattenfänger," are downright choppy, while "Frech und Froh I" sounds like an audition for the part of Mime. At lower levels, the sound can still be beautiful; the unjustly neglected *Suleika* songs are particularly fine, and "Grenzen der Menschheit," though lacking the weight of tone Kipnis brought to it, is superbly controlled and ultimately a more satisfying performance because the piano is properly balanced.

On occasion, the failings of the new set result from interpretive decisions: "Blumengruss" is now taken faster than in 1960, and has lost all the repose and *Innigkeit* of the earlier version. "Ganymed" is decked out with much swelling of tone, generating a layer of affectation that clouds the song's simplicity of line. And I really don't understand the eccentric launching of "Sankt Nepomuks Vorabend," where the first syllable ("Licht-" in the word "Lichtlein") is



Hugo Wolf  
Engraving after the Varges portrait

pushed out and separated from the rest of the word—especially since the rest of the song is finely sung, lovingly accompanied.

A particular disappointment is the performance of the *Harfenspieler Lieder* that open the set, so drained of impetus that there seems to be no personage behind them at all, rather than the complex solitary we heard in the earlier recording, or in those of Janssen and Hotter. If I were forced to choose between the two sets, this deficiency in the new one might well decide me—but I would greatly regret doing without many features of the new set, especially the remarkable justice done to Wolf's piano writing and to its essential role in the songs.

The additional material comprises a number of accomplished songs in a more traditional, less characteristic manner than that Wolf later mastered, including two lengthy examples of fairly conventional nature painting among the Lenau settings. To the best of my knowledge, none of these posthumously published songs has ever been recorded before, and they are intelligently sung and played.

Deutsche Grammophon provides texts and translations (new ones by Lionel Salter this time, a distinct improvement on the old singing versions used in the first volume), and also an index of titles and first lines. All the songs are individually banded, as they are not the Electrola issue of earlier recordings. D.H.

Recitals  
and  
Miscellany

**BASSOON AND RECORDER SONATAS.** Trio Primavera (Michael McGraw, recorder and bassoon; Julian Fifer, cello; Dennis Michno, harpsichord). CAMBRIDGE CRS 2826, \$6.98.

**MUSIC FOR FLUTE, HARPSICHORD, AND PIANO.** Continued on page 104



**London's remembrances of things past.** Since London began importing its British-processed music cassettes eleven months ago, the flow has become a flood. The latest release—eight Prestige Box sets, seventeen singles—must be my biggest review-tape shipment since Deutsche Grammophon's monumental release of twenty-four Prestige Boxes greeted in this column for October 1975. And just as in the previous London release, the new recordings are upstaged by a number of older ones no longer available in Ampex-processed open-reel and/or cassette editions. It's so good to get these not only back on tape again, but in technologically superior Dolby processings, that I can't refrain from deferring comment on any of the brand-new programs until I first pay deserved tribute to the restored treasures.

Two of these tower among the Himalayan Delectable Mountains of the all-time repertory. The 1973 versions of all five Beethoven piano concertos by Ashkenazy with Solti and the Chicagoans (CSA5 2404, three Dolby cassettes, boxed, \$31.95) are unique for the infectious elation of the performers and outstanding for the noble ring of their recorded sonics. And in its still incomparable 1963 composer's version, the mighty Britten *War Requiem* now serves (OSA5 1255, \$15.95) as a poignant memorial not only to the dead of both world wars, but also to the late Lord Britten himself.

Three other boxed sets (all including notes booklets, with texts where pertinent) are of somewhat lesser stature but still variously admirable. In any case, each represents the work's only currently available taping and is marginally or markedly preferable in direct A/B comparisons with the earlier, now O/P, reel or cassette edition. The 1973 Maazel/Cleveland version of Prokofiev's complete *Romeo and Juliet* ballet (CSA5 2312, \$23.95) is notable both for exquisite tonal coloring and for eloquent mood evocations. The 1968 Donizetti *Fille du régiment* starring Sutherland and Pavarotti with the Royal Opera House Chorus and Orchestra under Bonyngé (OSA5 1273, \$15.95), the only available recording, remains one of the liveliest of all fun-filled *opéras comiques*. I have more reservations about the 1972 Ashkenazy/Previn/London Symphony set of Rachmaninoff's four piano concertos and *Rhapsody on a Theme of Paganini* (CSA5 2311, \$23.95). There is immense solo bravura, but neither the accompaniments nor the recordings are fully up to Previn's and the engineers' standards. Fortunately, the best things here, the

by R. D. Darrell

# The Tape Deck

Fourth Concerto and the rhapsody, are available separately, coupled in CS5 6776, \$7.95.

**Muscovian/antipodean ballet axis.** Both the geographical and repertorial extremes of current ballet activities are delineated by three cassette releases ranging from a nineteenth-century Russian monument (played by a British orchestra under an American conductor) through an early-twentieth-century French masterpiece (by an American orchestra under a Frenchman) to a new Australian ballet metamorphosis of an Austrian operetta (by a Down Under orchestra under a Briton).

The Previn/London Symphony Tchaikovsky *Swan Lake* (Angel 4X3S 3834, three boxed Dolby XDR cassettes, \$23.98) is a more-than-complete version. (It includes the long-omitted Act III *pas de deux* from the original production.) As in his earlier *Nutcracker* and *Sleeping Beauty* (the latter as yet untaped), Previn is extremely persuasive in the sensuously lyrical and vivaciously scherzoistic passages, less so in those demanding theatrical impact and grandeur. Yet few listeners will not be musically and sonically enchanted by this beautifully airy, kaleidoscopically colored recording—the only one currently available on tape.

Few modern ballets have fared as consistently well on records as Ravel's magnum opus, *Daphnis et Chloé*: for years in the Munch, Monteux, and Ansermet versions; nowadays by Martinon for Angel and Boulez, with the New York Philharmonic and Cameraata Singers, for Columbia (MT 33523, Dolby cassette, \$7.98). The Boulez account is fascinating for its distinctively individual reading and is thrilling—indeed, often magical—in its vivid sonic immediacy.

The third entry is a hybrid work and of far lesser musical stature: Lanchbery's ingenious adaptation of Lehár's *Merry Widow* (Angel 4XS 37092, Dolby XDR cassette, \$7.98). As I noted in my November 1976 disc-edition review, these "highlights" omit three of the full score's nineteen "numbers" and the Adelaide Symphony isn't a particularly polished orchestra. But the Lehárian tunes, waltz rhythms, and voluptuous sonorities

surely will intoxicate all but aural teetotalers.

**Further Viennese Night illuminations.** Since my September 1976 "Tape Deck" discussion of noncommercial tapes in general and those of the Viennese Light Music Society in particular, the prospect of expanding its American membership has led the Society to some slight relaxation in its strict rules. Releases still are available only to enrolled members, of course, and may not be copied or sold. But the previous recording-artists' anonymity now is abandoned in crediting the first of a new series of "Viennese Nights: Rare Works of the Great Waltz Kings" (Blue Danube Recordings No. 120, Dolby cassette) to the Biedermeier Konzertorchester under Otto Schulz. And when rarity is claimed, the Society really means rare! The program comprises not only works recorded for the first time (to the best of my discographic knowledge), but also those unfamiliar even by name.

There is an illuminating contrast between five of the earliest published Johann Strauss II waltzes of 1844–48 with three polkas and a march of 1856–62 when the now-most-famous works were beginning to appear. In the former group are the *Sinngedichte*, Op. 1; *Gunstwerber*, Op. 4; *Die Sanguiniker*, Op. 27; *Klänge aus der Walachei*, Op. 50; and *Freiheitslieder*, Op. 52—all of them fascinating, but especially the imaginative Op. 4 and the delectable Op. 50. The shorter works are the jaunty *Deutscher Kriegermarsch*, Op. 284, and three bouncing polkas: *L'Inconnue*, Op. 182; *Maskenzug*, Op. 240; and *Veilchen*, Op. 256.

Herr Schulz is a more outspokenly vigorous conductor than the anonymous one of the cassette program I reviewed last September: the Biedermeier is perhaps a bit bigger than the unnamed orchestra; and the present recording is more robust in a more reverberant ambience and is processed at a higher modulation level. But if there is consequently some loss in delicacy and seductive grace, there is a gain in dramatic force. And Schulz himself demonstrates no less sure command of authentic stylistic idioms than his predecessor.

So again I'm happy to recommend Society membership to all Viennese-music aficionados. The annual subscription rate (now cited in American currency) is \$10, which covers a new catalog of the 140-cassette repertory. Individual Dolby cassettes are \$8.00 each, air postage paid. Write Reginald Woollard, Secretary, Viennese Light Music Society, "Pickwick Papers," Stickford, Boston, Lincs., England. ●



# ADVERTISING INDEX

Key No.		Page No.
1	Acoustiphase	20
2	ADC Professional Products Group. A division of BSR (USA) Ltd.	29
	Advent Corp.	44, 45
3	AIWA	8, 9
	American Audioport	127
4	Angel Records	94
5	Audio Discount Warehouse Sales	136
	Audio Technica U.S. Inc.	4
50	Avid Corp.	125
6	Bang & Olufsen of America	11
	BASF	67
	Bose Corp.	129
7	Carston Studios	133
8	Cerwin Vega	26
	Classified Ads.	134, 135
	Component Discounters	136
9	Crown International	100
48	Dahlquist	101
10	DBX, Inc.	85
	Design Acoustics	99
41	Discount Music Club	102
	Discwasher Inc.	5
	Dixie Hi-Fi	92
13	Dokorder	43
17	Dual	32
14	Empire Scientific Corp.	36
15	Hammond Industries	11
16	Hitachi Sales Corp.	25
18	Icelandic Airlines	126
19	Illinois Audio	93
20	JVC America, Inc.	7
30	Kenwood	Cover IV
21	Klipsch & Assoc.	96
22	Koss Corp.	131
23	Maxell Corp. of America	23
24	McIntosh Laboratory	20
	Midwest Hi-Fi	92
26	Mitsubishi	34, 35
	Music Listeners' Book Service	98, 133
	Music Listener's Record Service	93
27	Nikko Electric Corp. of America	69
28	Olympus Corp. of America	97
31	Optonica Electronics	21
32	Ortofon	123
33	Phase Linear Corp.	121
34	Pickering & Co., Inc.	2
29	Pioneer High Fidelity	Cover II, I
35	Pioneer High Fidelity	56, 57
	Radio Shack	77
	RTR Industries	15
49	Sankyo Seiki	91
36	Sansui Electronics Corp.	31
	Schwann Record Catalog	87
37	Sherwood Electronic Laboratories	83
38	Shure Brothers, Inc.	78
39	Sony Corp. of America	89
40	Sound Reproduction	133
12	Stereo Corp. of America	102
	Superscope, Inc.	138, Cover III
42	Tannoy	18
	Teac Corp. of America	10
46	Technics by Panasonic	12, 13
	3M Co.	95
43	Top Discount Audio	93
	Ultralinear	70
17	United Audio Products	32
44	Vanguard Records	90
45	Vor Industries	116
	Yamaha Audio	16, 17

**ANO.** Anne Diener Giles, flute; Allen Giles, harpsichord and piano. [Peter Christ, prod.] CRYSTAL S 312, \$6.98.

The smaller recording companies often perform special discographic services—partly in the presentation of highly specialized music and performing artists, even more in providing recording opportunities for talented musicians.

Of the present two examples, I give precedence to the more homogeneous all-baroque program of the apparently very young members of the Primavera Trio. It features a fine Bassoon Sonata in F minor by Telemann and less distinctive bassoon pieces by Boismortier and one Giovanni Antonio Bertoli (who is ignored by Grove's even though he was the first, in 1645, to publish bassoon/continuo sonatas). There are also the familiar Handel and Loeillet recorder sonatas, in F and G, respectively, plus a more obscure soprano-recorder sonata from the Op. 2 of Philibert de Lavigne (c. 1700-50). But this mostly very fine music is overcarefully played by Michael McGraw (doubling on bassoon and recorders) and is recorded with balances unduly favoring the soloist and the continuo cellist at the expense of the far too reticent harpsichordist.

The same imbalance exists in the Crystal release, where either the recording engineer or harpsichordist/pianist Allen Giles defers almost obsequiously to flutist Anne Diener Giles (principal of the Los Angeles Philharmonic) and where it's probably the close making that should be blamed for the unpleasantly penetrating high-register note qualities. The prime musical attraction is the second of two Op. 1 flute/harpsichord sonatas in B flat, by Frederick the Great's famous teacher, Johann Joachim Quantz; the other, in A minor, is less distinctive, and the recording is cut off too hurriedly at the end. The B-side flute/piano works—the quite well-known Sonatine by Dutilleux and, in what will may be a first recording, a Capriccio by the relatively obscure Swiss composer Paul Müller-Zürich—seldom if ever rise above the level of routine compositional professionalism. R.D.D.

**HEIFETZ-PIATIGORSKY CONCERTS.** Jascha Heifetz, violin; Gregor Piatigorsky, cello; Leonard Pennario, piano (in the Dvořák). [John Pfeiffer, prod.] COLUMBIA M 33447, \$6.98 [recorded in concert].

**DVOŘÁK:** Trio for Violin, Cello, and Piano, in F minor, Op. 65. **GLIÈRE:** Duo for Violin and Cello. **HANDEL-HALVORSEN:** Passacaglia. **STRAVINSKY:** Sulte italienne (arr. Heifetz and Piatigorsky).

If you are wondering how Heifetz, Piatigorsky, and Pennario fit the Dvořák Op. 65 Trio, which commonly lasts just under forty minutes, on one disc side, the answer is not super-breathless tempos. (In fact the Beaux Arts Trio takes the finale faster in its set of the trios, Philips 6703 015.) Nor are there any repeats to be omitted. The sad fact is that they make scattered cuts, most extensively in the finale. That will be enough to rule out the performance for most listeners, but the playing also shows a certain indifference to dynamic shadings and the mike setup allows for less stereo separation than we are nowadays accus-

tomed to. Despite some scintillating ensemble work, then, there is no challenge here to the aforementioned Beaux Arts, the Yuval Trio (DG 2530 371), or, best of all, the Suk Trio (Supraphon SUAST 50817).

The overside violin/cello works, however, form something of an instant mini-classic among instrumental recitals. The Glière Duo is a dreamy little delight, almost Hispanic in its veiled seductiveness. Halvorsen's Passacaglia (based on a theme from Handel's Seventh Harpsichord Suite), music written for a Dionysian order of virtuosity, is scrumptiously played to the hilt. And Heifetz and Piatigorsky give off sparks aplenty in their own arrangement of Stravinsky's violin/piano and cello/piano arrangements from his ballet *Pulcinella*, itself an arrangement of pieces by Pergolesi.

A.C.

**RENATA SCOTTO:** Serenata. Renata Scotto, soprano; John Atkins, piano. [Larry Morton, prod.] COLUMBIA M 34501, \$6.98.

**CATALANI:** Vieni! deh, vien, la notte è placida. **LEONCAVALLO:** Sérénade française; Sérénade napolitaine. **MASCAGNI:** M'ama, non m'ama; La Luna; Serenata. **PIZZETTI:** I Pastori. **PUCCINI:** Sole e amore; Menti all'avviso. **RESPIGHI:** Soupir; Au milieu du jardin; Povero core; Razzolan. **TOSTI:** Serenata; Malia. **WOLF-FERRARI:** Il Campiello.

Renata Scotto, an artist who in the field of verismo opera shows extraordinary gifts of intensity and communication, is here heard at her least persuasive. Though she is capable of exquisite and affective detail, she is essentially a grand and demonstrative performer. For all the subtlety she frequently brings to her operatic assumptions, she is not by nature a miniaturist. From the evidence of this record, she is not a song recitalist, either. Her notions of the requisite stylistic intimacy are unconvincing. In Respighi's "Soupir" (and, for that matter, in his "Razzolan," too), where she adopts a manner of almost murmuring confidentiality, half the syllables get lost and the music sinks beneath the weight of interpretive affectation. Songs like this need cleaner, more straightforward treatment to make their proper effect.

They also need a technique in better shape than Scotto's seems to be at present. The middle and lower reaches of the voice are still beautiful. The upper reaches are not. All the high notes on this recital, whether loud or soft, are uneasy, and some are downright painful. Unfortunately there are few aesthetic rewards to be found in the songs themselves, most of which strike me as dull. The naive and straightforwardly lyrical Tosti comes off best.

The piano accompaniments are beautifully played but have been recorded far too backwardly. By comparison the soprano sounds as if she is singing straight into one's ear. There are texts and translations, poorly proofread, but, sad to say, not a single word of information on any of this mostly unfamiliar music, not even the dates of composition. One would like to know something about the Puccini songs, for example. Even in the second edition of Mosco Carner's study of the composer, they are hardly mentioned. Incidentally, in "Sole e amore" one hears an anticipation of the quartet from Act III of *La Bohème* and in "Menti all'avviso" of Act I of *Manon Lescaut*. D.S.H.



Here's  
your  
**FREE**  
"at home"  
shopping  
service!



- 1 Just circle the number on the card that matches the number below the ad or editorial mention that interests you.  
You'll also find the key numbers for advertised products in the Advertiser's Index.
- 2 Then type or print your name and address. Don't forget your zip code.

- 3 Drop the postage-paid card into the mail.  
You'll receive literature, colorful brochures and specifications about the products that interest you . . . free and without obligation!
- Use HIGH FIDELITY's "at home" shopping service today!

**MAIL ORDER  
BUYER'S SERVICE**

Now you can enjoy  
the best in both  
musical worlds—  
in one colorful  
magazine:  
**HIGH FIDELITY/  
MUSICAL AMERICA**

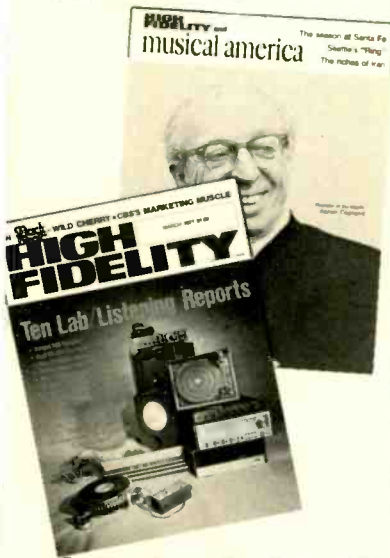

For the full story of music and musicians, include MUSICAL AMERICA as part of your High Fidelity subscription.

MUSICAL AMERICA covers the live musical scene completely. You'll get news, reviews and reports of important musical events all over the world—written by critics who know the score and how to write about it. You'll meet today's outstanding composers, conductors and performers . . . learn how they work and live . . . what they think and say about music.

MUSICAL AMERICA adds a new dimension to High Fidelity—and to your enjoyment of music. Use the postage-free card to start copies coming your way regularly.

(MUSICAL AMERICA is available only by subscription . . . and only with High Fidelity. It is not sold on newsstands. Another important reason to order your subscription now!)

- |     |     |     |     |     |     |     |     |     |     |     |     |     |     |     |
|-----|-----|-----|-----|-----|-----|-----|-----|-----|-----|-----|-----|-----|-----|-----|
| 1   | 2   | 3   | 4   | 5   | 6   | 7   | 8   | 9   | 10  | 11  | 12  | 13  | 14  | 15  |
| 16  | 17  | 18  | 19  | 20  | 21  | 22  | 23  | 24  | 25  | 26  | 27  | 28  | 29  | 30  |
| 31  | 32  | 33  | 34  | 35  | 36  | 37  | 38  | 39  | 40  | 41  | 42  | 43  | 44  | 45  |
| 46  | 47  | 48  | 49  | 50  | 51  | 52  | 53  | 54  | 55  | 56  | 57  | 58  | 59  | 60  |
| 61  | 62  | 63  | 64  | 65  | 66  | 67  | 68  | 69  | 70  | 71  | 72  | 73  | 74  | 75  |
| 76  | 77  | 78  | 79  | 80  | 81  | 82  | 83  | 84  | 85  | 86  | 87  | 88  | 89  | 90  |
| 91  | 92  | 93  | 94  | 95  | 96  | 97  | 98  | 99  | 100 | 101 | 102 | 103 | 104 | 105 |
| 106 | 107 | 108 | 109 | 110 | 111 | 112 | 113 | 114 | 115 | 116 | 117 | 118 | 119 | 120 |
| 121 | 122 | 123 | 124 | 125 | 126 | 127 | 128 | 129 | 130 | 131 | 132 | 133 | 134 | 135 |
| 136 | 137 | 138 | 139 | 140 | 141 | 142 | 143 | 144 | 145 | 146 | 147 | 148 | 149 | 150 |
| 151 | 152 | 153 | 154 | 155 | 156 | 157 | 158 | 159 | 160 | 161 | 162 | 163 | 164 | 165 |

- |     |     |     |     |     |     |     |     |     |     |     |     |     |     |     |
|-----|-----|-----|-----|-----|-----|-----|-----|-----|-----|-----|-----|-----|-----|-----|
| 1   | 2   | 3   | 4   | 5   | 6   | 7   | 8   | 9   | 10  | 11  | 12  | 13  | 14  | 15  |
| 16  | 17  | 18  | 19  | 20  | 21  | 22  | 23  | 24  | 25  | 26  | 27  | 28  | 29  | 30  |
| 31  | 32  | 33  | 34  | 35  | 36  | 37  | 38  | 39  | 40  | 41  | 42  | 43  | 44  | 45  |
| 46  | 47  | 48  | 49  | 50  | 51  | 52  | 53  | 54  | 55  | 56  | 57  | 58  | 59  | 60  |
| 61  | 62  | 63  | 64  | 65  | 66  | 67  | 68  | 69  | 70  | 71  | 72  | 73  | 74  | 75  |
| 76  | 77  | 78  | 79  | 80  | 81  | 82  | 83  | 84  | 85  | 86  | 87  | 88  | 89  | 90  |
| 91  | 92  | 93  | 94  | 95  | 96  | 97  | 98  | 99  | 100 | 101 | 102 | 103 | 104 | 105 |
| 106 | 107 | 108 | 109 | 110 | 111 | 112 | 113 | 114 | 115 | 116 | 117 | 118 | 119 | 120 |
| 121 | 122 | 123 | 124 | 125 | 126 | 127 | 128 | 129 | 130 | 131 | 132 | 133 | 134 | 135 |
| 136 | 137 | 138 | 139 | 140 | 141 | 142 | 143 | 144 | 145 | 146 | 147 | 148 | 149 | 150 |
| 151 | 152 | 153 | 154 | 155 | 156 | 157 | 158 | 159 | 160 | 161 | 162 | 163 | 164 | 165 |

NAME \_\_\_\_\_

ADDRESS \_\_\_\_\_

CITY \_\_\_\_\_

STATE \_\_\_\_\_

ZIP \_\_\_\_\_

I am a subscriber

I am not a subscriber

67

NAME \_\_\_\_\_

ADDRESS \_\_\_\_\_

CITY \_\_\_\_\_

STATE \_\_\_\_\_

ZIP \_\_\_\_\_

I am a subscriber

I am not a subscriber

67

FIRST CLASS  
PERMIT  
NO 570  
MARION, OHIO

**BUSINESS REPLY MAIL**

No Postage Necessary if Mailed in the United States

Postage will be paid by:

**HIGH FIDELITY**

1 Sound Avenue  
Marion, Ohio 43302

NAME \_\_\_\_\_

ADDRESS \_\_\_\_\_

CITY \_\_\_\_\_

STATE \_\_\_\_\_

ZIP \_\_\_\_\_

I am a subscriber

I am not a subscriber

67

Here's  
your  
**FREE**  
"at home"  
shopping  
service!



- 1** Just circle the number on the card that matches the number below the ad or editorial mention that interests you.  
You'll also find the key numbers for advertised products in the Advertiser's Index.
- 2** Then type or print your name and address. Don't forget your zip code.
- 3** Drop the postage-paid card into the mail.  
You'll receive literature, colorful brochures and specifications about the products that interest you . . . free and without obligation!  
Use HIGH FIDELITY's "at home" shopping service today!

## MAIL ORDER BUYER'S SERVICE

Three Great Buyer's Guides from HIGH FIDELITY—Order Now!



1977 Test Reports \$2.95 circle 161

Buying Guide

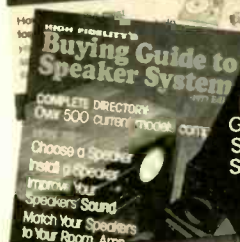

1977 Buyer's Guide to Speaker Systems \$1.50 circle 162



1977 Buyer's Guide to the World of Tape \$1.50 circle 163

To order, circle the number on the attached card that matches the number of the Buyer's Guide you want, enclose payment with your order and mail to:

Reader Service  
P.O. Box 14306, Annex Station  
Cincinnati, Ohio 45214

(Enclose payment. No credit orders.)

### BUSINESS REPLY MAIL

No postage stamp necessary if mailed in the United States

Postage will be paid by—

**HIGH FIDELITY**

Reader Service 77  
P.O. Box 14306  
Annex Station  
Cincinnati, Ohio 45214

First Class  
Permit No. 111  
Cincinnati, Ohio



### BUSINESS REPLY MAIL

No postage stamp necessary if mailed in the United States

Postage will be paid by—

**HIGH FIDELITY**

Reader Service 77  
P.O. Box 14306  
Annex Station  
Cincinnati, Ohio 45214

First Class  
Permit No. 111  
Cincinnati, Ohio



Please enter my subscription to HIGH FIDELITY magazine at the special rate of:

- 15 issues for only \$9.47     22 issues for only \$13.88  
 33 issues for only \$18.87

I prefer a full year of High Fidelity/MUSICAL AMERICA. I'll receive all of High Fidelity plus 40 pages each month of news and reviews of important musical happenings throughout the world—concerts, opera, etc.—for only \$18.00

E7FR

Name \_\_\_\_\_

Address \_\_\_\_\_

City \_\_\_\_\_

State \_\_\_\_\_

Zip \_\_\_\_\_

payment enclosed     bill me

For postage outside U.S.A. & possessions:  
High Fidelity—15 issues add \$2.00; 22 issues add \$4.00; 33 issues add \$6.00.  
High Fidelity/MUSICAL AMERICA—for one year add \$2.00.

### BUSINESS REPLY MAIL

No postage stamp necessary if mailed in the United States

Postage will be paid by—

**HIGH FIDELITY**

Reader Service 77  
P.O. Box 14306  
Annex Station  
Cincinnati, Ohio 45214

First Class  
Permit No. 111  
Cincinnati, Ohio

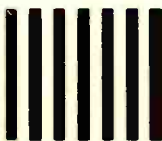



# Backbeat

## Peter Asher—Producer Power & a Touch of Class

by Sam Sutherland

8430 Santa Monica Boulevard is a two-story California Modern office building complete with tinted windows and a courtyard full of tropical plants. The building faces a pancake franchise, a bowling alley, a liquor store, and Barney's Beanery, which used to have the best jukebox in West Hollywood. But even with the disco vamps infiltrating Barney's machine, there still seems to be ample room for Linda Ronstadt's records—which is fitting: across the street in 8430 sits Peter Asher, her manager and producer.

The offices are modest by Hollywood's standards

and cramped by Beverly Hills's. And the current clutter of packing boxes and stacks of tape reels reveals Asher's surrender to the inevitable: After several years in these comfortably shaded rooms he has been forced to move to larger quarters. He has no choice—he's too successful.

Peter Asher has emerged as one of the most respected and bankable producers in Seventies pop, and it is in that role that he is best known to the public. His work on James Taylor's early, career-making records has proven as influential to the sound of pop/rock as



Taylor's writing has been to its content. In an era when six-figure and still spiraling production costs make breaking even on label balance sheets more and more difficult for artists, and the pop audience itself is growing increasingly fragmented, the stakes are clearly higher than they've ever been—and a producer's track record is a crucial consideration for any artist. Asher's careful output of durable albums has earned him that most elusive of commercial music distinctions: a consistency to the quality and finish of his work. In fact, his very liner credit is a selling point.

His style is difficult to characterize. Linda Ronstadt

---

**“‘Heart Like a Wheel’ was Asher’s first full production for Ronstadt, and marked the singer’s transition from survivor to star.”**

---

calls it simply “class,” as do any number of reviewers, perhaps because Asher's touch is distinguished less by specific technical or instrumental signatures than by a prevailing depth and clarity of sound and a concern for unity of content. His orientation as a producer has always been toward singers and songwriters; although his sessions are invariably played by excellent musicians, he has yet to yield space to lengthy instrumentals or melodramatic technical embellishments, preferring to focus on the singer. His instinct for selecting and presenting concise, commercial pop performances may be of primary value to his business associates. But to the average record buyer, Asher's presence is probably more conspicuous in the wealth of detail and color captured in his recordings: Elegantly arranged string settings, intricate percussion tracks, and smooth, high backing vocal harmonies are among his most evocative constants—each feature typically controlled to enhance and not eclipse the session's star.

That approach is grounded in Asher's own career as a performer. In the early Sixties, while still a student in an English public-school, he began singing informally with his friend Gordon Waller. Their modest coffee-house performing dates mushroomed with the first volleys of the British Invasion, and Peter & Gordon's subsequent EMI contract resulted in a global recording career. *World without Love*, the first of several Lennon-McCartney songs they recorded, became an international hit single in 1964 and marked the beginning of their four-year tenure as chart artists. Their melodic, gently folk-flavored arrangements subsequently evolved into more urgent, larger-scale pop productions like *To Know You is to Love You*, *I Go to Pieces*, and *Woman*.

“When we started, I wasn't listening to much pop music at all,” Asher says. “The Beatles' was really the first pop music that I listened to a whole lot of, except for Elvis' big hits. I was listening to a lot of Woody Guthrie at the time. It was mostly Gordon that made

me aware of all the other stuff; he made me listen to more Buddy Holly and Everly Brothers, and more of a lot of other records than I ever had before.”

In the late Sixties the pair drifted apart as response to their records tapered off and Waller became involved in a separate acting and recording career. Asher wasn't consciously planning his next move; it was his involvement in selecting material and musicians early in Peter & Gordon's career that led to his independent production work. “I was always interested in those aspects,” he recalls, “and I would insist on staying while the record was being mixed, which then was unusual to do.” At that time, pop recording both in London and the U.S. was still limited to four-track technology and tight recording schedules.

“The decision [to go into production] was really made for me by Paul Jones,” he explains. “We'd been together in the studio on various things before, and he'd watched me work and knew that I was interested in producing records. And he asked me if I'd produce some tracks with him. It was bold of him to ask me.”

Jones, lead singer for Manfred Mann's band during its most successful mid-Sixties incarnation, had graduated to a solo career in Europe, and his endorsement proved important. Those early sessions revealed that Asher was already astute in assembling session bands. “We did about three tracks,” he says, “of which the only one that was nearly a hit was a Bee Gees song called *And the Sun Will Shine*. . . . But it was a great session: I used Paul McCartney playing drums, Paul Samwell-Smith [a Yardbirds alumnus who, like Asher, has since emerged as a producer with commercial credits] playing bass, and Jeff Beck playing guitar. I don't know where the tapes for that are now, but based just on the personnel, it's obviously a legendary track.”

If the Jones sessions were Asher's baptism as a producer, his appointment as a&r director for the Beatles'



Linda Ronstadt—“we really work like a team”



then-embryonic Apple label set the stage for his commercial vindication. Asked to assume that post by McCartney when the label was still more an idea than a reality, Asher found himself at the center of an often chaotic situation. "It turned out to be a title that carried less power than the name implied, simply because of the nature of the four owners. You had to get a quorum of approval from them before you could actually do much. It made decision-making difficult, but at the same time I learned a great deal working with them."

While at Apple he received a call from James Taylor, referred by Danny "Kootch" Kortchmar. Kortchmar had accompanied Peter & Gordon on an American tour as a member of the King Bees before linking up with Taylor in the Flying Machine. The referral was more social than professional, but on hearing Taylor's songs, Asher signed him to Apple and produced his debut album. "James Taylor."

The LP wasn't an auspicious commercial success. By Asher's own recollection, it sold somewhere in the neighborhood of 8,000 copies in the U.S. Apple was meanwhile plagued by its own anarchic style, and in 1969 Asher departed for New York and a brief stint at MGM Records, partly because his friend Ron Kass was the president, and partly because "they offered to bring me and Betsy [his wife] and the cats and all our belongings over on the *Queen Elizabeth* first class, which was very important since I had no money at the time."

While still with MGM, he flew to Los Angeles to find a new label for Taylor, whom he was now manag-

**"It was a great session: Paul McCartney playing drums, Paul Samwell-Smith playing bass, and Jeff Beck playing guitar."**

ing. As it turned out, a fatefully large slice of those first albums had been scooped up by musicians, and Taylor's reputation as a cult artist persuaded Warner Bros. to take the gamble. Asher left MGM, moved to Los Angeles, and in 1969 produced a second album, "Sweet Baby James." After a slow start, it began to sell. A single that had already been covered by two artists, but without commercial success, followed. The song was *Fire and Rain*, and Taylor became the archetypal singer-songwriter.

Asher's growth as a producer and manager has been a careful, conservative process. After several outside assignments, he limited his production commitment to Taylor alone, later pairing him with other producers. In 1973 he took over the management of Linda Ronstadt's career, stepping in to wrap up the sessions for "Don't Cry Now," her first album for Asylum. That record, which offered a rotating cast of producers, managed to sell steadily if unspectacularly, at least partially sustained by Ronstadt's touring. Her next album, "Heart Like a Wheel," was Asher's first



*Peter & Gordon—once a star, now a star-maker*

full production for Ronstadt, and marked the singer's transition from survivor to star. Three singles from it—*You're No Good*, *When Will I Be Loved*, and *It Doesn't Matter Anymore*—followed, demonstrating the new breadth of Ronstadt's recorded style. The first, a striking remake of an old Betty Everett tune, was a soulful, desperate ballad that enjoyed broad pop success; the second scored on both pop and country charts; and the last became a major country hit. Without diminishing Ronstadt's country roots, Asher had succeeded in finding the convincing pop format for her. "Heart Like a Wheel" went Gold, then Platinum, and Asher the manager kept his new star on the road for a series of tours to ensure that her draw as a concert performer would equal her record sales.

Asher himself is unwilling to formalize his approach to either of his roles. He agrees with his friend John David Souther, one of the other producers involved with Ronstadt's "Don't Cry Now," who convincingly describes production as "the most undefined job in the world, because there's no guidebook as to what you should do." (Asher produced Souther's "Black Rose," released last year on Asylum; it was his first production agreement since Ronstadt's successes.)

What Asher clearly does do is to organize. Souther describes him as "a great organizer, and a great mixer who can sort out all the situations in the room, who can say no to people and make them dig it. . . . He's flexible enough to make it work."

"Everybody always knows exactly what's expected of them," Ronstadt says of Asher in the studio, "and

they try to do it the best they can. If they get off the track, he's real precise about guiding you back. . . . He's precise about saying exactly what it is when you're missing the mark, so nobody's ever wandering around in a state of confusion. The sessions are really well organized and well run, and I find it's like that notion—from the most discipline comes the most freedom. It just seems that when you provide a real strong framework like that, then everybody has the confidence to do their best."

Asher's own view of his studio approach is a far looser one. Asked whether his sessions are run autocratically or whether he acts merely as a translator and collaborator, he answers, "Somewhere in between, really: the captain of the ship so far as the engineer is concerned—you listen to everything that he thinks of and you let him do what he does best, but at the same time, ultimately, if you don't like it and he does, you win—whereas with the artist it's not that simple. . . ."

"You're certainly the captain of the ship in terms of being the coordinator of all the various aspects and

---

### "His very liner credit is a selling point."

---

forces involved; it's clearly your job to make sure that it all fits together, that what everyone is aiming at is a common goal. But as for saying, 'Sing this, sing it this way,' certainly not. Eventually, the thing should be based around the way the person sings the song best, and what the song is. That's where you really start."

Asher starts with pre-production planning—selecting material, arranging it, and then rehearsing his musicians long enough to achieve familiarity without exhausting the freshness of the songs. Once in the studio, however, he avoids carefully staging the recording process. "I prefer to have a lot of things cooking along at the same time, so that you're not suddenly faced with seven days of nothing but vocals, or just millions of guitar solos to put on and nothing else to do."

"I would rather know in my head that we've got this guitar solo to do, and we've got to do these background vocals, and we've got two more tracks to cut, and we've got a couple mixed, but two more sides still to mix. . . . I prefer to juggle it like that, which is a little bit confusing, but much more interesting because you don't suddenly have to mix millions of things one after the other."

Apart from that approach, and Asher's admitted obsession with "in-tuneness," he denies any master plan behind the steady evolution of his production style. "I think it changes all the time. I go through different phases. 'James Taylor' was less live, for example, than the subsequent album; 'Sweet Baby James' was an entirely different approach, where there was a great deal less overdubbing and a lot more live vocals. . . . Every album is different, really."

His attitude toward the studio itself mirrors that dis-

trust of formulas. He has gradually placed increasing emphasis on capturing basic band tracks and lead vocals with as live a session feel and as solid a sonic finish as possible. But his use of overdubbing and tonal effects has varied widely, ranging from simple, undorned studio performances to the carefully structured composite solos he and guitarist Andrew Gold create for Ronstadt's records. "There are a lot of effects there," he observes. "There's tons and tons of toys that I use all the time, but I think if they're used right, they can sound completely natural."

At least part of that naturalness stems from his long-standing practice of using the same core of full-time players for his sessions, rather than relying extensively on studio musicians. Thus, Ronstadt's touring band has remained the instrumental base for each of her Asher-produced records, with shifts in the lineup generally reflecting changes in her band rather than Asher's choice of guest performers. He'll also be returning to the basic Taylor band—guitarist Kortchmar, keyboard player Clarence McDonald, bassist Lee Sklar, and drummer Russ Kunkel—now that he has reassumed production/management duties for the artist. (Taylor recently switched from Warner Bros. to Columbia.)

Similarly, Asher's two most recent outside projects, Andrew Gold and John David Souther, both revolved around the basic Ronstadt band, yet in each case shifts in the lineup have yielded significantly different arranging styles. With Gold (leader of Ronstadt's band, and a multi-purpose instrumentalist, as reflected by his one-man-band success with *You're No Good* and *Heat Wave*), Asher used the full band, alternating sessions for his "What's Wrong with This Picture?" (see *BACKBEAT*, February issue) with Ronstadt's "Hasten Down the Wind." John David Souther's "Black Rose" uses the same band as instrumental base, but Asher and he succeeded in broadening the record's stylistic mix by adding jazz players Stanley Clark and Donald Byrd, along with a roomful of familiar rock players.

Peter Asher will probably never see more than a few of his records on the charts at the same time, in contrast to faster, more expedient producers whose reputation is built more on quantity of output than quality. But aside from his drawing power as a successful producer-manager, the most significant characteristic of Asher's career is musical. "He has such an incredible sense of taste," Linda Ronstadt emphasizes, "and always of what's appropriate. He knows exactly when to stop with something. And I trust that impeccably. Even though we really work like a team, and everybody's ideas are brought into play at some point or another, including mine, Peter's so great at taking all those ideas and just tuning them like a chord."

Asher has already weathered the pop spotlight as an artist, and it is perhaps that perspective that explains his empathy with musicians both successful and unknown. Having been a star, he now prefers making them. ■



## Making It in the Musicbiz: Myth & Reality

by John Storm Roberts

**A**h, the legendary toughness of the musicbiz! For every thousand that try, one makes it. The rest sling hash and pump gas, making fodder for the occasional country song before truckin' on home. Star-struck kids, born to die a little, born to feed a myth. . . .

Myths are good fun, and this is a handy one, providing copy for the flacks and hacks, a copout for those who don't make it, and ego food for those that do. But while public and publicists can groove on it without much harm, a musician who wants to get ahead better go with reality. My highly unscientific survey of various level-headed souls, some successful, some just beginning (and all—like Holly Golightly—still traveling), shows pretty clearly that if the myth ever approaches reality it's only by coincidence. For the land is aswarm with musicians who, without hitting those peaks reached by one in a thousand in any trade, are making it in one way or another with a little luck and a lot of struggle.

They call that struggle "paying dues." Most everybody hopes to skip it, courtesy of some hip Fairy Godmother, but things rarely happen that way. The good news is that without any dues-paying, the Big Break could become a Big Disaster. As progressive rock group City Lights's lead guitarist, John Berenzy, says, "It's a protection, because it forces you to really get it together."

Getting it together covers more than the intensive musical training playing night in and night out can give you. (If you're that lucky—rock group Foghat and Cathy Chamberlain's Rag 'n' Roll Revue, for instance, started out with two and three gigs a year.) More importantly, it involves getting in touch with the reality of the music business, which often has a lot more to do with business than with music.

Of course, one of the myths is that every businessman in the field is a rogue. A stanza in the *Ballad of Pretty Boy Floyd* runs: "I've traveled the whole world over./I've met lots of funny men,/Some will rob you with a six-gun,/And some with a fountain pen." Many are convinced the man was talking about the music

business, and, in the old days, the fringes could indeed be lawless. Johnny Martin recalls an occasion in the Mighty Clouds's early years when a promoter pulled a pistol to persuade them to forgo their fee. Bob Tullipan, a white manager who used to operate out of Florida, has seen the same thing happen even more recently in the South. "You'd get paid and right as you



Leland Bobber/P.M. Sessions

Guitarist John Berenzy—"it's a hungry world"

were getting paid there'd be somebody who had a gun to you, so you'd give the money right back. The people that you had met with to negotiate the deal would be really nice, but by the time you'd get there to play, those people weren't there!"

On the recording side, the smaller labels—especially in fields like jazz, r&b, and country—used to carry a marked reputation for Jaws-like practices. New York "salseros" remember vividly a former record-company owner's technique at renegotiation time, which was to say, in fatherly tones, "Write in any royalty rate you like, my boy—because I'm going to pay you what I'm going to pay you, anyway!"

But for the most part, the fountain pen has replaced the six-gun, and the business today is increasingly one of large corporations and know-how. And although stories of record companies' "creative accounting" practices are legion (albeit many who tell



*Songwriter Don Ramer—his own demo worked best*

them have grandiose ideas about their own potential market), on the whole the trend has led to a rise in straight, hard-nosed dealing. What's needed for the creative ego to deal with the corporate hard-nose is less paranoia and more level head. In fact, the infamous shark specializes in gobbling up artists who either believe business is beneath them or are prepared to pay for that mythical "inside edge." Better to find your own. For inevitably, hustling is a do-it-yourself proposition.

Getting your own foot in the door is really not all that horrendous. Bruised egos are prone to bind their wounds with the myth that you need "pull" to get heard in the crystal palaces of Babylon. But take heart: The reality didn't work out that way for Don Ramer, a young guitarist-songwriter still in the dues-paying scuffle. Like many others, he answered one of those alluring ads that offer to produce, publish, and promote a demo tape of three tunes, all for a mere \$500—plus, it turned out, all publishing, management, and production rights for three months! Fortunately, he had the savvy to do some checking and discovered another song shark. "I ended up making the same demo with four tunes, getting a better sound in a better studio myself for \$165, and I didn't have to give away anything!" With no pull at all, he then sent that same demo tape to Sire Records and almost immediately got an offer for two of his songs for a Stanky Brown album. (He ended up turning it down, but that's another story.)

"It was magical. I called the day after the demo was made and they saw me that afternoon. And there's not a company in the city that won't do that if you press hard enough and sound like you're on the case."

The same goes for getting club dates. In fact one struggler believes booking himself is "the most effec-



*Melba Moore—"you have to find out where you belong"*

tive way for a beginner, because without a record contract you're not going to be able to get a reputable agent." Some of the shadier booking agents are, in the words of an agent-turned-performer, "horrendous, to the point where musicians are contracted at \$50 apiece per night, and the agency gets \$500, illegally, by calling itself a production company, and doesn't even pay taxes on it."

There is nothing occult in selling yourself. You do what all salesmen do—you study the market. Melba Moore once commented, "You know you're going to do anything at first, but then you have to find out where you belong." Then, as former studio musician Lou Stevens learned when he went out to do his own post-rock acoustic thing the hard way, you "leave your

---

**"What's needed for the creative ego to deal with the corporate hard-nose is less paranoia, more level head."**

---

ego behind and deal with it as a business. Most club-owners are looking for a sound investment and not for musical quality."

Nor—despite the real exceptions—are club owners necessarily musician eaters. For the most part the hip musician needs more common sense than karate. Greg Coverdale has long experience of beating about the scenes. "I did the Top 40 disco scene when I was in high school in all the small bars and stuff, and I never had too many bad scenes about being paid. And that was because of approach." Specifically, his approach was to get the money up front: so much on fixing the date, and the balance before setting up.

Once you're in you can relegate some of the business aspects to a manager. Many have had good ones from the start of their career. But since ten percent of





*Cathy Chamberlain—showcases are a necessary evil*

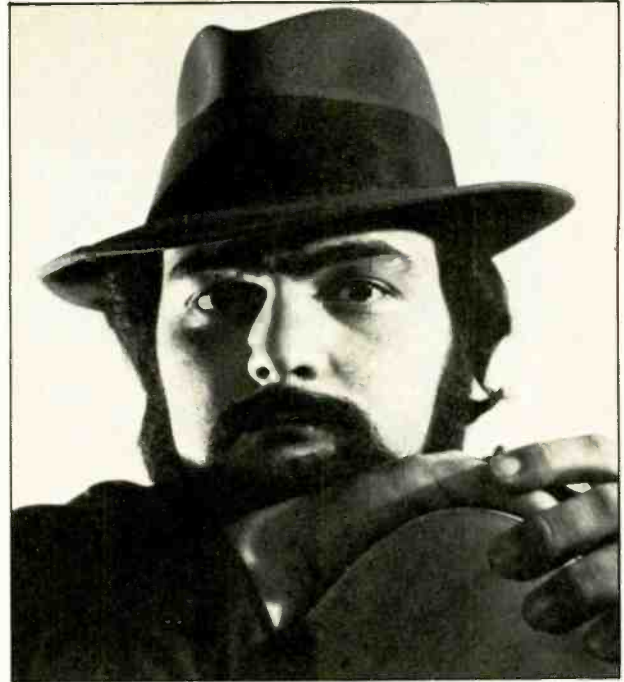

*Lou Stevens—"leave your ego behind"*

two gigs a year doesn't pay for a 57th Street name plate, let alone the offices behind it, most newcomers' managers are either newcomers themselves or are otherwise committed to The Cause. Cathy Chamberlain is married to hers. Foghat's manager, Tony Outeda, was a friend who joined them when things were so bad that "I couldn't even get us arrested." City Lights' lawyer-manager was once a guitar pupil of Berenzy's.

If you don't hitch up with some executive-minded and, importantly, competent risk-taker, then you go back and tend to business yourself, or else business will tend to you. As a songwriter put it, "For me to just sign this away to somebody—is like really asking for no respect."

Like any business, not all aspects are clearcut: right way, wrong way; good guys, bad guys. A prime example is the showcase. "Showcasing"—playing for free—is an established way of getting a hearing. Some musicians feel that it's a club racket aimed at getting free music rather than encouraging new talent, and that it can even be self-defeating. "You create problems for yourself in the long run, because a club owner doesn't want to hear that you showcased at another club, he wants to hear that you made money at another club and drew consistently." But Cathy Chamberlain found them valuable—"terrible on the one hand and a necessary thing to deal with. It's easy to complain about how awful it is and refuse to deal with it, but all that means is you don't get anywhere."

The real problems can arise when the newcomer is somewhere between susceptibility and stardom. The perfect example is the young performer who winds up entangled in some producer's strings. Andrea Vereen (Ben is her ex) is a young rock-oriented black gospel singer who aims to cross over into message-oriented rhythm and blues. But her producer had more traditional ideas: sexpotism.

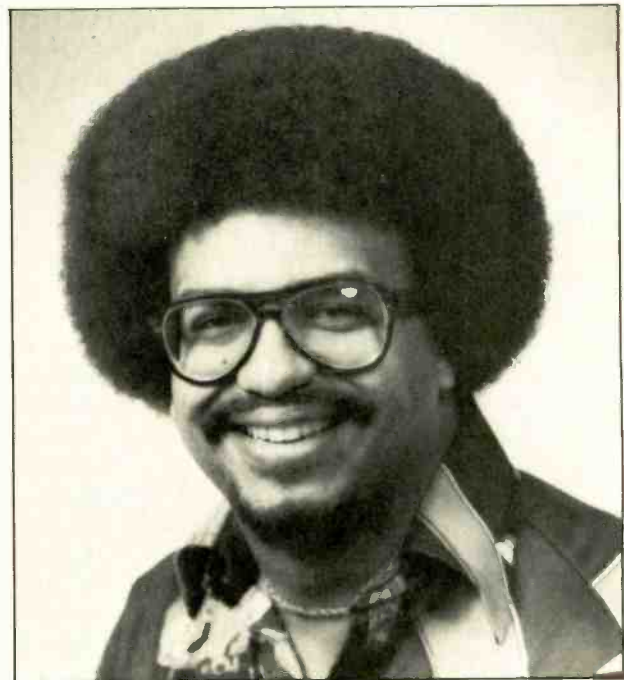

*Greg Coverdale—get the money up front*

Bill Stone



*Andrea Vereen—don't get entangled in a producers' strings*

"I refused to sing *Bring Your Body Over*. I said if I was a rock singer I wouldn't do *Bring Your Body Over*! He was disgusted. He said, 'Shut up and go back to church.'"

Cathy Chamberlain's first record deal (she has since signed to a new label) began to look less rosy when she found that "they wanted me to do Bette Midler. They were trying to get my record out and go national before hers came out!" She resisted, and the LP never came out. Her first—on Warner Bros.—was released in April.

A young songwriter has even less clout than a performer. Coverdale wrote one tune for Fathead Newman's last album. His *Feel the Music* started out as a rather tasty blend of r&b and Latin disco, but the producers wanted a formulaic disco sound, and, in the mixing, they got it. Coverdale views it philosophically.

"The tune they heard in my basement and the tune on the album are really not the same. There's a conga player on that cut who's doing the job, and you

---

**"A young songwriter has even less clout than a performer."**

---

just don't hear him. But we have to remember that there are a million right ways. Who's to say mine was best? They got what they wanted."

The final, and perhaps the greatest, problem is in dealing with all this psychologically. Here, the raunchier aspects of the musicbiz myth—the drugs, the public incidents of infantile behavior—and its reality most frequently coincide. Because in reality, the pressures in this business can be as great as those in "straight" life.

"It's a hungry world," John Berenzy says. "People who've heard me the first night want to hear

me top myself the next night. It becomes a real syndrome.

"Life on the road has become a cliché: It drives you to things. A corporate body trying to push you in a very nonaesthetic direction drives you to things. The fact that you haven't seen your loved ones in a while drives you to things. And the fact that your record isn't being pushed in the town in which you're playing is the equivalent of having frostbitten fingers for a guitar-player."

But despite the occasional rock freakout that gets the headlines and feeds the myth, most musicians willy-nilly develop strength to deal with the pressure, peaks, and crises of confidence that are part and parcel of anybody's reality. And lest we forget the power of positive thinking, John Lennon once said the reason the Beatles succeeded was that whenever things looked bleakest, at least one of the four was feeling up enough to say, look, we're going to make it. A prime example of that kind of determination is pianist/band leader Eddie Palmieri. In 1968, he was clearly finished—no band, no gigs, overwhelming personal and emotional problems, a terrible reputation for unreliability. But he hung in—and in both 1975 and 1976 he won the Grammy for Best Latin American Recording



*Calvin Coolidge—perseverance is the key to making it*

(respectively for "Sun of Latin Music" and "Unfinished Masterpiece.")

Old Cal Coolidge said it, way back when. More than talent, more than business savvy, intelligence, or luck, the essential quality for making it in any business is (yawn!) perseverance. Without it, you better stick to the gas pump. ●



### Introducing Equalization

Since we're covering a parametric equalizer this month, it seems an appropriate occasion to say a few words about equalizers in general, and parametrics in particular. Equalization (the alteration of tone color, or timbre) is achieved by boosting or attenuating the amplitude (volume) of certain portions of the frequency spectrum. (The frequency spectrum of the human ear runs roughly from 20 Hz to 20 kHz.)

As an example, equalization in a pop recording might be used to give the strings an "edge" or to beef up the bass. It's used in auditorium and home sound systems to tailor the frequency response to suit the characteristics of the room. It shouldn't be confused with the *reciprocal* sort of equalization that is used to bypass certain problems in the transmission of electrical signals. This type, conversely, does *not* affect tonal balance when it is used correctly. In the RIAA equalization of disc mastering (and playback), the NAB equalization for tape recording (and playback), and the 75-microsecond equalization of FM broadcasting (and reception), equalization (or pre-emphasis) at one step is precisely countered by the reciprocal equalization (or de-emphasis) at a later step. Net result: no equalization at all.

The simplest sort of equalization is the bass/treble tone control, found on most electronic instruments and home stereos. More sophisticated equalizers, found on recording-studio consoles, may divide the frequency spectrum into three or more separate bands, and within each, the equalization is usually selectable between several different frequencies. The user has the option to either boost or attenuate the selected frequency by perhaps 15 to 20 dB.

Further up the scale of sophistication is the so-called graphic equalizer, which divides the frequency spectrum into anywhere from six to thirty bands, depending on the unit's capabilities. With a typical ten-band graphic equalizer, each frequency band may be boosted or at-

tenuated by up to 15 dB or so. This type of equalizer is usually controlled by a series of vertical faders, which when in use give a "graphic" display of the resultant frequency response—hence its name.

As you may have gathered by now, two of the parameters (remember this word) with which equalizers concern themselves are frequency (*which* part of the audio frequency spectrum will be affected?) and amplitude (*how loud* will the affected portion be relative to the rest?) A third parameter is bandwidth. The individual sections of any equalizer boost or attenuate in the immediate vicinity of the selected frequency. Bandwidth tells you how much of the nearby spectrum is affected. When, for example, you boost 600 Hz by 10 dB, you are also boosting 580 Hz and 620 Hz—though generally, of course, by a smaller amount. (Shelving equalizers take effect only on one side of the selected frequency, and here bandwidth as such does not enter the picture.) Some of the more expensive equalizers may have a two-position switch to select wide or narrow bandwidth—sometimes referred to as low and high Q, respectively.

On conventional equalizers of any sort, the amplitude of the equalization is almost always continuously variable, while control over the selected frequency and the bandwidth (if any) is switch-

bandwidth may also be swept from a narrow band of several Hz to several thousand Hz. And, while amplitude control is just what you might find on any conventional equalizer, some parametrics offer attenuation capabilities far beyond the other equalizers. In effect, silence (almost) at the desired frequency. The parametric equalizer is an incredibly versatile production tool, as anyone who has used one will testify.

**Furman Sound Parametric Equalizer/Preamp Model PQ-3.** This is a three-band parametric equalizer that offers separate control of low, midrange, and high frequencies, with full facilities available within each range. The frequency range of the three sections overlaps, with the low section variable from 25 to 500 Hz, the midrange between 150 and 2,500 Hz, and the high from 600 Hz to 10 kHz. Within each band, equalization may be varied from a gain of 20 dB to an attenuation of more than 40 dB. Bandwidth is adjustable from less than 1/3 octave to over 4 octaves.

PQ-3 incorporates a variable-gain preamp, enabling the onstage user to couple the device directly to a power amplifier. High- and low-level input and output jacks make it possible to use the preamp section as a distortion unit. Parametric equalizers are among the best



Furman Sound Parametric Equalizer/Preamp

lectable. However, when these latter parameters are continuously variable, the equalizer is dubbed a "parametric" to distinguish it from its less-sophisticated cousins: the tone control, the graphic equalizer, and the others.

With a parametric equalizer, the user may sweep across one or more sections of the audio bandwidth. This in fact is the principle behind the famous wah-wah pedal. On many parametrics, the

anti-feedback devices around because you can zero in on the precise frequency that is howling without disturbing the rest of the audio spectrum. Parametrics also can shape a sound more critically than any other device; besides, they're fun to play with. For instance, during the course of the PQ-3's field test, we created wah-wah vocals and turned our grand into a toy piano. I also used it on a commercial recording to simulate an air-

plane pilot's voice coming through one of those wretched little intercom systems found on jetliners.

The PQ-3 generates no audible noise of its own and all of the controls are smooth. The preamp offers up to 27 dB of gain (depending on which input you use), and it may be used for reducing hum, increasing presence, or correcting deficiencies in some microphones. Musicians, meeting-hall managers, and especially basement recording studio engineers will find this a versatile low-cost tool with broad application. For the musician in particular, the PQ-3 offers more

color possibilities than any wah-wah pedal, fuzz, or flanger he ever dreamed of. The manufacturer's specifications list input impedance at 10,000 ohms, output at 10 ohms. Frequency response, with eq. out or set flat, is said to be  $\pm 1/2$  dB, 20 Hz to 20 kHz. The PQ-3 weighs five pounds, requires 115 volts AC, 4 watts, and retails for \$300.

CIRCLE 121 ON READER-SERVICE CARD

**Helpinstill Guitar Sensor.** This is an attractive, innovative idea for a steel-string acoustic guitar pickup. The Helpinstill Model 65 adheres to the body of the gui-



Helpinstill Guitar Sensor

tar with pressure pads (supplied) and fits under the strings near the bridge. It senses the strings as well as the body of the guitar, thereby combining the brightness of the metal's sound with the warmth of the wood's. We tried it with a Yamaha steel string and a Polytone amplifier; the sound was nice and the response even over all the strings and harmonics. The pickup's output cable runs to a transformer, which may be attached to a belt, loop, or pocket. A volume-control pot sits on top of the transformer box for easy access, and the output from the transformer is a standard phone jack. The input is a mini-phone plug/jack configuration and is of the shorting type. This means that if you pull the plug without first turning down your amplifier, the amp won't put out that nasty hum. Model 65 is virtually noiseless and, although it is somewhat sensitive to physical movement of the guitar, it is no more so than other acoustic pickups. Aside from a rather bright sound on the high strings, little other tone coloration was apparent. Suggested list price is \$79.50.

CIRCLE 126 ON READER-SERVICE CARD

**MXR Analog Delay.** Time-delay devices that employ either analog or digital circuits have become extremely popular in the past few years, specifically for recording and open-air concerts. Digital delay is used in vocal doubling, string thickening, and in delaying the onset of reverberation (thereby replacing the tape-slap technique). By combining a direct and a delayed signal, effects may range from a slight "fattening" of a sound all the way to a discrete echo, such as you might hear in the Grand Canyon.

Following the trend of adapting studio equipment (such as phasers, flangers, and reverberation devices), musicians have begun to use analog and digital delay. MXR's Analog Delay is designed specifically for electric instruments and gives the user time-delay control vari-

# — the — CLEAN MACHINE

Playing a dirty record results in wear and tear to your stylus as well as damage to delicate record grooves. You'll hear it in poor, distorted sound reproduction.

Now, there is a proven way to keep records clean without coating sprays or abrasive brushes, wipes or pads. It's the Vac-O-Rec vacuum record cleaning system. The Vac-O-Rec is a precision vacuum component that requires no additional expense for continuous record maintenance.

Gentle mohair fibers loosen and lift dust and dirt particles while a powerful vacuum blows it away from the record's surface. The Vac-O-Rec also reduces static electricity.

If you're listening to "dirty" records, you might as well be listening to an old Victrola. But if you really care about good sound from your albums and singles, you'll want to keep yours clean the Vac-O-Rec way.

**vac o rec**

VOR Industries, Inc., 1440 S. State College Blvd., Anaheim, Calif. 92806

—Available at fine audio and stereo stores everywhere.—

© 1977 Vor Industries, Inc.

CIRCLE 45 ON READER-SERVICE CARD



able from 25 to 500 milliseconds. Next to the DELAY is a MIX control, to balance the delayed signal with the normal direct signal. REGEN permits regeneration of the delayed output back to the input section for further blending and reverb possibilities. Finally, there is a foot-activated bypass switch to restore the signal to normal.



**MXR Analog Delay**

As with all analog delay units, there is some tradeoff between bandwidth and delay time. In other words, the longer the delay, the poorer the frequency response of the delayed signal. At 25 milliseconds, frequency response of the MXR is from 20 Hz to 20 kHz, while at 500 milliseconds the bandwidth tops out at 1 kHz. The unit is extremely quiet and well constructed. It offers a wide variety of sound possibilities, and the pots are predictable and consistent. Input impedance is listed at 500,000 ohms, output impedance at 100 ohms. Standard 1/4-inch phone jacks are at the side panel; power requirement is 105 to 125 volts AC. Manufacturer's suggested price is \$299.95.

CIRCLE 122 ON READER-SERVICE CARD

**Pro-Sound PS-74 Cable Tester.** For all you workbench hounds, console carriers, and electronic musicians, here's a simple

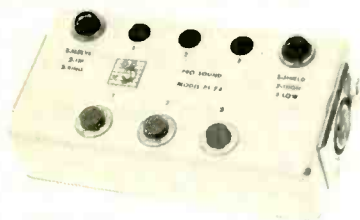

**Pro-Sound PS-74 Cable Tester**

way to find out what's wrong with that cable that only works on alternate Thursdays. The PS-74 cable tester has male and female 3-pin connectors, two female phone jacks, three pushbuttons, and three corresponding lights. First you plug in the cable. Then depress one button at a time. If the light above the depressed button goes on, all's well. If it doesn't, there's an open circuit. Two lights for one depressed button indicate a short circuit; one that lights but does not correspond to the button pressed in-

dicates cross-wiring. The PS-74 won't fix the cable for you, but its excellent diagnostic capabilities give you a good place to start looking for the problem. It's sturdy and simple, and runs on a single 9-volt battery. Manufacturer's suggested list price is \$46.

CIRCLE 123 ON READER-SERVICE CARD

**Tycobrahe Direct Box with Automatic Fader.**

The direct box idea had its origin years ago in the form of the matching transformer used to convert the high-impedance output signal of an electric guitar or bass to a low-impedance signal. This meant that the signal could be fed directly into the console, rather than via a microphone in front of the instrument's amplifier. With the guitar plugged into the transformer, however, there was no wire to go to its amplifier—thus the player couldn't hear himself. So the standard setup became a Y-connector, which let the musician plug into both amplifier and transformer. Then along came the "direct box," which took all of the features just mentioned, added a ground switch to reverse polarity when necessary (for hum reduction), and put the whole thing in a neat little box. It's a fine idea, and most studios have several. Sound people who work on stage have found them essential in eliminating feedback, since they can be substituted for microphones in many cases.

Tycobrahe's direct box offers a significant addition by incorporating a noise gate. Sometimes (often, in fact) the accumulation of hums, buzzes, and other eccentricities of electric instruments will render a signal useless for recording—not to mention annoying for stage use. The noise is most obvious between notes—say, while waiting out a four-bar rest. A noise gate closes the signal path from the instrument to the amplifier (or tape recorder) when little or no signal is passing through it. So, during that four-bar



**Tycobrahe Direct Box**

rest, the output from the instrument is reduced to a subaudible level. Some noise gates, however, tend to cut the signal off during its natural decay or make audible thumps when activated. Tycobrahe's noise-gate sensitivity control permits manual setting of the gate's

threshold, which should eliminate those thumps. A direct box with a controllable noise gate is an excellent notion by anyone's standards. Frequency response is rated at 5 Hz to 50 kHz, input impedance at 330,000 ohms, output at 100 ohms, noise at -90 dBm. The unit may be powered by a 9-volt battery or optional PS-9 power supply. List price is \$59.95.

CIRCLE 124 ON READER-SERVICE CARD

**Polyfusion Sound-A-Round.** A couple of months ago, avant-garde vocalist Joan La Barbara came into my studio with a technical problem. She was planning to give a concert in Berlin and wanted to create a whirlwind sound effect by moving the sound all around the room. Looking back to the days when quad was "happening," I recalled the joys of the joystick. Simply stated, a joystick is a potentiometer, analogous to the balance control on your stereo or panpot on your console, except that it covers 360 degrees instead of 180 (or less). I explained to Joan that she would have to have a joystick and accompanying controls made for her concert.

Shortly after our conversation, the literature on the Polyfusion Sound-A-Round arrived. It is said to do everything



**Polyfusion Sound-A-Round**

that a conventional quad joystick does, with a few electronic extras. One line-level signal at its input can be panned to any point around or within a circle. In addition, the unit has a built-in voltage-controlled oscillator so that in the AUTO mode the oscillator controls the movement of the sound. Speed of movement is governed by varying the oscillator, via a front-panel control or an optional foot pedal. DEPTH determines how large in diameter the circles of sound will be. Four LEDs indicate direction and speed of movement, and the former can be reversed by another front-panel switch.

Of course, all these functions can be controlled manually as well. So, if you need a whirlwind, here's just the thing for you. Ping-Pong, swirling, creating moods... your imagination is the only limitation. Sound-A-Round is powered by 115 volts AC; suggested list price is \$299.95.

FRED MILLER

CIRCLE 125 ON READER-SERVICE CARD

# Records

LEICESTER BAINES  
KEN EMERSON  
TODD EVERETT  
DON HECKMAN  
SAM SUTHERLAND  
ARIEL SWARTLEY  
JOHN S. WILSON

## Van Morrison Makes Another Good Album ... So?

**Van Morrison: A Period of Transition.** Van Morrison & Mac Rebennack, producers. Warner Bros. BS 2987, \$6.98. Tape: ●● M5 2987, ●● M8 2987, \$7.97.

There's a lot riding on this album. It's Van Morrison's first in two years, a comeback of sorts from a time of relative obscurity, rumors, and general uncertainty about the man's artistic, if not personal, future. The last couple of LPs before the hiatus were uneven in quality, giving rise to the suspicion among both musicians and fans that he might be through, in the same sense that a lot of people think Dylan is through.

Morrison is aware of all this as his al-

bum's title—"A Period of Transition"—proves. What a tentative, almost-embarrassed, overcompensatingly straight, baldly unpoetic title from one whose previous works' names rang in a way at once elemental and mythic: "Astral Weeks," "Moondance," "Tupelo Honey." The pressure to reaffirm his strengths with this LP must have been cruelly intense. It does, in fact, deliver many of the things he's good at and beloved for—believable and individual white blues, a rich singing voice whose rawness magically expresses tenderness as defined through pain, and instrumental and vocal backing that is unerringly tight and right.



Van Morrison—  
biding time  
to buy time

It seems churlish, then, to complain about an album this good that was made under the kind of circumstances we know produced it. But maybe that's exactly the problem. Like Dylan, Ochs, Lou Reed, the Randy Newman of "Good Old Boys," like seemingly all of our finest established rock songwriters, Van Morrison is afraid. One thing artists do when they fear their talents may be slipping is make safe albums. In my book, "New Morning" and "Planet Waves" were safe albums. "Northern Lights-Southern Cross" was a safe album. The last Who album was safe. I think "A Period of Transition" is better than any of those forgettable-to-abysmal efforts, but let's be straight about what it is and what it isn't. It is a solid record of Ray Charles-ish blues, waltzing funk, and warm ballads in a familiar mold of which Van Morrison is the undisputed master. In other words, it's a good album. But sometimes I think the thing I hate most in the world is good albums. They're frustrating because they don't allow you the conviction of healthy hate like pretentious, dishonest, or otherwise disastrous albums by major talents. But neither do they take you soaring to the heights their creators' masterpieces can. They exist in limbo, and end up imprisoning you and your relationship with the artist.

Perhaps all of this will seem less mean-spirited if I explain what this album is not. What it is not is closely related to certain reservations I've been harboring towards Morrison for some time. "A Period of Transition" is not what "Astral Weeks" (1968) was—an infinity-bound sheet of anguished yet lapidary poetry and yearning, which, combined with its flowing music, was so total an experience that it transformed you. You felt your humanity enhanced just by having been exposed to it. The source of its power was a brilliant mixture of opposites. Morrison found images of eternal life in the sleep of death, perceptions of celestial purity in the grubbiest, sleaziest back streets, and a closeness to life's sources in conditions that were blindingly destructive yet subtly stated. This guy was feeling so much, and it was flowing through him and the delicate mechanism of his talents so naturally, that it was awesome for all concerned. His vocals on that record actually sounded *humbled* by their own power. Glints of that power had come through his previous output often, most notably in *T.B. Sheets*—a wrenching recitation of the repulsion and heartbreak felt by a person visiting a dying loved one in a tuberculosis ward. And yet previous to "Astral Weeks," we had mainly thought of Van Morrison as simply a great rocker and author of classics like *Gloria* and



*Brown Eyed Girl.*

"Moondance" was the very different successor to "Astral Weeks," and consolidated his reputation as a writer/performer of music that crossed all barriers. Even people who had grown out of or were uncomfortable with hard rock in the first place could take it seriously. Not to say the LP wasn't a classic, but it seldom broke through to the levels of emotion or poetry its predecessor achieved. In retrospect, "Moondance" may have been the beginning of his troubles. Most of the albums that followed were more or less imitations, though never as good; it seemed to me that in *Domino* (from "His Band & the Street Choir," 1971) Van Morrison effectively announced his retirement in much the same way Dylan did in *Watching the River Flow*. There ensued a series of I-love-my-wife-and-gee-we're-so-happy-laid-back-on-our-farm albums that were not all that different in spirit from those Dylan was making at the time. And as with Dylan, you had the distinct impression that it was a lie, certainly a copout.

There were intermittent attempts to recover the spirit of "Astral Weeks." One, "St. Dominic's Preview" (1972), had at least a couple of songs on it that could rank with his best work. But his poetry—with its images of the infinite in the elements, in stars and earth and sand and sea—was itself thinning out. By Side 2 of "Hard Nose the Highway" (1973), he had been reduced to prattling incessantly about falling leaves.

Whether dealing with his personal experiences and feelings or the world around him, the Van Morrison of recent years seemed to be losing his grasp on how to say what he wanted to say. In fact, he left the impression that he might not even *know* what he wanted to say any more. In short, and again like Dylan, an artist out of touch with his art and possibly himself.

I'm feeling a combination of euphoria and sadness, and maybe even a little shame: "A Period of Transition" has been coursing through my headphones as I've been writing this, and the music on it is all beautiful and gets more lovely with each hearing. One song in particular, *The Eternal Kansas City*, seems destined to enter the pantheon of Morrison masterpieces. But at the risk of seeming pompous or corny I would be dishonest if I didn't say that this album begs the question, and that the period of transition itself is just biding time to buy time. It may be evil selfishness to expect pinnacles like "Astral Weeks" to come more than once in any artist's lifetime. The only trouble is that once you've breathed the air up there, those steadily coursing mainstream waters just all seem to run downhill.

L.B.

**Miles Davis: Water Babies.** Teo Macero, producer. Columbia PC 34396, \$6.98. Tape: ●● PCT 34396, ●● PCA 34396, \$7.98.

Columbia is playing dumb about this release, but both the personnel and the style date it back to around 1967 or '68, one of Davis' most productive periods. The two groups represented here (Herbie Hancock, Tony Williams, Ron Carter, and Wayne Shorter on Side 1; Hancock, Williams, Carter, Shorter, Chick Corea, and Dave Holland on Side 2) surely have to be among the best of the many fine ensembles Davis has led over the last two to three decades.

Which leads us to the question of *why* Columbia has chosen to release a ten-year-old recording and without any particular explanation. The obvious answer is simply that they had it, so why not release it? In fact, they have a lot more. Teo Macero, Davis' longtime producer, once told me that he had hours of unreleased Davis material, most of it at least as good as what has been issued already, some of it much better. And, given the creative uncertainty that seems to have afflicted Davis' current work, it's not hard to understand Columbia's desire to run with already proven material.

The Davis, Hancock, et al. group was probably the premiere jazz group of the Sixties (with the possible exception of the Coltrane-Elvin Jones-Jimmy Garrison-McCoy Tyner bands). If it had a failing, it was Davis' reluctance to deal directly with the iconoclastic currents which were buffeting the jazz world in those years. Although he had players—Williams and Hancock, in particular—who were quite capable of playing *out* music, Davis managed to keep a tight, conservative rein on things.

To his credit, his efforts usually worked, even if the results were not always as topical as some of his critics might have liked them to be. The three Shorter pieces on Side 1, *Water Babies*, *Capricorn*, and *Sweet Pea*, are superb examples of the final maturation of post-bebop jazz. Beautifully played, sometimes brilliantly improvised, they are virtual textbook examples of state-of-the-art modern jazz. *Two Faced*, on Side 2, obviously was recorded later than Side 1 and begins to show either the pre- or post-influence of the kind of musical thinking typical of Davis' "In a Silent Way." *Dual Mr. Tilman Anthony* is an early attempt at jazz/rock, and one that generally fails because of Williams' surprisingly clumsy drumming and an overall rhythmic ambivalence about what the hell is going on.

In sum, this is a fine collection of Miles Davis music, even if it is a bit out of sync, chronologically. Still, in lieu of whatever Miles' next stage is going to be (no



Miles Davis

doubt it will be every bit as vital and life-affirming as all of his previous ones), this will serve nicely. In fact I, for one, will have no objection if Teo Macero and Columbia dip into their vaults for a few more unreleased gold nuggets from the Davis glory years.

D.H.

**Dixie Hummingbirds: Live.** Ira Tucker, producer. ABC/Peacock PL 59231. \$6.98. Tape: ●● PL 59231, ●● PL 859231, \$7.98.

Since their formation by James Davis in 1928, the Dixie Hummingbirds have continued to be among the best and most influential gospel groups. For the uninitiated, you can hear them backing Paul Simon on several of his records, including *Love Me like a Rock*. Their own records have sold well enough through the years, at least by gospel music standards, but never near the level merited by their fine music. (Do you have to be a Catholic to appreciate a Lassus motet?) Rhyth-



mically and especially vocally their close harmonies and fine lead singing, *inspire* in the broadest sense of the word.

It's surprising that Peacock, their label of many years, should take so long to present a program of the sextet at their finest—in live performance (at the Tabernacle Baptist Church in New Brunswick, New Jersey), before an enthusiastic audience. There are no surprises here as to personnel or content. James Walker, the "kid" of the group, has been with them since 1954, founder Davis continues to lead the group, and their instrumental backing continues to be the lone guitar of Howard Carroll. Rhythm trappings are minimal—generally they use a Rhythm Ace, although it sounds like they sprung for a drummer and bassist for the album. (No performance credits—including the group's names—are listed anywhere.) The selections, nearly an hour's worth, range from a self-introduction in *Who Are We* through *Swing Low, Sweet Chariot* to *Let's Go Out to the Programs*, a series of imitations of other successful gospel groups.

I'm crazy about this album, and I urge anybody with the slightest interest in this music to give it a try. One caveat: Though the harmony singing is some of the best you'll ever hear, the lead vocals by Walker and the amazing Ira Tucker sometimes get pretty funky. This is not a compromise aimed at a wide crossover. Rather, the Hummingbirds are simply singing church music, echoing a heritage that goes back hundreds of years. These fellows are not your usual slicked-down vocal group, and these days that's quite a recommendation.

T.E.

**Peter Gabriel.** Bob Ezrin, producer. *Atco SD 36-147, \$6.98. Tape: CS 36-147, TP 36-147, \$7.97.*

As lead singer for Genesis, Peter Gabriel wrote and sang elaborate melodramas ripe with allegorical schema and amplified by a vivid theatrical sense. As producer for Alice Cooper, Kiss, and enough other heavy metal bands to qualify for a degree in metallurgy, Bob Ezrin perfected a thundering style using cavernous echo and synapse-melting distortion to heat up the attack of often-limited players while submerging their flaws. When Gabriel left Genesis, that band re-emerged with its delicacy intact but much of its bombast pared away; thus, when Ezrin started production on Gabriel's solo debut, it was assumed the results would be epic in scale and rather heavy-handed in execution.

Dumb assumptions indeed. "Peter Gabriel" is an inspired pop debut that contradicts such expectations with a collection of concise performances verifying the artist's newly focused powers as a songwriter and Ezrin's unexpected



Peter Gabriel—"eschewing theatrics"?

subtlety as a translator. While there are flashes of the aural theater familiar from Genesis' early work, as well as the hard-rock attack synonymous with Ezrin's clientele, these songs incorporate a far broader range of styles.

Gabriel's stance remains a canny balancing act between a romantic, even visionary innocence and existential ennui. Nowhere is that tension more successfully handled than on *Solsbury Hill*, the most arresting song here. Against a bright backdrop of acoustic guitars, Ezrin slowly adds recorders, then Gabriel's voice, and then the steady pulse of a kick drum. This builds together in a bitter-sweet dance describing the singer's hill-top vision, the smothering social matrix that binds him, and the triumphant rescue. Gabriel's often oblique narrative may haze over details, but the real goal here is atmosphere, and his urgent vocal achieves that restlessness with striking effect.

A darker, more pessimistic vantage point emerges on the moody *Humdrum*, anticipating the album's last two songs, *Down the Dolce Vita* and *Here Comes the Flood*. The former is an improbable mix of Richard Strauss and Barry White, juxtaposing a florid symphonic arrangement (performed by the London Symphony) with a chunky rhythm guitar; the latter evokes the brooding gothic cynicism of Procol Harum, its hopeless chorus capped by molten guitar lines from Dick Wagner that tap the same raw energy Robin Trower provided for Procol Harum. Had this dire spirit predominated, the results might have been numbing.

Gabriel's own sense of humor saves such exercises in tragedy from weighing down his debut, though. The tart mix of music hall/barbershop sentimentality and a tough lyric sense make *Excuse Me* one of the album's sleepers, while on

*Modern Life*, he takes full advantage of a sturdy heavy-metal riff to launch a passionate vocal performance, which is in turn undercut by the wan ennui of the lyric ("Modern love can be a strain...").

Throughout, Ezrin's production sound is stunning, moving from the Wagnerian scale of... *Dolce Vita* and... *Flood* to the warmer, more intimate presence on other songs. Subsequent listens, especially on headphones, reveal a wealth of careful instrumental details, hardly surprising in view of the session crew. Instead of a hard-rock rhythm section, Ezrin has used bassist Tony Levin and drummer Allan Schwartzberg—who have played everything from r&b to folk—for his bottom. Wagner and Steve Hunter, two heavy metal specialists, are featured guitarists, but both turn in versatile performances. Robert Fripp's guitar and a battery of keyboards and percussionists complete the band, and Gabriel and Ezrin use that varied lineup effectively, ranging from full-throttle rock arrangements to restrained solo work.

Peter Gabriel has clearly chosen to eschew theatrics in favor of music, a decision that has provided Bob Ezrin with a chance to display his intelligence and taste as a producer. The partnership is a promising one, based on their first collaboration.

s.s.

**Garland Jeffreys: Ghost Writer.** David Spinozza & Garland Jeffreys, producers. *A&M SP 4629, \$6.98. Tape: CS 4629, 8T 4629, \$7.98.*

Pop music may be the only art form flexible and syncretic enough to allow Garland Jeffreys to make some sort of aesthetic sense out of his bewildering background. His West Indian, Puerto Rican, white, and Brooklyn-born-American-black blood pulses through this, his first album in four years, flowing from spare reggae to r&b to straight-ahead rock & roll to a Spanish serenade. Jeffreys and his superb band of New York's finest studio musicians have created an aural *Family of Man*.

"Ghost Writer" is not, however, simply a virtuoso exercise in eclecticism. Jeffreys probes each musical genre and his and our relationship to it. Whereas the



Garland Jeffreys



# You've got to be serious.

If you're interested in Phase Linear, you've got to be serious. Serious about music. Serious about enjoying the most realistic sound possible from a home stereo system. Serious about acquiring quality state-of-the-art components built to deliver a lifetime of top performance.

The three components featured here represent the very finest technical achievements of the Phase Linear Corporation

## The Phase Linear

**5000 FM Tuner:** An advanced tuner with a Dynamic Range Expander that restores FM broadcast signals to rival your records and tapes.

**The Phase Linear 4000 Preamplifier:** An incredibly sophisticated preamp and control center that actually compensates for limitations inherent in the recording and playback process through noise reduction and dynamic range expansion.

**The Phase Linear 700B Power Amplifier:** The most powerful, most dependable stereo amplifier you can buy, at any price.

Phase Linear manufactures a complete line of amplifiers and preamplifiers, a noise reduction unit, and a speaker system. Ask your dealer for an audition. If you're serious.

*Phase Linear*  
The Powerful Difference

Manufactured in the USA Distributed in Canada by H. Roy Gray, LTD.



political protest aspect of reggae is usually remote to American fans who know little (and could care less) about conditions in Jamaica, he brings it to bear on busing, right here in the States. And his exploration of romance and repression South of the Border obliquely indicts the idle and often racist fantasies of so many white American performers.

As Jeffreys ponders his motley makeup and even shifts from one ethnic accent to another, his tough vocals never lose their distinct identity. He and his band know exactly what they're doing ("Ghost Writer" took only three weeks to record) and do it with polished authority. Co-producer David Spinozza joins forces with the other guitarists to blaze sinuous trails through Jeffreys' compositions, and the album's ambitious conceptual reach never exceeds its firm musical grasp. In all, this is the most insightful and accomplished album to be released by a singer-songwriter since Joni Mitchell's "Hejira." **K.E.**

**Nils Lofgren: I Came to Dance.** Nils Lofgren & Andy Newmark, producers. *A&M SP 4628, \$6.98. Tape: ●● CS 4628, ●● ST 4628, \$7.98.*



Lofgren—striking poses out of habit

"I'll play guitar all night and day, just don't ask me to think." So swears Lofgren on the LP's opener. But the problem with "I Came to Dance" is that his usually muscular guitar playing is subdued, even anemic, and that maybe he's begun to think but not nearly enough.

A gymnast in his youth, Lofgren has been poised on the brink of stardom for several years now, and previously his music achieved a balance between tender teenage romanticism and the make-believe snarl of a would-be tough. But age (Lofgren is now twenty-five) and, presumably, his own frustration at not yet attaining stellar success have under-

cut these poses, and he strikes them here more out of habit than conviction. His version of Keith Richard's *Happy* misses the fervor of *Keith Don't Go*, his earlier tribute to the Rolling Stones's guitarist. On other cuts Lofgren seems to grope for new personae; significantly, he sometimes sings from other people's points of view—that of his father or a touring musician's neglected wife. And while these are generally the most interesting tracks, it's clear that he hasn't yet broken through to a new identity. Too much of this album is empty attitudinizing.

Busy arrangements fail to conceal—indeed, they emphasize—Lofgren's uncertainty about his role. Horns and strings flank his guitar, which often sounds as if it were off in a corner filling and embellishing. His once-pungent singing is drowned in a soup of backup vocals, and, worst of all, most of the songs lack impetus and direction. Lofgren has so few points, musical or lyrical, to drive home that many tracks never get past their cluttered production. On *Goin' South*, an insipid female chorus warbles "Follow your heart." Lofgren doesn't seem to know where his is leading. **K.E.**

**Charlie Mariano: Helen 12 Trees.** Joachim E. Verendt, producer. *BASF G 22941, \$6.98.*

It is a mystery to me why Charlie Mariano continues to be a virtually forgotten jazz man. His records surprise, delight, and startle, and his playing has grown and matured in the twenty-five years or so that he has been a prominent professional musician.

Despite its title, his latest effort has nothing whatsoever to do with silent movies. (Twelve trees refers to the twelve people in the studio for the recording.) It is a remarkable collection of music by a group of musicians whose diverse origins remind us how international a music jazz has become. In addition to Mariano (who plays soprano and alto saxophones, flute, and *nagaswaram*—an Indian double-reed, oboe-like instrument), the group includes two Poles in keyboardist Jan Hammer and violinist Zbigniew Seifert, two Englishmen in drummer John Marshall and bassist Jack Bruce, and Japanese percussionist Nippy Noya.

Mariano clearly is the catalyst. No matter what instrument he plays, it is his energy and drive that makes a mixed bag of seven different compositions come together as a recording. Particularly interesting are two duets, *Sleep My Love* and *Charlotte*. In the first, Mariano plays flute with Seifert's violin. The interaction—it is not clear how much is improvisational, how much composed—combines the life and vitality of an impromptu jam session with the organic

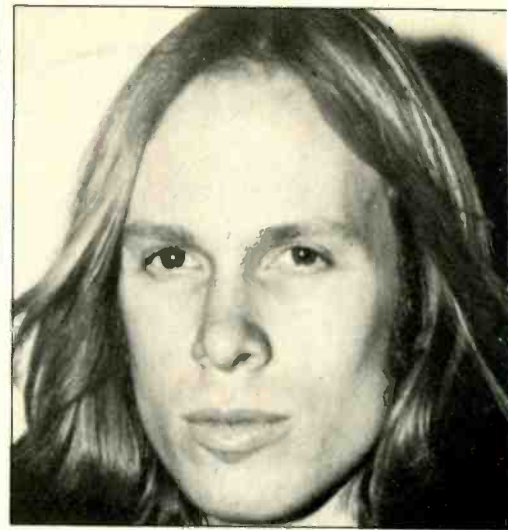

Elliott Murphy—could he write a book?

movement of a Bartók duo. *Charlotte*, with Mariano on soprano sax and Hammer on acoustic piano, bristles with a different, but just as exciting, energy.

Mariano's *nagaswaram* playing on *Parvati's Dance* also deserves mention. The instrument is fiendishly difficult to work with, and it simply doesn't lend itself to jazz articulation and phrasing. But none of these problems either deter or hinder Mariano, who succeeds in creating a rare and truthful synthesis of the elements of jazz and Karnatic music. Other pieces are struck from a contemporary mold, bubbling over with frisky percussion sounds, criss-crossing rhythms, and the occasional swoop of a synthesizer. Hammer's *Thorn of a White Rose* is a particularly fine example, but the general creative level in virtually every part of the recording is so high that it's difficult to praise one selection above another.

I'd call this a necessary recording for anyone who wants to get a fix on contemporary jazz. Mariano deserves the attention, sure, but the real point is that his music should be widely heard. "Helen 12 Trees" is a fine place to start. **D.H.**

**Elliott Murphy: Just a Story from America.** Robin Geoffrey Cable, producer. *Columbia PC 34653, \$6.98. Tape: ●● PCT 34653, ●● PCA 34653, \$7.98.*

The romanticism that Elliott Murphy's staunch defenders applaud sounds to me like mere nostalgia, but Murphy is still a fascinating—though frustrating—figure. He combines an idiosyncratic sensibility with a musical imagination that is banal in the extreme. His songs usually sound like someone else's (Dylan, Lou Reed, Springsteen) even as their lyrics describe a world of upper-middle-class angst that is, within the context of pop music, uniquely Murphy's.

"He could write a book" is the theme

Continued on page 127



# We made the first Ortofon cartridge for us.

As far back as 1945, Ortofon was making the cutterheads used throughout the world to cut the grooves in master phonograph records. But the phono playback cartridges then available could not put our cutterheads to the test for sensitivity and capacity.

So we made our first phono cartridge. For us.



The Ortofon cutterhead.

Since then our cutterheads have moved ahead—with a quality we couldn't even imagine in 1945. So have our phono cartridges.

The new MC20 moving coil phono cartridge is the best we've ever made. We believe it is the finest available for professional or home use.

The MC20 has the lowest stylus tip mass ever attained on a phono cartridge. A flawless, fine line diamond stylus is fixed directly (without the usual sleeve) to a stepped, low mass cantilever. Beryllium filling enables the cantilever to attain rigidity despite its minute dimensions. The moving coils are wound with wire one-fifth the thickness of a human hair.

The moving coil principle, with its low inertial mass, wider frequency response, low distortion as well as low tracking force, has clearly established its sonic superiority over any other phono cartridge system. Our new pre-preamplifier, the MCA-76, is also available to process the signal of the MC20 or any other moving coil cartridge. The MCA-76 features low-noise circuitry, a subsonic filter and a by-pass switch which accommodates all magnetic cartridges.

We'll be pleased to forward data on the entire Ortofon line. We suggest that you write to us directly. Ortofon, Dept. B, 122 Dupont Street, Plainview, New York 11803.

ortofon



## Brazil Is Alive & Well & Sneaking Into Your Record Collection

**B**razilian popular music, a superlative Afro-Indo-Portuguese amalgam of shifting, glancing melodies and joyously sophisticated percussion, has been an intermittent part of the U.S. music scene's exotic fringe since the mid-nineteenth century. Ghosts of its rhythms, left over from the '40s-samba and '60s-bossa nova eras, still haunt our stuffer dances and classier supermarkets. Unfortunately, the schmucks who think you and I can't digest anything solid have always foisted a kind of musical wheateana on us in-between times, enfeebling its greatest glory—the contrast between liquid melodies and strong but lilting percussion.

Now, once again, the Good News: signs that it may be third time around for Rio, U.S.A. A Brazilian fringe has been sneaking back into jazz ever since Miles Davis hired percussionist Airto for his "Bitches Brew" album in 1968. Brazilian percussionists have been popping up all over—Airto with both Davis and Chick Corea, Guilherme Franco with Keith Jarrett and McCoy Tyner, Portinho with Gato Barbieri, and Paulinho da Costa with Dizzy Gillespie.

Within the past few months, those early birds have been followed by a sudden summer's worth of swallows. That bellwether of Latin hyphenations, San-



Top and right:  
Milton Nascimento and Airto Moreira—  
sharing an avant-garde  
popularism; below: Ralph MacDonald

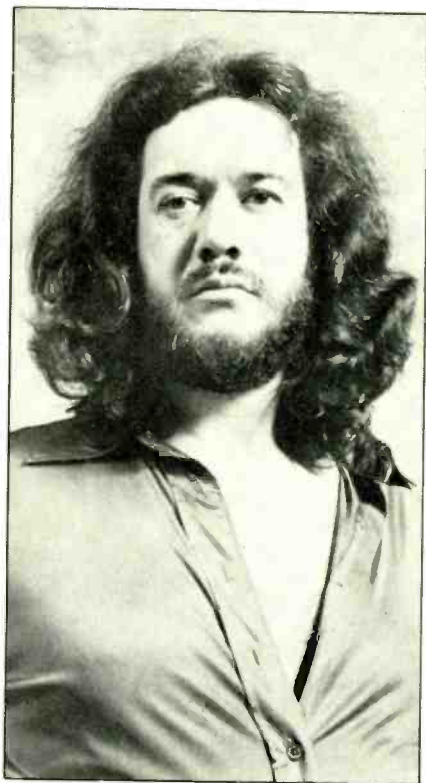
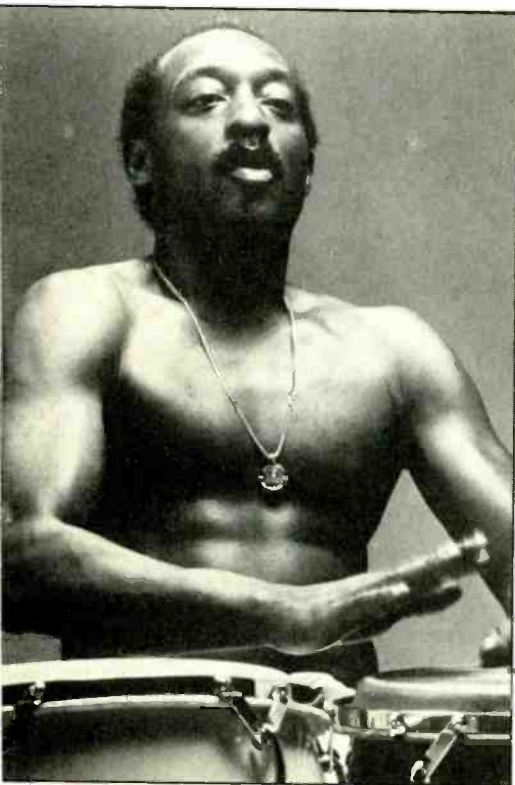

tana, included two strongly Brazilian tracks on his latest album, "Festival." An authentically new sound provided by the *cuica*—an excitable instrument named for its rhythmic squeaky-squeak—has recently enlivened such disco-oriented numbers as Ralph MacDonald's *The Only Time You Say You Love Me*, and Bill Summers' *Brazilian Skies*. Michael Franks's new "Sleeping Gypsy" includes a track in homage to Antonio Carlos Jobim, and a couple recorded in Brazil with some native musicians, though they all seem to be following a trend rather than doing anything interesting.

Dizzy Gillespie's latest album, "Dizzy's Party," shows how well fringe-Brazilianisms can work when the musician knows what he's doing (Gillespie has been exploring jazz-Latin fusions for almost forty years). Both its title track and *Harlem Samba* use part-funk, part-samba rhythms whose Brazilian elements remain strong and avoid the cocktail/jazz garnish to which Latin rhythms are often reduced.

At the heart of all this activity is a crop of recordings by Brazilians. Jorge Ben is one of that country's leading singers, and a major composer from the bossa-nova era (he wrote *Mas Que Nada*). Percussionist Airto, singer Milton Nascimento, and keyboardist Hermeto Pascoal share an avant-garde popularism and a tendency to appear with each other (e.g. "Slaves Mass"). None plays "Brazilian" music in any restrictively ethnic sense—though their strong combination of eclecticism and roots is typical of Brazil's highly experimental outlook. Their al-



# Introducing the Avid 101.

## A rational solution to the problems of 2-way speaker design.

Designing a reasonably priced 2-way speaker system has always had its problems. One of the most perplexing of which has been engineering a speaker system with both well-dispersed midrange and really extended bass.

### The bass vs. midrange dilemma.

In one respect, a 6 or 8 inch woofer is preferable for a 2-way speaker system because its small diameter

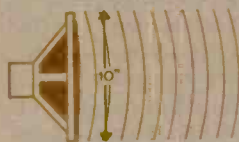

Conventional 10" woofer is directional in midrange.

affords better dispersion in the critical midrange area

up to the crossover point where the high frequency driver takes over.



8" woofer affords superior midrange dispersion.

But, a small diameter woofer just isn't capable of handling the power

required for really extended bass (say to 30 Hz) in traditional designs without the use of costly electronic equalizers.

A real dilemma. The best solution to which we feel lies in a unique new 2-way speaker system—the Avid Model 101.

### A rational solution.

The Avid 101 overcomes the traditional bass versus midrange

dilemma through an unusual combination of a large vented enclosure and a specially engineered 8 inch woofer.

Unlike conventional vented designs, the Avid 101's vented enclosure is used to *extend the bass response* of the system, rather than to increase the efficiency. This unique design (essentially a 4th order Chebychev filter alignment) achieves really extended bass—*down 3 dB at 30 Hz*—while the use of an 8 inch woofer insures a smooth, well dispersed midrange up to its 2500 Hz crossover point.

Of course, no ordinary 8" woofer could do the job. It took us over a year to perfect the woofer design and it's quite unique. For example, it utilizes an unusually large magnetic structure and a specially developed rubber-edged

core of almost twice the weight and stiffness typically used.

But you have to actually listen to the Model 101 to really appreciate just how well it solves the traditional problems of the 2-way speaker.

### A high end to match.

Things just wouldn't be complete if we didn't give the 101 a high-end performance that was every bit as good.

Which is why the 101 has three tweeters instead of just one.

A primary, front-facing tweeter that comes in at 2500 Hz and two side-firing units that kick in around 3500 Hz.

The result is full 180° dispersion in the high end all the way up to 15 kHz for a sense of imagery and openness which, until now, was unavailable in all but the highest priced speakers.

### The right choice for most listeners.

We believe that the Avid Model 101 truly represents an advancement in two-way loudspeaker design and is the completely right choice for the vast majority of serious listeners.

Find out for yourself at your nearest Avid dealer. Be an Avid listener.

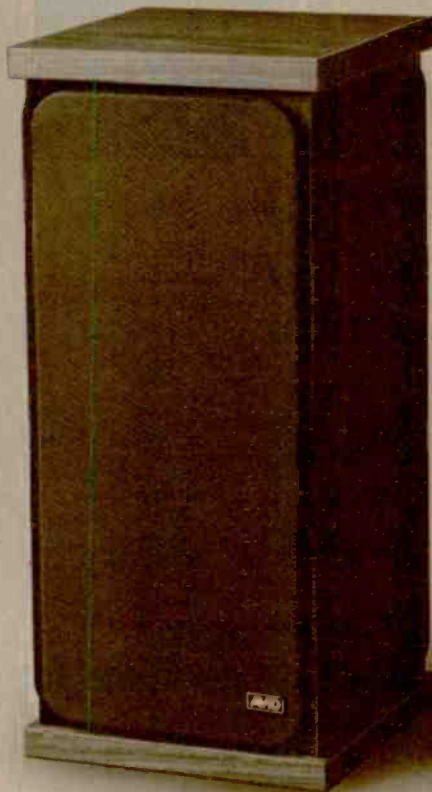
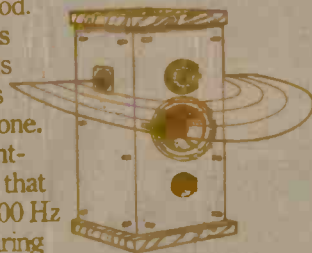

**AVID**  
CORPORATION

10 Trump Lane, East Prov., R.I. 02914

bums all make use of the popular street-sound, as well as the African and Portuguese ends of the ethnic spectrum; but they also contain strong rock and jazz elements, some English lyrics, a liking for experimentation, and occasional lapses into tiresome artiness.

Pascoal is by far the most experimental of them all. Though it has moments of avant-gardist silliness, "Slaves Mass" is creatively exciting in its mix of tape sounds (from human heartbeats to speeded-up chatter) with expressionism, and Pascoal's own excellent keyboard

work. Nascimento, Airtó, and Ben all blend rock and Brazilian rhythms and solos, with a good deal of success, besides letting their hair down on several traditional street-popular numbers. Airtó also lets his eccentric sense of humor loose on *Candango*, a zany vo-de-odo number with guitar out of the blues end of r&b. Ben is a master of casually beguiling Brazilian singing style, and his *O Namorado da Viúva* ("The Widow's Boyfriend") is a combination of sly lead singing, a gorgeous Rio carnival-chorus, kicking, shuffling rhythm, and—of all im-

probable but successful things—a steel band. It deserves to be an instant classic.

All three also prove that Brazilian melodies with English lyrics sound quite as mawkish as grand opera in English, and for the same reason: Music and language are linked, and English just doesn't work, sound or stress, with melodies other than its own.

Airtó, Ben, and Nascimento's fusions are mostly with rock—though the latter's "Milton" has fine solos from trombonist Raul de Souza, saxist Wayne Shorter, and Herbie Hancock on (acoustic) piano. Paulinho da Costa's "Agora" is quite another kettle of drums, heavy into Latin jazz, Brazilian style, with interweaving brass riffs like rolling tides, good brass and sax solos, and—in *Belisco*—an unusually effective jazz/Latin/disco feel. Like Airtó, da Costa gives the full Afro-Brazilian percussion sound its head on several tracks, notably a long reminiscence of Rio's samba schools, *Ritmo Number One* ("Rhythm Number One").

One reason the U.S. Brazilian crazes in the '40s and '60s faded so fast was the absence of a base of authenticity to counteract wheatenism, such as the Latin communities provide now in salsa. The presence in our midst of a nest of really influential Brazilians may provide that authenticity for the third return of the Rio Thing. Meanwhile, enjoy! J.S.R.



## Next time you plan a trip to Europe, make sure you visit the unique country.

Where can you find: Europe's largest waterfalls?  
Europe's blondest blondes?  
Europe's highest geysers?  
Europe's greatest glaciers?

And where can you find moonlike craters where the astronauts trained? More volcanos than anywhere else on earth? Historic landmarks of the world's oldest continuous parliament? Celebrations marking Europe's youngest republic?

The answer to all of these questions is—ICELAND. Next time you plan a trip to Europe, make sure you visit Iceland.

The only thing it may cost you is time well spent. Because you'll save enough money on Icelandic's lowest jet fares to Luxembourg to pay for your stopover in Iceland. Or, you can hop over from New York or Chicago for longer tours. See an erupting volcano. Take a cross-country pony trek.

Next time you plan a trip to Europe, ask your travel agent about Icelandic Airlines. Or phone Icelandic Airlines, for folders about Iceland and lowest jet fares to Europe. In New York State, phone (212) 757-8585. Elsewhere in U.S., phone (800) 555-1212 for local toll free number.

CIRCLE 18 ON READER-SERVICE CARD

**Airtó: Promises of the Sun.** Airtó Moreira & Flora Purim, producers. *Arista AL 4116*, \$6.98. ● *AL 4116-H*, \$7.95.

**Jorge Ben: Tropical.** Robin Jeffrey Cable, producer. *Island SLPS 9390*, \$6.98. *Tape: ●● ZC1 9390, ● Y81 9390*, \$7.98.

**Paulinho da Costa: Agora.** Claudio Slon, producer. *Pablo 2310 785*, \$7.98. *Tape: ●● K10 785, ● S10 785*, \$7.98.

**The Dizzy Gillespie 6: Dizzy's Party.** Norman Granz, producer. *Pablo 2310 784*, \$7.98. *Tape: ●● K10 784, ● S10 784*, \$7.98.

**Ralph MacDonald: Sound of a Drum.** Ralph MacDonald and William Salter, producers. *Marlin 2202*, \$6.98. *Tape: ●● and ● Marlin 2202*, \$6.98.

**Milton Nascimento: Milton.** Ron Fraboni, producer. *A&M SP 4611*, \$6.98. *Tape: ●● CS 4611, ● 8T 4611*, \$7.98.

**Hermeto Pascoal: Slaves Mass.** Airtó Moreira & Flora Purim, producers. *Warner Bros. BS 2980*, \$6.98. *Tape: ●● M5 2980, ● M8 2980*, \$7.97.

**Bill Summers: Feel the Heat.** Skip Scarborough, producer. *Prestige P 10102*, \$6.98. *Tape: ●● 5 10102, ● 8 10102*, \$7.98.



Continued from page 122

of this album's ad campaign, and that's his biggest problem: He seldom makes his literary ideas musically compelling. The most striking cut on this, his fourth LP, is a lament for the Princess Anastasia, but it never quite transcends the kitsch of its boy soprano backup choir. And the rockers cry out for a crack rhythm section and a lead guitarist whose playing is less perfunctory than Murphy's.

The feeling in his music is further enervated by an acute self-consciousness he criticizes ("You think too hard/You feel too little") but cannot overcome, and by the second-hand nature of some of his ideas. A trite allusion to *Gone with the Wind* reduces an initially convincing love song like *Darling (And She Called Me)* to a well-worded cliché. Murphy can be moving when his images seem generated by his own experience, as on *Summer House* and *Let Go*, but most of this album is spiritless. K.E.

**Flora Purim: Nothing Will Be as It Was . . . Tomorrow.** Leon "Ndugu" Chanceler, producer. Warner Bros. BS 2985, \$6.98. Tape: ●● M5 2985, ● M8 2985, \$7.97.

Flora Purim's rise to prominence as a "jazz singer" (she has won most of the major polls lately) tells us more about the decline of the style than it does about her qualities as a performer. Listening to this newest release, one is hard put to understand just why she is called a "jazz singer" at all.

That she is a gifted performer is beyond question. Of all the Latin American singers who have arrived on these shores in the last decade and a half, she is certainly the best—light years beyond the ethereal fumbling of her predecessor, Astrud Gilberto. But like Ms. Gilberto, Antonio Carlos Jobim, João Gilberto, etc., Ms. Purim confronts American music—and, specifically, American jazz-



Flora Purim—too many rhinestones

based music—with a couple of distinct and interrelated handicaps. First, the mechanics of Brazilian style involve dips, swoops, and misplaced accents that either sound out of tune or erratic when applied to the rhythms and articulations of American jazz. And second, heavily accented English is both a distraction and—when it messes up the logical accents in a sung phrase—an irritation. (It's no accident that English rock singers generally try to use something close to a Southern accent when they perform.)

One track here, *Corre Niña*, is so superior to the others that it might as well have been made by a different performer. And that's because it is the only song Ms. Purim sings in Spanish and the only one with a Latin backup group. Ironically, it is also the only track which can claim any of the intensity, the fire, and the bright improvisational spirit of jazz. The singer's problem lies in the comparison to the erratic language, awkward phrasing, and the too-slick studio production sound of the other tracks. They make *Corre Niña* gleam like a diamond in a pool of rhinestones.

And that, in turn, tells us something about Ms. Purim's real skills. Performing in her own idiom she confirms the fact that jazz is a genuinely international music, and one which is receptive to creative variation from other cultural influences. In short, when Flora Purim sings a form of jazz which is a natural extension of her abilities and her experience, she is a fine performer. It's when she tries to deal with a style that is beyond her view that she has problems. D.H.

**Bonnie Raitt: Sweet Forgiveness.** Paul A. Rothchild, producer. Warner Bros. BS 2990, \$6.98. Tape: ●● M5 2990, ● M8 2990, \$7.97.

Over the course of previous albums and performances, Bonnie Raitt has politely warned us not to expect any sudden, bold pop breakthroughs. Her early work as a blues and folk stylist established the central qualities of her singing and song sense that have remained fairly constant, despite shifts in production and arranging. Her sixth album respects that constancy while offering some intriguing new commercial wrinkles. There are slashing hard rock rhythm guitars (on *Gamblin' Man*) and atmospheric, cyclical string arrangements (on Jackson Browne's *Opening Farewell*) that may tempt her boosters to make a concerted chart assault, but the real strengths that surface after repeated plays are already familiar to Raitt's admirers.

Actually, "Sweet Forgiveness" represents a slight return to her earliest records, which emphasized a sometimes ragged but always appealing spontaneity

Continued on page 132

# Lentek

## From England With Love.

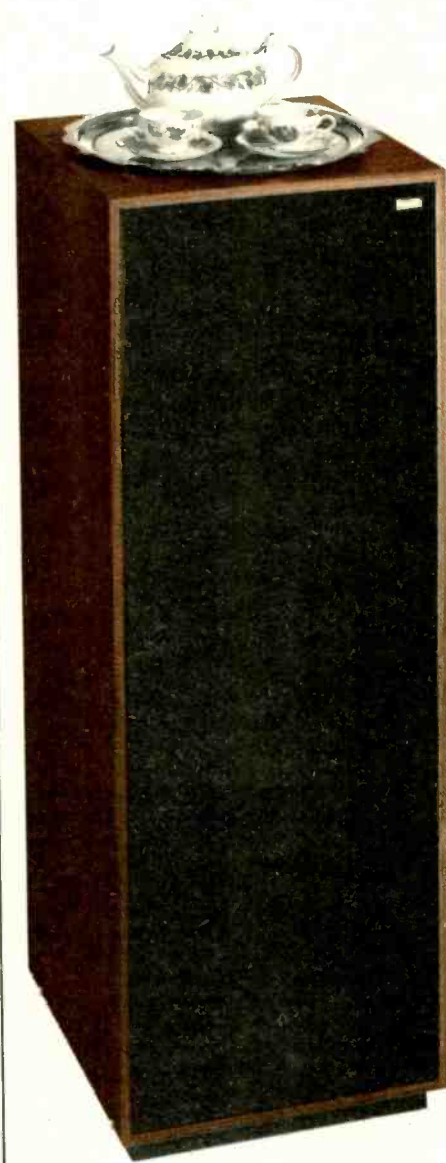

The Lentek Speaker System—elegant in appearance, impeccable in sound. The Lentek Monitor is a four-way system with a nine-foot transmission-line for extremely tight and flat bass response.

Lentek—so well reviewed by the cryptic journal *Gramophone* that we were accused of bribery!—from England, with love.



At American Audioport Dealers.  
1407 N. PROVIDENCE RD.  
COLUMBIA, MO 65201

## Carole Bayer Sager— So Much Is So Right

First steps are awkward and uneven; debut albums are usually the same. But Carole Bayer Sager may have been born a long-distance runner. Of course, she's not a fledgling—despite the husky, ugly-duckling voice. She's been writing lyrics for years and for almost everyone: Bette Midler, Johnny Mathis, Leo Sayer (*When I Need You*), Melissa Manchester (*Midnight Blue*). And the composers she's joined forces with on her first album—Manchester, Hamlisch, and more—are pros. Still, "Carole Bayer Sager" has the kind of musical identity that

eludes even more experienced artists.

The writing is fluent and often playful in a manner reminiscent of Broadway's Golden Age. She weaves delicate puns through outright sentiment and deftly skims a metaphor across an entire verse:

It's hard to make friends/  
When they all become  
Scratches in my phonebook/  
So many lines are disconnected.  
All my lines ring/  
But some of them ring truer.  
Friends can be found/  
Through a song when I sing.\*\*



But Sager's words are not her only strength as a lyricist. More important is the way in which they fall together to shape the music. The ten cuts are the work of six different composers, yet all but one (a disco fiasco entitled *Don't Wish Too Hard*) sound like the product of a single songwriter. Her rhythms of conversation and internal rhymes lead melodies into characteristic patterns. Simple short-lined verses are set off by artful embellishments. A phrase serves as a turnaround; the final line of a stanza is doubled in length.

In spite of the elegance of her material, the lady is no cool, forbidding debutante. Indeed, her voice is the perfect foil for her lyrics: rough-edged where they are smooth and formal, vulnerable where they are sophisticated. Like Carole King's, Sager's half-whispers and brave attempts at high notes call attention to the feelings kept so tightly under control in the songs themselves. Unfortunately, her quavers are sometimes smothered in strings and sleek male backups, obscuring that all-important dramatic tension between singer and song. Indeed, with so much so right, the brazen overproduction that mars "Carole Bayer Sager" seems criminal. No one over the age of five needs the choruses of hearty laughter (shades of *I Am the Walrus*) to appreciate the humor of *You're Moving out Today*. And the screaming guitar solo that erupts in the midst of the melancholy *Sweet Alibis* has the artistic impact of an alarm clock. The album's real flaw is its failure to rely on Carole Sager's extraordinary ability to sell herself. Nevertheless, it's going to take more than clumsy arrangements to trip up a talent as sure as this one. A.S.

**Carole Bayer Sager.** Brooks Arthur, producer. Elektra 7E 1100, \$6.98. Tape: ●● TC5 1100, ●● ET8 1100, \$7.97.

\**Shy as a Violet*. © 1974 by The New York Times Music Corporation and Irving Music, Inc., and Woolnough Music.

Used by permission



# The new Bose 901 Series III. Life-like, spacious sound unmatched by any other speaker.

The original Direct/Reflecting® Bose 901® has been described by music critics as "the only speaker to pour forth in true concert hall fashion" and "the speaker system to own, regardless of price, if one wants the ultimate in listening pleasure."\*

Now, in the new 901 Series III, Bose has introduced a speaker that clearly surpasses, in all important performance characteristics, the high standards set by its legendary predecessor.

## Spaciousness and Realism

The spaciousness and presence so characteristic of the original 901 are even more extraordinary in the 901 III: sound seems to come, not from the speakers, but from a space in

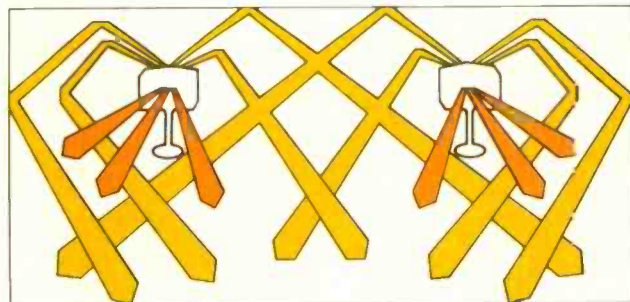

To achieve its extraordinary spatial properties, the Direct/Reflecting 901 Series III reflects most sound off back and side walls of the listening room, re-creating the balance of reflected and direct sound heard at a live performance.

front of you that actually seems deeper and wider than the room. Each instrument is easily localized, and the stereo effect is dramatically life-like almost anywhere in the room. Equally startling are the realism and accuracy with which the 901 III reproduces the unique details, textures, and sonic impact of each instrument.

The unique Injection-molded Acoustic Matrix™ enclosure forms a semi-isolated air cell behind each driver, along with three reactive air columns. The result is dramatically reduced cone motion at low frequencies, yielding clean, undistorted deep bass, even at very high volume.

## Efficiency and Power

At the same time, the 901 Series III is so efficient it requires less than 1/3 as much power as the original 901. It approaches the impact of the live performance with an amplifier with as little as 15 watts of power per channel. In fact, we suggest that anything over 70 watts per channel is simply unnecessary.

## Concepts and Technology

The spectacular performance of the 901 Series III results from combining proven concepts with new technology.



Like the original 901, it utilizes a balance of reflected and direct sound, active equalization, and nine matched, full-range drivers. Beyond this, it incorporates major technological innovations, including the unique Acoustic Matrix™ enclosure and a new ultra-high-efficiency driver.



A new high-performance driver with injection-molded frame and all-aluminum, helically wound voice coil is the key to the efficiency of the 901 Series III.

No advertisement can describe fully the 901 Series III and the technology behind it. So we've put together a comprehensive literature package that includes

a detailed 16-page color brochure, a 20-page owner's manual, and a copy of Dr. Amar Bose's paper on "Sound Recording and Reproduction," reprinted from *Technology Review*. To receive this literature, send \$1.00 to Bose, Dept. HF6, The Mountain, Framingham, Mass. 01701.

Even better, visit a Bose dealer and ask him to play the 901 Series III in comparison to any other speaker—regardless of size or price. That should tell you everything you need to know.



The electronic active equalizer assures more accurate frequency balance and wider range than are possible with conventional speakers.

**BOSE**<sup>®</sup>  
Better sound through research

\*Copies available on request. Patents issued and pending. Cabinets are walnut veneer. Pedestals are optional at extra cost.

# R&B

BY JOHN STORM ROBERTS

**The Gap Band.** John Ryan, producer. *Tattoo BJJ 1-2168*, \$6.98. *Tape: ●● BJK 1-2168, ●● BJS 1-2168, \$7.98.*

If you don't know black congregational music, check out *God Is Watching You*—not a bad evocation of what Old Time Religion still has to offer any Sunday night in the storefronts. And *Little Bit of Love* is Bob Marley-Bobby Bland-derived, with a touch of country in the guitar. In other words, this is another good, use-all-the-roots group—young, hungry, and having fun. There's a swing, punch, and joie de vivre here to which half of the chart-bound heavies can't even come close.

**The Hues Corporation: I Caught Your Act.** Wally Holmes, producer. *Warner Bros. BS 3043*, \$6.98. *Tape: ●● M5 3043, ●● M8 3043, \$7.97.*

I'm glad I caught theirs. Zesty group singing with all sorts of pleasing touches in the arrangements, right-on lead vocals, good humor, and great vibes. The prevalent gospel/funk mixture, but not merely *As Before*. Above all, they sound as if they like what they're doing, and give it the gusto that separates the pros from the hacks.

**CURTIS MAYFIELD**  
*Never Say You Can't Survive*  
Includes: *Show Me Love/Sparkle*  
*Just Want To Be With You*



**Curtis Mayfield: Never Say You Can't Survive.** Curtis Mayfield, producer. *Curtom CU 5013*, \$6.98. *Tape: ●● M5U 5013, ●● M8U 5013, \$7.97.*

Aside from having a damned long-winded title writer, this man's a real craftsman. His skilled and tasteful arrangements make top-o'-the-chart

formulae just memorable enough to stand out. Pity he sings falsetto so remorselessly that the frame ends up better than the picture. Still, it's all immaculate, though it does lack a little something. Conviction, maybe.

**Slave.** Jeff Dixon, producer. *Cotillion SD 9914*, \$6.98. *Tape: ●● TC 9914, ●● TP 9914, \$7.97.*

The Black New Wave seems hot for eclecticism run riot, with all sorts of strange goings-on held together by a mean funk/pump rhythm section. *Slave* isn't as all-fired maniacal as *Parliament*, but builds its own sound with a similar blend of parody, punch, almost-standard r&b with a faintly sinister twist, and the bonus of lead guitar braced between Hendrix and Santana. But fellas, lay off *Frankenstein*, will you? It's getting to be like whitey's *Star-Trek* rock—tiresome.

**Ohio Layers: Angel.** Ohio Players, producers. *Mercury SRM 1-3701*, \$6.98. *Tape: ●● MCR 41-3701, ●● MC 8 1-3701, \$7.98.*

The Ohio Players man the crossroads of church soul, hard

funk, and the New Weirdry with cool craft. The result is occasionally overly laid back, but mostly both soft and strong. Not particularly "original," but individual in detail and effect.

**Teddy Pendergrass.** Various producers. *Philadelphia International PZ 34390*, \$6.98. *Tape: ●● PZT 34390, ●● PZA 34390, \$7.98.*

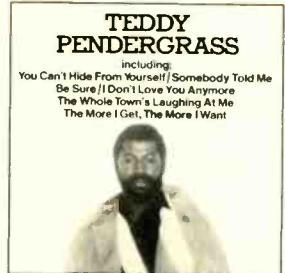

Some folks got merit, some folks got press coverage. Some folks got both, and here's one of them. Though this is standard gospel/soul in material and style, Pendergrass does it beautifully. It's the crucial little things that count—less the gravel-and-honey, dip-and-soar voice than the shifting, easy cross-rhythms of his phrasing. Even though he's weighted down with here-we-go-again arrangements and rentagroup backup vocals, eat your heart out, Harold Melvin!



**Minnie Riperton**  
*Stay in Love*

including:  
*Gettin' Ready For Your Love*  
*Young, Willing And Able/Could It Be I'm In Love*  
*Stick Together/Stay In Love*

**Minnie Riperton: Stay in Love.** Freddie Perren, producer. *Epic PE 34191*, \$6.98. *Tape: ●● PET 34191, ●● PEA 34191, \$7.98.*

Too many super-range singers keep taking off for the chandelier just to show they can. Luckily, this one spends most of her time at ground level, and the results are pretty nice.

Aretha she ain't, but Minnie she is—and that's a plus at a time when too many singers are just another set of pipes.

**Marlena Shaw: Sweet Beginnings.** Bert DeCoteaux, producer. *Columbia PC 34458*, \$6.98. *Tape: ●● PCT 34458, ●● PCA 34458, \$7.98.*

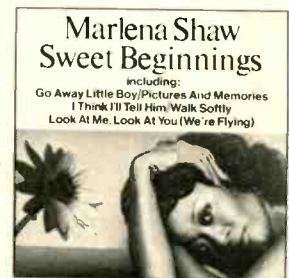

**Marlena Shaw**  
*Sweet Beginnings*

including:  
*Go Away Little Boy/Pictures And Memories*  
*I Think I'll Tell Him Walk Softly*  
*Look At Me, Look At You (We're Flying)*

Oh yes. Despite the hyped-up CBS arrangers' school appurtenances and a couple of crummy numbers, oh yes, indeed! Who ever thought up the album title

was full of it, since Ms. Shaw sang with Count Basie before cutting some good records with United Artists. She's got the jazz sophistication of phrasing and tone, plenty of r&b drive, and even a soupçon of the wit that black music has lost somewhere along the way.

**Joe Simon: Easy to Love.** John Richbourg & Joe Simon, producers. *Spring SP 1-6713*, \$6.98. *Tape: ●● CTSP 1-6713, ●● 8TSP 1-6713, \$7.98.*

The real thing comes in more than one flavor. Simon's heavy voice is out of a tradition that produced both the Kansas City shouters like Joe Turner and the southern r&b men like O.V. Wright. And the man sings like he knows what the lyrics mean. No world-shaker—the material is only fair, for one thing—but a square meal of an album in a world of Muzakburgers to go.



# Come and sit inside a song.



Your favorite tapes and records are loaded with intricacies of sound that most speakers don't let you in on. But the Koss HV/1LC's deliver your song the way the musicians played it. All the delicious touches of musical perfection unfold around you, putting you deep inside the tune. Taking you to a place where the honey-smooth power of the lead singer's voice is in delicate balance

with the instruments and back-up chorus. So that you're presented with every colorful spark of talent, from all angles—the way you'd hear it if you were standing in just the right spot on stage. And Koss HV/1LC's deliver all ten audible octaves, bringing you every ounce of everything from the low down throb of the bass, to the up-sweeping highs of the violin section.

And while the HV/1LC Stereophones bring you every note, their hear-thru design lets you catch every comment from people around you. Which in many cases may go like this: "let me try them."

So why not visit your audio specialist and slip into the exciting sound of Koss: the HV/1LC's with volume balance controls, or the HV/1's and HV/1a's. Or write us,

c/o Virginia Lamm for a free full color catalog of all our products. Get a pair of Koss High Velocity phones and come inside. The music's fine.

© Koss Corporation



Koss HV/1LC and HV/1 Stereophones

 **KOSS** stereophones  
from the people who invented Stereophones.



Continued from page 127

by featuring friends and band members rather than the expert session players that dominated her later work. Like its predecessor, "Home Plate," the new album was produced by veteran folk, blues, and pop producer Paul Rothchild, and continues that album's sleek pop finish and tough, spirited playing. But this time the emphasis is primarily on Bonnie's own excellent stage band, yielding a grittier, more spontaneous feel consistent with her live shows.

More obvious is a renewed emphasis on the blues vocal styles that were an early Raitt hallmark. She has always balanced her repertoire to include gentle ballads that display her delicate, even girlish upper register; recent albums have witnessed a straighter pop approach to such songs, but here the most lyrical, pop-styled material is given an even tougher punch. That occasional frailty in her top end is gone, replaced by a more flexible, resilient attack that is a woman's, not a girl's. When she uses that instrument to frame faster, blues-based



Bonnie Raitt

songs like *Three Time Loser* and Del Shannon's vintage '60s rocker, *Runaway*, she achieves a stunning mix of the survivor's toughness and the loser's pain, inviting comparison with r&b stylists like Ann Peebles and Aretha Franklin instead of the pop and rock singers Raitt is normally compared to.

The choice of material is familiar and underscores the premium that she and Rothchild place on the continuity of her work. In addition to songs from past Raitt contributors like Jackson Browne, Eric Kaz, Little Feat's Bill Payne, Paul Siebel, and Mark Jordan, there's a successful new interpretation of *Runaway* that is charged with wiry Memphis r&b guitar and a squealing harmonica solo that straddle rock and blues comfortably. That hard rock savvy, which also powers Kaz's *Gambler's Man*, is counter-

pointed by spare folk settings for Siebel's classic elegy, *Louise*, and Karla Bonoff's *Home*, either of which could have fit seamlessly into Bonnie's earliest records.

Summarizing Raitt's current stylistic mix are the album's more fully developed pop ballads, Jordan's excellent *Two Lives*, Payne's *Taking My Time*, *Opening Farewell*, and Daniel Moore's title song. On each, a lush romantic fullness is achieved with vocal harmonies and richly detailed arrangements, yet Raitt's own lithe singing and the slinky blues lines her guitarists favor are used to offset any bathos. *Two Lives* is perhaps the best example, capped by a swelling chorus that reveals a series of striking pop/gospel counter-melodies just beneath the moving lead vocal. Both here and on the title song, Raitt cuts loose on the fade, soaring into her upper register and roughing up the lyric to insert propulsive r&b syncopations, yet sustaining a warm timbre that is totally lyrical. S.S.

**Jim Robinson: Economy Hall Breakdown.** Sonny Faggart, producer. *Pearl 5*, \$6.98.

Even though this disc was recorded in Preservation Hall in New Orleans, it is not quite the customary vintage New Orleans jazz. Of the six men in the band, only trombonist Jim Robinson and Allen Jaffe, owner of the Hall and resident tuba puffer in the Preservation Hall Jazz Band, are drawn from the Hall's regular cast of characters. The remaining odd assortment of players gives this collection its special flavor and sets it apart from the innumerable other *déjà vu* New Orleans jazz LPs of recent years.

Trumpeter Johnny Wiggs, a leading light of white jazz activity in that city during the Twenties, plays a crisp, crackling trumpet, with frequent use of mutes—which is quite different from the big, brassy, open horn sound of such Preservation Hall regulars as Percy Humphrey and Kid Thomas. Raymond Burke, the bookseller of Bourbon Street, has a clarinet style that is his own idiosyncrasy—a blend of low-register New Orleans mellow, as in Barney Bigard's playing, with an eccentric manner of phrasing somewhat similar to Pee Wee Russell's. Bob Greene, the Jelly Roll Morton specialist, adds Morton's distinctive piano approach with trills, breaks, and his own Spanish tinge. And although drummer Yoichi Kimura is in the solid, steady rolling tradition of Zutty Singleton and Cie Frazier, the fact that he is Japanese adds an exotic touch.

The LP has some provocative moments, particularly on a lively *Economy Hall Breakdown* into which Wiggs incorporates King Oliver's *Dipper Mouth Blues* solo. Morton's *2:19 Blues* features an elegant Wiggs lead; and on *St. Peter*



Spector—a lot of nerve

*Street Breakdown*, a slow blues, Greene takes an idiomatic Morton solo. Jim Robinson, the greatest of the latter-day New Orleans trombonists, is consistently commanding, full-bodied, and genially positive in his gruff, swaggering statements, and Burke has a leprechaun charm. But despite its differences from the norm, this band, like others of its ilk, eventually becomes a victim of formula. By the end of the second side, what had been fresh and invigorating on Side 1 has worn thin from repetition. J.S.W.

**Phil Spector's Greatest Hits.** Phil Spector, producer. Warner/Spector *2SP 9104*, \$9.98 (two discs). Tape: ●● *2S5 9104*, ●● *2S8 9104*, \$11.97.

Spector, the self-styled creator of "Tomorrow's Sound Today" in the early Sixties, is just about the only record producer with the right, ability, or nerve to assemble a collection of singles and reissue them under his own name. Which is fitting, for this is the man who not only claims to have invented the term "producer" as it applies to recordings, but was among the first to place that role above the individual performer's. Indeed, his name is better known than those of many of his acts.

The twenty-four selections gathered here are legitimate hits ranging from 1958 with the Teddy Bears' *To Know Him Is to Love Him* (which Spector also wrote and sang on) to 1969 with Sonny Charles & the Checkmates' *Black Pearl*. Most of the artists represented here lasted no longer than their association with the man Tom Wolfe characterized as "the teen tycoon of pop." (Did you ever wonder whatever happened to Curtis Lee after *Pretty Little Angel Eyes* and *Under the Moon of Love*, the Paris Sisters after *I Love How You Love Me*, the



Checkmates, the Crystals, the Ronettes, Bob B. Soxx & the Blue Jeans, or Darlene Love?) But many of them have enjoyed healthy careers as hitmakers: Ben E. King (*Spanish Harlem*), Gene Pitney (*Every Breath I Take*), Ike & Tina Turner (*River Deep—Mountain High*), and the Righteous Brothers (*You've Lost that Lovin' Feelin'*).

Spector dominated his sessions. He preferred to work with exceptionally strong-voiced singers whose own artistic temperaments wouldn't conflict with his own. He hired talented arrangers and musicians but left little room for their creative impulses. He tended to use the same crew of songwriters (Greenwich/Barry; Goffin/King), often writing with them and always knowing that he could depend on their coming up with what he wanted.



Bob B. Soxx & the Blue Jeans

"What he wanted" he once described as "little symphonies for the kids." A Spector record was a three-and-a-half minute chunk of real life, drawn from the street and placed on plastic. His protagonist was a teenaged, lower-class/urban street urchin, misunderstood by his elders and determined to make something of himself. This sentiment and story line was applied to a Wagnerian backdrop, often described as a wall of sound, achieved by multiple overdubbing of strings, keyboards, and percussion to give the illusion of a huge orchestra and chorale. Earlier discs, like those of the Paris Sisters, the Teddy Bears, and Curtis Lee, were exceptions to this technique though strong in their own way.

Most of Spector's recordings have been out of print in this country for years, making this album valuable for seekers of his famous oldies. Serious-minded collectors will find some of the

Continued on page 136

## PIONEER CTF-9191



**293<sup>00</sup>**  
STEREO CASSETTE DECK with  
Dolby Noise Reduction System



Our 21st Year  
**SOUND REPRODUCTION**

460 CENTRAL AVENUE East Orange, New Jersey 07018  
(201) 673-0600

CIRCLE 40 ON READER-SERVICE CARD

## DISCOUNTS ON NATIONALLY ADVERTISED

• Turntables • Amplifiers • Cartridges  
• Tape Recorders • Speakers • Receivers

SEND FOR  
**YOUR FREE CATALOG**

FEATURING THOUSANDS  
OF COMPONENTS AT  
SPECIAL LOW DISCOUNT  
PRICES.



## Buy with confidence

THERE IS A DIFFERENCE IN MAIL ORDER. IT'S  
CALLED EXPERIENCE! WE HAVE 28 YEARS!



TEAC

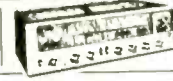

KENWOOD



SEND FOR QUOTES  
AND PRICE LISTS

BUY FROM NEW ENGLAND'S  
LARGEST STEREO HOUSE



ARSTON Studio

146 Old Brookfield Road, Danbury, Conn. 06810

(203) 744-6421 (212) 369-6212

Mon.-Fri. 9:00-5:30 Sat. 9:00-3:00

CIRCLE 7 ON READER-SERVICE CARD

Low Prices

Fast Service

## Handbook of Multichannel Recording



Here is very possibly the single most important book on sound recording for the layman or professional who wants to make quality recordings of musical groups. For the first time, here's a book that covers it all — dubbing, special effects, mixing, reverb, echo, synthesis — for both stereo and four-channel recording. Simply circle No. 781 on the coupon.

"Handbook of Multichannel Recording" is only one of a wide selection of carefully chosen audio books made available to HIGH FIDELITY readers through Music Listeners' Book Service. (Many of the selections are not readily available in bookstores.) Choose your books from the list, circle the numbers on the coupon, and enclose your check or money order. That's all there is to it.

No. 781 HANDBOOK OF MULTICHANNEL RECORDING. F. Alton Everest.

A comprehensive volume of 322 pages, with 201 illustrations, covering all aspects of live recording in both stereo and four-channel formats. Paperbound: \$7.95. Hardbound: \$10.95.

No. 603 DURABLE PLEASURES. A Practical Guide to Better Tape Recording. Hans Fantel.

Written in nontechnical language by one of the most respected writers in the field, this illustrated volume is a must for all tape recordists, whether beginners or old hands. \$8.95.

No. 756 FOUR-CHANNEL STEREO... FROM SOURCE TO SOUND. 2nd Edition (1974). Ken W. Sessions, Jr.

Complete technical and nontechnical information on all approaches to four-channel sound, both discrete and matrix. Paperbound: \$4.95. Hardbound: \$7.95.

No. 640 SELECTING AND IMPROVING YOUR HI-FI SYSTEM. (1973) Harvey Swearer.

A handy guide to what to look for, what to expect, and what to avoid in setting up or expanding your home audio system. Paperbound: \$4.95. Hardbound: \$7.95.

Check or money order must accompany your order.  
No cash or C.O.D.'s, please.  
Allow 60 days for delivery.

HIGH FIDELITY  
MUSIC LISTENERS' BOOK SERVICE  
Dept. HW  
2160 Patterson Street, Cincinnati, Ohio 45214

Here's my check for \$\_\_\_\_\_ Please send me, postpaid, the books I've circled below.

781 603 756 640

Name \_\_\_\_\_

Address \_\_\_\_\_

City, State, & Zip \_\_\_\_\_

HF677



# HIGH FIDELITY CLASSIFIED

130 East 59th St., New York, N.Y. 10022  
Phone: (212) 826-8393/94

**CLASSIFIED RATES:** 1-time \$1.20 per word per issue, minimum \$12. 6 consecutive issues—\$1.10 per word per issue. 12 consecutive issues—\$1.00 per word per issue. Words in caps—10¢ extra each.

Box Numbers: \$1.00 additional per insertion to cover cost of handling and forwarding mail. Count 10 extra words for box number and address.

**DISPLAY CLASSIFIED AND DISCOUNTS:** 1 inch by 1 column—\$230. 2 inch by 1 column—\$460. 3 inch by 1 column—\$690. Also 6 and 12 consecutive issue discount rates. Deadline is two months prior to publication date. Full payment must accompany All copy for classified ads.

## for sale

**ULTIMATE—"LIVE!"—Operatic, Symphonic—Open Reel bargains!** BOX 1101, WOODHAVEN, N.Y. 11421.

**3600' FRESH LOW NOISE HIGH OUTPUT AMPEX TAPE.** 10 1/2" metal reel. 6 for \$35 plus UPS \$3.50. Other tape also on special. Write for Catalog. S.I.C., POB 338, Dunwoody, GA. 30338.

## BUILD YOUR OWN SPEAKERS AND SAVE UP TO 50%.

Send for our free, fast packed 40 page catalog manual and learn how to assemble your own multi-element stereo speakers from scratch or from kits. Our catalog includes chapters on design, construction, crossovers, enclosures, mounting, speakers, tweeters and more. Write us today.

**SPEAKERLAB**  
Dept. HF A, 5501 35th N.E.  
Seattle, Washington 98105

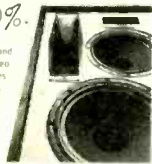

**HI-FI ENTHUSIASTS WANTED!!** Earn more than just spare money in your spare time. We need campus representatives to sell name brand stereo components at discount prices in your area. High commission, no investment required. Serious inquiries only, please. Contact: Alan Weisberg, K&L Sound Services Co., 75 No. Beacon St., Watertown, Mass. 02172. (617) 926-6100.

**PERFECTIONISTS PREFER DYNAKITS. BEFORE Purchase You Owe Yourself Our Quote.** MAINLINE III, 971 Fronheiser, Johnstown, Pa. 15902.

**PROTECT YOUR RECORDS POLY SLEEVES** for jackets 8¢ Roundbottom record sleeves 7¢ Poly lined paper sleeves 15¢ White jackets 35¢ Postage \$1.50. Record Supply House, Hillburn, New York 10931.

**DYNAKITS, SHURE, SME—lowest prices. FRIED LOUDSPEAKERS (not discounted).** Underground HiFi Sales, 324b Broadwater Road, Arnold, Md. 21012. (301) 647-0919 "evenings."

**AUDIOPHILES WANTED!!** Put your knowledge to use, earn an excellent spare time income. We need campus Dealers to sell name brand stereo equipment at substantial discounts in your area. No investment necessary. For information and application please write: ABCO, Dept. CR, 1201 East Main Street, Meriden, Conn. 06450. Call (203) 238-7979.

**THE WAREHOUSE—LOWEST PRICES ON TYPE-WRITERS, MANUAL AND ELECTRIC.** All brand new, factory sealed, and fully warranted. Free catalog and prices. YOU CAN'T BUY IT ANYWHERE FOR LESS! Fast service. THE WAREHOUSE, Dept. 8, 187 North Main Street, Milltown, New Jersey 08850.

**AUDIO STEREO COMPONENTS and SONY TV's** at rock bottom prices. Why pay up to 40% more? Arkay Audio, 68-B Watertown Street, (Route 16), Watertown, Mass. 02172.

**SAVE 50% build your own speaker system.** Write McGee Radio Electronics, 1901 McGee Street, Kansas City, Missouri 64108.

**SHOPPERS' GUIDE TO AUDIO MAIL ORDER DISTRIBUTORS—\$3.95.** Hundreds researched. Analysis, articles, and more! Box 94-H, Colmar, PA 18915.



BEST  
IN THE  
WORLD!



Order famous British loudspeaker components direct at discount prices. Build your own top quality hi-fi and disco speakers. Save 50-70%. Send today for free catalogue and free constructional details of 5/7/10 element speakers.

WILMSLOW AUDIO

EXPORT DEPARTMENT A, SWAN WORKS,  
BANK SQUARE WILMSLOW CHESHIRE,  
ENGLAND SK9 1 HF.

**MXR's 10 band Equalizer.** Discwasher systems, Maxell tape. Discounted. N.A.B. Audio, Dept. H., Post Office Box 7, Ottawa, Illinois 61350.

**SAVE ON SACRED COWS—BOSE, SAE, REVOX, Sansui, Kenwood, Marantz, BIC, Dokorder, Sony, JVC, Philips.** Over 50 top brands. Write for quotes: **SOUTHBOUND SOUND**, P.O. Box 52508, Atlanta, Georgia 30355.

**PROFESSIONAL HI-FI COURSE—Instructors include Len Feldman, Julian Hirsch, Larry Klein, Larry Zide.** Home study course available. Send \$2.00 for full color Audio Primer and Information on joining Society Audio Consultants (SAC). 49 E. 34th St., Dept. HF, NYC, NY 10016.

**STEREO REPRESENTATIVES—WOULD YOU LIKE TO DOUBLE YOUR PROFITS? YOU CAN, IF YOU CONTACT U.S. DIVISION OF TOKYO AUDIO LTD.,** 5466 Santa Monica Boulevard, Los Angeles, California 90029.

**AUDIOGRAM—The bi-monthly newsletter that gives you reviews, news, and our views on today's audio world.** Six issues \$15.00. Free Information. Write: **Audiogram** P.O. Box 17202, Wash., D.C. 20041.

**PRIVATE COLLECTION AUCTION—CLASSICAL/POPULAR ALL SPEEDS LIST 50¢ BOS-BEIJER, JAF-FREY, NH 03452.**

Check room acoustics, stereo balance, speakers, amplifiers with white noise generator. Better than sweeper, 49.50 ppd. with application notes. **Micronetics Inc.**, 36 Oak St., Norwood, New Jersey, 07648.

"The Import Alternative offers those interested in classical music on the British records a buying service. The EMI Numerical Catalogue is available for \$2.75. For further information please write: **Import Alternative**, 3023 M Street, N. W., Washington, D. C. 20007."

**THE ABSOLUTE SOUND™**, in its current issue, reviews Audio Research's solid state electronics; the much-discussed Van Alstine Double Dyna 400; a subwoofer and electronic low-pass filter from Dahlquist; the Grado Signature cartridge; the Fulton J. Modular speaker system; Yamaha's B-2 amplifier; Ampzilla II, the Stax tone arm, and much, much more. We also begin our investigation into why American records sound so awful; and continue our guide to the world's best sounding discs. Furthermore, there's poop on how to get imports, at home or abroad. You can have all this for \$12 (four issues)—\$13, if you live in Canada, add \$2 for first-class mail. Outside North America: \$16 (air). Send checks to **The Absolute Sound**, Box 5y, Northport, New York, 11768.

**CORNER HORN SPEAKER ENCLOSURE KITS—Send for free brochure.** Kneller Audio Cabinets 6428 W. 27th Place, Berwyn, Illinois 60402.

## miscellaneous

**DIAMOND NEEDLES and Stereo Cartridges** at Discount prices for Shure, Pickering, Stanton, Empire, Grado and ADC. Send for free catalog. All merchandise brand new and factory sealed. **LYLE CARTRIDGES**, Dept. H, Box 69, Kensington Station, Brooklyn, New York 11218.

**SLEEP-LEARNING—HYPNOTISM!** Strange catalog free. Autosuggestion, Box 24-F, Olympia, Washington 98501.

**CONGRATULATIONS! YOU ARE NOW READING ONE OF HIGH FIDELITY'S best read pages!** Use it yourself when you want to sell equipment, or a service, or want to let the avid music listener know about anything. **High Fidelity Classified**, 130 East 59th St., N.Y. 10022.

**SEARCHING? WRITE DISCONTINUED RECORDS**, 444 South Victory, Burbank, California 91502.

**PROTECT YOUR ALBUMS. WHITE CARDBOARD REPLACEMENT JACKETS 35c. PLASTIC LINED INNER SLEEVES 15c. POSTAGE \$1.25. OPERA BOXES, 78 SLEEVES AVAILABLE. FREE CATALOG.** CABCO 301-3, BOX 8212, COLUMBUS, OHIO 43201.

The Best New Stereo Systems Receive The Best New Stereo Records (Tapes too!) You need the Monthly **SCHWANN RECORD CATALOG** available from record shops everywhere or, for a sample copy PP, Send \$1.75 to: **SCHWANN**, 175 Newbury St., Boston MA 02116.

**FRITZ REINER SOCIETY—Founded 1973.** Details: Gary Horvik, 17543 Willow, Country Club Hills, IL 60477

## new equipment for sale

**SAVE UP TO 69% ON OVER 100 TOP BRAND AUDIO components** from Carston Studios. New England's audio supermarket, one of the oldest mail order firms (est. 1962) and certainly one of the most reliable. All orders shipped from stocked warehouse. Send for price quote and price list. **Carston Studios**, Old Brookfield Road, Danbury, Connecticut 06810.

## The Comfortable Alternative to Headphones

**YEAPLE Stereopillow™**  
Model 900—reviewed in High Fidelity, Stereo Review \$79.95

Model 400—New compact version \$34.95



FREE reviews and dealer list from: **Yeaple Corp.**, Dept. HF, 1255 University Ave., Rochester, NY 14607

**SANSUI and PICKERING! BELOW mail order prices!** Send to: **GSH Super Savings**, P. O. Box 86, Eden, N.C. 27288.

**SUBSTANTIAL SAVINGS on most High End lines.** The Sound Affair, 364 Mission Court, St. Louis, MO 63130.

**NEW SCOTT R-306: \$149.00. NEW SCOTT R-326: \$216.00. SHIPPING INCLUDED anywhere in continental U.S.** For savings like this and more on major brand components write for quote. **PIRATE'S DEN**, Box 10091, Elmwood, CT. 06110.

## tapes & records

**RARE OPERA, SYMPHONIC MUSIC ON OPEN REEL TAPE.** Historic performances. **EUROPEAN, DOMESTIC.** Free Catalogue. Underhill, Box "U," Bellport, NY 11713.

**TDK, BASF, Memorex, Maxell, cassettes, reels, 8-tracks.** Lowest prices, guaranteed, new. **S&S Audio**, P.O. Box 56039, Harwood Heights, IL 60656.

**QUADRAPHONIC RECORDS AND TAPES—WORLD'S LARGEST SELECTION—ALL LABELS, OVER 1000 TITLES—** at discount prices! For your free illustrated quad catalog, write: **SOUND CONCEPTS**, Box 654-B, Peoria, Illinois 61652.

**GOLDEN AGE RADIO—YOUR BEST SOURCE** for radio tapes. Box 25215-J, Portland, Oregon 97225.

**SOUNDTRACKS/OC, PERSONALITIES!—FREE NEWSLETTER!** RTSH, 3700 Plaza, F-211, Santa Ana, California 92704.

"SOUNDTRACKS, SHOW, NOSTALGIA & JAZZ—FREE Catalog & Auction List—A-1 Record Finders, P.O. Box 75071-H, L.A. CAL. 90075."

**SCOTCH RECORDING TAPE, LOWEST PRICES.** TAPE CENTER, Box 4305C, Washington, D.C. 20012.

**EVERYTHING ON OPEN REEL!** Classical, Popular, Dolby Quadrasonic. Latest releases. For "Reel News," send \$1.00. **Barclay-Crocker**, Room 857 H, 11 Broadway, New York 10004.

NOTICE: RECORD RATERS WANTED

No experience required. Each month we ship you NATIONAL LP's to rate. "You keep LP's." We pay postage. In return for your opinion, you can build your LP collection. A small membership fee is required. "First come basis." Send no money. For application write:

**E.A.R.S., INC.**, Dept. HF 3725 N. 126th St., Brookfield, WI 53005

**FREE SOUNDTRACK CATALOG.** STAR-168, BOX 337, Owings Mills, MD. 21117.



CLASSICAL LP's CURRENT/OOP BI-MONTHLY LIST. ETC. A.R.S., Musica 13 Dante Street, Larchmont, N.Y. 10538.

CUT-OUT RECORDS. HUGE STOCK. ALL NEW. No catalog, Cohn, 2205 Marylane, Broomall, Pa. 19008.

OLD RADIO PROGRAMS. 50c!! AM TREASURES, BOX 192, NC, Babylon, N.Y. 11702.

RAREST CLASSICAL, SOUNDTRACKS, SHOWS, PERSONALITY LPs. Huge catalog 50c. Grammy's Attic, Box 181, Bluffton, SC 29910.

CASH FOR USED RECORDS! Will Pay: \$1.00 to \$2.00 for quality LPs . . . 8-track and Cassette Tapes. (Rock, Jazz and Classical etc.) SEND list of your used albums or 25c for our complete Buying Guide! Rasputin Records, 2340 Telegraph Ave., Berkeley, Ca. 94704.

"VIENNESE NIGHTS"—Rare series of the repertoires of the great Waltz Kings in utterly complete, authoritative performances. Available to members on Dolby cassettes. Extensive catalogue of world's largest archives. Apply: VLMS, "Pickwick Papers," Stickford, Boston, Lincs. England."

SHOW ALBUMS—Rare, out-of-print LPs, 52-page list 50c ROBBER BRIDEGROOM 7" STEREO, 33 1/2, 4 songs—Jerry Orbach; Virginia Vestoff \$3.95. Broadway-Hollywood Recordings, Georgetown, CT 06829.

WE WILL BEAT any price sheet in America. Featuring TDK, MAXELL, and others. Tape World International, 220 Spring St., Butler, PA 16001.

SONAR'S OPEN REEL TAPES. Duped one-to-one from the master. All formats available. Highest quality anywhere! Send \$1.00 for catalog and mini sample stereo tape. Sonar Records, Box 455H, Kingsbridge, Bronx, NY 10463.

TDK SUPER AVILYN C-90 CASSETTES, \$3.19 Ea. 10 or more \$3.06 each. Shipping & Handling—add 10% under 20.00, 7% over \$20.00. Free Catalog, SAXITONE TAPE SALES, 1776 COLUMBIA RD. N.W., Dept. HF, WASHINGTON, D.C. 20009.

BASF TAPE: All widths 40—55% off. All tapes guaranteed! INTERGALACTIC, 1043 Kirts, Troy, Michigan 48084.

3000 LIVE OPERAS, RECITALS, SYMPHONIC. UNPARALLELED CHICAGO COVERAGE. OPEN REEL, CASSETTES. FREE CATALOG. H. WURM, 18826 W. LOUISE, LANSING, IL 60438.

PRE-RECORDED CLASSICAL CASSETTES. Complete inventory of quality imported and domestic selections, all dolbized. Fair Prices. Latest catalogue available 50c. B & W Sound, 5521 La Cienega, L.A., Cal 90056.

BUDGET CLASSICAL RECORD REVIEWS. 600+ listings covering fidelity, performance. \$5.00 to Allen Sawyer, Box 13029, Gainesville, Fla. 32604

ADVENT PROCESS CR/70 CASSETTE RECORDINGS. The best in the world. Hard to find? Don't give up. Write for free catalog and dealer list. Advent Corporation, Dept. CHF, 195 Albany St., Cambridge, Mass. 01239.

QUASI-RATIONAL PRODUCTS has everything in record protection; Paper-vinyl liners @ \$13.50/100 including shipping, blank jackets, vinyl jacket covers, Discwasher, Watts, Vacorec, etcetera. ALSO Maxell, Nortronics, Shure, Jensen and Pioneer auto. Marvelous prices and service. FREE CATALOG. QUASI-RATIONAL PRODUCTS, P.O. Box 171, Prospect Heights, Ill. 60070.

WHOLESALE CASSETTES 8-TRACKS BLANKS AND DUPLICATION \$1.00 SAMPLE POTENTIALS UNLIMITED, Dept. HF1, 2545 Berwyck, Grand Rapids, MI 49506.

CLASSICAL & POPULAR: Free monthly auction lists of carefully selected collectors' LPs. Also IMPORTS at discount. RECORDS RESURRECTED P.O. Box 143, Radnor, PA 19087.

RARE BROADWAY CAST. SOUNDTRACK, PERSONALITY and jazz auction. Send for free list. Records, P.O. Box 154, Boston, Mass. 02123.

OLD RADIO SHOWS on tape. Most have original commercials. Low as \$1.75 per hour. Catalog \$1.00. Phantom Empire, 2500 Pennington, Houston, Texas 77093.

IMPORTED + DOMESTIC HARD-TO-FIND SOUNDTRACKS, Shows, Nostalgic Personalities. Catalog \$1.00 (Refundable) List Communications, Box 916-T, NYC 10023.

"HISTORICAL OPERA DISC & TAPE—Magnificent quality, speedy service. Greatest live performances of past 50 years. Reel, cassette, disc. Free Catalog. Historical Recording Enterprises, Box 12, Kew Gardens, N.Y. 11415."

LIVE OPERA TAPES, UNBELIEVABLE VARIETY SATISFACTION GUARANTEED. FREE CATALOGUE. LIVE OPERA BOX 3141, STEINWAY STATION, L.I.C., N.Y. 11103.

OLDIES TAPES ON OPEN REEL TAPE. Rock 'n' Roll songs by their year of release. Over 100 songs per year. Free brochure. Rock 'n' Reel Rental, Dept. C, 4 Prescott Ave., Dix Hills, NY 11746.

CLASSICAL RECORDS—IMPORTED FROM RUSSIA: RARE OPERA, SYMPHONIC VOICE. ALSO FOLK FREE DETAILED CATALOGUE. ZNANIE IMPORTS, 5327 GEARY BLVD., SAN FRANCISCO, CALIF. 94118.

JAPANESE JAZZ IMPORTS. Send for free catalogue self addressed stamped envelope to ROB RECORDS, 1540 Broadway, N.Y.C., NY 10036.

**OPERA RARA RECORD CLUB**  
1977 Season

**DONIZETTI:** Ugo Conte di Parigi  
**OFFENBACH:** Christopher Columbus  
**MEYERBEER:** Dinorah  
**RICCI:** Crispino e la Comare

Commercial studio recordings, beautifully boxed with libretto, in stereo. **Ugo Conte di Parigi** features Janet Price, Yvonne Kenny, Christian du Plessis with the New Philharmonia Orchestra. For membership details, write to

**Opera Rara Record Club**  
8 Haverstock Street, London N1 2DL, England

COLLECTORS JEWEL! ANDRE WATTS performs historic concert Fords Theatre, Washington, D.C. in MacDowell Concerto and narrates Coplands Lincoln Portrait. Two record, professionally recorded set available for \$50.00 tax deductible contribution to Reading Symphony Orchestra. 219 North Fifth, Reading, Pennsylvania 19601. Limited to first 300 replies.

OLD RADIO PROGRAMS. Sales, rentals, Dolby. Catalog, \$1.00 (deductible). Airwaves, 925FL Eagle Heights, Madison, Wisconsin, 53705.

## business opportunities

BECOME MONEYBROKER!! Large Commissions. Experience unnecessary. Free Brochures. STULL CO., Since 1870, Box 5470-HF, Cleveland, OH 44101.

## wanted to buy

WRITING HISTORY OF SAN CARLO OPERA CO. U.S. Will buy programs, reviews, or reimburse for xerox and postage. No L.A. or N.Y. Bishop, 7735 Atlantic #63, Cudahy, CA 90201.

## publications

FM ATLAS AND STATION DIRECTORY shows all North America's FM stations at a glance. Gives full technical, program format data on 4,000 stations, listing stereo stations, coverage radii, tips on buying FM receivers, SCA, and more! For travelers, DXers, audiophiles. Fourth edition, 112 pages, \$2.95. FM Atlas, Adolph MN 55701.

CLASSICAL REVIEWS—Comprehensive comparison, discographies, imported and rare releases. Special Introductory Rate \$5.95. Subscribe now! American Record Guide, Box 812H, Melville, NY 11746.

AUDIO EXOTICA cordially invites the discerning audiophile to partake in a unique opportunity. A monthly presentation of previously owned esoteric exotica will be delivered to those persons who submit an annual membership tariff of \$20. Advertisements are presently being solicited for the nonnegotiable fee of \$50, acceptance contingent upon editor's approval. Division of Gelfen Industries, 797 Industrial Court, Bloomfield Hills, MI 48013, (313) 858-7773.

OLD RADIO SHOWS newsletter: \$6.00/12-issues. Send SASE for sample. Joe Webb, 5 Valley View, Yonkers, NY 10710.

## employment

TRAVEL! FOREIGN SHIPS! GOOD PAY! No experience. Men/women. Adventures abroad. Work. Study. Stamped long envelope. GLOBETROTTER, Box 1266-HFB, Kansas City 64141.

**HIGH FIDELITY**  
Classified Advertising Department  
130 East 59th St., New York, N.Y. 10022 212-826-8393/94  
Michael Littleford, Classified Advertising Manager

Please run the following classified advertisement in the next available issue.

---

Name \_\_\_\_\_

Address \_\_\_\_\_

City \_\_\_\_\_ State \_\_\_\_\_ Zip \_\_\_\_\_

Telephone \_\_\_\_\_

**RATE:** For Regular and Display, see schedule above. \*CASH MUST ACCOMPANY ORDER. Closing two months prior to issue.

# SAVE

TOP QUALITY GEAR  
LOWEST PRICES  
PROMPT DELIVERY  
SAVE ON FREIGHT  
SELECTION

GARRARD BSR  
KENWOOD DYNACO  
B.I.C. SANSUI  
DUAL PIONEER  
and more than 50 others

PLEASE REQUEST PRICE QUOTATIONS ON YOUR CHOICE OF QUALITY STEREO GEAR

## Component Discounters

Dept. 6HF  
17565 Meadowood  
Lathrup Village, Michigan 48076  
313-559-1270

**Audio Discount**  
**WAREHOUSE SALES**  
**"HOT STUFF"**  
**DIRECT TO PUBLIC**





**CALL TOLL FREE**

IN NEW JERSEY **800-822-8926**  
OUT OF STATE **800-631-2175**

Or Write Today for Our  
**FREE Audio Catalog**

Master Charge / BankAmericard honored on mail orders

**AUDIO DISCOUNT**  
**WAREHOUSE SALES**  
175 Monmouth Rd. W. Long Branch, N.J. 07764

Please rush me your FREE Audio Catalog and complete information. I understand there is no obligation.

Name \_\_\_\_\_  
Address \_\_\_\_\_  
City \_\_\_\_\_  
State \_\_\_\_\_ Zip \_\_\_\_\_

CIRCLE 5 ON READER-SERVICE CARD

Continued from page 133

oddball inclusions here typical of his projects: an alternate take of the Crystals' *He's Sure the Boy I Love* and an odd selection of mono and stereo mixes. Spector constantly preaches "back to mono," but some of the selections here—including that mentioned above, originally issued in mono—are in true stereo; others previously available in stereo, like the Righteous Brothers' and Ronettes' cuts, are here in mono. Ken Barnes's liner notes are thorough, and the cover art is excellent. T.E.

**The Marshall Tucker Band: Carolina Dreams.** Paul Hornsby, producer. *Capricorn CPK 0180, \$7.98. Tape: M5 0180, M8 0180, \$7.97.*

**Sea Level.** Stewart Levine, producer. *Capricorn CP 0178, \$6.98. Tape: M5 0178, M8 0178, \$7.97.*

Now that Jimmy's in the White House and "We Ain't Trash No More!," as proclaimed in a recent *Esquire* article, it will be interesting to see what (if any) influence the new cultural hot center will have on the sounds and demeanors of the Southern bands following in the Allmans' wake. As the most unreconstructed of American rock traditionalists, these groups change little if at all from album to album; but a big part of the Allmans' legacy was the outlaw stance, and it's pretty hard to make like Jesse James when—like Marshall Tucker—you play the Inaugural.

A partial answer might be found in one of Toy Caldwell's lyrics on the new Tucker album: "Well I'm ridin' along, singing that same ol' cowboy song/ That's been sung a hundred times before . . . But I'm livin', I'm happy, and I'm free."

Okay, y'all. Sentiments like that might alternately be taken as:

- (a) I-got-plenty-o'-nuttin' rustic wisdom;
- (b) a declaration of oafish laziness ("Who cares about sociological contradictions, I'm drunk!"); or

(c) outright deceit inasmuch as he is playing the same old song, but no part of a political machine (as Caldwell most certainly is) should be able to see the world in terms this simple.

I believe that he does, though, and have always found in the Marshall Tucker Band's work the down-home sincerity advertised. Ever the most sanguinely country-oriented of Capricorn groups, they still get my vote as the band worthiest of stepping into the Allmans' boot tracks. They don't have the parent group's poetry, anguish, gritty edge—but they play with a rippling lyrical flow that I've always found irresistible in spite of nigh-total predictability. Their first album, "The Marshall Tucker Band," is still their best, and if you liked the formula in the first place you'll find this one more consistently satisfying than those in-between.

Sea Level, featuring Allman vets Chuck Leavell (keyboards), bassist Lamar Williams and drummer Jai Johanny Johanson, as well as a young guitarist from Washington D.C. named Jimmy Nalls, is the first splinter band formed since the Allmans' breakup. Their sound combines funk readymades, Mahavishnesque fusion riffing (one way of disclaiming bumpkinism, I suppose), and patented Allman instrumental breaks. The singing is better than you'd expect, the Allman influence manages to temper (presumably) Nalls's more febrile tendencies, and Leavell's piano playing is as pretty yet limited as ever. They'd be nice in a bar, but as major league contenders their rock-oriented originals are just too slight; they're not really playing jazz either, because there's a crucial difference between improvisation and riffing. Still, as bands making this kind of music go, they're buoyant, refreshingly unpretentious, and therefore a veritable Ripley's Believe It or Not candidate simply for *not* being lethally offensive. A good time was obviously had by all making this record, and I can't think of a better buy in wallpaper this year. L.B.



*Sea Level: Williams, Leavell, Johanson, Nalls*



**BACKSTAGE PASSES: ROCK 'N' ROLL LIFE IN THE SIXTIES.** By Al Kooper with Ben Edmonds. *Stein and Day Publishers*, 254 pages; \$12.95 cloth, \$7.95 paper.

An editor at a major New York publishing house recently told me that rock books aren't selling any more. I can see why. After such major critical works as Greil Marcus' *Mystery Train*, historical reference books like *The Rolling Stone Illustrated History of Rock & Roll*, and perceptive looks at touring and the recording industry by Robert Greenfield in *S.T.P.* and Geoffrey Stokes in *Star-making Machinery*, there isn't a whole lot left to tell. One would think the potential readership's curiosity would be exhausted.

Al Kooper was hardly a household word in his prime as a performer. I have followed his career closely, but was frankly surprised to hear that he was writing an autobiography. The sessions he played with Bob Dylan have been covered before, his output in the last five years has been terrible to mediocre, and his work with the Blues Project and the original Blood, Sweat & Tears, while interesting, is essentially a footnote in



Al Kooper—merely a footnote in rock history?

rock & roll history.

And that's what *Backstage Passes* is—a none-too-revealing footnote. Kooper started as a teenage pro and Brill Building ghost in the late Fifties/early Sixties and progressed to songwriter and studio musician, thence to Dylan, the Blues Project, and so on. But plenty of people have a similar story to tell, and many of them (Carole King, for instance) would presumably deliver it with more candor, color, and insight. Kooper's life-of-the-party narrative style ("Every night after the other clubs closed, jam sessions with personnel that would make your stare hand on end took place until the sun came up.") attempts to cloak events in a significance they don't merit. In fact, the book's main virtue is the photographs (including some of Alice Ochs's best Dylan in-group shots), most of which have never appeared in print before. The breathless prose, hideously inflationary price, and non-story mark *Backstage Passes* as a strong contender for early remaindering.

ED WARD

**JOHN COLTRANE.** By Bill Cole. *Schirmer Books*, 264 pages; \$12.95.

It seems to happen every twenty years—a jazz musician comes along whose influence is so pervasive that it colors every aspect of the generation's music. It was Louis Armstrong in the '20s and '30s, Charlie Parker in the '40s and '50s, and over the last two decades, John Coltrane. In a way, Coltrane signifies what Parker might have been. Not that Parker didn't leave an impressive heritage. But the burden of drug addiction and alcoholism, carried by both musicians, drained and destroyed him. Coltrane, on the other hand, turned himself around, got clean, found a sense of discipline in his profoundly religious nature and, in the process, reached his highest creative levels. What, one wonders, might Parker have done if he had achieved as drastic a change in his life style?

Coltrane's story, unlike Parker's, is upbeat and inspirational—a potential guiding light. He was author Cole's second jazz idol (Cole's first was Miles Davis, about whom he has already written a book), and is treated with an admiration that verges on adoration.

Unusually strong attention is given to

Coltrane's religious feelings through lengthy quotations from Professor Fela Sowande, the Nigerian composer and folklorist. But the statements apply less to Coltrane than to an explanation of his religious heritage. This and his music are the principal strands that weave through the book. And while the two elements may seem disparate at first, in Coltrane's later years the one became inextricably involved with the other.

Cole has done a painstaking job of analyzing the recordings, looking at them almost phrase by phrase (with the help of Andrew White's transcriptions). But his subject's life and development are presented in a strangely split manner. Some of it is extremely personal. Cole recalls his reactions to Coltrane when he first heard him play in 1955. But they did not meet until 1961 and, even afterward seem to have had no significant conversations. For insights on Coltrane's thinking and points of view, Cole uses quotations from other sources, most notably an article by Coltrane with Don DeMichael, "Coltrane on Coltrane," in a September 1960 issue of *Down Beat*. For the performing student of Coltrane, this book is a gold mine of instructive points. But for the more general reader looking for insights into the man and his music, it can be pretty heavy going.

The author has an easy narrative style and enthusiastically rushes along, lingering on points that interest him and—unfortunately—all but dismissing those that don't. He inclines to casualness in his assumption that the reader knows the unmentioned—a fault that either he or his editors could have corrected. For example, Coltrane's second wife, Alice, is introduced only by her first name, although when she first played piano with him she was Alice McLeod. Similarly, Cole alludes to "all the pros and cons about [Coltrane's] music with Johnny Hartman" without mentioning what those pros and cons were. His discussion of Coltrane's death consists of a fifteen-line paragraph, three lines of which are devoted to Coltrane and the remainder to what Cole and his wife, newlyweds on their honeymoon, did on that day. This personal point of view admittedly has its merits, but in sum the book tells us almost as much about Cole as it does about John Coltrane.

JOHN S. WILSON

# The Revolutionary

Wow & flutter: .04%\*. Signal/noise ratio: 62 dB.\*\*

Introducing the incredible Elcaset system. Developed by Sony to bring you unsurpassed cassette sound.

**1.** The Elcaset tape is as wide as reel-to-reel tape: 1/4."

**2.** Tape moves twice as fast: 3 3/4 ips. Result: the widest dynamic range, the widest frequency response, the cleanest sound ever offered in a cassette format. Unlike the standard cassette, the Sony Elcaset sound is not compressed, constrained. It's expansive and full. It "breathes." It's true high fidelity.

**3.** The tape is lifted out from the cassette and guided across the heads by a stabilizing pin in the deck

itself — just as in reel-to-reel.

Result: lowest wow and flutter, superior tape/head alignment, even better frequency response. (See diagram).

**4.** All-new tape formulation with thicker oxide coating and thicker polyester for highest quality sound.

**5.** Automatic tape formulation adjustment. Small holes encoded on the cassette case "tell" the Elcaset deck what type of tape is being used (SLH, FeCr). The Elcaset then automatically adjusts both bias and EQ for optimum performance.

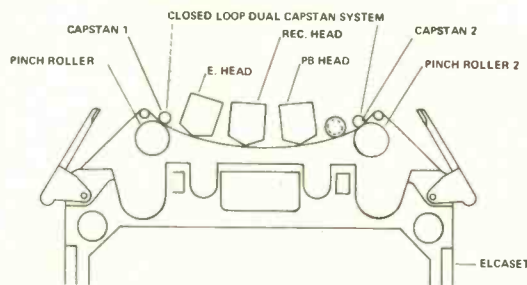

**Tape** (Actual Size)





# Sony Elcaset System

Frequency response: 25 Hz-22 kHz,  $\pm 3$  dB\*\*\*

An engineering triumph, the Sony EL-7 Stereo Elcaset Deck was designed exclusively for the new Elcaset tape.

**1. Closed-loop dual capstan tape drive.** One of the most advanced tape drive systems now available, it assures constant tape-to-head contact pressure, low wow and flutter and virtually nonexistent modulation noise.

**2. The 3-motor system starts with a DC servo motor** for utmost reliability. A sophisticated feedback circuit corrects for line voltage fluctuations, and other speed-altering factors. This is the finest tape recorder motor system money can buy. Proof? Wow and flutter of only .04%.

**3. Sony's 3-head system offers the most precise tape/head alignment possible.** All three heads are made of ferrite and ferrite—a super-strong formulation that lasts up to 200 times longer than standard perm-alloy. Head surfaces are mirror-smooth for friction-free tape travel and optimum tape/head contact. Incredibly close tolerances in the head gap assure widest frequency response.

**4. Direct coupling of playback head with the FET first-stage reproduction amplifier significantly reduces distortion, improves signal/noise ratio and frequency response linearity.**

Also available: The Sony EL-5 Stereo Elcaset Deck. Includes many of the same high performance features of the Sony EL-7, at a lower price.

## Deck

Brought to you by

**SUPERSCOPE**



Memory tape counter provides automatic sequential rewind and playback immediately after recording from a specific spot on the tape.

Timer activating capability, in conjunction with an external timer, turns on/off playback or record mode unattended.

Illuminated "feather-touch" solenoid operation. Logic-controlled system allows instantaneous mode change, bypassing stop.

A r-cushion eject slowly, softly opens tape compartment door, thus minimizing wear on eject system.

Dolby Noise Reduction System includes 25  $\mu$ S de-emphasis circuit for Dolby FM, as well as controls for standard Dolby applications.

\*WRMS \*\*FeCr tape, Dolby\*\*\*out. \*\*\*FeCr tape. \*\*\*\*TM Dolby Labs Inc (Source Sony Corp.)

© 1977 Superscope, Inc., 20525 Nordhoff St., Chatsworth, CA 91311. Prices and models subject to change without notice. Consult the Yellow Pages for your nearest Superscope dealer.



## THE INTEGRATED DC AMPLIFIER HAS ARRIVED.

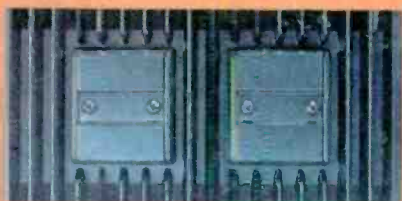

Gone is phase distortion. Gone is time-delay distortion.

The Kenwood KA-9100 integrated DC amplifier is here.

Its response is flat down to 0 Hz. It has three power supplies. The Total Harmonic Distortion is 0.03% over the full frequency range of 20-20k Hz. The Signal-to-Noise ratio is 83 dB at 2.5 mV. It has the best phono sensitivity (0.8 mV) of any integrated amplifier. For better heat dissipation, the KA-9100 has large heat sinks on either side.

It is an amplifier so advanced even the pre-amp has its own power supply.

It is the next generation Kenwood. The unit all others will be measured against. Just as they were when we pioneered dual power supplies.

The KA-9100 integrated DC amplifier. With 90 watts per channel, minimum RMS, at 8 ohms from 20 to 20,000 Hz with no more than 0.03% Total Harmonic Distortion.

And, as if all that wasn't enough, it costs less than \$500.\*

# KENWOOD

15777 S. Broadway, Gardena, CA 90248 · 72-02 Fifty-First Avenue, Woodside, NY 11377

\*handles optional

\*Suggested resale price. Actual prices are established by Kenwood dealers