

LAB TESTS OF FIVE NEW SPEAKERS

HIGH FIDELITY

OCTOBER 1976 \$1.00

ICD © 08398

SPEAKERS

What You Should Know Before

EXPERIENCE SIMULATION

Concert Hall

HE LTH3G24C069 OCT 76 1 03
MR C LATYAN
7424 GRIMBURY CIR
ST LOUIS MO
63123



Top to bottom:
Sound Concepts SD 50 time-delay system
Sansui DSD-1 Vario-Matrix synthesizer/decoder
Tapco 4400 reverberation system



A COMPARISON THAT'S NO COMPARISON.

	PIONEER SX-1250	MARANTZ 2325	KENWOOD KR-9400	SANSUI 9090
POWER, MIN. RMS. 20 TO 20,000 HZ	160W+160W	125W+125W	120W+120W	110W+110W
TOTAL HARMONIC DISTORTION	0.1%	0.15%	0.1%	0.2%
PHONO OVER- LOAD LEVEL	500 mV	100 mV	210 mV	200 mV
INPUT: PHONO AUX/MIC	2/1/2	1/1/no	2/1/mixing	1/1/mixing
TAPE MON. DUPL	2/yes	2/yes	2/yes	2/yes
TONE	Twin Tone	Bass-Mid- Treble	Bass-Mid- Treble	Bass-Mid- Treble
TONE DEFEAT	Yes	Yes	Yes	Yes
SPEAKERS	A.B.C	A.B	A.B.C	A.B.C
FM SENSITIVITY (1HF '58)	1.5 μ V	1.8 μ V	1.7 μ V	1.7 μ V
SELECTIVITY	90 dB	80 dB	80 dB	85 dB
CAPTURE RATIO	1.0 dB	1.25 dB	1.3 dB	1.5 dB

One look at the new Pioneer SX-1250, and even the most partisan engineers at Marantz, Kenwood, Sansui or any other receiver company will have to face the facts.

There isn't another stereo receiver in the world today that comes close to it. And there isn't likely to be one for some time to come.

In effect, these makers of high-performance receivers have already conceded the superiority of the SX-1250. Just by publishing the specifications of their own top models.

As the chart shows, when our best is compared with their best there's no comparison.

160 WATTS PER CHANNEL: AT LEAST 28% MORE POWERFUL THAN THE REST.

In accordance with Federal Trade Commission regulations, the power output of the SX-1250 is rated at 160 watts per channel minimum RMS at 8 ohms from 20 to 20,000 Hz, with no more than 0.1% total harmonic distortion.

That's 35 to 50 watts better than the cream of the competition. Which isn't just something to impress your friends with. Unlike the usual 5-watt and 10-watt "improvements," a difference of 35 watts or more is clearly audible.

And, for critical listening, no amount of power is too much. You need all you can buy.

To maintain this huge power output, the SX-1250 has a power supply section unlike any other receiver's.

A large toroidal-core transformer with split windings and four giant 22,000-microfarad electrolytic capacitors supply the left and right channels independently. That means each channel can deliver maximum undistorted power at the bass frequencies. Without robbing the other channel.

When you switch on the SX-1250, this power supply can generate an inrush current of as much as 200 amperes. Unlike other high-power receivers, the SX-1250 is equipped with a power relay controlled by a sophisticated protection circuit, so that its transistors and your speakers are fully guarded from this onslaught.

PREAMP SECTION CAN'T BE OVERLOADED.

Perhaps the most remarkable feature of the preamplifier circuit in the SX-1250 is the unheard-of phono overload level of half a volt (500 mV).

That means there's no magnetic cartridge in the world that can drive the preamp to the point where it sounds strained or hard. And that's the downfall of more than a few expensive units.

The equalization for the RIAA recording curve is accurate within ± 0.2 dB, a figure unsurpassed by the costliest separate preamplifiers.

THE CLEANEST FM RECEPTION THERE IS.

Turn the tuning knob of the SX-1250, and you'll know at once that the AM/FM tuner section is special. The tuning mechanism feels astonishingly smooth, precise and solid.

The FM front end has extremely high sensitivity, but that alone would be no great achievement. Sensitivity means very little unless it's accompanied by highly effective rejection of spurious signals.

The SX-1250 is capable of receiving weak FM stations cleanly because its front end meets both requirements without the slightest compromise. Thanks, among other things, to three dual-gate MOSFET's and a five-gang variable capacitor.

On FM stereo, the multiplex design usually has the greatest effect on sound quality. The SX-1250 achieves



Twin tone-control system with step-type settings, permitting 3025 possible combinations.

its tremendous channel separation (50 dB at 1000 Hz) and extremely low distortion with the latest phase-locked-loop circuitry. Not the standard IC chip.

Overall FM distortion, mono or stereo, doesn't exceed 0.3% at any frequency below 6000 Hz. Other receiver makers don't even like to talk about that.

AND TWO MORE RECEIVERS NOT FAR BEHIND.

Just because the Pioneer SX-1250 is in a class by itself, it would be normal to assume that in the class just below it the pecking order remains the same.

Not so.

Simultaneously with the SX-1250, we're introducing the SX-1050 and the SX-950. They're rated at 120 and 85 watts, respectively, per channel (under the same conditions as the SX-1250) and their design is very similar.

In the case of the SX-1050, you have to take off the cover to distinguish it from its bigger brother.

So you have to come to Pioneer not only for the world's best.

You also have to come to us for the next best.

U.S. Pioneer Electronics Corp., 75 Oxford Drive, Moonachie, New Jersey 07074



Click-stop volume control calibrated in decibels, with left/right tracking within 0.5 dB.



PIONEER®
Anyone can
hear the difference.

For informational purposes only, the SX-1250 is priced under \$900. The actual resale price will be set by the individual Pioneer dealer at his option.

CIRCLE 43 ON READER-SERVICE CARD

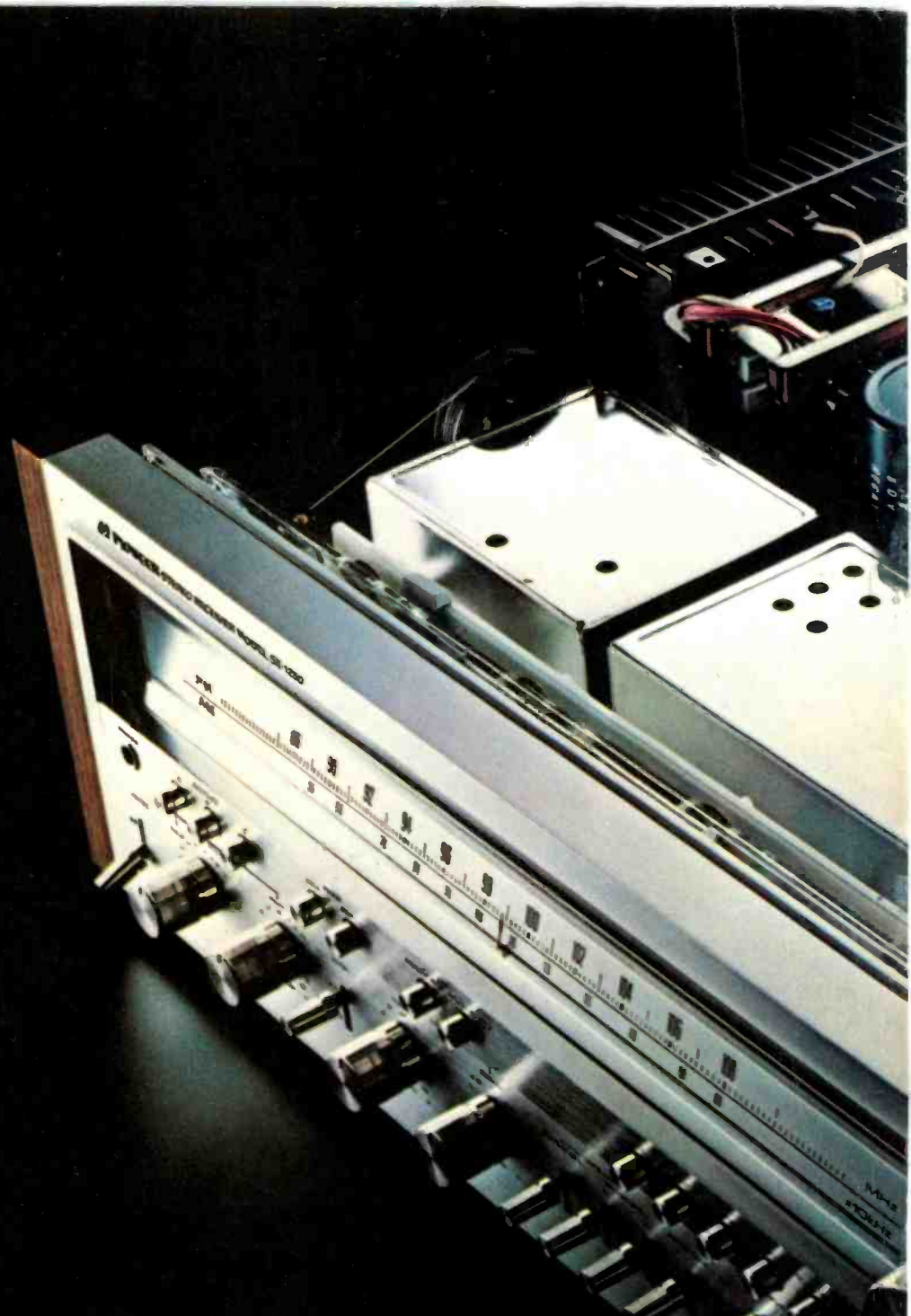

**PIONEER
HAS DEVELOPED
A RECEIVER EVEN
MARANTZ, KENWOOD AND
SANSUI WILL HAVE TO
ADMIT IS THE BEST.**

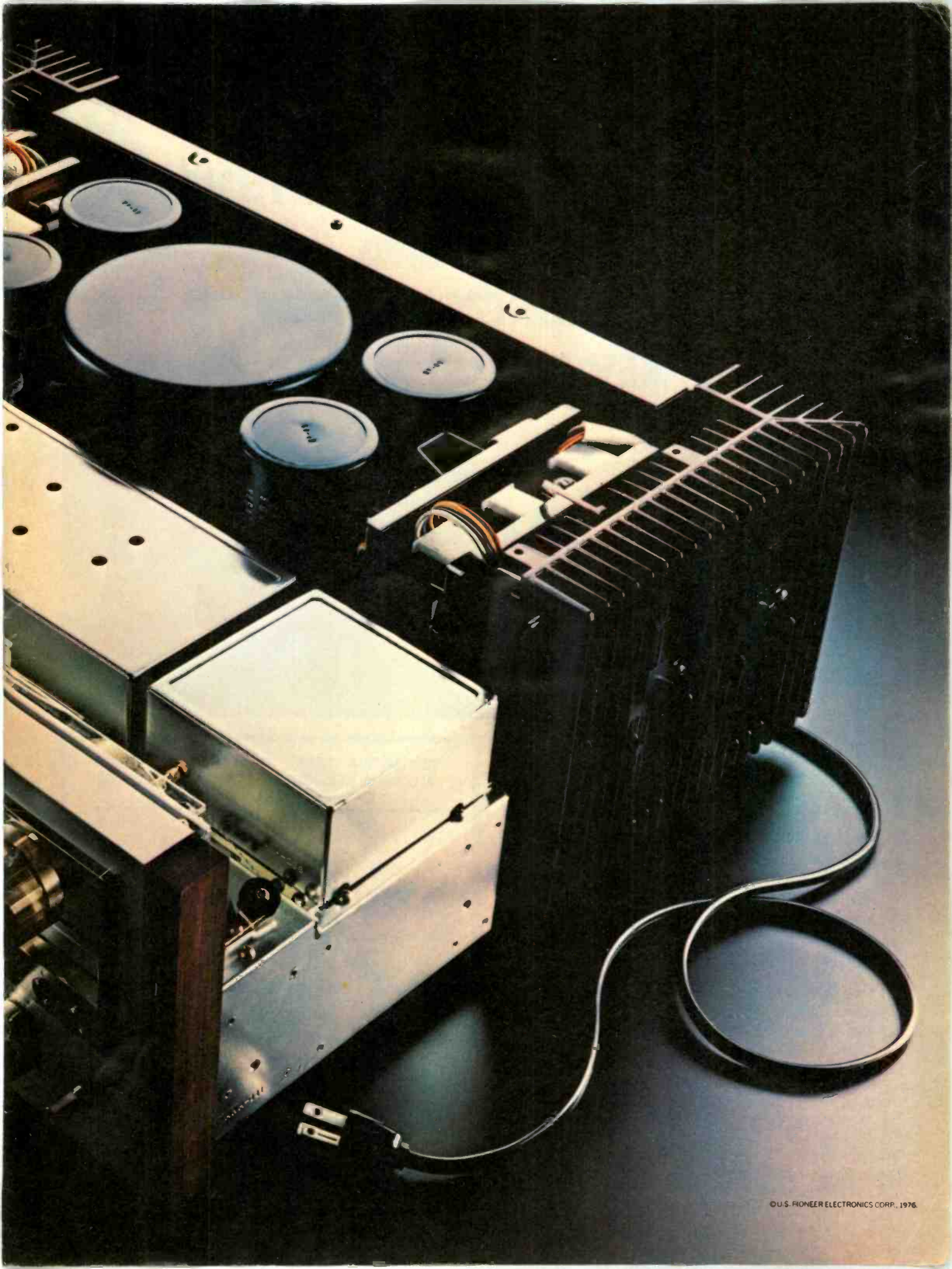

THE SOURCE OF PERFECTION **IN STEREO SOUND...** **PICKERING'S ALL NEW** **XSV/3000**



It features a totally unique construction (developed by Pickering through our pioneering efforts in discrete, 4-channel) plus a totally new stylus tip shape, the Stereohedron™, which has superior tracing ability and assures longer stylus and record life!

This new cartridge makes possible a wider, more open, finer sound — because it maximizes stereo tracing capabilities with the slightest, lightest touch a record ever had. It increases record life because force is spread over a greater contact area. And that means the least record wear achievable in these times (with a stereo cartridge).

For further information write to:
 Pickering & Co., Inc. Dept. HF
 101 Sunnyside Blvd., Plainview, New York 11803

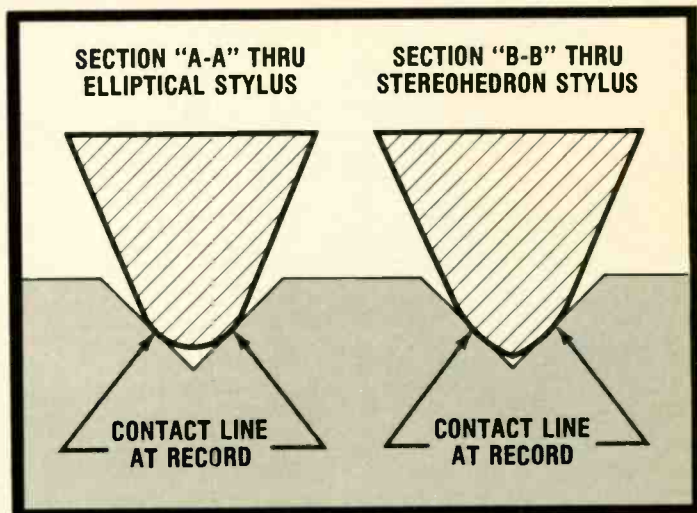

Conventional elliptical styli have a relatively limited bearing radius at the contact area with the groove. The Stereohedron combines the elliptical and Quadrahedron concepts to create a stylus having a larger bearing contact radius at the area in order to reduce stylus wear and prolong record life.



"for those who can hear the difference"

CIRCLE 42 ON READER-SERVICE CARD

HIGH FIDELITY MAGAZINE

OCTOBER 1976
VOLUME 26, NUMBER 10



HIGH FIDELITY

MUSIC AND MUSICIANS

- 4 A Repository of Recording Rights**
Leonard Marcus
- 20 When in Rome**
John Culshaw
Heat and confusion are as eternal as the charm
- 26 Johnny Mercer (1909-76)**
Gene Lees
A great lyricist, cantankerous but courageous
- 70 Back to Square One for Fisher Hall**
Hans Fantel
Full circle for the N.Y. Philharmonic's jinxed home?
- 86 The "Real" Voice of Enrico Caruso?**
James A. Drake
The tenor is data-processed; three musicians react
- 91 Melchior as Tristan**
Conrad L. Osborne
The Met's broadcast album has Flagstad's *Isolde*, too
- 94 Good/Bad News: Suk's/Du Pré's Beethoven**
Kenneth Furie
New releases do justice to one but not the other
- 96 Berryzied Beatles, Beatlized Monkees**
Mike Jahn
New and reissued discs from the Sixties favorites
- 98 Behind the Scenes**
More from Berman *Macbeth* and *Tosca* by two

AUDIO AND VIDEO

- 36 Too Hot to Handle**
- 38 News and Views**
New hope for TV sound Pickering aids antiquarians
- 40 Equipment in the News**
- 48 Sidney Harman**
Norman Eisenberg
Eleventh in a series of High Fidelity Pathfinders

53 Equipment Reports

Hartley Holton Jr. loudspeaker system
Lafayette Criterion 2005 loudspeaker system
Pioneer HPM-60 loudspeaker system
Scott PRO-100 loudspeaker system
GTE Sylvania GTE-412 loudspeaker system

60 Book Review: From Tin Foil to Stereo

Robert Long
Sams reissues an important recording history

63 Devices to Put You in the Concert Hall

Robert Long and Harold A. Rodgers
Ambience simulation can transform home listening

81 What You Should Know Before Buying a Speaker

Martin Clifford
Answers to every potential purchaser's questions

RECORD REVIEWS

91 Essay Reviews

Tristan und Isolde *Suk/Du Pré* *Beatles and Monkees*
(See Music and Musicians)

102 Classical

Bach by Chung Mozart's "Great" Mass

103 Critics' Choice—Classical

136 Lighter Side

George Benson Carly Simon Raspberries

137 Critics' Choice—Pops

140 Theater and Film

The Omen Miklós Rózsa Conducts *Missouri Breaks*

141 Jazz

John Arpin Duke Ellington Dave Brubeck

147 The Tape Deck

R. D. Darrell

ET CETERA

12 Letters

Peaks and power Welcome Culshaw Ralph Towner

44 Product Information

An at-home shopping service

47 HiFi-Croctic

106 Advertising Index



High Fidelity is published monthly by ABC Leisure Magazines, Inc., The Publishing House, Great Barrington, Mass. 01230, a subsidiary of American Broadcasting Companies, Inc. Copyright © 1976 by ABC Leisure Magazines, Inc. The design and contents are fully protected by copyright and must not be reproduced in any manner. Second-class postage paid at New York, New York, and at additional mailing offices. Authorized as second-class mail by the Post Office Department, Ottawa, and for payment of postage in cash. Yearly subscription in U.S.A., Possessions, and Canada \$7.95; in Pan-American Union \$8.95; elsewhere \$9.95. Single copies \$1.00. Subscribers: Send subscriptions, inquiries, and address changes to High Fidelity, 1 Sound Ave., Marlon, Ohio 43302. Change of address: Give old and new addresses, including ZIP code. Enclose address label from last issue and allow five weeks for change to become effective. Postmaster: Send Form 3579 to High Fidelity, 1 Sound Ave., Marlon, Ohio 43302.

A Repository of Rights

The dissolution, by order of a court in Texas, of the Arturo Toscanini Society earlier this year, combined with the current (at this writing) attempts of Congress to draft a permanent new copyright law, has brought back to mind a situation that has long bothered me. The background in the ATS case was briefly this:

After Arturo Toscanini died, his heirs, so their attorney told me, signed an agreement giving all their rights in his recorded performances to RCA, the Maestro's record company. Over the years, as the magic of the Toscanini name no longer sufficed to overcome sales resistance to his mono recordings, RCA dropped half his performances from its catalogue. Into the gap stepped the Maestro's fans, who circulated privately made tapes and discs of not only the commercially made recordings, but broadcasts and other performances. The most prominent of these unauthorized groups was the ATS. The late Walter Toscanini, Arturo's son and my longtime Riverdale (New York) neighbor, used to commend to me the ATS's activities in keeping his father's name before the public, as opposed to what he considered RCA's lack of enthusiasm. But, I was told, Walter would blow hot and cold on the subject. His sister Wanda (Mrs. Vladimir Horowitz) just blew cold at the Society, which was, after all, capitalizing on her father's artistry to make and sell recordings without authorization and without paying royalties. RCA tolerated the ATS as a cat does a moth, pouncing only when the Society had the audacity to license competitive record companies to issue "its" Toscanini recordings. So now, with the moth swatted, and all those woolen coats hanging safely in the closet, everyone can sleep a little easier.

But what about the public's right to experience these cultural documentations? Or indeed any performances unavailable on commercial records? Books and music have been copyrightable for a term of twenty-eight years, with a right to one renewal, since 1909. Recordings, not having been copyrightable until 1972 (via a provisional statute), remain under the owner's control forever. You may republish Sinclair Lewis' *Main Street* (1920) without violating any rights, but Leopold Stokowski himself could not reissue the recordings he made for RCA in 1917 without the company's permission. (Recording rights to other performances are more complex, if just as eternal. The Metropolitan Opera had to clear its 1941 *Tristan*, reviewed in this issue, with everyone from the Melchior estate to the musicians' union.)

With nearly a century of historic recordings upon us, most of them publicly unavailable, it is time to establish a Repository of Recording Rights. This public institution would assume the rights to all recorded performances, commercial or otherwise, that had been unavailable for a specified number of years; it would make these performances available to the public at a cost that would not put it into competition with commercial record companies; it would pay royalties to the previous owners; it would suspend its rights when that previous owner wishes to reissue the recording commercially (as RCA is in fact doing with Toscanini's Philadelphia recordings). Everyone would benefit.

Who would establish this RRR? Since the recordings involved will almost by definition be commercially insignificant, one cannot expect the record industry to spend much time on the venture. Nor has Congress, as far as I can determine, even touched upon the subject in its copyright deliberations. But there are foundations that could set up a repository and that could get record company cooperation. Many record collectors and enthusiasts in the industry would undoubtedly be willing to contribute their expertise in helping the initial establishment of such an institution. Not to mention the record magazines.

We certainly would.

Leonard Marcus

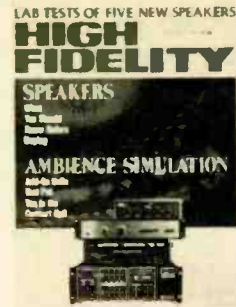

Cover: Roy Lindstrom

LEONARD MARCUS
Editor

ROBERT S. CLARK
Executive Editor

KENNETH FURIE
Music Editor

ROBERT LONG
Audio-Video Editor

HAROLD A. RODGERS
Associate Audio-Video Editor

SHIRLEY FLEMING
Editor, Musical America Section

WAYNE ARMENTROUT
Director of Production

REBECCA ABBOTT
Copy Editor

LYNDA CARLOTTA
CYNTHIA PEASE
Assistant Editors

GAIL KOOKOOLIS
Editorial Assistant

ROY LINDSTROM
Graphics Director

EDWARD GREENFIELD
European Editor

MORGAN AMES
ROYAL S. BROWN
JOHN CULSHAW
R. D. DARRELL
PETER G. DAVIS
HENRY EDWARDS
NORMAN EISENBERG
ALFRED FRANKENSTEIN
HARRIS GOLDSMITH
DAVID HAMILTON
DALE HARRIS
MIKE JAHN
PAUL HENRY LANG
GENE LEES
IRVING LOWENS
ROBERT C. MARSH
H. C. ROBBINS LONDON
Contributing Editors

MILTON GORBULEW
Senior Circulation Director

DAVID LEE
Circulation Manager

WARREN B. SYER
Publisher

From the company that's brought new thinking to speakers, come new speakers that think.

In a field where most of the leading brands have been established for decades, B-I-C VENTURI™ speaker systems have achieved eminence overnight.

In sales, where we are rapidly closing in on first place.

But, more importantly, in speaker technology.

At a time when most believed the technical frontiers had been thoroughly explored, B-I-C VENTURI speakers have been awarded two basic design patents in the space of six months.

#3,892,288 for the application of the 'venturi' principle to acoustics, which revolutionized bass reproduction.

And #3,930,561 for the BICONEX™ horn, which combined the virtues of conical and exponential flare rates.

The resulting gains in efficiency, bass response and dynamic range have established new performance/value criteria.

And, already, many long-time leaders in speaker design are attempting to follow our lead.

Thinking defined.

Now B-I-C VENTURI introduces two new high-efficiency speakers, that go on to do what no others have ever attempted.

They're called the Monitor Series.

And, by any definition, they're the first speakers that can think.

Both the Formula 5 and Formula 7 are equipped with electronic circuitry capable of taking measurements, displaying information, even initiating specific action.

For example, they can tell when your amplifier is 'clipping' and signal you.

They can warn when they're being overloaded, and protect themselves.

They can automatically adjust their frequency response to match the aural response of the human ear.

And the Formula 7 can even let you see what you're hearing.

These unique abilities elevate the loudspeaker to a new role in the stereo system. That of a system monitor, which can literally help you hear better.

Get 'clipped' no more.

Until now, there has been no way for the user to accurately identify amplifier distortion due to clipping, or the precise point at which it occurred.

But the new B-I-C VENTURI Monitor Series speakers come with a test record

that lets you pinpoint the output level at which your amplifier begins to clip the peaks of the waveform.

Each speaker has a Clipping Indicator lamp, and a control that adjusts lamp sen-



sitivity to your amplifier's maximum 'clean' output.

Once matched to your amplifier, the indicator will stay lit when clipping occurs. Lowering your amplifier until the lamp just flickers will allow musical peaks to be perfectly reproduced.

What's more, this circuit can be used to indicate speaker overload in those few instances where an amplifier has a power rating *higher* than the Formula 5 or 7 it's being matched with.

And, if overloaded, the speakers protect themselves by shutting off power to the stressed component. Individual indicator lamps (left above) signal you, and can also help isolate the problem.

Improving on nature.

One of the curious facts in acoustics is that the ideal in musical reproduction has long been 'flat' response.

Curious, because only at very high levels can the human ear hear flat. As listening levels decrease, the ear quickly loses bass and treble tones.

That's why our exclusive Dynamic Tonal Balance Compensation circuit (patent pending) was developed.

The idea is to improve on nature.

And by automatically compensating for what the ear can't normally hear, today's B-I-C VENTURI speakers bring you music that's music to the ears.

A balanced performance.

The Formula 7 takes the monitor concept an interesting step further.

A bank of Sound Pressure Level Indicators light in sequence, as speaker output increases. This visual display covers the range from 75db (normal speech) to 117db (jet engine at 70 feet).

A reference chart on the display panel further interprets the information.

Interesting in themselves, the SPL readings can also help you fine-tune your system to room acoustics, and compensate for imbalanced output levels in amplifier and tuner channels, tape heads and phono cartridges.

Tomorrow's technology today.

Once again, B-I-C VENTURI has extended the limits previously envisioned for speaker design.

These two new Monitor Series speakers take speaker technology an innovative step into the future. They establish a new, and larger, role for the loudspeaker.

And we confidently predict that they presage the speakers of tomorrow.



B-I-C VENTURI
Westbury, N.Y. 11590.
B-I-C, B-I-C VENTURI and
BICONEX are trademarks of British
Industries Co. Division of Avnet, Inc.
In Canada, C.W. Pointon, Toronto.

B-I-C VENTURI™ SPEAKER SYSTEMS
TOMORROW'S TECHNOLOGY TODAY

LOOK AT US NOW

Our Unitorque™ Motor means low wow and flutter.

We developed our exclusive Unitorque Motor to reduce wow and flutter to a remarkably low 0.025%. One of the lowest in the industry.

In simple terms, wow and flutter is a wavering in sound. And since Unitorque reduces wow and flutter, when you hear a sustained note — whether it's on a piano or bass — with the Hitachi PS/48 Turntable it is smooth. Consistent. And clean.

We achieved this breakthrough by developing an extremely accurate direct drive DC servo control motor. It utilizes a specially designed speed deviation detection system. This assures precise, virtually constant speed.

The new Hitachi PS/48 Turntable. With specs this good, it turns the tables on other turntables.



HITACHI
Believably Better

CIRCLE 23 ON READER-SERVICE CARD





Is it live, or is it Memorex?



The amplified voice
of Ella Fitzgerald can shatter
a glass. And anything Ella
can do, Memorex cassette tape
with MRX₂ Oxide can do.

If you record your own music,
Memorex can make all
the difference in the world.

MEMOREX Recording Tape.
Is it live, or is it Memorex?

©1976, Memorex Corporation, Santa Clara, California 95052

CIRCLE 33 ON READER-SERVICE CARD

COMING NEXT MONTH

Like everyone else, we've been watching donkeys and elephants make headlines as the nation undergoes its quadrennial political contest-cum-clambake. But we've kept our eye on non-headlined developments, too, and, lo and behold, as Alfred W. Myers relates in the November issue, there's **New Life in Four-Channel Sound**. Myers describes the significant improvements that have taken place in SQ, CD-4, and QS hardware and software recently. There will be **Ten Test Reports** of new equipment from Marantz, Onkyo, Shure, Stanton, Garrard, etc., etc. John McDonough and Allan Ross take us behind the scenes of the **Commercial Jingle Jangle**, the world of TV spots and their composers. There's also a profile of the "complete" pianist **Gunnar Johansen**, **High Fidelity Pathfinder Arthur M. Gasman**, **Stuart Scharf's Fifty-Buck Recording**, and more.

SOLUTION TO HIFI-CROSTIC NO. 16

[ROBERT C.] TOLL: *Blacking Up: The Minstrel Show [in Nineteenth-Century America]* Everything Foster wrote was romantic, sentimental, and emotionally moving. His fictional slaves were happy and carefree. Besides giving whites ludicrous caricatures of blacks, minstrelsy also created an idealized world with all the virtues.

ADVERTISING

Main Office: Ramon Rustia, Director of Advertising Sales, Leonard Levine, Advertising Promotion Manager, The Publishing House, Great Barrington, Mass. 01230. Telephone: 413-528-1300

New York: ABC Leisure Magazines, Inc., 130 E. 59th St., 15th floor, New York, N.Y. 10022. Telephone: 212-838-5710. Seymour Resnick, Eastern Advertising Manager.

New England: The Publishing House, Great Barrington, Mass. 01230. Telephone: 413-528-1300. G. F. Jerry Harris.

Midwest: ABC Leisure Magazines, Inc., The Publishing House, Great Barrington, Mass. 01230. Telephone: 413-528-1300. Leonard Levine, Midwest Advertising Manager.

Los Angeles: ABC Leisure Magazines, Inc., ABC Entertainment Center, 2040 Avenue of the Stars, Suite 270, Century City, Calif. 90067. Telephone: 213-553-5648. Andrew Spanberger, Western Advertising Manager.

Tokyo: Japan Advertising Communications, Inc., New Ginza Bldg., 7-3-13 Ginza, Chou-ku, Tokyo 104, Japan. Telephone: (03) 571-8748. Shigeru Kobayashi, President.

High Fidelity and **High Fidelity/Musical America** are published monthly by ABC Leisure Magazines, Inc., a subsidiary of American Broadcasting Companies, Inc., Warren B. Syer, President; I. Martin Pompadour, Chairman of the Board; Herbert Keppner, Vice President, Photographic Publishing Division; Milton Gorbunow, Vice President, Circulation; Cathleen Aloisi, Assistant to the President. Member Audit Bureau of Circulation. Indexed in Reader's Guide to Periodical Literature. Current and back copies of **High Fidelity** and **High Fidelity/Musical America** are available on microfilm from University Microfilms, Ann Arbor, Mich. 48106. Microfiche copies of these magazines (1973 forward) are available through Bell & Howell Micro Photo Division, Old Mansfield Road, Wooster, O. 44691.

Editorial correspondence should be addressed to The Editor, High Fidelity, Great Barrington, Mass. 01230. Editorial contributions will be welcomed, and payment for articles accepted will be arranged prior to publication. Unsolicited manuscripts should be accompanied by return postage.

Now learn the secrets of enjoying great music and understand the works of the masters as never before

**TIME
LIFE
RECORDS**

Great Men of Music

superb boxed collections of representative works by the greatest composers of all time, performed by the world's outstanding artists



An important secret of enjoying great composers' works is to understand the unique genius each one brings to his music. And to become so familiar with their individual styles that you can instantly identify the creator of each work you hear.

Now TIME-LIFE RECORDS, in cooperation with RCA, has developed an exciting new series which provides "total immersion" in the lives, times, musical styles of such masters as Beethoven, Bach, Chopin, Mozart, Handel and Prokofiev... and shows why they stand, for all time, as music's great men.

In each album, devoted exclusively to the life and work of one great composer, you hear outstanding selections of all musical forms in which he excelled, performed by our finest artists—Van Cliburn, Emil Gilels, Jascha Heifetz, Eugene Ormandy and the Philadelphia Orchestra, Leontyne Price, to name just a few.

Then, in a lavishly illustrated companion booklet, you'll discover facts about the composer's life, the forces that shaped his music, the people and places that surrounded him and you'll learn exactly what to listen for in his work.

Altogether you get nearly four hours of listening enjoyment on 4 stereo records, plus the illustrated booklet and rich gold-stamped slipcase and box. A collection of these albums makes not only an impressive array for your music shelf, but a magnificent addition to your music library.

To acquaint you with the series, you are invited to audition the first album, Tchaikovsky, free for 10 days. And as an added bonus, we will send you the deluxe edition of *The Golden Encyclopedia of Music* at no extra cost. Records of this calibre usually sell for \$6.98 each. The *Encyclopedia* retails for \$17.95. But as

As your introduction, you are invited to audition
TCHAIKOVSKY
free for 10 days

Hear Leontyne Price singing the Letter Scene from *Eugene Onegin*; the Boston Symphony's performance of fiery *Francesca da Rimini*. Van Cliburn recreating his performance of the *First Piano Concerto* which catapulted him into international fame, and more.

YOURS FREE

with purchase of Tchaikovsky album



THE DELUXE GOLDEN ENCYCLOPEDIA OF MUSIC

Hardbound, deluxe edition with 720-pages—a must for every reference shelf, retails for \$17.95.

a subscriber to the series you may keep this \$45.87 value for just \$17.95 plus shipping and handling as described in the reply card.

Or, if you decide against the album, return it and *The Encyclopedia* within 10 days without paying or owing anything. You will be under no further obligation. To take advantage of this free audition, mail the bound-in postpaid reply card. If the card is missing, write Time Life Books, Time & Life Building, Chicago, Ill. 60611.

The \$750 alternative.

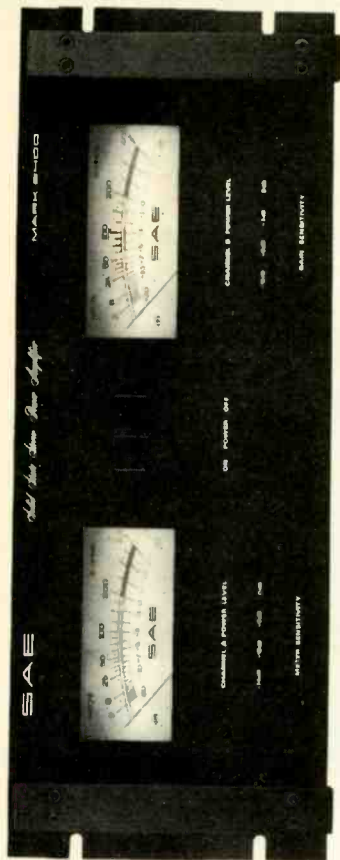

SAE 2400 Professional Dual-Channel Power Amplifier

- 200 Watts RMS, per channel, both channels driven into 4 or 8 Ohms from 20Hz to 20KHz at no more than 0.05% Total Harmonic Distortion.
 - 0.05% IM into 4 or 8 Ohms
 - (signal to noise) greater than 100dB
 - plug-in board modules
 - forced air cooling
 - only 11" deep
 - weighs less than 42 lbs.
 - superb construction using only the finest materials and component parts
 - available in black rack mount (as shown) or our traditional satin gold and black
- You'd have to look a long time to find a power amplifier that delivers this much value.



Scientific Audio Electronics, Inc. HF 1076
P.O. Box 60271, Terminal Annex
Los Angeles, California 90060

Please send me the reasons (including available literature) why the SAE 2400 Professional Amplifier is the "\$750 Alternative."

NAME _____

ADDRESS _____

CITY _____ STATE _____ ZIP _____

CIRCLE 47 ON READER-SERVICE CARD

Letters

W and Other NYC Problems

Congratulations to Leonard Marcus for his editorial about WNYC and New York in the July issue. It was a masterpiece of wisdom and insight!

Were it not for my own accidental discovery of WNYC back in 1939, I might never have been introduced to the kind of music that has become so deeply and seriously a part of my life. It all happened while twisting the dial (WNYC was sandwiched between what were then WABC and WJZ), scouting around for some children's adventure program—lo and behold, the *Masterwork Hour* was playing Dvořák's *New World Symphony*. I was lost forever, a willing captive of classical music.

And in my own case, if I may reword a line from the editorial, "Massachusetts is today reaping the cultural benefits." Were it not for WNYC, the southern Berkshire community might not enjoy Concert Party, a winter music series held at the Berkshire School in Sheffield; it might not have heard the New England debut of Lazar Berman last January; it might not be anticipating the International Chamber Music Festival, to be held [this month] in Stockbridge. My professional activities form the link between WNYC and all these events.

May the cities, towns, hamlets, and communities all over the nation, and perhaps the world, continue to reap the benefits of WNYC—the radio station with the strongest signal ever known to man!

Edgar Feldman
Sheffield, Mass.

The writer of the above letter is an impresario active mainly in Western Massachusetts.

If Leonard Marcus' sophistry-ridden plea that the rest of us buy for New Yorkers what we cannot afford for ourselves (free higher education, noncommercial radio) represents the new thrust of HIGH FIDELITY's editorial policy, then your second quarter-century will surely be less useful than your first.

It may well be that we out here in the hinterlands owe a considerable debt to the rugged souls who peopled Jamestown and Plymouth. But to the free-spending irresponsibles who now run New Amsterdam? Never!

William B. Bowman
Alliance, Ohio

Peaks and Power

Norman Eisenberg's attempt, in the June issue, to shed light on how much amplifier power is required to achieve a given sound pressure level (SPL) with a given speaker was long overdue and much appreciated. Unfortunately, a very important factor was overlooked, causing the recommended amplifier powers to be far too low.

Your standard method of determining speaker efficiency, using noise, is correct, I believe. But noise isn't music. The peak-to-average power ratio of noise is only about 4 dB; for music, the ratio is 10 to 20 dB! Unfortunately, the ear responds only to the average level in sensing loudness but, at the same time, hears peak clipping. Thus we have the worst of both worlds.

In the example given in the article, it is determined that, for the hypothetical speaker described, 6.3 watts would be sufficient to produce the desired SPL. If music were played at this level from a 6-watt amplifier, it would probably be quite distorted. (Roy Allison has shown that, depending on program source and listener, as little as 1 dB of peak clipping can be audible and annoying.) I don't think that I would be wrong in suggesting that another 10 dB be added to the recommended amplifier output to allow for the fact that music has far higher crest factors than noise.

This is the real advantage of high-power amplifiers: not that they can play louder, but that they can play cleaner. When you say to the gentleman in your June "Too Hot to Handle" column that an extra 2 dB of output power is negligible in terms of ultimate loudness, you are correct; but that 2 dB could mean all the difference in the world in getting subjectively clean sound at high volumes.

William Sommerwerck
Baltimore, Md.

Mr. Eisenberg's article did not directly address itself to the question implied in Mr. Sommerwerck's letter: how large an amplifier ought to be in order to deliver a given average power to the speakers and still rise to the occasion for peaks. But the 10 dB Mr. Eisenberg recommended you have left over for "impressing your friends" would very likely assure clean reproduction of peaks. Another way of looking at it would be to start with the fact that the worst-case peak-power capability of an amplifier is twice its continuous rating. "Derating" this figure by 10 dB to allow for peaks would mean that any amp could be expected to deliver an average power equal to 20% (about -7 dB) of its rated continuous power. For the safety of your speakers, you should remember that most amplifiers have a bit more peak headroom than this and that a clipped waveform will raise the power delivered to them.

Though Mr. Sommerwerck does not challenge us, we do want to point out that the peak factor of the noise used in rating loudspeaker efficiency is entirely beside the point as long as the meters that monitor the input and the output of the speaker respond in the same way. (In our testing they indicate average power.) The purpose of using noise as the test signal is to avoid an efficiency rating that is a function of particular frequencies, as it would be if a sine-wave signal were used.

Finally, we will stand by our statement

Still Number



...because unlike some record "care" products **Watts really works!**

Watts Disc Preener. World's most popular record cleaning tool. Simply add a few drops of Watts "Anti-Static" solution to its moistened core and *without* transferring any liquids to the record's surface, Preener cleans and preserves the grooves of your new records. Watts Preener leaves no residue to clog the stylus, which can degrade the sound quality of your favorite record.

Watts Parastat. 2 Cleaners in One. Parastat's special brush penetrates record grooves to loosen and remove dust and dirt. Ideal for records which have been mistreated with anti-static sprays. Parastat also provides cleaning action for the maintenance of new records. With a drop or two (we're not in the fluid business) of Watts "Anti-Static" solution, to the Parastat's lower pad, the proper degree of humidity is applied to relax dust-attracting static.

Watts Dust Bug. Elegantly simple in design and function, the famous Dust Bug keeps a new record clean by removing dirt and dust which may settle on the record while in use. When the red plush pad of the Bug is slightly dampened with Watts "Anti-Static" solution, which is supplied, Dust Bug provides just the proper degree of humidity to prevent the generation of static electricity. While imitated, the ultra-lightweight Watts Dust Bug has never been equalled in performance and effectiveness.



Record Care Products are distributed by:

ELPA MARKETING INDUSTRIES, INC. EAST: New Hyde Park, New York 11040 WEST: 7301 E. Evans Rd., Scottsdale, Arizona 85260

This is about as simply and as clearly as we can describe this latest achievement by Dual engineers. We could also describe the CS721 as the ultimate expression of the principles that determine the performance of tonearms and drive systems in record playback.

The tonearm is straight-line tubular from pivot to tonearm head, for lowest effective mass and greatest rigidity. It is centered within a true, four-point

The new Dual CS721. It represents everything Dual has learned about turntables.

gimbal in which the tonearm masses pivot at the intersection of both axes. This ensures dynamic balance throughout play, and turntable level is not critical.

Every critical tonearm setting has a special touch of precision.

Stylus overhang is adjustable for optimum horizontal tracking angle. Balance is vernier-adjustable. Stylus force is applied around the vertical pivot and remains perpendicular to the record even if the turntable is not level. Anti-skating is calibrated separately for all three stylus types and is self-compensating for groove diameter.

In addition to these refinements, the CS721 tonearm has an innovation to be found on no other integrated tonearm: Vertical Tonearm Control. A vernier height adjustment over an 8mm range allows this tonearm to parallel the record with cartridges of any depth and without the use of spacers. Thus, accurate vertical tracking is assured, and the effective mass of the tonearm is kept at a minimum. Another benefit: changing cartridges is much easier.

The CS721 direct-drive system is the most advanced today for record playback. It features all all-electronic, low speed, brushless, DC motor with Hall-effect feedback control and a regulated power supply. The motor's field coil design is unique. Two overlapping coil layers, each with eight coreless bifilar-wound coils, act to give a gapless rotating magnetic field. This eliminates the successive pulses of magnetic flux typical of all other motor designs.

Although the CS721 is Dual's most expensive model, it is hardly the most expensive turntable available today. When you make comparisons, as we believe you should, you may even consider the CS721 underpriced. Not to mention the even less expensive direct-drive CS704, with the same tonearm and drive system but with semi-automatic start and stop.

With either model, you will enjoy the advanced precision performance of the quietest turntable ever made.



United Audio Products

120 So. Columbus Ave., Mt. Vernon, N.Y. 10553

Exclusive U.S. Distribution Agency for Dual

CIRCLE 17 ON READER-SERVICE CARD

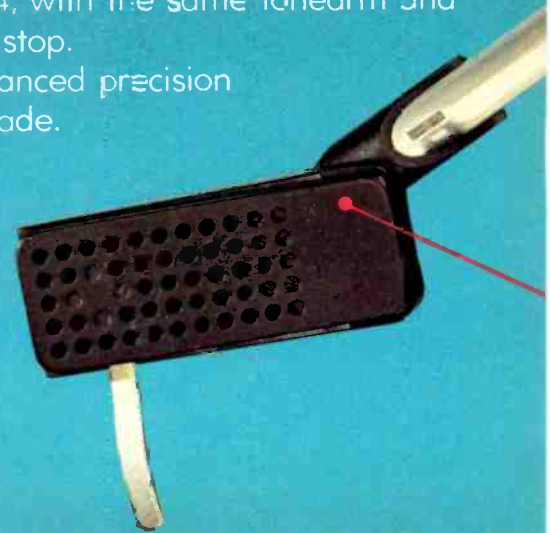

True four-point gimbal centers and pivots the tonearm mass at intersection of horizontal and vertical axes. Tonearm is dynamically balanced in all planes. The four needle-point pivots are first hardened, then lapped, a process which produces microscopically smooth surfaces.

The unique counter-balance contains two mechanical anti-resonance filters. These are separately tuned to absorb energy in the resonance-frequency ranges of the tonearm/cartridge system and chassis to minimize acoustical feedback.

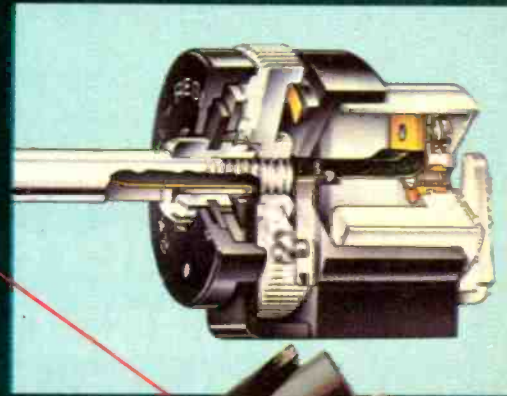

Cueing descent speed can be set from slow to rapid, and tonearm cueing height is adjustable. Result: complete control of stylus setdown via cue-control.

Vertical Tonearm Control sets and locks tonearm height at any point over an 8mm range. Tonearm thus exactly parallels the record with any size cartridge. Result: accurate vertical tracking without the added mass of cartridge spacers.

Straight-line tubular tonearm provides maximum torsional rigidity and lowest effective mass. With the same effective tonearm length and tangential tracking error any other shape must either sacrifice rigidity or increase mass.

Stylus pressure is applied via a long coiled spring centered around the vertical pivot. Pressure is always maintained perpendicular to the record even if the turntable is not level.

Fixed three-point suspension locks cartridge holder to tonearm head in identical position each time it is removed and replaced. Together with adjustable stylus overhang, this assures that correct vertical and horizontal tracking angle will be maintained.

The Dual CS721: fully automatic, single-play turntable with an electronic, direct-drive motor. Features include: Vertical Tonearm Control; variable cue-control lift height and descent speed; 10% electronic pitch-control for both speeds (33 $\frac{1}{3}$ and 45 rpm); illuminated strobe; dynamically-balanced 12" platter; cue-control viscous-damped in both directions; continuous-repeat.

Price: less than \$400, including base and dust cover. Dual CS704: similar, except semi-automatic. Ingenious mechanical sensor locates lead-in groove of 12" and 7" records; tonearm lifts and motor shuts off automatically at end of play. Less than \$310, including base and dust cover.

Fully-automatic, single-play/multi-play Duals: 1225, less than \$140; 1226, less than \$170; 1228, less than \$200; 1249, less than \$280. Semi-automatic, single-play Duals: 502, less than \$160; 510, less than \$200.

With the Dual Auto/Reverse Deck, a C-90 cassette will play back for ninety uninterrupted minutes. You don't have to remove and flip the cassette for the second forty-five minutes unless you want to. Any cassette can also be set to play indefinitely until you shut it off. What's more, the Auto/Reverse Deck records in both directions. Mechanics and electronics reverse at the touch of a button. The record/playback head never moves, so there is no problem of misalignment, the bane of previous reversing decks.

Now there are two cassette decks with Dual precision.

With the new Dual C919, you can take an especially creative approach to recording. Tape, disc or radio can be mixed with live material recorded via microphones.

Separate microphone and line-input level controls for each channel let you intermix all four inputs. There are also separate level controls for each headphone channel. Output level controls match the tape deck output to other program sources; there's no need to readjust volume settings when switching programs.

So much for convenience and versatility. What about performance? The C919 is too new for test reports, but it has the same motor, tape-head and electronics as the Auto/Reverse Deck, which has been reviewed, such as in *Audio* magazine:

"...another outstanding example of the great strides in cassette deck technology in recent years. Wow and flutter was indeed extremely low...measuring 0.065% (WRMS)...total harmonic distortion during playback (at 1 kHz) of 1.4%, well below the 2.0% claimed by the manufacturer...The fast-wind mechanism...is about the fastest and smoothest we have encountered...We also checked a couple of C-120 cassettes and found that the Dual deck was able to handle them smoothly....A distinct feeling of quality...seems well worth the price."

That's the caliber of performance you can expect with either Dual deck. All you have to decide is how much convenience and versatility you also want.

United Audio Products

120 So. Columbus Ave., Mt. Vernon, N.Y. 10553
Exclusive U.S. Distribution Agency for Dual

Dual[®]

The Dual Auto/Reverse.



The Dual C919.



Additional features of the Dual cassette decks: Common to both models: Viscous-damped cassette eject, inter-mode switching, 60 second rewind for C-60 cassette, *Dolby noise reduction system, professional VU-meter ballistics. Auto/Reverse only: Automatic bias switching, switchable ALC, Dolby oscillator and calibrators. Less than \$530. C919 only: Memory stop, FM Dolby, three-way bias and equalization. Less than \$450.

*Dolby is a trademark of Dolby Laboratories, Inc.

that 2 dB of extra power is virtually negligible. If amplifier A will produce a given sound pressure level without clipping peaks, amplifier B with the same relative headroom and 2 dB less output power will produce peaks just as cleanly as long as the SPL is also kept 2 dB lower.

How Much Is Twice as Loud?

It's amazing and discouraging how often the wheel has to be reinvented, and so often in an inoperable version. In "How Loud Are Your Speakers?" (June), Norman Eisenberg states that a two-to-one ratio of loudness requires approximately a 10-dB change in power. This is a subjective matter, which was investigated in great depth some fifty years ago. The results showed that loudness perception is a pressure-related phenomenon, rather than an energy-related one, and that a two-to-one change in loudness might be expected to require a 6-dB change in pressure (intensity). However, the average of numerous tests with many subjects yielded a figure somewhat less than 6 dB. The difference possibly relates to the low- and high-frequency compression of the equal-loudness/intensity curves. In any case, the order of a 5.5- to 6-dB increase in intensity for a judgment of "twice as loud" is still widely accepted.

Herman T. Carter
Madison, N.J.

As Mr. Carter indicates, the subjective perception of loudness is a function of frequency as well as of sound pressure level. Whatever the merits of the 5.5- to 6-dB figure, it is an average over the entire frequency spectrum. An amplifier cannot average to cover both the cases in which it coasts comfortably while doubling loudness and the cases in which it might be overdriven, but goes into clipping in the latter instead. Therefore the choice of 10 dB as a working "worst-case" figure for amps to insure that "twice-as-loud" requirements will be met seems entirely prudent to us.

Welcome, Culshaw!

I don't know whose happy inspiration it was to acquire the services of John Culshaw for a monthly column, but I heartily welcome his contributions. I have enjoyed each and every one of them, especially "Buried Treasure" (July). I would like to know, however—since Mr. Culshaw fails to mention it—when and on what label the Victor de Sabata set he discussed will be issued. De Sabata recordings seem to be in the same category as hen's teeth. Besides the Angel Tosca, the only other U.S. release in the recent past was the short-lived Heliodor disc (2548703) of the Brahms Fourth and Kodály's Dances of Galánta, with the Berlin Philharmonic, recorded in 1939. To collectors, general availability of his Eroica and others of the shorter pieces Mr. Culshaw mentioned would indeed cause "dancing in the corridors."

Mark W. Kluge
East Peoria, Ill.

Though London Records is considering release of the Eroica and other recordings Mr. Culshaw dealt with, no definite decision had been made as we went to press.

Ralph Towner

We were thrilled to see Morgan Ames's ecstatic review of Ralph Towner ("The Lighter Side," July), as we have been hoping for a solo album by this fine musician ever since we first heard him. The Gary Burton-Towner combination sounds like a great one, and it will be a pleasure to hear these albums.

However, Ms. Ames made no mention of Towner's previous association with Paul Winter, and it is our feeling that this experience should not be missed by any music lover. We were privileged to hear this group on the road twice, at the University of North Dakota, and found them unclassifiable and unique—a combination of musicians that just couldn't miss. The Winter

Consort released several albums in the early Seventies, the best of which is "Road" (A&M SP 4279), featuring Towner prominently. Other musicians were David Darling on cello, Paul McCandless, double reeds, Collin Walcott, consummate percussion, and Glen Moore, bass. We were sad to see these guys split up, but it's wonderful to hear again from Towner, at least.

Bruce and Becky Miller
East Wenatchee, Wash.

Columbia/Melodiya's Ilya

I have delayed writing until now about the new Columbia/Melodiya recording of Glière's *Ilya Murometz* Symphony under Nathan Rakhlin, and R. D. Darrell's review

How to be an audio architect

Design exactly the hi-fi system you want. Build with Crown components to provide precise control, monitoring and selection for your ultimate listening pleasure. Let us send you the complete specifications.



Select 8 inputs. IMD .002%

IC-150A. The new, improved Crown stereo pre-amp. Inputs include front panel jacks. 31-step precision loudness control. Exclusive panorama control. ISO loudness compensation. THD below .05%, S/N down 105 dB, IHF "A" weighting.



Select crossover points.

VFX-2. In bi-amp systems, select and change crossover points to fit your speakers and listening area.



Meters show clipping level.

OC-150A. The Crown stereo output control. Peak-reading or peak-sample-and-hold meters show precise clipping levels. Switch three pairs of speakers with front panel push-buttons. Two headphone jacks.

Fast playback coupon

Send directly to Crown for specs on control centers.

Name _____

Address _____

City _____

State _____ Zip _____



CROWN

Box 1000, Elkhart IN 46514

HF-7

CIRCLE 12 ON READER-SERVICE CARD

of it (March), as I was expecting some expert on turn-of-the-century Russian music to vent his spleen before I did. I am not such an authority, but I do possess a Soviet reprint of the score. And as Stokowski's *Ilya Murometz* on Capitol [currently available on Seraphim—Ed.] was the first LP I bought as a child with my own saved-up pocket money, I have a special affection for this curious masterpiece and was trembling with anticipation on seeing Columbia's ad for a new recording of the "complete" work.

Unfortunately it turns out to be no such thing, being not only heavily cut, but substantially reorchestrated in places. Unwritten harp glissandos and other paraphernalia abound, and the extraordinary contrabassoon solo that characterizes So-

lovei the Brigand in the second movement has been doubled (and therefore drowned) by a tuba throughout. I do not propose to tabulate all the cuts here, but I think Eugene Ormandy's RCA recording actually gives almost as much music as Rakhlin, who restores much of the most repetitious music but unconscionably cuts some very important passages, notably much of the climax of the first movement and most of the enormous (and beautiful) buildup of the slow movement, which is virtually complete in the Ormandy.

In some ways I feel that Stokowski's truncation of the work to something like half-length, though deplorable, is much more sensitively done than Rakhlin's excisions, which sometimes take the form of a cutoff, short pause, and segue into an unre-

lated section. Without knowledge of the score, it is virtually impossible to detect where Stokowski cuts, so skillful is the dovetailing. In any case, the Scherchen/Westminster remains the only complete version in the catalogue, and Ormandy's the best played and most representative cut version.

Oliver Knussen
Tring, Herts., England

Mr. Darrell replies: I stand gratefully corrected—and disillusioned. It's hard to accept that the astronomical (if not necessarily heavenly) length of Rakhlin's *Ilya* isn't complete after all, especially hard for anyone who, like myself, lacks Mr. Knussen's advantage of access to a printed full or study score. My memory of the 1952-53 mono Scherchen/Westminster uncut recording certainly isn't dependable enough to show up all the Stokowski (RCA Victor mono and Capitol/Odyssey stereo) and Ormandy excisions, let alone any of which Rakhlin now stands accused. And whenever I'm not reliably backed by the authority of official scoring specifications, I hesitate to guess to what extent aurally obvious differences between various recorded versions are composer-sanctioned alternatives or revisions and to what extent they are individual conductors' revisionist finaglings of the sort for which Stokowski is particularly notorious.

Turner's Lassus

I love old music and am writing so that others may not be put off by S.T.S.'s review of Bruno Turner's recording of the *Penitential Psalms* by Lassus (Archiv 2533 290) in the May issue. Your reviewer says, "The uniformity of tempos and volume levels . . . does nothing to alleviate the austere boredom of the whole."

This is spiritual music; it does not want variety and interpretation in performance. It wants beauty of line and phrase, and soulful singing. Turner's record has all these and more: It has the taste and sensitivity to let the music of this great master speak for itself.

Richard Reichman
Sante Fe, N. M.

One man's spirituality is another man's dullness (or woman's, rather—S.T.S. is Susan Thiemann Sommer). Whether, as Ms. Sommer suggests, the trouble lies with the composer or the conductor, the psalms, for her, were "not very appealing living-room listening."

Thomas Igloi

Please make mention of the sad circumstance of the death of Thomas Igloi, the wonderful twenty-nine-year-old cellist who studied with Casals and Fournier. I came to know his playing via his epochal recording of Schubert's Quintet in C with the Albern Quartet (CRD 1018); the teamwork of the five is unbelievable. What a loss to the world of music.

Ronald Pataki
Jersey City, N.J.

Ohm's Law #4

It is possible to make a loudspeaker that doesn't sound like a loudspeaker.



Traditional loudspeaker design states that a small driver can't reproduce bass notes, and a large driver can't reproduce high notes. So most loudspeakers use two or more piston-like drivers of varying sizes (woofers, midrangers and tweeters) to achieve wide frequency response.

Unfortunately, large drivers respond slower to the audio signal than small drivers. So "time delay" distortion is added to the music.

And time delay distortion is what makes a loud-

speaker sound like a loudspeaker.

But Ohm F loudspeakers boldly defy the traditional laws of loudspeaker design.

They employ a *single* patented Walsh Transmission Line Driver that not only reproduces all audible frequencies, from the lowest lows to the highest highs, it does it without adding time delay distortion to the music.

That's why when you listen to music with Ohm F loudspeakers, you hear the *music* . . . not the loudspeakers.



We make loudspeakers correctly
241 Taaffe Place, Brooklyn, N.Y. 11205

CIRCLE 39 ON READER-SERVICE CARD

If our tape sounds bad on your hi-fi system you need a better hi-fi system.



Maxell tapes are the best way to see just how good or bad your hi-fi system is. Because Maxell tapes are made to stricter standards than many hi-fi systems.

To begin with, only the highest quality materials go into Maxell tapes. The finest polyester, screws, hubs and pressure pads.

Every batch of magnetic oxide we use gets run through an electron microscope. If every particle isn't perfect, the sound you hear won't be either.

Since even a little speck of dust can make a difference in what you

hear, no one gets into our plant until they've been washed, dressed in a special dust free uniform, even vacuumed.

The fact that we're such fanatics about making Maxell tapes pays off for you, in the enjoyment of superior sound. And in the Maxell guarantee.

Which says if you ever have a problem with any Maxell tape, send it back and we'll send you a new one. No questions asked.

Naturally, a product this good doesn't come cheap. In fact, a single reel of our best tape costs more than

many inexpensive tape recorders.

So if you don't have a good hi-fi system, save yourself some money and buy cheaper tapes.



Maxell. The tape that's too good for most equipment.

Maxell Corporation of America, 130 West Commercial Ave., Moonachie, N.J. 07074

RTR unveils aesthetic sound

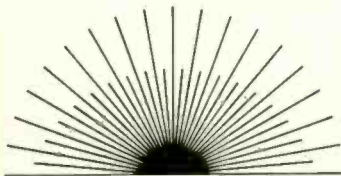

with the EXP bookshelf system
In a typical listening environment, the bookshelf speaker is a perfect design entity. It fits logically, aesthetically within a room. If only the sonic coloration could be eliminated, it would be an ideal loudspeaker.

Now RTR unveils audiophile bookshelf speakers for those who take their music seriously.

The EXP series delivers pure musical reproduction. Free of coloration, full of transparency, they reflect the most critical RTR standards. Wide-band tweeter exhibits the best transient performance from 1,000 to 15,000 Hz of any dynamic tweeter. Woofers deliver hair-line delineation coupled with natural boom-free bass.

All in a bookshelf package and price. Hear a pair of EXP's at your franchised RTR dealer.

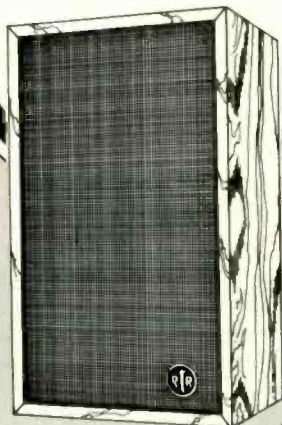
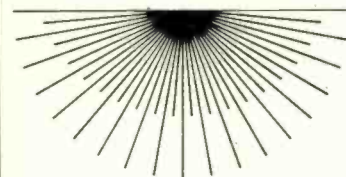

For dealer list and specifications, write
RTR, Dept. HF, 8116 Deering Ave.,
Canoga Park, CA 91304.

CIRCLE 46 ON READER-SERVICE CARD

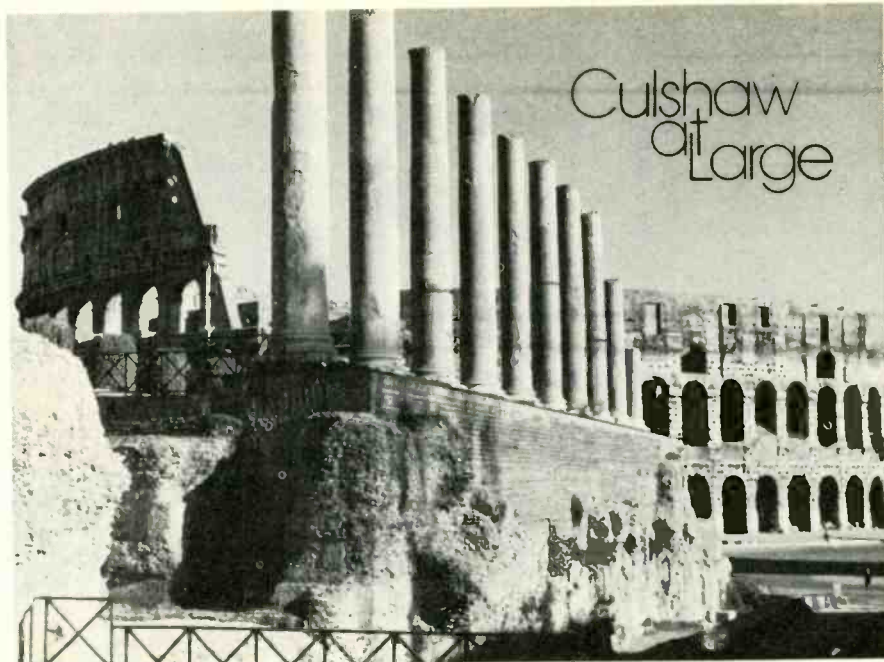

When in Rome

by John Culshaw

ONE NEVER NEEDS a reason for writing about Rome. It is simply there, and if you have been involved with the Eternal City, however spasmodically, you know what can happen. All sorts of things happened to me there, and although most of them were pretty uncomfortable I still think of the place with an affection that by far exceeds my memories of Vienna or Amsterdam or Paris. For the life of me I really don't know why, because it was insufferably hot, the working conditions were appalling, and the Italians are without question the second noisiest people on earth—the first being the Israelis, who, adore them as I may, somehow manage to talk, sing, crash cars, break windows, and rattle garbage containers at a decibel level that would shame the loudest Roman into silence.

My first experience in Rome was in the early 1950s, when there was that flurry of effort to record as many Italian operas as quickly as possible. Those were the golden years of Tebaldi. But at that stage I was not involved with the operas, and my miserable brief was to record whatever else was going on, which meant working between the operatic sessions. Of course the only reason for working in Rome at the height of the midsummer heat was simply that artists tended to be easily available at that time. I must add that the Accademia di Santa Cecilia, which was where we worked,

was not air-conditioned; so, sitting in our undershirts, we cursed the heat and the flies and the Italian maniacs rushing past every few minutes on motor scooters from which the mufflers had been removed. What we were trying to do was to record the New Italian Quartet.

My tape operator on that occasion was a man who said very little during sessions, though from time to time he had an endearing tendency to talk affectionately to his tape machine, a great green monster known as the BTR 1. I recall one particular day when we were trying to record a Beethoven quartet in a temperature more suitable for baking a pizza, and it happened the leader of the New Italian Quartet got stuck. He had a four-measure solo phrase that for some reason or other he simply could not play. We did take after take to no avail. Apart from wrong notes, nothing came out of the studio except Italian curses of mounting vehemence; and nothing came out of the control room except my escalating take numbers. I think I had reached Take 43 or thereabouts when the tape operator gave a long sigh. "Never mind," he said to his BTR 1, "in twenty years' time it'll be the Old (expletive deleted) Italian Quartet."

Later, my task in Rome was much more that of a troubleshooter than a producer; indeed, the only complete operas I ever produced there were the

look up to Realistic!®

You'll be surprised. Everything about the new Realistic Optimus® T-100 was designed with the discriminating music lover in mind. Tower design puts the speakers at perfect height, without special mounting or stands. Two active 8" acoustic suspension woofers and a 3" tweeter deliver sound so natural you can feel as well as hear its richness. Unlike many large high-performance speaker systems, the T-100 is efficient enough to be driven by almost any hi-fi equipment without pushing the amplifier, yet has the capacity to take 75-watt program peaks. The 3-ft. high, walnut veneer enclosure is finished on all sides to simplify placement and add fine furniture elegance. Sold only by Radio Shack. Ask for 40-2025 or find out what "towering sound" sounds like — today! **139⁹⁵***

Smart styling that's practical, too



Grille removes for easy speaker balance adjustment



Bottom-mounted terminals — speaker cables remain out of sight

Radio Shack®

A TANDY CORPORATION COMPANY

OVER 5000 LOCATIONS • 50 STATES • 9 COUNTRIES

*Retail price may vary at individual stores and dealers.



FREE!

164-page 1977 catalog. Full color. See what's really new in electronics. Get your copy now at our store near you.

New. Diverse. Consistent.

The instruments in this advertisement are new and diverse. They are also selective, deliberately. This is consistent with our attitude — to make components only where we feel we have something to contribute. Then, to give them the finest expression of which we are capable.

Our 330c stereo receiver is the most recent in a series that opened the world of true high fidelity to the music lover with a modest budget. Its predecessor, the 330B, earned extraordinary reviews and recommendations from the leading magazines and the most respected consumer organizations. Nevertheless, when improvement was practical, we replaced it.



The 330c has increased power, tighter phase linearity and wider bandwidth than its immediate predecessor. Yet it is offered at virtually the same price as the original 330, introduced seven years ago.

In its review of the HK1000 stereo cassette deck, *High Fidelity* said, "The HK1000 is the best so far . . . A superb achievement."

We've gone beyond it.

With the HK2000.

Performance specifications of the HK2000 are impressive. For example, wow and flutter: 0.07% (NAB) WRMS. The HK2000 is so sensitive to low frequencies that a subsonic filter has been incorporated which can be used to remove unwanted signals from warped records. But just as in all

Harman Kardon amplifiers and receivers, wide band design in the HK2000 produces sound quality that transcends its impressive specifications.

When we introduced our straight line tracking turntable, the ST-7, it was recognized at once as the definitive way of playing records. Precisely as the master was recorded. Without tracking error. Without skating.

The ST-7 was designed for the music lover who had to have the very best—and could afford it.

The ST-6 now joins the ST-7. Straight line tracking, with the demonstrable benefits it offers, is now available to a wider audience—without compromising performance.

The two turntables are virtually identical in appearance and operating capability. They use the same tonearm and straight line tracking mechanism. They are both belt driven and use the same platter and support bearing. Yet the ST-6 is available for little more than the cost of a deluxe record player of conventional design.

We'd like to tell you more about our new instruments and, equally important, about the point of view they represent. Write to us directly—without impersonal reply cards or coupons. We'll respond in kind with full information.

Harman Kardon, 55 Ames Court, Plainview, New York 11803.



harman/kardon

The great impostor.



If you love beautiful music, but haven't been able to find any speaker system that could reproduce it the way you think it should sound, Koss has a special treat for you.

Because Koss engineers have created a unique

3-way electrostatic and dynamic speaker system that will defy even the expert's vision of electrostatic perfection. Indeed, if the Koss Model One was perfect, the Koss Model Two is the world's greatest impostor.

But then, imagine a smaller, more compact version of the Koss Model One offering a room full of electrostatic sound unmatched by any other hybrid speaker system. You'll hear an electrostatic array of bass and mid-range panels that respond precisely to the deep, rich power of a pipe organ and to the brilliant charge of the brass section. And for delivering the crystal clear notes of a piccolo, Model Two's dynamic tweeter features a vertical and horizontal displacement through 12kHz to cover an included angle of 120°.

But most important of all is the way Koss engineers

developed a revolutionary new crossover system that brought the unique Model Two system together. A system so unique that it successfully combines dynamic element performance

with the finely tuned precision of electrostatic panels to produce the smoothest crossover network ever. And that means musical reproduction that's virtually distortion-free, with a close-up, transparent sound like no other speaker of its kind. A speaker that's clean and sharp, with bass and mid-range tones that resound with power and highs that are unquestionably brilliant.

So if you want to hear a speaker system that sounds almost as good as the one that came before it, ask your Audio Specialist for a live demonstration of the new Sound of Koss. Or write for a free full color brochure on the Koss Model One and Model Two Speakers, c/o Fred Forbes. After all, when you've kept the electrostatic promise anything else must be an impostor. Even if it's Model Two.

© Koss Corporation

from the people who kept the electrostatic promise

 **KOSS**® Model Two Electrostatic speakers

KOSS CORPORATION, 4129 N. Port Washington Ave., Milwaukee, Wisconsin 53212 • Koss International/London, Milan, Dublin, Paris, Frankfurt • Amsterdam • Koss Limited/Burlington, Ontario

CIRCLE 28 ON READER-SERVICE CARD

RCA *La Gioconda* and London's first *Ballo in maschera*, conducted by Solti. The troubleshooting began with the Tebaldi/Serafin *Butterfly*, for the producer and the schedule were in a state of almost total collapse by the time I got to Rome. I spent a day wrestling with the schedule until it became clear that there was literally only one way to save the recording, which was to go for extremely long takes with almost no hope of revisions. Faced with the prospect of royalties disappearing over the horizon, the artists stopped grumbling about the heat, and *Butterfly* was finished, though only just.

A similar situation was to arise several years later with the Nilsson/Correlli/Maazel *Tosca*, also of course in Rome, and once again I was summoned there. But the problems with *Tosca* were compounded by an attempt to make highlights in German at the same time, with Anja Silja replacing Birgit Nilsson and James King replacing Franco Corelli. (Some lunatic in Hamburg had thought that one up.) It was not exactly the happiest of assemblies, and tensions were at their height when it came to the final scene of Act III, which was made first in Italian with one cast and then repeated in German with the other. Nilsson insisted on coming into the control room to hear King's execution and Silja's final line, "O Scarpia, avanti a Dio!", just before she leaps from the parapet. Well, for some reason she didn't sing it. Nothing but a deadly silence came from the studio. "Ach!", Nilsson said with evident delight, "so she has chumped already!"

As for my own direct experience as a producer in Rome, I can vouch that it is an activity only for the brave. On one occasion I committed an appalling act. At the very moment when we had a crisis in the control room—the mixer had burst into flames, I think—Renata Tebaldi, on-stage, asked for a cup of tea, and the general manager of Italian Decca refused to take it to her on the grounds of *bruta figura* (which roughly means loss of dignity). So, stepping completely out of character, as those who know me will rush to confirm, I threw a full orchestral score at him from close range, which only goes to show that everyone becomes a different person when in Rome. That tape operator never talked to his BTR 1 in Geneva or Paris or Stuttgart, and whoever heard of Birgit Nilsson making snide remarks about her colleagues in New York or Vienna or London? Perish the thought. As for me, it is positively the only time in my life that I have thrown a score at anyone.

And I missed. ●

BSR. Finally, turntables worth building your whole system around.

When most people consider buying a stereo component system, they usually build it around either the receiver or the speakers. But when serious music lovers choose a system, they should think of the turntable first. Because the turntable dictates what comes out of the speakers. And when it comes to turntables, BSR offers more than Dual, BIC or Garrard.

First of all, the new BSR turntables are *belt-driven*, so they're engineered to be smooth, quiet and virtually trouble-free. They play automatically *and* manually. And to really turn the tables on our competitors, BSR includes the revolutionary ADC induced magnetic cartridge, the base *and* the dust cover in the price of the turntable.

BSR gives you still more. Like a *locking umbrella spindle*

that holds up to six records. A rotating single play spindle. A continuous repeat spindle so you can play your favorite record over and over again. And a *viscous damped cueing mechanism* that's smooth and precise to help protect your records.

What's more, BSR turntables are *pre-tested and pre-assembled*. So you can get down to the serious business of listening to your favorite music right away. And also enjoy another special feature; the price.* Under \$140 for the 200 BAX, \$110 for the 100 BAX and under \$100 for the 20 BPX automated single play turntable.

If you consider yourself a serious music lover who wants brilliant sound reproduction, consider BSR first. For full details see your dealer or write: Consumer Products Group, BSR (USA) Ltd., Blauvelt, N.Y. 10913.

*Suggested manufacturer's retail prices including ADC induced magnet cartridge, base and dustcover.



BSR THE HEART OF YOUR SYSTEM.



CIRCLE 16 ON READER-SERVICE CARD

A SHINING ERA in American popular music is almost ended. The great songwriters are dying off. And with the record and radio industries having supplanted the stage and movies as the most powerful sources of such music, the conditions that encouraged greatness have passed.

The latest to leave us is Johnny Mercer. He was a hero to me from adolescence onward, and when we became friends it was, perhaps inevitably, through a song—one for which I wrote the lyrics. Mercer sent me a letter saying, "A couple of days ago I heard a song called 'Someone to Light Up My Life,' and today I went out to buy the album to discover who wrote it, and guess what? That is some elegant song. It made me cry. I can only tell you that I wish I had written it."

I framed the letter, for I could imagine no greater compliment. Mercer was, all things considered, the greatest of American lyricists.

John was an odd sort of duck, cantankerous and kind, humorous and morose, a combination of poetry and bitterness. He kept the bitterness out of his work, however: You will find no trace of it in the lyrics, although there is often a sardonic self-mockery, as in the lines "when an irresistible force, such as you, meets an old immovable object, like me. . . ." It is not true that art is always expressive of the artist's self. The great artist usually wants to transcend himself, to rise above the paltry elements that inhere in every personality.

John's wife, the former Ginger Meehan, a dancer in the Garrick Gaieties when he met her and a marvelous woman always, said once, "We've had a wonderful life. We've never had to want for anything. I don't know why Johnny complains." Once on a television show, asked what it was like to be married to a man of John's stature, Ginger blurted out, "It's just hell." She quickly amended this, saying that it was difficult to live with a man who worked at home and was always wandering the house in an anguished search for ideas.

Mercer said once, "I tried to be a singer and failed. I tried to be an actor and failed. So I just naturally fell into lyric writing." The statement is not precisely accurate. True, he did not get into the Garrick Gaieties when he auditioned (the producer bought a song of his instead), but he was quite successful as a singer, with his own radio show and a series of delightful recordings that included "In the Cool, Cool, Cool of the Evening," "On the Atchison, Topeka, and Santa Fe," "Li'l Augie Is a Natural Man," and "Any Place I Hang My Hat Is Home,"

Johnny Mercer (1909-76)

Johnny Mercer

Greatness Was Too Easy

by Gene Lees

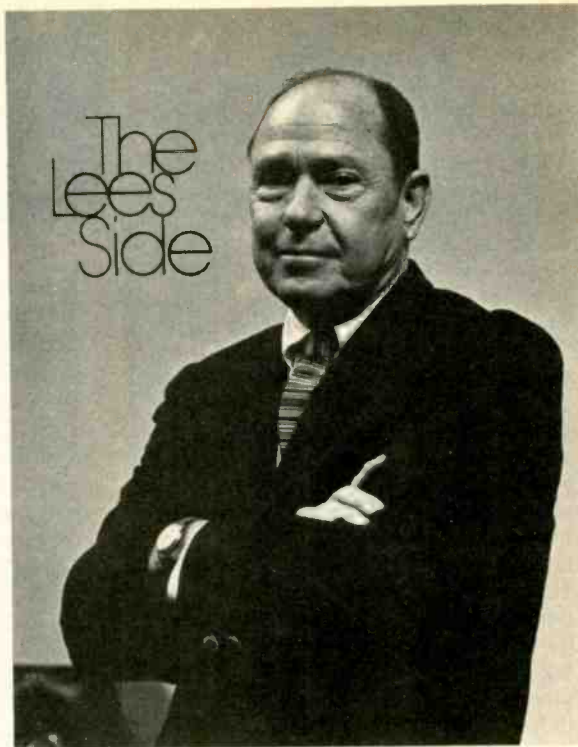

all of which he wrote. Perhaps he questioned his success as a recording artist because he was an owner—once the president and one of the founders—of the Capitol Record Company. Thus no one could nay-say him. Actually, his singing had a highly personal charm. It was bright, flippant, casual, and quite his own.

That he had achieved a giant's stature in lyric writing—I hesitate to use the word "poetry," for both Mercer and I thought lyric writing the higher and more difficult craft—apparently never compensated for the fact that he had not been the singer he wanted to be. This is a common songwriter's neurosis. Harold Arlen, with whom Mercer wrote some brilliant songs, including "That Old Black Magic" and those in the score of the musical *St. Louis Woman*, aspired only to be a singer. Antonio Carlos Jobim (the music for "Someone to Light Up My Life" was his) remarked once, "The problem is that we do not take seriously the talents that come easiest to us." Although lyrics sometimes came hard to Mercer (the superb "Skylark" was written over a period of a year), he had extraordinary facility. "Days of Wine and Roses" took five minutes. Hilaire Belloc wrote, "It is the best of all trades to make songs, and the second best to sing them." Stubborn to the end, John saw it the other way around.

It is possible to have technical skill without being a great artist, but it is doubtful that one can be a great artist without having technical skill. Mercer

had it all—the technique, the sensitivity, the imagery, and a wide emotional range. He could be humorous, as in "Something's Gotta Give" and "I'm an Old Cowhand," for which he wrote both music and lyrics, and poignantly gentle, as in "When the World Was Young" and "Once Upon a Summertime." Both the latter are French melodies, as was another of Mercer's important songs, "Autumn Leaves." He was able to create in English the feeling, flavor, and character of a French lyric. I was amazed to learn that he knew no French.

"Days of Wine and Roses" is a particularly interesting lyric from the standpoint of craft. It consists of only two sentences, into which Mercer packed all the melancholy surprise that comes to anyone who realizes that he's growing older and that much of life is irretrievably gone. And watch how he plays with sound at the end of "Emily": "As my eyes visualize a family, they see dreamily Emily too." An executive who didn't understand what John was doing changed that in the printed music to "... family, they see Emily, Emily, too." Mercer was furious.

To understand him and his work, it is necessary to keep in mind that he was from the South. He was a Georgia boy of Scottish ancestry, born in 1909 in Savannah. (Although he lived mostly in California, he kept a home in Savannah and his ashes were buried there.) The South, like the Celtic countries, drips poetry.

Continued on page 30

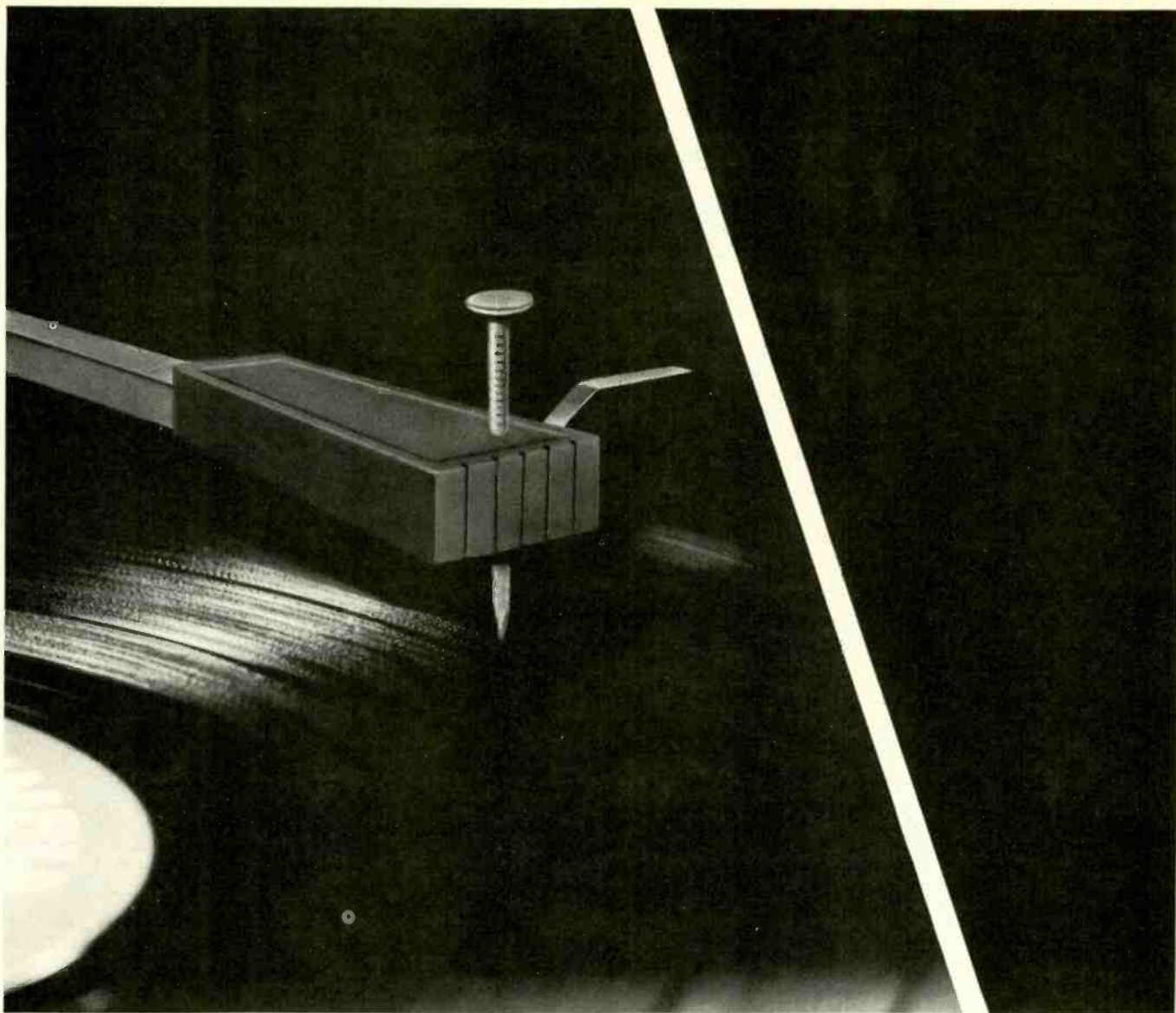

This is no way to nail down a hi-fi bargain.

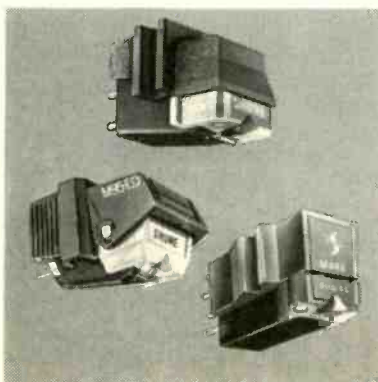

Some stores think that one of their cost-cutters in assembling a "bargain" stereo system is to install a run-of-the-mill, inexpensive cartridge. After all, who's going to notice a tiny cartridge when it's surrounded by powerful speakers and a dynamite turntable? Unfortunately, some shoppers are reluctant to insist on a better cartridge when buying one of these package specials. But you are made of sterner stuff! And if you insist on a Shure cartridge, "better" doesn't have to mean more expensive. Time and time again, consumer magazines have rated Shure cartridges the best in their price category. As the source of sound for the entire system, that tiny Shure cartridge and its critical stylus determine what you'll ultimately hear. And as bargains go, that's the best tip you'll hear today—or any day!

Shure Brothers Inc.
222 Hartrey Ave., Evanston, IL 60204
In Canada: A. C. Simmonds & Sons Limited



Manufacturers of high fidelity components, microphones, sound systems and related circuitry.



Electronically controlled speed selector and pitch controls.

Built-in stroboscope.

Bell shaped rubber suspensor.

Precision machine finished aluminum platter with speed monitor magnetic coating.

Rubber record mat with air-damped record cushions.

Lateral Balancer.

Tracking force ring.

Viscous-damped cueing lever.

Calibrated Anti-skating compensation.

Reject button

Cartridge not included

Pioneer's publicized \$200 direct drive manual turntable has just been shot down by our semi-automatic.

Sorry, Pioneer. But all's fair in love and product war.

In that spirit, Sony unveils the PS-3300. A \$200 direct drive turntable that's *semi-automatic*.

So the contest between our PS-3300 and their vaunted PL-510 is really no contest. Because in the crassest terms, we give you more: an automatic arm return and a reject button.

And that's a substantial difference, for no difference in price.

What's more, we didn't shave anything to make it possible.

The PS-3300 has a finely crafted direct drive system with a brushless and slotless DC servo-controlled motor.

The PS-3300 innovates with a speed monitoring system that state troopers would love to get their hands on: an electronic process using an 8-pole magnetic pick-up head and a pulse coated platter rim.

Plus there's independent fine speed adjustments, a tonearm that's so sensitive it's almost neurotic, and so on.

And to see the attention to detail that Sony stands for, note what the PS-3300 stands on. Bell-shaped rubber feet that are specially constructed to prevent both acoustic and mechanical feedback. (When it comes to feedback, we put our feet down.)

They absorb vibrations—whether from footsteps bouncing on the floor or sound waves bouncing off the wall. Otherwise, these vibrations would be transferred to the stylus, amplified, and be transferred back to the stylus—creating a vicious cycle.

If you're wondering how we managed to do this—how our semi-automatic shot down their high-flying manual—our response is a brief one.

While Pioneer relied on its reputation, Sony relied on its engineers.

SONY

The Sound Shaper. Because all rooms are not created equal.



You can own the finest component system and still be getting inferior sound.

Because unless you happen to have an acoustically perfect listening room, your system and space probably don't match. Hard walls, soft carpets, glass tables, even the size of a room can change sounds.

So ADC developed the new ADC 500 Sound Shaper Frequency Equalizer.

By adjusting the twelve frequency levels you can actually shape your sound to fit the shape of the room, and compensate for spaces and textures that interfere with sound. You can even tinker with the sound just for the fun of it: bring up a singer, lose a violin, actually re-mix your recording.

The new ADC 500 Sound Shaper can get your system into great shape.

ADC

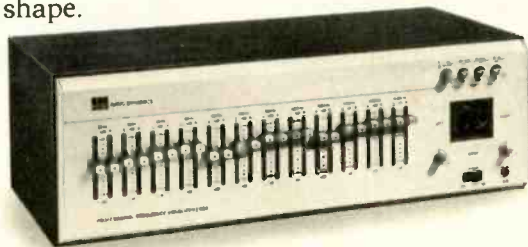

The Sound Shaper

ADC Professional Products Group. A division of BSR (USA) Ltd., Route 303, Blauvelt, N.Y. 10913

CIRCLE 2 ON READER-SERVICE CARD

Mercer regretted the passing of rural America and of the Old South. He talked with deep longing of the vanished Georgia of his childhood. As a native of more frigid climes, I found it hard to understand his feeling even for alligators. He spoke about the great masses of birds that covered the coastal wetlands in those days: "Now it's all covered with freeways." He wanted to show me Savannah, which, he said, had changed less than other places. Alas, I never got around to accepting his invitation.

Several of his songs were deeply southern: "Blues in the Night," "Lazy Bones," "Bob White," "Any Place I Hang My Hat Is Home," and the humorous song about his home town, "Hardhearted Hannah (the Vamp of Savannah, G-A.)." You could just smell the jasmine. And you could see the trains: "Hear that lonesome whistle blowin' 'cross the trestle, whoo-ee." "I peeked through the crack and looked at the track, the one goin' back to you." (Note the clicking rhythmic recurrence of the letter k in those phrases.) "And you see Laura on a train that is passing through." "Do ya hear that whistle down the line? I figure that it's Engine No. 49."

Mercer's words have passed into the American subconscious:

Jeepers, creepers, where'd you get those peepers? ... There's a dance pavilion in the rain, all shuttered down. ... This will be my shining hour, calm and happy and bright. ... A laugh that floats on a summer night that you can never quite recall. ... I wonder what became of me. ... I'm old-fashioned, I love the moonlight, I love the old-fashioned things. ... The sound of rain upon my windowpane, the starry song that April sings. ... Ah, the apple trees, blossoms in the breeze that we walked among. Summers at Bordeaux, rowing the bateau. ... Folks around these parts tell the time of day from the Atchison, Topeka, and Santa Fe. ... And we fade to a marvelous view: two lovers alone and out of sight, seeing images in the firelight. ... Two or three cars, parked under the stars, a winding stream, moon shining down on some little town. ... You may not know it, but buddy, I'm a kind o' poet, and I've got a lot of things to say.

How perfectly he captured in that last line (from "One for My Baby") the archetypal drunk, perched on a stool, convinced that he has attained profundity and poetry. The song, I have always suspected, is a self-satire. Yet in mocking himself Mercer expressed understanding and compassion for every melancholy tippler in the world.

He was difficult, and he drank too much. But he was something more im-

We thought a lot about loudspeakers before we began building them. Here's [some of] what we concluded.

The first premise is obvious. Great sound.

Before we sat down to design our loudspeaker line, we chalked some fundamental goals on the blackboard. Such as extended frequency response, all the way from the lowest bass notes to the highest overtones high fidelity program material may contain. And evenness of response, to avoid predominance of one

frequency over another.

Cardinal principles punctuate the opening pages of our engineering log. Thou shalt not compromise accuracy or introduce distortion. Honor transients, and faithfully reproduce them. Achieve wide power response and superior dispersion.

Not that these and other fundamental dictates are unfamiliar to manufacturers of high quality speakers. Where Presage differs from the flock is in our rigid adherence to them, our almost fanatical refusal to make compromises which, at best, result in a passable high fidelity loudspeaker.

A loudspeaker is seen as well as heard.

Sonic excellence is only a beginning in the process resulting in a finished hi-fi speaker. At Presage, we set out to build loudspeakers for home, not studio listening, one reason we developed our unique Piston Bass system (patent pending), which results in superior low frequency response from an

enclosure small enough for bookshelf mounting.

Other than our budget model, every Presage loudspeaker is encased in natural oak, walnut or rosewood veneer. A flat lacquer is then applied to the wood, allowing it to retain the natural shadings of its

grain as well as affording lasting protection against fading or discoloration.

We then face each speaker with a grille cloth of stretched jersey, chosen as much for its sonic transparency as for elegance. Then comes the Presage logo, constructed of solid brass.

Ideally, a speakermaker is a matchmaker.

A high fidelity loudspeaker is a system, an integrated network of component parts no better than its weakest link. Every Presage loudspeaker begins with parts carefully matched, chosen for quality and checked to insure uniform standards are maintained.

Because a loudspeaker functions as part of a matched system of audio components, Presage speakers are designed to fit logically into systems consistent with their price categories. You can connect our moderately priced Model 15 to a 10 watt receiver, for example, without sacrificing its capacity for clean response at loud levels. Our more expensive models, while also highly efficient for the



broad band of frequencies they reproduce accurately, are engineered to handle power without breaking up under the strain.

To facilitate hookup, we utilize 5-way binding posts which accommodate virtually any kind of connection from spade lugs to bare wire. And every Presage loudspeaker model provides at least one tone control to help match the acoustics of the room in which it must ultimately perform.

PRESAGE

Listen.

Presage Corporation
Dumaine Avenue
Nashua, New Hampshire 03060
(603) 883-7828

The Sherwood HP 2000: It adds a new kind of high to performance.

If power and versatility are the essential elements of high performance, the HP 2000 is unquestionably the high performance amplifier you've been waiting for.

This new top-of-the-line Sherwood amplifier puts you in full command of your sound system.

Consider the credentials:

Power: 120 watts per channel [minimum RMS at 8 ohms from 20-20,000 Hz] with no more than 0.08% Total Harmonic Distortion.

This rating is ensured by massive 16,000 μ f filter capacitors, backed by a zener regulated dual secondary power supply. The full complementary direct-

coupled OCL output circuitry employs output transistors with the largest S.O.A. [safe operating area] of any consumer device currently available. Dual power meters [which feature selectable sensitivity: normal, or -10dB] and LED power limiting indicators precisely monitor power output at all times. And rear-panel switching permits the independent operation of the pre-amp and power amplifier sections.

Precision: The film resistor step Loudness [Volume]

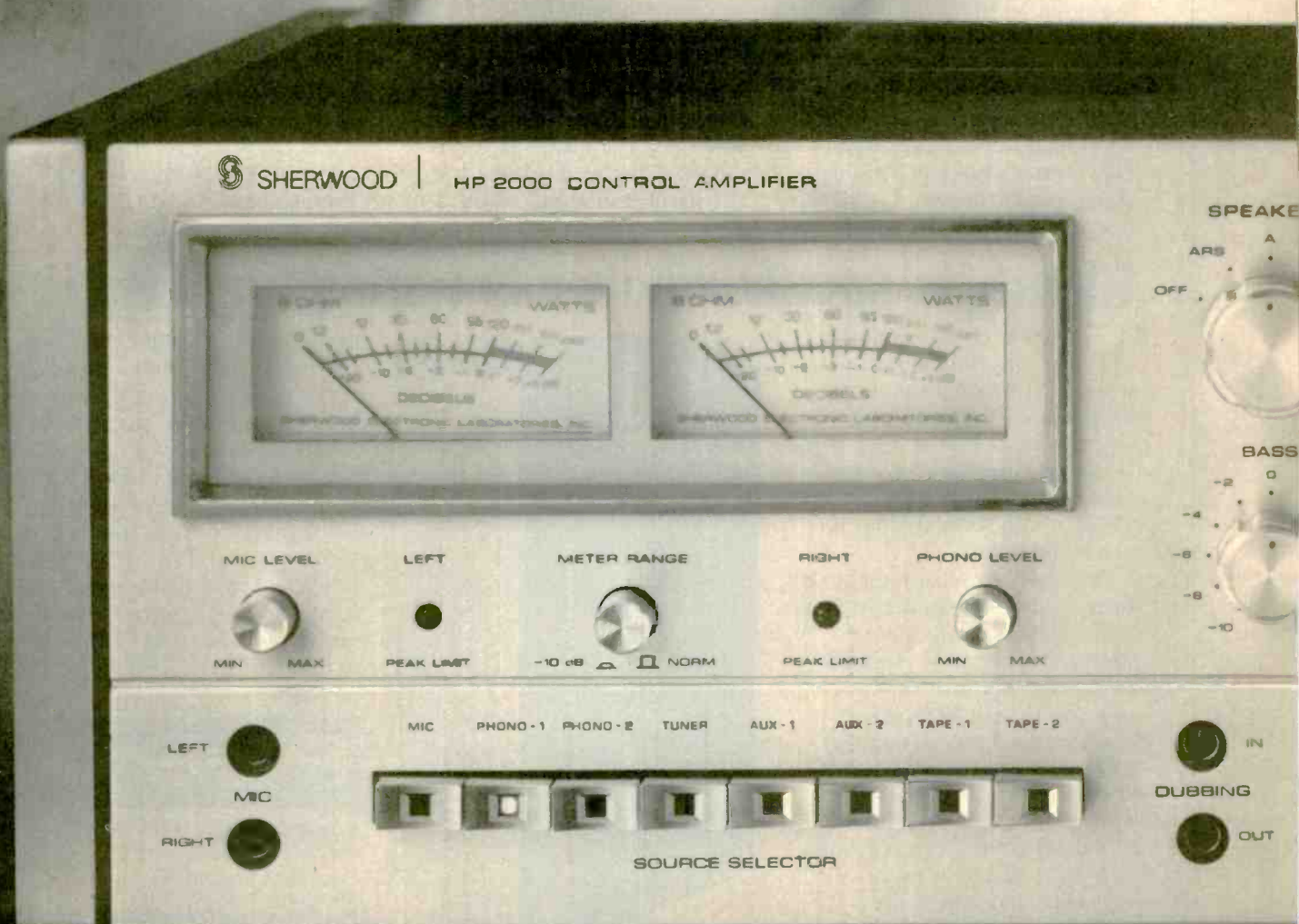

control features 22 accurately calibrated positions [both channels matched within 0.5dB in all steps]. Eleven position Variable Loudness Contour. Bass, Treble and Midrange controls have 11 detented positions each. Resetting to your exact acoustic preferences is never a matter of guesswork.

Master Tone Defeat, High and Low filters, and -20dB Audio Muting are controlled by convenient front panel switches.

Operational Flexibility: The HP 2000 can accommodate two turntables [Phono inputs are selected with IC analog switching and feature a front

panel level control]; two tape decks [tape-to-tape duplication is accomplished with the Tape-1, Tape-2 Monitor circuits]; and a pair of professional caliber microphones [mixing level determined by a separate front panel control]. Additional source capabilities include a Tuner; two Auxiliary components; and a 4-Channel Adaptor [which also serves as a third Tape Monitor if needed].

All Sources and Functions are activated by front panel push switches. ["On" posi-

tion is indicated by color change.]

The highest quality componentry: The HP 2000 has been meticulously engineered for durability, consistent performance standards, and ease of servicing: the mark of Sherwood design for over 20 years. All componentry has been selected to meet or exceed posted specifications. The P.C. boards and inter-board ribbon cable connectors plug into a "mother-board," for reliable operation.

The HP 2000 is the first in a new, highly sophisticated line of tuners and amplifiers from Sherwood Electronics.

Other units in this new High Performance Series will be available soon.

See the HP 2000. And treat yourself to performance that's as high as your expectations have always been.



Everything you hear is true.

Sherwood Electronic Laboratories, Inc.
4300 N. California Ave.
Chicago, IL 60618

CIRCLE 39 ON READER-SERVICE CARD

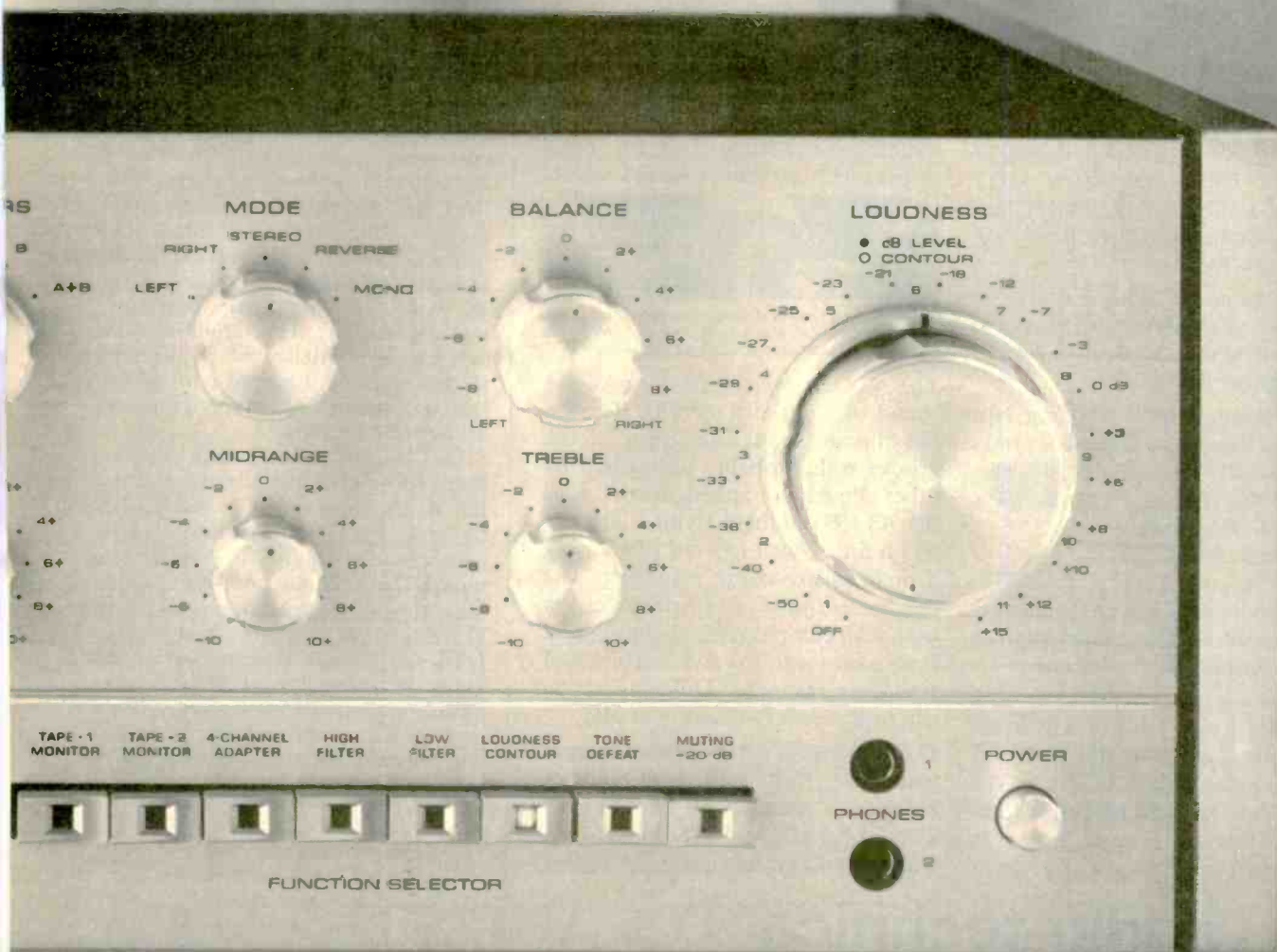

The phono cartridge that doesn't compromise any modern record.

AT15Sa



Choosing an AT15Sa can add more listening pleasure per dollar than almost anything else in your hi-fi system. First, because it is one of our UNIVERSAL phono cartridges. Ideally suited for every record of today: mono, stereo, matrix or discrete 4-channel. And look at what you get.

Uniform response from 5 to 45,000 Hz. Proof of audible performance is on an individually-run curve, packed with every cartridge.

Stereo separation is outstanding. Not only at 1 kHz (where everyone is pretty good) but also at 10 kHz and above (where others fail). It's a result of our exclusive Dual Magnet* design that uses an individual low-mass magnet for each side of the record groove. Logical, simple and very effective.

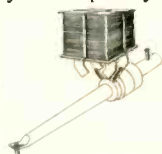

Now, add up the benefits of a genuine Shibata stylus. It's truly the stylus of the future, and a major improvement over any elliptical stylus. The AT15Sa can track the highest recorded frequencies with ease, works in

*TM. U.S. Patent Nos. 3,720,796 and 3,761,647.

any good tone arm or player at reasonable settings (1-2 grams), yet sharply reduces record wear. Even compared to ellipticals tracking at a *fraction* of a gram. Your records will last longer, sound better.



Stress analysis photos show concentrated high pressure with elliptical stylus (left), reduced pressure, less groove distortion with Shibata stylus (right).

The AT15Sa even helps improve the sound of old, worn records. Because the Shibata stylus uses parts of the groove wall probably untouched by other elliptical or spherical styli. And the AT15Sa Shibata stylus is mounted on a thin-wall tapered tube, using a nude square-shank mounting. The result is less mass and greater precision than with common round-shank styli. It all adds up to lower distortion and smoother response. Differences you can hear on every record you play.

Don't choose a cartridge by name or price alone. Listen. With all kinds of records. Then choose. The AT15Sa UNIVERSAL Audio-Technica cartridge. Anything less is a compromise.

audio-technica



INNOVATION □ PRECISION □ INTEGRITY

AUDIO-TECHNICA U.S., INC., Dept. 106H, 33, Shilawsee Ave., Fairlawn, Ohio 44313

portant than a "nice man": He was a good man, and it was precisely for that reason that he was bitter about the condition of the world and of pop music.

When I first got to know John, I heard from several mutual friends that he could unexpectedly turn on you and attack with eloquent verbal viciousness, particularly if he had been drinking. This did not happen to me, although I did a fair amount of drinking with him, sharing his taste for Glenfiddich single-malt Scotch. I mentioned to one of his collaborators that I was still waiting. "Don't worry," he said, "your turn will come."

But it never did, perhaps because I also shared Mercer's distaste for the current directions of the recording industry as well as the paranoid conviction of most lyricists that we are not given adequate recognition. On one occasion he said to me, "I think it takes more talent to write music, but it takes more courage to write lyrics. You have to dig so much." The public remembers composers' names, not lyricists', he would say. John was right about that—though he was an exception. Few lyricists have had as much personal fame as he had.

Mercer didn't think much of the "new" lyricists. Professionally, of course, he had to be discreet about his opinions of other writers, and I never quoted in print anything he said in our conversations. He thought Oscar Hammerstein was a master craftsman but that his lyrics were cloying. He thought that some of Ira Gershwin's lyrics were strained and awkward. He thought that Stephen Sondheim's lyrics were brilliant, brittle, and emotionally shallow. He hated what he saw as the cynicism of Sondheim's show *Company*. I agreed with all but the last, and on that we spent much of an evening arguing.

Near the end, a brain tumor caused him to lose physical control and fall down. It turned out to be benign, but he never regained his health after the operation to remove it. In the last month, he saw no one—not Johnny Mandel, not Henry Mancini, not Harry Warren, all of whom he had written with—and Ginger returned no phone calls. We heard that Mercer was unable to converse with anyone; for a man so in love with words, whose life was made of them, this was tragic.

*Well, that's how it goes,
and, Joe, I know you're gettin'
anxious to close.*

*So thanks for the cheer,
I hope you didn't mind
my bendin' your ear.*

No, John, we didn't mind. We didn't mind at all.

What It's All About

Dolby FM is multi-faceted.

It's about FM transmitting.

It's about FM receiving.

But more than that, it is about signal integrity.

About the possibility of total recoverability, by the listener at home, of the frequency response and dynamic range of the source material used at the station.

Right now, listeners who really enjoy wide dynamic range high-fidelity sound are often pretty discouraged by what they hear on FM. For instance, the sounds that are supposed to be quiet are almost indistinguishable from those that are supposed to be loud. Of course, these signal leveling practices arise because of station "ratings" and the belief that a signal which always sounds loud or brilliant keeps ratings high. The Top Forty stations probably always will broadcast in this way—and perhaps they should, if that's the sound their particular listening audience really prefers.

One station would be enough

We think it's time for some improvements for more discriminating radio listeners. Such individuals would be served well if, in each geographic territory, they could have just one quality conscious and embellishment-free station in each of the format categories that people really listen to, such as classical, folk, jazz, and progressive rock. The food business learned long ago that every town needs at least one gourmet restaurant.

We know that in the long run we are talking about only a fraction of all stations. But that would be enough. It would take care of the quality oriented radio listeners we are interested in. And those listeners are the ones who are most likely to buy receivers with built-in Dolby FM decoding.*

How you can help improve FM

You can help improve FM. First listen critically to the best FM stations in your area. If the contrast between loud and soft sounds is markedly less than you hear when playing your own records, and this bothers you, then write to these stations and offer your views. We'd appreciate it if you would point out that extra signal treatment is theoretically unnecessary when Dolby encoding is used (see explanation at right). You might even declare that you are as dismayed by the use of traditional limiting, compression, and equalization on these stations as you would be if the waiter in a fine restaurant poured ketchup and mustard all over your food before serving it to you.

If you know that your station is already Dolby encoding, and you still hear disturbing manipulations of the signal, then we are especially concerned that you should write. We know well that some of the 140 Dolby FM stations carry on using various types of conventional signal treatment in spite of the fact that our encoder unit removes the basic problem of high frequency overmodulation. But it's hard to change the habits of an industry overnight. It would help if you could assure these well meaning—but fearful of "ratings"—stations of your continued support if they would simply broadcast accurately the dynamic range and frequency response of the source material.

If we all care, we can have better FM broadcasting. At least from the stations we listen to. And that would be enough.

That's what Dolby FM is all about.

The reason for Dolby FM

Why Dolby FM encoding and decoding anyway? Why not just a high fidelity, wide dynamic range FM signal by itself? Because this is a technical and practical impossibility. If the FM station broadcasts at a reasonably high signal level, then the high frequencies have to be limited (due to historical reasons relating to the standard 75 microsecond boost employed at the transmitter). The station can reduce its level and use no signal treatment, but this wastes transmitting capability and reduces geographical coverage. Therefore, practically all stations employ high frequency limiting.

The inevitability of signal degradation apparently affects the thinking of many station personnel. Since it is already necessary to limit the signal somewhat, perhaps it seems defensible to experiment further with signal processing. This results not only in an effort to compensate for the sparkle lost in high frequency limiting, but also in an attempt to make the signal seem even more energetic and brilliant than the original. There seems to be a general belief among many broadcasters that listeners really prefer this kind of altered sound.

In comparison with many of these signal modification practices, Dolby FM encoding is rather unexciting. Basically, it amounts to a gentle form of high frequency limiting, but the difference is that it is done in a way which permits the listener at home to "un-limit" or to recover the signal. About half of the Dolby B-Type compression and expansion capability is used, together with a 25 microsecond boost, to solve the station's high frequency overmodulation problem (which gives a distortion-free channel between the transmitter and receiver); the other half is used to improve the signal to noise ratio.

** July 1976. Thirty-three different models are available from Dolby licensees. These products are tuners, receivers, and music centers with designed-in Dolby decode circuits, requiring no extra wiring, adaptors, or calibration procedures. Write for the latest list. Technical information on Dolby FM is also available.*



Dolby Laboratories Inc

'Dolby,' 'Dolbyized' and the double-D symbol are trade marks of Dolby Laboratories Inc.

731 Sansome Street
San Francisco CA 94111
Telephone (415) 392-0300
Telex 34409
Cable Dolbylabs

346 Clapham Road
London SW9
Telephone 01-720 1111
Telex 919109
Cable Dolbylabs London



If, for once, the editors of HIGH FIDELITY can be persuaded to stop their super-cautious pussyfooting, I would like to have some advice. What do you feel is the best buy in a really good set of headphones?—Arthur S. Huygens, New Paltz, N.Y.

If, by "pussyfooting," you mean our reluctance to impose our tastes and value judgments on readers who may have legitimate reasons for differing with us, we plead guilty. But, if you promise not to tell anyone, we would recommend the Yamaha HP-1 headphones, available for about \$65.

I have a Marantz 4240 quad receiver with 17 watts [12.3 dBW] per channel, 40 watts [16 dBW] in stereo. My speakers are Marantz 5Gs. I was thinking about new speakers, but the ones I like are Rectilinear 5s. These are much too inefficient for my system and too expensive for me to buy four. Then I was offered a deal in which, if I sold my receiver and speakers, I could buy two Rectilinear 5s and a Marantz 2275 with 75 watts [18.8 dBW] per channel for about \$120 more. Does quad have a great advantage over stereo with regard to realism? Several magazines said there is no definite advantage. Should I go to stereo or find cheaper, more efficient speakers for my quad?—John E. Schuck, Jamestown, N.D.

We would miss the quad. Why not replace the front pair of Marantz 5Gs with the Rectilinear 5s? Even with the limited power you have the Rectilinears would be able to reproduce music at about 85 dB in an average 2,000-cubic-foot room. While ideally the front and back speakers should be the same for quad, we have heard the 5Gs hold their own remarkably well with more expensive front speakers. If you can't get the sound levels you want, switch the 4240 to the stereo mode and drive the Rectilinears alone. The levels will be within 3 dB of what you would get with the 2275 receiver, and the quad option is retained. Eventually you will probably want to get another pair of Rectilinear 5s and a more powerful four-channel receiver. With 75 watts the Rectilinears will play just 6.4 dB louder than with 17 watts (18.8 vs. 12.3 dBW); concert hall levels require significantly greater power.

Avoiding the possible dangers of polonium

in the Staticmaster brush, I purchased Discwasher, which I use very often. I find it inconvenient (and costly) to replenish the rapidly consumed cleaning fluid. Is it safe to use distilled water or possibly alcohol as a cleaning fluid? Discwasher claims that its cleaning fluid kills some moisture-loving bacteria. Is there any truth in their claim?—William Chan, Brooklyn, N.Y.

The bacteria to which Discwasher refers love moist vinyl (who cares what they want to drink?). And as far as we know the claim is justified. While distilled water would appear to be safe, it is also less effective—in removing fingermarks as well as in controlling bacteria. As to the safety of polonium, in the Staticmaster 500 (the only record-care product we know of that applies this approach) we are satisfied that it presents an appreciable hazard only when used or handled in ways that normal prudence would forbid.

The manufacturer's instructions with my Harman-Kardon Model TA-260 receiver advise against using a TV antenna or homemade dipole and recommend the use of a four-foot length of wire if an FM-only antenna is not available. I tried this, and every station I pick up is fuzzy and distorted. Switching to FM mono helps a little. Since I live in an apartment, it is difficult for me to install an outdoor antenna. Is there any kind of indoor antenna that would remedy these problems?

Also, could my set need realignment? If so, whom would you recommend for the job? The unit has a setting marked "AM-FM." According to the manual, this is for receiving "stereophonic simulcasts." Could you please explain?—Paul Goldschmidt, Binghamton, N.Y.

Your letter implies that you have a TV antenna available. If that is so, we would recommend trying that, as the result is hardly likely to be worse than what you have now, and you won't damage anything. (The recommendation to avoid a TV antenna is usually made because some units include traps to remove FM signals. But not all do, and some traps can be defeated.) Before investing in an expensive indoor antenna, try a homemade dipole or a cheap set of "rabbit ears." If you don't get some improvement, the construction of your building and your location within it will probably thwart any in-

door antenna. A directional outdoor antenna (for multipath rejection as well as gain) really is the best way to go.

If your set needs realignment—and at its venerable age it well might—a factory-authorized service shop is the best we can recommend, but you may save some money by trying the antenna first.

Finally, the AM-FM switch setting feeds AM to one channel and FM to the other. This system was used in early experimental stereo transmissions.

I would like to add an octave equalizer to my system to flatten out the response somewhat. I have Dynaco A-50 speakers and thought it might be a good idea to trade up to a more expensive speaker first, one that could better take the bass equalization. But when I checked your test data on the A-50, I found that it will put out 110 dB SPL at 80 Hz without significant distortion. Does this mean the A-50 would probably handle a reasonable amount of bass equalization? (Much of this, of course, would probably occur below 80 Hz.)—John Burton, Bountiful, Utah.

Your A-50 speakers should accept bass equalization quite well, although the power-handling capability will be less at lower frequencies, of course. The 80-Hz rating point was chosen to allow comparison of the low-frequency power capability of different speakers.

I am planning to replace my stereo system, which consists of a Dynaco Stereo 120 power amp, PAT-4 preamp, and FM-5 tuner, Miracord Mark II record changer with Shure V-15 Type II pickup, and a pair of AR-3A speakers. The new system will have an SAE Mark IV-DM amp, at 200 watts [23 dBW] continuous per channel at 4 ohms, and Mark IX-B preamp-equalizer. I'm going to keep the Miracord and the speakers. Can I get better quality sound using the same speakers?—Roberto Bertran, Miami, Fla.

With the new power amp your system will play 4 to 5 dB louder without clipping of peaks, which will probably contribute to better sound. Before changing speakers, we would be inclined to replace the Shure V-15 Type II with a more recent pickup, perhaps Shure's own Type III.

Some thoughts on whether to simply upgrade your receiver or step up to separates.

As receivers become more powerful and versatile—approaching the performance of separate components—the original virtues of the one-chassis format diminish. Space-saving and convenience no longer exist when the chassis is too large for any normal shelf. All-in-one construction can now be considered an inherent *disadvantage*. No single element—tuner, preamplifier or amplifier—can be individually upgraded. And if any of these elements needs servicing, the entire receiver must be packed, shipped and done without.

These conditions are likely to worsen as the power race among receivers continues. With existing technology, higher power means physically larger (and heavier) power supplies and more massive heat sinks, leading to even more unmanageable proportions.

Control flexibility functions and facilities are other considerations. If you want filters with selectable cut-off points, turnover frequencies for each tone control, and if special refinements, such as a linear equalizer for phono, are preferred over basic controls, you're probably ready to consider separates. Which brings us to LUX.

Although our published specifications of LUX amplifiers and tuners are typically state of the art, independent test reports have found them very conservative. For example, Hirsch-Houck labs, after testing the L-100 integrated amplifier, reported the following in *Stereo Review*: "The harmonic distortion (THD) at 1,000 Hz and 10 watts output was 0.0087%, and it remained at that figure up to the rated 110 watts." (Note that at 110 watts,

the rated distortion from 20 to 20,000 Hz is 0.08%.)

Audio magazine had a similar experience with the T-310 tuner: "...most of our results were far superior to those claimed...distortion in mono and stereo was the lowest we have ever read for any tuner at any price...LUX's conservatism extends to some of the 'lesser' FM specs as well. We measured a capture ratio of 1.2 dB (1.5 claimed) and alternate channel selectivity turned out to be 76 dB (70 dB claimed.)..."

However, we regard measured specifications as no more than a partial indication of a component's ultimate performance. LUX's audiophile/engineers consider accuracy of music reproduction the most important goal in new product development and modify circuit parameters in pursuit of sonic excellence long after measurable goals have been reached.

Thus, we consider one of our finest tributes to date to be *Radio-Electronics'* overall evaluation of the L-100: "We heard a clarity and effortless power capability that is hard to describe in words but definitely is audible...LUX seems to have found some of the answers...about what makes one amplifier sound better than another."

Whether you simply trade in your present receiver for a better one, or move up to separates, it's likely to be expensive. We suggest therefore that you carefully examine *all* the relevant factors—size, weight, flexibility, specifications, performance, and expected reliability—in addition to the initial cost. The more care you take, the more likely it will work out to your ultimate advantage. And, we suspect, to ours also.

LUX Audio of America, Ltd.

200 Aerial Way, Syosset, New York 11791 • In Canada: White Electronics Development Corp., Ontario

At the moment, this is as close as you can get to a LUX "receiver."

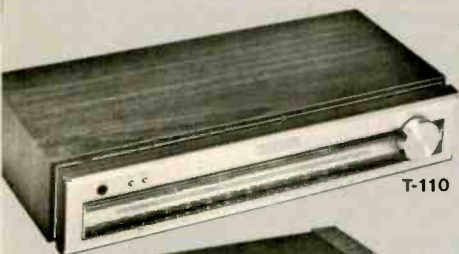

T-110



L-100

T-110 Stereo FM Tuner LUX's finest FM tuner. MOS-FET front-end, five-section tuning capacitor. Phase-locked-loop IC for FM multiplex. Special features include: antenna attenuator circuit; time-delay circuit protection; 75/25 microsecond de-emphasis for use with external Dolby* unit. \$525.00

L-100 Integrated Stereo Amplifier LUX's most powerful: 110 watts minimum continuous power per channel into 8 ohms, 20-20,000 Hz, with no more than 0.08% total harmonic distortion throughout. Features include: exclusive linear equalizer for custom-tailored phono response; variable phono input sensitivity and impedance; three turnover frequencies each for bass and treble; 20-dB-range volume attenuator for each step of master volume control. \$995.00

T-88V AM/Stereo FM Tuner LUX's least expensive tuner, yet includes FET front-end and linear-phase ceramic filters in IF section. \$345.00

L-80V Integrated Stereo Amplifier 50 watts per channel minimum continuous power into 8 ohms, 20-20,000 Hz, total harmonic distortion no more than 0.08%. Features include: two turnover frequencies each for bass and treble controls; two cutoff frequencies each for high and low filters; two-deck dubbing. \$475.00



T-88V

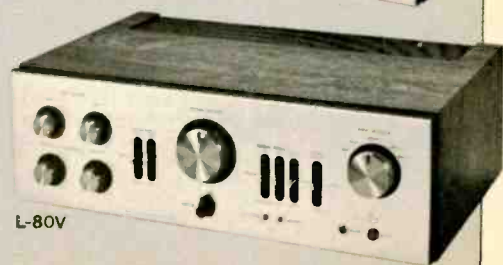

L-80V

*Dolby is a trademark of Dolby Laboratories, Inc.

New Hope for TV Sound

The Public Broadcasting Service has announced a new system, developed over the past several years, that delivers vastly improved network sound. Digital Audio for Television, or DATE, as it is called, would enable networks to distribute up to four channels of high fidelity audio to participating stations.

According to Hartford N. Gunn Jr., PBS vice chairman, stereophonic sound from the concert hall, studio, or theater can be transmitted over most existing telephone company microwave circuits (although this is not permitted at present) and received by the stations, using special equipment. When DATE programs are simulcast over local FM stations, viewers owning appropriate equipment will be able to receive high quality stereo (dare we hope for quad?) sound along with their TV programs.

Gunn predicted that TV set manufacturers would realize, were DATE implemented, "that there is a sizable and growing market for sets with good sound built in." The National Council on the Arts has recommended that the National Endowment for the Arts join PBS in effecting the system and has called for cooperation from manufacturers, broadcasters, common carriers, and the Federal Communications Commission.



New IHF Officers

Mitchell

Bernie Mitchell (president of U.S. Pioneer Electronics Corporation) has succeeded George DeRado (president of Teac Corporation of America) as president of the Institute of High Fidelity. DeRado was named vice president, and Walter Stanton (president of Stanton Magnetics and Pickering & Company) treasurer in the same election. Publisher Richard Ekstract (*Audio Times*, a trade paper) was tapped for the position of secretary. The new officers began their terms June 7, 1976, and will serve two years.

And . . .

The Du Pont Company has concluded an agreement with the Soviet Union whereby the latter will purchase equipment and technology for the manufacture of chromium

dioxide. Production is expected to begin in approximately three years. Included in the agreement are nonexclusive selling rights in India and the socialist countries of Eastern Europe.

DBX, Inc., has developed a version of its professional noise-reduction system as a direct plug-in replacement for the Dolby A system. According to the company, "a producer or recording engineer who prefers DBX noise reduction can take his own wherever he goes, provided there's a Dolby A rack to plug it into. . . ." The DBX system is said to reduce noise by more than 30 dB and totally eliminate residual tape hiss that otherwise is transferred to discs.

Norton Company, manufacturers of safety products, has begun packaging shooters' ear plugs for the rock-musician market. Now the musicians can protect themselves from the impaired hearing they are inflicting on their audiences.

Pickering to the Rescue of Antiquarians

Collectors of antique records have, for some years, looked to International Observatory Instruments as the supplier of the special stylus shapes and sizes (for use in the Shure M-44 cartridge) needed to trace the various types of grooves found in old records. They were consequently dismayed earlier this year to learn that I.O.I. was discontinuing its phonographic products. Who would step into the breach?

We have been making inquiries on behalf of collectors, and so far we have had only one positive response: from Pickering. The company—which began in the 78-rpm era—has always offered a 2.7-mil conical replacement stylus for all its cartridges. This variant of the nominal 3-mil tip was at one time considered the "professional" configuration because it was recommended for the reproduction of radio transcriptions, but it works excellently for most 78s produced in the electric era. For older records (particularly the Pathé hill-and-dale discs, which were cut with an extremely wide, shallow groove) other stylus configurations are required or, at least, preferable. Pickering now says it will custom-cut such styli for collectors and mount them in assemblies to fit Pickering or Stanton cartridges.

This is the first such offer from a pickup manufacturer we have encountered. The reason for the reluctance on the part of Pickering's competitors is not hard to find. Most do not cut their own diamonds, but rely on an outside supplier. Custom grinding is expensive; by the time the pickup manufacturer adds the markup that, in the normal course of business, he is entitled to, what was expensive has become prohibitive. But since Pickering has its own grinding facility (which it started in the early days of CD-4, when Shibata and similar styli could not be bought in sufficient quantities for Pickering's cartridge production), the han-

**The turntable
nobody had heard of
two years ago is
now Number One.
The most popular
turntable in America.
It's called a
"bee eye cee."
It's built five ways.
And it's imported.
From Michigan.**



Five ways means five models. And all five are belt drive turntables, with low speed (300 rpm) motor, program system, superior tone arm, and excellent performance characteristics. For more information pick up our "5 Turntables" folder at high-fidelity dealers or write to British Industries Co., Westbury, N.Y. 11590.

Model 920 about \$79—940 about \$109—960 about \$159—980 about \$199—1000 about \$279. Model 980 shown. ©1976 British Industries Co. A Division of Avnet Inc.

5 Turntables B I C™

ding of special requirements appears to be both simpler and less costly than it otherwise would be.

Generally speaking, spherical-tipped styli of the dimensions used by collectors can be had, for either Pickering or Stanton cartridges, for about \$25; truncated styli similar to those previously offered by I.O.I. cost about \$50. Collectors who want more information should write, specifying the stylus type they are interested in and the Pickering or Stanton model in which they plan to use it, to Ray Bennett, Pickering & Co., Inc., 101 Sunnyside Blvd., Plainview, N.Y. 11803.

The Case of the Dolby Booster

Following our March article on noise reduction, we have received reader letters claiming that our description of Dolby action was wrong. The Dolby-B circuit, these letters contend, does not (as we said) compress highs in recording and expand them in playback; it boosts them in recording and attenuates them (and high-frequency noise) in playback.

This, to be sure, is how the circuit is described in Dolby-

product owner's manuals. We, too, have doubtless used such verbiage ourselves at one time or another. It is easily grasped, but an oversimplification. Since the encode action does in fact compress dynamic range by pushing low-level high frequencies upward, these frequencies are, to that extent, boosted. But the word "boost," used all by itself, normally implies that the given frequency will be increased in amplitude to the given degree *no matter what level it occurs at*—and, in Dolby encoding, this simply is not true. Likewise the downward expansion of dynamic range needed to restore the highs to their original balance in decoding cannot technically be called "attenuation" since that implies the same degree of cut at any signal level.

The point that really disturbs us, however, is that some readers, hung up on the boost/cut idea, assume that a treble control can be used with as complete success as an alternative to a Dolby decoder with Dolby-encoded signals—whether recorded on tape or broadcast on FM. It cannot, nor, to the best of our knowledge, has Dolby Labs ever literally claimed that it would. Otherwise, why make decoders at all? What Dolby Labs has claimed is that a treble touchup can help if one has no decoder. It can, but since Dolby action changes high-frequency content with program level, the treble control cannot do the whole job.

Equipment in the News

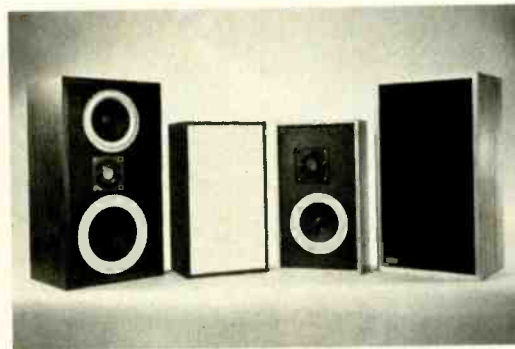

Speaker line expanded with Genesis II

The Genesis II loudspeaker from Genesis Physics Corporation incorporates features of acoustic suspension and vented designs. The speaker uses a passive radiator with a modified Thiele alignment. The result, according to Genesis Physics, has the advantages of both types of woofer loading with the disadvantages of neither. An 8-inch woofer and 1-inch inverted dome phenolic tweeter are the active drivers in the Genesis II. Frequency response is said to extend to 32 Hz. The system is available in a walnut finish or a deluxe oak version, costing \$144 and \$169, respectively.

CIRCLE 137 ON READER-SERVICE CARD

Kenwood's top-of-the-line amplifier

Kenwood's latest addition to its amplifier line is the KA-8300. Among the new features in this model is the complementary Darlingtton Power Block, which is said to contribute to efficiency by replacing individual parts with a single integrated unit. The preamp/phono-equalizer section, also newly designed, uses direct-coupled circuitry to lessen distortion and improve damping. A tape-through circuit allows the user to dub while listening to a different program source. The KA-8300's power output is rated at 80 watts (19 dBW) into 8 ohms from 20 Hz to 20 kHz, with harmonic distortion at no more than 0.1%. Suggested price is \$449.95.

CIRCLE 138 ON READER-SERVICE CARD



CIRCLE 29 ON READER-SERVICE CARD →

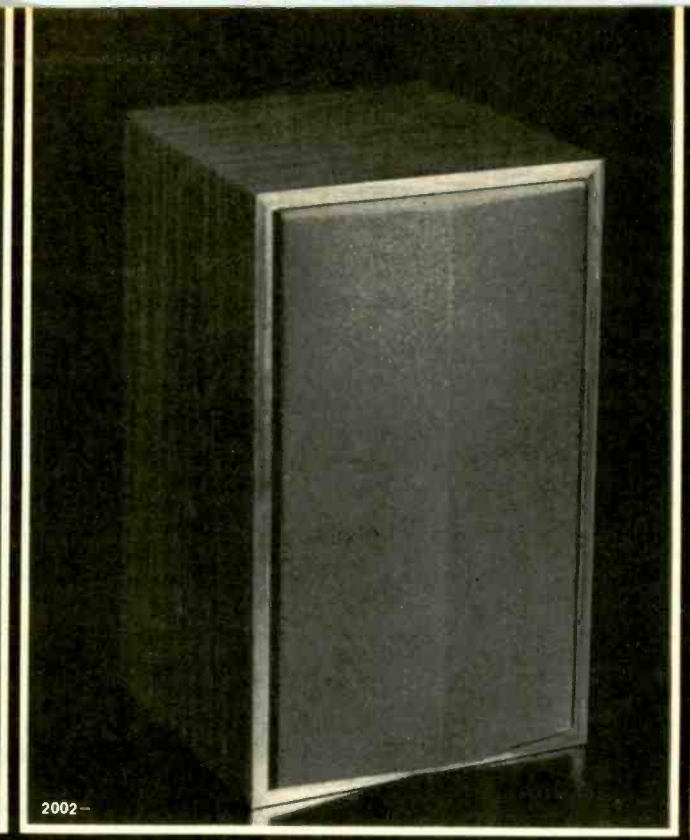
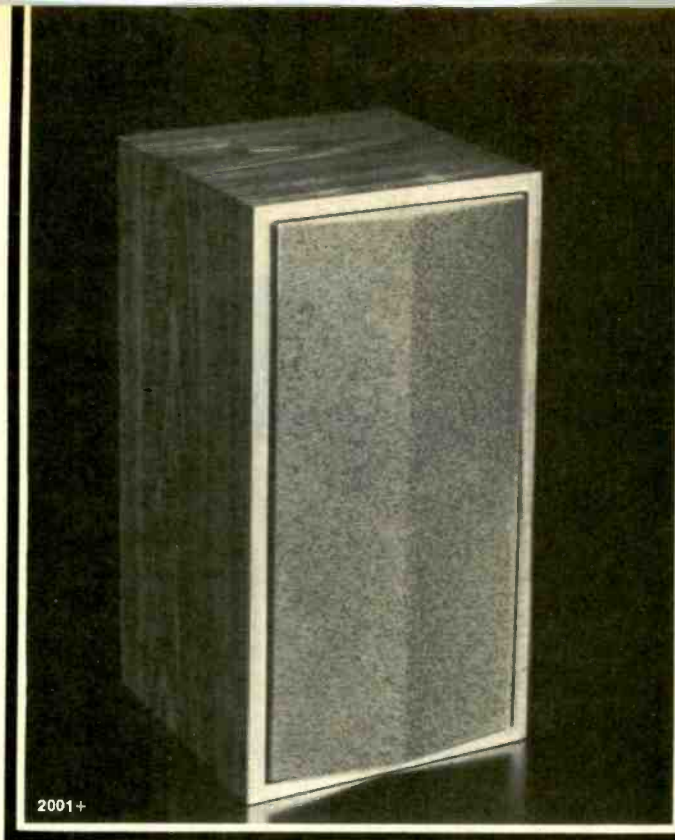

Survival is enough for some. Dominance is all we know.

Sometimes, the competitive instinct can lead to more than just survival, it can lead to dominance. As it has with the development of our new speaker systems. They're members of our Criterion 2000 Series. Each one is designed to make listening as pleasurable as loving. In the upper left is the 2001+. It's one of the most highly acclaimed 70 watt program 10" 3-way speaker systems ever developed. The 2002+, in the upper right, is a 90 watt program 4-speaker 3-way

system whose high efficiency has become a standard to be matched by those who offer comparably priced speakers. The 2005, shown below, is the kind of state-of-the-art speaker system that makes the rest of the art wonder what kind of state it's in. As do our other newly developed components. You'll find all of them, the speakers, receivers and turntables at Lafayette dealers and stores coast to coast. Once you'll hear them, you'll know why the competition doesn't want to.

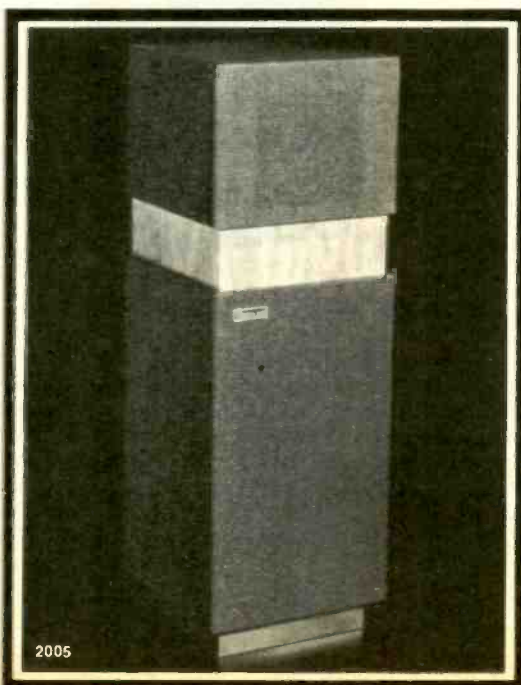

Specifications	2001+	2002+	2005
High	(1) Phenolic Ring Tweeter	(2) Phenolic Ring Tweeters	Hell Air-Motion Transformer Midrange/Tweeter
Mid	(1) 2x6" Exponential Horn	(1) 2x6" Exponential Horn	
Low	(1) 10" Woofer	(1) 12" Woofer	(1) 10" Woofer
Frequency Response	30-18,000 Hz	20-20,000 Hz	30-24,000 Hz
Max Watt Input	70 Program	90 Program	300 Music Peaks
Dimensions	25x13½x13¾"	26x16x15"	40x13¼x12½"
Price	\$99.95	\$149.95	\$199.95

Lafayette

There is no competition.

For more information and a free catalog please write:
Lafayette Radio Electronics,
Box 119, 111 Jericho Tpke., Syosset, N.Y. 11791
Copyright 1976 Lafayette Radio Electronics

Stereohedron-stylus pickup from Pickering

Pickering's XSV/3000 stereo cartridge, for manual and automatic turntables, has a new stylus tip called the Stereohedron. Based on the geometry of Pickering's Quadrahedral CD-4 tip, it is shaped to increase the area of vertical contact with the groove wall while keeping the tracing radius small, thus optimizing both performance and wear characteristics. Pickering says it has improved tracing by lowering the mass of the moving parts. Frequency response is rated from 10 Hz to 30 kHz. Recommended stylus force setting is 2 grams with the brush or 1 gram net stylus force (+ 1/2, -1/4 gram in either case). Recommended load is 47,000 ohms resistive with 275 pF shunt capacitance. The XSV/3000 costs \$99.95.

CIRCLE 136 ON READER-SERVICE CARD



Car tape-deck accessories from Uher

Owners of Uher CR-124, CR-134, and CR-210 portable cassette decks can now use their machines in their cars, powered by the auto's battery. The CR-200 Stereomatic comes in two parts: a stereo amplifier that can be placed anywhere in the car plus a stereo control preamp and mounting bracket. The bracket fits under the dash and holds both the preamp and the front-loading cassette deck. The preamp section has balance controls and a tone adjustment for high, midrange, and low frequencies. ICs in the power section turn the amplifier on when a signal appears at its input and shut it off when there is no signal. Power output is rated at 25 watts (14 dBW) continuous into 8 ohms, 50 Hz to 20 kHz, with no more than 3% harmonic distortion. The CR-200 Stereomatic costs \$195.

CIRCLE 139 ON READER-SERVICE CARD



Craig's three-way speaker system

As part of its component line, Craig is offering the Model 5702, a three-way speaker system that uses a 12-inch woofer, 4 1/2-inch midrange, and 2-inch tweeter and is designed to reproduce concert hall sound levels even if powered by an amplifier with modest capabilities. The woofer's high-compliance foam surround complements the 1 1/2-inch voice coil, and, according to Craig, allows the low frequencies to be reproduced more accurately. Rated frequency response is from 25 Hz to 20 kHz \pm 5 dB, with power handling ability of 30 watts (14.8 dBW) continuous into 8 ohms. The 5702 comes in a tuned, ducted-port enclosure with walnut finish and costs \$129.95. The Model 5701, a two-way version with a 10-inch woofer, is available for \$89.95.

CIRCLE 140 ON READER-SERVICE CARD



Test cartridge for 8-track recorders

Capitol Magnetic Products has developed a test cartridge designed to eliminate waiting time in adjusting balance levels and so on in 8-track recorders. With no rewind facility, 8-track decks can take up to 30 minutes (with a 2-hour tape) to return a test signal recorded in a standard cartridge to the head for evaluation. Capitol Magnetic's Music Tape test cartridge runs for only 1 minute per pass (total, 4 minutes) and costs less than \$3.00.

CIRCLE 141 ON READER-SERVICE CARD



Record them over and over again.
The life of a Scotch® brand cassette is a long one. Even when you record on it time after time after time.

Because there's a tough binder that keeps the magnetic coating from wearing off. So even after hundreds of replays or re-recordings, you get great sound quality.

We wish you a long and happy life. 'Cause you'll need it to keep up with your Scotch cassettes.



Play them back without jamming.
The life of a Scotch® brand cassette is a long one. Even when you play it time after time after time.

Because there's a Posi-Trak® backing that helps prevent jamming and reduces wow and flutter. And the cassette shell is made with a plastic that can withstand 150°F.

We wish you a long and happy life. 'Cause you'll need it to keep up with your Scotch cassettes.

Scotch® Cassettes. They just might outlive you.

Don't miss
THE PUZZLE CHILDREN
October 19 on PBS.

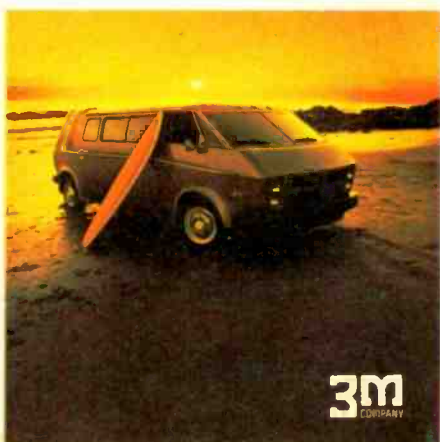
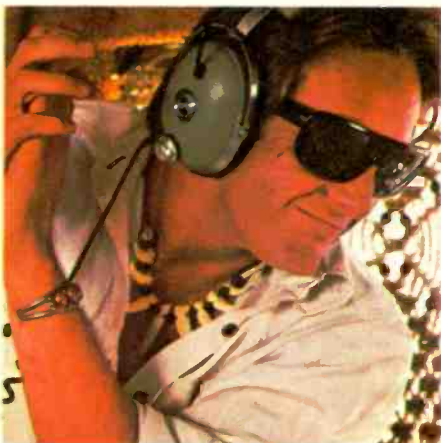
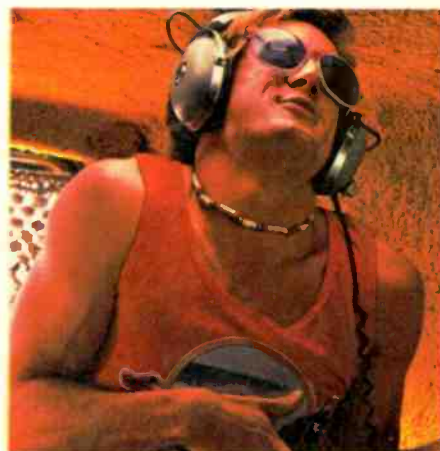

3M
CORPORATION

Beauty in sound. By Fuji.

Every Fuji cassette means beauty and purity in sound. No hiss, no dropouts. Widest frequency response and dynamic range. Total reliability. Fuji high-fidelity cassettes such as the FX will give you the best performance possible on your tape recorder. Already widely recognized by experts as the finest cassette in the world. Fuji. The cassette of the pro.



FUJI

Fuji Photo Film U.S.A., Inc., The Empire State Building, New York, N.Y. 10001

A	1	H	2	P	3		L	4	V	5	I	6	W	7	X	8	A	9	H	10		U	11	K	12	D	13				
E	14	F	15	X	16	R	17	A	18		C	19	N	20	U	21		T	22	J	23	D	24	R	25	O	26	S	27		
		W	28	X	29	G	30		A	31	U	32	L	33	H	34	K	35	B	36	Q	37		D	38	A	39	X	40		
H	41	P	42			B	43	I	44	S	45	A	46	C	47	F	48	G	49	J	50		R	51	L	52	A	53			
H	54	U	55	O	56			A	57	F	58	M	59	T	60			H	61	X	62	W	63	A	64	G	65	D	66		
E	67	A	68	P	69			U	70	R	71	M	72	I	73			B	74	A	75	K	76		L	77		U	78		
W	79	O	80	J	81			A	82	C	83	H	84	G	85	K	86	D	87			H	88	X	89		W	90	U	91	
M	92	Q	93			K	94	F	95	J	96	C	97	H	98			V	99	R	100	A	101		D	102	N	103	G	104	
H	105	S	106	P	107	I	108			U	109			W	110	H	111			L	112	N	113	R	114	O	115	G	116	T	117
S	118	A	119	F	120			E	121	K	122	J	123			P	124	O	125	D	126	W	127	B	128		A	129	R	130	
N	131	L	132			J	133	E	134	H	135	R	136	O	137			I	138	A	139	R	140		P	141	J	142	F	143	
L	144			H	145	C	146	G	147	I	148			X	149	O	150	U	151			K	152	B	153	P	154	U	155	A	156
D	157			T	158	H	159	E	160	A	161			C	162	K	163	R	164			T	165	J	166	F	167			M	168
V	169	U	170	A	171	O	172	P	173			U	174	H	175	A	176			W	177	I	178	C	179	R	180	A	181	U	182
G	183			H	184			E	185	A	186	U	187	M	188	W	189	V	190	D	191	L	192	J	193			T	194	M	195
C	196	A	197																												

DIRECTIONS

To solve these puzzles—and they aren't as tough as they first seem—supply as many of the Output words as you can in the numbered dashes following the Input. Unless otherwise specified in the Input, the Output consists of one English word. "Comp." means compound, or hyphenated, word.

Transfer each letter to the square in the diagram that bears the corresponding number. After only a few correct guesses you should begin to see words and phrases emerging in the diagram, which when filled in will contain a quotation related to music, recordings, or audio.

The words in the quotation are separated by darkened squares and do not necessarily end at the end of a row.

Try to guess at these words and transfer each newly decoded letter back to its appropriate dash in the Output. This will supply you with further clues.

A final clue: The source of the quotation—the author and his work—will be spelled out by the first letters in the Output, reading down.

The answer to HiFi-Croctic No 17 will appear in next month's issue of *High Fidelity*.

INPUT

- A. After *Die*, Beethoven's only ballet (3 Ger. wds.)
- B. An early viol
- C. Dutch composer (1903-50), became special adviser to the U.N. in 1945; 3 symphonies
- D. A musical ornamentation printed in small type (2 wds.)
- E. Female folksinger and guitarist (b. 1930), recorded on *Tradition*, *Vanguard*, *Fantasy*
- F. Italian jazz trumpeter (b. 1924), recorded on Columbia, RCA, several Italian labels
- G. Small keyboard instrument, also called a "bibi"
- H. Musical form, common in the 14th century, characterized by a reiterated scheme of time values (2 wds.)
- I. English organist and composer (1765-1838), a favorite pupil of Mozart, whose music he included in his opera *The Prisoner*
- J. Jazz trumpeter (b. 1923); worked with Count Basie, later in small groups (full professional name)
- K. An operetta by Gilbert and Sullivan

OUTPUT

64	197	161	46	139	171	176	82
39	119	53	9	156	31	129	
186	57	181	1	68	101	75	18
153	36	74	128	43			
47	162	19	146	97	196	83	179
191	66	38	102	13	24	126	157
							87
134	185	160	14	67	121		
48	143	167	15	95	120	58	
85	116	147	104	30	183	49	65
88	135	159	10	175	98	54	2
	111	184	105	61	84	34	41
							145
6	148	108	138	44	178	73	
193	133	166	123	96	23	142	81
							50
35	163	86	152	122	76	12	94

INPUT

- L. American composer (1898-1937), studied with Cowell and Riegger; *Swanee*, *Cuban Overture*
- M. Opera by Weber written to an English text
- N. Followed by "flute," a type of organ stop
- O. Soviet composer (b. 1900) 1905; *Turkmenia*
- P. French pianist and composer of fantasies and drawing-room pieces (1831-70)
- Q. *Le Roi d'* _____ opera by Lalo
- R. Birthplace of Yusef Lateef, Willred Middlebrooks, Bill Oldham, Bessie Smith
- S. Clancy Brothers' land
- T. Polish pianist and composer (b. 1898); 2 symphonies, many piano pieces
- U. Quasi-autobiography by Clarence Day (3 wds.)
- V. One of an enumerated series
- W. Italian composer (1660-1726) *La Rosaura*, (1685-1757) *Narciso*, (1718-77) *L'isola disabitata*
- X. The interval _____ for one

OUTPUT

112	132	33	4	192	144	77	52
72	168	92	59	195	188		
131	103	20	113				
137	125	26	80	150	115	56	172
141	69	154	124	3	107	173	42
93	37						
180	100	51	136	164	114	17	140
					71	25	130
106	27	118	45				
22	165	117	60	194	158		
78	155	70	21	187	109	174	55
		170	32	11	91	151	182
190	99	169	5				
127	177	63	189	7	110	28	90
							79
40	16	62	8	89	149	29	

FRAZIER

YOUR SOUND OUR SOUND

Listen to Frazier loudspeakers...
you'll hear your kind of sound.
Sound that flows like silk
... sparkles like diamonds.
Sound that's as crisp as
a fine autumn day.
It's our sound;
crystal clear
qualities
that come
only after years
of making fine
loudspeakers
... sound
that comes

from loudspeakers
where pride of crafts-
manship is the
by-word... super-
lative sound that
is only Frazier.



There is truly a
Frazier loud-
speaker for every
person.

From our fantastic
Super Midget at
under \$60 to our elegant ELEVEN at
\$1,200, you're sure to find a Frazier
loudspeaker that is perfect for you.

FRAZIER

INCORPORATED

1930 Valley View Lane
Dallas, Texas 75234
Phone 214-241-3441

* The best kept secret
in the audio industry

CIRCLE 20 ON READER-SERVICE CARD

by Norman Eisenberg

High Fidelity Pathfinders The Men Who Made an Industry



SIDNEY HARMAN
Eleventh in a series

THE "HARMAN" of Harman-Kardon, today a trim athletic figure who looks like a cross between Richard Conte and Peter Lawford, became something of a management genius after a false start as an engineer.

In 1939, fresh out of school (City College of New York with a B.S. degree in electrical engineering), Sidney Harman started working at Bogen, then manufacturing public-address equipment. After a few weeks in the engineering department, he was moved into administration at the management level by David Bogen, the company's founder. If ever a job change was well advised, this was it. Harman is still managing—as head of an industrial complex of international scale that *Fortune* magazine has listed as among the country's thousand major corporations and ninetieth in terms of return on investment. Harman International comprises the familiar audio-industry companies of Harman-Kardon, James B. Lansing, Tannoy, and its most recent acquisition, Ortofon; a separate international distribution setup that markets such other lines as Teac, Maxell, and Empire; an Exotic Metals Division; and an automotive division that turns out various accessories, including most of the outside mirrors found on cars the world over. Total revenues for last year topped the \$100-million mark. The organization employs some four thousand personnel in thirteen plants in the U.S., England, Scotland, and Germany.

While at Bogen in those early days,

the young engineer-turned-administrator had his career interrupted by World War II. Harman worked on a special U.S. Signal Corps "sonic deception" project, which made wire recordings of battle sounds that were projected over the battlefield to confuse the enemy, and then was put in charge of a Signal Corps technical school. At war's end he returned to Bogen, which was beginning to eye what looked like a bright new consumer field: high fidelity sound.

Always a music lover, Harman at various times "fooled around with transcription turntables and huge speakers mounted in 11½-foot-square hunks of plywood." At Bogen he got to know chief engineer Bernard Kardon well; the two shared an interest in high quality sound and had built their own amplifiers "for fun." In 1948, Bogen—largely on the prompting of Harman and Kardon—decided to build its first high fidelity amplifier, the PH-10. (The PH stood for phonograph, the 10 for the output wattage.) Original distribution was through radio-parts jobbers. The amplifier was thought of then not as the harbinger of home audio, but as a "refined" item in the company's public-address catalogue.

By the early Fifties it was apparent that a new industry was in the making, and in 1953, Harman—who had risen to executive vice president—decided it was time to strike out on his own. He and Kardon formed their now-familiar company. Harman recalls that one of their big moments came at the 1954 New York High Fi-

All rooms are not created equal. Nor speakers. Nor albums. Hear what Dynaco's truly superior Equalizer can accomplish with your music system. It will astound perfectionists who have rejected the coloration of other designs. The SE-10 is probably the finest sounding equalizer—certainly at its cost.

It's easier to use, more tolerant, (forget over-load, switch pop, and unity gain problems); and has greater versatility. Two separate line in/out pairs, plus tape monitor on one. No inductor saturation, with a hybrid

concept utilizing new design IC-simulated inductors at the four low frequencies, and superior performance gapped pot core inductors above 300 Hz, with all polyester control circuit capacitors.

8 ICs, 2 FETs, 5 transistors; IC-regulated power supply; 600 ohm output; typical distortion below 0.01%. Dynakit construction with a single pre-assembled circuit board—fast, easy and fun. Compact Dynaco size; optional wood cabinet shown.

Suggested List: Kit—\$249; Assembled \$349

unequaled



Dynaco
Dynakit

Write Dept. P., Box 88,
Blackwood, N.J. 08012



delity Show, when they exhibited sleekly styled equipment with colored front panels, a step looked on with misgivings by some of the industry's more conservative elements. "But," he says with a smile, "we felt our mission was to take audio equipment out of the basement and into the American living room." These products were the first of what might be called, without condescension, H-K's bread-and-butter line, styled and priced for home consumption.

Harman-Kardon soon developed a receiver, the Model D-1000. Whether it was actually the first combination tuner/amplifier, Harman cannot say. (At least a half-dozen companies introduced mono receivers more or less simultaneously in the mid-Fifties.) But H-K's certainly was among the first, and it presaged the equipment format that was to become dominant a decade or so later. The D-1000 caught the eye of a young salesman named Leon Kuby, who worked at Leonard Radio in New York City. Kuby asked Harman, "What is it?" Harman replied: "The most important single product in hi-fi." A lively discussion followed; shortly afterward Kuby joined the company and, save for one brief stint elsewhere, has been with Harman ever since.

When stereo came in during the late Fifties and early Sixties, sales manager Kuby, chief engineer Robert Furst, sales vice president Murray Rosenberg, and consultant Stewart Hegeman constituted a powerful team. It launched the Citation line, which not only earned considerable critical praise, but helped establish some new expectations for home sound reproduction, such as high power and wideband response. H-K also was among the first major companies to get into solid-state technology for home equipment.

In 1960 Harman-Kardon merged with the Jerrold Corporation; in 1963 Sidney Harman left. Soon afterward, when he was approached by the Jervis Corporation, an automotive-accessory manufacturer in need of capital investment, he became its chief executive. He revitalized the organization and, by 1969, not only had bought back Harman-Kardon from Jerrold, but also had acquired JBL in Los Angeles. In 1972, the company name was changed to Harman International, and Tannoy was soon acquired.

While all this empire-building was going on, Harman became interested in human social relations and began attending a branch of the Friends World College. He ended up teaching there and found himself chairman of a special committee of faculty mem-

bers, parents, and students that was set up to deal with unrest and other problems that mushroomed in schools in the late Sixties. In 1969, he was asked to succeed the school's president, who had retired—and he did, serving until 1973.

According to Harman, the period when he was "running a college in days of turmoil... was the beginning of a very important personal transformation." The board of trustees thought of him as a businessman; Harman thought of himself as an educator. The trustees felt that the college belonged to them and should turn out students cookie-cutter fashion along lines predetermined by them; Harman felt the college belonged to the students. He recalls paraphrasing Lincoln's words—"This country with its institutions belongs to the people who inhabit it"—at a board meeting and incurring its collective resentment. Firm in his conviction that "as students are changed by attending a school, so is the school changed by its students," he left his "extra job" as college head. He likes to joke that his leave-taking can be described in the same terms as his arrival: fired with enthusiasm.

Still interested in the humanities, Harman entered Union Graduate School and, after completing a thesis on "Education and Business—New Directions in a New Age," was awarded a Ph.D. in social and organizational psychology. His dissertation delves into the ideas that guide the inner workings of the complex he now heads. Harman saw a parallel between the alienation of students from their schools and the alienation of workers from their jobs and companies. He made an intensive study of business history and the rise of industrialism, concluding that "traditional business is structured so as to generate alienation. The average worker feels a sense of worthlessness; this results in poor work, poor products, and a poor life pattern for the individual and his or her family."

To upgrade "the quality of working life" and impart to all his employees a sense of dignity and self-worth has been a prime motivation of Harman's for some years now. His "work humanization" program has received considerable attention in the business press, in management journals, and in the U.S. Senate, where he has testified before the Senate Committee on Labor and Public Welfare. That it produces results that benefit the individual worker while also encouraging a steadily growing company income is something in which Harman takes as much pride as he does in the newest line from Harman International. ●



MODEL 19

We at Altec/Lansing are very proud of our newest and best speaker system, MODEL 19.

The key to the performance of MODEL 19 is an all-new high-frequency compression driver. It sports our exclusive new radial-design phase plug, The Tangerine™. With the Tangerine™ the driver produces greatly extended high-frequency response allowing our designers to employ a unique dual-range dividing network. This network permits variable equalization of mid and high-frequencies.



The dual-box design and tuned vent give MODEL 19 the proper internal volume and enclosure tuning to produce unprecedented low-frequency response.

MODEL 19 is available in oiled oak with removable brown knit grilles or oiled walnut with black knit grilles.

MODEL 19 turns your commitment to listening into a daring musical statement. Its solid beauty engulfs the senses as it bares the soul.

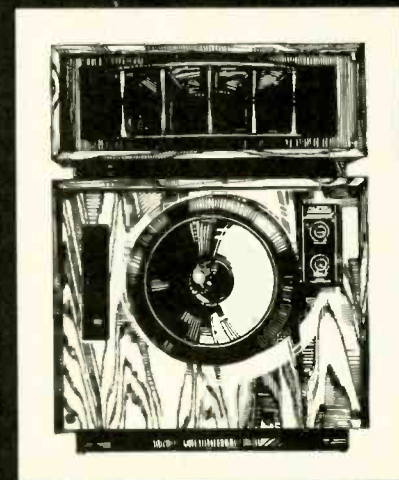

Altec/Lansing's full line of bookshelf and floor-standing speaker systems start at under \$100.

Send for free catalog:
Altec Sound Products, a Division of Altec Corp.,
1515 S. Manchester Ave., (Dept. HF), Anaheim,
CA 92803
*Patents Pending

*Alone with sea sounds and sunlight
the senses are freely touched
And whatever touches the senses
touches the soul.*



Model 100



*Speakers for people from
the people at Altec/Lansing*

©1976 Altec Corp.

The Best Way To Show You What You'll Get Out Of An Empire Phono Cartridge Is To Show You What Goes Into One

At Empire we make a complete line of phono cartridges. Each one has



slightly different performance characteristics which allow you to choose the cartridge most compatible to your turntable.

There are, however, certain advantages, provided by Empire's unique design, that apply to all our cartridges.

One is less wear on your records. Unlike other magnetic cartridges, Empire's moving iron design allows the diamond stylus to float free of its magnets and coils, imposing much less weight on your record's surface and insuring longer record life.

Another advantage is the better channel separation you get with Empire cartridges. We use a small, hollow iron armature which allows for a tighter fit in its positioning among the poles. So, even the most

minute movement is accurately reproduced to give you the space and depth of the original recording.

Finally, Empire uses 4 coils, 4 poles, and 3 magnets (more than any other cartridge) for better balance and hum rejection.

The end result is great listening. Audition one for yourself or write for our free brochure, "How To Get The Most Out Of Your Records". After you compare our performance specifications we think you'll agree that, for the money, you can't do better than Empire.

Empire Scientific Corp.
Garden City, New York
11530

EMPIRE

Already your system sounds better.

MODEL & STYLUS COLOR	4000 D/II	4000 D/II	4000 D/I	2000Z	2000 E/III	2000 E/II	2000 E/I	2000 E	2000
FREQUENCY RESPONSE	10Hz-50KHz ± 3 db	15Hz-50KHz ± 3 db	15Hz-50KHz ± 3 db	20Hz-20KHz ± 1 db	20Hz-20KHz ± 2 db	20Hz-20KHz ± 2 db	20Hz-20KHz ± 3 db	20Hz-20KHz ± 3 db	20Hz-20KHz ± 3 db
TRACKING FORCE RANGE	¾-1¼ gm	¾-1½ gm	1-1¼ gm	¾-1¼ gm	¾-1½ gm	¾-1½ gm	1-2 gm	1¼-2½ gm	1½-3 gm
SEPARATION: 15Hz to 1KHz 1KHz to 20KHz 20KHz to 50KHz 20 Hz to 500Hz 500Hz to 15KHz 15KHz to 20KHz	28 db 23 db 15 db	26 db 21 db 15 db	24 db 20 db 15 db	20 db 30 db 25 db	20 db 28 db 20 db	20 db 25 db 18 db	18 db 23 db 15 db	18 db 23 db 15 db	16 db 21 db 13 db
I. M. DISTORTION @ 3.54 cm/sec	.2% 2KHz-20KHz	.2% 2KHz-20KHz	.2% 2KHz-20KHz	.08% 2KHz-20KHz	.1% 2KHz-20KHz	.15% 2KHz-20KHz	.2% 2KHz-20KHz	.2% 2KHz-20KHz	.2% 2KHz-20KHz
STYLUS	.2 mil bi-radial	.2 mil bi-radial	.2 mil bi-radial	.2 x .7 mil elliptical	.2 x .7 mil elliptical	.2 x .7 mil elliptical	.2 x .7 mil elliptical	.3 x .7 mil elliptical	.7 mil radius spherical
EFFECTIVE TIP MASS	.4 milligram	.4 milligram	.4 milligram	.2 milligram	.6 milligram	.6 milligram	.6 milligram	.9 milligram	1 milligram
COMPLIANCE	30x10 ⁻⁶ cm/dyne	30x10 ⁻⁶ cm/dyne	30x10 ⁻⁶ cm/dyne	30x10 ⁻⁶ cm/dyne	20x10 ⁻⁶ cm/dyne	18x10 ⁻⁶ cm/dyne	17x10 ⁻⁶ cm/dyne	16x10 ⁻⁶ cm/dyne	14x10 ⁻⁶ cm/dyne
TRACKING ABILITY	32 cm/sec @ 1KHz @ 1 gm	32 cm/sec @ 1KHz @ 1¼ gm	30 cm/sec @ 1KHz @ 1½ gm	38 cm/sec @ 1KHz @ .9 gm	32 cm/sec @ 1KHz @ 1 gm	28 cm/sec @ 1KHz @ 1¼ gm	28 cm/sec @ 1KHz @ 1½ gm	28 cm/sec @ 1KHz @ 1¾ gm	32 cm/sec @ 1KHz @ 2 gm
CHANNEL BALANCE	within 1 db @ 1KHz	within 1 db @ 1KHz	within 1½ db @ 1KHz	within ¾ db @ 1KHz	within 1 db @ 1KHz	within 1¼ db @ 1KHz	within 1½ db @ 1KHz	within 1½ db @ 1KHz	within 1½ db @ 1KHz
INPUT LOAD	100K ohms/channel	100K ohms/channel	100K ohms/channel	47K ohms/channel	47K ohms/channel	47K ohms/channel	47K ohms/channel	47K ohms/channel	47K ohms/channel
TOTAL CAPACITANCE	under 100 pf/channel	under 100 pf/channel	under 100 pf/channel	300 pf/channel	400-500 pf/channel	400-500 pf/channel	400-500 pf/channel	400-500 pf/channel	400-500 pf/channel
OUTPUT @ 3.54 cm/sec	3 mv/channel	3 mv/channel	3 mv/channel	3 mv/channel	4.5 mv/channel	4.5 mv/channel	7 mv/channel	7 mv/channel	7 mv/channel

Preparation supervised by
Robert Long and Harold A. Rodgers
Laboratory data (unless otherwise noted)
supplied by CBS Technology Center

New A CONSUMER'S GUIDE Equipment Reports

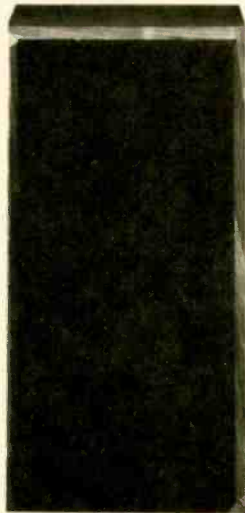

Hartley's Redesigned Magnetic-Suspension Holton Jr.

The Equipment: Holton Jr., a loudspeaker system in wood enclosure; available in symmetrical stereo pairs. Dimensions: 30 by 15 inches (front—intended for vertical placement), 12 inches deep. Price: \$290. Warranty: "limited," five years parts and labor. Manufacturer: Hartley Products Corp., 56 N. Summit St., Tenafly, N.J. 07670.

Comment: The present Holton Jr. is somewhat different in design and construction from the model reported on in September of 1969. In addition to the name, dimensions, and general appearance, the full-range driver from the original has been retained. But the duties that it formerly had above 5 kHz are now assigned to a 1-inch dome tweeter that seems capable of very good dispersion at high frequencies.

Rated at 5 to 8 ohms impedance by the manufacturer, the Holton Jr. tests out closer to the lower figure than to the higher, with a nominal rating of 5.3 ohms. The impedance curve recorded by CBS Technology Center is smooth with well-controlled peaks, but it lies low enough that we would not recommend paralleling two of these speakers off each channel of at least some solid-state amplifiers. In the range of 250 to 6,000 Hz, an electrical input of 0 dBW (1 watt) produces an average sound pressure level of 89½ dB 1 meter on axis, indicating efficiency that is well above average.

Tested for power-handling capability, the Hartley shows low-level, low-frequency harmonic distortion higher than that of most loudspeakers. The distortion increases rather slowly as power is raised, however, so the speaker can accept a 17-dBW (50-watt) input—for a continuous output of 106 dB SPL at 300 Hz—while keeping spurious output at acceptable levels. On pulses, the system does not display excessive distortion until driven with a peak power of 28.3 dBW (679 watts), all that the test amplifier could produce.

The sound pressure level of 117 dB produced under this condition indicates dynamic range comparable with the best we have found.

The average omnidirectional anechoic frequency response (± 4 dB, 50 Hz to 16 kHz, re 82½ dB SPL) is commendably flat. There are no balance controls—the back panel has only a pair of spring-loaded terminals meant for bared or possibly tinned wires—so any tailoring of response must be done via amplifier tone controls or equalizer. We found little adjustment necessary, save a slight low-frequency boost, which the speaker accepts without noticeable untoward effects.

On chamber music or delicate orchestral textures where levels are not too high, the sound of the Holton Jr. is attractive indeed. Probably because of the fine dispersion, the stereo image (which is very clear to begin with) is maintained for listening positions well off axis of the stereo pair. Transient response is good, with the bass kept under especially tight control. This is possibly because of the suspension design, in which the restoring force on the woofer cone is produced magnetically. The suspension is, as far as we know, an exclusive feature of Hartley's design.

The principal weakness that we find in this speaker is the somewhat high level of distortion for bass tones. Though generally quite innocuous, it can cause coloration

REPORT POLICY Equipment reports are based on laboratory measurements and controlled listening tests. Unless otherwise noted, test data and measurements are obtained by CBS Technology Center, Stamford, Connecticut, a division of Columbia Broadcasting System, Inc., one of the nation's leading research organizations. The choice of equipment to be tested rests with the editors of HIGH FIDELITY. Manufacturers are not permitted to read reports in advance of publication, and no report, or portion thereof, may be reproduced for any purpose or in any form without written permission of the publisher. All reports should be construed as applying to the specific samples tested; neither HIGH FIDELITY nor CBS Technology Center assumes responsibility for product performance or quality.

ranging from an artificial crispness to a slight muddiness. But it is not evident on short pulses. At low-to-medium levels the Holton Jr. is very accurate—and it has exceptional headroom for peaks.

Listening reaction varied a good deal. It seems that those who cherish big orchestral climaxes are the least impressed, finding more internal clarity in the sound pro-

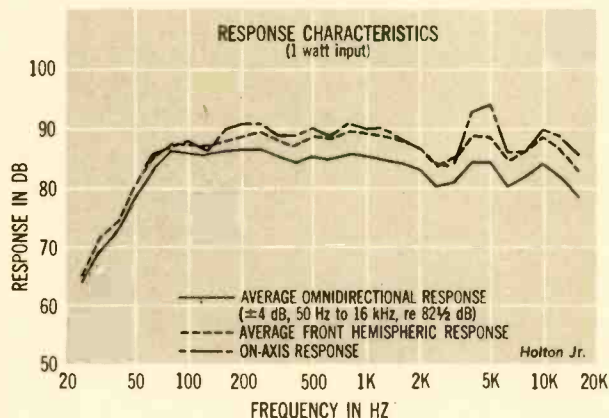

Lafayette Successfully Uses the Heil Driver

The Equipment: Lafayette Criterion 2005, a floor-standing, columnar loudspeaker system, in vinyl-finish wood enclosure. Dimensions: 13 by 13 inches (base), 39 inches high. Price: \$199.95. Warranty: "limited," five years parts and labor. Sole distributor: Lafayette Radio Electronics, 111 Jericho Turnpike, Syosset, N.Y. 11791.

Comment: The Heil Air Motion Transformer seems to keep broadening its horizons, and this time it has made its de-

duced by some other speakers. On the other hand, more intimate textures were termed "thrilling" by some listeners. One opera-lover, listening to the prison scene from *Mefistofele*, claimed he had never heard it so beautifully reproduced. Obviously the Holton Jr. must be auditioned—carefully—by each listener for himself.

CIRCLE 132 ON READER-SERVICE CARD

Holton Jr. Loudspeaker Harmonic Distortion*

Output Level (dB)	Frequency			
	80 Hz		300 Hz	
	% 2nd	% 3rd	% 2nd	% 3rd
75	1.0	0.70	0.38	0.28
80	1.3	1.0	0.45	0.28
85	2.1	1.2	0.38	0.30
90	3.1	2.1	0.33	0.28
95	4.5	3.0	0.85	0.44
100			1.5	0.47
105			1.0	1.0
106			0.75	1.6

*Distortion data are taken on all tested speakers until distortion exceeds the 10% level, the output level reaches 100 dB at 80 Hz, the input power reaches 100 watts at 300 Hz, or the speaker produces the spurious output known as buzzing, whichever occurs first.

but as a driver in a relatively inexpensive loudspeaker system. The performance of the ESS-built Heil tweeter is not particularly surprising—we have a good idea what to expect from it by now—but the total system is amazingly competent, as we shall see when we get down to specifics.

The "Corona Field" Heil driver is a small round unit (rated at 7.65 square inches of radiating area) mounted just behind the grille cloth in the top section of the speaker. The back wave from this tweeter fires into a cavity that is vented to the listening space at the top and rear and also in front at the sides of the driver itself. The lower section is devoted to a 10-inch conventional cone woofer. At the back are spring-loaded binding posts designed for bared (or tinned) wire leads, a continuous variable TREBLE (tweeter) control with a marked OPTIMUM RANGE, and a circuit-breaker reset button.

The sound of the Criterion 2005 can get very large with very little audible effort. In the CBS anechoic chamber the system delivers a continuous output of 107-dB sound pressure level at 300 Hz (at 1 meter on axis) without excessive harmonic distortion. The power required for this is 18 dBW (64 watts). Attempting to push the unit to 108 dB (with 19 dBW—80 watts) not only drives up distortion, but also trips the circuit breaker. On pulses, this speaker hangs in there with the best we have tested, reaching a peak SPL of 117.3 dB—and the limit of the test amplifier at 28.3 dBW (679 watts) peak—by the time it shows signs of undue strain. All this represents even better power handling than Lafayette's specs suggest. Efficiency of the unit is above average; a 0-dBW (1-watt) input produces an output of 87.3 dB. Dynamic range over-all is excellent.

Nominal impedance works out to 5.3 ohms, somewhat lower than rated by Lafayette—and low enough that caution should be observed in connecting two 2005s in parallel to either channel of a solid-state power amp. The im-

pedance curve is reasonably smooth, with one major and one minor peak, never dipping below the nominal rating.

The average omnidirectional anechoic frequency response shown on the graph is $\pm 5\frac{1}{2}$ dB between about 50 Hz and 13 kHz, but these figures require some qualification. In our listening room the bass output holds up well to about 30 Hz. And the speaker was measured with the TREBLE control set in the "optimum range," which we did not consider optimum when we came to listen. Rotating the control toward INCREASE adds up to 1 to 2 dB of output between approximately 2 and 4 kHz and up to about 5 dB of output at higher frequencies. (Turning the control all the way toward DECREASE effectively kills the tweeter output so that there is no useful response above 5 kHz—to our way of thinking a useless option.) We tended to prefer the sound with the tweeter full on. So the effective response range in our listening room is considerably broader than the curve suggests.

The sound of the Criterion 2005 is of truly high quality. Stereo imaging, enhanced by excellent dispersion of the highs, is convincing and consistent. High-frequency transients are superb, as we have come to expect with Heil tweeters. The woofer does not seem quite as agile (a somewhat tighter bass might be wished for), but the bottom end of the music is solidly there. Some listeners may find themselves a bit unnerved by the sharply etched attack transients from the bass instruments—bassoon "chirp," for example—that some speakers, lacking the Heil's superquickness, smear right over. The rather "forward" character of the system can be softened, if you wish, by backing off on the tweeter control, but overeagerness here can dim the clarity that is one of this speaker's most engaging features. One listener whom we know to be very fussy heard the Criterion 2005 and could find nothing to complain about but the price: He thinks it is too low.

CIRCLE 133 ON READER-SERVICE CARD

The Equipment: Pioneer HPM-60, a large bookshelf loudspeaker system, in wooden enclosure. Dimensions: 24 by 13 $\frac{3}{4}$ inches (front—intended for vertical placement), 12 $\frac{1}{2}$ inches deep. Price: approximately \$225. Warranty: "limited," three years parts and labor. Manufacturer: Pioneer Electronics Corp., Japan; U.S. distributor: U.S. Pioneer Electronics Corp., 75 Oxford Dr., Moonachie, N.J. 07074.

Comment: The designation HPM for this line of speakers (which includes the HPM-40 and HPM-100) refers to the high-polymer molecular film used in the supertweeters. This is a material that, like a piezoelectric crystal, undergoes a change in one or more of its physical dimensions when subjected to an electrical voltage. In this application, the film, which is an insulator, is coated on both sides with conductive foil to which an audio signal is applied. The film vibrates accordingly and radiates sound. In the HPM-60 the polymer supertweeter is hemicylindrical in shape for wide horizontal dispersion.

The system also includes a conventional cone tweeter, a 4-inch midrange driver, and a 10-inch woofer. The crossover frequencies are listed as 1.2, 4, and 12 kHz. On the back of the speaker, in the well with the spring-loaded lead connections (engineered for bared wires), are two balance adjustments, both variable on either side of an indicated NORMAL position, in which the lab tests were made. The MID control introduces up to 2 dB of "boost" or about 5 dB of attenuation between about 2 and 12 kHz. The HIGH con-

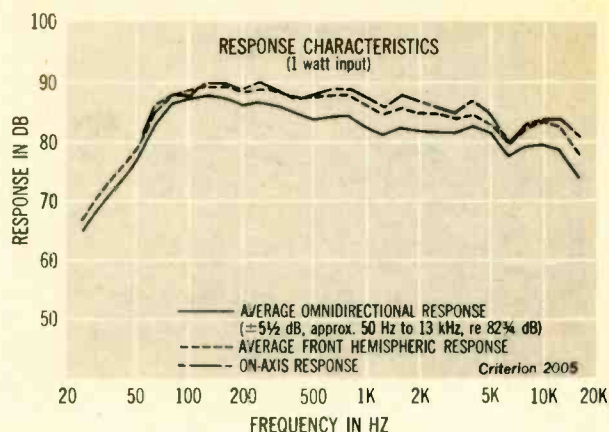

Lafayette Criterion 2005 Harmonic Distortion*

Output Level (dB)	Frequency			
	80 Hz		300 Hz	
	% 2nd	% 3rd	% 2nd	% 3rd
75	0.45	0.33	0.30	0.30
80	0.88	0.40	0.26	0.26
85	1.1	1.2	0.24	0.28
90	1.6	1.7	0.27	0.40
95	2.8	2.3	0.26	0.50
100			0.38	0.76
105			1.7	1.2
107			2.8	1.3

*Distortion data are taken on all tested speakers until distortion exceeds the 10% level, the output level reaches 100 dB at 80 Hz, the input power reaches 100 watts at 300 Hz, or the speaker produces the spurious output known as buzzing, whichever occurs first.

Pioneer's Polymer-Tweeter HPM-60

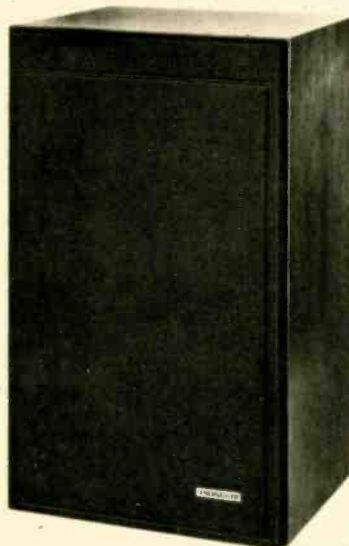

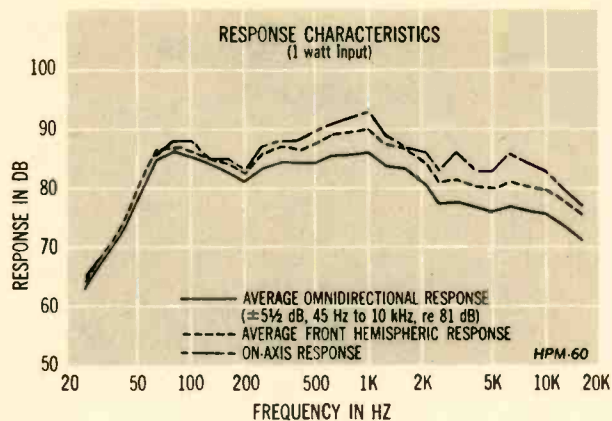

control yields very little "boost" but about 5 dB of attenuation between about 3 and 15 kHz. These ranges overlap, and the degree of change both with rotation angle and with frequency is nonlinear—meaning that the effect of the controls is not as straightforward as their labeling would suggest it is.

In the customary "torture test" in the CBS anechoic chamber, the HPM-60 proved itself capable of accepting virtually its full rated input power at a distortion level that is commendably low. When rated power is exceeded, breakup is sudden, but on pulses the unit accepts power approaching 27.4 dBW (550 watts) peak for a sound pressure level of nearly 114½ dB before excessive distortion occurs. An input of 0 dBW (1 watt) produces an average SPL of 87.8 dB in the range from 250 to 6,000 Hz, indicating above-average efficiency.

Apart from the twin peaks that are to be expected in a bass-reflex design, the impedance curve is unusually smooth and flat. The nominal impedance works out to 5.5 ohms—somewhat lower than the manufacturer's 8-ohm rating and into territory where one must be cautious about connecting two speaker pairs in parallel across solid-state amps.

Frequency response is one of the areas in which the HPM-60 asserts its ingratiating personality. Bass response

Pioneer HPM-60 Harmonic Distortion*

Output Level (dB)	Frequency			
	80 Hz		300 Hz	
	% 2nd	% 3rd	% 2nd	% 3rd
75	0.25	0.10	0.09	0.20
80	0.40	0.13	0.10	0.16
85	0.54	0.15	0.15	0.17
90	0.85	0.25	0.20	0.12
95	1.5	0.62	0.30	0.13
100	3.5	1.3	0.65	0.12
105			1.1	0.70

*Distortion data are taken on all tested speakers until distortion exceeds the 10% level, the output level reaches 100 dB at 80 Hz, the input power reaches 100 watts at 300 Hz, or the speaker produces the spurious output known as buzzing, whichever occurs first.

peaks at 80 Hz and falls off a bit at 200 Hz, followed by a midrange peak at 1 kHz, with a rapid rolloff to about 4 kHz and a gentler one above that. Dispersion of high-frequency energy would appear to be a strong point of the HPM super tweeters, for there is little evidence of beaming. These drivers turn out abundant and clear highs without drawing attention to themselves in any way.

To be sure, this is not an unusually neutral speaker. Whether you will like or dislike its particular coloration habits is a matter of individual taste. It has a way of rounding off the sharp corners and romanticizing the music that we believe will be pleasing to many. The balance controls have a good deal of influence on this property, though they do not allow radical alterations. (We like the units best with the MID control at -2 and the HIGH control at +1.) The stereo imaging is consistent with this sonic character: Its clarity allows you to hear all that the musicians are playing, but the effect is one of blending rather than precise, unequivocal individual placements.

The system impresses us with the attractiveness of its sound more than with its accuracy. If your listening habits are such that you can't be won over in this way, this speaker is not for you. But make no mistake about it, the HPM-60 has quite a few winning qualities.

CIRCLE 131 ON READER-SERVICE CARD

About the dBW . . .

As we announced in the June issue, we currently are expressing output power and noise in terms of dBW—meaning power in dB with a reference (0 dBW) of 1 watt. We repeat herewith the conversion table so that you can use the advantages of dBW in comparing current products with those we have reported on in the past. You can, of course, use the figures in watts that accompany the new dBW figures for these comparisons, but then you lose the ability to compare noise levels for outputs other than rated power and the ability to figure easily the levels to which specific amplifiers will drive specific speakers—a matter explained at some length in the June issue.

If you do not have the June issue and would like a reprint of the full exposition, send 25¢ (U.S.) to:

dBW, c/o High Fidelity Magazine, The Publishing House, Great Barrington, Mass. 01230.

WATTS	dBW	WATTS	dBW	WATTS	dBW
1.00	0	10.0	10	100	20
1.25	1	12.5	11	125	21
1.6	2	16	12	160	22
2.0	3	20	13	200	23
2.5	4	25	14	250	24
3.2	5	32	15	320	25
4.0	6	40	16	400	26
5.0	7	50	17	500	27
6.3	8	63	18	630	28
8.0	9	80	19	800	29



Scott's PRO-100, a Speaker in the Grand Manner

The Equipment: Scott PRO-100, a floor-standing loudspeaker system in wood cabinet. Dimensions: 29½ by 19 inches (front), 14½ inches deep. Price: \$350. Warranty: "limited," five years parts and labor. Manufacturer: H. H. Scott, Inc., 111 Powder Mill Rd., Maynard, Mass. 01754.

Comment: As the first completely new loudspeaker designed at H. H. Scott since the resurgence of the company some two years ago—and the apparent progenitor of a new line—the PRO-100 is of particular interest. Apart from its sound, the most distinctive feature of the design is the inclusion of upward-firing midrange and high-frequency drivers as well as conventional front-firing ones. Basically the system represents thoughtful application of well-known principles rather than any technological breakthrough.

The PRO-100 is rated by Scott at 4 ohms, and according to the company's "controlled impedance concept" the extremes of measured impedance are to lie between 4 and 12 ohms. The important part of this (from the amplifier's point of view) has been accomplished: CBS's test data show that approximately 4.5 ohms is the lowest measured value. A rise to almost 16 ohms at bass resonance is manifest but inconsequential. Unless the manufacturer of your amplifier advises you differently, however, two of these speakers should not be driven in parallel from a single output, though a midrange impedance rise (to about 10.5 ohms) makes them less current-draining than the lab's nominal 5-ohm rating might suggest.

When it comes to big sound, this unit has few peers. Most listeners' ears will give up before the speaker does—and not because of distortion, either. At 1 meter on axis it can produce a clean 300-Hz tone at a *continuous* sound pressure level of 110 dB. This feat is accomplished with an input of 20 dBW (100 watts). When reproducing pulses, the system is capable of 118.5 dB peak output without excessive distortion, and the actual limiting factor in this test was not the speaker but the test amp, which gave up at 28.6 dBW (720 watts) peak power. Efficiency—a hair shy of 89 dB SPL for a 0-dBW (1-watt) input—is solidly above average. And the dynamic range is just staggering.

To complement its array of drivers, the PRO-100 is well provided with controls. One of the three-position switches hidden behind the panel just below the grille cloth controls the midrange output in steps of about 2 dB in the octave or so, centered at 3.5 kHz. A second switch affects the tweeter similarly between about 5 kHz and the upper limit of the

bandpass but in somewhat larger steps (3 to 4 dB). The third switch allows 25, 35, or 50% of the total mid- and high-frequency output to be channeled to the upward-firing drivers.

Probably because of some difficulty involving the multiple midrange and tweeter units, we were not able to observe the usual degree of correlation between the average omnidirectional frequency response measured in the CBS anechoic chamber and the listening quality of the system. In particular, the broad dip centered between 3 and 4 kHz is not evident to the ear. The measured response of $\pm 4\frac{1}{2}$ dB between approximately 35 Hz and 15 kHz is a fair characterization of the PRO-100, however. In our listening room, the most pleasing balance was obtained with the midrange switch in the minimum position, the tweeter switch in the medium position, and 25% of their radiation directed upward. Useful bass output is evident to about 30 Hz.

The transient response of this system is not the most penetratingly clear we have ever heard, but it is nonetheless very good. High-frequency dispersion is superior and can be tailored to a degree by adjusting the output of the upward drivers. The broad outlines of the stereo image are excellent in spite of a slight vagueness in the location of solo instruments. Thus, even with its outstanding dynamic range, the speaker gives a fairly distant perspective on the music.

On the whole, we find the PRO-100 to be well above average in performance. It does some things about as well as we have heard them done and everything we can think of at least acceptably. It surely merits consideration by anyone looking for a speaker in this price range. If this represents Scott's new direction, things look promising indeed.

CIRCLE 134 ON READER-SERVICE CARD

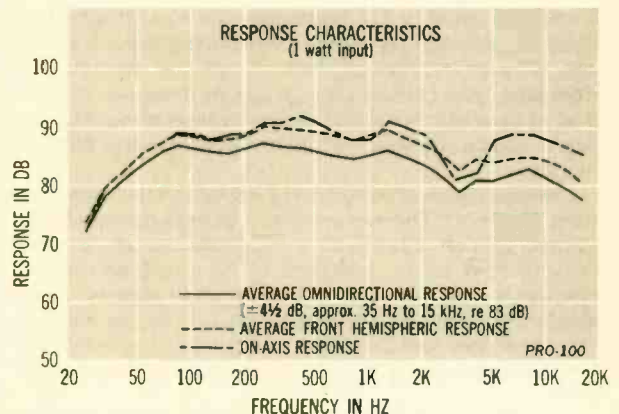

Scott PRO-100 Harmonic Distortion*

Output Level (dB)	Frequency			
	80 Hz		300 Hz	
	% 2nd	% 3rd	% 2nd	% 3rd
75	0.58	0.38	0.26	0.33
80	0.40	0.38	0.25	0.33
85	0.28	0.38	0.26	0.38
90	0.24	0.38	0.28	0.43
95	0.25	0.40	0.33	0.50
100	0.53	0.40	0.60	0.56
105	1.2	0.40	1.1	0.60
110			2.4	1.0

*Distortion data are taken on all tested speakers until distortion exceeds the 10% level, the output level reaches 100 dB at 80 Hz, the input power reaches 100 watts at 300 Hz, or the speaker produces the spurious output known as buzzing, whichever occurs first.

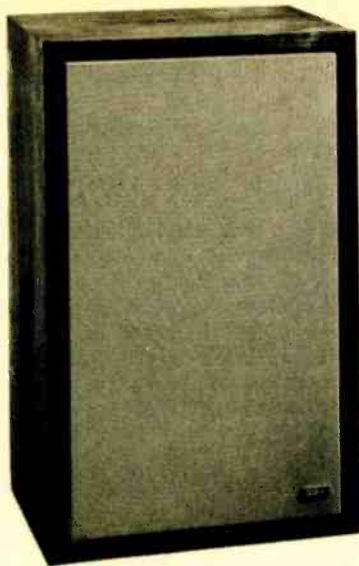

GTE-412, Top of Sylvania's Speaker Line

The Equipment: GTE-412, a floor-standing loudspeaker system in wood enclosure. Dimensions: 30½ by 18½ inches (front, including 2-inch base), 12½ inches deep. Price: \$249.95. Warranty: "limited," five years parts and labor. Manufacturer: GTE Sylvania, Inc., 700 Ellicott St., Batavia, N.Y. 14020.

Comment: The GTE-412 represents the current thrust of Sylvania audio componentry: It owes nothing, so far as we can discover, to the compact-cum-console background from which the componentry originally emerged. A good deal of careful engineering seems to have gone into the new products. They are worthy contenders in this difficult market.

The impedance of the GTE-412 is given by the manufacturer as 8 ohms. The nominal rating as determined at CBS Technology Center is 5.4 ohms, and the impedance curve (which is fairly peaky) falls twice to the neighborhood of 4 ohms and once as low as 3.2 ohms, all in regions where most music contains appreciable energy. To our mind, 4 ohms is a more realistic rating; we do not recommend running two systems in parallel from one solid-state amplifier output.

When it comes to muscle, this is a system that performs very creditably. The lab found continuous output produced 1 meter on axis to be a 106-dB sound pressure level, for an electrical power input of 20 dBW (100 watts). The system is safe (and about 2 dB louder) at the rated maximum input power (21.8 dBW, or 150 watts), but distortion is higher. With pulsed input at 300 Hz, the speaker produces a peak SPL of 111.2 dB, accepting the full peak power of the test amp (28.2 dBW, or 667 watts) without undue distortion. Efficiency is on the low side—a 0-dBW (1-watt) input translates to an 83.8 dB SPL average output in the range from 250 to 6,000 Hz. Dynamic range, over-all, is better than in most speakers.

Three three-position switches on the back of the loudspeaker cabinet (in addition to the color-coded binding posts that accommodate bare wires, large spade lugs, or banana plugs) control, respectively, the midrange driver, the tweeter, and the supertweeter. Midrange output can

be adjusted in steps of about 2½ dB between 700 and 1,800 Hz, tweeter output in 3-dB steps between 2.1 and 8 kHz, supertweeter output in 2-dB steps between 9 and 20 kHz. Each is marked HIGH, NORMAL, and LOW; the lab tested, and we preferred to listen, in the NORMAL position of all three. Interaction between the controls is measurable but not serious.

Average omnidirectional frequency response in the anechoic chamber is unusually flat. Moreover, there is plenty of useful output at 30 Hz and at 20 kHz. Sylvania's claim of excellent high-frequency dispersion is by and large vindicated; there is little perceptible change until one moves more than 45 degrees off axis.

As a reproducer of music, the GTE-412 can lay claim to areas in which it performs extremely well. With music that is not too active and not too loud it makes a clear, well-balanced, and fairly accurate sound. When asked to reproduce transients—particularly loud, complex transients—the system falls from grace somewhat and seems to blur the various frequency components in time. Sensitivity to this effect will vary from room to room and from listener to listener, but in severe cases it seems to tamper with rhythmic detail (the impression of orchestral ensemble, for example) and even, in rapidly moving passages, with tonal color. Stereo imaging is acceptable, though we would have liked more depth.

But there can be no doubt that this is a creditable loudspeaker. In company with many a successful speaker system, it is hardly at the forefront of state-of-the-art development. So while it is not a speaker of which you should expect exceptional things, neither is it a speaker you should pass over when you are auditioning.

CIRCLE 135 ON READER-SERVICE CARD

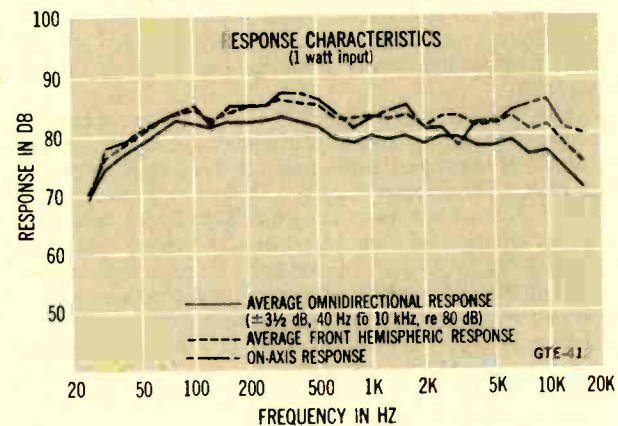

GTE-412 Speaker Harmonic Distortion*

Output Level (dB)	Frequency			
	80 Hz		300 Hz	
	% 2nd	% 3rd	% 2nd	% 3rd
75	0.20	0.55	0.09	0.60
80	0.35	0.65	0.10	0.80
85	0.60	0.70	0.15	0.80
90	1.1	0.72	0.22	0.50
95	1.9	1.2	0.82	1.1
100	7.0	4.0	1.5	1.2
105			3.5	1.8
106			4.0	2.0

*Distortion data are taken on all tested speakers until distortion exceeds the 10% level, the output level reaches 100 dB at 80 Hz, the input power reaches 100 watts at 300 Hz, or the speaker produces the spurious output known as buzzing, whichever occurs first.

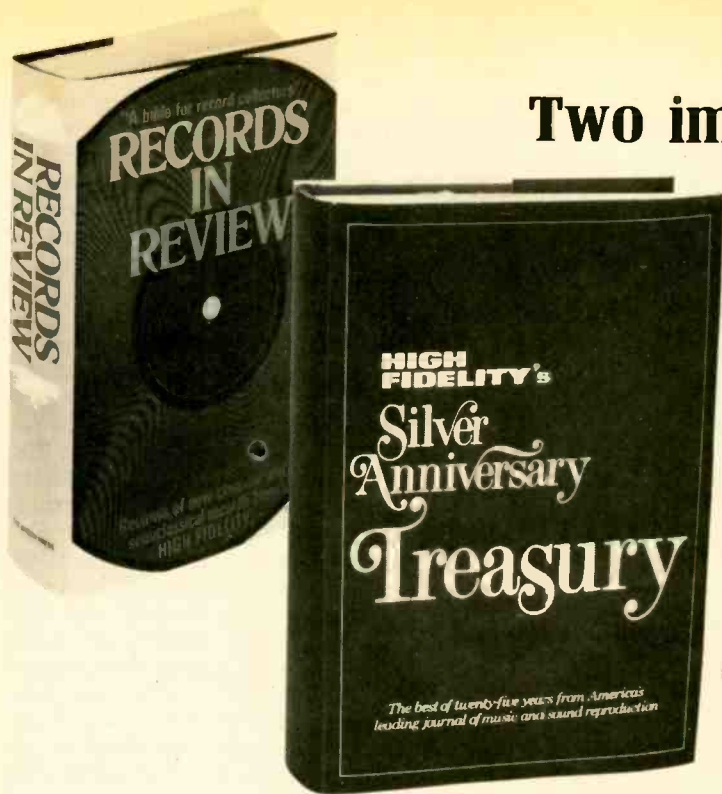

Two important new books

for the
music lover—

For reading pleasure . . .
For reference . . .

And a third book FREE
when you order both.

RECORDS IN REVIEW 1976 Edition

The 21st comprehensive edition of this "bible for record collectors" is now off the press. Considered a basic reference work for record lovers everywhere, this sturdy, hard-cover volume contains all record reviews of classical and semiclassical music that appeared in HIGH FIDELITY during 1975. These authoritative reviews cover all types of music—vocal, orchestral, chamber, and solo—from all periods, medieval to contemporary. And they treat all formats—discs, open-reel tape, cartridges, and cassettes, in both stereo and quadriphonic versions. Written by HIGH FIDELITY's staff of knowledgeable and noted critics, the reviews are arranged both alphabetically and by musical category for ready reference.

(Now Available)

HIGH FIDELITY'S SILVER ANNIVERSARY TREASURY

In observance of the 25th anniversary of HIGH FIDELITY Magazine, the editors have compiled a collection of the finest articles by the liveliest, most learned, and most accomplished writers to appear in HIGH FIDELITY's pages over the entire quarter-century of its existence. Here are such classics as Aaron Copland on Mozart, Ashley Montagu on Women Composers, Leonard Marcus on Bach, Roland Gelatt on Verdi's Italy, Gunther Schuller on Duke Ellington, Charles Rosen on Performance Style, Wieland Wagner on Richard Wagner, Conrad L. Osborne and John Culshaw writing on each other, and many, many more. It's a veritable treasure chest of the finest writing on music and sound reproduction to appear anywhere.

(Publication Date: November 1st)

Special Bonus for Ordering Both Books

Either or both of these landmark volumes may be ordered by simply filling in the coupon below and returning it with your check. And, as a special bonus, we are offering a FREE copy of the 20th Anniversary Edition of RECORDS IN REVIEW to everyone who orders both books at the same time—a \$14.95 value, absolutely without charge. This is almost the classic "offer you can't refuse." Even if you already have purchased your copy of the 20th Edition, it makes a thoughtful gift for a record collector, or could be a valuable addition to a library of your choice. And, of course, if you have put off ordering your own copy until now, here is a once-in-a-lifetime opportunity to get it absolutely free.

YES! I want to take advantage of your bonus offer. Enclosed is my check for \$24.90. Please send me HIGH FIDELITY's Silver Anniversary Treasury, along with both the 20th and 21st editions of *Records in Review*.

Enclosed is my check for \$9.95. Please send me HIGH FIDELITY's *Silver Anniversary Treasury* as soon as it is available.

Enclosed is my check for \$14.95. Please send me *Records in Review* (21st edition).

(Sorry—We cannot invoice. Payment must accompany order. Allow 60 days for shipping. Combination orders will be shipped upon publication of *Silver Anniversary Treasury*.)

WYETH



Wyeth Press

Box 550

Great Barrington, Mass. 01230

PRESS

Name _____

Address _____

City _____ State _____

Zip _____

Please enclose payment with order

HF-1076

BOOK REVIEW



From Tin Foil to Stereo, by Oliver Read and Walter L. Welch. Second edition (1976), Howard W. Sams & Company, Inc./Bobbs-Merrill Company, Inc., \$19.95; \$9.95 in paperback.

LET THERE BE no mistake: This is a seminal text that has no peer—required reading for anyone interested in phonographic history. But it is neither easy nor enjoyable reading. It is extravagantly wordy and repetitive, occasionally sloppy in minor details, and wanting in color and style, even for a nutsy-boltsy book whose pervading concern is with technology. Curiously its most colorful passages also tend to be those that betray what may be its most grievous fault: its intense partisanship. But I anticipate.

Read and Welch published the first edition of *From Tin Foil to Stereo* in 1959. In recent years used copies in only fair condition have been selling for \$40 or more when they could be found at all; their scarcity together with continued evolution and research in the phonograph industry plus, no doubt, the impending centennial of Thomas Edison's invention of the phonograph appear to have convinced Sams that a new edition was called for.

Without access to that elusive first edition, it's hard to tell what has been changed, though some passages (some of the most poorly judged) patently could not have been written in 1959. The thrust of the book, despite its title, has little to do with current phonographic history, however. The emphasis is overwhelmingly on the formative years, which are dealt with in great detail and documented with a wealth of illustrations, reproductions and transcriptions of original documents, and contemporary drawings.

This is not a history in the usual

sense. Of the thirty chapters, each constituting an individual essay, some trace historical developments ("The Local Phonograph Companies," "The Coin-Slot Phonograph Industry," "Wireless Telegraphy, Wireless Telephony, and Radio," "The Motion Picture and Sound Recording"), and some deal with specific issues that transcend time ("Discs Versus Cylinders" and "Realism, Romanticism, and Hi-Fi"). They are assembled in as close to chronological sequence as such a plan will allow.

It appears that the authors did not plan to take the reader by the hand and lead him through the puzzling progression that has been phonographic history over the last century. Rather, they seem to have intended that the reader will consume the book one portion at a time, dipping only into the chapter that will answer immediate questions. Any attempt to read it as a continuous narrative goes against the grain of the book—and probably of most readers. Not only does the scene shift radically between some of the contiguous chapters, but much matter is repeated each time it must be touched on—granted, a help to the researcher, since he need not thumb back to pick up earlier references.

The very quantity of material presented is enough to discourage the volume's wholesale consumption. Though there are 457 pages in the main text (exclusive of introduction, the excellent plates, some fascinating appendices, and index), they are set—two columns to the page—in such small type that they hold approximately four times as many words as a typical book page. So *Tin Foil* may constitute the equivalent of close to 1,600 pages. It would have required an order of literary craftsmanship well

beyond the reach of the authors to sustain interest throughout, even with so fascinating a topic. An editor with a strong hand, a feeling for style, an eye for detail, and a thorough knowledge of the subject might have made the book more readable; but only a recasting of its basic structure would have improved it significantly.

Read and Welch have avoided almost entirely the most colorful aspects of their subject: the artists who recorded for the phonograph and the repertoire they chose to record. (Excellent coverage of this aspect, Roland Gelatt's *The Fabulous Phonograph*, already was in print when *Tin Foil* first appeared.) Even the interesting figures that remain—from Edison himself through Emile Berliner and Fred Gaisberg to Louis Sterling and David Sarnoff, and including all manner of inventors, hucksters, tinkerers, lawyers, engineers, publicists, and what-not along the way—are characterized by little more than their phonographic accomplishments, or their want thereof.

And here the not-so-fine line between reportage and invective often is crossed. Edison is, by a large margin, the dominant figure of the book; Berliner and Eldridge Johnson, in developing the disc into a viable commercial reality, were important subsidiary figures. But commercial viability is, to the authors, a meager matter in the face of inventive genius. And Edison, as they establish in laborious detail, laid almost every important stone in the foundations on which modern recording technology is built. They make no effort to mask their contempt for those (including, one suspects, Gelatt) who in their opinions have sought to belittle or obscure that achievement. When those often successful efforts have been carried out in a spirit of intrigue and prompted by the crassest commercialism, the tone of the writing approaches righteous outrage. Perhaps outrage is justified, but these passages can hardly reassure the scholar of the authors' objectivity.

The pity of it is that in more skilled hands the documentation might have been allowed to speak for itself—at a considerable saving in both printing cost and readers' patience. But without such a cause to write about, the authors might never have produced this utterly unique book. Much of its content is to be had in no other readily available form, much less gathered together in a single work. It deserves its place in phonographic libraries and doubtless will command high prices once again as soon as the current printings run out.

ROBERT LONG

The New AIWA AD-6500:

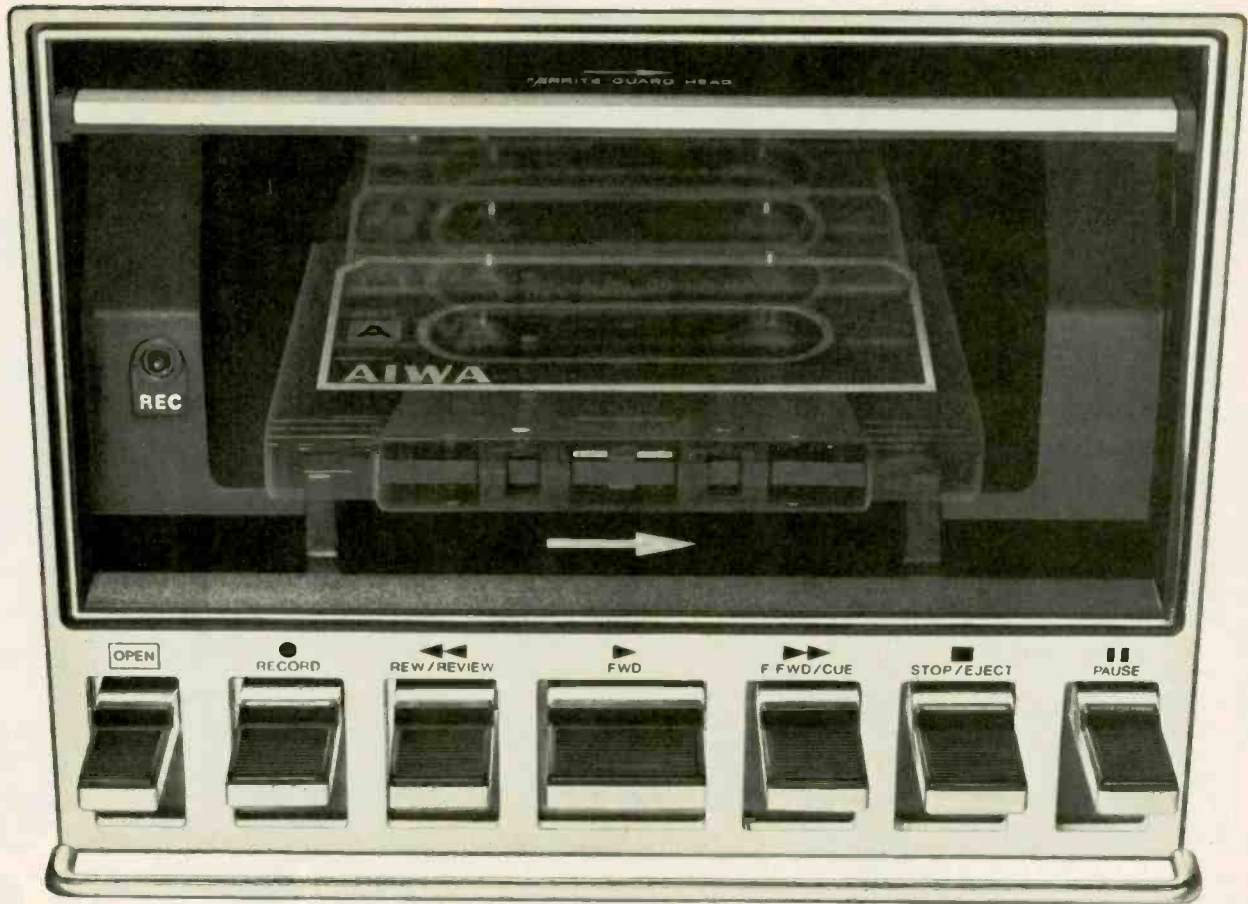

NOW YOU CAN GET LOADED AUTOMATICALLY.

Up to now loading a cassette into a front loading cassette deck was a little like putting a square block into a round hole. But now there's the AIWA AD-6500. The world's first cassette deck with automatic cassette loading. So you can play any cassette quickly, easily and precisely.

But there's a lot more to the AD-6500 than how you get a cassette into it. There's also the music that comes out of it. Like a frequency response of 30Hz to 17kHz with FeCr tape. Musically speaking that means hearing all the music—not just part of it.

And because we used Dolby* we also improved the S/N ratio to 62 dB. So you can listen

to the music instead of tape hiss.

You won't have to listen to speed variations either. Because the AD-6500 has a frequency controlled servo-motor as well as inaudible wow and flutter (0.07%).

And with the AD-6500 you can see as well as hear what you're listening to. With 2 VU meters complete with 2-step peak level indicator lights. There's also memory rewind and quick review/cue system for easy, efficient use. Three-step tape selector for the 3 different kinds of tape. Fully automatic stop.

A Ferrite Guard Head (FGH) and more.

So get the AIWA AD-6500. Because the only thing easier than loading it is listening to it.



AIWA®

Distributed in the U.S. by: MERITON ELECTRONICS, INC., 35 Oxford Drive, Moonachie, N.J. 07074
Distributed in Canada by: SHIRO (CANADA) LTD, 183 Bates Road, Montreal 256, P.Q. Canada

CIRCLE 3 ON READER-SERVICE CARD

*Dolby is a Trademark of Dolby Laboratories, Inc.

The Sensuous Speaker.

Yamaha's new two-way beryllium dome NS-500.

A very responsive speaker with a rich, luscious sound. A deeply involving sound. Highly defined, finely detailed.

The NS-500 is created from the same advanced beryllium technology that's made Yamaha's revolutionary NS-1000 Series speakers, in the eyes and ears of many audio experts, the highest standard of sound accuracy (Specific benefits of Yamaha's beryllium technology have been documented in a paper presented to the 22nd Convention of the Audio Engineering Society.)

With the NS-500, you get all of beryllium's advantages (transparency, detail, and lack of distortion that go beyond the best electrostatic speakers), but at a price roughly half that of the NS-1000. Only \$500 the pair, suggested retail price.

The joy of beryllium.

The ideal dome material for a high frequency driver must respond instantly to changes in amplitude and frequency of the input signal. So the ideal dome material must be virtually weightless as well as extremely rigid.

Beryllium is the lightest and most rigid metal known. Its density is less than two-thirds that of commonly used aluminum, and its rigidity is almost four times as great — thus preventing dome deformation and consequent distortion. What's more, beryllium's sound propagation velocity is twice that of aluminum.

The beryllium dome found on the NS-500's high frequency driver is the world's lightest — about half the weight of one petal of a small sweetheart rose. Which is one of the reasons for this speaker's exceptional sensitivity and response. And for its sensuous sound.

A closer look.

To be able to offer the sophistication of beryllium at a more affordable price, without sacrificing quality of performance, Yamaha designed the NS-500 as a two-way bass reflex system.

This gives the NS-500 a trace more emotion at the low end than the resolutely objective NS-1000. But it also gives the NS-500 more efficiency (91dB SPL at one meter with one watt RMS input). Which means you don't have to invest in the highest powered amplifiers or receivers in order to drive the NS-500 to its full rated output.

For an optimum match with the beryllium tweeter, Yamaha developed a very light, very rigid "shell" woofer. And a special hermetically-sealed air core I.C. crossover with a carefully selected 1.8kHz crossover point.

As a result of these design parameters, the NS-500 boasts an insignificant 0.03% THD below 50 dB SPL, from 40 Hz to 20 kHz, making it the perfect complement

to Yamaha's state-of-the-art low distortion electronics.

Underneath the sleek monolithic styling of its solidly crafted enclosures, the NS-500 is full of many exclusive Yamaha features and distinctive Yamaha touches of craftsmanship.

But to fully appreciate the beauty of the NS-500, you really should visit your Yamaha Audio Specialty Dealer.

Which brings us to something else.

Something more than just another speaker pamphlet.

Yamaha's *Reference Handbook of Speaker Systems* is a very thorough guide encompassing all aspects of speaker design, performance, and evaluation. Starting with a detailed explanation of speaker design principles, the discussion then turns to a solid base of objective criteria, written in easily understood language, to help you properly evaluate any speaker in any listening environment. Already a much sought-after reference work among audio professionals, Yamaha's *Reference Handbook of Speaker Systems* is available at your Yamaha Audio Specialty Dealer.

At \$5.00 a copy, it's well worth the cost. However, if you clip out the coupon in the bottom corner of this page, take it to your Yamaha Audio Specialty Dealer and hear a demonstration of the exciting NS-500 or any other Yamaha speaker, the book is yours for half the price.

And if you're not familiar with the name of your local Yamaha Audio Specialty Dealer, drop us a line. In turn, we'll also send you a free preprint of the Audio Engineering Society paper on Yamaha beryllium technology mentioned above.



This coupon is worth \$2.50 off the \$5.00 suggested retail price of Yamaha's *Reference Handbook of Speaker Systems*, when presented to any participating Yamaha audio dealer, with a demonstration of any Yamaha speaker system.

Offer expires March 1, 1977.

H



P. O. Box 6600, Buena Park, CA 90622

CIRCLE 59 ON READER-SERVICE CARD

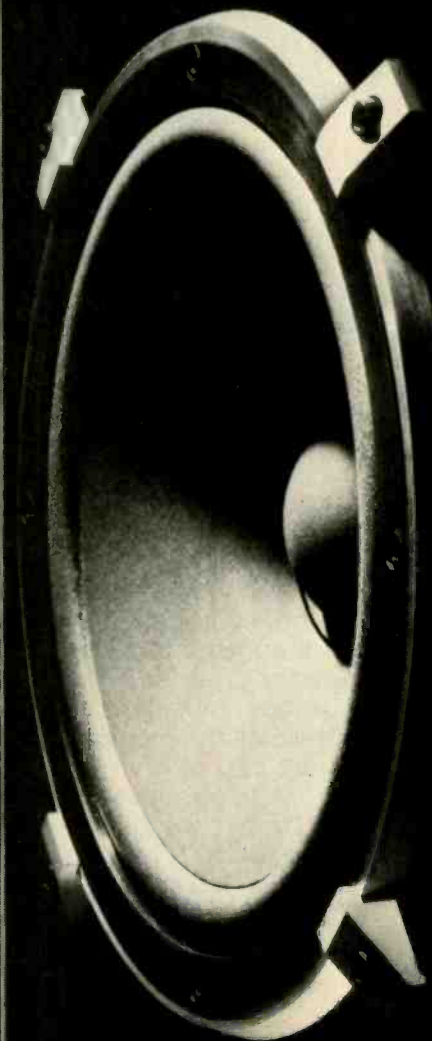

Four Ways to Put Yourself in the Concert Hall

Ambience-simulation devices can transform home listening

by Robert Long and Harold A. Rodgers

EVERY NOW AND THEN high fidelity takes a tack that nobody (or almost nobody) had expected but that, once it's begun, seems to catch the imaginations of the industry and the public alike. Ambience simulation is such a development. Within a few months we discovered that companies as diverse as Phase Linear, Bozak, and Acoustic Research—plus a number of smaller companies or ones that had never before offered products to the consumer audio market—were actively pursuing the means for generating “hall sound” in the home. The participants, including many of the “outsiders” who have heard the results of these labors, agree that simulated ambience can lend a new realism to stereo reproduction.

If the goal in listening to music via high fidelity equipment is to re-create the effect of a live performance—and not everyone would agree that it is—the game is lost as long as one is limited to using two loudspeakers located toward the front of the listening area. In a typical performance of music, up to half the sound reaching the listener's ears does so after being reflected from the boundaries of the space and so, obviously, must arrive in substantial part from directions other than straight ahead and later in time than the nonreflected signal. Sound is reflected from the walls of your listening room, of course; but such near-field reflections are totally different—particularly in terms of arrival time—from the reverberations inherent in the larger spaces associated with live musical events. Hence, in a sense, normal stereo offers you a broad sonic “window” through which you can “look” into the space where the music is being made; ambience simulation can put you into that space.

Robert Long and Harold A. Rodgers are Audio-Video Editor and Associate Audio-Video Editor of this magazine.

There is nothing new in this. In fact much of the original impetus of four-channel sound came from the desire for realism in the reproduction of this reflected or ambient hall sound. Whatever the merits of the quadriphonic approach, all of its various formats require special tape heads or program material that has been encoded in some way. Since there is a vast corpus of recorded material that predates quad, and numerous two-channel-only recordings are issued each year, there is room—indeed, a need—for some method that does not rely on such pre-encoding.

In preparing this article we worked with four representative consumer units, substantially the entire field at this writing—though more devices are available on the professional market (often at staggering prices), at least one of our units is available in other variants, and more consumer models are expected. The four are the Audio Pulse Model One Digital Time-Delay System; the Sound Concepts SD-50, an analogue time-delay system using “bucket brigade” ICs; Technical Audio Products Corporation's Tapco 4400 Reverberation System, an advanced spring-type reverb unit designed mainly for the professional market but available to the consumer as well; and the Sansui QSD-1 four-channel synthesizer/decoder, used in the “hall synthesize” mode. This last device is primarily a QS decoder with provision for extracting ambience that is concealed in the two-channel program material. It therefore is the only one that is designed for true quadriphonics as well as ambience simulation.

All four require four channels of amplification and four speakers; the devices can be inserted into existing quadriphonic systems to add hall sound to any stereo program material. All process the regular stereo signals going to the front speakers in

some way—usually incorporating a time delay—to yield the “ambience” signals that are reproduced on the back channels. All but one *could* be used

with mono program material as well, though we didn't place any emphasis on this capability in our investigation.

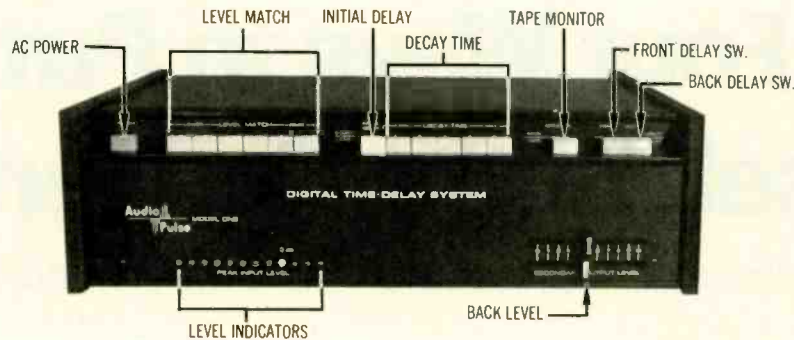

Audio Pulse and Digital Delay

The first of the new units we were to hear of comes from Audio Pulse, a company that has been producing digital-delay subassemblies for professional equipment before developing a consumer product of its own. Why digital? Because in theory a digitally encoded signal can be delayed indefinitely without acquiring noise, coloration, or other distortion. The digitalized signal is “dumped” from one shift register to the next, with no limitation beyond the number of available shift registers. When it is reconverted to analogue audio form, it simply sheds whatever spurious by-products the digital signal may have picked up.

The Model One's most important controls, obviously, are those for delay characteristics. The INITIAL DELAY button controls the time between the appearance of the original sound at the front speakers and the first reverberation at the back. The five DECAY buttons—which can be used in combination for in-between settings, as explained in the manual—control the degree to which delayed signals are recirculated into the delay line. This yields effective decay times from 0.3 to 1.3 seconds with the LONG initial delay, from 0.2 to 0.85 seconds with the SHORT initial delay. The INITIAL DELAY has most effect on the size of the apparent space in which you are hearing the music, the DECAY on its relative liveness; the entire group of buttons can be used together to simulate everything from a good-sized music room to a vast cavelike void. Lightly pressing any DECAY button releases them all and restores normal stereo.

For signals in which the original recording is so dry that significant reverberance in the back channels creates an abnormal disparity in this respect between front and back, the unit offers a delay option for the front channels (or “primary channels,” as Audio Pulse prefers to call them to avoid any in-

ference of true quadriphony). When the appropriate button is pushed down, some of the delay is mixed back into the front output, making it “juicier” than the original and therefore able to support the reverberance in the back channels.

Since the connections between the Model One and the front-channel amplifier normally are made through a tape-monitor loop, Audio Pulse gives you another loop so that a tape deck can be outboarded from the Model One. The signals to the deck are unaffected by the delay settings; the monitor return can be “ambienced” at will. If you wish to use the Model One to add reverberance to something you're recording, you must reconnect the deck so that its input is fed from a reverberance output (preferably that for the front channels, if you're using only two channels, to obviate mixing) of the Model One.

There are additional SHORT and LONG outputs intended for six-channel or eight-channel (!) reproduction. We did not test the unit in these modes, which we deemed a bit beyond the capabilities of most home systems, though Audio Pulse owners may want to “move up” after having lived with the

More information on the ambience-simulation devices discussed in this article may be obtained from the manufacturers:

Audio Pulse Model One, Audio Pulse, Inc., Crosby Drive, Bedford, Mass. 01730; Sound Concepts SD-50, Sound Concepts, Inc., P.O. Box 135, Brookline, Mass. 02146; Tapco 4400, Technical Audio Products Corp., 405 Howell Way, Edmonds, Wash. 98020; and Sansui QSD-1, Sansui Electronics Corp., 32-17 61st St., Woodside, N.Y. 11377.

four-channel option for a while. Nor did we test another hookup option suggested by the manufacturer for signals of exceptionally wide dynamic range: DBX processing fore and aft of the Model One. The dynamic range of the unit is adequate for normal signals. (The LEVEL-MATCH buttons optimize it in this respect for the signals at hand.) But in live material it may be difficult to find a setting of the LEVEL-MATCH that will prevent the peaks from overloading without putting the faintest sounds down near the noise. DBX compression ahead of the Model One, plus DBX expansion after it, can solve this problem.

The unit also has output level controls for the SECONDARY (back) channels, a back-panel CONTOUR switch that either leaves the reverberant channels flat (to about 8 kHz, the upper limit of their frequency rating) or adds a bass boost in imitation of the bass-favoring characteristics of natural reverberance, and a pair of unswitched AC convenience outlets. All in all it strikes us as a product to which a great deal of thought has been given, and one that goes far beyond the minimum flexibility to be expected for its intended purpose.

Among a number of suggestions in the manual Audio Pulse recommends that the back (sorry, secondary) speakers be placed at the sides of the room, toward the back—though not behind the listeners—and above ear level. We followed the advice (which may better simulate what you hear in

the concert hall, when you're flanked by other music lovers) to good effect, though we also enjoyed the results with other setups. As in quad, experimentation yields understanding and, sometimes, surprises; we recommend it.

That goes for the controls, too. On most music we found that we could get very convincing room sound with approximately the median settings of all the controls. When we cut them back too drastically there was little difference in effect between ambience-in and ambience-out settings; when we advanced them too far we could make the space sound ludicrously cavernous. But with the controls set to make an A/B-demonstrable difference that yet would not call attention to itself in regular listening we usually found the effect quite satisfying—and, as advertised, one of putting us in the same acoustic space with the musicians, an effect that we tend to feel deprived of as soon as it is turned off. Within limits—limits that depend on the nature of the music and the way it is recorded—the listener can then alter the acoustic space via the controls. But it's difficult to re-create the acoustic effect of familiar halls. In other words, there is a sensation of being in a hall but not necessarily in any specific hall. You can't necessarily "punch up" Symphony Hall on the controls, for example. Perhaps that's all one might hope for from such a unit, and it's well worth the \$630 price tag once you're hooked on the effect.

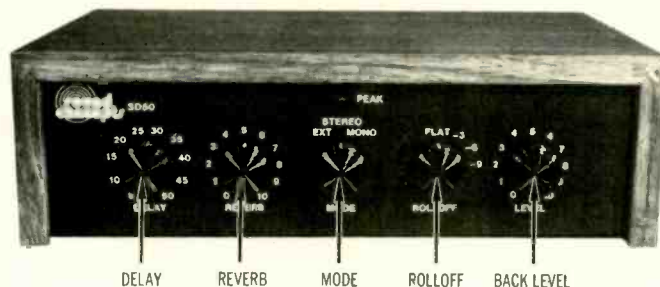

Sound Concepts SD-50

This unit is based on the bucket-brigade circuit (see "News and Views," HF, June 1976) that "dumps" actual audio signals from one capacitor to another in a long string to provide its time delay. No digital encode/decode processing is involved, therefore, so the signal is subject to some accumulation of noise and distortion, putting practical limits on the length of the delay.

The inherent back-channel bandwidth of the SD-50 is somewhat greater than that of the Model One: to about 10 kHz. The ROLLOFF control cuts this back still farther—to -3, -6, and -9 dB at 7 kHz—to simulate the natural rolloff of acoustic halls. Level matching is via a single peak indicator on the front

panel. Sound Concepts suggests that you adjust the output of the equipment feeding the SD-50 until this light flashes only occasionally; if this cannot be done, input-level adjustment is provided on the back panel.

The controls for REVERB, the amount of recirculation into opposite channels (left front into right back and vice versa), and for DELAY, the time between the original sound in the front and its first reverberation at the back, are continuously variable knobs. In theory this should make for more flexibility in the controls than discrete-setting buttons, though in practice we felt no need of additional options in the Model One.

The MODE offers three options: MONO, which doubles the delay time by cascading the two channels (and incidentally can cause oscillation if the reverb control is set too high in this mode); STEREO, the normal operation for present purposes; and EXT[ERNAL], which simply feeds signals from a separate quadriphonic set of inputs on the back panel straight through the unit, simplifying hookup to a full four-channel system without pre-empting any of its functions. This we deemed a significant advantage for the quadriphile who wants to add a function (ambience simulation) to his existing system—a deployment to which the Model One can be adapted but for which it is not specifically engineered.

Results with the SD-50 were not basically dissimilar to those with the Model One, with one ex-

ception: The SD-50 was judged notably less able to suggest huge spaces. Not only is its total delay more limited (presumably by the use of the bucket brigade), but there seems to be less blending within the reverberation. Hence at these extreme settings the simulated ambience contains a "slap" that, while admittedly less noticeable with program material with few sharp transients, tends to compromise the acoustic effect.

This tendency carries down somewhat into the less extreme settings as well, but here a judicious hand at the controls usually can come up with an adjustment in which it is minimized and in which there is still a fine sense of being in the same (again, not necessarily specific) space with the musicians. The SD-50's price is very close to that of the Model One: \$600.

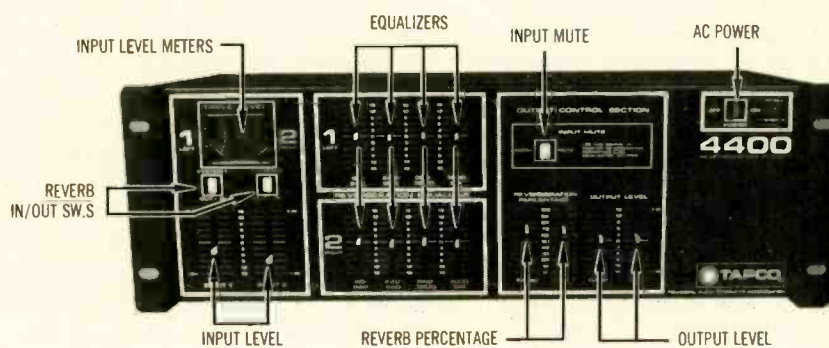

Tapco 4400 Spring Reverb

With the evolution of the Tapco 4400, moderate-priced spring reverberators can be said to have come a long way. The ping-boing-twang quality that we have come to expect (and hate) in cheap units of this type is almost completely absent. According to the engineers at Tapco, the unpleasant color associated with spring reverbs is caused by sharp, high-energy transients that overdrive the delay lines. The problem is solved in the 4400 by applying peak limiting to the signal before sending it through the delay lines. The unit is designed primarily as low-cost competition to professional mechanical reverb units used in recording and broadcast studios and usually costing far more.

The controls allow the input levels to be independently varied in each of the two channels. VU meters are provided to assist in setting optimum drive levels for the delay lines; this, it appears, is a broad rather than a critical adjustment. The reverberation can be switched out of either channel.

Each channel of the Tapco incorporates a four-band graphic equalizer (± 15 dB at 80-240 Hz, 240-960 Hz, 960-3,800 Hz, 3.8-12 kHz) that affects the reverberation signal only. Since in some of its applications the unit is required to mix reverb into the primary signal, each channel has a slide con-

trol for this purpose. Another pair of controls sets the level at the output, and a muting switch cuts out the input so that the reverb overhang can be sampled.

Obviously the user of this device has a wide range of options as to the coloration and level of the ambience signal that is generated. What he cannot do, however, is change the length of the individual delays or the rate at which the ambience signal decays. For the use to which we put the system, the lack of control over these parameters proved a little inconvenient. Sometimes the virtual space that was electromechanically created seemed too large for the music, and sometimes the reverb signal continued for too long after the primary signal had stopped. Moreover, the vestiges of spring coloration in the reverb signal, normally masked by the primary signal, obtrude audibly in its absence. (For professional applications this difficulty could be solved by running the reverb signal through an outboard expander, which would in effect control the decay time.) Withal, there is a wide range of program material on which the Tapco 4400 synthesizes a natural-sounding ambience. And the \$389 price has its attractions too.

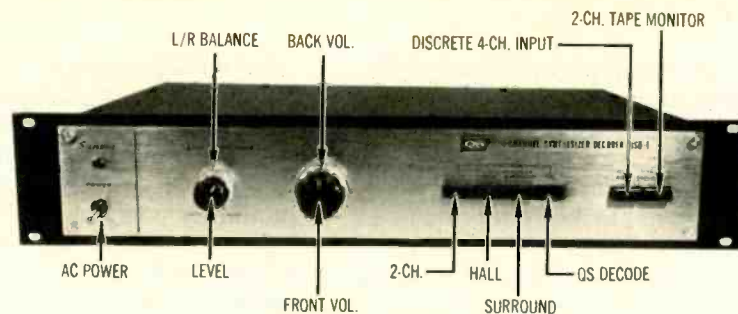

Sansui QSD-1 Vario-Matrix Decoder

The Sansui QSD-1 is intended primarily as a decoder for QS-encoded quadriphonic program material—a role it fills extremely well. One of its ancillary functions is to extract recorded ambience from two-channel program material. (The unit also has a SURROUND synthesis mode, in which the linear sound front between a stereo pair of speakers is “wrapped around” the listener via four channels. This effect has attractive qualities but is not really comparable to ambience synthesis.) Each of the functions of the QSD-1 is called into operation by a front-panel pushbutton. Its control options resemble every QS decoder we have worked with; they are not peculiar to this pro/semipro unit.

When ambient sound reaches the microphones used in recording normal stereo, it is, of course, after multiple reflections have taken place. This means that a reflected sound is as likely to be out of phase between the two channels as in phase. The QSD-1 extracts the signals that are out of phase and routes them to the back channels. Simple subtraction of the channels one from the other (the basic principle of the Dynaquad and other “speaker matrixing” ambience-simulation hookups) would also accomplish this, but Sansui’s Vario-Matrix circuit seems to deliver an ambience effect that is both a little more predictable and noticeably more convincing, with most program material, than that of any other matrix-type synthesizer we have worked with.

There is but one option available to the user in this HALL synthesis mode, and that is the balance between the front and back channels. Other than that he is at the mercy of the recording engineers. Thus, a stereo recording in which ambience has been neglected will put the QSD-1 at a definite disadvantage; a mono recording will produce no hall effect—which can be simulated from mono sources by the other three devices.

In the happier, and today much more common, situation where the recording contains abundant ambience, the QSD-1 can claim the virtue—unique among the units tested—of accuracy. The ambience is *recovered* (without time delay) rather than arbitrarily synthesized, and thus is more dependent on the original space than on the system’s adjustment. But since—particularly with the multiple-mike techniques so in fashion among recording-company engineers—some of the primary signals may be out of phase (a less than ideal arrangement in any case in our view), it can show up in the back channels, obscuring directionality in the perspective. Considering that this \$350 unit can virtually justify its comparatively modest price with its QS-decoding capability alone and that ambience recovery is a bonus feature, it is hard to fault the QSD-1 on its performance. And of course this HALL feature can be bought for even less in other Vario-Matrix decoders, like the new QSD-2.

How the Units Stack Up

The number of options—including speaker placements—that these four units present to the would-be listener is staggering. We spent a good deal of time living with each, sometimes individually, sometimes in A/B pairs. After listening and experimenting we found that their basic properties began to emerge quite clearly. It became progressively easier to find optimum settings of the various controls and to avoid gross misadjustments: hypercavernousness, overloud back channels, and the like. But we also found that the

emerging “personality” of each unit taught us to expect certain properties of it. Were we beginning to hear only what we expected to hear?

As a double-check of our evaluations we decided to get a listening panel’s reaction to a series of A/B comparisons, eliminating what we considered to be obviously inappropriate setups and asking the members to judge which setting options or unit comparisons gave the more natural and enjoyable sense of being in the same room with the music. Interestingly, some patterns emerged that

had more to do with the varied tastes and musical backgrounds of the individual panelists than with the equipment under test. But we'll come back to that.

For these tests we attempted to find a loudspeaker configuration suitable both for normal quadraphonics and for ambience enhancement. We ended up with a normal stereo pair at the front of our moderately small listening space and a second pair at the sides and toward the back. The back pair was angled inward so that no listener was subject to sound coming from more than about 20 degrees to the rear. This is not quite the arrangement recommended by Audio Pulse, but we felt that the listeners most likely to use ambience simulation would be those already set up for quadraphonics and that they would be unwilling to rearrange loudspeakers when going from one mode of listening to the other. Compatibility, therefore, was paramount.

We proceeded to find an optimum setting of the controls on each of the four devices. The signals sent to the back speakers were routed through one or another of the four units; the signals to the front were unprocessed. Various settings were tried on an A/B comparison basis until the consensus was that the settings were optimum for the program material in use: the first movement of Prokofiev's *Classical Symphony*.

The panel preferred the Tapco with a high, but not too high, ratio (about 70%) of reverb-to-direct sound at the back (for this use Tapco—logically but, according to the panel, incorrectly—recommends 100% reverb at the back) and a flat setting of the equalizer (again, logic would dictate some high-frequency rolloff in imitation of acoustic hall ambience). The Audio Pulse unit was preferred with the LONG delay, fairly short decay time, and (surprisingly) a flat rather than a contoured frequency response. The Sound Concepts SD-50 seemed most natural to the panel with a fairly long delay, a rolloff setting of -6 dB, and a rather modest level of sound in the back channels. The Sansui was judged to be at its best when the level in the back was quite low. It should be emphasized that these somewhat contradictory results represent a consensus, not unanimity.

In the next phase of testing, the panel was asked to compare the units two at a time on an A/B basis, again judging according to "naturalness." The preferences can be ranked in the following order: Audio Pulse, Sound Concepts, Tapco, Sansui. To determine how sensitive the test procedure was to the choice of program material, we switched to a very different sounding selection, an excerpt from Orff's *Carmina Burana*. There were no significant differences in the results, although it is entirely possible that some choice of program material could change the rankings.

But we suspect that changing the constitution of the panel (which was too small to represent a true statistical sample of music listeners) would affect the results far more than using different program material. In test after test the members divided; unanimity was rare indeed.

One point about which listeners showed characteristic and unequivocal preferences was how much direct sound they would tolerate coming from in back. One is tempted to reflect on the providence of nature in decreeing that concert halls have both backs and fronts, for it seems that some people are very fussy about their position with respect to the music. The most avid concertgoer on the panel felt least comfortable with sounds of any description coming from behind him in any quantity. An artist and amateur violinist fond of performing chamber music generally found the orchestra spread somewhat constricted when some sound was *not* coming from behind him. Obviously there were many tests in which these two came to opposite conclusions.

The beauty of all the systems at hand in this respect is that the quantity of sound at the back channels can be controlled by the user to suit his needs. Its quality also can be controlled to a limited extent with the Tapco, to a greater extent with both the Audio Pulse and Sound Concepts. And with long-term familiarity—something in which we have an obvious advantage over our panel—we find this control important in all three units.

The reason has to do with the personality that each imposes on the ambience it produces: the remnants of characteristic spring-reverb sound in the Tapco, the subtle "slap" of the Sound Concepts, the potential echoiness of the Audio Pulse. Uncontrolled, these tendencies can become intrusive, even with fairly careful setup, in long-term listening. This is the big advantage of the Sansui: Since it adds no delay of its own (only separating out some of the inherently delayed sound to present via the back speakers), it adds the least personality and is to that extent the easiest to live with. But by the same token it also is the least flexible and the least exciting for the adventurous listener.

All four units have one thing in common, however: They provide an extra measure of realism (confirmed, but not unanimously in every test, by our panel) in suggesting that the listener is sharing his listening space with the musicians, always provided that care is taken with the setup and adjustment of the system. The more complex the unit, the more problematic the adjustment can be; but the dividends that are paid by some experimentation are amply demonstrated—as they are in true quad—by simply shutting off the back channels. To paraphrase the old one-liner, it sounds so bad when you stop. ●

SOME OF THE HEAVIEST EQUIPMENT IN THE BUSINESS.

The next time you're looking at tape decks, pick up any piece of Akai equipment. They're heavy.

The motor, the drive system, the flywheel. Akai makes them big. As big and as strong as we possibly can. So they'll perform for you.

The Akai GX-630DSS is a good example. Pound for pound and dollar for dollar, it's one of our heaviest. It's driven by a big, heavy-duty AC servo capstan motor plus 2 eddy current motors for fast forward and rewind. It features Akai's Quadra-Sync® for

multiple track synchronization when recording. It offers complete versatility for mixing. And pitch control. It's got just about everything. For the guy who wants to do just about everything.

Our GX-650D stereo tape deck has just about everything, too. Closed loop dual capstan drive. One AC servo capstan motor plus 2 eddy current motors. Sound on sound. 3 speeds. It's got it.

That's the kind of equipment you can expect from Akai. Strong because we're heavy. Heavy because we're strong. Akai. Pick one up.

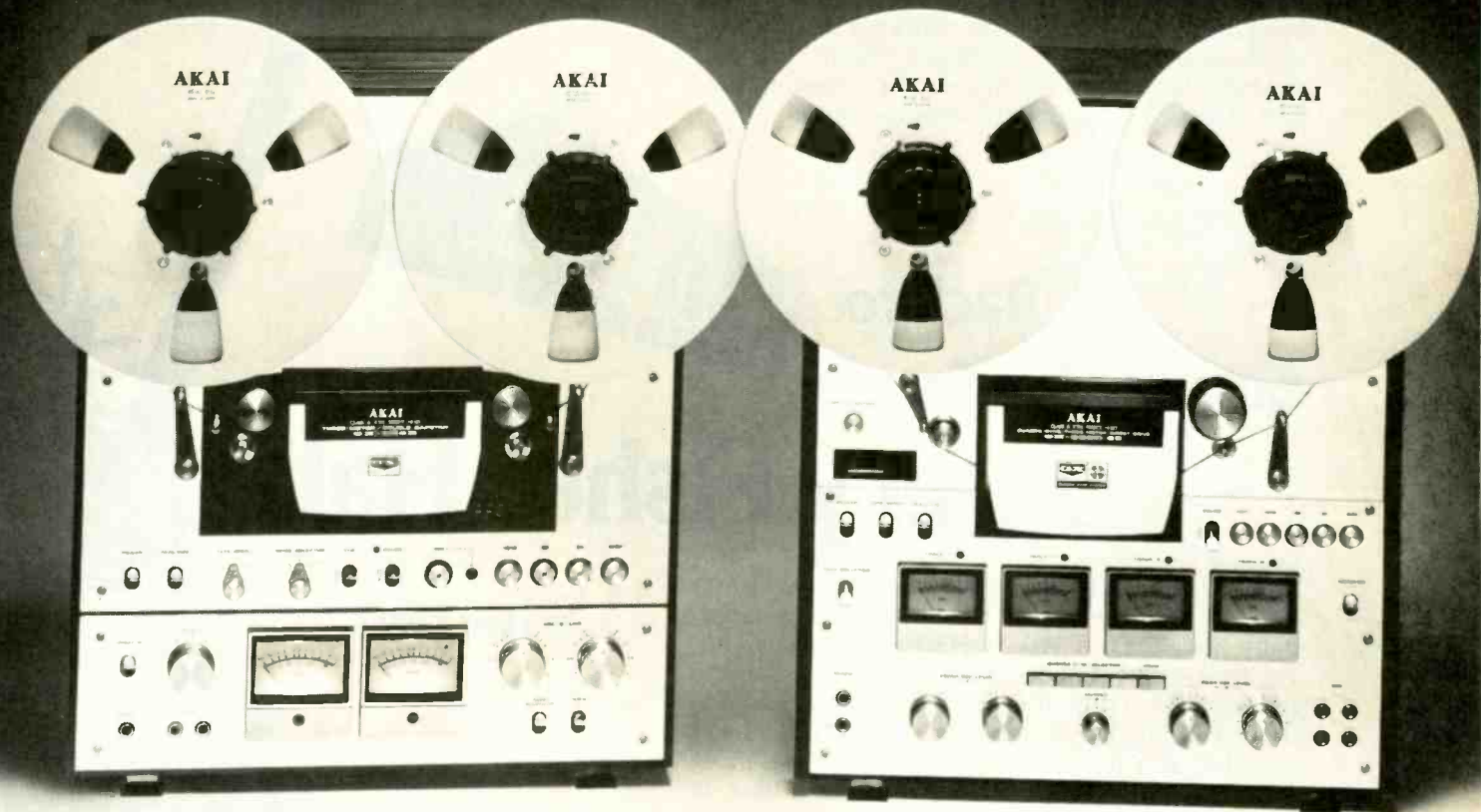

AKAITM
COMIN' ON STRONG!

Akai reel-to-reel tape decks from \$299.95 to \$1,495.00 suggested retail value. Akai America Ltd. 2139 East Del Amo Blvd. Compton, California 90220.

IN NEW YORK last spring, just as the wreckers moved into Avery Fisher Hall—née Philharmonic Hall—to rip out its unsound innards, Carnegie Hall celebrated its eighty-fifth anniversary as a musical shrine hallowed for its sonic splendor. The juxtaposition of events is ironic, for the perennially troubled new hall at Lincoln Center, touted before its completion as the ultimate triumph of modern acoustic science, was expected to surpass and replace the older auditorium located a mile to the south. According to plan, when the New York Philharmonic moved to its new quarters, Carnegie Hall was to be demolished to make room for a more profitable office building—a disaster prevented only at the last minute by violinist Isaac Stern, who privately raised the money to save the hall. Its vindication is a textbook example of poetic justice.

As for Avery Fisher Hall, music lovers still keep their fingers crossed. As this is written, it is being altered for the umpteenth time. Again, the object is to make the home of New York's premier orchestra an acoustically fit place for music. It has never been so in all its fourteen years.

This time, in contrast to earlier face-lifts, the hall has been completely gutted down to its supporting pillars, until nothing remains but the outer walls. The entire shape and concept of the structure are being transformed, the ceiling torn down, the stage rebuilt, and a new wooden floor installed. Wreckers and builders are working around the clock in an attempt to complete Fisher Hall's reconstruction in time for this month's opening concert of the New York Philharmonic season.

Back to Square One for Avery Fisher Hall

Obviously the Philharmonic and Lincoln Center felt that the time for Band-Aid treatments had finally passed. Dr. Cyril M. Harris, Columbia University's eminent acoustician, was called upon to redesign the hall and erase the unhappy remembrance of things past. When Dr. Harris' design was revealed at a press conference last spring, those with long memories immediately noticed that in

Hans Fantel's latest book is Durable Pleasures—a Practical Guide to Better Tape Recording (1976, E. P. Dutton).

After millions spent on reconstruction, New York's sonically jinxed concert hall will finally show some resemblance to the original design proposed by its first acoustician.

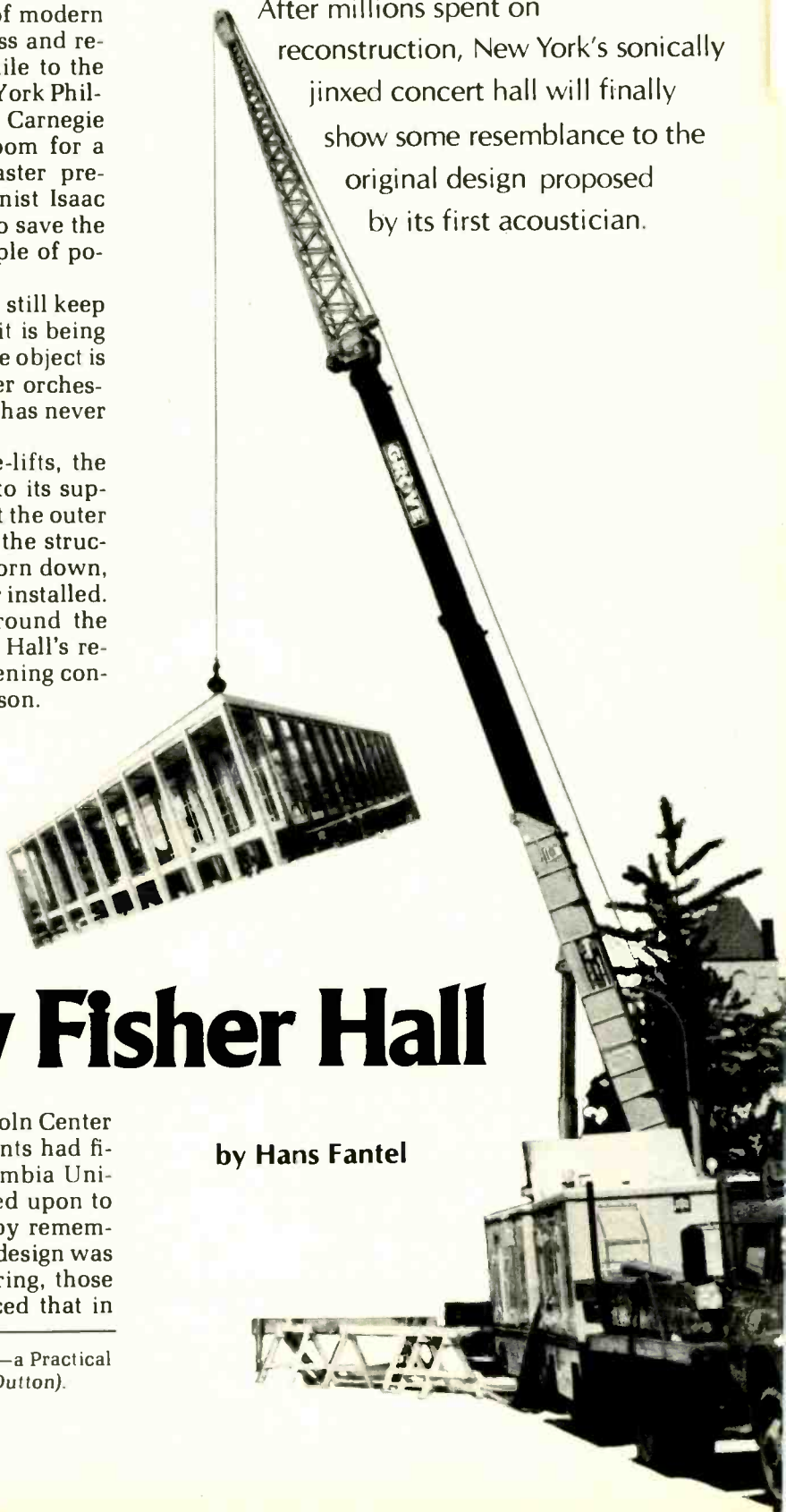

by Hans Fantel

several important aspects it was similar to the original plans proposed, but never carried out, seventeen years ago. So, with yet another \$5 million invested in the hall, and with hope rekindled for its acoustic future, the question naturally arises: Just what went wrong and why, and how is it finally to be fixed?

It is easier to raise these questions than to answer them. With a number of egos and reputations chafing against the facts, it was necessary to piece together the following account of Fisher Hall's debacle from different sources, one sometimes contradicting another, one sometimes filling in what another left out. But it is evident that the hall's troubles—at least at the start—stemmed not so much from acoustics as from politics. I leave it to the reader whether to regard this history as a comedy of errors, a tragedy of good intentions gone haywire, or simply an example of standard operating procedure.

In the beginning, there was sheer hubris—the spirit of the Fifties. Our nation under international hero Dwight D. Eisenhower was to build the world's greatest arts complex in its greatest city. That was the basic idea behind Lincoln Center, which naturally was to include the world's finest concert hall. The man entrusted with its acoustic design was a logical choice: Dr. Leo L. Beranek was a senior partner in Bolt, Beranek, & Newman, a leading firm of acoustic consultants, known in the trade as BBN. Recognized as the foremost authority in the field, Beranek had greatly expanded the theoretical basis of architectural acoustics, and his book *Music, Acoustics, and Architecture* (1962) was to become a classic text in the field.

To prepare himself for the new assignment, Beranek conducted a systematic survey of the world's best-sounding concert halls—notably the Grosser Saal of the Musikverein in Vienna, Amsterdam's Concertgebouw, and Boston's Symphony Hall—to isolate the factors responsible for their acoustic merit. His aim was to match the sound of these halls, which excelled in both tonal warmth and intimacy and provided exemplary orchestral blend without obscuring detail. In the generous sonics of these halls, listeners have long felt almost like participants in the performance rather than onlookers. Musicians never had to strain to achieve the volume necessary for an orchestral climax. String players, in particular, did not have to dig in with their bows to balance the brass, and thus sweetness and sonority combined even in fortissimo passages. Best of all, cellos and basses came through with the kind of roundness and depth of sound that puts a solid fundament under the whole structure of orchestral music.

Hoping to transplant this happy ambience to New York, Beranek and his staff drew up a set of detailed specifications. Basically, the new hall was to be rectangular, with proportions similar to

those of a shoebox, its size limited to a seating capacity of 2,400 and its width (measured between fronts of the side balconies) not to exceed 101 feet to prevent long side echoes. All major reflecting surfaces—except the faces of the balconies at the rear of the hall and the rear wall itself—were to be flat rather than concave to avoid focusing effects, and all surfaces were to have wooden sound-diffusing irregularities.

The Lincoln Center Board of Directors readily accepted this proposal in July 1959. So did Harrison & Abramovitz, the architects for the new hall, and Beranek went back to his home in Cambridge, Massachusetts.

No sooner was the proposed plan made public than the debate began. Cost accountants pointed out in the press that a mere 2,400 seats, even in a sold-out house, wouldn't pay for a performance—at least not for a full orchestra at union rates, even skimping on rehearsals. In the hope of eliminating deficits, an increase in the number of seats was urged. Replying in a detailed memorandum, Beranek advised the Board that enlarging the hall or changing its rectangular shape would imperil its acoustics.

At this point, according to Beranek, architect Max Abramovitz proposed a different plan: a barrel-shaped hall with walls bulging out to make room for 258 more seats. The directors liked the way it was to look, both on the drawing board and in the bookkeeping ledgers, and promptly ordered it built.

Beranek remembers first learning of the change when visiting the construction site. The foundations were obviously not for the rectangular hall he had recommended. "We should have quit right there," he told me ruefully in a recent interview.

Abramovitz, an architect often cited as the design brains behind his firm's contribution to such projects as the United Nations buildings and the Time-Life building in Rockefeller Center, tells a different story. There were no surprises for Beranek, he insists: "That's not the way we work with our consultants. We maintained uninterrupted liaison with Beranek's firm, and the shape of the hall was worked out jointly, gradually evolving in constant mutual consultation." Vincent Rousseau, at the time a draftsman for Harrison & Abramovitz and now a job captain there, remembers that "every time a new drawing or change to a drawing was made, a copy was sent to Leo's office." Moreover, Abramovitz recalls that both he and Beranek had accepted the need for a seating capacity greater than 2,400 from the beginning and points out that Boston's Symphony Hall, one of the acoustic models, has 2,631 seats, albeit not as roomy as the ones that were being planned for Philharmonic Hall. As for the curved walls, they were adopted for the sake of better sight lines as well as for seating capacity.

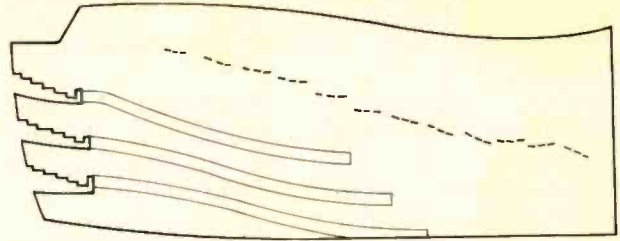
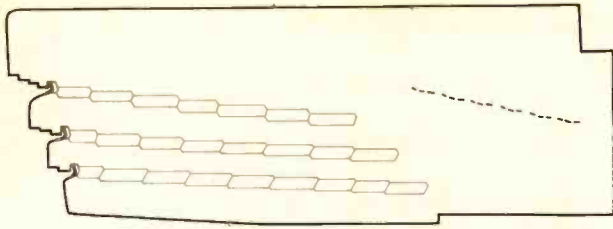

At left is a longitudinal section of the design for Philharmonic Hall "presented by the architects and accepted as the final concept" by Lincoln Center and the acousticians on July 28, 1959, according to Bolt, Beranek, & Newman. Note the balconies paralleling the floor and the reflecting panels over the stage area. At right is a comparable section showing the hall, with its balconies and panels, at the opening.

Be that as it may, Beranek tried to make the best of a situation that had become tricky, both politically and acoustically. One of his techniques involved the use of reflecting panels, sometimes called acoustical "clouds," suspended from the ceiling, and individually adjustable both in angle (manually) and in height (by an array of remote-controlled overhead hoists). Beranek proposed increasing the number of such panels, originally planned only for the area over the stage, so that they would extend over virtually the entire ceiling. With the great variability of resonance and reflection patterns thus attained, he hoped to counteract the problems created by the concave walls and downward-sloping balconies. But costs were exceeding the budget, and Lincoln Center balked at the expense. Beranek claims that fewer reflector panels were installed than he called for, and that the clouds could be raised and lowered only in arrays rather than individually. Rousseau, who was the draftsman for the panels, insists that all those Beranek called for were installed and that both height and angle were individually adjustable, but he confirms that Lincoln Center refused to go to the expense of installing the additional machinery to facilitate the adjustment of the clouds over the audience area. Each 500-pound panel had to be raised or lowered by hand, via block-and-tackle—surely a cumbersome means of adjustment when trying to "tune" a hall.

At the same time, according to Beranek, Lincoln

Center cut its construction costs by substituting smooth walls for the sound-deflecting wooden elements he called for. Furthermore, the installation of a projection booth and the covering of the space where an organ was later to be installed also played hob with his plans.

Beranek, by his own account, was still optimistic. He tuned the hall by adjusting the panels during a week-long series of test rehearsals in May and June 1962, before an audience of "instant people" made of glass-fiber mats. On the basis of these trial runs—at one point he even had the wooden fence surrounding the construction site sawed up to use as experimental reflector panels—he made final recommendations for additional panels and sound-absorbent and sound-reflecting materials. Between "test week" and the opening, work proceeded apace; though the recommended changes were largely accomplished, there was no opportunity for final evaluation or last-minute adjustment.

The gala opening, before an invited audience on September 23, 1962, was a great social success but an acoustical disaster. The over-all orchestral tone had a steely hardness, the fiddles sounded harsh, and the orchestra's sections failed to blend, as if invisible walls stood between strings, woodwinds, and brasses. Orchestral musicians complained that they couldn't hear each other adequately. As if all this weren't bad enough, there was almost no bass. You could see the cellos and contrabasses

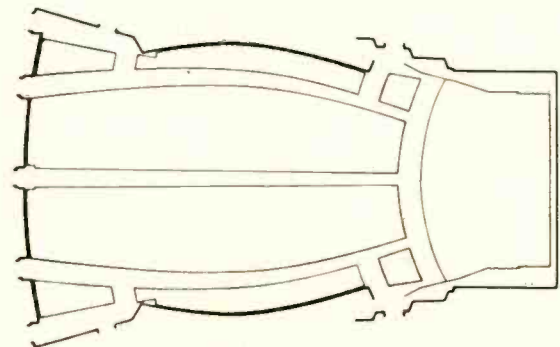
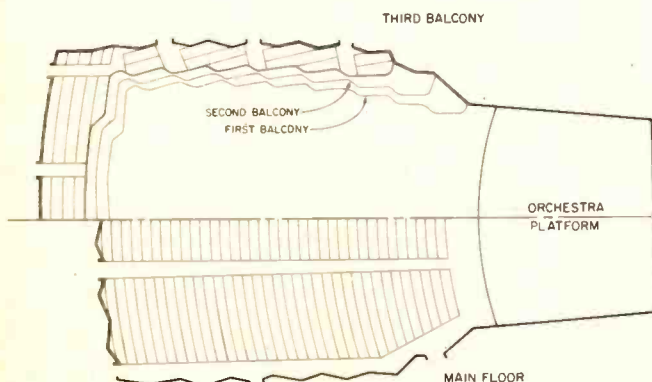

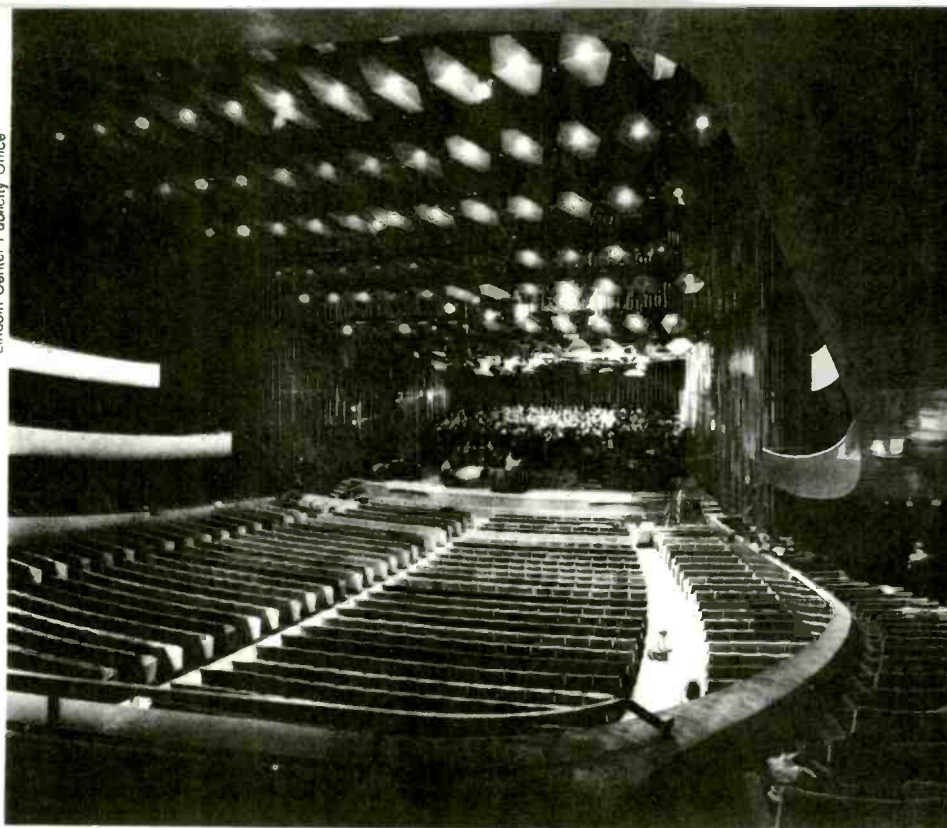

The hall as it appeared just before its September 1962 opening. The view is from the lowest balcony, which can be seen sloping down to the main floor. The hall's bulging shape is evident, as are the acoustical "clouds" that were first planned to cover only the stage area but were finally extended over the audience area as well.

sawing away, but you could hardly hear them.

New York's musical community seemed stunned by the \$20-million fiasco. But most critics were guided by the charitable precept that, if you can't say anything nice, say nothing. Not so Harold C. Schonberg, senior music critic of the *New York Times*. Unwilling to see the musical public of his city saddled with a third-rate hall, he never ceased to rail against the sound at Lincoln Center, which he likened to a hi-fi set with the treble 'way up and the bass 'way down. Helped by the enormous influence of the *Times*, Schonberg made acoustical savvy something akin to a civic virtue and raised the temperature of the debate.

Beranek soon diagnosed the trouble. One of the analytic criteria he had developed as a theoretical acoustician was the ratio between "early sound" (defined as the sound reaching the listener directly or by reflection within fifty milliseconds of onset) and later reverberations lasting much longer. Beranek found that, if this ratio, in certain regions of

the frequency spectrum, differs by just 5 dB from the optimum, the subjective sound impression suffers greatly.

"The early sound carries immediacy," Dr. Theodore Schultz, Beranek's chief associate, told me. "It gives a feeling of closeness and presence. But it's like garlic in a dish. Just a bit too much overbalances all else."

Since there had been no opportunity to test the final reflector adjustments under actual concert conditions, it had been impossible to detect that the crucial ratio had shifted, accounting for the hard, bright sound and the lack of orchestral blend. As for the flimsy bass, the still inadequate design of the ceiling-panel array caused cancellation effects that weakened the lower frequencies. Measurements showed that the hall began to roll off below 400 Hz, reaching a level 10 to 12 dB lower for all frequencies from 200 Hz down—a poor response curve for even a cheap loudspeaker.

Based on studies of this and other factors, Ber-

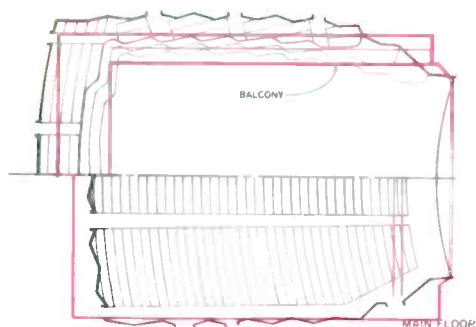

Far left is the "accepted" July 1959 floor plan, with a "basically rectangular" listening area, according to Leo Beranek; it corresponds to the longitudinal section at the top of the same column on the facing page. Next to it is the plan of the main floor at the opening. The sides have been "bulged" and lack the sound-diffusing irregularities seen along the sides and rear of Beranek's main-floor plan. At near right, an unofficial sketch of the rectangular outlines of the latest reconstruction (colored lines) has been superimposed upon the listening-area portion of the plan at far left. On the main floor the rows of seats are parallel to a now straight stage front; in the side balconies, the two rows are at right angles to it. (Only one balcony level is shown; all three levels are identical.) All the faces of the balconies will be straight. Note the 90-degree angles at every level. The walls' irregular surfaces, for sonic diffusion, are not shown in this sketch.

9090



How much

Sansui



5050



6060



**power
do you really need?**



7070



8080

Sansui has the answer.

Power is, of course, one of the most important characteristics in the quality of a receiver. But it is only one of them. There is also the tuner section which should offer especially high sensitivity and selectivity, and a great stereo separation. And the Sansui 9090 does: sensitivity of 9.8 dBf (1.7 μ V); selectivity of better than 85dB; stereo separation of



better than 40 dB at 1 kHz, and also a wide linear dial for both AM and FM tuning. Equally important are the capabilities and features of the pre-amplifier and control sections. Such as; triple tone controls, extremely accurate RIAA phono pre-amplifier with wide overload capability, many versatile inputs and outputs, microphone mixing control for blending mic signals with any other source, tone defeat switch, capability of handling three speaker systems, a



7-position tape copy switch, and a Dolby* 25 μ sec de-emphasis. Of all receivers available today only in the Sansui 9090 and 8080 will you find all of these desirable elements.

*tm, Dolby Labs

And when you select a receiver, look for well-designed protection circuits to protect your amplifier and speakers, and a solidly designed power supply capable of continually delivering the total power, undistorted. With the Sansui 9090, which delivers an ample 110 watts per channel into 8 ohms, min. RMS, from 20 Hz to 20 kHz with no more than 0.2 percent THD, you get both of these. The 9090, 8080 and 7070 also feature twin power meters for monitoring output, which few other manufacturers offer.

The other models in this outstanding new line of stereo receivers share many of the same fine characteristics as the top of the line models.

So remember. Your receiver is the heart of your high fidelity system. If you listen to a 9090 or any one of the fine



receivers in this Sansui series, you will quickly know that you are listening to the best receivers available today.

Go to your nearest franchised Sansui dealer today. He will make certain that you buy the receiver that matches your needs, your likes, and your budget. Sansui has the answer.

*Approximate nationally advertised value. The actual retail price will be set by the individual dealer at his option.

The 9090 is a superior value at less than \$750.* If the 9090 is more than you need ask for the 8080 with 80 watts per channel, min RMS, both channels into 8 ohms, from 20 Hz to 20 kHz with no more than 0.2% total harmonic distortion at less than \$650.* Or the 7070 with 60 watts per channel, min RMS, both channels into 8 ohms, from 20 to 20,000 Hz with no more than 0.3% total harmonic distortion at less than \$520.* Or the 6060 with 40 watts per channel, min RMS, both channels into 8 ohms, from 20 to 20,000 Hz with no more than 0.4% total harmonic distortion at less than \$420.* Or the 5050 with 30 watts per channel, min RMS, both channels into 8 ohms, from 20 to 20,000 Hz with no more than 0.5% total harmonic distortion at less than \$320.* 9090 in walnut veneer. All other cabinets in simulated walnut grain.

Sansui. A whole new world of music.



SANSUI ELECTRONICS CORP.

Woodside, New York 11377 • Gardena, California 90247

SANSUI ELECTRIC CO., LTD., Tokyo, Japan

SANSUI AUDIO EUROPE S.A., Antwerp, Belgium

In Canada: Electronic Distributors

CIRCLE 48 ON READER-SERVICE CARD



is it worth to you ?



7070



8080



The interior of Avery Fisher Hall looked almost bombed out during the recent reconstruction. The *New York Times* reported that all the suitable scaffolding on the East Coast had been rounded up for the job. Below, a worker passes through what was once a door in the auditorium's reinforced concrete rear wall, the thickness of which made the eventual task of tearing it out a difficult one.

beranek proposed a cure involving fairly simple expedients—increasing the effective size of the panels and rearranging them, for example—at a cost of \$60,000. That might have been the end of the story. But a new element was to be reckoned with.

Among the prominent conductors invited to the new hall during the early weeks of the season was the late George Szell, a man with a knack for honing orchestras, performances, and the sharper edges of his own temperament. Asked to render an opinion after conducting a concert, he confined himself to a brief observation: "Who can make love in a blue hall?" (Schultz later responded to this with an understatement: "The level of his remark indicates that Dr. Szell was prepared to dislike the hall.") Szell was a man of formidable persuasive power and political clout, and at the airport after the performance he is said to have offered three succinct recommendations to the Lincoln Center Board: (1) tear the hall down; (2) start all over; (3) fire Beranek. The Board adopted only suggestion number three.

An item of background information may illuminate these matters. The concert hall at Lincoln Center was not Szell's first encounter with the work of BBN. Two years before, he had conducted the Cleveland Orchestra for the opening of a high school auditorium, also a product of BBN, in Lakewood, Ohio. One of Beranek's young acousticians, sent out for the occasion, asked Szell how he liked the new hall. The conductor said there was exces-



Photos: Shirley Fleming

sive reflection from the rear. The young man from BBN agreed; but, he explained, it was a multipurpose hall not expressly designed for an orchestra. Other factors, such as speech projection, had to be taken into account. When Szell suggested that, for orchestral concerts, the rear wall might be screened off with fabric, the acoustician replied: "You wouldn't be able to hear the difference."

It was an unfortunate phrase. Dr. Szell, who was known to be one of the more serious and astute judges of concert hall acoustics among musicians,

Right, acoustician Leo Beranek—
"We should have quit right there."
Far right, conductor George Szell—
"Tear it down and start over."



apparently took the "you" personally. Still tense from the exertions of the concert and unsettled, perhaps, by the marginal paranoia that often afflicts great men (and may motivate them too), Szell thought the young man had asserted that he was getting old and couldn't hear very well. The conductor grew purple, stamped his feet, broke his baton, and bolted off. Witnesses sensed there would be repercussions, for Szell could hold a grudge like a Wagner pedal point. Now at last, on the subject of Philharmonic Hall, the bitterness was vented.

Beranek never had the chance to put into effect the \$60,000 revisions that might have set things right. Instead, he was replaced by a committee of acousticians, among whom the most prominent was Heinrich Keilholz, a former Deutsche Grammophon *Tonmeister* with many fine recordings to his credit but—by his own admission—only limited experience in architectural acoustics. Keilholz had been hired on Szell's recommendation, and although Beranek remembers attending a committee meeting to again air his views, he had no voice in its decisions. About this Beranek merely says: "I believe that a pooling of knowledge would have led to a better result at lower cost." For his part, Abramovitz remembers that Beranek was invited to join the committee but balked at the prospect of irreconcilable disagreements with the other members.

Although the acoustic consortium included individual members of unquestioned competence, their joint efforts recall the classic definition of a camel as a horse designed by a committee. In a sequence of alterations, taking place piecemeal between 1963 and 1969, they filled the space between ceiling reflectors to recapture errant bass, lined the walls with wooden slats to scatter sound and break up the "hot spots" created by the focusing effect of the curved walls, and ripped out the back cushions of most seats to increase "liveness." They

also changed the dominant color of the hall—to red.

New Yorkers eagerly pinned their hopes on each successive step and each time were disappointed. The alterations merely traded off one kind of trouble for another. But given enough time and money, the committee did manage to bring about substantial change. Six years and \$1,485,000 later, the hall was, for many listeners, worse than when alterations had started.

All this happened in a period when audiences for classical music, thanks to steady advances in recording techniques and electronic sound reproduction, had become increasingly aware of sonic quality and ambience as integral and essential components of musical enjoyment. Years ago, the concert hall was the standard against which the phonograph was measured. Now, ironically, the roles were reversed. New Yorkers found that they could hear their orchestra better on their stereo systems than in concert. Sonically sophisticated listeners in quest of live music stood in line for tickets to Carnegie Hall, where they could hear visiting orchestras in splendid acoustics.

Meanwhile, the New York Philharmonic, contractually bound to Fisher Hall, grew restive. A major source of discontent among orchestra members was the fact that, after all the changes in the hall, they could hear each other on-stage less well than before. Unable to sense the blend and balance of their playing, the orchestra could not make its best showing when playing on its home ground.

At this point the Board of Lincoln Center took recourse to what is known in the medical profession as "heroic measures," and Dr. Cyril Harris was called in to perform massive emergency surgery. By a rare stroke of luck, funds for the operation had become available. In an act of unexampled generosity, Avery Fisher, who had made a fortune as a manufacturer of high fidelity

At a recent news conference, Philip Johnson, architect for the reconstructed hall, stands next to an artist's conception of the new interior. Looking on: Avery Fisher, Lincoln Center's managing director John Mazzola and chairman Amyas Ames, and Dr. Cyril Harris.

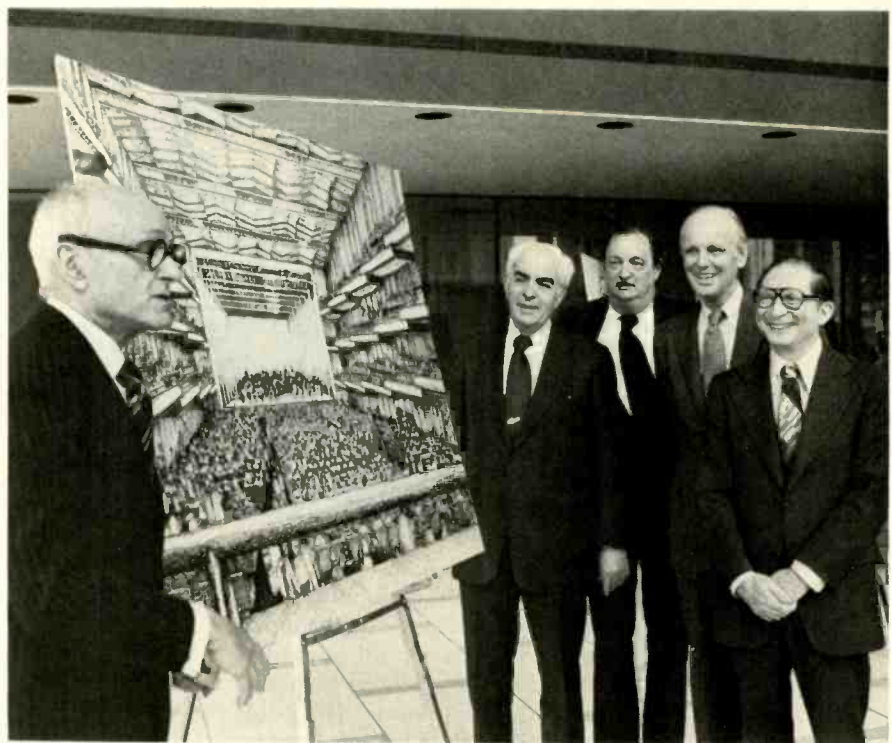

Lincoln Center

equipment, contributed \$10 million as an endowment for the hall, which was henceforth to bear his name. Throughout his career, Fisher had created electronic devices in the service of music; now he wanted to pay a debt of gratitude and a tribute of love to the art that had sustained him and his work. Half the endowment will be used to make the hall a fit testimonial to a man professionally devoted to good sound.

The task facing Harris was enormously complex. Many technical factors influence the sound of a concert hall: total reverberation time, the fading rate of the echoes, resonances, the absorptive and reflective properties of building materials, and the directional patterns of sound reflections, to name but the main considerations. What complicates matters further is that all these factors vary at different locations within the hall and in different segments of the musical frequency spectrum, thus opening up a veritable Pandora's box of combinations and permutations. In consequence, acoustic design is an art as much as a science, requiring intuitive appraisal of technical data as much as the data itself.

Harris seems to have the right hunches to go along with his formidable technical acumen. His most recent accomplishments include Kennedy Center in Washington and Orchestra Hall in Minneapolis, both hailed as acoustic marvels by artists and audiences.

Harris' approach is basically classical, relying on proven traditional forms. His design resembles Beranek's original proposal—the one that was

never constructed. There's the same shoebox shape, the same straight walls (or, to be precise, walls in a single plane with articulated facets for better sound diffusion), the same nonsloping, non-bulging balconies. But Harris believes that the dimensions and shape of the hall must in themselves create its ambience, and he does not rely on movable reflectors to modify the inherent acoustics. In particular, he is concerned with bass projection and will install a wooden floor to act as a transmission surface for low frequencies, hoping that with such an enormous bass radiator the low notes will be felt in an almost tactile sense. He also plans wood sidewalls thick enough, properly braced, to be sufficiently rigid so that they reflect bass energy, rather than dissipating it as frictional heat by moving with the sound waves. And with all that, he'll still get in 2,726 seats (more than Beranek's original 2,400 but fewer than the 2,836 just ripped out) by straightening out the bulge, by relocating viewing and broadcasting rooms away from the sides of the stage so that the front rows can be extended sideways (there will now be more seats in the front rows than in those farther back), and by making the seat dimensions somewhat narrower—again, ironically, an original Beranek proposal.

Thus, after a long odyssey of misadventure, the New York Philharmonic may at last find a proper home. When I spoke with Beranek, he sounded quite pleased to find that some of his original ideas had been reinstated and quietly summed up everyone's feeling: "I hope Harris succeeds. New York deserves a first-rate hall." ●

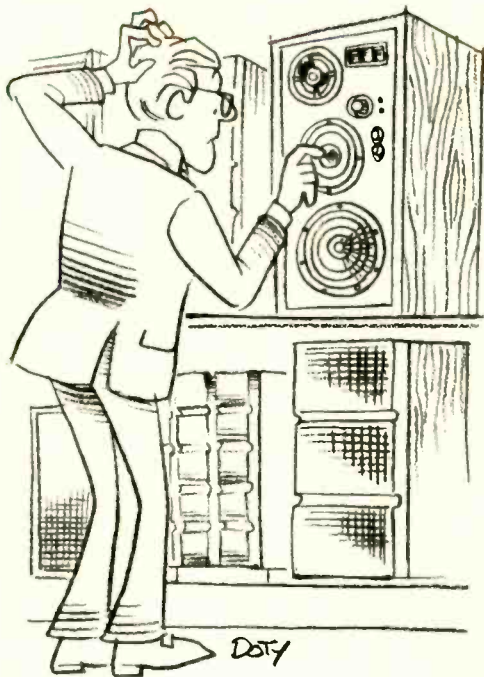

What You Should Know Before Buying a Speaker

by Martin Clifford

Is a three-way speaker system inherently better than a two-way system?

No. Crossovers are no automatic panacea; it is only the concept that is better.

A single driver can be used for the full audio range, but the requirements are severe if there are to be no compromises in response, distortion, dispersion, or other properties in at least some portions of the range. By splitting the frequency spectrum into smaller "chunks" and designing the drivers for best possible performance only within their respective portions of the range, the compromises can be minimized. From this point of view the more drivers the better; but that can mean more phase distortion due to the added crossovers, more inter-driver interference, more cost, and similar ills.

Does crossover design affect the sound?

Yes. When iron-core coils are used in the crossover instead of air-core types, for example, they

can become nonlinear at high power levels. The effect of iron as a core is to increase the inductance of the coil in the crossover, permitting the use of fewer turns of wire. But if signal levels are so high that the iron core becomes magnetically saturated, the effect is somewhat like removing some of the iron, with a consequent lowering of inductance. Under such conditions the crossover does not maintain constant characteristics: The crossover will shift to a higher frequency region, changing the distribution of signal to the drivers. And distortion may become severe.

Does it make any difference where the speakers cross over?

While manufacturers often indicate crossover frequencies in their speaker spec sheets, this information is of no practical value to the listener. It is dictated by the over-all system design and, especially, that of the drivers it employs.

What is meant by phase response, and why is it important in loudspeakers?

Essentially, phase response is a measure of the way signal components may be altered in time without any concomitant alteration in amplitude. With complex waveforms, composed simultaneously of several frequencies, the wave can be changed in shape by delaying some frequencies more than others. This is phase distortion. A given uniform phase shift will imply a different absolute time shift for each frequency. For example, a 90-degree phase lag (which "moves" the signal by one-quarter of its wavelength) will delay the frequency representing middle C by half as much as the C an octave below it, whose wavelength is twice as long. Thus transients, in which all frequencies are "in step" with each other, will be spread out in time, with the highest frequencies delayed least by a phase lag.

How easily this phase distortion can be perceived by the listener is a long-standing subject of debate, though recent research suggests that under some conditions phase distortion is by no means the impertinent subject it once was thought to be. For this reason many current loudspeaker designs (best known, perhaps, are those of Jon Dahlquist) seek to minimize phase shifts in the perceived sound. The most common means to this end is the placement of drivers so that all voice coils are in the same plane and therefore equidistant from the listener—as long as he remains at the assumed listening position.

Does this mean that if all the voice coils are equidistant from the listener the sound will be phase corrected?

Not necessarily. Phase depends on more than driver positioning. Actually, phase distortion caused by driver positioning is relatively minor compared to that produced by the passive filter networks in typical loudspeaker crossovers. Some crossovers use a rolloff of 6 dB per octave, which introduces no phase distortion, but the modern trend is to 12-dB and in some instances 18-dB crossovers.

In order to correct the resulting phase peculiarities, one manufacturer (Bang & Olufsen) has introduced "filler drivers," which operate in the region of the crossover and are included solely because their presence cancels the phase anomalies that would occur without them.

What is diffraction in loudspeakers?

It is a propagation effect associated with boundary-edges in the physical design of the system. Sharp corners at the edge of an enclosure, for example, can disturb the way the sound is propagated into the room and therefore may inhibit dispersion—particularly of the highs. Diffraction effects can be used to increase dispersion as well, however. The diffraction "lens" found at the front of some tweeters is one application of the principle.

What is meant by a dipole radiator?

A dipole radiator is one that delivers sound more or less equally (though of opposite phase) at front and back but produces little output at the sides—that is, in the plane of the speaker itself. Dipole drivers can be cones, as in the Leslie DVX design, though the commonest dipoles are the electrostatics and the Heil Air Motion Transformers.

Most speakers are not dipole types since they "use" only the frontal radiation, suppressing or diffusing the energy coming from the back of the diaphragm in one way or another to prevent its interference with the front wave. To prevent similar interference in dipoles, they normally can't be placed immediately in front of a wall that will reflect the back wave.

What about systems that intentionally aim some of the drivers toward the back?

The intention here is to increase dispersion and, perhaps, the apparent size of the stereo image by delivering a significant portion of the radiated sound (as opposed to the back wave of a dipole, which, again, is generally out of phase with the direct radiation from the front) indirectly, via walls and ceilings. Such systems often are called "omnidirectional," though most are omnidirectional—or close to it—in the horizontal plane.

What is a "piezoelectric" tweeter?

If mechanical pressure is applied to one axis of a piezoelectric substance, a voltage will be developed across another axis of the material. Conversely, if a voltage is put across one axis of the material, there will be a mechanical contraction or expansion along another axis. This effect appears in varying degrees in various substances. The piezoelectric effect is nothing new. Crystal and ceramic phono cartridges and microphones have long taken advantage of the piezoelectric transducer effect to convert mechanical into electrical energy.

Piezoelectric tweeters were developed a few years ago by Motorola and have found wide use in high fidelity speaker systems because of their excellent transient response and their ability to reproduce super-high frequencies. But the amount of air such a device can displace is very small, so a horn made of metal or plastic normally must be fitted to it for good acoustical matching to the air in the listening room. Electrically, the piezoelectric element "looks" like a capacitive load (similar to that presented by an electrostatic tweeter) to the amplifier.

What is a "high polymer" tweeter?

It's really quite similar to the piezoelectric tweeter in that the material of which its membrane is made—the high-polymer film after which it's named—contracts and expands in response to audio voltages and therefore produces sound without the usual magnet-and-coil structure.

The high-polymer drivers developed by Pioneer are cylindrical or hemicylindrical in form, for good horizontal dispersion, and may be either tweeters or supertweeters. (The HPM-200 system has both.) The high-polymer membrane is coated with aluminum, using a vacuum process, to act as the electrodes and is backed by polyurethane and glass wool to act as a sound-absorbing bolster.

Actually, the high-polymer tweeter belongs in the electret class—a type of permanently charged capacitor. The electret principle is most commonly used in condenser (capacitor) microphones, to dispense with the externally produced polarizing voltage that is required at the capacitor element if an electret is not used.

Is magnet weight important in choosing a speaker?

Not by itself. What is important (primarily to the speaker designer) is the available magnetic flux. Flux density depends on the material of which the magnet is made, the magnetization force originally applied in the manufacture of the magnet, and the



space between the poles. (The narrower the gap, the higher the flux density.) And, in any event, "more" is not necessarily "better" in this respect—the implications of some loudspeaker ads notwithstanding.

Since there is a relationship between flux density and magnet weight, it would be unreasonable to expect a speaker with a 5-ounce magnet to have the same field intensity as a 20-pounder. But by the same token it would be unreasonable to assume that a speaker with a 6-pound magnet is necessarily better than one with a 5-pound—or even a 1-pound—magnet.

Since all amplifiers today are rated at 8 ohms, are they designed to work best with speakers that also are rated at 8 ohms?

Federal Trade Commission rules on the rating and advertising of amplifier power have canonized the 8-ohm test load as standard, but that doesn't mean that amplifiers can't or won't work well into other loads.

In fact any loudspeaker presents a load that varies in impedance depending on the frequency of the signal. If the minimum impedance in the range just above bass resonance is 8 ohms (what is normally meant by an 8-ohm rating), the impedance at bass resonance may be several times that figure and at higher frequencies it generally will be somewhat higher than 8 ohms. Sometimes it is lower. So what the 8-ohm rating means (or should mean; practice varies from one manufacturer to another) is that the impedance "seen" by the amplifier will not be appreciably lower than 8 ohms at any frequency where the speaker will be asked to handle high signal levels.

Since solid-state amplifiers essentially deliver voltage, the actual power they put through the speaker depends on its impedance. Lower the impedance and the same voltage will cause more current to flow—because of the lowered impedance—and the power (the product of voltage times current) will therefore be greater. So a given amplifier

usually can deliver more power when it's connected to a 4-ohm speaker than when it's connected to one rated at 8 ohms. If, however, the decrease in impedance triggers any current-limiting protective circuitry in the amplifier, the available power may actually be less with the 4-ohm speaker.

Distortion, too, is affected by the speaker's impedance and its influence on the current through the output transistors. Generally distortion goes up as impedance goes down.

But in neither respect is the difference great enough to imply incompatibility. Most transistor amplifiers can take in stride impedances from about 2 ohms upward. The 8-ohm amplifier rating simply is a comfortable median point that happens to represent the nominal impedance rating of a great many loudspeaker systems currently on the market.

Why do so many receiver and amplifier manufacturers tell you not to use 4-ohm speakers if you're going to add a remote pair?

Because the main and remote outputs from the amplifier usually are connected in parallel, which would result in too low an effective impedance and, with some equipment, even damage the amplifier. Remember that when you connect two identical speakers in parallel to the same channel, the resulting impedance is half that of a single speaker. Therefore, if they are rated at 4 ohms, they will present a nominal load of only 2 ohms in parallel; if at some frequency the actual speaker impedance is 3 ohms, the actual load of the combination at that frequency will be only 1.5 ohms.

What is meant by speaker "loading"?

The question can be answered in two ways, depending on whether you're concerned with electric or acoustic loading. The speaker acts as an electrical load or impedance on the power amplifier to which it is connected. The rule-of-thumb measurement of the load is the speaker's impedance. If it is extremely high, it represents so much load that the amplifier can't drive it efficiently; if the impedance is extremely low—again, below about 2 ohms—the amplifier may be able to drive it all too efficiently and either burn itself out or trip its protective circuitry in pumping so much current through the speaker. Fortunately for the amplifier, speakers are designed to avoid these loading extremes, though they do vary considerably within them.

Just as the speaker presents an electrical load to the amplifier, the air in the listening room and within the speaker enclosure presents an acoustic load to the speaker. The amount of this load is de-

terminated by the air in contact with the cone or other diaphragm surface, so one factor is the area of the diaphragm. Another is the pattern of sound reflections and standing waves within the room, and these in turn are governed by the dimensions and shape of the listening room. The resulting acoustic load affects the electrical load—that is, it changes the effective impedance of the speaker and hence the efficiency with which it can be driven by the amplifier.

An important part of the acoustic load presented to the speaker is provided by the enclosure. An enclosure that, because it is poorly designed, presents an "incorrect" load to the driver will materially compromise performance.

Why do most electrostatics have either restricted bass response or a conventional dynamic woofer?

It's a question of the quantity of air that must be moved in reproducing low frequencies. Though electrostatic panels can be made large, the diaphragms' front-to-back motion is much more limited than that of typical dynamic drivers. This limitation on the electrostatics' ability to move air can be compensated for only by making the panels larger still. With respect to deep bass, therefore, the designer—working with any given type of electrostatic panel—has four basic choices: give up some of the bass, make the diaphragm larger and the system therefore more expensive than it might be, redesign the panel itself for greater excursion, or use a dynamic driver below whatever frequency he deems to be the point of diminishing (bass) returns for the sort of system he has in mind.

Does a passive radiator really radiate sound? How can it, since it is not driven electrically?

A passive radiator, also called a drone, is driven acoustically, rather than electrically, and does radiate sound energy. It is used in many loudspeaker systems—a growing number, in fact—as a way of controlling the deep-bass output from the woofer, whose back wave, propagated through the air within the enclosure, is what drives the drone. In one sense the drone is part of the acoustic loading system on the driven woofer; in another it is a sort of resonator whose own sonic output, added to that of the driven woofer, improves the over-all deep-bass response.

What is meant by a "transmission line" system?

First, a transmission line is a low-loss propagation medium used typically in microwave and similar technologies. The term is applied as well—and often very loosely—to audio.

The driver may be called a transmission line (the term has been applied to the Walsh principle used by both Ohm Acoustics and Infinity) in recognition of its basic operating principle: The sound wave travels along the cone, a property quite different from the piston action for which the typical cone driver is designed. Alternatively, one may speak of "transmission-line loading" in the system (typically for the woofer, but sometimes for other drivers as well). In such a design it is implicit that the back wave from the driver is carried off—usually by some form of labyrinthine ducting—much as an electromagnetic transmission line carries its signal.

What does a "feedback loudspeaker" do?

It acts as part of a negative-feedback, distortion-canceling loop. The negative-feedback loop is widely used in electronics as a way of controlling nonlinearities of various sorts. In a sense it compares the output of the device within the loop to its input; any difference between the two is fed back into the circuit but inverted in polarity so that it is largely self-canceling.

Several companies have adapted the principle to loudspeakers, which are among the least linear of audio devices, of course. The feedback signal may be picked up by a separate transducer (the Philips MFB systems use a piezoelectric element) at the speaker cone, measuring its motion and feeding this back as an electrical signal, or it may use purely electrical means (as in the C/M Labs systems) to isolate any back voltage generated by the speaker itself—which therefore acts as its own motion-sensing transducer—and feed this back into the amplifier circuitry. ●



The Beogram[®] 4002. If music in your home is important to you, it should begin here.

The Beogram 4002 is a fully automatic turntable which exhibits a level of creativity and engineering skill unequalled in the field of audio components. Its tangential tracking permits the record to be played back in exactly the same manner that the master disc was cut. Electronic logic circuits, activated by a single light touch on the control panel, automatically select the record size and correct

speed, cue the stylus, and turn off the unit when the selection is finished. Furnished with Bang & Olufsen's finest cartridge, in itself an acknowledged masterpiece of audio engineering.

Request our product brochure and the name of your local Bang & Olufsen dealer. For our detailed, full color catalog, please enclose one dollar to cover postage and handling (available free at your local Bang & Olufsen dealer).

Rarely has technology
served music so well.

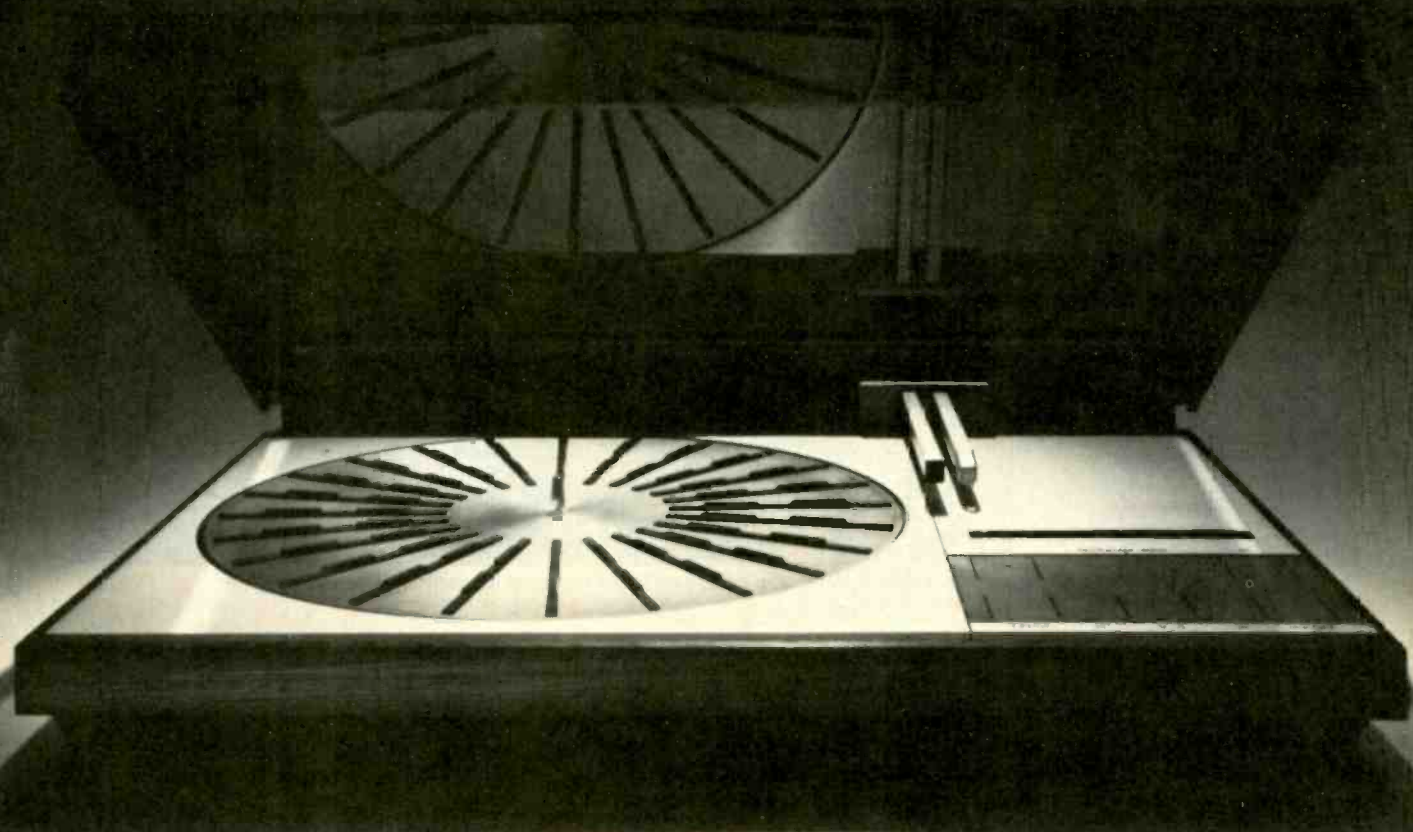

Bang & Olufsen

Bang & Olufsen of America, Inc., Dept. 11E, 515 Busse Road, Elk Grove Village, Illinois 60007

Put the great tenor's acoustic recordings through a computer process that enhances space photography, and what do you get? Three musicians who knew the voice first hand react.

The "Real" Voice of Enrico Caruso?

by James A. Drake

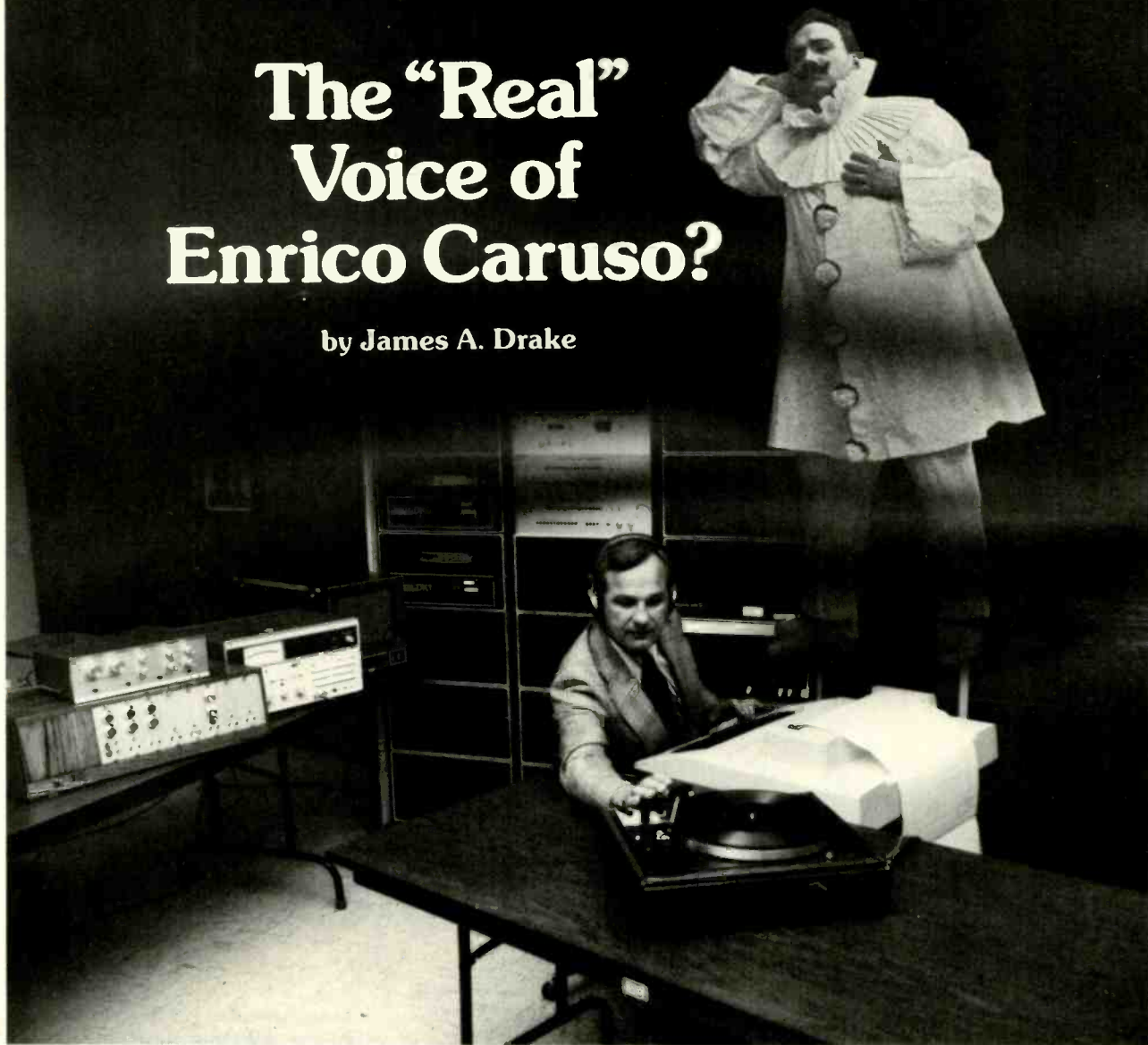

Dr. Thomas G. Stockham Jr. at work in his Soundstream laboratory, "attended" by Caruso as Canio.

IT WOULD NOT BE NEWS if a group of opera devotees gathered to hear Enrico Caruso's 1907 recording of "Vesti la giubba" from Leoncavallo's *I Pagliacci*. But the audience at an unusual and much publicized "opera soiree" held in January 1975 was composed mainly of scientists. The occasion was a lecture delivered by Dr. Thomas G. Stockham Jr., professor of computer science at the University of James A. Drake, associate director of continuing education at Ithaca College, is a lover of fine singing.

Utah, to the convention of the American Association for the Advancement of Science, and the news was not really the composition of the audience, but rather the sonic quality of the voice it heard.

More than a century after his birth, Caruso's name and fame are still international and his recordings still sell. All of his commercial discs have been reissued on one label or another, along with a number of originally unpublished discs and

alternate takes. But even the best of reissues played on the best equipment have not given modern listeners a satisfactory answer to the intriguing question of what he sounded like in person.

Caruso's recordings were all made by the acoustic process. Though his voice took to recording better than most (Fred Gaisberg, the enterprising American a&r man for the Gramophone Company who oversaw Caruso's first sessions, called him "the answer to a recording man's dream"), he suffered from the limitations of the primitive machinery. For example, a singer could not use full voice as he would in an opera house. Whereas an operatic score might call for a fortissimo followed by a piano phrase, the acoustic process demanded that a tone be neither too loud nor too soft. Fortissimos would cause the laterally moving cutting stylus to vibrate excessively and overreach its excursion limitations, causing the kind of distortion known as "blasting." Soft notes, if produced too faintly, would simply not be audible through surface noise. Also, the brief playing time of the 78-rpm acoustic disc—a maximum of four and a half minutes—often forced Caruso to record an aria faster than he would have chosen to sing it in a performance. But the problems go beyond these—which brings us back to Tom Stockham and his lecture, in which he explained how he had restored the voice of Caruso through the use of computers.

In the early Seventies, Stockham, a specialist in "information processing," began to experiment with statistics and digital computer processing in the separation of signals that are mixed in various ways—including mixture by "convolution," most often involving just two signals. The method he used, known as "deconvolution," has wide applications: Petroleum geologists use computers to "deconvolve" seismic signals while exploring for oil; astronomers and astronautical engineers use such techniques in clarifying blurred space photographs. But applying the method to the audio signals embodied in an acoustic recording is a little trickier—and therefore more challenging.

At the outset, Stockham and his associates decided that, among the various kinds of sonic "degradation" on the Caruso recordings, recording-mechanism resonance was the most troublesome aurally. By comparison, surface noise, limited frequency range, and distortion (that is, nonlinear response) seemed to them of relatively minor consequence. They determined this was so by passing a modern recording through cutoff filters that eliminated frequencies below about 200 Hz and above 4,000 Hz, and adding artificial noise. (They found, in working with archive-quality Caruso discs, that for the most part distortion was amazingly low.) In playback, this ersatz acoustic disc still sounded better than a real one. So their attack was to be concentrated on isolating the resonance signal. But in its basic applications, the method of de-

convolution presupposes that the characteristics of one of the two convolved signals are known and easily translated into computer data. In the case of the Caruso recordings, however, the deconvolution had to be "blind"—that is, neither the recorded voice nor the resonance characteristics of the recording equipment were known in sufficient detail for their purposes.

Resonance, of course, afflicts all acoustic recordings. Stockham and his associates found that the resonance of old equipment generally introduced dynamic variations of 10 to 20 dB or more in the frequency range between 100 and 1,000 Hz, where most of the voice signal lies. This produced a megaphone quality around the voice and unpleasant bursts of loudness when certain frequencies were played or sung. But, unfortunately for then-existing methodology, these effects varied from mechanism to mechanism and even from disc to disc. The recording technicians of those days—"excellent craftsmen," according to Stockham—were always trying to improve their results, and their constant retuning of the recording mechanism's sound box and changes in horn placement render it impossible to draw any conclusions by comparing discs known to have been made by a performer in the same studio but on different days—and perhaps even on the same day but of different selections. One method proved helpful: comparison of acoustic and electrical discs of the same piece sung by the same artist, and in sessions separated by only a few years, to minimize such factors as changes in a singer's voice. But for that last and other reasons, including the drawbacks of the early electrical recording process, such comparisons could provide only the roughest "empirical" evidence. And, of course, Caruso himself made no electrical recordings.

So the conclusion was inescapable: The hard data for determining the effect of the acoustic process on any recording would have to be derived from the recording itself. Stockham and his colleagues took the sung portion of "*Vesti la giubba*" and chopped it up into more than two hundred segments, each lasting half a second and overlapping one another by a fixed ratio. Each segment therefore represented a different musical passage perturbed by the same recording mechanism. Put another way, for purposes of sorting out the convolved signals, each segment had its own frequency spectrum that was the product of the musical spectrum and the response of the recording mechanism. The ensuing steps involve complex techniques of statistical averaging of these discrete segments by computer. By these means a profile of the average distribution of signal energies across the recording's frequency spectrum was derived. Such a profile, of course, included both music and horn resonance. To subtract the former from the total (a logarithmic

conversion changes the product to a sum), a modern recording (by Jussi Bjoerling) of the same aria, made on equipment assumed to have virtually flat frequency response, was chopped up and subjected to the same kind of averaging. The frequency-energy averages for both recordings were translated into decibels, and the difference between them was taken to represent the frequency response of the Caruso recording mechanism. A compensating digital filter was constructed to eliminate the horn resonances, digital samples of the original were processed through the filter, and the result was converted to an analogue signal and recorded on analogue tape for listening.

Stockham is candid about the possible deficiencies of this technique. He points out one basic and perhaps questionable assumption: that the "prototype" recording (Bjoerling's) has the same statistical properties as Caruso's original singing. Furthermore, the techniques can be applied only to the frequency band in which the old recordings have appreciable components and thus cannot affect their limited range (attempts to do so only increase surface noise); the deconvolved recordings sound somewhat bass-deficient and require an "empirically determined" bass boost in the compensating filter; and questions of the influence of surface noise, "nonstationarity" of signals, and possible phase distortion on such blind deconvolution have not been entirely resolved.

And it should be remembered that Stockham and his associates are scientists interested primarily in the broad applications of deconvolution and not only in recapturing voices of the Golden Age. Still, in their estimation, the results are "very

striking." To quote from their paper published in the *Proceedings of the IEEE* (April 1975), "All the restorations we have made, which so far concentrate on the recordings of Enrico Caruso, retain some of the 'acoustic flavor,' but the clarity of expression, the texture of the voice, and the artistic interest are dramatically changed. In addition, the prominent surges in volume caused when the pitch of the singing voice strikes the recording horn resonances are almost entirely gone. The voice seems much closer to the listener, the megaphone sound having been almost completely eliminated. The realistic qualities of the voice provided by the upper range of frequencies within the range of the restoration process are dramatically obvious."

Buoyed by his success, Stockham secured leave from his academic position and took the Caruso deconvolution project, among other things, further at Soundstream, Inc., his own company in Salt Lake City. In order to demonstrate the effectiveness of his process, Stockham used good quality pressings sent to him by an East Coast collector, choosing three of Caruso's familiar Victor Red Seal issues. One was the Act I duet, "O soave fanciulla," from Puccini's *La Bohème* (recorded in 1907), the only disc on which Caruso and Nellie Melba sang together. The other two were solo performances: his last recording of the "Siciliana" from *Cavalleria Rusticana* (1910) and "Je crois entendre encore" from Bizet's *Les Pêcheurs de Perles* (1916).

To this listener, familiar with acoustic recordings generally and the Caruso discs in particular, the deconvolved versions sound remarkably dif-

At Soundstream:
Stockham and colleagues
Richard B. Warnock, James E. Youngberg,
and Robert B. Ingebretsen





Three musicians who knew Caruso's voice intimately compare the deconvolved recordings with their memories of the living voice: from left, Nina Morgana, Rosa Ponselle, and Wilfred Pelletier.

ferent. Although surface noise tends to be more pronounced, the voice of Caruso reproduces in a full and rounded way. Irregularities in the way vowels were originally recorded (the Italian a sound seems fuller than the others) are reduced, and consonants, including the elusive sibilants, seem to be heard clearly. Best of all, the ringing quality of Caruso's famous upper voice and the rich baritone timbre of his low notes are evident.

But do the processed recordings reproduce Caruso's "real" voice? Three distinguished musicians whose careers were linked with his listened to them and addressed this question.

Nina Morgana, wife of the late Bruno Zirato, Caruso's only secretary, probably knew the tenor and the man better than anyone now living. She first met him in 1908 when a concert tour brought him to Buffalo, New York, her home town. Just sixteen years old at the time, she had been singing publicly since the age of five. Buffalo's Italian consul arranged a meeting and audition with Caruso, and the tenor, finding the girl's voice impressive, recommended study in Italy. She went to Milan to study with Teresa Arkel and in 1910 made her debut in Bellini's *La Sonnambula*. A series of La Scala performances followed. Upon her return to the U.S. she was engaged by the Chicago Civic Opera, and in 1920 made her Metropolitan Opera debut. In 1918 she shared the stage with Caruso in Buffalo in a joint recital; thereafter she toured the country with him, appearing in theaters, convention halls, armories, and any other structures large enough to accommodate the thousands who came to hear the "Voice of the Century."

"Singing in concert with Caruso," Madame Morgana told me, "was one of two great privileges I was accorded. The other was coming to know him well as a person, the man as well as the vocalist. Because my husband was his secretary, our lives and Caruso's intertwined. We dined with him regularly, delighted in his superb caricatures and his practical jokes, and sat in the audience for some of his finest performances at the Met.

"Over the years I suppose I have listened to many, if not most, of his Victor recordings, includ-

ing his very early ones. A good number of the arias and songs he recorded I heard him sing in person, often standing just a few feet off-stage so that I could watch him and note the audience's reactions as well. Of course, his recordings, good as they are, are incomplete experiences in themselves. Only the voice was captured by them, and the part the audiences cheered—Caruso the man—eluded the apparatus. . . . Then as well as now, however, I can remain objective about his singing, as any singer, critic, or student of singing should be able to do with any artist. I will say emphatically that he had the most compelling tenor voice I have ever been privileged to hear."

Listening to the processed versions of Caruso's recordings, Morgana judged them more accurate than any of the commercial discs. "One must bear in mind, however, that he was very well recorded to begin with, better than almost any other artist of his day," she said. "Most of his recordings strike me as being rather clear reproductions of his voice. . . . Yet in the end there is something about the recordings—for want of a better term I shall call it a 'mechanical' quality—which makes them incomplete. These new recordings, however, reduce this mechanical quality and at the same time accent the roundness of his voice. When Caruso and Melba are singing together, the process clearly favors him. Caruso's voice reproduces much better. Still, when Melba sings alone, there are passages that sound very much as I remember her.

"These recordings are to me a marvelous accomplishment, and while one can lament the fact that Caruso's voice was not recorded in the same sophisticated way modern artists' voices are, they give us a remarkably clear portrait of Caruso's singing."

Rosa Ponselle, the great American-born diva, provided a similar assessment of the processed recordings. Following her debut—opposite Caruso—in *La Forza del destino* at the Metropolitan Opera in November 1918, critic James Huneker dubbed her a "Caruso in petticoats." Barely twenty-one years old at that time, she had never sung before an opera audience, having been a

headliner in vaudeville with her sister Carmela. She went on to become the Met's reigning dramatic soprano until her retirement in 1937.

"Caruso had a saying," Miss Ponselle recalls, "To be a great artist, it is necessary that one suffer.' As much as I suffered from nerves and exhaustion the night I made my debut opposite him, believe me, he suffered every bit as much, even though he was already a legend by then. Once he got on-stage, he was the picture of confidence. . . . As a colleague he was wonderful: Since he and I were both Neapolitans—my parents were both *Napuletane*—we took to each other well. He was the greatest tenor I have ever heard in my life, and, happily, our voices blended beautifully. He brought out the very best in me whenever we sang together.

"I haven't heard all of his recordings by any means, although some of the ones I've listened to are good indications of what he sang like. Still, the way he had to make records made it impossible to sing the way he sang in person. I speak from personal experience here, because my first records were made the way his were, and none of the early ones I made captured the full timbre of my voice. The same with Caruso's records, although when I hear his '*Rachel, quand du Seigneur*' from *La Juive*, I get something of his actual voice. . . . When I listen to these new computerized recordings, I can sense more of his living voice, even though his recordings, at least in my opinion, could never give a total impression of his performances. . . . All in all, the new computerized recordings bring us close to Caruso's singing, maybe as close as any recording of his voice can come."

Canadian conductor Wilfred Pelletier began his career as an accompanist but eventually became a much-sought-after operatic coach. Through the French bass Léon Rothier, he was tapped to coach Caruso when the tenor began studying the role of Samson in Saint-Saëns's *Samson et Dalila*. At Caruso's apartment for his first session, he listened as the tenor vocalized with score in hand, offering interpretive suggestions as the morning progressed. Rothier was anxious to speak to Pelletier afterward, for this was the first time the young man had heard Caruso's voice. "Rothier asked me, 'What did you think of the voice? Wasn't it incredible?' I had to tell him in all sincerity that I was having difficulty understanding why, with that voice, Caruso was so well respected and so famous all over the world. Rothier asked me what I meant, and I told him that throughout the session the voice sounded rather breathy, pinched, not very large, and not at all what I had expected.

"Rothier laughed, and said to me, 'Go back to his apartment this afternoon and listen to him again. Then you'll see what the rest of the world is talking about!' Afterward, I understood what he meant. It seemed that Caruso had what he called a 'morning

voice' that he used in rehearsing and coaching. He saw no reason to use his full voice in such circumstances. . . . In the afternoons, when he was more accustomed to singing, he would open the voice fully. So when I went back to his apartment that afternoon, I heard the real Caruso for the first time. It was as if his voice were a great organ and suddenly he had opened all the stops. I have never heard another like him again, believe me!

"Unfortunately, his recordings do not reveal the full quality of his voice, and this is such a pity. . . . The voice on the records is very recognizably Caruso's, but the resonance and the power are there only in part. I would estimate that perhaps two-thirds of the actual voice of Caruso can be heard on many of his recordings. The rest is only a memory for those of us who heard him."

Listening to the opening measures of the processed "*Je crois entendre encore*" from *Pêcheurs de Perles*, a role in which he had coached Caruso, Pelletier was visibly moved. Afterward, when he was asked whether the recording represented Caruso's living voice, his response was, "Unquestionably. It is full and rich, just as I remember hearing him sing the aria." Pelletier considered the *Cavalleria* and *Pagliacci* re-recordings to be accurate depictions of Caruso's artistry but had reservations about the Melba-Caruso *Bohème* duet. "The voice of Melba is not perhaps accurate, and their performance together is not as moving as Caruso's solo performances on the other recordings. Otherwise, these re-recordings are incredible."

Based on the comments of these witnesses, it seems safe to say that the deconvolved recordings approach Caruso's living voice more closely than any development in recording technology has previously made possible. Beyond Caruso, it is difficult to draw any conclusion. Morgana's and Pelletier's comments about the sound of Melba's voice stand out by virtue of being unique—the only opinions of observers who heard the singer live about the viability of the process for voices less well recorded than that of Caruso. Still, Ivan Berger, writing in *Saturday Review* in October 1975, sounded a more hopeful note: "Hearing Stockham's restoration [of "*O soave fanciulla*"], a musician who had closely studied Melba's electrical recordings commented: 'I don't know if that's what Caruso sounded like, but that sure is Melba.' " And Stockham himself, despite reservations, has had sufficient endorsement by musicians of his laboratory efforts on other acoustic recordings—such as Gershwin's, with Paul Whiteman, of *Rhapsody in Blue*—to feel confident. RCA is currently releasing sixteen processed Caruso recordings, with publicity on their deconvolved nature, and Gershwin's recording of the *Rhapsody*, with no mention of any special remastering. How they are received by the public will determine if future re-releases will be so processed. [We hope to be able to review both recordings next month.—Ed.]

Melchior as Tristan: Crowning Glory of the Wagnerian Golden Age

*Melchior's epochal assumption
highlights the Met's 1941 Tristan, a
memento of the days when Wagner's
operas were actually sung.*

by Conrad L. Osborne



THIS RECORDING, a by-product of a Metropolitan Opera broadcast of over thirty-five years ago, is in no sense competitive with other available *Tristans*. Its sound is very good by standards familiar to those who collect "pirated" air-check recordings, and quite poor by any other criterion, including that of commercial recordings of the same date (1941). It is not sold through retail channels, and costs \$100, in the form of a contribution for that amount or more to the Metropolitan Opera.

These considerations free us, I hope, from the consumer-comparison aspects of reviewing, always so desirable from the collector's viewpoint, but often felt as limiting by those of us who must do the comparing. I should like to make it clear that reservations expressed here do not constitute any negative recommendation. Those who acquire the set will do so primarily because they wish to make the contribution. The cause is clearly worthy, and I don't believe anyone interested in a memento of the Met's great Wagner days will be seriously disappointed. The individuals and organizations (including several unions and RCA Records) who have contributed services or waived rights to make the release possible have certainly earned some goodwill.

"A memento of the Met's great Wagner days" this truly is, and in some ways the most fitting—for despite the efforts of the accompanying booklet to represent the performance as one of the half-dozen peak occasions of Metropolitan history, this is a rather run-of-the-mill Wagner performance of that time. Kirsten Flagstad and Lauritz Melchior are in good, representative form, but not quite their very best; the supporting cast is only decent by the then-prevailing standard; Erich Leinsdorf is simply a good, straightforward, no-nonsense young conductor; the orchestra performs at about its expectable level, the chorus (in its very brief excursions) a bit below its.

Just another Saturday afternoon in the season of 1940-41—it's just that those Saturday afternoons, at

least when the composer was Wagner, offered as a matter of course certain values we have since learned to live without, the most important being competent vocalism from rise to fall of curtain (and the fall, incidentally, can be distinctly heard at the end—an evocative noise for those of us with lots of Thirty-ninth Street mileage).

Longtime readers must forgive me if I tax their patience by again giving pride of place to Melchior's *Tristan*. I do so not merely because it was never recorded complete commercially (as was Flagstad's *Isolde*), but, because of all the magnificent individual assumptions of the Wagnerian Golden Age (1925-45, give or take), this is, for me, the greatest—and I do not except the *Isolde* and *Brünnhilde* of Flagstad, even the *Sachs of Schorr*. (I speak only of the aural evidence now. I saw Melchior's *Tristan* once, as it happens the very last he sang. I remember how fat he was, how silly he looked on the couch, how constricted the battle-worn voice sounded at moments. I also remember being stirred, thrilled, moved by the impingement of the tone at its best and the obvious sincerity of intent.)

Let me argue the case for a moment, using as reference this recording, the 1936 Covent Garden performance under Reiner (Flagstad's London debut, with Sabine Kalter, Herbert Janssen, and Emanuel List, a private recording), and the extensive excerpts that were recorded commercially.

I imagine that few lovers of singing will deny Melchior's superiority in realizing the heroic aspects of Wagner's tenor roles, if only because no other voice of which we have extensive evidence has been capable of repeatedly and reliably fulfilling the demands of the more brilliant, strenuous pages of the scores. But as the present performance reminds us, this reliability was based on the most thoroughgoing classical technical discipline, in terms of both sheer vocal mechanics and shaping of the vocal gestures. However much the vocal line of *Tristan* may emerge

from the harmonic and orchestral fabric, Melchior sings it just as he would (and did) that of Meyerbeer, Leoncavallo, or Verdi—as the melodic *raison d'être* of the writing, realized primarily through a perfectly sustained legato and the renewing power of the *messa di voce* (swell and diminish of the tone), and through a subtle sensitivity to the relationship between the vocal line and the accompaniment. Thus, some two-thirds of the lengthy *Liebesnacht* episode is sung in degrees of half-voice—something that may not be immediately recognizable to listeners conditioned by latter-day singers to think of soft singing as a “special effect,” rather than as simply the quieter side of an integrated continuum. From this basis, Melchior opens out into the forte moments with an absolutely even augmentation of intensity. This is most clearly heard at points where he accomplishes the change on a single sustained note. One example among many occurs at pp. 353–54 of the Dover full score. After swelling to a small climax at “*heil'ger Dämmerung hehres Ahnen,*” back to *mezza-voce* and then swelling again for “*löscht des Wähns Graus,*” he attacks the F natural at “*welterlösen aus*” in a firm true *mezza-voce*, which he sustains through the slow 3/4 bar, opening the vowel and swelling the tone on the downbeat of the next bar, simultaneous with the height of the orchestral crescendo, the harmonic and time change, and the soprano entrance on the same word an octave higher. It is an effect aimed for by virtually every tenor here, but it defeats all of them as they attempt to move on a chromatically ascending line through the break. Seldom as it is encountered in the work of Germanic singers, it was commonplace in the vocalism of the better Italians, like Battistini or Caruso, and it is to their art that Melchior's shows a close correspondence.

In the third act, Melchior adds an accomplishment of another sort: the complete realization of a character's emotional and physical condition (an extreme one) through the verbal and musical text. Here his work may be compared with that of a Chaliapin or a Muzio, except that Melchior's is achieved in a context infinitely more demanding. The opening pages of the delirium scene he renders in a dull, utterly exhausted tone that, for once, we recognize as the artist's choice rather than the tenor's vocal condition. He sinks back into this in subsequent moments of Tristan's weakness, sometimes letting the vibrato and resonance turn dead in a fashion that would alarm us with any other singer. But at each of Tristan's fevered arousals he is back with his most ringing, passionate full voice, reaching joyous climaxes at such points as “*Isolde kommt! Isolde naht!*,” quite terrible ones in places like “*Verflucht sei dieses Trank!*,” and still able to begin the final challenge (“*O diese Sonne*”) with fresh, spinning tone, and cap it with brilliant A naturals at “. . . ha! Die Leuchte verlischt. Zu ihr! Zu ihr!”

The first of these A's, by the way, is an interpolation (something he does in both the Met and Covent Garden performances, but not in his 1943 Act III for Columbia, now on *Odyssey*). It is his only liberty of this sort, but it brings us to the question of his musical inaccuracy, for which he is much berated by commentators who only tut amusedly at Chaliapin's most blatant indiscretions or (to bring the matter closer to home) fail to even note the quite regular



Tristan und Isolde, Act I, at the Met . . .

Flagstad habit of flattening out dotted figures, sometimes to the great disadvantage of the music. I believe this question to be preposterously exaggerated. (I am happy to note that the same view is voiced by my English colleague J. B. Steane, surely a thorough and critical listener.) We may leave aside the commercial recordings, where even the most negligent artists generally get pulled together. (Robert Merrill, for example, is a musically attentive performer in his studio recordings and a notoriously sloppy and forgetful one in live performance.) Having followed a good number of Melchior's broadcast recordings with score in hand, I have concluded that on most occasions he was at a good operatic average in terms of musical accuracy. Here, he pulls away from tempo for a couple of bars three or four times in Act III and suffers a brief memory lapse in “*O König.*” He often cuts the values of the half notes at phrase ends in the delirium scene—clearly, in my opinion, a legitimate part of his musical characterization. Granted, I have heard more musically precise Tristans, not one of whom is in the same league with Melchior as a musicodramatic artist.

Altogether, he is in excellent form here, the voice fresher and more integrated than in his Victor *Liebesnacht* or his Columbia Act III, though a trifle less so than in the Covent Garden performance or the '29 excerpts recorded with Leider, where the head voice is more consistently a part of the tone *a piena voce*.

Flagstad's Isolde here is perhaps more a memento than an artistic revelation. Its value vis-à-vis her 1952 recording under Furtwängler is the earlier date—it represents the prewar Flagstad in live performance, unedited and un-Schwarzkopfiz. But this advantage is compromised by the fact that the recording catches her very poorly. Her upper fourth comes through fuzzily; sometimes the tone is clear but lacking in impact, at others it is vague, and she often sounds to be backing away from phrases lying from G upward, attacking notes in a gingerly manner or releasing the center of the singing position before the time value of a note is quite over, giving the effect of trailing off.

Part of this, I think, inheres in her singing at this performance: The Bs and Cs are obviously thinner and less secure than in the 1936 performance, and some of the tentativeness sounds much like that heard in most of her postwar recordings. The top, to put it directly, was beginning to slip. But more of the problem, I am sure, lies with the recording itself, for we have enough other contemporaneous evidence of



Flagstad and Melchior in the title roles

Flagstad's vocal condition to know that the upper range was not suffering habitual weakness of the sort indicated here. At its best (notably in the *Liebessnacht*), the performance reminds us of the lovely purity of her tone, the simple musicality of her phrasing, and the unique sensation of timelessness induced by her timbre and the even periodicity of her vibrato. It is a more purely musical performance than Melchior's, beautiful in its way and unchallengeably right in the more restful, dreamy pages. But this is another way of saying that an element of dramatic commitment, of imaginative response to the verbal text, of variety of color, is missing, and when the recording conditions do not bring us the full impact of her voice, this lack is more urgently felt. The same problem is present to a degree in the Covent Garden recording, particularly in Act I, but as the performance goes on is much less troublesome. I would have to counsel reference to her commercial recordings—both the complete Furtwängler edition and the prewar excerpts—as more satisfying and accurate guides to the powers of her Isolde.

Among the supporting singers, the most complete performance is the Marke of Alexander Kipnis. This is in spite of the fact that the voice is already a bit past its best, spreading badly when under pressure toward the top. But its basic beauty and format are still present, the dips into the low notes so easy, the soft singing full of a depth and reserve that still projects. His monologue becomes an emotionally logical, proportioned progression (it is, but how often do performances make us feel that way?), and the character becomes an individual of unquestioned stature—we know from Kipnis' first lines that this is not the house bass, but an important, authoritative performer.

Kerstin Thorborg was a mezzo-soprano of solid competence, at her best in rather aggressive music; her air-check Ortrud is quite marvelous, her commercial discs of Fricka and Waltraute solos—not on LP, unfortunately—very convincing. [The *Walküre* and *Götterdämmerung* excerpts are likely to reappear on Preiser's promised Thorborg LP; the former was recently available in Victrola's German-opera miscellany, VIC 1455.—Ed.] She has some fine moments in this performance, but Brangäne, in essence a high-lying, lyrical role (soprano, by the score—and Wagner wanted Lilli Lehmann to sing it), is not really her meat—the long, sustained lines disclose some tremulousness and a lack of economy with the breath, and her intonation is not always above suspi-

cion. At that, she need take no back seat to any commercially recorded Brangäne (the role is seldom done well), but Kalter, in the Covent Garden recording, is decidedly superior.

It is nice to have some preservation of the baritone Julius Huehn, who so far as I know made no commercial recordings during his war-shortened career. His voice was a clear, sizable high baritone with a good deal of vitality, and in all his performances I have been able to hear (Escamillo, Pizarro, and Telramund; in addition to this Kurwenal) he impresses as a solid professional not afraid to throw himself into the music. Regrettably, he seems to have always sung the upper notes in an overly open fashion, a bit raw and shallow to the ear of the listener, and a bit perilous to the throat of the vocalist. In this part, the highest of Wagner's baritone roles, this is obviously a drawback, but it's a scrappy performance that doesn't let the third act down. Emery Darcy, who had a clear, strong voice that made him an unusually good secondary tenor, is well above average in his doubling of the Sailor and Melot.

I have already characterized Leinsdorf's leadership, and have little further to add: It is a bit quick and pressed for my taste, but firm and clear. The orchestra does not sound very colorful or sensuous, but the restricted range of the recording really precludes any fair comment about this aspect of the performance.

In a brief reminiscent essay in the accompanying booklet, Leinsdorf leaves the impression that he restored much material usually cut in previous *Tristans* at the Met and (by implication) that the present performance reflects this. I wonder what on earth might be further cut—this is one of the most drastically shortened editions I have heard: a whacking cut, mostly in Tristan's music, in Act II (everything from Isolde's "bot ich dem Tage Trutz!" to Tristan's "O nun wären wir Nachtgeweihte!," some fifty-one pages in full score), and all the cuts ever justified in Act III (the same as those in the *Odyssey* Act III), including the beautiful monologue at the return of the "alte Weise." This last is restored in the Covent Garden performance, which thus remains the only source for Melchior's performance of this passage.

The presentation package is a handsome blue velvet box. The Met's current edition of the libretto (with Stewart Robb's translation) is included (though again, without any indication of the cuts taken). The booklet is handsomely laid out and does nicely enough as a piece of memorabilia in that time-encrusted Met style we might call Congratulatory Genteel, but contains nothing at all of substance about the work itself, as if to assure the culture consumer that he or she is indeed getting the certified best and that there is no call for inquiry as to just what that is.



WAGNER: Tristan und Isolde.

Isolde	Kirsten Flagstad (s)	A Shepherd	Karl Laufkoetter (t)
Brangäne	Kerstin Thorborg (ms)	Kurwenal	Julius Huehn (b)
Tristan	Lauritz Melchior (t)	King Marke	Alexander Kipnis (bs)
A Sailor; Melot	Emery Darcy (t)	The Steersman	John Gurney (bs)

Metropolitan Opera Chorus and Orchestra, Erich Leinsdorf, cond. MET 3 (four discs, mono, automatic sequence) [recorded from broadcast, February 8, 1941]. Available with a donation of \$100 or more to the Metropolitan Opera Fund, Lincoln Center, New York, N.Y. 10023.

Josef Suk



Maricel Anders

Good News/Bad News: Suk/Du Pré

Recent Beethoven releases represent the great Czech violinist impressively but do the British cellist a serious disservice.

by Kenneth Furie

THERE IS, or should be, a moment of pure magic in the Andante of Beethoven's Violin Sonata, Op. 12, No. 2.

It comes after twenty-four bars so preposterously simple that Beethoven is obviously up to something. The piano has begun with a neat eight bars of near-noodling (you can hardly call it a tune) in and around A minor. These eight bars are then repeated almost exactly, but with the top line, raised an octave, taken by the violin. A tidy, rather primitive sixteen-bar unit.

Yet another simple eight-bar block follows: Without any modulation, the piano, playing softly, suddenly slips into the relative major key (C), harping on it for four bars and then wandering back into A minor. And now we are tipped off: At bar 25, the violin will take up the top line of the preceding phrase, raised an octave to fall neatly on the silvery E string. If the player is any good at all, the effect of that little C-major eruption will be striking. If the violinist is really good—if he understands the power of simple, direct utterance, of intensity born not of tonal excess, but of pure, concentrated tone—that phrase will offer a burst of soul-stirring radiance, immediately checked by the return to the minor.

But that is not the whole trick, for it reckons without that key subjective listening element: anticipation. For if the violinist is really good, an experienced listener (and the only experience required is hearing one player get it right) will spend those eight preceding bars tensely expectant.

One violinist above all comes to mind for his ability to use the most direct communicative tools to strike most deeply into the emotions: Fritz Kreisler. So it rather startled me when, reaching that point in Josef Suk's recording, I felt that same shiver of anticipation—handsomely rewarded, I might add.

On reflection, the parallel seems apt. Suk, like Kreisler, is not notably aggressive in temperament and yet has all the discipline necessary for a major classical stylist. He is the great lyricist among today's violinists, and like Kreisler he makes many of his most memorable impressions at soft dynamic levels. (Most violinists need to churn out lots of noise to catch your ear.) His technical equipment is mightily impressive, to be sure, but one almost never notices it; whatever his musical imagination demands, his fingers and bow arm produce.

Thus Suk can make the *Kreutzer* Sonata sound, if not easy, at any rate untaxing, without calling attention to his virtuosity. The dominant feature of the reading, beyond the easy, unexaggerated tonal allure, is its compelling, unforced logic: the way each phrase leads committedly into the next, the way each new rhythmic pattern has a fully formed identity—articulated by both violinist and pianist—that yet relates directly to what precedes.

It puzzles and saddens me that Suk is not better-known in this country. He has no catchy gimmick and has benefited from no media hype. True, his name is familiar, both as soloist and as leader of the remarkable Suk Trio, otherwise composed of his Czech compatriots cellist Josef Chuchro and pianist Jan Panenka. But he was never a Youthful Wonder, and at age forty-seven he is at least a decade away from consideration for Old Master indulgence.

In a more rational universe, artistry of this order would guarantee comparable celebrity. Bad enough that Suk visits these shores so infrequently; worse still, there seems to be insufficient demand for his recordings to insure that they even circulate here.

The "new" Supraphon set of Beethoven sonatas with Panenka was first published, according to the

labels, in 1968. Suk has been recording in the interim, and not only in his homeland. In 1971, EMI issued a recording of the Beethoven violin concerto with an unexpected but highly congenial collaborator, Sir Adrian Boult, conducting the New Philharmonia. Then came an EMI set of the Bach unaccompanied sonatas and partitas (issued in England as SLS 818). In 1972, Suk played and conducted the Mozart concertos with the Prague Chamber Orchestra, a Supraphon/Eurodisc coproduction that has turned up via Eurodisc and British RCA. He later recorded the Beethoven triple concerto with Chuchro, Panenka, and the Czech Philharmonic under Kurt Masur. Supraphon now promises the Brahms concerto with the Czech Philharmonic under Václav Neumann.

The Supraphon recordings have official, if sadly limited, domestic distribution through U.S. Qualiton Records, though collectors have no reliable way of knowing what's available. The EMI recordings, however, having been passed up by Angel, have reached us only on a sporadic import basis—at least until Vanguard licensed the Beethoven concerto with Boult for release on the budget-priced Everyman label.

It's a beautiful performance. Though the New Philharmonia sounds somewhat thick-toned in loud tuttis, Sir Adrian's realization of the orchestral part is lovingly shaped and well-nigh ideally balanced and recorded.

The tempo of the first movement is very close to the exceptionally broad pace Colin Davis attempted with Arthur Grumiaux (Philips 6500 775, June 1975), but Boult brings it off. Where Davis' gait tends to break down into bars, set off by plodding downbeats, Boult's flows easily. The slow movement is dazzling: The singing quality of Suk's musical personality expands to the fullest in such music (as did Kreisler's), and Boult balances his players—including the soloist—masterfully. The reading as a whole again recalls Kreisler; specifically, the earlier (1926) of his two recordings, with Leo Blech, one of the supreme accounts on disc, recently accorded an astonishingly good LP transfer by EMI in England (HLM 7062).

As an added point of interest, Suk has turned up a pair of cadenzas by one Váňa Příhoda, and they are, in their nonexhibitionistic way, sensational: patterned after the structure of the respective movements, with much fascinatingly intricate, impeccably tasteful figuration.

All in all, the Suk/Boult Beethoven concerto seems to me the equal of any in the current domestic catalogue, and it is a more personal performance than my other favorites, the Heifetz/Munch (RCA LSC 1992 et al.) and Szeryng/Haitink (Philips 6500 531, February 1975). There ought to be a Grumiaux version in that group, but the Grumiaux/Davis—with that earthbound, timpani-mad first movement—doesn't quite belong in such company; try instead to find the deleted Grumiaux/Galliera (Philips 802 719, August 1969). The English issue of the Suk/Boult included *Coriolan* as a filler—a fine performance, but hardly relevant to the concerto and, especially at the Everyman price, a minimal loss.

The new Supraphon recording of the triple concerto is also impressive, though perhaps not a first

choice. Not surprisingly, the close relationship among the soloists produces a degree of teamwork unmatched on any other recording. The seemingly spontaneous shaping of the violin part carries over into those frequent passages that pair the violin and cello—Suk and Chuchro phrase with breathtaking unanimity.

I wish that Chuchro were more assertive in his first-movement solos, but in the later movements he takes his rightful place. Panenka keeps a tight rein on the range of his tonal and dynamic resources; he plainly doesn't want to imbalance the proceedings with the power and tonal juice of which the modern piano is capable. Within those limits, his playing is spectacularly sensitive: pearly runs, an effortless legato that doesn't depend on pedal, and soft playing of melting warmth. He is not afraid to assume full partnership with his colleagues, but he resolutely refuses to swamp them. If the soloists incline to intimate projection, power is supplied by conductor Masur's orchestral backdrop, which is large-scaled and rock-solid. The impression of breadth is clearly a matter of rhythmic projection rather than tempo, for the movement timings are not slow.

The description of Panenka's contribution to the triple concerto applies too to his collaboration with Suk alone in the violin sonatas. It is a true collaboration, with both instruments given fair measure in the close, rather dry recording—an analytical ambience that would crucify many instrumentalists but succeeds well with these gifted colorists.

All ten sonata performances are fully competitive with any on record, and perhaps more important all ten obviously grow out of years of joint scrutiny. There is not a single ill-considered movement, and scarcely a phrase without some treasurable insight. If Suk's genius for simplicity suits the smaller-scaled early works ideally, he and Panenka also project better than I have ever heard the distinctly eerie, off-kilter fantasy flavor of the first movement of Op. 96. The variation movements are simply transcendent; listen to what Suk does with the simple repeated-note descendant of the Kreutzer's first variation. If you want to hear unanimity of phrasing, listen to Panenka's trills in the second theme of Op. 30, No. 1's first movement, followed by Suk's in the violin statement.

Turning from these fully conceived, movingly executed renditions to Angel's set of the Beethoven cello sonatas by Jacqueline du Pré and Daniel Barenboim is a depressing experience. In view of the tragic curtailment of Du Pré's career, I can understand the impulse to release these performances ("by arrangement with BBC Records"), recorded live at the 1970 Edinburgh Festival, and as a matter of principle I am all in favor of issuing memorable live performances. But these aren't memorable performances; they sound more like the product of a student recital.

Barenboim's pianism is thoroughly professional: solid in rhythm, positive in touch (the sound, by the way, is splendid for the source), coherent in structure. It is also pretty uninteresting, and his inability to execute rapid passagework cleanly, let alone purposefully, would be obtrusive if the performances could be taken seriously.

But what are they doing on records? Du Pré's tone

is so unfocused, her dynamic range so limited, that she has virtually no expressive options for this tempestuous, haunting music. There is no bite anywhere: When she tries for volume, the tone turns harsh and gritty; perhaps for that reason, accents and sforzandos are rarely attempted.

Nor do I detect any sense of what the music is about. Slow movements and sections of movements meander aimlessly. Du Pré's 1966 studio recording of Op. 69 and Op. 102, No. 2, wasn't very good; the only hints of imaginative realization came from pianist Stephen Bishop. The 1970 performances are more tightly bound by Barenboim's solidly orthodox

work, but the cellist still seems lost. It was a generous thought to issue these recordings; in fact, though, I think Du Pré has been done a large disservice.

There must be a market for this set, for Angel has so far bypassed Barenboim's 1974 set of the violin sonatas with Pinchas Zukerman (issued in England as SLS 871)—not a world-beater, but considerably more accomplished than the present offering. From an artistic standpoint, it is regrettable that Angel chose this set over the lovely 1972 cello sonatas of Paul Tortelier and Eric Heidsieck (issued in England as SLS 836). And in connection with the Suk/Panenka set of the violin sonatas, it should be noted that Chuchro

Berryized Beatles, Beatlized Monkees,



"Rock 'n' Roll Music" shows the Beatles raiding Chuck Berry; another reissue and a new disc show Monkees then and now.



From the top: The Monkees (Jones, Tork, Dolenz, and Nesmith) then; the Beatles then; Dolenz and Jones now

THE BEATLES, whose enormous reputation resulted primarily from the song-writing abilities of John Lennon and Paul McCartney, devoted a large portion of their early career to the playing of American rock and roll. Of course, nearly every rock band in the world started out with Chuck Berry songs. But it was only after such Lennon/McCartney hits as "I Want to Hold Your Hand" and "Please Please Me" had established the Beatles in the pop world that they issued recordings of American tunes, like Berry's "Rock 'n' Roll Music" and Larry Williams' "Slow Down" and "Bad Boy."

Whether their incursion derived from a genuine feeling for rock and roll or just from a desperate search for releasable material is a question whose answer is probably lost for good. Whatever the reason, at the height of their popularity the Beatles abruptly took a break from their own compositions and began recording a form of music that is very nearly exclusively American. Few foreigners have been really good at it. The Beatles were.

In a new two-disc re-release from Capitol they give the sparse sound of Chuck Berry a richness it had never before possessed. As recorded by Berry, "Roll Over Beethoven" was a compromise, half blues and half country. As done by the Beatles, the tune gains ten years in style and a lot of life. It is as much élan as music. The same can be said of their versions of Carl Perkins' "Matchbox" and "Everybody's Trying to Be My Baby," Leiber and Stoller's "Kansas City," and Lennon/McCartney's own "Back in the U.S.S.R.," a spoof of Berry's "Back in the U.S.A."

This "Rock 'n' Roll Music" anthology contains a

and Panenka have recorded the cello sonatas and variations splendidly (Supraphon 1 11 1091/3).

Suk and Panenka take all repeats in the violin sonatas, and the quality of their playing makes them all welcome. Du Pré and Barenboim take first-movement repeats in Nos. 4 and 5, but not in Nos. 1-3, though the third-movement repeat of No. 3 is observed. Does it matter?

B **BEETHOVEN:** Concerto for Violin and Orchestra, in D, Op. 61. Josef Suk, violin; New Philharmonia Orchestra, Adrian Boult, cond. [Christopher Bishop, prod.] VANGUARD EVERMAN SRV 353 SD, \$3.98.

BEETHOVEN: Concerto for Violin, Cello, Piano, and Orchestra, in C, Op. 56. Josef Suk, violin; Josef Chuchro, cello; Jan Panenka, piano; Czech Philharmonic Orchestra, Kurt Masur, cond. [Eduard Herzog, prod.] SUPRAPHON 1 10 1558, \$6.98.

BEETHOVEN: Sonatas for Violin and Piano (10). Josef Suk, violin; Jan Panenka, piano. [Zdeněk Zahradník, Miloslav Kuba, and Eduard Herzog, prod.] SUPRAPHON 1 11 0561/5, \$34.90 (five discs, manual sequence).

B **BEETHOVEN:** Sonatas for Cello and Piano (5). Variations: on "Ein Mädchen," Op. 66; on "See, the conquering hero comes," WoO. 45; on "Bei Männern," WoO. 46. Jacqueline du Pré, cello; Daniel Barenboim, piano. ANGEL SCB 3832, \$13.98 (three discs, manual sequence) [recorded in concert at the 1970 Edinburgh Festival].

Unmonkeed "Dolenz, Jones . . ." by Mike Jahn

number of tunes that do not belong. "Helter Skelter" is not rock and roll, but the lugubrious sort of hard rock played by Led Zeppelin. "Got to Get You into My Life" and "The Night Before" are pretty Beatles songs, neither of which rocks to an appreciable extent. And even "Taxman" is too low-keyed for such an album. Still, these inclusions hardly diminish the value of the set.

It is ironic that at about the time the Beatles were copying American rock and roll, American groups were copying the Beatles. The Monkees were one of them. They were much maligned critically when their recordings appeared in the mid-1960s, largely because of the asinine television program in which the four members starred. But the Monkees' rock was quite good—even excellent. "Last Train to Clarksville," "Daydream Believer," and "I'm a Believer," for example, were every bit as fresh and exciting as the Beatles' early releases. "The Monkees' Greatest Hits" (previously issued as "The Monkees/Refocus," when Arista was still Bell Records) includes these and eight other tunes, most of them good ones. Michael Nesmith's "Listen to the Band" is the equal of many lionized Lennon/McCartney songs. The Monkees deserve recognition, and perhaps when the Sixties undergo the inevitable "nostalgia" revival, they will get their due.

Following the group's dissolution, two of the members—Nesmith and Peter Tork—tried to dissociate themselves from the band, launching careers as "serious" rock artists; neither met with noticeable success. Now, ironically, Davey Jones and Mickey Dolenz, the two who always seemed perfectly happy just being Monkees, have recorded an album that is head and shoulders above the work done by their former comrades. In league with Tommy Boyce and Bobby Hart, who produced them as Monkees, they have issued "Dolenz, Jones, Boyce, & Hart," a rock LP of considerable merit.

Boyce and Hart are song-writers blessed with the golden touch that has made millionaires out of people like Barry Manilow. Their ability to produce appealing little tunes that stick in one's mind is well known. "Last Train to Clarksville" was theirs, as are the new disc's "Right Now," "I Love You (And I'm Glad That I Said It)," and "I Remember the Feeling."

The last-mentioned song has all the markings of a pop hit. If I read my rock right, there is no logic if it doesn't become one.

The album doesn't sound very much like the Monkees, though traces remain in the singing of Davey Jones and in the sense of youthful vigor that permeates its grooves. The accompaniment is fancier and more calculated than that of the older group, and the songs are more modern. Whether written by Boyce and Hart, by Dolenz and Jones, or by someone else, the tunes are more reminiscent of Tony Orlando or Manilow than of "Last Train to Clarksville." That is not a putdown, merely an observation. The only thing wrong with this record is the presence of a little bit of between-bands foolishness—i.e., talking dolphins and computers and other childish nonsense of that ilk. Forget it—the music is fine.

THE BEATLES: Rock 'n' Roll Music. John Lennon and George Harrison, vocals and guitars; Paul McCartney, vocals and bass; Ringo Starr, vocals and drums; instrumental accompaniment. *Twist and Shout; You Can't Do That; Boys; Long Tall Sally; Rock 'n' Roll Music; Kansas City; Money; Bad Boy; Matchbox; Roll Over Beethoven; Everybody's Trying to Be My Baby; Revolution; Back in the U.S.S.R.; Got to Get You into My Life; Get Back;* thirteen more. [George Martin, prod.] CAPITOL SKBO 11537, \$10.98 (two discs). Tape: ●● 4X2K 11537, \$12.98; ● 8X2K 11537, \$12.98.

THE MONKEES: The Monkees' Greatest Hits. Peter Tork, vocals and guitar; Davey Jones, vocals; Michael Nesmith, vocals and bass; Mickey Dolenz, drums; vocal and instrumental accompaniment. *Monkees' Theme; Last Train to Clarksville; She; Daydream Believer; Listen to the Band; A Little Bit Me, A Little Bit You; I'm a Believer; I Wanna Be Free; Pleasant Valley Sunday;* two more. [Tommy Boyce, Bobby Hart, Jack Keller, Chip Douglas, Michael Nesmith, and Jeff Barry, prod.] ARISTA AL 4089, \$6.98. Tape: ●● 5301-4089H, \$7.95; ● 8301-4089H, \$7.95.

DOLENZ, JONES, BOYCE, & HART. Mickey Dolenz, drums; Davey Jones, vocals; Tommy Boyce, guitar; Bobby Hart, keyboards; vocal and instrumental accompaniment. *Right Now; I Love You (And I'm Glad That I Said It); You and I; Teenager in Love; Sail On Sailor; It Always Hurts the Most in the Morning; Moonfire; You Didn't Feel That Way Last Night (Don't You Remember); Along Came Jones; Savin' My Love for You; I Remember the Feeling; Sweet Heart Attack.* [Tommy Boyce and Bobby Hart, prod.] CAPITOL ST 11513, \$6.98. Tape: ●● 8XT 11513, \$7.98.

Lazar Berman (continued). Following the success of Berman's recording of the Tchaikovsky First Piano Concerto with Herbert von Karajan and the Berlin Philharmonic, Deutsche Grammophon has taped the two concertos of Liszt, the composer with whom Berman has thus far been most closely associated in the West. Carlo Maria Giulini conducts the Vienna Symphony, of which he is principal conductor. (Giulini and the VSO have also been recording for EMI; a Bruckner Second Symphony has been released in Europe.)

Giulini's insistence on using his own orchestra, European Editor Edward Greenfield reports, sat well with the DG engineers, eager to have another go at the Simmeringerhof, a turn-of-the-century baroque hall on one of the roads to the airport, used over the years for small political meetings and dances. When DG recorded there before—Karl Böhm's Beethoven symphonies with the Philharmonic—some problems were encountered, notably with players' ability to hear each other, but the engineers remained hopeful that they might be able to "adopt" the Simmeringerhof for Vienna sessions as Decca/London has adopted the Sofiensaal.

"Producer Karl Meyer was delighted with the sound," Greenfield notes, "and Giulini had a magic touch in working alongside a Soviet artist who is, to say the least, a positive character." The First Concerto, in the active repertory of both soloist and orchestra, was done quickly, in long takes. Berman explained that he likes to record basically in two takes, with the second always the best. "If I need a third," he said, "I start to get worried." Multiple takes were necessary in the Second Concerto, which the pianist had not played for some years and which was not in the orchestra's current repertory. Still, Greenfield saw no evidence of third-take phobia, noting Berman's "remarkable ability to switch on at full intensity the moment a take starts, not once but, if necessary, many times."

Macbeth by two. DG also has a new recording site in Milan, where it plans a series of Verdi recordings in collaboration with La Scala and its music director, Claudio Abbado. The Centro Tecnico Cinematografico (CTC) is a complex of facilities for television, films, and recording, located in a vast stretch of high-rises on the city's outskirts. The CTC was far from complete last winter when *Macbeth* was recorded, as previously reported, with a cast headed by Piero Cappuccilli, Shirley Verrett, Plácido Domingo

Behind the Scenes

(who did not sing in the new Giorgio Strehler production on which the recording was based), and Nicolai Ghiaurov.

As projected, yet another *Macbeth* followed this summer in London. Riccardo Muti conducted his third Verdi opera for EMI, once again using the New Philharmonia. Sherrill Milnes and Fiorenza Cossotto are Mr. and Mrs. *Macbeth*. José Carreras sings Macduff; Ruggero Raimondi, Banquo. Muti recorded all the numbers from the opera's original version that were excised by the composer in his revision; they will be included as an appendix.

Tosca by two. As previously forecast, Philips has recorded *Tosca* in London with Montserrat Caballé, José Carreras, and Ingvar Wixell, conducted by a most unexpected Puccinian, Colin Davis. Davis' own Covent Garden orchestra was on hand for the sessions at Watford Town Hall, where Philips has been recording as a result of serious storm damage to its usual site, Brent Town Hall. (Philips has also been planning a *Lucia di Lammermoor* with Caballé and Carreras.)

The summer also found the Rostropovich family at work on *Tosca*—in Paris for Deutsche Grammophon. Mstislav Rostropovich conducted the Orchestre National, with his wife, Galina Vishnevskaya, in the title role. Franco Bonisoli is the Cavaradossi; Matteo Manuguerra was brought in for Scarpia when illness forced Giangiacomo Guelfi to withdraw.

Beethoven and Brahms. Both DG and EMI have new cycles of the Beethoven and Brahms symphonies in the offing. Rafael Kubelik's DG Beethoven set using nine orchestras, in the works for several years, was announced for release in last month's recordings preview. The DG Brahms cycle is a sequel of sorts to the label's last Beethoven cycle, with Karl Böhm conducting the Vienna Philharmonic.

Both EMI cycles will be recorded by Eugen Jochum (the first projects under his new EMI contract), with London's top two orchestras. In the midst of London's most intense heat wave in a century, Jochum began recording Brahms (Second and Fourth Symphonies, *Tragic Overture*) in the

mornings with the London Philharmonic and Beethoven (*Eroica Symphony*) in the evenings with the London Symphony. All sessions were held at Kingsway Hall, with producer Christopher Bishop heading the same recording team for both projects. Bishop told us that, despite the heat, he has never known a conductor to behave in the studio so like an eager schoolboy as the septuagenarian Jochum. During playbacks he would comment on the balance with the principal players there, as though sculpting in sound. In the slow movement of the Brahms Fourth, for example, he made molding gestures to LPO concertmaster Rodney Friend (soon to take up his new appointment with the New York Philharmonic): "If you are good, you can do a little portamento. But not Mahler!"

Verdi in Vienna. After recording five early Verdi operas in London, the Philips team—headed by producer Erik Smith and conductor Lamberto Gardelli—moved to Vienna's Konzerthaus for *I due Foscari*, produced in collaboration with Austrian Radio, whose orchestra and chorus were used. The cast features Katia Ricciarelli, José Carreras, and Piero Cappuccilli.

Erato's Faust. Recordings of Gounod's *Faust* remain decidedly uncommon; it is sobering to note that the version now in the works chez Erato will be only the third in stereo. As in Erato's *Carmen* (reviewed in December 1975), Alain Lombard conducts the Strasbourg Philharmonic and the chorus of the Opéra du Rhin, but the *Faust* cast has a more international, specifically Spanish, flavor: Montserrat Caballé and Giacomo Aragall are the Marguerite and Faust. Pierre Thau is announced as Méphistophélès, with Philippe Huttenlocher as Valentin, Anita Terzian as Siebel, Jocelyne Tailon as Marthe, and Pierre-Yves Le Maigat as Wagner.

BASF's history. The rapidly growing BASF series of historical recordings has been trickling into this country to tantalize U.S. collectors. Now German News Company has acquired rights to import the historical series, with the first shipment expected around the time you read this. Of BASF's new recordings, an increasing number will be issued domestically by the principal U.S. licensee, Audiofidelity Enterprises; some titles—including the complete recording of Mozart's *Lucio Silla* conducted by Leopold Hager—have been licensed for domestic release by Columbia. ●

Skeptics Agree!

Excerpt from
ELECTRONICS ENGINEERING TIMES
January 27, 1975 "Keep Your Records Clean"

"Up to now, I've had to wash records as dirty as these in a sink, with the attendant risks of mishandling. The Discwasher got rid of all the dirt and fingerprints in one easy operation, far more effective than any other record-cleaning tool I have come across. For simply dusting records, it is also very effective and does not leave that line of dust across the disc when you pick it up from the surface. At \$15.00 it's not cheap, but if you care for your records, it's worth it."

Excerpt from
AUDIO
May, 1976

"For the daily care of records, to wit, the ounce of prevention that can assure your records of reasonable longevity and noise-free plays, the Discwasher with D-II solution and the Zerostat should do the best job of keeping your records clean with a minimum of noise problem."

Excerpt from
STEREO
Winter, 1975

"We were frankly at a loss as to how to test the 'performance' of the Discwasher System... Each time we examined the residue that adhered to the surface of the Discwasher brush, and each time we were amazed at the amount of debris that this combination of brush and fluid was able to remove. It was frightening to realize that our stylus had been grinding away at these minute particles and globules for so long—but that seems to be the irrefutable case."

Excerpt from
DANISH HIGH FIDELITY MAGAZINE
December, 1974—"Testing"

"Discwasher D-II has been tried out on many different records in many different conditions..."

"All the other record cleaning devices used did not give results. Discwasher D-II not only cleaned the records but brought them back to their original state of high quality."

"On the grounds of the fantastic results, which can come about by using the Discwasher D-II, many will ask the question, 'IS IT WORTH 128 KRONER?' ... But it does exactly what it says it does and this is where all of the others fail."

"It pays for itself, and is highly recommended."

Excerpt from
STEREO SOUND
Summer, 1975 (Japan) Page 303

K. Yamanaka, "This is the record cleaner. It is really effective. We can now listen to our old records with new discoveries."



 **DISCWASHER**
COLUMBIA, MO 65201



The Micro Seiki DDX-1000.

The Problem.

Any cartridge is subject ultimately to your personal taste. That's why so many serious audiophiles own and regularly use more than one cartridge. But changing cartridges is really a major undertaking. Not any more.

The Solution.

The Micro Seiki DDX-1000. It will accept up to three high quality tonearms. No matter how cultivated and diversified your musical tastes are, the DDX-1000 will let you discern the subtlety of interplay between disc and cartridge, cartridge and tonearm.

A direct drive DC servo controlled motor drives the large, balance-tested platter at near perfect speed. Wow and flutter is an unprecedented 0.025%. Additionally, the neon strobe lamp is driven by an independent built-in 45Hz oscillator with a frequency fluctuation of less than 0.03%.

A unique 3-point aluminum alloy supporting frame and special shock mounting provide optimum stability. The two-layer absorber system (consisting of cushion rubber and insulator balls with built-in springs) eliminates any possibility of acoustic feedback. The completely isolated power supply/control unit eliminates hum and electrical noise. And micro-switches provide fast, exact operational control. The signal-to-noise ratio is greater than 63 dB.

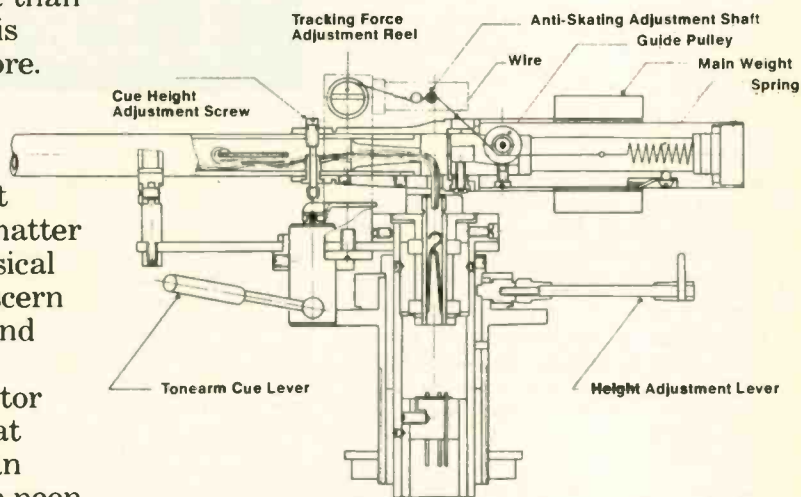
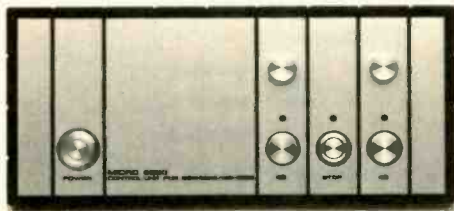

The MA-505.

Pictured is the Micro Seiki MA-505*, the first audiophile quality dynamic balance tonearm. Since it does not depend on gravity to maintain the proper tracking force, it will compensate better for surface and groove irregularities present in many mass produced discs. In addition, the stylus pressure may be adjusted while the disc is playing to assure the best possible reproduction.

*Not included with DDX-1000. Supplied without cartridge.

**The DDX-1000 and MA-505. Creative design.
Superior execution. The complete turntable system
for the most critically demanding audiophile.**

MICRO SEIKI

Distributed by TEAC Corporation of America, 7733 Telegraph Road, Montebello, California 90640 © TEAC 1976

reviewed by ROYAL S. BROWN

ABRAM CHIPMAN

R. D. DARRELL

PETER G. DAVIS

SHIRLEY FLEMING

ALFRED FRANKENSTEIN

KENNETH FURIE

HARRIS GOLDSMITH

DAVID HAMILTON

DALE S. HARRIS

PHILIP HART

PAUL HENRY LANG

ROBERT LONG

IRVING LOWENS

ROBERT C. MARSH

ROBERT P. MORGAN

CONRAD L. OSBORNE

ANDREW PORTER

H. C. ROBBINS LONDON

HAROLD A. RODGERS

PATRICK J. SMITH

SUSAN THIEMANN SOMMER



Alix B. Williamson

Kyung-Wha Chung—Bach—playing to make you sit up and listen

BACH: Sonatas and Partitas for Solo Violin (6), S. 1001–6. Yehudi Menuhin, violin. [Suvi Raj Grubb, prod.] ANGEL SC 3817, \$20.98 (three discs, automatic sequence).

Sonatas: No. 1, in G minor, S. 1001; No. 2, in A minor, S. 1003; No. 3, in C, S. 1005. Partitas: No. 1, in B minor, S. 1002; No. 2, in D minor, S. 1004; No. 3, in E, S. 1006.

BACH: Partita for Solo Violin, No. 2, in D minor, S. 1004; Sonata for Solo Violin, No. 3, in C, S. 1005. Kyung-Wha Chung, violin. [Christopher Raeburn, prod.] LONDON CS 6940, \$6.98.

Comparisons:

Milstein DG 2709 047
Szeryng Ods. 32 36 0013; DG 2709 028

The old pros can't keep away from the Bach unaccompanied sonatas: Milstein recently recorded them for the second time, and now Menuhin has done the same. Admirers of Menuhin's intelligence and integrity will be more than content with the results, for these are strong, sensitive performances, without evidence of the eccentricities or the technical problems that have sometimes marked the violinist's work. Interestingly enough, neither Milstein nor Menuhin seems to have undergone any radical change of attitude during the years that separate the first effort from the second; in Menuhin's case, certain movements are smoother in the old version, others are easier-sounding in the new. Both the Adagio and the Fugue of Sonata No. 3, for example, have more lift and breath in the early edition; but the early Largo, with heavier accents, becomes somewhat disjointed in comparison with the new.

In general—and this will come as no surprise to those who know the kind of violinist Menuhin is—these performances are not as elegant and effortless as the Milstein or Szeryng versions, but to dwell on this would be to present Menuhin in an unfair light. Certainly his playing is heavier-handed and somewhat more laborious than either of the others, and he does not always keep the unflinching rock-steady pulse that is so remarkable a feature of those sets. The

double stops of the Sarabande of Partita No. 1 detain him longer, and his tone is occasionally rough in chord work elsewhere. But the communicating power of the playing comes through, and the musical comprehension and logic are persuasive.

Angel's recorded sound is unduly fat and tubby, and the discs (in the initial pressing, at least) are mislabeled for manual sequence—the records are in automatic sequence.

While the old pros take on unaccompanied Bach for the second time, a new pro approaches it for the first, and with extraordinary results. Kyung-Wha Chung's Partita No. 2 and Sonata No. 3 carve out a commanding position for themselves, charged with a vitality and a youthful intensity that stand alone. She is a more poised fiddler than Menuhin and, in this recording, a warmer, more sonorous, less classical Bach player than Milstein. She isn't bashful about taking liberties—in even-note movements like the Allemande, for instance, she does not hesitate to distort the note patterns to make a musical point, and her unusually elastic use of dynamics verges on the fussy. But when greater rhythmic variety is built into the music, as in the Courante, she hews closer to the written page and proves that, when it comes to projecting rhythmic definition, no violinist in the solo-Bach catalogue can surpass her.

What makes Chung's work exceptional here is the attention to dynamics; she is enormously adept at creating dynamic plateaus, and in the Chaconne each variation seems to be played at its own special decibel level. She is also adept at bringing out melody lines, sometimes to almost exaggerated effect: In the arpeggio sections of the Chaconne she concentrates heavily on the bottom line, scarcely brushing over the arches of notes above it. She overdoes it a bit, but you certainly can't miss where the melody is. The Fugue of the sonata is never overdone, and the voices are beautifully highlighted. This is possibly the most vi-

brant version of the movement on records—the subject sings, there is life in every note.

Chung's technical capabilities seem limitless, and at one point—only one—she lets technique carry her away. The Allegro assai of the sonata takes off at the speed of a meteor, with accented notes fired off like pistol shots at point-blank range. It is panache carried to the point of arrogance. But this violinist's Bach-playing is something to make you sit up and listen, and I recommend that you do so. S.F.

BARBER: Quartet for Strings—See Ives: Quartet for Strings, No. 2.



BARTÓK: Music for Strings, Percussion, and Celesta; Dance Suite. Philharmonia Hungarica, Antal Dorati, cond. PHILIPS 6500 931, \$7.98.

Dorati knows this music as well as anyone, and he gives clear and warmly communicative readings of both works.



There are some idiosyncrasies that I find irritating, particularly in regard to tempos. For example, the many changes in pacing in the last movement of *Music for Strings, Percussion, and Celesta* are handled in a rather cavalier fashion. Not only are indi-

Explanation of symbols

Classical:

-  Budget
-  Historical
-  Reissue

Recorded tape:

-  Open Reel
-  8-Track Cartridge
-  Cassette

vidual tempos often at some distance from the markings in the score, but Dorati also makes sudden changes where none are indicated. And when sudden changes are indicated, he often prefers to bridge the gap by gradually accelerating or retarding from one tempo to the next. Nevertheless, there are many nice moments, and the orchestra, with some minor exceptions, plays well. But on the whole I am more comfortable with the much tighter readings of Solti (the Music on CS 6783 with the *Miraculous Mandarin Suite*, the *Dance Suite* on CS 6784 with the *Concerto for Orchestra*).

R.P.M.

BEETHOVEN: Concertos: for Violin and Orchestra; for Violin, Cello, Piano, and Orchestra. Sonatas: for Violin and Piano; for Cello and Piano. For an essay review, see page 94.

BEETHOVEN: Sonatas for Piano: No. 8, in C minor, Op. 13 (*Pathétique*); No. 21, in C, Op. 53 (*Waldstein*); No. 26, in E flat, Op. 81a (*Lebewohl*). Vladimir Ashkenazy, piano. [Ray Minshull, prod.] LONDON CS 6921, \$6.98.

Pianistically these are brilliant performances. Musically they represent a kind of middle-of-the-road, unrheterical good sense, an over-all honesty commonly characteristic of Ashkenazy's art. Yet, particularly in relation to his recent couplings of Op. 10, No. 3, and Op. 57 (CS 6821) and Opp. 110 and 111 (CS 6843), this is a disappointing disc.

Surprisingly, given Ashkenazy's customary textual scrupulousness, his *Waldstein* contains a number of dubious details: octave amplifications in the bass; an unfortunately halfhearted solution to Beethoven's controversial—and in my opinion often unjustly unheeded—pedal indications in the finale; a rather generalized appreciation of inner-voice sforzandos and the like in the Adagio *introduzione*. But even more important, this is a somewhat sectionalized, only intermittently propelled rendering of a work that is best launched as a single thrusting entity. Brendel's recent re-recording (Philips 6500 762, August 1976) is more strongly characterized.

The *Pathétique* fares better but offers no particular revelations. Ashkenazy takes the first-movement allegro very briskly, and his left-hand octaves "beat" perfectly in time with his right hand. The Adagio cantabile is genial enough, although I have heard some of the bridge passages treated in a more vocal, declamatory way. Similarly the rondo: It is sturdy and accurate, but lacking the poignant charm it can have. Though the *Lebewohl's* first movement proper and scurrying finale are brilliantly done, the first-movement introduction and the second movement don't quite lead the listener from note to note, phrase to phrase, modulation to modulation with the rapt authority of the greatest performances.

This is honest re-creation, yet it doesn't even approach Ashkenazy's present-day best. Good, clearly defined, but not particularly alluring piano sound. H.G.

BERLIOZ: Harold in Italy, Op. 16. Nobuko Imai, viola; London Symphony Orchestra, Colin Davis, cond. PHILIPS 9500 026, \$7.98. Tape: ●● 7300 441, \$7.95.

Comparisons:
Cooley, Toscanini/NBC Sym. (1953) AT 112
Menuhin, Davis/Philharmonia Ang. S 36123

It may be terribly naive and old-fashioned of me to believe—in this era of omnipotent producers, multiple channels, and clever (or sometimes not so clever) mixing and mastering—that orchestral balance and clarity begin at the conductor's desk. But my continued preference for the 1953 Cooley/Toscanini *Harold in Italy* among commercial recordings rests partly on its subsequently unmatched combination of impact, delicacy, and clarity. For that matter, even in the cramped, restricted 8H sonics of Toscanini's incandescent 1939 broadcast performance with Primrose, important instrumental details and balances are clearly registered; in fact, the *ppp possibile* of the first movement—played with superhuman delicacy by Primrose (and the accompanying harp and clarinets)—sounds more magical in that primitive broadcast transcription than on any "modern" recording.

Beyond Toscanini's sheer technical control, of course, is his intuitive understanding of Berlioz' unique mixture of

flaming introversion and disciplined boisterousness. Colin Davis, recording his second *Harold*, once again tries to project the music's poetry and classicism as well as its drama, and once again he falls short. He has altered his interpretation since his Angel recording with Menuhin, and most of the alterations are improvements. The Allegro of the first movement now swings in rollicking, forthright manner; the quicker final "Orgie des brigands" conveys much more of the requisite abruptness and ferocity.

Other sections, however, remain tepidly characterized. The first-movement introduction is well paced but genteel (or, put more bluntly, aimless); the "Pilgrims' March" is drab rather than introverted. Most disappointing of all is the third-movement "Serenade of an Abruzzi mountaineer to his sweetheart." Both Mehta (London CS 6951, April 1976) and Toscanini give the Allegro assai introduction in swinging, lusty, broadly accented fashion, and Toscanini in particular carries that impetus into the ensuing Allegretto. Those conductors keep the mountaineer's objective plainly in sight, and the succinct *ppp* viola solo at the end (so beautifully managed by both Cooley and Primrose in the Toscanini performances) makes clear that he has won his suit. Davis, by contrast, lacks both persistence and passion. Soloist Nobuko Imai tries

Critics' The best classical records
Choice reviewed in recent months

- BACH:** Cantatas, Vol. 14 (Nos. 51, 52, 54–56). Leonhardt. TELEFUNKEN 26.35304 (2), Aug.
- BACH:** Motets (6), S. 225–30. Halsey. OISEAU-LYRE SOL 340/1, (2), July.
- BEETHOVEN:** Sonatas Nos. 31, 32. Graffman. COLUMBIA M 33890, Sept.
- BEETHOVEN:** Symphonies (9). Kempe. SERAPHIM SIH 6093 (8), Aug.
- BRAHMS:** Choral Works. Andqr. HUNGAROTON SLPX 11691, Aug.
- BRAHMS:** Haydn Variations. **ELGAR:** Enigma Variations. Jochum. DEUTSCHE GRAMMOPHON 2530 586, Aug.
- DUKAS:** Symphony; Sorcerer's Apprentice. Weller. LONDON CS 6995, Sept.
- FALLA:** Three-Cornered Hat (complete); Harpsichord Concerto. DeGaetani; Kipnis; Boulez. COLUMBIA M 33970, Aug.
- GOUNOD:** Faust. **BERLIOZ:** Damnation of Faust (excerpts). Busser; Coppola. CLUB 99 OP 1000 (3), July.
- HANDEL:** Messiah. Leppard. RCA RED SEAL CRL 3-1426 (3), Sept.
- HAYDN:** La Fedeltà premiata. Dorati. PHILIPS 6707 028, June.
- IVES:** Songs. DeGaetani, Kalish. NONESUCH H 71325, Aug.
- MOZART:** Canons and Songs. Berlin Soloists, Knothe. PHILIPS 6500 917, Sept.
- PROKOFIEV:** Sonata in F minor. **JANÁČEK:** Sonata, Op. 21. Oistrakh; Bauer. WESTMINSTER GOLD WGM 8292, Aug.
- RESPIGHI:** Ancient Airs and Dances, Suites 1–3. Marriner. ANGEL S 37301, July.
- SCARLATTI, A.:** Madrigals. Jürgens. ARCHIV 2533 300, Aug.
- SCHUBERT:** String Quartets, Nos. 1–15; Quartettsatz. Melos. DEUTSCHE GRAMMOPHON 2740 123 (7), July.
- SCHUBERT:** String Quartets, Nos. 9, 13. Berg. TELEFUNKEN 6.41882, Aug.
- STRAUSS, J.:** Waltzes. Fiedler. LONDON PHASE-4 SPC 21144, Aug.
- STRAVINSKY:** Oedipus Rex. Cocteau, Stravinsky. ODYSSEY Y 33789, Sept.
- TCHAIKOVSKY:** Songs. Vishnevskaya, Rostropovich. ANGEL S 37166, Sept.
- VERDI:** Il Corsaro. Gardelli. PHILIPS 6700 098 (2), Sept.
- VERDI:** Luisa Miller. Maag. LONDON OSA 13114 (3), Sept.
- VIVALDI:** Gloria, Kyrie, Credo. Corboz. RCA GOLD SEAL AGL 1-1340 Aug.
- WAGNER:** Die Meistersinger. Furtwängler. EMI ODEON 1C 181 01797/801 (5), Sept.
- WALTON:** Facade. Randall, Fiedler. COLUMBIA M 33980, Sept.
- AMERICAN SINGS, VOLS. 1–2.** Gregg Smith Singers. Vox SVBX 5305 (3), 5304 (3), July.
- EARLY MUSIC QUARTET:** Music of the Minstrels. TELEFUNKEN 6.41928, July.
-

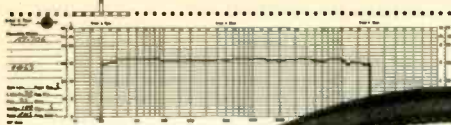

**MODEL AT-706
electret condenser
headphones**
20 to 22,000 Hz \pm 2 dB*

**"...this is
nothing
short of
incredible."**

— LEN FELDMAN

*Mr. Feldman, reporting in *Tape Deck Quarterly*, Spring, 1975 noted that the AT-706 response varied no more than \pm 2 dB from 20 to 22,000 Hz. He also stated, "What we heard corresponded with what we had plotted..." Hear the incredible new AT-706 headphones at Audio-Technica dealers everywhere.



audio-technica.

AUDIO-TECHNICA U.S., INC., Dept. 106H, 33 Shiawassee Ave., Fairlawn, Ohio 44313
Available in Canada from Superlor Electronics, Inc.

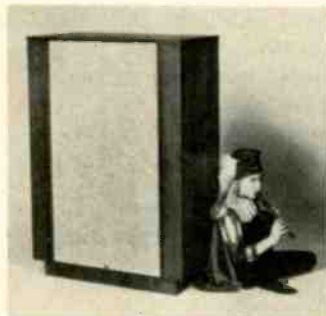

Bozak

for the discriminating

For more than a quarter century, the most knowledgeable musicians and audio engineers alike have looked to Bozak to establish the standards for realistic reproduction. We regard it as a sacred trust that this integrity of product shall continue to be our hallmark.

Our consumer products catalog is available at no cost.



BOZAK, Inc.
P.O. Box 1166
Darien, Connecticut 06820



Loudspeakers • Mixer/Preamplifiers • Amplifiers

valiantly, but vainly, to raise the emotional temperature of the performance.

The solo contribution does, however, deserve a special word of praise. By any standard but the sui generis 1939 Primrose performance, this is playing of the greatest refinement, tonal chiaroscuro, and distinctive musicianship—compare Menuhin's absurd affectation on the earlier Davis recording. The viola here is also heard in correct perspective: as a prominent obbligato rather than a spotlighted main attraction—compare the worst-case Trampler/Prêtre/RCA edition. Otherwise, though, I am not happy with the sound, whose distant perspective makes it hard to gain meaningful contact with the performance. The light, feathery string passages almost disappear, and the rambunctious tuttis are diminished by too much resonance.

For poetry, passionate intensity, and sheer incandescence, no commercial recording of *Harold* has come within hailing distance of the 1939 Toscanini performance. But the 1953 recording, the subtlest and most fiery we have had, is available (in an excellent German pressing, imported by German News), and on it you will hear at least as much detail as—and far more of the music than—in any other version. Perhaps Karajan and the Berlin Philharmonic can be persuaded to have a go at this score; a recording comparable to their superb recent *Symphonie fantastique* (DG 2530 597, February 1976) could be the *Harold* we have been waiting for.

H.G.

CHOPIN: Concertos for Piano and Orchestra: No. 1, in E minor, Op. 11*; No. 2, in F minor, Op. 21*. Fantasy on Polish Airs, Op. 13.† Krakowiak, Op. 14.* Garrick Ohlsson, piano; Polish Radio Symphony Orchestra, Jerzy Maksymiuk, cond. [David Mottley, prod.] ANGEL S 37179* and S 37180*, \$6.98 each SQ-encoded disc.

The encouraging direction noted in Garrick Ohlsson's recent Liszt recordings (April and May 1976) is fortunately again much in evidence here. In fact, it can be dramatically measured by comparing this fluent account of the E minor Concerto with the prizewinning "live" Warsaw competition performance, issued on Connoisseur Society CS 2030. The new performance is much more resourceful and flexible in its personalized phrasing, more cushioned and sophisticated in terms of legato and textural variety.

The account of the F minor Concerto is if anything even more enjoyable. The young conductor Jerzy Maksymiuk makes a real contribution with precise shaping of phrases (except at one fleeting instant in the third movement) and cultivated molding of woodwind solos. The *Polish Fantasy* is played with grace and brio, but the lovely *Krakowiak* rondo, done with lots of efficiency, forward pressure, and a slightly large, unrhythmic orchestra, doesn't capture the charming, folkish appeal I recall in the deleted DG interpretation of Stefan Askenase and Willem van Otterloo.

H.G.

B DEBUSSY: Etudes. Paul Jacobs, piano. [Marc J. Aubort and Joanna Nickrenz, prod.] NONESUCH H 71322, \$3.96.

Creative Technology!

The MXR StereoGraphic Equalizer

The Technical Equalizer

The primary function of the MXR StereoGraphic Equalizer is to provide precise compensation for aural tone quality discrepancies that may be caused by room acoustics, speaker inadequacies, or program source quality.

The MXR Equalizer is a 2-channel frequency equalizer that offers 10 bands of discrete adjustment on each channel. Nominal center frequencies are: 31hz, 62hz, 125hz, 250hz, 500hz, 1khz, 2khz, 4khz, 8khz, and 16khz. Each of these octave bands may be cut or boosted independently to plus or minus 12 decibels by using the slide controls. The MXR StereoGraphic Equalizer features a bypass switch which enables the user to switch the equalization in and out of the signal path for instant source comparison. The unit has an internal power supply and is designed to work into output loads of 600 ohms or higher. These input and output characteristics make the MXR StereoGraphic Equalizer compatible with any stereo Hi-Fi equipment.

The Creative Equalizer

Become creative with the MXR StereoGraphic Equalizer whether you want to decrease the "boomy" mid-bass sounds or increase the deep-bass sounds, decrease nasality, harshness or shrillness or move the sound source closer or further away, it's all at the touch of a slide control. Tailor your playback to suit any number of variables and develop the mood you want to hear.

The MXR StereoGraphic Equalizer is compact, stylish and handsomely packaged in brushed aluminum with walnut side panels. Its design and circuitry will complement any modern Hi-Fi system at the attractive price of \$199.95. At MXR, we combine engineering excellence and creativity to provide you with superior products. For more information see your nearest MXR dealer or direct inquiries to MXR, 277 N. Goodman St., Rochester, New York 14607, (716) 442-5320.



MXR

Consumer
Products Group

You can study the glowing consumer reports in your favorite hi-fi magazine. Objective, informative, helpful.

You can talk with knowledgeable owners who often talk of little else. Subjective, enthusiastic, convincing.

But it isn't until you actually listen to an Avid speaker system for yourself that you learn why they have won such unprecedented critical acclaim.

Only then can you sense the superb



design, engineering, and craftsmanship that have made Avid the most accurate speakers in their price range.

Only then, in light of your own listening pleasure, can you understand why Avid speakers can be your best buy.

That's why we invite you to audition one or more of the fine selection of Avid speaker systems at your Avid dealer. Be an Avid listener.

Avid.

The most widely acclaimed new line of hi-fidelity speakers.

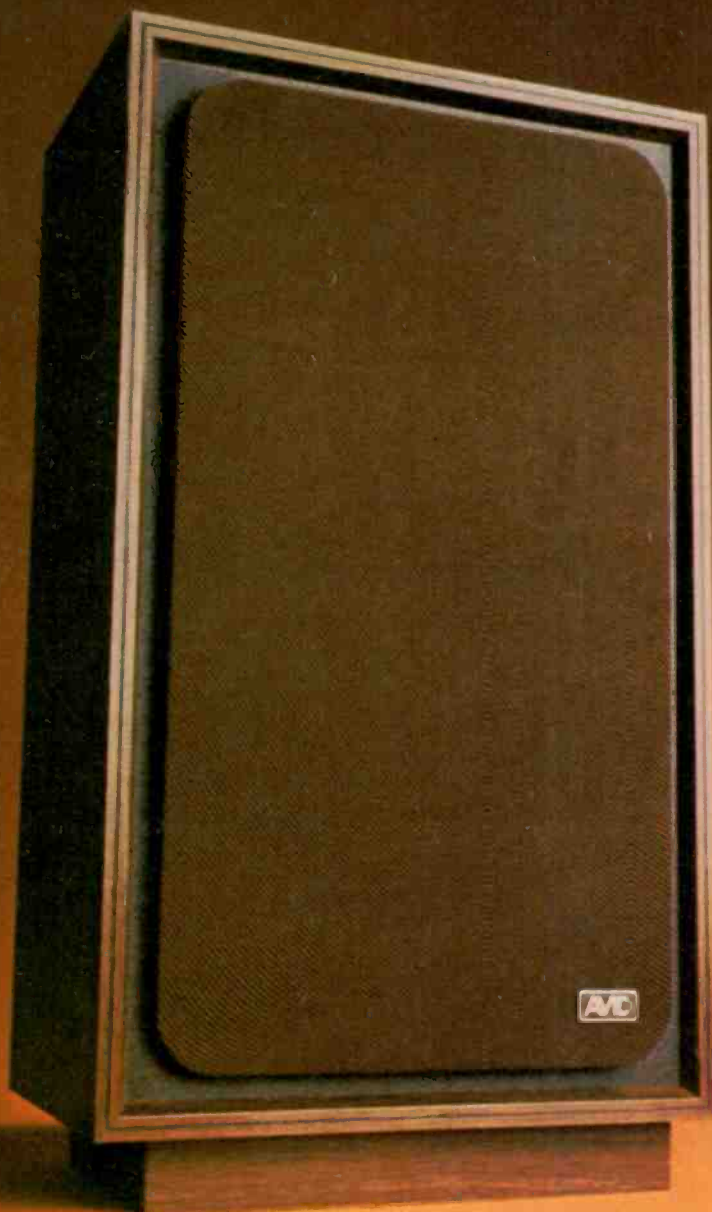

AVID.

CIRCLE 7 ON READER-SERVICE CARD

Avid Corp., 10 Tripps Lane, E. Prov., R.I. 02914. Distributed in Canada by: Kairon Electronics, Montreal, Quebec.

ADVERTISING INDEX

Key No.	Page No.
1	ABC Records.....117
64	Acoustiphase.....132
2	ADC Professional Products Group A division of BSR (USA) Ltd.....30
	Advent Corp.....112
3	AIWA.....61
	Akai America Ltd.....69
4	Altec.....50, 51
5	Allison Acoustics Inc.....114
62	Ampex Corp.....133
6	Angel Records.....116
	Audio Technica U.S., Inc.....34, 104
7	Avid Corp.....106
9	Bang & Olufsen of America.....85
10	Bang & Olufson of America.....124
	Bose Corp.....125
	Bozak, Inc.....104
34	British Industries.....5
8	British Industries.....39
16	BSR (USA) Ltd.....25
11	Carston Studio.....139
	Component Discounters.....134
	Classified Ads.....143-145
12	Crown International.....130
13	DBX, Inc.....104
14	Discount Music Club.....140
	Discwasher.....99
	Dixie Hi-Fidelity.....134
15	Dokorder.....135
	Dolby Laboratories, Inc.....35
17	Dual.....14, 15, 16
65	Dynaco, Inc.....49
66 67	Electro-Voice Inc.....126, 127
	Elpa Marketing Industries, Inc.....13
19	Empire Scientific Corp.....52
20	Frazier, Inc.....48
21	Fuji Photo Film U.S.A. Inc. Magnetic Tape Division.....46
	Harman-Kardon, Inc.....22, 23
22	Heath Co.....118
23	Hitachi Sales Corp. of America.....6, 7
24	Icelandic Airlines.....139
25	Illinois Audio.....134
26	International Hi-Fi Distributors.....146
30	Kenwood.....Cover IV
27	Klipsch & Assoc. Inc.....110
28	Koss Corp.....24
29	Lafayette Radio Electronics.....41
	Lansing, James B., Sound, Inc.....129
	Lux Audio of America Ltd.....37
	Marantz Co.....148, Cover III
31	Maxell Corp. of America.....19
32	McIntosh Laboratory.....109
33	Memorex Corp.....8
60	Mitsubishi Speaker Systems.....142
	Music Listener's Book Service.....124, 141
	Musical Heritage Society.....119
35	MXR Innovations, Inc.....105
36	National Record Plan.....115
37	Neosonic Corp.....109
38	Nikko Electric Co.....128
39	Ohm Acoustics.....18
40	Olympus Corp. of America.....122
41	Phase Linear Corp.....138
42	Pickering & Co., Inc.....2
43	Pioneer High Fidelity.....Cover II, 1
44	Pioneer Electronics.....123
63	Presage Corp.....31
	Radio Shack.....21
45	RCA Records.....113
46	RTR Industries.....20
47	SAE, Inc.....12
48	Sansui Electronic Corp.....74-77
49	Sherwood Electronic Laboratories.....32, 33
50	Shure Brothers, Inc.....27
51	Shure Brothers, Inc.....121
53	Sony Corp.....28, 29
54	Sound Reproduction.....140
	Speakerlab.....146
52	Spectro Acoustics, Inc.....120
55	Stereo Corp. of America.....146
56	Superex Electronics Corp.....131
	TDK Electronics.....111
	Teac Corp. of America.....100, 101
	3M Company.....45
	Time/Life Records.....9, 9A, 9B, 10, 11
57	Top Discount Audio.....146
58	Ultralinear Products.....141
17	United Audio Products.....14, 15, 16
61	Vor Industries.....128
34	Venturi.....5
	Wyeth Press.....59
59	Yamaha International Corp.....62

As Paul Jacobs points out in his splendid annotations, Debussy composed these etudes in a last Indian-summer flush of creativity. After their completion (they date from August and September 1915), little more was to come from the already mortally ill composer, who died of cancer in 1918 at age fifty-six. The etudes, then, represent "late Debussy," a style—witty, modernistic, spare, even a shade cerebral—far removed from the popular "Clair de lune" Impressionism that has won the composer most of his fame. That partially explains the etudes' relative obscurity, although it should be noted that the music can be made to sound surprisingly accessible when treated "impressionistically," as witness Anthony di Bonaventura's excellent recent account for Connoisseur Society (November 1975).

Jacobs' performances immediately command attention and respect for their probity and unaffected directness. One cannot say that they are better or worse than Di Bonaventura's, for the two pianists' aesthetic responses (mirrored in the engineering) are so totally dissimilar. Di Bonaventura, heard rather distantly in resonant surroundings, goes all out for a kind of patrician charm and rippling symmetry. This approach stresses the kinship between the opening of the first etude and the whimsical, sophisticated world of *Children's Corner*. Jacobs, too, has a great deal of whimsy, but his bolder, more directly visceral approach, coupled with a full-bodied, proximate pickup, gives the material more toughness and impact. For all the clarity and wonderful linear thrust, Jacobs is not in the least inattentive to color values and atmospheric niceties. He pedals resourcefully, never out of convenience, for his fingerwork is as brilliantly virtuosic as that of any pianist who has recorded these difficult works. Though quite different in detail, Jacobs' version recalls the taut assurance and textural acerbity of Charles Rosen's deleted Epic account.

In short, a wonderful disc. H.G.

B **HANDEL:** Concerti grossi (12), Op. 6. Southwest German Chamber Orchestra, Paul Angerer, cond. Vox QSVBX 558, \$10.98 (three QS-encoded discs).

There are a few genuine bargains; this is one of them. Angerer is well versed in the style, and his fine orchestra is well recorded. These performances may not displace Karl Richter's for Archiv (at nearly three times the cost), but for most record buyers the Vox set will prove equally acceptable, and Angerer's readings actually have the greater vitality.

This is the Italianate Handel (though Op. 6 dates from 1739, by which time the composer, in his mid-fifties, had been resident in London for more than two decades), looking backward to Corelli, but in fact writing music with a vigor, variety of content, range of expression, and dramatic force that that master could match only in his finest moments. The sheer force of the sustained Handelian lyricism in these works is quite astonishing. When it comes

FREE McIntosh CATALOG and FM DIRECTORY

Get all the newest and latest information on the new McIntosh Solid State equipment in the McIntosh catalog. In addition you will receive an FM station directory that covers all of North America.



MX 113

FM/FM STEREO - AM TUNER AND PREAMPLIFIER

SEND TODAY!

McIntosh Laboratory, Inc.
East Side Station P.O. Box 96
Binghamton, N.Y. 13904

NAME _____
ADDRESS _____
CITY _____ STATE _____ ZIP _____

If you are in a hurry for your catalog please send the coupon to McIntosh.
For non rush service send the *Reader Service Card* to the magazine.

CIRCLE 32 ON READER-SERVICE CARD

Face the music

You always face the music with Sonosphere-Plus because its top-mounted speaker can be rotated in any direction or placed away from the woofer. It's the only system that fully uses the directional characteristics of mid and high frequency sound. Gives you true stereo effect wherever you are in the room.

The woofer produces non-

directional lower frequencies smoothly, without distortion, using the dual bass reflex principles; blends with the top-mounted Sonosphere for a frequency range below 50 to 16,000 Hz. Handles 25 watts RMS (40 watts music).

Face it, it's what you've been looking for. Write for the location of your nearest dealer.

Dimensions 4 1/2" h x 12 1/2" w x 7 3/4" d

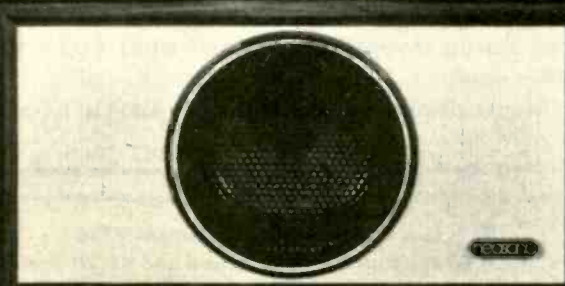

SPW-25

sonosphere® plus
NEOSONIC Corporation of America 180 Miller Place Hicksville, N.Y. 11801

Exclusive U.S. distributor of Sonosphere home & auto speakers

CIRCLE 37 ON READER-SERVICE CARD

at you from four speakers with the fine sense of surround this set provides, the unique pleasures of the late baroque style are bountifully placed before you. For \$10.98, you can hardly resist. R.C.M.

IVES: Quartet for Strings, No. 2; Scherzo for String Quartet. **BARBER:** Quartet for Strings, in B minor, Op. 11. Cleveland Quartet. [Jay David Saks, prod.] RCA RED SEAL ARL 1-1599, \$6.98. Quadriphonic: ARD 1-1599 (Quadradisc), \$7.98.

It would be nice to be able to report that the outer sections of Samuel Barber's 1936 String Quartet are worthy of the famous Adagio second movement. Unfortunately,

this is not the case. In spite of some rather Beethovenish energy and an attractive snippet here and there, the first movement comes on basically as a choppy mishmash of pedestrian rhythmic figures and surprisingly ordinary (for Barber) themes, while the final movement, which follows the Adagio without pause, does little but restate this material in an even more perfunctory manner. In this setting, the gloriously flowing, long-phrased, and decidedly melancholic Adagio stands out even more strongly for the masterpiece it is. It is certainly worth hearing in its original version, particularly as performed by the Cleveland Quartet, whose members have sensitively fathomed the expressivity of this twentieth-century Romanticism, adding to

their interpretive finesse a well-nigh perfect blending of string sonority.

The string quartet was an especially propitious medium for Charles Ives, who certainly took stronger advantage of the independence of the four instruments than any composer before him. Written at the beginning of this century (1911-13), his Second Quartet is filled with staggeringly rich textures that continue to reveal new facets even after many hearings. Furthermore it shows at certain points (such as the opening of the first movement, with its wide melodic leaps and its near atonality) interesting parallels with Schoenberg; even when Ives indulges in his characteristic quotations from American folk material, it should be remembered that Schoenberg was not alien to such devices, as is proved by the "Ach du Lieber, Augustine" tidbit that creeps into his Second String Quartet.

Especially in the second movement, entitled "Arguments," Ives's quartet also contains a fair amount of purely American iconoclastic humor that cannot be fully appreciated without the score, which contains such indications as "Andante con scratchy" (as tuning up) and "Allegro con fistiswatto" (as in K.O.). The composer had strong ideas on "masculine" music, and in "Arguments" a gooey, excessively "pretty" theme, complete with soupy portamento, is entitled "Andante emasculata"! In the Second Quartet, as in the brief Scherzo for string quartet finished a year later, this point-proving virility can become oppressive at times. But the originality is so dazzling, the humor so infectious, and, on occasion, the expressive content so deeply moving that the listener should be more than willing to tolerate the excesses.

To my mind, the Cleveland Quartet gives a definitive performance of the Ives works. The remarkable precision of its ensemble playing (and there are few moments in either piece where all the instruments are not performing at once) is put to the service of an energetic, vibrantly sonorous, and invariably "right" interpretation. The musicians also accomplish the exceptionally difficult feat of maintaining the independence of the simultaneously played, usually strongly contrasting individual lines, while at the same time creating a unified sound that is pure Ives. And as in the Barber quartet, the timbre blending is truly impressive.

To this must be added the excellence of the recorded sound. Besides obtaining realistic, clear reproduction of the performances, producer Jay David Saks has miked the instruments in such a way that an exciting sense of movement, obviously inherent in the Ives scores, is frequently communicated, giving the listener an almost concrete impression of the musical space defined by the playing. R.S.B.

In quad: At first hearing, this disc gives the impression that the quartet has disposed itself at the four points of the compass in a misguided and futile attempt to surround the audience, but after a little tinkering with balance and level control one finds oneself right in the center of a group of musicians playing in a room that is just a little too reverberant. The effect may unsettle a concertgoer but grows on one with time.

The quad sound is audibly undistorted,

You Already Own Important Parts of a Fine Stereo System — Your Room Corners

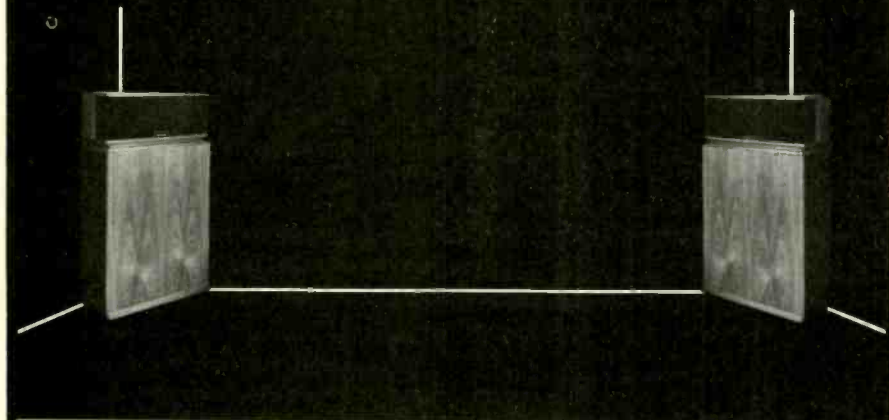

When **KLIPSCHORN**® loudspeakers are placed in them, they become final flares of the giant bass horns. They make it possible to move the huge amounts of air required to reproduce honest contra bass. You might approach that with a wall of "acoustic suspension" speakers and their flopping cones. But the distortion would be unbearable.

So Klipsch designed the **KLIPSCHORN** that puts your room corners to work. The **KLIPSCHORN** doesn't have to labor to reproduce the full range. And horn loading leaves it virtually free from distortion. That's been true ever since it was designed by Paul Klipsch over thirty-five years ago. It will still be true over thirty-five years from now. That's why the **KLIPSCHORN** can be your best stereo investment, priced from \$675 to \$1040. Hear it at your dealer's.

Send this coupon for information on all Klipsch loudspeakers.

klipsch

P.O. Box 688 H-10, Hope, Arkansas 71801

Please send me your latest brochure and list of dealers.

Name _____

Address _____

City _____ State _____ Zip _____



In Canada: Superior Electronics, Inc.

Plywood construction.

CIRCLE 27 ON READER-SERVICE CARD

TDK SA. WE DEFY ANYONE TO MATCH OUR VITAL STATISTICS.

Manufacturer	Brand	MAGAZINE A		MAGAZINE B	
		S/N Ratio Weighted in dB	Output @ 3% THD	S/N in dB (re: 3% THD)	THD at 0 dB (%)
TDK	SA	66.5	+4.2	66.0	0.9
AMPEX	20:20+	56.4	+1.9	—	—
FUJI	FX	60.0	+2.3	—	—
MAXELL	UD	—	—	58.5	1.1
MAXELL	UDXL	62.5	+2.7	—	—
NAKAMICHI	EX	60.0	+2.3	55.0	1.1
SCOTCH	CHROME	—	—	64.0	1.3
SCOTCH	CLASSIC	62.5	+2.0	—	—
SONY	FERRICHROME	64.0	+2.1	64.0	1.8

Decks used for tests: Magazine A, Pioneer CT-F9191 (cross-checked on DUAL 901, TEAC 450); Magazine B, NAKAMICHI 1000.

Two leading hi-fi magazines working independently tested a wide variety of cassettes. In both tests, TDK SA clearly outperformed the other premium priced cassettes.

The statistics speak for themselves. TDK SA provides a greater S/N ratio (66.5 dB weighted and 66.0 dB @ 3% THD), greater output sensitivity (+4.2 dB @ 3% THD), and less distortion (THD 0.9%) than these tapes.

When you convert these statistics into sound, TDK SA allows you to play back more of the original signal with less distortion and noise.

Put these facts and figures together and TDK SA adds up to the State of the Art because it provides greater dynamic range. This means cleaner, clearer, crisper recordings, plain and simple. Sound for sound, there isn't a cassette that can match its vital statistics.

Statistics may be the gospel of the audiophile, but the ultimate judge is your own ear. Record a piece of music with the tape you're using now. Then record that same music at the same levels using TDK SA. You'll hear why TDK SA defies anyone to match its sound.

Or its vital statistics.

TDK Electronics Corp., 755 Eastgate Boulevard, Garden City, New York 11530. Also available in Canada.



 **TDK**®

Wait till you hear what you've been missing.

*(You Can Spend Two or Three or
Four Times As Much And Not Do Better.)*

The Advent Loudspeaker.



According to the best information we have, from magazine surveys and other sources, the Advent Loudspeaker is the best-selling speaker system in the United States—as it has been for the past three years.

We think the reason is that it offers the highest level of audibly useful speaker performance at a fraction of the usual cost.* Its usable frequency range is as wide as any speaker's (with bass response that is not only unsurpassed but mostly unapproached). Its distortion is very low at all listening levels likely to be tolerable in a home. And its musical balance is convincing with any kind of music or recording technique.

If you listen to speakers on a wide range of musical material before you buy, so that you can gauge the kind of satisfaction you might get in day-after-day listening to different kinds of music and recordings, we think you won't easily find a reason to spend more money on a loudspeaker.

For more information on the Advent Loudspeaker, please send us the coupon.

Thank you.

To: Advent Corporation, 195 Albany Street, Cambridge, MA 02139

Please send more information on the Advent Loudspeaker and a list of Advent dealers.

Name _____ Address _____

City _____ State _____ Zip _____

Advent Corporation,

195 Albany Street, Cambridge, Massachusetts 02139

*The suggested price of the Advent Loudspeaker, subject to change without notice, ranges from \$121 to \$149, depending on cabinet finish and where it has been shipped. The cabinet shown is finished in genuine walnut veneer.

with just a smidgen of hiss—provided that a really good demodulator is used. The exposed texture of a string quartet is very intolerant of demodulator error. The wide setting of the players weakens the feeling of intimacy somewhat (how do they manage to stay together?), but the details of the music seem to be all there (along with some very loud breathing from the first violinist). All in all, though, a good job. H.A.R.

B **Khachaturian:** Concerto for Violin and Orchestra, in D minor—arr.
R Rampal for flute and orchestra. Jean-Pierre Rampal, flute; Orchestre National de l'ORTF, Jean Martinon, cond. ODYSSEY Y 33906, \$3.98 [from MUSICAL HERITAGE MHS 1186, 1972].

Comparison—orig. version:
Oistrakh, Khachaturian

Mel./Ang. SR 40002

I missed the Musical Heritage Society's first release of this extraordinary Erato recording, so I was quite unprepared for its revelations of both consummate flute virtuosity and unexpected musical delights. In the concerto's original form, I'd always considered it a dazzling display of fiddling showmanship, but—even (or especially) as played by its dedicatee, David Oistrakh, with the composer conducting—too uninhibitedly theatrical for repeated home enjoyment. But Khachaturian and Rampal knew something I'd never suspected: that, unlikely as it might seem at first, this music not only could be readily adapted for a flute soloist (as Rampal did in 1968, twenty-eight years after the violin version's composition), but would achieve entirely new charm in the metamorphosis.

I wonder if even the great Rampal has the superhuman endurance to play in concert what must be the longest as well as probably the most difficult of all flute concertos. Even with the rest intervals available in recording sessions, he has to meet unconscionable demands. Yet he makes everything sound (well, almost) easy, while at the same time bringing to the music's originally somewhat too facile exoticism and gypsy fervor (both italicized by Oistrakh) a cooler, more restrained lyrical grace. I find his characteristic objectivity, which in other repertoires sometimes seems to be the only Rampal quality one can criticize adversely, actually highly advantageous here.

For full good measure, Rampal's superb executant skills are properly supported by Martinon's tautly controlled, well-balanced accompaniment, and both soloist and orchestra are cleanly if not exceptionally vividly recorded. Even regardless of a budget price, this recorded performance is a unique documentation of technical bravura and magnetic music-making not to be missed. R.D.D.

Liszt: Hungarian Rhapsodies Nos. 1–16, 19. György Cziffra, piano. [Eric Macleod, prod.] CONNOISSEUR SOCIETY CS 2097 (Nos. 1–6), CS 2098 (Nos. 7–12), and CS 2099 (Nos. 13–16, 19), \$6.98 each.

The Hungarian Cziffra is reputed to have some gypsy blood, which translates into musical terms in a certain interpretive un-

RCA RED SEAL ANNOUNCES ITS MOST IMPORTANT MUSICAL EVENT IN OVER TWO DECADES.

THE HISTORIC RETURN OF VLADIMIR HOROWITZ.



ARLI-1766

His brilliant recording career began on RCA Records forty years ago. Now after a long absence, the unique Vladimir Horowitz returns to RCA Red Seal on a stunning new release featuring two of his most prized live performances, never recorded by him before.

The historic return of Vladimir Horowitz to Red Seal. A musical event of spectacular proportions.

RCA

RED SEAL
Where artists become legends.



CIRCLE 45 ON READER-SERVICE CARD

ALLISON: THREE



\$260†

The ALLISON:THREE is a corner speaker system with performance characteristics identical to those of the ALLISON:ONE. Its price is \$100 less.

Extremely wide dispersion at all audible frequencies makes it useful in a wide variety of applications. A pair can be used as main speakers in corners at opposite ends of a wall, with spacing considerably greater than is common for stereo speakers. Integrity of the stereo image will be maintained even when the angle from a listener to the two speaker systems is very wide.

Alternatively, one ALLISON:THREE can be used as a main stereo speaker system with an ALLISON:ONE or an ALLISON:TWO as the other main speaker. This is an excellent combination for cases in which there is inadequate free wall space available for a pair of ONE or TWO systems, or in which the main listening area is displaced to one side of a room.

Finally, ALLISON:THREE systems have unique advantages as back speakers in four-channel and ambience-synthesis systems of all kinds. Back corners are the best locations for such speakers because they are the farthest possible distance from the listening area. ALLISON:THREE systems have flat bass power output in a corner location, a capability shared only by corner horn systems.

Descriptive literature on all ALLISON speaker systems, which contains technical specifications and a statement of warranty, is available on request.

ALLISON ACOUSTICS INC.

7 Tech Circle, Natick, Massachusetts 01760

†higher in the South and West

CIRCLE 5 ON READER-SERVICE CARD

predictability (or, less euphemistically, willfulness). His treatment of rhythm, particularly in the flamboyant fast sections, tends toward capricious leeway, an alternation of anticipation and holding back. Then too, he often places teasing accents at strategic points and employs sudden dynamic contrasts for dramatic effect.

If there is any repertory where such practices are accepted, even beneficial, this is it. There are other ways of treating this material—for example, Arrau's thoughtful, lyrical accounts of Nos. 8-11 and 13 (Desmar DSM 1003) or Michele Campanella's basically patrician way with the entire set (Philips 6747 108). But Cziffra does striking work here, more than justifying his long-standing reputation as a Lisztian. His slow introductions are highly refined in sound and color, and his freewheeling treatment of the text (he spices up passagework in No. 19, a piece that Horowitz also elaborated, and considerably lengthens the cadenzas of No. 16) is sanctioned by both precedent and the composer's directions. Only occasionally do climaxes verge on hectoring brittleness and lack of repose. Most often, Cziffra offers exciting, communicative pianism.

Cziffra omits Nos. 17 and 18, presumably for personal reasons. The sound is rather resonant and moderately distant (no crushing hammer blows and pulverizing Horowitz sonorities here), and the pressings are quite good. H.G.

B MOZART: Mass in C minor, K. 427. Ileana Cotrubas and Kiri Te Kanawa, sopranos; Werner Krenn, tenor; Hans Sotln, bass; John Alldis Choir; New Philharmonia Orchestra, Raymond Leppard, cond. [Suvi Raj Grubb, prod.] SERAPHIM S 60257, \$3.98.

MOZART: Mass in C minor, K. 427. Carole Bogard, soprano; Ann Murray, mezzo; Richard Lewis, tenor; Michael Rippon, bass; Amor Artis Chorale; English Chamber Orchestra, Johannes Somary, cond. [Seymour Solomon and Christa Landon, prod.] VANGUARD VSD 71210, \$6.98.

Comparisons:
Davis/London Sym. Phl. 6500 235
Fricsay/Berlin Radio Sym. DG 138 124

In a letter to his father, Mozart says that he made a vow in his "heart of hearts" to compose a Mass if his fiancée, Constanze, recovered from an illness and he could marry her. The tremendous torso known as the "Great" Mass in C minor, K. 427, with the Requiem the outstanding if incomplete setting of the Mass between Bach's B minor and Beethoven's D major, represents the partially fulfilled promise.

One cannot escape some questions concerning the artistic genesis of this Mass. Why would a votive Mass, celebrating a happy event, be of such proportions, so awe-inspiring as portions of this work are? And why was this great edifice, three-quarters completed and obviously composed with the utmost devotion and care, then left unfinished? The Kyrie, Gloria, Sanctus, and Benedictus are fully set; in the Credo the vocal parts and the bass of the first section are written out and the accompaniment indicated at several places, while in the "Et incarnatus est" the soprano solo, the concertante wind parts, and the bass are composed, but the Crucifixus and the Agnus Dei

are entirely missing. Many theories have been advanced, but the most plausible one is what we may call the "Bach-Handel crisis" experienced by the young composer in the years 1782-83, when in Baron van Swieten's informal concerts he came face to face with the two giants of the baroque.

Handel, with whom he shared Italian godparents, he could absorb without difficulty, as the magnificent choruses in the Mass demonstrate (there is even a literal quotation from *Messiah* in the Gloria), but Bach was another matter. Until Mozart became acquainted with *The Well-Tempered Clavier* and the motets, he knew only the Fux-Martini type of learned counterpoint; he knew it well, but whenever he resorted to it the music was a bit formal, almost as if he were using a device. Now he discovered what living polyphony means and was shaken to such a degree that in 1782-83 several compositions in which he tried to reconcile his world with that of the old Thomas cantor's remained unfinished; he was not satisfied with the synthesis.

In a year or so the crisis was over. Mozart regained his confidence and equilibrium because he had the supreme gift of creating beauty from the greatest incompatibility of material, form, and style. This quality cannot be analyzed or catalogued, cannot even be named, because there is no word for it. But he also had an infallible sense for what is artistically right, and one may suppose that he came to realize that no matter how magnificent the individual numbers in the C minor Mass (he loved this work), the archaic does not mix well with the musical world he created for himself. Archaic this Mass certainly was; such so-called cantata-Masses (Bach's B minor is one of them) were no longer being composed by the leading masters. So, as he abandoned Gluck after *Idomeneo*, he abandoned literal Bachian archaism, but the profound impression of this encounter was never forgotten, and counterpoint assumed a new meaning for him.

Nothing in Mozart's earlier Masses prepares us for the proportions of this work. Several of the choral numbers are in five parts, the tremendous "Qui tollis" in eight. And something appears here that he had never exhibited before, something he learned from Handel: monumentality. Mozart obviously wanted a full orchestra, the kind he used in the somber D minor Kyrie (K.341) composed a year before for Munich. But Salzburg could not muster half the numbers of the well-endowed ducal orchestra, so he had to forget about flutes and clarinets, as well as the second brace of horns. On the other hand, he was encumbered by the set of trombones used in Salzburg and in many of the churches and small court establishments to add weight to their small ensembles.

The baroque influence in this Mass is direct in the choruses, indirect but palpable in the ensembles, and totally absent in the solo numbers—the stylistic components of K. 427 are indeed heterogeneous. The "Christe," the "Laudamus," and especially the "Et incarnatus est" are Mozart at his most suave, elegiac, brilliant, poetic, and candidly sensuous, a style that his great biographer, Hermann Abert, calls "dangerously close to opera." Northern Christians pause at the ineffable beauty—and

NATIONAL RECORD PLAN (not a "club")

**FOR 14 YEARS WE'VE FILLED
MAIL ORDERS THE WAY
CUSTOMERS LIKE.**

We send fresh, perfect records or tapes, packed so that damage seldom occurs. We double-check to prevent errors. We send CASH refund if (on rare occasions) we can't deliver. Prices, tough to beat, anywhere! Sale ends October 31, 1976.

RECORDS SUPER-SPECIALS UP TO 50% OFF

Featuring all these great Labels

**COLUMBIA — ODYSSEY — CAPITOL — ANGEL
SERAPHIM — WARNER — REPRISE
ELEKTRA — NONESUCH — ASYLUM
ATLANTIC — ATCO — LONDON
LONDON IMPORTS — STEREO TREASURY
HI-PARROT — ABC — IMPULSE
AUDIO TREASURY — BLUE THUMB**

Every Category: Classical, Pop, Blues, Soul, Disco, Show, Jazz, Rock, Opera, etc., Top Names, Top Hits.

Any Record or tape on above labels

List price per LP	\$6.98	NOW ONLY	\$3.69	per LP
	\$7.98	NOW ONLY	\$4.19	
	\$3.98	NOW ONLY	\$1.99	

Any other list price 47% off for these labels only.

TAPE: \$7.98 list NOW ONLY \$4.69, above labels only.

Any other list price, 40% off.

Need Catalog? Send \$1 for Schwann (records) or Harrison (tapes) or \$1.50 for both. If you order catalog, we extend sale ending date so you can order. You may deduct the price of the catalog(s) from your first order if over \$20.

SPECIAL ON ALL OTHER LABELS NOT LISTED ABOVE —

If list price per LP is	\$3.98	Dazzling Discount:	
	\$6.98	During Sale	\$2.29
	\$7.98	During Sale	\$3.99
		During Sale	\$4.59

Any list price not listed here 43% off.

TAPE: \$7.98 list NOW ONLY \$4.99. Any other list price 33-1/3% off. Above offers LIMITED TIME ONLY. Sale Ends October 31, 1976.

NATIONAL RECORD PLAN, Dept. HF3

44 West 18th St., New York, N.Y. 10011

Our Guarantee: Record or tape replaced at no charge, after one play, if defective.

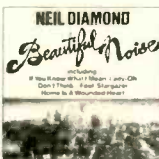

WARNER

George Benson-Breezin': W.B. 2919 \$ 3.69⁹⁵
Fleetwood Mac-Fleetwood Mac: Rep. 2225 \$ 3.69⁹⁵
Gary Wright-Dream Weaver: W.B. 2868 \$ 3.69⁹⁵
Alice Cooper-Goes To Hell: W.B. 2896 \$ 3.69⁹⁵

ELEKTRA-NONESUCH

Vaudeville-Songs Of The Great Ladies Of The Musical Stage: None 71330 \$ 1.99
Orleans-Walking and Dreaming: Elek./Asy. 7E-1070 \$ 3.69⁹⁵
Linda Ronstadt-Hasten Down The Wind: Elek./Asy. 7E-1072 \$ 3.69⁹⁵
Eagles-Eagles Greatest Hits: Elek./Asy. 7E-1052 \$ 3.69⁹⁵

ATLANTIC

Spinners-Happiness Is Being With The Spinners: Atl. 18181 \$ 3.69⁹⁵
The Selma Album-Original Cast Album: The Life Of Martin Luther King. 2 L.P.'s; Coti. 2-110 \$ 5.29⁹⁵
Jon Anderson-Olias of Sunhillow: Atl. 18180 \$ 3.69⁹⁵
Manhattan Transfer-Comeing Out: Atl. 18183 \$ 3.69⁹⁵

COLUMBIA-ODYSSEY

Neil Diamond-Beautiful Noise: Includes If You Don't Know What I Mean, others: Col. PC 33965 \$ 3.69⁹⁵
Chicago-Chicago X: Brand new release. Col. PC 34200 \$ 3.69⁹⁵
Lou Rawls-All Things In Time: Includes You'll Never Find Another Love Like Mine. Col. PC 33957 \$ 3.69⁹⁵
The Concert Of The Century-Celebrating The 85th Anniversary Of Carnegie Hall: Recorded LIVE. 20 Famous Artists. Extraordinary! 2 L.P.'s. Col. M2X 34256 \$ 7.68
Lazar Berman Plays Liszt Sonata In B Minor: Col. M 33927 \$ 3.69
Gershwin-Rhapsody In Blue: Original Version. Col. XM 34205 \$ 2.99⁹⁵
Kurt Weill-Three Penny Opera In German. Starring Lotte Lenya. 2 L.P.'s & Libretto. Ody. Y2-32977 \$ 4.19
Sidewalks Of New York: Nostalgic music rolls on the Wurlitzer 164 Band Organ. Col. M 34159 \$ 3.69

CAPITOL

Helen Reddy-Music, Music: Cap. 11547 \$ 3.69⁹⁵
Wings-At The Speed Of Sound: Cap. 11525 \$ 3.69⁹⁵
Beatles-Rock And Roll Music: 2 L.P.'s; Cap. 11537 \$ 5.82⁹⁵
Natalie Cole-Natalie: Cap. 11517 \$ 3.69⁹⁵
Beach Boys-Endless Summer: 2 L.P.'s; Cap. 11307 \$ 3.69⁹⁵

ANGEL-SERAPHIM

Itzhak Perlman-Plays Fritz Kreisler: Angel 37171 \$ 3.69⁹⁵
Berlioz-Requiem: Robert Tear (Tenor). 2 L.P.'s; Angel SB 3814 \$ 7.38
Haydn-Cello Concerto In D Major & C Major: Rostropovich: Angel 37193 \$ 3.69
Karajan Conducts Music Of Johann Strauss: Angel 37222 \$ 3.69
Beethoven-Missa Solemnis: Featuring Harper, Baker, Tear. 2 L.P.'s Angel SB 3836 \$ 7.38

LONDON-IMPORTS-STEREO TREASURY

Gershwin-Porgy And Bess: Maazel and The Cleveland Orch. 3 L.P.'s Lond. OSA 13116 \$11.07⁹⁵
Bizet-Carmen: Featuring Troyanos, Domingo. 3 L.P.'s. Lond. OSA 13115 \$11.07⁹⁵
Haydn-String Quartets: Vol. 1, Op. 71 & 74. Aeolian Qt. 3 L.P.'s Lond. STS 15325/7 \$ 5.97
Verdi-Luisa Miller: Caballe, Milnes. 3 L.P.'s. Lond. OSA 13114 \$11.07⁹⁵
Bach-Cantatas: Vol. XIV, Harnoncourt. 2 L.P.'s. Tele. 26353Q4 \$ 7.38
Tchaikovsky-Symphony No. 5: Solti and the Chicago Symphony. Lond. CS 6983 \$ 3.69⁹⁵

ABC IMPULSE

John Coltrane-Gentle Side Of John Coltrane: 2 L.P.'s. Imp. 9306/2 \$ 3.69⁹⁵
John Klemmer-Bearfoot Ballet: Brand new release. ABC 950. \$ 3.69
John Handy-Hard Work: ASD 9314 \$ 3.69⁹⁵
Keith Jarrett-Mysteries: ASD 9315 \$ 3.69⁹⁵
Bobby Bland & B.B. King: ASD 9317 \$ 3.69⁹⁵
The Crusaders-Those Southern Knights: BTS D 6024 \$ 3.69⁹⁵

*Also Available In 8 Track/Cassette — add \$1 per L.P.

NATIONAL RECORD PLAN

Dept. HF-3, 44 West 18th St., New York, N.Y. 10011

Name _____

Address _____

City _____

State _____ Zip _____

NO LIMIT. ORDER ALL THE RECORDS AND TAPES YOU WANT WHILE SALE IS IN EFFECT
Send me the following at Sale prices advertised:

**SALE ENDS
OCT. 31, 1976**

OFFICE USE ONLY	DESCRIPTION, ARTIST.	LABEL & NO. (IF KNOWN)	CHECK ONE			LIST	AD PRICE
			LP	8-TR	CASS		

FOR MORE RECORDS AND TAPES ATTACH YOUR OWN SHEET.

MAIL YOUR ORDER TODAY! ADD 85¢ for first record or tape, 20¢ for EACH additional PLUS 40¢ insurance for entire order. NYC residents, add 8% Sales Tax; others, applicable tax CHECK or MONEY ORDER (no C.O.D.) enclosed for total

AMERICAN EXPRESS, BANKAMERICARD or MASTER CHARGE accepted—give name on card, number, expiration date, and sign order. Minimum credit card order, \$10

CIRCLE 36 ON READER-SERVICE CARD

NEW RECORDING (OR 2) FOR EVERYONE.

Sills' newest portrayal.



*SCLX-3832 (LP & Cassette)

A new Martinon classic.



*S-37138 (LP & Cassette)

New Rachmaninoff LPs
from Previn.



*S-37158

*S-37169

A bouquet of "standards"
from Sir Adrian.



S-37227

*compatible Stereo/SQ quad



CIRCLE 6 ON READER-SERVICE CARD

brilliance—of a piece like the "Et incarnatus est," not realizing how strongly the words "homo factus est" recall to the southern Catholic the lovely picture of the crèche, evoking the pastoral rhythm. On the other hand, the awesome power of the "Qui tollis," with its inexorable, heavily accented quasi-ostinato and the avoidance of full cadences, was unsettling within the framework of the Mass.

Raymond Leppard seems to approach his task with some hesitation. This Mass, being incomplete, should be his cup of tea, for he is notorious for tampering with scores; this score is actually in need of a little tampering because the missing middle voices in the strings and other elements must be supplied. No objections on this count should be raised, except perhaps the addition of the plainsong incipits, which are pointless except when intoned by the celebrant in actual services. We usually forgive Leppard his trespasses, because he is a fine musician and a good conductor, but this time he fails, though it must be said that the sound engineering has a large share in this failure. The first mistake, one that often ruins the best-laid plans, was recording the work in a church, presumably because of the organ, which is not needed. The blanketing echo, the shrill highs, the muddy choral sound, and the rumbling timpani cause bedlam whenever there is fast contrapuntal motion at elevated dynamics.

Leppard is a little unsure of his tempos, repeatedly miscalculating them; the "Christe," for instance, is almost painfully slow, and there are allargandos of royal proportions. The great fugues are close to disaster: loud, opaque, brassy, and undifferentiated. As a musicologist/performer, Leppard should know better than to let the trombones ruin his choral sound. As mentioned before, the great Kyrie composed for Munich called for neither trombones nor organ because the musical establishment there had ample forces in every category, but in Salzburg he had to use trombones to supply volume to the small ensemble. Since like the ducal forces of yore Leppard had a full complement of players and singers, the trombones should have been muzzled; any able musician can tell where they are needed and where they are just trotting along. The Requiem is also disfigured by this unthinking use of these mighty tonal bellows.

The singers are good but are not very well handled. Ileana Cotrubas has a nice, clear, high soprano that is of a more lyric than dramatic timbre, yet here she has to hold her own with power because the mezzo-alto part is constantly intruding into her region, and that "alto," Kiri Te Kanawa, outclasses her in volume and brilliance. The soprano part was composed for Constanze Mozart, who, according to a number of witnesses, was a very good singer. If she could negotiate it in this work, she must have been almost as good as her sister, Aloysia, a renowned professional. The soprano has to descend to A flat below middle C, then suddenly vault up two octaves, and so forth. Cotrubas cannot produce the low tones, and there are some awkward moments. Te Kanawa does well with the alto part, though she is really a soprano with a bright top register. Werner Krenn and Hans Sotin

function acceptably; the chorus, one can tell from the undisturbed quiet passages, is fine but is imposed upon by the engineers, and the New Philharmonia Orchestra is good, though at times it sounds a bit placid.

Johannes Somary's performance does not cheer us up either. Again the engineering is responsible for choral untidiness in the animated sections, and the highs tend to be shrill. But aside from the poor sound, there are serious shortcomings in concept and execution. The music often moves measure by measure, as in the Kyrie, which is much too slow; this results in too many detached tones (also in the "Domine Deus"), and soon the context is lost. On the other hand, some sections, like the Credo, are too fast. In the ensembles the soloists do not always phrase with unanimity, which is clearly the conductor's fault.

It is surprising that an experienced choral conductor like Somary could miss the essential construction of the "Qui tollis." It is the key to the movement (aside from the quasi-ostinato), which is articulated not unlike a relay run: The second four-part chorus enters and for two or three beats runs along with the first one until it hands over the baton, so to speak. This must be made unequivocal, but the way it sounds in this recording one could not even be sure whether there are two choirs. Also, the rhythm in this overwhelming piece is not sharp enough; those chords should fall like weighty blows. The singers are good, but they are not led with sufficient authority to make optimum use of their capabilities.

It is perhaps no coincidence that we lack an entirely satisfactory recording of this great work, but there are two that surpass Leppard's and Somary's by a considerable margin. Colin Davis recorded the Mass in his series of Mozart church compositions (available singly or in the boxed set, Philips 6707 016), and his recording displays what we have come to expect from this excellent musician: a positive concept, good tempos, fastidious phrasing, and unexceptionable ensemble work. Yet the recording is flawed. Once more the taping was done in a church, there is too much reverberation, and the fugues soon get untidy as a result.

The best recording is still Deutsche Grammophon's with the late Ferenc Fricsay conducting a superb cast. While the Hungarian conductor can be as sentimental as a Mischa Elman—the "Christe" is close to being treacly—and some of his cadences are asthmatic, there is also an uninhibited enjoyment of the music, sharp rhythm, excellent dynamic scale, and a commendable solicitude to give the voices the right of way. And Fricsay, though not a musicologist, was a first-class musician; unlike his more learned colleagues, he knew instinctively what to do with the troublesome trombones. The Maria Stader/Hertha Töpfer combination is a marvel to hear: The alto can match the soprano tone for tone up to high B flat, and the soprano can match the alto down to a low A flat. Above all, the sound is beautifully clear, and one can hear the chorus in all its glory.

Few works in the sacred repertory are as difficult to perform as this tumultuous, heavenly, uneven, but withal overwhelming Mass. Perhaps someday Davis could re-record it in a good studio, with a

ABC Records proudly announces a new label for domestic and imported works of uncommon merit:

abc Classics

®

Our first release is comprised entirely of recent recordings from the prestigious SEON line—thoroughly researched compositions and exemplary performances on period instruments, creating a sound most nearly resembling that heard by the composer himself.

This holiday season, one Christmas recording will be distinguishable from all others.



WEIHNACHTSMUSIK DES 15. UND 16. JAHRHUNDERTS CAPELLA ANTIQUA MÜNCHEN/Konrad Ruhland ABCL-67002

Drawing upon an extensive collection of early manuscripts and authentic instruments, conductor Konrad Ruhland has created a unique album of little-known Christmas music that will be most refreshing to the jaded modern ear.

HAYDN: STRING QUARTETS OP. 20, #2 & #4/QUARTETTO ESTERHAZY ABCL-67011

Listening to Haydn's String Quartets performed as the composer would have heard them is a new and exhilarating experience. Exactly performed by the Quartetto Esterházy on instruments made by Gagliano, Gobetti, Klotz, Tononi, and Celoniatus.

BAROCKLAUTE VOL. 1 EUGEN DOMBOIS, lute ABCL-67006

Dombois is widely recognized as the foremost performing artist of Renaissance and Baroque lute music. His painstaking research and impeccable performances provide a thorough and most rewarding musical experience.

THOMAS STOLTZER: VIER DEUTSCHEN PSALMEN/CAPELLA ANTIQUA MÜNCHEN/KONRAD RUHLAND ABCL-67003/2

One of Stoltzer's last and most impressive works, these four Psalm settings share particular historical significance as the earliest known compositions (1526) based upon translations by Martin Luther. Faithfully performed from his original texts.

JOHN BLOW: ODE ON THE DEATH OF MR. HENRY PURCELL/AMPHION ANGLICUS/GUSTAV LEONHARDT, conductor ABCL-67004

Gustav Leonhardt directs two of Europe's most celebrated countertenors and a group of leading singers and instrumentalists in a brilliant performance of English composer John Blow's spirited music. Played and sung from 17th century first editions.

HÄNDEL: WOODWIND SONATAS/FRANS BRÜGGEN, conductor ABCL-67005/3

Franz Brüggen gives splendid performances of twelve Händel woodwind sonatas on instruments from the period crafted by the esteemed Stanesby Family of London.

ALPENLÄNDER (ORGANS OF ALPINE COUNTRIES) GUSTAV LEONHARDT, organ ABCL-67008/2

Of all the old organs in Europe only a few remain intact, preserved from modernization and decay. For this recording, Leonhardt searched the Alpine countries to find six remarkable instruments, then selected a special repertoire to manifest each one's character.

J. S. BACH: MUSIKALISCHES OPFER BWV 1079 GUSTAV LEONHARDT, conductor ABCL-67007

The "Musical Offering" grew out of improvisations by Bach on a theme set by King Frederick the Great. It is a classic example of his late style, characterized by austere, extremely dense polyphony. With inspired interpretation by Leonhardt conducting a select group of Europe's finest Baroque instrumentalists.

MOZART: VIOLIN CONCERTOS/JAAP SCHRÖDER, violin; FRANS BRÜGGEN, conductor ABCL-67010/2

With this recording Brüggen realized a long-standing desire to record Mozart violin works on authentic instruments and according to the prevailing traditions of the time. Upon European release the critics were overwhelmed.

ANTOINE FORQUERAY: PIÈCES DE CLAVECIN GUSTAV LEONHARDT, harpsichord ABCL-67009

Forqueray, child prodigy on the viola da gamba in the court of Louis XIV, wrote these 'pièces de clavecin' in homage to great contemporary composers. Leonhardt gives an electric performance of these unusual and heretofore unheard compositions.

ABC CLASSICS: The First Release ABCL-67001

A sampler album has been prepared for your review containing selections from the SEON recordings that comprise our initial offering. Available now at all fine record shops.

©1975, ABC Records, Inc., Los Angeles, California 90048, New York, New York 10019.

CIRCLE 1 ON READER-SERVICE CARD

FREE!

NEW Heathkit Catalog



An audiophile's delight, describing some of the finest hi-fi products you can buy—all with Heathkit build-it-yourself savings and satisfaction. Stereo components including the sensational Modulus™—the system that defies obsolescence because it grows as your listening needs change.

"Separates" including a Stereo Preamplifier with incredible specifications and an equally incredible low price, and a matching

equalizer that gives you far better tone control than conventional bass and treble controls. A complete line of speaker systems including the AS-1373—a three-way system that sets an industry standard for mid-priced speakers. Other products include digital clocks and weather instruments, new audio service gear, Amateur Radio equipment, auto and marine accessories. Nearly 400 kits in all.

Heath Co., Dept. 8-22, Benton Harbor, MI 49022

SEND FOR YOUR COPY TODAY

HEATH	
Schlumberger	
Heath Company, Dept. 8-22 Benton Harbor, Michigan 49022	
Please send me the new Heathkit Catalog. I am not on your mailing list.	
Name _____	
Address _____	
City _____	State _____
HF-310	Zlp _____

CIRCLE 22 ON READER-SERVICE CARD

stronger cast, and with the trombones properly held on a short leash. It is a challenge that would be very much worth his while.

P.H.L.

SAINT-SAËNS: Symphony No. 3, in C minor, Op. 78 (*Organ*). Gaston Litaize, organ; Chicago Symphony Orchestra, Daniel Barenboim, cond. [Günther Breest, prod.] DEUTSCHE GRAMMOPHON 2530 619, \$7.98. Tape: ●● 3300 619, \$7.98.

Comparisons:

Gavoty, Martinon/Orch. National
Zamkochian, Munch/Boston Sym.

Ang. S37122
RCA LSC 2341

The gimmick here is a hands-and-ears-across-the-sea collaboration: The Chicago orchestra plays under an Argentinian-born Israeli conductor while a French organist plays the obbligato part in the cathedral of Chartres! The trick is done remarkably well, but it hardly seems worth all the trouble and cost. The organ here plays no more if no less significant a role than in other recordings, and it is tonally less attractive than in some, notably the Martinon and Munch versions.

Of course, the Chicagoans' playing is highly virtuosic and indeed is spectacularly recorded with especially impressive dynamic range. But for me, if a genuine French touch is lacking (as it is here despite the presence of organist Gaston Litaize), the *Organ Symphony* is inevitably the blatant display of sound-and-fury rhetoric its disparagers long have claimed it to be. I find Barenboim's reading hyperactive, too nervously intense, deficient in poetic grace—and I find particularly annoying his tendency to press hard even when the score specifically warns "sans presser."

On a wide-range playback system, this disc is unquestionably a bring-the-house-down stereo spectacular. But for a far more idiomatic and eloquent version, yet one even more virilely dramatic since it is more tautly shaped and controlled, I'll take Martinon's for Angel every time. And I'll always go back gladly to the unfaded magical grandeur of the memorable 1960 Munch/RCA version.

R.D.D.

STRAUSS, J. (ARR. KORNGOLD, BITTNER, AND COOLS): Valses de Vienne.

Resi
Countess
Pepi
Léopold
Strauss Jr.
Ebeséder
(plus speaking roles)

Mady Mesplé (s)
Christiane Sutzmann (s)
Arta Verlen (s)
Philippe Gaudin (t)
Bernard Sinclair (b)
Jacques Loreau (b)

René Duclos Chorus; Opéra-Comique Orchestra, Jean Doussard, cond. CONNOISSEUR SOCIETY CS2 2106, \$13.96 (two discs, manual sequence).

Vienna Waltzes is a pastiche derived from the orchestral music of Johann Strauss Jr. (and, I believe, from Johann Strauss Sr. too, though he is given no credit on this recording) by Erich Wolfgang Korngold and Julius Bittner. The jejune libretto is an account of how, with the contrivance of a friendly countess, Johann Strauss Jr. surmounts the objections of his father and becomes a composer in his own right, at the same time winning the love of a pastry cook's daughter, Resi. There is nothing new in the practice of adapting Strauss's tunes for the

stage by fitting words to them and devising a story as a framework for them. Strauss himself gave his approval for Adolf Müller, a conductor at the Theater an der Wien, to tailor his music to a book by Victor Leon and Leo Stein. (The result was *Wiener Blut*, which appeared in 1899, shortly after the composer's death.)

Though *Vienna Waltzes* makes use of several of Strauss's most familiar compositions—*The Blue Danube*, *Tales from the Vienna Woods*, *Voices of Spring*, and the *Annen Polka*—most of the other numbers have been taken by Korngold and Bittner not from whole works, but from bits and pieces, connecting passages, introductions, and the like. The bulk of the score might best be described as a fantasia on themes by Johann Strauss.

In its time *Vienna Waltzes* was a big success. At its first London presentation (1931) it ran for seven hundred performances and featured Alexandra Danilova as leading dancer. Three years later, with the book adapted by Moss Hart and renamed *The Great Waltz*, it prospered in New York. It was even filmed, in 1933, by Alfred Hitchcock with Jessie Matthews—an effort the director rightly regards as one of his most wretched works. But it was as *Valses de Vienne*, further adapted by the French composer Eugène Cools and the librettists Mouézy-Eon and J. Mariette, that the operetta enjoyed its greatest popularity. After a premiere engagement at the Porte St. Martin, Paris, in 1933, it was successfully revived at the Théâtre du Châtelet at least four times.

The present recording, by no means the first, suggests that the French appetite for kitsch is inexhaustible. The performance seems to have been derived from a radio adaptation, complete with a discreet narrator to set the scene. Thus we begin with the *Annen Polka*, after a few bars of which we learn through a voice-over that "Nous sommes dans la célèbre pâtisserie de M. Ebéséder. . . ." The musical performance under Jean Doussard is lively, if not especially graceful. The singing and the acting (there is spoken dialogue throughout) are very proficient. Bernard Sinclair makes a pleasing Strauss Jr.; Mady Mesplé, whom the recording catches in her most secure vocal state, warbles prettily; the rest of the cast manages well. A synopsis is included but no texts.

D.S.H.

B **STRAUSS, R.:** *Orchestral Works.* Vienna Philharmonic Orchestra, Richard Strauss, cond. VANGUARD EVERYMAN SRV 325/9, \$19.90 (five discs, mono, manual sequence) [recorded June 1944].

Don Juan, Op. 20; Tod und Verklärung, Op. 24; Till Eulenspiegel, Op. 28; Also sprach Zarathustra, Op. 30; Ein Heldenleben, Op. 40; Sinfonia domestica, Op. 53; Le bourgeois Gentilhomme Suite, Op. 60; Schlagobers (ballet), Op. 70; Waltz.

There's a long and still largely obscure story behind these unique historical documentations of Richard Strauss as composer/conductor—the rights to which are credited to the East German Deutsche Schallplatten company but are licensed (O mysterious East!) by the Tokuma Musical Industries Ltd., Japan.

In June 1944, Strauss's eightieth birthday

MUSIC LOVERS!

You are cordially invited to accept
COMPLIMENTARY MEMBERSHIP
 in *Musical Heritage Society*
 and receive these benefits:

1. **FREE CATALOG** of over 2,000 records and cassettes. Spanning our entire musical heritage, this catalog offers music from all periods:
 MEDIEVAL - GOTHIC - RENAISSANCE - BAROQUE - ROCOCO - CLASSICAL - ROMANTIC - MODERN
 Further, every serious musical form is covered, i.e.:
 OPERAS - SYMPHONIES - CONCERTOS - CANTATAS - CHAMBER MUSIC - FOLK MUSIC
 ORATORIOS - MASSES - REQUIEMS - GREGORIAN CHANT, etc.
 Performances are of such a high order that over 150 recordings have won coveted international awards: GRAND PRIX DU DISQUE, MONTREUX FESTIVAL and others. As these records and cassettes are made to the highest standards of the industry, you're due for some sonic delights.
2. **THE PRIVILEGE** of buying ANY three records of your choice for only \$1.00 each! (or any three cassettes for \$2.00 each)
3. **FREE SUBSCRIPTION** to the Society's NEW RELEASE ANNOUNCEMENTS. The Society issues 12 to 20 new recordings per month.
4. **AN ACCOUNT** in your name. This permits you the convenience of charging your purchases - - - of paying for your recordings after you have received and tried them. The Society wants you to keep only those recordings you're happy with.
5. **NO PURCHASE OBLIGATION!** Membership involves no fees or purchase obligation, even if all you buy is the three records or cassettes at a token price or even nothing at all.

ENJOY THE DELIGHTS OF GREAT MUSIC SOON!
 MAIL THE COMPLIMENTARY MEMBERSHIP REQUEST FORM TODAY!!

THE WORLD'S GREATEST ARTISTS ARE

ON THE SOCIETY'S RECORDINGS!

You can enjoy the superb artistry of such musical luminaries as MAURICE ANDRE, JEAN-PIERRE RAMPAL, LILY LASKINE, JEAN MARTINON, PIERRE MONTEUX, ALICIA DE LARROCHA, FRANCO GULLI, HELMUTH RILLING, MARIE-CLAIRE ALAIN, JÖRG DEMUS, NICOLAS HARNONCOURT and many others.

THE LARGEST RECORDING PROJECTS IN HISTORY HAVE BEEN REALIZED BY THE SOCIETY!

The Society's feats have the music world happily agog.

Every year many of the Society's recordings receive international honors and awards.

Bold and pioneering in its policy, the Society dares to record rare music for the first time - - - music that has graced the archive shelves for centuries. The Society has proven to be of inestimable value to music lovers and scholars.

Some composers, notably Telemann, Pachelbel, Fasch, Gilles and others have become noteworthy in the music world due almost solely to the Society's efforts.

Many large and prestigious projects have been realized to the consternation and delight of the music world! Even large companies had failed in some of these projects. For example, the Society:

1. Was the first to issue all 107 of HAYDN's symphonies on 49 records.
2. Has undertaken the recording and issue of all the works of JOHANN SEBASTIAN BACH. On this 200 plus record project, over 125 records have already been issued.
3. Has issued all the solo piano works of SCHUMANN on 20 records and all his symphonies too.

4. Has issued many other complete series, notably all MOZART's piano concertos and string quartets; all BEETHOVEN's symphonies, quartets, piano sonatas, trios, cello sonatas; and all Buxtehude's organ works plus much much more.

Wouldn't you like to participate in this program and thus aid the Society make music appreciation more widespread in America?

A complimentary membership is yours on request. Why not accept it today?

HOW THE SOCIETY OPERATES

The Society's recordings are not sold in stores. They are offered directly to music lovers through new release announcements mailed at three week intervals. Records and cassettes are sold

at low producer-direct-to-user prices of \$3.50 per record or \$4.95 per cassette.

When the Society receives your request, it sets up an account in your name, sends you its latest catalog and includes a certificate entitling you to buy up to three records of your choice for \$1.00 each plus shipping. (Or you may buy up to three cassettes for \$2.00 each.)

The Society will begin sending you new release announcements. There is no purchase obligation and you may cancel your subscription at any time. As a subscriber two outstanding selections will be scheduled for shipment to you from each release. You may accept the scheduled selections by not returning the advice form always provided; you may order only the recordings you want or you may advise us to ship no recordings at all.

MUSICAL HERITAGE SOCIETY

Musical Heritage Society Building - Oakhurst, New Jersey 07755

Complimentary Membership Request Form

MUSICAL HERITAGE SOCIETY, Dept. HF-10

Musical Heritage Society Building, Oakhurst, New Jersey 07755

Ladies and Gentlemen of the Society,

Please enter my complimentary membership in the Society.

I am interested in: () 12" Stereo Records
 () Dolbyized Stereo Cassettes
 Also please: () Both

- Set up an account in my name.
- Send me your catalog of over 2,000 classical records and cassettes.
- Send me a certificate entitling me to buy three records for only \$1.00 each plus shipping (or three cassettes for \$2.00 each).
- Enter my subscription to your new release announcements. It is understood that no fees or purchase obligation is involved and that I may cancel at any time. I understand that, as a subscriber, two outstanding selections from each release announcement will be scheduled for shipment to me. I further understand that I may accept these selections by not returning the advice form, order only what I want or decline everything by returning the advice form.

NAME _____

ADDRESS _____

CITY _____ STATE _____ ZIP _____

OFFER OPEN TO NEW MEMBERS ONLY.
 *
 OFFER VALID IN U.S.A. ONLY.

FLEXIBLE

STRAIGHTLINE

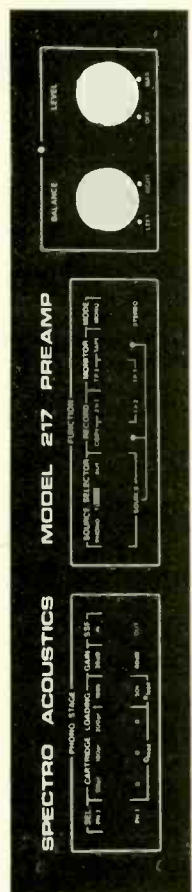

Model 217 Suggested Retail \$250.00

PREAMPLIFIER

The Spectro Acoustics Model 217 is the first preamplifier to provide complete facility to accurately "load" any standard phono cartridge to the manufacturer's specifications. With these idealized conditions, true ultra-accurate "flat" response is possible. A gain selector optimizes noise and overload conditions depending on the output of the individual cartridge and a third order Butterworth subsonic filter eliminates sub-audible turntable rumble and potentially destructive low frequency acoustic feedback from high power amplifiers. Switching includes two phono inputs for A/B cartridge comparisons and bi-directional bypass copying for two tape decks.

Distortion:

THD 0.05% 20Hz-20kHz
IMD 0.0075% SMPTE

Noise:

Phono: S/N 82 db "A" weighted
High Level: S/N 110 db "A" weighted

Frequency Response:

10Hz-100kHz ± 1 db
(Flat within 1 db to the limits of a calibrated Sound Technology 1700A analyzer)

The straight-line design has no tone controls or equalization to alter the linear response in any way. However, full flexibility is maintained for the audiophile who wishes to patch in an equalizer or any other outboard signal processor.

SPECTRO ACOUSTICS INC.

1309 E. Spokane Pasco, Washington
(509) 545-1829 99301

CIRCLE 52 ON READER-SERVICE CARD

was celebrated by a wartime Vienna Philharmonic festival led by the composer himself. The recordings, in mono of course, probably were made on Magnetophon tape for delayed broadcast, apparently not in live performances, as was once assumed, but in a relatively empty hall. For years only a couple of examples appeared on commercial discs, in the U.S.A., at least: the *Bourgeois Gentilhomme* in 1952-53 Regent and Urania editions, both long OP; and the *Domestica* from Vox in 1952, later reissued as Turnabout TV 4363, still listed in Schwann-2. Others were not available until the fall of 1973, when the Bruno Walter Society began to distribute an "Archiv" (not DG's!) set of all except the *Domestica*, crammed onto only three discs, with the *Zarathustra* and *Gentilhomme* each given a thirty-five-minute single side. A year later the *Zarathustra*, running over onto a second side filled out by the *Schlagobers* Waltz, also appeared in electronic rechannelings on both Turnabout THS 65021 and Olympic 8111. It's only now that we get all eight performances—from miraculously cleaned-up masters and in far superior disc processings—as an integral set, and a budget-priced one at that.

Without denigrating in the least the incalculable documentary value of this set or its essentiality to every institutional library and every Strauss specialist's collection, I can't in good conscience recommend it without serious reservations even to connoisseur home listeners. Strauss was a fine conductor (if perhaps less so in his own music than in that of Beethoven and Mozart), but here he seemed to be in erratic control, permitting many, if few really serious, bobbles and imprecisions. And his readings—generally routine, often oversentimental in the lyrical passages, hard-pressed in the stormy ones—rarely disclose (for me, anyway) arrestingly subtle or profound insights. These 1944 recordings are very uneven in quality: unexpectedly vivid in some spotlighted woodwind passages; blurry or thick-textured in tuttis; unpleasantly thin or even shrill-toned in most loud high-register string passages; and pervasively hollow in empty-hall ambience.

Despite all such handicaps, the *Domestica* and *Heldenleben* have at least near-satisfactory moments and fare best overall. The *Tod und Verklärung* is almost intolerable throughout, however, while the others fall variously somewhere within these extremes. Obviously, the whole set is better suited for study than enjoyment. And since Dr. Joseph Braunstein's authoritative notes deal with the music only, the full provenance of these recordings and their highly checkered history still remain tantalizingly mysterious. R.D.D.

STRAVINSKY: *Canticum sacrum**; Symphony of Psalms. Richard Morton, tenor*; Marcus Creed, baritone*; Choir of Christ Church Cathedral, Oxford; Philip Jones Ensemble, Simon Preston, cond. [Michael Bremner, prod.] ARGO ZRG 799, \$6.98.

Comparison—*Canticum sacrum*:
Stravinsky/L.A. Festival Sym. CMS 6022
Comparison—*Symphony of Psalms*:
Stravinsky/CBC Sym. MS 6548

Stravinsky's *Canticum sacrum*, praising

the patron saint of Venice (the city in which he would, in time, be buried), is a formal, ceremonial work of devotion in which the composer uses a Latin text as ritual language. It was composed in 1955 and intended for performance in Venice's San Marco cathedral; as San Marco has five domes, the music has five parts. Two years after it was composed, Stravinsky recorded it in a Los Angeles studio, providing a serviceable documentation of the work but little more. That disc has long been out of the regular catalogue (it has reappeared in Columbia's Collectors' Series). The result is that the score has been neglected.

This Argo version should remedy that. The acoustics are better than those of the Stravinsky version, a real churchlike effect prevails, and a true mood of reverence and worship is sustained. This is important late Stravinsky, especially for those who value his vocal and religious works, and you should acquire it while you have the chance.

The overside *Symphony of Psalms* will not be much competition for the composer's 1963 Toronto recording. Here the cathedral acoustic simply puts everything too far away and obscures detail. One point is of interest, however: The Oxford choir uses boy sopranos, so the effect of the vocal writing is different from the usual performance in which women sing the upper lines. This option has the complete approval of the composer, who obviously liked the clear, bright sounds of boys' voices, but the effect is more ethereal than expressive.

R.C.M.

TCHAIKOVSKY: *Symphony No. 5*, in E minor, Op. 64. Concertgebouw Orchestra, Bernard Haitink, cond. PHILIPS 6500 922, \$7.98. Tape: ●● 7300 365, \$7.95.

TCHAIKOVSKY: *Symphony No. 5*, in E minor, Op. 64. Chicago Symphony Orchestra, Georg Solti, cond. [Ray Minshull, prod.] LONDON CS 6983, \$6.98. Tape: ●● CS 5 6983, \$7.95.

Comparisons:

Solti/Paris Conservatory St. Treas. STS 15060
Ozawa/Chicago Sym. RCA LSC 3071
Markevitch/London Sym. Phi. 802 703

Solti and Haitink are generally in accord as to how this symphony ought to go. Both choose tempos that are predominantly expansive—perceptibly below Tchaikovsky's metronome marks in the first and third movements. Neither indulges in the extreme distentions of rhythm and phrasing and the editorial changes (or even cuts) that have variously marked such personalized recorded performances as those of Mengelberg, Stokowski, Mitropoulos, Silvestri, and Bernstein. Both are scrupulous about dynamic levels, and each favors forward balancing of the brasses, especially Solti, whose producers have spotlighted as well the considerably impactful timpani. (But, where, pray tell, did that cymbal-crash of a noise come from at bar 140 in the first movement?) Each has on hand an orchestra that is unsurpassable today for individual and collective musicianship, tonal splendor, and virtuosity.

There are differences. The engineering, for one: Philips' ambience is a bit more resonant than London's. Then, the Dutch



Revolutionary! Sound-shaping taping mike.



Never before — a single microphone that gives you the versatility of 16 microphones! Four tiny frequency filter switches built into the new Shure 516EQ E-Qualidyne Microphone let you tailor sound for studio effects in virtually any recording situation: flick a switch to add sizzle to vocals . . . flick another switch to highlight the sound of a bass drum. You can even compensate for the acoustic response of a room — *right from the microphone!* In all, the 516EQ creates 16 different response variations that can add a new, professional sound to every tape you make. Available singly or in pairs for stereo recording. Ask to hear a recorded demonstration at your participating Shure dealer.

Shure Brothers Inc.
222 Hartrey Ave., Evanston, IL 60204
In Canada: A. C. Simmonds & Sons Limited



Manufacturers of high fidelity components, microphones, sound systems and related circuitry.

CIRCLE 51 ON READER-SERVICE CARD

"I've got a 60-minute recording studio in my pocket."

It's called the MICROCASSETTE® PearlCorder-S®.



A MICROCASSETTE recorder that's so unique, it's like having your own mini-studio in your pocket with remarkably good fidelity for music as well as voice. It's smaller than a checkbook (5 1/4" from top to bottom, slightly thicker than a pack of cards), and lightweight (12 ounces with batteries), but it's packed with studio precision and professional features:

- 60 minutes recording time.
- Capstan drive for constant tape speed, built-in electret condenser microphone, AC bias, record-warning light.
- All metal construction for years of dependable service.
- One-hand operation; instant loading.
- Fast forward and rapid rewind.
- Automatic level control.
- Connects to your stereo or full-size recorder with a Compaticord, for both recording and playback.

The PearlCorder-S performs beautifully in an office, in your car, even on airplanes; and it's backed by the reputation of the Olympus Optical Co., Ltd., a company famous for fine cameras, medical and other precision scientific instruments.

The PearlCorder-S. Carry one. And have a studio with you.

Available at fine photographic, audio, and A-V dealers everywhere. Or write for our brochure, "Pocket Full of Miracles."

OLYMPUS CORPORATION OF AMERICA
TWO NEVADA DRIVE/NEW HYDE PARK, NEW YORK 11040

60 minutes of sound in this actual-size MICROCASSETTE.®



CIRCLE 40 ON READER-SERVICE CARD

players seem more intent on grace and beauty of delivery (especially the limp solo work of oboe and French horn), whereas the Chicagoans favor fiercer, more biting articulation and rhythm. Solti lets himself get worked up more by such climactic passages as the coda to the first movement, where the unmarked accelerando is quite effective. But both editions can be similarly described, over-all, by such adjectives as big, brooding, opulent, and (technically) dazzling.

It must be an embarrassment indeed to have Solti's Parisian version still in the catalogue, even as a budget offering. Although I prefer some of its brisker pacing (e.g., the andante opening), the looser rhythmic control, the murky textures, and the really execrable playing could certainly be invoked as proof of the Hungarian's phenomenal growth in the twenty-year interval between his two recordings. But there is plenty of other evidence that Solti was a master of his craft in the Fifties, so perhaps the difference might support a reversal of Mahler's adage and prove that "there are no great conductors, only great orchestras." Indeed, the last Chicago version, under Ozawa, is pretty excitingly played (not all that different in tonal character from the new Solti), immensely driving in its free-wheeling way, and an important contender when one considers it is the only Tchaikovsky Fifth to have a filler (a damn good Mussorgsky Night on Bare Mountain. As to Haitink's "direct competition," the 1928 Mengelberg/Concertgebouw version (not in the current catalogue), despite its undeniable inferiority in frequency response, signal-to-noise ratio, presence, and smoothness, is as translucently clear in basic balancing of choirs as the new Haitink—proving, perhaps, that there are no great producers/engineers, only great halls.

Even if you aren't in the market for a romanticized Fifth, or for a more reticent and introverted one (the best examples, Mravinsky's and Klemperer's, are deleted, in any case), you may still want something a bit brisker than the two at hand and even stricter than Ozawa's (or Szell's on Odyssey Y 30670). In which case, all signs point to Markevitch—an extraordinarily taut, rock-steady, and militantly intense reading that comes closer to Tchaikovsky's printed speed directions, and deviates less from them, than any other commercially available interpretation. Haitink or no, I hope Philips keeps Markevitch in print forever.

A.C.

TELEMANN: Don Quichotte (suite); Concerto for Viola and Strings, in G⁺; Overture for Oboes, Horns, and Strings, in D. Stephen Shingles, viola^{*}; Academy of St. Martin-in-the-Fields, Neville Marriner, cond. [Michael Bremner, prod.] ARGO ZRG 836, \$6.98.

Long before Richard Strauss in 1897 epiphanyed in music Cervantes' melancholy Don, Telemann composed an amusingly depictive eight-scene suite, a great favorite on discs some years back. But with the possible exception of the very first recording (by Fiedler's Sinfonietta, 1943), I've never heard it played more evocatively and pointedly than by Marriner, and it's

certainly never before been recorded with such gleaming transparency as it is now.

The same praise applies to the often-recorded viola concerto despite the fact that this work, one of the earliest and still best of its kind, has been recorded relatively often and by bigger-name virtuosos than Stephen Shingles of the St. Martin's Academy. (Compare the more romanticized solo playing and heavy-handed conducting of Zukerman in his recently issued Columbia version, M 33979.)

The late (1765) Overture in D is currently available in only one other version: an apparent second in Schwann is a different work entirely, but the right one by Douatte for Nonesuch (H 71124, 1966) offers Marriner's no challenge whatever. The new one reminds us what magnificent music Telemann was still capable of creating in his eighties. Quite comparable with Bach's suites, this work is itself actually a suite: beginning with an overture, sure enough, but going on to lighter movements intriguingly titled "Plainte," "Réjouissance," "Carillon" (unexpectedly using oboes and string pizzicatos for its chiming effects), "Tintamar," "Loure," and "Minuets." Delectably catchy, often exultant, invariably witty and invigorating music-making.

R.D.D.

B **VERDI: La Traviata.**

R Violetta Maria Callas (s)
Annina Ines Marietti (s)
Flora Ede Marietti Gandolfo (ms)
Alfredo Francesco Albanese (t)
Gastone Mariano Caruso (t)
Giuseppe Tommaso Saley (t)
Germont Ugo Savarese (b)
Baron Douphol Alberto Albertini (b)
Marquis d'Obigny; Doctor Grenvil
Mario Zorognotti (bs)

Cetra Chorus; Radio Italiana Orchestra, Turin, Gabriele Santini, cond. TURNABOUT THS 65047/8, \$7.96 (two discs, mono, automatic sequence) [from CETRA LPC 1246, recorded September 1953].

B **VERDI: Il Trovatore.**

R Leonora Caterina Mancini (s)
Inez Graziella Scutti (s)
Azucena Miriam Pflazzini (ms)
Manrico Giacomo Lauri-Volpi (t)
Ruiz; Messenger Mario Carlin (t)
Count di Luna Carlo Tagliabue (b)
Ferrando Alfredo Colella (bs)
An Old Gypsy Ezio Achilli (bs)

Radio Italiana Chorus and Orchestra, Turin, Fernando Previtali, cond. TURNABOUT THS 65037/9, \$11.94 (three discs, mono, automatic sequence) [from CETRA LPC 1226, recorded 1951].

Violetta was the role, after Norma, that Maria Callas sang most often: fifty-eight times, against eighty-four Normas, fifty-three Toscas, and forty-three Lucias. It was not one of her earliest parts; she did it first in Florence, in 1951, and then in several other productions before this Cetra recording was made in September 1953 (misdated 1954 in the Turnabout reissue) and published the following year.

Hearing the set again has provided some surprises. Once the sound of Callas' later Violettas was in one's ears, and the sight of them in one's eyes, this album tended to be left on the shelf. There are things in even earlier recordings of hers—the first Lucia, the first Tosca, the Puritani, the Cavalleria—to which one returns eagerly, but Violetta was a role that later she sang so

"I TESTED OUR NEW FM CAR RADIO IN THE HEART OF THE JUNGLE!"

by Steve Tillack

When I said "Take me down to Wall Street," the cabie thought I was nuts.

Then when I pulled out an FM car stereo and started testing it, he knew I was bananas. *Until* he heard the terrific music I got.



It all started two years ago. Pioneer wondered what would happen if you designed a car stereo to high fidelity specs. Nobody ever did that before. So Pioneer engineered the Supertuners. Four of them. With built-in cassette or 8-track. Muting. Local/distance switch. And a 1.8 dB capture ratio that pulls in FM stations like you never heard before.

Even on Wall Street.

Everybody knows those tall buildings are murder on FM reception. Signals bounce around like ping-pong balls.

But not our Supertuner. While the other FM radios were full of interference and stations piled on top of each other, Supertuner came in loud and clear.

The specifications say it's the best line of car radios ever built.

The cab driver says he's buying one. He gets enough static from his customers.

**THE PIONEER
SUPER TUNERS**



Pioneer Electronics of America, 1925 East Dominguez Street, Long Beach, California 90810

CIRCLE 44 ON READER-SERVICE CARD

What you don't know
about effective tip mass
won't hurt you,
just your records.



You can find out
what you don't know
by contacting us for our
comprehensive
cartridge brochure.

Bang & Olufsen

Bang & Olufsen of America, Inc., Dept. 11E
515 Busse Road, Elk Grove Village 60007

CIRCLE 10 ON READER-SERVICE CARD



Reflections On Wagner's Ring

John Culshaw has molded his acclaimed Saturday Metropolitan Opera broadcast intermission talks into a

No. 601 REFLECTIONS ON WAGNER'S RING. John Culshaw.
An invaluable compilation of information based on Culshaw's Saturday Metropolitan Opera broadcast intermission talks. **\$6.95**

No. 512 SEASON WITH SOLTI. William Barry Furlong.
A sustained close-up view of Georg Solti and his Chicago Symphony. Human and readable. **\$12.50**

No. 597 RECORDS IN REVIEW 20th Annual Edition Compiled and edited by Edith Carter.
A 553-page compilation of all reviews of classical and semi-classical records appearing in HIGH FIDELITY magazine during the preceding year. A bible for record collectors everywhere. The reviews are organized alphabetically by composer for quick, easy reference—and, in the case of composers frequently recorded, further subdivided by categories of music. In addition, there is a special section on recitals and miscellany, as well as a complete index of all performers reviewed during the year. **\$14.95**

Check or money order must accompany your order.
No cash or C.O.D.'s please.
Allow 60 Days for Delivery.

highly readable volume on Wagner's famed Ring. No opera lover—and certainly no student of Wagner—can afford to miss this masterpiece. To order, simply circle No. 601 on the coupon below.

"Reflections on Wagner's Ring" is only one of the wide selection of carefully chosen books made available to HIGH FIDELITY readers through Music Listeners' Book Service. (Many of the selections are not readily available in bookstores.) Choose your books today from the list below, circle the numbers on the coupon, and enclose your check or money order. That's all there is to it.

HIGH FIDELITY MUSIC LISTENERS' BOOK SERVICE Dept. HW 2160 Patterson Street, Cincinnati, Ohio 45214		
Here's my check for \$ _____ Please send me, postpaid, the books I've circled below.		
601	512	597
Name _____		
Address _____		
City, State & Zip _____		
HF-1076		

much more delicately, beautifully, eloquently that the recorded *Traviata* could be regarded as a sketch for what was to come. (Since Callas never re-recorded the opera, it is perhaps worth noting that private records have circulated of both the famous 1955 Scala production, with Di Stefano, conducted by Giulini, and of the Covent Garden performance of 1958.)

The sketch, however, has fine passages in it. In *The Record Guide Supplement*, Desmond Shawe-Taylor opined that the heroine was "far more distinguished [than Renata Tebaldi] in the first act and no less moving in the third, though with the usual moments of sour or shrill or excessively vibrating tone to offset her great virtues; Francesco Albanese sings Alfredo's music with considerable delicacy, Ugo Savarese makes a gentle, if not quite firm, Germont père; and Gabriele Santini conducts with great rhythmic vivacity and attention to light and shade. The recording is good, though it has some rough patches."

It doesn't sound quite that way to me. By comparison with Gianni Poggi on that early London set (now Richmond RS 63021), Albanese is indeed a marvel of delicacy, and he does sing with a feeling for phrase and emotion, but he is not the most graceful of Alfredos. Savarese is not an outstanding Germont, though he is better than many and never uncouth. Santini is less sprawly than London's Molinari-Pradelli. He gives slow, lush, heavily charged readings of the preludes, in the old style, which is rather pleasing to hear again. Most modern conductors take *La Traviata* too fast, but sometimes I find Santini too slow.

Callas' timbre in the opening exchanges is dark and tragic; it does not seem a very sparkling party, and through the first act there is a curious, uncommitted quality about the performance. It is not in the big numbers, but in the little dialogues—after Alfredo's aria and before the duet in Act II, and at the start of the last scene—that we hear most convincingly the "great" Callas, uttering the words beautifully and able to invest even the simplest phrases with dramatic life. Even at this time, her stage performances (I heard a Verona *Traviata* the previous year) were more vivid than this studio version. The recording may have much to do with it: The intense, poignant *filo di voce* that could steal through even the huge Verona Arena emerges from the speakers strangely colorless.

My old six-side version of this set (not on hand for comparison) was roughly pressed, but I think it was rather more immediate than the reissue. Compression may have affected the quality; it is now on four sides, three of them nearly thirty-two minutes long. The stretta of the Violetta/Germont duet and the Act IV finale are horribly distorted, and so is the third of the big phrases for the heroine that rise through the Act II finale. The Flora is dreadfully shrill and excitable. The standard cuts are made.

As a "document" of the soprano who was electrifying Europe, Mexico, and South America in the early Fifties, the set does of course have its value. Callas' power and her passion were apparent from the start; it is only by comparison with her own more supple, refined, and exquisitely molded

Odd Couple.

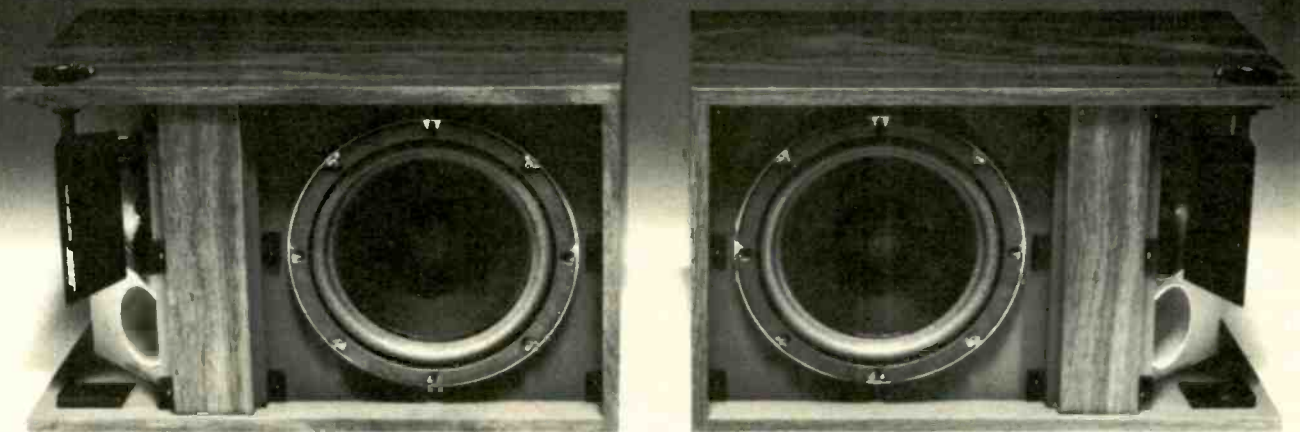

This is a pair of Bose Model 301 Direct/Reflecting® bookshelf speakers with their grilles removed.

What's odd about them might not be immediately obvious, but it's very significant. Unlike most pairs of speakers, they're not identical. Instead, the left-hand speaker is a mirror image of the right-hand speaker.

Bose goes to the extra trouble and expense of making the two speakers of the pair you buy different to provide the proper proportion of reflected and direct sound at high frequencies, a feature unique among bookshelf speakers.

To accomplish this, each speaker is of an "asymmetrical"

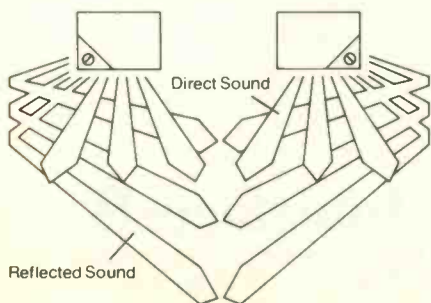

design. As a result, a pair of Model 301s has woofers pointing straight ahead and tweeters angled outward. A large proportion of the high frequency energy is reflected off the side walls and then into the center of the listening room, rather than being aimed directly at the listener. As in a live performance, the listener is surrounded with a balance of reflected and direct sound. This is the same principle used in the Bose 501 and in the legendary Bose 901® Direct/Reflecting speaker system. The result is extraordinarily open, natural, and spacious sound.

In addition, the Model 301 Dual Frequency Crossover™ network causes the woofer and tweeter to operate simultaneously for more than an octave, providing exceptionally smooth midrange response and an open spatial quality.

With the unique Direct Energy Control, the Model 301 provides excellent performance in a wide variety of rooms, including small apartments and dormitory rooms. And it is truly small enough to fit in a bookshelf.

These features make the Model 301 an unusual speaker with unusually fine performance. Its suggested retail price—less than \$100 per speaker—makes it an extraordinary value.

You already know the Model 301 looks different from other bookshelf speakers. Now visit a Bose dealer and hear how different it sounds.

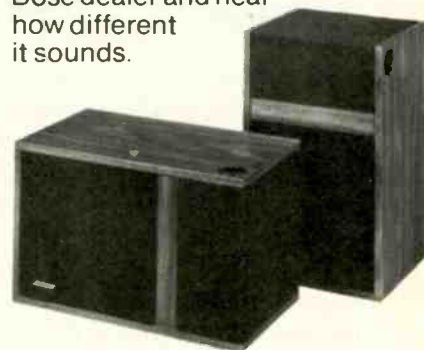

BOSE®

The Mountain
Framingham, Mass. 01701

Patents issued and pending.

For a full-color brochure on the Model 301, write: Bose, Dept. HF10, The Mountain, Framingham, Mass. 01701.

later performances that this one may be found disappointing. For the rest, the album "documents" what decent Italian second-string performances of its time were like. As an interpretation of Verdi's opera, it is not in the class of such earlier "historical" sets as the Gigli/Serafin *Ballo*, the Gigli/Caniglia *Andrea Chénier*, and the Dal Monte/Gigli *Butterfly* (all now on Seraphim), which gathered the best casts of their day and—except in recording quality—bear comparison with any later performances of those operas.

The *Cetra Trovatore*, a relic of Italian Radio's 1951 Verdi commemorations, need not detain us long. Its chief singularity is the star billing given to Inez: On the box, Lauri-Volpi's name is larger than any other, and then comes Graziella Scutti, the Inez. (Her singing is rather narrow and hard.)

Caterina Mancini had a large voice and a large style; for a while, the mantle of Maria Caniglia seemed to have descended on her, with all that that implies: grandeur and power and confidence, but a tendency for the singing to become undisciplined as the emotional temperature rose. There are some beautiful notes here, and beautiful phrases, especially in "D'omor sull'ali rosee," but there are several other Leonoras on record whom I listen to more eagerly. Lauri-Volpi is a brute in the serenade, and, from a powerful high D flat at the end of Act I onward, his chief care seems to have been to show how much voice he still had left at the age of fifty-nine. True, there are some of the famous "melting" notes in "Ah si, ben

mio," but "Di quello piro" is coarse. Carlo Tagliabue was a very sound, reliable baritone of not quite the first rank. Miriam Pizzini does not hit her notes cleanly in the center. Fernando Previtali was an underrated conductor, though one might not guess it from this *Trovatore*; given this cast, he seems to have settled for holding it together as best he can. The recording becomes badly constricted whenever the forces grow large. The duettino for Leonora and Manrico in Act III, "L'onda de' suoni mistici," is included, but otherwise the usual old cuts (including Leonora's "Tu vedrai che amore in terra") are made.

In each box there is a little Ricordi (Italian-only, and complete) libretto, its wrapper overprinted with the cast of the performance. A.P.

VIVALDI: Concertos for Violin and Strings (12), Opp. 11–12. Salvatore Accardo, violin; I Musici. PHILIPS 6747 189, \$23.94 (three discs, manual sequence).

What's in a name? Plenty! In record sales, anyway, if you compare the popularity of Vivaldi's "named" sets of violin concertos (*The Seasons*, *La Cetra*, etc.) with that of the unnamed present sets, the last two to which he gave opus numbers. They have been sparsely represented on records before now, and here we have them recorded in toto for the first time, as best I can tell. Yet these 1729 publications (most of them probably written earlier) include some of

the Red Priest's most mature and captivating compositions in this form: Op. 11, No. 2 (which does have an individual name, *Lo Favorito*); Op. 12, No. 3, a *ripieno* rather than solo concerto; Op. 12, No. 6; and the original violin version (issued first as No. 3 in Op. 9, *La Cetra*), which is sensibly substituted here for the oboe version of the music published as Op. 11, No. 6. Moreover, there are many exceptionally delightful single movements, such as the enchanting Andante aria of Op. 11, No. 3, and the bring-the-house-down finale of Op. 12, No. 5.

This whole album is an invaluable, even essential addition to the Vivaldian discography. I just wish I could recommend it as heartily as a source of musical enjoyment, but I can't—except perhaps to listeners who are not as put off as I am by soloist Accardo's romanticized, too stickily sweet (musically as well as tonally) playing or by I Musici's too often hard-driven performances. These are the same faults that bothered me in these artists' three Tartini concertos (6500 784, June 1975); if you could tolerate them there, you needn't be deterred from the present set. It is excellently recorded (at least if you ascribe the pervading tonal hardness to the players), and Michael Talbot's informative trilingual notes include a valuable table of applicable Pincherle and various other identification numberings. R.D.D.

WAGNER: *Tristan und Isolde*. For an essay review, see page 91.

We'd be nuts not to publicize these reviews.



Put yourself in our place. You've designed what you believe is an exceptional speaker system—the vented, equalized Interface:B. And then the reviewers agree. That really makes it all worthwhile.

The *Stereo Review* test, 4/76. "It retains virtually all the features and fine acoustic qualities of the Interface:A." "The dispersion of the highs was excellent—easily as good as we have ever heard from a forward facing cone driver and rivaling that of most dome radiators." "The bass was true and powerful when the program material called for it." "The



efficiency of the Interface:B was relatively high for a small enclosure..."

The *High Fidelity* test, 4/76. "The peak level sound produced (114 dB) bespeaks good dynamic range." "...we found that fundamental bass tones remain audible to about 38 Hz. High frequencies are there up to about 17.5 kHz and are well dispersed, remaining audible to about 45 degrees of axis." It produces a well blended sound..." "It is capable of making a modest audio system rise to new heights—and, at quite an attractive price."

We've published a book with these excellent reviews reprinted in full. For a copy, write us or see your E-V dealer.

Interface: B™

Electro-Voice, Inc., a Gulton company
619 Cecil Street, Dept. 1064H, Buchanan, Michigan
49107

CIRCLE 67 ON READER-SERVICE CARD

B **WAGNER:** *Wesendonck Lieder**; *Siegfried: Final Scene*†. Eileen Farrell, soprano; Set Svanholm, tenor†; Leopold Stokowski and his Symphony Orchestra*; Rochester Philharmonic Orchestra, Erich Leinsdorf, cond.*. RCA VICTROLA AVM 1-1413, \$3.98 (mono) [* from LM 1066, recorded c. 1947; † from LM 1000, recorded c. 1949].

B **WAGNER:** *Götterdämmerung: Immolation Scene; Tristan und Isolde: Prelude and Liebestod*. Eileen Farrell, soprano; Boston Symphony Orchestra, Charles Munch, cond. [Peter Dellheim, prod.] RCA GOLD SEAL AGL 1-1274, \$4.98 [from LSC 2255, recorded c. 1958].

Comparison—*Lieder, Immolation:* Farrell, Bernstein/N.Y. Phil.

In Col. D3M 32992

The records listed above comprise the entire commercially published evidence in the case of this century's most notable Wagnerian noncareer, that of Eileen Farrell. When the Stokowski-accompanied *Wesendonck Lieder* first appeared on 78s, the general opinion was that America's next great voice, the eventual successor to Helen Traubel, had been found. The *Siegfried* scene seemed to confirm that, even though the lack of theatrical experience was clearly evident.

After this, Farrell began to turn up regularly as soloist in all-Wagner concerts, singing the standard excerpts. She took on difficult assignments, such as Marie in the Mitropoulos concert *Wozzeck* (Odyssey Y2 33126). In 1955 she made rather a powerful

impression in a concert version of Cherubini's *Medea* (later recorded in part on Odyssey Y 32358). Some out-of-town appearances in stage performances followed, and she finally reached the Met in 1960, in Gluck's *Alceste*. Later she sang *Gioconda*, the *Forza Leonora*, *Chénier's Maddalena*, and *Santuzza* there, and took part in the concert version of Falla's *Atlántida* during the opening week of Lincoln Center (a bit of casting that reputedly lost the Met the services of Victoria de los Angeles, who, as Spain's leading singer, felt she should have been asked).

These Met appearances generated limited enthusiasm; for reasons that seem to have involved temperament more than Farrell's obvious physical limitations (which were certainly no worse than those of several singers who made notable careers in the same repertory; cf. my review of Odyssey Y 31739, April 1973). In the meantime, the repertory that Farrell seemed best suited to was sometimes in the hands of Birgit Nilsson, but on many nights in those of Anita Väkki, Gladys Kuchta, Ludmila Dvořáková, and the like. Whether this stemmed entirely from diffidence on her part (she has on occasion in interviews evinced a lack of enthusiasm for Wagner) or from some prejudice of management's, it seemed—and still seems—a serious misapplication of her talents and resources. She sang at the Met sporadically until 1966, since when her operatic career has effectively lapsed, though concert appearances have continued, including several lengthy

Wagnerian enterprises with Leonard Bernstein and the Philharmonic. (Some of these, including Act I of *Walküre*, have circulated on pirate discs.)

The early recordings on the Victrola disc are pretty much as one remembers them, tonally impressive and interpretively bland. The most plangent criticism of the early *Wesendonck Songs* comes from the singer herself, in her 1961 remake with Bernstein (unfortunately now available only in a three-disc miscellany of Wagnerian snippets), impressive evidence of artistic growth. The later version, subtly colored, sensitively enunciated, and confidently shaped, is still probably the best orchestral version of these songs around, while the early one is just a splendid young voice treading somewhat gingerly through unfamiliar words and notes. Connoisseurs of Stokowski-isms will observe certain affectations—the last note of the main motive of "*Im Treibhaus*" barely sounded, for example—but for the rest, this can be relegated to the historical curiosity shelf, as can the *Siegfried* duet with its dramatically inert Brünnhilde. Svanholm, dry but vigorous, did himself equal justice in the slightly later version of the duet with Flagstad (Seraphim 60082), though this one includes his opening lines before the lady wakes up. (It originally included the entire orchestral interlude depicting Siegfried's ascent of the mountain, but that has been excised in this new issue to make room for the songs.) Leinsdorf gets remarkably good results from his provincial orchestra.

A "noteworthy example of intelligent engineering" that "transcends the commonplace" and "is, simply, a great speaker system."³



We couldn't have said it better ourselves.

In our time, the vented, equalized Interface:A has received a small deluge of complimentary reviews from high fidelity magazines. Including the one you're reading.

¹The *Stereo Review* test, 3/74.

"Interface:A can deliver a level of undistorted bass far superior to any other speaker its size we have tested."

²The *High Fidelity* test, 2/74.

"... unusually flat (plus or minus 1 3/4 dB from 63 Hz to 16 kHz!) in the omnidirectional measurement."



³The *Stereo & Hi-Fi Times* test, 4/75. "... clarity of the bass is most impressive."

The *FM Guide* test, 4/75. "... we measured sound pressure levels of 110 dB during the very loud passages ... the systems handled such musical moments with ease."

The *Sound* test, 2/76. "The on-axis position results in an exceptional curve which is — by speaker standards — virtually flat from 100 Hz out to 20 kHz."

The reviewers are convinced. Maybe you should be too. We've published a book with these sparkling reviews reprinted in full. For a copy, write us or see your E-V dealer.

Interface:A™

Electro-Voice, Inc., a Gulton company
619 Cecil Street, Dept. 1064H, Buchanan, Michigan
49107

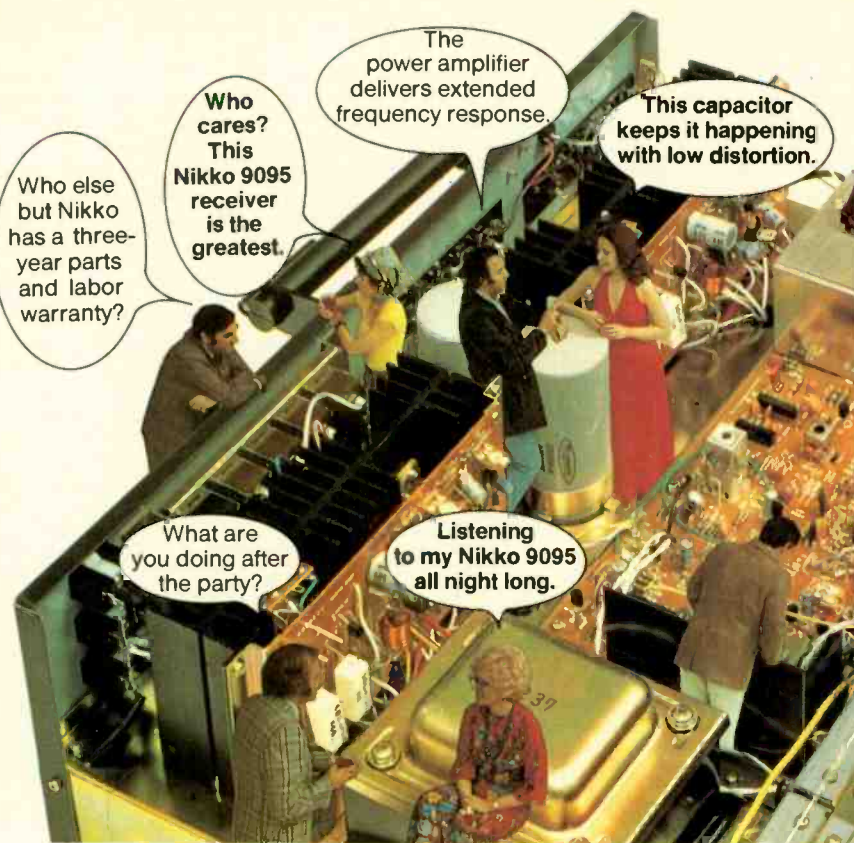

16270 Raymer, Van Nuys, California 91406
In Canada: Superior Electronics, Quebec, Canada

CIRCLE 38 ON READER-SERVICE CARD

EXCITING NEW CONCEPT IN AUTOMATIC RECORD CARE

- KEEP YOUR RECORDS IN MINT CONDITION
- ADD YEARS TO ALL ALBUMS
- REDUCE STYLUS WEAR

vac @ rec®

Vacuum Cleans and Reduces Static automatically . . . safely . . . in seconds!

Ideal care for all records—33½, 45, 78 RPM

In just 30 seconds VAC-O-REC safely vacuum cleans and reduces static automatically. Soft, resilient natural mohair brushes reach deep into grooves to gently loosen and lift damaging micro-dust particles. Vacuuming action immediately removes dust. Static reduction circuit reduces dust-attracting electromagnetism to near neutral voltage.



Available at all Leading Hi-Fi Dealers

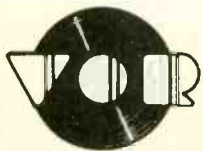

VOR INDUSTRIES

1440 S. State College Blvd., Anaheim, Calif. 92806
(714) 635-2400

CIRCLE 61 ON READER-SERVICE CARD

Comparison of the two Immolation Scenes sheds light on another aspect of the Farrell question. She wasn't, apparently, a self-starter by temperament, and to Munch's slack leadership she responds with a placid, understated performance. Bernstein, on the other hand, elicits from her genuine intensity in the earlier pages, real excitement later on; for all his occasional crude overemphases, his performance has vitality and impetus, and Farrell grabs ahold of it. (The recorded sound is richer and stronger, too.) Munch does little better with the Tristan material, so one can't help concluding that the essential Farrell Wagner is to be found on the Columbia disc. (Columbia gives texts and translation, RCA neither.) D.H.

WALDTEUFEL: Waltzes. National Philharmonic Orchestra, Douglas Gamley, cond. [Michael Woolcock, prod.] LONDON CS 6899, \$6.98.

Les Patineurs, Op. 183; Mon Réve, Op. 151; Toujours ou jamais, Op. 156; Les Grenadiers; España, Op. 236; Dolores, Op. 170; Pomone, Op. 155.

While Emil Waldteufel may be no match for Johann Strauss II as a symphonic-waltz poet, he is Strauss's peer as an inspired creator of irresistibly intoxicating waltz tunes, as demonstrated so persuasively in *Toujours ou jamais*, *Dolores*, and *Pomone*. He deserves to be known for more than the inevitable *Skaters*, and he once was: In my *Gramophone Shop Encyclopedia of Recorded Music* of 1936, I listed no fewer than twenty-two of his waltzes available on disc.

That said, I'm regretfully forced to recommend the present release only with strong reservations. Programmatically it's fine, with two selections—*Toujours ou jamais* and *Dolores*—not included on Henry Krips's excellent 1958 Waldteufel disc with the Philharmonia Promenade Orchestra (Angel S 35426, out of print since 1970). Technically it boasts wondrously vivid, full-blooded sonics. But Douglas Gamley, a British specialist in Proms/Pops programs, does justice to the music only in its and his more relaxed moments. Too often he is brutally overemphatic. If you should be lucky enough to dig up a copy of the OP Angel disc, grab it. R.D.D.

Recitals and Miscellany

MARIAN ANDERSON: Spirituals. Marian Anderson, alto; Franz Rupp, piano. [Peter Dellheim, reissue prod.] RCA VICTROLA AVM 1-1735, \$3.98 (mono) [from RCA Victor LM 2032, recorded 1947 and 1952].

Deep River; He's Got the Whole World in His Hands; Roll, Jerd'n, Roll; Go Down, Moses; Crucifixion; Sometimes I Feel Like a Motherless Child; Let Us Break Bread Together; Plenty Good Room; Everytime I Feel de Spirit; If He Change My Name; O What a Beautiful City! [recorded 1952]. Nobody Knows the Trouble I See; Hear de Lam's a-Cryin'; My Lord, What a Morning; Were You There?; On Ma Journey; De Gospel Train; Soon-a Will Be Down; Sln-

JBL Loudspeaker Components



Twelve brand new pages. Forty-seven JBL components—dividing networks, lenses, horns, transducers, everything.

Lots of these goodies have never been available as individual components before. (They've been performing inside JBL's newest professional studio monitors.)

Write us. We'll send you the catalogue, free, along with the name and location of your nearest

authorized JBL Loudspeaker Components Dealer.

He's important. Besides all those components, he's got a fresh supply of the new JBL Enclosure Construction Kits that tell you everything you need to know about building your own JBL enclosure.

Fill out this coupon and send it along to JBL, the people who wrote the book on sound.



3249 Casitas Avenue
Los Angeles 90039

Gentlemen:
I can't beat the price. Send
me the book.

Name _____

Address _____

City _____ State _____ Zip _____

James B. Lansing Sound, Inc.
High fidelity loudspeakers
from \$99 to \$3210.

dbx 128 tape copies sound better than your records



First, you play your favorite records, tapes or FM broadcasts through the expander section of our Model 128 to restore missing dynamics and reduce noise that's been robbing you of live performance realism.

Then, you preserve the dynamics of this vibrantly enhanced program by copying through the 128 noise reduction section to eliminate tape hiss normally added by copying.

Finally, you play back your taped copy through the decoder of your dbx 128 and hear music with more dynamic range and detail than you've ever heard before off any tape. Sound unbelievable? Well, it was until the dbx 128 came along. But now you can make dynamically enhanced copies that sound better than the originals, with no hiss build-up, on any open-reel, cartridge or cassette recorder.

To learn how, ask the dbxpert at your local dealer for a demonstration of the new dbx 128. For full product information and a list of demonstrating dbx 128 dealers, circle reader service number or contact:

dbx, Incorporated, 296 Newton Street
Waltham, Massachusetts 02154 • (617) 899-8090

CIRCLE 13 ON READER-SERVICE CARD

dbx

ner. Please; Honor, Honor; Ride On, King Jesus [recorded 1947].

The elevation of Marian Anderson into a national institution came about so soon after her spectacular appearance at Town Hall in December 1935 that her exceptional vocal and musical qualities were soon obscured by her indeed historic social role. Too, she remained active when the vocal endowment had markedly dwindled—not that an Anderson recital ever failed to communicate powerfully, but those who heard her only in the later years missed the full range of her extraordinary artistry. And those who turn to the currently available recordings will find precious little of the very best Anderson: the recordings of the 1930s, when she had freshly returned from Europe. The Brahms songs on RCA LM 2712, from 1939 and 1941, do show what she could do in her prime (and even those that are burdened with grotesque orchestral accompaniments at least suggest the clarion quality of the voice when extended), but everything else now listed is later and less magnificent.

The present collection of spirituals, now lowered in price category from Red Seal to Victrola, is far from negligible. The communication is so direct—the words roll out so naturally on a tone still remarkably firm at all dynamic levels—that one might easily overlook the canny shaping of lines, the subtle changes of color (on "Lord," in "Deep River," for example), the rock-steady rhythmic swing, all of which combine to make the experience so rich and varied.

One may even overlook the vibrato that in Anderson's earliest recordings appears to come and go at the singer's command but in 1947, and especially in 1952, was evidently less voluntary; in these recordings, too, there is occasional uncertain pitching. Still remarkable is the voice's over-all coloristic range, each song characterized with an unmistakable primary color that sounds different from every other one.

But if you have heard Miss Anderson's first recordings of these pieces (i.e., the ones with Kosti Vehanen at the piano), you will find the Victrola versions wanting. Why, when perfection was sitting in its vaults, did RCA settle for something less? How about making amends with a package of those early recordings—the Schubert and Sibelius songs as well as the spirituals? That would be an occasion for celebration.

D.H.

ALICIA DE LARROCHA: Spanish Encores. Alicia de Larrocha, piano. [Michael Woolcock, prod.] LONDON CS 6953, \$6.98.

"Spanish Encores" may suggest a collection of "Ritual Fire Dance"-like pieces; in fact this is a fascinating and memorable recital from every standpoint. The repertory ranges from the Scarlatti-derived sonatas of Matteo Albéniz and Antonio Soler (gems one and all, especially in such exquisitely lapidarian performances) through the Romanticism of Isaac Albéniz (six pieces) and Granados (the famed "Andaluza" and one of its less celebrated companion Spanish Dances, the "Valenciana") to the spicy near-modernism of Turina (his "Sacro-Monte" and "Zapateado").



The TL-3 won't replace your speaker systems, but it will give them some rest.

If you're a typical music lover, you've invested several hundreds of dollars—perhaps thousands—in your component system. Plus a lot of time and thought. But you can't always use that system at its best.

Some speaker problems solved by headphones

Not everyone in the house wants to hear what you want to hear. Or when. Or that loud. So from time to time, you miss the impact of the full dynamic range that only high level listening can achieve.

Even when you're alone, you may not always be satisfied. The room acoustics may be tricky, or the seating arrangement not quite right for critical listening.

If you recognize any of these situations, chances are you've been doing all your listening via speakers. Which means you've never experienced headphones at their best.

Provide unique listening experiences

Headphones do more than merely solve some speaker problems. They provide a unique listening experience of their own. They bring you into more intimate contact with the music. They achieve wider frequency response, with more brilliant highs. In fact, some experienced audiophiles believe that headphones come closer to the ideal than speakers.

The TL-3 wins most auditions

If we've stimulated or rekindled your interest in headphones, keep these thoughts in mind the next time you visit your audio dealer. When you're there, you should audition our lightweight trans-linear TL-3. Rather than attempt to describe the "shimmering highs" and "thundering bass" achieved by its Mylar* driver, we'll just mention what most music lovers (including audio specialists) have experienced with this remarkable phone. When they compare it with any other phone, at any price, they prefer the TL-3.

They like its sound, especially its full bass response. They like its foam-cushion comfort. And its modest price (\$40) is a pleasant surprise. It's very little to pay for so much additional pleasure that your speakers alone can never give you.

*Mylar is a registered DuPont trademark.

 **SUPEREX**
PRODUCTS WITH A DIFFERENCE

151 Ludlow St., Yonkers, N.Y. 10705
In Canada: Paco Electronics Ltd., Montreal

Mme. de Larrocha's command of this material is well known, even legendary. She has the most beautiful trills imaginable, and her wonderfully spare textures are perpetually enlivened by gracefully scintillating rhythms and brilliant accentuation. Though her playing is too linear to be called sensual (at least in the erotic, Stokowskian sense), its color and personality make it a definite "turn-on."

It remains to be added only that the artist's superb natural musicality—quite a different thing from sophisticated musicianship, a quality De Larrocha also displays here—has been ideally served by the crisp, biting reproduction of her instrument. That London can produce such intimate piano sound in the resonant reaches

of Kingsway Hall, the site that yielded such unwieldy clatter in Ashkenazy's recent *Kreisleriana*, shows how important microphone placement can be. H.G.

NEVILLE MARRINER: American Orchestral Works. Academy of St. Martin-in-the-Fields, Neville-Marriner, cond. [Chris Hazell, prod.] ARGO ZRG 845, \$6.98.

IVES: Symphony No. 3 (*The Camp Meeting*). **BARBER:** Adagio for Strings. **COPLAND:** Quiet City (with Cella Nicklin, English horn; Michael Laird, trumpet). **COWELL:** Hymn and Fuguing Tune, No. 10 (with Cella Nicklin, oboe). **CRESTON:** A Rumor.

This made-in-England release contains an impressive cross section of modern American music, all of it fairly conservative. Even

the Ives Third Symphony (1901-4) is one of that composer's tamer works, much of it (particularly the second movement) sounding like a rather disjointed Mendelssohn—a style with which, I might add, conductor Neville Marriner obviously identifies. Yet a heady primitiveness seeps through here and there in the ingenuousness of the strangely archaic chorale progressions, which at several points (such as the opening) bring to mind the music of Erik Satie.

Both in its scoring (English horn, trumpet, and string orchestra) and in its wide-spaced harmonic structures, Copland's *Quiet City* (1940) strongly evokes a feeling of openness and loneliness that I somehow associate with a certain brand of American theater. The very contrapuntal Cowell *Hymn and Fuguing Tune No. 10*, for oboe and string orchestra (1955), has to it a folksy simplicity (not unlike what one hears in parts of the Ives) that does not represent my favorite side of Cowell. Paul Creston's bantering *A Rumor*, on the other hand, is a perfect example of the rhythmic and instrumental vitality that pervades that composer's best works.

Marriner and his forces concentrate strongly on unified sound, a tendency that peaks in the almost excessively vibrant shimmer imparted to the climax of the deeply elegiac Barber Adagio. And although this approach makes for rewarding listening, especially combined with the excellent Argo engineering, it strikes me that Marriner makes everything just a bit too smooth, both in the vertical textures, whose component parts are not delineated enough, and in the transitions—particularly in the Ives—which are toned down in favor of a kind of facile limpidity. The performances sound far from "wrong," however, and the repertoire and sonics make this release quite attractive. R.S.B.

OUR MUSICAL PAST: A Concert for Brass Band, Voice, and Piano. Merja Sargon, soprano; Bernard Rose, piano; brass band, Frederick Fennell, dir. LIBRARY OF CONGRESS OMP 101/2, \$10 plus 50¢ postage (two discs; Recorded Sound Section, Music Division, Library of Congress, Washington, D.C. 20540).

BENEDICT: The Rose of Erin; Hunters' Chorus. **DÓMI-ZETTI:** Don Pasquale; O Summer Night. **FOSTER:** Ah! May the Red Rose Live Alway; Old Memories; Why, No One To Love? **LINDBLAD:** The Herdsman's Mountain Song; Upon a Summer Day (in Swedish). **GRAFULLA:** Captain Shepherd's Quickstep; Captain Finch's Quickstep. **JAEGER:** Indiana Polka (arr. Schatzman). **FARMER:** Moonbeam Waltzes (arr. Downing). **LYSBERG:** La Fontaine. **NOEREN:** Midnight (arr. Schatzman). **WALLACE:** Scots Wha Hae Variations. **KNAEBLE:** General Taylor Storming Monterey. **FRIEDERICH:** Lilly Belle Quickstep. **GOODWIN:** Door Latch Quickstep. **BALFE:** The Bohemian Girl; The Heart Bowed Down. **DOWNING (arr.):** Free and Easy.

After bringing out some ninety records devoted to folk music, the Library of Congress has at long last broken its own precedent and issued a two-record album devoted to music written, for the most part, by identifiable composers. "Our Musical Past" is perhaps an overly ambitious title, however, since the album explores only one small dark corner of our musical heritage—that is, the style and quality of American popular music during the 1850s and 1860s.

"Our Musical Past" is, in fact, an attempted re-creation of a concert for brass

We're the fastest selling speaker you've never heard of



We're a small company with a big idea. To produce quality loudspeakers at a reasonable price. Something everyone claims — then spends more on advertising than on research and craftsmanship.

For the past year and a half a group of us in Vermont have been achieving that idea — quality and reasonable price. But it hasn't left anything for advertising, so unless you've been to one of our dealers, you've probably never heard of us.

Acousti-phase speakers start at \$79, and incorporate a bass port at the rear of a heavy unyielding enclosure; employ massive woofer, efficient midrange drivers, mylar dome tweeters and sophisticated crossover networks. The results are highly efficient speaker systems with flat response that can be driven with less than 10 or as much as 100 watts per channel.

Acousti-phase

A Tribute to Sound

CIRCLE 64 ON READER-SERVICE CARD

THE PREMIUM CASSETTE PLAY-OFFS.

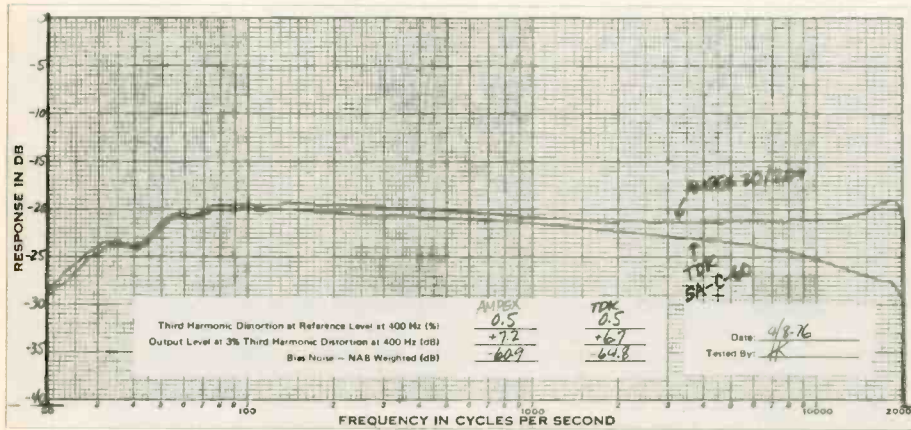

AMPEX 20/20+ VS. TDK SA.

THE WINNER: AMPEX.

Play-offs were held April 8, 1976 in the Ampex Magnetic Tape Research Laboratory at Redwood City, California, using a Nakamichi-1000 cassette deck at standard factory bias setting and following each tape manufacturer's play-back instructions. We measured frequency response at a record level 20 dB below 200 nwb/m, third harmonic distortion at zero dB (200 nwb/m, 400 Hz), output at 3% third harmonic distortion (400 Hz), and N.A.B. weighted noise. C60 cassettes were used. The photos are unretouched chart recorder output. You can see why Ampex 20/20+ is the best quality cassette you can buy.

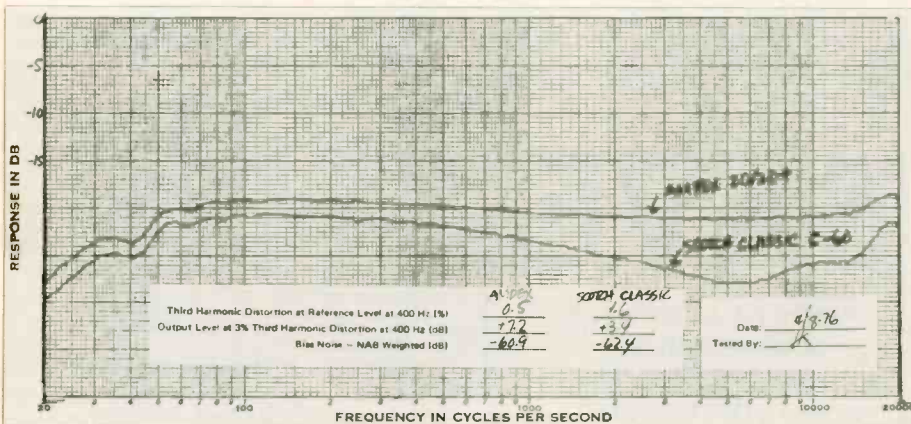

AMPEX 20/20+ VS. SCOTCH CLASSIC.

THE WINNER: AMPEX.



AMPEX
The best cassette yet.

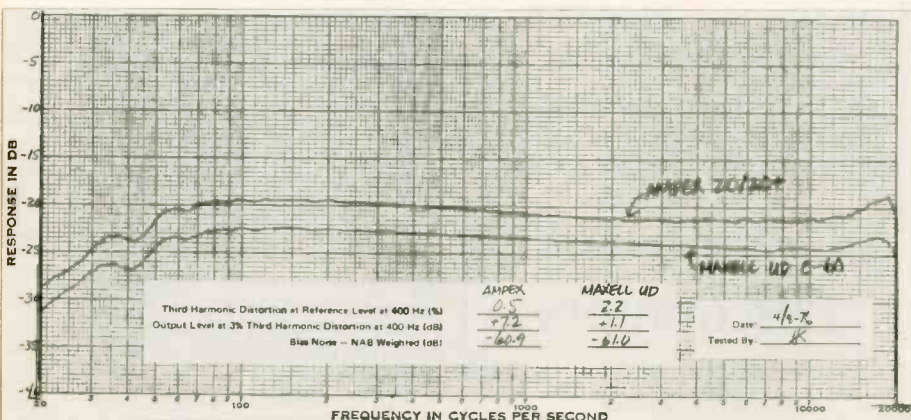

AMPEX 20/20+ VS. MAXELL UD.

THE WINNER: AMPEX.

CIRCLE 62 ON READER-SERVICE CARD

DIXIE SAVE ON Brand Name Audio Components

BY MAIL

Write Today for Our **FREE**
Direct to Consumer Audio Catalog

DIXIE is one of the oldest and largest audio component mail order houses in the country. Our prices on brand name components are actually **LOWER** than "Discounters". See our new catalog or call us for a price quote. Everything shipped factory-sealed with full manufacturer's warranty.

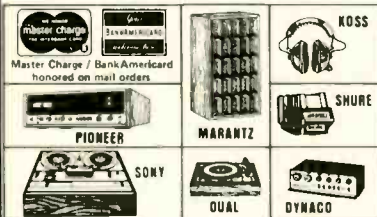

DIXIE HI-FIDELITY

2040 Thalbro St., Richmond, VA. 23230
Phone: 1-804-257-4241

Please rush me your **FREE** Audio Catalog and complete information. I understand there is no obligation.

Name _____
Address _____
City _____
State _____ Zip _____ HF-10

SAVE!

MONEY • TIME • FREIGHT

- 🎵 QUALITY STEREO EQUIPMENT AT LOWEST PRICES.
- 🎵 YOUR REQUEST FOR QUOTATION RETURNED SAME DAY.
- 🎵 FACTORY SEALED CARTONS—GUARANTEED AND INSURED.
- 🎵 SAVE ON NAME BRANDS LIKE:

A.D.C.	KLH
A.R.	SHURE
DYNACO	KOSS
FISHER	SONY

PIONEER
AND MORE THAN 50 OTHERS
BUY THE MODERN WAY
BY MAIL—FROM

illinois audio

Department 217H
12 E. Delaware Place
Chicago, Illinois 60611
312-664-0020

CIRCLE 25 ON READER-SERVICE CARD

band, voice, and piano that might have taken place in our land ten or fifteen years before the Civil War. And it also is more or less a duplication of a concert that actually took place in 1974 in the Coolidge Auditorium under the direction of Frederick Fennell, in which authentic instruments of the period (including saxhorns, tenor horns, cornets, and an 1850 Chickering square grand) borrowed from the collections of the Smithsonian Institution were utilized.

Jon Newsom, head of the Reference Section of the Library's Music Division, has spent a considerable amount of time exploring this particular byway of our music history, and he states that it was customary in those days to add variety to band concerts by featuring a vocal or piano solo every now and then. Thus, the presence of soprano Merja Sargon and pianist Bernard Rose is not without precedent.

As one might expect from the Library of Congress, the album is extensively annotated, by Newsom. He devotes considerable space in the handsome accompanying booklet to the history of the brass instruments in addition to very thorough annotations of the rather esoteric repertory, much of which was taken from the manuscript band books of the Manchester (New Hampshire) Cornet Band and the Port Royal (South Carolina) band books of the Third New Hampshire Volunteer Infantry.

Fennell's eighteen musicians make astonishingly pleasant music out of such strange materials as Sir Julius Benedict's *The Rose of Erin*, Claudio S. Grafulla's *Captain Shepherd's Quickstep*, and Henry

Farmer's *Moonbeam Waltzes* in brass-band arrangements. The orotund, mellow sound of the all-brass ensemble (nameless in the recording) combined with the astounding virtuosity demanded by the band arrangers of the era make listening to this kind of thing more of a pleasure than a chore.

I did not find myself quite so pleased with the vocal and piano selections, however. Sargon does quite well with the pair of Lindblad songs (sung in the original Swedish) and the Balfe aria from *The Bohemian Girl*. But her Foster is completely outclassed by Jan DeGaetani (Nonesuch H 71268), and I found myself wishing that other selections had been substituted for the three Foster items. Bernard Rose's artistry was not helped at all by the boxy, constricted sound of the Smithsonian's Chickering, and his two solo selections, Lysberg's *La Fontaine* and Wallace's variations on Scots *Wha Hae*, were the most expendable pieces in the album.

The sound is excellent, and the surfaces are just about noiseless. Even though the ground covered is minuscule, this set must be classed as one of the more memorable releases inspired by the Bicentennial. I.L.

VLADIMIR PLESHAKOV: Poets of the Piano. Vladimir Pleshakov, piano. [Giveon and Mar-ion Cornfield, prod.] ORION ORS 75178, \$6.98.

DUSSEK: La Consolation, Op. 62. **HUMMEL:** Rondo-Fantasy in E, Op. 19; Sonata in F minor, Op. 20. **VOŘÍŠEK:** Sonata in B flat minor, Op. 20.

This collection supplements not only Pleshakov's own recordings of sonatas by Dussek (ORS 7296), Woelfl (ORS 6901), and Rust (ORS 7023)—all lesser-known but distinguished exponents of the classical tradition—but also Rudolf Firkusny's excellent Dussek/Benda/Voříšek/Tomášek record (Candide CE 31086, October 1975). These compositions are without exception superbly crafted and decidedly worth anybody's time.

The Voříšek B flat minor Sonata, in fact, strengthens my suspicion—roused by the lovely A major Impromptu recorded by Firkusny and the impetuous D major Sinfonia recorded by Charles Mackerras and the English Chamber Orchestra (Philips 6500 203)—that we have somehow overlooked a truly great master. (There is a vast stockpile of unrecorded Voříšek works available to help reach that verdict.) This fiery, starkly individual sonata speaks with an original and quite unique voice. By comparison, the other works on this disc, fine as they are, often tend to sound a bit like other things—hints of Mozart, Weber, et al.

Pleshakov turns in his characteristically sturdy, workmanlike performances. The Shanghai-born, Russian-American pianist has a forthright, efficient technical address, which he uses with scrupulous honesty and—as far as it goes—sensitivity. A bit more tonal chiaroscuro, flexibility of rhythm, and charm (*real* charm, not Viennese-style affectation!) would lift his super-competent pianism into the realm of real artistry. Orion's reproduction is slightly reverberant but also uncomfortably proximate; the close pickup sometimes makes fortes harshly percussive. H.G.

SAVE

TOP QUALITY GEAR
LOWEST PRICES
PROMPT DELIVERY
SAVE ON FREIGHT
SELECTION

GARRARD **BSR**
KENWOOD **DYNACO**
B.I.C. **SANSUI**
DUAL **PIONEER**
and more than 50 others

PLEASE REQUEST PRICE QUOTATIONS ON YOUR CHOICE OF QUALITY STEREO GEAR

Component Discounters

Dept. 10HF
17565 Meadowood
Lathrup Village, Michigan 48076
313-559-1270

THE FRONT ISN'T THE ONLY PLACE THIS DECK IS LOADED.

Front load design means you can stack this deck anywhere; you put your components together the way you want them; no more tail wagging the dog.

Cue and Review function lets you pick out your selection when you fast forward or rewind a tape.

Self locking pause control stops transport in play or record without canceling that mode.

Built-in Dolby-B noise reduction system helps eliminate tape noise without impairing overall frequency response.

Separate bias and EQ switches for standard and Chromium tapes.

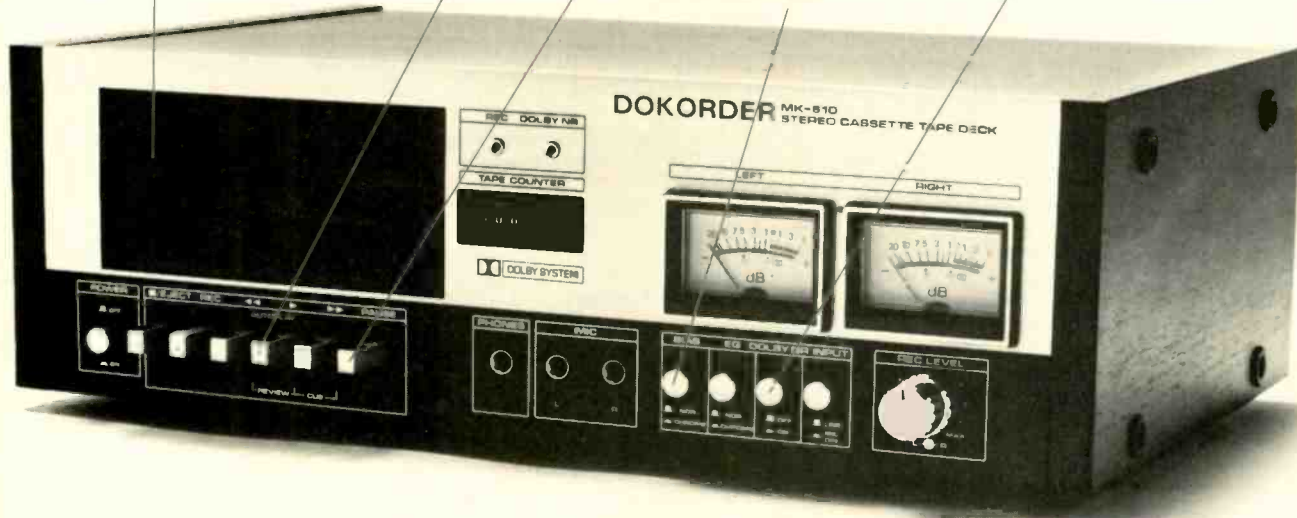

The MK-610 Front Loading
Cassette Deck with Dolby.
Suggested retail price
\$249.95.

DOKORDER

5430 Rosecrans Avenue Lawndale, CA 90260

CIRCLE 15 ON READER-SERVICE CARD

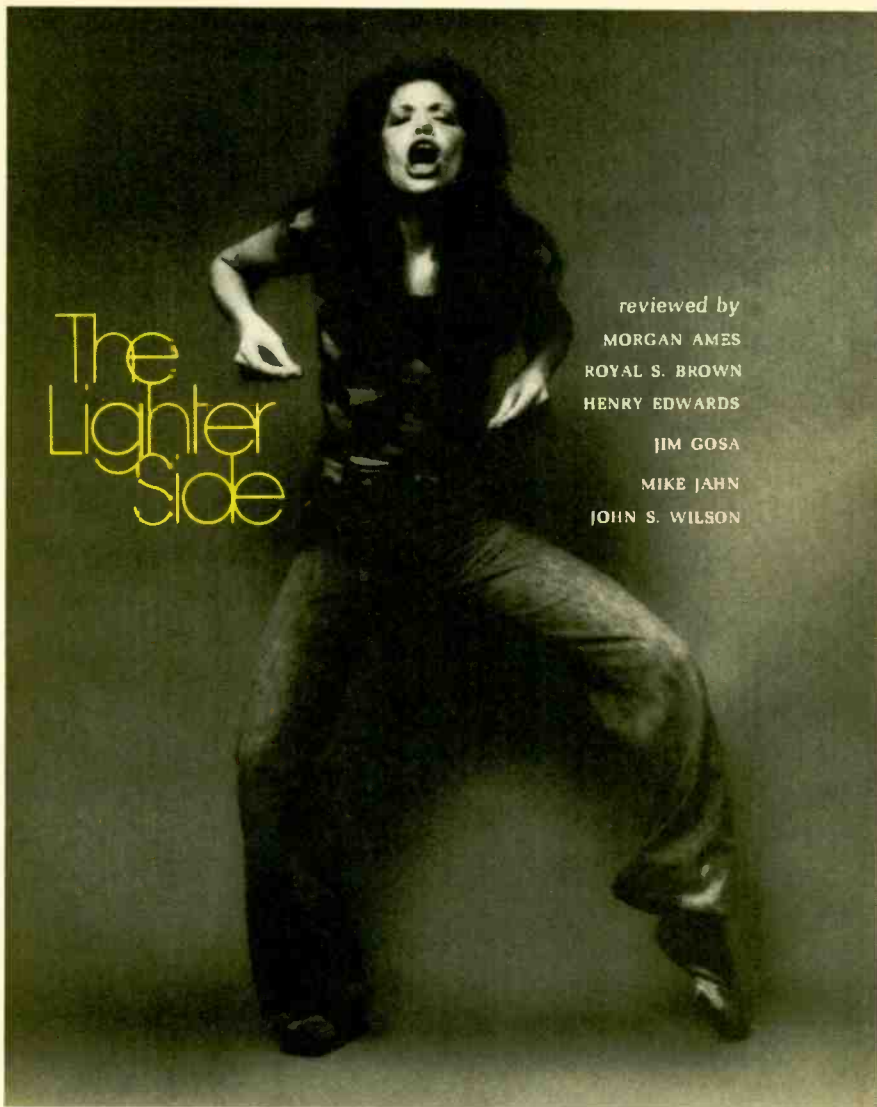

The Lighter Side

reviewed by
 MORGAN AMES
 ROYAL S. BROWN
 HENRY EDWARDS
 JIM GOSA
 MIKE JAHN
 JOHN S. WILSON

Carly Simon—an artist who succeeds on her own terms.

* **CARLY SIMON:** Another Passenger. Carly Simon, guitar, keyboards, vocals, and songs; instrumental accompaniment. *Half a Chance; Fair-Weather Father; Cow Town; Riverboat Gambler; Be with Me; Darkness 'til Dawn*; six more. [Ted Templeman, prod.] ELEKTRA 7E 1064, \$6.98. Tape: ●● TC5 1064, \$7.97; ● ET8 1064, \$7.97.

The first time I saw Carly Simon, like the first time I saw Carole King, was as an introductory act to more famous performers. I've forgotten who the "famous" people were, but I know who Carly and Carole are: undoubtedly the most successful female singers/composers in the business. Despite the temptation to pander, to stick with the formula that worked the last time, they remain artists who, in my estimation, succeed on their own terms.

In "Another Passenger," Simon again manages to insinuate herself into some crevice of our own experience with nearly every song. Somehow it's comforting to know that someone else has the same foibles and fears and failings that we recognize and regret or maybe even deny in ourselves. It's too much to expect a simple song to supply an answer or a solution to our

wonderings and our problems. But here's Carly saying, "A storm can never rage forever/and darkness only lasts 'til dawn . . ." or "Why are you in such a hurry/To be lonely one more night?/I know what it means to hide your heart/From a long time ago . . ." At least there's someone to empathize and understand.

I've often wondered how a song-writer can continue to invoke the Muse. What can you do when you have to have two more tunes to fill out an album, and you don't have them? How did Cole Porter, say, or Rodgers and Hart, Irving Berlin, et al., keep them coming for so many years? To be sure, they hit some clinkers sometimes. But their songs were the standards—not just in the music-biz definition, but the standards of excellence by which other songs were measured. And they spoke in a vocabulary understood by millions, popular music in the real sense of the term. Now, somehow, those songs do not have the same impact on contemporary listeners. But we hear an echo of those thoughts, a paraphrase, even an actual phrase lifted unwittingly by today's song-makers.

That Carly Simon has mastered the contemporary vocabulary is abundantly clear in this collection. If she misses the mark a

bit here and there, if there's an occasional awkward phrase, more often than not the words ring true. J.G.

JON ANDERSON: Olias of Sunhallow. Jon Anderson, vocals and instrumentals. *Ocean Song; Meeting (Garden of Geda); Sound Out the Galleon; Dance of Ranyart; Olias (To Build the Moorglade)*; five more. [Jon Anderson, prod.] ATLANTIC SD 18180, \$6.98. Tape: ●● CS 18180, \$7.97; ● TP 18180, \$7.97.

Yes lead singer Jon Anderson, who also writes songs and plays acoustic guitar and incidental percussion, has always been one of the group's strategic members. As a vocalist, his tastefulness is matched by his gift for nuance. When working with musicians as technically proficient as Yes's Steve Howe and Chris Squire, he has turned examples of intricate musicianship into thoroughly emotive compositions.

In "Olias of Sunhallow," Anderson has created an LP that in many ways reflects his contribution to Yes. Steeped in the same mixture of science fiction and English lore that has made Yes pieces like "Starship Trooper" and "Close to the Edge" so fascinating, his libretto is both absorbing and thought-provoking. Unfortunately, the music does not support his lyrical strengths. Unlike the other members of Yes whose solo albums preceded him, Anderson is not a master of any instrument. His melodies are graceful and evocative, but they are executed in the most elementary ways: Strummed acoustic guitars are substituted for the searing, intense guitar playing that Howe could have contributed; droning mellotrons replace Patrick Moraz's cutting keyboard style.

Did ego stop Anderson from employing competent musicians? Did he wish to make a personal statement all by himself? Though attractive and graceful, this disc ultimately is a bore—the calm without the storm. H.E.

* **GEORGE BENSON:** Good King Bad. George Benson, guitar; instrumental accompaniment. *Shell of a Man; Em; One Rock Don't Make No Boulder; Cast Your Fate to the Wind*; two more. [Creed Taylor, prod.] CTI 6062, \$6.98. Tape: ●● CTC 6062, \$7.98; ● CT8 6062, \$7.98.

Because of the phenomenal success of "Breezin'" on Warner Bros. Records, this album by George Benson for his former label, CTI, may enjoy a greater success than might otherwise be expected. But it is certainly good enough to stand on its own merits.

Explanation of symbols

* exceptional recording

Recorded tape:

- Open Reel
- 8-Track Cartridge
- Cassette

Some years ago, when he was one of the first jazzmen to flirt with pop/rock music, guitarist Gabor Szabo predicted a time when the musical and social (and financial?) boundaries between rock and jazz would diminish. He forecast a coming together of the then widely separated ideals. Considering that both rock and jazz are rooted in black American music traditions, it isn't really so surprising that they should eventually achieve some success at cohabitation.

This LP attests to that compatibility. Benson draws his major inspiration from the same source as the late Wes Montgomery: blues and soul (in the jazz sense of that word). Indeed, he was hailed at one time as the logical successor to Wes's pop/jazz success. He can whip out those octave licks for sure, but Benson is more than a Montgomery soundalike. In the era of unparalleled proliferation of guitarists (surpassing even the piano in popularity), he is one of the most admired, most accomplished pickers.

This eclecticism is also reflected in some of the other participants: trumpeter Randy Brecker, from Horace Silver to Blood, Sweat, & Tears to his own rock/jazz Brecker Brothers band; the ubiquitous David Sanborn, who has worked with Stevie Wonder, Cat Stevens, and Gil Evans; pianist Bobby Lyles, from Sly's band. Dave Matthews has become CTI's house arranger, replacing Bob James, who defected to another label. Matthews was formerly with soul singer James Brown. These widely varying musical experiences have come together to create a highly enjoyable album, in which Benson's exhilarating guitar is heard bounteously.

The production and engineering bear the unmistakable stamp of Creed Taylor and Rudy van Gelder. J.G.

RICK DERRINGER: Derringer. Rick Derringer and Danny Johnson, guitars and vocals; Kenny Aaronson, bass and background vocals; Vinny Appice, drums. *Let Me In; You Can Have Me; Loosen Up Your Grip*; five more. [Rick Derringer, prod.] BLUE SKY PZ 34181, \$6.98. Tape: ●● PZT 34181, \$7.98; ●● PZA 34181, \$7.98.

Even though he is only in his late twenties, Rick Derringer can look back on a relatively long career as a second-generation guitar star. Making his mark as the utterly tasteless soloist on the 1965 McCoys' smash "Hang On Sloopy," he went on to a long association with rock impresario Steve Paul's roster of rock superstars.

Derringer's solos for performers like Edgar and Johnny Winter have been notable more for intent than for musical realization; too much of his playing has soured when his ideas could not be executed properly because of lack of technique. As a writer, he has fared somewhat better. His solo LP "All-American Boy," with its tales of adolescent love—lost, found, and unrequited—substituted capable song-writing for many of the clichés that made his backup playing so uninteresting.

The sensitivity that highlighted "All-American Boy" has been abandoned in this solo follow-up, and "Derringer" can only be classified as dull. In addition, the group on

this disc alternates between amateurishness and an excessive tastefulness that is totally out of place. The lame backup band tries to energize the screeching guitarist, who at times copies Robin Trower and Johnny Winter.

Derringer needs to do a great deal of rethinking before he achieves the authentic superstardom that he has been reaching for all these years. H.E.

*** RASPBERRIES:** Best, Featuring Eric Carmen. Eric Carmen, rhythm guitar, piano, synthesizer, and vocals; Wally Bryson, guitars and vocals; Scott McCarl, bass, acoustic guitar, and vocals; Michael McBride, drums and vocals. *Ecstasy; Tonight, Go All the Way*; seven more. [Jimmy Ienner, prod.] CAPITOL ST 11524, \$6.98. Tape: ●● 4XT 11524, \$7.98; ●● 8XT 11524, \$7.98.

If any band deserves the right to gripe, it's the Raspberries. After four dazzling LPs and a string of hit singles, all that is left is lead singer Eric Carmen's solo career, which has veered toward hit-making rather than fulfilling the intentions of the group.

The Raspberries wanted to be entertaining enough to have hits, while retaining enough musical solidity to earn a legitimate progressive following. And it succeeded handsomely. Its most memorable material took the best of the Beach Boys' harmonic approach and merged it with a musical attack worthy of the Who. Songwriter Carmen also produced lyrics of teenage lust and unrequited love that always rang true and then delivered them explosively.

Yet the Raspberries never became superstars. Part of the blame must fall to Capitol Records, which pushed the group as its best act since the Cowsills. The company should have studied those discs, where killer rockers appeared side by side with apt demonstrations of lyrical and melodic grace.

This "best of" LP is superb, with liner notes by fans as well as critics, making it an even more pleasurable souvenir of work well done. H.E.

*** BILL COSBY:** Bill Cosby Is Not Himself These Days—Rat Own, Rat Own, Rat Own. Bill Cosby, vocals; vocal and instrumental accompaniment. Yes, Yes, Yes; *Chick on the Side; Shift Down; I Luv Myself Better Than I Luv Myself; Do It to Me; Ben; You're Driving Me Crazy; Garbage Truck Lady; Luv Is*. [Stu Gardner, prod.] CAPITOL ST 11530, \$6.98. Tape: ●● 8XT 11530, \$7.98.

This is an amusing satire on superserious soul music such as is practiced by Isaac Hayes. Cosby's wit is so sharp that this LP might be mistaken for the real item by many soul-music fans. A reading of the enclosed libretto should dispel any such misconception.

Cosby has taken the chief clichés of soul-music lyrics and magnified them to the point of absurdity. In "Yes, Yes, Yes," a chorus of female singers repeats the word "yes" while Cosby mumbles lyrics in which the protagonist's wife admits to a variety of sins. The casual listener will hear only the "yesses" and think this a serious ballad.

In all, a worthy and funny effort. M.J.

*** ALLEN ROBIN:** Naked, Really Naked. Allen Robin, narration. *Nixon; Humphrey; Rockefeller*; six more. [Allen Robin, prod.] CARROT CA 317, \$6.98.

Allen Robin is the man who, nearly a decade ago, produced the hilarious LP "Welcome to the LBJ Ranch," in which he employed the taped voices of various political figures and had them answering questions they were never asked. Robin does the same with "Naked, Really Naked," a lovely piece of scurrilousness perfectly designed for this election year.

Robin plays the role of a psychiatrist whose patients include Nixon, Humphrey, Rockefeller, McGovern, Agnew, Ted Kennedy, and John Lindsay. One day they all show up at once. That is the essence of the album. Robin has taken pieces of taped speeches and formed them into an exquisite, absurd tapestry revealing all of these figures as scatological, lecherous, and vin-

Critics' Choice

The best pop records reviewed in recent months

- AEROSMITH:** Rocks. COLUMBIA PC 34165. Sept.
HOYT AXTON: Fearless. A&M SP 4571. Sept.
BLUE OYSTER CULT: Agents of Fortune. COLUMBIA PC 34164. Sept.
GUY CLARK: Old No. 1. RCA APL 1-1303. Aug.
FOLK MUSIC IN AMERICA, VOLS. 1-2. LIBRARY OF CONGRESS LBC 1/2. July.
EDDIE HAZELL TRIO: Take Your Shoes Off, Baby. MONMOUTH-EVERGREEN 7975. July.
MILLIE JACKSON: Free and in Love. SPRING SP 16709. Aug.
J. R. MONTEROSE: Straight Ahead. XANADU 126. Sept.
TONY ORLANDO & DAWN: To Be with You. ELEKTRA 7E 1049. July.
DAVID RAKSIN CONDUCTS HIS GREAT FILM SCORES. RCA RED SEAL ARL 1-1490. Aug.
SAVOY JAZZ REISSUES: Charlie Parker. SAVOY/ARISTA SJL 2201. Aug.
IRA SULLIVAN. HORIZON SP 706. Sept.
RALPH TOWNER: Solstice. ECM 1060. July.
VERVE JAZZ REISSUES: Lester Young. VERVE/POLYDOR VE 2-2502. Aug.

Stravinsky made us do it.



Stravinsky . . . and every composer who has ever written music with the range, power and majesty of "Rites of Spring" . . . music that demands far more than any stereo can deliver without adequate amplifier power.

The Phase Linear 700B Power Amplifier faithfully reproduces the most difficult passages of the most demanding recorded music. It lets *all* of the music through at realistic volume levels. You never have to reach for your volume or tone controls to prevent clipping.

The 700B has the highest power, widest frequency response and lowest distortion of any stereo amplifier in the world. Take Stravinsky to your dealer and listen to what we mean.



Phase Linear 700-B

THE POWERFUL DIFFERENCE

PHASE LINEAR CORPORATION,
P. O. BOX 1335,
LYNNWOOD, WASHINGTON 98036
CIRCLE 41 ON READER-SERVICE CARD

dictive. And those are their good points. It's a funny record, suffering only from the absence of Jimmy Carter and Gerald Ford.

What is especially nice about this offering is that Robin managed to get through the whole thing without once invoking the gods of Watergate. He preferred, wisely, to tar everyone with the same brush and to use a brush that is essentially apolitical—or perhaps antipolitical. M.J.

DAVID BOWIE: *Changes One*. David Bowie, vocals; instrumental accompaniment. *Space Oddity; John, I'm Only Dancing; Changes*; eight more. [David Bowie, Tony Visconti, Harry Maslin, Gus Dudgeon, Main Man, Gem, and Ken Scott, prod.] RCA APL 1-1732, \$6.98. Tape: **APK** 1-1732, \$7.95; **APS** 1-1732, \$7.95.

A "best of" album, especially one in which the tunes are arranged in chronological order, gives the listener the opportunity to put the recording artist in question in fair perspective. High points—as well as low ones—somehow are sharply defined.

Such is the case with "Changes One," a David Bowie "best of" collection. At the very least, this disc is honestly exciting. Present at the outset are the best-known selections from the period when Bowie first launched his career. Granted, "Changes" and "John, I'm Only Dancing," the smash British single packed with sexual innuendo that was not released stateside, might seem somewhat contrived. Nevertheless, his flair for writing catchy pop melodies and singing in his cool, airy, detached manner is clearly evident.

The Bowie of the orange-haired, androgynous, pop god period, while notable for the songs included here, also delivered some intriguing tunes ("Five Years," "Rock and Roll Suicide," and "Moonage Daydream") that have unfortunately been left out. In addition, selections from the later albums "Aladdin Sane" and "Diamond Dogs" have lost their freshness.

When Bowie abandoned the pseudo-sci-fi, apocalyptic image, he conveniently opted to become a disco star. His big disco hits bring this LP to a conclusion, and they are as good as anything recorded in Philadelphia's Sigma Studios, home of sleek, slick rhythm-and-blues music. "Changes One" obviously does its job by presenting the many faces of a constantly changing star. What will "Changes Two" show us? H.E.

*** NILSSON:** *That's the Way It Is*. Harry Nilsson, vocals; vocal and instrumental accompaniment. *That Is All; Just One Look; Baby, I'm Yours; Moonshine Bandit; I Need You; A Thousand Miles Away; Sail Away; She Sits Down on Me; Daylight Has Caught Me; Zombie Jamboree*. [Trevor Lawrence, prod.] RCA APL 1-1119, \$6.98. Tape: **APK** 1-1119, \$7.95; **APS** 1-1119, \$7.95.

A few years ago it became modish for pop artists to issue versions of old upbeat rock-and-roll tunes arranged as languid ballads. Bette Midler did "Do You Want to Dance" as a torch song, and Neil Sedaka re-recorded his old "Breaking Up Is Hard to Do"



RCA Records

Harry Nilsson
Whimsy gets the better of judgment?

as a piano ballad. Now Harry Nilsson has given us a version of "Just One Look" that qualifies for respectability. While not a ballad by any means, it has a kind of urbane sophistication it never enjoyed during its previous life.

The song is one of the ten offerings on "That's the Way It Is," Nilsson's newest LP for RCA. The album is a good one, containing his familiar blend of the serious and the silly, all wrapped up in arrangements employing so many instrumentalists that one suspects Nilsson sessions may soon figure as a fringe benefit in contract negotiations by the musicians' union.

Among the high points is George Harrison's "That Is All," which opens the album and is repeated in a peculiarly endearing way at the end. "Just One Look" is worthy, as is Gerry Beckey's "I Need You" and Austin Talbot's amusing "She Sits Down on Me." But Nilsson's attempts to sing Randy Newman's "Sail Away" and Conrad E. Mauge Jr.'s "Zombie Jamboree" fall rather flat. He is much too aggressive for Newman's quietly ironic ballad and not nearly aggressive enough for Mauge's peppery calypso, which has been done better by many others, including the Kingston Trio. The fault, I think, is that Nilsson, so addicted to whimsy, occasionally lets his sense of humor get the better of his judgment. The result can be overblown and sophomoric. "Sail Away" was never intended to be howled. M.J.

ELLIOTT MURPHY: *Night Lights*. Elliott Murphy, vocals, harmonica, guitar, Arp synthesizer; vocal and instrumental accompaniment. *Diamonds by the Yard; Deco Dance; Rich Girls; Abraham Lincoln Continental; Isadora's Dancers; You Never Know*

What You're In For; Lady Stiletto; Lookin' for a Hero; Never as Old as You. [Steve Katz and Elliott Murphy, prod.] RCA APL 1-1318, \$6.98. Tape: ●● APK 1-1318, \$7.95; ● APS 1-1318, \$7.95.

Elliott Murphy apparently is trying to do the same thing that was done by Lou Reed and Bruce Springsteen: create fairly hard rock that is modestly literate. He falls short of the mark in two respects. His melodies aren't interesting, and his lyrics are ineffectual.

Murphy tries to depict lost souls wandering through a landscape sometimes chic, sometimes garbage-strewn. But his characters never come to life. He isn't able to make us feel that they really exist or to care whether or not they do. Perhaps this is because he tries the risky lyrical ploy of flirting with ambiguous images. Bob Dylan used that technique to great advantage, but then, he made his filmy images most evocative.

There is some good in this LP. Murphy's singing, again reminiscent of Lou Reed, is appealing, and there is some very good musicianship, especially from Murphy on electric guitar and Ralph Schuckett on keyboards. One tune, "You Never Know What You're In For," though very much like several Springsteen songs, is worth hearing. The rest, though, are sad examples of noble intentions seeking a means of expression.

M.J.

STEVE HARLEY AND COCKNEY REBEL: Timeless Flight. Steve Harley, vocals; Stuart Elliott, drums; Duncan Mackay, keyboards; Jim Cregan, guitar; George Ford, bass; Lindsay Elliott, percussion; vocal and instrumental accompaniment. *Red Is a Mean, Mean Colour; White, White Dove; Understand; Black or White (And Step on It); Nothing Is Sacred (It's Everything Else)*; three more. [Steve Harley, prod.] CAPITOL ST 11500, \$6.98. Tape: ●● 8XT 11500, \$7.98.

Capitol Records refers to this album as a "sound collage, another musical vision full of ravenous vitality." Harley's fifth LP is a "concept" album, where one song flows into the next and the entire recording is to be considered one prolonged piece rather than just a collection of songs. Concept albums were the rage in the late 1960s, then fell out of favor, perhaps because rock musicians ran out of things to say—or at least ran out of things that take more than three minutes to say.

"Timeless Flight" suffers from just that problem. It has nothing identifiable to say, yet raises a great deal of dust in the attempt. Though some of the musicianship is pleasing, especially Duncan Mackay's work on various keyboards, the album is over-produced and the lyrics bounce about erratically without ever settling on a point. Sometimes Harley seems on the verge of creating a pretty image, then ruins it by tossing in an incongruous word or phrase. In "Understand," he gets most of the way through a very nice love song, filled with lovely, flowing lyrics, only to sink it by using the word "shtick." Later, in "Nothing Is Sacred," Harley rhymes "bitch" with "kitsch" to destroy what started out as a rather nice, atmospheric landscape.

Buy with confidence

THERE IS A DIFFERENCE IN MAIL ORDER. IT'S CALLED EXPERIENCE! WE HAVE 28 YEARS!



PIONEER



KENWOOD

TEAC



BIC

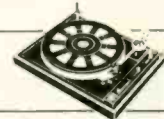

SEND FOR QUOTES AND PRICE LISTS

BUY FROM NEW ENGLAND'S LARGEST STEREO HOUSE



ARSTONS

146 Old Brookfield Road, Danbury, Conn. 06810

(203) 744-6421 (212) 369-6212

Mon.-Fri. 9:00-5:30 Sat. 9:00-3:00

CIRCLE 11 ON READER-SERVICE CARD



Next time you plan a trip to Europe, make sure you visit the unique country.

Where can you find: Europe's blondest blondes?
Europe's highest geysers?
Europe's greatest glaciers?
Europe's largest waterfalls?

And where can you find moonlike craters where the astronauts trained? More volcanos than anywhere else on earth? Historic landmarks of the world's oldest continuous parliament? Celebrations marking Europe's youngest republic?

The answer to all of these questions is—ICELAND. Next time you plan a trip to Europe, make sure you visit Iceland.

The only thing it may cost you is time well spent. Because you'll save enough money on Icelandic's lowest jet fares to Luxembourg to pay for your stopover in Iceland. Or, you can hop over from New York or Chicago for longer tours. See an erupting volcano. Take a cross-country pony trek.

Next time you plan a trip to Europe, ask your travel agent about Icelandic Airlines. Or phone Icelandic Airlines, for folders about Iceland and lowest jet fares to Europe. In New York State, phone (212) 757-8585. Elsewhere in U.S., phone (800) 555-1212 for local toll free number.

CIRCLE 24 ON READER-SERVICE CARD

DISCOUNTS

On Nationally Advertised

- TURNTABLES
- CARTRIDGES
- COMPACTS
- RECEIVERS
- AMPLIFIERS
- TAPE RECORDERS
- SPEAKERS
- SYSTEMS



PIONEER
SX-1250
AM/FM
Stereo Receiver

LIST \$900
SR Price
567⁰⁰



This is one of the many thousands of discount prices in our FREE catalog. Send for catalog today.

Our 20th Year
SOUND REPRODUCTION
INC.

460 CENTRAL AVENUE
East Orange, New Jersey 07018
(201) 673-0600

CIRCLE 54 ON READER-SERVICE CARD

FREE details... A DIFFERENT KIND OF RECORD CLUB

TREMENDOUS SAVINGS

on every record and tape in print—no "agree-to-purchase" obligations of any kind
DISCOUNTS OF 43% TO 73%
off mfg. suggested list... special catalog features hundreds of titles and artists

ALL LABELS AVAILABLE

including most imports through special custom ordering service—guarantees satisfaction

SCHWANN CATALOG

lists thousands of titles, classical, pop, jazz, country, etc.

DISCOUNT DIVIDEND CERTIFICATES

Dividend Gifts—certificates redeemable immediately for extra discounts.

NEWSLETTERS

informational news and happenings in the world of music... special super-sale listings.

DISCOUNT ACCESSORY GUIDE

Diamond needles, cloths, tape cleaners, etc.

QUICK SERVICE

same day shipping on many orders... rarely later than the next several days.

100% IRON-CLAD GUARANTEES

on all products and services—your total satisfaction is unconditionally guaranteed

Discount Music Club is a no-obligation membership club that guarantees tremendous discounts on all stereo records and tapes and lets you buy what you want... when you want... or not at all if you choose.

These are just a few of the money-saving reasons to write for free details. You can't lose so why not fill out and mail the coupon below for immediate information.

DISCOUNT MUSIC CLUB, INC. DEPT 8-1076
650 Main Street, New Rochelle, N.Y. 10801

Name _____
Address _____
City _____
State _____ Zip _____

CIRCLE 14 ON READER-SERVICE CARD

Harley seems afraid of making a statement, which has always been the bane of the hip. Instead, he makes fun of his own words and relies on the flow of the music to take up the slack. It's a technique long associated with concept albums. Years ago, sympathetic rock critics and liner-note writers advised us to "go with the flow" and stop worrying about the content of individual parts, or else suggested that we get stoned before listening. That too is an old story—advising the victim of a blind date to get drunk so that his companion will seem better-looking.

Subjected to the slightest scrutiny, "Timeless Flight" becomes neither timeless nor much of a flight—just another bunch of overpaid juveniles trying to justify their salaries by pretending significance. M.]

Theater and Film

MIKLÓS RÓZSA CONDUCTS. Royal Philharmonic Orchestra, Miklós Rózsa, cond. [Brian Culverhouse, prod.] POLYDOR 2383 384, \$7.98 (distributed by HNH Distributors, Box 222, Evanston, Ill. 60204).

Knight Without Armor; *Tribute to a Badman*; *The Asphalt Jungle*; *Moonfleet*; *Double Indemnity*; *Lust for Life*; *Men of the Fighting Lady*.

There is much to admire on this recording (not to be confused with the earlier "Miklós Rózsa Conducts His Great Film Music," Polydor 2383 327, January). But a good deal of the material is terribly predictable, both in its use of film-music clichés—as in the "Siberia" sequence from *Knight Without Armor*—and in the too frequent appearances of harmonic and rhythmic patterns by now overly familiar to Rózsa devotees. As more and more of his film music finds its way onto disc, it is definitely proving subject to the law of diminishing returns, and I found myself imagining, while listening to this recording, how beautifully such superlative performances and sound would serve Rózsa's exciting *Theme, Variations, and Finale*, which could easily be coupled with a complete recording of the *Double Concerto*.

The high points are the jarring, brutally tense scores for two films noirs, John Huston's *The Asphalt Jungle* and Billy Wilder's *Double Indemnity*. And I have always loved the nostalgically mellow *Lust for Life*. (A full version of the sweeping main theme for this previously recorded score certainly should have been included, however.) The "Blind Flight" music from the 1954 *Men of the Fighting Lady* generates considerable drama and contains a melody strongly reminiscent of the main theme for Rózsa's extraordinary violin concerto (which could also use a new recording), composed around the same time.

The short, innocuous excerpts from *Tribute to a Badman* and *Moonfleet* are a waste, particularly since space was not found for the *Julius Caesar* overture on this disc. And the 1937 *Knight Without Armor*, Rózsa's

first film score, is a minor effort, unconvincingly blending Russian folk themes into a blandly romantic musical tapestry. R.S.B.

MISSOURI BREAKS. Original film soundtrack recording. Composed and conducted by John Williams. UNITED ARTISTS UA-LA 623G, \$6.98. Tape: ●● CA 623H, \$6.98; ●● EA 623H, \$6.98.

For a late-1800s western with a heroine who could easily have stepped out of modern-day Greenwich Village and a heavy who suffers from a kind of existential mythomania, John Williams' score has a certain appropriateness. No sooner does the music suggest, via logical harmonica/guitar/harp combinations, a kind of open-spaces simplicity than it moves into a pop style complete with diverse electronic instruments, creating sounds that would work quite well for *The Rockford Files*. And some sequences, including the unsettling title music, "Bizarre Wake," and "The Confrontation," definitely evoke nightmares and nervous twitches.

I must confess, however, that Arthur Penn's cinematic schizophrenia worked well for me, and, given the way Williams' score complements Penn's efforts, I found much of it greatly appealing. Not a milestone, but certainly worthwhile in its own disjointed way, and splendidly recorded.

R.S.B.

* **THE OMEN.** Original film soundtrack recording. Composed by Jerry Goldsmith; Lionel Newman, cond. [Jerry Goldsmith, prod.] TATTOO BJL 1-1888, \$6.98.

One of the most controversial films of 1976 is Richard Donner's *The Omen*, which deals in a fairly Grand-Guignolesque fashion with the upheavals, both immediate and potential, caused by a Satanic power play of which a young boy is the agent. One New York critic, with his typical sanctimonious smugness, even suggested that viewers paying money to see this film need only to blame themselves for the violence in society today. But although the movie has drawbacks, especially in the David Seltzer script, it manages to create (at least for me) an ominously powerful atmosphere of terror and doom, and one essential element of this is the music of Jerry Goldsmith, which represents, both in scope and effect, the outstanding film score of the year so far.

Inasmuch as the theme of Satanism has had its strongest symbolic expressions in the Catholic Church, Goldsmith deliberately evokes the church tradition by using, in the title theme and elsewhere, a chorus gloomily chanting a Latin text (with a plethora of rhymes in -us and -ibus) over darkly churning passages in the orchestra. The musical style is somewhat reminiscent of Stravinsky via Orff, but the emotional impact is a good deal more eerie and oppressive. Throughout, Goldsmith enhances the nerve-gripping tensions in the choral writing by pitting the low male voices, very often used in an ostinato, against the female voices, which sometimes almost shriek and at other times sigh in weird glissandos. And at several points, the chorus is reduced to chaotic whisperings, creating a

percussive effect all the more unsettling because of its human origins.

There are a number of purely instrumental sequences (in an immediately recognizable Goldsmith style), most of them involving a simple, nonresolving motive and its extension as a theme, both of which have the bittersweet quality of a rather desperate lullaby. Adding immeasurably to the over-all effectiveness are the brilliant orchestrations by Arthur Morton, who has managed to maintain the individual characters of the large variety of instruments (none electronic) deployed, so that, rather than a smooth symphonic blend, the impression created is one of scattered forces at war with one another.

Although the musical sequences do not follow the narrative of the film, they are presented on this disc in a way that produces a maximum contrast of the many moods involved. The only drawback is a vocal arrangement of the main theme, with lyrics and singing supplied by Carol Heather, who fortunately is not heard in the film itself. The conducting by Lionel Newman, performances, and sound are excellent. A superlative document of a major achievement in film scoring, as they say at the Academy Awards (hint). R.S.B.



JAMES DAPOGNY: Piano Music of Ferdinand "Jelly Roll" Morton. James Dapogny, piano. *The Pearls; New Orleans Blues; Big Foot Ham*; nine more. SMITHSONIAN N 003, \$6.50 (Smithsonian Collection, P.O. Box 23345, Washington, D.C. 20024).

In recording an album of piano solos by Jelly Roll Morton, a performer inevitably plays himself into a corner. Because Morton as a pianist had a very distinctive style, the definitive way to play any of his compositions is Morton's way. So the project stands or falls on how well the pianist can imitate the Morton style.

In this case, James Dapogny achieves a fairly consistent approximation. But there is always that fine line that separates an original improvisation or creation from a copy of it. Morton had the freedom to go wherever his instincts took him, while Dapogny has to be conscious of following Morton's fingers. Sometimes he does it so well—on "Frances," "Kansas City Stomp," and "Big Foot Ham"—that his execution seems completely unfettered. At other times, there is a suggestion of stiffness—on "The Pearls"—that goes counter to the laid-back ease of a Morton performance, or he becomes too enthusiastically jaunty—on "Frog-i-More Rag."

Since Morton recorded all these tunes, one might wonder why there should be a need for this secondhand recording. Of course the sound quality of many of Morton's piano-solo recordings is distinctly low fidelity and several of the titles were made only by Morton's Red Hot Peppers, in which his solos were incidental. His origi-

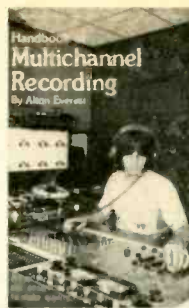

Handbook of Multichannel Recording

Here is very possibly the single most important book on sound recording for

No. 781 HANDBOOK OF MULTICHANNEL RECORDING. F. Alton Everest.

A comprehensive volume of 322 pages, with 201 illustrations, covering all aspects of live recording in both stereo and four-channel formats. Paperbound: \$7.95. Hardbound: \$10.95.

No. 598 OFFICIAL GUIDE TO HIGH FIDELITY. Compiled by the Institute of High Fidelity.

An informative introduction to the various components that make up a modern high fidelity system, covering everything from phono cartridges to quad systems. Paperbound: \$2.00.

No. 756 FOUR-CHANNEL STEREO . . . FROM SOURCE TO SOUND, 2nd Edition (1974). Ken W. Sessions, Jr.

Complete technical and nontechnical information on all approaches to four-channel sound, both discrete and matrix. Paperbound: \$4.95. Hardbound: \$7.95.

Check or money order must accompany your order.
No cash or C.O.D.'s, please.
Allow 60 Days for Delivery.

the layman or professional who wants to make quality recordings of musical groups. For the first time, here's a book that covers it all—dubbing, special effects, mixing, reverb, echo, synthesis—for both stereo and four-channel recording. Simply circle No. 781 on the coupon below.

"Handbook of Multichannel Recording" is only one of a wide selection of carefully chosen audio books made available to HIGH FIDELITY readers through Music Listeners' Book Service (Many of the selections are not readily available in bookstores.) Choose your books today from the list below, circle the numbers on the coupon, and enclose your check or money order. That's all there is to it.

HIGH FIDELITY
MUSIC LISTENERS' BOOK SERVICE
Dept. HW
2160 Patterson Street, Cincinnati, Ohio 45214

Here's my check for \$_____. Please send me, postpaid, the books I've circled below.

781 598 756

Name _____

Address _____

City, State & Zip _____

HF-1076

IF YOU OWN A MARANTZ YOU SHOULD HEAR IT THROUGH ULTRALINEAR SPEAKERS

Your Marantz receiver, no matter how minute the distortion, will sound only as good as your speakers. Speakers with a clean, full sound. Speakers that will pick up the highs and bring out the lows. Speakers that will sound smooth in the middle. The ULTRALINEAR 450 TowerPower Speaker System. The efficient speakers.

ULTRALINEAR speakers are designed for your Marantz—or any moderately-priced receiver. Designed to bring out all its good, solid features with full, round sound. There's nothing "thin" about a pair of 450 TowerPowers. Listen to them through your Marantz. Ask your dealer to play a pair of Ultralinear speakers for you. Hear what your receiver should sound like.

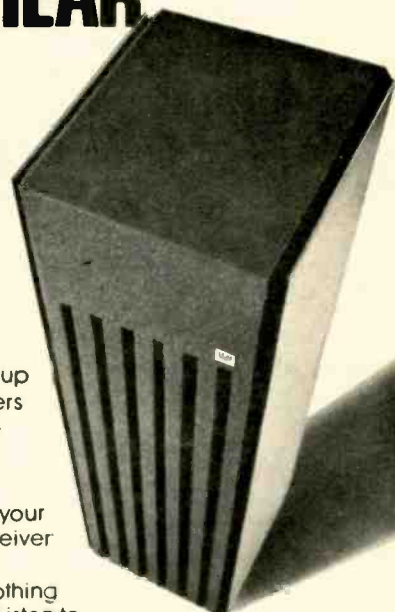

Ultralinear

HEAR WHAT YOUR RECEIVER SHOULD SOUND LIKE!

CIRCLE 58 ON READER-SERVICE CARD

Never trust a sound you can't see.



The biggest drawback about a pair of ears is the head between them.

Because everybody's mind, it seems, interprets sound a little differently.

So, at Mitsubishi, we go one step beyond the human ear. We use laser holography, to actually photograph the sound our speaker is producing. Which shows us exactly which kind of sounds are coming from which part of the speaker. Something even a highly trained pair of ears could never do.

So when you buy speaker systems, ask the salesman to show you what the sound looks like.

He may be a very nice dealer.

But if he can't show you a laser holograph, he isn't one of ours.



Melco Sales, Inc.
3030 E. Victoria St.
Compton, CA 90221

Gentlemen:

I, too, am very particular about loudspeakers. Please send me a brochure and the name of my nearest dealer.

Name _____

Address _____

City _____

State _____ Zip _____

CIRCLE 60 ON READER-SERVICE CARD

nal performances are still the ones to have, despite the sound, but this set can be a clarifying backup collection. J.S.W.

*** JOHN ARPIN:** Solo Piano. John Arpin, piano. *Over the Bars; Memories of You; Jim Jams*; nine more. EUBIE BLAKE MUSIC 10, \$6.95.

Canadian pianist John Arpin explores what Rudi Blesh calls "ragtime's second period"—the Twenties and early Thirties—in this unusual and revealing collection. Barring Eubie Blake's "Memories of You" and Willie "the Lion" Smith's "Finger Buster," most of the pieces are unfamiliar, but the composers are well known: James P. Johnson, Roy Bargy, Duke Ellington, Art Tatum, and Zez Confrey, among others. There is a jaunty feeling about many of the songs, the old ragtime lilt riding on the new stride and jazz approach of the Twenties. But in pieces by Ellington and Tatum there is also a reflective feeling typical of their work.

Arpin moves easily between the two extremes and contributes an original of his own, "Cumberland Stroll," that is close to the Ellington vein. Like the dappled sunlight and shadow through which Arpin takes his "Cumberland Stroll," the album wanders in and out of the jazz world, emphasizing the close relationship that existed between the jazz pianists and the so-called "novelty" pianists of the Twenties. J.S.W.

*** DAVE BRUBECK:** All the Things We Are. Dave Brubeck, piano; Anthony Braxton and Lee Konitz, alto saxophones; Jack Six, bass; Alan Dawson and Roy Haynes, drums. *Like Someone in Love; In Your Own Sweet Way; All the Things You Are*; six more. [Michael Cuscuna, prod.] ATLANTIC SD 1684, \$6.98. Tape: CS 1684, \$7.97; TP 1684, \$7.97.

At first glance, the juxtaposition of Dave Brubeck, one of the established icons of jazz, with the iconoclastic avant-gardist Anthony Braxton seems somewhat bizarrely contrived. But this is an album of extraordinary music and musicians, which demonstrates all that jazz can achieve in spontaneity, inventiveness, and challenge to performer and listener. The gourmet menu is varied and satisfying.

Side 1 opens with Lee Konitz and Brubeck in a quartet setting with Jack Six and Roy Haynes. Our ears have been so trained down through the years to listen for Paul Desmond's liquid lyricism in the Brubeck ensemble that to hear the sharp-edged Konitz cutting across Brubeck's brilliant comping takes some getting used to at first. Hardly before the first chorus is finished they've got you shaking your head in wonder. Konitz is the Lennie Tristano of the alto sax: an exceptional player/composer, a pioneer, a major influence on the instrument, and virtually unknown outside the jazz inner circle.

Braxton, if I may draw another keyboard comparison, is the Cecil Taylor of alto players. His music in his own albums is a virtual definition of avant-garde. His playing here is the most accessible and acceptable to a general audience that I've heard. He solos

on Brubeck's "In Your Own Sweet Way." The interplay between saxes on "All the Things You Are" is something to behold. The confrontation of two such individualistic stylists and their responses to one another's playing is one of the special treats in this recording. The presence of the formidable Haynes on drums is no small blessing either.

Side 2 has a long (more than twenty minutes) medley of Jimmy van Heusen standards played by Brubeck in a rarely heard trio context with his regular bassist and drummer, Six and Alan Dawson. For those who have become blasé about Brubeck or take him for granted, listen hard to this primal lesson in jazz piano. From a caressing statement of a lovely melody line to incredibly complex variations, his virtuosity sings and swings. And it proves to me, at least, that Dave Brubeck is in the front rank of major modern pianists. He retains the passion and intensity that have always marked his playing, and you are reminded that the piano is a percussion instrument. He can take you as far "outside" as you can go on those flights of improvisation and yet never lets you forget his open admiration and allegiance to Fats Waller and Duke Ellington.

Perhaps that's why he chose to close this set with "Don't Get Around Much Any More" in a direct salute to the Duke. All in all, this is one of the finest jazz albums you're likely to hear this year. Or many more to come. J.G.

*** DUKE ELLINGTON:** Jazz Violin Session. Duke Ellington and Billy Strayhorn, pianos; Svend Asmussen, Stéphane Grappelli, and Ray Nance, violins; Ernie Shepard, bass; Sam Woodyard, drums; Russell Procope and Paul Gonsalves, saxophones; Buster Cooper, trombone. *In a Sentimental Mood; Don't Get Around Much Any More; Cotton Tail*; eight more. ATLANTIC SD 1688, \$6.98. Tape: CS 1688, \$7.97; TP 1688, \$7.97.

DUKE ELLINGTON: Washington, D.C., Armory Concert. Clark Terry, Willie Cook, and Cat Anderson, trumpets; Ray Nance, trumpet and violin; Quentin Jackson, Britt Woodman, and John Sanders, trombones; Paul Gonsalves, Jimmy Hamilton, Russell Procope, Rick Henderson, and Harry Carney, reeds; Duke Ellington, piano; Jimmy Woode, bass; Dave Black, drums. JAZZ GUILD 1002, \$6.98 (mono); Jazz Guild, 4991 Delray St., Pierrefonds, P.Q., H8Z 1Y3, Canada).

*** DUKE ELLINGTON:** The Unusual Ellington. Clark Terry, Willie Cook, and Cat Anderson, trumpets; Ray Nance, trumpet and violin; Quentin Jackson, Britt Woodman, Juan Tizol, and John Sanders, trombones; Paul Gonsalves, Jimmy Hamilton, Russell Procope, Willie Smith, Rick Henderson, and Harry Carney, reeds; Duke Ellington, piano; Wendell Marshall and Jimmy Woode, basses; Louis Bellson, Butch Ballard, and Dave Black, drums. *Stomp, Look, and Listen; Warm Valley; Sultry Serenade*; nine more. JAZZ GUILD 1004, \$6.98 (mono).

This month's quota of Ellingtonia is unusually fresh and provocative, showing the Duke in situations that continue to add luster to his career.

The most interesting and revealing of these three albums is Atlantic's "Jazz Violin

HIGH FIDELITY

CLASSIFIED

130 East 59th St., New York, N.Y. 10022
Phone: (212) 826-8393/94

CLASSIFIED RATES: 1-time \$1.20 per word per issue, minimum \$12. 6 consecutive issues—\$1.10 per word per issue. 12 consecutive issues—\$1.00 per word per issue. Words in caps—10¢ extra each. Box Numbers: \$1.00 additional per insertion to cover cost of handling and forwarding mail. Count 10 extra words for box number and address.

DISPLAY CLASSIFIED AND DISCOUNTS: 1 inch by 1 column—\$230. 2 inch by 1 column—\$460. 3 inch by 1 column—\$690. Also 6 and 12 consecutive issue discount rates. Deadline is two months prior to publication date. Full payment must accompany All copy for classified ads.

for sale

ULTIMATE—"LIVE"—Operatic, Symphonic—Reel & Cassette Bargains! BOX 1101, WOODHAVEN, N.Y. 11421.

CANADIAN DISCOUNT CATALOG. NAME BRAND STEREO EQUIPMENT, CALCULATORS, CB Gear, Parts, Surplus, Factory close-outs, and dumps. Rush \$1.00. OCTO-HF, 521 5th Ave., NYC 10017.

THOUSANDS OF LIKE NEW LP's and pre-recorded tapes. Catalog \$1.50. House of Records, Hillburn, New York 10931.

BUILD YOUR OWN SPEAKERS AND SAVE UP TO 50%



You can assemble your own high quality multi-element stereo speakers in a few hours and save up to half the cost of comparable speakers. Send for our free 32-page catalogue of speaker kits, raw speakers and accessories.

SPEAKERLAB
Dept. HF, 4, 5500-35th N.E.
Seattle, Washington, 98105

STEREO CARTRIDGES AND STYLUS REPLACEMENTS FOR: ADC, Audio Technica, B&O, Grado, Empire, Micro/Acoustics, Pickering, Ortofon, Shure, Stanton, Supex. Write for free catalog: NEEDLE IN A HAYSTACK, Dept. MH, P.O. Box 17435, Washington, D.C. 20041.

3600' FRESH LOW NOISE HIGH OUTPUT AMPEX TAPE, 10 1/2" metal reel, 6 for \$35 plus UPS \$3.50. Other tape also on special. Write for Catalog, S.I.C., POB 338, Dunwoody, GA 30338.

SAVE ON SACRED COWS—BOSE, SAE, REVOX, Sansui, Kenwood, Marantz, BIC, Dokorder, Sony, JVC, Philips. Over 50 top brands. Write for quotes. SOUTHBOUND SOUND, P.O. Box 52508, Atlanta, Georgia 30355.

AUDIOPHILES WANTED!! Put your knowledge to use, earn an excellent spare time income. We need campus representatives to sell name brand stereo equipment at substantial discounts in your area. No investment necessary. For information and application please write: ABCO, Dept. CR, 1201 East Main Street, Meriden, Conn. 06450. Call (203) 238-7979.

PROFESSIONAL HI-FI COURSE—Instructors include Len Feldman, Julian Hirsch, Larry Klein and Larry Zide. Home study and live course available. Send \$1.00 for audio primer and full information on joining Society Audio Consultants (SAC), 49 E. 34th Street, Dept. HF, New York City 10016.

HI-FI ENTHUSIASTS WANTED!! Earn more than just spare money in your spare time. We need campus representatives to sell name brand stereo components at discount prices in your area. High commission, no investment required. Serious inquiries only, please. Contact: Alan Weisberg, K&L Sound Services Co., 75 No. Beacon St., Watertown, Mass. 02172. (617) 787-4073.

DYNAKITS, DYNASPEAKERS, SHURE, SME—lowest prices. FRIED LOUDSPEAKERS (not discounted). Perfectionist modifications. Underground HiFi Sales, 324b Broadwater Road, Arnold, Md. 21012. (301) 647-0919.



**BEST
IN THE
WORLD!**



Order famous British loudspeaker components direct at discount prices. Build your own top quality hi-fi and disco speakers. Save 50-70%. Send today for free catalogue and free constructional details of 5/7/10 element speakers.

WILMSLOW AUDIO
EXPORT DEPARTMENT A, SWAN WORKS,
BANK SQUARE WILMSLOW CHESHIRE,
ENGLAND SK9 1 HF.

YELLOW PAGES OF AUDIO—\$3.95 REFERENCE TO over 5,000 audio products and 1,000 publications. Box 94, Colmar, Pa. 18915.

AUDIOGRAM REVIEWS THAT ARE CLEAR, CONCISE AND Comprehensive. The Audiogram will not leave you in doubt as to what a component sounds like. Rate \$10.00 12 issues. Write The Audio Advisor, P.O. Box 17202, Washington, D.C. 20041.

THE ABSOLUTE SOUND, in its upcoming issue (= 8), will take a look at the renaissance of the tone arm, reviewing three striking new pivoted arms (from Infinity, Mayware (Formula 4) and Grace) and two highly sophisticated modifications of the straight-line tracking Rabco SL-8E. There has also been a resurgence of interest in tube-type electronics, we'll be examining the latest manifestations of this—Dyna's Mark VI (a 120-watt basic amp); Audio Research's Dual 150; and the Paragon and Luxman pre-amps. To be sure, there have been innovations in solid-state equipment, many of them striking, including Infinity's all-FET pre-amp; Its Class D Switching Amp; Stax's Class A amp, all of which we will review. Nor is that the end of it. The speakers reviewed: the full-range Acoustal electrostatic; the Audio Research Tympani IC; the Koss full-range electrostatic (and more). The cartridges? Well, there's the German EMT moving coil; the Sonus series; the new Micro-Acoustics; three versions of the Satin moving coil; the Decca elliptical (and more). Still not tempted? Well, we're expanding our review section on state-of-the-art recordings. The price for a subscription: \$10 (four issues, third class mail. Add \$4 for first class mailing. Canadians: \$11 (third class), \$15 (first). Foreign: \$16 (air mail). Back issues (1-6): \$3 each, add 50 cents for each issue sent first class. The Absolute Sound, Box 5c, Northport, New York 11768.



Louisville Orchestra
FIRST EDITION RECORDS
NOW IN RETAIL STORES!

For catalogue write: The Louisville Orchestra
333 W. Broadway, Louisville, KY 40202

UNIQUE GIFTS FOR MUSIC ENTHUSIASTS! Request catalog GIFTS MUSICA, Dept. H, Box 16099, Seattle, Washington 98136.

SPEAKER KITS, LOUDSPEAKERS AND ACCESSORIES. FREE CATALOG. SPEAKER WORLD, DEPT. H, BOX 1653, MARYSVILLE, CALIFORNIA 95901.

STATE OF THE ART SPEAKER KITS. Complete kits from \$60 to \$260 including Cabinets, Drivers X-Overs. Complete laboratory facility. \$40,000 worth of test equipment. All speakers supplied with machine run 1/2 octave response curve. AUDIO-TECH ELECTRONICS, 3863 Stellicom Blvd. S.W., Tacoma, WA 98499 206-584-0332.

BUILD A HIGH ACCURACY, monitor quality speaker for much less than comparable brand name speakers. Kit includes the KEF B139 oval bass radiator B110 mid-range, and T-27 tweeter. Complete with wired second order Butterworth crossover at 350 and 3500 hertz, back plate, controls, and binding posts. Kit comes with one bass reflex and two transmission line plans. 265.00/pair Separate Drivers: B139-62, B110-24, T-27-15. To order or for more information: Accurate Sound, 1213 "M" Street, Lincoln, Nebraska 68508 (402) 489-1218.

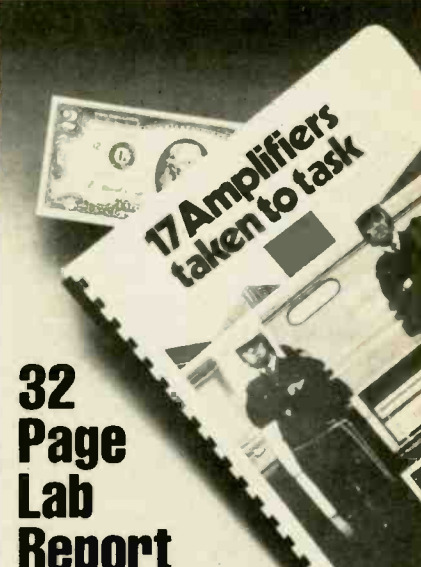

**32
Page
Lab
Report**

**17 Amplifiers
taken to task**

The most definitive and comprehensive test report ever conducted on high powered audio amplifiers—reprinted from the prestigious English journal, *Hi-Fi For Pleasure*. The spiral bound, hard-cover report presents readable research data taken from exhaustive subjective listening panel evaluations corroborated by standard laboratory tests. Some of the products reviewed in this Spring '76 report:

- Accuphase P250 • Crown D150A
- BGW Model 250 • Lux M6000
- Yamaha B1

Mailed first class upon receipt of two dollars and your full address.
Amplifier Reports, P.O. Box 3742, Dept. HF, Beverly Hills, Ca., 90212

PERSONALIZED MINIATURE ORCHESTRA CHAIRS boost fundraising efforts. Free details: Seton Corp., Dept. 916, New Haven, Conn. 06505.

STEREO REPRESENTATIVES NEEDED!!! LOWEST PRICE LIST BUYING!! OVER 100 BRANDS!! KRASCO, 623 Campbell Ave., West Haven, Conn. 06516.

RARE ROMANTIC PIANO SCORES—Moscheles, Henselt, Herz, Litoff, Scharwenka, Scriabin, etc. Free catalog. MUSIC TREASURE PUBLICATIONS, 620 Ft. Washington Ave., 1-F, New York, N.Y. 10040.

SPEAKER ENCLOSURES WITH GRILL BOARDS—Details SASE Stereo Workbench, 214-B, Montauk Avenue, New London, CT 06320.

SPEAKERKITS—COMPLETE HIGH QUALITY STEREO speakers from Kits. Free Catalog. SOUNDMOVE SPEAKERKITS, P.O. Box 236, Jericho, N.Y. 11753.

PERFECTIONISTS PREFER *DYNAKITS. BEFORE Purchase You Owe Yourself Our Quote. MAINLINE II, 971 Fronheiser, Johnstown, Pa. 15902.

The Independently
Owned



Liberty
MUSIC SHOP
of Ann Arbor,
417 EAST LIBERTY STREET
ANN ARBOR, MICH. 48108 U.S.A.

Possibly the Most Comprehensively Stocked
Record Shop of Classical LP's and Cassettes —
Imported, U.S. Domestic & Unlisted Labels —
Sym., Op., Cham., as well Pop, Folk, Spoken,
International (Opened, Visually Inspected)
Enquiries invited

WORLD WIDE SERVICE

CONTROL-I—AUTOMATIC SIGNAL ACTIVATED SHUT OFF for Hi-Fi components, \$49.95. Details, Electromedia Design, Inc., Box 26, Livingston, NJ 07039.

AUCTION—CLASSICAL RECORD COLLECTION—FREE Lists. Brian O'Flaherty, P.O. Box 5892, San Francisco, Calif. 94101.

OUR NON-COMMERCIAL CLASSIFIED RATES: \$0 per word! AUDIOMART, Box 821, Stratford, Connecticut 06497 55/12.

PROTECT YOUR RECORDS POLY SLEEVES for jackets 8¢ Roundbottom record sleeves 7¢ Poly lined paper sleeves 15¢ White jackets 35¢ Postage \$1.50. Record Supply House, Hillburn, New York 10931.

miscellaneous

DIAMOND NEEDLES and Stereo Cartridges at Discount prices for Shure, Pickering, Stanton, Empire, Grado and ADC. Send for free catalog. All merchandise brand new and factory sealed. LYLE CARTRIDGES Dept. H, Box 69, Kensington Station, Brooklyn, New York 11218.

SLEEP-LEARNING—HYPNOTISM! Strange catalog free. Autosuggestion, Box 24-F, Olympia, Washington 98501.

CONGRATULATIONS! YOU ARE NOW READING ONE OF HIGH FIDELITY'S best read pages! Use it yourself when you want to sell equipment, or a service, or want to let the avid music listener know about anything. High Fidelity Classified, 130 East 59th St., N.Y. 10022.

SEARCHING? WRITE DISCONTINUED RECORDS, 216 NORTH ROSE, BURBANK, California 91505.

DISPLAY AND STORE 100 LPs in beautiful five-compartment smoke-grey acrylic cabinet!! \$39.50 plus \$2.50 shipping BUNDY CRAFTS, RFD 3, Putney, VT. 05346.

CUT! OUTTAKES FROM HOLLYWOOD'S GREATEST MUSICALS. Never before released by Garland, Astaire, Grable, Nicholson and more! Albums \$7.00 plus 50¢ postage/handling. Send check/money order OUTTAKE RECORDS, INC., P.O. Box 1066, Ansonia Station, New York 10023.

new equipment for sale

DON'T PAY THE HIGH MAIL ORDER PRICES. THIEVES WAREHOUSE OF TAMPA, 1531 SOUTH DALE MABRY, TAMPA, FLORIDA 33609.

DON'T PAY THE HIGH MAIL ORDER PRICES. THIEVES WAREHOUSE OF SARASOTA, 6564 GATEWAY AVENUE, SARASOTA, FLORIDA 33581.

DON'T PAY THE HIGH MAIL ORDER PRICES. THIEVES WAREHOUSE OF FT. WALTON BEACH, 652-D BEAL PARKWAY, N. W., FT. WALTON BEACH, FLORIDA 32548.

DON'T PAY THE HIGH MAIL ORDER PRICES. THIEVES WAREHOUSE OF MOBILE, 1770 BELTLINE HIGHWAY, MOBILE, ALABAMA 36609.

35% to 55% DISCOUNT ON PROFESSIONAL GUITARS, Amplifiers, P.A. Systems. Free Catalog. Carvin, Escondido, Calif. 92029.

DON'T PAY THE HIGH MAIL ORDER PRICES. THIEVES WAREHOUSE OF PENSACOLA, 3731 NAVY BOULEVARD, PENSACOLA, FLORIDA 32507.

DON'T PAY THE HIGH MAIL ORDER PRICES. THIEVES WAREHOUSE OF MONTGOMERY, 3386 NORMAN BRIDGE ROAD, MONTGOMERY, ALABAMA 36105.

DON'T PAY THE HIGH MAIL ORDER PRICES. THIEVES WAREHOUSE OF ATLANTA, 3164 PEACHTREE ROAD, N.E., ATLANTA, GEORGIA 30303.

DON'T PAY THE HIGH MAIL ORDER PRICES. THIEVES WAREHOUSE OF ATLANTA, 4166 BUFORD HIGHWAY, N.E., ATLANTA, GEORGIA 30345.

DON'T PAY THE HIGH MAIL ORDER PRICES. THIEVES WAREHOUSE OF ATLANTA, 1030-3 CHEROKEE ROAD, SMYRNA, GEORGIA 30080.

DON'T PAY THE HIGH MAIL ORDER PRICES. THIEVES WAREHOUSE OF NORTH TAMPA, 1441 EAST FLETCHER AVENUE, TAMPA, FLORIDA 33612.

DON'T PAY THE HIGH MAIL ORDER PRICES. THIEVES WAREHOUSE OF TALLAHASSEE, 1119 APALACHEE PARKWAY, PARKWAY SHOPPING CENTER, TALLAHASSEE, FLORIDA 32301.

DON'T PAY THE HIGH MAIL ORDER PRICES. THIEVES WAREHOUSE OF ATLANTA, 4162 JONESBORO ROAD, ZAYRE CENTER, FOREST PARK, GEORGIA 30050.

DON'T PAY THE HIGH MAIL ORDER PRICES. THIEVES WAREHOUSE OF ATLANTA, 2769 LAKEWOOD AVENUE, S.W., ATLANTA, GEORGIA 30315.

DON'T PAY THE HIGH MAIL ORDER PRICES. THIEVES WAREHOUSE OF ST. PETERSBURG, 9151 PARK BOULEVARD, NORTH LARGO, FLORIDA.

DON'T PAY THE HIGH MAIL ORDER PRICES. THIEVES WAREHOUSE OF PANAMA CITY, 5220 WEST HIGHWAY 98, SUITE D, PANAMA CITY, FLORIDA 32401.

DON'T PAY THE HIGH MAIL ORDER PRICES. THIEVES WAREHOUSE OF BIRMINGHAM, 123 ROEBUCK PLAZA DRIVE, BIRMINGHAM, ALABAMA 35206.

DON'T PAY THE HIGH MAIL ORDER PRICES. THIEVES WAREHOUSE OF ORLANDO, 1915 EAST COLONIAL DRIVE, ORLANDO, FLORIDA 32803.

DON'T PAY THE HIGH MAIL ORDER PRICES. THIEVES WAREHOUSE OF ATLANTA = 6, BELVEDERE PLAZA SHOPPING CENTER, 1203 COLUMBIA DRIVE, DECATUR, GEORGIA 30032.

DON'T PAY THE HIGH MAIL ORDER PRICES. THIEVES WAREHOUSE OF KNOXVILLE, 5710 KINGSTON PIKE, KNOXVILLE, TENNESSEE 37919.

DON'T PAY THE HIGH MAIL ORDER PRICES. THIEVES WAREHOUSE OF JACKSONVILLE 1239 ARLINGTON ROAD & LONE STAR JACKSONVILLE, FLORIDA 32211.

"DUBIE CD-5 RECORDING SYSTEM IS A MUST FOR the serious hobbyist" or anyone owning two or more recorders. DUBIE CD-5 allows you to be more creative in multiple taping, mixing, dubbing, and editing. Available at Olson and Team Electronics stores for only \$59.95 or write Dubie, Route 4, Box 98, Stigler, Oklahoma 74462.

DON'T PAY THE HIGH MAIL ORDER PRICES. THIEVES WAREHOUSE OF JACKSONVILLE, 6078 OLD ST. AUGUSTINE ROAD, JACKSONVILLE, FLORIDA 32217.

DON'T PAY THE HIGH MAIL ORDER PRICES. THIEVES WAREHOUSE OF MIAMI, 1756 S. W. 8th STREET, = 201 MIAMI, FLORIDA 33135.

SAVE UP TO 69% ON OVER 100 TOP BRAND AUDIO components from Carston Studios. New England's audio supermarket, one of the oldest mail order firms (est. 1962) and certainly one of the most reliable. All orders shipped from stocked warehouse. Send for price quote and price list. Carston Studios, Old Brookfield Road, Danbury, Connecticut 06810.

DON'T PAY THE HIGH MAIL ORDER PRICES. THIEVES WAREHOUSE OF MOBILE/VILLAGE SQUARE, 301 SOUTH CRAFT HIGHWAY, MOBILE, ALABAMA.

DON'T PAY THE HIGH MAIL ORDER PRICES. THIEVES WAREHOUSE OF BIRMINGHAM, 103 SOUTH 8th STREET, BIRMINGHAM, ALABAMA.

DON'T PAY THE HIGH MAIL ORDER PRICES. THIEVES WAREHOUSE OF CLEARWATER, 1502 A GULF TO BAY BOULEVARD, CLEARWATER, FLORIDA.

FANTASTIC DISCOUNTS on Hi-Fi Components. Write for FREE catalog! Gochenour's Sound House, P. O. Box 86, Eden, N. C. 27288.

DON'T PAY THE HIGH MAIL ORDER PRICES. THIEVES WAREHOUSE OF PENSACOLA = 2, 3820 NORTH 9th AVENUE, PENSACOLA, FLORIDA 32503.

DON'T PAY THE HIGH MAIL ORDER PRICES. THIEVES WAREHOUSE OF PLANTATION, 231 SOUTH STATE ROAD 7, PLANTATION, FLORIDA 33317.

DON'T PAY THE HIGH MAIL ORDER PRICES. THIEVES WAREHOUSE OF NORTH MIAMI BEACH, 1807 N.E. 164th STREET, MIAMI, FLORIDA 33162.

DON'T PAY THE HIGH MAIL ORDER PRICES. THIEVES WAREHOUSE OF HIALEAH, 6741 WEST 4th AVENUE, HIALEAH, FLORIDA 33012.

DON'T PAY THE HIGH MAIL ORDER PRICES. THIEVES WAREHOUSE OF DUMONT, 78 WASHINGTON AVENUE, DUMONT, NEW JERSEY 07628.

DON'T PAY THE HIGH MAIL ORDER PRICES. THIEVES WAREHOUSE OF FAIR LAWN, 34-09 BROADWAY, FAIR LAWN, NEW JERSEY 07410.

DON'T PAY THE HIGH MAIL ORDER PRICES. THIEVES WAREHOUSE OF RIDGEWOOD, 25 GODWIN AVENUE, RIDGEWOOD, NEW JERSEY 07450.

DON'T PAY THE HIGH MAIL ORDER PRICES. THIEVES WAREHOUSE OF ATLANTA = 7, 215 COPELAND ROAD, ATLANTA, GEORGIA 30342.

DON'T PAY THE HIGH MAIL ORDER PRICES. THIEVES WAREHOUSE OF GAINESVILLE, 434 N.W. 13th STREET, GAINESVILLE, FLORIDA 32601.

DON'T PAY THE HIGH MAIL ORDER PRICES. THIEVES WAREHOUSE OF FT. LAUDERDALE, 3347 NORTH FEDERAL HIGHWAY, FT. LAUDERDALE, FLORIDA 33306.

DON'T PAY THE HIGH MAIL ORDER PRICES. THIEVES WAREHOUSE OF BOCA RATON, 499 N.E. 20th STREET BOCA RATON, FLORIDA 33431.

BUY DIRECT FROM ENGLAND'S HI-FI MAIL ORDER SPECIALISTS. Save on B&O, Celestion, Tandberg, Revox, Transcriptors, Jordan-Watts, Lowther, KEF, Rogers, SME, Ariston, HPD, Sugden, Radford, Neal, Technics, Sony, AIWA, Pioneer, AR etc. Shipping list free or send \$3 bills to include literature. Goodwins, 7 The Broadway, WoodGreen, London. N22. Phone: 888 0077. Visitors welcome.

DON'T PAY THE HIGH MAIL ORDER PRICES. THIEVES WAREHOUSE OF HOLLYWOOD, 5719 HOLLYWOOD BOULEVARD, HOLLYWOOD, FLORIDA 33021.

DON'T PAY THE HIGH MAIL ORDER PRICES. THIEVES WAREHOUSE OF JACKSONVILLE = 3, CEDAR HILLS SHOPPING CENTER, 3716 BLANDING BLVD., JACKSONVILLE, FLORIDA 32210.

FORMULA 4 PLS4/D THE BEST SOUNDING UNIVERSAL TONE ARM AVAILABLE. U.S. AUDIO DEALERS LITERATURE ONE DOLLAR BILL. MAYWARE, LTD., 15 HEATHER WALK, EDGBWARE, MIDDLESEX, ENGLAND.

BRITISH AND EUROPEAN EQUIPMENT direct to you. Ariston, Armstrong, Celef, Celestion, Connoisseur, Chartwell, Decca, Fons, IMF International, KEF, KMAL, Lecson, Monitor Audio, Ortofon, Quad, Radford, Revox, Rogers, SME, Spendor, Sugden, Tannoy, Transcriptor. Other makes available. Price quotes free, for brochures send 2.00 mentioning makes required. Audio T-Dept. A, 190 West End Lane, London NW6. Phone 01-794-7848. Visitors welcome.

DON'T PAY THE HIGH MAIL ORDER PRICES. THIEVES WAREHOUSE OF BIRMINGHAM = 3, 2134 A&B WARRIOR ROAD, BIRMINGHAM, ALABAMA 35208.

DON'T PAY THE HIGH MAIL ORDER PRICES. THIEVES WAREHOUSE OF DAYTONA, 1769 SOUTH RIDGEWOOD, SOUTH DAYTONA, FLORIDA 32019.

DON'T PAY THE HIGH MAIL ORDER PRICES. THIEVES WAREHOUSE OF BILOXI, 441 PORTER AVENUE, BILOXI, MISSISSIPPI 39530.

DON'T PAY THE HIGH MAIL ORDER PRICES. THIEVES WAREHOUSE OF FT. MYERS, 3081 CLEVELAND AVENUE, FT. MYERS, FLORIDA 33901.

tapes & records

OPERA TAPES—DISCS OPEN REEL AND CASSETTES—historical performances of last 40 years—Unbelievable treasure and rarities—ALSO LP RECORDS. Ed Rosen, 66-33 Saunders St., Rego Park, N.Y. 11374.

FILM-STAGE SOUNDTRACKS. Large free list. A. Lutsky, P.O. Box 557342, Miami, Fla. 33155.

CUT-OUT RECORDS. HUGE STOCK. ALL NEW. No catalog. Cohn, 2205 Marylane, Broomall, Pa. 19008.

TAPES. CLASSICAL SINGERS, CONDUCTORS, instrumentalists in live performance. Emphasis on Superior Sound. Catalogues. Good Sound Associates, PO Box 489, Planetarium Station, New York, N.Y. 10024.

RARE OPERA, SYMPHONIC MUSIC ON OPEN REEL TAPE. Historic performances. EUROPEAN, DOMESTIC. Free Catalogue. Underhill, Bellport, NY 11713.

TDK, BASF, Memorex, Maxell, cassettes, reels, 8-tracks. Lowest prices, guaranteed, new. S&S Audio, P.O. Box 56039, Harwood Heights, IL. 60656.

SHOW ALBUMS—Rare, out-of-print LPs, 52-page list 50¢, Broadway/Hollywood Recordings, Georgetown, CT 06829.

QUADRAPHONIC RECORDS AND TAPES—WORLD'S LARGEST SELECTION—ALL LABELS, OVER 1000 TITLES—at discount prices! For your free illustrated quad catalog, write: SOUND CONCEPTS, Box 654-B, Peoria, Illinois 61601.

SONAR'S OPEN REEL TAPES. Duped one-to-one from the master. Quad and stereo: ¼, ½ track, 7½, 15 ips, 7", 10 ½" reels. Highest quality anywhere! Sonar Records Corp., P.O. Box 455H, Kingsbridge, Bronx, NY 10463.

SOUNDTRACKS/OC, PERSONALITIES!—FREE NEWSLETTER! RTSH, 3700 Plaza, F-211, Santa Ana, California 92704.

LIVE OPERA TAPES. TREMENDOUS SELECTION. SATISFACTION GUARANTEED. FREE CATALOGUE. C. HANDELMAN, 34-10 75th St., JACKSON HTS. N.Y.C. 11372.

CASSETTES/LABELS

Plain white cassette labels, Norelco cassette cleaners, famous brand cassettes. Send for open reel and cassette discount catalog. 1-9 10-99 100 1000 10M
 Cassette Labels .02 .015 .01 .006
 Norelco Cassette Cleaner .65 .60 .55 .50 .45
 Plus Postage by Weight and Zone Minimum Order \$5.00

OPEN REEL STEREO TAPE BUYERS!

At Last! An open reel catalog, including titles, songs, etc. of 95 long play, 2-3 hour albums by American Airlines or Ampex 4-track stereo tapes. Send \$1.00—and we will also mail you a 140-page Harrison Stereo Tape Guide—so you'll get both for \$1.00—and this \$1.00 is refundable on your first \$10.00 purchase of open reel stereo tapes at our 20% discount.

WE'VE GOT THE "SPIRIT", THE PRICES AND THE ADDRESS TO PROVE IT

Saxitone's Bicentennial Tape Shoppe

1776 Columbia Road, N.W., Washington, D.C. 20009



GOLDEN AGE RADIO—YOUR BEST SOURCE for radio tapes. Box 25215-J, Portland, Oregon 97225.

"SOUNDTRACKS, SHOW, NOSTALGIA & JAZZ—FREE Catalog & Auction List—A-1 Record Finders, P.O. Box 75071-H, L.A. CAL 90075."

AT LEAST 1/2 OFF ALL RECORDS AT ALL TIMES, INCLUDING PRESIER AND EURODISC. Write BERKSHIRE RECORD OUTLET, 910 South St., Pittsfield, Mass. 01201 For Details.

SUPERB IMPORTED + DOMESTIC SELECTIONS—HARD-TO-FIND Soundtracks, Shows, Nostalgia. Catalog \$1.00 (Refundable). List Communications, Box 916-T, NYC 10023.

CLASSICAL LPs OOP CURRENT LIST. A.R.S., 13 Dante Street, Larchmont, N.Y. 10538.

"Rare Out of Print Jazz & Popular Vocal LP's Sold by Auction. Free Lists. Leon Levavitt, 824 1/2 North Las Palmas, Los Angeles, CA 90038."

WHOLESALE ALBUMS—TAPES! Outstanding prices! All titles! Save 50%-90%! Send stamp, MusiCom, 1611 Capitol, Des Moines, IA 50316.

RADIO PROGRAMS FREE CATALOGUE. STONEGROUND, DEPT. A, BOX 335, COULCIL BLUFFS, IA 51501.

IMPORTED CLASSICAL, FOLK, JAZZ AND ROCK records from Eastern Europe. Send for free catalogues to: QUALITON RECORDS, LTD., 65-37 Austin Street, Rego Park, N.Y. 11374.

8-TRACK STEREO TAPES \$2.98 each. Free catalog. Triangle Electronics, 56F Central Blvd., Merrick, N.Y. 11566.

BASF TAPE: NEW STOCK. 40-55% SAVINGS! CASSETTES, REELS, GUARANTEED! Write Larry or Mike, INTERGALACTIC, 1047 Kirts, #134, Troy, Michigan 48084.

SCOTCH RECORDING TAPE, LOWEST PRICES. TAPE CENTER, Box 4305C, Washington, D.C. 20012.

WE WILL BEAT any distributor, wholesaler, jobber, or dealer in America. Featuring TDK, BASF, AMPEX, and others. Tape World, International, Box 231, Butler, PA 16001.

JAZZ RECORDS EXCLUSIVELY—CURRENT, RARE, out-of-print. FREE LISTS—Dept. HF5, PO Box 125, Jamaica, NY 11415.

QUASI-RATIONAL PRODUCTS now carries everything in record protection—Paper-vinyl liners, preeners, fluids, etc. ALSO the finest in blank tapes & accessories. Royce C.B.'s—Jensen car speakers—Pioneer auto stereos. Marvelous prices and service. FREE CATALOG. QUASI-RATIONAL PRODUCTS, P.O. Box 171, Prospect Heights, Ill. 60070.

SELECT LIKE-NEW CLASSICAL LP's. LIST \$1.00 (refundable). Recycled Records, 5722 N. 20th St., Arlington, VA 22205.

AVAIL. SPELLBOUND orig. rem. L.P. Also Hi-Lo's Starlite 7005 and Columbia CL952. Best offer. Bert Cohen, 11 Fifth Ave. N.Y., NY 10003.

LP RECORDS SOLD AT AUCTION INDICATE WHICH category. J. Pilon, 152 Davenport Ave., NE St. Petersburg, Florida 33702.

MANY SUPERB OPERATIC TAPES BARGAIN PRICES. COMPLETE OPERAS, RECITALS, GALAS. FREE CATALOG FROM J.A. GEORGE BOX #140, HIGH FIDELITY, 130 EAST 59th STREET, NEW YORK, NY 10022.

BIGGER DISCOUNTS ON RECORDING TAPE. Write M.A.D. REPROGRAPHICS INC., P.O. Box 532, Southfield, MI 48037. (313) 559-6913.

RARE BROADWAY SHOWS ON TAPE INCLUDING PRIVATE AND LIVE RECORDINGS. CATALOG \$1.00. DAVID HUMMEL 2820 South Memorial Highway Traverse City, Michigan 49684.

SERVICES

DAMAGED NEEDLES RECONDITIONED. WORN DIAMONDS replaced. Any make. Diatix Industries, Box 762, Hightstown, N.J. 08520.

personals

DATES GALORE! Meet singles—anywhere. CALL DATELINE, toll-free (800) 451-3245.

wanted to buy

"CASH PAID FOR QUALITY USED CLASSICAL LP's. SEND LIST. SNEAD, 5722N. 20th St., Arlington, VA. 22205."

CASH FOR UNWANTED LPs AND PRE-RECORDED reel to reel, 8-track tapes. Tapes, Hillburn Post Office, New York 10931.

business opportunities

COLLEGE STUDENTS

Some campus reps earn their entire tuition costs helping other students select high fidelity equipment. It's not hard. If you know enough about high fidelity components to mount a cartridge and hook up a pair of speakers, we'll supply the material.

Nothing to invest. The more you sell, the more you make. And it's fun. Call Internation Hi Fi, Baltimore, MD, 21206 and ask for Mike Krizman 301-488-9600 daily between 11 A.M.—7 P.M.

BROADCAST STATION. Start your own. Free booklet, "Broadcasting," Box 5516-DJ, Walnut Creek, CA 94596.

cabinets

QUALITY WOOD FURNITURE for your components in a wide selection of styles. Finished, unfinished, and kits. Sold in fine stores and direct. Send 50¢ for all new full color brochure . . . AUDIO ORIGINALS—546 S. Meridian St. "H" Indianapolis, Indiana 46225.

employment opportunities

INTERNATIONAL TRAVEL ESCORT REPORT. All Expenses. Salary. Free Transportation. To Escort Groups Worldwide. Complete Employment Guide. \$5.00 (Satisfaction Guaranteed) Escort, 1210-G Howard Circle, Wheaton, Ill. 60167.

HIGH FIDELITY

Classified Advertising Dept.
 130 East 59th St., New York, N.Y. 10022
 Phone: 212-826-8393/94, Michael Littleford

Please run the following attached classified ad in the next available issue.

Name _____

Address _____

City _____

State _____

Zip _____

Telephone _____

RATE: For Regular and Display, see schedule above. *CASH MUST ACCOMPANY ORDER. Closing two months prior to issue.

Session," which has been waiting for release for thirteen years and which shows the Duke in the role of producer, working with two musicians from outside his band—Stéphane Grappelli and Svend Asmussen—as well as resident violinist Ray Nance. It is a thoughtfully balanced program, giving each of the violinists a solo opportunity on an Ellington standard, putting all three together on two other well-known Ellington tunes, pulling out a pair of tunes written by the Duke for earlier sessions with non-Ellingtonians (Coleman Hawkins and John Coltrane), and introducing four previously unrecorded pieces by the Duke or Billy Strayhorn.

That's quite a cornucopia, and the fiddlers make it an even more treasurable experience. Each has a very distinctive sound and attack, which makes for variety and gives the ensemble playing an unexpected depth. Asmussen on viola has, somewhat surprisingly, the most Ellingtonian sound—dark, brusque, and gutsy, in the tradition of the Ellington horns. Nance had already established his place within the Ellington context, of course. Grappelli brings a light and airy quality to the performances. Even with two strangers in the front line and the unaccustomed emphasis on strings, the Ellington colors still dominate these pieces—in the voicings, in the phrasing, and through the presence of the Duke's accompanying piano. They indicate that, even though the Duke had moved into a wide range of musical areas, there were others, such as this, that he had only begun to explore.

The two Jazz Guild albums, part of the first batch of releases from a new Canadian label, strike a balance between the overdone and the rare. "The Unusual Ellington" actually is unusual in that it offers some of his rarely heard material ("Cobb's Tune," "Coffee and Kisses," "Change My Ways"); a striking version of "Passion Flower" with Nance, on cornet, taking the role usually played by Johnny Hodges; a program that steers clear of the warhorses; some remarkably good recording (the period is 1952-55); and the easy, enthusiastic atmosphere of dance situations.

On the other hand, "The Washington, D.C., Armory Concert," a 1955 event, leans toward pieces that have been played and recorded beyond all reason: "Perdido," Cat Anderson shrieking up through "La Virgen de la Macarena," and "Take the 'A' Train." But there is the bonus of an improvised solo blues by the Duke.

J.S.W.

HERB ELLIS AND ROSS TOMPKINS: A Pair to Draw To. Herb Ellis, guitar; Ross Tompkins, piano. *They Didn't Believe Me; Here's That Rainy Day; Someday My Prince Will Come;* six more. CONCORD JAZZ 17, \$6.98.

Before Ross Tompkins moved to California a few years ago with the *Tonight Show* band, he was one of the more serviceable pianists on the East Coast, playing with Benny Goodman and leading the house trio at the Half Note in New York. In California, however, he developed and expanded on what had been only an occasional coloration of his playing—a percussive attack with a rumbling, rolling flow that was reminiscent of the remarkably driving style of the late Eddie Costa.

50%

Build your own speakers and save up to

MAIL TO: **Speakerlab®**
Dept. HF1
5500 - 35th N.E., Seattle, WA 98105

When you buy a Speakerlab kit, you get about twice as much for your money as you do with ready-built models. Suddenly you can afford exponential horn/drivers, 12 butyl wooders, sturdy 1 1/2" walnut veneer enclosures, high-grade acoustic fiberglass, L-pads and all the other goodies you only find on speakers costing \$500-\$1000 each.

For a free, 32-page catalog and speaker-building manual, send in the coupon below. Please print clearly because it's actually your return mailing label in disguise.

HF1

NAME

ADDRESS

CITY

STATE

ZIP

Tompkins does not automatically go into this approach whenever he has a solo, but, building into it logically, he is apt to use it as a signature to identify himself within whatever group he happens to be playing. In this set of piano-guitar duets with Herb Ellis, he uses it relatively sparingly—possibly because, under the circumstances, there is no need to establish his identity, but more likely because much of the material is simply not suited to this kind of attack. This is essentially a romantic mood album, in which the rhythmic propulsion is kept very light or ad lib much of the time. Tompkins' rumbling roll is completely at home on "You Stopped out of a Dream" and "They Didn't Believe Me" and appears in modified form on "You and the Night and the Music" and in parts of a constantly changing "The More I See You." But his two unaccompanied piano solos, "Spring Can Really Hang You Up the Most" and "Someday My Prince Will Come," are far removed from the forcefulness of that style and, in fact, seem rather odd choices for extended piano solos.

Ellis plays a secondary role throughout the set, although he has two slow and gentle solos on "A Child Is Born" and "Here's That Rainy Day." J.S.W.

In Brief

MOTT: Shouting and Pointing. COLUMBIA PC 34236, \$6.98. Tape: ●● PCT 34236, \$7.98; ● PCA 34236, \$7.98.

This set has more guts than Mott's last outing, its first without Ian Hunter. Not only is the singing more potent, but the group has also found the hot guitarist it has always craved. His name: Ray Major. H.E.

NEIL DIAMOND: Beautiful Music. COLUMBIA PC 33965, \$6.98. Tape: ●● PCT 33965, \$7.98; ● PCA 33965, \$7.98.

This talented composer has finally given up philosophizing for ten-year-olds and has come up with an honestly emotional LP. And Robbie Robertson's production adds depth while allowing Diamond to communicate clearly with his listeners. H.E.

BOB JAMES: Three. CTI 6063, \$6.98. Tape: ●● CTC 6063, \$7.98; ● CT8 6063, \$7.98.

The immensely talented Bob James has another opportunity to display all his skills—pianist, composer, arranger, conductor, producer—in this third album under his own name. (He has participated in countless others.) This is mostly light weight stuff, and it's all pretty good (including a lot of solo space for "guest star" Grover Washington Jr.). But "pretty good" is disappointing from an artist of such incalculable potential. I'm waiting for the day when James pulls out all the stops and uses the full range of his prodigious gifts. That's gonna be some album! J.G.

PRICE WAR

AMERICA'S #1 VALUE LEADER

STEREO CORPORATION OF AMERICA

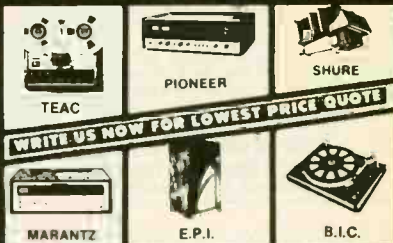

WRITE US NOW FOR LOWEST PRICE QUOTE

AUDIO DISCOUNTING STARTED IN NEW YORK & NOW WITH THE END OF FAIR-TRADE WE ARE SURE THAT NO ONE CAN BEAT OUR PRICES:

- We Discount Over 70 Major Brands
- Over 10 Years Of Reliable Service In The Mail Order Field
- Largest Inventory/Lowest Prices!

We Get The Best Deals From The Manufacturers. You Get The Best Deal From Us!

SHOP BY PHONE!

(212) 253-8888
9-5 Mon. thru Sat.
Use Your Charge Card

FREE

WRITE OR CALL
FREE
Stereo Price
Catalogue

STEREO CORPORATION OF AMERICA

M-F 1629 Flatbush Ave.
Brooklyn N.Y. 11210
Tel: (212) 253-8888

CIRCLE 55 ON READER-SERVICE CARD

BIG DISCOUNTS

STEREO COMPONENTS

Largest selection of top name brands... try us and see...

It's worth a call
(301) 488-9600

INTERNATIONAL
HI-FI
DISTRIBUTORS

6330 Frankford Ave.
Baltimore, Md. 21206

All mail answered within 24 hours

Phone Daily 9 AM to 9 PM
Saturday 9 AM to 4 PM
Phone (301) 488-9600

CIRCLE 26 ON READER-SERVICE CARD

TOP Discount AUDIO

Your NATIONAL HEADQUARTERS

For Famous Brand Electronics By Mail

1150 N. Powis Rd., West Chicago, Ill. 60185 • (312) 293-1825

All Orders Shipped In Factory-Sealed Cartons

Write Or Call For The Lowest Prices Anywhere!

MILLION \$\$\$ INVENTORY

LOWEST PRICES ON

RECEIVERS SPEAKERS TAPE DECKS CALCULATORS
TURNABLES CHANGERS AMPLIFIERS COMPACTS
TUNERS CARTRIDGES HEADPHONES CAR AUDIO

Top Discount Audio
1150 N. Powis Rd.
West Chicago, Ill. 60185
(312) 293-1825

HF-10

Date

Please send me a quote on:

MR
MS

CIRCLE 57 ON READER-SERVICE CARD

XDR—in hoc signo vinces. For perhaps the first time since the memorable Decca/London FFRR, an audio acronym/logo really means something. For whatever other technological advances may be involved in the new sound of Angel XDR cassette tape, it does boast a markedly Expanded Dynamic Range with higher modulation levels than I've encountered in earlier musicassettes. Listening to the first dozen releases (one of which, 4XNP 37400, specially priced at \$1.25, is a convenient anthology/sampler), I've consistently had to reduce my playback level by at least the 4 dB claimed in Angel advertisements. That in itself significantly reduces background noise, but Angel also has adopted Dolby-B processing—belatedly, to be sure, but that's all the more cause for rejoicing. (Now if only RCA, following up its welcome new policy of rational cassette side breaks, would provide Dolby-B cassettes in this country as it already does overseas, the Dolby war against tape noise would be triumphantly won on all fronts.)

XDRs, I'm told, exploit advanced duplicator circuit and component techniques as well as the extra headroom of Capitol Magnetic Products' high-output, low-noise ferric-oxide tape for standard 120-microsecond high-frequency playback equalization. In addition, of course, there is Dolby-B quieting—highly effective, too, if not quite up to the near-ideal optimum of Advent's chromium-dioxide (70-microsecond equalization) cassettes. Among ferric-oxide cassettes, however, the XDRs seem generally supreme technically, uniquely so where Maximum Recorded Level characteristics are concerned.

Angelic musical, as well as technical, expansions. Not only audiophiles will find the first XDRs exceptionally rewarding. These tapes also proffer much to nontechnically minded musical connoisseurs, not least in the major item, a three-cassette small-boxed edition of the first-ever recording of Bellini's *I Capuleti e i Montecchi* starring Janet Baker and Beverly Sills (as Romeo and Juliet) with the John Alldis Choir and New Philharmonia Orchestra under Giuseppe Patanè (4X3S 3824, \$23.94; libretto on request). Likely to be as new to most listeners as it is to me, this opera arrestingly illuminates unfamiliar dramatic as well as familiar bel canto aspects of Bellini's genius, and it is made even more persuasive by robustly expansive recording of the particularly distinctive choral and orchestral parts.

Similar combinations of artistic and technical attractions are achieved not

only in the splendid Marriner/Los Angeles Respighi *Ancient Airs and Dances* of last July (4XS 37301), but also in the superb 1972 Tuckwell/Marriner Mozart horn concertos (4XS 36840). The lute-piece transcriptions represent Respighi more engagingly than any of his original works; the Mozart set is an incomparable blend of creative and executant inspiration.

Other Angel XDR Dolby-B cassettes (\$7.98 each) include tapings of two disc programs I reviewed in February and May 1975: Previn's Holst *Planets* (4XS 36991) and Rostropovich's Rimsky-Korsakov *Scheherazade* (4XS 37061), both of which I continue to find more impressive sonically than interpretatively. More pertinent now, though, is to report these tapes' ability—in direct A/B comparisons with the disc editions—to command a dynamic range just as wide if not wider, just as brilliant highs and solid lows, and (thanks to Dolby-B advantages and the occasional shortcomings of Angel's disc processing) often quieter surfaces.

by R. D. Darrell

The Tape Deck

Marriner's argosies. Like the recent processed-in-Britain London musicassettes, those under the sister label Argo have begun to appear here on a regular basis rather than only via import specialists. With only one lamentable exception, the first eleven releases are devoted to the gloriously catholic and musicianly recorded repertory of the Academy of St. Martin-in-the-Fields under Neville Marriner. Resisting momentarily the appeals of the Bach, Dvořák/Grieg, Mozart, Rossini, Tchaikovsky, and Vivaldi programs, I've been delightedly playing and replaying the two of quintessentially English music. Five Elgarian string orchestral works (Argo KZRC 573, Dolby-B cassette, \$7.95) range from the great *Introduction and Allegro* and early *Serenade* to the less familiar *Elegy*, *Sospiri*, and *Spanish Lady Suite*. The Vaughan Williams program (KZRC 15696) combines the favorite fantasias—on "Greensleeves" and on a theme by Tallis—with the less often heard but if anything even more beautiful *Lark Ascending* (Iona Brown, solo violin) and "Dives and Lazarus" *Variants*, topped off by three songs from a Robert Tear/Philip

Ledger recital program. How well these 1972 recorded performances stand up may be demonstrated by comparisons with the good but less distinguished 1975 Barenboim/English Chamber Orchestra *Greensleeves* and *Lark Ascending* (with Pinchas Zukerman) in Deutsche Grammophon 3300 500, Dolby-B cassette, \$7.98. But it's only fair to note that the latter program also proffers two Walton *Henry V* film-score excerpts and five short pieces by Delius.

Pianistic generation gaps. My awareness of the approach differences of the older and newer schools of virtuoso pianism has been sharpened by hearing Lazar Berman's Deutsche Grammophon 3300 678 (Rachmaninoff's *Moments musicaux* and Prokofiev's *Eighth Sonata*) and 3300 677 (the Tchaikovsky *First Concerto*, with the Berlin Philharmonic under Karajan), Dolby-B cassettes, \$7.98 each. A true Old School giant, Berman ideally combines bravura and yearning in the Rachmaninoff, but he romanticizes Prokofiev and (along with Karajan) is almost outrageously mannered in the Tchaikovsky concerto. In contrast, the Ilana Vered/LSO/Kazimierz Kord Tchaikovsky *First* (London Phase-4 SPC5 21148, Dolby-B cassette, \$7.98) may not be as prodigiously virtuosic, yet it radiates far more excitement and relish. In the coupled Stravinsky *Petrushka* movements Vered plays with impressive bravura as well as spirit, and in both works she is more vividly recorded than Berman.

There are smaller chronological gaps—if those in aesthetic approach are still obvious—between "classical romanticist" Alfred Brendel and now-generation Peter Serkin and Maurizio Pollini. Brendel's fans will find as much as ever to admire in his latest Mozart concertos with Marriner, K. 456 and K. 595 (Philips 7300 383), and in his Schubert *Wanderer Fantasy* and D. 960 B flat Sonata (Philips 7300 396, Dolby-B cassettes, \$7.98 each). But I find more buoyant pianism and less constraint in young Serkin's Mozart K. 449 and K. 450 Concertos, with the English Chamber Orchestra under Alexander Schneider (RCA Red Seal ARK/ARS 1-1492, cassette/cartridge, \$7.95 each). I also find more gripping drama and authority in Pollini's Schubertian coupling of the same *Wanderer Fantasy* with the spellbinding D. 845 A minor Sonata (Deutsche Grammophon 3300 504, Dolby-B cassette, \$7.98). Every generation discovers something different in the standard masterpieces. And the closer the interpreter/listener affinities are, the more persuasive the communication between them. ●

“Marantz offers—in one speaker—both air suspension and ported design. It’s the ultimate in flexibility—and quality.”

February, 1976:
Marantz engineers invited audio experts to comment on the new Marantz High Definition Speaker Systems. The following remarks were taken from that taped discussion:

“It’s one thing to design an acoustic air suspension system that will have low distortion. And it’s another to design a ported system for high efficiency. But here, in one unit, Marantz offers the audiophile the best of both worlds.”

“It’s incredible. Marantz calls it **Vari-Q***. Pull out the high density acoustic foam plug and the system becomes a tuned port reflex. Push it back in and the port is absolutely sealed and the speaker becomes air suspension.”

“It doesn’t matter what kind of music the listener is into, either. Air suspension with the plug in is great for full orchestra, because it damps better and doesn’t peak the lower frequencies. But when you listen to rock, pull the plug and you increase the low end efficiency. It pumps up the lows at about 75 Hz and really delivers that low end oomph.”



HD-88

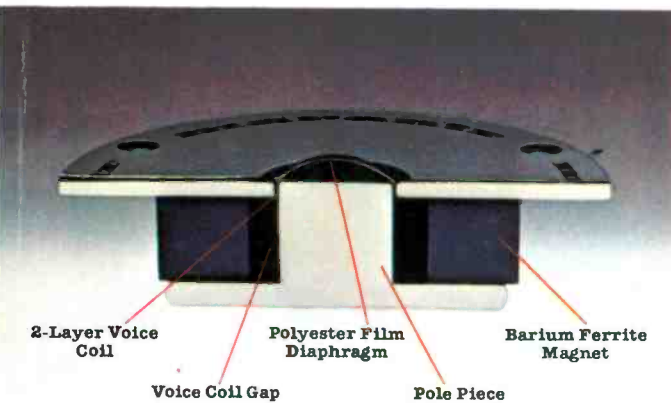

Linear Polyester Film Dome Tweeter

“Another tremendous feature is the **linear polyester film domes** on the tweeters. The dome shape disperses high frequencies over a much wider area. And because the polyester film is so lightweight, it’s more efficient.

It takes less power to do the same job. And they’re practically indestructible. And higher efficiency means greater distortion-free accuracy in reproducing high-frequency transients.”

We call them High Definition Speaker Systems. You’ll call them the ultimate in flexibility and listening excitement. Five models in all (three with Vari-Q) ranging from the bookshelf-sized HD-44 with frequency response from 45 Hz to 18 kHz (± 3 dB – all controls set flat) and power handling capacity of 60 Watts – to the super-powerful HD-88 with frequency response from 25 Hz to 25 kHz (± 3 dB – all controls set flat) and power handling capacity of 300 Watts. Marantz High Definition Speaker Systems start as low as \$89.95.** Experience the professionals’ choice today at your Marantz dealer. He’s in the Yellow Pages.

marantz.[®]
We sound better.

HD-88

HD-66

HD-55

HD-77

HD-44

The Exceptionals

TWO HIGH-PERFORMANCE CASSETTE DECKS FROM KENWOOD, ENGINEERED THREE WAYS BETTER:



KX-720 Stereo Cassette Deck

Precision Drive Systems for Low Wow and Flutter. Total stability characterizes the KENWOOD tape drive systems. A large, heavy fly-wheel driven by an electronically controlled motor holds wow and flutter to imperceptible levels: 0.08% WRMS for the KX-720, 0.09% for the KX-620.

Precision Electronics for High Signal-to-Noise Ratio. Both system-generated and tape-related noises are held to new lows by KENWOOD engineering. The famous Dolby[®] Noise Reduction System further improves S/N by a good 10 dB for every tape type.



KENWOOD STEREO CASSETTE DECK KX-620



KX-620 Front-Load Stereo Cassette Deck

Precision Controls for Best Frequency and Dynamic Response. KENWOOD extends high frequency response with separate Bias and Equalization Controls for every tape type. To improve dynamic response, KENWOOD lowers RECORD reference level for 0 VU, thus increasing recording headroom and minimizing the danger of oversaturated tapes.

[®]Dolby is a trademark of Dolby Laboratories, Inc.

For complete information, write:
the sound approach to quality

 **KENWOOD**

15777 S. Broadway, Gardena, CA 90248
72-02 Fifty-first Ave., Woodside, N.Y. 11377
In Canada: Magnasonic Canada, Ltd.
CIRCLE 30 ON READER-SERVICE CARD